

MARKS PUBLISHED FOR OPPOSITION

The following marks are published in compliance with section 12(a) of the Trademark Act of 1946. Applications for the registration of marks in more than one class have been filed as provided in section 30 of said act as amended by Public Law 772, 87th Congress, approved Oct. 9, 1962, 76 Stat. 769. Opposition under section 13 may be filed within thirty days of the date of this publication. See rules 2.101 to 2.105.

A separate fee of three hundred dollars (\$300.00) for opposing each mark in each class must accompany the opposition.

SECTION 1.— INTERNATIONAL CLASSIFICATION

The short titles associated below with the international class numbers are terms designed merely for quick identification and are not an official part of the international classification. The full names of international classes are given in section 6.1 of the trademark rules of practice.

The designation "U.S. Cl." appearing in this section refers to the U.S. class in effect prior to Sep. 1, 1973 rather than the international class which applies to applications filed on or after that date. For adoption of international classification see notice in the OFFICIAL GAZETTE of Jun. 26, 1973 (911 O.G. TM 210).

Application in more than one class

SN 76-296,575. LIBERMAN BROADCASTING OF CALIFORNIA LLC, BURBANK, CA. FILED 8-6-2001.

LA ESTACION DE LA RAZA

REGISTRATION LIMITED TO THE AREA COMPRISING TEXAS, NEW MEXICO, ARKANSAS AND OKLAHOMA PURSUANT TO CONCURRENT USE PROCEEDING NO. 94002530. CONCURRENT REGISTRATION WITH SER. NOS. 76372222; 76396687; 76385716; 76373385; 76344398; 76344399 AND 78370758.

NO CLAIM IS MADE TO THE EXCLUSIVE RIGHT TO USE "LA ESTACION", APART FROM THE MARK AS SHOWN.

THE ENGLISH TRANSLATION OF "LA ESTACION DE LA RAZA" IS "THE STATION OF THE RACE".

CLASS 38—COMMUNICATION

FOR RADIO BROADCASTING SERVICES (U.S. CLS. 100, 101 AND 104).
FIRST USE 11-0-1998; IN COMMERCE 11-0-1998.

CLASS 41—EDUCATION AND ENTERTAINMENT

FOR PRODUCTION OF RADIO PROGRAMS; ENTERTAINMENT SERVICES IN THE NATURE OF ON-GOING RADIO PROGRAMS FEATURING MUSIC, NEWS, TALK SHOWS, LISTENER CALL-INS, TRAFFIC REPORTS AND EVENTS (U.S. CLS. 100, 101 AND 107).
FIRST USE 11-0-1998; IN COMMERCE 11-0-1998.
RAUL CORDOVA, EXAMINING ATTORNEY

REGISTRATION LIMITED TO THE AREA COMPRISING TEXAS, NEW MEXICO, ARKANSAS AND OKLAHOMA PURSUANT TO CONCURRENT USE PROCEEDING NO. 94002530. CONCURRENT REGISTRATION WITH SER. NOS. 76372222; 76396687; 76385716; 76373385; 76344398; 76344399 AND 78370758.

NO CLAIM IS MADE TO THE EXCLUSIVE RIGHT TO USE "98.5 Y 103.3 FM", APART FROM THE MARK AS SHOWN.

THE ENGLISH TRANSLATION OF "LA RAZA" IS "THE RACE" AND "Y" IS "AND".

CLASS 38—COMMUNICATION

FOR RADIO BROADCASTING SERVICES (U.S. CLS. 100, 101 AND 104).
FIRST USE 7-4-2001; IN COMMERCE 7-4-2001.

CLASS 41—EDUCATION AND ENTERTAINMENT

FOR PRODUCTION OF RADIO PROGRAMS; ENTERTAINMENT SERVICES IN THE NATURE OF ON-GOING RADIO PROGRAMS FEATURING MUSIC, NEWS, TALK SHOWS, LISTENER CALL-INS, TRAFFIC REPORTS AND EVENTS (U.S. CLS. 100, 101 AND 107).
FIRST USE 7-4-2001; IN COMMERCE 7-4-2001.
RAUL CORDOVA, EXAMINING ATTORNEY

SN 76-702,477. INTERNATIONAL ROAD DYNAMICS, INC, SASKATOON, SASKATCHEWAN, CANADA, FILED 4-13-2010.

SLC

SN 76-296,584. LIBERMAN BROADCASTING OF CALIFORNIA LLC, BURBANK, CA. FILED 8-6-2001.

LA RAZA 98.5 Y 103.3 FM

THE MARK CONSISTS OF STANDARD CHARACTERS WITHOUT CLAIM TO ANY PARTICULAR FONT, STYLE, SIZE, OR COLOR.

THE MARK CONSISTS OF STANDARD CHARACTERS WITHOUT CLAIM TO ANY PARTICULAR FONT, STYLE, SIZE, OR COLOR.

PRIORITY CLAIMED UNDER SEC. 44(D) ON CANADA APPLICATION NO. 1,472,925, FILED 3-9-2010, REG. NO. TMA810992, DATED 11-3-2011, EXPIRES 11-3-2026.

CLASS 9—ELECTRICAL AND SCIENTIFIC APPARATUS

FOR TRUCK TRAFFIC MONITORING SYSTEMS AND TRAFFIC ENGINEERING PRODUCTS, NAMELY, TRAFFIC COUNTERS PRIMARILY COMPRISED OF PRESSURE SENSORS, IMAGE SENSORS, ELECTRONIC DISPLAY INTERFACES, VIDEO CAMERAS, COMPUTER SOFTWARE FOR DETECTING VEHICLE LOCATION; COMBINED TRAFFIC COUNTERS PRIMARILY COMPRISED OF PRESSURE SENSORS, ELECTRONIC DISPLAY INTERFACES, VIDEO CAMERAS, COMPUTER SOFTWARE FOR DETECTING VEHICLE LOCATION, INFRARED CAMERAS; CLASSIFIERS, NAMELY, WEIGH-IN-MOTION SCALES; CIRCUIT BOARDS; MANUAL TRAFFIC COUNTERS, NAMELY, PRESSURE SENSORS AND COMPUTER SOFTWARE FOR COUNTING VEHICLES; AUTOMATIC VEHICLE IDENTIFICATION SYSTEMS, NAMELY, SCANNERS, ELECTRONIC LOCATION AND IMMOBILIZATION DEVICES INSTALLED AFTER PURCHASE FOR USE WITH VEHICLES, LASER OBJECT DETECTORS FOR USE ON VEHICLES; TOLL PLAZA AND TOLL ROAD DATA COLLECTION SYSTEMS, NAMELY, COIN-OPERATED GATES FOR TOLL PLAZA FACILITIES, ELECTRONIC AUTOMATIC COIN DISPENSERS, MECHANISMS FOR COIN OPERATED APPARATUS; PARKING LOT MONITORS, NAMELY, ELECTRONIC PARKING LOT TICKET DISPENSERS, TV MONITORS; VEHICLE MONITORING CONTROLLERS, ELECTRIC CONTROL PANELS, ELECTRIC CONTROLLING DEVICES, ELECTRICAL CONTROLLERS, HIGH SPEED WEIGH-IN-MOTION SCALES, LOW SPEED WEIGH-IN-MOTION SCALES; ROAD SURFACE ANALYZERS, NAMELY, HARDWARE AND SOFTWARE FOR DETECTING AND ANALYZING ROAD SURFACE CONDITIONS; PORTABLE WHEEL LOAD SCALES; ON-VEHICLE WEIGHING SCALES; DISPLAY INDICATORS, NAMELY, PRESSURE DISPLAY INDICATORS, SPEED DISPLAY INDICATORS; ON-BOARD COMPUTERS AND STATIC SCALES; ACOUSTIC SENSORS AND MICRO-PROCESSOR EMBEDDED SMART CARDS CONTAINING PROGRAMMING USED TO PROVIDE TOLL THROUGH ACCESS FOR VEHICLE TRANSPORTATION ESPECIALLY FOR USE BY FEDERAL, PROVINCIAL, LOCAL AND PRIVATE ROADWAY AUTHORITIES TO COUNT AND CLASSIFY MOTOR VEHICLES (U.S. CLS. 21, 23, 26, 36 AND 38).

CLASS 39—TRANSPORTATION AND STORAGE

FOR TRUCK TRAFFIC AND INFORMATION SERVICES (U.S. CLS. 100 AND 105).
 CHARISMA HAMPTON, EXAMINING ATTORNEY

SN 76-704,890. FORENSIC MEDICAL MANAGEMENT SERVICES, PLC, NASHVILLE, TN. FILED 10-14-2010.

FORENSIC MEDICAL MANAGEMENT SERVICES

THE MARK CONSISTS OF STANDARD CHARACTERS WITHOUT CLAIM TO ANY PARTICULAR FONT, STYLE, SIZE, OR COLOR.

NO CLAIM IS MADE TO THE EXCLUSIVE RIGHT TO USE "MANAGEMENT SERVICES", APART FROM THE MARK AS SHOWN.
 SEC. 2(F).

CLASS 35—ADVERTISING AND BUSINESS

FOR PROVIDING FORENSIC MEDICAL SERVICES, NAMELY, MEDICAL EXAMINER SERVICES IN THE NATURE OF BUSINESS MANAGEMENT OF FORENSIC MEDICAL CENTERS, SPECIFICALLY BUSINESS MANAGEMENT, PHYSICIAN STAFFING, AND STAFFING OF ANCILLARY PERSONNEL (U.S. CLS. 100, 101 AND 102).

FIRST USE 7-1-1997; IN COMMERCE 7-1-1997.

CLASS 44—MEDICAL, BEAUTY AND AGRICULTURAL SERVICES

FOR PROVIDING FORENSIC MEDICAL SERVICES, NAMELY, MEDICAL EXAMINER SERVICES IN THE FIELDS OF FORENSIC AUTOPSIES, FORENSIC INVESTIGATIONS, FORENSIC TESTING, FORENSIC RADIOLOGY, FORENSIC DENTAL, FORENSIC ANTHROPOLOGY, FOR THE PURPOSE OF DEATH INVESTIGATION, SPECIFICALLY INVESTIGATION OF THE NATURE AND CAUSE AND MANNER OF DEATH OR INJURY BY MEANS OF INVESTIGATION OF THE DEATH SCENE OR ACCIDENT SCENE, BY MEANS OF REVIEW OF ACCIDENT REPORTS AND POLICE REPORTS AND FIRE MARSHAL REPORTS, BY MEANS OF IDENTIFICATION OF THE REMAINS USING RADIOLOGIC, DENTAL AND ANTHROPOLOGIC FORENSICS, AND BY MEANS OF IDENTIFICATION AND RETENTION OF FORENSIC EVIDENCE; AND FOR THE PURPOSE OF PERFORMING FORENSIC AUTOPSIES IN THE FIELDS OF AUTOPSIES AND FORENSIC TESTING, SPECIFICALLY, MEDICOLEGAL AUTOPSIES, EXHUMATION AUTOPSIES, AUTOPSIES TO DETERMINE CAUSE OF DEATH, AUTOPSIES TO DETERMINE POSITIVE IDENTIFICATION OF DECEASED, AND AUTOPSY FORENSIC TESTING PERFORMED IN THE FIELDS OF X-RAYS, TOXICOLOGY, HISTOLOGY, NEUROPATHOLOGY (U.S. CLS. 100 AND 101).

FIRST USE 7-1-1997; IN COMMERCE 7-1-1997.

CLASS 45—PERSONAL AND LEGAL SERVICES

FOR PROVIDING FORENSIC MEDICAL SERVICES, NAMELY, FORENSIC TESTIMONY IN THE FIELDS OF EXPERT WITNESS SERVICES IN LEGAL MATTERS IN THE FIELD OF CRIMINAL AND CIVIL COURT CASES, SPECIFICALLY EXPERT FORENSIC MEDICAL OPINION SERVICES FEATURING EXPERT COURT TESTIMONY, WRITTEN REPORTS, INTERVIEWS, LEGAL DEPOSITIONS AND LEGAL PROCEEDINGS, AND IN THE FIELDS OF EXPERT FORENSIC MEDICAL OPINION PROVIDED TO MEDICAL, LEGAL AND LAW ENFORCEMENT PROFESSIONALS REGARDING NATURE OF DEATHS, SPECIFICALLY EXPERT WITNESS SERVICES FEATURING AUTOPSY REPORTS PREPARED WITH EXPERT OPINION AS TO CAUSE AND MANNER OF DEATH, EXPERT WITNESS SERVICES FEATURING SECOND AUTOPSY REPORTS, INCLUDING REVIEW AND EVALUATION OF THE FINDINGS OF THE FIRST AUTOPSY AND THE RESULTS OF THE SECOND AUTOPSY WITH EXPERT OPINION, EXPERT WITNESS SERVICES FEATURING REVIEWS OF AUTOPSY REPORTS PREPARED BY OTHER PHYSICIANS AND EXPERT WITNESS SERVICES FEATURING EXPERT OPINIONS AS TO THE FINDINGS AND CONCLUSIONS MADE; FORENSIC MEDICAL SERVICES, NAMELY, EXPERT WITNESS SERVICES IN LEGAL MATTERS IN THE FIELD OF FORENSIC PATHOLOGY FEATURING EXHUMATION AUTOPSY REPORTS; FORENSIC MEDICAL SERVICES, NAMELY, EXPERT WITNESS SERVICES IN LEGAL MATTERS FOLLOWING THE COMPLETION OF A FORENSIC AUTOPSY IN THE FIELD OF FORENSIC PATHOLOGY (U.S. CLS. 100 AND 101).

FIRST USE 7-1-1997; IN COMMERCE 7-1-1997.
 JAMES STEIN, EXAMINING ATTORNEY

SN 76-706,192. VALTERRA PRODUCTS, INC., MISSION HILLS, CA. FILED 1-31-2011.



OWNER OF U.S. REG. NO. 1,974,911.

THE MARK CONSISTS OF THE WORDING "VALTERRA" IN STYLIZED FONT OVER A CURVE DESIGN.

CLASS 1—CHEMICALS

FOR WASTE WATER HOLDING TANK TREATMENT CHEMICALS FOR RECREATIONAL VEHICLES (U.S. CLS. 1, 5, 6, 10, 26 AND 46).
FIRST USE 12-31-2002; IN COMMERCE 12-31-2002.

CLASS 9—ELECTRICAL AND SCIENTIFIC APPARATUS

FOR WATER PRESSURE GAUGES (U.S. CLS. 21, 23, 26, 36 AND 38).
FIRST USE 12-31-2002; IN COMMERCE 12-31-2002.

CLASS 11—ENVIRONMENTAL CONTROL APPARATUS

FOR PLUMBING FITTINGS FOR RECREATIONAL VEHICLES, NAMELY, WASTE VALVES, VALVE REPLACEMENT HANDLES, VALVE REPLACEMENT SEALS, VALVE EXTENSION RODS, CAPS AND HOSE ADAPTORS, TOILETS, DRAIN CONNECTORS, FITTING THAT CONNECTS TO WASTE SYSTEM VALVE TO FLUSH OUT THE WASTE SYSTEM WITH WATER, FITTING WITH A TUBE TO INSERT INTO WATER TANK FILL FITTING TO FILL THE TANK, AND REFRIGERATOR FANS (U.S. CLS. 13, 21, 23, 31 AND 34).
FIRST USE 12-31-2002; IN COMMERCE 12-31-2002.

CLASS 16—PAPER GOODS AND PRINTED MATTER

FOR BATHROOM TISSUE AND TOILET PAPER (U.S. CLS. 2, 5, 22, 23, 29, 37, 38 AND 50).
FIRST USE 12-31-2002; IN COMMERCE 12-31-2002.

CLASS 17—RUBBER GOODS

FOR NON-METAL FITTING THAT SLIPS OVER TO FIT ON THE END OF A HOSE TO ALLOW FOR A BETTER GRIP ON THE HOSE, NON-METAL HOSE FITTING USING HANDLE AND BALL VALVE COMBINATION TO SHUT OFF WATER FLOW, NON-METAL FITTINGS TO ADAPT END OF NOZZLE TO HOSE END, NON-METAL FITTINGS THAT CONNECT PIPES TO FILL TANKS, WATER PRESSURE REGULATORS, FLUID TRANSFER HOSES AND TUBING, HOLDING TANK DRAIN HOSES AND DRAIN HOSE ATTACHMENT FITTINGS, WATER HOOK-UP HOSES, FOR RECREATIONAL VEHICLES (U.S. CLS. 1, 5, 12, 13, 35 AND 50).
FIRST USE 12-31-2002; IN COMMERCE 12-31-2002.

CLASS 20—FURNITURE AND ARTICLES NOT OTHERWISE CLASSIFIED

FOR PLASTIC WHEEL CHOCK FOR RECREATIONAL VEHICLES (U.S. CLS. 2, 13, 22, 25, 32 AND 50).
FIRST USE 12-31-2002; IN COMMERCE 12-31-2002.
JULIE VEPPUMTHARA, EXAMINING ATTORNEY

SN 76-707,988. DAVID BRIGGS ENTERPRISES, INC., METAIRIE, LA. FILED 6-14-2011.

FUEL THE PARTY

THE MARK CONSISTS OF STANDARD CHARACTERS WITHOUT CLAIM TO ANY PARTICULAR FONT, STYLE, SIZE, OR COLOR.

CLASS 33—WINES AND SPIRITS

FOR PREPARED ALCOHOLIC COCKTAILS (U.S. CLS. 47 AND 49).

CLASS 43—HOTEL AND RESTAURANT SERVICES

FOR BAR AND RESTAURANT SERVICES (U.S. CLS. 100 AND 101).
BERNICE MIDDLETON, EXAMINING ATTORNEY

SN 76-708,103. PATENT CATEGORY CORPORATION, WALNUT, CA. FILED 6-23-2011.

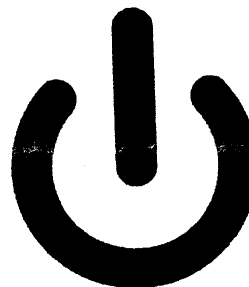

THE MARK CONSISTS OF A SEMI-CIRCLE CONTAINING A CROSS TAKING THE OVERALL SHAPE OF WHAT IS COMMONLY KNOWN AS THE UNIVERSAL SYMBOL FOR POWER, SLEEP OR STANDBY.

CLASS 16—PAPER GOODS AND PRINTED MATTER

FOR PRINTED MATTER, THREE-DIMENSIONAL ARTWORK, TWO-DIMENSIONAL ARTWORK, VISUALS AND GRAPHICS, NAMELY, ART PRINTS, PHOTOGRAPHS, POSTERS AND WORKS OF ART MADE FROM CUSTOM-MANUFACTURED PAPER (U.S. CLS. 2, 5, 22, 23, 29, 37, 38 AND 50).

CLASS 25—CLOTHING

FOR CLOTHING, NAMELY, T-SHIRTS, SHIRTS, PANTS, HATS, JACKETS, SOCK AND SHOES (U.S. CLS. 22 AND 39).
SEAN CROWLEY, EXAMINING ATTORNEY

SN 76-708,160. SYNC MY HOME, INC, MONTEREY, CA. FILED 6-27-2011.

SYNC MY HOME

THE MARK CONSISTS OF STANDARD CHARACTERS WITHOUT CLAIM TO ANY PARTICULAR FONT, STYLE, SIZE, OR COLOR.

CLASS 35—ADVERTISING AND BUSINESS

FOR REFERRALS IN THE FIELD OF INTRUSION AND SECURITY ALARM INSTALLERS, AUDIO AND VIDEO ENTERTAINMENT SYSTEM INSTALLERS, INSTALLERS OF AUTOMATED HOME LIGHTING CONTROLS, INSTALLERS OF AUTOMATED HOME ENVIRONMENTAL CONTROLS AND INSTALLERS OF REMOTE HOME MONITORING CONTROL SYSTEMS; PROVIDING ADVERTISING AND PUBLICITY SERVICES RELATED TO THE GOODS AND SERVICES OF OTHERS, NAMELY, PROVIDING SPACE AT A WEB SITE FOR THE ADVERTISEMENT OF THE GOODS AND SERVICES OF OTHERS, PROMOTING THE GOODS AND SERVICES OF OTHERS THROUGH ALL PUBLIC COMMUNICATION MEANS, PROVISION OF INFORMATION AND ADVICE TO CONSUMERS REGARDING THE SELECTION OF PRODUCTS AND ITEMS TO BE PURCHASED; PROMOTING THE GOODS AND SERVICES OF OTHERS BY PROVIDING A WEBSITE FEATURING PRODUCT REVIEWS WITH RESPECT TO INTRUSION AND SECURITY ALARM SYSTEMS, AUDIO AND VIDEO ENTERTAINMENT SYSTEMS, AUTOMATED HOME LIGHTING CONTROL SYSTEMS, AUTOMATED HOME ENVIRONMENTAL CONTROL SYSTEMS AND REMOTE HOME MONITORING CONTROL SYSTEMS (U.S. CLS. 100, 101 AND 102).

CLASS 45—PERSONAL AND LEGAL SERVICES

FOR VENDOR VERIFICATION SERVICES IN THE NATURE OF VERIFYING THE BACKGROUND CREDENTIALS OF INTRUSION AND SECURITY ALARM SYSTEM INSTALLERS, AUDIO AND VIDEO ENTERTAINMENT SYSTEM INSTALLERS, AUTOMATED HOME LIGHTING CONTROL SYSTEM INSTALLERS, AUTOMATED HOME ENVIRONMENTAL CONTROL SYSTEM INSTALLERS AND REMOTE HOME MONITORING CONTROL SYSTEM INSTALLERS (U.S. CLS. 100 AND 101).

ANNE E. GUSTASON, EXAMINING ATTORNEY

SN 76-708,430. TOOKAY CANDY - US LLC, MEDFORD, NJ. FILED 7-21-2011.



NO CLAIM IS MADE TO THE EXCLUSIVE RIGHT TO USE "SWEET", APART FROM THE MARK AS SHOWN. THE MARK CONSISTS OF A BANNER WITH A STYLIZED TREE IN THE CENTER OF BANNER WITH THE WORDING "SWEET BY NATURE" BENEATH THE TREE.

CLASS 29—MEATS AND PROCESSED FOODS

FOR SWEET TREATS AND SNACKS, NAMELY, FRUIT-BASED SNACK FOOD (U.S. CL. 46).

CLASS 30—STAPLE FOODS

FOR SWEET TREATS AND SNACKS, NAMELY, CANDY (U.S. CL. 46).
ESTHER A. BORSUK, EXAMINING ATTORNEY

SN 76-708,392. PATENT CATEGORY CORPORATION, WALNUT, CA. FILED 7-18-2011.



THE MARK CONSISTS OF A STYLIZED PERCENTAGE SYMBOL.

CLASS 16—PAPER GOODS AND PRINTED MATTER

FOR PRINTED MATTER, THREE-DIMENSIONAL ARTWORK, TWO-DIMENSIONAL ARTWORK, VISUALS AND GRAPHICS, NAMELY, ART PRINTS, PHOTOGRAPHS, POSTERS AND WORKS OF ART MADE FROM CUSTOM-MANUFACTURED PAPER (U.S. CLS. 2, 5, 22, 23, 29, 37, 38 AND 50).

CLASS 25—CLOTHING

FOR CLOTHING, NAMELY, T-SHIRTS, SHIRTS, PANTS, HATS, JACKETS, SOCK AND SHOES (U.S. CLS. 22 AND 39).
SEAN CROWLEY, EXAMINING ATTORNEY

SN 76-708,456. RYLAND ORGANIZATION COMPANY, CALABASAS, CA. FILED 7-21-2011.



OWNER OF U.S. REG. NO. 3,961,986.
NO CLAIM IS MADE TO THE EXCLUSIVE RIGHT TO USE "HOUSE", APART FROM THE MARK AS SHOWN.

CLASS 37—CONSTRUCTION AND REPAIR

FOR CONSTRUCTION SERVICES, NAMELY, PLANNING, LAYING OUT AND CONSTRUCTION OF NEW RESIDENTIAL HOMES BASED ON DESIGN AND CONSTRUCTION CRITERIA THAT PROVIDES HIGHER ENERGY EFFICIENCIES AND IMPROVED ENVIRONMENTAL QUALITY CONTROL FEATURES; PROVIDING INFORMATION VIA THE INTERNET AND WORLD WIDE WEB RELATING TO BUILDING CONSTRUCTION OPTIONS THAT PROVIDE HIGHER ENERGY EFFICIENCIES AND IMPROVED ENVIRONMENTAL QUALITY CONTROL FEATURES; CONSULTATION IN THE FIELD OF BUILDING CONSTRUCTION, NAMELY, PROVIDING CONSULTATION TO POTENTIAL HOME BUYERS REGARDING CONSTRUCTION OPTIONS THAT PROVIDE HIGHER ENERGY EFFICIENCIES AND IMPROVED ENVIRONMENTAL QUALITY CONTROL FEATURES (U.S. CLS. 100, 103 AND 106).

CLASS 42—SCIENTIFIC AND COMPUTER SERVICES

FOR PROVIDING CONSULTATION SERVICES TO NEW HOME BUYERS RELATING TO RESIDENTIAL HOME DESIGNS, SPECIFICALLY, DESIGNS THAT PROVIDE HIGHER ENERGY EFFICIENCIES AND IMPROVED ENVIRONMENTAL QUALITY CONTROL FEATURES; PROVIDING INFORMATION VIA THE INTERNET AND WORLD WIDE WEB ABOUT DESIGNING RESIDENTIAL HOMES THAT PROVIDE HIGHER ENERGY EFFICIENCIES AND IMPROVED ENVIRONMENTAL QUALITY CONTROL FEATURES (U.S. CLS. 100 AND 101).

JOSETTE BEVERLY, EXAMINING ATTORNEY

SN 76-708,620. H.E.R. ACCESSORIES, LTD, NEW YORK, NY. FILED 8-5-2011.

SWEET STUFF

THE MARK CONSISTS OF STANDARD CHARACTERS WITHOUT CLAIM TO ANY PARTICULAR FONT, STYLE, SIZE, OR COLOR.

CLASS 14—JEWELRY

FOR COSTUME JEWELRY FOR ADULTS (U.S. CLS. 2, 27, 28 AND 50).

CLASS 26—FANCY GOODS

FOR HAIR ACCESSORIES FOR ADULTS, NAMELY, BARRETTES, HAIR CLIPS, HAIR ELASTIC BANDS, HAIR BOWS, HAIR TIES, BOBBY PINS, HAIR WRAPS, TWISTERS, AND PONY TAIL HOLDERS (U.S. CLS. 37, 39, 40, 42 AND 50).

LINDA M. KING, EXAMINING ATTORNEY

SN 76-709,015. SHARP KABUSHIKI KAISHA, TA SHARP CORPORATION, OSAKA, JAPAN, FILED 9-8-2011.



OWNER OF U.S. REG. NOS. 2,830,322, 3,612,818 AND OTHERS.

NO CLAIM IS MADE TO THE EXCLUSIVE RIGHT TO USE "LIVE", APART FROM THE MARK AS SHOWN.

THE COLOR(S) BLUE, GREEN, GRAY AND WHITE IS/ ARE CLAIMED AS A FEATURE OF THE MARK.

THE MARK IS PRESENTED IN A STYLIZED FORMAT OF THE WORDING "AQUOS ADVANTAGE LIVE" IN ALL CAPS, WITH "AQUOS ADVANTAGE" IN A SMALLER FONT POSITIONED ABOUT "LIVE", WHICH IS PRESENTED IN A LARGER, BOLDER FONT POSITIONED FLUSH RIGHT BENEATH, WITH A SMALL CIRCLE TO THE LEFT OF "LIVE". COLOR CLAIM: APPLICANT CLAIMS THE COLORS BLUE, GREEN, GRAY AND WHITE, WITH THE LETTERS IN THE WORDING "AQUOS ADVANTAGE" FEATURED IN GRAY, WHEREAS THE WORD "LIVE" IS FEATURED IN A BOLD WHITE. THE CIRCLE IS FEATURED IN SHADES OF GREEN AND THE WORDING AND CIRCLE ARE POSITIONED ON A GEOMETRIC BACKGROUND REFLECTING VARIOUS SHADES OF BLUE.

CLASS 37—CONSTRUCTION AND REPAIR

FOR REPAIR SERVICE FOR LCD TELEVISIONS FEATURING IN SITU REPAIR AND LOANER SERVICES, AND REMOTE SERVICES PROVIDED VIA THE INTERNET OR TELEPHONE (U.S. CLS. 100, 103 AND 106).

FIRST USE 10-0-2009; IN COMMERCE 10-0-2009.

CLASS 42—SCIENTIFIC AND COMPUTER SERVICES

FOR CONSULTING IN THE FIELD OF TELECOMMUNICATIONS TECHNOLOGY RELATING TO LCD TELEVISIONS FEATURING TRAINED TECHNICAL ADVISERS IN THE AREA OF LCD TELEVISION TECHNOLOGY, PROVIDING ONLINE OR TELEPHONE INFORMATION AND SUPPORT SERVICES IN THE AREA OF LCD TELEVISION TECHNOLOGY, AND PROVIDING IN SITU OR REMOTE ASSISTANCE IN INITIAL PRODUCT SET-UP, SETTINGS MANAGEMENT, CONNECTIVITY ASSISTANCE (INCLUDING CABLE SET-UP), AUDIO-VIDEO SET-UP, SYSTEM CHECK-UPS, SYSTEMS REPAIR AND UPDATING, AND PERSONALIZED CALIBRATIONS FOR LCD TELEVISIONS (U.S. CLS. 100 AND 101).

FIRST USE 10-0-2009; IN COMMERCE 10-0-2009.

JOHN SCHUYLER YARD, EXAMINING ATTORNEY

SN 76-709,872. BUCK COMMANDER, L.L.C., WEST MONROE, LA. FILED 12-1-2011.



THE MARK CONSISTS OF THE DESIGN OF THE HEAD, ANTLERS, NECK AND SHOULDER PORTION OF A BUCK DEER POSED WITH ITS HEAD TURNED AND LOOKING BACK OVER ITS SHOULDER TOWARDS THE RIGHT OF THE DESIGN.

CLASS 9—ELECTRICAL AND SCIENTIFIC APPARATUS

FOR PRERECORDED AUDIO AND VIDEO CASSETTES, TAPES, COMPACT DISKS, LASER DISKS AND DVD'S FEATURING DEER HUNTING THEMES (U.S. CLS. 21, 23, 26, 36 AND 38).

FIRST USE 6-20-2008; IN COMMERCE 6-20-2008.

CLASS 16—PAPER GOODS AND PRINTED MATTER

FOR DECALS AND POSTERS (U.S. CLS. 2, 5, 22, 23, 29, 37, 38 AND 50).

FIRST USE 2-11-2009; IN COMMERCE 2-11-2009.

CLASS 20—FURNITURE AND ARTICLES NOT OTHERWISE CLASSIFIED

FOR LICENSE PLATES, NOT OF METAL; KEY RINGS, NOT OF METAL (U.S. CLS. 2, 13, 22, 25, 32 AND 50).
FIRST USE 4-6-2010; IN COMMERCE 4-6-2010.

CLASS 25—CLOTHING

FOR APPAREL, NAMELY, SHIRTS, CAPS (U.S. CLS. 22 AND 39).
FIRST USE 9-12-2007; IN COMMERCE 9-12-2007.

CLASS 28—TOYS AND SPORTING GOODS

FOR HUNTING GAME CALLS FOR DEER (U.S. CLS. 22, 23, 38 AND 50).
FIRST USE 8-19-2009; IN COMMERCE 8-19-2009.

CLASS 41—EDUCATION AND ENTERTAINMENT

FOR PRODUCTION OF TELEVISION SHOWS (U.S. CLS. 100, 101 AND 107).
FIRST USE 6-30-2010; IN COMMERCE 6-30-2010.
SUZANNE BLANE, EXAMINING ATTORNEY

SN 76-710,565. WILLIS, GABE, VISTA, CA. FILED 2-7-2012.



THE MARK CONSISTS OF THE STYLIZED LETTERS "SS" PLACED ABOVE THE TERM "STRAIGHTSTREET".

CLASS 25—CLOTHING

FOR MEN'S, WOMEN'S AND CHILDREN'S SHIRTS, PANTS, SLACKS, TROUSERS, JEANS, SHORTS, OVERALLS, T-SHIRTS, BLOUSES, SKIRTS, DRESSES, VESTS, SKIRTS, JACKETS, COATS, SPORT COATS, SWEATERS, SWEATSHIRTS, ACTIVEWEAR IN THE NATURE OF TANK TOPS, SWEAT BANDS, AND GLOVES, SWEATPANTS, HATS, SOCKS, SHOES, BATHING SUITS, TANK TOPS AND RUNNING APPAREL IN THE NATURE OF SHOES AND RUNNING SHORTS (U.S. CLS. 22 AND 39).

CLASS 28—TOYS AND SPORTING GOODS

FOR SKATEBOARDS (U.S. CLS. 22, 23, 38 AND 50).
AHSEN KHAN, EXAMINING ATTORNEY

SN 77-256,704. VITERRA INC., REGINA, CANADA, FILED 8-16-2007.



PRIORITY CLAIMED UNDER SEC. 44(D) ON CANADA APPLICATION NO. 1359166, FILED 8-9-2007, REG. NO. TMA810,578, DATED 10-28-2011, EXPIRES 10-28-2026.
OWNER OF U.S. REG. NOS. 999,467 AND 1,642,507.
THE WORDING "VITERRA" HAS NO MEANING IN A FOREIGN LANGUAGE.

CLASS 5—PHARMACEUTICALS

FOR NON-MEDICATED ADDITIVES FOR ANIMAL FEED FOR USE AS NUTRITIONAL PROTEIN SUPPLEMENTS (U.S. CLS. 6, 18, 44, 46, 51 AND 52).

CLASS 29—MEATS AND PROCESSED FOODS

FOR PULSES (U.S. CL. 46).

CLASS 31—NATURAL AGRICULTURAL PRODUCTS

FOR LIVESTOCK SUPPLIES, NAMELY, ANIMAL FEED, GRAIN SCREENING PELLETS IN THE NATURE OF UNPROCESSED GRAIN, MILL ANIMAL FEEDS; AGRICULTURAL SEED AND UNPROCESSED GRAIN, NAMELY, REGISTERED, COMMERCIAL OILSEEDS AND UNPROCESSED CEREALS (U.S. CLS. 1 AND 46).

CLASS 35—ADVERTISING AND BUSINESS

FOR WHOLESALE DISTRIBUTORSHIPS AND RETAIL STORE SERVICES ALL FEATURING AGRICULTURAL PRODUCTS, NAMELY, GRAINS, OILSEEDS, LEGUMES AND FORAGES, AND SEEDS OF AGRICULTURAL PRODUCTS AND PRIMARY BY-PRODUCTS OF AGRICULTURAL PRODUCTS; WHOLESALE DISTRIBUTORSHIPS AND RETAIL STORE SERVICES ALL FEATURING ANIMAL FEEDS, NAMELY, COMPLETE FEEDS, CONCENTRATED VITAMIN PREMIX FEEDS, MINERAL PREMIX FEEDS, CONCENTRATED VITAMIN AND MINERAL PREMIX FEEDS, SUPPLEMENT FEEDS AND FEED CONCENTRATES; WHOLESALE DISTRIBUTORSHIPS AND RETAIL STORE SERVICES ALL FEATURING ANIMAL FEED NUTRIENTS AND ADDITIVES; WHOLESALE DISTRIBUTORSHIPS AND RETAIL STORE SERVICES ALL FEATURING ANIMAL FEED MEDICATIONS AND INJECTABLES TO TREAT AND PREVENT DISEASE IN ANIMALS; MERCHANDISING SERVICES, NAMELY, STRATEGIC DEVELOPMENT, ADVERTISEMENT AND MARKETING RELATING TO THE PRODUCTION, PURCHASE AND SALE OF THE FOLLOWING PRODUCTS OF OTHERS AGRICULTURAL PRODUCTS, NAMELY, GRAINS, OILSEEDS, LEGUMES AND FORAGES, AND SEEDS OF AGRICULTURAL PRODUCTS AND PRIMARY BY-PRODUCTS OF AGRICULTURAL PRODUCTS (U.S. CLS. 100, 101 AND 102).

CLASS 40—MATERIAL TREATMENT

FOR CONTRACT MANUFACTURING IN THE FIELD OF AGRICULTURAL PRODUCTS, NAMELY, GRAINS, OILSEEDS, LEGUMES AND FORAGES, AND SEEDS OF AGRICULTURAL PRODUCTS AND PRIMARY BY-PRODUCTS OF AGRICULTURAL PRODUCTS, ANIMAL FEEDS, NAMELY, COMPLETE FEEDS, CONCENTRATED VITAMIN PREMIX FEEDS, MINERAL PREMIX FEEDS, CONCENTRATED VITAMIN AND MINERAL PREMIX FEEDS, SUPPLEMENT FEEDS AND FEED CONCENTRATES; ANIMAL FEED NUTRIENTS AND ADDITIVES, ANIMAL FEED MEDICATIONS AND INJECTABLES TO TREAT AND PREVENT DISEASE IN ANIMALS (U.S. CLS. 100, 103 AND 106).

LINDA ESTRADA, EXAMINING ATTORNEY

SN 77-262,989, KABUSHIKI KAISHA SONY COMPUTER ENTERTAINMENT, DBA SONY COMPUTER ENTERTAINMENT INC., TOKYO, JAPAN, FILED 8-23-2007.



OWNER OF ERPN CMNTY TM OFC REG. NO. 006220248, DATED 11-20-2008, EXPIRES 8-22-2017.

THE MARK CONSISTS OF A SOLID CIRCLE WITH A STYLIZED SQUARE, TRIANGLE, "O" AND "X" SUPERIMPOSED ON THE CIRCLE.

CLASS 9—ELECTRICAL AND SCIENTIFIC APPARATUS

FOR MOUSE PADS FOR COMPUTERS; MOUSE FOR COMPUTERS; ELECTRONIC CIRCUITS, MAGNETIC DISCS AND MAGNETIC TAPES, ENCODED WITH COMPUTER PROGRAMS FOR ENCRYPTING OR DECRYPTING INFORMATION DATA; INFORMATION PROVING DEVICES, NAMELY, ENCRYPTING AND MICRO PROGRAMMING DEVICES FOR INFORMATION PROCESSING MACHINES, ENCRYPTING AND MICRO PROGRAMMING DEVICES FOR INFORMATION PROCESSING MACHINES, NAMELY, COMPUTER AND VIDEO GAME MACHINES FOR USE WITH TELEVISIONS; STRAPS FOR CELLULAR PHONES; INSTANT CAMERAS WITH FILMS; DOWNLOADABLE COMPUTER PROGRAMS FOR VIDEO GAME MACHINES WITH TELEVISION FOR COMMERCIAL USE; DOWNLOADABLE MUSIC VIA THE INTERNET; DOWNLOADABLE IMAGES, NAMELY, GRAPHICS, FILMS AND ELECTRONIC BOOKS, ALL RELATING TO COMPUTER GAMES AND VIDEO GAMES; DOWNLOADABLE MOVIES IN THE FIELD OF SCIENCE FICTION, DRAMA, AND COMEDY; DOWNLOADABLE ELECTRONIC PUBLICATIONS IN THE NATURE OF BOOKS AND MAGAZINES FEATURING COMPUTER GAMES AND VIDEO GAMES; DOWNLOADABLE VIDEO GAME SOFTWARE; READ-ONLY CARTRIDGE TYPE ELECTRONIC CIRCUITS RECORDED WITH ASSEMBLERS, COMPILERS AND COMPUTER PROGRAMS FOR SOFTWARE DEVELOPMENT AND COMPUTER PROGRAMMING; MAGNETIC DISCS, MAGNETIC TAPES, OPTICAL DISCS, CD-ROMS AND MAGNETIC CARDS ALL FEATURING RECORDED ASSEMBLERS, COMPILERS AND COMPUTER PROGRAMS FOR SOFTWARE DEVELOPMENT AND COMPUTER PROGRAMMING; ENCRYPTION DEVICES USED FOR SCRAMBLING IN TELECOMMUNICATION, NAMELY, COMPUTERS AND COMPUTER PERIPHERALS; ELECTRONIC CIRCUITS, MAGNETIC DISCS, OPTICAL DISCS, MAGNETIC OPTICAL DISCS, CD-ROMS, MAGNETIC TAPES AND DVD-ROMS ENCODED WITH VIDEO GAME PROGRAMS FOR PERSONAL USE; ELECTRONIC CIRCUITS, MAGNETIC DISCS, OPTICAL DISCS, MAGNETIC OPTICAL DISCS, CD-ROMS, MAGNETIC TAPES AND DVD-ROMS ENCODED WITH VIDEO GAME PROGRAMS FOR BUSINESS USE; CONTROLLERS, JOYSTICKS, MEMORY CARDS, VOLUME CONTROLLERS, MOUSE AND KEYBOARDS FOR VIDEO GAME MACHINES FOR USE WITH TELEVISIONS FOR PERSONAL USE; PRE-RECORDED MAGNETIC DISCS, OPTICAL

DISCS, MAGNETIC OPTICAL DISCS, CD-ROMS, MAGNETIC TAPES AND DVD-ROMS ENCODED WITH MAGAZINES, BOOKS, NEWSPAPERS, MAPS, PICTURES, IMAGES AND LITERAL INFORMATION ALL FEATURING INFORMATION ABOUT VIDEO GAMES, MUSIC AND VIDEO MOVIES; APPARATUS AND INSTRUMENTS FOR SCIENTIFIC RESEARCH IN LABORATORIES, NAMELY, AIR-GAS PRODUCING UNITS FOR USE IN LABORATORIES, CONSTANT TEMPERATURE INCUBATORS FOR USE IN LABORATORIES; MEASURING APPARATUS BY STANDARD MEASURING UNITS, NAMELY, PRESSURE GAUGES, LEVEL INDICATORS, ACOUSTIC METERS, TACHOMETERS, ACCELEROMETERS; MEASURING APPARATUS BY DERIVED MEASURING UNITS, NAMELY, PRESSURE GAUGES, LEVEL INDICATORS, ACOUSTIC METERS, TACHOMETERS, ACCELEROMETERS; PRECISION MEASURING MACHINES AND INSTRUMENT, NAMELY, ANGLE GAUGES, ANGLE DIVIDING MACHINES, SPHEROMETERS, INCLINOMETERS; MATERIAL TESTING MACHINES AND INSTRUMENTS, NAMELY, COMPRESSION TESTING UNITS FOR METALLIC MATERIALS, HARDNESS TESTING MACHINES FOR METALLIC MATERIALS, STRENGTH TESTING UNITS FOR METALLIC MATERIALS; ASTROMETRIC MEASURING MACHINES AND INSTRUMENTS, NAMELY, MERIDIAN TRANSITS, ASTRONOMICAL SPECTROGRAPHS, TELESCOPES; POWER DISTRIBUTION AND/OR CONTROL APPARATUS, NAMELY, ELECTRIC SWITCHES, ELECTRIC RELAYS, CIRCUITS BREAKERS, POWER CONTROLLERS, CURRENT RECTIFIERS, ELECTRIC CONNECTORS, ELECTRIC CIRCUIT CLOSERS; ELECTRIC CAPACITORS, ELECTRIC RESISTORS, LOCAL SWITCHES, POWER DISTRIBUTING BOXES, SWITCHBOARDS, FUSES FOR ELECTRIC CURRENT, LIGHTNING ARRESTERS, ELECTRIC TRANSFORMERS, INDUCTION VOLTAGE REGULATORS, ELECTRIC REACTORS; ROTARY CONVERTERS; PHASE MODIFIERS; DRY CELLS; WET CELLS; ELECTRIC ACCUMULATORS AND BATTERIES; PHOTOVOLTAIC CELLS; ELECTRIC MAGNETIC METERS AND AMPERAGE TESTERS; ELECTRIC WIRES; ELECTRIC CABLES, PHOTOGRAPHIC APPARATUS AND INSTRUMENTS, NAMELY, TILTING HEADS FOR CAMERAS, CAMERAS, RANGE FINDERS FOR CAMERAS, PHOTO-DEVELOPING, PRINTING, ENLARGING AND FINISHING UNITS, TRIPODS FOR CAMERAS, SHUTTERS FOR CAMERAS; CINEMATOGRAPHIC APPARATUS AND INSTRUMENTS; TELESCOPES; MICROSCOPES; EYEGLASSES AND SKI GOGGLES; PARTS AND ACCESSORIES FOR EYEGLASSES AND GOGGLES, NAMELY, CONTAINERS FOR CONTACT LENSES, SPECTACLE TEMPLES, PINCE-NEZ FRAMES, PINCE-NEZ CHAINS, PINCE-NEZ CORDS, SPECTACLE CASES, SPECTACLE WIPES, SPECTACLE GLASSES, SPECTACLE FRAMES; OPTICAL GLASSES; LIFE NETS; LIFEBELTS; LIFE-JACKETS; LIFE-BUOYS; TELEPHONE APPARATUS, NAMELY, INTERCOMS, AUTOMATIC SWITCHING APPARATUS FOR TELECOMMUNICATION, MANUAL SWITCHING APPARATUS FOR TELECOMMUNICATION, TELEPHONE SETS; WIRE COMMUNICATION APPARATUS, NAMELY, TELETYPEWRITERS, AUTOMATIC TELEGRAPH UNITS, PHOTO TELEGRAPHY UNITS; FREQUENCY-CARRIER APPARATUS, NAMELY, AUDIO FREQUENCY TRANSMISSION GENERATORS, CABLE-TYPE FREQUENCY-CARRIER GENERATORS, POWER-LINE-TYPE FREQUENCY-CARRIER GENERATORS, OPEN-WIRE-TYPE FREQUENCY-CARRIER GENERATORS, CARRIER-FREQUENCY REPEATERS; BROADCASTING APPARATUS, NAMELY, TELEVISION RECEIVERS, TELEVISION TRANSMITTERS, RADIO RECEIVERS AND RADIO TRANSMITTERS, RADIO COMMUNICATION APPARATUS, NAMELY, AERONAUTICAL RADIO COMMUNICATION MACHINES AND APPARATUS, MARINE RADIO COMMUNICATION MACHINES AND APPARATUS AND SINGLE-CHANNEL RADIO COMMUNICATION MACHINES AND APPARATUS FOR FIXED STATIONS; RADIO APPLICATION APPARATUS, NAMELY, RADIO BEACON UNITS, RADIO DIRECTION FINDERS, RADARS, LORAN NAVIGATION UNITS; REMOTE CONTROL APPARATUS, NAMELY, REMOTE CONTROL TELEMETERING APPARATUS; AUDIO FREQUENCY APPARATUS, NAMELY, PUBLIC-ADDRESS SYSTEMS, JUKE BOXES, TAPE RECORDERS, ELECTRIC PHONOGRAPHS, RECORD PLAYERS, VIDEOTAPE RECORDERS; VIDEO FREQUENCY APPARATUS, NAMELY, VIDEO CAMERAS, VIDEODISC PLAYERS, VIDEOTAPE

RECORDERS; PARTS AND ACCESSORIES FOR ELECTRIC COMMUNICATION APPARATUS AND INSTRUMENTS, NAMELY, ANTENNAS, HEADPHONES, MICROPHONES AND BLANK VIDEO TAPES; PHONOGRAPH RECORDS FEATURING MUSIC; METRONOMES; RECORDED COMPACT DISCS FEATURING MUSIC; COMPUTERS; ELECTRON MICROSCOPES; ELECTRONIC DESK CALCULATORS; WORD PROCESSORS; PHOTO-SENSITIVE TUBES FOR LABORATORY USE; VACUUM TUBES; RECTIFIER TUBES; CATHODE RAY TUBES; THERMISTORS; DIODES; TRANSISTORS; ELECTRON TUBES; SEMI-CONDUCTOR DEVICES. INTEGRATED CIRCUITS; LARGE SCALE INTEGRATED CIRCUITS; ELECTRIC FLAT IRONS FOR HOUSEHOLD USE; ELECTRIC HAIR-CURLERS FOR HOUSEHOLD USE; ELECTRIC BUZZERS FOR HOUSEHOLD USE; EXPOSED CINEMATOGRAPHIC FILMS; EXPOSED SLIDE FILMS; PHOTOGRAPHIC SLIDE TRANSPARENTS; SLIDE FILM MOUNTS; PRERECORDED VIDEO DISCS AND TAPES FEATURING VIDEO GAMES, MOVIES, AND MUSIC; VENDING MACHINES; VIDEO GAME MACHINES FOR USE WITH TELEVISION FOR PERSONAL USE (U.S. CLS. 21, 23, 26, 36 AND 38).

CLASS 16—PAPER GOODS AND PRINTED MATTER

FOR ADDRESS PLATES FOR ADDRESSING MACHINES; ADDRESS STAMPS; ADDRESSING MACHINES; ADHESIVE BANDS FOR STATIONERY OR HOUSEHOLD PURPOSES; ADHESIVE TAPES FOR STATIONERY OR HOUSEHOLD PURPOSES; ADVERTISEMENT BOARDS OF PAPER OR CARDBOARD; ALBUMS FOR STICKERS, COINS, AND PHOTOGRAPHS; ALMANACS; ARCHITECTS' MODELS; PRINTED ARITHMETICAL TABLES; ATLASES; BALLS FOR BALL-POINT PENS; BIBS OF PAPER; BLACKBOARDS; BLOTTERS; BLUEPRINTS; BOOKBINDING CLOTH; BOOKBINDING CORDS; BOOKBINDING MATERIALS; BOOK BINDINGS; BOOKENDS; BOOKLETS ABOUT VIDEO GAME MACHINES AND VIDEO GAME SOFTWARE; BOOK-MARKERS; BOOKS ABOUT VIDEO GAME MACHINES AND VIDEO GAME SOFTWARE; BOTTLE ENVELOPES OF CARDBOARD OR PAPER; BOTTLE WRAPPERS OF CARDBOARD OR PAPER; BOXES FOR PENS; BOXES OF CARDBOARD OR PAPER; PRINTED CALCULATING TABLES; CALENDARS; CANVAS FOR PAINTING; CARBON PAPER; CARDBOARD; CARDBOARD ARTICLES, NAMELY, CARDBOARD BOXES; CARDBOARD TUBES; CARDS, NAMELY, INDEX CARDS, GREETING CARDS; PRINTED CATALOGUES IN THE FIELD OF VIDEO GAMES USED WITH TELEVISION AND VIDEO GAME SOFTWARE; CHALK FOR LITHOGRAPHY; CHALK HOLDERS; CHAPLETS; CHARCOAL PENCILS; PRINTED CHARTS; CHROMOS, NAMELY, CHROMOLITHOGRAPHS; PAPER CLIPS FOR OFFICES; CLOTH FOR BOOKBINDING; COASTERS OF PAPER; COMIC BOOKS; COMPASSES FOR DRAWING; CORDS FOR BOOKBINDING; COVERS OF PAPER FOR FLOWER POTS; CREAM CONTAINERS OF PAPER; DECALCOMANIAS; DRAWING T-SQUARES; DRAWING BOARDS; DRAWING INSTRUMENTS; DRAWING PADS; DRAWING PENS; DRAWING PUSH PINS; DRAWING SQUARES; ROTARY DUPLICATORS; ELASTIC BANDS FOR OFFICES; ELECTROCARDIOGRAPH PAPER; ELECTROTYPES; ENGRAVING PLATES; ENGRAVINGS; ENVELOPE SEALING MACHINES, FOR OFFICES; ERASING PRODUCTS, NAMELY, ERASERS, INK ERASERS, AND CORRECTING FLUID FOR TYPE; ERASING SHIELDS; ETCHING NEEDLES; ETCHINGS; FABRICS FOR BOOKBINDING; FACE TOWELS OF PAPER; FILTER PAPER; FLOWER-POT COVERS OF PAPER; FOLDERS FOR PAPERS; FOUNTAIN PENS. FRENCH DRAWING CURVES; GEOGRAPHICAL MAPS; GLUE FOR STATIONERY OR HOUSEHOLD PURPOSES; PAINTING INSTRUMENTS, NAMELY, GRAINING COMBS; GRAPHIC PRINTS; GRAPHIC REPRESENTATIONS; GRAPHIC REPRODUCTIONS; GREETING CARDS; GUMMED CLOTH FOR STATIONERY PURPOSES; HAND-RESTS FOR PAINTERS; HANDKERCHIEFS OF PAPER; PRINTED HANDWRITING SPECIMENS FOR COPYING; HAT BOXES OF CARDBOARD; HECTOGRAPHS; PRINTED HISTOLOGICAL SECTIONS REPRODUCTIONS FOR TEACHING PURPOSES; HOUSE PAINTERS' PAINT ROLLERS; HYGIENIC PAPER; TELEPHONE INDEXES; INDIAN INKS; INDIA INKS; INK STICKS; INKING PADS; INKING RIBBONS; INKING RIBBONS FOR COMPUTER PRIN-

TERS; INKING SHEETS FOR DOCUMENT REPRODUCING MACHINES; INKING SHEETS FOR DUPLICATORS; INKSTANDS; INKWELLS; ISINGLASS PASTE FOR STATIONERY OR HOUSEHOLD PURPOSES; JACKETS FOR PAPERS, NAMELY, PAPER FILE JACKETS; PAPER LABELS; LETTER TRAYS; LITHOGRAPHIC STONES; LITHOGRAPHIC WORKS OF ART; LITHOGRAPHS; LOOSE-LEAF BINDERS; LUMINOUS PAPER; MARKING CHALK; PAPER MATS FOR BEER GLASSES; MIMEOGRAPH MACHINES; MODELING CLAY; MODELING MATERIALS FOR USE BY CHILDREN; MODELING PASTE; MODELING WAX, NOT FOR DENTAL PURPOSES; MUSICAL GREETING CARDS; NAPKINS OF PAPER FOR REMOVING MAKE-UP; NEWSLETTERS ABOUT VIDEO GAME MACHINES USED WITH TELEVISIONS AND VIDEO GAME SOFTWARE; NEWSPAPERS; PEN NIBS; PEN NIBS OF GOLD; NOTE BOOKS; NUMBERING MACHINES; OFFICE PERFORATORS; OFFICE REQUISITES, EXCEPT FURNITURE, NAMELY, ENVELOPE SEALING MACHINES; OLEOGRAPHS; PACKING PAPER; PAINT-BRUSHES; PAINTERS' EASELS; PALETTES FOR PAINTERS; PRINTED PAMPHLETS IN THE FIELD OF VIDEO GAMES USED WITH TELEVISION AND VIDEO GAME SOFTWARE; PAPER CLASPS; PAPER FOR RECORDING MACHINES; PAPER RIBBONS; PAPER TAPES AND CARDS FOR THE RECORDING OF COMPUTER PROGRAMS; PAPER-CLIPS; PAPERWEIGHTS; PAPER MACHE; PARCHMENT PAPER; PASSPORT HOLDERS; PASTES FOR STATIONERY OR HOUSEHOLD PURPOSES; PRINTED PATTERNS FOR DRESS-MAKING; PRINTED PATTERNS FOR MAKING CLOTHES, PEN CASES; PEN CLIPS; CELLULOSE PEN WIPERS; PENCIL HOLDERS; PENCIL LEAD HOLDERS; PENCIL LEADS; PENCIL SHARPENERS; PENCIL SHARPENING MACHINES; PENCILS; PENHOLDERS; PERFORATED CARDS FOR JACQUARD LOOMS; PRINTED PERIODICALS IN THE FIELD OF VIDEO GAMES, MUSIC, MOVIES, AND PLAYS; PHOTO-ENGRAVINGS; PHOTOGRAPH STANDS; PHOTOGRAPHS; PICTURES; PLACARDS OF PAPER OR CARDBOARD; PLACE MATS OF PAPER; PRINTED PLANS; PLASTIC FILM FOR WRAPPING FOOD FOR HOUSEHOLD USE; PLASTICS FOR MODELING; PORTRAITS; POSTAGE STAMPS; PRINTED HIDING-CHARTS FOR IDENTIFYING HIDING POWER OF PAINT (U.S. CLS. 2, 5, 22, 23, 29, 37, 38 AND 50).

CLASS 28—TOYS AND SPORTING GOODS

FOR ARCHERY IMPLEMENTS, NAMELY, BOW-STRINGS, ARCHERY GLOVES, TARGETS FOR ARCHERY, ARROWS FOR ARCHERY, QUIVERS FOR ARCHERY, BOWS FOR JAPANESE ARCHERY, BOWS FOR ARCHERY; BACKGAMMON GAME SETS; BALLS FOR GAMES; BAR-BELLS; BASEBALL GLOVES; BATS FOR GAMES; BELLS FOR CHRISTMAS TREES; BILLIARD BALLS; BILLIARD CUE TIPS; BILLIARD CUES; BILLIARD MARKERS; BILLIARD TABLE CUSHIONS; BILLIARD TABLES; BLADDERS OF BALLS FOR GAMES; BOARD GAMES; BOB-SLEIGHS; BODY-BUILDING APPARATUS; BODY-TRAINING APPARATUS; BOWLING APPARATUS AND MACHINERY; BOXING GLOVES; BUILDING GAMES; CANDLE HOLDERS FOR CHRISTMAS TREES; CHALK FOR BILLIARD CUES; CHECKERBOARDS; CHESS GAMES; CHESSBOARDS; CHRISTMAS TREE STANDS; CHRISTMAS TREES OF SYNTHETIC MATERIAL; CLAY PIGEON TRAPS; CLIMBERS' HARNESSES; COIN-OPERATED BILLIARD TABLES; CONJURING APPARATUS, NAMELY, MAGIC TRICKS; BAGS SPECIALLY ADAPTED FOR SPORTS EQUIPMENT, NAMELY, CRICKET BAGS; CUPS FOR DICE; DARTS; DECOYS FOR HUNTING OR FISHING; DICE; DISCUSES FOR SPORTS; DOLLS; DOLLS' BEDS; DOLLS' CLOTHES; DOLLS' FEEDING BOTTLES; DOLL'S HOUSES; DOLLS' ROOMS; DOMINOES; DRAUGHT BOARDS; DUMB-BELLS; EDGES OF SKIS; FENCING GAUNTLETS; FENCING MASKS; FENCING WEAPONS; FISH HOOKS; FISHING TACKLE; FLIPPERS FOR SWIMMING; FLOATS FOR FISHING; FOILS FOR FENCING; GLOVES FOR GAMES, NAMELY, BASEBALL GLOVES; GOLF BAGS WITH OR WITHOUT WHEELS; GOLF CLUBS; GOLF GLOVES; GUT FOR FISHING; GUT FOR RACKETS; HAND-HELD GAME WITH LIQUID CRYSTAL DISPLAY; HAND HELD UNIT FOR PLAYING ELECTRONIC GAMES; HANG GLIDERS; HOCKEY STICKS; HORSESHOE GAMES; ICE SKATES; KITE REELS; KITES; LANDING NETS FOR ANGLERS;

LINES FOR FISHING; LURES FOR HUNTING OR FISHING; MAHJONG; MARBLES FOR GAMES; MARIONETTES; NETS FOR SPORTS; NINEPINS; PARAGLIDERS; PARLOR GAMES; PLAY BALLONS; PLAY BALLS; PLAYING CARDS; PLUSH TOYS; PUPPETS; QUOITS; RACKETS; REELS FOR FISHING; RING GAMES; ROCKING HORSES; RODS FOR FISHING; ROLLER SKATES; ROLLERS FOR STATIONARY EXERCISE BICYCLES; SAILBOARDS; SCALE MODEL VEHICLES; SCRAPERS FOR SKIS; SHUTTLECOCKS; SKATEBOARDS; SKATING BOOTS WITH SKATES ATTACHED; SKI BINDINGS; SKIS; SKITTLES; SOLE COVERINGS FOR SKIS; STATIONARY EXERCISE BICYCLES; STRINGS FOR RACKETS; SURF BOARDS; SURF SKIS; SWINGS; TABLES FOR INDOOR FOOTBALL; TABLES FOR TABLE TENNIS; TARGETS; TEDDY BEARS; TENNIS NETS; THEATRICAL MASKS; TOY MASKS; TOY PISTOLS; TOY VEHICLES; TOY ACTION FIGURES; TOYS FOR DOMESTIC PETS; TWIRLING BATONS; WATERSKIS; WAX FOR SKIS; CONFETTI (U.S. CLS. 22, 23, 38 AND 50).

CLASS 35—ADVERTISING AND BUSINESS

FOR BUSINESS ADMINISTRATION CONSULTANCY; AUTOMATED DATA PROCESSING; COMPUTER DATA PROCESSING; COMPUTERIZED BUSINESS INFORMATION PROCESSING SERVICES, NAMELY, COLLECTION, PREPARATION, COMPOSITION, PROCESSING, ACQUISITION AND PROVISION OF BUSINESS INFORMATION, DATA, STATISTICS AND INDICES; COMPUTERIZED DATA PROCESSING SERVICES; DATA PROCESSING SERVICES; DATA PROCESSING SERVICES FOR BUSINESSES; DATA PROCESSING FOR THE COLLECTION OF DATA FOR BUSINESS PURPOSES; ELECTRONIC DATA PROCESSING SERVICES; INFORMATION SERVICES RELATING TO DATA PROCESSING; ON-LINE DATA PROCESSING SERVICES, NAMELY, DATA PROCESSING SALES AND PROMOTIONAL DATA AND PREPARING BUSINESS REPORTS FEATURING SUCH SALES AND PROMOTIONAL DATA FOR EVALUATING CONSUMER RESPONSE TO PROMOTIONAL ACTIVITY IN THE CONSUMER GOODS INDUSTRY, AND PROVIDING AN ON-LINE COMPUTER DATABASE IN THE FIELD OF BUSINESS REPORTS FEATURING SALES AND PROMOTIONAL DATA FOR EVALUATING CONSUMER RESPONSE TO PROMOTIONAL ACTIVITY IN THE CONSUMER GOODS INDUSTRY; ADMINISTRATION OF THE BUSINESS AFFAIRS OF RETAIL STORES OF OTHERS; COMPUTERIZED POINT-OF-SALE DATA COLLECTION SERVICES FOR RETAILERS; MANAGEMENT OF A RETAIL ENTERPRISE FOR OTHERS; THE BRINGING TOGETHER, FOR THE BENEFIT OF OTHERS, OF A VARIETY OF GOODS, ENABLING CUSTOMERS TO CONVENIENTLY VIEW AND PURCHASE THOSE GOODS IN THE FIELD OF RETAIL ELECTRICAL GOODS; ONLINE RETAIL STORE SERVICES FEATURING GENERAL CONSUMER MERCHANDISE AND A WIDE VARIETY OF CONSUMER GOODS OF OTHERS; RETAIL STORE SERVICES FEATURING DOMESTIC VIDEO GAME MACHINES; ACCOUNTING SERVICES; ADVERTISING SERVICES; ADVERTISING AGENCIES; ADVERTISING BY MAIL ORDER, NAMELY, DIRECT MAIL ADVERTISING; AUCTIONEERING; ACCOUNT AUDITING; ADVERTISING BY BILL-POSTING; BOOK-KEEPING; BUSINESS APPRAISALS; BUSINESS INFORMATION SERVICES; BUSINESS INQUIRIES; BUSINESS INVESTIGATIONS; BUSINESS MANAGEMENT AND ORGANIZATION CONSULTANCY; BUSINESS MANAGEMENT ASSISTANCE; BUSINESS MANAGEMENT CONSULTANCY; BUSINESS MANAGEMENT OF HOTELS FOR OTHERS; BUSINESS MANAGEMENT FOR PERFORMING ARTISTS; BUSINESS ORGANIZATION CONSULTANCY; BUSINESS RESEARCH; COMMERCIAL INFORMATION AGENCIES; COMMERCIAL AND INDUSTRIAL MANAGEMENT ASSISTANCE; COMPILATION OF INFORMATION INTO COMPUTER DATABASES; COMPUTERIZED ON-LINE ORDERING SERVICES IN THE FIELD OF VIDEO GAME MACHINES FOR USE WITH TELEVISION RECEIVER ONLY AND SOFTWARE THEREOF; COST PRICE ANALYSIS; DEMONSTRATION OF GOODS FOR OTHERS FOR ADVERTISING PURPOSE; DIRECT MAIL ADVERTISING; DISSEMINATION OF ADVERTISING MATTER; DISTRIBUTION OF SAMPLES; DOCUMENT REPRODUCTION; ECONOMIC FORECASTING; EFFICIENCY EXPERTS; EMPLOYMENT AGENCIES; EVALUATION OF STAND-

ING TIMBER; EVALUATION OF WOOL; IMPORT-EXPORT AGENCIES; LOCATION OF FREIGHT CARS BY COMPUTER; MARKETING RESEARCH; MARKETING STUDIES; MODELING FOR ADVERTISING OR SALES PROMOTION; OFFICE MACHINES AND EQUIPMENT RENTAL; PUBLIC OPINION POLLING; ORGANIZATION OF EXHIBITIONS FOR COMMERCIAL OR ADVERTISING PURPOSES; ARRANGING AND CONDUCTING TRADE FAIRS FOR COMMERCIAL OR ADVERTISING PURPOSES; PREPARING AND PLACING OUTDOOR ADVERTISING FOR OTHERS; PAYROLL PREPARATION; PERSONNEL MANAGEMENT CONSULTANCY; PERSONNEL RECRUITMENT; PHOTOCOPYING; PROVIDING INFORMATION SERVICES ABOUT NEW PRODUCTS, NAMELY, MAGAZINES, VIDEO GAMES AND VIDEOS; PUBLIC RELATIONS; PUBLICATION OF PUBLICITY TEXTS; PUBLICITY CONSULTATION; PUBLICITY AGENTS; WRITING OF PUBLICITY COLUMNS; RENTAL OF PUBLICITY MATERIALS; RADIO ADVERTISING, NAMELY, PRODUCTION AND DISTRIBUTION OF RADIO COMMERCIALS; PRODUCTION AND DISTRIBUTION OF RADIO COMMERCIALS; RELOCATION SERVICES FOR BUSINESSES; RENTAL OF ADVERTISING SPACE; RENTAL OF PHOTOCOPYING MACHINES; RETAIL STORE SERVICES AND ON-LINE RETAIL STORE SERVICES FEATURING VIDEO GAME MACHINES AND VIDEO GAME SOFTWARE; SECRETARIAL SERVICES; SHOP WINDOW DRESSING; SHORTHAND SERVICES; PROVIDING STATISTICAL INFORMATION; SYSTEMIZATION OF INFORMATION INTO COMPUTER DATABASES; TAX PREPARATION; TELEVISION ADVERTISING AGENCIES; PRODUCTION OF TELEVISION COMMERCIALS; STENOGRAPHIC TRANSCRIPTION; TYPING; UPDATING OF ADVERTISING MATERIAL, PROVIDING BUSINESS INFORMATION IN THE NATURE OF VALUATION OF STANDING TIMBER; WORD PROCESSING; CLEARANCE AGENCY SERVICES, NAMELY, MONEY ACCOUNTING SERVICES VIA COMPUTER NETWORKS (U.S. CLS. 100, 101 AND 102).

CLASS 36—INSURANCE AND FINANCIAL

FOR ACCIDENT INSURANCE UNDERWRITING; ACCOMMODATION BUREAU, NAMELY, LEASING OF APARTMENTS; ACTUARIAL SERVICES; FINANCIAL ANALYSIS; ANTIQUE APPRAISAL; APARTMENT HOUSE MANAGEMENT; ART APPRAISAL; BAIL-BONDING; BANKING; CAPITAL INVESTMENT; CHARITABLE FUND RAISING; CHECK VERIFICATION; CLEARANCE AGENCY SERVICES, NAMELY, MONEY EXCHANGE AND MONEY COLLECTION VIA COMPUTER NETWORKS; CREDIT BUREAU; CREDIT CARD SERVICES; CUSTOMS BROKERAGE; DEBIT CARD SERVICES; DEBT COLLECTION AGENCIES; DEPOSITS OF VALUABLES, NAMELY, SAFE DEPOSIT BOX SERVICES; ELECTRONIC FUNDS TRANSFER; ELECTRONIC TOLL COLLECTION SERVICES; ELECTRONIC COMMERCE PAYMENT SERVICES, NAMELY, ESTABLISHING FUNDED ACCOUNTS USED TO PURCHASE GOODS AND SERVICES ON THE INTERNET; EXCHANGING MONEY; FACTORING; FIDUCIARY REPRESENTATIVES; FINANCIAL CONSULTANCY; FINANCIAL EVALUATION OF INSURANCE BANKING AND REAL ESTATE; FINANCIAL INFORMATION; FINANCIAL MANAGEMENT; FINANCIAL SPONSORSHIP, NAMELY, THE FUNDING OF SPORT EVENTS, CULTURAL EXHIBITIONS AND EVENTS, FESTIVALS, ART EXHIBITIONS, ART FOUNDATIONS, HEALTH RESEARCH, AND HUMANITARIAN ACTIONS FOR ADVERTISING AND COMMERCIAL PURPOSES; FINANCING SERVICES; FIRE INSURANCE UNDERWRITING; FISCAL ASSESSMENTS; FUND INVESTMENTS; MONEY ORDER PAYMENT GUARANTEE SERVICES; HEALTH INSURANCE UNDERWRITING; HIRE-PURCHASE FINANCING; HOME BANKING; HOUSING AGENTS; INSURANCE OF CHARGE FOR GOODS AND SERVICES THROUGH THE INTERNET; INSTALLMENT LOANS; INSURANCE BROKERAGE; INSURANCE CONSULTANCY; PROVIDING INSURANCE INFORMATION; INSURANCE UNDERWRITING FOR ALL TYPE INSURANCE; ISSUANCE OF CREDIT CARDS; ISSUE OF TOKENS OF VALUE; ISSUING OF TRAVELERS' CHECKS; LEASE-PURCHASE FINANCING; LEASING OF FARMS; LEASING OF REAL ESTATE; LENDING AGAINST SECURITY; LIFE INSURANCE UNDERWRITING; LOAN FINANCING; MARINE INSURANCE UN-

DERWRITING; MORTGAGE BANKING; MUTUAL FUNDS; NUMISMATIC APPRAISAL; ORGANIZATION OF COLLECTIONS, NAMELY, COLLECTION AGENCIES; PAWN BROKERAGE; REAL ESTATE AGENCIES; REAL ESTATE APPRAISAL; REAL ESTATE BROKERS; REAL ESTATE MANAGEMENT; RENT COLLECTION; RENTAL OF OFFICES; RENTING OF APARTMENTS; RENTING OF FLATS; RETIREMENT PAYMENT SERVICES; SAFE DEPOSIT SERVICES; SAVINGS BANKS; SECURITIES BROKERAGE; STAMP APPRAISAL; STOCK EXCHANGE QUOTATIONS; STOCKS AND BONDS BROKERAGE; SURETY SERVICES; TRUSTESHIP (U.S. CLS. 100, 101 AND 102).

CLASS 38—COMMUNICATION

FOR BROADCASTING SERVICES AND PROVISION OF TELECOMMUNICATION ACCESS TO FILMS AND VIDEO PROGRAMS PROVIDED VIA A VIDEO-ON-DEMAND SERVICE; CABLE TELEVISION BROADCASTING; CELLULAR TELEPHONE COMMUNICATION; COMMUNICATIONS BY COMPUTER TERMINALS; COMMUNICATIONS BY TELEGRAMS; COMMUNICATIONS BY TELEPHONE; COMPUTER AIDED TRANSMISSION OF MESSAGES AND IMAGES; ELECTRONIC MAIL; ELECTRONIC BULLETIN BOARD SERVICES; FACSIMILE TRANSMISSION; PROVIDING INFORMATION ABOUT TELECOMMUNICATION; MESSAGE SENDING BY ELECTRONIC MAIL; NEWS AGENCIES, NAMELY, THE TRANSMISSION OF NEWS ITEMS TO NEWS REPORTING ORGANIZATIONS; PROVIDING TELECOMMUNICATIONS CONNECTIONS TO A GLOBAL COMPUTER NETWORK; PROVIDING USER ACCESS TO A GLOBAL COMPUTER NETWORK; RADIO BROADCASTING; RENTAL OF FACSIMILE APPARATUS; RENTAL OF MESSAGE SENDING APPARATUS, NAMELY, TELETXT MACHINES; RENTAL OF MODEMS; RENTAL OF TELECOMMUNICATION EQUIPMENT; RENTAL OF TELEPHONES; SATELLITE TRANSMISSION SERVICES; SENDING OF TELEGRAMS; TELECOMMUNICATION ROUTING AND JUNCTION SERVICES; TELECONFERENCING SERVICES; TELEGRAPH SERVICES; TELEPHONE SERVICES; TELEVISION BROADCASTING; TELEVISION BROADCASTING SERVICES PROVIDED ON-LINE FROM A COMPUTER NETWORK; SERVICES OF A COMMUNICATIONS SYSTEM CONSISTING OF TELETYPEWRITERS CONNECTED TO A TELEPHONIC NETWORK TO SEND AND RECEIVE SIGNALS; TRANSMISSION OF TELEGRAMS; VIDEO ON DEMAND TRANSMISSION SERVICES; WIRE SERVICE; PROVIDING ON-LINE ELECTRONIC BULLETIN BOARDS FOR TRANSMISSION OF MESSAGES AMONG COMPUTER USERS CONCERNING VIDEO GAMES; PROVIDING ACCESS TO ELECTRONIC BULLETIN BOARDS VIA TELECOMMUNICATIONS NETWORKS; ELECTRONIC MAIL SERVICES (U.S. CLS. 100, 101 AND 104).

CLASS 41—EDUCATION AND ENTERTAINMENT

FOR AMUSEMENT PARKS; AMUSEMENTS, NAMELY, PROVIDING FACILITIES FOR A HAUNTED HOUSE ATTRACTION; ANIMAL TRAINING; ARRANGING AND CONDUCTING OF COLLOQUIUMS IN THE FIELD OF COMPUTER AND VIDEO GAMES; ARRANGING AND CONDUCTING OF EDUCATIONAL CONFERENCES IN THE FIELD OF COMPUTER AND VIDEO GAMES; ARRANGING AND CONDUCTING OF CONGRESSES IN THE FIELD OF COMPUTER AND VIDEO GAMES; ARRANGING AND CONDUCTING OF SEMINARS IN THE FIELD OF COMPUTER AND VIDEO GAMES; ARRANGING AND CONDUCTING OF SYMPOSIUMS IN THE FIELD OF COMPUTER AND VIDEO GAMES; ARRANGING OF BEAUTY CONTESTS; BOARDING SCHOOLS; BOOKING OF SEATS FOR SHOWS; BOOKMOBILE SERVICES; CIRCUSES; EDUCATION IN THE FIELD OF COMPUTER, MUSIC, AND VIDEO GAMES RENDERED THROUGH CORRESPONDENCE COURSES; DISCOTHEQUE SERVICES, NAMELY, OPERATING DISCOTHEQUES; DUBBING; PROVIDING INFORMATION ABOUT EDUCATION; EDUCATIONAL EXAMINATION SERVICES; EDUCATIONAL SERVICES, NAMELY, CONDUCTING ON-LINE EXHIBITIONS AND DISPLAYS AND INTERACTIVE EXHIBITS IN THE FIELD OF VIDEO GAME; ENTER-

TAINMENT SERVICES, NAMELY, PROVIDING ON-LINE COMPUTER GAMES; PROVIDING INFORMATION ABOUT ENTERTAINMENT; FILM PRODUCTION; GYMNASIAC INSTRUCTION; HEALTH CLUB SERVICES, NAMELY, PROVIDING EQUIPMENT AND INSTRUCTION IN THE FIELD OF PHYSICAL FITNESS; PROVIDING FITNESS AND EXERCISE FACILITIES, GOLF COURSES, TENNIS COURTS, HORSEBACK RIDING FACILITIES, COURSES OF INSTRUCTION AT THE KINDERGARTEN LEVEL, CINEMA THEATRE FACILITIES, DISCOTHEQUES, MUSEUMS; LENDING LIBRARIES; MOBILE LIBRARY SERVICES; MODELING FOR ARTISTS; MOVIE STUDIOS; MUSIC-HALLS; NURSERY SCHOOLS; OPERATING LOTTERIES; ORCHESTRA SERVICES; ORGANIZATION OF BALLS; ORGANIZATION OF EXHIBITIONS FOR CULTURAL OR EDUCATIONAL PURPOSES; ORGANIZATION OF SPORTS COMPETITIONS; PHYSICAL EDUCATION; PRODUCTION OF RADIO AND TELEVISION PROGRAMS; PRODUCTION OF TELEVISION SHOWS; PROVIDING AMUSEMENT ARCADE SERVICES; PROVIDING SPORTS FACILITIES; PUBLICATION OF BOOKS, PUBLICATION OF ELECTRONIC BOOKS AND JOURNALS ON-LINE FROM A COMPUTER NETWORK; RADIO ENTERTAINMENT, NAMELY, PRODUCTION OF RADIO PROGRAMS; RECORDING STUDIO SERVICES; PROVIDING INFORMATION ON RECREATIONAL ACTIVITIES, NAMELY, FESTIVALS, FAIRS, CONCERTS, WATER PARKS, THEME PARKS, AND LOCATIONS FOR BOATING, FISHING, CANOEING, SNORKELING, SWIMMING, WATER SKIING, SNOW SKIING, SNOWBOARDING, ICE SKATING, SNOWSHOEING, AND SLEDDING; RENTAL OF AUDIO EQUIPMENT; RENTAL OF CAMCORDERS; RENTAL OF CINE-FILMS; RENTAL OF LIGHTING APPARATUS FOR THEATRICAL SETS OR TELEVISION STUDIOS; RENTAL OF MOTION PICTURES; RENTAL OF MOVIE PROJECTORS AND ACCESSORIES; RENTAL OF RADIO AND TELEVISION SETS; RENTAL OF SHOW SCENERY; RENTAL OF SKIN DIVING EQUIPMENT; RENTAL OF SOUND RECORDINGS; RENTAL OF STADIUM FACILITIES; RENTAL OF STAGE SCENERY; RENTAL OF TENNIS COURTS; RENTAL OF VIDEO CAMERAS; RENTAL OF VIDEO CASSETTE RECORDERS; RENTAL OF VIDEOTAPES; SCRIPTWRITING SERVICES; SPORT CAMP SERVICES; TEACHING IN THE FIELD OF MUSIC, VIDEO GAMES; ENTERTAINMENT, NAMELY, TELEVISION PROGRAMS IN THE FIELD OF NEWS, VARIETY SHOWS, MUSIC AND MOVIE; ENTERTAINMENT IN THE NATURE OF THEATRE PRODUCTIONS; TIMING OF SPORTS EVENTS; TUITION SERVICES, NAMELY, PROVIDING INSTRUCTIONAL CLASSES IN THE FIELD OF INFORMATION TECHNOLOGY; EDUCATION SERVICES, NAMELY, PROVIDING CLASSES, SEMINARS, WORKSHOPS IN THE FIELD OF TUITION VIDEO TAPE EDITING; VIDEO TAPE FILM PRODUCTION; ZOOLOGICAL GARDENS; PROVIDING INFORMATION ONLINE ABOUT COMPUTER GAMES AND COMPUTER GAME PROGRAMS; PUBLICATION SERVICES, NAMELY, MAKING MANUALS FOR VIDEO GAME PROGRAMS FOR VIDEO GAME MACHINES WITH TELEVISIONS FOR PERSONAL USE; RENTAL AND LEASING OF MAGNETIC TAPES ENCODED WITH SYSTEM PROGRAMS FOR VIDEO GAME MACHINES WITH TELEVISIONS FOR COMPUTER SYSTEM SECURITY (U.S. CLS. 100, 101 AND 107).

CLASS 42—SCIENTIFIC AND COMPUTER SERVICES

FOR ENCRYPTION OF INFORMATION AVAILABLE ON A COMPUTER; PLANNING, DEVELOPING AND MAINTAINING COMPUTER SYSTEM PROGRAMS FOR OTHERS FOR DATA SECURITY AVAILABLE ON A COMPUTER; ENCRYPTION OF COMPUTER DATA IN RELATION TO ELECTRONICALLY TRANSMITTED INFORMATION ON A GLOBAL COMMUNICATION NETWORK; PROVIDING ELECTRONIC VERIFICATION OF ONLINE ORDERS OF DIGITAL CONTENT AND GENERATING ELECTRONIC PERMISSION CODES WHICH THEN ALLOW USERS TO ACCESS SAID DIGITAL CONTENT ONLINE; CONDUCTING COMPUTER SEARCHES OF DATABASES ABOUT NEWS ARTICLES FOR OTHERS; COMPUTER AIDED GRAPHIC DESIGN; DESIGNING AND DEVELOPING COMPUTER GRAPHICS PROGRAMS FOR OTHERS; ESTABLISHING AND MANAGING INTERNET WEB SITES FOR OTHERS; ESTABLISHING AND MAINTAINING INTER-

NET WEBSITES FOR OTHERS; PREPARATION OF TECHNICAL CALCULATIONS BY COMPUTER FOR OTHERS IN THE FIELD OF COMPUTER PROGRAMMING; COMPUTER SERVICES, NAMELY, MAINTAINING AND MANAGING ELECTRONIC MAIL SERVERS FOR OTHERS; CONVERSION OF DATA OR DOCUMENTS FROM PHYSICAL TO ELECTRONIC MEDIA; DATA CONVERSION OF COMPUTER PROGRAMS AND DATA, NOT PHYSICAL CONVERSION; PROFESSIONAL CONSULTANCY REGARDING THE SELECTION OF COMPUTER SYSTEMS; PROFESSIONAL CONSULTANCY REGARDING DESIGNING COMPUTER SYSTEMS; DEVELOPING COMPUTER SYSTEMS FOR OTHERS; DEVELOPING SOFTWARE FOR VIDEO GAME MACHINES; PROVIDING ELECTRONIC VERIFICATION OF ON-LINE USERS OF ELECTRONIC MAIL AND WEB PAGE AND GENERATING ELECTRONIC PERMISSION CODES WHICH THEN ALLOW USERS TO ACCESS SAID DIGITAL CONTENT; DESIGNING PROGRAMS FOR OTHERS FOR VIDEO GAME MACHINES WITH TELEVISION FOR PERSONAL USE; PROVIDING INFORMATION ABOUT COMPUTER PROGRAMS AND COMPUTERS; WRITING TECHNICAL MANUALS FOR OTHERS FOR USE WITH COMPUTER PROGRAMS AND COMPUTERS, COMPUTER PROFESSIONAL CONSULTANCY REGARDING CREATION, PROCESSING, AND PROVIDING DATA THROUGH USE OF A COMPUTER; DESIGNING AND MAINTAINING INFORMATION PROCESSING SYSTEMS BY A COMPUTER; COMPUTER SOFTWARE DEVELOPMENT AND CUSTOMIZATION; DESIGNING COMPUTER NETWORKS FOR OTHERS; PROFESSIONAL CONSULTANCY REGARDING DESIGNING AND STUDYING COMPUTER NETWORKS; RENTAL AND LEASING OF MAGNETIC TAPES ENCODED WITH COMPUTER PROGRAMS FOR MAINTAINING COMPUTER SYSTEM SECURITY; LEASING OF SERVERS FOR WEB PAGES; RENTAL AND LEASING OF COMPUTERS AND COMPUTER PROGRAMS; HOURLY RENTAL AND LEASING OF COMPUTERS VIA ON-LINE NETWORK; COMPUTER SERVICES, NAMELY, DESIGNING, IMPLEMENTING, TESTING, AND ANALYZING SECURITY, AUTHORIZATION, AUTHENTICATION, AND ENCRYPTION SYSTEMS TO PROVIDE SECURE ACCESS TO COMPUTER SOFTWARE, COMPUTER HARDWARE, AND COMPUTER NETWORKS (U.S. CLS. 100 AND 101).

CLASS 43—HOTEL AND RESTAURANT SERVICES

FOR PROVIDING TEMPORARY ACCOMMODATION; ACCOMMODATION BUREAU, NAMELY, BROKERING RESERVATIONS FOR HOTELS AND BOARDING HOUSES; PROVIDING TEA, COFFEE, COCOA, CARBONATED DRINKS OR FRUIT JUICE BEVERAGES, IN A SETTING WHICH INCLUDES PERMITTING CUSTOMERS TO PLAY GAMES ON INSTALLED VIDEO GAME MACHINES WHILE CONSUMING THEIR BEVERAGES; PROVIDING FOOD AND BEVERAGES IN A SETTING WHICH INCLUDES PERMITTING CUSTOMERS TO USE EQUIPMENT WHICH ENABLES ACCESS TO THE INTERNET; PROVIDING UDON AND SOBA, JAPANESE NOODLES; PROVIDING COOKED EELS; PROVIDING SUSHI; PROVIDING TEMPURA; PROVIDING PORK CUTLETS; PROVIDING ITALIAN CUISINE; PROVIDING SPANISH CUISINE; PROVIDING FRENCH CUISINE; PROVIDING RUSSIAN CUISINE; PROVIDING INDIAN CUISINE; PROVIDING KWANGTUNG STYLE CHINESE CUISINE; PROVIDING SICHUAN STYLE CHINESE CUISINE; PROVIDING SHANGHAI STYLE CHINESE CUISINE; PROVIDING BEIJING STYLE CHINESE CUISINE; PROVIDING ALCOHOLIC BEVERAGES; PROVIDING CAFE SERVICES FEATURING TEA, COFFEE, COCOA, CARBONATED DRINKS AND FRUIT JUICE BEVERAGES; PROVIDING OF FOODS AND BEVERAGES; BOARDING FOR ANIMALS; PRESCHOOLER AND INFANT CARE AT DAYCARE CENTERS; CARING OF ELDERLY, NAMELY, RETIREMENT HOMES COMMUNITY PROVIDING CONTINUING CARE SERVICES IN THE NATURE OF ELDER CARE; RENTAL OF MEETING ROOMS; PROVIDING FACILITIES FOR EXHIBITIONS; RENTAL OF FUTON AND QUILTS; RENTAL OF COOKING EQUIPMENT FOR INDUSTRIAL PURPOSES; RENTAL OF NON-ELECTRIC COOKING HEATERS; RENTAL OF KITCHEN WORKTOPS; RENTAL OF SINKS; RENTAL OF CURTAINS; RENTAL OF FURNITURE; RENTAL OF WALL HANGINGS; RENTAL OF FLOOR COVERINGS (U.S. CLS. 100 AND 101).

ALYSSA STEEL, EXAMINING ATTORNEY

SN 77-312,933. FONDATION ONE DROP, MONTREAL, QUEBEC, CANADA, FILED 10-25-2007.



PRIORITY CLAIMED UNDER SEC. 44(D) ON CANADA APPLICATION NO. 1368930, FILED 10-24-2007, REG. NO. TMA821,672, DATED 4-5-2012, EXPIRES 4-5-2027.

THE STIPPLING IS A FEATURE OF THE MARK.

THE MARK CONSISTS OF A STYLIZED NUMERAL "1" WITH A WATER DROP AT THE LOWER RIGHT SIDE AND THE WORDS "ONE DROP" AT THE UPPER RIGHT SIDE.

CLASS 14—JEWELRY

FOR FINE AND COSTUME JEWELRY, NAMELY, JEWELRY PINS, BROOCHES, EARRINGS, BRACELETS, NECKLACES, RINGS, CHARMS, TIE CLIPS, ORNAMENTAL PINS; KEY RINGS MADE OF PRECIOUS METAL, KEY CHAINS AND SCULPTURES MADE OF PRECIOUS METAL; CLOCKS AND WATCHES (U.S. CLS. 2, 27, 28 AND 50).

CLASS 25—CLOTHING

FOR CLOTHING, WEARING APPAREL AND ACCESSORIES, NAMELY, SHIRTS, SWEATSHIRTS, T-SHIRTS, JERSEYS, SWEATERS, TANKS TOPS, PANTS, SWEAT PANTS, SHORTS, BOXER SHORTS, BATHROBES, NIGHT SHIRTS, PAJAMAS, COATS, JACKETS, WIND-RESISTANT JACKETS, VESTS, DRESSES, SKIRTS, BLOUSES, ROMPERS, SWIMWEAR; RAINWEAR, NAMELY, RAINCOATS, RAIN BONNETS, RAIN BOOTS AND RAIN CAPES; TIES, ASCOTS, BELTS, SCARVES, FOOTWEAR, NAMELY, SHOES, BOOTS AND SOCKS; HEADGEAR, NAMELY, HATS, CAPS AND BEANIES; APRONS; MASQUERADE COSTUMES (U.S. CLS. 22 AND 39).

CLASS 35—ADVERTISING AND BUSINESS

FOR BUSINESS MANAGEMENT, PLANNING, AND DEVELOPMENT OF HUMANITARIAN PROJECTS FOR IMPROVING QUALITY OF LIFE AND LIVING CONDITIONS OF UNDERPRIVILEGED POPULATIONS (U.S. CLS. 100, 101 AND 102).

CLASS 36—INSURANCE AND FINANCIAL

FOR BUSINESS MANAGEMENT, PLANNING, AND DEVELOPMENT OF HUMANITARIAN PROJECTS FOR IMPROVING QUALITY OF LIFE AND LIVING CONDITIONS OF UNDERPRIVILEGED POPULATIONS (U.S. CLS. 100, 101 AND 102).

MIDGE BUTLER, EXAMINING ATTORNEY

SN 77-486,572. GLG LIFE TECH CORPORATION, VANCOUVER, CANADA, FILED 5-29-2008.

REBPURE

THE MARK CONSISTS OF STANDARD CHARACTERS WITHOUT CLAIM TO ANY PARTICULAR FONT, STYLE, SIZE, OR COLOR.

PRIORITY CLAIMED UNDER SEC. 44(D) ON CANADA APPLICATION NO. 1381516, FILED 1-31-2008, REG. NO. TMA792161, DATED 3-4-2011, EXPIRES 3-4-2026.

CLASS 1—CHEMICALS

FOR ARTIFICIAL SWEETENERS; LOW CALORIE ARTIFICIAL SWEETENERS; ARTIFICIAL SWEETENERS FOR USE IN THE MANUFACTURE AND PROCESSING OF FOOD, BEVERAGES, AND PHARMACEUTICALS (U.S. CLS. 1, 5, 6, 10, 26 AND 46).

CLASS 30—STAPLE FOODS

FOR LOW CALORIE SUGAR SUBSTITUTE; NATURAL SWEETENERS; LOW CALORIE NATURAL SWEETENERS; SUGAR SUBSTITUTE; LOW CALORIE SUGAR SUBSTITUTE; NATURAL SWEETENERS FOR USE IN THE MANUFACTURE AND PROCESSING OF FOOD, BEVERAGES AND PHARMACEUTICALS (U.S. CL. 46).
KRISTIN DAHLING, EXAMINING ATTORNEY

SN 77-491,762. PEI MEDIA LIMITED, LONDON, UNITED KINGDOM, FILED 6-5-2008.

PRIVATE EQUITY INTERNATIONAL

THE MARK CONSISTS OF STANDARD CHARACTERS WITHOUT CLAIM TO ANY PARTICULAR FONT, STYLE, SIZE, OR COLOR.

PRIORITY CLAIMED UNDER SEC. 44(D) ON ERPNCMNTY TM OFC APPLICATION NO. CTM6508154, FILED 12-12-2007, REG. NO. 006508154, DATED 7-10-2009, EXPIRES 12-12-2017.

NO CLAIM IS MADE TO THE EXCLUSIVE RIGHT TO USE "PRIVATE EQUITY", APART FROM THE MARK AS SHOWN.

SEC. 2(F).

CLASS 9—ELECTRICAL AND SCIENTIFIC APPARATUS

FOR (BASED ON 44(E)) ELECTRONIC PUBLICATIONS IN THE NATURE OF BOOKS, MAGAZINES, NEWSLETTERS, DIRECTORIES, PAMPHLETS, E-ZINES AND REPORTS IN THE FIELDS OF MARKET STUDIES, MARKET RESEARCH, ASSET SALE AND PURCHASE, FINANCIAL SERVICES, INVESTMENTS, STOCKS AND SHARES; CD-ROMS FEATURING DATA IN THE FIELDS OF MARKET STUDIES, MARKET RESEARCH, ASSET SALE AND PURCHASE, FINANCIAL SERVICES, INVESTMENTS, STOCKS AND SHARES; CDS, CDROMS, CDIS, DVDS, AND MACHINE READABLE PRE-RECORDED DIGITAL MEDIA FEATURING MAGAZINES AND REPORTS RELATING TO MARKET STUDIES, MARKET RESEARCH, ASSET SALE AND PURCHASE, FINANCIAL SERVICES, INVESTMENTS, STOCKS AND SHARES; INSTRUCTION MANUALS FOR THE FOREGOING RECORDED ON CD-ROM AND DOWNLOADABLE COMPUTER SOFTWARE FEATURING INSTRUCTION MANUALS FOR EACH OF THE FOREGOING (U.S. CLS. 21, 23, 26, 36 AND 38).

CLASS 16—PAPER GOODS AND PRINTED MATTER

FOR (BASED ON 44(E)) PRINTED MATTER AND PUBLICATIONS, NAMELY, BOOKS, MAGAZINES, NEWSLETTERS, DIRECTORIES, PAMPHLETS, GUIDES AND REPORTS IN THE FIELDS OF MARKET STUDIES, MARKET RESEARCH, ASSET SALE AND PURCHASE, FINANCIAL SERVICES, INVESTMENTS, STOCKS AND SHARES; PRINTED INSTRUCTIONAL AND TEACHING MATERIALS IN THE FIELDS OF MARKET STUDIES, MARKET RESEARCH, ASSET SALE AND PURCHASE, FINANCIAL SERVICES, INVESTMENTS, STOCKS AND SHARES; DRAWINGS; ILLUSTRATIONS IN THE NATURE OF ART PRINTS AND POSTERS (U.S. CLS. 2, 5, 22, 23, 29, 37, 38 AND 50).

CLASS 36—INSURANCE AND FINANCIAL

FOR (BASED ON USE IN COMMERCE) ELECTRONIC DATA BANKS, NAMELY, PROVIDING ONLINE FINANCIAL INFORMATION ABOUT INVESTMENTS, STOCKS AND SHARES; PROVIDING INTERACTIVE DATABASES FEATURING FINANCIAL INFORMATION ABOUT INVESTMENTS, STOCKS AND SHARES (U.S. CLS. 100, 101 AND 102).

FIRST USE 12-31-2001; IN COMMERCE 12-31-2001.

CLASS 41—EDUCATION AND ENTERTAINMENT

FOR (BASED ON USE IN COMMERCE) ELECTRONIC NON-DOWNLOADABLE PUBLICATIONS IN THE NATURE OF BOOKS, MAGAZINES, NEWSLETTERS, DIRECTORIES, PAMPHLETS, E-ZINES AND REPORTS IN THE FIELDS OF MARKET STUDIES, MARKET RESEARCH, ASSET SALE AND PURCHASE, FINANCIAL SERVICES, INVESTMENTS, STOCKS AND SHARES (U.S. CLS. 100, 101 AND 107).

FIRST USE 12-31-2001; IN COMMERCE 12-31-2001.
BRENDAN MCCAULEY, EXAMINING ATTORNEY

SN 77-533,074. INQ ENTERPRISES LIMITED, NASSAU, NEW PROVIDENCE, BAHAMAS, FILED 7-28-2008.

THE MARK CONSISTS OF THE LETTERS "INQ" IN STYLIZED LETTERS WITH THE LETTER "Q" APPEARING WITH A CIRCLE WITHIN THE LETTER.

CLASS 9—ELECTRICAL AND SCIENTIFIC APPARATUS

FOR MOBILE TELEPHONES; MOBILE INTERNET DEVICES, NAMELY, MOBILE TELEPHONES, COMPUTERS, COMPUTER TABLETS, PERSONAL DIGITAL ASSISTANTS WITH INTERNET CONNECTING CAPABILITY; ELECTRONIC MEMORY CARDS; MOBILE NETWORK CREDIT TOP-UP CARDS, NAMELY, CREDIT OR DEBIT CARDS WITH A UNIQUE CODE THROUGH WHICH, ONCE VERIFIED THROUGH THE MOBILE NETWORK PROVIDER, CONSUMERS CAN REDEEM PRE-PAID CREDIT FOR A MOBILE SERVICE ACCOUNT; STANDS FOR TELEPHONES; TELEPHONE EARPIECES; CASES FOR MOBILE DEVICES (U.S. CLS. 21, 23, 26, 36 AND 38).

CLASS 16—PAPER GOODS AND PRINTED MATTER

FOR PRINTED MATTER, NAMELY, PRINTED GUIDES FOR MARKETING, ADVERTISING AND SELLING MOBILE TELEPHONE AND MOBILE INTERNET DEVICES, MOBILE TELEPHONE AND DATA NETWORK SERVICES, AND MOBILE TELEPHONE AND DATA NETWORK APPLICATIONS; PRINTED INSTRUCTIONAL AND TEACHING MATERIALS, IN THE FIELD OF MOBILE TELEPHONES, MOBILE INTERNET DEVICES, MOBILE TELEPHONE SERVICES, DATA NETWORK SERVICES, MOBILE TELEPHONE APPLICATIONS AND DATA NETWORK APPLICATIONS (U.S. CLS. 2, 5, 22, 23, 29, 37, 38 AND 50).

CLASS 35—ADVERTISING AND BUSINESS

FOR RETAIL STORE SERVICES FEATURING MOBILE TELEPHONE AND MOBILE INTERNET DEVICES; ON-LINE RETAIL STORE SERVICES FEATURING MOBILE TELEPHONE AND MOBILE INTERNET DEVICES; PROVISION OF INFORMATION AND ADVICE RELATING TO ALL THE AFORESAID SERVICES (U.S. CLS. 100, 101 AND 102).

CLASS 38—COMMUNICATION

FOR TELECOMMUNICATIONS SERVICES, NAMELY, MOBILE TELEPHONE SERVICES AND MOBILE INTERNET SERVICES; PROVISION OF AN ELECTRONIC TOP-UP CREDIT SYSTEM FOR MOBILE TELECOMMUNICATIONS SERVICES, NAMELY, AN ON-LINE SYSTEM TO ISSUE A UNIQUE CODE OR TO ISSUE A CARD WITH A UNIQUE PRE-PRINTED CODE, EACH OF WHICH CONSUMERS CAN REDEEM PRE-PAID CREDIT FOR A MOBILE SERVICE ACCOUNT, ONCE VERIFIED BY THE PHONE NETWORK PROVIDER; ELECTRONIC MAIL SERVICES; PROVIDING USER ACCESS TO THE INTERNET; PROVIDING TELECOMMUNICATIONS CONNECTIONS TO THE INTERNET OR DATABASES; PROVIDING ONLINE INTERACTIVE BULLETIN BOARDS FOR TRANSMISSION OF MESSAGES AMONG USERS IN THE FIELD OF GENERAL INTEREST; PROVISION OF INFORMATION AND ADVICE RELATING TO THE FOREGOING (U.S. CLS. 100, 101 AND 104).

CLASS 40—MATERIAL TREATMENT

FOR MANUFACTURE OF TELECOMMUNICATIONS APPARATUS ALL TO THE ORDER AND OR SPECIFICATION OF OTHERS; PROVISION OF INFORMATION AND ADVICE RELATING TO THE AFORESAID SERVICES (U.S. CLS. 100, 103 AND 106).

CLASS 42—SCIENTIFIC AND COMPUTER SERVICES

FOR DESIGN CONSULTANCY SERVICES IN THE FIELD OF MOBILE TELEPHONES AND MOBILE INTERNET DEVICES; DESIGN OF TELECOMMUNICATIONS APPARATUS, MOBILE TELEPHONE HANDSETS AND ACCESSORIES FOR MOBILE TELEPHONE HANDSETS (U.S. CLS. 100 AND 101).

BRENDAN MCCAULEY, EXAMINING ATTORNEY

SN 77-551,747. OLIVER SCHROTT KOMMUNIKATION GMBH, 50668 KÖLN, FED REP GERMANY, FILED 8-20-2008.

PRIORITY CLAIMED UNDER SEC. 44(D) ON ERP N CMNTY TM OFC APPLICATION NO. 007112551, FILED 7-30-2008, REG. NO. 007112551, DATED 5-25-2009, EXPIRES 7-30-2018.

NO CLAIM IS MADE TO THE EXCLUSIVE RIGHT TO USE "BRAND RELEVANCE", APART FROM THE MARK AS SHOWN.

THE COLOR(S) LIGHT BLUE, DARK BLUE, WHITE AND BLACK IS/ARE CLAIMED AS A FEATURE OF THE MARK.

THE MARK CONSISTS OF THE WHITE LETTER "B" ON A DARK BLUE BACKGROUND, THE WHITE LETTER "R" ON A LIGHT BLUE BACKGROUND AND THE WORDS "BRAND RELEVANCE" IN BLACK.

CLASS 16—PAPER GOODS AND PRINTED MATTER

FOR GOODS OF PAPER AND CARDBOARD, NAMELY, SIGNBOARDS, NAME BADGES, BANNERS, BOOKMARKS, PRINTED POINT OF SALE INFORMATION DISPLAYS IN THE NATURE OF POSTERS AND SIGNBOARDS, EVENT DECORATIONS IN THE NATURE OF PAPER RIBBONS AND DECORATIVE PAPER CENTERPIECES, AND FOLDERS; PRINTED GOODS, NAMELY, PROMOTIONAL FLYERS FEATURING INFORMATION ABOUT THE GOODS AND SERVICES OF OTHERS, PRESS KITS FEATURING INFORMATION ABOUT THE GOODS AND SERVICES OF OTHERS CONSISTING OF BROCHURES, FLYERS, AND PRESS RELEASES, BROCHURES FEATURING INFORMATION ABOUT THE GOODS AND SERVICES OF OTHERS, INVITATIONS, POSTERS FEATURING INFORMATION ABOUT THE GOODS AND SERVICES OF OTHERS, ADVERTISING MATERIAL FEATURING INFORMATION ABOUT THE GOODS AND SERVICES OF OTHERS, NAMELY, NEWSLETTERS, BROCHURES, CATALOGUES, FLYERS AND FACT SHEETS, AGENDAS, EVENT PROGRAMS; POSTERS, CALENDARS, CATALOGS FEATURING MERCHANDISE OF OTHERS, PHOTOGRAPHS; NONE OF THE FOREGOING IN THE FIELDS OF REAL ESTATE SALES, REAL ESTATE BROKERAGE, REAL ESTATE APPRAISAL, MORTGAGE BROKERING, MORTGAGE LENDING, NURSING, EMPLOYEE BENEFITS ISSUES OR RELATING IN ANY WAY TO EMPLOYEE BENEFITS (U.S. CLS. 2, 5, 22, 23, 29, 37, 38 AND 50).

CLASS 35—ADVERTISING AND BUSINESS

FOR ADVERTISING, SALES PROMOTION AND PRODUCT MERCHANDISING, PUBLIC RELATIONS, MARKETING, CONSULTING SERVICES IN THE FIELDS OF MARKETING AND COMMUNICATIONS RELATING TO THE AUTOMOTIVE INDUSTRY, TO THE TRANSPORTATION AND LOGISTICS INDUSTRIES, TO TECHNOLOGY AND INDUSTRIAL GOODS, TO ENVIRONMENTAL GOODS AND SERVICES, TO CONSUMER PRODUCTS AND ELECTRONICS, AND TO LUXURY AND LIFESTYLE PRODUCTS; BUSINESS CONSULTING SERVICES IN THE FIELD OF COMMUNICATIONS; EVENT SERVICES FOR OTHERS, NAMELY, ORGANIZATION OF EVENTS, EXHIBITIONS, FAIRS AND SHOWS FOR COMMERCIAL, PROMOTIONAL AND ADVERTISING PURPOSES; DISSEMINATION OF ADVERTISING FOR OTHERS VIA THE INTERNET; ORGANIZATION OF EXHIBITIONS FOR COMMERCIAL AND ADVERTISING PURPOSES; BUSINESS MANAGEMENT CONSULTING; ORGANIZATION OF BUSINESS CONVENTIONS; NONE OF THE FOREGOING IN ANY MANNER RELATING TO EMPLOYEE BENEFITS ISSUES AND ALSO EXCLUDING THE FIELD OF DIRECT MARKETING FOR OTHERS IN THE FIELD OF CRUDE OIL AND NATURAL GAS (U.S. CLS. 100, 101 AND 102).

CLASS 41—EDUCATION AND ENTERTAINMENT

FOR PRODUCTION OF TELEVISION AND RADIO SHOWS, FILM PRODUCTION; VIDEO PRODUCTION; ORGANIZATION AND REALIZATION OF EDUCATIONAL SEMINARS AND CONVENTIONS IN THE FIELD OF PUBLIC RELATIONS, INFORMATION MANAGEMENT AND MARKETING; ARRANGING AND CONDUCTING SPECIAL EVENTS AND EXHIBITIONS FOR EDUCATIONAL PURPOSES, NAMELY, ARRANGING AND CONDUCTING EXHIBITS IN THE FIELDS OF PUBLIC RELATIONS, MARKETING, AND THE PRESENTATION AND DISPLAY OF PRODUCTS AND GOODS FOR OTHERS; EVENT SERVICES FOR OTHERS, NAMELY, BOOKING OF VENUES, ARTISTS, AND ENTERTAINERS, ALL FOR COMMERCIAL, PROMOTIONAL AND ADVERTISING PURPOSES (U.S. CLS. 100, 101 AND 107).

CLASS 42—SCIENTIFIC AND COMPUTER SERVICES

FOR ADVISING OTHERS CONCERNING THE DESIGN OF HOMEPAGES AND INTERNET SITES; DESIGN AND CREATION OF INTERNET SITES FOR THIRD PARTIES (U.S. CLS. 100 AND 101).

KRISTINA MORRIS, EXAMINING ATTORNEY

SN 77-665,048. THE MOG, INC., GRAND ISLAND, NY. FILED 2-6-2009.

M.O.G.
Medically Oriented Gym

THE MARK CONSISTS OF STANDARD CHARACTERS WITHOUT CLAIM TO ANY PARTICULAR FONT, STYLE, SIZE, OR COLOR.

NO CLAIM IS MADE TO THE EXCLUSIVE RIGHT TO USE "MEDICALLY ORIENTED GYM", APART FROM THE MARK AS SHOWN.

CLASS 35—ADVERTISING AND BUSINESS

FOR BUSINESS CONSULTING SERVICES FOR PHYSICAL THERAPY FACILITIES, MEDICAL FACILITIES AND EXERCISE AND FITNESS FACILITIES IN THE FIELD OF BUSINESS OPERATIONS OF SUCH FACILITIES (U.S. CLS. 100, 101 AND 102).

FIRST USE 12-15-2007; IN COMMERCE 12-15-2007.

CLASS 41—EDUCATION AND ENTERTAINMENT

FOR CONSULTING FOR PHYSICAL THERAPY FACILITIES, MEDICAL FACILITIES AND EXERCISE AND FITNESS FACILITIES IN THE FIELD OF PROVIDING EDUCATIONAL PROGRAMS AND INSTRUCTION DESIGNED FOR MEDICALLY COMPROMISED INDIVIDUALS IN EXERCISE, FITNESS, NUTRITION, HEALTH AND WELLNESS; PROVIDING PROGRAMS IN THE NATURE OF CLASSES, WORKSHOPS AND INSTRUCTION SPECIALLY DESIGNED FOR MEDICALLY COMPROMISED ADULTS AND CHILDREN IN THE FIELDS OF EXERCISE, FITNESS, NUTRITION, HEALTH AND WELLNESS (U.S. CLS. 100, 101 AND 107).

FIRST USE 12-15-2007; IN COMMERCE 12-15-2007.

LESLIE RICHARDS, EXAMINING ATTORNEY

SN 77-680,836. BACKBONE ENTERTAINMENT, IRVINE, CA. FILED 2-28-2009.



THE MARK CONSISTS OF A SERIES OF HORIZONTAL LINES PRESENTED IN AN HOURGLASS SHAPE THAT REPRESENTS THE DOUBLE HELIX GEOMETRIC SHAPE OFTEN ASSOCIATED WITH DNA.

CLASS 9—ELECTRICAL AND SCIENTIFIC APPARATUS

FOR COMPUTER GAME CARTRIDGES AND DISCS; COMPUTER GAME SOFTWARE; DOWNLOADABLE DESIGNING GAME VIA THE INTERNET AND WIRELESS DEVICES; ELECTRONIC GAME SOFTWARE FOR HANDHELD ELECTRONIC DEVICES; ELECTRONIC GAME SOFTWARE FOR WIRELESS DEVICES; VIDEO GAME CARTRIDGES AND DISCS (U.S. CLS. 21, 23, 26, 36 AND 38).

FIRST USE 9-30-2008; IN COMMERCE 9-30-2008.

CLASS 42—SCIENTIFIC AND COMPUTER SERVICES

FOR DESIGNING AND DEVELOPING COMPUTER GAME SOFTWARE AND VIDEO GAME SOFTWARE FOR USE WITH COMPUTERS, VIDEO GAME PROGRAM SYSTEMS AND COMPUTER NETWORKS (U.S. CLS. 100 AND 101).

FIRST USE 3-27-2008; IN COMMERCE 3-27-2008.

LINDA LAVACHE, EXAMINING ATTORNEY

SN 77-693,949. FRANK SINATRA ENTERPRISES, LLC,
BURBANK, CA. FILED 3-18-2009.

SINATRA

THE MARK CONSISTS OF STANDARD CHARACTERS WITHOUT CLAIM TO ANY PARTICULAR FONT, STYLE, SIZE, OR COLOR.

PRIORITY CLAIMED UNDER SEC. 44(D) ON ERPN CMNTY TM OFC APPLICATION NO. 7245046, FILED 9-19-2008.

OWNER OF U.S. REG. NOS. 3,201,113, 3,243,889 AND OTHERS.

CLASS 9—ELECTRICAL AND SCIENTIFIC APPARATUS

FOR (BASED ON USE IN COMMERCE) (BASED ON 44(D) PRIORITY APPLICATION) MUSICAL SOUND RECORDINGS; DOWNLOADABLE MUSICAL SOUND RECORDINGS; PRE-RECORDED ELECTRONIC AND DIGITAL MEDIA FEATURING AUDIO RECORDINGS OF MUSIC, MUSICAL ENTERTAINMENT AND PERFORMING ARTISTS; DOWNLOADABLE RING TONES VIA THE INTERNET AND WIRELESS DEVICES; MUSICAL VIDEO RECORDINGS; PRE-RECORDED ELECTRONIC AND DIGITAL MEDIA FEATURING VIDEO AND AUDIOVISUAL RECORDINGS OF MUSIC, MUSICAL ENTERTAINMENT, AND PERFORMING ARTISTS (U.S. CLS. 21, 23, 26, 36 AND 38).

FIRST USE 0-0-1943; IN COMMERCE 0-0-1943.

CLASS 14—JEWELRY

FOR (BASED ON USE IN COMMERCE) WATCHES (U.S. CLS. 2, 27, 28 AND 50).

FIRST USE 7-0-2004; IN COMMERCE 7-0-2004.

CLASS 16—PAPER GOODS AND PRINTED MATTER

FOR (BASED ON USE IN COMMERCE) (BASED ON 44(D) PRIORITY APPLICATION) PHOTOGRAPHS; ART PRINTS; LITHOGRAPHIC WORKS OF ART; PRINTED ART REPRODUCTIONS; COFFEE TABLE BOOKS FEATURING ENTERTAINMENT AND LIFESTYLE; SONG BOOKS; PLASTIC CUSHIONING MATERIAL THAT CONTAINS ENCAPSULATED AIR CELLS FOR WRAPPING OR PACKAGING; PAPER MAIL POUCHES; CALENDARS (U.S. CLS. 2, 5, 22, 23, 29, 37, 38 AND 50).

FIRST USE 9-0-1999; IN COMMERCE 9-0-1999.

CLASS 28—TOYS AND SPORTING GOODS

FOR (BASED ON USE IN COMMERCE) (BASED ON 44(D) PRIORITY APPLICATION) DECORATIONS FOR CHRISTMAS TREES; CHRISTMAS TREE ORNAMENTS (U.S. CLS. 22, 23, 38 AND 50).

FIRST USE 10-0-1999; IN COMMERCE 10-0-1999.

CLASS 35—ADVERTISING AND BUSINESS

FOR (BASED ON USE IN COMMERCE) (BASED ON 44(D) PRIORITY APPLICATION) ON-LINE RETAIL STORE SERVICES FEATURING MUSICAL SOUND RECORDINGS, VIDEO RECORDINGS, DOWNLOADABLE PRE-RECORDED MUSIC, PRE-RECORDED ELECTRONIC AND DIGITAL MEDIA FEATURING AUDIO, VIDEO AND AUDIOVISUAL RECORDINGS OF MUSIC, MUSICAL ENTERTAINMENT, PERFORMING ARTISTS, MUSICAL MOTION PICTURES AND DRAMATIC MOTION PICTURES, BOOKS, CLOTHING, BAGS, SPORTING GOODS, AND GIFTS (U.S. CLS. 100, 101 AND 102).

FIRST USE 10-0-2006; IN COMMERCE 10-0-2006.

CLASS 41—EDUCATION AND ENTERTAINMENT

FOR (BASED ON USE IN COMMERCE) (BASED ON 44(D) PRIORITY APPLICATION) PROVISION OF ENTERTAINMENT INFORMATION RELATING TO ENTERTAINMENT AND CULTURAL EVENTS AND ACTIVITIES, VIA THE INTERNET OR OTHER COMMUNICATIONS NETWORKS; PROVIDING ONLINE ENTERTAINMENT INFORMATION IN THE FIELD OF MUSIC, ENTERTAINMENT, AND MUSICAL ARTISTS VIA THE INTERNET; FAN CLUBS; PROVIDING A WEB SITE FEATURING NON-DOWNLOADABLE MUSICAL SOUND RECORDINGS, MUSICAL VIDEOS, RELATED FILM CLIPS, PHOTOGRAPHS AND OTHER ENTERTAINMENT MULTIMEDIA MATERIALS FEATURING MUSIC, MUSICAL ENTERTAINMENT AND PERFORMING ARTISTS, AND NEWS AND INFORMATION ABOUT MUSIC, MUSICAL ENTERTAINMENT, FILM, AND PERFORMING ARTISTS; PROVIDING NEWSLETTERS AND ALERTS, NAMELY, ENTERTAINMENT NEWS AND INFORMATION IN THE FIELD OF MUSIC, ENTERTAINMENT, MUSICAL ARTISTS, AND FILM VIA E-MAIL; GAMING SERVICES IN THE NATURE OF CASINO GAMING AND ONLINE GAMING SERVICES; ENTERTAINMENT SERVICES, NAMELY, PROVIDING ONGOING RADIO PROGRAMS IN THE FIELD OF MUSIC; ARRANGING AND CONDUCTING ENTERTAINMENT EVENTS, NAMELY, MUSICAL EVENTS AND PARTIES; ARRANGING ENTERTAINMENT EVENTS, NAMELY, DANCE EVENTS AND THEATRICAL EVENTS; ORGANIZATION OF GOLF TOURNAMENTS (U.S. CLS. 100, 101 AND 107).

FIRST USE 7-0-2008; IN COMMERCE 7-0-2008.

CLASS 42—SCIENTIFIC AND COMPUTER SERVICES

FOR (BASED ON USE IN COMMERCE) (BASED ON 44(D) PRIORITY APPLICATION) HOSTING AN ONLINE COMMUNITY WEBSITE FOR REGISTERED USERS TO PARTICIPATE IN DISCUSSIONS, GET FEEDBACK FROM THEIR PEERS, FORM VIRTUAL COMMUNITIES, AND ENGAGE IN SOCIAL NETWORKING (U.S. CLS. 100 AND 101).

FIRST USE 7-0-2008; IN COMMERCE 7-0-2008.

CLASS 43—HOTEL AND RESTAURANT SERVICES

FOR (BASED ON USE IN COMMERCE) (BASED ON 44(D) PRIORITY APPLICATION) RESTAURANT SERVICES; BAR SERVICES (U.S. CLS. 100 AND 101).

FIRST USE 12-0-2008; IN COMMERCE 12-0-2008.

DARRYL SPRUILL, EXAMINING ATTORNEY

SN 77-761,556. FUSIONCAST INC., OAKVILLE, ONTARIO, CANADA, FILED 6-17-2009.

FUSIONCAST

THE MARK CONSISTS OF STANDARD CHARACTERS WITHOUT CLAIM TO ANY PARTICULAR FONT, STYLE, SIZE, OR COLOR.

PRIORITY CLAIMED UNDER SEC. 44(D) ON CANADA APPLICATION NO. 1423135, FILED 12-29-2008, REG. NO. TMA797042, DATED 5-10-2011, EXPIRES 5-10-2026.

CLASS 6—METAL GOODS

FOR COMPOSITE CASTINGS MADE PREDOMINANTLY OF METAL AND CONTAINING LESSER AMOUNTS OF NON-METAL MATERIALS FOR USE IN THE MANUFACTURE OF SIGNS, PLAQUES, AND GRAVE MARKERS; NON-LUMINOUS AND NON-MECHANICAL SIGNS, AND WALL PLAQUES AND RECOGNITION PLAQUES ALL OF WHICH ARE CAST PREDOMINANTLY FROM NON-PRECIOUS METALS AND LESSER AMOUNTS OF NON-METAL MATERIALS; AND GRAVE MARKERS CAST PREDOMINANTLY FROM NON-PRECIOUS METAL AND LESSER AMOUNTS OF NON-METAL MATERIALS (U.S. CLS. 2, 12, 13, 14, 23, 25 AND 50).

CLASS 20—FURNITURE AND ARTICLES NOT OTHERWISE CLASSIFIED

FOR COMPOSITE CASTINGS MADE PREDOMINANTLY OF NON-METAL RESINOUS MATERIALS AND CONTAINING LESSER AMOUNTS OF METAL FOR USE IN THE MANUFACTURE OF SIGNS, PLAQUES AND GRAVE MARKERS; NON-LUMINOUS AND NON-MECHANICAL SIGNS CAST PREDOMINANTLY FROM NON-METAL RESINOUS MATERIALS AND LESSER AMOUNTS OF METAL; PLAQUES AND GRAVE MARKERS CAST PREDOMINANTLY FROM NON-METAL RESINOUS MATERIALS WITH LESSER AMOUNTS OF METAL, NAMELY, WALL PLAQUES, RECOGNITION PLAQUES AND GRAVE MARKERS (U.S. CLS. 2, 13, 22, 25, 32 AND 50).

GRETCHEN ULRICH, EXAMINING ATTORNEY

SN 77-782,535. CUSTARD SQUARE LIMITED, AUCKLAND, NEW ZEALAND, FILED 7-16-2009.

DINOSAURUS

THE MARK CONSISTS OF STANDARD CHARACTERS WITHOUT CLAIM TO ANY PARTICULAR FONT, STYLE, SIZE, OR COLOR.

PRIORITY CLAIMED UNDER SEC. 44(D) ON NEW ZEALAND APPLICATION NO. 801444, FILED 1-16-2009, REG. NO. 801444, DATED 1-16-2009, EXPIRES 1-16-2019.

CLASS 9—ELECTRICAL AND SCIENTIFIC APPARATUS

FOR APPARATUS FOR RECORDING, TRANSMISSION OR REPRODUCTION OF SOUND OR IMAGES; AUDIO AND VISUAL RECORDINGS FEATURING AUDIO, MUSIC, TEXT, STILL IMAGES, ANIMATION AND VIDEO; INTERACTIVE AUDIO AND VISUAL RECORDINGS FEATURING AUDIO, MUSIC, TEXT, STILL IMAGES, ANIMATION AND VIDEO AUDIO CASSETTE PLAYERS; AUDIO CASSETTE RECORDERS; AUDIO CASSETTES FEATURING SOUND AND MUSIC; AUDIO DISCS FEATURING SOUND AND MUSIC; AUDIO SPEAKERS; AUTOMATIC VENDING MACHINES AND MECHANISMS FOR COIN-OPERATED APPARATUS; BINOCULARS; CALCULATING MACHINES; CALCULATORS; CAMCORDERS; CAMERAS; PRERECORDED CD-ROMS FEATURING SOUND, MUSIC, TEXT, STILL IMAGES, VIDEO AND ANIMATION; COMPACT DISC PLAYERS; COMPACT DISC RECORDERS; COMPACT DISCS FEATURING AUDIO, MUSIC, TEXT, STILL IMAGES, ANIMATION AND VIDEO; INTERACTIVE COMPACT DISCS FEATURING AUDIO, MUSIC, TEXT, STILL IMAGES, ANIMATION AND VIDEO; COMPUTER DISK DRIVES; COMPUTER GAME CARTRIDGES; COMPUTER GAME DISCS; COMPUTERS; COMPUTER GAME PROGRAMS; COMPUTER HARDWARE; COMPUTER KEYBOARDS; COMPUTER MONITORS; COMPUTER MOUSE; COMPUTER SOFTWARE FOR TRANSMITTING TEXT, IMAGES AND

SOUND IN RELATION TO LEARNING ACTIVITIES, GAMES AND ENTERTAINMENT; DATA PROCESSING EQUIPMENT; DECORATIVE MAGNETS; DIGITAL AUDIO TAPE RECORDERS; DIGITAL CAMERAS; DIGITAL VERSATILE DISCS FEATURING AUDIO, MUSIC, TEXT, STILL IMAGES, ANIMATION AND VIDEO; INTERACTIVE DIGITAL VERSATILE DISCS FEATURING AUDIO, MUSIC, TEXT, STILL IMAGES, ANIMATION AND VIDEO; DIGITAL VIDEO DISCS FEATURING AUDIO, MUSIC, TEXT, STILL IMAGES, ANIMATION AND VIDEO; INTERACTIVE DIGITAL VIDEO DISCS FEATURING AUDIO, MUSIC, TEXT, STILL IMAGES, ANIMATION AND VIDEO DIGITAL VIDEO RECORDERS; DVD PLAYERS; DVD RECORDERS; ELECTRONIC PERSONAL ORGANIZERS; EYEGLASSES AND CASES THEREFOR; HEADPHONES; KARAOKE MACHINES; LASER VIDEO DISCS FEATURING AUDIO, MUSIC, TEXT, STILL IMAGES, ANIMATION AND VIDEO; INTERACTIVE LASER VIDEO DISCS FEATURING AUDIO, MUSIC, TEXT, STILL IMAGES, ANIMATION AND VIDEO; LOUDSPEAKERS; PRE-RECORDED MAGNETIC DATA CARRIERS FEATURING AUDIO, MUSIC, TEXT, STILL IMAGES, ANIMATION AND VIDEO; INTERACTIVE PRE-RECORDED MAGNETIC DATA CARRIERS FEATURING AUDIO, MUSIC, TEXT, STILL IMAGES, ANIMATION AND VIDEO; MICROPHONES; MINIDISC PLAYERS; MINIDISKS FEATURING SOUND, MUSIC, TEXT, STILL IMAGES, ANIMATION AND VIDEO; MOBILE PHONE CASES, STEREO HEADSETS, EXTERNAL SPEAKERS, DOWNLOADABLE RING TONES VIA MOBILE PHONES, MOBILE PHONE ACCESSORIES, NAMELY, COVERS AND FACEPLATES, SOFTWARE FOR DOWNLOADING AND TRANSMITTING SOUND, MUSIC, TEXT, ANIMATION, VIDEO AND IMAGES; DOWNLOADABLE MUSIC VIA MOBILE PHONES; DOWNLOADABLE ELECTRONIC GAME PROGRAMS VIA MOBILE PHONES, HAND-HELD UNITS FOR PLAYING ELECTRONIC GAMES FOR USE WITH EXTERNAL DISPLAY SCREENS OR MONITORS, ELECTRONIC GAME PROGRAMS FEATURING AVATARS, ELECTRONIC GAMES FEATURING VIRTUAL WORLDS, HAND-HELD ELECTRONIC GAMES ADAPTED FOR USE WITH TELEVISION RECEIVERS ONLY, DOWNLOADABLE ELECTRONIC GAME PROGRAMS VIA THE INTERNET, MOBILE TELEPHONES; MOTION PICTURE FILMS ABOUT CULTURAL ARTIFACTS; MOUSE PADS; MP3 PLAYERS; MP3 RECORDERS; PAGERS; PERSONAL DIGITAL ASSISTANTS; PERSONAL STEREO; PHONOGRAPH RECORDS FEATURING MUSIC; PORTABLE TELECOMMUNICATION INSTANT MESSAGING DEVICES; PRINTERS; RADIOS; RECORDING DISCS, NAMELY, PRE-RECORDED COMPACT DISCS FEATURING AUDIO, MUSIC, TEXT, STILL IMAGES, ANIMATION AND VIDEO; INTERACTIVE RECORDING DISCS, NAMELY, PRE-RECORDED COMPACT DISCS FEATURING AUDIO, MUSIC, TEXT, STILL IMAGES, ANIMATION AND VIDEO; SUNGLASSES AND CASES THEREFOR; TELEPHONES; TELEVISIONS; VIDEO CAMERAS; VIDEO CASSETTES FEATURING AUDIO, MUSIC, TEXT, STILL IMAGES, ANIMATION AND VIDEO; INTERACTIVE VIDEO CASSETTES FEATURING AUDIO, MUSIC, TEXT, STILL IMAGES, ANIMATION AND VIDEO; VIDEO DISCS FEATURING AUDIO, MUSIC, TEXT, STILL IMAGES, ANIMATION AND VIDEO; VIDEO GAME CARTRIDGES AND DISCS; VIDEO TAPES FEATURING AUDIO, MUSIC, TEXT, STILL IMAGES, ANIMATION AND VIDEO; INTERACTIVE VIDEO TAPES FEATURING AUDIO, MUSIC, TEXT, STILL IMAGES, ANIMATION AND VIDEO; VIDEO PHONES; WALKIE-TALKIES; WRIST AND ARM SUPPORT PADS FOR USE WITH COMPUTERS; VIDEO GAME SOFTWARE (U.S. CLS. 21, 23, 26, 36 AND 38).

CLASS 16—PAPER GOODS AND PRINTED MATTER

FOR ADDRESS BOOKS; ADHESIVES FOR STATIONERY OR HOUSEHOLD PURPOSES; ALMANACS; APPLIQUES IN THE FORM OF DECALS; APPOINTMENT BOOKS; ART PRINTS; ARTS AND CRAFT PAINT KITS; AUTOGRAPH BOOKS; BABY BOOKS; BALLPOINT PENS; BASEBALL CARDS; BINDERS; BOOKBINDING MATERIAL; BOOKENDS; BOOKMARKS; FICTIONAL BOOKS FOR CHILDREN; CALENDARS; CARTOON STRIPS; CARTOON PRINTS; CHALK; CHILDREN'S ACTIVITY BOOKS; CHRISTMAS CARDS; COIN ALBUMS; COLOUR PENCILS; COLOURING BOOKS; COMIC BOOKS; COMIC STRIPS; COUPON BOOKS; DECORATIVE PAPER CENTREPIECES; DIARIES; DISPOSABLE DIAPERS FOR BABIES; DRAWING RULERS; ENVELOPES; ERASERS; FELT PENS; FLASH CARDS; PAPER GIFT CARDS; GIFT WRAPPING PAPER; GLOBES; GREETING CARDS; GUEST BOOKS; LETTER OPENERS OF PRECIOUS METAL; MAGAZINES IN THE FIELDS OF SCIENCE, HEALTH, CARTOONS, BUSINESS, ENTERTAINMENT, ONLINE GAMING, AND CHILDREN'S AND PARENTING MAGAZINES; MAPS; MEMO PADS; MODELING CLAY; NEWSPAPERS; NEWSLETTERS IN THE FIELDS OF SCIENCE, HEALTH, CARTOONS, BUSINESS, ENTERTAINMENT, ONLINE GAMING, AND CHILDREN'S AND PARENTING NEWSLETTERS; UNGRADUATED RULERS; NOTE PAPER; NOTEBOOK PAPER; NOTEBOOKS; PAINT BRUSHES; PAINTINGS; PAPER CAKE DECORATIONS; PAPER COASTERS; PAPER FLAGS; PAPER GIFT WRAP BOWS; PAPER MATS; PAPER NAPKINS; PAPER PARTY BAGS; PAPER PARTY DECORATIONS; PAPER PENNANTS; PAPER PLACE MATS; PAPER TABLE CLOTHS; PAPER WEIGHTS; PAPER, CARDBOARD; PEN AND PENCIL BOXES; PEN AND PENCIL CASES; PEN OR PENCIL HOLDERS; PENCIL SHARPENERS; PENCILS; PENS; PRINTED PERIODICALS IN THE FIELDS OF SCIENCE, HEALTH, CARTOONS, BUSINESS, ENTERTAINMENT, ONLINE GAMING, AND CHILDREN'S AND PARENTING PERIODICALS; PHOTO-ENGRAVINGS; PHOTOGRAPH ALBUMS; PHOTOGRAPHS; PICTORIAL PRINTS; PICTURE BOOKS; PORTRAITS; POSTCARDS; POSTERS; PRINTED AWARDS; PRINTED CERTIFICATES; PRINTED INVITATIONS; PRINTED MATTER AND PUBLICATIONS, NAMELY, BOOKS AND HANDOUTS IN THE FIELDS OF SCIENCE, HEALTH, CARTOONS, BUSINESS, ENTERTAINMENT, ONLINE GAMING, AND CHILDREN'S AND PARENTING PUBLICATIONS, NAMELY, BOOKS AND HANDOUTS IN THE FIELD OF PARENTING; PRINTED MENUS; PRINTERS' TYPE; PRINTING BLOCKS; RECIPE BOOKS; RUBBER STAMPS; SCHOOL SUPPLIES, NAMELY, NOTEBOOKS, WRITING PADS, WIREBOUND NOTEBOOKS, ENVELOPES, FOUNTAIN PENS, BALLPOINT PENS, ROLLERBALL PENS, PENCILS, POROUS POINT PENS, ADHESIVE TAPES AND DISPENSERS; SCORE CARDS; STAMP ALBUMS; STAPLERS; STATIONERY; STICKERS; TRADING CARDS; TYPEWRITERS; WRITING IMPLEMENTS; WRITING PAPER; BIBS OF PAPER; PAPER PARTY FAVORS (U.S. CLS. 2, 5, 22, 23, 29, 37, 38 AND 50).

CLASS 25—CLOTHING

FOR CLOTHING, FOOTWEAR AND HEADGEAR, NAMELY, ATHLETIC SHOES; BANDANAS; BASEBALL CAPS; BATHING SUITS; BEACH COVER-UPS; BEACHWEAR; BELTS; CLOTH BIBS; EAR MUFFS; BIKINIS; BLAZERS; BOW TIES; BRAS; CHAPS; BOOTS; CAPS; COATS; COSTUMES FOR USE IN CHILDREN'S DRESS UP PLAY; DRESSES; GLOVES; GOLF SHIRTS; HALLOWEEN AND MASQUERADE COSTUMES; HATS; HEAD BANDS; HOSIERY; INFANT WEAR; JACKETS; JEANS; JERSEYS; KERCHIEFS; LEG WARMERS; LEOTARDS; MITTENS; NECKTIES; NECKWEAR; NIGHT GOWNS; NIGHT SHIRTS; PANTS; PANTY HOSE; POLO SHIRTS; PONCHOS; PAJAMAS; RAINWEAR; ROBES; SANDALS; SLACKS; SCARVES; SHIRTS; SHOES; SHORTS; SKIRTS; INFANT SLEEPERS; SLEEPWEAR; SLIPPERS; SOCKS; STOCKINGS; SWEAT PANTS; SWEAT SHIRTS; SWEATERS; SWIMSUITS; TANK TOPS; TIGHTS; T-SHIRTS; UNDERWEAR; VESTS; WRIST BANDS (U.S. CLS. 22 AND 39).

CLASS 28—TOYS AND SPORTING GOODS

FOR ACTION FIGURES AND ACCESSORIES THEREFOR; ACTION SKILL GAMES; BADMINTON SETS; BALLOONS; BASEBALLS; BASKETBALLS; BATH TOYS; BATTERY-OPERATED ACTION TOYS; BEACH BALLS; BEAN BAG DOLLS; BEAN BAG TOYS; BOARD GAMES; BOWLING BALLS; TOY BOWS AND ARROWS; BUBBLE MAKING WANDS AND SOLUTION SETS; TOY BUILDING BLOCKS; CARD GAMES; CHESS SETS; CHILDREN'S MULTIPLE ACTIVITY TOYS; CHILDREN'S PLAY COSMETICS; CHRISTMAS TREE ORNAMENTS AND DECORATIONS; CRIB MOBILES; CRIB TOYS; COLLECTABLE TOY FIGURES; DISC-TYPE TOSS TOYS; DOLL ACCESSORIES; DOLL PLAYSETS; DOLLS AND DOLL CLOTHING; ELECTRIC ACTION TOYS; EQUIPMENT SOLD AS A UNIT FOR PLAYING CARD GAMES; FACE MASKS; FISHING TACKLES; GAMES, TOYS AND PLAYTHINGS, NAMELY, AVATAR GAMES, ROLE PLAYING GAMES, CHILDREN'S TOYS, NAMELY, ARTICLES OF CLOTHING FOR TOYS, ATTACHABLE, WEARABLE, MAGNETIC TOY FIGURINES, BENDABLE TOYS, CASES FOR TOY STRUCTURES, CASES FOR TOY VEHICLES, CHILDREN'S WIRE CONSTRUCTION AND ART ACTIVITY TOYS, CHILDREN'S TOY BICYCLES OTHER THAN FOR TRANSPORT, CONSTRUCTION TOYS, DRAWING TOYS, EDUCATIONAL TOYS FOR TEACHING MATH PRINCIPLES TO CHILDREN, NAMELY, MANIPULATIVE BLOCKS FOR DISPLAYING PATTERNS AND GROUPINGS, EDUCATIONAL TOYS IN THE NATURE OF AN ILLUSTRATED WALL MAP, ELECTRONIC ACTION TOYS, ELECTRONIC LEARNING TOYS, ELECTRONIC TOY BUILDING BLOCKS THAT LIGHT UP AS A NIGHT LIGHT, ELECTRONIC TOY VEHICLES, ELECTRONICALLY OPERATED TOY MOTOR VEHICLES, FANTASY CHARACTER TOYS, HAND-POWERED NON-MECHANICAL FLYING TOYS, LEVER ACTION TOYS, MECHANICAL TOYS, MODEL TOY VEHICLES, MOLDED TOY FIGURES, NON-ELECTRONIC TOY VEHICLES, PLASTIC CHARACTER TOYS, PLAYING PIECES IN THE NATURE OF MINIATURE ACTION FIGURES AND TOY MODEL VEHICLES FOR USE WITH TABLE TOP HOBBY BATTLE GAMES IN THE NATURE OF BATTLE, WAR AND SKIRMISH GAMES, AND FANTASY GAMES, PLUSH TOYS, POP UP TOYS, POSITIONABLE TOY FIGURES, PRINTED POSITIONABLE TOYS FOR USE IN CHILDREN'S BOARD GAMES, PRINTING TOYS, PULL TOYS, PUSH TOYS, RACKS AND STANDS SPECIFICALLY DESIGNED TO HOLD TOY SCOOTERS, RACKS AND STANDS SPECIFICALLY DESIGNED TO HOLD TOY VEHICLES, RADIO CONTROLLED TOY VEHICLES, RIDE-ON TOYS, RUBBER CHARACTER TOYS, SANDBOX TOYS, SKETCHING TOYS, SOFT SCULPTURE TOYS, STACKING TOYS, TALKING TOYS, TOY AND NOVELTY FACE MASKS, TOY ANIMALS, TOY BALLOONS, TOY BANKS, TOY BOXES, TOY BUILDING BLOCKS CAPABLE OF INTERCONNECTION, TOY CANDY DISPENSERS, TOY CAP PISTOLS, TOY CARS, TOY CLOCKS AND WATCHES, TOY CONSTRUCTION SETS, TOY FIGURES, TOY FILM CARTRIDGES AND VIEWERS, TOY FIREWORKS, TOY FURNITURE, TOY HARMONICAS, TOY HOUSES, TOY MASKS, TOY MODELING DOUGH, TOY MUSIC BOXES, TOY PRISM GLASSES, TOY PUTTY, TOY ROBOTS, TOY SCOOTERS, TOY SNOW GLOBES, TOY STAMPS, TOY TELESCOPES, TOY TOOLS, TOY WEAPONS, BATTERY-POWERED COMPUTER GAMES WITH LCD SCREENS WHICH FEATURE ANIMATION AND SOUND EFFECTS, CHILDREN'S DRESS-UP ACCESSORIES, TWO AND THREE DIMENSIONAL POSITIONABLE TOY FIGURES SOLD AS A UNIT WITH OTHER TOYS, AND WATER TOYS; GOLF BALL MARKERS; GOLF BALLS; GOLF GLOVES; HAND HELD UNITS FOR PLAYING ELECTRONIC GAMES OTHER THAN THOSE ADAPTED FOR USE WITH AN EXTERNAL DISPLAY SCREEN OR MONITOR; HOCKEY PUCKS; INFLATABLE TOYS; JIGSAW PUZZLES; JUMP ROPES; KITES; MAGIC TRICKS; MANIPULATIVE GAMES; MARBLES; MECHANICAL TOYS; MOBILES FOR CHILDREN; MUSIC BOX TOYS; MUSICAL TOYS; PAPER PARTY HATS; PARLOUR GAMES; PARTY GAMES; PARTY FAVORS IN THE NATURE OF SMALL TOYS; PLAYING CARDS; PLUSH TOYS; PUPPETS; ROLE PLAYING GAMES; ROLLER SKATES; RUBBER BALLS; SKATEBOARDS; SOCCER BALLS; SPINNING TOPS; SQUEEZE TOYS; STUFFED TOYS; TABLE TENNIS TABLES; TARGET GAMES; TEDDY BEARS; TENNIS BALLS; TOY SCOOTERS; TOY BANKS; TOY BUCKET AND SHOVEL SETS; TOY CARS; MOD-

ELED PLASTIC TOY FIGURINES; TOY GUNS; TOY HOLSTERS; TOY MOBILES; TOY MODEL HOBBY-CRAFT KITS; TOY ROCKETS; TOY TRUCKS; TOY VEHICLES; TOY WATCHES; ELECTRONIC GAMES FOR TEACHING CHILDREN; WIND-UP TOYS; YO-YOS (U.S. CLS. 22, 23, 38 AND 50).

SN 77-791,455. AUDIGIER BRAND MANAGEMENT GROUP, LLC., CULVER CITY, CA. FILED 7-28-2009.

CLASS 30—STAPLE FOODS

FOR ARTIFICIAL COFFEE; BAGELS; BAKERY DESSERTS; FROZEN DAIRY DESSERTS, NAMELY, ICE CREAM DESSERTS; BAKERY GOODS; BISCUITS; BREAKFAST CEREALS; BREAD; CAKE MIXES; CAKES; CANDY; CHEWING AND BUBBLE GUM; READY TO EAT, CEREAL DERIVED SNACK BARS; CHOCOLATE AND WHITE CHOCOLATE; CHOCOLATE-BASED BEVERAGES WITH MILK; COCOA MIXES; PREPARED COCOA, COCOA-BASED BEVERAGES; COFFEE; CONES FOR ICE CREAM; COOKIES; CONFECTIONERY MADE OF SUGAR; CORN CHIPS; CORN-BASED SNACK FOODS; CRACKERS; DELI SANDWICHES; EDIBLE CAKE DECORATIONS; FLOUR; FROZEN CONFECTIONS, NAMELY, ICE CREAM, SORBETS AND YOGURT; FROZEN MEALS CONSISTING PRIMARILY OF PASTA OR RICE; FROZEN YOGURT; GINGERBREAD; HONEY; ICE MILK; EDIBLE ICES; KETCHUP; LIQUORICE; LOLLIPOPS; MARSHMALLOWS; MAYONNAISE; MUESLI BARS; MUFFINS; MUSTARD; NOODLES; OAT-MEAL; PANCAKE MIXES; PANCAKE SYRUP; PANCAKES; PASTA, PREPARED PASTA, PACKAGED MEAL MIXES OR KITS CONSISTING PRIMARILY OF PASTA, PASTA AND NOODLES, PASTA SALAD AND PASTA FOR SOUPS; PASTRIES; PEANUT BRITTLE; PIES AND PIZZAS; POPCORN; PRETZELS; DESSERTS PUDDINGS; READY-TO-SERVE MEALS AND SEMI-COOKED MEALS, NAMELY, FROZEN, PREPARED OR PACKAGED MEALS CONSISTING PRIMARILY OF PASTA, RICE, NOODLES, MEAT, VEGETABLES, AND/OR FRUIT; RICE; ROLLS; SAGO; SALAD DRESSINGS; SALT; SANDWICHES; SAUCES; SHERBETS; SPAGHETTI; SPICES; SUGAR; TABLE SYRUP; TAPIOCA; TARTS AND WAFFLES; TEA; TORTILLAS; TREACLE; YEAST (U.S. CL. 46).

CLASS 41—EDUCATION AND ENTERTAINMENT

FOR AMUSEMENT PARK AND THEME PARK SERVICES; EDUCATION SERVICES, NAMELY, EDUCATIONAL WORKSHOPS, SEMINARS, CLASSES FOR PRIMARY AND SECONDARY SCHOOLS IN THE FIELD OF EARTH SCIENCE AND PREHISTORIC SUBJECT MATTER; THEME PARKS SERVICES, PROVIDING ENTERTAINMENT INFORMATION; ENTERTAINMENT IN THE NATURE OF LIVE STAGE PERFORMANCES IN THE NATURE OF PLAYS AND MUSICALS; ENTERTAINMENT IN THE NATURE OF LIVE PERFORMANCES IN THE NATURE OF PLAYS AND MUSICALS; ENTERTAINMENT IN THE NATURE OF TELEVISION NEWS SHOWS; ENTERTAINMENT IN THE NATURE OF PROGRAMS, SEGMENTS, MOVIES, SHORT FILM, GAMES, ANIMATION AND CARTOONS FEATURING COMEDY, STORYTELLING, VARIETY AND COMMENTARY BROADCAST OVER TELEVISION, RADIO, INTERNET, SATELLITE AND TELECOMMUNICATION NETWORKS; PRODUCTION OF ENTERTAINMENT SHOWS, NAMELY, ICE SHOWS, ONE-MAN SHOWS, MUSICALS AND VARIETY SHOWS FOR DISTRIBUTION VIA TELEVISION, CABLE, SATELLITE, AUDIO AND VIDEO MEDIA, CARTRIDGES, LASER DISCS, COMPUTER DISCS AND ELECTRONIC MEANS; PRODUCTION, DISTRIBUTION AND RENTAL OF MOTION PICTURE FILMS; PRODUCTION AND RENTAL OF SOUND AND VIDEO RECORDINGS; PRODUCTION OF TELEVISION AND RADIO PROGRAMS; ORGANIZING SPORTING AND CULTURAL EVENTS; THEATRE PRODUCTIONS; PROVIDING INFORMATION VIA COMMUNICATION AND COMPUTER NETWORKS IN RELATION TO THE AFORESAID SERVICES; ENTERTAINMENT SERVICES, NAMELY, PROVIDING ONLINE ELECTRONIC GAMES; PROVIDING ONLINE ELECTRONIC GAMES, NAMELY, ELECTRONIC MASSIVELY MULTI PLAYER ONLINE GAMES AND ELECTRONIC ROLE-PLAYING ONLINE GAMES (U.S. CLS. 100, 101 AND 107).

MICHELE SWAIN, EXAMINING ATTORNEY

THE SAME GUY

THE MARK CONSISTS OF STANDARD CHARACTERS WITHOUT CLAIM TO ANY PARTICULAR FONT, STYLE, SIZE, OR COLOR.

NO CLAIM IS MADE TO THE EXCLUSIVE RIGHT TO USE "GUY", APART FROM THE MARK AS SHOWN.

CLASS 3—COSMETICS AND CLEANING PREPARATIONS

FOR BATH FOAMS, BATH GEL, BATH OILS, BODY CREAM, BODY SPRAYS, BODY WASHES, PERFUME, COLOGNE, EAU DE PARFUM, EAU DE TOILETTE, ESSENTIAL OILS FOR PERSONAL USE, AFTER-SHAVE BALMS, AFTER-SHAVE LOTIONS, SKIN MOISTURIZER, BODY LOTION, HAND CREAM, HAIR SHAMPOO, SOAPS FOR PERSONAL USE, AND PERSONAL DEODORANTS (U.S. CLS. 1, 4, 6, 50, 51 AND 52).

CLASS 9—ELECTRICAL AND SCIENTIFIC APPARATUS

FOR SUNGLASSES, EYEGLASSES, EYEGLASS FRAMES, EYEGLASS CASES, AND GOGGLES FOR SPORTS (U.S. CLS. 21, 23, 26, 36 AND 38).

CLASS 18—LEATHER GOODS

FOR HANDBAGS, TOTE BAGS, CLUTCH BAGS, WALLETS, PURSES, KEY CASES, CREDIT CARD CASES, BUSINESS CARD CASES, LUGGAGE, AND TRAVELING BAGS (U.S. CLS. 1, 2, 3, 22 AND 41).

CLASS 24—FABRICS

FOR BEDSHEETS AND PILLOWCASES, BED LINENS, PILLOW SHAMS, BEDSPREADS, BED BLANKETS, COMFORTERS, DUVET COVERS, COVERS FOR CUSHIONS, COVERLETS, THROWS, BEDSKIRTS AND DUST RUFFLES, TOWELS, BATH SHEETS, WASHCLOTHS, AND SHOWER CURTAINS (U.S. CLS. 42 AND 50).

CLASS 25—CLOTHING

FOR CLOTHING, NAMELY, BLOUSES, COATS, JEANS, UNDERWEAR, SLEEPWEAR, SWIMWEAR, VESTS, BELTS, SOCKS, AND FOOTWEAR (U.S. CLS. 22 AND 39).

CLASS 26—FANCY GOODS

FOR BELT BUCKLES (U.S. CLS. 37, 39, 40, 42 AND 50).

CLASS 35—ADVERTISING AND BUSINESS

FOR RETAIL STORE SERVICES AND COMPUTERIZED ONLINE RETAIL STORE SERVICES IN THE FIELDS OF CLOTHING, CLOTHING ACCESSORIES, LEATHER GOODS, BAGS, AND JEWELRY (U.S. CLS. 100, 101 AND 102).

MARC LEIPZIG, EXAMINING ATTORNEY

SN 77-863,949. KVG GROUP INC., TORONTO, ONTARIO, CANADA, FILED 11-3-2009.

DERMAL INFUSION TECHNOLOGY

THE MARK CONSISTS OF STANDARD CHARACTERS WITHOUT CLAIM TO ANY PARTICULAR FONT, STYLE, SIZE, OR COLOR.

PRIORITY CLAIMED UNDER SEC. 44(D) ON CANADA APPLICATION NO. 1457654, FILED 11-2-2009, REG. NO. TMA819,232, DATED 3-6-2012, EXPIRES 3-6-2027.

NO CLAIM IS MADE TO THE EXCLUSIVE RIGHT TO USE "DERMAL" AND "TECHNOLOGY", APART FROM THE MARK AS SHOWN.

CLASS 3—COSMETICS AND CLEANING PREPARATIONS

FOR FOOT CARE PREPARATIONS, NAMELY, FOOT LOTIONS, FOOT DEODORANT SPRAYS, FOOT CREAMS, FOOT GELS, AND FOOT POWDERS (U.S. CLS. 1, 4, 6, 50, 51 AND 52).

CLASS 35—ADVERTISING AND BUSINESS

FOR ONLINE RETAIL STORE SERVICES, RETAIL STORE AND WHOLESALE DISTRIBUTIONSHIP SERVICES FEATURING FOOT CARE PREPARATIONS; PROVIDING A WEBSITE FEATURING GENERAL CONSUMER INFORMATION IN THE FIELD OF FOOT CARE AND FOOT CARE PREPARATIONS (U.S. CLS. 100, 101 AND 102).

DARRYL SPRUILL, EXAMINING ATTORNEY



SN 77-870,226. ALIMENTS IN FOODS INC., MONTREAL, QUEBEC, FILED 11-11-2009.

IN SNAX

THE MARK CONSISTS OF STANDARD CHARACTERS WITHOUT CLAIM TO ANY PARTICULAR FONT, STYLE, SIZE, OR COLOR.

PRIORITY CLAIMED UNDER SEC. 44(D) ON CANADA APPLICATION NO. 1447231, FILED 8-5-2009, REG. NO. TMA816224, DATED 1-26-2012, EXPIRES 1-26-2027.

NO CLAIM IS MADE TO THE EXCLUSIVE RIGHT TO USE "SNACKS", APART FROM THE MARK AS SHOWN.

CLASS 29—MEATS AND PROCESSED FOODS

FOR FROZEN MEALS CONSISTING PRIMARILY OF MEAT, FISH, POULTRY OR VEGETABLES; CANDIED FRUIT SNACKS; DEHYDRATED FRUIT SNACKS; FRUIT-BASED SNACK FOOD; MEAT-BASED SNACK FOODS; NUT AND SEED-BASED SNACK BARS; POTATO-BASED SNACK FOODS; SNACK DIPS EXCLUDING SALSA AND OTHER SAUCES USED AS DIPS; SNACK MIX CONSISTING OF DEHYDRATED FRUIT AND PROCESSED NUTS; TOFU-BASED SNACKS; VEGETABLE-BASED SNACK FOODS; DIPS EXCLUDING SALSA AND OTHER SAUCES USED AS DIPS; PRE-PACKAGED DINNERS CONSISTING OF PRIMARILY OF MEAT, SEAFOOD OR POULTRY SERVED WITH PASTA; CHEESE SPREADS; DAIRY-BASED SPREADS; FRUIT-BASED SPREADS; MEAT-BASED SPREADS; VEGETABLE-BASED SPREADS; FROZEN, PREPARED OR PACKAGED SIDE DISH CONSISTING PRIMARILY OF MASHED POTATOES OR PUREED VEGETABLES; FROZEN, PREPARED OR PACKAGED SIDE DISH CONSISTING PRIMARILY OF POTATOES MIXED WITH VEGETABLES; SHELLED NUTS; ROASTED NUTS; PROCESSED NUTS; NUT-BASED SNACK FOODS (U.S. CL. 46).

CLASS 30—STAPLE FOODS

FOR STUFFING MIXES CONTAINING BREAD, STUFFING MIXES CONTAINING RICE, STUFFING MIXES CONTAINING POTATOES; FROZEN MEALS CONSISTING PRIMARILY OF PASTA OR RICE; SALSA; SAUCES; CEREAL-BASED SNACK FOODS; MULTI-GRAIN-BASED SNACK FOODS; RICE-BASED SNACK FOODS; FROZEN CONFECTIONERY; RICE; FROZEN, PREPARED OR PACKAGED MEALS CONSISTING PRIMARILY OF RICE; PITA BREAD AND PITA CHIPS; FRUIT PIES; PIES (U.S. CL. 46).

LESLEY LAMOTHE, EXAMINING ATTORNEY



SN 77-870,911. ALIMENTS IN FOODS INC., MONTREAL, QUEBEC, FILED 11-12-2009.

I AM IN

THE MARK CONSISTS OF STANDARD CHARACTERS WITHOUT CLAIM TO ANY PARTICULAR FONT, STYLE, SIZE, OR COLOR.

PRIORITY CLAIMED UNDER SEC. 44(D) ON CANADA APPLICATION NO. 1,458,476, FILED 11-9-2009, REG. NO. TMA816221, DATED 1-26-2012, EXPIRES 1-26-2027.

CLASS 29—MEATS AND PROCESSED FOODS

FOR FROZEN MEALS CONSISTING PRIMARILY OF MEAT, FISH, POULTRY OR VEGETABLES; CANDIED FRUIT SNACKS; DEHYDRATED FRUIT SNACKS; FRUIT-BASED SNACK FOOD; MEAT-BASED SNACK FOODS; NUT AND SEED-BASED SNACK BARS; POTATO-BASED SNACK FOODS; SNACK DIPS EXCLUDING SALSA AND OTHER SAUCES USED AS DIPS; SNACK MIX CONSISTING OF DEHYDRATED FRUIT AND PROCESSED NUTS; TOFU-BASED SNACKS; VEGETABLE-BASED SNACK FOODS; DIPS EXCLUDING SALSA AND OTHER SAUCES USED AS DIPS; PRE-PACKAGED DINNERS CONSISTING OF PRIMARILY OF MEAT, SEAFOOD OR POULTRY SERVED WITH PASTA; CHEESE SPREADS; DAIRY-BASED SPREADS; FRUIT-BASED SPREADS; MEAT-BASED SPREADS; VEGETABLE-BASED SPREADS; FROZEN, PREPARED OR PACKAGED SIDE DISH CONSISTING PRIMARILY OF MASHED POTATOES OR PUREED VEGETABLES; FROZEN, PREPARED OR PACKAGED SIDE DISH CONSISTING PRIMARILY OF POTATOES MIXED WITH VEGETABLES; SHELLED NUTS; ROASTED NUTS; PROCESSED NUTS; NUT-BASED SNACK FOODS (U.S. CL. 46).

CLASS 30—STAPLE FOODS

FOR STUFFING MIXES CONTAINING BREAD, STUFFING MIXES CONTAINING RICE, STUFFING MIXES CONTAINING POTATOES; FROZEN MEALS CONSISTING PRIMARILY OF PASTA OR RICE; SALSA; SAUCES; CEREAL-BASED SNACK FOODS; MULTI-GRAIN-BASED SNACK FOODS; RICE-BASED SNACK FOODS; FROZEN CONFECTIONERY; RICE; FROZEN, PREPARED OR PACKAGED MEALS CONSISTING PRIMARILY OF RICE; PITA BREAD AND PITA CHIPS; FRUIT PIES; PIES (U.S. CL. 46).

LESLEY LAMOTHE, EXAMINING ATTORNEY

SN 77-886,376. SCHMEISSER GMBH, KREFELD, FED REP GERMANY, FILED 12-4-2009.

SCHMEISSER

THE MARK CONSISTS OF STANDARD CHARACTERS WITHOUT CLAIM TO ANY PARTICULAR FONT, STYLE, SIZE, OR COLOR.

OWNER OF ERPN CMNTY TM OFC REG. NO. 008485286, DATED 3-8-2010, EXPIRES 8-11-2019.

THE WORDING "SCHMEISSER" HAS NO MEANING IN A FOREIGN LANGUAGE.

CLASS 8—HAND TOOLS

FOR CUTLERY; SIDE ARMS, NOT INCLUDING FIREARMS, NAMELY, SWORDS, BAYONETS (U.S. CLS. 23, 28 AND 44).

CLASS 9—ELECTRICAL AND SCIENTIFIC APPARATUS

FOR OPTICAL APPARATUS AND INSTRUMENTS, NAMELY, OPTICAL SIGHTING MECHANISM FOR FIREARMS, OPTICAL LENS SIGHTS FOR FIREARMS; TELESCOPIC SIGHTS; BINOCULARS (U.S. CLS. 21, 23, 26, 36 AND 38).

CLASS 13—FIREARMS

FOR SIGHTS, NAMELY, NON-TELESCOPIC, OPEN-SIGHTS FOR USE ON FIREARMS; FIREARM ATTACHMENTS, NAMELY, MOUNTS FOR ATTACHING TELESCOPIC SIGHTS TO A FIREARM; FIREARMS AND STRUCTURAL PARTS THEREFORE; AMMUNITION; PROJECTILES; EXPLOSIVES; FIREWORKS; PISTOLS (U.S. CLS. 2 AND 9).

ELISSA GARBER KON, EXAMINING ATTORNEY

SN 77-908,817. DR. GUM INC., CHATEAUGUAY, QUEBEC, CANADA, FILED 1-11-2010.

DR. GUM

THE MARK CONSISTS OF STANDARD CHARACTERS WITHOUT CLAIM TO ANY PARTICULAR FONT, STYLE, SIZE, OR COLOR.

OWNER OF CANADA REG. NO. TMA800290, DATED 6-20-2011, EXPIRES 6-20-2026.

OWNER OF U.S. REG. NO. 4,018,611.

CLASS 3—COSMETICS AND CLEANING PREPARATIONS

FOR CLEANING PREPARATIONS FOR INDUSTRIAL AND HOUSEHOLD APPLICATIONS TO REMOVE GUM, GRAFFITI, PAINTS, GREASE, GLUE, DIRT, BLOOD, GARBAGE SLUDGE, FOOD AND INDOOR STAINS, BIRD DROPPINGS AND TAPE RESIDUE FROM ANY SURFACE (U.S. CLS. 1, 4, 6, 50, 51 AND 52).

CLASS 7—MACHINERY

FOR STEAM MACHINE FOR CLEANING AND SANITIZING SIDEWALKS, LAMP POSTS, STREET FURNITURE, CARPETS, UPHOLSTERY AND ARCHITECTURAL SURFACES; STEAM MACHINE FOR REMOVING GUM, GRAFFITI, PAINTS, GREASE, GLUE, DIRT, BLOOD, GARBAGE SLUDGE, FOOD AND INDOOR STAINS, BIRD DROPPINGS AND TAPE RESIDUE FROM ANY SURFACE (U.S. CLS. 13, 19, 21, 23, 31, 34 AND 35).

CLASS 37—CONSTRUCTION AND REPAIR

FOR ALL-SURFACE CLEANING SERVICES, NAMELY, CLEANING AND SANITIZING SIDEWALKS, LAMP POSTS, STREET FURNITURE, CARPETS, UPHOLSTERY AND ARCHITECTURAL SURFACES; ALL-SURFACE CLEANING SERVICES, NAMELY, REMOVING GUM, GRAFFITI, PAINTS, GREASE, GLUE, DIRT, BLOOD, GARBAGE SLUDGE, FOOD AND INDOOR STAINS, BIRD DROPPINGS AND TAPE RESIDUE FROM ANY SURFACE (U.S. CLS. 100, 103 AND 106).

ANNE E. GUSTASON, EXAMINING ATTORNEY

SN 77-913,563, IP APPLICATION DEVELOPMENT LLC,
WILMINGTON, DE. FILED 1-16-2010.

IPAD

THE MARK CONSISTS OF STANDARD CHARACTERS WITHOUT CLAIM TO ANY PARTICULAR FONT, STYLE, SIZE, OR COLOR.

PRIORITY CLAIMED UNDER SEC. 44(D) ON TRINIDAD/
TOBAGO APPLICATION NO. 41168, FILED 7-16-2009.
SEC. 2(F).

CLASS 38—COMMUNICATION

FOR TELECOMMUNICATION ACCESS SERVICES; COMMUNICATIONS BY COMPUTER TERMINALS; COMMUNICATION SERVICES BETWEEN COMPUTERS, NAMELY, ELECTRONIC TRANSMISSION OF DATA AND DOCUMENTS AMONG USERS OF COMPUTERS; ELECTRONIC SENDING OF DATA AND DOCUMENTATION VIA THE INTERNET OR OTHER DATABASES; ELECTRONIC TRANSMISSION OF NEWS AND DATA; PROVIDING TELECOMMUNICATION ACCESS TO WEBSITES AND ELECTRONIC NEWS SERVICES ONLINE ALLOWING THE DOWNLOAD OF INFORMATION AND DATA; PROVIDING TELECOMMUNICATION ACCESS TO WEB SITES ON THE INTERNET; DELIVERY OF DIGITAL MUSIC BY TELECOMMUNICATIONS; PROVIDING WIRELESS TELECOMMUNICATIONS, NAMELY, TRANSMISSION OF VOICE, AUDIO, VISUAL IMAGES, AND DATA, VIA ELECTRONIC COMMUNICATIONS NETWORKS; WIRELESS DIGITAL MESSAGING, PAGING SERVICES, AND ELECTRONIC MAIL SERVICES, INCLUDING SERVICES THAT ENABLE A USER TO SEND AND/OR RECEIVE MESSAGES THROUGH A WIRELESS DATA NETWORK; ONE-WAY AND TWO-WAY PAGING SERVICES; TELETEXT, TELEGRAM TRANSMISSION, AND TELEPHONE SERVICES; BROADCASTING OR TRANSMISSION OF RADIO AND TELEVISION PROGRAMS; PROVISION OF TELECOMMUNICATIONS ACCESS AND THE INTERNET; ELECTRONIC TRANSMISSION OF STREAMED AND DOWNLOADABLE AUDIO AND VIDEO FILES FOR OTHERS VIA COMPUTER AND OTHER COMMUNICATIONS NETWORKS; WEBCASTING SERVICES (TRANSMISSION); DELIVERY OF MESSAGES BY ELECTRONIC TRANSMISSION; PROVISION OF TELECOMMUNICATION CONNECTIVITY SERVICES AND ACCESS TO ELECTRONIC COMMUNICATIONS NETWORKS, FOR TRANSMISSION OR RECEPTION OF AUDIO, VIDEO OR MULTIMEDIA CONTENT; PROVISION OF TELECOMMUNICATIONS CONNECTIONS TO ELECTRONIC COMMUNICATION NETWORKS, FOR TRANSMISSION OR RECEPTION OF AUDIO, VIDEO OR MULTIMEDIA CONTENT; PROVIDING TELECOMMUNICATION ACCESS TO DIGITAL MUSIC WEB SITES ON THE INTERNET; PROVIDING TELECOMMUNICATION ACCESS TO MP3 WEB SITES ON THE INTERNET; DELIVERY OF DIGITAL MUSIC BY TELECOMMUNICATIONS, NAMELY, BY ELECTRONIC TRANSMISSION; PROVISION OF TELECOMMUNICATIONS CONNECTIONS TO THE INTERNET OR COMPUTER DATABASES, ELECTRONIC MAIL SERVICES; TELECOMMUNICATION OF INFORMATION, NAMELY, COMPUTER AIDED TRANSMISSION OF INFORMATION AND IMAGES, INCLUDING WEBPAGES; VIDEO BROADCASTING, BROADCASTING PRE-RECORDED VIDEOS FEATURING MUSIC AND ENTERTAINMENT, TELEVISION PROGRAMS, MOTION PICTURES, NEWS, SPORTS, GAMES, CULTURAL EVENTS, AND ENTERTAINMENT-RELATED PROGRAMS OF ALL KINDS, VIA A GLOBAL COMPUTER NETWORK; STREAMING OF VIDEO CONTENT VIA A GLOBAL COMPUTER NETWORK; SUBSCRIPTION AUDIO BROADCASTING VIA A GLOBAL COMPUTER NETWORK; AUDIO BROADCASTING; AUDIO BROADCASTING OF SPOKEN WORD, MUSIC, CONCERTS, AND RADIO PROGRAMS, BROADCASTING PRE-RECORDED VIDEOS FEATURING MUSIC AND ENTERTAINMENT, TELEVISION PROGRAMS, MOTION PICTURES, NEWS, SPORTS, GAMES, CULTURAL EVENTS, AND ENTERTAINMENT-RELATED PROGRAMS OF ALL KINDS, VIA COMPUTER AND OTHER COMMUNICATIONS NETWORKS; STREAMING OF AUDIO CONTENT VIA A GLOBAL COMPUTER NETWORK; ELECTRONIC TRANSMISSION OF MUSIC, VIDEO, AND AUDIO RECORDINGS AMONG COMPUTERS VIA COMMUNICATION NETWORKS; PROVIDING ON-LINE BULLETIN BOARDS FOR THE TRANSMISSION OF MESSAGES AMONG COMPUTER USERS CONCERNING ENTERTAINMENT, MUSIC, CONCERTS, VIDEOS, RADIO, TELEVISION, FILM, NEWS, SPORTS, GAMES AND CULTURAL EVENTS; RENTAL OF TELECOMMUNICATION APPARATUS; PROVIDING EMAIL SERVICES; NEWS AGENCY SERVICES FOR ELECTRONIC TRANSMISSION; TELECOMMUNICATIONS CONSULTATION; FACSIMILE, MESSAGE COLLECTION AND TRANSMISSION SERVICES; TRANSMISSION OF DATA AND OF INFORMATION BY ELECTRONIC MEANS, NAMELY, BY COMPUTER, CABLE, RADIO, TELEPRINTER, TELETYPE, ELECTRONIC MAIL, TELECOPIER, TELEVISION, MICROWAVE, LASER BEAM, COMMUNICATIONS SATELLITE OR ELECTRONIC COMMUNICATION MEANS; ELECTRONIC TRANSMISSION OF DATA, NAMELY, TRANSMISSION OF DATA BY DIGITAL AUDIO-VISUAL APPARATUS CONTROLLED BY ELECTRONIC DATA PROCESSING APPARATUS OR COMPUTERS; INFORMATION, ADVISORY AND CONSULTANCY SERVICES RELATING TO ALL THE AFORESAID. PROVISION OF TELECOMMUNICATION ACCESS TO WEB-SITES FEATURING MULTIMEDIA MATERIALS; PROVIDING TELECOMMUNICATION ACCESS TO DATABASES AND DIRECTORIES VIA COMMUNICATIONS NETWORKS FOR OBTAINING DATA IN THE FIELDS OF MUSIC, VIDEO, FILM, BOOKS, TELEVISION, GAMES AND SPORTS; PROVIDING USERS WITH TELECOMMUNICATION ACCESS TIME TO ELECTRONIC COMMUNICATIONS NETWORKS WITH MEANS OF IDENTIFYING, LOCATING, GROUPING, DISTRIBUTING, AND MANAGING DATA AND LINKS TO THIRD-PARTY COMPUTER SERVERS, COMPUTER PROCESSORS AND COMPUTER USERS; INTERNET ACCESS PROVIDER SERVICES (U.S. CLS. 100, 101 AND 104).

TAINMENT-RELATED PROGRAMS OF ALL KINDS, VIA COMPUTER AND OTHER COMMUNICATIONS NETWORKS; STREAMING OF AUDIO CONTENT VIA A GLOBAL COMPUTER NETWORK; ELECTRONIC TRANSMISSION OF AUDIO AND VIDEO FILES VIA COMMUNICATIONS NETWORKS; PEER-TO-PEER NETWORK COMPUTER SERVICES, NAMELY, ELECTRONIC TRANSMISSION OF MUSIC, VIDEO, AND AUDIO RECORDINGS AMONG COMPUTERS VIA COMMUNICATION NETWORKS; PROVIDING ON-LINE BULLETIN BOARDS FOR THE TRANSMISSION OF MESSAGES AMONG COMPUTER USERS CONCERNING ENTERTAINMENT, MUSIC, CONCERTS, VIDEOS, RADIO, TELEVISION, FILM, NEWS, SPORTS, GAMES AND CULTURAL EVENTS; RENTAL OF TELECOMMUNICATION APPARATUS; PROVIDING EMAIL SERVICES; NEWS AGENCY SERVICES FOR ELECTRONIC TRANSMISSION; TELECOMMUNICATIONS CONSULTATION; FACSIMILE, MESSAGE COLLECTION AND TRANSMISSION SERVICES; TRANSMISSION OF DATA AND OF INFORMATION BY ELECTRONIC MEANS, NAMELY, BY COMPUTER, CABLE, RADIO, TELEPRINTER, TELETYPE, ELECTRONIC MAIL, TELECOPIER, TELEVISION, MICROWAVE, LASER BEAM, COMMUNICATIONS SATELLITE OR ELECTRONIC COMMUNICATION MEANS; ELECTRONIC TRANSMISSION OF DATA, NAMELY, TRANSMISSION OF DATA BY DIGITAL AUDIO-VISUAL APPARATUS CONTROLLED BY ELECTRONIC DATA PROCESSING APPARATUS OR COMPUTERS; INFORMATION, ADVISORY AND CONSULTANCY SERVICES RELATING TO ALL THE AFORESAID. PROVISION OF TELECOMMUNICATION ACCESS TO WEB-SITES FEATURING MULTIMEDIA MATERIALS; PROVIDING TELECOMMUNICATION ACCESS TO DATABASES AND DIRECTORIES VIA COMMUNICATIONS NETWORKS FOR OBTAINING DATA IN THE FIELDS OF MUSIC, VIDEO, FILM, BOOKS, TELEVISION, GAMES AND SPORTS; PROVIDING USERS WITH TELECOMMUNICATION ACCESS TIME TO ELECTRONIC COMMUNICATIONS NETWORKS WITH MEANS OF IDENTIFYING, LOCATING, GROUPING, DISTRIBUTING, AND MANAGING DATA AND LINKS TO THIRD-PARTY COMPUTER SERVERS, COMPUTER PROCESSORS AND COMPUTER USERS; INTERNET ACCESS PROVIDER SERVICES (U.S. CLS. 100, 101 AND 104).

CLASS 42—SCIENTIFIC AND COMPUTER SERVICES

FOR PROVIDING WEB-SITES, VIA A GLOBAL COMPUTER NETWORK, TO ENABLE USERS TO PROGRAM THE SCHEDULING OF AUDIO, VIDEO, TEXT AND OTHER MULTIMEDIA CONTENT, INCLUDING MUSIC, CONCERTS, VIDEOS, RADIO, TELEVISION, NEWS, SPORTS, GAMES, CULTURAL EVENTS, AND ENTERTAINMENT-RELATED PROGRAMS AS THEY WILL BE AIRED; DESIGN AND DEVELOPMENT OF COMPUTER HARDWARE AND SOFTWARE; COMPUTER HARDWARE AND SOFTWARE CONSULTING SERVICES; RENTAL OF COMPUTER HARDWARE AND SOFTWARE APPARATUS AND EQUIPMENT; MULTIMEDIA SOFTWARE AND AUDIO-VISUAL SOFTWARE CONSULTING SERVICES; COMPUTER PROGRAMMING; SUPPORT AND CONSULTATION SERVICES FOR DEVELOPING COMPUTER SYSTEMS, DATABASES AND SOFTWARE APPLICATIONS; GRAPHIC DESIGN FOR THE COMPILATION OF WEB PAGES ON THE INTERNET; PROVIDING A WEBSITE THAT FEATURES INFORMATION ON COMPUTER TECHNOLOGY AND PROGRAMMING; CREATING AND MAINTAINING WEB-SITES; HOSTING THE WEB-SITES OF OTHERS; PROVIDING SEARCH ENGINES FOR OBTAINING DATA VIA COMMUNICATIONS NETWORKS; APPLICATION SERVICE PROVIDER (ASP) SERVICES FEATURING SOFTWARE FOR USE IN CONNECTION WITH ONLINE MUSIC SUBSCRIPTION SERVICE, SOFTWARE THAT ENABLES USERS TO PLAY AND PROGRAM MUSIC AND ENTERTAINMENT-RELATED AUDIO, VIDEO, TEXT AND MULTIMEDIA CONTENT, AND SOFTWARE FEATURING MUSICAL SOUND RECORDINGS, ENTERTAINMENT-RELATED AUDIO, VIDEO, TEXT AND MULTIMEDIA CONTENT; PROVIDING TEMPORARY USE OF ON-LINE NON-DOWNLOADABLE SOFTWARE TO ENABLE USERS TO PROGRAM AUDIO, VIDEO, TEXT AND OTHER MULTIMEDIA CONTENT, INCLUDING MUSIC, CONCERTS, VIDEOS, RADIO, TELEVISION, NEWS, SPORTS, GAMES, CULTURAL

EVENTS, AND ENTERTAINMENT-RELATED PROGRAMS; PROVIDING SEARCH ENGINES FOR OBTAINING DATA ON A GLOBAL COMPUTER NETWORK; INFORMATION, ADVISORY AND CONSULTANCY SERVICES RELATING TO ALL THE AFORESAID; PROVISION OF INTERNET SEARCH ENGINES; CREATING INDEXES OF ONLINE INFORMATION, SITES AND OTHER RESOURCES AVAILABLE ON GLOBAL COMPUTER NETWORKS FOR OTHERS; PROVIDING WEBSITES, VIA A GLOBAL COMPUTER NETWORK, FEATURING TECHNOLOGY THAT ENABLES USERS TO PROGRAM THE SCHEDULING OF AUDIO, VIDEO, TEXT, AND OTHER MULTIMEDIA CONTENT, INCLUDING MUSIC, CONCERTS, VIDEOS, RADIO, TELEVISION, NEWS, SPORTS, GAMES, CULTURAL EVENTS, AND ENTERTAINMENT-RELATED PROGRAMS AS THEY WILL BE AIRED (U.S. CLS. 100 AND 101).
HELENE LIWINSKI, EXAMINING ATTORNEY

SN 77-923,987. KAYABA INDUSTRY CO., LTD., AKA KAYABA KOGYO KABUSHIKI KAISHA, MINATO-KU, TOKYO, JAPAN, FILED 1-29-2010.

EHESS

THE MARK CONSISTS OF STANDARD CHARACTERS WITHOUT CLAIM TO ANY PARTICULAR FONT, STYLE, SIZE, OR COLOR.

PRIORITY CLAIMED UNDER SEC. 44(D) ON JAPAN APPLICATION NO. 2009-057946, FILED 7-30-2009, REG. NO. 5325129, DATED 5-21-2010, EXPIRES 5-21-2020.

CLASS 7—MACHINERY

FOR PRESSURE CONTROL VALVES BEING PARTS OF MACHINES; FLOW CONTROL VALVES, NAMELY, FLOW CONTROL AND FLOW DIVIDING VALVES, ALL BEING PARTS OF MACHINES; SWITCHING VALVES BEING PARTS OF MACHINES; REGENERATIVE HYDRAULIC STARTER MOTORS FOR DRIVING HYDRAULIC PUMPS; ELECTRIC HYDRAULIC PUMPS; RADIATORS FOR ELECTRIC MOTORS AND INVERTER MOTORS FOR CONSTRUCTION MACHINES AND APPARATUS; COOLING WATER PUMPS FOR USE IN ELECTRIC MOTORS AND INVERTERS; ELECTRIC MOTORS FOR MACHINES; ELECTRICITY GENERATORS NOT FOR LAND VEHICLES; REDUCTION GEARS FOR MACHINES; MINING MACHINES, NAMELY, MINE BORERS, EARTH DRILLING MACHINES, AND ELECTRIC MINE DRAINAGE PUMPS, AND STRUCTURAL PARTS THEREOF; CONSTRUCTION AND EARTH MOVING MACHINES, NAMELY, POWER SHOVELS, BULLDOZERS, POWER-OPERATED DIGGERS, AND EXCAVATORS, AND STRUCTURAL PARTS THEREOF; LOADING AND UNLOADING MACHINES AND STRUCTURAL PARTS THEREOF; MACHINE ELEMENTS, NAMELY, GASOLINE ENGINES NOT FOR LAND VEHICLES, DIESEL ENGINES NOT FOR LAND VEHICLES, KEROSENE ENGINES NOT FOR LAND VEHICLES; PNEUMATIC OR HYDRAULIC MACHINES AND INSTRUMENTS, NAMELY, ELECTRIC PUMPS; MACHINE ELEMENTS, NAMELY, SHAFT COUPLINGS FOR MACHINES, AXLES FOR MACHINES, ENGINE BEARINGS, AND VALVES BEING PARTS OF MACHINES; MACHINE ELEMENTS IN THE NATURE OF PRESSURE CONTROL VALVES BEING PARTS OF MACHINES FOR THE GENERATION, STORAGE AND UTILIZATION OF REGENERATIVE ENERGY (U.S. CLS. 13, 19, 21, 23, 31, 34 AND 35).

SN 77-919,008. GROWCAMP A/S, 4300 HOLBÆK, DENMARK, FILED 1-25-2010.

GROWCAMP

THE MARK CONSISTS OF STANDARD CHARACTERS WITHOUT CLAIM TO ANY PARTICULAR FONT, STYLE, SIZE, OR COLOR.

PRIORITY CLAIMED UNDER SEC. 44(D) ON CANADA APPLICATION NO. 1464732, FILED 1-5-2010.

CLASS 19—NON-METALLIC BUILDING MATERIALS

FOR NON-METALLIC BUILDING MATERIALS, NAMELY, MOULDINGS, BASE STONES, FRAMES FOR GREENHOUSES, INSECT SCREENS, PRE-FABRICATED GREENHOUSES, PLANTING BEDS, GLASS FOR BUILDINGS; DRAIN PIPES MADE OF CONCRETE, EARTHENWARE, POLYETHYLENE OR SANDSTONE, NON-METALLIC RIGID PIPES FOR BUILDING; ASPHALT, PITCH AND BITUMEN; NON-METALLIC TRANSPORTABLE BUILDINGS, NAMELY, GREENHOUSES; MONUMENTS, NOT OF METAL (U.S. CLS. 1, 12, 33 AND 50).

CLASS 44—MEDICAL, BEAUTY AND AGRICULTURAL SERVICES

FOR MEDICAL SERVICES; VETERINARY SERVICES; HYGIENIC AND BEAUTY CARE FOR HUMAN BEINGS OR ANIMALS; AGRICULTURE, HORTICULTURE AND FORESTRY SERVICES, NAMELY, PEST CONTROL SERVICES, VERMIN EXTERMINATION, AGRICULTURAL ADVICE, COMPOST SPREADING, AGRICULTURAL ADVICE, NAMELY, PROVIDING RECOMMENDATIONS FOR PLANT AND SOIL NUTRITION SUPPLEMENTS (U.S. CLS. 100 AND 101).
DARRYL SPRUILL, EXAMINING ATTORNEY

CLASS 9—ELECTRICAL AND SCIENTIFIC APPARATUS

FOR BATTERY SYSTEMS CONSISTING PRIMARILY OF BATTERY PACKS; BATTERY CHARGERS; BATTERY MANAGEMENT INTERFACES CONTROLLED BY COMPUTERS; BATTERY CHARGERS; BATTERIES; INVERTERS; INTERFACES FOR COMPUTERS, ELECTRONIC DISPLAY INTERFACES FOR POWER CONTROLLERS; ELECTRONIC MACHINES, APPARATUS AND THEIR PARTS, NAMELY, REGENERATIVE ELECTRONIC CIRCUITS; POWER DISTRIBUTION OR CONTROL MACHINES AND APPARATUS, NAMELY, ELECTRICAL CONTROLLERS FOR HYBRID SYSTEMS; PERSONAL COMPUTERS; POWER DISTRIBUTION BOXES; ELECTRONIC MACHINES, APPARATUS AND THEIR PARTS, NAMELY, POWER-ASSISTED HYDRAULIC PRINTED CIRCUITS; TELECOMMUNICATION DEVICES AND APPARATUS, NAMELY, ELECTRIC INSTALLATIONS FOR THE REMOTE CONTROL OF INDUSTRIAL OPERATIONS; ELECTRONIC MACHINES AND APPARATUS, NAMELY, COMPUTERS AND COMPUTER PERIPHERAL DEVICES, AND STRUCTURAL PARTS THEREOF; PNEUMATIC OR HYDRAULIC MACHINES AND INSTRUMENTS, NAMELY, ELECTRIC ACCUMULATORS (U.S. CLS. 21, 23, 26, 36 AND 38).
DAWN HAN, EXAMINING ATTORNEY

SN 77-929,498. LIVE INTENT, INC., NEW YORK, NY. FILED 2-5-2010.

LINDA E. BLOHM, EXAMINING ATTORNEY

LIVEINTENT

THE MARK CONSISTS OF STANDARD CHARACTERS WITHOUT CLAIM TO ANY PARTICULAR FONT, STYLE, SIZE, OR COLOR.

CLASS 35—ADVERTISING AND BUSINESS

FOR ADVERTISING, MARKETING AND PROMOTION SERVICES BY THE TRANSMISSION OF ADVERTISING MATERIAL AND THE DISSEMINATION OF ADVERTISING MESSAGES ON COMPUTER NETWORKS AND WIRELESS COMMUNICATIONS NETWORKS; ON-LINE BUSINESS NETWORKING SERVICES; AFFILIATE MARKETING SERVICES, NAMELY, PROMOTING THE GOODS AND SERVICES OF OTHERS BY PLACING PROMOTIONAL ADVERTISEMENTS VIA THE INTERNET AND WIRED AND WIRELESS COMMUNICATION DEVICES; ONLINE ADVERTISING AND MARKETING SERVICES, NAMELY, PROVIDING PAY FOR PERFORMANCE AND PAY-PER-CLICK ADVERTISING; ONLINE AUCTION SERVICES, NAMELY, AN ONLINE AUCTION EXCHANGE FOR BUYING AND SELLING DIGITAL ADVERTISING (U.S. CLS. 100, 101 AND 102).

FIRST USE 11-23-2009; IN COMMERCE 11-23-2009.

CLASS 38—COMMUNICATION

FOR TELECOMMUNICATION SERVICES, NAMELY, PROVIDING ONLINE FACILITIES FOR REAL-TIME INTERACTION BETWEEN AND AMONG USERS OF COMPUTERS, MOBILE AND HANDHELD COMPUTERS, AND WIRED AND WIRELESS COMMUNICATION DEVICES IN THE FIELD OF GENERAL INTEREST (U.S. CLS. 100, 101 AND 104).

FIRST USE 11-29-2009; IN COMMERCE 11-29-2009.

CLASS 41—EDUCATION AND ENTERTAINMENT

FOR ENTERTAINMENT SERVICES, NAMELY, PROVIDING ONLINE BLOGS FEATURING AUDIO CLIPS, VIDEO CLIPS, MULTI-MEDIA MATERIAL AND USER-DEFINED CONTENT IN THE FIELD OF SOCIAL NETWORKING (U.S. CLS. 100, 101 AND 107).

FIRST USE 11-23-2009; IN COMMERCE 11-23-2009.

CLASS 42—SCIENTIFIC AND COMPUTER SERVICES

FOR APPLICATION SERVICE PROVIDER FEATURING SOFTWARE TO ENABLE UPLOADING, POSTING, SHOWING, DISPLAYING, TAGGING, BLOGGING, SHARING OR PROVIDING ELECTRONIC MEDIA OVER THE INTERNET OR OTHER COMMUNICATIONS NETWORKS; COMPUTER SERVICES, NAMELY, CREATING AN ONLINE COMMUNITY FOR REGISTERED USERS TO ENGAGE IN SOCIAL NETWORKING; COMPUTER SERVICES, NAMELY, PROVIDING TEMPORARY USE OF ONLINE NON-DOWNLOADABLE SOFTWARE TO MANAGE AN ONLINE AFFILIATE MARKETING NETWORK; PROVIDING TEMPORARY USE OF ONLINE NON-DOWNLOADABLE SOFTWARE TO MANAGE AN ADVERTISING EXCHANGE (U.S. CLS. 100 AND 101).

FIRST USE 11-23-2009; IN COMMERCE 11-23-2009.

CLASS 45—PERSONAL AND LEGAL SERVICES

FOR ONLINE SOCIAL NETWORKING SERVICES (U.S. CLS. 100 AND 101).

FIRST USE 11-23-2009; IN COMMERCE 11-23-2009.

SN 77-946,849. NAVIGANT CONSULTING, INC., CHICAGO, IL. FILED 2-28-2010.

ETHOS PARTNERS

THE MARK CONSISTS OF STANDARD CHARACTERS WITHOUT CLAIM TO ANY PARTICULAR FONT, STYLE, SIZE, OR COLOR.

NO CLAIM IS MADE TO THE EXCLUSIVE RIGHT TO USE "PARTNERS", APART FROM THE MARK AS SHOWN.

CLASS 35—ADVERTISING AND BUSINESS

FOR MEDICAL AND HEALTHCARE PROVIDER REVENUE CYCLE MANAGEMENT SERVICES, NAMELY, ADMINISTRATION, BILLING, AND RECONCILIATION OF ACCOUNTS ON BEHALF OF OTHERS; MEDICAL BILLING OUTSOURCING SERVICES AND MEDICAL BILLING SUPPORT SERVICES; MEDICAL AND HEALTHCARE PROVIDER SUPPORT SERVICES IN THE NATURE OF BILLING CODING SERVICES (U.S. CLS. 100, 101 AND 102).

FIRST USE 7-12-2005; IN COMMERCE 7-12-2005.

CLASS 36—INSURANCE AND FINANCIAL

FOR DEBT COLLECTION MANAGEMENT FOR MEDICAL AND HEALTHCARE PROVIDERS, NAMELY, PROVIDING FINANCIAL OVERSIGHT, SUPERVISION AND COORDINATION WITH RESPECT TO MONIES OWED MEDICAL AND HEALTHCARE PROVIDERS; INSURANCE CLAIM ADMINISTRATION AND ADJUSTMENT; DEVELOPMENT OF AMBULATORY SURGICAL CENTERS, NAMELY, CONDUCTING FINANCIAL FEASIBILITY STUDIES (U.S. CLS. 100, 101 AND 102).

FIRST USE 7-12-2005; IN COMMERCE 7-12-2005.

MARCIE MILONE, EXAMINING ATTORNEY

SN 77-956,879. HB, L.L.C., SANTA MONICA, CA. FILED 3-11-2010.

GLO

THE MARK CONSISTS OF STANDARD CHARACTERS WITHOUT CLAIM TO ANY PARTICULAR FONT, STYLE, SIZE, OR COLOR.

CLASS 36—INSURANCE AND FINANCIAL

FOR PROVIDING AN INTERACTIVE WEBSITE FEATURING INFORMATION IN THE FIELD OF PERSONAL FINANCE (U.S. CLS. 100, 101 AND 102).

CLASS 39—TRANSPORTATION AND STORAGE

FOR PROVIDING AN INTERACTIVE WEBSITE FEATURING INFORMATION IN THE FIELD OF TRAVEL (U.S. CLS. 100 AND 105).

CLASS 41—EDUCATION AND ENTERTAINMENT

FOR PROVIDING NEWS, INFORMATION AND COMMENTARY IN THE FIELDS OF FASHION, ENTERTAINMENT, HOME DECOR, INTERIOR DECORATING, INTERIOR DESIGN, MUSIC, MOVIES, BOOKS, CURRENT EVENTS, AND CLOTHING; NONE OF THE AFORESAID SERVICES IN CONNECTION WITH THE STUDY OF THE BIBLE OR CHRISTIAN PUBLICATIONS (U.S. CLS. 100, 101 AND 107).

CLASS 43—HOTEL AND RESTAURANT SERVICES

FOR PROVIDING AN INTERACTIVE WEBSITE FEATURING INFORMATION IN THE FIELDS OF CUISINE AND COOKING (U.S. CLS. 100 AND 101).

CLASS 44—MEDICAL, BEAUTY AND AGRICULTURAL SERVICES

FOR PROVIDING AN INTERACTIVE WEBSITE FEATURING INFORMATION IN THE FIELDS OF HEALTH AND BEAUTY (U.S. CLS. 100 AND 101).

CLASS 45—PERSONAL AND LEGAL SERVICES

FOR PROVIDING AN INTERACTIVE WEBSITE FEATURING INFORMATION ON LIFESTYLES AND PERSONAL AND PROFESSIONAL RELATIONSHIPS (U.S. CLS. 100 AND 101).

PATRICIA EVANKO, EXAMINING ATTORNEY

SN 77-982,321. IP APPLICATION DEVELOPMENT LLC, WILMINGTON, DE. FILED 1-16-2010.

IPAD

THE MARK CONSISTS OF STANDARD CHARACTERS WITHOUT CLAIM TO ANY PARTICULAR FONT, STYLE, SIZE, OR COLOR.

PRIORITY CLAIMED UNDER SEC. 44(D) ON TRINIDAD/TOBAGO APPLICATION NO. 41168, FILED 7-16-2009. SEC. 2(F).

CLASS 9—ELECTRICAL AND SCIENTIFIC APPARATUS

FOR HANDHELD MOBILE DIGITAL ELECTRONIC DEVICES COMPRISING A TABLET COMPUTER, ELECTRONIC BOOK READER, DIGITAL AUDIO AND VIDEO PLAYER, ELECTRONIC PERSONAL ORGANIZER, PERSONAL DIGITAL ASSISTANT, ELECTRONIC CALENDAR, AND GLOBAL POSITIONING SYSTEM (GPS) DEVICE, AND CAPABLE OF PROVIDING ACCESS TO THE INTERNET AND SENDING, RECEIVING, AND STORING MESSAGES AND OTHER DATA; USER MANUALS IN ELECTRONICALLY READABLE, MACHINE READABLE OR COMPUTER READABLE FORM FOR USE WITH, AND SOLD AS A UNIT WITH, THE AFOREMENTIONED GOODS (U.S. CLS. 21, 23, 26, 36 AND 38).

CLASS 28—TOYS AND SPORTING GOODS

FOR HAND HELD UNITS FOR PLAYING ELECTRONIC GAMES OTHER THAN THOSE ADAPTED FOR USE WITH AN EXTERNAL DISPLAY SCREEN OR MONITOR (U.S. CLS. 22, 23, 38 AND 50).

HELENE LIWINSKI, EXAMINING ATTORNEY

SN 78-709,994. ENTERTAINMENT NETWORKS LIMITED, ALDERNEY, CHANNEL ISLANDS, FILED 9-9-2005.

PokerTime

THE MARK CONSISTS OF STANDARD CHARACTERS WITHOUT CLAIM TO ANY PARTICULAR FONT, STYLE, SIZE, OR COLOR.

PRIORITY CLAIMED UNDER SEC. 44(D) ON ERP CMNTY TM OFC APPLICATION NO. 4599999, FILED 8-22-2005.

OWNER OF BELIZE REG. NO. 7780.11, DATED 12-12-2011, EXPIRES 5-12-2021.

CLASS 9—ELECTRICAL AND SCIENTIFIC APPARATUS

FOR COMPUTER SOFTWARE FOR PLAYING CASINO-TYPE GAMES THAT MAY BE DOWNLOADED FROM A GLOBAL COMPUTER NETWORK; ELECTRONIC BOARD GAME SOFTWARE; DOWNLOADABLE ELECTRONIC PUBLICATIONS IN THE NATURE OF MAGAZINES, NEWSLETTERS, INFORMATION SHEETS AND INSTRUCTION MANUALS FEATURING INFORMATION CONCERNING BETTING, GAMBLING, GAMING, CASINO GAMING AND GAMES OF CHANCE PROVIDED ONLINE FROM DATABASES OR THE INTERNET; DOWNLOADABLE ELECTRONIC PUBLICATIONS IN THE NATURE OF MAGAZINES, NEWSLETTERS, INFORMATION SHEETS AND INSTRUCTION MANUALS FEATURING INFORMATION CONCERNING BETTING, GAMBLING, GAMING, CASINO GAMING AND GAMES OF CHANCE PROVIDED BY ELECTRONIC MAIL; GAMING MACHINES FOR USE IN GAMING ESTABLISHMENTS; SLOT MACHINES (U.S. CLS. 21, 23, 26, 36 AND 38).

CLASS 28—TOYS AND SPORTING GOODS

FOR CASINO GAMBLING AND BETTING GAME EQUIPMENT, NAMELY, PLAYING CARDS, CHIPS, POKER CHIPS, GAMING TABLES, POKER TABLES (U.S. CLS. 22, 23, 38 AND 50).

CLASS 41—EDUCATION AND ENTERTAINMENT

FOR PROVISION OF CASINO SERVICES; BETTING SERVICES; GAMBLING SERVICES; GAMING SERVICES, NAMELY, PROVIDING LOTTERIES, SWEEPSTAKES, GAMES OF CHANCE, CARD GAMES, NUMBER GAMES AND CONTESTS BY MEANS OF COMPUTER NETWORKS, INTRANETS AND THE INTERNET; INFORMATION SERVICES RELATING TO BETTING, GAMBLING AND GAMING SERVICES; OPERATION OF ONLINE BETTING SERVICES VIA THE INTERNET; OPERATION OF ONLINE GAMBLING SERVICES VIA THE INTERNET; OPERATION OF ONLINE GAMING SERVICES VIA THE INTERNET, NAMELY, PROVIDING ONLINE POKER GAMES AND ONLINE INTERACTIVE COMPUTER GAMES; PROVIDING AN ONLINE COMPUTER DATABASE FEATURING INFORMATION ON BETTING, GAMBLING, GAMING, POKER AND CASINOS (U.S. CLS. 100, 101 AND 107).

KRISTINA MORRIS, EXAMINING ATTORNEY

SN 78-787,667. MARTELLO, JEANNETTE, SOUTH PASADENA, CA. FILED 1-9-2006.

SN 79-071,329. GETRONICS N.V., AMSTERDAM, NETHERLANDS, FILED 11-13-2008.

MORE THAN SKIN DEEP



THE MARK CONSISTS OF STANDARD CHARACTERS WITHOUT CLAIM TO ANY PARTICULAR FONT, STYLE, SIZE, OR COLOR.

OWNER OF U.S. REG. NO. 2,932,593.

CLASS 3—COSMETICS AND CLEANING PREPARATIONS

FOR NON-MEDICATED SKIN CARE PREPARATIONS, ASTRINGENTS FOR COSMETIC PURPOSES, BATH OILS FOR COSMETIC PURPOSES, BLEACHING PREPARATIONS FOR COSMETIC PURPOSES, BODY AND BEAUTY CARE COSMETICS, COSMETIC CLEANSING CREAMS, COCOA BUTTER FOR COSMETIC PURPOSES, CONCEALERS, COSMETIC CREAMS FOR SKIN CARE, COSMETIC FACIAL BLOTING PAPERS, COSMETIC OILS, COSMETIC PADS, COSMETIC PENCILS, COSMETIC PREPARATIONS FOR SKIN RENEWAL, COSMETIC PREPARATIONS FOR BODY CARE, COSMETIC PREPARATIONS AGAINST SUNBURN, COSMETIC PREPARATIONS FOR EYE LASHES, COSMETIC PREPARATIONS FOR THE CARE OF MOUTH AND TEETH, COSMETIC PRODUCTS IN THE FORM OF AEROSOLS FOR SKIN CARE, COSMETIC ROUGES, COSMETIC SOAPS, COSMETIC SUNTAN LOTIONS, FACE CREAMS FOR COSMETIC USE, FOAMS CONTAINING COSMETICS AND SUNSCREENS, FOUNDATIONS, NUTRITIONAL OILS FOR COSMETIC PURPOSES, PENCILS FOR COSMETIC PURPOSES, ROSE OIL FOR COSMETIC PURPOSES, SHAMPOOS, TONERS, WRINKLE REMOVING SKIN CARE PREPARATIONS, WRINKLE REDUCTION SKIN CARE PREPARATIONS, AGE RETARDANT LOTION, BABY LOTION, BODY LOTION, BEAUTY LOTIONS, EYE LOTIONS, HAND LOTIONS, FACE LOTIONS, LOTIONS FOR CELLULITE REDUCTION, LOTIONS FOR STRENGTHENING THE NAILS, SHAVING LOTION, MAKE-UP REMOVING LOTIONS; MAKE-UP REMOVING MILK, GEL, LOTIONS AND CREAMS, NON-MEDICATED STIMULATING LOTIONS FOR THE SKIN, SKIN CLEANSING LOTION, HAIR LOTIONS, STYLING LOTIONS, SUN TAN LOTIONS, SUN CARE LOTIONS, SUN-BLOCK LOTIONS, TONING LOTION, FOR THE FACE, BODY AND HANDS, TEETH CLEANING LOTIONS (U.S. CLS. 1, 4, 6, 50, 51 AND 52).

CLASS 5—PHARMACEUTICALS

FOR ALMOND OIL FOR PHARMACEUTICAL PURPOSES, ANTIBACTERIAL PHARMACEUTICALS, PHARMACEUTICAL ASTRINGENTS, BISMUTH PREPARATIONS FOR PHARMACEUTICAL PURPOSES, DERMATOLOGICAL PHARMACEUTICAL PRODUCTS, PHARMACEUTICAL PREPARATIONS FOR TREATING SKIN DISORDERS, PHARMACEUTICAL PREPARATIONS FOR USE IN DERMATOLOGY, PHARMACEUTICAL PRODUCTS AND PREPARATIONS FOR CHLOASMA, PHARMACEUTICAL PRODUCTS AND PREPARATIONS FOR HYDRATING THE SKIN DURING PREGNANCY, PHARMACEUTICAL PRODUCTS AND PREPARATIONS FOR PREVENTING SKIN BLEMISHES DURING PREGNANCY, PHARMACEUTICAL PRODUCTS AND PREPARATIONS TO PREVENT STRETCH MARKS, PHARMACEUTICAL SKIN LOTIONS (U.S. CLS. 6, 18, 44, 46, 51 AND 52).

ADA HAN, EXAMINING ATTORNEY

PRIORITY DATE OF 10-23-2008 IS CLAIMED.

OWNER OF INTERNATIONAL REGISTRATION 1008811 DATED 11-13-2008, EXPIRES 11-13-2018.

THE COLOR(S) BLACK, WHITE, GREEN, BLUE, ORANGE, RED IS/ARE CLAIMED AS A FEATURE OF THE MARK.

THE MARK CONSISTS OF A BLACK RECTANGLE FEATURING HORIZONTAL LINES IN THE COLORS GREEN, RED, ORANGE, BLUE AND WHITE. THE LINES IN THE CENTER OF THE DRAWING FORM A CIRCLE AND ARE SHADED IN RED, GREEN, ORANGE, BLUE AND WHITE, FROM TOP TO BOTTOM. THE WORDING "GETRONICS" APPEARS OVER THE LINES, WITH THE LETTERS "GETR" AND "NICS" APPEARING IN WHITE AND THE "O" IS THE CIRCLE FORMED BY THE COLORED HORIZONTAL LINES.

CLASS 35—ADVERTISING AND BUSINESS

FOR ADVERTISING SERVICES; BUSINESS MANAGEMENT; BUSINESS ADMINISTRATION; PROVIDING OFFICE FUNCTIONS; PROFESSIONAL BUSINESS CONSULTANCY; BUSINESS MANAGEMENT, BUSINESS ECONOMICS AND BUSINESS ADMINISTRATION CONSULTANCY; BUSINESS SERVICES IN THE FIELD OF AUTOMATIC DATA PROCESSING, NAMELY, CONSULTANCY REGARDING THE SYSTEMATIC ORDERING OF INFORMATION IN COMPUTER DATABASES AND COMPILATION OF INFORMATION IN COMPUTER DATABASES; BUSINESS MEDIATION WITH REGARD TO THE PURCHASE AND SALE OF COMPUTERS, COMPUTER PERIPHERALS, TELECOMMUNICATIONS AND DATA COMMUNICATIONS DEVICES, COMPUTER SOFTWARE AND OFFICE MACHINES FOR THIRD PARTIES; SALES PROMOTION, FOR OTHERS, WITH REGARD TO COMPUTERS, COMPUTER PERIPHERALS, TELECOMMUNICATIONS AND DATA COMMUNICATIONS DEVICES, COMPUTER SOFTWARE AND OFFICE MACHINES; DEMONSTRATION OF COMPUTERS, COMPUTER PERIPHERALS, TELECOMMUNICATIONS AND DATA COMMUNICATIONS DEVICES, COMPUTER SOFTWARE AND OFFICE MACHINES FOR COMMERCIAL AND ADVERTISING PURPOSES; BRINGING TOGETHER, FOR OTHERS, OF COMPUTERS, COMPUTER PERIPHERALS, TELECOMMUNICATIONS AND DATA COMMUNICATIONS DEVICES, COMPUTER SOFTWARE AND OFFICE MACHINES EXCEPT THE TRANSPORT THEREOF, TO ALLOW CONSUMERS TO VIEW AND PURCHASE THE AFORESAID GOODS EASILY; PROCESSING OF SALARY DATA, CALCULATING SALARIES, PROCESSING DATA IN THE FIELD OF PERSONNEL MANAGEMENT; RETAIL STORE SERVICES IN RESPECT OF TELECOMMUNICATIONS APPARATUS, SOFTWARE AND COMPUTER APPARATUS, PHOTOGRAPHIC APPARATUS AND INSTRUMENTS (U.S. CLS. 100, 101 AND 102).

CLASS 36—INSURANCE AND FINANCIAL

FOR PROFESSIONAL FINANCIAL CONSULTANCY; ELECTRONIC FUNDS TRANSFER (U.S. CLS. 100, 101 AND 102).

CLASS 37—CONSTRUCTION AND REPAIR

FOR INSTALLATION, REPAIR AND MAINTENANCE OF COMPUTER HARDWARE; TECHNICAL CONSULTANCY REGARDING THE INSTALLATION, REPAIR AND MAINTENANCE OF COMPUTER HARDWARE; BUILDING CONSTRUCTION; MAINTENANCE AND REPAIR OF COMPUTERS, COMPUTER PERIPHERALS, INTERNET COMPUTER DEVICES, TELECOMMUNICATIONS AND DATA COMMUNICATIONS DEVICES AND OFFICE MACHINES; INSTALLATION OF COMPUTERS; INSTALLATION OF CABLES AND NETWORKS IN OFFICES; INSTALLATION OF AIR-CONDITIONING INSTALLATIONS; INSTALLATION OF TRANSMISSION APPARATUS FOR COMMUNICATIONS AND MOBILE COMMUNICATIONS; CONSULTANCY REGARDING THE INSTALLATION AND MAINTENANCE OF COMPUTER HARDWARE, AS PART OF A LOCAL OR WIDE-AREA NETWORK OR A GLOBAL COMPUTER NETWORK OR INDEPENDENT OF SUCH NETWORKS (U.S. CLS. 100, 103 AND 106).

CLASS 38—COMMUNICATION

FOR TELECOMMUNICATION SERVICES, NAMELY, PROVIDING TELEPHONE COMMUNICATIONS SERVICES; PROVIDING ACCESS TO THE INTERNET; ELECTRONIC DATA TRANSMISSION; TECHNICAL ADVICE WITH REGARD TO TELECOMMUNICATIONS SERVICES, EQUIPMENT, AND PERIPHERAL EQUIPMENT; TELECOMMUNICATIONS SERVICES, NAMELY, TELEPHONE SERVICES; DATA COMMUNICATIONS BY ELECTRONIC MAIL; OPTICAL FIBRE NETWORK COMMUNICATIONS SERVICES; CALL SERVICES MAKING USE OF RADIO, TELEPHONE OR OTHER ELECTRONIC MEANS OF COMMUNICATION, NAMELY, ELECTRONIC COMMUNICATIONS NETWORKS; WIRELESS BROADBAND COMMUNICATIONS SERVICES; COMMUNICATION SERVICES WITH REMOTE SCREENS, NAMELY, VIDEO CONFERENCING; INSTANT MESSAGE-SENDING SERVICES; COMMUNICATIONS SERVICES USING REMOTE COMPUTERS; ARTIFICIAL SATELLITE COMMUNICATIONS SERVICES; PROVIDING INFORMATION IN THE FIELD OF TELECOMMUNICATIONS; ELECTRONIC MAIL; TELEPHONE SERVICES; TELEPHONE COMMUNICATIONS SERVICES; COMPUTER-AIDED TRANSMISSION OF MESSAGES AND IMAGES; COMPUTER COMMUNICATIONS SERVICES, NAMELY, ELECTRONIC TRANSMISSION OF DATA AND DOCUMENTS AMONG USERS OF COMPUTERS; MOBILE TELEPHONE COMMUNICATIONS SERVICES; CABLE TELEVISION BROADCASTING (U.S. CLS. 100, 101 AND 104).

CLASS 42—SCIENTIFIC AND COMPUTER SERVICES

FOR CONSULTANCY REGARDING COMPUTERS, COMPUTER PERIPHERALS AND COMPUTER SOFTWARE; COMPUTER SOFTWARE MAINTENANCE; COMPUTER SOFTWARE DEVELOPMENT AND ADJUSTMENT, NAMELY, UPDATING; COMPUTER DATA SOFTWARE ADJUSTMENT, NAMELY, UPDATING; COMPUTER PROGRAMMING; RENTAL OF ACCESS TIME TO GLOBAL COMPUTER DATABASES; RENTAL OF COMPUTERS AND COMPUTER PERIPHERALS; CONSULTANCY REGARDING THE DESIGN, INSTALLATION, INTEGRATION MANAGEMENT AND MAINTENANCE OF SOFTWARE AND LOCAL AND WIDE-AREA COMPUTER NETWORKS AND GLOBAL COMPUTER NETWORKS; CONSULTANCY REGARDING COMPUTER HARDWARE DESIGN; CONSULTANCY REGARDING INTEGRATION MANAGEMENT IN RESPECT OF COMPUTER HARDWARE; CONSULTANCY REGARDING THE DESIGN AND MAINTENANCE OF WEBSITES AND PORTALS; DESIGN OF WEBSITES AND PORTALS; TECHNICAL CONSULTING AND ASSISTANCE WITH COMPUTER-BASED INFORMATION SYSTEMS AND COMPONENTS; COMPUTER CONSULTANCY REGARDING THE SELECTION OF

COMPUTER HARDWARE, COMPUTER SOFTWARE AND LOCAL AND WIDE-AREA NETWORKS AND GLOBAL NETWORKS; TECHNICAL CONSULTANCY AND ASSISTANCE WITH COMPUTER BASED INFORMATION SYSTEMS AND COMPONENTS, NAMELY, COMPUTER HARDWARE NOT INCLUDING THE INSTALLATION, REPAIR AND MAINTENANCE OF HARDWARE, SOFTWARE AND COMPUTERISATION CONCEPTS; LEASING OF COMPUTERS, COMPUTER PERIPHERALS, DATA COMMUNICATIONS APPARATUS, COMPUTER SOFTWARE AND OFFICE MACHINES (U.S. CLS. 100 AND 101).

MARILYN IZZI, EXAMINING ATTORNEY

SN 79-074,712. MAPEI S.P.A., ITALY, FILED 7-2-2009.

MAPEI ULTRALITE

THE MARK CONSISTS OF STANDARD CHARACTERS WITHOUT CLAIM TO ANY PARTICULAR FONT, STYLE, SIZE, OR COLOR.

OWNER OF INTERNATIONAL REGISTRATION 1018203 DATED 7-2-2009, EXPIRES 7-2-2019.

OWNER OF U.S. REG. NOS. 2,252,757, 3,623,147 AND OTHERS.

NO CLAIM IS MADE TO THE EXCLUSIVE RIGHT TO USE "ULTRALITE", APART FROM THE MARK AS SHOWN.

CLASS 1—CHEMICALS

FOR CHEMICAL PRODUCTS FOR USE IN INDUSTRY; UNPROCESSED ARTIFICIAL AND SYNTHETIC RESINS; DISPERSIONS OF PLASTICS, NAMELY, PLASTICIZERS AND PLASTISOLS FOR USE AS ADDITIVES IN CEMENT AND CONCRETE; ADHESIVES FOR INDUSTRIAL USE; ROOFING ADHESIVES; CONSTRUCTION INDUSTRY ADHESIVES, ADHESIVES FOR GENERAL INDUSTRIAL USE, ADHESIVES FOR USE IN APPLYING WALL COVERINGS, ADHESIVES FOR USE IN THE MANUFACTURE OF FURNITURE; SCALE PREVENTIVE AGENTS, NAMELY, CHEMICAL PRODUCTS FOR PREVENTING SCALE; CHEMICAL PRODUCTS FOR IMPROVING THE CHARACTERISTICS OF MORTARS AND CEMENT BLOCKS, NAMELY, DUAL COMPONENT CHEMICAL ADDITIVES FOR USE AS A BINDING AGENT IN CEMENT MORTARS (U.S. CLS. 1, 5, 6, 10, 26 AND 46).

CLASS 19—NON-METALLIC BUILDING MATERIALS

FOR CEMENT MIXES; CEMENT, NAMELY, PORTLAND CEMENT, MAGNESIA CEMENT, NON-AGRICULTURAL LIME FOR USE IN CONSTRUCTION; CEMENT GLUE, NAMELY, FILLING CEMENT; SLAG-LIME CEMENT; MORTAR; CONCRETE; CONCRETE ROAD PAVEMENT BOARDS, CRASH BARRIERS OF CONCRETE FOR ROADS; CONCRETE PANELS; LATEX FOR MIXING WITH CEMENT AND SAND AND FOR USE IN THE BUILDING INDUSTRY (U.S. CLS. 1, 12, 33 AND 50).

JESSICA FATHY, EXAMINING ATTORNEY

SN 79-083,964. WORLD FAMILY OF RADIO MARIA, I-00186 ROMA, ITALY, FILED 5-24-2010.

WORLD FAMILY OF RADIO MARIA

THE MARK CONSISTS OF STANDARD CHARACTERS WITHOUT CLAIM TO ANY PARTICULAR FONT, STYLE, SIZE, OR COLOR.

OWNER OF INTERNATIONAL REGISTRATION 1042654 DATED 5-24-2010, EXPIRES 5-24-2020.

NO CLAIM IS MADE TO THE EXCLUSIVE RIGHT TO USE "WORLD" AND "RADIO", APART FROM THE MARK AS SHOWN.

CLASS 9—ELECTRICAL AND SCIENTIFIC APPARATUS

FOR RECORDING DISCS, NAMELY, BLANK MAGNETIC DISCS, BLANK OPTICAL DISCS; RECORDING DISCS, NAMELY, PRE-RECORDED DVDS, CDS, CD-ROMS, AND VIDEOCASSETTES ALL FEATURING RELIGIOUS CONTENTS; RADIO APPARATUS, NAMELY, RADIOS (U.S. CLS. 21, 23, 26, 36 AND 38).

CLASS 16—PAPER GOODS AND PRINTED MATTER

FOR PAPER, CARDBOARD AND GOODS MADE FROM THESE MATERIALS, NOT INCLUDED IN OTHER CLASSES, NAMELY, PAPER AND CARDBOARD BOXES, ADHESIVE LABELS, ADHESIVE NOTE PADS; POSTCARDS, BOOKMARKS, NOTEBOOKS, DIARIES, CALENDARS, AND HOLY PICTURES; PRINTED MATTER, NAMELY, NEWSPAPERS, PHOTOGRAPHS, MAGAZINES, BOOKS, PRINTED PERIODICALS, NEWSLETTERS, AND BROCHURES ALL IN THE FIELD OF RELIGION (U.S. CLS. 2, 5, 22, 23, 29, 37, 38 AND 50).

CLASS 38—COMMUNICATION

FOR TELECOMMUNICATIONS, NAMELY, BROADBAND RADIO COMMUNICATIONS SERVICES, AUDIO TELECONFERENCING, CABLE RADIO BROADCASTING, CALL FORWARDING SERVICES, CHAT ROOM SERVICES FOR SOCIAL NETWORKING; RADIO BROADCASTING STATIONS (U.S. CLS. 100, 101 AND 104).

CLASS 41—EDUCATION AND ENTERTAINMENT

FOR EDUCATION SERVICES, NAMELY, PROVIDING CLASSES, SEMINARS, AND WORKSHOPS IN THE FIELD OF RELIGION; ORGANIZING COMMUNITY SPORTING AND CULTURAL EVENTS (U.S. CLS. 100, 101 AND 107).

HAI-LY LAM, EXAMINING ATTORNEY

THE MARK CONSISTS OF A STYLIZED HEART CONTAINING THE WORDING "TEA SISTERS" WITH A SMALL HEART OVER THE "I" IN "SISTERS", FIVE STYLIZED MICE WITH HAIR AND CLOTHING, AND A BACKGROUND DESIGN OF STYLIZED BRANCHES OR FANCIFUL CURVED LINES.

CLASS 3—COSMETICS AND CLEANING PREPARATIONS

FOR BLEACHING PREPARATIONS AND OTHER SUBSTANCES FOR LAUNDRY USE, NAMELY, LAUNDRY DETERGENTS, LAUNDRY SOAP, LAUNDRY BLEACH, ESSENTIAL OILS AS PERFUME FOR LAUNDRY PURPOSES, LAUNDRY STARCH; CLEANING, POLISHING, SCOURING AND ABRASIVE PREPARATIONS; SOAPS; PERFUMERY; ESSENTIAL OILS; COSMETICS, HAIR LOTIONS, DENTIFRICES; FRAGRANCED BODY CARE PREPARATIONS, NAMELY, BODY SCRUBS, SHOWER GELS, BODY BALM, BODY POLISH; SHAMPOOS; NON-MEDICATED BALMS FOR USE ON HAIR, SKIN AND LIPS; SKIN AND BODY CREAMS (U.S. CLS. 1, 4, 6, 50, 51 AND 52).

CLASS 14—JEWELRY

FOR PRECIOUS METALS AND THEIR ALLOYS AND GOODS IN PRECIOUS METALS OR COATED THEREWITH, NOT INCLUDED IN OTHER CLASSES, NAMELY, BRACELETS, BANGLES, BODY PIERCING RINGS, BUCKLES, CHARMS, CHOKERS, CUFF LINKS, DECORATIVE BOXES MADE OF PRECIOUS METAL, EAR CLIPS, EAR STUDS, EARRINGS, FANCY KEY RINGS, KEY CHAINS, KEY HOLDERS, FIGURINES, CHAINS, PENDANTS, RINGS, ANKLETS, ARM CUFFS, NECKLACES, LOCKETS, TIE BARS, TIE CLIPS; JEWELRY, PRECIOUS STONES; HOROLOGICAL AND CHRONOMETRIC INSTRUMENTS (U.S. CLS. 2, 27, 28 AND 50).

CLASS 16—PAPER GOODS AND PRINTED MATTER

FOR PAPER, CARDBOARD AND GOODS MADE FROM THESE MATERIALS, NOT INCLUDED IN OTHER CLASSES, NAMELY, ADDRESS BOOKS, PAPER LABELS, PAPER AND CARDBOARD; PRINTED MATTER, NAMELY, PRINTED AWARDS, PRINTED INVITATIONS, GREETING CARDS, SCRAPBOOKS; BAGS, ENVELOPES AND/OR POUCHES OF PAPER AND/OR PLASTICS FOR PACKAGING, BOOKMARKERS, DISPOSABLE BABIES' DIAPERS OF PAPER AND CELLULOSE, TOWELS OF PAPER, NAPKINS OF PAPER, MODELING CLAY; PRINTED MATTER, NAMELY, TEACHING MATERIALS IN THE FIELD OF MATHEMATICS, GEOGRAPHY, HISTORY, ORGANIC AND INORGANIC SCIENCE, COMPUTING, LANGUAGE; BOOKBINDING MATERIAL; PHOTOGRAPHS; STATIONERY; ADHESIVES FOR STATIONERY OR HOUSEHOLD PURPOSES; ARTISTS' MATERIALS, NAMELY, BRUSHES, PASTELS; PAINT BRUSHES, DRAWING BOARDS, DRAWING INSTRUMENTS, NAMELY, PADS, PENS AND PINS; TYPEWRITERS AND OFFICE REQUISITES, NAMELY, STAPLERS, RUBBER BANDS, PENCILS, PENS, RUBBER ERASERS; PRINTED INSTRUCTIONAL AND TEACHING MATERIAL IN THE FIELD OF PUBLICATION OF TEXTS, BOOKS, MAGAZINES AND OTHER PRINTED MATTER IN THE FORM OF NEWSPAPERS, PHOTOGRAPHS, MAGAZINES, BOOKS, PRINTED PERIODICALS, SONG BOOKS, ALMANACS, BOOKLETS, NEWSLETTERS, AND BROCHURES IN THE FIELD OF MATHEMATICS, GEOGRAPHY, HISTORY, ORGANIC AND INORGANIC SCIENCE, COMPUTING, LANGUAGE; PLASTIC MATERIALS FOR PACKAGING, NAMELY, AN ALL-IN-ONE PORTABLE CARDBOARD BOX THAT DISPENSES BOTH CUPS MADE OF PAPER, PLASTIC OR OTHER MATERIAL AND LIQUIDS, NAMELY, FOR DOMESTIC USE; PRINTERS' TYPE; PRINTING BLOCKS; PHOTOGRAPHIC ALBUMS, PHOTOGRAPHIC PRINTS, POSTAGE STAMPS (U.S. CLS. 2, 5, 22, 23, 29, 37, 38 AND 50).

SN 79-088,139. ATLANTYCA SPA, ITALY, FILED 7-26-2010.



PRIORITY DATE OF 3-25-2010 IS CLAIMED.
OWNER OF INTERNATIONAL REGISTRATION 1053294 DATED 7-26-2010, EXPIRES 7-26-2020.

NO CLAIM IS MADE TO THE EXCLUSIVE RIGHT TO USE "TEA" IN CLASSES 30, 32 AND 43, APART FROM THE MARK AS SHOWN.

CLASS 20—FURNITURE AND ARTICLES NOT OTHERWISE CLASSIFIED

FOR FURNITURE, MIRRORS, PICTURE FRAMES; GOODS OF WOOD, CORK, REED, CANE, WICKER, HORN, BONE, IVORY, WHALEBONE, SHELL, AMBER, MOTHER-OF-PEARL, MEERSCHAUM AND SUBSTITUTES FOR ALL THESE MATERIALS, OR OF PLASTICS, NAMELY, PLASTIC SLEEPING BAGS FOR CAMPING, BINS NOT OF METAL, CHAIRS, CHESTS FOR TOYS, BOTTLE CLOSURES NOT OF METAL, PLASTIC CUSHIONS, PLASTIC PET CUSHIONS, DECORATIONS OF PLASTIC FOR FOODSTUFFS, FIGURINES AND/OR STATUETTES OF WOOD, WAX, PLASTER OR PLASTIC, COAT HANGERS, MATS FOR INFANT PLAYPENS, INFANT WALKERS, INFLATABLE PUBLICITY OBJECTS, PLASTIC PILLOWS, SCHOOL FURNITURE NOT OF METAL, NAMELY, CHAIRS, DESKS, WRITING DESKS (U.S. CLS. 2, 13, 22, 25, 32 AND 50).

CLASS 24—FABRICS

FOR TEXTILES AND TEXTILE GOODS, NOT INCLUDED IN OTHER CLASSES, NAMELY, PLACE MATS, HANDKERCHIEFS, ADHESIVE FABRIC FOR APPLICATION BY HEAT, BATH LINEN, EXCEPT CLOTHING, COVERS FOR CUSHIONS, HOUSEHOLD LINEN, LABELS OF CLOTH, MATTRESS COVERS, SHOWER CURTAINS OF TEXTILE OR PLASTIC, TABLE RUNNERS, BED BLANKETS AND TEXTILE TABLE COVERS (U.S. CLS. 42 AND 50).

CLASS 25—CLOTHING

FOR CLOTHING, NAMELY, PANTS, SHIRTS, BELT, BOTTOMS, BABIES' DIAPERS OF TEXTILE, TEXTILE BABIES' NAPPIES, BABIES' PANTS, BANDANAS, BATH ROBES, BATHING SUITS, BATHING TRUNKS, BEACHWEAR, CAMISOLES, CLOTHING FOR GYMNASTICS, NAMELY, LEOTARDS, GYMNASTIC SHOES, ATHLETIC TIGHTS, ATHLETIC UNIFORMS, PADDED SHORTS, PADDED PANTS, PADDED SHIRTS, GYM BOOTS; MASQUERADE COSTUMES, GLOVES, JUMPERS, LEGGINGS, PANTS, PAPER CLOTHING IN THE NATURE OF SHIRTS, SKIRTS, PANTS, BELTS, TIES, BOTTOMS, TROUSERS, JACKETS, PULLOVERS, PYJAMAS, SANDALS, SCARVES, SLIPS, SOCKS, SWEATERS, TROUSERS, UNDERWEAR, WATERPROOF CLOTHING IN THE NATURE OF SHIRTS, SKIRTS, PANTS, BELTS, TIES, BOTTOMS, TROUSERS, JACKETS; FOOTWEAR, NAMELY, BATH SANDALS, BATH SLIPPERS, BEACH SHOES, BOOTS, FOOTBALL BOOTS, FOOTBALL SHOES, GYMNASTIC SHOES, INNER SOLES; HEADGEAR, NAMELY, HATS, CAPS, BATHING CAPS, BERETS (U.S. CLS. 22 AND 39).

CLASS 28—TOYS AND SPORTING GOODS

FOR GAMES AND PLAYTHINGS, NAMELY, DICE GAMES, CRIB TOYS, AIR PISTOLS, AMUSEMENT GAME MACHINES, AUTOMATIC AND COIN-OPERATED, ARTIFICIAL FISHING BAIT, BALLOONS, BALLS FOR GAMES, BASEBALL GLOVES, BATS FOR GAME, BATTING GLOVES, BILLIARD BALLS, BILLIARD CUE TIPS, BILLIARD CUES, BILLIARD MARKERS, BILLIARD TABLE CUSHIONS, BILLIARD TABLES, COIN-OPERATED BILLIARD TABLES, BINGO CARDS, FISHING TACKLE, BUILDING BLOCKS, BOARD GAMES, BOB-SLEIGHS, BODY BOARDS, SKATING BOOTS WITH SKATES ATTACHED, BOWLING APPARATUS AND MACHINERY, BOXING GLOVES, BUILDING GAMES, BUTTERFLY NETS, PLAYING CARDS, CHECKERBOARDS, CHECKERS, CHESS GAMES, CHESSBOARDS, GOLF CLUBS, COIN-OPERATED BILLIARD TABLES, CRICKET BAGS, CUPS FOR DICE, DARTS, DICE, DOLLS, DOLLS' BEDS, DOLLS' CLOTHES, DOLLS' FEEDING BOTTLES, DOLLS' HOUSES, DOLLS' ROOMS, DOMINOES, DRAUGHTBOARDS, DRAUGHTS, DUMB-BELLS, ELECTRONIC TARGETS FOR GAMES AND SPORTS, FLIPPERS FOR SWIMMING, FLYING DISCS, TABLES FOR INDOOR FOOTBALL GAMES, MARBLES FOR GAMES, GOLF BAGS WITH OR WITHOUT WHEELS, ICE SKATES, IN-LINE ROLLER SKATES, JIGSAW PUZZLES, PRACTICAL JOKES IN THE NATURE OF FAKE TEETH, FAKE FLOWERS SQUIRTING

WATER, FAKE FINGERS, FAKE HANDS, FAKE FEET, FAKE PISTOLS SQUIRTING WATER, FAKE CIGARS, KALEIDOSCOPIES, MAH-JONG, MARIONETTES, SCALE MODEL VEHICLES, PINATAS, TOY SWIMMING POOLS, PUPPETS, RACKETS, RADIO-CONTROLLED TOY VEHICLES, RING GAMES, ROLLER SKATES, TOY SCOOTERS, SKATEBOARD, ICE SKATES, SNOW GLOBES, TOY SOAP BUBBLES, TABLES FOR TABLE TENNIS, TEDDY BEARS, THEATRICAL MASKS, TOY MASKS, TOY VEHICLES, TOYS FOR DOMESTIC PETS; GYMNASTIC AND SPORTING ARTICLES NOT INCLUDED IN OTHER CLASSES, NAMELY, BALANCE BEAMS, TENNIS BALLS; DECORATIONS FOR CHRISTMAS TREES (U.S. CLS. 22, 23, 38 AND 50).

CLASS 29—MEATS AND PROCESSED FOODS

FOR MEAT, FISH, POULTRY AND GAME, MEAT EXTRACTS, TINNED MEAT, PRESERVED, FROZEN, DRIED AND COOKED FRUITS AND VEGETABLES, JELLIES, JAMS, COMPOTES, EGGS, EDIBLE OILS AND FATS; LIQUID MILK, LIQUID MILK PRODUCTS, NAMELY, HALF AND HALF, VANILLA MILK, YOGURT, FLAVOURED MILK, LIQUID MILK AND YOGURT BASED PRODUCTS BUT NOT INCLUDING ANY OTHER DAIRY PRODUCTS, NAMELY, YOGURT-BASED BEVERAGES AND DRINKS, MILK BEVERAGES, NAMELY, BEVERAGES HAVING A MILK BASE (U.S. CL. 46).

CLASS 30—STAPLE FOODS

FOR COFFEE, TEA, COCOA, SUGAR, RICE, TAPIOCA, SAGO, ARTIFICIAL COFFEE; FLOUR AND PREPARATIONS MADE FROM CEREALS, NAMELY, CEREAL-BASED SNACK FOODS, BISCUITS MADE WITH CEREALS, BREAD, PASTRY AND CONFECTIONERY, NAMELY, FROZEN CONFECTIONERY, CRYSTAL SUGAR PIECES, ICES; HONEY, TREACLE; YEAST, BAKING-POWDER; SALT, MUSTARD; VINEGAR, SAUCES; SPICES; ICE; ALMOND CONFECTIONERY, ALMOND PASTE, ANISEED FOR USE AS A FLAVORING IN FOOD AND DRINKS, AROMATIC PREPARATIONS FOR FOOD IN THE NATURE OF SPICES, ARTIFICIAL COFFEE, BEER VINEGAR, COCOA-BASED BEVERAGES, COFFEE-BASED BEVERAGES, TEA-BASED BEVERAGES, GINGER BREAD, BREAD ROLLS, CAKE PASTE FLAVOURED WITH CHOCOLATE, ALMOND, VANILLA, BUTTER, CITRUS, PISTACHIO, NUT, YOGURT, CAKE POWDER FLAVORED WITH CHOCOLATE, ALMOND, VANILLA, BUTTER, CITRUS, PISTACHIO, NUT, YOGURT, CAKES, EDIBLE DECORATIONS FOR CAKES, CANDY FOR FOOD, CANDY CARAMELS, CEREAL PREPARATIONS, NAMELY, GRAIN-BASED ITEMS IN THE NATURE OF TACO SHELLS, BREAD, BISCUITS, TOASTED BREAD SLICES, BREADSTICKS, CEREAL-BASED SNACK FOOD, CHEWING GUM NOT FOR MEDICAL PURPOSES, CHOCOLATE, COFFEE, COFFEE BEVERAGES WITH MILK, COFFEE-BASED BEVERAGES, CORN FLAKES, CORN MEAL, CRACKERS, ICE CREAM, EDIBLE ICES, FARINACEOUS FOOD PASTES FOR HUMAN CONSUMPTION, ROLLED OATS AND WHEAT; FROZEN YOGURT, HONEY, ICED TEA, KETCHUP, MACARONI, PASTRY MACAROONS, MARZIPAN, MAYONNAISE, MUESLI, NOODLES, PANCAKES, PASTA, PETIT-BEURRE BISCUITS, PIES, PIZZAS, POWDERS FOR ICE CREAM, RAVIOLI, RICE, RICE CAKES, RICE-BASED SNACK FOOD, SANDWICHES, SPAGHETTI, SUGAR, CEREAL OR GRAIN BASED TACO SHELLS, TAPIOCA, TARTS, TEA, ICED TEA, TORTILLAS (U.S. CL. 46).

CLASS 32—LIGHT BEVERAGES

FOR BEER, NON-ALCOHOLIC BEVERAGES IN THE NATURE OF CARBONATED AND NON-CARBONATED BEVERAGES, NAMELY, FRUIT JUICES, NON CARBONATED SOFT DRINKS, NON-ALCOHOLIC HONEY-BASED BEVERAGES, NON-ALCOHOLIC CIDER, NON-ALCOHOLIC COCKTAILS, NON-ALCOHOLIC FRUIT EXTRACTS, NON-ALCOHOLIC FRUIT JUICE BEVERAGES, FRUIT JUICES, GINGER ALE, LEMONADES, MINERAL WATER, NON-ALCOHOLIC BEVERAGES, NAMELY, LOW CALORIE SOFT DRINKS, SODA WATER, SYRUPS FOR BEVERAGES, SYRUPS FOR LEMONADE, PREPARATIONS FOR MAKING AERATED WATER, MILK OF ALMONDS, NON-ALCOHOLIC APERITIFS (U.S. CLS. 45, 46 AND 48).

CLASS 41—EDUCATION AND ENTERTAINMENT

FOR SERVICES FOR EDUCATION AND ENTERTAINMENT, NAMELY, PROVIDING CLASSES IN THE FIELD OF SCIENCE, LIVE MUSIC CONCERTS; ORGANIZATION OF EDUCATIONAL, TRAINING AND REFRESHER COURSES IN THE FIELD OF SCIENCE, MATH, COLLOQUIUMS, SEMINARS, EXHIBITIONS, SHOWS, EVENTS, COMPETITIONS, ALL IN THE FIELD OF SCIENCE, MATH, CULTURAL AND SPORTING ACTIVITIES ALL FOR ENTERTAINMENT AND/OR EDUCATIONAL PURPOSES, ON-LINE PUBLICATION OF BOOKS AND TEXTS, FILM PRODUCTION, THEATRE PRODUCTIONS, PRODUCTION AND SHOWING OF TELEVISION AND RADIO EVENTS AND SHOWS (U.S. CLS. 100, 101 AND 107).

CLASS 43—HOTEL AND RESTAURANT SERVICES

FOR PROVIDING OF FOOD AND DRINK; TEMPORARY ACCOMMODATION (U.S. CLS. 100 AND 101).
TOBY BULLOFF, EXAMINING ATTORNEY

SN 79-092,312. SÜDWOLLE GMBH & CO. KG, FED REP GERMANY, FILED 12-15-2010.

STÖHR
BY SÜDWOLLE

PRIORITY DATE OF 8-4-2010 IS CLAIMED.
OWNER OF INTERNATIONAL REGISTRATION 1064356 DATED 12-15-2010, EXPIRES 12-15-2020.

THE COLOR(S) BLACK AND WHITE IS/ARE CLAIMED AS A FEATURE OF THE MARK.

THE MARK CONSISTS OF THE STYLIZED WORDING "STÖHR BY SUDWOLLE" IN BLACK WITHIN A WHITE RECTANGLE.

THE ENGLISH TRANSLATION OF "SUDWOLLE" IN THE MARK IS ROUGHLY SOUTHERN WOOL WHERE "SUDWOLLE" IS A COMBINATION OF TWO GERMAN WORDS "SUD" (SOUTH) AND "WOLLE" (WOOL).

CLASS 23—YARNS AND THREADS

FOR GOODS MADE IN SUBSTANTIAL PART OF WOOL, NAMELY, YARNS AND THREADS, FOR TEXTILE USE (U.S. CL. 43).

CLASS 24—FABRICS

FOR TEXTILES AND TEXTILE GOODS MADE IN SUBSTANTIAL PART OF WOOL, NAMELY, BATH LINEN, COTTON-BLEND FABRICS, BED BLANKETS, BED LINEN, BED SHEETS, BED COMFORTERS, COVERS FOR CUSHIONS, BILLIARDS CLOTHS, CHENILLE FABRICS, CREPON DAMASK, DRUGGET, FELT, LINEN CLOTHS, FLANNEL, FABRICS FOR TEXTILE USE, TOWELS OF TEXTILE, HOUSEHOLD LINEN, UPHOLSTERY AND UNFITTED SEAT COVERS OF TEXTILES, LINEN LINING FABRIC FOR SHOES, AND TABLE LINEN; PLASTIC TABLE COVERS (U.S. CLS. 42 AND 50).

CLASS 25—CLOTHING

FOR T-SHIRTS AND WET SUIT GLOVES; CLOTHING MADE IN SUBSTANTIAL PART OF WOOL, NAMELY, PULLOVERS, SPORTS JACKETS, RAINCOATS, SPORTS UNDERWEAR, JACKETS, CLIMBING TROUSERS, TRAINING SUITS, SKI CLOTHES, NAMELY, SCARVES, HEADWEAR, NAMELY, BOBBLE CAPS, SKI CAPS, WOOLEN HATS, WOOLEN CAPS, SKI PANTS, SKI JACKETS, SKI SUITS AND SOCKS, GLOVES, SAILING CLOTHES, NAMELY, TROUSERS, JACKETS, SOCKS AND SAILING SUITS, NAMELY, PANTS, SHIRTS, ONE-PIECE SUITS, CYCLING CLOTHING, NAMELY, PANTS, JACKETS, CYCLING SUITS, NAMELY, SHORTS, SHIRTS, AND SOCKS, JOGGING CLOTHES, NAMELY, PANTS, JACKETS, JOGGING SUITS AND SOCKS, HEADGEAR, NAMELY, HATS, CAPS, HEADBANDS, AND FOOTWEAR, HORSEBACK RIDING GLOVES (U.S. CLS. 22 AND 39).

CLASS 28—TOYS AND SPORTING GOODS

FOR GAMES AND PLAYTHINGS, NAMELY, KITES; GYMNASTIC AND SPORTING ARTICLES, NAMELY, ELBOW GUARDS FOR ATHLETIC USE, GOLF BAGS, GYMNASTICS APPARATUS, GLOVES FOR GAMES, NAMELY, BOXING GLOVES, FENCING GLOVES, BASEBALL GLOVES, FOOTBALL GLOVES, SOCCER GLOVES, KEEPER GLOVES, WORKOUT GLOVES, GOLF GLOVES, FITNESS GLOVES, RUNNING GLOVES, CLIMBING GLOVES, BOWLING GLOVES, HOCKEY GLOVES, SKATING GLOVES, RUGBY GLOVES, SURFING GLOVES, SKY DIVING GLOVES, TENNIS GLOVES, KNEE GUARDS FOR ATHLETIC USE, NETS FOR SPORTS AND PARAGLIDERS (U.S. CLS. 22, 23, 38 AND 50).

TRACY FLETCHER, EXAMINING ATTORNEY

SN 79-092,626. INTHEA S.R.L., I-10121 TORINO, ITALY, FILED 12-6-2010.

INTHEA

THE MARK CONSISTS OF STANDARD CHARACTERS WITHOUT CLAIM TO ANY PARTICULAR FONT, STYLE, SIZE, OR COLOR.

PRIORITY DATE OF 12-1-2010 IS CLAIMED.
OWNER OF INTERNATIONAL REGISTRATION 1065286 DATED 12-6-2010, EXPIRES 12-6-2020.

THE WORDING "INTHEA" HAS NO MEANING IN A FOREIGN LANGUAGE.

CLASS 1—CHEMICALS

FOR DRY ICE COMPRISED OF CARBON DIOXIDE; FATTY ACIDS FOR USE IN THE MANUFACTURE OF FOOD AND BEVERAGES, COSMETICS, PHARMACEUTICALS, CHEMICALS AND LEATHER; ACIDS FOR USE IN INDUSTRY, NAMELY, ACETIC ACID, ACID ANHYDRIDES, ACID GELLING AGENTS, ACID PROOF CHEMICAL COMPOSITIONS, ACIDS FOR USE IN ETCHING, ADIPIC ACID, AGRICULTURAL ACIDS, AMINO ACIDS FOR INDUSTRIAL PURPOSES, ANTRANILIC ACID, ARSENIOS ACID, BENZENE-BASED ACIDS, BENZOIC ACID, BORIC ACID, CARBONIC ACIDS, CARBONIC ACID GAS, CHLORINATED ACIDS, CHLOROSULPHONIC ACID, CHOLIC ACID, CHROMIC ACID, CITRIC ACID, CITRIC ACID FOR INDUSTRIAL PURPOSES, CORROSIVE ACIDS, CROTONIC ACID, ESTERS OF FATTY ACIDS, ETCHING MORDANTS ACIDS, FLUORIC ACID, FLUOROSILICIC ACID, FORMIC ACID, GALLOTANNIC ACID, GALLIC ACID, GLUCONIC ACID, HALIDES AND HALOGEN ACID SALTS, HUMIC ACID, HYDROCHLORIC ACID, HYDROCHLORIC ACID (HYDROGEN CHLORIDE), HYDROFLUORIC ACID, HYDROHALIC ACIDS, IODIC ACID, LACTIC ACID, METHACRYLIC ACID, MINERAL ACIDS, MONOCHLOROACETIC ACID, MONOCHLOROACETIC ACID, NUCLEIC ACIDS, OLEIC ACID, OXALIC ACID, PALMITIC ACID, PERCHLORIC ACID, PERSULPHURIC ACID, PHOSPHORIC ACID, PHTHALIC ACID, PICRIC ACID, POLYUNSATURATED FATTY ACIDS, PYROGALLIC ACID, PYROLIGNEOUS ACID, SALICYLIC ACID, SALTS ORGANIC ACIDS, SEBACIC ACID, STEARIC ACID, SUCCINIC ACID, SUCROSE ESTERS OF ACIDS, SULFINIC ACID, SULPHONIC ACIDS, SULPHURIC ACID, SULPHUROUS ACID, SULPHUROUS ACID GAS (SULPHUR DIOXIDE), TANNIC ACID; TARTARIC ACID, TUNGSTIC ACID, VALERIC ACID; ALKALIES; MANGANESE DIOXIDE; GRAPHITE FOR INDUSTRIAL PURPOSES; SALTS, NAMELY, ALKALINE SALTS, ALUMINIUM SALTS, AMMONIACAL SALTS, AMMONIUM SALTS, CALCIUM SALTS, CHROME SALTS, CHROMIC SALTS, RAW SALTS USED IN THE MANUFACTURE OF COLORED METAL, GLUCONIC SALTS, GOLD SALTS, HALIDES AND HALOGEN ACID SALTS, IRON SALTS, MAGNESIUM SALTS, MERCURY SALTS, METAL SALTS, RARE EARTH SALTS, RAW SALT, ROCK SALT; SALTS FOR INDUSTRIAL PURPOSES, SALTS FROM RARE EARTH METALS, SALTS OF ALKALINE METALS, SALTS OF METALS, SALTS OF PRECIOUS METALS FOR INDUSTRIAL PURPOSES, SALTS ORGANIC ACIDS, SODIUM SALTS CHEMICAL PREPARATIONS, SORREL SALT FOR INDUSTRIAL PURPOSES; ACETATES; ACETYLENE; ETHERS, NAMELY, BENZYL ETHER, CHLOROMETHYL ETHER, DIISOPROPYL ETHER, ETHER ALCOHOLS, ETHYL ETHER, GLYCOL ETHER, METHYL ETHER, SULPHURIC ETHER; PHENOL FOR INDUSTRIAL PURPOSES; CHEMICALS FOR USE IN INDUSTRY AND SCIENCE, NAMELY, ALKALOIDS; KETONES; ALDEHYDES; ESTERS, NAMELY, ACETATE ESTERS, ACETIC ACID ESTERS, FATTY ACID ESTERS, FOOD ESTERS, GLYCERINE ESTERS, METHYL ESTERS; PROTEIN IN RAW MATERIAL FORM USED IN THE MANUFACTURE OF FOOD AND BEVERAGES, TEXTILES, PAPER PRODUCTS, COSMETICS, PHARMACEUTICALS, CHEMICALS, RUBBER AND PLASTICS PRODUCTS; ENZYMES FOR INDUSTRIAL PURPOSES IN THE FIELD OF FOOD AND BEVERAGES, TEXTILES, PAPER PRODUCTS, COSMETICS, PHARMACEUTICALS, CHEMICALS, LEATHER, RUBBER AND PLASTICS PRODUCTS; CHEMICALS FOR USE IN INDUSTRY AND SCIENCE, NAMELY, SURFACE-ACTIVE CHEMICAL AGENTS; DIOXIDE OF HYDROGEN; DISTILLED WATER; ALCOHOL FOR INDUSTRIAL PURPOSES; CHEMICALS FOR USE IN INDUSTRY AND SCIENCE, NAMELY, ISOTOPES FOR INDUSTRIAL PURPOSES; INDUSTRIAL CHEMICALS; AGRICULTURAL CHEMICALS, EXCEPT FUNGICIDES, WEEDKILLERS, HERBICIDES, INSECTICIDES AND PARASITICIDES; CHEMICAL REAGENTS OTHER THAN FOR MEDICAL OR VETERINARY PURPOSES; CHEMICAL PREPARATIONS FOR USE IN PHOTOGRAPHY; PLASTICS, UNPROCESSED; FERTILIZERS, NAMELY, CHEMICAL ADDITIVES FOR FERTILISERS, AMMONIUM CHLORIDE FERTILIZER, AMMONIUM NITRATE FERTILIZER,

AMMONIUM SULPHATE FERTILIZER, CALCINED POTASSIUM FERTILIZER, CALCIUM SILICATE FERTILIZER, CALCIUM SUPERPHOSPHATE FERTILIZER, CHEMICAL FERTILIZERS, CHEMICALLY CONVERTED COMPOUND FERTILIZERS, CHLORINE-FREE FERTILIZERS, COMPLEX FERTILIZER, FERTILIZERS CONTAINING NITROGEN AND MAGNESIUM, FERTILIZERS FOR AGRICULTURAL USE, FERTILIZERS FOR DOMESTIC USE, INORGANIC FERTILIZERS, LIQUID FERTILISERS, MANGANESE FERTILIZER, MARINE FERTILIZER, MINERAL FERTILIZERS, MIXED FERTILIZER, NATURAL FERTILIZERS, NITROGENOUS FERTILISERS, SODIUM NITRATE FERTILIZER; FIRE EXTINGUISHING COMPOSITIONS; QUENCHER, NAMELY, QUENCHING FLUIDS FOR USE IN METALWORKING; SOLDERING FLUXES; CHEMICAL SUBSTANCES FOR PRESERVING FOODSTUFFS; FILTERING PREPARATIONS FOR THE BEVERAGES INDUSTRY (U.S. CLS. 1, 5, 6, 10, 26 AND 46).

CLASS 36—INSURANCE AND FINANCIAL

FOR INSURANCE UNDERWRITING, NAMELY, ACCIDENT INSURANCE UNDERWRITING SERVICES, FIRE INSURANCE UNDERWRITING, HEALTH INSURANCE UNDERWRITING, INSURANCE UNDERWRITING SERVICES FOR ALL TYPES OF INSURANCE, LIFE INSURANCE UNDERWRITING, MARINE INSURANCE UNDERWRITING, MEDICAL INSURANCE UNDERWRITING, TRANSIT INSURANCE UNDERWRITING, INSURANCE ADMINISTRATION FOR BUSINESSES, ADVISORY SERVICES RELATING TO INSURANCE, ARRANGING INVESTMENTS, IN PARTICULAR CAPITAL INVESTMENTS, FINANCING SERVICES; EVALUATION RELATING TO INSURANCE, NAMELY, FINANCIAL EVALUATION FOR INSURANCE PURPOSES; CONSULTANCY RELATING TO INSURANCE, UNDERWRITING OF INSURANCE FOR ALL TYPES OF INSURANCE, NAMELY, BUSINESS AND COMPANY INSURANCE; FINANCING SERVICES; JEWELLERY APPRAISAL; REAL ESTATE AGENCIES; ACCOMMODATION BUREAUX FOR APARTMENTS, NAMELY, RENTAL OF APARTMENTS AND OFFICES, ARRANGING OF LEASES AND RENTAL AGREEMENTS FOR REAL ESTATE, REAL ESTATE AGENCY SERVICES FOR SALE AND RENTAL OF BUILDINGS, REAL ESTATE AGENCY SERVICES FOR SALE AND RENTAL OF BUSINESSES, REAL ESTATE MANAGEMENT SERVICES, REAL ESTATE INSURANCE SERVICES, NAMELY, REAL ESTATE INSURANCE UNDERWRITING SERVICES, REAL ESTATE TITLE INSURANCE UNDERWRITING SERVICES; BROKERAGE, NAMELY, BROKERAGE SERVICES IN THE FIELD OF ART, STOCKS, FINANCIAL INVESTMENT BROKERAGE, NAMELY, BROKERAGE SERVICES FOR ARRANGING FINANCING BY OTHER FINANCIAL INSTITUTION AND BROKERAGE SERVICES FOR CAPITAL INVESTMENTS, BROKERAGE SERVICES RELATING TO FINANCIAL INSTRUMENTS, NAMELY, REAL ESTATE NOTE BROKERAGE, BROKERAGE IN THE FIELD OF OPTIONS, SECURITIES; FINANCIAL GUARANTEES; CHARITABLE FUND RAISING; FACTORING AGENCIES; PAWN, NAMELY, PAWN BROKERAGE (U.S. CLS. 100, 101 AND 102).

CLASS 42—SCIENTIFIC AND COMPUTER SERVICES

FOR RESEARCH AND DEVELOPMENT FOR OTHERS IN THE BIOCHEMICAL INDUSTRY, PRODUCT RESEARCH AND DEVELOPMENT IN THE PHARMACEUTICAL AND BIOTECHNOLOGY FIELDS AND IN THE FIELD OF COMPUTER HARDWARE AND SOFTWARE, RESEARCH AND DEVELOPMENT OF NEW PRODUCTS, RESEARCH AND DEVELOPMENT SERVICES, RESEARCH, DEVELOPMENT, DESIGN AND UPGRADING OF COMPUTER SOFTWARE; QUALITY CONTROL FOR OTHERS; CALIBRATION; CHEMICAL RESEARCH; BIOLOGICAL RESEARCH; WEATHER FORECASTING; MATERIAL TESTING; PHYSICS RESEARCH; MECHANICAL RESEARCH; INDUSTRIAL DESIGN; ARCHITECTURE, NAMELY, ARCHITECTURE CONSULTANCY SERVICES, PROFESSIONAL CONSULTANCY

RELATING TO ARCHITECTURE, ENGINEERING SERVICES RELATING TO ARCHITECTURE, PREPARATION OF REPORTS RELATING TO ARCHITECTURE IN THE FIELD OF SCIENTIFIC RESEARCH, ENGINEERING RESEARCH, TECHNICAL RESEARCH, GREEN PRODUCTS; SCIENTIFIC RESEARCH RELATING TO ARCHITECTURE; DRESS DESIGNING; COMPUTER SOFTWARE DESIGN; CREATING AND MAINTAINING WEB SITES FOR OTHERS; HOSTING COMPUTER WEB SITES; PROVIDING SEARCH ENGINES FOR THE INTERNET; AUTHENTICATING WORKS OF ART (U.S. CLS. 100 AND 101).

ALLISON SCHRODY, EXAMINING ATTORNEY

CLASS 41—EDUCATION AND ENTERTAINMENT

FOR EDUCATIONAL SERVICES, NAMELY, PROVIDING CLASSES, INSTRUCTION AND SEMINARS IN THE FIELD OF GYMNASTICS AND EXERCISE; PROVIDING GYMNASTICS AND PHYSICAL FITNESS TRAINING, BOXING TRAINING AND DANCE TRAINING; ENTERTAINMENT SERVICES, NAMELY, CONDUCTING AND PRODUCING GYMNASTIC, PHYSICAL FITNESS, BOXING AND DANCE EXHIBITIONS AND PERFORMANCES; CONDUCTING SPORTING EVENTS AND COMPETITIONS, NAMELY, GYMNASTIC AND PHYSICAL FITNESS COMPETITIONS, AND ORGANIZING AND CONDUCTING DANCE AND BOXING COMPETITIONS; HEALTH CLUB SERVICES, NAMELY, PROVIDING INSTRUCTION AND EQUIPMENT IN THE FIELD OF PHYSICAL EXERCISE AND TRAINING; AND PROVIDING EXERCISE FACILITIES AND GYMNASIUMS (U.S. CLS. 100, 101 AND 107).

SEAN CROWLEY, EXAMINING ATTORNEY

SN 79-092,893. VERTICAL LEISURE LTD, POTTERS BAR, HERTFORDSHIRE EN6 5AW, UNITED KINGDOM, FILED 9-23-2010.



PRIORITY DATE OF 3-24-2010 IS CLAIMED.
OWNER OF INTERNATIONAL REGISTRATION 1065976
DATED 9-23-2010, EXPIRES 9-23-2020.

OWNER OF U.S. REG. NO. 3,787,618.

NO CLAIM IS MADE TO THE EXCLUSIVE RIGHT TO USE "EXPERT", APART FROM THE MARK AS SHOWN.

THE COLOR(S) MAUVE AND WHITE IS/ARE CLAIMED AS A FEATURE OF THE MARK.

THE MARK CONSISTS OF WORD "XPERT" IN MAUVE WORD "X-POLE" IN WHITE SUPERIMPOSED OVER DOTTED MAUVE "X".

CLASS 28—TOYS AND SPORTING GOODS

FOR SPORTING AND GYMNASTIC EQUIPMENT, NAMELY, VERTICAL AND HORIZONTAL POLES FOR USE IN GYMNASTICS; EXERCISE EQUIPMENT NOT FOR MEDICAL USE, NAMELY, MANUALLY OPERATED WEIGHT AND RESISTANCE EXERCISERS FOR PHYSICAL FITNESS DEVELOPMENT AND ATTACHMENTS TO SUCH EQUIPMENT TO INCREASE MUSCLE RESISTANCE, SUSPENDED WEIGHTS ATTACHED TO RESISTANCE CABLES FOR TWISTING, LIFTING AND STEPPING EXERCISES, ALL OF THE ABOVE BEING ATTACHED TO VERTICAL OR HORIZONTAL POLES BY MEANS OF METAL SUPPORTS AND BRACKETS, AND REPLACEMENT PARTS AND FITTINGS THEREFOR (U.S. CLS. 22, 23, 38 AND 50).

SN 79-093,721. SÜDWOLLE GMBH & CO. KG, FED REP GERMANY, FILED 12-15-2010.

PRIORITY DATE OF 8-4-2010 IS CLAIMED.

OWNER OF INTERNATIONAL REGISTRATION 1067516
DATED 12-15-2010, EXPIRES 12-15-2020.

THE COLOR(S) BLACK AND WHITE IS/ARE CLAIMED AS A FEATURE OF THE MARK.

THE MARK CONSISTS OF THE STYLIZED WORDING "SUDWOLLEGROUP" IN BLACK WITHIN A WHITE RECTANGLE.

THE ENGLISH TRANSLATION OF "SUDWOLLE" IN THE MARK IS ROUGHLY "SOUTHERN WOOL" WHERE "SUDWOLLE" IS A COMBINATION OF TWO GERMAN WORDS "SUD" (SOUTH) AND "WOLLE" (WOOL).

CLASS 23—YARNS AND THREADS

FOR GOODS MADE IN SUBSTANTIAL PART OF WOOL, NAMELY, YARNS AND THREADS, FOR TEXTILE USE (U.S. CL. 43).

CLASS 24—FABRICS

FOR TEXTILES AND TEXTILE GOODS MADE IN SUBSTANTIAL PART OF WOOL, NAMELY, BATH LINEN, COTTON-BLEND FABRICS, BED BLANKETS, BED LINEN, BED SHEETS, BED COMFORTERS, COVERS FOR CUSHIONS, BILLIARDS CLOTHS, CHENILLE FABRICS, CREPON DAMASK, DRUGGET, FELT, LINEN CLOTHS, FLANNEL, FABRICS FOR TEXTILE USE, TOWELS OF TEXTILE, HOUSEHOLD LINEN, UPHOLSTERY AND UNFITTED SEAT COVERS OF TEXTILES, LINEN LINING FABRIC FOR SHOES, AND TABLE LINEN; PLASTIC TABLE COVERS (U.S. CLS. 24 AND 50).

CLASS 25—CLOTHING

FOR T-SHIRTS AND WET SUIT GLOVES; CLOTHING MADE IN SUBSTANTIAL PART OF WOOL, NAMELY, PULLOVERS, SPORTS JACKETS, RAINCOATS, SPORTS UNDERWEAR, JACKETS, CLIMBING TROUSERS, TRAINING SUITS, SKI CLOTHES, NAMELY, SCARVES, HEADWEAR, NAMELY, BOBBLE CAPS, SKI CAPS, WOOLEN HATS, WOOLEN CAPS, SKI PANTS, SKI JACKETS, SKI SUITS AND SOCKS, GLOVES, SAILING CLOTHES, NAMELY, TROUSERS, JACKETS, SOCKS AND SAILING SUITS, NAMELY, PANTS, SHIRTS, ONE-PIECE SUITS, CYCLING CLOTHING, NAMELY, PANTS, JACKETS, CYCLING SUITS, NAMELY, SHORTS, SHIRTS, AND SOCKS, JOGGING CLOTHES, NAMELY, PANTS, JACKETS, JOGGING SUITS AND SOCKS, HEADGEAR, NAMELY, HATS, CAPS, HEADBANDS, AND FOOTWEAR; HORSEBACK RIDING GLOVES (U.S. CLS. 22 AND 39).

CLASS 28—TOYS AND SPORTING GOODS

FOR GAMES AND PLAYTHINGS, NAMELY, KITES; GYMNASIAC AND SPORTING ARTICLES, NAMELY, ELBOW GUARDS FOR ATHLETIC USE, GOLF BAGS, GYMNASIAC APPARATUS, GLOVES FOR GAMES, NAMELY, BOXING GLOVES, FENCING GLOVES, BASEBALL GLOVES, FOOTBALL GLOVES, SOCCER GLOVES, KEEPER GLOVES, WORKOUT GLOVES, GOLF GLOVES, FITNESS GLOVES, RUNNING GLOVES, CLIMBING GLOVES, BOWLING GLOVES, HOCKEY GLOVES, SKATING GLOVES, RUGBY GLOVES, SURFING GLOVES, SKY DIVING GLOVES, TENNIS GLOVES, KNEE GUARDS FOR ATHLETIC USE, NETS FOR SPORTS AND PARAGLIDERS (U.S. CLS. 22, 23, 38 AND 50).

TRACY FLETCHER, EXAMINING ATTORNEY

SN 79-094,152. KIM, JONG MIN, GEUMJEONG-GU, BUSAN, REPUBLIC OF KOREA, FILED 1-11-2011.



OWNER OF INTERNATIONAL REGISTRATION 1068664 DATED 1-11-2011, EXPIRES 1-11-2021.

THE COLOR(S) BLUE, RED, ORANGE, BEIGE, BLACK, GREEN, GREY AND WHITE IS/ARE CLAIMED AS A FEATURE OF THE MARK.

THE MARK CONSISTS OF STRIPES, A CHARACTER AND WORDING "CHALLENGE KING"; THE STRIPES ARE BLUE; THE CHARACTER'S HAIR IS RED WITH GRADIENT ORANGE; THE CHARACTER'S EYEBROWS ARE ORANGE; THE CHARACTER'S FACE IS BEIGE AND THE EYES AND MOUTH ARE BLACK; THE CHARACTER'S ARM IS GREEN, THE CHARACTER'S HAND IS WHITE WITH GRAY SHADING AND A GRAY BORDER; THE WORDING "CHALLENGE KING" IS BLACK.

CLASS 9—ELECTRICAL AND SCIENTIFIC APPARATUS

FOR PRE-RECORDED ELECTRONIC MEDIA FEATURING IMAGES; PRE-RECORDED DVDS AND VIDEOS FEATURING FILM OF IMAGES; DOWNLOADABLE ELECTRONIC MEDIA, NAMELY, NEWSLETTERS IN THE FIELD OF ENTERTAINMENT, DRAMA, DOCUMENTARY FILM, EDUCATION, ANIMATION AND GAME SHOWS; DOWNLOADABLE FILMS AND TELEVISION SHOWS FEATURING DRAMA, ENTERTAINMENT AND EDUCATION INFORMATION, ANIMATION AND GAME SHOWS; DOWNLOADABLE ELECTRONIC DATA FILES FEATURING IMAGES; EXPOSED CINEMATOGRAPHIC FILMS (U.S. CLS. 21, 23, 26, 36 AND 38).

CLASS 25—CLOTHING

FOR FOOTWEAR; HEADWEAR; SPORTSWEAR FOR EXCLUSIVE USE FOR SPORTS, NAMELY, SPORTS SHIRTS, SPORTS PANTS, CARDIGANS, AND CAPS; OVERCOATS EXCLUDING OVERCOATS FOR USE IN SPORTS AND KOREAN CLOTHES; BEACH CLOTHES, NAMELY, SWIM SUITS, BEACH GOWNS, AND BATHING CAPS; FUR COATS; LEATHER TROUSERS; GOLF TROUSERS; FISHING TROUSERS; CLIMBING TROUSERS; SHORTS; TROUSERS FOR SWEATING; BRIEFS; LADIES' PANTS; SNOWBOARD PANTS; SKATEBOARD PANTS; SKI PANTS; BREECHES; TROUSERS; BABIES' PANTS; BLUE JEANS; SWEATERS; DRESS SHIRTS; TEE-SHIRTS; CHILDREN'S CLOTHING, NAMELY, TROUSERS, SHIRTS, JACKETS, INFANTS CLOTHING, OVERCOATS, AND CAPS; JACKETS; PARKAS; VESTS; SHIRTS; COATS; RUNNING CLOTHES, NAMELY, SPORTS SHIRTS, SPORTS PANTS, AND CAPS; PANTS; BLOUSES; JUMPERS; OUTER CLOTHING, NAMELY, OVERCOATS; UNDERWEAR; UNDERGARMENTS; CLIMBING CLOTHES, NAMELY, SHIRTS FOR CLIMBING, TROUSERS FOR CLIMBING, AND CAPS FOR CLIMBING; MEN'S SUITS; SUITS; SKIRTS; TRAINING WEAR, NAMELY, SHIRTS, PANTS, AND CAPS FOR EXERCISE (U.S. CLS. 22 AND 39).

CLASS 41—EDUCATION AND ENTERTAINMENT

FOR PRODUCTION OF DOCUMENTARIES; PRODUCTION OF IMAGE FILES; PRODUCTION OF LIVE PERFORMANCES; PRODUCTION OF LIVE SHOWS; PRODUCTION OF MUSIC VIDEOS; RENTAL OF CAMCORDERS; PRODUCTION OF VIDEOTAPE MOVIES; ENTERTAINMENT INFORMATION; CINEMA PRESENTATIONS, NAMELY, CINEMA THEATERS; PRODUCTION AND DISTRIBUTION OF MOVIES, FILM AND TELEVISION SHOWS FEATURING DRAMA, DOCUMENTARIES, AND COMEDY; PREPARATION OF SPECIAL EFFECTS FOR FILMS; TELEVISION SHOW PRODUCTION; TELEVISION ENTERTAINMENT, NAMELY, ENTERTAINMENT IN THE NATURE OF ON-GOING TELEVISION PROGRAMS IN THE FIELD OF NEWS, COMEDY, VARIETY, MOVIE, DRAMA, AND DOCUMENTARY; PRODUCTION OF TELEVISION PROGRAMS (U.S. CLS. 100, 101 AND 107).

MICHELE SWAIN, EXAMINING ATTORNEY

SN 79-094,277. MICHAEL CANDREIA, SWITZERLAND, FILED 1-4-2011.

Cankobi

THE MARK CONSISTS OF STANDARD CHARACTERS WITHOUT CLAIM TO ANY PARTICULAR FONT, STYLE, SIZE, OR COLOR.

OWNER OF INTERNATIONAL REGISTRATION 1068924 DATED 1-4-2011, EXPIRES 1-4-2021.

THE WORDING "CANKOBI" HAS NO MEANING IN A FOREIGN LANGUAGE.

CLASS 9—ELECTRICAL AND SCIENTIFIC APPARATUS

FOR APPARATUS FOR RECORDING, TRANSMISSION OR REPRODUCTION OF SOUND OR IMAGES; MAGNETIC DATA CARRIERS, NAMELY, BLANK MAGNETIC DATA CARRIERS, PRE-RECORDED MAGNETIC DATA CARRIERS FEATURING MUSIC, RECORDING DISKS, NAMELY, BLANK RECORD DISKS AND PRE-RECORDED DIGITAL VIDEO DISCS FEATURING RECORDED MUSIC; AUTOMATIC VENDING MACHINES AND MECHANISMS FOR COIN-OPERATED APPARATUS; CASH REGISTERS, CALCULATING MACHINES, DATA PROCESSING EQUIPMENT AND COMPUTERS; FIRE EXTINGUISHERS (U.S. CLS. 21, 23, 26, 36 AND 38).

CLASS 38—COMMUNICATION

FOR TELECOMMUNICATIONS, NAMELY, TELECOMMUNICATIONS BY E-MAIL; TELEPHONE TELECOMMUNICATIONS SERVICES PROVIDED VIA PREPAID TELEPHONE CALLING CARDS (U.S. CLS. 100, 101 AND 104).

CLASS 41—EDUCATION AND ENTERTAINMENT

FOR EDUCATIONAL SERVICES, NAMELY, CONDUCTING CLASSES, SEMINARS, CONFERENCES, WORKSHOPS, IN THE FIELD OF MUSIC, PROVIDING OF TRAINING SERVICES IN THE FIELD OF MUSIC; ENTERTAINMENT IN THE NATURE OF VISUAL AND AUDIO PERFORMANCES, AND MUSICAL, VARIETY, NEWS AND COMEDY SHOWS; ORGANIZING COMMUNITY SPORTING AND CULTURAL EVENTS (U.S. CLS. 100, 101 AND 107).

BARBARA RUTLAND, EXAMINING ATTORNEY

SN 79-094,683. SILICON FIRE AG, CH-6045 MEGGEN, SWITZERLAND, FILED 2-7-2011.



PRIORITY DATE OF 8-19-2010 IS CLAIMED. OWNER OF INTERNATIONAL REGISTRATION 1069984 DATED 2-7-2011, EXPIRES 2-7-2021.

NO CLAIM IS MADE TO THE EXCLUSIVE RIGHT TO USE "CLEAN", APART FROM THE MARK AS SHOWN.

THE MARK CONSISTS OF THE WORDING "FORMULA CLEAN" WITH THE DESIGN OF A FLAME.

CLASS 4—LUBRICANTS AND FUELS

FOR INDUSTRIAL OILS AND GREASES; LUBRICANTS, NAMELY, LUBRICANTS FOR METALWORKING AND DRILLING LUBRICANTS; FUELS, NAMELY, MOTOR SPIRIT AND FUELS FOR LIGHTING AND HEATING (U.S. CLS. 1, 6 AND 15).

CLASS 7—MACHINERY

FOR ENGINES FOR BOATS AND YACHTS (U.S. CLS. 13, 19, 21, 23, 31, 34 AND 35).

CLASS 12—VEHICLES

FOR MOTORIZED VEHICLES, NAMELY, MOTORCYCLES, SCOOTERS, ALL TERRAIN VEHICLES, CARS, TRACTORS; SNOWMOBILES; MOTORIZED GOLF CARTS; MOTORIZED VEHICLES, NAMELY, GO CARTS, MOTOR BUSES, MOTOR COACHES; HELICOPTERS, AIRCRAFT, MOTORIZED BOATS AND YACHTS; PERSONAL WATERCRAFTS, NAMELY, SMALL POWER BOATS, MOTORIZED WATERBIKES, MOTORIZED HYDROJET BOATS, SPEED BOATS WITH INBOARD AND OUTBOARD MOTORS (U.S. CLS. 19, 21, 23, 31, 35 AND 44).

CLASS 16—PAPER GOODS AND PRINTED MATTER

FOR PAPER, CARDBOARD AND STATIONERY; PRINTED CARDBOARD; PRINTED MATTER, NAMELY, BOOKS, FLYERS, MAGAZINES, BROCHURES, AND LEAFLETS IN THE FIELD OF RACING, MOTOR RALLYING, REGENERATIVE FUELS, BOATING, AND YACHTING; PRINTED MATTER FOR ADVERTISING SIGNBOARDS, NAMELY, CARDBOARD SIGNS; CALENDARS; PHOTOGRAPHS; PRINTED COLLECTING CARDS MADE PRIMARILY OF PAPER; PRINTED STICKERS AND ALBUMS FOR STICKERS; PRINTED PAPER PLACARDS; TRADING CARDS; ADDRESS BOOKS; AGENDAS OF PAPER; WRITING PAPER AND PAPER NOTEPADS; PRINTING, PAINTING AND DRAWING SETS COMPRISED OF PENS, PENCILS, PAINT BRUSHES, DRAWING PAPER; PRINTED CATALOGS IN THE FIELD OF RACING, MOTOR RALLYING, REGENERATIVE FUELS, BOATING, AND YACHTING; ITINERARIES MADE PRIMARILY OF PAPER, PRINTED MAPS, PLANS AND CHARTS MADE PRIMARILY OF PAPER; PRINTED POSTERS; PICTURES; RUBBER STAMPS; BOOK COVERS AND BINDINGS; STATIONERY-TYPE PORTFOLIOS; NEWSPAPERS; PRINTED PUBLICATIONS, NAMELY, MAGAZINES, PERIODICALS, MANUALS, DIRECTORIES IN THE FIELD OF RACING, MOTOR RALLYING, REGENERATIVE FUELS, BOATING, AND YACHTING; BUSINESS PAPERS, NAMELY, BUSINESS CARDS, LETTERHEAD MADE OF PAPER; AUTOGRAPH BOOKS AND AGENDAS MADE OF PAPER; SCRIBBLING BOOKS, NAMELY, WRITING AND DRAWING PADS; FILE FOLDERS; TIME USE DIARIES; PRINTED COMPUTER DOCUMENTATION MADE OF PAPER; STENCILS; IRON ON AND GLUE ON TRANSFERS; GIFT WRAPPING PAPER; WRAPPING PAPER; PORTRAITS (U.S. CLS. 2, 5, 22, 23, 29, 37, 38 AND 50).

CLASS 25—CLOTHING

FOR CLOTHING, NAMELY, BATHING SUITS; RAINWEAR; CLOTHING FOR SPORTS, NAMELY, TROUSERS, T-SHIRTS, TRACK SUITS; LEISURE WEAR, NAMELY, TROUSERS, T-SHIRTS, SHIRTS, BLOUSES; NIGHTWEAR; SKIWEAR; UNDERWEAR; COMBINATIONS; PELERINES; SUITS; BATH ROBES; POLO SHIRTS; CAPS AND HEADGEAR, NAMELY, VISORS; CAP PEAKS; BASEBALL CAPS; NECKTIES; SCARVES AND COLLARS; GLOVES; BELTS; BRACES FOR CLOTHING; BOOTS, SKI BOOTS, SPATS; FOOTWEAR, SOCKS; HEAD AND WRIST SWEATBANDS; BOOTS FOR SPORTS (U.S. CLS. 22 AND 39).

CLASS 28—TOYS AND SPORTING GOODS

FOR GAMES AND PLAYTHINGS, NAMELY, CARD GAMES, BOARD GAMES; GYMNASTIC AND SPORTING ARTICLES, NAMELY, TRAMPOLINES, EXERCISE MACHINES; ARCADE GAMES, TOYS, NAMELY, DOLLS, TEDDY BEARS; AND PLAYING CARDS (U.S. CLS. 22, 23, 38 AND 50).

CLASS 35—ADVERTISING AND BUSINESS

FOR PROMOTION AND ADVERTISING; THE BRINGING TOGETHER, FOR THE BENEFIT OF OTHERS, OF A VARIETY OF GOODS IN THE FIELD OF SPORTING EQUIPMENT OR REQUISITES, CLOTHING, GAMES, TOYS, SOUVENIRS, PRINTED MATTER, BOOKS AND SOFTWARE, ENABLING CUSTOMERS TO VIEW AND PURCHASE THEM CONVENIENTLY, VIA COMPUTERS, INTERACTIVE COMMUNICATION MEDIA, AND ELECTRONIC MEDIA SUCH AS THE INTERNET AND OTHER DATA COMMUNICATIONS SERVERS; PROVIDING A DATABASE FEATURING BUSINESS INFORMATION FOR COMPUTERIZED STORING AND RETRIEVAL OF BUSINESS INFORMATION; PROVIDING A DATABASE FEATURING BUSINESS INFORMA-

TION ABOUT RACING, MOTOR RALLYING, REGENERATIVE FUEL, BOATING, AND YACHTING, FOR COMPUTERIZED STORING AND RETRIEVAL OF BUSINESS INFORMATION; EXHIBITION SERVICES FOR PROMOTIONAL PURPOSES; COMPILATION AND DISSEMINATION OF ADVERTISING MATTER; PRODUCTION OF PROMOTIONAL MATERIAL; PROVIDING SUBSCRIPTIONS TO PRINTED MATTER, NAMELY, NEWSPAPERS, MAGAZINES FOR OTHERS BY ELECTRONIC MEANS AND VIA INTERACTIVE COMMUNICATION MEDIA (U.S. CLS. 100, 101 AND 102).

CLASS 38—COMMUNICATION

FOR RADIO AND TELEVISION BROADCASTING, INCLUDING BY MEANS OF A PAY TV SYSTEM; SATELLITE AND CABLE BROADCASTING; RADIO AND TELEVISION BROADCASTING VIA DIGITAL NETWORKS, PARTICULARLY THE INTERNET AND ASSOCIATED INTERACTIVE TELECOMMUNICATIONS SERVICES; TELECOMMUNICATIONS SERVICES, NAMELY, CELLULAR TELEPHONE SERVICES; ELECTRONIC TRANSMISSION OF DATA, IMAGES AND SOUNDS VIA COMPUTER TERMINALS AND COMPUTER NETWORKS; PROVIDING ACCESS TO REAL-TIME CHAT FORUMS IN THE FIELD OF SPORTS (U.S. CLS. 100, 101 AND 104).

CLASS 40—MATERIAL TREATMENT

FOR PRINTING (U.S. CLS. 100, 103 AND 106).

CLASS 41—EDUCATION AND ENTERTAINMENT

FOR ARRANGING, ORGANIZING AND STAGING OF SPORTS EVENTS, TOURNAMENTS AND COMPETITIONS; PRODUCTION OF SPORTS EVENTS, TOURNAMENTS AND COMPETITIONS FOR RADIO, FILM AND TELEVISION; PROVISION OF SPORTS INFORMATION USING REAL-TIME CHAT FORUMS AND COMPUTER BULLETIN BOARDS; PROVISION OF RECREATION FACILITIES FOR SPORTS EVENTS, TOURNAMENTS AND COMPETITIONS; PHOTOGRAPHY SERVICES (U.S. CLS. 100, 101 AND 107).

CLASS 42—SCIENTIFIC AND COMPUTER SERVICES

FOR PROVIDING ACCESS TO INTERACTIVE DATABASES IN THE FIELD OF SPORTS; PROVIDING ACCESS TO ELECTRONIC BULLETIN BOARDS IN THE FIELD OF SPORTS (U.S. CLS. 100 AND 101).

CLASS 43—HOTEL AND RESTAURANT SERVICES

FOR HOTEL, RESTAURANT AND CATERING SERVICES (U.S. CLS. 100 AND 101).
KRISTIN DAHLING, EXAMINING ATTORNEY

SN 79-095,133. INTERNATIONAL FEDERATION OF ORGANIC AGRICULTURE MOVEMENTS, FED REP GERMANY, FILED 2-15-2011.



OWNER OF INTERNATIONAL REGISTRATION 1071190 DATED 2-15-2011, EXPIRES 2-15-2021.

OWNER OF U.S. REG. NOS. 2,518,278 AND 2,520,871.

NO CLAIM IS MADE TO THE EXCLUSIVE RIGHT TO USE "ORGANIC", APART FROM THE MARK AS SHOWN.

THE COLOR(S) GREEN AND RED IS/ARE CLAIMED AS A FEATURE OF THE MARK.

THE MARK CONSISTS OF THE STYLIZED WORDING "ORGANIC" IN THE COLOR GREEN WITH A GLOBE DEPICTED IN THE COLOR RED INSIDE THE LETTER "O" OF "ORGANIC." A LINE BELOW APPEARS THE STYLIZED WORDING "IFOAM" IN THE COLOR RED. THE COLOR WHITE APPEARING IN THE MARK REPRESENTS BACKGROUND AND IS NOT CLAIMED AS A FEATURE OF THE MARK.

CLASS 25—CLOTHING

FOR CLOTHING, NAMELY, PANTS, SHORTS, SHIRTS, TOPS, SKIRTS, DRESSES, GOWNS, COATS, JACKETS, JUMPERS, OVERALLS, COVERALLS, VESTS, PULLOVERS, SWEATERS, PAJAMAS, ROBES, APRONS, UNDERWEAR, GLOVES, MITTENS, SOCKS, STOCKINGS, LEGGINGS, SCARVES, BELTS, NECKTIES, DIAPERS; FOOTWEAR; HEADGEAR, NAMELY, HATS, CAPS, VISORS, ALL OF THE PRECEDING COMPRISED IN WHOLE OR IN PART OF ORGANIC MATERIALS (U.S. CLS. 22 AND 39).

CLASS 29—MEATS AND PROCESSED FOODS

FOR MEAT, FISH, POULTRY AND GAME; MEAT EXTRACTS; PRESERVED, FROZEN, DRIED AND COOKED FRUITS AND VEGETABLES; JELLIES, JAMS, COMPOTES; EGGS, MILK AND MILK PRODUCTS, EXCLUDING ICE CREAM, ICE MILK AND FROZEN YOGURT; EDIBLE OILS AND FATS, ALL OF THE PRECEDING BEING ORGANIC OR MADE FROM ORGANIC INGREDIENTS (U.S. CL. 46).

CLASS 30—STAPLE FOODS

FOR COFFEE, TEA, COCOA, SUGAR, RICE, TAPIOCA, SAGO, ARTIFICIAL COFFEE; FLOUR AND PREPARATIONS MADE FROM CEREALS, NAMELY, GRANOLA-BASED SNACK BARS, MUFFINS; BREAD, PASTRY AND CONFECTIONERY, NAMELY, CONFECTIONERY MADE OF SUGAR; ICES; HONEY, TREACLE; YEAST, BAKING-POWDER; SALT, MUSTARD; VINEGAR, SAUCES; SPICES; ICE, ALL OF THE PRECEDING BEING ORGANIC OR MADE FROM ORGANIC INGREDIENTS (U.S. CL. 46).

CLASS 31—NATURAL AGRICULTURAL PRODUCTS

FOR AGRICULTURAL, HORTICULTURAL AND FORESTRY PRODUCTS AND GRAINS NOT INCLUDED IN OTHER CLASSES, NAMELY, LIVE TREES, UNPROCESSED GRAIN, LIVE HATCHING EGGS; LIVE ANIMALS; FRESH FRUITS AND VEGETABLES; SEEDS, NAMELY, GRASS SEEDS, FRUIT SEEDS, VEGETABLE SEEDS; NATURAL PLANTS AND FLOWERS; FOODSTUFFS FOR ANIMALS; MALT, NAMELY, MALT FOR BREWING AND DISTILLING, ALL OF THE PRECEDING BEING ORGANIC OR MADE FROM ORGANIC INGREDIENTS (U.S. CLS. 1 AND 46).

CLASS 32—LIGHT BEVERAGES

FOR BEERS; MINERAL AND AERATED WATERS AND OTHER NON-ALCOHOLIC DRINKS, NAMELY, SOFT DRINKS; FRUIT DRINKS AND FRUIT JUICES; SYRUPS AND OTHER PREPARATIONS FOR MAKING BEVERAGES, ALL OF THE PRECEDING BEING ORGANIC OR MADE FROM ORGANIC INGREDIENTS (U.S. CLS. 45, 46 AND 48).

CLASS 42—SCIENTIFIC AND COMPUTER SERVICES

FOR SCIENTIFIC AND TECHNOLOGICAL SERVICES, NAMELY, ACCREDITATION SERVICES, NAMELY, EVALUATING ORGANIZATIONS TO DETERMINE WHETHER THE ORGANIZATIONS CONFORM TO AN ESTABLISHED STANDARD; INDUSTRIAL ANALYSIS AND RESEARCH SERVICES, NAMELY, INDUSTRIAL RESEARCH IN THE FIELDS OF FOOD, AGRICULTURE, AND PROCESSED GOODS; SCIENTIFIC RESEARCH (U.S. CLS. 100 AND 101).

ALLISON SCHRODY, EXAMINING ATTORNEY

SN 79-095,657. TURBOCOATING S.P.A., (PARMA), ITALY, FILED 11-5-2010.



PRIORITY DATE OF 5-5-2010 IS CLAIMED.
OWNER OF INTERNATIONAL REGISTRATION 1072727 DATED 11-5-2010, EXPIRES 11-5-2020.

NO CLAIM IS MADE TO THE EXCLUSIVE RIGHT TO USE "GROUP", APART FROM THE MARK AS SHOWN.

THE MARK CONSISTS OF THE REPRESENTATION OF THE WORDING "UNITEDCOATINGS GROUP" ABOVE A BAND AND PRECEDED BY A SQUARE IMAGE COMPOSED OF TWO TRIANGLES PLACED OPPOSITE EACH OTHER AND A SERIES OF SQUARES IN DECREASING ORDER OF SIZE AND ARRANGED DIAGONALLY BETWEEN THE TWO TRIANGLES.

CLASS 7—MACHINERY

FOR MATERIAL PROCESSING INSTALLATIONS, NAMELY, MACHINE FOR SPECIAL PROCESSES IN THE NATURE OF SPRAYING AND APPLYING SURFACE TREATMENTS AND COATINGS ON COMPONENT PARTS AND MANUFACTURING PROTECTIVE COATINGS FOR COMPONENTS USED IN INDUSTRIAL GAS TURBINES AND AERO ENGINES (U.S. CLS. 13, 19, 21, 23, 31, 34 AND 35).

CLASS 40—MATERIAL TREATMENT

FOR TREATMENT OF MATERIALS, NAMELY, HEAT TREATMENT AND COATING OF COMPONENTS USED IN INDUSTRIAL GAS TURBINES AND AERO ENGINES; METAL TREATMENT; TREATMENT OF METAL; ALL THE FOREGOING EXCLUDING METAL REFINING SERVICES (U.S. CLS. 100, 103 AND 106).

SARA BENJAMIN, EXAMINING ATTORNEY

SN 79-095,970. SCHÜCO INTERNATIONAL KG, 33609 BIELEFELD, FED REP GERMANY, FILED 2-4-2011.



PRIORITY DATE OF 8-4-2010 IS CLAIMED.

OWNER OF INTERNATIONAL REGISTRATION 1073489 DATED 2-4-2011, EXPIRES 2-4-2021.

THE MARK CONSISTS OF THREE QUADRILATERALS OF DIFFERENT SHAPES FORMING A STYLIZED REPRESENTATION OF A CROWN.

CLASS 6—METAL GOODS

FOR BUILDING MATERIALS MADE OF METAL, NAMELY, PROFILES, TUBES, PLATES, SHEETS AND FOILS FOR WINDOWS, DOORS, GATES, STAIRS, BALCONIES, FACADES, SKYLIGHTS, SOLAR COLLECTORS AND FRAMES; METAL BUILDING MATERIALS, NAMELY, WINDOWS, DOORS, GATES, STAIRS, PARTITION WALLS, FACADES, BALCONIES, CONSERVATORIES, ROOFS, FRAMES, NAMELY, DOOR FRAMES, WINDOW FRAMES, COLLECTOR FRAMES AND PREFABRICATED COMPONENTS FOR COLLECTOR FRAMES AND PREFABRICATED STRUCTURAL PART THEREFOR, BLADES FOR SHADING INSTALLATIONS, SHUTTERS MADE OF METAL, BALUSTRADES FOR STAIRS AND BALCONIES, WINDOWSILLS, RAIN LEADING SHEETS AND PROFILES, LETTER BOXES, FENCES, SCAFFOLDS; IRONMONGERY, SMALL ITEMS OF METAL HARDWARE, NAMELY, NUTS AND SCREWS, MECHANICAL LOCKING AND OPENING DEVICES FOR WINDOWS, DOORS AND GATES, NAMELY, METAL LOCKS; TRANSPORTABLE BUILDINGS MADE OF METAL, AS MOVABLE PAVILIONS AND EXHIBITION STANDS, ALL THE AFOREMENTIONED GOODS MADE OF METAL ALSO IN COMBINATION WITH GLASS, WOOD OR PLASTIC (U.S. CLS. 2, 12, 13, 14, 23, 25 AND 50).

CLASS 7—MACHINERY

FOR METAL AND PLASTICS WORKING MACHINES; MECHANICAL TOOLS EXCEPT FOR ELECTRIC INSTALLATION PURPOSES, NAMELY, POWER TOOLS AND DRILLS; MACHINE FRAMES FOR TREATMENT OF ANY MATERIAL, DRIVING GEARS FOR WINDOWS AND DOORS (U.S. CLS. 13, 19, 21, 23, 31, 34 AND 35).

CLASS 8—HAND TOOLS

FOR HAND OPERATED TOOLS EXCEPT FOR ELECTRIC INSTALLATION PURPOSES, NAMELY, DRILLS, SAWS, SCREWDRIVERS, HAND PUNCHING TOOLS, NAMELY, PUNCHING DIES, SCISSORS, FOIL ROLL COATERS, KNIVES, AUGERS; AND PLANNING BLADES FOR SHADING SYSTEMS (U.S. CLS. 23, 28 AND 44).

CLASS 9—ELECTRICAL AND SCIENTIFIC APPARATUS

FOR MEASURING, CONTROLLING AND REGULATING APPARATUS FOR BUILDINGS, WINDOWS, DOORS, SHADING INSTALLATIONS, SOLAR HEATING INSTALLATIONS, PHOTOVOLTAIC INSTALLATIONS, SOLAR COLLECTORS, AS WELL AS PARTS THEREOF, FOR MEASURING, CONTROLLING AND REGULATING TEMPERATURE, MOISTURE, LIGHT, AIR CONDITIONING AND WIND; COMPUTERS (U.S. CLS. 21, 23, 26, 36 AND 38).

CLASS 11—ENVIRONMENTAL CONTROL APPARATUS

FOR APPARATUS FOR LIGHTING, HEATING, REFRIGERATING, VENTILATING, SOLAR COLLECTORS FOR HEATING PURPOSES (U.S. CLS. 13, 21, 23, 31 AND 34).

CLASS 17—RUBBER GOODS

FOR PACKING AND INSULATING MATERIAL, PACKAGING AND PACKING MATERIAL, NAMELY, SEALS MADE OF PLASTIC, SEALING COMPOUNDS; PLASTIC IN EXTRUDED FORM FOR USE IN MANUFACTURE; NON-METAL SEALS OF PLASTIC; WEATHER STRIPPING IN THE NATURE OF SEALING BRUSHES FOR WINDOWS AND DOORS FOR GENERAL MANUFACTURING USE; POLYURETHANE FILM FOR FORMING SEALS (U.S. CLS. 1, 5, 12, 13, 35 AND 50).

CLASS 19—NON-METALLIC BUILDING MATERIALS

FOR NON-METALLIC BUILDING MATERIALS, NAMELY, PROFILES, TUBES, PLATES, SHEETS AND FOILS FOR WINDOWS, DOORS, GATES, BALCONIES, CONSERVATORIES, ROOFS, SOLAR COLLECTORS AND FRAMES; WINDOWS, DOORS, GATES, STAIRS, PARTITION WALLS, BALCONIES, CONSERVATORIES, ROOFS, FRAMES, FACINGS AND PREFABRICATED STRUCTURAL PARTS THEREFOR; BLADES FOR SHADING INSTALLATIONS, SHUTTERS NON-METALLIC, BALUSTRADES FOR STAIRS AND BALCONIES, WINDOWSILLS, RAIN LEADING PROFILES, FENCES, SCAFFOLDS, TRANSPORTABLE BUILDINGS NON-METALLIC, AS MOVABLE PAVILIONS AND EXHIBITION STANDS, ALL THE AFOREMENTIONED GOODS NOT OF METAL OR ONLY IN COMBINATION WITH METALS (U.S. CLS. 1, 12, 33 AND 50).

CLASS 20—FURNITURE AND ARTICLES NOT OTHERWISE CLASSIFIED

FOR FURNITURE, SHELVES, GLASS CABINETS, FITTED CUPBOARDS; FITTINGS FOR FURNITURE, NAMELY, LATCHES, HINGES, LOCKS, HANDLES, CORNER GUIDES, CORNER JOINTS, TURN-TILT BALANCE ARMS AND LOCKING AND OPENING SYSTEMS FOR FURNITURE MADE OF OR MAINLY MADE OF PLASTIC AND IN COMBINATION WITH METAL; FRAMES, NAMELY, FRAMES FOR FURNITURE, CUPBOARDS, LOCKERS, AND WALK-IN CLOSETS; FURNITURE FITTINGS, NOT OF METAL (U.S. CLS. 2, 13, 22, 25, 32 AND 50).

CLASS 22—CORDAGE AND FIBERS

FOR SUN-BLINDS AND SUNSHADES IN THE NATURE OF AWNINGS, BLINDS, AND LOUVERS MADE OF PLASTICS, TEXTILE MATERIAL OR METAL OR IN COMBINATIONS WITH THESE MATERIALS (U.S. CLS. 1, 2, 7, 19, 22, 42 AND 50).

FLORENTINA BLANDU, EXAMINING ATTORNEY

SN 79-096,820. ITREC B.V., NETHERLANDS, FILED 11-30-2010.

MPT

THE MARK CONSISTS OF STANDARD CHARACTERS WITHOUT CLAIM TO ANY PARTICULAR FONT, STYLE, SIZE, OR COLOR.

PRIORITY DATE OF 5-31-2010 IS CLAIMED.
OWNER OF INTERNATIONAL REGISTRATION 1075539 DATED 11-30-2010, EXPIRES 11-30-2020.

CLASS 7—MACHINERY

FOR DRILLING EQUIPMENT, NAMELY, INDUSTRIAL DRILLING RIGS; POWER DRILLS FOR THE OIL AND GAS EXPLORATION AND PRODUCTION INDUSTRY; DERRICKS; CRANES; GROUND DRILLING MACHINES; INSTALLATIONS, NAMELY, MACHINERY AND EQUIPMENT FOR LAYING DRAIN PIPES (U.S. CLS. 13, 19, 21, 23, 31, 34 AND 35).

CLASS 37—CONSTRUCTION AND REPAIR

FOR INSTALLATION, MAINTENANCE AND REPAIR OF ITEMS USED IN THE OIL AND GAS EXPLORATION AND PRODUCTION INDUSTRY, NAMELY, DRILLING MACHINES, DERRICKS AND THEIR PARTS, CRANES, AND PIPE LAYING MACHINES, WELL DRILLING MACHINES (U.S. CLS. 100, 103 AND 106).

CLASS 42—SCIENTIFIC AND COMPUTER SERVICES

FOR DESIGN, DEVELOPMENT IN THE OIL AND GAS EXPLORATION AND PRODUCTION INDUSTRY; TECHNICAL CONSULTING SERVICES, NAMELY, ENGINEERING FOR THE OIL AND GAS EXPLORATION AND PRODUCTION INDUSTRIES IN CONNECTION WITH LOCATION, RECOVERY, PROCESSING, STORAGE AND DISTRIBUTION OF OIL AND NATURAL GASES RENDERED BY AN ENGINEER IN REGARD TO THE CONSTRUCTION OF DERRICKS, WELLS AND OTHER PRODUCTS, NAMELY, DRILLING MACHINES, PIPE LAYING MACHINES AND CRANES (U.S. CLS. 100 AND 101).

STEVEN JACKSON, EXAMINING ATTORNEY

SN 79-097,060. ID GROUP, F-59100 ROUBAIX, FRANCE, FILED 1-5-2011.



PRIORITY DATE OF 12-6-2010 IS CLAIMED.
OWNER OF INTERNATIONAL REGISTRATION 1076264 DATED 1-5-2011, EXPIRES 1-5-2021.

THE COLOR(S) GREY, YELLOW, GREEN AND RED IS/ARE CLAIMED AS A FEATURE OF THE MARK.

THE MARK CONSISTS OF THE WORD "OXYBUL" IN GREY WITH A STYLIZED CUBE IN THE CENTER OF THE LETTER "O" COMPRISED OF THREE SQUARES WHICH DO NOT TOUCH. THE LEFT SQUARE IS GREEN, THE TOP SQUARE IS YELLOW AND THE RIGHT SQUARE IS RED.

CLASS 8—HAND TOOLS

FOR HAND OPERATED HAND TOOLS AND IMPLEMENTS, NAMELY, CLAMPS, HAMMERS, CHISELS; NON-ELECTRIC CUTLERY, NAMELY, TABLE FORKS; SPOONS; SCISSORS; HAND-OPERATED GARDENING TOOLS, NAMELY, GARDENING TROWELS, WEEDING FORKS, SPADES, HOES; MECHANICAL TOOLS FOR CHOPPING AND CUTTING FOODSTUFFS, NAMELY, HAND OPERATED CHOPPERS; NON ELECTRIC CAN OPENERS; NUTCRACKERS; RAZORS, RAZOR BLADES; NAIL NIPPERS AND FILES, NAIL CLIPPERS; MANICURE AND PEDICURE SETS; ELECTRIC AND NON-ELECTRIC HAIR CLIPPERS FOR PERSONAL USE, NON-ELECTRIC CURLING IRONS, NAMELY, CURLING TONGS; HAIR-REMOVING TWEEZERS (U.S. CLS. 23, 28 AND 44).

CLASS 9—ELECTRICAL AND SCIENTIFIC APPARATUS

FOR SCIENTIFIC, OTHER THAN MEDICAL, NAUTICAL, SURVEYING, PHOTOGRAPHIC, CINEMATOGRAPHIC, OPTICAL, WEIGHING, MEASURING, SIGNALING, CHECKING AND LIFE-SAVING APPARATUS AND INSTRUMENTS, NAMELY, CAMERAS; TEACHING APPARATUS AND INSTRUMENTS, NAMELY, MEDICAL TEACHING MANNEQUINS; APPARATUS AND INSTRUMENTS FOR CONDUCTING, SWITCHING, TRANSFORMING, ACCUMULATING, REGULATING OR CONTROLLING ELECTRICITY, NAMELY, ELECTRICITY CONDUITS, ELECTRICITY LIMITERS, ADAPTERS; MATERIAL FOR ELECTRICITY MAINS, NAMELY, ELECTRICITY WIRES AND CABLES; ELECTRIC SWITCHES, SOCKETS, PLUGS AND OTHER CONTACTS, NAMELY, SAFETY CONTACT PLUGS, ELECTRICAL CONNECTORS, ELECTRICAL CONNECTIONS; FUSES, ELECTRIC SOCKET; BATTERIES, ELECTRIC; BATTERIES FOR LIGHTING; APPARATUS FOR RECORDING, TRANSMISSION OR REPRODUCTION OF SOUND OR IMAGES; AMPLIFIERS; HEADPHONES; LOUDSPEAKERS; MAGNETIC RECORDING MEDIA, NAMELY, BLANK MAGNETIC DATA CARRIERS; BLANK MAGNETIC DISKS; BLANK MAGNETIC COMPUTER TAPES; SOUND RECORDING, MAGNETIC AND OPTICAL DISKS, AUDIO AND VIDEO COMPACT DISKS, NAMELY, BLANK MAGNETIC AND OPTICAL DISKS FOR SOUND RECORDING, BLANK MAGNETIC AND OPTICAL DISKS, BLANK AUDIO AND VIDEO COMPACT DISKS; PRERECORDED MAGNETIC AND OPTICAL DISKS FEATURING MUSIC; DIGITAL, VERSATILE, OPTICAL DISK PLAYERS; DVD PLAYERS; CAMCORDERS; VIDEOTAPES, NAMELY, BLANK VIDEOTAPES, PRERECORDED VIDEOTAPES FEATURING MOVIES; FACSIMILE MACHINES; TELEPHONES APPARATUS; ADAPTERS DESIGNED FOR TELEPHONES, BATTERY CHARGERS FOR USE WITH TELEPHONES; BAGS, COVERS AND CASES SPECIALLY ADAPTED FOR MOBILE TELEPHONES AND TELEPHONE EQUIPMENT; ANSWERING MACHINES; HANDS FREE KITS FOR PHONES; TELEVISION APPARATUS, NAMELY, TELEVISIONS, TELEVISION CAMERAS, TELEVISION TRANSMITTERS; ANTENNAS; PHOTOGRAPHIC SLIDES, PROJECTION APPARATUS AND SCREENS, NAMELY, SLIDE AND PHOTOGRAPHIC PROJECTION APPARATUS, TRANSPARENCY PROJECTION APPARATUS, COMPUTER SCREENS, FLAT PANEL DISPLAY SCREENS, PROJECTION SCREENS; PHOTOGRAPH FLASH-BULBS; EXPOSED CAMERA, CINEMATOGRAPHIC, PHOTOGRAPHIC, SLIDE, X-RAY FILMS, CASES SPECIALLY MADE FOR PHOTOGRAPHIC APPARATUS AND INSTRUMENTS; AUTOMATED TELLER MACHINES; CALCULATING MACHINES; DATA PROCESSING APPARATUS, NAMELY, DATA PROCESSORS, MEMORIES FOR DATA PROCESSING EQUIPMENT, INTERFACE CARDS FOR DATA PROCESSING EQUIPMENT IN THE FORM OF PRINTED CIRCUITS; COMPUTERS; COMPUTER PERIPHERAL DEVICES; DATA PROCESSING EQUIPMENT, NAMELY, FLASH CARD, OPTICAL, SMART CARD READERS; FLOPPY DISKS, NAMELY, BLANK FLOPPY COMPUTER DISKS; MODEMS; ELECTRONIC AGENDAS; VIDEO GAME CARTRIDGES; BINOCULARS; OPTICS, NAMELY, SPECTACLES; SPECTACLE CASES; INTEGRATED CIRCUIT CARDS, NAMELY, BLANK INTEGRATED CIRCUIT CARDS; MAGNETICALLY ENCODED DEBIT, CREDIT, KEY, IDENTITY CARDS; CREDIT AND PAYMENT CARDS, NAMELY, MAGNETICALLY ENCODED CREDIT CARDS, MAGNETICALLY ENCODED DEBIT CARDS, ELECTRONIC AND MAGNETIC ID CARDS FOR USE IN CONNECTION WITH PAYMENT FOR SERVICES; MAGNETIC CODED PAYMENT GIFT CARDS; MAGNETICALLY ENCODED IDENTITY CARDS; TELEPHONE CARDS, NAMELY, MAGNETICALLY ENCODED PRE-PAID TELEPHONE CALLING CARDS; DIRECTIONAL COMPASSES; SWIMMING LIFE BELTS AND LIFE JACKETS; DIVING MASKS, NAMELY, FACE MASKS FOR DIVING, SCUBA DIVING MASKS, SKIN DIVING MASKS; WET SUITS, IN THE NATURE OF SURVIVAL SUITS; BABY, CALCULATING, WEIGHING SCALES; PROTECTIVE HELMETS; PROTECTION DEVICES FOR PERSONAL USE AGAINST ACCIDENTS, NAMELY, ARTICLES OF PROTECTIVE CLOTHING FOR PROTECTION AGAINST ACCIDENT OR INJURY FOR USE IN MOTORCYCLING, SKATEBOARDING, SURFING, EYE COVERS FOR PROTEC-

TIVE PURPOSES, PROTECTIVE EAR COVERINGS, PROTECTIVE EYEWEAR; NETS FOR PROTECTION AGAINST ACCIDENTS; CLOTHING FOR PROTECTION AGAINST ACCIDENTS, IRRADIATION AND FIRE; BAROMETERS; FIRE EXTINGUISHERS; EGG TIMERS; LOCKS, ELECTRIC; ELECTRIC DOOR BELLS; BURGLAR, FIRE, ELECTRONIC DOOR ALARMS; ANTI-THEFT ALARMS, NAMELY, BURGLAR ALARMS; MAGNETS; DECORATIVE MAGNETS (U.S. CLS. 21, 23, 26, 36 AND 38).

CLASS 12—VEHICLES

FOR VEHICLES, NAMELY, LAND VEHICLES, BOATS, MOTORCYCLES; APPARATUS FOR LOCOMOTION BY LAND, AIR OR WATER, NAMELY, LAND VEHICLES, BOATS, AIRPLANES, MOTORCYCLES; BICYCLES; GOODS HANDLING CARTS; SUN BLINDS ADAPTED FOR AUTOMOBILES; HEAD RESTRAINTS AND SAFETY BELTS FOR VEHICLE SEATS; CHILDREN'S SAFETY SEATS FOR VEHICLES; KICKSTANDS; BICYCLE, LICENSE PLATE FRAMES; NETS, NAMELY, NET CARGO CARRIERS FOR VEHICLES, NET CARGO STORAGE BINS ESPECIALLY ADAPTED TO FIT IN CARS, TRUCKS AND SUVs; BICYCLE, VEHICLE, MOTORCYCLE BRAKES; HANDLEBARS; BICYCLE SADDLES; BICYCLE PUMPS; PUSH CHAIRS; FITTED VEHICLE COVERS; SEAT COVERS FOR VEHICLES; LUGGAGE CARRIERS FOR VEHICLES; BICYCLE RACKS FOR VEHICLES; SKI CARRIERS FOR VEHICLES; PUSH CHAIRS; PUSH CHAIR HOODS; ANTI-THEFT DEVICES FOR VEHICLES; SHOPPING TROLLEYS (U.S. CLS. 19, 21, 23, 31, 35 AND 44).

CLASS 14—JEWELRY

FOR PRECIOUS METALS AND THEIR ALLOYS OTHER THAN FOR DENTAL USE; JEWELRY; PRECIOUS STONES; JEWELRY CASES OF PRECIOUS METAL; JEWELRY CASES; HOROLOGICAL AND CHRONOMETRIC INSTRUMENTS; WATCHES AND WATCH BANDS; CUFF LINKS; TIE PINS; ORNAMENTAL PINS; JEWELRY, NAMELY, LAPEL BADGES OF PRECIOUS METAL; TRINKETS AND FOBS, NAMELY, KEY RINGS OF PRECIOUS METAL; SUNDIALS; BOXES OF PRECIOUS METAL; COLLECTIBLE, COMMEMORATIVE, NON-MONETARY COINS; FIGURINES AND STATUETTES OF PRECIOUS METAL; WORKS OF ART OF PRECIOUS METAL AND PRECIOUS STONES; LAPEL PINS (U.S. CLS. 2, 27, 28 AND 50).

CLASS 15—MUSICAL INSTRUMENTS

FOR MUSICAL INSTRUMENTS AND COMPONENT PARTS OF MUSICAL INSTRUMENTS, NAMELY, FOOT PEDALS FOR USE IN CONNECTION WITH MUSICAL INSTRUMENTS, STANDS FOR MUSICAL INSTRUMENTS, MUSICAL INSTRUMENT STRINGS; MUSICAL BOXES; BRIDGES FOR MUSICAL INSTRUMENTS, NAMELY, GUITAR BRIDGES; TUNING FORKS; CASES FOR MUSICAL INSTRUMENTS (U.S. CLS. 2, 21 AND 36).

CLASS 16—PAPER GOODS AND PRINTED MATTER

FOR PAPER; UNPROCESSED AND SEMI-PROCESSED CARDBOARD; CARDBOARD FOR STATIONERY USE; CARDBOARD ARTICLES, NAMELY, CARDBOARD BOXES, CARDBOARD CARTONS, CARDBOARD CONTAINERS; PAPER AND PLASTIC PACKAGING BAGS, POUCHES AND SHEETS; PAPER SHEETS, NAMELY, STATIONERY; PRINTED MATTER, NAMELY, PRINTED AWARDS, PRINTED CALENDARS, PRINTED CHARTS; PRINTING TYPE; BOOKBINDING MATERIALS; PHOTOGRAPHS; PRINTING BLOCKS; STATIONERY; GLUES FOR STATIONERY OR HOUSEHOLD PURPOSES; ARTISTS' MATERIALS, NAMELY, ARTISTS' BRUSHES, ARTISTS' PASTELS, ARTISTS' PENCILS, ARTISTS' PENS; PAINTBRUSHES; ARTICLES FOR USE IN SCHOOL, NAMELY, PAINT BOXES; MODELING PASTE; TYPEWRITERS AND OFFICE REQUISITES EXCEPT FURNITURE, NAMELY, FRANKING MACHINES, PAPER EMBOSSERS, PUNCHES; PRINTED INSTRUCTIONAL, EDUCATIONAL AND TEACHING MATERIALS IN THE FIELD OF MUSIC, PROTECTION AND

RIGHTS OF CHILDREN, CHILDREN PSYCHOLOGY, CHILDCARE, AND ENVIRONMENTAL PROTECTION; WRITING AND DRAWING MATERIALS, NAMELY, DRAWING BRUSHES, DRAWING INSTRUMENTS, WRITING INSTRUMENTS; SCHOOL SUPPLIES, NAMELY, SCHOOL WRITING BOOKS, PENS, PENCILS; STAPLES FOR OFFICES; THUMB TACKS; PENCIL SHARPENERS; CORRECTING FLUIDS FOR TYPE; PAPER KNIVES; PENCILS; WRITING CHALK; PENCIL LEAD HOLDERS; RUBBER ERASERS; ENVELOPES; CARD, DOCUMENT, LETTER FILES; COIN, EVENTS, PHOTOGRAPHIC ALBUMS; BOOKS AND PERIODICALS IN THE FIELD OF MUSIC; COMIC BOOKS; ALMANACS; PAMPHLETS IN THE FIELD OF MUSIC AND ADVERTISING; WRITING AND DRAWING BOOKS, NAMELY, SCHOOL WRITING BOOKS, DRAWING PADS, DRAWING TABLETS; CATALOGUES IN THE FIELD OF MUSIC; CALENDARS; LITHOGRAPHS; ENGRAVINGS; PAINTINGS; POSTERS; GEOGRAPHICAL MAPS; NEWSPAPERS; INKING RIBBONS FEATURING A SPOOL; MAILERS, NAMELY, MAILING LABELS, CARDBOARD MAILING TUBES, PAPER MAIL POUCHES; POSTAGE STAMPS; OFFICE REQUISITES, NAMELY, ADHESIVE TAPE DISPENSERS; TISSUES OF PAPER FOR REMOVING MAKE-UP; BABIES' DIAPERS OF PAPER AND CELLULOSE; PICTURES; DECALCOMANIAS; GARBAGE BAGS OF PAPER AND OF PLASTICS; BAGS FOR MICROWAVE COOKING; SIGNBOARDS OF PAPER AND CARDBOARD; TOILET PAPER; BIBS OF PAPER, TABLE LINEN OF PAPER; TOWELS OF PAPER, HANDKERCHIEFS OF PAPER; GREETING CARDS; POSTCARDS; PATTERNS FOR DRESSMAKING; TERRESTRIAL GLOBES; NON-MAGNETICALLY ENCODED LOYALTY CARDS; NON-MAGNETICALLY ENCODED IDENTITY CARDS (U.S. CLS. 2, 5, 22, 23, 29, 37, 38 AND 50).

CLASS 18—LEATHER GOODS

FOR LEATHER AND IMITATIONS OF LEATHER; ANIMAL SKINS; TRUNKS; SUITCASES; SMALL CASES, NAMELY, ATTACHE CASES, CALLING CARD CASES, BUSINESS CARD CASES; UMBRELLAS; PARASOLS; WALKING STICKS; WHIPS; HARNESSES AND SADDLERY; HANDBAGS; BEACH BAGS; BAGS, NAMELY, ATHLETIC BAGS, ALL-PURPOSE CARRYING BAGS; TRAVELING SETS CONSISTING OF TRAVELING BAGS, GARMENT BAGS FOR TRAVEL, GROOMING ORGANIZERS FOR TRAVEL; TRUNKS; VANITY CASES, NOT FITTED; COSMETIC SETS CONSISTING OF COSMETIC BAGS SOLD EMPTY, COSMETIC CASES SOLD EMPTY; SHOPPING NETS AND BAGS, NAMELY, MESH SHOPPING BAGS, STRING BAGS FOR SHOPPING, CANVAS SHOPPING BAGS, LEATHER SHOPPING BAGS; BACKPACKS; SPORTS BAGS; WHEELED SHOPPING BAGS; GARMENT BAGS FOR TRAVEL; SCHOOL BAGS; WALLET; NOTE CASES, NAMELY, NAME, BUSINESS, CALLING CARD CASES; BRIEFCASES; LEATHER KEY CASES; PURSES; TOOL BAGS OF LEATHER SOLD EMPTY; HAT BOXES OF LEATHER; SATCHEL BAGS, NAMELY, SACHELS, SCHOOL SACHEL; SLINGS FOR CARRYING INFANT CHILDREN; COLLARS AND CLOTHING FOR ANIMALS (U.S. CLS. 1, 2, 3, 22 AND 41).

CLASS 19—NON-METALLIC BUILDING MATERIALS

FOR BUILDING MATERIALS, NOT OF METAL, NAMELY, BUILDING GLASS, SEMI-WORKED WOODS, BUILDING STONE; CEMENT, NAMELY, CEMENT AGGREGATES, CEMENT MIXES, FILLING CEMENT; CONCRETE; COATINGS, NAMELY, ASPHALT ROOF COATINGS, BITUMINOUS ROOF COATINGS, PROTECTIVE SEALING COATINGS SOLD AS AN INTEGRAL COMPONENT OF GRANITE AND STONE; PLASTER; ARTIFICIAL, BUILDING, FOOTING STONE; MARBLE; BUILDING TIMBER; WOOD VENEER; WOOD PANELING; PLYWOOD; PARQUET FLOOR BOARDS; FIRED, UNFIRED, COMMEMORATIVE, GLASS BRICKS; WINDOW GLASS FOR BUILDING; NONSTRUCTURAL BUILDING MATERIALS, NAMELY, BRICK VENEER, CEMENT PANELS; BUILDING MATERIALS, NAMELY, MANUFACTURED BRICK VENEER FOR USE ON INTERIOR AND EXTERIOR WALLS, FLOORS AND SURFACES, PATIOS, POOL SIDES AND DRIVEWAYS; BUILDING STONE; BUILDING TIMBER; CEMENT-

TIUS MATERIAL FOR BUILDING PURPOSES; CONCRETE BUILDING MATERIALS, NAMELY, BLOCKS, BRICKS, POSTS, SLABS, PANELS; NONSTRUCTURAL SURFACE BUILDING MATERIALS IN THE NATURE OF GRANITE USED IN DECORATIVE SURFACE APPLICATIONS FOR COUNTERTOPS AND VANITY TOPS; TILE FLOORINGS, NOT OF METAL, NAMELY, FLOOR TILES OF WOOD, RUBBER FLOOR TILES, NON-METAL FLOOR TILES; CHIMNEYS, NOT OF METAL; STAIRCASES, NOT OF METAL; WINDOWS AND DOORS, NOT OF METAL; BLINDS OUTDOOR, NOT OF METAL AND NOT OF TEXTILE; NON-METAL SWIMMING POOLS; NON-METALLIC SWIMMING POOLS; CABANAS NOT OF METAL; WATER PIPES, NOT OF METAL; NON-METALLIC TRANSPORTABLE BUILDINGS; NON-TRANSPORTABLE NON-METALLIC BUILDINGS, NAMELY, PREFABRICATED NON-METAL BUILDINGS; AQUARIA STRUCTURES, NAMELY, AQUARIUM GRAVEL, AQUARIUM SAND, DECORATIVE AQUARIUM STONES; MONUMENTS, NOT OF METAL; ADVERTISEMENT COLUMNS, NOT OF METAL; DUCKBOARDS, NOT OF METAL (U.S. CLS. 1, 12, 33 AND 50).

CLASS 20—FURNITURE AND ARTICLES NOT OTHERWISE CLASSIFIED

FOR FURNITURE; DISPLAY STANDS; LOOKING GLASSES, NAMELY, MIRRORS; FRAMES EXCEPT CONSTRUCTION FRAMES, NAMELY, BED FRAMES, PICTURE FRAMES, FURNITURE FRAMES, MIRROR FRAMES; WORKS OF ART MADE OF WOOD, WAX, PLASTER, CORK, REED, CANE, WICKER, HORN, BONE, IVORY, WHALEBONE, SHELL, AMBER, MOTHER-OF-PEARL, MEERSCHAUM AND SUBSTITUTES FOR ALL THESE MATERIALS OR PLASTIC; NON-METALLIC BASKETS AND TRAYS, NAMELY, NON-METALLIC BASKETS FOR TRANSPORTING GOODS FOR COMMERCIAL PURPOSES, NON-METALLIC BAKER'S BREAD BASKETS, COMPUTER KEYBOARD TRAYS, PACKAGING MATERIALS IN THE NATURE OF RIGID PLASTIC TRAYS; PACKAGING CONTAINERS OF PLASTIC; DECORATIVE, LETTER BOXES OF WOOD AND PLASTIC; HOUSES FOR HOUSEHOLD PETS, NAMELY, PET CRATES, PLAYHOUSES FOR PETS; BEDS FOR HOUSEHOLD PETS; DISPLAY BOARDS; WORK BENCHES; EMBROIDERY FRAMES; REGISTRATION PLATES, NOT OF METAL, NON-METAL IDENTITY PLATES, NON-METAL NAME PLATES, NONMETAL NOVELTY LICENSE PLATES; SIGNBOARDS OF WOOD AND PLASTICS; NON-METALLIC AND NON-ELECTRICAL METAL WORK, NAMELY, NON-METAL HOSE HANGERS, NON-METAL CASTORS, NON-METAL BOLTS; NON-METALLIC HINGES AND PEGS; PLAYPENS FOR BABIES; CRADLES; INFANT WALKERS; BEDDING MATERIAL EXCLUDING LINEN, NAMELY, BED FRAMES, BED HEADBOARDS, BED PILLOWS, BED MATTRESSES; BEDS; SLEEPING BAGS FOR CAMPING; CUSHIONS; PILLOWS; BOLSTERS; BEDSPRINGS; MATTRESSES; CLOTHES HANGERS; COVERS, NAMELY, FITTED FABRIC FURNITURE COVERS, PLASTIC TISSUE BOX COVERS, FITTED COVERS FOR HIGH CHAIRS; CURTAIN RINGS, RODS AND HOOKS; DOOR HANDLES, NOT OF METAL; TOWEL DISPENSERS, FIXED, NOT OF METAL; COSTUME DISPLAY STANDS; UMBRELLA STANDS; LADDERS OF WOOD AND PLASTICS; DECORATIONS OF PLASTIC FOR FOODSTUFFS; SLATED INDOOR BLINDS; MANNEQUINS; FANS FOR PERSONAL USE, NON-ELECTRIC (U.S. CLS. 2, 13, 22, 25, 32 AND 50).

CLASS 21—HOUSEWARES AND GLASS

FOR NON-ELECTRIC UTENSILS FOR HOUSEHOLD OR KITCHEN USE, NAMELY, SPATULAS, STRAINERS, TURNERS, SIEVES; CONTAINERS FOR HOUSEHOLD OR KITCHEN USE; COMBS; BATH, CLEANING, SCOURING SPONGES; BRUSHES, EXCEPT PAINT BRUSHES, NAMELY, BATH BRUSHES, CLEANING BRUSHES FOR HOUSEHOLD USE, COSMETIC BRUSHES; BROOMS; BOWLS; ARTICLES FOR CLEANING PURPOSES, NAMELY, CLEANING CLOTHS, CLEANING SPONGES, CLEANING RAGS; STEEL WOOL; GLOVES FOR HOUSEHOLD PURPOSES; CLEANING CLOTHS; CHAMOIS LEATHER FOR CLEANING; GLASS, UNWORKED OR SEMIWORKED,

EXCEPT BUILDING GLASS; UTENSILS FOR KITCHEN AND TABLEWARE USE OF GLASS, PORCELAIN AND EARTHENWARE, NAMELY, BEVERAGE GLASSWARE, GLASS DISHES, FRUIT BOWLS OF GLASS; COOKING POT SETS; THERMALLY INSULATED CONTAINERS FOR FOOD AND BEVERAGES; DRINKING FLASKS FOR TRAVELERS; NON-ELECTRIC PORTABLE COOLERS; TABLEWARE, OTHER THAN KNIVES, FORKS AND SPOONS, NAMELY, PLATES, BOWLS, DRINKING GLASSES; VASES; NON-ELECTRIC CANDELABRA; CANDLE EXTINGUISHERS; PICNIC BASKETS FITTED WITH DISHES; CORKSCREWS; BOTTLE OPENERS; BOXES OF METAL FOR DISPENSING PAPER TOWELS; TOWEL RAILS AND RINGS; SOAP AND TOILET PAPER DISPENSERS; TOILET PAPER HOLDERS; CHAMBER POTS; DRYING RACKS FOR WASHING, NAMELY, CLOTHES DRYING RACKS, DISH DRYING RACKS; CLOTHES PEGS; DUST BINS; IRONING BOARDS AND IRONING BOARD COVERS; ISOTHERMIC BAGS, NAMELY, THERMAL INSULATED BAGS FOR FOOD OR BEVERAGES; INSECT TRAPS; FLOWER POTS; COVERS, NOT OF PAPER, FOR FLOWER POTS; LITTER TRAYS FOR PETS; CAGES FOR HOUSEHOLD PETS; INDOOR AQUARIA; COMBS FOR ANIMALS; WATERING DEVICES, NAMELY, WATER TROUGHES, WATERING CANS, WATERING POTS; GARDENING GLOVES; TOOTHBRUSHES; FLOSS FOR DENTAL PURPOSES; SOAP BOXES; COSMETIC UTENSILS, NAMELY, MICRODERMABRASION SPONGES FOR COSMETIC USE, NON-WOVEN FABRIC COSMETIC WIPES, TOILET SETS CONSISTING OF TOILET BRUSHES, TOILET BRUSH HOLDERS, TOILET SPONGES; PERFUME VAPORIZERS AND ATOMIZERS, SOLD EMPTY; PORTABLE BABY BATHTUBS; SHOE HORNS; PIGGY BANKS, NOT OF METAL; WORKS OF ART OF PORCELAIN, TERRACOTTA AND GLASS (U.S. CLS. 2, 13, 23, 29, 30, 33, 40 AND 50).

CLASS 24—FABRICS

FOR FABRIC, NAMELY, FABRIC FOR THE MANUFACTURE OF CLOTHING, FABRIC FOR TEXTILE USE, COTTON FABRIC; ADHESIVE FABRIC FOR APPLICATION BY HEAT; UPHOLSTERY FABRICS; BED AND HOUSEHOLD LINEN; TABLE LINEN, NOT OF PAPER; BED, BATH SHEETS; PILLOWCASES; BED COVERS; BATH LINEN, EXCEPT CLOTHING; TEXTILE FACE CLOTHS AND TOWELS; BILLIARD CLOTH; WALL HANGINGS OF TEXTILE; CURTAINS OF TEXTILE AND PLASTIC; TABLECLOTHS, NOT OF PAPER; OIL-CLOTH FOR USE AS TABLECLOTHS; SLEEPING BAGS IN THE NATURE OF SHEETING; NAPKINS, OF CLOTH, FOR REMOVING MAKE-UP; MOSQUITO NETS; LABELS OF CLOTH; CANVAS FOR EMBROIDERY; LOOSE COVERS FOR FURNITURE, NAMELY, UNFITTED FURNITURE COVERS NOT OF PAPER; BLINDS OF TEXTILE, NAMELY, FABRIC WINDOW CURTAINS AND DRAPERIES; HANDKERCHIEFS OF TEXTILE (U.S. CLS. 42 AND 50).

CLASS 25—CLOTHING

FOR CLOTHING, NAMELY, SHIRTS, PANTS, JACKETS; KNITWEAR, NAMELY, KNIT BOTTOMS, KNIT DRESSES, KNIT JACKETS; UNDERWEAR; PAJAMAS; DRESSING GOWNS; SWEATERS; SKIRTS; FROCKS; TROUSERS; JACKETS; COATS; WATERPROOF CLOTHING, NAMELY, WATERPROOF JACKETS AND PANTS; SHIRTS; NECKTIES; SCARVES; SASHES FOR WEAR; BELTS; CLOTHING GLOVES; BRACES FOR CLOTHING; HEADGEAR FOR WEAR, NAMELY, HATS, CAPS, BERTS, VISORS; HATS; CAPS; FOOTWEAR; SOCKS; STOCKINGS; TIGHTS; FOOTWEAR EXCLUDING ORTHOPEDIC FOOTWEAR; SLIPPERS, BOOTS; BEACH SHOES, SKI BOOTS; BOOTS FOR SPORTS; BATHING TRUNKS AND COSTUMES; CLOTHING FOR SPORTS EXCLUDING DIVING CLOTHING, NAMELY, SPORTS JERSEYS, SPORTS VESTS, SKI WEAR; LAYETTES; BABIES' PANTS (U.S. CLS. 22 AND 39).

CLASS 26—FANCY GOODS

FOR HABERDASHERY, EXCEPT THREAD, NAMELY, BEADS OTHER THAN FOR MAKING JEWELRY; LACE TRIMMINGS; LACE AND EMBROIDERY; RIBBONS AND BRAID; BUTTONS; HOOKS AND EYES; MARKING, SEWING, SAFETY PINS AND NEEDLES; SNAP FASTENERS; ARTIFICIAL FLOWERS AND FRUITS; HOOKS AND FASTENERS IN THE NATURE OF SNAP FASTENERS, SNAP CLIPS FOR CLOTHING; CLOTHING BUCKLES; ORNAMENTAL NOVELTY BADGES; HAT ORNAMENTS NOT OF PRECIOUS METAL; HAIR ORNAMENTS; HAIR BANDS AND HAIR NETS; HAIR PINS AND GRIPS; BARRETTES; WIGS; ZIP FASTENERS; SHOE LACES; BUCKLES FOR FOOTWEAR; FASTENINGS FOR SUSPENDERS; BELT CLASPS; ELASTIC RIBBONS; LACEWORK, NAMELY, FRILLS FOR ATTACHMENT TO CLOTHING; HABERDASHERY, NAMELY, HEAT ADHESIVE PATCHES FOR DECORATION AND REPAIR OF TEXTILE ARTICLES; SPANGLES FOR CLOTHING; SEWING BOXES (U.S. CLS. 37, 39, 40, 42 AND 50).

CLASS 28—TOYS AND SPORTING GOODS

FOR GAMES, NAMELY, BOARD GAMES, CARD GAMES, HAND HELD UNITS FOR PLAYING ELECTRONIC GAMES OTHER THAN THOSE ADAPTED FOR USE WITH AN EXTERNAL DISPLAY SCREEN OR MONITOR; TOYS, NAMELY, ACTION FIGURES, ELECTRONIC LEARNING TOYS; GYMNAS TIC AND SPORTING ARTICLES EXCEPT FOR SWIMMING ARTICLES, CLOTHING, FOOTWEAR AND MATS, NAMELY, GYMNAS TIC APPARATUS, HORIZONTAL BARS, BASKETBALLS, BASEBALL BATS; RACKETS; PARTS OF SPORTS SUITS, NAMELY, PROTECTIVE PADDING FOR PLAYING FOOTBALL, SOCCER, HOCKEY; SHIN GUARDS, NAMELY, SHIN PADS FOR ATHLETIC USE; KNEE GUARDS, NAMELY, KNEE PADS FOR ATHLETIC USE; NETS FOR SPORTS; ARCHERY IMPLEMENTS; CLAY PIGEON TRAPS; TARGETS, DARTS; FENCING WEAPONS; DISCUSES FOR SPORTS; SKIS; SURF BOARDS; SKATING BOOTS WITH SKATES ATTACHED; ICE SKATES; ROLLER SKATES; SKATEBOARDS; KITES; ORNAMENTS FOR CHRISTMAS TREES EXCEPT ILLUMINATION ARTICLES AND CONNECTIONERY; NOVELTIES FOR PARTIES AND DANCES, NAMELY, PAPER AND PLASTIC PARTY HATS, PARTY GAMES, PARTY FAVORS IN THE NATURE OF CRACKERS AND NOISEMAKERS; TOY MASKS; SWINGS; BOWLING BALLS, BOWLING PINS, BOWLING BAGS; PLAY BALLS AND BALLOONS; ROCKING HORSES; SPORTS AND PLAY ARTICLES, NAMELY, PLAY, INFLATABLE SWIMMING POOLS; MARBLES AND COUNTERS FOR GAMES; PLUSH TOYS; DOLLS AND DOLLS' HOUSES; PUPPETS; DOLLS' CLOTHES; TOY FIGURINES, NAMELY, MODELED PLASTIC TOY FIGURINES, ATTACHABLE, WEARABLE, MAGNETIC TOY FIGURINES; PARLOR GAMES; BUILDING GAMES; TOY SPINNING TOPS; TOY MOBILES; TOY VEHICLES AND SCOOTERS; KITES; GAMES AND GAME APPLIANCES OTHER THAN THOSE DESIGNED TO BE USED ONLY WITH TELEVISION RECEIVER, AN EXTERNAL DISPLAY SCREEN OR MONITOR, NAMELY, ELECTRONIC GAMES OTHER THAN THOSE ADAPTED FOR USE WITH TELEVISION RECEIVERS ONLY, FLOOR-STANDING UNITS FOR PLAYING ELECTRONIC GAMES OTHER THAN IN CONJUNCTION WITH A TELEVISION OR COMPUTER, HAND HELD UNITS FOR PLAYING ELECTRONIC GAMES OTHER THAN THOSE ADAPTED FOR USE WITH AN EXTERNAL DISPLAY SCREEN OR MONITOR (U.S. CLS. 22, 23, 38 AND 50).

CLASS 35—ADVERTISING AND BUSINESS

FOR ADVERTISING; PUBLICATION OF PUBLICITY TEXTS; DIRECT MAIL ADVERTISING; BILL POSTING, NAMELY, BILL STICKING, BILL PRESENTMENT SERVICES; COMMERCIAL AND INDUSTRIAL MANAGEMENT ASSISTANCE; BUSINESS MANAGEMENT; BUSINESS MANAGEMENT ASSISTANCE; EFFICIENCY EXPERTS; BUSINESS CONSULTING, INFORMATION AND INQUIRIES; ORGANIZATION AND MANAGEMENT OF SHOPPING MALLS, NAMELY, BUSINESS ORGANIZATION CONSULTING FOR SHOPPING MALLS; PROFESSIONAL BUSINESS CONSULTANTS; SECRETARIAL SERVICES; BOOKKEEPING; RENTAL

OF OFFICE MACHINERY AND EQUIPMENT; RENTAL OF VENDING MACHINES; ARRANGING NEWSPAPER SUBSCRIPTIONS FOR OTHERS; ELECTRONIC NEWSPAPER SUBSCRIPTION SERVICES; TELEPHONE SUBSCRIPTION SERVICES; ARRANGING SUBSCRIPTIONS TO TELECOMMUNICATIONS SERVICES FOR OTHERS TO A WIRELESS TELEPHONY SERVICE AND TO A RADIO-PAGING SERVICE; ARRANGING SUBSCRIPTION SERVICES FOR SUBSCRIBING TO TELECOMMUNICATION SERVICES; ARRANGING SUBSCRIPTION SERVICES FOR SUBSCRIBING TO A GLOBAL TELECOMMUNICATION NETWORK IN THE NATURE OF THE INTERNET AND PRIVATE ACCESS NETWORKS IN THE NATURE OF INTRANETS; ARRANGING SUBSCRIPTION SERVICES TO A DATABASE AND MULTIMEDIA SERVER CENTER FOR OTHERS; ARRANGING SUBSCRIPTIONS FOR OTHERS TO TELEMATIC SERVICES AND DATA TRANSMISSION SERVICES USING TELEMATIC MEANS; ARRANGING SUBSCRIPTIONS FOR OTHERS TO A CENTRAL SERVICE PROVIDING ACCESS TO A COMPUTER NETWORK OR DATA COMMUNICATION NETWORK; ARRANGING SUBSCRIPTIONS FOR OTHERS TO COMPUTER DATABASES; GOODS IMPORT-EXPORT AGENCIES; COMMERCIAL INFORMATION AGENCIES; COST PRICE ANALYSIS; MARKET STUDY; MARKET RESEARCH; OPINION POLLING, NAMELY, PUBLIC OPINION POLLING, MARKET OPINION POLLING STUDIES; PRICE COMPARISON SERVICES; COMPILATION OF STATISTICS; PUBLIC RELATIONS; PRESENTATION OF GOODS ON ANY COMMUNICATION MEDIA FOR RETAIL PURPOSES, NAMELY, SALES PROMOTION; COMMERCIAL INFORMATION AND ADVICE FOR CONSUMERS; ADMINISTRATIVE PROCESSING OF PURCHASE ORDERS; ORGANIZATION OF EXHIBITIONS AND TRADE FAIRS FOR COMMERCIAL OR ADVERTISING PURPOSES; COMPUTERIZED FILE MANAGEMENT; COMPILATION AND SYSTEMIZATION OF DATA INTO COMPUTER DATABASES; DOCUMENT REPRODUCTION, BRINGING TOGETHER, FOR THE BENEFIT OF OTHERS, OF A VARIETY OF GOODS, EXCLUDING TRANSPORT, TO ENABLE CUSTOMERS TO EXAMINE AND CONVENIENTLY VIEW AND PURCHASE THOSE GOODS, NAMELY, RETAIL STORE SERVICES, WHOLESALE STORE SERVICES, ONLINE AND WHOLESALE ORDERING SERVICES, RETAIL STORES, DISTRIBUTORSHIPS SERVICES, MAIL ORDER SERVICES, INTERNET RETAIL STORE SERVICES, AND COMPUTERIZED ONLINE ORDERING SERVICES FEATURING BLEACHING PREPARATIONS AND OTHER SUBSTANCES FOR LAUNDRY USE, CLEANING, POLISHING, SCOURING AND ABRASIVE PREPARATIONS AND PRODUCTS, STAIN REMOVERS, FABRIC SOFTENERS, LAUNDRY BLUEING, SOAP, PERFUMES, TOILET WATER, PERFUMERY IN THE NATURE OF DEODORANTS FOR PERSONAL USE, COSMETICS, PREPARATIONS FOR HAIR CARE, HAIR DYES, SHAMPOOS, DENTIFRICES, MOUTH WASHES NOT FOR MEDICAL PURPOSES, DEPILATORIES, MAKE-UP AND MAKE-UP REMOVING PREPARATIONS, SHAVING PREPARATIONS, TOILETRIES, NAIL VARNISH AND PREPARATIONS FOR REMOVING NAIL VARNISH, COSMETIC PREPARATIONS FOR BATHS AND FOR SKIN TANNING, TOILETRY SWABS, COTTON WOOL FOR COSMETIC PURPOSES, TISSUES IMPREGNATED WITH COSMETIC LOTIONS, COSMETIC PREPARATIONS FOR SKIN TANNING IN THE NATURE OF SUNSCREENS, SHAMPOOS FOR PETS, INCENSE, SCENTED WOOD, FRAGRANCES IN THE NATURE OF POTPOURRIS, LIGHTING IN THE NATURE OF CANDLES AND WICKS, TAPERS, PERFUMED CANDLES, GREASE FOR LEATHER, FOODSTUFFS AND LACTEAL FLOUR FOR BABIES, ANTISEPTIC COTTON NOT IMPREGNATED WITH PREPARATIONS FOR TREATING ACNE OR SIMILAR SKIN CONDITIONS, COTTON WOOL NOT IMPREGNATED WITH PREPARATIONS FOR TREATING ACNE OR SIMILAR SKIN CONDITIONS, SANITARY PADS, NAPKINS AND PANTIES, BREAST-NURSING PADS, STERILIZING PREPARATIONS, METAL CONSTRUCTION MATERIALS, LADDERS OF METAL, NON-ELECTRIC CABLES AND WIRES OF COMMON METAL, NONELECTRICAL LOCKSMITHING ARTICLES, HARDWARE OF METAL, CHAINS OF METAL, RINGS OF METAL, HINGES OF METAL, KEYS, PADLOCKS, METAL BOXES, CRATES, BINS, BASKETS AND CONTAINERS, CLOTHES HOOKS OF METAL, WORKS OF ART OF COMMON METAL, HAND-HELD TOOLS NOT MANUALLY DRIVEN, ELECTRO-MECHANICAL APPARATUS FOR THE PREPARA-

TION OF FOODSTUFFS AND BEVERAGES, ELECTRIC MACHINES AND FOOD PROCESSORS, SEWING AND KNITTING MACHINES, HAND-OPERATED HAND TOOLS AND IMPLEMENTS, NON-ELECTRIC CUTLERY, TABLE FORKS, SPOONS OTHER THAN FOR FISHING AND FOR MEDICINES, SCISSORS, HAND-OPERATED HAND TOOLS AND IMPLEMENTS FOR GARDENING, MECHANICAL TOOLS FOR CHOPPING AND CUTTING FOODSTUFFS, NON-ELECTRICAL CAN OPENERS, NUTCRACKERS, RAZORS, RAZOR BLADES, NAIL NIPPERS AND FILES, NAIL CLIPPERS, MANICURE AND PEDICURE SETS, ELECTRIC AND NON-ELECTRIC HAIR CLIPPERS FOR PERSONAL USE, ELECTRIC OR NON-ELECTRIC DEPILATION APPLIANCES, HAIR-REMOVING TWEEZERS, SCIENTIFIC OTHER THAN MEDICAL, NAUTICAL, SURVEYING, PHOTOGRAPHIC, CINEMATOGRAPHIC, OPTICAL, WEIGHING, MEASURING, SIGNALING, SUPERVISION CHECKING AND LIFE-SAVING APPARATUS AND INSTRUMENTS, APPARATUS AND INSTRUMENTS FOR CONDUCTING, SWITCHING, TRANSFORMING, ACCUMULATING, REGULATING OR CONTROLLING ELECTRICITY, MATERIAL FOR ELECTRICITY MAINS IN THE NATURE OF WIRES, CABLES, ELECTRIC SWITCHES, PLUGS, SOCKETS AND OTHER CONTACTS, FUSES, SOCKET COVERS, ELECTRIC BATTERIES, BATTERIES FOR LIGHTING, ELECTRIC FLAT IRONS, APPARATUS FOR RECORDING, TRANSMISSION OR REPRODUCTION OF SOUND OR IMAGES, MAGNETIC RECORDING MEDIA, SOUND RECORDING, MAGNETIC AND OPTICAL DISKS, AUDIO AND VIDEO COMPACT DISKS, VIDEO TAPES, FACSIMILE MACHINES, TELEPHONE APPARATUS, ADAPTORS DESIGNED FOR TELEPHONES, BATTERY CHARGERS FOR TELEPHONES, BAGS, COVERS AND CASES FOR MOBILE TELEPHONES AND TELEPHONE EQUIPMENT, TELEPHONE ANSWERING MACHINES, ANTENNAS, PROJECTION APPARATUS AND SCREENS, PHOTOGRAPHY FLASH-BULBS, EXPOSED FILMS, CASES ESPECIALLY MADE FOR PHOTOGRAPHIC APPARATUS AND INSTRUMENTS, DICTATION MACHINES, CASH REGISTERS, CALCULATING MACHINES, DATA PROCESSING APPARATUS, COMPUTERS, COMPUTER PERIPHERAL DEVICES, COMPUTER SOFTWARE, FLOPPY DISKS, MODEMS, ELECTRONIC AGENDAS, APPARATUS FOR GAMES ADAPTED FOR USE ONLY WITH TELEVISION RECEIVERS, INDEPENDENT DISPLAY SCREENS OR MONITORS, VIDEO GAME CARTRIDGES, BINOCULARS, OPTICS IN THE NATURE OF SPECTACLES, SPECTACLE CASES, INTEGRATED CIRCUIT CARDS IN THE NATURE OF SMART CARDS, MAGNETIC CARDS, TELEPHONE CARDS, DIRECTIONAL COMPASSES, SWIMMING BELTS AND JACKETS, DIVING MASKS AND WET SUITS, WEIGHING SCALES, PROTECTIVE HELMETS, PROTECTION DEVICES FOR PERSONAL USE AGAINST ACCIDENTS, NETS FOR PROTECTION AGAINST ACCIDENTS, CLOTHING FOR PROTECTION AGAINST ACCIDENTS, IRRADIATION AND FIRE, BAROMETERS, FIRE EXTINGUISHERS, EGG-TIMERS, ELECTRIC LOCKS, ELECTRIC DOOR BELLS, ALARMS, ORNAMENTAL MAGNETS, FEEDING BOTTLES, FEEDING BOTTLE TEATS, SPOONS FOR ADMINISTERING MEDICINE, DROPPERS FOR MEDICAL PURPOSES, PACIFIERS FOR BABIES, BREAST-FEEDING TEATS MADE OF LATEX OR SILICONE, TEETHING RINGS, NURSING APPLIANCES, BREAST PUMPS, THERMOMETERS FOR MEDICAL PURPOSES, MATERNITY BELTS, UMBILICAL BELTS, NASAL ASPIRATOR DEVICES, APPARATUS FOR LIGHTING, HEATING, STEAM GENERATING, COOKING, REFRIGERATING, DRYING, VENTILATING, DISINFECTING, WATER SUPPLY, APPARATUS FOR AIR DEODORIZING AND PURIFICATION, ELECTRIC FANS FOR PERSONAL USE, WATER PURIFYING APPARATUS, STERILIZERS, ELECTRIC HEATERS FOR FEEDING BOTTLES, ICE CHESTS, HAIR DRYERS, ELECTRIC LAUNDRY DRYERS, LIGHT BULBS AND ELECTRIC LAMPS, VEHICLES, APPARATUS FOR LOCOMOTION BY LAND, AIR AND WATER, BICYCLES, GOODS HANDLING CARTS, VEHICLES IN THE NATURE OF TRAILERS, SUN-BLINDS ADAPTED FOR AUTOMOBILES, WINDSHIELD WIPERS, INNER TUBES AND SPIKES FOR WHEEL TIRES, WHEEL TIRES, HEAD RESTRAINTS AND SAFETY BELTS FOR VEHICLE SEATS, CHILDREN'S SAFETY SEATS FOR VEHICLES, BICYCLE PUMPS, BABY CARRIAGES, SCOOTERS, VEHICLE COVERS, SEAT COVERS FOR VEHICLES, LUGGAGE CARRIERS, BICYCLE RACKS, SKICAR-

RIERS FOR VEHICLES, STROLLERS, ANTI-THEFT DEVICES FOR VEHICLES, SHOPPING TROLLEYS, FIREWORKS, FIRECRACKERS, JEWELRY PRODUCTS, JEWEL CASES OF PRECIOUS METAL, PRESENTATION CASES, HOROLOGICAL AND CHRONOMETRIC INSTRUMENTS, WATCHES AND WATCH BANDS, CUFF LINKS, TIE PINS, KEY RINGS IN THE NATURE OF TRINKETS AND FOBS, BOXES OF PRECIOUS METAL, STATUETTES OF PRECIOUS METAL, WORKS OF ART OF PRECIOUS METAL AND OF PRECIOUS STONES, MUSICAL INSTRUMENTS AND COMPONENT PARTS OF MUSICAL INSTRUMENTS, MUSICAL BOXES, BRIDGES FOR MUSICAL INSTRUMENTS, TUNING FORKS, CASES FOR MUSICAL INSTRUMENTS, PAPER, UNPROCESSED AND SEMI-PROCESSED CARDBOARD, CARDBOARD FOR STATIONERY USE, CARDBOARD ARTICLES, PAPER AND PLASTIC PACKAGING BAGS, POUCHES AND SHEETS, STATIONERY PAPER SHEETS, PRINTED MATTER, BOOKBINDING ARTICLES, PHOTOGRAPHS, STATIONERY, ADHESIVE GLUES FOR STATIONERY OR HOUSEHOLD PURPOSES, ARTISTS' MATERIALS, PAINTBRUSHES, PAINT BOXES FOR USE IN SCHOOL, TYPEWRITERS AND OFFICE REQUISITES EXCEPT FURNITURE, INSTRUCTIONAL AND TEACHING MATERIAL EXCEPT APPARATUS, SCHOOL SUPPLIES, ENVELOPES, FILES, SCRAPBOOKS, BOOKS, PERIODICALS, ALMANACS, PAMPHLETS, WRITING OR DRAWING BOOKS, CALENDARS, LITHOGRAPHS, ENGRAVINGS, PAINTINGS, POSTERS, GEOGRAPHICAL MAPS, NEWSPAPERS, MAILERS, PAPER TISSUES FOR REMOVING MAKE-UP, BABIES' NAPKIN-PANTS IN THE NATURE OF DIAPER-PANTS OF PAPER AND CELLULOSE, DECALCOMANIAS, GARBAGE BAGS OF PAPER OR OF PLASTICS, BAGS FOR MICROWAVE COOKING, SIGNBOARDS OF PAPER AND CARDBOARD, TOILET PAPER, TABLE LINEN OF PAPER, HAND TOWELS, HANDKERCHIEFS OF PAPER, GREETING CARDS, POSTCARDS, SEWING PATTERNS, TERRESTRIAL GLOBES, SEALING AND INSULATING GASKETS, ELASTIC AND PLASTIC THREADS AND YARNS NOT FOR TEXTILE USE, LEATHER AND IMITATIONS OF LEATHER, ANIMAL SKINS, PELTS AND HIDES, TRUNKS, SUITCASES AND SMALL CASES, SUN UMBRELLAS, UMBRELLAS, PARASOLS AND WALKING STICKS, WHIPS, HARNESES AND SADDLERY, HANDBAGS, BEACH BAGS, BAGS, TRAVELING SETS AND TRUNKS, VANITY CASES NOT FITTED, COSMETIC SETS, SHOPPING NETS AND BAGS, BACKPACKS, SPORTS BAGS EXCEPT THOSE ADAPTED TO THE PRODUCT THAT THEY ARE INTENDED TO CONTAIN, WHEELED BAGS, GARMENT BAGS FOR TRAVEL, SCHOOL BAGS, WALLETS, CARD CASES IN THE NATURE OF WALLETS, ATTACHE CASES, LEATHER KEY CASES, PURSES, EMPTY TOOL SET BAGS, HAT BOXES OF LEATHER, SACHEL BAGS AND SLINGS FOR CARRYING CHILDREN, COLLARS AND CLOTHING FOR ANIMALS, NON-METAL CONSTRUCTION MATERIALS, CEMENT, COATINGS, PLASTER, BUILDING TIMBER, VENEER, BRICKS, SURFACING FOR BUILDING, NON-METAL FLOOR TILES, NON-METAL CHIMNEYS, NON-METAL WINDOWS AND DOORS, NON-METAL AND NON-TEXTILE OUTDOOR BLINDS, SWIMMING POOLS, NON-METALLIC TRANSPORTABLE CONSTRUCTIONS, AQUARIA STRUCTURES, FURNITURE, DISPLAY STANDS, LOOKING GLASSES IN THE NATURE OF MIRRORS, FRAMES EXCEPT CONSTRUCTION FRAMES, WORKS OF ART MADE OF WOOD, WAX, PLASTER, CORK, REED, CANE, WICKER, HORN, BONE, IVORY, WHALEBONE, SHELL, AMBER, MOTHER-OF-PEARL, MEERSCHAUM, SUBSTITUTES FOR ALL THESE MATERIALS AND PLASTIC, NON-METALLIC BASKETS AND TRAYS, PACKAGING CONTAINERS OF PLASTIC, BOXES OF WOOD AND PLASTIC, HOUSES AND BEDS FOR HOUSEHOLD PETS, DISPLAY BOARDS, VISE BENCHES, EMBROIDERY FRAMES, SIGNBOARDS OF WOOD AND PLASTICS, NON-METALLIC AND NON-ELECTRICAL METAL WORK, NON-METALLIC HINGES AND PEGS, PLAYPENS FOR BABIES, BASSINETS, INFANT WALKERS, NON-METAL DUCKBOARDS, BEDDING MATERIAL EXCLUDING LINEN, SLEEPING BAGS FOR CAMPING, CUSHIONS, PILLOWS, BOLSTERS, BED BASES, MATTRESSES, CLOTHES HANGERS AND COVERS, CURTAIN RINGS, RODS AND HOOKS, NON-METAL DOOR HANDLES, FIXED NON-METAL TOWEL DISPENSERS, BOTTLE RACKS, BOTTLE STOPPERS, NON-METAL BROOM HANDLES, UMBRELLA STANDS, LADDERS OF WOOD AND PLASTICS, DECORATIONS OF PLAS-

TIC FOR FOODSTUFFS, STRAWS FOR DRINKING, SLATTED INDOOR BLINDS, MANNEQUINS, FANS FOR PERSONAL USE, NON-ELECTRIC UTENSILS AND CONTAINERS FOR HOUSEHOLD OR KITCHEN USE, COMBS AND SPONGES, BRUSHES EXCEPT PAINTBRUSHES, BROOMS, BASINS, MATERIAL FOR BRUSH-MAKING, ARTICLES FOR CLEANING PURPOSES, STEEL WOOL, GLOVES FOR HOUSEHOLD PURPOSES, CLEANING CLOTHS, CHAMOIS LEATHER FOR CLEANING, UTENSILS FOR KITCHEN AND TABLEWARE USE OF GLASS, PORCELAIN AND EARTHENWARE, COOKING POT SETS, DRINKING FLASKS FOR TRAVELLERS, NON-ELECTRIC PORTABLE COOLERS, TABLEWARE OTHER THAN KNIVES, FORKS AND SPOONS, VASES, CANDLE HOLDERS, FITTED PICNIC BASKETS INCLUDING DISHES, BOTTLE OPENERS, SOAP AND TOILET PAPER DISPENSERS, TOILET PAPER ROLL HOLDERS, CHAMBER POTS, DRYING RACKS FOR WASHING, CLOTHESPINS, TRASH CANS, IRONING BOARDS AND IRONING BOARD COVERS, ISOTHERMIC BAGS, INSECT TRAPS, FLOWER POTS, FLOWER-POT COVERS NOT OF PAPER, SPRINKLING DEVICES, GARDENING GLOVES, TOOTHBRUSHES, SOAP BOXES, COSMETIC UTENSILS, TOILET SETS, PERFUME VAPORIZERS AND ATOMIZERS, PORTABLE BATHS FOR BABIES, PIGGY BANKS, NOT OF METAL, WORKS OF ART, OF PORCELAIN, TERRA-COTTA OR GLASS, ROPES NEITHER MADE OF RUBBER, NOR INTENDED AS STRINGS FOR RACKETS OR MUSICAL INSTRUMENTS, STRING, TENTS, TARPAULINS NEITHER AS SAFETY TARPAULINS, NOR AS PUSH-CHAIR COVERS, BAGS AND POUCHES FOR PACKAGING MADE OF TEXTILES, PADDING AND STUFFING MATERIALS EXCEPT OF RUBBER AND PLASTICS, HAMMOCKS, NONMETAL THREAD FOR WRAPPING AND BINDING, YARNS AND THREADS FOR TEXTILE USE, SPUN WOOL, ELASTIC AND PLASTIC THREADS AND YARNS FOR TEXTILE USE, FABRICS, BED AND HOUSEHOLD LINEN, TABLE LINEN NOT OF PAPER, BATH LINEN EXCEPT CLOTHING, WALL HANGINGS OF TEXTILE, SHEETING IN THE NATURE OF SLEEPING BAGS, TEXTILE TISSUES FOR REMOVING MAKE-UP, MOSQUITO NETS, HOUSEHOLD LINEN, LABELS OF CLOTH, BLINDS OF TEXTILE, HANDKERCHIEFS OF TEXTILE, CLOTHING, BELTS, CLOTHING GLOVES, SUSPENDERS, HATS, FOOTWEAR, SOCKS, STOCKINGS, TIGHTS, FOOTWEAR EXCLUDING ORTHOPEDIC FOOTWEAR, SLIPPERS, BOOTS, INNER SOLES, BEACH SHOES, SKI BOOTS, SPORTS FOOTWEAR, BONNETS, BATHING SUITS AND TRUNKS, CLOTHING FOR SPORTS EXCLUDING DIVING CLOTHING, SLEEPING MASKS, HABERDASHERY EXCEPT THREAD, LACE TRIMMINGS, LACE AND EMBROIDERY, RIBBONS AND BRAID, BUTTONS, HOOKS AND EYES, PINS AND NEEDLES, ARTIFICIAL FLOWERS AND FRUITS, ORNAMENTAL NOVELTY BADGES, HAT ORNAMENTS NOT OF PRECIOUS METAL, HAIR ORNAMENTS, HAIR BANDS AND HAIR NETS, HAIR PINS AND GRIPS, BARRETTES, WIGS, ZIP FASTENERS, SHOE LACES, HABERDASHERY IN THE NATURE OF HEAT ADHESIVE PATCHES FOR DECORATION OR REPAIR OF TEXTILE ARTICLES, SEWING BOXES, CARPETS, RUGS, MATS AND MATTING, LINOLEUM AND OTHER MATERIALS FOR COVERING FLOORS EXCLUDING FLOOR TILING AND PAINT, NON-TEXTILE WALL HANGINGS, BATH MATS, GYMNASIUM MATS, NON-SLIP MATS, GAMES, TOYS, PRACTICAL JOKES IN THE NATURE OF NOVELTIES, ORNAMENTS FOR CHRISTMAS TREES EXCEPT ILLUMINATION ARTICLES AND CONFECTIONERY, PARTY FAVORS, TOY MASKS, KITES; PLAYING CARDS, GYMNASIUM AND SPORTING ARTICLES EXCEPT FOR SWIMMING ARTICLES, CLOTHING, FOOTWEAR AND MATS, RODS FOR FISHING, EXERCISERS AND BODYBUILDING APPARATUS, TOYS FOR DOMESTIC PETS, COIN-OPERATED AMUSEMENT MACHINES, GAMES AND GAMES APPARATUS OTHER THAN THOSE DESIGNED TO BE USED ONLY WITH TELEVISION RECEIVERS, SEPARATE DISPLAY SCREENS OR MONITORS, MEAT, FISH, POULTRY AND GAME, PRESERVED, FROZEN, DRIED AND COOKED FRUITS AND VEGETABLES, FRUIT PULP AND SALADS, VEGETABLE SALADS, CANNED MEAT, FISH, VEGETABLES AND FRUIT, JAMS, MARMALADES, STEWED FRUIT, JELLIES FOR FOOD, SOUPS, EGGS, MILK, BUTTER, CREAM, YOGHURTS, CHEESE AND OTHER DAIRY PRODUCTS, EDIBLE OILS AND FATS, COFFEE, TEA, COCOA, CHOCOLATE, CHOCOLATE GOODS, BEVERAGES MADE WITH COFFEE, TEA, COCOA, CHOCOLATE,

NON-MEDICINAL INFUSIONS, SUGAR, RICE, PASTA, SEMOLINA, FLOURS AND CEREAL PREPARATIONS, BREAD, PASTRY, CONFECTIONERY, EDIBLE ICES, HONEY, SALT, MUSTARD, VINEGAR, CONDIMENTS IN THE NATURE OF SAUCES, SANDWICHES, PIZZAS, AGRICULTURAL, HORTICULTURAL AND FORESTRY PRODUCTS NEITHER PREPARED NOR TRANSFORMED, SOWING SEEDS, FRESH FRUITS AND VEGETABLES, TREES, SHRUBS, NATURAL PLANTS AND FLOWERS, CHRISTMAS TREES, MINERAL AND AERATED WATERS AND OTHER NON-ALCOHOLIC DRINKS (U.S. CLS. 100, 101 AND 102).

SN 79-097,228. FILL GESELLSCHAFT M.B.H., A-4942 GURTEN, AUSTRIA, FILED 3-22-2011.

FILL

CLASS 41—EDUCATION AND ENTERTAINMENT

FOR PRACTICAL TRAINING, NAMELY, EDUCATIONAL DEMONSTRATIONS; ENTERTAINMENT SERVICES, NAMELY, LIVE PERFORMANCES BY MUSICAL BANDS, PREPARATION OF SPECIAL EFFECTS, CONDUCTING CONTESTS; AMUSEMENT PARKS; SPORTING ACTIVITIES, NAMELY, ORGANIZATION OF SPORTS COMPETITIONS, SPORT CAMP SERVICES, SPORTS INSTRUCTION SERVICES; PROVIDING SPORTS FACILITIES; ORGANIZATION OF SPORTS COMPETITIONS; ENTERTAINMENT AND EDUCATION SERVICES, NAMELY, COUNTRY, FAN CLUB SERVICES; CULTURAL ACTIVITIES, NAMELY, ORGANIZATION OF EXHIBITIONS FOR CULTURAL PURPOSES, ORGANIZING CULTURAL EVENTS; PUBLICATION OF BOOKS AND REVIEWS; PUBLICATION OF TEXTS OTHER THAN ADVERTISING TEXTS; LENDING LIBRARIES; ELECTRONIC DESKTOP PUBLISHING; PUBLICATION OF ELECTRONIC BOOKS AND INTERACTIVE ONLINE WEB JOURNALS FEATURING GAME SERVICES PROVIDED ON-LINE FROM A COMPUTER NETWORK, NAMELY, PROVIDING ON-LINE COMPUTER GAMES, PROVIDING ONLINE VIDEO GAMES, PROVIDING ONLINE ELECTRONIC GAMES; MUSIC COMPOSITION FOR OTHERS; TELEVISION SHOW AND FILM PRODUCTION; RENTAL OF MOTION PICTURE FILMS, VIDEO RECORDERS, TELEVISION SETS, VIDEO TAPES, PHONOGRAPH RECORDINGS, SOUND RECORDINGS, AUDIO EQUIPMENT, VIDEO CAMERAS, VIDEO RECORDERS, RADIO AND TELEVISION SETS, CINEMATOGRAPHIC PROJECTION APPARATUS, CINEMATOGRAPHIC APPARATUS AND ACCESSORIES AND THEATER AND SHOW SETS; RENTAL OF SPORTS EQUIPMENT EXCEPT VEHICLES AND UNDERWATER DIVING EQUIPMENT; ORGANIZATION OF COMPETITIONS IN THE FIELD OF EDUCATION AND ENTERTAINMENT, NAMELY, ATHLETIC COMPETITIONS, CULINARY COMPETITIONS; ORGANIZATION OF EXHIBITIONS FOR CULTURAL OR EDUCATIONAL PURPOSES; BOOKING OF SEATS FOR SHOWS; ARRANGING AND CONDUCTING OF SPECIAL EVENTS FOR SOCIAL ENTERTAINMENT PURPOSES; ORGANIZING COMMUNITY SPORTING AND CULTURAL EVENTS; TICKET AGENCY SERVICES FOR ENTERTAINMENT EVENTS; OPERATING LOTTERIES; PRODUCTION OF RADIO AND TELEVISION PROGRAMS; DIGITAL IMAGING SERVICES; PHOTOGRAPHY; PHOTOGRAPHIC REPORTING; NEWS REPORTERS SERVICES; VIDEOTAPING; VIDEO TAPE EDITING; MICROFILMING FOR OTHERS; TRANSLATION; CONFERENCE SERVICES, NAMELY, ARRANGING AND CONDUCTING EDUCATIONAL CONFERENCES; ENTERTAINMENT SERVICES, NAMELY, PROVIDING DIGITAL NON-DOWNLOADABLE PRERECORDED MUSIC FROM THE INTERNET; ENTERTAINMENT SERVICES, NAMELY, PROVIDING DIGITAL NON-DOWNLOADABLE PRERECORDED MUSIC IN MP3 FORMAT FROM WEBSITES ON THE INTERNET (U.S. CLS. 100, 101 AND 107).

LOURDES AYALA, EXAMINING ATTORNEY

THE MARK CONSISTS OF STANDARD CHARACTERS WITHOUT CLAIM TO ANY PARTICULAR FONT, STYLE, SIZE, OR COLOR.

PRIORITY DATE OF 10-11-2010 IS CLAIMED.

OWNER OF INTERNATIONAL REGISTRATION 1076745 DATED 3-22-2011, EXPIRES 3-22-2021.

CLASS 7—MACHINERY

FOR MACHINES FOR FOUNDING, NAMELY, ROBOTER SYSTEMS, PORTAL MANIPULATORS, TURN-TABLES; MACHINES FOR COOLING, TRANSPORTATION AND CORE REMOVAL OF CASTINGS; MACHINES FOR PROCESSING OF CASTINGS; CIRCULAR SAWS; CONVEYORS; FOUNDRY MACHINES; METAL WORKING MACHINES, NAMELY, BENDING MACHINES, BORING MACHINES, CUTTING MACHINES, DRILLING AND DEBURRING MACHINES, GRINDING MACHINES, MILLING MACHINES, SHAPING MACHINES, SHEARING MACHINES, SLOTTING MACHINES; MACHINE TOOLS FOR DRILLING, TURNING, BORING, DEBURRING, GRINDING, SHAPING, MILLING, SAWING, CUTTING, PENDING, AND SAWS; MACHINES FOR WOODWORKING, NAMELY, BANDSAWS, PRESSES, MACHINES FOR REPAIRING DEFECTS IN WOOD, CONVEYORS, TRANSPORTATION; MACHINES FOR PLASTICS WORKING, NAMELY, FOAMING MACHINES, FORMING MACHINES, PREFORMING MACHINES, PRESSES; MACHINES FOR PRODUCING SKIES AND SNOWBOARDS (U.S. CLS. 13, 19, 21, 23, 31, 34 AND 35).

CLASS 9—ELECTRICAL AND SCIENTIFIC APPARATUS

FOR SCIENTIFIC, NAUTICAL, SURVEYING, PHOTOGRAPHIC, CINEMATOGRAPHIC, OPTICAL, WEIGHING, MEASURING, SIGNALING, CHECKING (SUPERVISION), LIFE-SAVING AND TEACHING APPARATUS AND INSTRUMENTS IN THE NATURE OF ULTRASONIC DEVICES FOR ULTRASONIC INSPECTION AND TESTING OF LIGHT-WEIGHT STRUCTURES, NAMELY, STRUCTURES THE SHAPE OF WHICH IS DETERMINED THROUGH AN OPTIMIZATION PROCESS TO EFFICIENTLY CARRY THE LOADS FROM A CRITICAL LOADING CASE, AS WELL AS THEIR COMPOSITE COMPONENTS, DISTANCE MEASURING APPARATUS; ELECTRONIC ULTRASONIC TEST EQUIPMENT, NAMELY, ULTRASONIC FLAW DETECTORS, THICKNESS TESTERS AND HARDNESS TESTERS, FOR NON-MEDICAL USE; APPARATUS AND INSTRUMENTS FOR CONDUCTING, SWITCHING, TRANSFORMING, ACCUMULATING, REGULATING OR CONTROLLING ELECTRICITY IN THE NATURE OF CONDUCTORS, SWITCHES, TRANSFORMERS, ACCUMULATORS, VOLTAGE REGULATORS AND CONTROLLERS; APPARATUS FOR RECORDING, TRANSMISSION OR REPRODUCTION OF SOUND OR IMAGES; DATA PROCESSING EQUIPMENT, NAMELY, DATA PROCESSORS; COMPUTERS (U.S. CLS. 21, 23, 26, 36 AND 38).

CLASS 37—CONSTRUCTION AND REPAIR

FOR BUILDING CONSTRUCTION; REPAIR OF MACHINES FOR FOUNDING, NAMELY, ROBOTER SYSTEMS, PORTAL MANIPULATORS, TURNTABLES; REPAIR OF MACHINES FOR COOLING, TRANSPORTATION, CORE REMOVAL OF CASTINGS, MACHINES FOR PROCESSING OF CASTINGS, CIRCULAR SAWS, CONVEYORS AND FOUNDRY MACHINES; REPAIR OF METAL WORKING MACHINES, NAMELY, BENDING MACHINES, BORING MACHINES, CUTTING MACHINES, DRILLING AND DEBURRING MACHINES, GRINDING MACHINES, MILLING MACHINES, SHAPING MACHINES, SHEARING MACHINES, SLOTTING MACHINES; REPAIR OF MACHINE TOOLS FOR DRILLING, TURNING, BORING, DEBURRING, GRINDING, SHAPING, MILLING, SAWING, CUTTING, PENDING, AND SAWS; REPAIR OF MACHINES FOR WOODWORKING, NAMELY, BANDSAWS, PRESSES, MACHINES FOR REPAIRING DEFECTS IN WOOD, CONVEYORS, TRANSPORTATION; REPAIR OF MACHINES FOR PLASTICS, NAMELY, FOAMING MACHINES, FORMING MACHINES, PREFORMING MACHINES, PRESSES; REPAIR OF MACHINES FOR PRODUCING SKIES AND SNOWBOARDS; INSTALLATION SERVICES AND MAINTENANCE FOR MACHINES FOR FOUNDING, NAMELY, ROBOTER SYSTEMS, PORTAL MANIPULATORS, TURNTABLES; REPAIR OF MACHINES FOR COOLING, TRANSPORTATION, CORE REMOVAL OF CASTINGS, MACHINES FOR PROCESSING OF CASTINGS, CIRCULAR SAWS, CONVEYORS AND FOUNDRY MACHINES; REPAIR OF METAL WORKING MACHINES, NAMELY, BENDING MACHINES, BORING MACHINES, CUTTING MACHINES, DRILLING AND DEBURRING MACHINES, GRINDING MACHINES, MILLING MACHINES, SHAPING MACHINES, SHEARING MACHINES, SLOTTING MACHINES; REPAIR OF MACHINE TOOLS FOR DRILLING, TURNING, BORING, DEBURRING, GRINDING, SHAPING, MILLING, SAWING, CUTTING, PENDING, AND SAWS; INSTALLATION SERVICES AND MAINTENANCE OF MACHINES FOR WOODWORKING, NAMELY, BANDSAWS, PRESSES, MACHINES FOR REPAIRING DEFECTS IN WOOD, CONVEYORS, TRANSPORTATION; INSTALLATION SERVICES AND MAINTENANCE OF MACHINES FOR PLASTICS, NAMELY, FOAMING MACHINES, FORMING MACHINES, PREFORMING MACHINES, PRESSES; INSTALLATION SERVICES AND MAINTENANCE OF MACHINES FOR PRODUCING SKIES AND SNOWBOARDS (U.S. CLS. 100, 103 AND 106).

CLASS 40—MATERIAL TREATMENT

FOR TREATMENT OF MATERIALS, NAMELY, TREATMENT OF METAL; WOODWORKING; CUSTOM ASSEMBLING OF MATERIALS FOR OTHERS, NAMELY, ASSEMBLY OF PRODUCTS FOR OTHERS; METAL CASTING (U.S. CLS. 100, 103 AND 106).

CLASS 42—SCIENTIFIC AND COMPUTER SERVICES

FOR SCIENTIFIC AND TECHNOLOGICAL SERVICES, NAMELY, SCIENTIFIC RESEARCH, ANALYSIS, AND TESTING, IN THE FIELDS OF MACHINES FOR FOUNDING, NAMELY, ROBOTER SYSTEMS, PORTAL MANIPULATORS, TURNTABLES, REPAIR OF MACHINES FOR COOLING, TRANSPORTATION, CORE REMOVAL OF CASTINGS, MACHINES FOR PROCESSING OF CASTINGS, CIRCULAR SAWS, CONVEYORS, FOUNDRY MACHINES, REPAIR OF METAL WORKING MACHINES, NAMELY, BENDING MACHINES, BORING MACHINES, CUTTING MACHINES, DRILLING AND DEBURRING MACHINES, GRINDING MACHINES, MILLING MACHINES, SHAPING MACHINES, SHEARING MACHINES, SLOTTING MACHINES, REPAIR OF MACHINE TOOLS FOR DRILLING, TURNING, BORING, DEBURRING, GRINDING, SHAPING, MILLING, SAWING, CUTTING, PENDING, AND SAWS; SCIENTI-

FIC RESEARCH AND DESIGN RELATING THERETO IN THE FIELDS OF COMPUTER NETWORKING HARDWARE, COMPUTER DATA CENTER ARCHITECTURE, COMPUTER MODELING SERVICES, NAMELY, COMPUTER SIMULATION FROM COMPUTER PROGRAMS FOR OTHERS; INDUSTRIAL ANALYSIS AND RESEARCH SERVICES IN THE FIELD OF ENGINEERING; DESIGN AND DEVELOPMENT OF COMPUTER HARDWARE AND SOFTWARE; ENGINEERING; CONSTRUCTION DRAFTING; TECHNICAL PROJECT STUDIES IN THE NATURE OF TECHNICAL RESEARCH IN THE FIELD OF ENGINEERING (U.S. CLS. 100 AND 101).

ANN E. SAPPENFIELD, EXAMINING ATTORNEY

SN 79-097,317. METSÄ TISSUE OYJ, FINLAND, FILED 12-28-2010.



PRIORITY DATE OF 7-8-2010 IS CLAIMED.
OWNER OF INTERNATIONAL REGISTRATION 1076912 DATED 12-28-2010, EXPIRES 12-28-2020.

THE COLOR(S) RED AND WHITE IS/ARE CLAIMED AS A FEATURE OF THE MARK.

THE MARK CONSISTS OF A RED CIRCLE CONTAINING THE WORDS "SAGA ONE-UP" IN WHITE ALONG WITH A DEPICTION OF A WHITE POP-UP BOX FOR FOOD CONTACT PAPER.

CLASS 6—METAL GOODS

FOR ALUMINUM FOIL AND GOODS MADE THEREOF INCLUDED IN THIS CLASS, NAMELY, BAKING CUPS AND PACKAGES FOR FOODSTUFFS IN THE NATURE OF ALUMINUM FOIL SANDWICH POUCHES (U.S. CLS. 2, 12, 13, 14, 23, 25 AND 50).

CLASS 16—PAPER GOODS AND PRINTED MATTER

FOR PAPER AND GOODS MADE THEREOF INCLUDED IN THIS CLASS, NAMELY, COOKING PAPER AND BAKING PAPER, BAKING CUPS, PAPER PACKAGING AND CONTAINERS FOR FOODS, ALL THE AFORESAID GOODS ONLY FOR BAKING AND COOKING PURPOSES; PLASTIC MATERIALS FOR PACKAGING, NAMELY, PLASTIC FILMS FOR PACKAGING FOR HOUSEHOLD USE, PLASTIC BAGS FOR PACKAGING, PLASTIC WRAPS FOR PACKAGING AND INTEGRATED FASTENERS THEREFOR (U.S. CLS. 2, 5, 22, 23, 29, 37, 38 AND 50).

SANI KHOURI, EXAMINING ATTORNEY

SN 79-097,376. GIOVANNETTI SIMONA, I-57031 CAPOLIVERI (LI), ITALY, FILED 4-8-2011.



OWNER OF INTERNATIONAL REGISTRATION 1077113 DATED 4-8-2011, EXPIRES 4-8-2021. THE WORDING "DAMPAL" HAS NO MEANING IN A FOREIGN LANGUAGE.

CLASS 14—JEWELRY

FOR IMITATION JEWELLERY (U.S. CLS. 2, 27, 28 AND 50).

CLASS 25—CLOTHING

FOR CLOTHING, NAMELY, SHIRTS, PANTS, COATS, DRESSES; FOOTWEAR; HEADGEAR, NAMELY, HATS, VISORS (U.S. CLS. 22 AND 39).
MARILYN IZZI, EXAMINING ATTORNEY

SN 79-097,703. PETER SCHÖTTLER GMBH, FED REP GERMANY, FILED 9-20-2010.



PRIORITY DATE OF 3-25-2010 IS CLAIMED. OWNER OF INTERNATIONAL REGISTRATION 1078106 DATED 9-20-2010, EXPIRES 9-20-2020. THE MARK CONSISTS OF A DESIGN OF A HOOK WITHIN A RECTANGLE WITH CURVED EDGES.

CLASS 6—METAL GOODS

FOR METAL CASTINGS AND METAL FORGINGS; WORKED AND UNWORKED CASTINGS AND FORGINGS, IN PARTICULAR FORGED PIECES OF UNALLOYED, ALLOYED, RUST AND/OR ACID RESISTANT METAL MATERIALS, WORKED AND UNWORKED CASTINGS AND FORGINGS MADE OF STEELS; METAL FORGINGS MADE BY DROP FORGING; CHAIN TENSIONERS MADE OF METAL, ROPE TENSIONERS MADE OF METAL AND BELT TENSIONERS MADE OF METAL; METAL GUIDANCE FOR GUIDING CHAINS, ROPES AND BELTS, NAMELY, METAL GUIDE BARS FOR RAILING, METAL GUIDE RAILS, METAL GUIDE RODS FOR RAILING, DUCTS OF METAL FOR GUIDING CHAINS, ROPES AND BELTS FOR USE IN LIFTING, LASHING, AND RIGGING AS WELL AS CONVEYORS; METAL SHORTENERS FOR ADJUSTING THE LENGTH OF A CHAIN, ROPE AND BELT, NAMELY, SHORTENING CLAWS, SHORTENING HOOKS, SHORTENING CLUTCHES AND SHORTENING COUPLERS; METAL CONNECTORS AND CONNECTING LINKS FOR USE IN LIFTING, LASHING AND RIGGING AS WELL AS CONVEYORS; METAL CHAIN CONNECTORS FOR USE IN LIFTING, LASHING AND RIGGING AS WELL AS CONVEYORS; METAL CHAIN JOINTS AND CHAIN LINKS FOR LIFTING, LASHING AND RIGGING; METAL LIFTING CHAINS AND ROPES, THIN METAL BANDS, BELTS OF METAL FOR HANDLING LOADS, METAL SLINGS FOR LOADING, WIRE ROPE SLINGS, CARGO SLINGS OF METAL; LIFTING GEAR COMPRISING METAL ROPES, METAL CHAINS, METAL BANDS, METAL SLINGS AS WELL AS METAL BEAMS, MECHANICAL FASTENING ELEMENTS OF METAL, METAL BARS, METAL CHAINS, WIRE NETS, METAL BEAMS, METAL HOOKS, METAL CATCH HOOKS, METAL SINGLE HOOKS, METAL DOUBLE HOOKS, METAL FORK HEAD HOOKS, METAL EYE HOOKS, METAL SLIDING HOOKS, METAL WIDE-MOUTH HOOKS, METAL EYEBOLTS, LONG METAL EYES FOR WELDING, SWIVEL EYEBOLTS OF METAL, LONG SWIVEL EYES FOR WELDING OF METAL, SWIVELS, METAL CLAMPS, NAMELY, GRABS AND CLAWS, METAL CLAMPS, NAMELY, CLAWS, SHACKLES AND SPREADER BARS OF METAL; METAL SECURING ELEMENTS FOR LIFTING, LASHING AND FASTENING MEANS, NAMELY, HOOK CATCHES, COFFER PINS, PINS, RINGS, BOLTS, SCREWS (U.S. CLS. 2, 12, 13, 14, 23, 25 AND 50).

CLASS 40—MATERIAL TREATMENT

FOR TREATMENT OF MATERIALS, IN PARTICULAR METALWORKING AND FORGING, IN PARTICULAR TREATMENT OF METAL IN THE NATURE OF ABRADING, DEBURRING, BLASTING, SANDBLASTING, DYEING, LACQUERING, COATING, ELECTROPLATING, PUNCHING, FORGING, DROP FORGING, ANNEALING AND TEMPERING, HARDENING, PLATING, POLISHING, GRINDING, WELDING, ROLLING; CUSTOM ASSEMBLING AND FINISHING OF MATERIALS, IN PARTICULAR METALS, FOR OTHERS, NAMELY, METAL FINISHING SERVICES; CUSTOM MANUFACTURE OF TOOLS FOR OTHERS (U.S. CLS. 100, 103 AND 106).

CLASS 42—SCIENTIFIC AND COMPUTER SERVICES

FOR TECHNICAL PROJECT RESEARCH AND TECHNICAL PRODUCT PLANNING, ENGINEERING IN THE FIELD OF METALWORKING AND FORGING; MATERIAL TESTING; DEVELOPMENT OF NEW PRODUCTS, FOR OTHERS (U.S. CLS. 100 AND 101).
CHRISTINA SOBRAL, EXAMINING ATTORNEY

SN 79-097,993. PROFERO LIMITED, LONDON, UNITED KINGDOM, FILED 1-17-2011.

profero

THE MARK CONSISTS OF STANDARD CHARACTERS WITHOUT CLAIM TO ANY PARTICULAR FONT, STYLE, SIZE, OR COLOR.

OWNER OF INTERNATIONAL REGISTRATION 1079022 DATED 1-17-2011, EXPIRES 1-17-2021.

CLASS 9—ELECTRICAL AND SCIENTIFIC APPARATUS

FOR COMPUTER OPERATING RECORDED PROGRAMS; DOWNLOADABLE COMPUTER SOFTWARE FOR DIGITAL AND SOCIAL MEDIA ADVERTISING SERVICES, NAMELY, FOR ENHANCING AND OPTIMIZING USER EXPERIENCE, CUSTOMER RELATIONS MANAGEMENT AND INFRASTRUCTURE ARCHITECTURE IN THE FORM OF MOBILE APPLICATIONS, BANNERS, WEBSITES AND BRANDED CONTENT WITHIN OTHER PLATFORMS, NAMELY, SOCIAL NETWORKING SITES, ENTERTAINMENT SITES AND SEARCH ENGINES, AND SEARCH ENGINE OPTIMIZATION TOOLS (U.S. CLS. 21, 23, 26, 36 AND 38).

CLASS 38—COMMUNICATION

FOR PROVIDING INTERNET CHAT ROOMS; ELECTRONIC BULLETIN BOARD SERVICES; PROVIDING ACCESS TO DATABASES AND THE INTERNET; ELECTRONIC MAIL SERVICES (U.S. CLS. 100, 101 AND 104).

CLASS 41—EDUCATION AND ENTERTAINMENT

FOR EDUCATIONAL SERVICES, NAMELY, PROVIDING COURSES OF INSTRUCTION AND TRAINING IN THE FIELD OF ADVERTISING (U.S. CLS. 100, 101 AND 107).

CLASS 42—SCIENTIFIC AND COMPUTER SERVICES

FOR DESIGN AND DEVELOPMENT OF COMPUTER HARDWARE AND SOFTWARE; UPDATING OF COMPUTER SOFTWARE FOR OTHERS; DESIGNING, CREATING, MAINTAINING, AND HOSTING WEBSITES FOR OTHERS; COMPUTER PROGRAMMING (U.S. CLS. 100 AND 101).

EDWARD NELSON, EXAMINING ATTORNEY

SN 79-097,996. CHENG SHU YING, CHINA, FILED 5-4-2011.

Lyrique

OWNER OF INTERNATIONAL REGISTRATION 1079028 DATED 5-4-2011, EXPIRES 5-4-2021.

THE ENGLISH TRANSLATION OF "LYRIQUE" IN THE MARK IS "OPERA".

CLASS 18—LEATHER GOODS

FOR BACKPACKS; BANDS OF LEATHER; ANIMAL SKINS; IMITATION LEATHER; PURSES; HANDBAGS; TRAVELING BAGS; UMBRELLAS; WALKING STICKS; GUT FOR MAKING SAUSAGE CASINGS (U.S. CLS. 1, 2, 3, 22 AND 41).

CLASS 25—CLOTHING

FOR CLOTHING, NAMELY, T-SHIRTS, SHIRTS, DRESSES, TROUSERS, JACKETS; LAYETTES; BELTS; WATERPROOF CLOTHING, NAMELY, JACKETS AND PANTS; FOOTWEAR; SOCKS; GLOVES; NECKTIES; HEADGEAR FOR WEAR, NAMELY, HATS AND CAPS; SASHES FOR WEAR AND SCARVES (U.S. CLS. 22 AND 39).

DAVID HOFFMAN, EXAMINING ATTORNEY

SN 79-098,117. DODUCO GMBH, FED REP GERMANY, FILED 2-24-2011.



PRIORITY DATE OF 8-25-2010 IS CLAIMED.

OWNER OF INTERNATIONAL REGISTRATION 1079298 DATED 2-24-2011, EXPIRES 2-24-2021.

THE COLOR(S) BLUE AND RED IS/ARE CLAIMED AS A FEATURE OF THE MARK.

THE MARK CONSISTS OF THE STYLIZED WORDING "DODUCO" IN BLUE WITH A RED SQUARE AT THE BEGINNING OF THE WORD.

CLASS 1—CHEMICALS

FOR CHEMICAL PREPARATIONS FOR USE IN INDUSTRY; CHEMICAL PREPARATIONS FOR SCIENTIFIC PURPOSES; PHOTOGRAPHIC CHEMICALS; UNPROCESSED ARTIFICIAL RESINS, UNPROCESSED PLASTICS; FERTILIZING PREPARATIONS; FIRE EXTINGUISHING COMPOSITIONS; CHEMICAL PREPARATIONS FOR HARDENING, TEMPERING, BRAZING AND SOLDERING OF METALS; CHEMICAL PREPARATIONS FOR PRESERVING FOODSTUFFS; ADHESIVES FOR INDUSTRIAL PURPOSES; GALVANIZING BATHS FOR ELECTROLYTIC TREATMENT AND COATING OF SURFACES AND CHEMICAL PREPARATIONS FOR SUCH BATHS; CHEMICAL BATHS FOR ELECTROLESS PLATING OF SURFACES AND CHEMICAL PREPARATIONS FOR SUCH BATHS; CERAMIC SUBSTRATES COATED WITH COMMON METALS AND THEIR ALLOYS FOR ELECTRIC OR ELECTRONIC COMPONENTS; CERAMIC SUBSTRATES COATED WITH PRECIOUS METALS AND THEIR ALLOYS FOR ELECTRIC OR ELECTRONIC COMPONENTS; CHEMICALS FOR THE SURFACE PRE-TREATMENT OF METALS BEFORE ELECTROPLATING AND BEFORE ELECTROLESS PLATING; CHEMICALS FOR GALVANOPLASTICS; GALVANIZING BATHS; SALTS FROM PRECIOUS METALS; RESINATES ON THE BASIS OF PRECIOUS METALS; OILS, CORROSION INHIBITORS AND CLEANING AGENTS FOR ELECTRIC CONTACT PIECES; ION EXCHANGER RESINS FOR PRECIOUS METAL RECOVERY; CHEMICAL CATALYSTS OF PRECIOUS OR NON-PRECIOUS METALS; EMBEDDING COMPOUNDS FOR MANUFACTURING MOLDS FOR USE IN CENTRIFUGAL CASTING; CHEMICALS FOR BRAZING AND SOLDERING; ELECTRICALLY CONDUCTING ADHESIVES FOR INDUSTRIAL PURPOSES (U.S. CLS. 1, 5, 6, 10, 26 AND 46).

CLASS 2—PAINTS

FOR PAINTS, VARNISHES, LACQUERS; PRE-TREATMENT COATINGS FOR INORGANIC METAL SURFACES TO IMPROVE ADHESION AND CORROSION RESISTANCE AGAINST RUST; COLORANTS; MORDANT DYES; RAW NATURAL RESINS; METALS IN FOIL AND POWDER FORM FOR PAINTERS, DECORATORS, PRINTERS AND ARTISTS; PAINTS, LACQUERS AND PRINTERS' PASTES CONTAINING METALLIC PIGMENTS FOR USE IN INDUSTRY AND METALLIC POWDER PIGMENTS FOR PREPARING SUCH PAINTS, LAQUERS AND PRINTERS' PASTES; COATING COMPOSITIONS IN THE NATURE OF PAINTS, LAQUERS AND PASTES CONTAINING THERMOSETTING RESINS AND METALLIC PIGMENTS FOR INDUSTRIAL APPLICATIONS; BRONZING POWDERS (U.S. CLS. 6, 11 AND 16).

CLASS 3—COSMETICS AND CLEANING PREPARATIONS

FOR CLEANING AGENTS FOR ELECTRIC CONTACTS (U.S. CLS. 1, 4, 6, 50, 51 AND 52).

CLASS 6—METAL GOODS

FOR COMMON METALS AND THEIR ALLOYS; TRANSPORTABLE BUILDINGS OF METAL; MATERIALS OF METAL FOR RAILWAY TRACKS; NON-ELECTRIC CABLES AND WIRES OF COMMON METAL; SMALL ITEMS OF METAL HARDWARE, NAMELY, NUTS, SCREWS, SPRINGS, DISCS, PINS, RIVETS, PLATES; PIPES AND TUBES OF METAL; METAL SAFES; RAW MATERIALS, NAMELY, POWDERS, FLAKES AND GRANULES OF COMMON METALS AND THEIR ALLOYS, AND COMPOSITE MATERIALS, NAMELY, POWDERS, FLAKES AND GRANULES COMPOSED OF COMMON METALS AND METAL OXIDES OR OF COMMON METALS AND METALLOIDS OR OF COMMON METALS AND GRAPHITE; METAL WIRES, BANDS, STAMPED BANDS, TAPES, STRIPS, BARS, PLATES, STAMPINGS AND PROFILES MADE OF COMMON METALS AND THEIR ALLOYS OR COATED WITH COMMON METALS AND THEIR ALLOYS, OR OF COMPOSITE MATERIALS CONTAINING COMMON METALS OR THEIR ALLOYS AND GRAPHITE OR METAL OXIDES OR METALLOIDS FOR USE IN INDUSTRY; RAW MATERIALS, COMPOSITE MATERIALS, WROUGHT MATERIALS, NAMELY, POWDERS, FLAKES AND GRANULES OF THE AFORESAID MATERIALS, AND SEMI-FINISHED PRODUCTS, NAMELY, METAL WIRES, BANDS, STAMPED BANDS, TAPES, STRIPS, BARS, PLATES, STAMPINGS AND PROFILES MADE OF COMMON METALS AND THEIR ALLOYS OR COATED WITH COMMON METALS AND THEIR ALLOYS, OR OF COMPOSITE MATERIALS CONTAINING COMMON METALS OR THEIR ALLOYS AND GRAPHITE OR METAL OXIDES OR METALLOIDS FOR ELECTRIC CONTACTS, ELECTRIC AND ELECTRONIC APPLICATIONS AND FUSES; SOLDERING ALLOYS AND BRAZING ALLOYS CONSISTING OF COMMON METALS; COMMON METALS AND THEIR ALLOYS IN THE FORM OF FOILS, POWDERS, BIMETALS, LAMINATED METALS, SINTERED MATERIALS, MATERIALS CONTAINING GRAPHITE, MATERIALS CONTAINING METAL OXIDES AND MATERIALS CONTAINING METALLOIDS (U.S. CLS. 2, 12, 13, 14, 23, 25 AND 50).

CLASS 9—ELECTRICAL AND SCIENTIFIC APPARATUS

FOR APPARATUS AND INSTRUMENTS FOR CONDUCTING, SWITCHING, TRANSFORMING, ACCUMULATING, REGULATING OR CONTROLLING ELECTRICITY, NAMELY, ELECTRIC LEADS, ELECTRIC LEAD-FRAMES, ELECTRIC SENSORS, ELECTRIC ACTUATORS, ELECTRIC CURRENT AND VOLTAGE LIMITERS, DEVICES FOR PREVENTING OR EXTINGUISHING AN ELECTRICAL DISCHARGE; APPARATUS FOR RECORDING, TRANSMISSION OR REPRODUCTION OF DATA, SOUND OR IMAGES; BLANK OPTICAL DATA CARRIERS; BLANK MAGNETIC DATA CARRIERS; AUTOMATIC VENDING MACHINES AND MECHANISMS FOR COIN-OPERATED

APPARATUS; CASH REGISTERS, CALCULATING MACHINES, DATA PROCESSING EQUIPMENT AND COMPUTERS; FIRE-EXTINGUISHING APPARATUS; ELECTRIC CONTACTS AND PARTS THEREFOR, NAMELY, ELECTRIC CONTACT RIVETS, ELECTRIC CONTACT TIPS, ELECTRIC CONTACT PINS, ELECTRIC BURN-OFF PIECES, FOR USE IN ELECTRIC SWITCHES, ELECTRIC CONTACT TULIPS, ELECTRIC CONTACT TUBES, ELECTRIC CONTACT RINGS, ELECTRIC CONTACT DISCS, ELECTRIC CONTACT SPRINGS, WELD BUTTONS; ELECTRIC SHAPED PARTS, NAMELY, METALLIC PREFORMED PARTS MOUNTED WITH CONTACT PIECES FOR MAKING ELECTRIC CONTACT; ELECTRIC CONTACT PARTS, NAMELY, SNAP DISCS FOR ELECTRIC SWITCHES, CONTACT RIVETS, CONTACT SPRINGS, SELECTIVELY ELECTROPLATED CONTACTS AS INDIVIDUAL PARTS OR AS CONTINUOUS STRIPS OR STAMPED STRIPS FOR ELECTRIC CONNECTORS, FOR LEAD-FRAMES, FOR SWITCHES, ALSO FOR VACUUM SWITCHES AND FOR HIGH-VOLTAGES SWITCHES; ELECTRIC CONTACT PARTS COATED WITH PLASTIC OR CERAMIC OR MOUNTED THEREIN, ALSO IN THE FORM OF ELECTRIC OR ELECTRONIC CIRCUIT MODULES; ELECTRIC SWITCHES; ELECTROMECHANIC SWITCHES; ELECTRIC SWITCHGEARS; HOUSINGS FOR ELECTRIC AND ELECTRONIC SWITCH MODULES, FOR ELECTRIC AND ELECTRONIC CIRCUITS AND FOR COMPONENTS OF ELECTRIC AND ELECTRONIC CIRCUITS, HYBRID FRAMES, NAMELY, COMPOSITE HOUSINGS, INCLUDING MOLDED PLASTIC HOUSINGS AND MOLDED CERAMIC HOUSINGS, HAVING ELECTRIC LEADS AND/OR ELECTRIC CONTACTS AND/OR COMPONENTS OF ELECTRIC OR ELECTRONIC CIRCUITS INTEGRATED IN THE MOLDED PLASTIC OR IN THE MOLDED CERAMIC, FOR USE IN INDUSTRY; ELECTRIC CIRCUIT MODULES; ELECTRONIC CIRCUIT MODULES; MODULES CONTAINING ELECTROMECHANIC COMPONENTS; ELECTRODES (U.S. CLS. 21, 23, 26, 36 AND 38).

CLASS 14—JEWELRY

FOR PRECIOUS METALS AND THEIR ALLOYS; JEWELLERY AND PRECIOUS STONES; HOROLOGICAL AND CHRONOMETRIC INSTRUMENTS; RAW MATERIALS, NAMELY, POWDERS, FLAKES AND GRANULES OF PRECIOUS METALS AND THEIR ALLOYS, AND COMPOSITE MATERIALS, NAMELY, POWDERS, FLAKES AND GRANULES COMPOSED OF PRECIOUS METALS AND METAL OXIDES OR OF PRECIOUS METALS AND METALLOIDS OR OF PRECIOUS METALS AND GRAPHITE; METAL WIRES, BANDS, STAMPED BANDS, TAPES, STRIPS, BARS, PLATES, STAMPINGS AND PROFILES MADE OF PRECIOUS METALS AND THEIR ALLOYS OR COATED WITH PRECIOUS METALS AND THEIR ALLOYS, OR OF COMPOSITE MATERIALS CONTAINING PRECIOUS METALS OR THEIR ALLOYS AND GRAPHITE OR METAL OXIDES OR METALLOIDS FOR USE IN INDUSTRY AND IN MAKING JEWELLERY; RAW MATERIALS, COMPOSITE MATERIALS, WROUGHT MATERIALS NAMELY, POWDERS, FLAKES AND GRANULES OF THE AFORESAID MATERIALS, AND SEMI-FINISHED PRODUCTS, NAMELY, METAL WIRES, BANDS, STAMPED BANDS, TAPES, STRIPS, BARS, PLATES, STAMPINGS AND PROFILES MADE OF PRECIOUS METALS AND THEIR ALLOYS OR COATED WITH PRECIOUS METALS AND THEIR ALLOYS, OR OF COMPOSITE MATERIALS CONTAINING PRECIOUS METALS OR THEIR ALLOYS AND GRAPHITE OR METAL OXIDES OR METALLOIDS FOR ELECTRIC CONTACTS, ELECTRIC AND ELECTRONIC APPLICATIONS AND FUSES; SOLDERING ALLOYS AND BRAZING ALLOYS CONTAINING PRECIOUS METALS; PRECIOUS METALS AND THEIR ALLOYS IN THE FORM OF FOILS, POWDERS, BIMETALS, LAMINATED METALS, SINTERED MATERIALS, MATERIALS CONTAINING GRAPHITE, MATERIALS CONTAINING METAL OXIDES AND MATERIALS CONTAINING METALLOIDS (U.S. CLS. 2, 27, 28 AND 50).

CLASS 40—MATERIAL TREATMENT

FOR TREATMENT OF MATERIALS, NAMELY, COATING OR PLATING THE MATERIALS WITH METALS; REFINING AND RECYCLING OF PRECIOUS METALS; COATING SERVICES, NAMELY, ELECTROLYTIC COATING, ELECTROLESS COATING, COATING BY PHYSICAL VAPOUR DEPOSITION PROCESSES, CHEMICAL VAPOUR DEPOSITION PROCESSES, SPUTTERING AND BY OTHER METHODS FOR DEPOSITION OF METALS FROM GASEOUS PHASES, COATING BY ROLLING, COATING BY SPRAYING, METAL TREATING AND CASTING, HARDENING OF METAL AND METAL PRODUCTS FOR USE IN ELECTROTECHNOLOGY, ELECTRONICS, AUTOMOTIVE ENGINEERING, AEROSPACE ENGINEERING, HIGH-FREQUENCY ENGINEERING, CHEMICAL ENGINEERING, MEDICAL ENGINEERING, MECHANICS, LASER OPTICS; COATING OF CIRCUIT BOARDS; COATING OF BANDS AND PRE-CUT BANDS; COATING OF STAMPED PARTS; COATING OF WIRES; COATING OF WIRES, BANDS, STAMPED BANDS, TAPES, STRIPS, PLATES, STAMPINGS, PROFILES, MACHINED PARTS AND MOLDED PARTS BY USE OF PHYSICAL VAPOUR DEPOSITION PROCESSES, CHEMICAL VAPOUR DEPOSITION PROCESSES, SPUTTERING AND BY OTHER METHODS FOR DEPOSITION OF METALS FROM GASEOUS PHASES; CHEMICAL AND ELECTROLYTICAL COATING OF CARRIERS FOR ELECTRIC AND ELECTRONIC COMPONENTS, IN PARTICULAR OF CERAMIC CARRIERS, WITH COMMON METALS AND PRECIOUS METALS; MANUFACTURING TOOLS FOR STAMPING AND PLASTIC MOLDING TO THE ORDER AND SPECIFICATION OF OTHERS; TECHNICAL CONSULTING AND TECHNICAL SUPPORT SERVICES, NAMELY, PROVIDING TECHNICAL ADVICE RELATED TO MANUFACTURING IN THE FIELDS OF MATERIALS, SURFACE ENGINEERING, JOINING TECHNOLOGY, POWDER METALLURGY, PROTECTIVE COATINGS, DECORATIVE COATINGS AND OPERATIONAL COATINGS, ELECTRICAL CONTACTS AND ELECTRICAL SWITCHES, SURFACE ANALYSIS, TESTING OF SWITCHES, ENDURANCE TESTS, LIFETIME TESTS (U.S. CLS. 100, 103 AND 106).

CLASS 42—SCIENTIFIC AND COMPUTER SERVICES

FOR RESEARCH SERVICES AND ANALYTICAL STUDIES IN THE FIELD OF MATERIALS, SURFACE ENGINEERING, JOINING TECHNOLOGY, POWDER METALLURGY, PROTECTIVE COATINGS, DECORATIVE COATINGS AND OPERATIONAL COATINGS, ELECTRICAL CONTACTS AND ELECTRICAL SWITCHES; TECHNOLOGICAL SERVICES, NAMELY, DESIGNING TOOLS FOR STAMPING AND PLASTIC MOLDING; DESIGN AND DEVELOPMENT OF COMPUTER HARDWARE AND SOFTWARE; CREATION OF DATA PROCESSING PROGRAMS AND COMPUTER SOFTWARE; CREATION OF PROGRAMS FOR PROCESS CONTROL; TECHNICAL CONSULTING IN THE FIELD OF PHYSICS, MATERIAL SCIENCE, SURFACE ENGINEERING, JOINING TECHNOLOGY, POWDER METALLURGY, ELECTRICAL ENGINEERING, SURFACE ANALYSIS, TESTING OF SWITCHES; CHEMISTRY SERVICES, NAMELY, DEVELOPING BATH COMPOSITIONS FOR ELECTROLYTICAL AND ELECTROLESS COATING PROCESSES; ENGINEERING; TESTING OF SWITCHGEARS; MATERIAL TESTING AND EVALUATION, NAMELY, METALLOGRAPHIC ANALYSIS, CHEMICAL ANALYSIS, GAS ANALYSIS, SURFACE ANALYSIS, ELECTRON MICROSCOPY AND ANALYSIS BY USE OF X-RAYS; RESEARCH AND DEVELOPMENT IN THE FIELD OF MATERIALS, SURFACE TECHNOLOGY, ANALYTICS, JOINING TECHNOLOGY, POWDER METALLURGY, WEAR-RESISTANT COATINGS, DECORATIVE COATINGS AND FUNCTIONAL COATINGS (U.S. CLS. 100 AND 101).

PAUL MORENO, EXAMINING ATTORNEY

SN 79-098,518. IOPENER LIMITED, UNITED KINGDOM, FILED 2-15-2011.

THE MARK CONSISTS OF STANDARD CHARACTERS WITHOUT CLAIM TO ANY PARTICULAR FONT, STYLE, SIZE, OR COLOR.

PRIORITY DATE OF 12-21-2010 IS CLAIMED.

OWNER OF INTERNATIONAL REGISTRATION 1080252 DATED 2-15-2011, EXPIRES 2-15-2021.

CLASS 9—ELECTRICAL AND SCIENTIFIC APPARATUS

FOR DOWNLOADABLE QUESTIONNAIRES, PSYCHOMETRIC TESTS AND WRITTEN REPORTS FEATURING PERSONAL ATTITUDES, APTITUDES AND CHARACTER TRAITS, AS WELL AS ORGANIZATIONAL MANAGEMENT INFORMATION, PROVIDED ON-LINE FROM DATABASES OR THE INTERNET; COMPUTER SOFTWARE FOR THE ASSESSMENT OF PERSONAL DATA, NAMELY, PERSONAL ATTITUDES, APTITUDES AND CHARACTER TRAITS; ELECTRONIC DATABASES IN THE FIELD OF BUSINESS AND PERSONNEL ASSESSMENT AND MANAGEMENT CONTAINING INFORMATION REGARDING PERSONAL ATTITUDES, APTITUDES AND CHARACTER TRAITS RECORDED ON COMPUTER MEDIA; DOWNLOADABLE ELECTRONIC PUBLICATIONS IN THE NATURE OF QUESTIONNAIRES, PSYCHOMETRIC TESTS, PRINTED REPORTS IN THE FIELD OF BUSINESS AND PERSONNEL ASSESSMENT AND MANAGEMENT, AS WELL AS PERSONNEL DEVELOPMENT; DOWNLOADABLE MANUALS AND INSTRUCTION MATERIALS FEATURING EDUCATIONAL, INSTRUCTIONAL, COACHING, TRAINING AND TEACHING MATERIAL IN THE FIELD OF BUSINESS AND PERSONNEL ASSESSMENT AND MANAGEMENT, AS WELL AS PERSONNEL DEVELOPMENT PROVIDED BY ELECTRONIC MEANS AND OTHER ON-LINE COMMUNICATIONS (U.S. CLS. 21, 23, 26, 36 AND 38).

CLASS 16—PAPER GOODS AND PRINTED MATTER

FOR PRINTED MATTER, NAMELY, BOOKS, PAMPHLETS, JOURNALS, NEWSLETTERS AND BOOKLETS IN THE FIELD OF BUSINESS AND PERSONNEL MANAGEMENT, PERSONNEL ASSESSMENT, ORGANISATIONAL CHANGE MANAGEMENT, EXECUTIVE COACHING, TEAM AND PERSONNEL DEVELOPMENT; PRINTED QUESTIONNAIRES FOR PERSONAL ASSESSMENT; PRINTED PSYCHOMETRIC TESTS FOR SELF-ASSESSMENT AND EMPLOYEE ASSESSMENT; PRINTED REPORTS IN THE FIELD OF BUSINESS AND PERSONNEL MANAGEMENT, PERSONNEL ASSESSMENT, ORGANISATIONAL CHANGE MANAGEMENT, EXECUTIVE COACHING, TEAM AND PERSONNEL DEVELOPMENT; PRINTED TRAINING GUIDES IN THE FIELD OF BUSINESS AND PERSONNEL MANAGEMENT, PERSONNEL ASSESSMENT, ORGANISATIONAL CHANGE MANAGEMENT, EXECUTIVE COACHING, TEAM AND PERSONNEL DEVELOPMENT; PRINTED INSTRUCTION MATERIALS IN THE FIELD OF BUSINESS AND PERSONNEL MANAGEMENT, PERSONNEL ASSESSMENT, ORGANISATIONAL CHANGE MANAGEMENT, EXECUTIVE COACHING, TEAM AND PERSONNEL DEVELOPMENT (U.S. CLS. 2, 5, 22, 23, 29, 37, 38 AND 50).

CLASS 35—ADVERTISING AND BUSINESS

FOR BUSINESS MANAGEMENT CONSULTANCY AND BUSINESS APPRAISAL SERVICES; BUSINESS MANAGEMENT, BUSINESS APPRAISAL AND BUSINESS CONSULTANCY SERVICES IN RELATION TO ORGANIZATIONAL CHANGE MANAGEMENT AND DEVELOPMENT, PERSONNEL MANAGEMENT AND PERFORMANCE MANAGEMENT; ARRANGING, ORGANIZING AND CONDUCTING PSYCHOMETRIC TESTS, SURVEYS, QUESTIONNAIRES AND POLLS FOR BUSINESS PURPOSES, TO DETERMINE EMPLOYEE SKILLS, OPINIONS, ATTITUDES, APTITUDES AND CHARACTER, AS WELL AS ORGANIZATIONAL CULTURE; BUSINESS INFORMATION SERVICES, NAMELY, COMPILATION, ANALYSIS AND PROVISION OF BUSINESS DATA AND STATISTICAL INFORMATION; COMPILATION, ANALYSIS AND PROVISION OF PSYCHOMETRIC DATA AND STATISTICAL INFORMATION FOR BUSINESS PURPOSES TO DETERMINE EMPLOYEE SKILLS, OPINIONS, ATTITUDES, APTITUDES AND CHARACTER, AS WELL AS ORGANIZATIONAL CULTURE; PREPARATION OF BUSINESS AND BUSINESS MANAGEMENT REPORTS; BUSINESS INFORMATION, BUSINESS ADVISORY AND BUSINESS CONSULTANCY SERVICES; PROVIDING AN ON-LINE COMPUTER DATABASE IN THE FIELD OF BUSINESS INFORMATION; ON-LINE BUSINESS MANAGEMENT CONSULTANCY AND BUSINESS APPRAISAL SERVICES; ON-LINE ARRANGING, ORGANIZING AND CONDUCTING PSYCHOMETRIC TESTS, SURVEYS, QUESTIONNAIRES AND POLLS FOR BUSINESS PURPOSES, TO DETERMINE EMPLOYEE SKILLS, OPINIONS, ATTITUDES, APTITUDES AND CHARACTER, AS WELL AS ORGANIZATIONAL CULTURE; ON-LINE BUSINESS INFORMATION SERVICES, NAMELY, COMPILATION, ANALYSIS AND PROVISION OF BUSINESS DATA AND STATISTICAL INFORMATION; ON-LINE COMPILATION, ANALYSIS AND PROVISION OF PSYCHOMETRIC DATA AND STATISTICAL INFORMATION FOR BUSINESS PURPOSES TO DETERMINE EMPLOYEE SKILLS, OPINIONS, ATTITUDES, APTITUDES AND CHARACTER, AS WELL AS ORGANIZATIONAL CULTURE; ONLINE PREPARATION OF BUSINESS AND BUSINESS MANAGEMENT REPORTS; ON-LINE BUSINESS INFORMATION, BUSINESS ADVISORY AND BUSINESS CONSULTANCY SERVICES (U.S. CLS. 100, 101 AND 102).

CLASS 41—EDUCATION AND ENTERTAINMENT

FOR EDUCATIONAL, INSTRUCTIONAL, COACHING, TRAINING AND TEACHING SERVICES, NAMELY, PROVIDING CLASSES, SEMINARS AND WORKSHOPS IN THE FIELD OF BUSINESS AND PERSONNEL MANAGEMENT, PERSONNEL ASSESSMENT, ORGANIZATIONAL CHANGE MANAGEMENT, EXECUTIVE COACHING, TEAM AND PERSONNEL DEVELOPMENT; BUSINESS TRAINING SERVICES, NAMELY, PERSONNEL AND EXECUTIVE COACHING, LEADERSHIP AND TEAM DEVELOPMENT SERVICES, INCLUDING THE AFORESAID IN RELATION TO ORGANIZATIONAL CHANGE MANAGEMENT AND DEVELOPMENT, BUSINESS MANAGEMENT, PRESENTATION SKILLS, INTERCULTURAL MANAGEMENT, LEADERSHIP, NEGOTIATING, STRESS MANAGEMENT, TEAM DEVELOPMENT AND WRITING SKILLS; TRAINING IN RELATION TO THE DESIGN AND USE OF PSYCHOMETRIC TESTS, SURVEYS, QUESTIONNAIRES AND POLLS; EDUCATIONAL SERVICES, NAMELY, ORGANIZING AND CONDUCTING CLASSES, WORKSHOPS, TRAINING COURSES, SEMINARS, SYMPOSIUMS, EDUCATIONAL CONFERENCES AND EDUCATIONAL EXHIBITIONS IN THE FIELD OF BUSINESS AND PERSONNEL MANAGEMENT, PERSONNEL ASSESSMENT, ORGANIZATIONAL CHANGE MANAGEMENT, EXECUTIVE COACHING, TEAM AND PERSONNEL DEVELOPMENT; PUBLISHING AND ELECTRONIC PUBLISHING SERVICES, NAMELY, PUBLICATION OF BOOKS, MAGAZINES, PAMPHLETS, JOURNALS, NEWSLETTERS, BOOKLETS, QUESTIONNAIRES, PSYCHOMETRIC TESTS, PRINTED REPORTS AND ELECTRONIC PUBLICATIONS; PROVISION OF ONLINE QUESTIONNAIRES, PSYCHOMETRIC TESTS AND REPORTS IN THE NATURE OF NON-DOWNLOADABLE ELECTRONIC PUBLICATIONS IN THE FIELD OF PERSONNEL MANAGEMENT, PERSONNEL ASSESSMENT,

TEAM AND PERSONNEL DEVELOPMENT; PROVIDING ONLINE NON-DOWNLOADABLE ELECTRONIC PUBLICATIONS IN THE NATURE OF ARTICLES, INFORMATION SHEETS, EDUCATIONAL AND TRAINING MATERIAL IN THE FIELD OF BUSINESS AND PERSONNEL MANAGEMENT, PERSONNEL ASSESSMENT, ORGANIZATIONAL CHANGE MANAGEMENT, EXECUTIVE COACHING, TEAM AND PERSONNEL DEVELOPMENT; PRODUCTION, DISTRIBUTION, SYNDICATION, AND RENTAL OF TELEVISION PROGRAMS, RADIO PROGRAMS, FILMS, VIDEOS, AND SOUND/VIDEO RECORDINGS; PROVIDING ONLINE NON-DOWNLOADABLE MANUALS AND INSTRUCTION MATERIALS IN THE FIELD OF BUSINESS AND PERSONNEL MANAGEMENT, PERSONNEL ASSESSMENT, ORGANIZATIONAL CHANGE MANAGEMENT, EXECUTIVE COACHING, TEAM AND PERSONNEL DEVELOPMENT PROVIDED BY ELECTRONIC MEANS AND OTHER ON-LINE COMMUNICATIONS; INFORMATION, ADVISORY AND CONSULTANCY SERVICES, NAMELY, PROVIDING PROFESSIONAL, GROUP, AND EXECUTIVE COACHING IN THE FIELDS OF BUSINESS, LEADERSHIP DEVELOPMENT, AND PERSONNEL DEVELOPMENT; INFORMATION, ADVISORY AND CONSULTANCY SERVICES PROVIDED ON-LINE, NAMELY, PROVIDING PROFESSIONAL, GROUP, AND EXECUTIVE COACHING IN THE FIELDS OF BUSINESS, LEADERSHIP DEVELOPMENT, AND PERSONNEL DEVELOPMENT; ORGANIZING AND CONDUCTING CLASSES, WORKSHOPS, TRAINING COURSES, SEMINARS, SYMPOSIUMS, EDUCATIONAL CONFERENCES AND EDUCATIONAL EXHIBITIONS IN THE FIELD OF BUSINESS AND PERSONNEL MANAGEMENT, PERSONNEL ASSESSMENT, ORGANIZATIONAL CHANGE MANAGEMENT, EXECUTIVE COACHING, TEAM AND PERSONNEL DEVELOPMENT, ALL PROVIDED ON-LINE (U.S. CLS. 100, 101 AND 107).

CLASS 45—PERSONAL AND LEGAL SERVICES

FOR LICENSING OF BUSINESS MANAGEMENT AND CONSULTANCY SERVICES IN THE FIELD OF ORGANIZATIONAL CHANGE MANAGEMENT AND DEVELOPMENT, PERSONNEL MANAGEMENT AND PERFORMANCE MANAGEMENT; LICENSING OF EDUCATIONAL INSTRUCTIONAL, COACHING, TRAINING AND TEACHING SERVICES IN THE FIELD OF ORGANIZATIONAL CHANGE MANAGEMENT AND DEVELOPMENT, PERSONNEL MANAGEMENT AND PERFORMANCE MANAGEMENT; LICENSING OF DOWNLOADABLE MATERIAL, PRINTED MATTER, ELECTRONIC DATABASES AND COMPUTER SOFTWARE, ALL USED IN THE FIELD OF ORGANIZATIONAL CHANGE MANAGEMENT AND DEVELOPMENT, PERSONNEL MANAGEMENT AND PERFORMANCE MANAGEMENT, TO BUSINESSES, PERSONNEL CONSULTANTS AND EXECUTIVE COACHES (U.S. CLS. 100 AND 101).

DAVID HOFFMAN, EXAMINING ATTORNEY

SN 79-098,904. ACAL PLC, UNITED KINGDOM, FILED 5-12-2011.



THE MARK CONSISTS OF STANDARD CHARACTERS WITHOUT CLAIM TO ANY PARTICULAR FONT, STYLE, SIZE, OR COLOR.

PRIORITY DATE OF 11-19-2010 IS CLAIMED.

OWNER OF INTERNATIONAL REGISTRATION 1081393 DATED 5-12-2011, EXPIRES 5-12-2021.

CLASS 35—ADVERTISING AND BUSINESS

FOR THE BRINGING TOGETHER, FOR THE BENEFIT OF OTHERS OF A VARIETY OF GOODS ENABLING CUSTOMERS TO CONVENIENTLY VIEW AND PURCHASE THOSE GOODS, NAMELY, ELECTRIC, ELECTRONIC, COMMUNICATION, ELECTROMECHANICAL, IMAGING, MAGNETIC AND OPTICAL APPARATUS, EQUIPMENT AND INSTRUMENTS, SENSORS, LASERS, SCANNERS, SEMICONDUCTORS, MICROSYSTEMS AND PHOTONICS BY WHOLESALE OR IN A RETAIL STORE OR FROM A CATALOGUE BY MAIL ORDER OR BY MEANS OF TELECOMMUNICATIONS OR FROM AN INTERNET WEBSITE; BUSINESS MANAGEMENT SERVICES; BUSINESS ADMINISTRATION SERVICES; OFFICE FUNCTIONS; MARKETING SERVICES; ADVERTISING SERVICES; ADVISORY SERVICES RELATING TO MARKETING; ADVISORY SERVICES FOR BUSINESS MANAGEMENT; THE PROVISION OF INFORMATION AND/OR ADVICE RELATING TO RETAIL SERVICES (U.S. CLS. 100, 101 AND 102).

CLASS 39—TRANSPORTATION AND STORAGE

FOR TRANSPORTATION, PACKAGING, STORAGE AND DISTRIBUTION OF ELECTRIC, ELECTRONIC, COMMUNICATION, ELECTROMECHANICAL, IMAGING, MAGNETIC AND OPTICAL APPARATUS, EQUIPMENT AND INSTRUMENTS, SENSORS, LASER, SCANNERS, SEMICONDUCTORS, MICROSYSTEMS AND PHOTONICS (U.S. CLS. 100 AND 105).

CLASS 42—SCIENTIFIC AND COMPUTER SERVICES

FOR SCIENTIFIC AND TECHNOLOGICAL SERVICES, NAMELY, RESEARCH AND DESIGN IN THE FIELD OF COMPUTER NETWORKING HARDWARE; INDUSTRIAL RESEARCH IN THE FIELD OF COMMUNICATIONS NETWORKS, MEDICAL, ELECTRIC, ELECTRONIC, ELECTRO MECHANICAL, IMAGING, MAGNETIC AND OPTICAL APPARATUS, EQUIPMENT AND INSTRUMENTS; COMPUTER PROGRAMMING; COMPUTER SOFTWARE DESIGN AND DEVELOPMENT; DESIGN AND DEVELOPMENT OF COMPUTER HARDWARE; ENGINEERING SERVICES AND RESEARCH RELATING TO MECHANICAL ENGINEERING; RESEARCH AND DEVELOPMENT RELATING TO MEDICAL, ELECTRIC, ELECTRONIC, COMMUNICATION, ELECTROMECHANICAL, IMAGING, MAGNETIC AND OPTICAL APPARATUS, EQUIPMENT AND INSTRUMENTS; RESEARCH AND DEVELOPMENT RELATING TO MICROSYSTEMS AND PHOTONICS; RESEARCH AND DEVELOPMENT AND CONSULTATION RELATED THERETO IN THE FIELD OF MEDICAL, ELECTRIC, ELECTRONIC, COMMUNICATION, ELECTROMECHANICAL, IMAGING, MAGNETIC AND OPTICAL APPARATUS, EQUIPMENT AND INSTRUMENTS, MICROSYSTEMS AND PHOTONICS; MEDICAL AND SCIENTIFIC RESEARCH INFORMATION IN THE FIELD OF MEDICAL, ELECTRIC, ELECTRONIC, COMMUNICATION, ELECTROMECHANICAL, IMAGING, MAGNETIC AND OPTICAL APPARATUS, EQUIPMENT AND INSTRUMENTS, MICROSYSTEMS AND PHOTONICS; TECHNOLOGICAL CONSULTATION IN THE TECHNOLOGY FIELD OF COMPUTER HARDWARE SYSTEMS; TECHNICAL SUPPORT SERVICES, NAMELY, TROUBLESHOOTING OF COMPUTER SOFTWARE PROBLEMS; TECHNICAL ADVICE RELATING TO OPERATION OF COMPUTERS AND PRODUCT DEVELOPMENT CONSULTATION (U.S. CLS. 100 AND 101).
ZACHARY BELLO, EXAMINING ATTORNEY

SN 79-098,939. SCIOTEC DIAGNOSTIC TECHNOLOGIES GMBH, AUSTRIA, FILED 5-13-2011.

DAOSIN

THE MARK CONSISTS OF STANDARD CHARACTERS WITHOUT CLAIM TO ANY PARTICULAR FONT, STYLE, SIZE, OR COLOR.

OWNER OF INTERNATIONAL REGISTRATION 1065130 DATED 11-12-2010, EXPIRES 11-12-2020.

THE WORDING "DAOSIN" HAS NO MEANING IN A FOREIGN LANGUAGE.

CLASS 5—PHARMACEUTICALS

FOR PHARMACEUTICAL PREPARATIONS FOR THE TREATMENT OF HISTAMINE INTOLERANCE; CHEMICO-PHARMACEUTICAL PREPARATIONS FOR THE TREATMENT OF HISTAMINE INTOLERANCE; SANITARY PREPARATIONS FOR MEDICAL PURPOSES; BIOLOGICAL PREPARATIONS FOR MEDICAL PURPOSES, NAMELY, FOR THE TREATMENT OF HISTAMINE INTOLERANCE; CHEMICAL PREPARATIONS FOR MEDICAL PURPOSES, NAMELY, FOR THE TREATMENT OF HISTAMINE INTOLERANCE; ENZYMES AND ENZYME PREPARATIONS FOR MEDICAL PURPOSES; DIETETIC FOODS ADAPTED FOR MEDICAL PURPOSES; DIAGNOSTIC PREPARATIONS FOR MEDICAL PURPOSES; CHEMICAL REAGENTS FOR MEDICAL PURPOSES; NUTRITIONAL ADDITIVES FOR MEDICAL PURPOSES FOR USE IN FOODS AND DIETARY SUPPLEMENTS FOR HUMAN CONSUMPTION; NUTRITIONAL ADDITIVES TO FOODSTUFFS FOR ANIMALS FOR MEDICAL PURPOSES (U.S. CLS. 6, 18, 44, 46, 51 AND 52).

CLASS 29—MEATS AND PROCESSED FOODS

FOR FOOD ADDITIVES, NAMELY, NATURAL FOOD EXTRACTS DERIVED FROM PIG, NOT FOR MEDICINAL PURPOSES AND FOR HUMAN CONSUMPTION; PROTEIN FOR USE AS A FOOD ADDITIVE; PROTEIN PELLETS FOR HUMAN CONSUMPTION FOR USE AS A FOOD ADDITIVE; PROTEINS BEING FOODSTUFFS FOR HUMAN CONSUMPTION (U.S. CL. 46).

ELIZABETH HUGHITT, EXAMINING ATTORNEY

SN 79-100,247. DECATHLON SA, F-59650 VILLENEUVE D'ASCQ, FRANCE, FILED 4-1-2011.



PRIORITY DATE OF 11-29-2010 IS CLAIMED.
OWNER OF INTERNATIONAL REGISTRATION 1084759 DATED 4-1-2011, EXPIRES 4-1-2021.

THE MARK CONSISTS OF A DESIGN COMPRISED OF THREE CONCENTRIC CIRCLES WITH THE OUTER CIRCLE HAVING A GAP IN THE UPPER LEFT PORTION OF THE CIRCLE. WITHIN THE GAP IS A WEDGE-LIKE DESIGN THAT APPEARS AS AN EXCLAMATION POINT.

CLASS 18—LEATHER GOODS

FOR BAGS FOR SPORTS, BACKPACKS, AND TRAVELING BAGS, ALL IN THE FIELD OF ARCHERY, DARTS AND SKILL GAMES (U.S. CLS. 1, 2, 3, 22 AND 41).

CLASS 25—CLOTHING

FOR CLOTHING FOR USE IN ARCHERY, DARTS AND SKILL GAMES, NAMELY, T-SHIRTS, SHORTS, PANTS, JACKETS AND SWEAT SHIRTS; FOOTWEAR FOR USE IN ARCHERY, DARTS AND SKILL GAMES; HEADWEAR FOR USE IN ARCHERY, DARTS AND SKILL GAMES (U.S. CLS. 22 AND 39).

CLASS 28—TOYS AND SPORTING GOODS

FOR SPORTS ITEMS FOR ARCHERY, NAMELY, BOWS, TARGETS, BOWSTRINGS, ARROWS, ARROW RESTS, GRIPS, BOW CASES, WRIST GUARDS, HAND GUARDS, ARROW CASES, BOW COVERS, ARROWS, ARROWHEADS, ARROW SHAFTS, DARTS, BOWS, TARGETS, PROTECTIVE NETS FOR SPORTS, CROSSBOWS, SLING SHOTS, PEASHOOTERS, PETANQUE BALLS, ELECTRONIC TARGETS OTHER THAN THOSE DESIGNED TO BE USED ONLY WITH A TELEVISION SET (U.S. CLS. 22, 23, 38 AND 50).

CLASS 41—EDUCATION AND ENTERTAINMENT

FOR TEACHING IN THE FIELD OF ARCHERY AND DARTS; PROVIDING OF TRAINING IN THE USE OF ARCHERY AND DARTS SPORTING EQUIPMENT; ORGANIZATION OF SPORTING EVENTS IN THE NATURE OF ARCHERY AND DARTS COMPETITIONS (U.S. CLS. 100, 101 AND 107).

ALLISON SCHRODY, EXAMINING ATTORNEY

SN 79-100,293. AEROCRINE AB, SWEDEN, FILED 6-13-2011.



PRIORITY DATE OF 12-16-2010 IS CLAIMED.
OWNER OF INTERNATIONAL REGISTRATION 1084868 DATED 6-13-2011, EXPIRES 6-13-2021.
OWNER OF U.S. REG. NOS. 2,595,291, 3,303,027 AND OTHERS.

CLASS 9—ELECTRICAL AND SCIENTIFIC APPARATUS

FOR COMPUTER EQUIPMENT FOR DIAGNOSIS AND MONITORING OF AIRWAY INFLAMMATION AND RESPIRATORY STATUS, NAMELY, COMPUTER SOFTWARE FOR DIAGNOSIS AND MONITORING OF AIRWAY INFLAMMATION AND RESPIRATORY STATUS; RECORDED COMPUTER PROGRAMS, NAMELY, COMPUTER SOFTWARE FOR USE IN THE CALIBRATION, CALCULATION AND CORRECTION OF DATA VALUES FOR USE IN MONITORING OF AIRWAY INFLAMMATION AND RESPIRATORY STATUS; AND COMPUTER HARDWARE (U.S. CLS. 21, 23, 26, 36 AND 38).

CLASS 10—MEDICAL APPARATUS

FOR MEDICAL APPARATUS FOR SAMPLING OF GASES IN HUMAN ORGANS AND FOR CONTROL OF PULMONARY FUNCTIONALITY; FLOW REGULATORS FOR EXHALATION CONTROL; CONTAINERS FOR STORAGE OF EXHALATION TESTS; RESPIRATORY FILTERS AND NOZZLES FOR USE IN SAMPLING OF EXHALATION; CONTAINERS FOR SAMPLING AND STORAGE OF GAS TESTS (U.S. CLS. 26, 39 AND 44).
SKYE YOUNG, EXAMINING ATTORNEY

SN 79-100,462. PETER SCHNEIDER, GEORGENTHAL, FED REP GERMANY, FILED 11-4-2010.



PRIORITY DATE OF 5-6-2010 IS CLAIMED.
OWNER OF INTERNATIONAL REGISTRATION 1085234 DATED 11-4-2010, EXPIRES 11-4-2020.

OWNER OF U.S. REG. NO. 3,968,836.
THE COLOR(S) BLACK, RED AND WHITE IS/ARE CLAIMED AS A FEATURE OF THE MARK.

THE MARK CONSISTS OF THE WORDING "THUROS" IN THE COLOR BLACK WITH STYLIZED FLAME IN THE COLORS RED AND WHITE ABOVE THE "U".

THE WORD(S) "THUROS" HAS NO MEANING IN A FOREIGN LANGUAGE.

CLASS 8—HAND TOOLS

FOR HAND GRILL TOOLS, NAMELY, GRILL SCRAPERS, GRILL TONGS, GRILL FORKS AND GRILL SPATULAS (U.S. CLS. 23, 28 AND 44).

CLASS 11—ENVIRONMENTAL CONTROL APPARATUS

FOR PARTS AND ACCESSORIES FOR GRILLS, NAMELY, GRIDIRONS AND WARMING GRIDIRONS, GRILL HOODS AND GRILL COVERS, DRIP PANS, STAINLESS STEEL SHELVES, GRILL SPITS WITH MOTOR, ROTATABLE TUBE FOR GRILLING, MOUNTABLE WIND DEFLECTORS, AND HEATERS AND FIREPLACE INSERTS, ELECTRIC GRILL ELEMENT, GRILL STAND AND GRILL CARTS; SMOKING CABINETS, NOT FOR MEDICAL PURPOSES (U.S. CLS. 13, 21, 23, 31 AND 34).

CLASS 20—FURNITURE AND ARTICLES NOT OTHERWISE CLASSIFIED

FOR FURNITURE (U.S. CLS. 2, 13, 22, 25, 32 AND 50).

CLASS 21—HOUSEWARES AND GLASS

FOR HOUSEHOLD AND KITCHEN GOODS, NAMELY, GRIDIRONS FOR GRILLING, ROASTING SPITS, MEAT SKEWERS, FISH ROASTING PANS, GRILL PANS, GRILL POTS, BARBECUE CUPS, GLOVES FOR HOUSEHOLD PURPOSES, NAMELY, GRILL GLOVES, AND BARBECUE CLEANING BRUSHES, GRILL SCRAPERS, INCENSE BURNERS (U.S. CLS. 2, 13, 23, 29, 30, 33, 40 AND 50).

LESLIE RICHARDS, EXAMINING ATTORNEY

SN 79-100,670. PRESSMASTER AB, SWEDEN, FILED 7-4-2011.

pressmaster
Quality To Hand

OWNER OF INTERNATIONAL REGISTRATION 1085721 DATED 7-4-2011, EXPIRES 7-4-2021.

OWNER OF U.S. REG. NO. 990,779.

THE COLOR(S) BLUE IS/ARE CLAIMED AS A FEATURE OF THE MARK.

THE MARK CONSISTS OF THE WORDING "PRESSMASTER" IN BLUE FOLLOWED UNDERNEATH BY THE WORDING "QUALITY TO HAND" IN BLUE.

CLASS 7—MACHINERY

FOR HAND-HELD TOOLS, NAMELY, HAND-HELD POWERED AND BATTERY ACTUATED HYDRAULIC CRIMP TOOL (U.S. CLS. 13, 19, 21, 23, 31, 34 AND 35).

CLASS 8—HAND TOOLS

FOR HAND TOOLS, NAMELY, CRIMP WRENCHES AND CRIMP WRENCH SETS; HAND TOOLS, NAMELY, WIRE CRIMPERS; HAND STRIPPING TOOLS FOR PREPARING ELECTRONIC AND ELECTRICAL WIRES AND CABLES (U.S. CLS. 23, 28 AND 44).

HAI-LY LAM, EXAMINING ATTORNEY

SN 79-100,675. SANKO TEKSTIL ISLETMELERI SANAYI VE TICARET ANONIM SIRKETI, TURKEY, FILED 12-28-2010.

İSKO FUTURE FACE

THE MARK CONSISTS OF STANDARD CHARACTERS WITHOUT CLAIM TO ANY PARTICULAR FONT, STYLE, SIZE, OR COLOR.

PRIORITY DATE OF 12-24-2010 IS CLAIMED.

OWNER OF INTERNATIONAL REGISTRATION 1085726 DATED 12-28-2010, EXPIRES 12-28-2020.

OWNER OF U.S. REG. NO. 3,885,599.

NO CLAIM IS MADE TO THE EXCLUSIVE RIGHT TO USE "FUTURE FACE", APART FROM THE MARK AS SHOWN.

THE WORDING "İSKO" HAS NO MEANING IN A FOREIGN LANGUAGE.

CLASS 24—FABRICS

FOR WOVEN TEXTILE FABRICS FOR USE IN THE MANUFACTURE OF CLOTHING, TOWELS, TABLE LINEN, BED LINEN, HOUSEHOLD LINEN; NON-WOVEN TEXTILE FABRICS FOR USE IN THE MANUFACTURE OF CLOTHING, TOWELS, TABLE LINEN, BED LINEN, HOUSEHOLD LINEN; FIBERGLASS FABRICS FOR TEXTILE USE; FABRIC IMPERVIOUS TO GASES FOR AERONAUTICAL BALLOONS; WATERPROOF FABRICS, NAMELY, WATERPROOF FABRIC FOR MANUFACTURING CLOTHING, FURNITURE AND AUTOMOBILE UPHOLSTERY, AND LUGGAGE; GUMMED WATERPROOF CLOTH; FABRIC OF IMITATION ANIMAL SKINS; TEXTILE LININGS, NAMELY, LINEN LINING FABRIC FOR SHOES, UNFINISHED TEXTILE FOR THE MANUFACTURE OF LININGS FOR GARMENTS, TEXTILE USED AS LINING FOR CLOTHING; BUCKRAM; FILTERING MATERIALS OF TEXTILE, NAMELY, CHEMICAL FIBER FABRICS, SYNTHETIC FIBER FABRICS AND INORGANIC FIBER MIXED FABRICS, ALL OF THE FOREGOING FOR USE IN FILTERING LIQUIDS AND POWDERS; QUILTS OF TEXTILE, LAP BLANKETS; WASHING MITTS, BATH LINEN, HAND TOWELS, FACE TOWELS OF TEXTILE, BATHING TOWELS; HANDKERCHIEFS OF TEXTILE, BANNERS OF TEXTILE, NAMELY, CLOTH BANNERS; FLAGS NOT OF PAPER, NAMELY, CLOTH FLAGS, FABRIC FLAGS; TRAVELING RUGS, NAMELY, LAP RUGS; CURTAINS OF TEXTILE, SHOWER CURTAINS OF TEXTILE, SHOWER CURTAINS OF PLASTICS; OIL-CLOTH FOR USE AS TABLE CLOTHS; BED COVERS, NAMELY, BEDBLANKETS, BED SHEETS, BEDSPREADS, BED LINEN, PILLOW CASES, QUILT COVERS; UPHOLSTERY FABRICS; TABLE NAPKINS OF TEXTILE (U.S. CLS. 42 AND 50).

CLASS 25—CLOTHING

FOR CLOTHING, NAMELY, TROUSERS, JACKETS, OVERCOATS, COATS, SKIRTS, SUITS, JERSEYS, WAISTCOATS, SHIRTS, T-SHIRTS, SWEATSHIRTS, DRESSES, BERMUDA SHORTS, SHORTS, PAJAMAS, PULLOVERS, JEANS, TRACKSUITS, RAINWEAR, BEACHWEAR, BATHING SUITS, SWIMMING SUITS; ARTICLES OF CLOTHING MADE FROM COTTON DENIM, NAMELY, DENIM JACKETS AND DENIM JEANS, ARTICLES OF CLOTHING MADE FROM KNITTED FABRICS, NAMELY, KNIT SHIRTS AND KNIT JACKETS, CLOTHING FOR SPORTSWEAR, NAMELY, SHIRTS, SHORTS AND TRACK SUITS, CLOTHING FOR BABIES, NAMELY, SHIRTS AND PANTS; UNDERCLOTHING, NAMELY, BOXER SHORTS, BRASSIERES, BRIEFS, PANTS, SOCKS, FOOTWEAR, NAMELY, SHOES EXCLUDING ORTHOPEDIC SHOES, SANDALS, WATERPROOF BOOTS, WALKING BOOTS, BOOTIES, SPORTING SHOES, SLIPPERS; SHOE PARTS, NAMELY, HEELPIECES, NAMELY, HEEL PIECES FOR SHOES, INSOLES FOR FOOTWEAR, FOOTWEAR UPPERS, NAMELY, UPPERS OF WOVEN RATTAN FOR JAPANESE STYLE SANDALS, HEADGEAR, NAMELY, CAPS, SKULL CAPS, SPORTS CAPS, HATS, BERETS; GLOVES, STOCKINGS, BELTS, CAMISOLES, SARONGS, SCARVES, NECK SCARVES, SHAWLS, COLLARS, MUFFLERS, NECKTIES, TIES, SUSPENDER BELTS (U.S. CLS. 22 AND 39).

CLASS 35—ADVERTISING AND BUSINESS

FOR ADVERTISING AGENCIES, MARKETING CONSULTING AND PUBLICITY BUREAU SERVICES; ADVERTISEMENT AND PUBLICITY SERVICES BY TELEVISION, RADIO, MAIL; DISSEMINATION OF ADVERTISING MATTER, WRITING OF PUBLICITY TEXTS, ORGANIZING EXHIBITIONS AND FAIRS FOR COMMERCIAL AND ADVERTISING PURPOSES, ADVERTISING SERVICES, ADVERTISING AGENCIES, NAMELY, PROMOTING THE GOODS AND SERVICES OF OTHERS; PRODUCTION AND DISTRIBUTION OF RADIO AND TELEVISION COMMERCIALS; ORGANIZATION OF EXHIBITIONS FOR PROMOTING THE SALE OF CLOTHING AND TEXTILES, MODELING FOR ADVERTISING OR SALES PROMOTION, CONDUCTING MARKETING STUDIES; PUBLICITY AND SALES PROMOTION SERVICES; WINDOW DRESSING AND DISPLAY ARRANGEMENT SERVICES; PUBLIC OPINION POLLING; PUBLIC RELATIONS; PROVIDING OFFICE FUNCTIONS; BUSINESS MANAGEMENT OF

PERFORMING ARTISTS; SECRETARIAL SERVICES, DOCUMENT REPRODUCTION, PHOTOCOPYING, TYPING SERVICES, WORD PROCESSING, COMPILATION OF INFORMATION INTO COMPUTER DATABASES, SYSTEMIZATION OF INFORMATION INTO COMPUTER DATABASES, TELEPHONE ANSWERING SERVICES, ARRANGING NEWSPAPER SUBSCRIPTIONS FOR OTHERS, RENTAL OF TYPEWRITERS AND COPYING MACHINES, RENTAL OF VENDING MACHINES; BUSINESS ADMINISTRATION CONSULTANCY; COMMERCIAL AND INDUSTRIAL MANAGEMENT ASSISTANCE, BUSINESS MANAGEMENT AND ORGANIZATION CONSULTANCY, BUSINESS MANAGEMENT OF HOTELS FOR OTHERS; BUSINESS INVESTIGATIONS; PROVIDING STATISTICAL INFORMATION FOR BUSINESS AND COMMERCIAL PURPOSES, PERSONNEL MANAGEMENT CONSULTANCY, PERSONNEL RECRUITMENT, ACCOUNTING SERVICES, FINANCIAL STATEMENT PREPARATION AND ANALYSIS FOR BUSINESSES; BUSINESS AUDITING; COST/PRICE ANALYSIS; ECONOMIC FORECASTING AND ANALYSIS; PAYROLL PREPARATION, TAX PREPARATION; IMPORT AND EXPORT AGENCIES; BUSINESS INVESTIGATIONS, EVALUATIONS, EXPERT APPRAISALS, AUCTIONEERING; BRINGING TOGETHER, FOR THE BENEFIT OF OTHERS, OF WOVEN AND NON-WOVEN TEXTILE FABRICS FOR USE IN THE MANUFACTURE OF CLOTHING, TOWELS, TABLE LINEN, BED LINEN, HOUSEHOLD LINEN, CLOTHING, FOOTWEAR, HEADGEAR, ENABLING CUSTOMERS TO VIEW AND PURCHASE THOSE GOODS (U.S. CLS. 100, 101 AND 102).

CLASS 40—MATERIAL TREATMENT

FOR METAL TREATMENT SERVICES, NAMELY, GALVANIZING, METAL PLATING, METAL CASTING, CUSTOM MANUFACTURE OF BOILERS, METAL TEMPERING, PROVIDING MATERIAL TREATMENT INFORMATION, NICKEL PLATING, CADMIUM PLATING, CHROMIUM PLATING, TIN PLATING, LEAD WORKING; PRECIOUS METAL TREATMENT SERVICES, NAMELY, GOLD PLATING, SILVER PLATING, SILVERSMITHING; PROCESSING OF CINEMATOGRAPHIC FILMS, PHOTOGRAPHIC PROCESSING, PHOTOGRAPHIC FILM DEVELOPING, PHOTOGRAPHIC PRINTING, PHOTOGRAVURE, PHOTOCOMPOSING SERVICES; PROCESSING OF RAW MATERIALS FOR USE IN THE MANUFACTURE OF FOOD; MILLWORKING, FLOUR MILLING, FOOD CANNING; SLAUGHTERING OF ANIMALS; FUR AND LEATHER TREATMENT, NAMELY, FUR DYEING, LEATHER STAINING, TANNING OF LEATHER, MOTH-PROOFING, FUR CONDITIONING, LEATHER CONDITIONING, FUR GLOSSING, LEATHER GLOSSING; SADDLERY WORKING; TREATMENT OF FABRIC, NAMELY, YARN WARPING USING LOOMS FOR WEAVING, MOTH-PROOFING OF FABRIC, EDGING OF FABRIC, CUTTING OF FABRIC, BLEACHING OF FABRIC, DYEING OF FABRIC, PERMANENT PRESS TREATMENT OF FABRIC, FIREPROOFING OF FABRIC, WATERPROOFING OF FABRIC, PRE-SHRINKING OF FABRIC, CREASE RESISTANT TREATMENT OF FABRIC, WOOL TREATMENT AND FINISHING; TAILORING OR DRESSMAKING, SEWING SERVICES, CUTTING OF CLOTH, CLOTHING ALTERATION, EMBROIDERY SERVICES; WOODWORKING, TIMBER FELLING AND PROCESSING, TIMBER LOGGING, ENGRAVING; FRAMING OF WORKS OF ART; ENVIRONMENTAL REMEDIATION SERVICES, NAMELY, WASTE AND WATER TREATMENT SERVICES, AIR DEODORIZING, RECYCLING OF WASTE MATERIALS, SORTING OF WASTE AND RECYCLABLE MATERIAL, FUEL TREATMENT SERVICES, FUEL REFINING, WATER TREATMENT AND PURIFICATION; TREATMENT OF GLASS MATERIALS, OPTICAL GLASS GRINDING, GLASS BLOWING, GLASS TINTING, GLASS PLATING, NAMELY, SOLDERING TOGETHER TWO OR MORE LAYERS OF GLASS, GRINDING AND POLISHING GLASS FOR EYEGASSES; CUSTOM ASSEMBLING OF PRODUCTS FOR OTHERS; DENTAL TECHNICIAN SERVICES; POTTERY FIRING; PRODUCTION OF ENERGY, RENTAL OF ELECTRIC POWER GENERATORS; PAPER TREATMENT, PAPER FINISHING; PRINTING OF BOOKS, OFFSET PRINTING, LITHOGRAPHIC PRINTING, SILK SCREEN PRINTING, PRINTING OF PATTERNS ON TEXTILES, BOOKBINDING; MATERIAL

TREATMENT OF PLASTICS, NAMELY, LAMINATING OF PLASTIC SHEETS, INJECTION MOLDING OF PLASTICS FOR OTHERS (U.S. CLS. 100, 103 AND 106).
NANCY CLARKE, EXAMINING ATTORNEY

SN 79-100,715. PETER ZU SAYN-WITTGENSTEIN, CH-6612 ASCONA, SWITZERLAND, FILED 6-10-2011.

SOULNESS

THE MARK CONSISTS OF STANDARD CHARACTERS WITHOUT CLAIM TO ANY PARTICULAR FONT, STYLE, SIZE, OR COLOR.

PRIORITY DATE OF 3-30-2011 IS CLAIMED.
OWNER OF INTERNATIONAL REGISTRATION 1085819 DATED 6-10-2011, EXPIRES 6-10-2021.

CLASS 3—COSMETICS AND CLEANING PREPARATIONS

FOR BLEACHING PREPARATIONS AND OTHER SUBSTANCES FOR LAUNDRY USE, NAMELY, LAUNDRY SOAP, LAUNDRY PRE-SOAK AND LAUNDRY STARCH; CLEANING, POLISHING, DEGREASING AND ABRASIVE PREPARATIONS; SOAP; PERFUMERY, ESSENTIAL OILS, COSMETICS, HAIR LOTIONS, DENTIFRICES (U.S. CLS. 1, 4, 6, 50, 51 AND 52).

CLASS 10—MEDICAL APPARATUS

FOR SURGICAL, MEDICAL AND VETERINARY APPARATUS AND INSTRUMENTS FOR USE IN GENERAL SURGERY; DENTAL INSTRUMENTS, NAMELY, PICKS, BURRS, MIRRORS AND ORAL IRRIGATORS; DENTAL APPARATUS, NAMELY, INTRA-ORAL LIGHT SYSTEMS; ARTIFICIAL LIMBS, EYES AND TEETH; ORTHOPAEDIC ARTICLES, NAMELY, BELTS, BRACES, JOINT, SUPPORTS; SUTURE MATERIALS (U.S. CLS. 26, 39 AND 44).

CLASS 16—PAPER GOODS AND PRINTED MATTER

FOR PAPER, CARDBOARD AND GOODS MADE FROM THESE MATERIALS PROVIDED THAT THEY ARE NOT INCLUDED IN OTHER CLASSES, NAMELY, PAPER BAGS, BOXES OF CARDBOARD, CARDBOARD PACKAGING; PRINTED MATTER, NAMELY, NEWSPAPERS, PHOTOGRAPHS, MAGAZINES, BOOKS, PRINTED PERIODICALS, PUBLICATIONS, NEWSLETTERS AND BROCHURES ALL IN THE FIELDS OF SCIENCE, HEALTH, TRAVEL AND LEISURE, LIFESTYLE, DESIGN AND DECORATION, ARCHITECTURE, CONSCIOUSNESS, WELL-BEING, FITNESS AND WELLNESS AS WELL AS FICTION BOOKS AND NOVELS; BOOKBINDING MATERIAL; PHOTOGRAPHS; STATIONERY; ADHESIVES GLUES FOR STATIONERY OR HOUSEHOLD PURPOSES; ARTISTS MATERIALS, NAMELY, BRUSHES, PENCILS, CANVAS PANELS; PAINTBRUSHES; TYPEWRITERS AND OFFICE REQUISITES, NAMELY, STAPLERS, HOLE PUNCHES; INSTRUCTIONAL AND TEACHING MATERIALS, NAMELY, STUDY GUIDES; PLASTIC MATERIALS FOR PACKAGING, PROVIDED THAT THEY ARE NOT INCLUDED IN OTHER CLASSES, NAMELY, PLASTIC BAGS, PLASTIC BUBBLE PACKS; PRINTING TYPE; PRINTING BLOCKS (U.S. CLS. 2, 5, 22, 23, 29, 37, 38 AND 50).

CLASS 25—CLOTHING

FOR CLOTHING, NAMELY, BEACH COVER-UPS, BEACHWEAR, BELTS, BERMUDA SHORTS, BIKINIS, BLAZERS, BLOOMERS, BLOUSES, BLOUSONS, BODY SUITS, BOTTOMS, BOW TIES, CATSUITS, CHAPS, CORSETS, EVENING GOWNS, GLOVES, GYM SHORTS, GYM SUITS, JACKETS, JEANS, JOGGING SUITS, LEATHER COATS, LEATHER JACKETS, LEGGINGS, LINGERIE, LOUNGEWEAR, MANTLES, MINISKIRTS, OVERALLS, PAJAMAS, PANTIES, PANTS, PANTSUITS, PANTYHOSE, PLAY SUITS, POLO SHIRTS, PONCHOS, PULLOVERS, ROBES, SHIRTS, SHORTS, SKI WEAR, SLEEPWEAR, SLIPPERS, SNOW SUITS, SOCKS, SPORT COATS, SPORT SHIRTS, STOCKINGS, SUITS, SWEAT PANTS, SWEAT SHIRTS, SWEAT SHORTS, SWEATERS, SWIM WEAR, SWIMSUITS, TAILLEURS, TANK TOPS, TENNIS WEAR, TIGHTS, TUXEDOS, UNDERWEAR, UNIFORMS, VESTED SUITS, VESTS, WET SUITS AND WIND RESISTANT JACKETS; FOOTWEAR, NAMELY, ATHLETIC FOOTWEAR, ATHLETIC SHOES, BOOTS, FOOTWEAR, HEELS, SANDALS, SHOES AND SNEAKERS; HEADGEAR, NAMELY, HATS, CAPS AND VISORS (U.S. CLS. 22 AND 39).

CLASS 32—LIGHT BEVERAGES

FOR BEER, MINERAL AND AERATED WATERS AND OTHER NON-ALCOHOLIC DRINKS, NAMELY, COCONUT WATER, COCONUT-BASED BEVERAGES, COLAS, DRINKING WATER, ENERGY DRINKS, FLAVOURED MINERAL WATER, FLAVOURED WATER, FRUIT FLAVOURED SOFT DRINKS, LAGER, LEMONADE, NON-ALCOHOLIC BEER, NON-ALCOHOLIC COCKTAIL MIXES, NON-ALCOHOLIC WINES, PUNCH, SELTZER WATER, SODA WATER, SOFT DRINKS, SPORTS DRINKS, SPRING WATER, TABLE WATER, TOMATO JUICE, VEGETABLE JUICE; FRUIT DRINKS AND FRUIT JUICES; SYRUPS FOR MAKING BEVERAGES; CONCENTRATES AND POWDERS FOR MAKING SOFT DRINKS AND FRUIT DRINKS (U.S. CLS. 45, 46 AND 48).

CLASS 41—EDUCATION AND ENTERTAINMENT

FOR TEACHING, NAMELY, EDUCATION COURSES AND CONFERENCES AND PROVIDING CLASSES, SEMINARS AND WORKSHOPS IN THE FIELDS OF SCIENCE, HEALTH, SPORTS, DANCING, CONSCIOUSNESS, WELL-BEING, FITNESS, WELLNESS, LIFESTYLE, SELF- AND PERSONAL AWARENESS; GYMNASIUMS; PROVIDING TRAINING IN THE FIELDS OF COMPUTER AND MULTIMEDIA EDUCATION; ENTERTAINMENT, NAMELY, CONCERTS, CABARETS, CASINOS, CINEMA STUDIOS, CINEMA THEATRES, DISC JOCKEYS FOR PARTIES AND EVENTS, DISCOTHEQUES, DISTRIBUTION FOR TELEVISION PROGRAMS FOR OTHERS, DANCE PERFORMANCES, LASER SHOWS, WINE TASTINGS, MOTION PICTURE FILM PRODUCTION, NIGHT CLUBS, PARTY PLANNING, ONLINE ELECTRONIC PUBLISHING OF BOOKS AND PERIODICALS, PUBLICATION OF BOOKS, TELEVISION SHOW PRODUCTION AND VIDEOTAPE PRODUCTION; SPORTING AND CULTURAL ACTIVITIES, NAMELY, ORGANIZING COMMUNITY AND CULTURAL EVENTS; COUNTRY CLUBS PROVIDING INTERACTIVE WEBSITE FEATURING SOCIAL COMMUNITY ACTIVITIES AND INFORMATION IN THE FIELDS OF SCIENCE, HEALTH, SPORTS, WELL-BEING-FITNESS, WELLNESS, CONSCIOUSNESS TRAVEL AND LEISURE, LIFESTYLE AND ENTERTAINMENT (U.S. CLS. 100, 101 AND 107).

CLASS 42—SCIENTIFIC AND COMPUTER SERVICES

FOR SCIENTIFIC AND TECHNOLOGICAL SERVICES, NAMELY, SCIENTIFIC RESEARCH, DEVELOPMENT AND CONSULTATION IN THE FIELDS OF, MEDICINE, PHYSICS AND CHEMISTRY, BIOPHYSICS AND BIO-CHEMISTRY, SEXOLOGY, SPORTS, HEALTH, WELLNESS, CONSCIOUSNESS, PSYCHOLOGY; AND RESEARCH AND DESIGN RELATING THERETO; INDUSTRIAL ANALYSIS AND RESEARCH SERVICES IN THE FIELDS OF PHARMACEUTICAL, BIOMEDICAL, COSMETICS, AND CHEMICAL MANUFACTURING; DESIGN AND DEVELOPMENT OF COMPUTERS AND SOFTWARE; PRODUCT RESEARCH AND DEVELOPMENT; SURVEYING AND ENGINEERING; INTERIOR DECORATING; ARCHITECTURAL DESIGN (U.S. CLS. 100 AND 101).

CLASS 43—HOTEL AND RESTAURANT SERVICES

FOR SERVICES FOR PROVIDING FOOD AND DRINK, NAMELY, BAR SERVICES, COCKTAIL LOUNGE BUFFETS, CONTRACT FOOD SERVICES, DELICATESSEN SERVICES, RESTAURANT SERVICES, RESTAURANTS FEATURING HOME DELIVERY, SALAD BARS, TAKE-OUT RESTAURANT SERVICES, WINE BARS; ARRANGING TEMPORARY HOUSING ACCOMMODATIONS; MAKING HOTEL RESERVATIONS FOR OTHERS; PROVIDING TEMPORARY HOUSING ACCOMMODATIONS; TEMPORARY PUBLIC HOUSING SERVICES; RESIDENTIAL HOTEL SERVICES; RESORT HOTEL SERVICES; RESORT LODGING SERVICES; TEMPORARY RETIREMENT HOMES; TOURIST HOMES; PROVIDING TEMPORARY ACCOMMODATIONS AND MEALS TO CLIENTS OF A HEALTH OR BEAUTY SPA; TRAVEL AGENCY SERVICES, NAMELY, MAKING RESERVATIONS AND BOOKING FOR TEMPORARY LODGING (U.S. CLS. 100 AND 101).

CLASS 44—MEDICAL, BEAUTY AND AGRICULTURAL SERVICES

FOR MEDICAL SERVICES; HEALTH CARE; ADDICTION TREATMENT SERVICES; ALTERNATIVE MEDICINE SERVICES; AROMATHERAPY SERVICES; BODYWORK THERAPY; CHIROPRACTICS, COSMETIC AND PLASTIC SURGERY; COSMETICIAN SERVICES; DIETITIAN SERVICES; EMERGENCY MEDICAL SERVICES; VETERINARY SERVICES; HEALTH SPA SERVICES, NAMELY, WELLNESS PROGRAMS AND COSMETIC BODY CARE SERVICES; MASSAGE; MEDICAL CLINICS; MENTAL HEALTH SERVICES; NURSING CARE; NUTRITION COUNSELLING; OPERATION OF SAUNA FACILITIES; PERFORMING DIAGNOSIS OF DISEASE; PHYSICAL THERAPY; PROVIDING BATH HOUSES; PROVIDING HOT TUB FACILITIES; PROVIDING PUBLIC BATH FACILITIES; PROVIDING MENTAL AND PHYSICAL REHABILITATION FACILITIES; PSYCHOLOGICAL CONSULTATION AND COUNSELLING; SANITARIUMS; WEIGHT REDUCTION DIET PLANNING AND SUPERVISION; HOME HEALTH CARE SERVICES; HYPNOSES SERVICES; TELEMEDICINE SERVICES; PROVIDING A WEBSITE FEATURING CONTENT REGARDING HEALTHY LIVING, NUTRITION, FITNESS AND LIFESTYLE WELLNESS; HYGIENIC AND BEAUTY CARE FOR HUMAN BEINGS OR ANIMALS; BEAUTY SALONS; SKIN CARE SALONS; TANNING SALONS; PROVIDING INFORMATION ABOUT BEAUTY; WELLNESS AND HEALTH-RELATED CONSULTING SERVICES; AGRICULTURE SERVICES, NAMELY, AGRICULTURAL ADVISE; LANDSCAPE GARDENING; LANDSCAPE GARDENING DESIGN FOR OTHERS; GREENHOUSE SERVICES; HORTICULTURAL SERVICES; AND FORESTRY SERVICES IN THE NATURE OF MANAGING HARVESTING FORESTS (U.S. CLS. 100 AND 101).

RON FAIRBANKS, EXAMINING ATTORNEY

SN 79-101,052. YENISTA OPTICS S.A., F-22300 LANNION, FRANCE, FILED 6-23-2011.

SN 79-101,091. SURFING AUSTRALIA INC, AUSTRALIA, FILED 5-27-2011.

YENISTA



THE MARK CONSISTS OF STANDARD CHARACTERS WITHOUT CLAIM TO ANY PARTICULAR FONT, STYLE, SIZE, OR COLOR.

OWNER OF INTERNATIONAL REGISTRATION 1086773 DATED 6-23-2011, EXPIRES 6-23-2021.

THE WORDING "YENISTA" HAS NO MEANING IN A FOREIGN LANGUAGE.

CLASS 9—ELECTRICAL AND SCIENTIFIC APPARATUS

FOR SCIENTIFIC, OPTICAL, WEIGHING, MEASURING, SIGNALING, CHECKING, TEACHING APPARATUS AND INSTRUMENTS, FIBER OPTIC TEST APPARATUS NAMELY, TUNABLE LASERS, TUNABLE FILTERS, DFB LASERS, DBR LASERS, EXTERNAL CAVITY LASERS, SLED / SUPERLUMINESCENT, LIGHT EMITTING DIODES, VARIABLE OPTICAL ATTENUATORS, VARIABLE OPTICAL BACKREFLECTORS, SHUTTERS, SWITCHES, PMD ANALYZERS, PDM ANALYZERS, CHROMATIC DISPERSION ANALYZERS, OPTICAL POWER METERS, OPTICAL, BACKREFLECTION METERS, OPTICAL SPECTRUM ANALYZERS, OPTICAL CHANNEL MONITORS, OPTICAL TIME DOMAIN, REFLECTOMETERS, OPTICAL COMPONENT TESTERS; APPARATUS AND INSTRUMENTS FOR THE SUPPLY, DISTRIBUTION, TRANSFORMATION, ACCUMULATION, REGULATION OR CONTROL OF ELECTRICITY, NAMELY, ELECTRICAL POWER SUPPLIES; APPARATUS FOR RECORDING, TRANSMISSION OR REPRODUCTION OF SOUND OR IMAGES; OPTICAL APPARATUS AND INSTRUMENTS, NAMELY, INTERFEROMETERS, LENSED FIBERS, FILTERS, MULTIPLEXERS, DEMULTIPLEXERS, OPTICAL FIBERS LIGHT CONDUCTING FILAMENTS, FIBER OPTIC CABLES, OPTICAL CABLES, OPTICAL FILTERS, OPTICAL LASERS NOT FOR MEDICAL USE, OPTICAL COUPLERS, OPTICAL SWITCHES, OPTICAL SHUTTERS (U.S. CLS. 21, 23, 26, 36 AND 38).

CLASS 38—COMMUNICATION

FOR TELECOMMUNICATIONS, NAMELY, TRANSMISSION OF PODCASTS; COMMUNICATIONS BY FIBER OPTIC NETWORKS, TELECOMMUNICATIONS ROUTING AND JUNCTION SERVICES, COMPUTER AIDED TRANSMISSION OF INFORMATION, MESSAGES AND IMAGES; ELECTRONIC BULLETIN BOARD SERVICES; TELECOMMUNICATIONS SERVICES, NAMELY, CALL HUNTING (U.S. CLS. 100, 101 AND 104).

CLASS 42—SCIENTIFIC AND COMPUTER SERVICES

FOR SCIENTIFIC AND INDUSTRIAL RESEARCH AND DEVELOPMENT IN THE FIELD OF OPTICAL APPARATUS AND INSTRUMENTS; TECHNICAL PROJECT STUDIES IN THE FIELD OF OPTICAL APPARATUS AND INSTRUMENTS (U.S. CLS. 100 AND 101).
ALLISON HOLTZ, EXAMINING ATTORNEY

PRIORITY DATE OF 5-17-2011 IS CLAIMED.
OWNER OF INTERNATIONAL REGISTRATION 1086875 DATED 5-27-2011, EXPIRES 5-27-2021.

NO CLAIM IS MADE TO THE EXCLUSIVE RIGHT TO USE "SURF GROMS", APART FROM THE MARK AS SHOWN.

THE COLOR(S) BLUE AND WHITE IS/ARE CLAIMED AS A FEATURE OF THE MARK.

THE MARK CONSISTS OF THE FOLLOWING: THE LITERAL PORTION "SURF GROMS" OUTLINED IN BLUE WITH WHITE FILL, WHERE THE "O" IN "GROMS" IS STYLIZED TO ENCOMPASS A WAVE DESIGN WITH STARS WHERE THE TWO WAVES ARE WHITE, THE FIVE STARS ARE WHITE, THE WATER IS REPRESENTED IN BLUE WITH A WHITE OUTLINING AND A LIGHTER BLUE OUTLINE NEAR THE BOTTOM OF THE "O"; EMANATING FROM THE "O" IS A LARGER WAVE DESIGN THAT CURLS ABOVE THE WORDING "SURF" AND HAS A BLUE STREAK, A WHITE STREAK, LIGHT BLUE STREAK, ANOTHER WHITE STREAK AND FINALLY ANOTHER BLUE STREAK.

CLASS 16—PAPER GOODS AND PRINTED MATTER

FOR PRINTED EDUCATIONAL MATERIALS FOR USE IN TEACHING IN THE FIELD OF SURFING; EDUCATIONAL MATERIALS IN PRINTED FORM IN THE FIELD OF SURFING; EDUCATIONAL MATERIALS IN WRITTEN FORM IN THE FIELD OF SURFING; TRAINING BOOKLETS IN THE FIELD OF SURFBOARD RIDING; TRAINING GUIDES IN THE FORM OF PRINTED MATTER IN THE FIELD OF SURFING; TRAINING MANUALS IN THE FORM OF PRINTED MATTER IN THE FIELD OF SURFING; BROCHURES IN THE FIELD OF SURF TRAINING; INDIVIDUALLY DESIGNED PRINTED BROCHURES IN THE FIELD OF SURF TRAINING; PRESENTATION BROCHURES IN THE FIELD OF SURF TRAINING; PRINTED PUBLICATIONS FOR ADVERTISING PUBLICATIONS, NAMELY, ADVERTISING POSTERS; ADVERTISING PUBLICATIONS, NAMELY, ADVERTISING PAMPHLETS; PRINTED MATTER FOR ADVERTISING PURPOSES, NAMELY, ADVERTISING PAMPHLETS; PRINTED PUBLICATIONS FOR ADVERTISING BUSINESSES, NAMELY, ADVERTISING PAMPHLETS; TEACHING MATERIALS FOR EDUCATION IN THE FIELD OF SURFING; TEACHING MATERIALS FOR INFORMATION IN THE FIELD OF SURFING; TEACHING MATERIALS FOR INSTRUCTION IN THE FIELD OF SURFING; PHOTOGRAPHS (U.S. CLS. 2, 5, 22, 23, 29, 37, 38 AND 50).

CLASS 18—LEATHER GOODS

FOR BACKPACKS; ATHLETICS BAGS; BAGS FOR CLOTHES, NAMELY, LUGGAGE; BEACH BAGS; ALL PURPOSE CARRYING BAGS OTHER THAN DISPOSABLE CARRIER BAGS; CASUAL BAGS, NAMELY, BUM BAGS; GYM BAGS; LUGGAGE BAGS; OVERNIGHT BAGS; SCHOOL BAGS; SHOULDER BAGS; SHOULDER BAGS FOR USE BY CHILDREN; SPORT BAGS, OTHER THAN ADAPTED (SHAPED) TO CONTAIN SPECIFIC SPORTS APPARATUS; TRAVEL BAGS (U.S. CLS. 1, 2, 3, 22 AND 41).

CLASS 25—CLOTHING

FOR APPAREL, CLOTHING, NAMELY, SHORTS, TANK TOPS, T-SHIRTS, PANTS, SPORTS CAPS; ATHLETIC CLOTHING, NAMELY, ATHLETIC UNIFORMS, ATHLETIC FOOTWEAR; BEACH CLOTHING, NAMELY, T-SHIRTS, BOARDSHORTS, TANK TOPS, BIKINIS, SPORTS CAPS; BOYS' CLOTHING, NAMELY, T-SHIRTS, BOARDSHORTS, TANK TOPS, BIKINIS, SPORTS CAPS; CASUAL CLOTHING, NAMELY, T-SHIRTS, BOARDSHORTS, TANK TOPS, BIKINIS, SPORTS CAPS; CHILDREN'S CLOTHING, NAMELY, T-SHIRTS, BOARDSHORTS, TANK TOPS, BIKINIS, SPORTS CAPS; CLOTHING, NAMELY, T-SHIRTS, BOARDSHORTS, TANK TOPS, BIKINIS, SPORTS CAPS; CLOTHING FOR BABIES, NAMELY, ONE PIECE GARMENT FOR TODDLERS; CLOTHING FOR SURFING, NAMELY, WETSUITS, BOARDSHORTS, RASHVESTS; GIRLS' CLOTHING, NAMELY, T-SHIRTS, BOARDSHORTS, TANK TOPS, BIKINIS, SPORTS CAPS; INFANTS' CLOTHING, NAMELY, T-SHIRTS, BOARDSHORTS, TANK TOPS, BIKINIS, SUN HATS; JACKETS; LADIES' CLOTHING, NAMELY, T-SHIRTS, BOARDSHORTS, TANK TOPS, BIKINIS, SPORTS CAPS; MEN'S CLOTHING, NAMELY, T-SHIRTS, BOARDSHORTS, TANK TOPS, BIKINIS, SPORTS CAPS; THONGS; WRISTBANDS; SPORTSWEAR, NAMELY, WETSUITS FOR SURFING; FOOTWEAR; HEADGEAR, NAMELY, HEADBANDS, HOODS, SPORTS CAPS (U.S. CLS. 22 AND 39).

CLASS 35—ADVERTISING AND BUSINESS

FOR ADVERTISING; ADVERTISING SERVICES PROVIDED BY TELEVISION; ADVERTISING SERVICES PROVIDED OVER THE INTERNET; DISTRIBUTION OF ADVERTISING MATERIAL; PRODUCTION OF VIDEO RECORDINGS FOR ADVERTISING PURPOSES; PRODUCTION OF VISUAL ADVERTISING MATTER; TELEVISION ADVERTISING; BUSINESS ADMINISTRATION; BUSINESS ADMINISTRATION ADVISORY SERVICES; BUSINESS ADMINISTRATION CONSULTANCY; PROVISION OF INFORMATION IN RELATION TO BUSINESS ADMINISTRATION; BUSINESS MARKETING SERVICES, NAMELY, ADMINISTRATION RELATING TO MARKETING; PROMOTIONAL SPONSORSHIP OF SURFING EVENTS, SURF TRAINING (U.S. CLS. 100, 101 AND 102).

CLASS 41—EDUCATION AND ENTERTAINMENT

FOR DISSEMINATION OF EDUCATIONAL MATERIAL OF OTHERS IN THE FIELD OF SURFING; PUBLICATION OF EDUCATIONAL MATERIALS; ADVISORY SERVICES RELATING TO TRAINING, NAMELY, BUSINESS TRAINING CONSULTANCY SERVICES; ARRANGING AND CONDUCTING OF TRAINING WORKSHOPS, EDUCATION IN THE FIELD OF SURFING; CONDUCTING TRAINING WORKSHOPS, EDUCATION IN THE FIELD OF SURFING; ORGANISATION OF TRAINING COURSES, EDUCATION IN THE FIELD OF TRAINING; PROVISION OF TRAINING EDUCATION IN THE FIELD OF SURFING; DISTRIBUTION OF VIDEOS IN THE FIELD OF SURFING; PRODUCTION OF VIDEOS IN THE FIELD OF SURFING; ARRANGING OF SPORTS COMPETITIONS; INSTRUCTION IN SPORTS; OFFICIATING AT SPORTS CONTESTS; ORGANISATION OF SPORTS COMPETITIONS; PROVIDING SPORTS TRAINING FACILITIES; SPORTS COACHING; SPORTS TRAINING; EVENT MANAGEMENT SERVICES, NAMELY, ORGANISATION OF SURF TRAINING, SOCIAL ENTERTAINMENT, SPORTING OR CULTURAL EVENTS (U.S. CLS. 100, 101 AND 107).

BENJAMIN OKEKE, EXAMINING ATTORNEY

SN 79-101,106. LÖCKER,CHRISTIAN, FED REP GERMANY, FILED 7-12-2011.

accurapuls

THE MARK CONSISTS OF STANDARD CHARACTERS WITHOUT CLAIM TO ANY PARTICULAR FONT, STYLE, SIZE, OR COLOR.

PRIORITY DATE OF 3-1-2011 IS CLAIMED.

OWNER OF INTERNATIONAL REGISTRATION 1086916 DATED 7-12-2011, EXPIRES 7-12-2021.

CLASS 7—MACHINERY

FOR NUMERICALLY CONTROLLED MACHINES AND MACHINE TOOLS FOR MACHINING PARTS; MACHINES AND MACHINE TOOLS FOR TREATING SURFACES AND FOR STABILIZING SURFACES, NAMELY, KNOCKING MACHINES FOR THE TREATMENT OF CERAMICS AND METALS (U.S. CLS. 13, 19, 21, 23, 31, 34 AND 35).

CLASS 9—ELECTRICAL AND SCIENTIFIC APPARATUS

FOR SOFTWARE FOR CONTROLLING MACHINES AND MACHINE TOOLS, NAMELY, KNOCKING MACHINES FOR THE TREATMENT OF CERAMICS AND METALS; ENGINEERING DESIGN SOFTWARE FOR THE CALCULATION AND PICTORIAL REPRESENTATION OF SURFACES, MATERIAL STRENGTHS AND VOLUMES (U.S. CLS. 21, 23, 26, 36 AND 38).

CLASS 40—MATERIAL TREATMENT

FOR TREATMENT OF MATERIALS, NAMELY, BY KNOCKING AND STRAIN HARDENING; MACHINE SHOP SERVICES, NAMELY, MACHINING OF PARTS FOR OTHERS; METAL TREATING BY MEANS OF STRAIN HARDENING; PROCESSING OF PLASTICS BY MEANS OF STRAIN HARDENING (U.S. CLS. 100, 103 AND 106).

WILLIAM BRECKENFELD, EXAMINING ATTORNEY

SN 79-101,123. AHOU GELE ZON HOLDING B.V., NL-9503 GA STADSKANAAL, NETHERLANDS, FILED 4-28-2010.

DOUTZEN KROES

THE MARK CONSISTS OF STANDARD CHARACTERS WITHOUT CLAIM TO ANY PARTICULAR FONT, STYLE, SIZE, OR COLOR.

PRIORITY DATE OF 10-29-2009 IS CLAIMED.

OWNER OF INTERNATIONAL REGISTRATION 1086963 DATED 4-28-2010, EXPIRES 4-28-2020.

THE NAME(S), PORTRAIT(S), AND/OR SIGNATURE(S) SHOWN IN THE MARK IDENTIFIES "DOUTZEN KROES", WHOSE CONSENT(S) TO REGISTER IS MADE OF RECORD.

CLASS 3—COSMETICS AND CLEANING PREPARATIONS

FOR COSMETIC SKIN AND HAIR TREATMENT PRODUCTS, NAMELY, MAKE-UP; HAIR LOTIONS; HAIR SHAMPOO; SKIN SOAP; CONDITIONERS FOR HAIR TREATMENT, SKIN LOTION; BODY LOTION, BODY CREAMS; DEODORANTS FOR PERSONAL USE; BATH FOAM AND SHOWER GEL, PARFUMS AND EAU-DE-COLOGNE; ESSENTIAL OILS; TOOTHPASTE AND TOOTH CLEANING PREPARATIONS (U.S. CLS. 1, 4, 6, 50, 51 AND 52).

CLASS 9—ELECTRICAL AND SCIENTIFIC APPARATUS

FOR ELECTRONIC PUBLICATIONS, NAMELY, DOWNLOADABLE ELECTRONIC PUBLICATIONS IN THE NATURE OF MAGAZINES AND JOURNALS IN THE FIELD OF FASHION, ACTING, THEATER AND MUSIC; SUNGLASSES AND SPECTACLES, FASHION SPECTACLES, PROTECTIVE SPECTACLES, PROTECTION MASKS, AND SPECTACLES FOR SPORTS, SPECTACLE FRAMES AND FRAMES FOR PROTECTION MASKS; CASES, NAMELY, SPECTACLE CASES AND CASES FOR PROTECTION MASKS; CORDS FOR SUNGLASSES; MOUSE MATS; OPTICAL APPARATUS AND INSTRUMENTS, NAMELY, OPTICAL LENSES; COMPUTERS; HARDWARE AND SOFTWARE FOR SCHEDULING FASHION SHOWS, PROGRAMMING AUTOMATIC LIGHTING EFFECTS AND COMPOSING MUSIC FOR USE IN THE FIELDS OF FASHION, ACTING, THEATER AND MUSIC, AUDIO OR VIDEO RECORDINGS IN THE FIELDS OF FASHION, THEATER AND MUSIC; MAGNETS, WIRELESS MOBILE PHONES AND REPLACEMENT PARTS THEREFOR; MOBILE PHONE FACE PLATES, RING TONES BEING DOWNLOADABLE RING TONES, SOUND RECORDING MEDIUMS, NAMELY, MP3 PLAYERS; DOWNLOADABLE GRAPHICS AND VIDEO IMAGES FOR WIRELESS MOBILE COMMUNICATION DEVICES; TELEPHONE SETS; PRERECORDED VIDEOTAPES, COMPACT DISCS AND CD-ROMS ALL FEATURING INTERVIEWS, MODELING INSTRUCTION AND FASHION SHOWS WITH THE DUTCH MODEL AND ACTRESS DOUTZEN KROES; DVD DISKS FEATURING INTERVIEWS, MODELING INSTRUCTION AND FASHION SHOWS WITH THE DUTCH MODEL AND ACTRESS DOUTZEN KROES; VIDEO GAME PROGRAMS RECORDED ON CARTRIDGES, DISCS, CD-ROMS, CASSETTES, TAPES, AND MINI DISCS; COMPUTER GAME SOFTWARE RECORDED ON DISCS, CD ROMS, AND MINI DISCS (U.S. CLS. 21, 23, 26, 36 AND 38).

CLASS 16—PAPER GOODS AND PRINTED MATTER

FOR PRINTED MATTER IN THE NATURE OF JOURNALS, PERIODICALS, MAGAZINES AND BROCHURES ALL IN THE FIELD OF FASHION, ACTING, THEATER AND MUSIC; NEWSPAPERS, BOOKBINDING MATERIAL, PHOTOGRAPHS; STATIONERY, ADHESIVES FOR STATIONERY OR HOUSEHOLD PURPOSES; STICKER POSTERS IN THE NATURE OF SELF ADHESIVE POSTERS; OFFICE AND SCHOOL SUPPLIES, NAMELY, NOTE BOOKS AND WRITING PADS, LOOSE LEAF NOTEBOOK COVERS, WRITING INSTRUMENTS, NAMELY, PENS, PENCILS, BALL-POINT PENS, PEN CASES AND PENCIL CASES, FINE LINERS IN THE NATURE OF FINE TIP PENS, ROLLER-BALL PENS, FELT TIP MARKERS, CALENDARS, SELF-ADHESIVE NOTE PADS, POSTERS, GREETING CARDS AND COLORING BOOKS, ARTISTS' MATERIALS, NAMELY, PAINT BRUSHES, ARTISTS PASTELS AND ARTISTS PENCILS; PAPER, CARDBOARD AND PRODUCTS MADE THEREOF NOT INCLUDED IN OTHER CLASSES, NAMELY, CARDBOARD HANG TAGS, CARDBOARD PACKAGING, ENVELOPES AND PAPER BAGS; TYPEWRITERS AND OFFICE REQUISITES, NAMELY, PAPER TRIMMERS, RUBBER BANDS AND STAPLERS; PLASTIC MATERIALS FOR PACKAGING, NAMELY, PLASTIC BAGS FOR PACKAGING (U.S. CLS. 2, 5, 22, 23, 29, 37, 38 AND 50).

CLASS 25—CLOTHING

FOR CLOTHING, NAMELY, BATH WEAR IN THE NATURE OF BIKINIS, BATHING SUITS, PAREOS, BATHROBES, SLIPPERS AND DRESSES THAT MAY BE USED AS TOWELS AND SPORTSWEAR IN THE NATURE OF SPORTS PANTS, SPORTS SHIRTS, SPORTS BRAS, SHORTS, SWEATPANTS AND SWEATSHIRTS; LINGERIE AND BELTS; SHOES AND HEADGEAR, NAMELY, HEAD BANDS, HATS, CAPS AND VISORS (U.S. CLS. 22 AND 39).

CLASS 35—ADVERTISING AND BUSINESS

FOR ADVERTISING; BUSINESS INTERMEDIARY SERVICE IN THE FIELD OF SELLING PRODUCTS AND RENDERING SERVICES; BUSINESS MANAGEMENT; BUSINESS ADMINISTRATION; PERSONNEL INTERMEDIARY SERVICES, NAMELY, TEMPORARY PLACEMENT OF MODELS OR ACTRESSES AND FILLING THE TEMPORARY AND PERMANENT STAFFING NEEDS OF BUSINESSES; SERVICES IN THE FIELD OF PUBLICITY, NAMELY, PRODUCT AND SERVICE DEMONSTRATIONS IN SHOP WINDOWS AND STORES BY LIVE MODELS; PRODUCT MERCHANDISING AND BUSINESS ADVICE FOR OTHERS IN THE FIELD OF PUBLICITY AND MERCHANDISING PROVIDED BY MODELS; RETAIL STORE AND ONLINE RETAIL STORE SERVICES IN THE FIELD OF COSMETICS, SKIN AND HAIR TREATMENT PRODUCTS INCLUDING MAKE-UP, HAIR LOTIONS, HAIR SHAMPOO, SKIN SOAP, CONDITIONERS FOR HAIR TREATMENT, SKIN LOTION, BODY LOTION, BODY CREAMS, DEODORANTS FOR PERSONAL USE, BATH FOAM AND SHOWER GEL, PERFUMES AND EAU DE COLOGNE, ESSENTIAL OILS, TOOTHPASTE AND TOOTH CLEANSING PRODUCTS, PHARMACEUTICAL AND VETERINARY PREPARATIONS, SANITARY PREPARATIONS FOR MEDICAL PURPOSES, DIETETIC SUBSTANCES ADAPTED FOR MEDICAL USE, FOOD FOR BABIES, PLASTERS, BANDAGE MATERIAL, MATERIAL FOR STOPPING TEETH, DENTAL WAX, DISINFECTANTS, PREPARATIONS FOR DESTROYING VERMIN, FUNGICIDES, HERBICIDES, ELECTRONIC PUBLICATIONS, SUNGLASSES AND SPECTACLES, FASHIONABLE SPECTACLES, PROTECTIVE SPECTACLES, MASKS AND SPECTACLES FOR SPORTS, SPECTACLE FRAMES AND MASKS, CASES, SPECTACLE CASES AND FACE MASKS, CORDS FOR SUNGLASSES, MOUSE MATS, OPTICAL APPARATUS AND INSTRUMENTS, ELECTRICAL APPARATUS, COMPUTERS, HARDWARE AND SOFTWARE, MUSICAL SOUND OR VIDEO RECORDINGS IN THE FIELD OF FASHION, THEATER AND MUSIC, MAGNETS, WIRELESS MOBILE PHONES AND PARTS THEREOF, MOBILE PHONE FACE PLATES, RING TONES BEING DOWNLOADABLE RING TONES, SOUND RECORDING MEDIUMS, MP3S, GRAPHICS AND VIDEO IMAGES FOR WIRELESS MOBILE COMMUNICATION DEVICES, TELEPHONE SETS, VIDEOTAPES, COMPACT DISCS, CD-ROMS, DVD DISKS, VIDEO GAME PROGRAMS RECORDED ON CARTRIDGES, DISCS, CD-ROMS, CASSETTES, TAPES, AND MINI DISCS, COMPUTER GAME SOFTWARE RECORDED ON DISCS, CD ROMS AND MINI DISCS, PRECIOUS METALS AND THEIR ALLOYS AND GOODS IN PRECIOUS METALS OR COATED THEREWITH, JEWELRY AND BIJOUTERIE INCLUDING CHAINS, EARRINGS, RINGS, BRACELETS, ORNAMENTAL PINS, BROOCHES, PRECIOUS STONES, CLOCKS, HOROLOGICAL INSTRUMENTS INCLUDING WATCHES, KEY RINGS AND KEY CORDS, JOURNALS, PERIODICALS, MAGAZINES, BROCHURES, NEWSPAPERS, PRINTED MATTER, BOOKBINDING MATERIAL, PHOTOGRAPHS, STATIONERY, ADHESIVES FOR STATIONERY OR HOUSEHOLD PURPOSES, STICKERS, POSTERS, OFFICE AND SCHOOL SUPPLIES, NAMELY, NOTE BOOKS AND WRITING PADS, LOOSE COVERS, WRITING INSTRUMENTS, INCLUDING PENS, PENCILS, BALL-POINT PENS, PEN CASES AND PENCIL CASES, FINE LINERS IN THE NATURE OF FINE TIP PENS, ROLLER-BALL PENS, FELT TIP MARKERS, CALENDARS, SELF-ADHESIVE NOTE PADS, POSTERS, GREETING CARDS AND COLORING BOOKS, ARTISTS' MATERIALS, PAINTBRUSHES, PAPER, CARDBOARD AND PRODUCTS MADE THEREOF, TYPEWRITERS AND OFFICE REQUISITES, INSTRUCTIONAL AND TEACHING MATERIAL, PLASTIC MATERIALS FOR PACKAGING, LEATHER AND IMITATIONS OF LEATHER AND GOODS MADE OF THESE MATERIALS, TRUNKS AND TRAVELING BAGS, UMBRELLAS, PARASOLS AND WALKING STICKS, WHIPS, HARNESS AND SADDLERY, FURNITURE, MIRRORS, PICTURE FRAMES MADE OF WOOD, CORK, REED, CANE, WICKER, HORN, BONE, IVORY, WHALEBONE, SHELL, AMBER, MOTHER-OF-PEARL, MEERSCHAUM AND SUBSTITUTES FOR ALL THESE MATERIALS, GOODS MADE OF PLASTICS, CLOTHING, INCLUDING BATH WEAR AND SPORTSWEAR, LINGERIE AND BELTS, SHOES AND HEADGEAR, GAMES AND PLAYTHINGS, GYMNASTIC AND SPORTING ARTICLES, DECORATIONS FOR CHRISTMAS TREES, PLAYING CARDS,

MEAT, FISH, POULTRY AND WILD, MEAT EXTRACTS, PRESERVED, FROZEN, DRIED AND COOKED FRUITS AND VEGETABLES, JELLIES, JAMS, COMPOTES, EGGS, MILK PRODUCTS, EDIBLE OILS AND FATS, COFFEE, TEA, COCOA, SUGAR, RICE, TAPIOCA, SAGO, ARTIFICIAL COFFEE, FLOUR AND PREPARATIONS MADE FROM CEREALS, BREAD, PASTRY AND CONFECTIONERY, ICE CREAM, HONEY, TREACLE, YEAST, LEAVEN, SALT, MUSTARD, VINEGAR, SAUCES, SPICES, ICE, AGRICULTURAL, HORTICULTURAL AND FORESTRY PRODUCTS AND GRAINS, LIVE ANIMALS, FRESH FRUITS AND VEGETABLES, SEEDS, NATURAL PLANTS AND FLOWERS, FOODSTUFFS FOR ANIMALS, MALT, BEERS, MINERAL AND AERATED WATERS AND OTHER NON-ALCOHOLIC DRINKS, FRUIT DRINKS AND FRUIT JUICES, SYRUPS AND OTHER PREPARATIONS FOR MAKING BEVERAGES, ALCOHOLIC BEVERAGES, WINES; MANAGEMENT OF PROFESSIONAL MODELS; MEDIATION OF TRADE BUSINESS FOR THIRD PARTIES IN THE FIELD OF COSMETICS, SKIN AND HAIR TREATMENT PRODUCTS INCLUDING MAKE-UP, HAIR LOTIONS, HAIR SHAMPOO, SKIN SOAP, CONDITIONERS FOR HAIR TREATMENT, SKIN LOTION, BODY LOTION, BODY CREAMS, DEODORANTS FOR PERSONAL USE, BATH FOAM AND SHOWER GEL, PERFUMES AND EAU DE COLOGNE, ESSENTIAL OILS, TOOTHPASTE AND TOOTH CLEANSING PRODUCTS, PHARMACEUTICAL AND VETERINARY PREPARATIONS, SANITARY PREPARATIONS FOR MEDICAL PURPOSES, DIETETIC SUBSTANCES ADAPTED FOR MEDICAL USE, FOOD FOR BABIES, PLASTERS, BANDAGE MATERIAL, MATERIAL FOR STOPPING TEETH, DENTAL WAX, DISINFECTANTS, PREPARATIONS FOR DESTROYING VERMIN, FUNGICIDES, HERBICIDES, ELECTRONIC PUBLICATIONS, SUNGLASSES AND SPECTACLES, FASHIONABLE SPECTACLES, PROTECTIVE SPECTACLES, MASKS AND SPECTACLES FOR SPORTS, SPECTACLES FRAMES AND MASKS, CASES, SPECTACLE CASES AND FACE MASKS, CORDS FOR SUNGLASSES, MOUSE MATS, OPTICAL APPARATUS AND INSTRUMENTS, ELECTRICAL APPARATUS, COMPUTERS, HARDWARE AND SOFTWARE, MUSICAL SOUND OR VIDEO RECORDINGS IN THE FIELD OF FASHION, THEATER AND MUSIC, MAGNETS, WIRELESS MOBILE PHONES AND ACCESSORIES, MOBILE PHONE FACE PLATES, RING TONES BEING DOWNLOADABLE RING TONES, SOUND RECORDING MEDIUMS, MP3S, GRAPHICS AND VIDEO IMAGES FOR WIRELESS MOBILE COMMUNICATION DEVICES, TELEPHONE SETS, VIDEOS, COMPACT DISCS, CD-ROMS, DVD DISKS, VIDEO GAME PROGRAMS RECORDED ON CARTRIDGE, DISCS, CD-ROMS, CASSETTES, TAPES AND MINI DISCS, COMPUTER GAME SOFTWARE RECORDED ON DISCS, CD ROMS AND MINI DISCS, PRECIOUS METALS AND THEIR ALLOYS AND GOODS IN PRECIOUS METAL OR COATED THEREWITH, JEWELRY AND BIJOUTERIE INCLUDING CHAINS, EARRINGS, RINGS, BRACELETS, ORNAMENTAL PINS, BROOCHES, PRECIOUS STONES, CLOCKS, HOROLOGICAL INSTRUMENTS INCLUDING WATCHES, KEY RINGS AND KEY CORDS, JOURNALS, PERIODICALS, MAGAZINES, BROCHURES, NEWSPAPERS, PRINTED MATTER, BOOKBINDING MATERIAL, PHOTOGRAPHS, STATIONERY, ADHESIVES FOR STATIONERY OR HOUSEHOLD PURPOSES, STICKERS, POSTERS, OFFICE AND SCHOOL SUPPLIES, NAMELY, NOTE BOOKS AND WRITING PADS, LOOSE COVERS, WRITING INSTRUMENTS, INCLUDING PENS, PENCILS, BALL-POINT PENS, PEN CASES AND PENCIL CASES, FINE LINERS IN THE NATURE OF FINE TIP PENS, ROLLER-BALL PENS, FELT TIP MARKERS, CALENDARS, SELF-ADHESIVE NOTE PADS, POSTERS, GREETING CARDS AND COLORING BOOKS, ARTISTS' MATERIALS, PAINTBRUSHES, PAPER, CARDBOARD AND PRODUCTS MADE THEREOF, TYPEWRITERS AND OFFICE REQUISITES, INSTRUCTIONAL AND TEACHING MATERIAL, PLASTIC MATERIALS FOR PACKAGING, LEATHER AND IMITATIONS OF LEATHER AND GOODS MADE OF THESE MATERIALS, TRUNKS AND TRAVELING BAGS, UMBRELLAS, PARASOLS AND WALKING STICKS, WHIPS, HARNESS AND SADDLERY, FURNITURE, MIRRORS, PICTURE FRAMES MADE OF WOOD, CORK, REED, CANE, WICKER, HORN, BONE, IVORY, WHALEBONE, SHELL, AMBER, MOTHER-OF-PEARL, MEERSCHAUM AND SUBSTITUTES FOR ALL THESE MATERIALS, OR GOODS MADE OF PLASTIC, CLOTHING, INCLUDING BATH WEAR AND SPORTSWEAR, LINGERIE AND

BELTS, SHOES AND HEADGEAR, GAMES AND PLAYTHINGS, GYMNASTIC AND SPORTING ARTICLES, DECORATIONS FOR CHRISTMAS TREES, PLAYING CARDS, MEAT, FISH, POULTRY AND WILD, MEAT EXTRACTS, PRESERVED, FROZEN, DRIED AND COOKED FRUITS AND VEGETABLES, JELLIES, JAMS, COMPOTES, EGGS, MILK AND MILK PRODUCTS, EDIBLE OILS AND FATS, COFFEE, TEA, COCOA, SUGAR, RICE, TAPIOCA, SAGO, ARTIFICIAL COFFEE, FLOUR AND PREPARATIONS MADE FROM CEREALS, BREAD, PASTRY AND CONFECTIONERY, ICES, HONEY, TREACLE, YEAST, LEAVEN, SALT, MUSTARD, VINEGAR, SAUCES, SPICES, ICE, AGRICULTURAL, HORTICULTURAL AND FORESTRY PRODUCTS AND GRAINS, LIVE ANIMALS, FRESH FRUITS AND VEGETABLES, SEEDS, NATURAL PLANTS AND FLOWERS, FOODSTUFFS FOR ANIMALS, MALT, BEERS, MINERAL AND AERATED WATERS AND OTHER NON-ALCOHOLIC DRINKS, FRUIT DRINKS AND FRUIT JUICES, SYRUPS AND OTHER PREPARATIONS FOR MAKING BEVERAGES, ALCOHOLIC BEVERAGES, WINES (U.S. CLS. 100, 101 AND 102).

ELLEN PERKINS, EXAMINING ATTORNEY

SN 79-101,404. MANUFACTURE ROGER DUBUIS SA, SWITZERLAND, FILED 6-30-2011.



PRIORITY DATE OF 1-14-2011 IS CLAIMED.
OWNER OF INTERNATIONAL REGISTRATION 1087648
DATED 6-30-2011, EXPIRES 6-30-2021.
THE MARK CONSISTS OF A HIGHLY STYLIZED ABSTRACT DESIGN OF THE LETTERS "RD".

CLASS 14—JEWELRY

FOR CUFF LINKS, TIE CLIPS, RINGS, BRACELETS, EARRINGS, NECKLACES, BROOCHES, KEY RINGS OF PRECIOUS METALS, WATCHES, CHRONOMETERS, CLOCKS, WATCH BANDS, BOXES OF PRECIOUS METAL FOR WATCHES AND JEWELRY, ALARM CLOCKS (U.S. CLS. 2, 27, 28 AND 50).

CLASS 35—ADVERTISING AND BUSINESS

FOR ADVERTISING; BUSINESS MANAGEMENT; BUSINESS ADMINISTRATION; DISSEMINATION OF ADVERTISING MATTER; PROCUREMENT SERVICES FOR OTHERS, NAMELY, PURCHASING GOODS AND SERVICES FOR OTHER BUSINESSES IN THE FIELD OF JEWELRY AND WATCHES; PRESENTATION OF GOODS ON COMMUNICATION MEDIA, FOR RETAIL PURPOSES; COMMERCIAL INFORMATION AND ADVICE FOR CONSUMERS; DEMONSTRATION OF GOODS; DIRECT MAIL ADVERTISING; AUCTIONEERING; ORGANIZATION OF EXHIBITIONS FOR COMMERCIAL OR ADVERTISING PURPOSES; ORGANIZATION OF TRADE FAIRS FOR COMMERCIAL OR ADVERTISING PURPOSES; SALES PROMOTION FOR OTHERS; PUBLICATION OF PUBLICITY TEXTS; ON-LINE ADVERTISING ON A COMPUTER NETWORK; PUBLIC RELATIONS; NEWS CLIPPING SERVICES; GATHERING, FOR THE BENEFIT OF OTHERS, OF GOODS IN THE FIELD OF JEWELRY AND WATCHES, ENABLING THE CONSUMER TO VIEW AND PURCHASE THESE GOODS CONVENIENTLY IN A STORE; GATHERING, FOR THE BENEFIT OF OTHERS, OF GOODS IN THE FIELD OF JEWELRY AND WATCHES, ENABLING THE CONSUMER TO VIEW AND PURCHASE THESE GOODS CONVENIENTLY FROM A GENERAL CATALOG OF GOODS BY E-MAIL OR BY ANY OTHER TELECOMMUNICATION MEANS; GATHERING, FOR THE BENEFIT OF OTHERS, OF GOODS IN THE FIELD OF JEWELRY AND WATCHES, ENABLING THE CONSUMER TO VIEW AND PURCHASE THESE GOODS CONVENIENTLY FROM AN INTERNET SITE (U.S. CLS. 100, 101 AND 102).
KRISTIN CARLSON, EXAMINING ATTORNEY

CLASS 35—ADVERTISING AND BUSINESS

FOR COMPILING, STORING, ANALYZING AND RETRIEVING DATA AND INFORMATION, NAMELY, ELECTRONIC DATA COLLECTION AND DATA SUBMISSION SERVICES FOR BUSINESS PURPOSES IN THE FIELDS OF MEDICINE AND HEALTHCARE; ADMINISTERING, INDEXING AND ELECTRONICALLY DISTRIBUTING INFORMATION MATERIALS, NAMELY, ELECTRONIC DATA COLLECTION AND DATA SUBMISSION SERVICES FOR BUSINESS PURPOSES IN THE FIELDS OF MEDICINE AND HEALTHCARE; CREATING INDICES FOR INFORMATION, WEBSITES AND OTHER INFORMATION SOURCES, NAMELY, COMPILING OF INFORMATION INTO COMPUTER DATABASES AND COMPILATION AND SYSTEMATIZATION OF INFORMATION IN DATABANKS; COMPILATION AND SYSTEMIZATION OF INFORMATION INTO COMPUTER DATABASES; ORGANIZING COMMERCIAL TRANSACTIONS VIA ELECTRONIC COMMUNICATIONS NETWORKS, NAMELY, PROVIDING A SECURED ACCESS DATABASE VIA THE INTERNET THROUGH WHICH DOCUMENTS AND IMAGES CAN BE VIEWED, COPIED, AND PRINTED FOR PURPOSES OF CONDUCTING COMMERCIAL MEDICAL TRANSACTIONS (U.S. CLS. 100, 101 AND 102).

CLASS 38—COMMUNICATION

FOR TELECOMMUNICATION AND COMMUNICATION SERVICES, NAMELY, ELECTRONIC TRANSMISSION OF DATA AND DOCUMENTS VIA COMPUTER TERMINALS; PROVIDING ACCESS TO ELECTRONIC COMMUNICATIONS NETWORKS AND THE INTERNET AND EXTRANETS, NAMELY, PROVIDING ACCESS TO ELECTRONIC COMMUNICATIONS NETWORKS; ELECTRONICALLY TRANSMITTING MAIL AND MESSAGES; INTERNET SERVICE PROVIDER (ISP) SERVICES; PROVIDING INFORMATION RELATING TO TELECOMMUNICATION AND COMMUNICATIONS SERVICES, INCLUDING TELECOMMUNICATION AND COMMUNICATIONS SERVICES PROVIDED ONLINE FROM A COMPUTER NETWORK OR VIA THE INTERNET OR EXTRANETS, NAMELY, INFORMATION ABOUT TELECOMMUNICATION; TRANSMITTING AND DISSEMINATING INFORMATION AND DATA VIA COMPUTER NETWORKS AND THE INTERNET, NAMELY, ELECTRONIC EXCHANGE OF DATA STORED IN DATABASES ACCESSIBLE VIA TELECOMMUNICATION NETWORKS; SERVICES FOR ACCESSING WEBSITES, NAMELY, PROVIDING ACCESS TO ELECTRONIC COMMUNICATIONS NETWORKS; PROVIDING ACCESS TO PROPRIETARY COLLECTIONS OF INFORMATION, NAMELY, PROVIDING ACCESS TO DATABASES CONSISTING OF PROPRIETARY COLLECTIONS OF MEDICAL INFORMATION; CONSULTANCY SERVICES ALL RELATING TO TELECOMMUNICATIONS AND COMMUNICATIONS SERVICES, NAMELY, TELECOMMUNICATIONS CONSULTATION; CONSULTANCY SERVICES ALL RELATING TO ORGANIZING COMMERCIAL TRANSACTIONS VIA ELECTRONIC COMMUNICATION NETWORKS, NAMELY, TELECOMMUNICATIONS CONSULTATION WITH RESPECT TO ELECTRONIC DATA INTERCHANGE SERVICES IN THE FIELD OF HEALTHCARE TRANSACTIONS SUCH AS CLAIMS, ELIGIBILITY, CLAIM STATUS, ELECTRONIC REMITTANCE ADVICE, PRIOR AUTHORIZATIONS, ATTACHMENTS AND REFERRALS THAT ALLOW DIRECT TRANSACTION AND PAYMENT COMMUNICATIONS BETWEEN HEALTHCARE PROVIDERS AND PAYERS; CONSULTANCY SERVICES ALL RELATING TO ELECTRONICALLY TRANSMITTING MAIL AND MESSAGES, NAMELY, TELECOMMUNICATIONS CONSULTATION WITH RESPECT TO ELECTRONICALLY TRANSMITTED MAIL AND MESSAGES; CONSULTANCY SERVICES ALL RELATING TO INTERNET SERVICE PROVIDER (ISP) SERVICES INCLUDING SUCH SERVICES PROVIDED ONLINE FROM A COMPUTER NETWORK OR FROM THE INTERNET OR EXTRANETS, NAMELY, TELECOMMUNICATIONS CONSULTATION WITH RESPECT TO PROVIDING MULTIPLE-USER ACCESS TO A GLOBAL COMPUTER INFORMATION NETWORK; PROVIDING ACCESS TO COMPUTER DATABASES; PROVIDING ACCESS, LEASING ACCESS TIME, AND PROVIDING SEARCH, RETRIEVAL, INDEXING, LINKING AND DATA ORGANIZATION CAPABILITIES FOR THE INTERNET, ELECTRONIC COMMUNICATIONS NETWORKS AND ELECTRONIC

SN 79-101,748. BRAINLAB AG, FED REP GERMANY, FILED 4-18-2011.

QUENTRY

THE MARK CONSISTS OF STANDARD CHARACTERS WITHOUT CLAIM TO ANY PARTICULAR FONT, STYLE, SIZE, OR COLOR.

PRIORITY DATE OF 10-19-2010 IS CLAIMED.
OWNER OF INTERNATIONAL REGISTRATION 1088540 DATED 4-18-2011, EXPIRES 4-18-2021.

CLASS 9—ELECTRICAL AND SCIENTIFIC APPARATUS

FOR APPARATUS FOR RECORDING, TRANSMISSION OR REPRODUCTION OF SOUND OR IMAGES; DATA-PROCESSING EQUIPMENT AND COMPUTERS; COMPUTER SOFTWARE, NAMELY, COMPUTER SOFTWARE FOR USE IN VIEWING, EDITING, STORING, SHARING, ANALYZING AND UPDATING MEDICAL DIAGNOSTIC IMAGES AND PATIENT MEDICAL INFORMATION FOR USE BY MEDICAL PRACTITIONERS; COMPUTER HARDWARE; COMPUTER FIRMWARE, NAMELY, COMPUTER SOFTWARE FOR USE IN VIEWING, EDITING, STORING, SHARING, ANALYZING AND UPDATING MEDICAL DIAGNOSTIC IMAGES AND PATIENT MEDICAL INFORMATION FOR USE BY MEDICAL PRACTITIONERS; ELECTRONIC AND ELECTROMECHANICAL PERIPHERAL APPARATUS ALL FOR USE WITH COMPUTERS, NAMELY, COMPUTER PERIPHERAL APPARATUS; COMPUTER NETWORK EQUIPMENT, NAMELY, COMPUTER NETWORK SERVER (U.S. CLS. 21, 23, 26, 36 AND 38).

DATABASES, NAMELY, PROVIDING ACCESS TO TELECOMMUNICATION NETWORKS, AND PROVIDING ACCESS TO THE INTERNET (U.S. CLS. 100, 101 AND 104).

CLASS 42—SCIENTIFIC AND COMPUTER SERVICES

FOR COMPUTER SERVICES IN THE NATURE OF CONSULTANCY, DESIGN, TESTING, RESEARCH, ANALYSIS, TECHNICAL SUPPORT AND OTHER TECHNICAL AND ADVISORY SERVICES ALL RELATING TO COMPUTING, NAMELY, DESIGN OF COMPUTER HARDWARE AND SOFTWARE FOR OTHERS; COMPUTER PROGRAMMING FOR OTHERS; RESEARCHING, DEVELOPING, DESIGNING AND UPDATING OF COMPUTER SOFTWARE FOR OTHERS; INFORMATION, CONSULTANCY AND ADVISORY SERVICES ALL RELATING TO THE AFORESAID, INCLUDING SUCH SERVICES PROVIDED ONLINE FROM A COMPUTER NETWORK OR VIA THE INTERNET OR EXTRANETS, NAMELY, CONSULTING SERVICES IN THE FIELD OF CLOUD COMPUTING, TECHNICAL CONSULTING SERVICES IN THE FIELDS OF DATACENTER ARCHITECTURE, PUBLIC AND PRIVATE CLOUD COMPUTING SOLUTIONS, AND EVALUATION AND IMPLEMENTATION OF INTERNET TECHNOLOGY AND SERVICES; PROVIDING SOFTWARE INTERFACES VIA NETWORKS TO PROVIDE PERSONALIZED ACCESS TO GLOBAL COMPUTER INFORMATION NETWORKS FOR TRANSMITTING AND DISSEMINATING OF INFORMATION IN THE FORM OF TEXT, ELECTRONIC DOCUMENTS, DATABASES, GRAPHICS AND AUDIO-VISUAL INFORMATION, NAMELY, PROVIDING TEMPORARY USE OF NON-DOWNLOADABLE SOFTWARE FOR USE IN VIEWING, EDITING, STORING, SHARING, ANALYZING AND UPDATING MEDICAL DIAGNOSTIC IMAGES AND PATIENT MEDICAL INFORMATION FOR USE BY MEDICAL PRACTITIONERS (U.S. CLS. 100 AND 101).

MICHAEL TANNER, EXAMINING ATTORNEY

SN 79-102,142. BEACONSFIELD FOOTWEAR LIMITED, SKELMERSDALE; LANCASHIRE WN8 9PT, UNITED KINGDOM, FILED 7-8-2011.

HOTTER COMFORT CONCEPT

THE MARK CONSISTS OF STANDARD CHARACTERS WITHOUT CLAIM TO ANY PARTICULAR FONT, STYLE, SIZE, OR COLOR.

OWNER OF INTERNATIONAL REGISTRATION 1089690 DATED 7-8-2011, EXPIRES 7-8-2021.

OWNER OF U.S. REG. NOS. 2,503,117 AND 2,665,999.

NO CLAIM IS MADE TO THE EXCLUSIVE RIGHT TO USE "COMFORT", APART FROM THE MARK AS SHOWN.

CLASS 25—CLOTHING

FOR ARTICLES OF OUTER CLOTHING, NAMELY, COATS, GLOVES, JACKETS, JUMPERS, SCARVES AND SOCKS; FOOTWEAR; BOOTS, SHOES, SLIPPERS AND SANDALS (U.S. CLS. 22 AND 39).

CLASS 35—ADVERTISING AND BUSINESS

FOR THE BRINGING TOGETHER OF, FOR THE BENEFIT OF OTHERS, A VARIETY OF FASHION ACCESSORIES, CLOTHING, FOOTWEAR AND HEADGEAR, ENABLING CUSTOMERS TO CONVENIENTLY VIEW AND PURCHASE THOSE GOODS IN A CLOTHING STORE, IN A MAIL ORDER CATALOGUE, OR VIA AN INTERNET WEBSITE; BUSINESS INFORMATION, ADVISORY AND CONSULTANCY SERVICES RELATING TO THE AFORESAID SERVICES (U.S. CLS. 100, 101 AND 102).

HAI-LY LAM, EXAMINING ATTORNEY

SN 79-102,246. FESTO AG & CO. KG, FED REP GERMANY, FILED 12-10-2010.

FESTO

THE MARK CONSISTS OF STANDARD CHARACTERS WITHOUT CLAIM TO ANY PARTICULAR FONT, STYLE, SIZE, OR COLOR.

OWNER OF INTERNATIONAL REGISTRATION 1089902 DATED 12-10-2010, EXPIRES 12-10-2020.

OWNER OF U.S. REG. NO. 1,502,778.

THE WORDING "FESTO" HAS NO MEANING IN A FOREIGN LANGUAGE.

CLASS 4—LUBRICANTS AND FUELS

FOR INDUSTRIAL OILS AND GREASES; INDUSTRIAL LUBRICANTS; DUST ABSORBING, WETTING AND BINDING COMPOSITIONS; FUELS; CANDLES AND WICKS FOR LIGHTING (U.S. CLS. 1, 6 AND 15).

CLASS 6—METAL GOODS

FOR COMMON METALS AND THEIR ALLOYS; METAL BUILDING MATERIALS; TRANSPORTABLE BUILDINGS OF METAL; MATERIALS OF METAL FOR RAILWAY TRACKS; NON-ELECTRIC CABLES AND WIRES OF COMMON METAL; IRONMONGERY, NAMELY, SMALL ITEMS OF METAL HARDWARE, NAMELY, SCREWS AND BOLTS; PIPES AND TUBES OF METAL; METAL SAFES; CONNECTING PIECES AND LINKS OF METAL OR MAINLY OF METAL FOR PIPE AND TUBES, NAMELY, PLUG-IN CONNECTORS, CONNECTORS, COUPLINGS, NIPPLES, ANGLE PIECES, T-PIECES, PUSH-IN FITTINGS, PLUG-IN CARTRIDGES, BARBED FITTINGS, QUICK CONNECTORS, HOSE FITTINGS, COUPLING PLUGS, DISTRIBUTORS, ROTARY DISTRIBUTORS, ADAPTERS, THREADED FITTINGS, DOUBLE NIPPLES, SLEEVES AND REDUCTIONS; TUBES AND PIPELINES OF METAL OR MAINLY OF METAL; FASTENING ELEMENTS OF METAL OR MAINLY OF METAL, FOR TUBES AND PIPELINES, NAMELY, PIPE CLIPS AND HOSE CLAMPS; VALVES OF METAL, OTHER THAN PARTS OF MACHINES; PORTABLE CONTAINERS OF METAL; METAL SHELTER BUILDINGS AND PARTS THEREFOR; REPLACEMENT PARTS FOR ALL THE AFORESAID GOODS (U.S. CLS. 2, 12, 13, 14, 23, 25 AND 50).

CLASS 7—MACHINERY

FOR MACHINES, NAMELY, FOR METAL, WOOD OR PLASTIC PROCESSING, EXCEPT RINSING AND WASHING MACHINES; WOODWORKING MACHINES; MACHINES FOR USE IN THE CHEMICAL INDUSTRY, PHARMACEUTICAL INDUSTRY, AGRICULTURE, MINING; TEXTILE MACHINES; MACHINES FOR THE DRINKS INDUSTRY; CONSTRUCTION MACHINES; PACKAGING MACHINES; MACHINE TOOLS; COMPRESSED-AIR MACHINES; MATERIALS HANDLING MACHINES; ROBOTIC MACHINES; SORTING MACHINES FOR INDUSTRY; CRANKCASES FOR MACHINES, MOTORS AND ENGINES; CYLINDERS FOR MACHINES; TABLES FOR MACHINES; MOTORS AND ENGINES, EXCEPT FOR LAND VEHICLES; MACHINE COUPLING AND TRANSMISSION COMPONENTS, EXCEPT FOR LAND VEHICLES; AGRICULTURAL IMPLEMENTS OTHER THAN HAND-OPERATED; INCUBATORS FOR EGGS; PNEUMATIC TOOLS, NAMELY, GRINDERS, SANDERS, POLISHERS, ROUTERS, JIGSAWS, CIRCULAR SAWS, CHAINSAWS, DRILLING MACHINES, PLANERS, SCREWDRIVERS AND MILLING MACHINES; ELECTRIC POWER TOOLS AND BATTERY-OPERATED ELECTRIC POWER TOOLS, NAMELY, GRINDERS, SANDERS, POLISHERS, ROUTERS, JIGSAWS, CIRCULAR SAWS, CHAINSAWS, DRILLING MACHINES, PLANERS, SCREWDRIVERS AND MILLING MACHINES; HYDRAULIC, PNEUMATIC AND ELECTRONIC CONTROLS FOR MACHINES, MOTORS AND ENGINES; PNEUMATIC,

HYDRAULIC AND ELECTRIC DRIVE ELEMENTS AND EQUIPMENT, NAMELY, LINEAR ACTUATORS, ROTARY ACTUATORS, SWIVEL ACTUATORS, FLUID-ACTIVATED ACTUATORS, PNEUMATIC CYLINDERS, HYDRAULIC CYLINDERS, ELECTRIC LINEAR ACTUATORS AND LINEAR MOTORS, FEED APPARATUS, PISTONS, MOBILE ROBOTS, RODLESS CYLINDERS, LINEAR DRIVES, ROTARY DRIVES, SEMI-ROTARY DRIVES, SWIVEL MODULES, SWIVEL-LINEAR DRIVE UNITS, TANDEM CYLINDERS, HIGH-FORCE CYLINDERS, MULTI-POSITION CYLINDERS, STOPPER CYLINDERS, CLAMPING CYLINDERS, BELLOWS DRIVES, DIAPHRAGM DRIVES, BELLOWS CYLINDERS, ROTARY INDEXING TABLES, SERVO DRIVES, CYLINDER-VALVE COMBINATIONS, SHOCK ABSORBERS, HYDRAULIC CUSHIONING CYLINDERS, LINEAR GUIDES, GUIDE UNITS FOR PNEUMATIC CYLINDERS, CLAMPING UNITS, FREEWHEEL UNITS, DRIVES WITH DISPLACEMENT ENCODER, ELECTRO-MECHANICAL DRIVES, LINEAR SLIDES, ELECTRICAL CYLINDERS, SPINDLE AXES, TOOTHED BELT AXES, ELECTRIC SLIDES, CANTILEVER AXES, ELECTRIC HANDLING MODULES, ROTARY/LIFTING MODULES, ELECTRIC DIRECT DRIVES AND SHORT-STROKE CYLINDERS; PNEUMATIC, HYDRAULIC, ELECTRIC AND ELECTRONIC CONTROL AND REGULATING ELEMENTS AND APPARATUS, NAMELY, VALVES, VALVE TERMINALS, TAPS, STOPCOCKS, OIL BRAKE CYLINDERS, PRESSURE SWITCHES, PRESSURE REGULATORS, PROPORTIONAL DIRECTIONAL CONTROL VALVES, SERVO-PNEUMATIC POSITIONING SYSTEMS, PROPORTIONAL VALVES, PROCESS VALVES, PNEUMATIC CONTROLLERS, ELECTRO-PNEUMATIC CONTROLLERS, PNEUMATIC-MECHANICAL SEQUENCERS AND MEMORY MODULES, ELECTRO-PNEUMATIC CONTROL UNITS AND ELECTRO-PNEUMATIC TRANSDUCERS; VALVE PARTS FOR MACHINES; CONNECTOR PLATES AND DISTRIBUTOR PLATES FOR VALVES; MECHANICAL HANDLING APPARATUS; VACUUM-BASED HANDLING APPARATUS; ELECTRIC DRIVE MOTORS, AND SERVODRIVES; COMPRESSORS; COMPRESSED-AIR ACCUMULATORS; COMPRESSED-AIR MAINTENANCE APPARATUS FOR TREATING COMPRESSED AIR; SHOCK ABSORBERS BEING PARTS OF MACHINES; SILENCERS FOR COMPRESSED AIR; AIR FILTERS; BEARINGS FOR MACHINES; MACHINES AND MECHANICALLY-OPERATED APPARATUS, FOR WORK PIECE MACHINING, THE TREATMENT OF MATERIALS, HANDLING TECHNOLOGY, PRODUCTION TECHNOLOGY AND ASSEMBLY TECHNOLOGY, NAMELY, SAWS, MILLING MACHINES, ROUTERS, GRINDERS, PLANERS, DRILLING MACHINES, SCREWDRIVERS, GRIPPERS, MANIPULATORS, VACUUM-BASED HANDLING APPARATUS, SUCTION CUPS FOR VACUUM-BASED HANDLING APPARATUS, AGITATORS, CLAMPING DEVICES, STAPLING APPARATUS, GRIPPERS, PARALLEL GRIPPERS, THREE-POINT GRIPPERS, ANGLED GRIPPERS, RADIAL GRIPPERS, HANDLING SYSTEMS, PICK AND PLACE SYSTEMS AND HANDLING MODULES; TOOLS AS PARTS OF MACHINES, NAMELY, IN THE FORM OF SAW BLADES, MILLING CUTTERS OR GRINDING PLATES; VACUUM CLEANING DEVICES AND INSTALLATIONS; ELECTRIC CLEANING MACHINES AND EQUIPMENT, NOT PORTABLE; FITTINGS FOR PNEUMATIC USE; REPLACEMENT PARTS FOR ALL THE AFORESAID GOODS (U.S. CLS. 13, 19, 21, 23, 31, 34 AND 35).

CLASS 8—HAND TOOLS

FOR HAND TOOLS AND IMPLEMENTS, NAMELY, HAND SAWS, FILES, FINGERNAIL POLISHERS, HAND GRINDERS, MANUAL CLAMPS, HAMMERS AND SCREWDRIVERS; CUTLERY; SIDE ARMS NOT INCLUDING FIREARMS, NAMELY, HUNTING KNIVES AND SWORDS; RAZORS; REPLACEMENT PARTS FOR ALL THE AFORESAID GOODS (U.S. CLS. 23, 28 AND 44).

CLASS 9—ELECTRICAL AND SCIENTIFIC APPARATUS

FOR SCIENTIFIC, NAUTICAL, SURVEYING, PHOTOGRAPHIC, CINEMATOGRAPHIC, OPTICAL, WEIGHING, MEASURING, SIGNALING APPARATUS AND INSTRUMENTS, NAMELY, FOR CONDUCTING, SWITCHING, TRANSFORMING, ACCUMULATING, REGULATING AND CONTROLLING ELECTRICITY; APPARATUS AND INSTRUMENTS FOR COMMUNICATIONS ENGINEERING, NAMELY, FOR COMMUNICATIONS, HIGH FREQUENCY AND CONTROL ENGINEERING; APPARATUS AND INSTRUMENTS FOR SCIENTIFIC RESEARCH IN LABORATORIES; MAGNETIC DATA CARRIERS, RECORDING DISCS; AUTOMATIC VENDING MACHINES AND MECHANISMS FOR COIN-OPERATED APPARATUS; CASH REGISTERS, CALCULATING MACHINES, DATA PROCESSING EQUIPMENT AND COMPUTERS; FIRE EXTINGUISHING APPARATUS, NOT PORTABLE; ELECTRIC AND ELECTRONIC CONTROL AND REGULATING APPARATUS, NAMELY, ELECTRONIC CONTROL UNITS FOR VALVES AND DRIVES, AXIS CONTROLLERS, END-POSITION CONTROLLERS, DISPLACEMENT ENCODERS AND MOTOR CONTROLLERS; ELECTRIC, ELECTRONIC, PNEUMATIC AND OPTICAL MEASURING AND MONITORING ELEMENTS AND APPARATUS, NAMELY, SENSORS, DISPLACEMENT ENCODERS, FORK LIGHT BARRIERS, IMAGE PROCESSING SYSTEMS, OPTICAL POSITION AND ORIENTATION DETECTORS, OPTICAL WORKPIECE TYPE DETECTORS, OPTICAL QUALITY INSPECTION SYSTEMS AND POSITION DETECTING DEVICES; SENSORS, NAMELY, POSITION SENSORS, SPEED SENSORS, DISTANCE SENSORS, PRESSURE SENSORS, VACUUM SENSORS, FLOW SENSORS, COLOR SENSORS, TEMPERATURE SENSORS, INDUCTIVE SENSORS, PROXIMITY SENSORS, AIR GAP SENSORS AND FLOW SENSORS; ACCUMULATORS AND BATTERIES; ACCUMULATOR AND BATTERY CHARGES; ELECTRIC CABLES AND WIRES; CONNECTING COMPONENTS FOR ELECTRIC CABLES AND LINES; ELECTRIC SWITCHES; RELAYS; SWITCH CABINETS; METEOROLOGICAL BALLOONS; COMPUTERS; DATA READERS; DEVICES FOR DISPLAYING DATA, FOR EXAMPLE MONITORS; SCANNERS; PRINTERS; PLOTTERS; DEVICES FOR INPUTTING DATA AND COMMANDS, NAMELY, TOUCH SCREEN DISPLAYS AND KEYBOARDS; APPARATUS FOR GENERATING, RECORDING, STORAGE, TRANSMISSION, PROCESSING AND/OR REPRODUCTION OF IMAGES AND/OR SOUND OR OTHER DATA AND SIGNALS; DATA-PROCESSING APPARATUS; COMPUTER PROGRAMS AND SOFTWARE, NAMELY, FOR DESIGNING FLUID CIRCUITS, FOR DESIGNING LABORATORIES, AND FOR THE PURPOSES OF LEARNING, TRAINING, CONTROLLING, VISUALIZATION, INFORMATION, DESIGNING, DRAWING AND SIMULATING, EACH IN THE FIELDS OF PNEUMATICS, ELECTRO-PNEUMATICS, HYDRAULICS, ELECTRO-HYDRAULICS, ELECTRICAL ENGINEERING, ELECTRONICS, ELECTRICAL SAFETY MEASURES AND AUTOMATION TECHNOLOGY; MACHINE-READABLE DATA CARRIERS EQUIPPED WITH PROGRAMS; INSTRUCTIONAL AND TEACHING MATERIAL AND APPARATUS, NAMELY, INTERFACES, MAGNETIC SYMBOL SETS, DRAWING TEMPLATES, PNEUMATIC TIMERS, VALVES, SINGLE ACTING CYLINDERS, DOUBLE ACTING CYLINDERS, DIFFERENTIAL CYLINDERS, CYLINDER LOAD SIMULATORS, WEIGHTS FOR CYLINDERS, COVERS FOR CYLINDERS, MEASURING STROKES FOR CYLINDERS, DISPLACEMENT ENCODERS FOR CYLINDERS, PROXIMITY SWITCHES, PRESSURE REGULATORS, PRESSURE GAUGES, MANIFOLDS, PLASTIC TUBING, COMPRESSORS, MOUNTING PLATES, PNEUMATIC PRESET COUNTERS, STEPPER MODULES, ELECTRICAL SIGNAL INPUTS, RELAYS, LIMIT SWITCHES, SENSORS, POWER SUPPLY UNITS, ELECTRONIC CONTROLLERS, VALVE TERMINALS, ELECTRIC AND PNEUMATIC DRIVES, VACUUM GAUGES, SUCTION GRIPPERS, AIR PRESSURE RESERVOIRS, VACUUM GENERATORS, ELECTRIC GRIPPERS, COMPARATORS, POSITION ENCODERS, SHOCK ABSORBERS, OSCILLOSCOPES, DIGITAL MULTIMETERS, CABLE CONNECTORS, HYDRAULIC MOTORS, HYDRAULIC POWER UNITS AND POWER PACKS, HOSE LINES, QUICK RELEASE COUPLINGS FOR TUBING AND HOSE LINES, PNEUMATIC AND HYDRAULIC DISTRIBUTORS, MOUNTING KITS,

PRESSURE SWITCHES, DIAPHRAGM ACCUMULATORS, ELECTRICAL EMERGENCY STOP PUSHBUTTONS, INPUT-OUTPUT DATA CABLES, PROPORTIONAL AMPLIFIERS, PRESSURE FILTERS, ELECTRICAL INDICATOR UNITS AND DISTRIBUTORS, PID CONTROLLERS, STATUS CONTROLLERS, PATCH PANELS, SAFETY JUMPER PLUGS, POWER CABLES, MICROCONTROLLERS, INPUT-OUTPUT MODULES, SEQUENCERS, CONTACTOR BOARDS, MOTOR TECHNOLOGY CONTACTOR SETS, OPERATOR AND SIGNALING UNITS, NET BOARDS, SERVO BRAKE AND DRIVE SYSTEMS, ELECTRO MOTORS, FREQUENCY CONVERTERS, SERVO DRIVES, STEPPER MOTORS, PROGRAMMABLE LOGIC CONTROLLERS, HOLDER SYSTEMS AND RACK SYSTEMS FOR MODULE MOUNTING, ELECTRONIC SIMULATION MODULES, TOUCH PANELS, OPERATOR PANELS, ELECTRONIC CONTROL MODULES, ELECTRONIC SLAVE MODULES, SWITCH MODULES, INTERNET LINK MODULES, ETHERNET INTERFACES, SENSORS FOR OBJECT DETECTION, ACTUATOR/SENSOR INTERFACES FOR FIELDBUS TECHNOLOGY, DIGITAL CONNECTION UNITS, CALIPERS, ACCUMULATOR FILLING DEVICES, SPARE FILTER CARTRIDGES FOR PRESSURE FILTERS, MEASURING LEAD HOLDERS, PHASE SEQUENCE INDICATORS, VOLTAGE AND CONTINUITY TESTERS, CURRENT CLAMPS, POWER SUPPLY ANALYZERS, DIGITAL AND ANALOGUE SIMULATION BOXES, DIGITAL AND ANALOGUE CONNECTION UNITS, ADDRESSING DEVICES, MOUNTING RAILS, INDICATOR LIGHTS, PID INDUSTRIAL CLOSED-LOOP CONTROLLERS, ELECTRICAL SLIDES, LIGHT CURTAINS, DC WATTMETERS, WLAN ACCESS POINTS, MODULAR PRODUCTION SYSTEMS, TRANSFER SYSTEMS, STACKING MAGAZINE STATIONS, MODULAR PRODUCTION STATIONS, TESTING STATIONS, TURNING STATIONS, MEASURING STATIONS, DRILLING STATIONS, SORTING STATIONS, DISPENSING STATIONS, CAMERA INSPECTION STATIONS, DISTRIBUTING STATIONS, BUFFER STATIONS, ROBOT STATIONS, PICK AND PLACE STATIONS, PROCESSING STATIONS, HANDLING STATIONS, ASSEMBLY STATIONS, FILTERING STATIONS, MIXING STATIONS, REACTOR STATIONS, BOTTLING STATIONS, FILTRATION STATIONS, HOLDER MODULES, PUNCHING STATIONS, WORKPIECE SEPARATING STATIONS, STORING STATIONS, ORDER COMPILATION STATIONS, AUTOMATIC WAREHOUSE STATIONS, INCOMING GOODS/OUTGOING GOODS STATIONS, PALLET TRANSPORT SYSTEMS, WORKPIECE CHANGER MODULES, STACKING MAGAZINE MODULES, MEASURING MODULES, WORKPIECE SEPARATOR MODULES, CONVEYOR MODULES, RECOGNITION MODULES, LIFTING MODULES, TESTING MODULES, SORTING GATE MODULES, STOPPER MODULES, DRILL HOLE MONITORING MODULES, TRANSFER MODULES, RFID MODULES, DRILLING MODULES, ROTARY INDEXING TABLE MODULES, CLAMPING MODULES, EJECTING MODULES, MEASURING MODULES, PNEUMATIC SLIDE MODULES, ENGRAVING MODULES, PRESS MODULES, STORAGE MODULES, PAD PRINTING MODULES, DRYING MODULES, PICK AND PLACE MODULES, TRANSFER LINES, CONVEYORS, EMERGENCY STOP MODULES, WORKPIECE SETS, MILLING MACHINES, TURNING MACHINES, BOTTLE SETS, COOLING UNITS WITH HEAT EXCHANGER, PNEUMATICS TRAININGS PACKAGES; ELECTRO-PNEUMATICS TRAININGS PACKAGES; VACUUM TECHNOLOGY TRAININGS PACKAGES; HYDRAULICS TRAININGS PACKAGES; ELECTRICAL ENGINEERING TRAININGS PACKAGES; ELECTRONICS TRAININGS PACKAGES; AUTOMATION TECHNOLOGY TRAININGS PACKAGES; PROGRAMMABLE LOGIC CONTROLLER, TRAININGS PACKAGES; PROCESS INDUSTRY TRAININGS PACKAGES; MECHATRONICS LEARNING SYSTEMS AND TRAINING FACTORY PACKAGES; EDUCATIONAL COMPUTERS; ELECTRONIC EDUCATIONAL APPARATUS, NAMELY, COMPUTERS; REPLACEMENT PARTS FOR ALL THE AFORESAID GOODS; LABORATORY FURNITURE (U.S. CLS. 21, 23, 26, 36 AND 38).

CLASS 11—ENVIRONMENTAL CONTROL APPARATUS

FOR APPARATUS FOR LIGHTING, HEATING, STEAM GENERATING, COOKING, REFRIGERATING, DRYING, VENTILATING, WATER SUPPLY AND SANITARY PURPOSES, NAMELY, LIGHT FIXTURES, STEAM GENERATORS, ELECTRIC SPACE HEATERS, AIR DRYERS; AERATION AND VENTILATION INSTALLATIONS FOR BUILDINGS; HUMIDIFIERS, AIR PURIFIERS AND WATER IONIZERS; AIR-CONDITIONING APPARATUS; BREAD MAKING MACHINES; REPLACEMENT PARTS FOR ALL THE AFORESAID GOODS (U.S. CLS. 13, 21, 23, 31 AND 34).

CLASS 12—VEHICLES

FOR APPARATUS FOR LOCOMOTION BY LAND, VEHICLES AND LOCOMOTIVE APPARATUS, THE AFORESAID GOODS OTHER THAN POWERED BY COMBUSTION ENGINES OR ELECTRIC MOTORS, NAMELY, AUTOMOBILES; APPARATUS FOR LOCOMOTION BY AIR OR WATER, INCLUDING REMOTE-CONTROLLED APPARATUS, NAMELY, AUTOMOBILES; AIR CUSHION VEHICLES; AERONAUTICAL APPARATUS, MACHINES AND APPLIANCES, NAMELY, AEROSTATS AND AERODYNAMIC WINGS FOR AIRPLANES; AIR VEHICLES, NAMELY, AIRPLANES AND AIRCRAFT; WATER VEHICLES, NAMELY, HYDROFOIL BOATS SUPPORTED BY SINGULAR OR MULTI HULLS AND STRUCTURAL PARTS THEREFOR; VEHICULAR BALLOONS, HOT AIR BALLOONS, GAS BALLOONS, COMBINATION HOT AIR AND GAS BALLOONS, PARACHUTES, AIR SHIPS; REPLACEMENT PARTS FOR ALL THE AFORESAID GOODS (U.S. CLS. 19, 21, 23, 31, 35 AND 44).

CLASS 16—PAPER GOODS AND PRINTED MATTER

FOR FOILS, BAGS AND POUCHES OF PLASTIC FOR PACKAGING; ROTARY DUPLICATORS; PRINTED MATTER, NAMELY, BOOKS, BROCHURES, JOURNALS, MAGAZINES AND PERIODICALS, NAMELY, ON THE SUBJECTS OF PNEUMATICS, HYDRAULICS, SENSORS, ELECTRONICS, ELECTRICAL ENGINEERING, PROGRAMMABLE LOGICAL CONTROLLERS, ELECTRICAL CLOSED-LOOPED CONTROL TECHNOLOGY, MECHATRONICS, HANDLING TECHNOLOGY, PROCESS AUTOMATION, METAL TECHNOLOGY, CNC TECHNOLOGY, AUTOMATION TECHNOLOGY, METAL WORKING TECHNOLOGY, PROCUREMENT AND LOGISTICS, PRODUCT DEVELOPMENT, LEAN PRODUCTION AND COMPETENCE MANAGEMENT; BOOK-BINDING MATERIAL; PHOTOGRAPHS; STATIONERY; ADHESIVES FOR STATIONERY OR HOUSEHOLD PURPOSES; PAINT BRUSHES; TYPEWRITERS; INSTRUCTIONAL AND TEACHING MATERIAL, NAMELY, PRINTED INSTRUCTIONAL AND TEACHING MATERIAL IN THE FIELDS OF PNEUMATICS, HYDRAULICS, SENSORS, ELECTRONICS, ELECTRICAL ENGINEERING, PROGRAMMABLE LOGICAL CONTROLLERS, ELECTRICAL CLOSED-LOOPED CONTROL TECHNOLOGY, MECHATRONICS, HANDLING TECHNOLOGY, PROCESS AUTOMATION, METAL TECHNOLOGY, CNC TECHNOLOGY, AUTOMATION TECHNOLOGY AND METAL WORKING TECHNOLOGY; PRINTERS' TYPE; PRINTING BLOCKS; WRITING IMPLEMENTS, NAMELY, BALL-POINT PENS (U.S. CLS. 2, 5, 22, 23, 29, 37, 38 AND 50).

CLASS 17—RUBBER GOODS

FOR GASKETS MADE OF RUBBER, GUTTA-PERCHA, GUM, ASBESTOS OR MICA, NAMELY, PIPE GASKETS; GOODS OF PLASTIC, SEMI-WORKED, NAMELY, IN THE FORM OF FILMS, SHEETS AND RODS; PADDING AND STUFFING MATERIALS OF RUBBER AND PLASTICS; PACKING, STOPPING AND INSULATING MATERIALS; FLEXIBLE TUBES, NOT OF METAL OR MAINLY NOT OF METAL; CONNECTING PIECES AND LINKS, NOT OF METAL OR MAINLY NOT OF METAL, FOR PIPES AND TUBES, NAMELY, PLUG-IN CONNECTORS, CONNECTORS, COUPLINGS, NIPPLES, ANGLE PIECES, T-PIECES, PUSH-IN FITTINGS, PLUG-IN CARTRIDGES, BARBED FITTINGS, QUICK CONNECTORS, HOSE FITTINGS, COUPLING PLUGS, DISTRIBUTORS, ROTARY DISTRIBUTORS, ADAPTERS, THREADED FITTINGS, DOUBLE NIPPLES, SLEEVES AND REDUCTIONS; FLEXIBLE TUBES, NOT OF METAL; FASTENING DEVICES NOT OF METAL FOR TUBES AND PIPEWORK, NAMELY, HOOKS FOR PIPES AND HOSE CLIPS; REPLACEMENT PARTS FOR ALL THE AFORESAID GOODS (U.S. CLS. 1, 5, 12, 13, 35 AND 50).

CLASS 19—NON-METALLIC BUILDING MATERIALS

FOR NON-METALLIC BUILDING MATERIALS, NAMELY, PIPES; NON-METALLIC RIGID PIPES FOR BUILDING; ASPHALT, PITCH AND BITUMEN; NON-METALLIC TRANSPORTABLE BUILDINGS; MONUMENTS, NOT OF METAL; BUILDING GLASS, NAMELY, IN THE FORM OF TILES AND ROOFING PANELS; BUILDINGS AND STRUCTURES OF ALL KINDS OTHER THAN THOSE OF METAL, NAMELY, FAIR STANDS; REPLACEMENT PARTS FOR ALL THE AFORESAID GOODS (U.S. CLS. 1, 12, 33 AND 50).

CLASS 20—FURNITURE AND ARTICLES NOT OTHERWISE CLASSIFIED

FOR FURNITURE, EXCEPT KITCHEN FURNITURE, FITTED KITCHENS AND BATHROOM FURNITURE; MIRRORS, PICTURE FRAMES; NON-METAL VALVES OTHER THAN PARTS OF MACHINES, NAMELY, FOR COMPRESSED AIR PIPES AND FOR WATER PIPES; CURTAIN RODS; WORKING TABLES; WORKBENCHES; PLASTIC STORAGE CONTAINERS; STORAGE RACKS; REPLACEMENT PARTS FOR ALL THE AFORESAID GOODS (U.S. CLS. 2, 13, 22, 25, 32 AND 50).

CLASS 28—TOYS AND SPORTING GOODS

FOR GAME CARDS; BUILDING GAMES; TOY REMOTE-CONTROLLED VEHICLES, AIRCRAFT AND SHIPS; SCALE-MODEL VEHICLES, AIRCRAFT AND SHIPS; DECORATIONS FOR CHRISTMAS TREES; SPORT BALLS; BATS FOR GAMES; TRAMPOLINES; FISHING TACKLE; PARAGLIDERS AND KITES (U.S. CLS. 22, 23, 38 AND 50).

CLASS 35—ADVERTISING AND BUSINESS

FOR ADVERTISING SERVICES; CONSULTATION BUSINESS MANAGEMENT SERVICES; BUSINESS MANAGEMENT AND ORGANIZATION CONSULTANCY SERVICES; PERSONNEL MANAGEMENT CONSULTANCY; MARKET RESEARCH; RETAIL AND WHOLESALE STORES FEATURING PNEUMATIC, ELECTRONIC, ELECTROTECHNICAL, CONTROL, REGULATING AND AUTOMATION SYSTEMS AND INSTRUCTIONAL AND EDUCATIONAL MATERIALS THEREFOR; BUSINESS ADMINISTRATION; OFFICE FUNCTIONS; ARRANGING AND CONDUCTING OF TRADE FAIRS AND TRADE EXHIBITIONS IN THE FIELDS OF EDUCATION (U.S. CLS. 100, 101 AND 102).

CLASS 41—EDUCATION AND ENTERTAINMENT

FOR VOCATIONAL GUIDANCE; PUBLICATION OF PRINTED MATTER; PUBLISHING OF ELECTRONIC PUBLICATIONS, BOOKS AND MAGAZINES; EDUCATIONAL SERVICES, NAMELY, ARRANGING AND CONDUCTING OF SEMINARS AND TRAINING COURSES AND KNOWLEDGE TESTING ON THE SUBJECTS OF PNEUMATICS, HYDRAULICS, SENSORS, ELECTRONICS, ELECTRICAL ENGINEERING, PROGRAMMABLE LOGICAL CONTROLLERS, ELECTRICAL CLOSED-LOOPED CONTROL TECHNOLOGY, MECHATRONICS, HANDLING TECHNOLOGY, PROCESS AUTOMATION, METAL TECHNOLOGY, CNC TECHNOLOGY, AUTOMATION TECHNOLOGY, METAL WORKING TECHNOLOGY, PROCESS OPTIMIZATION, LEAN MANUFACTURING, FLOW-EFFICIENT PRODUCTION PROCESSES, PULL PRODUCTION, EQUIPMENT EFFICIENCY, SETUP OPTIMIZATION, VALUE-STREAM ANALYSIS, TARGET ENGINEERING, CUSTOMER CENTRICITY, PROBLEM-SOLUTION PROCESSES, MODERATING TEAMS, EFFICIENT COMMUNICATION, INTERCULTURAL COMPETENCE AND MANAGEMENT SKILLS (U.S. CLS. 100, 101 AND 107).

CLASS 42—SCIENTIFIC AND COMPUTER SERVICES

FOR SCIENTIFIC AND TECHNOLOGICAL SERVICES AND RESEARCH AND DESIGN IN THE FIELDS OF PNEUMATICS, HYDRAULICS, SENSORS, ELECTRONICS, ELECTRICAL ENGINEERING, PROGRAMMABLE LOGICAL CONTROLLERS, ELECTRICAL CLOSED-LOOPED CONTROL TECHNOLOGY, MECHATRONICS, HANDLING TECHNOLOGY, PROCESS AUTOMATION, METAL TECHNOLOGY, CNC TECHNOLOGY, AUTOMATION TECHNOLOGY AND METAL WORKING TECHNOLOGY; INDUSTRIAL DESIGN; MATERIALS TESTING; INDUSTRIAL ANALYSIS AND RESEARCH SERVICES; DESIGN AND DEVELOPMENT OF COMPUTER HARDWARE AND SOFTWARE; COMPUTER PROGRAMMING; TECHNICAL CONSULTANCY AND ENGINEERING IN THE FIELDS OF PNEUMATICS, HYDRAULICS, SENSORS, ELECTRONICS, ELECTRICAL ENGINEERING, PROGRAMMABLE LOGICAL CONTROLLERS, ELECTRICAL CLOSED-LOOPED CONTROL TECHNOLOGY, MECHATRONICS, HANDLING TECHNOLOGY, PROCESS AUTOMATION, METAL TECHNOLOGY, CNC TECHNOLOGY, AUTOMATION TECHNOLOGY, METAL WORKING TECHNOLOGY, PROCUREMENT AND LOGISTICS, PRODUCT DEVELOPMENT, LEAN PRODUCTION AND COMPETENCE MANAGEMENT (U.S. CLS. 100 AND 101).

EDWARD NELSON, EXAMINING ATTORNEY

SN 79-102,249. WONIK IPS CO., LTD, REPUBLIC OF KOREA, FILED 3-16-2011.



PRIORITY DATE OF 3-2-2011 IS CLAIMED.
OWNER OF INTERNATIONAL REGISTRATION 1089910 DATED 3-16-2011, EXPIRES 3-16-2021.

THE COLOR(S) BLUE, RED, GRAY AND WHITE IS/ARE CLAIMED AS A FEATURE OF THE MARK.

THE MARK CONSISTS OF THE WORDING "WONIK IPS" AND A CIRCULAR BLUE, GRAY AND WHITE DESIGN FEATURE TO THE LEFT OF THE WORDING. THE WORDING "WONIK" IS IN BLUE, WITH A CIRCULAR GRAY AND WHITE DESIGN WITHIN THE LETTER "O", AND THE WORDING "IPS" IS IN RED.

THE WORDING "WONIK" HAS NO MEANING IN A FOREIGN LANGUAGE.

CLASS 7—MACHINERY

FOR SEMICONDUCTOR MANUFACTURING EQUIPMENT, NAMELY, THIN FILM DEPOSITION APPARATUS, SPUTTERING APPARATUS, ETCHING APPARATUS, EVAPORATION DEPOSITION APPARATUS, PLASMA CHEMICAL VAPOR DEPOSITION APPARATUS, COUPLED PLASMA CHEMICAL VAPOR DEPOSITION APPARATUS, ATOMIC LAYER DEPOSITION APPARATUS, ION BEAM DEPOSITION APPARATUS, ION BEAM ETCHING APPARATUS, ANNEALING APPARATUS, RAPID THERMAL PROCESSING APPARATUS, LOW TEMPERATURE ANNEALING APPARATUS, COUPLED SPUTTERING APPARATUS, MULTIPLE SPUTTERING APPARATUS, LASER SUBLIMATION DEPOSITION APPARATUS, ORGANIC MOLECULAR CHEMICAL VAPOR DEPOSITION APPARATUS, ION BEAM GENERATION APPARATUS, ION BEAM SPUTTER DEPOSITION APPARATUS, ION BEAM ETCHING APPARATUS, ION BEAM ASSISTED DEPOSITION APPARATUS, ELECTRON BEAM ASSISTED DEPOSITION APPARATUS, ELECTRON BEAM CRYSTALLIZATION APPARATUS, ELECTRON BEAM ANNEALING APPARATUS, OXIDATION MECHANICAL APPARATUS, ION IMPLANTATION APPARATUS, CHEMICAL VAPOR PRECIPITATION MECHANICAL APPARATUS, SPUTTERING MECHANICAL APPARATUS, AND PROBE; LIQUID CRYSTAL DISPLAY MANUFACTURING EQUIPMENT, NAMELY, FILM DEPOSITION APPARATUS, SPUTTERING APPARATUS, COUPLED SPUTTERING APPARATUS, ETCHING APPARATUS, EVAPORATION DEPOSITION APPARATUS, PLASMA CHEMICAL VAPOR DEPOSITION APPARATUS, ION BEAM DEPOSITION APPARATUS, ION BEAM ETCHING APPARATUS AND ANNEALING APPARATUS, SPUTTERING MECHANICAL APPARATUS, AND PROBE; ORGANIC ELECTROLUMINESCENCE DISPLAY MANUFACTURING EQUIPMENT, NAMELY, THIN FILM DEPOSITION APPARATUS, SPUTTERING APPARATUS, COUPLED SPUTTERING APPARATUS, ETCHING APPARATUS, EVAPORATION DEPOSITION APPARATUS, PLASMA CHEMICAL VAPOR DEPOSITION APPARATUS, ION BEAM DEPOSITION APPARATUS, ION BEAM ETCHING APPARATUS AND ANNEALING APPARATUS; PLASMA DISPLAY PANEL MANUFACTURING EQUIPMENT, NAMELY, THIN FILM DEPOSITION APPARATUS, SPUTTERING APPARATUS, COUPLED SPUTTERING APPARATUS, ETCHING APPARATUS, EVAPORATION DEPOSITION APPARATUS, PLASMA CHEMICAL VAPOR DEPOSITION APPARATUS, ION BEAM DEPOSITION APPARATUS, ION BEAM ETCHING APPARATUS AND ANNEALING APPARATUS; SOLAR CELL MANUFACTURING EQUIPMENT, NAMELY, THIN FILM DEPOSITION APPARATUS, SPUTTERING APPARATUS, COUPLED SPUTTERING APPARATUS, ETCHING APPARATUS, EVAPORATION DEPOSITION APPARATUS, PLASMA CHEMICAL VAPOR DEPOSITION APPARATUS, ION BEAM DEPOSITION APPARATUS, ION BEAM ETCHING APPARATUS, ELECTRON BEAM ANNEALING APPARATUS; MICROELECTROMECHANICAL SYSTEMS (MEMS) MANUFACTURING EQUIPMENT, NAMELY, THIN FILM DEPOSITION APPARATUS, SPUTTERING APPARATUS, EVAPORATION DEPOSITION APPARATUS AND CHEMICAL VAPOR DEPOSITION APPARATUS; ACTIVE MATRIX ORGANIC LIGHT EMITTING DIODE (AMOLED) DISPLAY MANUFACTURING EQUIPMENT, NAMELY, THIN FILM DEPOSITION APPARATUS, SPUTTERING APPARATUS, COUPLED SPUTTERING APPARATUS, ETCHING APPARATUS, EVAPORATION DEPOSITION APPARATUS, PLASMA CHEMICAL VAPOR DEPOSITION APPARATUS, ION BEAM DEPOSITION APPARATUS AND ION BEAM ANNEALING APPARATUS (U.S. CLS. 13, 19, 21, 23, 31, 34 AND 35).

CLASS 37—CONSTRUCTION AND REPAIR

FOR INSTALLATION, REPAIR AND MAINTENANCE OF SEMICONDUCTOR PROCESSING MACHINES, SEMICONDUCTOR WAFER PROCESSING APPARATUS, ATOMIC LAYER DEPOSITION APPARATUS, LOW PRESSURE CHEMICAL VAPOR DEPOSITION APPARATUS, DIFFUSION FURNACES, PLASMA CHEMICAL VAPOR DEPOSITION APPARATUS, METAL ORGANIC CHEMICAL VAPOR DEPOSITION APPARATUS, FAST-HEATING PROCESSING APPARATUS, HIGH TEMPERATURE CHEMICAL VAPOR DEPOSITION APPARATUS, VAPOR EPITAXY APPARATUS, LIQUID EPITAXY APPARATUS, NORMAL PRESSURE CHEMICAL VAPOR DEPOSITION APPARATUS, MID PRESSURE CHEMICAL VAPOR DEPOSITION APPARATUS, ETCHERS, SPUTTERING APPARATUS, PHOTOLITHOGRAPHY APPARATUS, DEVELOPERS, ASHING APPARATUS, CLEANING APPARATUS AND POLISHING APPARATUS, ALL FOR THE MANUFACTURE OF SEMICONDUCTORS; INSTALLATION, REPAIR AND MAINTENANCE OF DEPOSITION APPARATUS ETCHERS, SPUTTERING APPARATUS, PHOTOLITHOGRAPHY APPARATUS, DEVELOPERS, ASHING APPARATUS, CLEANING APPARATUS AND POLISHING APPARATUS, ALL FOR THE MANUFACTURE OF LIQUID CRYSTAL DISPLAY PANELS; INSTALLATION, REPAIR AND MAINTENANCE OF DEPOSITION APPARATUS, ETCHERS FOR MANUFACTURING SOLAR CELLS, SPUTTERING APPARATUS, PHOTOLITHOGRAPHY APPARATUS, DEVELOPERS FOR MANUFACTURING SOLAR CELLS, ASHING APPARATUS, CLEANING APPARATUS AND POLISHING APPARATUS, ALL FOR THE MANUFACTURE OF SOLAR CELLS; MAINTENANCE OF DEPOSITION APPARATUS, ETCHERS, SPUTTERING APPARATUS, PHOTOLITHOGRAPHY APPARATUS, DEVELOPERS, ASHING APPARATUS, CLEANING APPARATUS, AND POLISHING APPARATUS, ALL FOR THE MANUFACTURE OF LED AND AMOLED DISPLAYS (U.S. CLS. 100, 103 AND 106).

STEVEN R. FINE, EXAMINING ATTORNEY

SN 79-102,269. BIORGANIC PHARMA, S.L., SPAIN, FILED 7-5-2011.

PSAGING

THE MARK CONSISTS OF STANDARD CHARACTERS WITHOUT CLAIM TO ANY PARTICULAR FONT, STYLE, SIZE, OR COLOR.

OWNER OF INTERNATIONAL REGISTRATION 1089970 DATED 7-5-2011, EXPIRES 7-5-2021.

CLASS 3—COSMETICS AND CLEANING PREPARATIONS

FOR SKIN ABRASIVE PREPARATIONS; SOAPS FOR PERSONAL USE; PERFUMERY, ESSENTIAL OILS, COSMETICS, HAIR LOTIONS; DENTIFRICES (U.S. CLS. 1, 4, 6, 50, 51 AND 52).

CLASS 5—PHARMACEUTICALS

FOR PHARMACEUTICAL PREPARATIONS FOR USE IN DERMATOLOGY; DIETETIC FOOD AND SUGAR ADAPTED FOR MEDICAL USE (U.S. CLS. 6, 18, 44, 46, 51 AND 52).

CLASS 35—ADVERTISING AND BUSINESS

FOR ADVERTISING SERVICES; BUSINESS MANAGEMENT; BUSINESS ADMINISTRATION; PROVIDING OFFICE FUNCTIONS; ORGANIZATION OF EXHIBITIONS FOR COMMERCIAL OR ADVERTISING PURPOSES, WHOLESALE AND RETAIL STORE SERVICES FEATURING COSMETICS, LAUNDRY PRODUCTS AND PERSONAL CARE PRODUCTS; ONLINE WHOLESALE AND RETAIL STORE SERVICES FEATURING COSMETICS, LAUNDRY PRODUCTS AND PERSONAL CARE PRODUCTS (U.S. CLS. 100, 101 AND 102).

REBECCA POVARCHUK, EXAMINING ATTORNEY

SN 79-102,539. RAMON RAMON REAL, SPAIN, FILED 8-31-2011.

CAVIAROLI

PRIORITY DATE OF 3-1-2011 IS CLAIMED.
OWNER OF INTERNATIONAL REGISTRATION 1090760 DATED 8-31-2011, EXPIRES 8-31-2021.

THE WORDING "CAVIAROLI" HAS NO MEANING IN A FOREIGN LANGUAGE.

CLASS 29—MEATS AND PROCESSED FOODS

FOR EDIBLE OILS AND FATS, NAMELY, OLIVE OIL (U.S. CL. 46).

CLASS 35—ADVERTISING AND BUSINESS

FOR RETAIL STORE SERVICES AND WHOLESALE STORE SERVICES VIA THE INTERNET FEATURING OLIVE OIL (U.S. CLS. 100, 101 AND 102).

JAMES STEIN, EXAMINING ATTORNEY

SN 79-102,611. PHOENIX CONTACT GMBH & CO. KG, 32825 BLOMBERG, FED REP GERMANY, FILED 3-24-2011.

SOLARCHECK

THE MARK CONSISTS OF STANDARD CHARACTERS WITHOUT CLAIM TO ANY PARTICULAR FONT, STYLE, SIZE, OR COLOR.

PRIORITY DATE OF 9-29-2010 IS CLAIMED.
OWNER OF INTERNATIONAL REGISTRATION 1090854 DATED 3-24-2011, EXPIRES 3-24-2021.

CLASS 9—ELECTRICAL AND SCIENTIFIC APPARATUS

FOR PROTECTION SYSTEMS FOR STRINGS OF PHOTOVOLTAIC INSTALLATIONS, NAMELY, VOLTAGE SURGE PROTECTORS; SURGE PROTECTION SYSTEMS, NAMELY, VOLTAGE SURGE SUPPRESSORS, VOLTAGE SURGE PROTECTORS, TRANSIENT VOLTAGE SURGE SUPPRESSORS WITH POWER CONDITIONING TECHNOLOGY; ELECTRICAL AND ELECTRONIC DEVICES FOR SURGE PROTECTION, NAMELY, VOLTAGE SURGE SUPPRESSORS, VOLTAGE SURGE PROTECTORS, TRANSIENT VOLTAGE SURGE SUPPRESSORS WITH POWER CONDITIONING TECHNOLOGY; SYSTEMS AND DEVICES FOR MONITORING PHOTOVOLTAIC INSTALLATIONS, NAMELY, ALARM MONITORING SYSTEMS, ELECTRONIC DEVICES FOR MONITORING AND OPTIMIZING PHOTOVOLTAIC STRINGS AND ARRAYS, COMPUTER HARDWARE AND COMPUTER SOFTWARE FOR MONITORING AND CONTROLLING PHOTOVOLTAIC INSTALLATIONS; SYSTEMS AND DEVICES FOR MEASURING AND TRANSMITTING DATA AND INFORMATION,

NAMELY, VOLTAGE MEASURING APPARATUS, CURRENT MEASURING APPARATUS, LIGHT MEASURING APPARATUS, COMPUTER CHIPSETS FOR USE IN TRANSMITTING DATA AND INFORMATION TO AND FROM A CENTRAL PROCESSING UNIT, COMPUTER HARDWARE AND COMPUTER SOFTWARE FOR MEASURING AND TRANSMITTING DATA AND INFORMATION; SYSTEMS AND DEVICES FOR MEASURING AND TRANSMITTING ELECTRICAL VOLTAGES AND TEMPERATURE, NAMELY, VOLTAGE REGULATORS, VOLTAGE MONITOR MODULES, VOLTAGE MEASURING APPARATUS, COMPUTER HARDWARE AND COMPUTER SOFTWARE FOR MEASURING AND TRANSMITTING ELECTRICAL VOLTAGES, TEMPERATURE REGULATORS, TEMPERATURE MONITOR MODULES, TEMPERATURE MEASURING APPARATUS, COMPUTER HARDWARE AND COMPUTER SOFTWARE FOR MEASURING AND TRANSMITTING TEMPERATURE; SYSTEMS AND DEVICES FOR DETECTING AND TRANSMITTING STATES OF SURGE PROTECTION SYSTEMS, NAMELY, TELECOMMUNICATION TRANSMITTERS, DIGITAL TRANSMITTERS, APPARATUS FOR MONITORING SURGE PROTECTION SYSTEMS, COMPUTER HARDWARE AND COMPUTER SOFTWARE FOR DETECTING AND TRANSMITTING STATES OF SURGE PROTECTION SYSTEMS; PHOTOVOLTAIC STRINGS FOR PHOTOVOLTAIC MODULES; PHOTOVOLTAIC STRINGS OF PHOTOVOLTAIC MODULES; JUNCTION BOXES; ELECTRONIC CONTROL SYSTEMS FOR MACHINES; ELECTRONIC MODULES FOR DETECTING DATA AND INFORMATION; ELECTRONIC MODULES FOR COLLECTING DATA AND INFORMATION; ELECTRONIC MODULES FOR MEASURING ELECTRICAL CURRENTS; CONCENTRATOR MODULES FOR PHOTOVOLTAIC INSTALLATIONS; ELECTRIC JUNCTION AND CONNECTING ELEMENTS MADE OF METAL AND PLASTICS FOR ELECTRICAL AND ELECTRONIC APPLICATIONS FOR INDUSTRIAL USE, PARTICULARLY TERMINAL CLAMPS AND CONNECTING TERMINALS; ELECTRONIC DATA TRANSMISSION DEVICES AND SOFTWARE FOR ELECTRONIC DATA TRANSMISSION; INDUSTRIAL PLUG-IN CONNECTORS; PLUG AND SOCKET DEVICES, NAMELY, ELECTRICAL PLUGS AND SOCKETS; ELECTRICAL CABLE AND LINE CONNECTORS; ADAPTERS FOR CONNECTING DIFFERENT PLUG-IN CONNECTORS; ELECTRICAL INSERT CONNECTORS; ELECTRICAL CONNECTOR MOUNTING PLATES; ELECTRICAL CABLE AND FLAT CABLE ADAPTER; ELECTRICAL EXTENSION, SOCKET AND COUPLING HOUSINGS FOR PLUG-IN CONNECTORS; MODULAR PLUG-IN CONNECTORS; ELECTRICAL TERMINAL CLAMPS AND CONNECTORS; ELECTRICAL, ELECTRONIC, OPTICAL WEIGHING, MEASURING, SIGNAL, CONTROL DEVICES AND INSTRUMENTS, PARTICULARLY FOR THE CONDUCTION, TRANSFORMATION, STORAGE, ADJUSTMENT AND CONTROL OF ELECTRICAL CURRENTS, NAMELY, ELECTRICAL CONDUCTORS, ELECTRONIC MONITORS AND MONITOR MODULES FOR MONITORING ELECTRIC CURRENT, ELECTRICAL CONTROLLERS; ELECTRICAL AND ELECTRONIC INSTALLATIONS, NAMELY, ELECTRIC INSTALLATIONS FOR THE REMOTE CONTROL OF INDUSTRIAL OPERATIONS, ELECTRICAL INSTALLATIONS FOR POWER TRANSMISSION, ELECTRICAL INSTALLATIONS FOR POWER DISTRIBUTION; COMPONENT PARTS AND DEVICES, NAMELY, AUTOMATION TERMINALS, PARTICULARLY BUS TERMINALS, INPUT TERMINALS, OUTPUT TERMINALS, INPUT MODULES, OUTPUT MODULES, POWER TERMINALS AND SAFETY TERMINALS, PARTICULARLY THOSE ADAPTED FOR SNAPPING ONTO A TOP-HAT RAIL, IN AS FAR AS THEY ARE INCLUDED IN THIS CLASS; DATA PROCESSING EQUIPMENT AND COMPUTERS; SOFTWARE FOR TRANSMITTING DATA; SIGNAL TRANSMISSION SYSTEMS AND COMPONENTS FOR SIGNAL TRANSMISSION SYSTEMS, PARTICULARLY SAFETY-RELATED CONTROLLERS AND DEVICES, NAMELY, CABLES, CONNECTORS AND PLUGS FOR ELECTRICAL OR OPTICAL SIGNAL TRANSMISSION; ELECTRICAL PLUG-IN CONNECTORS FOR PHOTOVOLTAIC APPLICATIONS; ELECTRICAL TERMINAL HOUSINGS FOR PHOTOVOLTAIC APPLICATIONS; DEVICES AND EQUIPMENT FOR DISTRIBUTING ELECTRICAL ENERGY, NAMELY, ELECTRICAL DISTRIBUTION BOXES, ELECTRICAL POWER DISTRIBUTION UNITS, ELECTRIC DISTRIBUTION CONSOLES; ELECTRICAL DISTRIBUTION CABINETS; ELECTRICAL DISTRIBUTION BOXES; ELECTRICAL

TERMINAL PARTS, NAMELY, ELECTRICAL TERMINAL BLOCKS, COMPUTER TERMINALS; CONNECTION PARTS, NAMELY, ELECTRIC CONNECTIONS, CONNECTION CABLES, CONNECTION PLUGS, CONNECTION SOCKETS; METAL GROUNDING CABLE CLAMPS FOR USE ONLY AS PARTS AND FITTINGS FOR ELECTRIC CABLES, AND NOT FOR NON-ELECTRIC CABLE OR MACHINERY OR MACHINERY PART; ELECTRIC CONTACTS; ELECTRICAL CABLE DUCTS; ELECTRICAL CONDUCTORS; ELECTRICAL SOCKETS; ELECTRIC INDICATOR DEVICES, NAMELY, ELECTRONIC INDICATOR BOARDS, ELECTRONIC INDICATOR PANELS, TEMPERATURE INDICATORS, VOLTAGE INDICATORS, CURRENT INDICATORS; DATA PROCESSING EQUIPMENT AND COMPUTERS FOR REMOTE CONTROL AND DIAGNOSIS OF INDUSTRIAL PROCESSES; ELECTRICAL INSTALLATIONS FOR REMOTE CONTROL AND DIAGNOSIS OF INDUSTRIAL PROCESSES; ELECTRICAL HOUSINGS FOR ELECTRICAL AND ELECTRONIC INSTALLATIONS; DEVICES FOR DATA TRANSMISSION, NAMELY, TRANSMITTERS OF ELECTRONIC SIGNALS, SOUND TRANSMITTING APPARATUS, WIRELESS TRANSMITTERS AND RECEIVERS; ELECTRICAL CURRENT TRANSDUCERS; ELECTRICAL MONITORING DEVICES; NAMELY, ALARM MONITORING SYSTEMS, ELECTRONIC DEVICES FOR MONITORING AND OPTIMIZING PHOTOVOLTAIC STRINGS AND ARRAYS, COMPUTER HARDWARE AND COMPUTER SOFTWARE FOR MONITORING AND CONTROLLING PHOTOVOLTAIC INSTALLATIONS; LIGHTNING AND SURGE PROTECTION ELEMENTS, NAMELY, LIGHTNING ARRESTERS, LIGHTNING CONDUCTORS, VOLTAGE SURGE PROTECTORS; TERMINAL AND CONNECTING ELEMENTS MADE OF METAL AND PLASTICS FOR ELECTRICAL AND ELECTRONIC APPLICATIONS, PARTICULARLY TERMINAL CLAMPS, CONNECTING TERMINALS AND CONNECTOR BLOCKS; ELECTRICAL TERMINAL STRIPS; ELECTRICAL TERMINAL STRIPS FOR MEASURING ELECTRICAL CURRENTS; ELECTRICAL TERMINAL STRIPS FOR TRANSMITTING PROTOCOLS, MESSAGES, INFORMATION AND DATA; ELECTRICALLY CONDUCTING CABLES; ELECTRICAL COMMUNICATION CABLES; ELECTRICAL CABLES FOR TRANSMITTING PROTOCOLS, MESSAGES, INFORMATION AND DATA; PROGRAMMABLE LOGIC CONTROLLER (PLC); ELECTRICAL NETWORKS, NAMELY, COMPUTER NETWORK SERVERS, COMPUTER NETWORKING HARDWARE, NETWORK ROUTERS; COMPUTER NETWORKS, NAMELY, COMPUTER NETWORK SERVERS, COMPUTER NETWORKING HARDWARE, NETWORK ROUTERS; SYSTEMS FOR DATA TRANSMISSION, NAMELY, APPARATUS, COMPUTER HARDWARE AND COMPUTER SOFTWARE FOR DATA TRANSMISSION, APPARATUS FOR POWER DISTRIBUTION, APPARATUS FOR POWER TRANSMISSION; BIDIRECTIONAL SYSTEMS FOR DATA TRANSMISSION, NAMELY, APPARATUS, COMPUTER HARDWARE AND COMPUTER SOFTWARE FOR BIDIRECTIONAL DATA TRANSMISSION (U.S. CLS. 21, 23, 26, 36 AND 38).

CLASS 37—CONSTRUCTION AND REPAIR

FOR INSTALLATION AND REPARATION SERVICES, PARTICULARLY FOR PHOTOVOLTAIC INSTALLATIONS (U.S. CLS. 100, 103 AND 106).

CLASS 42—SCIENTIFIC AND COMPUTER SERVICES

FOR SERVICES FOR PROGRAMMING OF DIAGNOSIS SOFTWARE FOR PHOTOVOLTAIC INSTALLATIONS, AS FAR AS THEY ARE INCLUDED IN THIS CLASS; PLANNING AND DESIGNING OF LIGHTNING AND SURGE PROTECTION ELEMENTS; DEVELOPMENT SERVICES IN TERMS OF NOVEL PRODUCTS IN THE FIELD OF ELECTRICAL ENGINEERING AND ELECTRONICS FOR THIRD PARTIES; ENGINEERING CONSULTANCY IN RELATION TO THE IMPLEMENTATION AND MEASUREMENTS FOR ELECTRONIC DEVICES; ENGINEERING CONSULTATION IN RELATION TO ELIMINATING FAULTS FROM A PROGRAM (U.S. CLS. 100 AND 101).

KRISTIN CARLSON, EXAMINING ATTORNEY

SN 79-102,788. OBSHCHESTVO S OGRANICHENNOI OTVETSTVENNOSTYU "LUDING", RUSSIAN FED., FILED 7-19-2011.

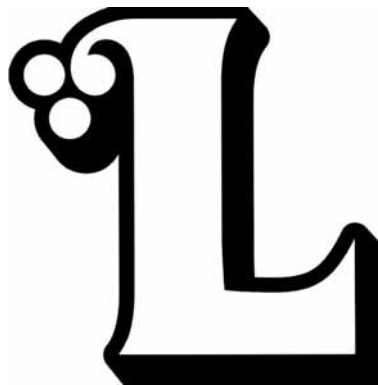

OWNER OF INTERNATIONAL REGISTRATION 1091370 DATED 7-19-2011, EXPIRES 7-19-2021.

THE MARK CONSISTS OF THE LETTER "L" IN STYLIZED FONT, WITH TWO CIRCLES ATTACHED TO THE CURLED TOP OF THE LETTER "L".

CLASS 16—PAPER GOODS AND PRINTED MATTER

FOR PAPER, CARDBOARD AND GOODS MADE FROM THESE MATERIALS, NOT INCLUDED IN OTHER CLASSES, NAMELY, COPY PAPER, COLLAPSIBLE BOXES OF PAPER; PRINTED MATTER, NAMELY, PAPER SIGNS, BOOKS, MANUALS, CURRICULUM, NEWSLETTERS, INFORMATIONAL CARDS AND BROCHURES IN THE FIELD OF ALCOHOLIC BEVERAGES AND ALCOHOLIC BEVERAGE INDUSTRY; BOOK-BINDING MATERIAL; PRINTED PHOTOGRAPHS; STATIONERY; ADHESIVES FOR STATIONERY OR HOUSEHOLD PURPOSES; ARTISTS' MATERIALS, NAMELY, CANVAS STRETCHER BARS FOR ARTISTS; PAINT BRUSHES; ELECTRICAL AND ELECTRONIC TYPEWRITERS OFFICE REQUISITES, NAMELY, ENVELOPE SEALING MACHINES, PAPER EMBOSSERS, ELECTRIC PAPER HOLE PUNCHES, CORRECTING TAPES, ADHESIVE TAPE DISPENSERS; PAPER INSTRUCTIONAL AND TEACHING MATERIALS IN THE FIELD OF ALCOHOLIC BEVERAGES AND ALCOHOLIC BEVERAGE INDUSTRY; PLASTIC MATERIALS FOR PACKAGING, NAMELY BAGS, BUBBLE PACKS; PRINTERS' TYPE; PRINTING BLOCKS (U.S. CLS. 2, 5, 22, 23, 29, 37, 38 AND 50).

CLASS 32—LIGHT BEVERAGES

FOR BEERS; MINERAL AND AERATED WATERS; NON-ALCOHOLIC DRINKS, NAMELY, ENERGY SHOTS, DRINKS FLAVORED WITH TEA AND COFFEE; FRUIT DRINKS AND FRUIT JUICES; SYRUPS AND OTHER PREPARATIONS FOR MAKING NON-ALCOHOLIC BEVERAGES (U.S. CLS. 45, 46 AND 48).

CLASS 33—WINES AND SPIRITS

FOR ALCOHOLIC BEVERAGES EXCEPT BEER (U.S. CLS. 47 AND 49).

CLASS 35—ADVERTISING AND BUSINESS

FOR ADVERTISING AND MARKETING SERVICES, NAMELY, PROMOTING THE GOODS AND SERVICES OF OTHERS; BUSINESS OPERATION, BUSINESS ADMINISTRATION AND OFFICE FUNCTIONS (U.S. CLS. 100, 101 AND 102).

CLASS 38—COMMUNICATION

FOR TELECOMMUNICATION SERVICES, NAMELY, TRANSMISSION OF VOICE, DATA, GRAPHICS, IMAGES, AUDIO AND VIDEO BY MEANS OF TELECOMMUNICATIONS NETWORKS, WIRELESS COMMUNICATION NETWORKS, AND THE INTERNET (U.S. CLS. 100, 101 AND 104).

CLASS 39—TRANSPORTATION AND STORAGE

FOR TRANSPORT, PACKAGING AND STORAGE OF GOODS; COORDINATING TRAVEL ARRANGEMENTS FOR INDIVIDUALS AND GROUPS (U.S. CLS. 100 AND 105).

CLASS 41—EDUCATION AND ENTERTAINMENT

FOR EDUCATION SERVICES, NAMELY, PROVIDING CLASSES, SEMINARS, WORKSHOPS IN THE FIELD OF ALCOHOLIC BEVERAGES AND ALCOHOLIC BEVERAGE INDUSTRY ; ENTERTAINMENT IN THE NATURE OF MUSICAL GROUP, TELEVISION COMEDY SERIES, ETHNIC FESTIVAL, AUTOMOBILE RACES, AIR SHOWS; SERVICES IN CONNECTION WITH THE ARRANGING AND CONDUCTING OF SPORTING AND CULTURAL ACTIVITIES, NAMELY, PROVISION OF INFORMATION RELATING TO SPORTING, CULTURAL AND LIVE THEATRICAL PRODUCTIONS, AND TICKET RESERVATION AND BOOKING SERVICES FOR ENTERTAINMENT, SPORTING AND CULTURAL EVENTS (U.S. CLS. 100, 101 AND 107).

CLASS 43—HOTEL AND RESTAURANT SERVICES

FOR SERVICES FOR PROVIDING FOOD AND DRINK, NAMELY, SERVING FOOD AND DRINKS, PROVIDING OF FOOD AND DRINKS FOR GUESTS, CATERING OF FOOD AND DRINKS; PROVIDING TEMPORARY HOUSING ACCOMMODATION (U.S. CLS. 100 AND 101).

HENRY S. ZAK, EXAMINING ATTORNEY

CLASS 9—ELECTRICAL AND SCIENTIFIC APPARATUS

FOR POWER OUTLETS, NAMELY, ELECTRICAL OUTLET, MULTI-OUTLET SOCKET BLOCKS; POWER CONNECTORS FOR HIGH VOLTAGE AND MODULAR CONNECTORS; PLUGS, NAMELY, ELECTRIC PLUGS, ELECTRICAL PLUGS, SAFETY CONTACT PLUGS; APPARATUS AND INSTRUMENTS FOR TRANSMITTING DATA, NAMELY, ELECTRONIC AND ELECTRICAL CONNECTORS FOR DATA BUS SYSTEMS, TRANSCEIVERS, COMPUTERS, COMPUTER CHIPSET FOR USE IN TRANSMITTING DATA TO AND FROM A CENTRAL PROCESSING UNIT, AND APPARATUS FOR RECORDING, TRANSMISSION, PROCESSING AND REPRODUCTION OF DATA; APPARATUS AND INSTRUMENTS FOR CONVEYING, DISTRIBUTING, TRANSFORMING, STORING, REGULATING OR CONTROLLING ELECTRIC CURRENT; APPARATUS AND INSTRUMENTS FOR CONVEYING, DISTRIBUTING, TRANSFORMING, STORING, REGULATING OR CONTROLLING DATA, NAMELY, BLANK MAGNETIC DATA CARRIERS, BLANK OPTICAL DATA CARRIERS, CALCULATING MACHINES AND DATA PROCESSING EQUIPMENT, COMPUTERS, ELECTRONIC DATA LOGGERS, INTERFACE CARDS FOR DATA PROCESSING EQUIPMENT IN THE FORM OF PRINTED CIRCUITS, TRANSCEIVERS, ELECTRIC CAPACITORS, ELECTRIC RESISTORS, ELECTRICAL TRANSFORMERS, CHANGE-OVER SWITCHES, FUSES, PICKUPS, TELECOMMUNICATION CABLES; VOLTAGE REGULATORS FOR VEHICLES; MEASURING, SIGNALING AND CONTROL APPARATUS AND INSTRUMENTS, NAMELY, COORDINATE MEASURING MACHINES, DISTANCE MEASURING APPARATUS, GRAVITY MEASURING INSTRUMENTS, INSTRUMENTS FOR DETECTING AND MEASURING TWO-DIMENSIONAL DISTRIBUTION OF FORCE AND PRESSURE, INSTRUMENTS FOR MEASURING LENGTH, LASER MEASURING SYSTEMS, LEVEL MEASURING MACHINES, BEVELS, RAIN GAUGES, ANGLE FINDERS, MEASURING CUPS, MEASURING RULES, DIGITIZERS, MECHANICAL AND ELECTRONIC MEASURING MACHINES FOR IDENTIFYING AND ANALYZING STRUCTURAL DAMAGE TO VEHICLES, DIGITAL SIGNAL PROCESSORS, SIGNAL BELLS, SIGNAL SPLITTERS FOR ELECTRONIC APPARATUS, SIGNALING BUOYS, AUTOMATIC COMBUSTION CONTROL MACHINES AND INSTRUMENTS, BRAKE CONTROLLERS, ELECTRICAL CONTROLLING DEVICES, ELECTRONIC CONTROL SYSTEMS FOR MACHINES (U.S. CLS. 21, 23, 26, 36 AND 38).

SN 79-102,850. GIMOTA AG, CH-8954 GEROLDSWIL, SWITZERLAND, FILED 3-1-2011.



OWNER OF INTERNATIONAL REGISTRATION 0807178 DATED 5-12-2003, EXPIRES 5-12-2013.

THE COLOR(S) DARK BLUE, LIGHT BLUE, GREEN, YELLOW, ORANGE, AND BLACK IS/ARE CLAIMED AS A FEATURE OF THE MARK.

THE MARK CONSISTS OF THE STYLIZED WORDING "GIMOTA" IN THE COLOR BLACK, AND THE DESIGN OF AN ARC-SHAPED BAND IN A GRADIENT OF COLORS, STARTING WITH DARK BLUE ON THE LEFT, THEN GOING RIGHT LIGHT BLUE, GREEN, YELLOW, AND ENDING WITH ORANGE ON THE RIGHT.

THE WORDING "GIMOTA" HAS NO MEANING IN A FOREIGN LANGUAGE.

CLASS 12—VEHICLES

FOR VEHICLE COMPONENT PARTS, NAMELY, STRUCTURAL PARTS FOR AUTOMOBILES, STRUCTURAL PARTS FOR RAIL VEHICLES AND TRAINS, SHOCK ABSORBERS, AND SENSORS FOR LAND VEHICLES IN THE NATURE OF ELECTRIC POWER STEERING TORQUE SENSORS, SOLD AS A COMPONENT OF THE POWER STEERING SYSTEM (U.S. CLS. 19, 21, 23, 31, 35 AND 44).

JAY BESCH, EXAMINING ATTORNEY

SN 79-102,943. OUT OF DI RIGHI FEDERICO, ITALY, FILED 7-21-2011.

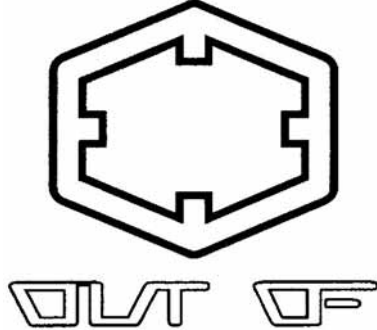

OWNER OF INTERNATIONAL REGISTRATION 1091745 DATED 7-21-2011, EXPIRES 7-21-2021.
THE MARK CONSISTS OF A DOUBLE LINE HEXAGONAL SHAPE ABOVE THE WORDING "OUT OF" IN STYLIZED CHARACTERS.

CLASS 25—CLOTHING

FOR CLOTHING, NAMELY, PANTS, T-SHIRTS, SHORTS, SWEATSHIRTS, HOODED SWEATSHIRTS, SWEATERS, FOOTWEAR, BELTS, HATS AND CAPS AND OUTERWEAR JACKETS FOR SKI AND SNOWBOARD USE (U.S. CLS. 22 AND 39).

CLASS 28—TOYS AND SPORTING GOODS

FOR PARLOR GAMES; GYMNASIAC AND SPORTING ARTICLES NOT INCLUDED IN OTHER CLASSES, NAMELY, BINDINGS FOR ALPINE SKIS, COVERS FOR SKI BINDINGS, HARNESSSES SPECIALLY ADAPTED FOR CARRYING SNOWBOARDS, SKIS AND SKATEBOARDS, PORTABLE SKI CARRIERS, SCRAPERS FOR SKIS, SKI BAGS, SKI BINDINGS, SKI BINDINGS AND PARTS THEREFORE, SKI POLES, SKI ROPES, SKIS; DECORATIONS FOR CHRISTMAS TREES (U.S. CLS. 22, 23, 38 AND 50).
JESSICA A. POWERS, EXAMINING ATTORNEY

SN 79-102,994. SEA ISLAND CLUB CO., LTD, JAPAN, FILED 6-7-2011.



OWNER OF INTERNATIONAL REGISTRATION 1091874 DATED 6-7-2011, EXPIRES 6-7-2021.
NO CLAIM IS MADE TO THE EXCLUSIVE RIGHT TO USE "USA", APART FROM THE MARK AS SHOWN.

CLASS 24—FABRICS

FOR WOVEN FABRICS; KNITTED FABRICS; PERSONAL BELONGING OF WOVEN TEXTILE, NAMELY, TOWELS, JAPANESE COTTON TOWELS, HANDKERCHIEFS, JAPANESE CEREMONIAL WRAPPING CLOTH; MOSQUITO NETS; BED SHEETS; FUTON QUILTS; LINEN FUTON QUILTS CASES; FUTON TICKS, NAMELY, UNSTUFFED FUTON COVERS NOT OF PAPER; PILLOWCASES; BED BLANKETS; LAP BLANKETS; TRAVELLING BLANKETS; SERVIETTES OF TEXTILE; DISH TOWELS OF TEXTILE FOR DRYING; UNFITTED FABRIC CHAIR COVERS, NAMELY, SEAT COVERS OF TEXTILE; WALL HANGINGS OF TEXTILE; CURTAINS; FABRIC TABLE RUNNERS; DRAPERIES, NAMELY, THICK DROP CURTAINS (U.S. CLS. 42 AND 50).

CLASS 25—CLOTHING

FOR CLOTHING, NAMELY, SUITS, JACKETS, PANTS, DRESSES, SKIRTS, COATS, SWEATERS, CARDIGANS, DENIMS, KNIT JACKETS, KNIT BOTTOMS, KNIT DRESSES, SHIRTS, T-SHIRTS, KNIT SHIRTS, KNIT TOPS, SHORTS, BLOUSES, UNDERWEAR, CAMISOLES, NIGHTWEAR, SOCKS, FOOTWEAR, KNITTED GLOVES, SCARVES, SHAWLS; CHILDREN'S CLOTHING, NAMELY, JUMPERS, OVERALLS, SLEEPERS, PAJAMAS, ROMPERS, ONE-PIECE GARMENTS; GARTERS; SOCK SUSPENDERS; TROUSER STRAPS; WAIST BANDS; BELTS FOR CLOTHING; CLOTHING FOR SPORTS, NAMELY, SPORT SHIRTS, SPORT BRAS, SPORTS PANTS, SPORTS JERSEYS, SPORTS OVER UNIFORMS (U.S. CLS. 22 AND 39).
NAAKWAMA ANKRAH, EXAMINING ATTORNEY

SN 79-103,058. POOLRITE RESEARCH PTY LTD, AUSTRALIA, FILED 6-21-2011.



PRIORITY DATE OF 5-9-2011 IS CLAIMED.
OWNER OF INTERNATIONAL REGISTRATION 1092065 DATED 6-21-2011, EXPIRES 6-21-2021.
THE MARK CONSISTS OF THE WORD "AEROBOT" IN STYLIZED LETTERING WITH BOTH OF THE LETTER "O'S BEING FORMED BY STYLIZED FAN DESIGNS FROM WHICH BUBBLES ARE BEING EMITTED.

CLASS 7—MACHINERY

FOR SWIMMING POOL AND SPA CLEANING AND MAINTENANCE MACHINES AND EQUIPMENT, NAMELY, VACUUM CLEANERS, AUTOMATIC SWIMMING POOL CLEANERS AND PARTS THEREOF; SWEEPING MACHINES AND POWER-OPERATED SWEEPING APPARATUS FOR USE IN POOLS AND SPAS; POWER-OPERATED SKIMMERS FOR CLEANING POOLS AND SPAS; PUMPS, NAMELY, PUMPS FOR RECYCLING WATER IN SWIMMING POOLS AND SPAS (U.S. CLS. 13, 19, 21, 23, 31, 34 AND 35).

CLASS 11—ENVIRONMENTAL CONTROL APPARATUS

FOR WATER PURIFYING AND FILTRATION APPARATUS FOR SWIMMING POOLS AND SPAS, NAMELY, WATER FILTERS (U.S. CLS. 13, 21, 23, 31 AND 34).
JENNIFER MARTIN, EXAMINING ATTORNEY

SN 79-103,098. SIGVARIS AG, CH-9014 ST. GALLEN, SWITZERLAND, FILED 8-19-2011.



PRIORITY DATE OF 3-7-2011 IS CLAIMED.
OWNER OF INTERNATIONAL REGISTRATION 1092186
DATED 8-19-2011, EXPIRES 8-19-2021.

OWNER OF U.S. REG. NO. 3,892,678.
NO CLAIM IS MADE TO THE EXCLUSIVE RIGHT TO USE "STOCKINGS", APART FROM THE MARK AS SHOWN.

THE MARK CONSISTS OF THE WORDS "CONTROLLED EFFICACY STOCKINGS" WITH A DOT BETWEEN "STOCKINGS" AND "CONTROLLED" WITHIN THE BORDER OF A CIRCLE. IN THE MIDDLE OF THE CIRCLE ARE THE LETTERS "CES" AND A GRAPHIC DESIGN DEPICTING LINES AND SWIRLS.

CLASS 10—MEDICAL APPARATUS

FOR MEDICAL STOCKINGS, NAMELY, MEDICAL COMPRESSION STOCKINGS AND COMPRESSION SOCKS AS WELL AS MEDICAL SUPPORT STOCKINGS AND SUPPORT TIGHTS/PANTYHOSE (U.S. CLS. 26, 39 AND 44).

CLASS 25—CLOTHING

FOR HOSIERY, NAMELY, SUPPORT STOCKINGS AND SUPPORT TIGHTS/PANTYHOSE FOR NON-MEDICAL PURPOSES (U.S. CLS. 22 AND 39).

CARYN GLASSER, EXAMINING ATTORNEY

SN 79-103,110. WOOGA GMBH, FED REP GERMANY, FILED 7-5-2011.

DREAM CRUISE

THE MARK CONSISTS OF STANDARD CHARACTERS WITHOUT CLAIM TO ANY PARTICULAR FONT, STYLE, SIZE, OR COLOR.

PRIORITY DATE OF 1-6-2011 IS CLAIMED.
OWNER OF INTERNATIONAL REGISTRATION 1092218
DATED 7-5-2011, EXPIRES 7-5-2021.

CLASS 9—ELECTRICAL AND SCIENTIFIC APPARATUS

FOR COMPUTERS, RECORDED AND DOWNLOADABLE COMPUTER PROGRAMS AND SOFTWARE FOR VIDEO, ONLINE AND BROWSER GAMES AND FOR COMPUTER GAME PROGRAMS ON MOBILE PHONES (U.S. CLS. 21, 23, 26, 36 AND 38).

CLASS 25—CLOTHING

FOR CLOTHING, NAMELY, HEADWEAR, CAPS AND T-SHIRTS; OUTERWEAR, NAMELY, JACKETS (U.S. CLS. 22 AND 39).

CLASS 28—TOYS AND SPORTING GOODS

FOR ELECTRONIC GAMES OTHER THAN THOSE ADAPTED FOR USE WITH TELEVISION RECEIVERS; BOARD GAMES; HAND-HELD UNITS FOR PLAYING ELECTRONIC GAMES OTHER THAN THOSE ADAPTED FOR USE WITH AN EXTERNAL DISPLAY SCREEN OR MONITOR; LCD GAME MACHINES (U.S. CLS. 22, 23, 38 AND 50).

CLASS 35—ADVERTISING AND BUSINESS

FOR ADVERTISING SERVICES, ONLINE ADVERTISING FOR OTHERS ON A COMPUTER NETWORK, DISSEMINATION OF ADVERTISEMENTS FOR OTHERS, DISTRIBUTION OF ADVERTISING MATERIAL IN THE NATURE OF FLYERS, LEAFLETS, PRINTED MATTER, SAMPLES (U.S. CLS. 100, 101 AND 102).

CLASS 38—COMMUNICATION

FOR PROVIDING ACCESS TO AN INTERNET PAGE AND PROVIDING ELECTRONIC TRANSMISSION OF INFORMATION IN THE FORM OF TEXT, IMAGES, SPEECH AND SOUNDS VIA AN INTERNET PAGE; RENTAL OF ACCESS TIME TO AN INTERNET PAGE; PROVIDING ACCESS TO A SOFTWARE IN DATA NETWORKS FEATURING SOFTWARE FOR INTERNET ACCESS; BROADCASTING OF MOVIE, TELEVISION, RADIO, VIDEO TEXT, TELETEXT PROGRAMS OR BROADCASTS IN PARTICULAR ADVERTISING SPOTS; PROVIDING ACCESS TO DATABASES; PROVIDING ACCESS TO DATABASES OR THE INTERNET (U.S. CLS. 100, 101 AND 104).

CLASS 41—EDUCATION AND ENTERTAINMENT

FOR ORGANISING OF GAMES IN THE INTERNET; ENTERTAINMENT, NAMELY, PROVIDING ONLINE COMPUTER, VIDEO AND BROWSER GAMES, ONLINE COMPUTER GAME PROGRAMS FOR MOBILE PHONES AND PROVIDING ENTERTAINMENT INFORMATION ON THE INTERNET; PROVIDING GAME SERVICES OFFERED ONLINE (U.S. CLS. 100, 101 AND 107).

DEIRDRE ROBERTSON, EXAMINING ATTORNEY

SN 79-103,113. CLEAN WRAP CO., LTD., REPUBLIC OF KOREA, FILED 7-19-2011.

ZAZEN BEAR

PRIORITY DATE OF 3-31-2011 IS CLAIMED.
OWNER OF INTERNATIONAL REGISTRATION 1092224
DATED 7-19-2011, EXPIRES 7-19-2021.

THE WORD "ZAZEN" IDENTIFIES A FORM OF ZEN YOGA MEDITATION.

CLASS 3—COSMETICS AND CLEANING PREPARATIONS

FOR COSMETICS; BABY OIL; PERFUMES; SHAMPOOS; BATH SOAP; DENTIFRICES; NATURAL PERFUMERY; BEAUTY MASKS (U.S. CLS. 1, 4, 6, 50, 51 AND 52).

CLASS 10—MEDICAL APPARATUS

FOR BABIES' BOTTLES; NURSING APPLIANCES; BREAST PUMPS; PACIFIERS FOR BABIES; MEDICAL APPARATUS AND INSTRUMENTS (U.S. CLS. 26, 39 AND 44).

CLASS 12—VEHICLES

FOR BABY CARRIAGES; SAFETY SEATS FOR CHILDREN, FOR AUTOMOBILES; WHEELCHAIRS; CHILDREN'S BICYCLES FOR TRANSPORT (U.S. CLS. 19, 21, 23, 31, 35 AND 44).

CLASS 43—HOTEL AND RESTAURANT SERVICES

FOR RESTAURANTS; CAFES; FAST-FOOD RESTAURANTS; HOLIDAY CAMP SERVICES (LODGING); DAY-NURSERIES (U.S. CLS. 100 AND 101).

HENRY S. ZAK, EXAMINING ATTORNEY

SN 79-103,147. YANUA INTERNATIONAL PTE. LTD., SINGAPORE, FILED 2-24-2011.



PRIORITY DATE OF 2-13-2011 IS CLAIMED.
OWNER OF INTERNATIONAL REGISTRATION 1092338
DATED 2-24-2011, EXPIRES 2-24-2021.

THE MARK CONSISTS OF A CIRCULAR DESIGN MADE FROM INTERCONNECTED ELEMENTS OF THE LETTER "Y".

CLASS 9—ELECTRICAL AND SCIENTIFIC APPARATUS

FOR MOTION PICTURE FILMS FEATURING CHILDREN'S ENTERTAINMENT; MUSICAL RECORDINGS; AUDIO RECORDINGS IN THE FIELDS OF MUSIC, SELF-IMPROVEMENT, MATHEMATICS INSTRUCTION; VIDEO RECORDINGS IN THE FIELDS OF MUSIC, SELF-IMPROVEMENT, MATHEMATICS INSTRUCTION; PRERECORDED AUDIO TAPES AND DISCS IN THE FIELDS OF MUSIC, SELF-IMPROVEMENT, MATHEMATICS INSTRUCTION; PRERECORDED VIDEO TAPES AND DISCS IN THE FIELDS OF MUSIC, SELF-IMPROVEMENT, MATHEMATICS INSTRUCTION; MAGNETIC, OPTICAL AND DIGITAL RECORDING MEDIA PRERECORDED WITH EDUCATIONAL AND ENTERTAINING PROGRAMS IN THE FIELDS OF MUSIC, SELF-IMPROVEMENT, MATHEMATICS INSTRUCTION; ELECTRONIC APPARATUS FOR TESTING AUTOMOBILE ENGINE OIL, IN THE NATURE OF MOTION DETECTORS; APPARATUS FOR RECEIVING AND TRANSMITTING SOUND, IMAGES, AND AUDIO AND VIDEO PROGRAMS, NAMELY, SATELLITE TRANSMITTERS AND RECEIVERS, WIRELESS TRANSMITTERS AND RECEIVERS; AUDIO AND VIDEO RECORDING AND REPRODUCING APPARATUS; AUDIO AND VIDEO MACHINES FOR SINGING WITH PRERECORDED BACKGROUND MUSIC, NAMELY, KARAOKE PLAYERS; MICROPHONES; HEADPHONES; SPEAKERS, NAMELY, AUDIO SPEAKERS, LOUD SPEAKERS, BASS SPEAKERS; CABLES, NAMELY, AUDIO CABLES, COAXIAL CABLES AND CONNECTORS, NAMELY, ELECTRIC CONNECTORS, PLUG CONNECTORS; CALCULATORS; DATA PROCESSING EQUIPMENT, NAMELY, DATA PROCESSORS; COMPUTERS; COMPUTER HARDWARE AND SOFTWARE FOR USE IN DATABASE MANAGEMENT, USE AS A

SPREADSHEET, WORD PROCESSING; COMPUTER KEYBOARDS, COMPUTER MOUSE AND MOUSE PADS; WEB CAMS; COMPUTER PERIPHERAL DEVICES AND USB DEVICES, NAMELY, USB (UNIVERSAL SERIAL BUS) HARDWARE, BLANK USB FLASH DRIVES; DATA CARRIERS, NAMELY, BLANK MAGNETIC DATA CARRIERS, BLANK OPTICAL DATA CARRIERS, PRERECORDED MAGNETIC DATA CARRIERS FEATURING MUSIC; RECORDING DISCS, NAMELY, PRERECORDED VIDEO DISCS FEATURING MUSIC, BLANK COMPACT DISCS; BLANK FLASH DRIVES; ELECTRONIC PERSONAL ORGANIZERS; PERSONAL DIGITAL ASSISTANTS; WIRELESS APPARATUS, NAMELY, WIRELESS TELEPHONY APPARATUS, WIRELESS TRANSCEIVER RADIO; TELEPHONES; VIDEOPHONES; CORDLESS TELEPHONES; CELLULAR TELEPHONES; CELLULAR TELEPHONE ACCESSORIES, NAMELY, BELT CLIPS, WIRELESS CELLULAR PHONE HEADSETS; CELLULAR TELEPHONE CASES; RADIOS; WALKIE-TALKIES; ELECTRONIC GAMES PROGRAMS; VIDEO GAME MACHINES FOR USE WITH TELEVISIONS OR MONITORS; PORTABLE GAMING SYSTEMS COMPRISED OF AND GAMING MACHINES ALL FOR USE WITH TELEVISIONS OR MONITORS; STANDALONE PORTABLE VIDEO GAMES, NAMELY, HANDHELD ELECTRONIC GAME UNITS ADAPTED FOR USE WITH TELEVISIONS OR MONITORS; VIDEO GAME DISCS, SOFTWARE, CARTRIDGES; VIDEO AND COMPUTER GAME PROGRAMS; VIDEO AND COMPUTER GAME CARTRIDGES; VIDEO AND COMPUTER GAME DEVICES, NAMELY, HAND HELD JOY STICK UNITS FOR PLAYING VIDEO AND COMPUTER GAMES; PRERECORDED VIDEO GAME DISCS; PRERECORDED OPTICAL AND MAGNETIC DATA CARRIERS FEATURING, MUSIC, SELF-IMPROVEMENT, MATHEMATICS INSTRUCTION; INTERACTIVE VIDEO GAME PROGRAMS; MOTION-CONTROLLED VIDEO GAME PROGRAMS; MOTION-CONTROLLED VIDEO GAME MACHINES FOR USE WITH TELEVISIONS OR MONITORS; MOTION-SENSITIVE GAME CONTROLLERS FOR VIDEO GAMES; INTERACTIVE MULTIMEDIA COMPUTER GAME PROGRAMS; VIDEO AND COMPUTER INTERACTIVE GAME PROGRAMS COMBINING ANIMATED IMAGES OR LIVE-ACTION IMAGES WITH DATA AND SYNCHRONIZED SOUND FOR ENTERTAINMENT AND EDUCATIONAL USE; PLAYING APPARATUS FOR USE WITH TELEVISIONS OR MONITORS, NAMELY, VIRTUAL REALITY HEADSETS AND HELMETS FOR USE IN PLAYING VIDEO GAMES; DVD AND CD ROMS WITH RECORDED GAME SOFTWARE; VIDEO GAME CARDS, NAMELY, VIDEO GAME CARTRIDGES; VIDEO AND COMPUTER GAME DATA STORAGE APPARATUS, NAMELY, VIDEO AND COMPUTER GAME DISCS; DOWNLOADABLE GAMING PROGRAMS FOR VIDEO AND COMPUTER GAMES, NAMELY, DOWNLOADABLE ELECTRONIC GAME PROGRAMS; DOWNLOADABLE GAMING PROGRAMS FOR PORTABLE LCD ELECTRONIC GAMES, NAMELY, DOWNLOADABLE ELECTRONIC GAME PROGRAMS; VIDEO GAME JOYSTICKS; HANDHELD JOYSTICK UNITS FOR PLAYING VIDEO AND COMPUTER GAMES; CONTROLLERS AND ACCESSORIES, NAMELY, GUITAR SKINS FOR ELECTRONIC GUITAR GAME CONTROLLERS FOR PLAYING VIDEO AND COMPUTER GAMES; ELECTRONIC GAME PROGRAMS; GAME SOFTWARE; VIDEO GAME SYSTEMS COMPRISED OF AUDIO AND VISUAL HEADSETS FOR USE IN PLAYING VIDEO GAMES AND VIDEO GAME MACHINES ALL FOR USE WITH EXTERNAL DISPLAY SCREEN OR MONITOR; VIDEO AND COMPUTER GAME CONTROLLERS; VIDEO AND COMPUTER GAME ACCESSORIES, NAMELY, GAMING HEADSETS FOR USE IN PLAYING VIDEO AND COMPUTER GAMES; ACCESSORIES FOR VIDEO AND COMPUTER GAME CONTROLLERS, NAMELY, GUITAR SKINS FOR ELECTRONIC GUITAR GAME CONTROLLERS; OPTICAL APPARATUS AND INSTRUMENTS, NAMELY, OPTICAL MIRRORS, OPTICAL LENSES; MAGNIFYING DEVICES, NAMELY, MAGNIFYING GLASSES, MAGNIFYING LENSES AND VIDEO DEVICES, NAMELY, VIDEO DISK PLAYERS, VIDEO PROCESSORS; BINOCULARS; THREE DIMENSIONAL VIEWERS, NAMELY, THREE DIMENSIONAL GLASSES; BATTERIES; BATTERY CHARGERS; TRANSFORMERS; PHOTOGRAPHIC AND CINEMATOGRAPHIC APPARATUS AND INSTRUMENTS, NAMELY, VIDEO CAMERAS; TEACHING APPARATUS AND INSTRUMENTS, NAMELY, MEDICAL TEACHING MANNEQUINS, COMPUTERS; AUTOMATIC VENDING MACHINES AND MECHANISMS

FOR COIN-OPERATED APPARATUS; EYEGLASSES; SUNGLASSES; EYEGLASS CASES; DECORATIVE MAGNETS; PARTS AND FITTINGS FOR ALL THE AFORESAID GOODS (U.S. CLS. 21, 23, 26, 36 AND 38).

CLASS 16—PAPER GOODS AND PRINTED MATTER

FOR WRITING ARTICLES, INSTRUMENTS AND MATERIALS, NAMELY, PENCILS, PENS, NOTEBOOKS; DRAWING ARTICLES, INSTRUMENTS AND MATERIALS, NAMELY, COLOR PENCILS, DRAWING BOARDS; ARTS AND CRAFT PAINT KITS AND ACCESSORIES, NAMELY, ART PAPER, CRAFT PAPER; COLORING PENCILS; CRAYONS; STAMPS, NAMELY, INK STAMPS, RUBBER STAMPS AND INKS, NAMELY, STAMP INKS, WRITING INK; PRINTED MATTER, NAMELY, GREETING CARDS, PRINTED PERIODICALS IN THE FIELD OF DANCE; BOOKS AND BOOKLETS IN THE FIELDS OF HISTORY, FASHION; PICTURE BOOKS; COMIC BOOKS; COMIC STRIPS; CARTOON STRIPS; MAGAZINES IN THE FIELDS OF GARDENING, FASHION; PRINTED PERIODICALS IN THE FIELDS OF GARDENING, FASHION; MOVIE NOVELS; PRINTED GUIDES FOR VIDEO GAMES; PAINTINGS; PORTRAITS; PHOTOGRAPHS; PICTURES; POSTERS; ART PRINTS; POSTCARDS; STICKERS; DECALS; IRON-ON AND PLASTIC PRINTED TRANSFERS; CHRISTMAS CARDS; GREETING CARDS; INVITATION CARDS; STATIONERY; LETTERHEAD PAPER; ENVELOPES; NAME CARDS, NAMELY, BUSINESS CARDS, PAPER NAME BADGES; NOTEBOOKS; NOTE PAPER; MEMO PADS; CALENDARS; DIARIES; ADDRESS BOOKS; GUEST BOOKS; PENS AND PENCILS; INK REFILLS FOR PENS AND PENCIL LEAD REFILLS FOR PENCILS; PENCIL SHARPENERS; PEN AND PENCIL CASES AND BOXES; RULERS, NAMELY, UNGRADUATED RULERS, DRAFTING RULERS; ERASERS; SCHOOL WRITING BOOKS AND SLATE BOARDS, LAP BOARDS FOR WRITING; WIRE-BOUND BOOKS FOR DRAWING AND DRAWING BOARDS; COLORING BOOKS AND PAPER BOARDS FOR COLORING; PICTURE BOOKS AND ILLUSTRATION BOARDS; CHILDREN'S ACTIVITY BOOKS; TRADING CARDS; FLASH CARDS; ADHESIVES FOR STATIONERY OR HOUSEHOLD PURPOSES; BOOKBINDING MATERIALS; STAPLERS; BINDERS; BOOK COVERS; BOOKMARKS; PHOTOGRAPH ALBUMS; STAMP ALBUMS; COIN ALBUMS; PAPER AND PAPER ARTICLES, NAMELY, GRAPH PAPER, PAPER LABELS; CARDBOARD AND CARDBOARD ARTICLES, NAMELY, CARDBOARD BOXES, CARDBOARD SIGNBOARDS; ARTISTS' MATERIALS, NAMELY, ARTISTS' PASTELS, CANVAS FOR PAINTING; PAINT BRUSHES; MODELING PLASTICS, NAMELY, MOLDS FOR MODELING CLAYS; MODELING COMPOUNDS AND MATERIALS, NAMELY, MODELING CLAY, MODELING PASTE; PRINTED INSTRUCTIONAL, TEACHING AND EDUCATIONAL MATERIALS IN THE FIELDS OF MATH, SCIENCE; OFFICE REQUISITES EXCEPT FURNITURE, NAMELY, STAPLERS, PUNCHES; BOOKENDS; PAPERWEIGHTS; PRINTERS' TYPE; PRINTING BLOCKS; DISPOSABLE DIAPERS FOR BABIES; PAPER NAPKINS; PLASTIC MATERIALS FOR PACKAGING PURPOSES, NAMELY, PLASTIC BUBBLE PACKS FOR PACKAGING, PLASTIC BAGS FOR PACKAGING; GIFT CARDS; GIFT WRAPPING PAPER; DECORATIVE PAPER, NAMELY, ART PAPER; PAPER BAGS AND CARDBOARD BOXES; PRINTED ADVERTISING AND PROMOTIONAL MATERIALS, NAMELY, PRINTED ADVERTISING PAMPHLETS, PRINTED ADVERTISING SIGNS OF PAPER OR CARDBOARD (U.S. CLS. 2, 5, 22, 23, 29, 37, 38 AND 50).

CLASS 28—TOYS AND SPORTING GOODS

FOR TOYS, GAMES AND PLAYTHINGS, NAMELY, CONSTRUCTION TOYS, BOARD GAMES, PUPPET THEATRES; TOY ACTION FIGURES; DOLLS AND DOLL PLAY SETS; DOLL CLOTHING, DOLL ACCESSORIES; TOY ANIMALS; PLUSH TOYS; STUFFED TOYS; TOY VEHICLES; SPINNING TOYS, NAMELY, SPINNING TOPS; TOY WHEELS, NAMELY, FINGERBOARD WHEELS, SKATEBOARD WHEELS; INTERACTIVE TOYS AND GAMES, NAMELY, INTERACTIVE ACTION FIGURE TOYS, INTERACTIVE PINBALL GAMES; CHILDREN'S MULTIPLE ACTIVITY TOYS AND PLAY SETS; OUTDOOR ACTIVITY TOYS,

NAMELY, BASEBALL BATS, SOCCER BALLS; FLYING TOYS, NAMELY, FLYING SAUCERS, TOY AIRPLANES; KITES; WATER TOYS AND POOL TOYS, NAMELY, BEACH BALLS, SWIM FLOATS FOR RECREATIONAL USE; WATER SQUIRTING TOYS; TOY BUCKET AND SHOVEL SETS; BEACH BALLS; INFLATABLE TOYS; BUBBLE MAKING WAND AND SOLUTION SETS; CONSTRUCTION TOYS; TOY BUILDING BLOCKS; MUSICAL TOYS; ELECTRONIC LEARNING TOYS; TOY SCALE MODELS OR REPLICAS, NAMELY, SCALE MODEL AIRCRAFT, SCALE MODEL VEHICLES; COLLECTIBLE TOY FIGURES; PUPPETS; TOY MOULDS, NAMELY, MOLDED TOY FIGURES AND MOULDING COMPOUNDS AND MATERIALS, NAMELY, TOY PUTTY; JIGSAW PUZZLES; PLAYING CARDS; CARD GAMES; BOARD GAMES; BALL GAMES, NAMELY, PADDLE BALL GAMES, HAND BALLS; TOY SPORTING ARTICLES, NAMELY, BALL PITCHING SCREENS, TENNIS RACKETS; ATHLETIC, GYMNASTIC AND SPORTING ARTICLES, NAMELY, MOUTH GUARDS, SPRINGBOARDS; SPORT BALLS; GOLF BALLS; GOLF BALL MARKERS; JUMP ROPES; SKATEBOARDS; KNEE GUARDS AND WRIST GUARDS FOR ATHLETIC USE; ORNAMENTS AND DECORATIONS FOR CHRISTMAS TREES; CHRISTMAS STOCKINGS; BALLOONS; PARTY GAMES; CHARACTER PLAYING TOYS, NAMELY, FACE MASKS; PAPER PARTY HATS AND COSTUME MASKS; PARTY FAVORS IN THE NATURE OF SMALL TOYS; FESTIVAL TOYS, NAMELY, PINATAS; TOY PLAY SETS FOR DOLLS; ELECTRONIC TOYS, NAMELY, ELECTRONIC ACTION TOYS, ELECTRONIC LEARNING TOYS; ELECTRIC TOYS, NAMELY, ELECTRIC ACTION TOYS, ELECTRIC TOY TRAIN TRANSFORMERS; MECHANICAL TOYS; WIND-UP TOYS; SQUEEZE TOYS; ACTION SKILL GAMES; TARGET GAMES; SHOOTING GAME TOYS, NAMELY, TOY GUNS, PAINTBALL GUNS; DRIVING GAME TOYS, NAMELY, TOY CARS; TOYS WITH LIGHT VISUAL EFFECTS AND AUDIO SOUND EFFECTS, NAMELY, ELECTRONIC ACTION TOYS, TALKING ELECTRONIC PRESS-DOWN TOY; PARLOR GAMES; ELECTRONIC GAMES NOT FOR USE WITH TELEVISIONS OR MONITORS; VIDEO GAMES NOT FOR USE WITH TELEVISIONS OR MONITORS, NAMELY, STANDALONE VIDEO GAME MACHINES; HANDHELD UNIT FOR PLAYING ELECTRONIC GAMES OTHER THAN THOSE ADAPTED FOR USE WITH AN EXTERNAL DISPLAY SCREEN OR MONITOR; HANDHELD UNIT FOR PLAYING VIDEO GAMES OTHER THAN THOSE ADAPTED FOR USE WITH AN EXTERNAL DISPLAY SCREEN OR MONITOR; HANDHELD LCD GAME MACHINES; BATTERY-POWERED VIDEO GAME WITH LCD SCREEN WHICH FEATURES ANIMATION AND SOUND EFFECTS; PARTS AND FITTINGS FOR ALL THE AFORESAID GOODS (U.S. CLS. 22, 23, 38 AND 50).

CLASS 29—MEATS AND PROCESSED FOODS

FOR MEAT, FISH, POULTRY AND GAME; MEAT EXTRACTS; PRESERVED, FROZEN, DRIED AND COOKED FRUITS AND VEGETABLES; JELLIES, JAMS, COMPOTES; EGGS, MILK AND MILK PRODUCTS EXCLUDING ICE CREAM, ICE MILK AND FROZEN YOGURT; EDIBLE OILS AND FATS; CHEESE; DIARY BASED FOOD PRODUCTS, NAMELY, DAIRY-BASED DIPS, DAIRY-BASED FOOD BEVERAGES; NON-DAIRY CREAMERS (U.S. CL. 46).

CLASS 30—STAPLE FOODS

FOR COFFEE, TEA, COCOA, SUGAR, RICE, TAPIOCA, SAGO, ARTIFICIAL COFFEE; FLOUR AND PREPARATIONS MADE FROM CEREALS, NAMELY, BREAKFAST CEREALS, CEREAL BASED SNACK FOOD; BISCUITS, CAKES, COOKIES, WAFERS, PUDDINGS; ICE CREAM; CHOCOLATE, CHOCOLATE PRODUCTS, NAMELY, CHOCOLATE CHIPS, CHOCOLATE MOUSSE; CHOCOLATE-BASED PREPARATIONS, NAMELY, CHOCOLATE FONDUE, CHOCOLATE-BASED FILLINGS FOR CAKES AND PIES AND BEVERAGES WITH A CHOCOLATE BASE; BREAD, PASTRY AND CONFECTIONERY, NAMELY, FONDANTS, PASTILLES; EDIBLE ICES; HONEY, TREACLE; YEAST, BAKING-POWDER; SALT, MUSTARD; VINEGAR; SAUCES; SPICES; ICE; PASTA; NOODLES; PIZZAS; SANDWICHES; TEA-BASED BEVERAGES (U.S. CL. 46).

CLASS 32—LIGHT BEVERAGES

FOR BEERS, MINERAL AND AERATED WATERS AND OTHER NON-ALCOHOLIC DRINKS, NAMELY, LEMONADES, COLAS; FRUIT DRINKS AND FRUIT JUICES; SYRUPS AND OTHER PREPARATIONS FOR MAKING BEVERAGES, NAMELY, FRUIT DRINKS, LEMONADES; SOYA-BASED BEVERAGES NOT BEING MILK SUBSTITUTES; MALT-BASED BEVERAGES, NAMELY, MALT BEER; NON-ALCOHOLIC BEVERAGES WITH TEA FLAVOR, SOFT DRINKS FLAVORED WITH TEA; READY TO DRINK BEVERAGES, NAMELY, SODA POPS, FRUIT BEVERAGES; ISOTONIC BEVERAGES (U.S. CLS. 45, 46 AND 48).

CLASS 34—SMOKERS' ARTICLES

FOR TOBACCO, RAW OR MANUFACTURED; TOBACCO PRODUCTS, NAMELY, CIGARS, CIGARETTES, CIGARILLOS, TOBACCO FOR ROLL YOUR OWN CIGARETTES, PIPE TOBACCO, CHEWING TOBACCO, SNUFF TOBACCO, KRETEK CIGARETTES, SNUSS; TOBACCO SUBSTITUTES NOT FOR MEDICAL PURPOSES; SMOKERS' ARTICLES, NAMELY, CIGARETTE PAPER AND TUBES, POCKET APPARATUS FOR ROLLING CIGARETTES, CIGARETTE FILTERS, TOBACCO TINS, CIGARETTE CASES, SMOKING PIPES, TOBACCO PIPE FILTERS, ASHTRAYS, TOBACCO SMOKE FILTERS, LIGHTERS FOR SMOKERS; MATCHES (U.S. CLS. 2, 8, 9 AND 17).

CLASS 41—EDUCATION AND ENTERTAINMENT

FOR ENTERTAINMENT AND RECREATIONAL SERVICES, NAMELY, DANCE CLUB SERVICES, LIVE MUSIC CONCERTS; PROVISION OF ENTERTAINMENT FACILITIES, NAMELY, PROVISION OF CINEMA FACILITIES, PROVIDING SPORTS FACILITIES; CLUB SERVICES FOR ENTERTAINMENT, RECREATION, HEALTH, SPORT AND EDUCATION PURPOSES, NAMELY, COUNTRY CLUBS, GOLF CLUB SERVICES; PROVIDING KARAOKE FACILITIES; DISCOTHEQUE SERVICES; NIGHT CLUBS; PROVISION OF RECREATIONAL AND SPORTS FACILITIES; HEALTH CLUB SERVICES, NAMELY, PROVIDING INSTRUCTION AND EQUIPMENT IN THE FIELD OF PHYSICAL EXERCISE; RECREATION AND LEISURE CLUB SERVICES, NAMELY, COUNTRY CLUBS; GOLF COURSES AND DRIVING RANGES; PROVIDING TENNIS COURT FACILITIES; PROVIDING SWIMMING POOL FACILITIES; PROVISION OF FITNESS AND EXERCISE FACILITIES; PHYSICAL FITNESS AND EXERCISE INSTRUCTIONS; PROVISION OF GYMNASIUM AND HEALTH CLUB FACILITIES, NAMELY, PROVIDING INSTRUCTION AND EQUIPMENT IN THE FIELD OF PHYSICAL EXERCISE; BODY TRAINING AND SPORTS INSTRUCTIONS; PHYSICAL EDUCATION SERVICES; ENTERTAINMENT, SPORTING AND CULTURAL ACTIVITIES, NAMELY, TRIATHLONS, RECREATIONAL CAMPS; ARRANGING AND ORGANIZATION OF MEETINGS, CONFERENCES, EXHIBITIONS, SOCIAL EVENTS, SHOWS AND DISPLAYS ALL FOR SPORTING AND CULTURAL PURPOSES; ART GALLERY SERVICES, NAMELY, ART EXHIBITION SERVICES; PUBLICATION OF BOOKS, BOOKLETS, PICTURE BOOKS, COMIC BOOKS, COMIC STRIPS, CARTOON STRIPS, MAGAZINES, PERIODICALS, MOVIE NOVELS AND VIDEO GAME GUIDES; ON LINE AND ELECTRONIC PUBLISHING SERVICES OF BOOKS, MAGAZINES; EDUCATION, NAMELY, PROVIDING CLASSES, SEMINARS, WORKSHOPS IN THE FIELDS OF MUSIC, MATH; PROVIDING OF TRAINING IN THE FIELDS OF MUSIC, COMPUTERS; PROVISION OF EDUCATION AND LEARNING FACILITIES, NAMELY, LIBRARIES, BOARDING SCHOOLS; EDUCATION AND TRAINING CENTERS, NAMELY, DANCE SCHOOLS, BEAUTY SCHOOLS; ARRANGING AND CONDUCTING EDUCATIONAL COURSES, LECTURES, SEMINARS, TRAINING PROGRAMS AND WORKSHOPS IN THE FIELDS OF MUSIC, COMPUTERS; TRAINING OF PERSONNEL IN THE FIELDS OF COMPUTER EDUCATION; MOTION PICTURE ENTERTAINMENT, NAMELY, MOTION PICTURE THEATERS, MOTION PICTURE FILM PRODUCTION; TELEVISION ENTERTAINMENT, NAMELY, TELEVISION NEWS SHOWS, ON-GOING TELEVISION PROGRAMS IN THE FIELD OF SPORTS; LIVE ENTERTAINMENT SERVICES, NAMELY, LIVE MUSICAL PERFORMANCES, PRESENTATION OF LIVE COMEDY SHOWS; PRODUCTION, PRESENTATION, DISTRIBUTION AND RENTAL OF MOTION PICTURE FILMS; PRODUCTION AND RENTAL OF MUSICAL RECORDINGS, AUDIO RECORDINGS AND VIDEO RECORDINGS; PRODUCTION, PRESENTATION, DISTRIBUTION AND RENTAL OF TELEVISION PROGRAMS AND RADIO PROGRAMS; PRODUCTION, PRESENTATION, DISTRIBUTION AND RENTAL OF EDUCATIONAL AND ENTERTAINING TELEVISION, RADIO PROGRAMS; PRODUCTION OF INTERACTIVE EDUCATIONAL AND ENTERTAINING TELEVISION, RADIO PROGRAMS; PROVISION OF CONTINUING EDUCATIONAL AND ENTERTAINING PROGRAMS FEATURING NEWS, COMEDY, COMMENTARY DELIVERED VIA GLOBAL COMMUNICATION NETWORKS, COMPUTER NETWORKS AND THE INTERNET; PRODUCTION AND PROVISION OF ANIMATED TELEVISION SERIES; PROVISION OF ELECTRONIC GAMES PLAYABLE VIA GLOBAL COMMUNICATION NETWORKS, COMPUTER NETWORKS AND THE INTERNET, NAMELY, PROVIDING ONLINE ELECTRONIC GAMES; PROVISION OF DOWNLOADABLE COMPUTER GAMES VIA GLOBAL COMMUNICATION NETWORKS, COMPUTER NETWORKS AND THE INTERNET, NAMELY, PROVIDING ON-LINE COMPUTER GAMES; CINEMA THEATERS; AMUSEMENT PARKS; THEME PARKS; GAME ARCADES, NAMELY, AMUSEMENT ARCADES, VIDEO ARCADE SERVICES; CASINOS AND CASINO GAMING SERVICES; LIVE STAGE SHOWS, NAMELY, LIVE MUSIC CONCERTS, LIVE COMEDY SHOWS; LIVE MUSICAL CONCERTS; PRODUCTION AND PRESENTATION OF LIVE SHOW PERFORMANCES BY SINGERS, MUSICIANS, COMEDIANS; THEATRE PRODUCTIONS; ONLINE EDUCATION SERVICES, NAMELY, PROVIDING ONLINE CLASSES, ONLINE SEMINARS, ONLINE WORKSHOPS IN THE FIELDS OF MUSIC, MATH; ONLINE ENTERTAINMENT SERVICES, NAMELY, PROVIDING ON-LINE INTERACTIVE CHILDREN'S STORIES, PROVIDING ONLINE VIDEO GAMES; ON-LINE GAME SERVICES, NAMELY, PROVIDING ON-LINE CARD GAMES, PROVIDING AN ON-LINE BOARD GAME, PROVIDING ON-LINE COMPUTER GAMES (U.S. CLS. 100, 101 AND 107).

FOR HOSPITALITY SERVICES, NAMELY, SERVING FOOD AND DRINKS, BED AND BREAKFAST INN SERVICES; PROVISION OF TEMPORARY ACCOMMODATIONS AND LODGINGS; HOTEL, MOTEL, MOTOR INN, RESORT LODGING AND GUESTHOUSE SERVICES; ARRANGING TEMPORARY HOUSING ACCOMMODATIONS AT HOLIDAY VILLAS, COTTAGES, LODGES AND RETREATS; PROVISION OF FACILITIES FOR MEETINGS, CONFERENCES AND EXHIBITIONS; PROVISION OF FACILITIES FOR SOCIAL FUNCTIONS AND EVENTS; PROVISION OF HOTEL FACILITIES, NAMELY, BALL ROOMS, FUNCTION ROOMS AND MEETING ROOMS; HOTEL CONCIERGE SERVICES; RESTAURANT, HOT POT RESTAURANT, BARBECUE RESTAURANT, SASHIMI AND SUSHI BAR, TEA HOUSE, COFFEE SHOP, CAKE SHOP, NAMELY, CAFES FEATURING CAKES, CATERING IN THE FIELD OF CAKES; CAFE, CAFETERIA, FAST FOOD RESTAURANTS, SELF-SERVICE RESTAURANT, CANTEEN, SNACK BAR AND FOOD COUNTER SERVICES, NAMELY, MOBILE CAFE SERVICES FOR PROVIDING FOOD; COCKTAIL AND BAR LOUNGE SERVICES; PROVISION OF FOOD AND DRINK FOR DINE IN, TAKE HOME AND DELIVERY; PROVISION OF FOOD AND DRINK FOR CONSUMPTION ON AND OFF HOTEL PREMISES; CATERING AND BANQUETING SERVICES; PROVISION OF BANQUET AND SOCIAL FUNCTION FACILITIES; THE OPERATION OF HOTELS AND RESORTS, NAMELY, HOTELS AND RESORT HOTELS SERVICES; RESTAURANTS AND BARS; RESERVATION SERVICES FOR TEMPORARY ACCOMMODATIONS, HOTEL SERVICES AND HOTEL FACILITIES (U.S. CLS. 100 AND 101).

CLASS 43—HOTEL AND RESTAURANT SERVICES

JORDAN BAKER, EXAMINING ATTORNEY

SN 79-103,159. COCHLEAR LIMITED, NSW 2109, AUSTRALIA, FILED 6-30-2011.

MYCOCHLEAR

THE MARK CONSISTS OF STANDARD CHARACTERS WITHOUT CLAIM TO ANY PARTICULAR FONT, STYLE, SIZE, OR COLOR.

PRIORITY DATE OF 6-9-2011 IS CLAIMED.
OWNER OF INTERNATIONAL REGISTRATION 1092373 DATED 6-30-2011, EXPIRES 6-30-2021.

CLASS 42—SCIENTIFIC AND COMPUTER SERVICES

FOR DESIGN AND DEVELOPMENT OF COMPUTER HARDWARE AND SOFTWARE; PROVIDING A WEBSITE FEATURING ONLINE NON-DOWNLOADABLE SOFTWARE FOR MANAGEMENT OF PATIENT MEDICAL AND DEVICE INFORMATION; COMPUTER SERVICES, NAMELY, CREATING AN ON-LINE COMMUNITY FOR REGISTERED USERS TO PARTICIPATE IN DISCUSSIONS, FORM VIRTUAL COMMUNITIES, AND ENGAGE IN SOCIAL NETWORKING (U.S. CLS. 100 AND 101).

CLASS 44—MEDICAL, BEAUTY AND AGRICULTURAL SERVICES

FOR MEDICAL SERVICES; PROVIDING MEDICAL AND MEDICAL DEVICE INFORMATION INCLUDING IN THE FIELD OF PROSTHETIC HEARING DEVICES VIA THE INTERNET (U.S. CLS. 100 AND 101).

CLASS 45—PERSONAL AND LEGAL SERVICES

FOR ONLINE SOCIAL NETWORKING SERVICES (U.S. CLS. 100 AND 101).
KRISTIN CARLSON, EXAMINING ATTORNEY

SN 79-103,182. INDUSTRIA DE DISEÑO TEXTIL, S.A. (INDITEX, S.A.), E-15142 ARTEIXO (A CORUÑA), SPAIN, FILED 9-7-2010.

BERSHKA

OWNER OF INTERNATIONAL REGISTRATION 0928432 DATED 1-2-2007, EXPIRES 1-2-2017.

OWNER OF U.S. REG. NOS. 2,539,882, 4,019,521 AND OTHERS.

THE WORD(S) "BERSHKA" HAS NO MEANING IN A FOREIGN LANGUAGE.

CLASS 9—ELECTRICAL AND SCIENTIFIC APPARATUS

FOR SCIENTIFIC, NAUTICAL, SURVEYING, PHOTOGRAPHIC, CINEMATOGRAPHIC, OPTICAL, WEIGHING, MEASURING, SIGNALLING, MONITORING, SUPERVISION, EMERGENCY, LIFE-SAVING AND TEACHING APPARATUS AND INSTRUMENTS, NAMELY, MEDICAL TEACHING MANNEQUINS, PHOTOGRAPHIC SLIDES, AND OPTICAL FIBERS; APPARATUS AND INSTRUMENTS FOR CONDUCTING, SWITCHING, TRANSFORMING, ACCUMULATING, REGULATING OR CONTROLLING ELECTRICITY, NAMELY, ELECTRICAL SWITCHES, ELECTRIC CONDUCTORS, ELECTRIC TRANSFORMERS; APPARATUS FOR RECORDING, TRANSMITTING, AND REPRODU-

CING SOUND OR IMAGES; MAGNETIC DATA MEDIA, NAMELY, BLANK MAGNETIC DATA CARRIERS, PRE-RECORDED MAGNETIC DATA CARRIERS FEATURING MUSIC, FILMS AND PHOTOGRAPHS; SOUND RECORDING DISKS, NAMELY, BLANK RECORDABLE OPTICAL DISCS; AUTOMATIC VENDING MACHINES AND MECHANISMS FOR COIN-OPERATED APPARATUS; CASH REGISTERS; CALCULATING MACHINES; DATA PROCESSING AND COMPUTER EQUIPMENT, NAMELY, DATA PROCESSORS AND COMPUTERS; COMPUTER PERIPHERAL DEVICES; FIRE EXTINGUISHERS; ANTI-DAZZLE SPECTACLES; EYEGLASSES; PINCE-NEZ; OPTICAL LENSES; PINCE-NEZ CHAINS; CONTACT LENSES; PINCE-NEZ CORDS; DRESSMAKERS' MEASURES, NAMELY, MEASURING TAPES; SPECTACLES; SPECTACLE LENSES; SPECTACLES CASES; SPECTACLE FRAMES AND LENSES; EYEGLASSES; SUNGLASSES; CASES FOR EYEGLASSES AND FOR CONTACT LENSES; SHOES FOR PROTECTION AGAINST ACCIDENTS, IRRADIATION AND FIRE; BULLETPROOF JACKETS; LIFE JACKETS; FIRE PROTECTION SUITS AND CLOTHING; GLOVES FOR DIVERS; GLOVES FOR PROTECTION AGAINST ACCIDENTS; SURVIVAL SUITS, NAMELY, INSULATED OVERALL WETSUITS; MAGNETIC CARDS, NAMELY, MAGNETIC IDENTIFYING CARDS AND MAGNETIC CODED GIFT CARDS; MAGNETIC IDENTITY CARDS; CLOTHING FOR PROTECTION AGAINST ACCIDENTS AND IRRADIATION; PROTECTIVE SUITS FOR AVIATORS; ELECTRONIC AGENDAS; ELECTRIC APPLIANCES FOR REMOVING MAKE-UP; TELEPHONE SETS; WEIGHING SCALES; COMPASSES; ACCOUNTING MACHINES, NAMELY, AUTOMATED BILLING MACHINES FOR PROCESSING ACCOUNTING INFORMATION; PROTECTIVE HELMETS; SPYGLASSES; CHRONOGRAPHS FOR USE AS SPECIALIZED TIME RECORDING APPARATUSES; MEASURING SPOONS; PEDOMETERS; AUDIO-VIDEO COMPACT DISCS FEATURING MUSIC, FILMS AND PHOTOGRAPHS; READ-ONLY MEMORY COMPACT DISKS FEATURING MUSIC, FILMS AND PHOTOGRAPHS; MIRRORS, NAMELY, INSPECTIONS MIRRORS AND REFLECTIVE MIRRORS TO PREVENT ACCIDENTS; SWIM FLOATS FOR SAFETY PURPOSES FOR BATHING AND SWIMMING; BINOCULARS; PRINTERS FOR USE WITH COMPUTERS; TEMPERATURE INDICATORS; COMPUTER GAME PROGRAMS; CASSETTE PLAYERS; BAR CODE READERS; OPTICAL SIGNAL AND MAGICAL LANTERNS; OPTICAL LAMPS, NAMELY, FLASH LAMPS; MAGNIFYING GLASSES; DICTATING MACHINES; TEST WEIGHTS; ELECTRIC, GALVANIC AND SOLAR BATTERIES; ELECTRIC IRONS; COMPUTER SOFTWARE FOR CREATING DATABASES AND FOR ORDERING, CONFIGURING AND PREPARING PRICE QUOTES FOR ELECTRICAL DISTRIBUTION PRODUCTS; RECORDED COMPUTER OPERATING PROGRAMS; COMPUTER MICE; ELECTRONIC POCKET TRANSLATORS; TRANSISTORS; THERMOMETERS NOT FOR MEDICAL USE; APPARATUS FOR GAMES ADAPTED FOR USE WITH TELEVISION RECEIVERS ONLY; INTERCOMS; BLANK VIDEO CASSETTES; VIDEO DISKS AND VIDEO TAPES WITH RECORDED ANIMATED CARTOONS; TEACHING APPARATUS, NAMELY, MEDICAL TEACHING MANNEQUINS; BABY CRY DETECTORS, NAMELY, BABY MONITORS; WALKIE-TALKIES; DOWNLOADABLE ELECTRONIC PUBLICATIONS IN THE NATURE OF MAGAZINES IN THE FIELDS OF TEXTILES, RETAIL SERVICES, FASHION AND BUSINESS ADMINISTRATION; SANDGLASSES; ACOUSTIC SOUND ALARMS; THEFT ALARMS; FIRE ALARMS; MOUSEPADS; LOUDSPEAKERS; APPARATUS FOR SOUND AMPLIFICATION, NAMELY, SOUND AMPLIFIERS; ANTENNAE; ANTI-DAZZLE SHADES, NAMELY, ANTI-DAZZLE SUNGLASSES; HEADSETS FOR TELEPHONES; HEADSETS FOR MUSIC, NAMELY, EARPHONES; TELEPHONE ANSWERING MACHINES; FALSE COIN DETECTORS, NAMELY, COIN ACCEPTORS FOR SEPARATING GOOD COINS FROM COUNTERFEITS; MONEY COUNTING AND SORTING MACHINES; ELECTRONIC TAGS FOR GOODS; SPORTS GLASSES; MAGNETS; LIGHT-EMITTING ELECTRONIC POINTERS; EAR PLUGS NOT FOR MEDICAL PURPOSES; MOBILE TELEPHONES (U.S. CLS. 21, 23, 26, 36 AND 38).

CLASS 14—JEWELRY

FOR PRECIOUS METALS AND THEIR ALLOYS; GOODS IN PRECIOUS METALS OR COATED THEREWITH NOT INCLUDED IN OTHER CLASSES, NAMELY, CUFF LINKS OF PRECIOUS METAL AND FIGURES OF PRECIOUS METAL; JEWELRY; PRECIOUS STONES; HOROLOGICAL AND CHRONOMETRIC INSTRUMENTS; ORNAMENTAL PINS; TIE PINS; NEEDLE CASES OF PRECIOUS METAL; CASES FOR NEEDLES OF PRECIOUS METALS; NAPKIN RINGS OF PRECIOUS METAL; WORKS OF ART OF PRECIOUS METAL; FANCY KEY RINGS OF PRECIOUS METAL; MEDALS; COLLECTIBLE COINS; SILVER AND GOLD-PLATED ITEMS EXCEPT KNIVES, FORKS AND SPOONS, NAMELY, JEWELRY; BADGES OF PRECIOUS METAL; ORNAMENTS OF PRECIOUS METALS FOR FOOTWEAR AND HATS; ASHTRAYS OF PRECIOUS METAL FOR SMOKERS; CUFF LINKS; WATCH CHAINS; CLOCK CASES; CRUETS OF PRECIOUS METAL; VASES OF PRECIOUS METAL; TEA AND COFFEE SERVICES IN PRECIOUS METALS; THREADS OF PRECIOUS METAL; JEWEL CASES IN PRECIOUS METALS; CIGARETTE CASES OF PRECIOUS METAL; POWDER COMPACTS OF PRECIOUS METAL (U.S. CLS. 2, 27, 28 AND 50).

CLASS 16—PAPER GOODS AND PRINTED MATTER

FOR PAPER, CARDBOARD AND GOODS MADE OF THESE MATERIALS, NAMELY, BOXES OF PAPER, CARDBOARD TUBES, PAPER MACHE FIGURINES, CARDBOARD BOXES, AND HANG TAGS; PRINTED MATTER, NAMELY, PRINTED CALENDARS AND PRINTED FORMS; BOOKBINDING MATERIAL; PHOTOGRAPHS; STATIONERY; ADHESIVES FOR STATIONERY OR HOUSEHOLD PURPOSES; ARTISTS' SUPPLIES, NAMELY, ARTISTS' BRUSHES, ARTISTS' PENS, EASELS, ARTISTS' PENCILS, ARTISTS' PASTELS AND MODELING CLAY; PAINTBRUSHES; TYPEWRITERS; OFFICE REQUISITES, NAMELY, PUNCHES, STAPLERS AND PAPER EMBOSSERS; INSTRUCTIONAL AND TEACHING MATERIAL, NAMELY, PRINTED TEACHING MATERIALS IN THE FIELD OF TEXTILES, RETAIL SERVICES, FASHION AND BUSINESS ADMINISTRATION; PLASTIC MATERIALS FOR PACKAGING, NAMELY, PLASTIC BAGS FOR PACKAGING; PRINTERS' TYPE; PRINTING BLOCKS; ENGRAVED WORKS OF ART, NAMELY, LITHOGRAPHIC WORKS OF ART; CARDBOARD OR PAPER BOXES; PRINTED PATTERNS FOR MAKING CLOTHES AND SEWING; PAPER TISSUES FOR REMOVING MAKE-UP; STENCIL CASES; NON-TEXTILE LABELS, NAMELY, SHIPPING LABELS, ADHESIVE LABELS, PAPER LABELS AND MAILING LABELS; TABLE LINEN OF PAPER; TABLE NAPKINS OF PAPER; DISPOSABLE BABIES' DIAPERS OF PAPER AND CELLULOSE; DISPOSABLE NAPPIES OF PAPER OR CELLULOSE; PAPER HANDKERCHIEFS; PEN HOLDERS; CHECK BOOK HOLDERS; STATIONERY CASES; INKING SHEETS FOR DOCUMENT REPRODUCING MACHINES FOR REPRODUCING IMAGES IN THE PRINTING INDUSTRY; BAGS, ENVELOPES AND POUCHES OF PAPER OR PLASTICS FOR MERCHANDISE PACKAGING; TAILORS' CHALK; FACE TOWELS OF PAPER; HAT BOXES OF PAPER; TRACING PAPER; BOOKBINDING CLOTH; CANVASES FOR PAINTING; HAND TOWELS OF PAPER; PHOTOGRAPH, STAMP AND STICKER ALBUMS; ALMANACS; HAND LABELING APPLIANCES, NAMELY, HANDHELD LABELING DEVICES; LOOSE-LEAF BINDERS; WRITING ARTICLES AND INSTRUMENTS, NAMELY, PENS AND PENCILS; IRON-ON TRANSFERS AND PLASTIC TRANSFERS; CALENDARS; POSTERS; PAPER FILE JACKETS FOR PAPERS; PASSPORT HOLDERS; CATALOGUES IN THE FIELD OF CLOTHING, FOOTWEAR, JEWELRY, ACCESSORIES, PERFUMES AND COSMETICS; CHROMOS, NAMELY, PICTURE CARDS; DRAWING SETS COMPRISED OF DRAWING PADS, DRAWING CURVES, AND DRAWING BRUSHES; DAILY NEWSPAPERS; NEWSPAPERS; MAGAZINES FEATURING TEXTILES, RETAIL SERVICES, FASHION AND BUSINESS ADMINISTRATION; SEALING WAX; BOOKS IN THE FIELD OF TEXTILES, RETAIL SERVICES, FASHION AND BUSINESS ADMINISTRATION; LITHOGRAPHS; WRAPPING PAPER; TOILET PAPER; PAPERWEIGHTS; MATS FOR BEER GLASSES, NAMELY, COASTERS OF PAPER; BOOKMARKERS; BOOKENDS; INKWELLS; PAPER

BIBS; DRAWING ARTICLES, NAMELY, DRAWING BOARDS AND DRAWING CURVES; DESIGNS, NAMELY, EMBROIDERY DESIGN PATTERNS; SCHOOL SUPPLIES, NAMELY, SCHOOL WRITING BOOKS; WRITING SLATES; COMIC BOOKS; EMBROIDERY DESIGN PATTERNS; PAPER AND PLASTIC PACKING BAGS; GEOGRAPHICAL MAPS; TERRESTRIAL GLOBES; FINGER MOISTENERS; PRINTED PLANS; STENCILS; PAPER OR CARDBOARD PLACARDS; PRINTED CHARTS; PUBLICATIONS, NAMELY, BOOKS, HANDOUTS, WORKBOOKS, MAGAZINES, BROCHURES, BOOKLETS IN THE FIELDS OF TEXTILES, RETAIL SERVICES, FASHION AND BUSINESS ADMINISTRATION (U.S. CLS. 2, 5, 22, 23, 29, 37, 38 AND 50).

CLASS 25—CLOTHING

FOR MEN'S, WOMEN'S AND CHILDREN'S READY-TO-WEAR CLOTHING, NAMELY, JACKETS, SHIRTS, PANTS, SKIRTS, TROUSERS, JEANS, DRESSES, LEGGINGS, T-SHIRTS, BLOUSES, JERSEYS, SHORTS, TOPS, COATS, PARKAS, UNDERSHIRTS, OVERCOATS, WAISTCOATS, SWEATERS, PULLOVERS, VESTS, SUITS, BLAZERS; FOOTWEAR; HEADGEAR, NAMELY, HATS, CAPS, HEADWEAR, BERETS; CLOTHING FOR MOTORISTS AND CYCLISTS, NAMELY, CYCLING SHOES, CYCLING SHORTS, MOTORIST BOOTS, MOTORIST JACKETS AND MOTORIST PANTS; BIBS NOT OF PAPER; HEADBANDS; BATHROBES; SWIMMING COSTUMES; BATHING CAPS AND SANDALS; BOAS; LINGERIE; BABIES' PANTS; SCARVES; HOODS; SHAWLS; BELTS; MONEY BELTS; WATER SKIING WETSUITS; TIES; CORSETS; FUR STOLE; FOULARDS; CAPS; GLOVES FOR WEAR; UNDERWEAR; MANTILLAS; STOCKINGS; SOCKS; BANDANAS; TEXTILE NAPPIES; FURS, NAMELY, FUR CLOAKS, FUR HATS, FUR STOLE, FUR MUFFS AND FUR COATS; PYJAMAS; SOLES; HEELS; VEILS; BRACES; PAPER CLOTHING, NAMELY, PAPER APRONS, AND PAPER SHOES USED WHEN GOING THROUGH METAL DETECTORS TO KEEP FEET AND SOCKS CLEAN; GYMNASMIC AND SPORTS OUTFITS, NAMELY, GYMNASMIC SHOES, LEOTARDS AND TIGHTS; LAYETTES; COLLARS; SINGLETS; MITTENS; EAR MUFFS; INNER SOLES; SHOULDER PADS FOR CLOTHING; BOW TIES; PAREUS; DRESSING GOWNS; POCKETS SQUARES FOR CLOTHING; SOCK SUSPENDERS; GARTER BELTS; PETTICOATS; TIGHTS; APRONS; HEADDRESSES IN THE NATURE OF HEADWEAR; CARNIVAL MASQUERADE COSTUMES; UNIFORMS; CAP PEAKS; CLOGS; CAPS; COMBINATION UNDERWEAR; GARTERS (U.S. CLS. 22 AND 39).

CLASS 26—FANCY GOODS

FOR LACE AND EMBROIDERY, RIBBONS AND BRAID; BUTTONS, HOOKS AND EYES; HAIR PINS, MARKING PINS, SAFETY PINS AND HAT PINS; NEEDLES; ARTIFICIAL FLOWERS; TINSELS IN THE NATURE OF TRIMMINGS FOR CLOTHING, NAMELY, LACE TRIMMING; PIN CUSHIONS; HAT AND SHOE ORNAMENTS NOT OF PRECIOUS METAL; HAIR ORNAMENTS; HABERDASHERY ARTICLES, NAMELY, BEADS OTHER THAN FOR MAKING JEWELRY; HAIR BANDS; ARM BANDS; REINS FOR GUIDING CHILDREN; BROOCHES AS CLOTHING ACCESSORIES; SEWING KIT BOXES COMPRISED OF NEEDLES, THIMBLES, SCISSORS AND THREAD SOLD AS A UNIT; BELT CLASPS; SHOE LACES; ARTIFICIAL GARLANDS AND CROWNS OF ARTIFICIAL FLOWERS; TEA COSSIES; ORNAMENTAL NOVELTY BADGES; SEWING THIMBLES; NEEDLE CASES, NOT OF PRECIOUS METAL; BOXES FOR NEEDLES, NOT OF PRECIOUS METAL; CLOTHING BUCKLES; SHOE BUCKLES; HAIR PINS; ORNAMENTAL NOVELTY BADGES, NOT OF PRECIOUS METAL; CLOTHING SEQUINS; BODKINS; HAIRCLIPS; LACE TRIMMINGS; FEATHERS FOR ORNAMENTATION; ARTS AND CRAFTS FINDINGS, NAMELY, POMPONS; ZIP FASTENERS; COMPETITORS' NUMBERS NOT OF TEXTILE; WHALEBONES FOR CORSETS; FALSE HAIR; WIGS; ARTIFICIAL FRUIT (U.S. CLS. 37, 39, 40, 42 AND 50).

CLASS 28—TOYS AND SPORTING GOODS

FOR GAMES AND TOYS, NAMELY, ACTION SKILL GAMES, BACKGAMMON GAMES AND BOARD GAMES; GYMNASTIC AND SPORTING ARTICLES NOT INCLUDED IN OTHER CLASSES, NAMELY, GYMNASTIC APPARATUS, GYMNASTIC TRAINING STOOLS, AND HORIZONTAL BARS; DECORATIONS FOR CHRISTMAS TREES; FISHING TACKLE; FISHING RODS; CARNIVAL AND THEATRE MASKS; DOLLS' HOUSES; CLIMBERS' HARNESES; PARTY FAVORS IN THE NATURE OF SMALL TOYS; SWIMMING, SOCCER AND FOOTBALL GLOVES; BASEBALL, BOXING, FENCING AND GOLF GLOVES; MARIONETTES; AUTOMATIC GAMES APPARATUS FOR ELECTRONIC GAMES NOT ADAPTED FOR USE WITH TELEVISION RECEIVERS; MACHINES FOR PHYSICAL EXERCISES; CHRISTMAS TREES OF SYNTHETIC MATERIAL; BLADDERS BEING STRUCTURAL PARTS OF BALLS FOR GAMES; SHIN, ELBOW AND KNEE PADS FOR USE IN SKATING, SOCCER AND FOOTBALL; KITES; BABY RATTLES; KALEIDOSCOPES; ROCKING HORSES; TOY CONSTRUCTION SETS; PREPAID AUTOMATIC ARCADE GAMES MACHINES; CARD GAMES; PLUSH TOYS; DOLLS; DOLLS' CLOTHES; DOLLS' FEEDING BOTTLES; CHESS GAMES; DRAUGHTBOARDS; TOYS FOR DOMESTIC PETS; PLAY BALLS; BILLIARD TABLES, CUE STICKS, BILLIARD BALLS AND CUES; BOWLS, NAMELY, BOWLING APPARATUS AND MACHINERY; SWINGS; TOBOGGANS; FLYING DISCS; DICE; DARTS; SKIS; TABLES FOR TABLE FOOTBALL; TABLES FOR TABLE TENNIS; SCALE MODELS OF VEHICLES; SKATEBOARDS; TOY SCOOTERS; ROLLER AND ICE SKATES; PINATAS; PAINTBALL GUNS; PUZZLES; SQUASH, TENNIS, BADMINTON AND TABLE TENNIS RACKETS; PARLOUR GAMES; TOY VEHICLES; SPRING BOARDS; GOLF CLUBS; SOAP BUBBLES, NAMELY, BUBBLE MAKING WAND AND SOLUTION SETS; TOY MOBILES (U.S. CLS. 22, 23, 38 AND 50).

CLASS 35—ADVERTISING AND BUSINESS

FOR ADVERTISING SERVICES; COMMERCIAL BUSINESS MANAGEMENT; BUSINESS ADMINISTRATION AND OFFICE WORK; SERVICES OF ASSISTANCE IN THE BUSINESS MANAGEMENT OR COMMERCIAL FUNCTIONS OF AN INDUSTRIAL OR COMMERCIAL COMPANY; ORGANIZATION OF EXHIBITIONS WITH COMMERCIAL OR ADVERTISING PURPOSES; PROMOTION SERVICES PROVIDED BY A COMMERCIAL COMPANY BY MEANS OF A CUSTOMER LOYALTY CARD; MODELING SERVICES FOR ADVERTISING OR SALES PROMOTION; PUBLISHING OF ADVERTISING TEXTS; SHOP WINDOW DRESSING SERVICES; SERVICES OF ASSISTANCE FOR THE OPERATION OF COMMERCIAL COMPANIES AS FRANCHISES, NAMELY, FRANCHISING, NAMELY, OFFERING BUSINESS MANAGEMENT ASSISTANCE IN THE ESTABLISHMENT AND/OR OPERATION OF RETAIL CLOTHING, FOOTWEAR, HEADWEAR, ACCESSORIES, PERFUMES, JEWELRY, DECORATION AND FURNITURE STORES; DEMONSTRATION OF GOODS; ORGANIZATION OF TRADE FAIRS FOR COMMERCIAL OR ADVERTISING PURPOSES; SALES PROMOTION SERVICES FOR OTHERS; PUBLIC AUCTION SERVICES; SERVICES OF SALES PROMOTION AND BUSINESS MANAGEMENT OF COMMERCIAL CENTERS; SERVICES OF ASSISTANCE IN THE COMMERCIAL FUNCTIONS OF BUSINESS, NAMELY, ELECTRONIC PROCESSING OF ORDERS FOR OTHERS AND ORDER FULFILLMENT SERVICES VIA GLOBAL COMMUNICATION NETWORKS; ONLINE WHOLESALE AND RETAIL STORE SERVICES FEATURING CLOTHING, CLOTHING ACCESSORIES, FOOTWEAR, EYEGLASSES, SUNGLASSES AND THEIR ACCESSORIES, APPARATUS FOR RECORDING, TRANSMITTING, AND REPRODUCING SOUND OR IMAGES, WATCHES AND CLOCKS, LEATHER AND ARTIFICIAL LEATHER GOODS, LUGGAGE AND BAGS, JEWELRY, PERSONAL CARE PRODUCTS, PERFUMERY AND COSMETICS; MAIL ORDER SERVICES FEATURING CLOTHING, CLOTHING ACCESSORIES, FOOTWEAR, EYEGLASSES, SUNGLASSES AND THEIR ACCESSORIES, APPARATUS FOR RECORDING, TRANSMITTING, AND REPRODUCING SOUND OR IMAGES, WATCHES AND CLOCKS, LEATHER AND ARTIFICIAL LEATHER GOODS, LUGGAGE AND BAGS, JEWELRY, PERSONAL CARE PRO-

DUCTS, PERFUMERY AND COSMETICS; ELECTRONIC CATALOG SERVICES FEATURING CLOTHING, CLOTHING ACCESSORIES, FOOTWEAR, EYEGLASSES, SUNGLASSES AND THEIR ACCESSORIES, APPARATUS FOR RECORDING, TRANSMITTING, AND REPRODUCING SOUND OR IMAGES, WATCHES AND CLOCKS, LEATHER AND ARTIFICIAL LEATHER GOODS, LUGGAGE AND BAGS, JEWELRY, PERSONAL CARE PRODUCTS, PERFUMERY AND COSMETICS; TELEPHONE ORDERING SERVICES IN THE FIELD OF CLOTHING, CLOTHING ACCESSORIES, FOOTWEAR, EYEGLASSES, SUNGLASSES AND THEIR ACCESSORIES, APPARATUS FOR RECORDING, TRANSMITTING, AND REPRODUCING SOUND OR IMAGES, WATCHES AND CLOCKS, LEATHER AND ARTIFICIAL LEATHER GOODS, LUGGAGE AND BAGS, JEWELRY, PERSONAL CARE PRODUCTS, PERFUMERY AND COSMETICS; PROVIDING HOME SHOPPING SERVICES IN THE FIELD OF CLOTHING, CLOTHING ACCESSORIES, FOOTWEAR, EYEGLASSES, SUNGLASSES AND THEIR ACCESSORIES, APPARATUS FOR RECORDING, TRANSMITTING, AND REPRODUCING SOUND OR IMAGES, WATCHES AND CLOCKS, LEATHER AND ARTIFICIAL LEATHER GOODS, LUGGAGE AND BAGS, JEWELRY, PERSONAL CARE PRODUCTS, PERFUMERY AND COSMETICS BY MEANS OF TELEVISION AND OTHER ELECTRONIC MEANS; IMPORT-EXPORT AGENCIES; ONLINE ADVERTISING ON A COMPUTER NETWORK; PROCUREMENT SERVICES FOR OTHERS, NAMELY, PURCHASING CLOTHING, CLOTHING ACCESSORIES, FOOTWEAR, EYEGLASSES, SUNGLASSES AND THEIR ACCESSORIES, APPARATUS FOR RECORDING, TRANSMITTING, AND REPRODUCING SOUND OR IMAGES, WATCHES AND CLOCKS, LEATHER AND ARTIFICIAL LEATHER GOODS, LUGGAGE AND BAGS, JEWELRY, PERSONAL CARE PRODUCTS, PERFUMERY AND COSMETICS FOR OTHER BUSINESS; NEWSPAPER SUBSCRIPTION SERVICES FOR OTHERS; DISTRIBUTION OF SAMPLES; COMPILATION AND SYSTEMIZATION OF INFORMATION INTO COMPUTER DATABASES; MANAGEMENT OF COMPUTER FILES; PUBLIC RELATIONS; WHOLESALE AND RETAIL STORE SERVICES FEATURING CLOTHING, CLOTHING ACCESSORIES, FOOTWEAR, EYEGLASSES, SUNGLASSES AND THEIR ACCESSORIES, APPARATUS FOR RECORDING, TRANSMITTING, AND REPRODUCING SOUND OR IMAGES, WATCHES AND CLOCKS, LEATHER AND ARTIFICIAL LEATHER GOODS, LUGGAGE AND BAGS, JEWELRY, PERSONAL CARE PRODUCTS, PERFUMERY AND COSMETICS (U.S. CLS. 100, 101 AND 102).

KATHERINE E. HALMEN, EXAMINING ATTORNEY

SN 79-103,316. MITUTOYO CORPORATION, JAPAN, FILED 3-29-2011.

Ko-ga-me

THE MARK CONSISTS OF STANDARD CHARACTERS WITHOUT CLAIM TO ANY PARTICULAR FONT, STYLE, SIZE, OR COLOR.

PRIORITY DATE OF 9-30-2010 IS CLAIMED.

OWNER OF INTERNATIONAL REGISTRATION 1092743 DATED 3-29-2011, EXPIRES 3-29-2021.

THE ENGLISH TRANSLATION OF "KO-GA-ME" IN THE MARK IS "CHILD TURTLE".

CLASS 7—MACHINERY

FOR SPARK EROSION MACHINES, AND THEIR PARTS OR ACCESSORIES; METAL WORKING MACHINES AND TOOLS, AND THEIR PARTS OR ACCESSORIES; MACHINES AND APPARATUS FOR LUMBERING, WOOD-WORKING, OR VENEERING OR PLYWOOD MAKING; MACHINES FOR PLASTICS WORKING; SEMICONDUCTOR MANUFACTURING MACHINES, AND THEIR PARTS OR ACCESSORIES; STONE WORKING MACHINES AND APPARATUS (U.S. CLS. 13, 19, 21, 23, 31, 34 AND 35).

CLASS 9—ELECTRICAL AND SCIENTIFIC APPARATUS

FOR MICROSCOPES AND PARTS THEREOF; COORDINATE MEASURING MACHINES; STRAIGHTNESS TESTING MACHINES AND INSTRUMENTS; DEVICES FOR DETECTING SEISMIC MOTION; VIBRATION METERS; SURFACE ROUGHNESS TESTING MACHINES AND INSTRUMENTS; FLATNESS TESTING MACHINES AND INSTRUMENTS; DISTANCE MEASURING APPARATUS; COMPUTERS; CENTRAL PROCESSING UNITS (CPU); MAGNETIC ENCODED CARD READERS; SCANNERS; DATA PROCESSORS; ELECTRONIC MAGNETIC-CODED IDENTIFYING CARDS; ELECTRONIC MAGNETIC ID CARDS FOR USE IN CONNECTION WITH PAYMENT FOR SERVICES; COMPUTER OPERATIONAL SOFTWARE FOR MONITORING AND CONTROLLING FACTORY MANUFACTURING PROCESSES; COMPUTER OPERATIONAL SOFTWARE FOR 3D MEASURING MACHINES AND INSTRUMENTS (U.S. CLS. 21, 23, 26, 36 AND 38).

JANICE KIM, EXAMINING ATTORNEY

SN 79-103,363. OWEC TOWER AS, NORWAY, FILED 7-28-2011.

OWEC Quattropod

THE MARK CONSISTS OF STANDARD CHARACTERS WITHOUT CLAIM TO ANY PARTICULAR FONT, STYLE, SIZE, OR COLOR.

PRIORITY DATE OF 1-28-2011 IS CLAIMED.

OWNER OF INTERNATIONAL REGISTRATION 1092900 DATED 7-28-2011, EXPIRES 7-28-2021.

CLASS 6—METAL GOODS

FOR PIPES AND TUBES OF METAL; FOUNDATION STRUCTURES AND PARTS THEREFOR, OF METAL, NAMELY, METAL SHEETING, ALUMINUM SIDING, AND METAL FOUNDATION BOARDS; FOUNDATION STRUCTURES AND PARTS THEREFOR, OF METAL, FOR TURBINES AND WIND TURBINES, NAMELY, METAL SHEETING, ALUMINUM SIDING, AND METAL FOUNDATION BOARDS (U.S. CLS. 2, 12, 13, 14, 23, 25 AND 50).

CLASS 7—MACHINERY

FOR TURBINES, OTHER THAN FOR LAND VEHICLES; WIND TURBINES; PARTS AND FITTINGS FOR THE AFOREMENTIONED GOODS (U.S. CLS. 13, 19, 21, 23, 31, 34 AND 35).

JACLYN KIDWELL WALKER, EXAMINING ATTORNEY

SN 79-103,398. BVO, LONDON, UNITED KINGDOM, FILED 6-20-2011.



PRIORITY DATE OF 1-21-2011 IS CLAIMED. OWNER OF INTERNATIONAL REGISTRATION 1092966 DATED 6-20-2011, EXPIRES 6-20-2021.

THE COLOR(S) WHITE, BLACK AND TURQUOISE IS/ARE CLAIMED AS A FEATURE OF THE MARK.

THE TEXT OF "LEADERSIN" IS IN WHITE AND THE BACKGROUND TO THE TEXT IS BLACK AND TURQUOISE.

THE MARK CONSISTS OF WORDING "LEADERSIN" IN WHITE AGAINST A BLACK BACKGROUND WITH STRAIGHT AND WAVY HORIZONTAL LINES IN TURQUOISE BEHIND THE WORDING "LEADERSIN".

CLASS 35—ADVERTISING AND BUSINESS

FOR ADVERTISING AND COMMERCIAL INFORMATION SERVICES ALL PROVIDED VIA THE INTERNET; RENTAL OF ADVERTISING SPACE; BUSINESS INFORMATION SERVICES PROVIDED ONLINE FROM A GLOBAL COMPUTER NETWORK; PROVIDING A SEARCHABLE ONLINE ADVERTISING GUIDE FEATURING THE GOODS AND SERVICES OF PUBLIC SPEAKERS AND PROVIDERS OF EDUCATIONAL AND INFORMATIONAL CONTENT; ARRANGING BUSINESS INTRODUCTIONS, NAMELY, BUSINESS NETWORKING SERVICES; FACILITATING NETWORKING AND SOCIALIZING OPPORTUNITIES FOR BUSINESS PURPOSES BETWEEN PUBLIC SPEAKERS AND PROVIDERS OF EDUCATIONAL AND INFORMATIONAL CONTENT TO POTENTIAL CLIENTS; ARRANGING AND CONDUCTING OFFLINE AND ONLINE NETWORKING EVENTS FOR BUSINESS PURPOSES (U.S. CLS. 100, 101 AND 102).

CLASS 38—COMMUNICATION

FOR INTERNET BROADCASTING SERVICES; TELEVISION AND RADIO BROADCASTING SERVICES; TELECOMMUNICATION SERVICES, NAMELY, TRANSMISSION AND PEER-TO-PEER SHARING OF VOICE, DATA, GRAPHICS, IMAGES, AUDIO AND VIDEO BY MEANS OF TELECOMMUNICATIONS NETWORKS, WIRELESS COMMUNICATION NETWORKS, AND THE INTERNET; PROVISION OF ACCESS TO A PORTAL ENABLING USERS TO SHARE VIDEOS, AUDIO CONTENT AND MULTIMEDIA CONTENT; PROVISION OF ONLINE FORUMS ON WHICH USERS CAN POST, SEARCH, WATCH, RATE, ASSESS, CRITIQUE AND COMMENT ON VIDEOS, AUDIO CONTENT AND MULTIMEDIA CONTENT; VIDEOPHONE CONFERENCING SERVICES; AUDIO CONFERENCING SERVICES; VIDEO-CONFERENCING SERVICES; PROVIDING ACCESS TO A VIDEO SHARING PORTAL FOR ENTERTAINMENT AND EDUCATION PURPOSES (U.S. CLS. 100, 101 AND 104).

CLASS 41—EDUCATION AND ENTERTAINMENT

FOR TRAINING SERVICES, NAMELY, INTERACTIVE ON-LINE TRAINING SERVICES IN THE FIELDS OF BUSINESS PRODUCTIVITY, LEADERSHIP, INNOVATION, MARKETING AND ENTREPRENEURSHIP; TRAINING SERVICES, NAMELY, BUSINESS TRAINING; PROVISION INFORMATION ABOUT EDUCATION OVER A GLOBAL COMPUTER NETWORK OR THE INTERNET; PROVISION OF INFORMATION RELATING TO EDUCATIONAL AND TRAINING CONFERENCES AND SEMINARS; ARRANGING AND CONDUCTING EDUCATIONAL CONFERENCES; EDUCATIONAL SERVICES, NAMELY, CONDUCTING COURSES, SEMINARS, WORKSHOPS, CLASSES AND WEBINARS IN THE FIELD OF IN THE FIELDS OF BUSINESS PRODUCTIVITY, LEADERSHIP, INNOVATION, MARKETING AND ENTREPRENEURSHIP; ARRANGING AND CONDUCTING EDUCATIONAL CONFERENCES OVER A GLOBAL COMPUTER NETWORK OR THE INTERNET; EDUCATIONAL SERVICES, NAMELY, CONDUCTING COURSES, SEMINARS, WORKSHOPS AND CLASSES PROVIDED OVER A GLOBAL COMPUTER NETWORK OR THE INTERNET IN THE FIELD OF IN THE FIELDS OF BUSINESS PRODUCTIVITY, LEADERSHIP, INNOVATION, MARKETING AND ENTREPRENEURSHIP (U.S. CLS. 100, 101 AND 107).

JANICE KIM, EXAMINING ATTORNEY

SN 79-103,404. KARL STORZ GMBH & CO. KG, FED REP GERMANY, FILED 8-17-2011.



PRIORITY DATE OF 3-12-2011 IS CLAIMED.
OWNER OF INTERNATIONAL REGISTRATION 1092979 DATED 8-17-2011, EXPIRES 8-17-2021.

THE MARK CONSISTS OF A RECTANGLE CONTAINING THE SHAPE OF AN OCTOPUS AND WORD "TENTACLES".

CLASS 10—MEDICAL APPARATUS

FOR MEDICAL APPARATUS AND INSTRUMENTS, NAMELY, SURGICAL INSTRUMENTS AND APPARATUS CONSISTING OF AN ILLUMINATED MODULAR RETRACTOR FOR MINIMALLY INVASIVE SPINAL SURGERY (U.S. CLS. 26, 39 AND 44).

CLASS 16—PAPER GOODS AND PRINTED MATTER

FOR PRINTED MATERIAL, NAMELY, CATALOGUES, MAGAZINES, JOURNALS, BROCHURES AND INFORMATIONAL FLYERS, LETTERS AND SHEETS IN THE FIELD OF MEDICAL TECHNOLOGY RELATED TO AN ILLUMINATED MODULAR RETRACTOR FOR MINIMALLY INVASIVE SPINAL SURGERY; PRINTED TEACHING AND INSTRUCTIONAL MANUALS IN THE FIELD OF MEDICAL TECHNOLOGY RELATED TO AN ILLUMINATED MODULAR RETRACTOR FOR MINIMALLY INVASIVE SPINAL SURGERY; BINDERS; PHOTOGRAPHS (U.S. CLS. 2, 5, 22, 23, 29, 37, 38 AND 50).
JOHN DWYER, EXAMINING ATTORNEY

SN 79-103,422. INTERACOUSTICS A/S, DENMARK, FILED 6-1-2011.

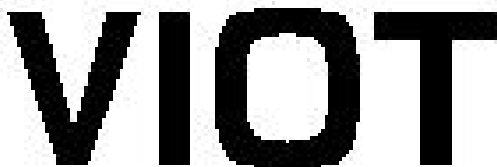

THE MARK CONSISTS OF STANDARD CHARACTERS WITHOUT CLAIM TO ANY PARTICULAR FONT, STYLE, SIZE, OR COLOR.

PRIORITY DATE OF 1-7-2011 IS CLAIMED.
OWNER OF INTERNATIONAL REGISTRATION 1093033 DATED 6-1-2011, EXPIRES 6-1-2021.

CLASS 9—ELECTRICAL AND SCIENTIFIC APPARATUS

FOR SOFTWARE FOR MEASURING APPARATUS AND INSTRUMENTS, NAMELY, SOFTWARE TO TRANSMIT OTOSCOPE IMAGES TO COMPUTER SCREENS; EARPHONES, VIDEO PROJECTORS, VIDEO GLASSES (U.S. CLS. 21, 23, 26, 36 AND 38).

CLASS 10—MEDICAL APPARATUS

FOR MEASURING APPARATUS AND INSTRUMENTS, NAMELY, AUDIOLOGICAL MEASURING EQUIPMENT AND BALANCE MEASURING EQUIPMENT, AUDIOLOGICAL, NEUROLOGIC AND VESTIBULAR MEASURING INSTRUMENTS, MIDDLE EAR ANALYZERS, AUDIOMETERS, HEARING AID ANALYZERS AND PATIENT COUNSELING TOOLS AND INSTRUMENTATIONS FOR ADAPTATION AND INDIVIDUALIZATION OF HEARING AIDS; VIDEO OTOSCOPE; PARTS OF AND FITTINGS FOR MEDICAL AND CLINICAL PURPOSES FOR ALL THE AFORESAID GOODS (U.S. CLS. 26, 39 AND 44).

AMY C. KEAN, EXAMINING ATTORNEY

SN 79-103,448. SAIBENE ALFONSO, ITALY, AND SAIBENE CARLOTTA, ITALY, FILED 6-8-2011.



THE MARK CONSISTS OF STANDARD CHARACTERS WITHOUT CLAIM TO ANY PARTICULAR FONT, STYLE, SIZE, OR COLOR.

PRIORITY DATE OF 5-30-2011 IS CLAIMED.
OWNER OF INTERNATIONAL REGISTRATION 1093081 DATED 6-8-2011, EXPIRES 6-8-2021.

CLASS 24—FABRICS

FOR TEXTILE AND TEXTILE GOODS, NAMELY, CURTAINS, BED AND TABLE LINENS, WALL HANGINGS, AND TEXTILE FABRICS FOR HOME AND COMMERCIAL INTERIORS; BED COVERS AND PLASTIC TABLE COVERS (U.S. CLS. 42 AND 50).

CLASS 25—CLOTHING

FOR CLOTHING, NAMELY, COATS, MANTLES, RAINCOATS, DRESSES, SUITS, SKIRTS, JACKETS, TROUSERS, WAISTCOATS, SHIRTS, T-SHIRTS, BLOUSES, JERSEYS, SWEATERS, BLAZERS, CARDIGANS, STOCKINGS, SOCKS, UNDERWEAR, CORSETS, NIGHTGOWNS, PAJAMAS, BATHROBES, BATHING SUITS, SUNSUITS, JEANS, SPORT JACKETS, WIND-RESISTANT JACKETS, ANORAKS, SWEATSUITS, TIES, NECKTIES, SCARVES, SHAWLS, FOULARDS, CAPS, HATS, GLOVES, SASHES, AND BELTS; FOOTWEAR, NAMELY, BOOTS, SHOES, AND SLIPPERS; HEADWEAR (U.S. CLS. 22 AND 39).

CLASS 40—MATERIAL TREATMENT

FOR CUSTOM ASSEMBLY OF THREAD, YARN AND TEXTILES FOR OTHERS (U.S. CLS. 100, 103 AND 106).
CHRISIE B. KING, EXAMINING ATTORNEY

SN 79-103,518. ENTE AUTONOMO PER LE FIERE DI VERONA, ITALY, FILED 1-26-2011.



PRIORITY DATE OF 9-16-2010 IS CLAIMED.
OWNER OF INTERNATIONAL REGISTRATION 1093181 DATED 1-26-2011, EXPIRES 1-26-2021.

THE MARK CONSISTS OF A SIGN DEPICTING THE WORDING "MARMOMACC" IN FANCY CHARACTERS, UNDER WHICH THERE IS A SERIES OF STYLIZED BOXES PLACED HORIZONTALLY ONE NEXT TO THE OTHER, UNDER WHICH THERE ARE THE WORDINGS "MEETS DESIGN" IN FANCY CHARACTERS.

THE WORDING "MARMOMACC" HAS NO MEANING IN A FOREIGN LANGUAGE.

CLASS 35—ADVERTISING AND BUSINESS

FOR ORGANIZATION OF TRADE SHOW EXHIBITIONS AND TRADE FAIRS FOR COMMERCIAL AND ADVERTISING PURPOSES FOR THE STONE INDUSTRY AND MACHINERY AND TOOLS RELATED THERETO; ADMINISTRATIVE MANAGEMENT OF EXHIBITION, CONVENTION AND TRADE FAIR FACILITIES, NAMELY, PROVIDING FACILITIES FOR TRADE EXHIBITIONS; ADVERTISING SERVICES, NAMELY, PROMOTING FOR OTHERS MARBLES, GRANITES, STONES AND TOOLS AND MACHINERY RELATED THERETO; ADVERTISING SERVICES, PUBLIC RELATIONS AND MARKETING SERVICES, NAMELY, PROMOTING AND MARKETING THE GOODS, SERVICES AND BRAND IDENTITY OF OTHERS THROUGH ALL PUBLIC COMMUNICATION MEANS; BUSINESS ADVISORY SERVICES IN THE FIELD OF ARCHITECTURE, INTERIOR DESIGN AND URBAN PLANNING DESIGN; COST PRICE ANALYSIS AND ASSESSMENT; CONGRESS AND CONVENTION SERVICES IN EXHIBITION CENTERS, NAMELY, ORGANIZATION OF BUSINESS CONVENTIONS, ON SHOW GROUNDS AND IN UNIVERSITY CENTERS FOR BUSINESS AND ADVERTISING PURPOSES; CONVENTIONS AND BRIEFINGS PROMOTING MARBLE AND STONES TO ARCHITECTS AND DESIGNERS; AFORESAID SERVICES ON BEHALF OF THIRD PARTIES (U.S. CLS. 100, 101 AND 102).

CLASS 41—EDUCATION AND ENTERTAINMENT

FOR ORGANIZATION OF EXHIBITIONS OR FAIRS FOR CULTURAL, EDUCATIONAL, SPORTING, AND ENTERTAINING PURPOSES FOR THE STONE INDUSTRY AND THE MACHINERY AND TOOLS RELATED THERETO; ARRANGING AND CONDUCTING OF EDUCATIONAL SEMINARS, SYMPOSIUMS, CONFERENCES, CONGRESSES AND CONVENTIONS FOR THE STONE INDUSTRY AND TOOLS AND MACHINERY RELATED THERETO; SERVICE PROVIDING FOR EDUCATIONAL FACILITIES, NAMELY, PROVIDING FACILITIES FOR EDUCATIONAL CONVENTIONS; EDUCATION SERVICES, NAMELY, PROVIDING SEMINARS, WORKSHOPS, LECTURES AND TUTORIALS FOR CERTIFICATION OF PROFESSIONALS IN THE STONE INDUSTRY AND IN CONSTRUCTION IN THE FIELD OF BUILDINGS; PROVIDING AMUSEMENT FACILITIES; PUBLISHING OF PRINTED MATTER, NAMELY, BOOKS, MAGAZINES, NEWSPAPERS, PHOTOGRAPHS, PRINTED PERIODICALS, NEWSLETTERS AND BROCHURES RELATING TO GRANITES, STONES, MARBLES, MACHINERY AND ARCHITECTURAL DESIGN; PROVIDING AN ONLINE NON-DOWNLOADABLE MAGAZINE IN THE FIELD OF GRANITES, STONES, MARBLES, MACHINERY AND ARCHITECTURAL DESIGN; CONGRESS AND CONVENTION SERVICES IN EXHIBITION CENTERS, NAMELY, PROVIDING SEMINARS, WORKSHOPS, LECTURES AND TUTORIALS IN THE FIELD OF GRANITES, STONES, MARBLE, MACHINERY AND ARCHITECTURAL DESIGN; ON SHOW GROUNDS AND IN UNIVERSITY CENTERS FOR CULTURAL, EDUCATIONAL, SPORTING AND ENTERTAINMENT PURPOSES; PROFESSIONAL TRAINING SERVICES FOR ARCHITECTS AND DESIGNERS; ALL THE AFORESAID SERVICES ON BEHALF OF THIRD PARTIES (U.S. CLS. 100, 101 AND 107).

CLASS 43—HOTEL AND RESTAURANT SERVICES

FOR PROVIDING FACILITIES FOR EXHIBITIONS; PROVIDING CONFERENCE ROOMS; ALL THE AFORESAID SERVICES ON BEHALF OF THIRD PARTIES (U.S. CLS. 100 AND 101).

AMY ALFIERI, EXAMINING ATTORNEY

SN 79-103,531. WONIK IPS CO., LTD, REPUBLIC OF KOREA, FILED 3-16-2011.



The logo for WONIK IPS features the word "WONIK" in a blue, sans-serif font. The letter "O" is replaced by a stylized circular graphic consisting of a gray outer ring and a white inner circle. To the right of "WONIK" is the word "IPS" in a bold, red, sans-serif font.

PRIORITY DATE OF 3-10-2011 IS CLAIMED.
OWNER OF INTERNATIONAL REGISTRATION 1093207 DATED 3-16-2011, EXPIRES 3-16-2021.

THE COLOR(S) BLUE, RED AND GRAY IS/ARE CLAIMED AS A FEATURE OF THE MARK.

THE MARK CONSISTS OF THE STYLIZED WORDING "WONIK" IN BLUE, THE STYLIZED LETTERS "IPS" IN RED, AND A GRAY CIRCULAR DESIGN INSIDE THE CHARACTER "O".

THE WORDING "WONIK" HAS NO MEANING IN A FOREIGN LANGUAGE.

CLASS 7—MACHINERY

FOR SEMICONDUCTOR MANUFACTURING EQUIPMENT, NAMELY, THIN FILM DEPOSITION APPARATUS, SPUTTERING APPARATUS, ETCHING APPARATUS, EVAPORATION DEPOSITION APPARATUS, PLASMA CHEMICAL VAPOR DEPOSITION APPARATUS, COUPLED PLASMA CHEMICAL VAPOR DEPOSITION APPARATUS, ATOMIC LAYER DEPOSITION APPARATUS, ION BEAM DEPOSITION APPARATUS, ION BEAM ETCHING APPARATUS, ANNEALING APPARATUS, RAPID THERMAL PROCESSING APPARATUS, LOW TEMPERATURE ANNEALING APPARATUS, COUPLED SPUTTERING APPARATUS, MULTIPLE SPUTTERING APPARATUS, LASER SUBLIMATION DEPOSITION APPARATUS, ORGANIC MOLECULAR CHEMICAL VAPOR DEPOSITION APPARATUS, ION BEAM GENERATION APPARATUS, ION BEAM SPUTTER DEPOSITION APPARATUS, ION BEAM ETCHING APPARATUS, ION BEAM ASSISTED DEPOSITION APPARATUS, ELECTRON BEAM ASSISTED DEPOSITION APPARATUS, ELECTRON BEAM CRYSTALLIZATION APPARATUS, ELECTRON BEAM ANNEALING APPARATUS, OXIDATION MECHANICAL APPARATUS, ION IMPLANTATION APPARATUS, CHEMICAL VAPOR PRECIPITATION MECHANICAL APPARATUS, SPUTTERING MECHANICAL APPARATUS, AND PROBE; LIQUID CRYSTAL DISPLAY MANUFACTURING EQUIPMENT, NAMELY, FILM DEPOSITION APPARATUS, SPUTTERING APPARATUS, COUPLED SPUTTERING APPARATUS, ETCHING APPARATUS, EVAPORATION DEPOSITION APPARATUS, PLASMA CHEMICAL VAPOR DEPOSITION APPARATUS, ION BEAM DEPOSITION APPARATUS, ION BEAM ETCHING APPARATUS AND ANNEALING APPARATUS, SPUTTERING MECHANICAL APPARATUS, AND PROBE; ORGANIC ELECTROLUMINESCENCE DISPLAY MANUFACTURING EQUIPMENT, NAMELY, THIN FILM DEPOSITION APPARATUS, SPUTTERING APPARATUS, COUPLED SPUTTERING APPARATUS, ETCHING APPARATUS, EVAPORATION DEPOSITION APPARATUS, PLASMA CHEMICAL VAPOR DEPOSITION APPARATUS, ION BEAM DEPOSITION APPARATUS, ION BEAM ETCHING APPARATUS AND ANNEALING APPARATUS; PLASMA DISPLAY PANEL MANUFACTURING EQUIPMENT, NAMELY, THIN FILM DEPOSITION APPARATUS, SPUTTERING APPARATUS, COUPLED SPUTTERING APPARATUS, ETCHING APPARATUS, EVAPORATION DEPOSITION APPARATUS, ION BEAM DEPOSITION APPARATUS, ION BEAM ETCHING APPARATUS, AND ANNEALING APPARATUS; SOLAR CELL MANUFACTURING EQUIPMENT, NAMELY, THIN FILM DEPOSITION APPARATUS, SPUTTERING APPARATUS, COUPLED SPUTTERING APPARATUS, ETCHING APPARATUS, EVAPORATION DEPOSITION APPARATUS, PLASMA CHEMICAL VAPOR DEPOSITION APPARATUS, ION BEAM DEPOSITION APPARATUS, RAPID THERMAL PROCESSING APPARATUS, ION BEAM DEPOSITION APPARATUS, ION BEAM ETCHING APPARATUS AND ANNEALING APPARATUS; LIGHT EMITTING DIODE (LED) MANUFACTURING EQUIPMENT, NAMELY, THIN FILM DEPOSITION APPARATUS, CHEMICAL VAPOR DEPOSITION APPARATUS, SPUTTERING APPARATUS, COUPLED SPUTTERING APPARATUS, ETCHING APPARATUS, EVAPORATION DEPOSITION APPARATUS, PLASMA CHEMICAL VAPOR DEPOSITION APPARATUS, ION BEAM DEPOSITION APPARATUS, ION BEAM ETCHING APPARATUS,

ELECTRON BEAM ANNEALING APPARATUS; MICRO-ELECTROMECHANICAL SYSTEMS (MEMS) MANUFACTURING EQUIPMENT, NAMELY, THIN FILM DEPOSITION APPARATUS, SPUTTERING APPARATUS, EVAPORATION DEPOSITION APPARATUS AND CHEMICAL VAPOR DEPOSITION APPARATUS; ACTIVE MATRIX LIGHT EMITTING DIODE (AMOLED) DISPLAY MANUFACTURING EQUIPMENT, NAMELY, THIN FILM DEPOSITION APPARATUS, SPUTTERING APPARATUS, COUPLED SPUTTERING APPARATUS, ETCHING APPARATUS, EVAPORATION DEPOSITION APPARATUS, PLASMA CHEMICAL VAPOR DEPOSITION APPARATUS, ION BEAM DEPOSITION APPARATUS AND ION BEAM ANNEALING APPARATUS (U.S. CLS. 13, 19, 21, 23, 31, 34 AND 35).

CLASS 37—CONSTRUCTION AND REPAIR

FOR INSTALLATION, REPAIR AND MAINTENANCE OF SEMICONDUCTOR PROCESSING MACHINES, SEMICONDUCTOR WAFER PROCESSING APPARATUS, ATOMIC LAYER DEPOSITION APPARATUS, LOW PRESSURE CHEMICAL VAPOR DEPOSITION APPARATUS, DIFFUSION FURNACES, PLASMA CHEMICAL VAPOR DEPOSITION APPARATUS, METAL ORGANIC CHEMICAL VAPOR DEPOSITION APPARATUS, FAST-HEATING PROCESSING APPARATUS, HIGH TEMPERATURE CHEMICAL VAPOR DEPOSITION APPARATUS, VAPOR EPITAXY APPARATUS, LIQUID EPITAXY APPARATUS, NORMAL PRESSURE CHEMICAL VAPOR DEPOSITION APPARATUS, MID PRESSURE CHEMICAL VAPOR DEPOSITION APPARATUS, ETCHERS, SPUTTERING APPARATUS, PHOTOLITHOGRAPHY APPARATUS, DEVELOPERS, ASHING APPARATUS, CLEANING APPARATUS AND POLISHING APPARATUS, ALL FOR THE MANUFACTURE OF SEMICONDUCTORS; INSTALLATION, REPAIR AND MAINTENANCE OF DEPOSITION APPARATUS ETCHERS, SPUTTERING APPARATUS, PHOTOLITHOGRAPHY APPARATUS, DEVELOPERS, ASHING APPARATUS, CLEANING APPARATUS AND POLISHING APPARATUS, ALL FOR THE MANUFACTURE OF LIQUID CRYSTAL DISPLAY PANELS; INSTALLATION, REPAIR AND MAINTENANCE OF DEPOSITION APPARATUS, ETCHERS FOR MANUFACTURING SOLAR CELLS, SPUTTERING APPARATUS, PHOTOLITHOGRAPHY APPARATUS, DEVELOPERS FOR MANUFACTURING SOLAR CELLS, ASHING APPARATUS, CLEANING APPARATUS AND POLISHING APPARATUS, ALL FOR THE MANUFACTURE OF SOLAR CELLS; MAINTENANCE OF DEPOSITION APPARATUS, ETCHERS, SPUTTERING APPARATUS, PHOTOLITHOGRAPHY APPARATUS, DEVELOPERS, ASHING APPARATUS, CLEANING APPARATUS, AND POLISHING APPARATUS, ALL FOR THE MANUFACTURE OF LED AND AMOLED DISPLAYS (U.S. CLS. 100, 103 AND 106).

ROBIN MITTLER, EXAMINING ATTORNEY

SN 79-103,534. GUANGXI GOLDEN THROAT CO., LTD., CHINA, FILED 6-1-2011.

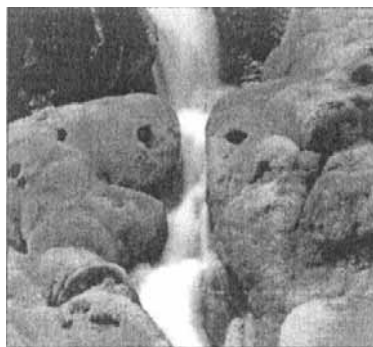

幽幽清泉

PRIORITY DATE OF 5-4-2011 IS CLAIMED.

OWNER OF INTERNATIONAL REGISTRATION 1093210 DATED 6-1-2011, EXPIRES 6-1-2021.

OWNER OF U.S. REG. NO. 3,956,809.

THE MARK CONSISTS OF A WATERFALL RUNNING THROUGH DARK ROCKS, ALL APPEARING IN A SQUARE. ASIAN CHARACTERS APPEAR BENEATH THE SQUARE.

THE ENGLISH TRANSLATION OF THE FOREIGN WORD(S) IN THE MARK IS: "QUIET CLEAR SPRING".

THE TRANSLITERATION OF THE NON-LATIN CHARACTERS IN THE MARK IS: YOU YOU QING QUAN.

CLASS 5—PHARMACEUTICALS

FOR MEDICINES FOR HUMAN PURPOSES, NAMELY, THROAT LOZENGES, MEDICATED LOZENGES, ANALGESICS, ANTI-INFECTIVES, ANTI-FLAMMATORIES, ANTIBIOTICS, ANTIVIRALS, ANTI-DEPRESSANTS, ANTIPLATULANTS, ANTIPARASITICS AND ANTISEPTICS; MEDICATED CANDY; SANITARY STERILIZING PREPARATIONS; GASES FOR MEDICAL PURPOSES; MEDICINAL TEA; MEDICATED LIQUOR FOR USE IN ACTIVATING BLOOD CIRCULATION AND ELIMINATE BLOOD STASIS, TO RELIEVE MUSCULAR CONTRACTURE, TO REMOVE SWELLING AND PAIN, TO TREAT TRAUMATIC INJURIES, AND TO ELIMINATE FATIGUE BEFORE AND AFTER EXERCISE; SYRUPS FOR MEDICAL PURPOSES, NAMELY, COUGH SYRUPS; CONTACT LENS CLEANING PREPARATIONS; CANDY FOR MEDICAL PURPOSES; CHEWING GUM FOR MEDICAL PURPOSES; DIETETIC SUBSTANCES ADAPTED FOR MEDICAL USE, NAMELY, DIETETIC FOODS ADAPTED FOR MEDICAL PURPOSES, DIETARY SUPPLEMENTAL DRINKS, DIETARY SUPPLEMENTS, DIETARY AND NUTRITIONAL SUPPLEMENTS AND LIQUID NUTRITIONAL SUPPLEMENTS; DIETETIC BEVERAGES ADAPTED FOR MEDICAL PURPOSES; FOOD FOR BABIES; AIR PURIFYING PREPARATIONS; MEDICINES FOR VETERINARY PURPOSES, NAMELY, VETERINARY VACCINES FOR BOVINES AND HORSES; PESTICIDES; SANITARY TOWELS; ADHESIVE BANDS FOR MEDICAL PURPOSES; MEDICINAL HEALTH KITS CONSISTING PRIMARILY OF MEDICAL HERBS; TEETH FILLING MATERIALS, NAMELY, FILLINGS FOR TEETH (U.S. CLS. 6, 18, 44, 46, 51 AND 52).

CLASS 30—STAPLE FOODS

FOR COFFEE; COFFEE-BASED BEVERAGES; TEA; TEA-BASED BEVERAGES; SUGAR; CANDY; HONEY; DIETETIC SUBSTANCES IN LIQUID FORM NOT FOR MEDICAL PURPOSES, NAMELY, HERBAL FOOD BEVERAGES; CHEWING GUM, NOT FOR MEDICAL PURPOSES; PASTRIES; INSTANT RICE IN THE NATURE OF DRIED COOKED-RICE; EIGHT INGREDIENT PORRIDGE, NAMELY, RICE BASED PORRIDGE CONTAINING DRIED LONGAN PULP, LOTUS NUT, PEANUT, RED BEAN, GREEN BEAN, RED JUJUBE, GLUTINOUS RICE AND DRIED LILY BULB; CEREAL PREPARATIONS, NAMELY, PROCESSED CEREALS AND BREAKFAST CEREALS; OAT FLAKES; NOODLES; INSTANT NOODLES; GOODS MADE FROM SESAME SEEDS, NAMELY, SESAME PASTE; CRISPY RICE, NAMELY, RICE-BASED SNACK FOODS; FOOD STARCH; ICE CREAM; SALT; VINEGAR; SOY SAUCES; SEASONINGS; YEAST; FLAVORINGS FOR FOODS, EXCLUDING ETHERIC ESSENCES AND ESSENTIAL OILS; MEAT TENDERIZERS FOR HOUSEHOLD PURPOSES (U.S. CL. 46).

KAREN SEVERSON, EXAMINING ATTORNEY

SN 79-103,555. 4B COMPANY S.R.L., ITALY, FILED 7-13-2011.

brosway

THE MARK CONSISTS OF STANDARD CHARACTERS WITHOUT CLAIM TO ANY PARTICULAR FONT, STYLE, SIZE, OR COLOR.

PRIORITY DATE OF 4-28-2011 IS CLAIMED.
OWNER OF INTERNATIONAL REGISTRATION 1093273 DATED 7-13-2011, EXPIRES 7-13-2021.
OWNER OF U.S. REG. NO. 3,307,569.

CLASS 9—ELECTRICAL AND SCIENTIFIC APPARATUS

FOR SCIENTIFIC, NAUTICAL APPARATUS AND INSTRUMENTS, NAMELY, ANEMOMETERS; SURVEYING APPARATUS AND INSTRUMENTS, NAMELY, DISTANCE MEASURING APPARATUS; PHOTOGRAPHIC, CINEMATOGRAPHIC APPARATUS AND INSTRUMENTS, NAMELY, VIDEO CAMERAS, STILL CAMERAS; INSTRUMENTS OPTICAL, NAMELY, EYE GLASSES, SUNGLASSES, OPTICAL GLASSES; WEIGHING INSTRUMENTS, NAMELY, BALANCES; MEASURING INSTRUMENTS, NAMELY, RULES, COMPASSES; SIGNALING, CHECKING, SUPERVISION, LIFE-SAVING AND TEACHING APPARATUS AND INSTRUMENTS, NAMELY, LIFE JACKETS, LIFE RAFTS, MEDICAL TEACHING MANNEQUINS, DIGITAL SIGNAL . PROCESSIONS; APPARATUS AND INSTRUMENTS FOR CONDUCTING, SWITCHING, TRANSFORMING, ACCUMULATING, REGULATING OR CONTROLLING ELECTRICITY, NAMELY, ELECTRICAL CONDUCTORS, ELECTRIC SWITCHES, ELECTRIC TRANSFORMERS, ELECTRIC ACCUMULATORS, VOLTAGE REGULATORS FOR ELECTRIC POWER; COMPUTERS, COMPUTER HARDWARE AND COMPUTER GAME SOFTWARE; APPARATUS FOR RECORDING, TRANSMISSION OR REPRODUCTION OF SOUND OR IMAGES, NAMELY, HI-FI AUDIO SPEAKERS, AMPLIFIERS, HI-FI SOUND EQUALIZERS, AUDIO, VIDEO AND COMPUTER ELECTRICAL CONNECTORS; MAGNETIC DATA CARRIERS, NAMELY, HARD DISK PLAYERS AND RECORDERS, FLOPPY DISCS FOR COMPUTERS AND RECORDERS, FLOPPY DISCS FOR COMPUTERS FOR USE IN DATABASE MANAGEMENT, FOR USE AS A SPREADSHEET, AND FLOPPY DISK DRIVES; PRE-RECORDED VIDEO DISCS FEATURING MUSIC; AUTOMATIC VENDING MACHINES AND MECHANISMS FOR COIN-OPERATED APPARATUS; CASH REGISTERS, CALCULATING MACHINES, DATA PROCESSING EQUIPMENT AND COMPUTERS; FIRE-EXTINGUISHING APPARATUS (U.S. CLS. 21, 23, 26, 36 AND 38).

CLASS 16—PAPER GOODS AND PRINTED MATTER

FOR PAPER, CARDBOARD AND GOODS MADE FROM THESE MATERIALS, NOT INCLUDED IN OTHER CLASSES, NAMELY, WRITING PAPER AND PRINTING PAPER; PRINTED MATTER, NAMELY, PRINTED GUIDES FOR CARD GAMES; BOOK BINDING MATERIAL; PHOTOGRAPHS; STATIONERY; ADHESIVES FOR STATIONERY OR HOUSEHOLD PURPOSES; ARTISTS' MATERIALS, NAMELY, ARTISTS' BRUSHES; PAINT BRUSHES; TYPEWRITERS AND OFFICE REQUISITES EXCEPT FURNITURE, NAMELY, CORRECTING FLUID FOR TYPE; INSTRUCTIONAL AND TEACHING MATERIAL EXCEPT APPARATUS, NAMELY, PRINTED INSTRUCTIONAL AND TEACHING MATERIALS IN THE FIELD OF MUSIC; PLASTIC MATERIALS FOR PACKAGING NOT INCLUDED IN OTHER CLASSES, NAMELY, PLASTIC BAGS FOR PACKAGING; PRINTERS' TYPE; PRINTING BLOCKS (U.S. CLS. 2, 5, 22, 23, 29, 37, 38 AND 50).

CLASS 25—CLOTHING

FOR CLOTHING, NAMELY, COATS, JACKETS, SKIRTS, TROUSERS, SHORTS, JERSEYS, SHIRTS; FOOTWEAR, NAMELY, BOOTS, SLIPPERS, MULES; HEADGEAR, NAMELY, CAPS AND HATS (U.S. CLS. 22 AND 39).

COLLEEN DOMBROW, EXAMINING ATTORNEY

SN 79-103,610. ATLISSIAN PTY LTD (ACN 102 443 916), AUSTRALIA, FILED 8-16-2011.

GREENHOPPER

THE MARK CONSISTS OF STANDARD CHARACTERS WITHOUT CLAIM TO ANY PARTICULAR FONT, STYLE, SIZE, OR COLOR.

PRIORITY DATE OF 5-31-2011 IS CLAIMED.
OWNER OF INTERNATIONAL REGISTRATION 1093422 DATED 8-16-2011, EXPIRES 8-16-2021.

CLASS 9—ELECTRICAL AND SCIENTIFIC APPARATUS

FOR DOWNLOADABLE COMPUTER SOFTWARE FOR MANAGING BACKLOG, PLANNING SPRINTS AND TRACKING TEAMS IN THE FIELDS OF PROJECT MANAGEMENT AND DEVELOPMENT; COMPUTER SOFTWARE FOR MANAGING BACKLOG, PLANNING SPRINTS AND TRACKING TEAMS IN THE FIELDS OF PROJECT MANAGEMENT AND DEVELOPMENT RECORDED ON COMPUTER MEDIA; COMPUTER PROGRAMS AND RECORDED SOFTWARE FOR MANAGING BACKLOG, PLANNING SPRINTS AND TRACKING TEAMS IN THE FIELDS OF PROJECT MANAGEMENT AND DEVELOPMENT; DOWNLOADABLE ELECTRONIC PUBLICATIONS, NAMELY, NEWSLETTERS, BROCHURES, TECHNICAL DATA SHEETS, PAMPHLETS AND REPORTS IN THE FIELDS OF PROJECT MANAGEMENT AND DEVELOPMENT; ELECTRONIC PUBLICATIONS, NAMELY, NEWSLETTERS, BROCHURES, TECHNICAL DATA SHEETS, PAMPHLETS AND REPORTS IN THE FIELDS OF PROJECT MANAGEMENT AND DEVELOPMENT RECORDED ON COMPUTER MEDIA; DOWNLOADABLE ELECTRONIC NEWSLETTERS IN THE FIELDS OF PROJECT MANAGEMENT AND DEVELOPMENT; DOWNLOADABLE EDUCATIONAL SOFTWARE FEATURING INSTRUCTION IN PROJECT MANAGEMENT AND DEVELOPMENT (U.S. CLS. 21, 23, 26, 36 AND 38).

CLASS 41—EDUCATION AND ENTERTAINMENT

FOR EDUCATION AND TRAINING, NAMELY, PROVISION OF SEMINARS AND TRAINING TOOLS FOR USING COMPUTER SOFTWARE AND COMPUTER PROGRAMS; PROVIDING EDUCATIONAL SERVICES, NAMELY, SEMINARS AND TUTORIALS IN THE FIELDS OF PROJECT MANAGEMENT AND DEVELOPMENT BY ELECTRONIC MEANS VIA A GLOBAL COMPUTER NETWORK AND DISTRIBUTION OF INSTRUCTIONAL MATERIALS THEREWITH (U.S. CLS. 100, 101 AND 107).

CLASS 42—SCIENTIFIC AND COMPUTER SERVICES

FOR COMPUTER SERVICES, NAMELY, HOSTING AND MAINTAINING AN ON-LINE WEB SITE TO ENABLE OTHERS TO MANAGE USER STORIES, REQUIREMENTS AND DEVELOPMENT TASKS; CONSULTING SERVICES IN THE FIELD OF DESIGN AND DEVELOPMENT OF COMPUTER SOFTWARE; SERVICES OF AN APPLICATION SERVICE PROVIDER, NAMELY, HOSTING COMPUTER SOFTWARE APPLICATIONS OF OTHERS; COMPUTER SOFTWARE DESIGN; INSTALLATION, MODIFICATION AND MAINTENANCE OF COMPUTER SOFTWARE; COMPUTER SYSTEM DESIGN AND ANALYSIS; DATE HOSTING SERVICES, NAMELY, APPLICATION SERVICE PROVIDER IN THE FIELD OF KNOWLEDGE MANAGEMENT TO HOST COMPUTER APPLICATION SOFTWARE FOR CREATING SEARCHABLE DATABASES OF INFORMATION AND DATA AND INTERACTIVE HOSTING SERVICES WHICH ALLOW THE USER TO PUBLISH AND SHARE THEIR OWN CONTENT AND IMAGES ONLINE; DATA CONVERSION OF COMPUTER PROGRAMS AND DATA, NOT PHYSICAL CONVERSION; CONSULTANCY SERVICES IN THE FIELD OF COMPUTERS AND SOFTWARE; PROVIDING INFORMATION AND CONSULTANCY SERVICES IN THE FIELDS OF DESIGN AND DEVELOPMENT OF COMPUTER SOFTWARE, COMPUTER SOFTWARE SYSTEM DESIGN AND ANALYSIS AND DATA HOSTING SERVICES, INCLUDING BY ELECTRONIC MEANS VIA A GLOBAL COMPUTER NETWORK (U.S. CLS. 100 AND 101).

ANNE FARRELL, EXAMINING ATTORNEY

CLASS 41—EDUCATION AND ENTERTAINMENT

FOR VIDEOTAPING; PUBLICATION OF BOOKS; PROVIDING INFORMATION ABOUT EDUCATION; PROVIDING INFORMATION IN THE FIELD OF RECREATION; ENTERTAINMENT INFORMATION; MOVIE STUDIOS; VIDEOTAPE EDITING; PRODUCTION OF RADIO AND TELEVISION PROGRAMS; PROVIDING NON-DOWNLOADABLE, ON-LINE ELECTRONIC PUBLICATIONS IN THE NATURE OF MAGAZINES AND BOOKS IN THE FIELD OF ARCHITECTURE, ENGINEERING AND INTERIOR DESIGN; ORGANIZATION OF EXHIBITIONS FOR CULTURAL OR EDUCATIONAL PURPOSES; PROVIDING RECREATION FACILITIES; ARRANGING AND CONDUCTING OF COLLOQUIUMS IN THE FIELD OF ARCHITECTURE, ENGINEERING AND INTERIOR DESIGN; ARRANGING AND CONDUCTING OF CONGRESSES IN THE FIELD OF ARCHITECTURE, ENGINEERING AND INTERIOR DESIGN; ARRANGING AND CONDUCTING OF CONFERENCES IN THE FIELD OF ARCHITECTURE, ENGINEERING AND INTERIOR DESIGN; ARRANGING AND CONDUCTING OF WORKSHOP TRAININGS IN THE FIELD OF ARCHITECTURE, ENGINEERING AND INTERIOR DESIGN; ARRANGING AND CONDUCTING OF SEMINARS IN THE FIELD OF ARCHITECTURE, ENGINEERING AND INTERIOR DESIGN; ARRANGING AND CONDUCTING OF SYMPOSIUMS IN THE FIELD OF INTERIOR DESIGN; ARRANGING AND CONDUCTING OF CONCERTS AND PUBLIC ENTERTAINMENT EVENTS IN THE FIELD OF ARCHITECTURE, ENGINEERING AND INTERIOR DESIGN; EDUCATIONAL AND ENTERTAINMENT SERVICES, NAMELY, ORGANIZATION OF COMPETITIONS FOCUSED ON REVEALING THE MOST TALENTED AND ORIGINAL ARCHITECTURAL AND DESIGN DECISIONS, ORGANIZATION OF DISCUSSIONS CONCERNING TOPICAL ISSUES OF ARCHITECTURE AND DESIGN; OPERATING LOTTERIES; PROVIDING VOCATIONAL GUIDANCE, EDUCATION OR TRAINING ADVICE; TELEVISION ENTERTAINMENT, NAMELY, PROVIDING ON-GOING TELEVISION PROGRAMS IN THE FIELD OF ARCHITECTURE, ENGINEERING AND INTERIOR DESIGN; VIDEOTAPE FILM PRODUCTION; FILM PRODUCTION; ANIMATED FILM PRODUCTION; ELECTRONIC DESKTOP PUBLISHING; PUBLICATION OF ELECTRONIC BOOKS AND JOURNALS ON-LINE; PUBLICATION OF TEXTS, OTHER THAN PUBLICITY TEXTS; SUBTITLING; RADIO ENTERTAINMENT, NAMELY, PROVIDING ON-GOING RADIO PROGRAMS IN THE FIELD OF ARCHITECTURE, ENGINEERING AND INTERIOR DESIGN; ENTERTAINMENT SERVICES, NAMELY, CONDUCTING CONTESTS IN THE FIELD OF INTERIOR DESIGN; EDUCATIONAL SERVICES IN THE FIELD OF ARCHITECTURE, ENGINEERING AND INTERIOR DESIGN; TRANSLATION; PHOTOGRAPHY; PHOTOGRAPHIC REPORTING; ENTERTAINMENT, NAMELY, PRODUCTION OF SHOWS (U.S. CLS. 100, 101 AND 107).

SN 79-103,779. THE INDEPENDENT NONCOMMERCIAL ORGANIZATION "COUNCIL OF EXPERTS IN INTERIOR DESIGN AND ARCHITECTURAL ENVIRONMENT", RUSSIAN FED., FILED 8-31-2011.

INTERIA AWARDS

THE MARK CONSISTS OF STANDARD CHARACTERS WITHOUT CLAIM TO ANY PARTICULAR FONT, STYLE, SIZE, OR COLOR.

PRIORITY DATE OF 6-30-2011 IS CLAIMED.

OWNER OF INTERNATIONAL REGISTRATION 1093864 DATED 8-31-2011, EXPIRES 8-31-2021.

NO CLAIM IS MADE TO THE EXCLUSIVE RIGHT TO USE "AWARDS" , APART FROM THE MARK AS SHOWN.

THE WORDING "INTERIA" HAS NO MEANING IN A FOREIGN LANGUAGE.

CLASS 42—SCIENTIFIC AND COMPUTER SERVICES

FOR ARCHITECTURE, NAMELY, ARCHITECTURAL DESIGN AND INTERIOR DESIGN; AUTHENTICATING WORKS OF ART; GRAPHIC ARTS DESIGNING; ARCHITECTURAL CONSULTATION; DRESS DESIGNING; DESIGN OF INTERIOR DECOR; INDUSTRIAL DESIGN; INDUSTRIAL DESIGN STYLING SERVICES; PACKAGING DESIGN SERVICES (U.S. CLS. 100 AND 101).

RICHARD WHITE, EXAMINING ATTORNEY

SN 79-103,942. SANKO TEKSTIL ISLETMELERI SANAYI VE TICARET ANONIM SIRKETI, GAZIANTEP, TURKEY, FILED 7-8-2011.



PRIORITY DATE OF 7-5-2011 IS CLAIMED.
OWNER OF INTERNATIONAL REGISTRATION 1094287 DATED 7-8-2011, EXPIRES 7-8-2021.
THE COLOR(S) WHITE AND GREY IS/ARE CLAIMED AS A FEATURE OF THE MARK.
THE MARK CONSISTS OF A PIECE OF GREY TULLE FORMING A STYLIZED LETTER "Z" ON A WHITE BACKGROUND.

CLASS 23—YARNS AND THREADS

FOR YARNS AND THREADS FOR TEXTILE USE, SEWING THREADS, EMBROIDERY THREADS, KNITTING THREADS, COTTON THREADS AND ELASTIC THREADS FOR TEXTILE USE (U.S. CL. 43).

CLASS 24—FABRICS

FOR WOVEN TEXTILE FABRICS FOR USE IN THE MANUFACTURE OF CLOTHING, TOWELS, TABLE LINEN, BED LINEN, HOUSEHOLD LINEN; NON-WOVEN TEXTILE FABRICS FOR USE IN THE MANUFACTURE OF CLOTHING, TOWELS, TABLE LINEN, BED LINEN, HOUSEHOLD LINEN; HAND TOWELS, FACE TOWELS OF TEXTILE, BATH TOWELS (U.S. CLS. 42 AND 50).

CLASS 25—CLOTHING

FOR CLOTHING, NAMELY, SHIRTS, T-SHIRTS, TROUSERS; UNDERCLOTHING, NAMELY, BOXER SHORTS, BRASSIERES, BRIEFS, PANTS; BATHROBES (U.S. CLS. 22 AND 39).
ROBERT STRUCK, EXAMINING ATTORNEY

SN 79-104,022. CEGEDIM, FRANCE, FILED 9-15-2011.

PRIORITY DATE OF 4-8-2011 IS CLAIMED.
OWNER OF INTERNATIONAL REGISTRATION 1094504 DATED 9-15-2011, EXPIRES 9-15-2021.
NO CLAIM IS MADE TO THE EXCLUSIVE RIGHT TO USE "SMART" FOR GOODS IN CLASS 9 ONLY, APART FROM THE MARK AS SHOWN.
THE MARK CONSISTS OF THE WORD "SMART" IN STYLIZED LETTERS FOLLOWED BY THE LETTERS "RH" IN A RAISED SUPERSCRIPIT.

CLASS 9—ELECTRICAL AND SCIENTIFIC APPARATUS

FOR HUMAN RESOURCE MANAGEMENT AND PAYROLL PAYMENTS SOFTWARE (U.S. CLS. 21, 23, 26, 36 AND 38).

CLASS 35—ADVERTISING AND BUSINESS

FOR BUSINESS MANAGEMENT ASSISTANCE AND BUSINESS MANAGEMENT IN THE FIELDS OF HUMAN RESOURCES AND PAYROLL PAYMENTS; HUMAN RESOURCE MANAGEMENT (U.S. CLS. 100, 101 AND 102).

CLASS 41—EDUCATION AND ENTERTAINMENT

FOR TRAINING SERVICES IN THE FIELDS OF HUMAN RESOURCES AND PAYROLL PAYMENTS (U.S. CLS. 100, 101 AND 107).
JOHN WILKE, EXAMINING ATTORNEY

SN 79-104,031. HORST KEPNER, REICHENSCHWAND, FED REP GERMANY, FILED 7-25-2011.

THE MARK CONSISTS OF STANDARD CHARACTERS WITHOUT CLAIM TO ANY PARTICULAR FONT, STYLE, SIZE, OR COLOR.
OWNER OF INTERNATIONAL REGISTRATION 1094518 DATED 7-25-2011, EXPIRES 7-25-2021.

CLASS 9—ELECTRICAL AND SCIENTIFIC APPARATUS

FOR RECORDED DATA MEDIA, NAMELY, DVDS CONTAINING TRAINING INSTRUCTIONS IN THE FIELD OF SPORTS TRAINING; PRE-RECORDED CDS CONTAINING MUSIC; ERGOMETERS FOR STATIONARY BICYCLES, NOT FOR MEDICAL PURPOSES; APPARATUS FOR RECORDING, TRANSMISSION AND REPRODUCTION OF SOUND, IMAGES AND DATA, NAMELY, VIDEO CASSETTE RECORDERS AND PLAYERS, CD AND DVD RECORDERS AND PLAYERS; REVOLUTION COUNTERS FOR BICYCLE WHEELS, TACHOMETERS; COMPUTER HARDWARE FOR USE WITH BICYCLES; SPORTS EQUIPMENT IN THE NATURE OF PORTABLE ELECTRONIC DEVICES SHOWING TRAINING DATA, NAMELY, TIME, HEART RATE, OUTPUT AND SPEED INCORPORATING CLOCKS (U.S. CLS. 21, 23, 26, 36 AND 38).

CLASS 10—MEDICAL APPARATUS

FOR HEART RATE MONITORS, MEDICAL APPARATUS SHOWING TRAINING DATA, NAMELY, HEART RATE, BODILY OUTPUT, AND SPEED (U.S. CLS. 26, 39 AND 44).

CLASS 12—VEHICLES

FOR BICYCLES FOR SPORTS; PARTS OF BICYCLES FOR SPORTS, NAMELY, SADDLES AND PEDALS (U.S. CLS. 19, 21, 23, 31, 35 AND 44).

CLASS 16—PAPER GOODS AND PRINTED MATTER

FOR PRINTED MATTER, NAMELY, MANUALS, INSTRUCTIONAL AND TEACHING MATERIAL IN THE FIELD OF BICYCLE TRAINING (U.S. CLS. 2, 5, 22, 23, 29, 37, 38 AND 50).

CLASS 25—CLOTHING

FOR CLOTHING, NAMELY, JOGGING SUITS, EXERCISE TOPS AND BOTTOMS, BRAS, BUSTIERS, COATS, JACKETS, PANTS, SHORTS, SHIRTS, DRESSES, SKIRTS, VESTS, SWEATERS, BLOUSES, BODY SUITS, SWEAT SUITS, HOSIERY, SOCKS AND STOCKINGS, UNDERWEAR, LINGERIE, SLIPS, UNDERCLOTHES, BELTS, SCARVES AND SHAWLS, KERCHIEFS, TIES AND BOW TIES, FASHION AND DRESS GLOVES; FOOTWEAR; HEADGEAR, NAMELY, HATS AND CAPS, SWEATBANDS, HEAD SCARVES (U.S. CLS. 22 AND 39).

CLASS 28—TOYS AND SPORTING GOODS

FOR STATIONARY EXERCISE BICYCLES FOR SPORTS AS AN APPARATUS FOR FITNESS TRAINING, STATIONARY BICYCLES FOR FITNESS TRAINING, APPARATUS FOR FITNESS TRAINING AND APPARATUS FOR SPORTS, NAMELY, DUMB-BELLS, EXERCISE BALLS, EXERCISING CABLE PULLEYS, EXERCISERS IN THE NATURE OF CHEST EXPANDERS, CORE ABDOMINAL BOARDS, AEROBIC STEPS, STATIONARY TRAINING CYCLES; PARTS OF THE AFOREMENTIONED GOODS, NAMELY, HANDLEBARS, SADDLES AND PEDALS (U.S. CLS. 22, 23, 38 AND 50).

CLASS 41—EDUCATION AND ENTERTAINMENT

FOR PROVIDING OF TRAINING AND ADVANCED TRAINING IN THE FIELD OF SPORTS WITH STATIONARY BICYCLES; ENTERTAINMENT SERVICES, NAMELY, PROVIDING MOTIVATIONAL AND EDUCATIONAL SPEAKERS IN THE FIELD OF SPORTS WITH STATIONARY BICYCLES AND PROVIDING LIVE CONTESTS, GAMES, PERFORMANCES AND SHOWS IN THE FIELD OF SPORTS WITH STATIONARY BICYCLES; PROVIDING SPORTING AND CULTURAL ACTIVITIES AND EVENTS, NAMELY, ORGANIZING, SANCTIONING, CONDUCTING, REGULATING AND GOVERNING SPORT PROGRAMS AND ACTIVITIES IN THE FIELD OF SPORTS WITH STATIONARY BICYCLES; PROVIDING OF THE SERVICES OF A GYM (U.S. CLS. 100, 101 AND 107).

TRACY CROSS, EXAMINING ATTORNEY

CLASS 6—METAL GOODS

FOR IRON AND STEEL; UNWROUGHT OR SEMI-WROUGHT IRON; UNWROUGHT OR SEMI-WROUGHT STEEL; NONFERROUS METALS AND THEIR ALLOYS; UNWROUGHT OR SEMI-WROUGHT BRASS, UNWROUGHT OR SEMI-WROUGHT COPPER; METAL ORES; MATERIALS OF METAL FOR BUILDING AND CONSTRUCTION, NAMELY, SOFFITS; PULLEYS, SPRINGS AND VALVES OF METAL, NOT INCLUDING MACHINE ELEMENTS; METAL CLASPS FOR DOOR SECURITY HARDWARE; BINDING SCREWS OF METAL FOR CABLES; METAL HARDWARE, NAMELY, PLUGS, RIVETS, CASTER, AND SLEEVES; BINDINGS OF METAL FOR CABLES AND PIPES; CLIPS OF METAL FOR CABLES AND PIPES; NUTS OF METAL; HARDWARE, NAMELY, METAL PINS; RINGS OF METAL FOR GASKETS; SCREWS OF METAL; WASHERS OF METAL; BOXES OF COMMON METAL; ALLOYS OF COMMON METAL; COMMON METALS, UNWROUGHT OR SEMI-WROUGHT; INGOTS OF COMMON METAL; METAL PIPES AND TUBES (U.S. CLS. 2, 12, 13, 14, 23, 25 AND 50).

CLASS 7—MACHINERY

FOR METALWORKING MACHINES AND TOOLS; DRILL CHUCKS BEING PARTS OF MACHINES; GRINDING MACHINES; HAND-HELD TOOLS, OTHER THAN HAND-OPERATED, NAMELY, BATTERY ACTUATED HYDRAULIC CRIMP TOOLS; HEMMING MACHINES; LATHES BEING MACHINE TOOLS; METALWORKING MACHINES; MILLING MACHINES; CHEMICAL PROCESSING MACHINES AND APPARATUS; MACHINE ELEMENTS NOT FOR LAND VEHICLES, NAMELY, SHAFT COUPLINGS AS PARTS OF MACHINES, SHAFT COUPLINGS FOR MACHINES, AXLES OR SPINDLES, BEARINGS, CONNECTORS, SHOCK ABSORBERS, SPRINGS, PNEUMATIC SHOCK ABSORBERS, AIR SPRINGS, SPRING SHOCK ABSORBERS, SPRING-ASSISTED HYDRAULIC SHOCK ABSORBERS, SPIRAL SPRINGS, LAMINATED LEAF-SPRINGS; SEMICONDUCTOR MANUFACTURING MACHINES, AND SEMICONDUCTOR MANUFACTURING MACHINES SOLD AS A UNIT; PRINTED CIRCUIT BOARDS PROCESSING MACHINES AND MACHINE TOOLS; PRINTED CIRCUIT BOARDS MANUFACTURING MACHINES SOLD AS A UNIT; PRINTED ELECTRONIC CIRCUIT BOARDS PROCESSING MACHINES AND MACHINE TOOLS (U.S. CLS. 13, 19, 21, 23, 31, 34 AND 35).

CLASS 9—ELECTRICAL AND SCIENTIFIC APPARATUS

FOR CINEMATOGRAPHIC INSTRUMENTS AND APPARATUS; APPARATUS AND INSTRUMENTS FOR TESTING PRINTED CIRCUIT BOARDS AND THEIR PARTS; PROBES FOR TESTING INTEGRATED CIRCUITS, AND ULTRASOUND PROBES, NOT FOR MEDICAL USE; MEASURING PROBES FOR USE OF NEAR-INFRARED SPECTROANALYSIS APPARATUS; SURVEYING INSTRUMENTS; ELECTRIC OR MAGNETIC METERS AND TESTERS, NAMELY, PHASE INDICATORS, OSCILLOGRAPHS AND OSCILLOSCOPES, CIRCUIT TESTERS, ANTENNA PARAMETER MEASURING APPARATUS, DETECTORS FOR ELECTRIC OR MAGNETIC METERS AND TESTERS, GROUND DETECTORS, NAMELY, ELECTRIC LEAKAGE DETECTORS, MAGNETOMETERS, FREQUENCY METERS, VACUUM TUBE CHARACTERISTIC TESTERS, WATT HOUR METERS, RESISTANCE MEASURING INSTRUMENTS, AMMETERS, WATTMETERS, OSCILLATORS AND CAPACITY MEASURES FOR ELECTRIC OR MAGNETIC METERS AND TESTERS; AMMETERS; ELECTRIC LOSS INDICATORS; FREQUENCY METERS; GALVANOMETERS; OHMMETERS; VOLTMETERS; WAVE-METERS (U.S. CLS. 21, 23, 26, 36 AND 38).

SN 79-104,054. SANKEI ENGINEERING CO.,LTD., JAPAN,
FILED 5-6-2011.



PRIORITY DATE OF 11-8-2010 IS CLAIMED.
OWNER OF INTERNATIONAL REGISTRATION 1094560
DATED 5-6-2011, EXPIRES 5-6-2021.

NO CLAIM IS MADE TO THE EXCLUSIVE RIGHT TO USE "PROFESSIONALS", APART FROM THE MARK AS SHOWN.

CLASS 35—ADVERTISING AND BUSINESS

FOR ADVERTISING; PROMOTING THE GOODS AND SERVICES OF OTHERS THROUGH THE ISSUANCE OF TRADING STAMPS; BUSINESS MANAGEMENT ANALYSIS OR BUSINESS CONSULTANCY; MARKETING RESEARCH; PROVIDING INFORMATION ON SALES OF GOODS AND PRESENTATION OF GOODS ON COMMUNICATION MEDIA, FOR RETAIL PURPOSES; BUSINESS APPRAISALS; BUSINESS MANAGEMENT OF PERFORMING ARTISTS; PROFESSIONAL BUSINESS CONSULTANCY; BUSINESS INFORMATION; BUSINESS INVESTIGATIONS; BUSINESS MANAGEMENT AND ORGANIZATION CONSULTANCY; RELOCATION SERVICES FOR BUSINESSES; COST PRICE ANALYSIS; ECONOMIC FORECASTING; EFFICIENCY EXPERTS; COMMERCIAL AND INDUSTRIAL MANAGEMENT ASSISTANCE; PERSONNEL MANAGEMENT CONSULTANCY; PSYCHOLOGICAL TESTING FOR THE SELECTION OF PERSONNEL; PREPARATION OF FINANCIAL STATEMENTS OF ACCOUNTS; AUDITING; TAX PREPARATION; EMPLOYMENT AGENCIES; PERSONNEL RECRUITMENT; IMPORT-EXPORT AGENCIES (U.S. CLS. 100, 101 AND 102).

CLASS 41—EDUCATION AND ENTERTAINMENT

FOR EDUCATIONAL AND INSTRUCTION SERVICES, NAMELY, WORKSHOPS, CLASSES, TUTORING RELATING TO MEASURING AND TESTING MACHINES AND INSTRUMENTS; EDUCATION OR TRAINING ADVICE IN THE NATURE OF VOCATIONAL GUIDANCE; EDUCATION INFORMATION; ARRANGING, CONDUCTING AND ORGANIZATION OF SEMINARS; ARRANGING AND CONDUCTING OF COLLOQUIUMS; ARRANGING AND CONDUCTING OF EDUCATIONAL CONFERENCES; ARRANGING AND CONDUCTING OF EDUCATIONAL CONGRESSES; ARRANGING AND CONDUCTING OF EDUCATIONAL SYMPOSIUMS; ARRANGING AND CONDUCTING OF TRAINING WORKSHOPS IN THE FIELDS OF MEASURING AND TESTING MACHINES AND INSTRUMENTS; PROVIDING ELECTRONIC PUBLICATIONS IN THE NATURE OF BOOKS, MAGAZINES, BROCHURES IN THE FIELD OF MEASURING AND TESTING MACHINES AND INSTRUMENTS; SERVICES OF REFERENCE LIBRARIES FOR LITERATURE AND DOCUMENTARY RECORDS; ORGANIZATION OF ENTERTAINMENT EVENTS FOR MEASURING AND TESTING MACHINES AND INSTRUMENTS; PROVIDING AMUSEMENT FACILITIES; PROVIDING FACILITIES FOR MOVIES, SHOWS, PLAYS, MUSIC OR EDUCATIONAL TRAINING; RENTAL OF RECORDS OR SOUND-RECORDED MAGNETIC TAPES; ORGANIZATION OF COMPETITIONS FOR EDUCATION OR ENTERTAINMENT PURPOSES IN THE FIELD OF MEASURING AND TESTING MACHINES AND INSTRUMENTS; ORGANIZATION OF EXHIBITIONS FOR CULTURAL OR EDUCATIONAL PURPOSES (U.S. CLS. 100, 101 AND 107).

CLASS 42—SCIENTIFIC AND COMPUTER SERVICES

FOR DESIGNING OF MACHINES, APPARATUS, INSTRUMENTS, INCLUDING THEIR PARTS OR SYSTEMS COMPOSED OF SUCH MACHINES, APPARATUS AND INSTRUMENTS, ALL IN THE FIELDS OF MEASURING AND TESTING MACHINES AND INSTRUMENTS; DESIGNING, NAMELY, GRAPHIC DESIGNING; COMPUTER PROGRAMMING; TECHNICAL ADVICE RELATING TO COMPUTERS; TESTING OR RESEARCH ON MACHINES, APPARATUS AND INSTRUMENTS; CALIBRATION (MEASURING); MECHANICAL RESEARCH; RENTAL OF COMPUTERS; DESIGNING COMPUTER PROGRAMS TO THE SPECIFICATIONS OF OTHERS; RENTAL OF LABORATORY APPARATUS AND INSTRUMENTS (U.S. CLS. 100 AND 101).

KEVIN DINALLO, EXAMINING ATTORNEY

SN 79-104,056. I.V.A.R. S.P.A., BRESCIA, ITALY, FILED 6-15-2011.

IVAR

THE MARK CONSISTS OF STANDARD CHARACTERS WITHOUT CLAIM TO ANY PARTICULAR FONT, STYLE, SIZE, OR COLOR.

PRIORITY DATE OF 5-17-2011 IS CLAIMED.
OWNER OF INTERNATIONAL REGISTRATION 1094569
DATED 6-15-2011, EXPIRES 6-15-2021.
OWNER OF U.S. REG. NO. 3,071,277.

CLASS 6—METAL GOODS

FOR METAL ACCESSORIES FOR PLUMBING PLANTS, NAMELY, METAL HOSES FOR PLUMBING USE AND METAL PIPE FITTINGS; METAL CONNECTING TUBES; METAL CONDUITS FOR CENTRAL HEATING; METAL MANIFOLDS FOR PIPELINES; METAL ELBOW TUBES; METAL FITTINGS FOR TUBES; VALVES FOR METAL WATER CONDUITS; METAL DRAINAGE TUBE VALVES; METAL VALVES NOT PARTS OF MACHINES; METAL SPHERE VALVES; METAL CUT-OUT VALVES; METAL CHECK VALVES; UNWORKED OR SEMI-FINISHED BRASS (U.S. CLS. 2, 12, 13, 14, 23, 25 AND 50).

CLASS 11—ENVIRONMENTAL CONTROL APPARATUS

FOR APPARATUS AND PLANTS FOR WATER DISTRIBUTION AND RELATIVE COMPONENTS AND ACCESSORIES, NAMELY, MANUALLY-OPERATED PLUMBING VALVES; PLUMBING FITTINGS, NAMELY, BTBBS, MANIFOLDS, COCKS, TRAPS, DRAINS, VALVES, COUPLERS AND BAFFLES; PLUMBING PLANTS AND RELATIVE COMPONENTS AND ACCESSORIES, NAMELY, PLUMBING FITTINGS, NAMELY, VALVES; WATER INJECTION, MIXING AND DISTRIBUTION SYSTEMS FOR HEATING APPARATUS, COMPRISING TUBES, PIPES AND PRE-ASSEMBLED MANIFOLDS THROUGH WHICH COLD OR LOW TEMPERATURE WATER CIRCULATES; HEATING SYSTEMS COMPOSED PRIMARILY OF TUBES, PIPES AND MANIFOLDS THROUGH WHICH WARM OR HIGH TEMPERATURE WATER CIRCULATES; REGULATING AND SAFETY ACCESSORIES FOR HYDRAULIC PLANTS, NAMELY, THERMOSTATIC VALVES; PRESSURE REGULATORS FOR SANITARY INSTALLATIONS; HEATING PLANTS, NAMELY, HEATING INSTALLATIONS; CENTRAL HEATING RADIATORS; HOT WATER HEATING PLANTS; SOLAR MANIFOLDS FOR HEATING; PLUMBING FITTINGS, NAMELY, THERMOSTAT VALVES BEING PARTS OF HEATING PLANTS; PLUMBING FITTINGS, NAMELY, THERMOSTATIC HEADS; REGULATING ACCESSORIES, NAMELY, PRESSURE REGULATORS FOR WATER INSTALLATIONS (U.S. CLS. 13, 21, 23, 31 AND 34).

CLASS 17—RUBBER GOODS

FOR NON-METAL FLEXIBLE CONDUIT FITTINGS; NON-METAL FITTINGS FOR NON-METAL FLEXIBLE TUBES; NON-METAL FITTINGS FOR FLEXIBLE TUBES; NON-METAL CONNECTORS FOR NON-METAL FLEXIBLE TUBES; NON-METAL CONNECTORS FOR FLEXIBLE TUBES AND GASKETS (U.S. CLS. 1, 5, 12, 13, 35 AND 50).

CLASS 19—NON-METALLIC BUILDING MATERIALS

FOR NON-METAL WATER CONDUITS; NON-METAL WATER PIPE FITTING TUBES FOR JOINING AND TERMINATING PIPES (U.S. CLS. 1, 12, 33 AND 50).

KEVIN DINALLO, EXAMINING ATTORNEY

SN 79-104,189. MANN+HUMMEL GMBH, FED REP GERMANY, FILED 8-12-2011.

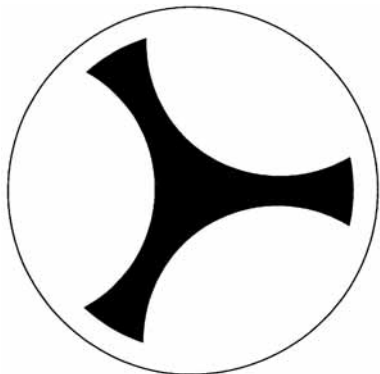

PRIORITY DATE OF 2-18-2011 IS CLAIMED.
OWNER OF INTERNATIONAL REGISTRATION 1094867
DATED 8-12-2011, EXPIRES 8-12-2021.

THE MARK CONSISTS OF TRIANGULAR SHAPES WITHIN A CIRCLE CARRIER.

CLASS 7—MACHINERY

FOR MACHINE TOOLS FOR PROCESSING OF COMPONENTS AND TOOLS; ELECTRIC DISCHARGE MACHINES FOR PROCESSING OF CONDUCTIVE MATERIALS; FILTERS FOR MACHINE TOOLS FOR PROCESSING OF COMPONENTS AND TOOLS AND FOR FILTERING DIELECTRIC FLUIDS, USED BY ELECTRIC DISCHARGE MACHINES FOR PROCESSING OF CONDUCTIVE MATERIALS; FILTER ELEMENTS FOR MACHINE TOOLS FOR PROCESSING OF COMPONENTS AND TOOLS AND FOR FILTERING DIELECTRIC FLUIDS, USED BY ELECTRIC DISCHARGE MACHINES FOR PROCESSING OF CONDUCTIVE MATERIALS; FILTER ELEMENTS FOR FILTERING DIELECTRIC FLUIDS, USED BY ELECTRIC DISCHARGE MACHINES FOR PROCESSING OF CONDUCTIVE MATERIALS; LIQUID FILTERS FOR MACHINE TOOLS FOR PROCESSING OF COMPONENTS AND TOOLS; LIQUID FILTERS FOR FILTERING DIELECTRIC FLUIDS, USED BY ELECTRIC DISCHARGE MACHINES FOR PROCESSING OF CONDUCTIVE MATERIALS; FILTER ELEMENTS FOR LIQUID FILTERS FOR MACHINE TOOLS FOR PROCESSING OF COMPONENTS AND TOOLS AND FOR FILTERING DIELECTRIC FLUIDS, USED BY ELECTRIC DISCHARGE MACHINES FOR PROCESSING OF CONDUCTIVE MATERIALS; AND PARTS THEREOF OF THE AFORESAID GOODS (U.S. CLS. 13, 19, 21, 23, 31, 34 AND 35).

CLASS 16—PAPER GOODS AND PRINTED MATTER

FOR PRINTED MATTER, NAMELY, PAMPHLETS, PERIODICALS, BROCHURES, PROSPECTUSES, CATALOGUES, PRINTED ADVERTISING, NAMELY, LEAFLETS, POSTERS AND PRODUCT ADVERTS IN PROFESSIONAL JOURNALS, OPERATION MANUALS, INSTALLATION GUIDES, USER INSTRUCTIONS, PRESS KITS FEATURING PRESS RELEASES, ALL FEATURING MACHINE TOOLS FOR PROCESSING OF COMPONENTS AND TOOLS AND FILTERS FOR FILTERING DIELECTRIC FLUIDS, USED BY ELECTRIC DISCHARGE MACHINES FOR PROCESSING OF CONDUCTIVE MATERIALS (U.S. CLS. 2, 5, 22, 23, 29, 37, 38 AND 50).

CLASS 37—CONSTRUCTION AND REPAIR

FOR REPAIR OF MACHINE TOOLS AND OF FILTERS FOR MACHINE TOOLS AND THEIR SPARE PARTS; REPAIR OF ELECTRIC DISCHARGE MACHINES AND OF FILTERS FOR ELECTRIC DISCHARGE MACHINES AND THEIR SPARE PARTS; REPAIR OF LIQUID FILTERS FOR MACHINE TOOLS AND THEIR SPARE PARTS; REPAIR OF LIQUID FILTERS FOR ELECTRIC DISCHARGE MACHINES AND THEIR SPARE PARTS (U.S. CLS. 100, 103 AND 106).

JOSETTE BEVERLY, EXAMINING ATTORNEY

SN 79-104,546. PATWAL GMBH, SPEICHER, SWITZERLAND, FILED 9-27-2011.

EIWAL

THE MARK CONSISTS OF STANDARD CHARACTERS WITHOUT CLAIM TO ANY PARTICULAR FONT, STYLE, SIZE, OR COLOR.

OWNER OF INTERNATIONAL REGISTRATION 1095732
DATED 9-27-2011, EXPIRES 9-27-2021.

CLASS 9—ELECTRICAL AND SCIENTIFIC APPARATUS

FOR MAGNIFYING GLASSES FOR READING, MAGNIFYING GLASSES (U.S. CLS. 21, 23, 26, 36 AND 38).

CLASS 12—VEHICLES

FOR SHOPPING CARTS (U.S. CLS. 19, 21, 23, 31, 35 AND 44).

FRANK LATTUCA, EXAMINING ATTORNEY

SN 79-104,652. SHL TELEMEDICINE INTERNATIONAL LTD., TEL AVIV, ISRAEL, FILED 6-21-2011.

SMART HEART

THE MARK CONSISTS OF STANDARD CHARACTERS WITHOUT CLAIM TO ANY PARTICULAR FONT, STYLE, SIZE, OR COLOR.

PRIORITY DATE OF 1-2-2011 IS CLAIMED.

OWNER OF INTERNATIONAL REGISTRATION 1096059
DATED 6-21-2011, EXPIRES 6-21-2021.

NO CLAIM IS MADE TO THE EXCLUSIVE RIGHT TO USE "HEART", APART FROM THE MARK AS SHOWN.

CLASS 9—ELECTRICAL AND SCIENTIFIC APPARATUS

FOR COMPUTER APPLICATION SOFTWARE FOR MOBILE DEVICES, NAMELY, SOFTWARE FOR COMMUNICATION AND TRANSMISSION OF DATA DIRECTLY FROM A MOBILE DEVICE TO A MEDICAL CENTER PROVIDING EMERGENCY RESPONSE (U.S. CLS. 21, 23, 26, 36 AND 38).

CLASS 10—MEDICAL APPARATUS

FOR MEDICAL EQUIPMENT, NAMELY, AN ELECTROCARDIOGRAPHIC (ECG) RECORDER WHICH RECORDS THE ELECTRIC ACTIVITY OF THE HEART AND TRANSMITS THE DATA TO AN END-USER'S MOBILE DEVICE (U.S. CLS. 26, 39 AND 44).

CLASS 38—COMMUNICATION

FOR ELECTRONIC TRANSMISSION OF MEDICAL DATA (U.S. CLS. 100, 101 AND 104).

CLASS 44—MEDICAL, BEAUTY AND AGRICULTURAL SERVICES

FOR PROVISION OF MEDICAL SERVICES, NAMELY, PROVISION OF HEALTH CARE AND MEDICAL SERVICES BY HEALTH CARE PROFESSIONALS VIA THE INTERNET OR TELECOMMUNICATION NETWORKS (U.S. CLS. 100 AND 101).

JIM RINGLE, EXAMINING ATTORNEY

SN 79-104,676. PINO PHARMAZEUTISCHE PRÄPARATE GMBH, FED REP GERMANY, FILED 6-29-2011.

Liquiderma

OWNER OF INTERNATIONAL REGISTRATION 0377981 DATED 3-30-1971, EXPIRES 3-30-2021.

THE MARK CONSISTS OF THE WORDING "LIQUIDERMA" IN STYLIZED FONT.

CLASS 3—COSMETICS AND CLEANING PREPARATIONS

FOR COSMETIC PREPARATIONS (U.S. CLS. 1, 4, 6, 50, 51 AND 52).

CLASS 5—PHARMACEUTICALS

FOR VEGETABLE OILS AND PLANT EXTRACTS FOR MEDICAL AND SANITARY PURPOSES (U.S. CLS. 6, 18, 44, 46, 51 AND 52).

HEATHER BIDDULPH, EXAMINING ATTORNEY

SN 79-104,901. ATIKER METAL ITHALAT IHRACAT; VE IMALAT; SANAYI TICARET ANONIM SIRKETI, TURKEY, FILED 8-22-2011.



PRIORITY DATE OF 7-26-2011 IS CLAIMED. OWNER OF INTERNATIONAL REGISTRATION 1096409 DATED 8-22-2011, EXPIRES 8-22-2021.

THE COLOR(S) GREEN, RED AND WHITE IS/ARE CLAIMED AS A FEATURE OF THE MARK.

THE MARK CONSISTS OF THE WORDING "GASNORD" IN WHITE INSIDE A GREEN RECTANGLE WHICH HAS FOUR RED TRIANGLES ON THE OUTSIDE OF EACH SIDE OF THE RECTANGLE. THE ENTIRE MARK IS ON A WHITE BACKGROUND.

CLASS 6—METAL GOODS

FOR CONTAINERS OF METAL FOR COMPRESSED GAS OR LIQUID AIR, EMPTY METAL CONTAINERS FOR LIQUEFIED PETROLEUM GAS (LPG), METAL CONTAINERS FOR GAS (U.S. CLS. 2, 12, 13, 14, 23, 25 AND 50).

CLASS 7—MACHINERY

FOR FUEL ECONOMIZERS FOR ENGINES, LIQUEFIED PETROLEUM GAS (LPG) FUEL CONVERSION APPARATUS FOR INTERNAL COMBUSTION ENGINES (U.S. CLS. 13, 19, 21, 23, 31, 34 AND 35).

CLASS 9—ELECTRICAL AND SCIENTIFIC APPARATUS

FOR ELECTRONIC DEVICES USED IN MACHINES AND DEVICES, NAMELY, SEMI-CONDUCTORS, ELECTRONIC CIRCUITS, INTEGRATED CIRCUITS, CHIPS, PHOTOCELLS, DIODES, TRANSISTORS, CIRCUIT BOARDS, CRYSTAL OSCILLATORS, CAPACITORS, INTERFACE CIRCUITS FOR VIDEO CAMERAS AND FOR DATA PROCESSING EQUIPMENT IN THE FORM OF PRINTED CIRCUITS, ELECTRONIC LCD DISPLAY UNITS, ELECTRONIC HYBRID CIRCUITS, ELECTRONIC HEAT SENSORS, ELECTRONIC CONVERTERS, MAGNETIC HEAD CLEANER APPARATUS, ELECTRONIC INDICATORS FOR VEHICLES; SPEED INDICATORS, OIL LEVEL INDICATORS, FUEL LEVEL INDICATORS AND TEMPERATURE INDICATORS, TACHOMETERS, TAXIMETERS (U.S. CLS. 21, 23, 26, 36 AND 38).

AISHA CLARKE, EXAMINING ATTORNEY

SN 79-105,092. LUKE ROPER LTD, UNITED KINGDOM, FILED 7-29-2011.



PRIORITY DATE OF 5-6-2011 IS CLAIMED. OWNER OF INTERNATIONAL REGISTRATION 1096855 DATED 7-29-2011, EXPIRES 7-29-2021.

THE NAME "LUKE" IDENTIFIES A LIVING INDIVIDUAL WHOSE CONSENT IS OF RECORD.

THE MARK CONSISTS OF THE DESIGN OF A LION WEARING A CROWN WITH HIS TONGUE OUT ABOVE THE WORDING "LUKE". THE LETTERS "L" AND "E" APPEAR MORE DISTINCT THAN THE LETTERS "U" AND "K".

CLASS 14—JEWELRY

FOR JEWELLERY AND KEY RINGS IN PRECIOUS METALS OR COATED THEREWITH; PRECIOUS STONES; HOROLOGICAL AND CHRONOMETRIC INSTRUMENTS, NAMELY, CLOCKS AND WATCHES (U.S. CLS. 2, 27, 28 AND 50).

CLASS 18—LEATHER GOODS

FOR WALLETS; POCKET WALLETS; HOLDALLS FOR CLOTHING, SUITS AND SHOES; VANITY CASES SOLD EMPTY; BAGS, NAMELY, LUGGAGE, HANDBAGS, SHOULDER BAGS, ATTACHÉ CASES, BRIEFCASES (U.S. CLS. 1, 2, 3, 22 AND 41).

CLASS 25—CLOTHING

FOR CLOTHING, NAMELY, SHIRTS, DENIM SHIRTS, T-SHIRTS, BLOUSES, SWEAT SHIRTS, KNITWEAR, NAMELY, SWEATERS, JUMPERS AND CARDIGANS, JACKETS, DENIM JACKETS, LEATHER JACKETS, COATS, SHORTS, PANTS, TROUSERS, CLOTHING BELTS, SUITS FOR MEN, SUITS FOR WOMEN, JEANS, DRESSES, SKIRTS, SCARVES, GLOVES, MITTENS, SOCKS; FOOTWEAR, NAMELY, SHOES, SNEAKERS AND SANDALS; HEADGEAR, NAMELY, HATS AND CAPS; BELTS MADE OF LEATHER; BELTS MADE OF IMITATION LEATHER (U.S. CLS. 22 AND 39).

JESSICA FATHY, EXAMINING ATTORNEY

SN 79-105,175. EMMI AG, SWITZERLAND, FILED 8-12-2011.

SN 79-105,118. CONFIGURA SVERIGE AB, SWEDEN, FILED 9-19-2011.



OWNER OF INTERNATIONAL REGISTRATION 1096925 DATED 9-19-2011, EXPIRES 9-19-2021.

OWNER OF U.S. REG. NOS. 3,348,123, 3,348,124 AND 3,703,934.

THE COLOR(S) GREY AND BLACK IS/ARE CLAIMED AS A FEATURE OF THE MARK.

THE MARK CONSISTS OF A STYLIZED LETTER "C" IN GREY TO THE LEFT OF THE STYLIZED WORD "CONFIGURA" IN BLACK. THE WHITE IS NOT PART OF THE MARK AND REPRESENTS BACKGROUND AREA.

**CLASS 9—ELECTRICAL AND SCIENTIFIC APPARATUS**

FOR COMPUTER PROGRAMS FOR USE IN CREATING PROPOSALS IN THE FORM OF TWO-AND THREE-DIMENSIONAL LAYOUT DRAWINGS OF SPACE-UTILIZATION REQUIREMENTS FOR ROOMS AND BUILDINGS, PROVIDING COST QUOTATIONS IN THE PROPOSALS TO IMPLEMENT THE SPACE LAYOUTS DESIGNED, ITEMIZING MATERIALS NEEDED TO IMPLEMENT THE SPACE LAYOUTS DESIGNED IN THE PROPOSALS AND COSTS ASSOCIATED WITH SAID MATERIALS, AND CREATING PHOTO-REALISTIC IMAGES OF THE LAYOUTS DESIGNED IN THE PROPOSALS, FOR SELLERS, MANUFACTURERS, DISTRIBUTORS, AND CONSULTANTS IN INDUSTRIES REQUIRING CONFIGURATION AND SPACE PLANNING; COMPUTER PROGRAMS USED FOR MONITORING COSTS OF MATERIAL AND LABOR FOR SPACE LAYOUTS OF ROOMS AND BUILDINGS FOR SELLERS, MANUFACTURERS, DISTRIBUTORS, AND CONSULTANTS IN THE INDUSTRIES REQUIRING CONFIGURATION AND SPACE PLANNING; INTERFACES FOR COMPUTERS (U.S. CLS. 21, 23, 26, 36 AND 38).

CLASS 16—PAPER GOODS AND PRINTED MATTER

FOR PRINTED INSTRUCTIONAL AND TEACHING MATERIALS IN THE FIELD OF THE USE AND OPERATION OF COMPUTER SOFTWARE FOR SPACE LAYOUT DESIGN, SPACE-UTILIZATION AND CONFIGURATION OF INTERIOR OF ROOMS AND BUILDINGS; CATALOGS IN THE FIELD OF INTERIOR COMPONENTS AND SPACE LAYOUT DESIGN; HANDBOOKS IN THE FIELD OF SPACE LAYOUT DESIGN (U.S. CLS. 2, 5, 22, 23, 29, 37, 38 AND 50).

CLASS 42—SCIENTIFIC AND COMPUTER SERVICES

FOR DESIGN AND DEVELOPMENT OF COMPUTER HARDWARE AND SOFTWARE (U.S. CLS. 100 AND 101). ELLEN B. AWRICH, EXAMINING ATTORNEY

PRIORITY DATE OF 3-18-2011 IS CLAIMED. OWNER OF INTERNATIONAL REGISTRATION 1097078 DATED 8-12-2011, EXPIRES 8-12-2021.

OWNER OF U.S. REG. NOS. 2,344,670, 3,421,077 AND OTHERS.

THE COLOR(S) BLUE, RED AND WHITE IS/ARE CLAIMED AS A FEATURE OF THE MARK.

THE MARK CONSISTS OF A WHITE CROWN AND THE TERM "EMMI" IN WHITE UNDERLINED WITH A WHITE CURVED LINE INSIDE AN OVAL SHAPE THAT IS BLUE AND RED, WITH A RED BANNER APPEARING TO THE LEFT AND RIGHT OF THE OVAL SHAPE. THE REMAINDER OF THE WHITE IN THE MARK IS FOR BACKGROUND PURPOSES ONLY AND IS NOT CLAIMED AS A FEATURE OF THE MARK.

CLASS 5—PHARMACEUTICALS

FOR DIETETIC FOODS ADAPTED FOR MEDICAL USE; FOOD FOR BABIES (U.S. CLS. 6, 18, 44, 46, 51 AND 52).

CLASS 29—MEATS AND PROCESSED FOODS

FOR MILK AND MILK PRODUCTS EXCLUDING ICE CREAM, ICE MILK AND FROZEN YOGURT (U.S. CL. 46).

CLASS 30—STAPLE FOODS

FOR COFFEE, COCOA, EDIBLE ICES (U.S. CL. 46).

CLASS 32—LIGHT BEVERAGES

FOR MINERAL AND AERATED WATERS AND OTHER NON-ALCOHOLIC DRINKS, NAMELY, NON-ALCOHOLIC BEVERAGES CONTAINING FRUIT JUICES AND SOFT DRINKS; FRUIT DRINKS AND FRUIT JUICES; SYRUPS FOR MAKING BEVERAGES (U.S. CLS. 45, 46 AND 48).

AMY ALFIERI, EXAMINING ATTORNEY

SN 79-105,327. DUNKERMOTOREN GMBH, FED REP GERMANY, FILED 8-24-2011.



OWNER OF INTERNATIONAL REGISTRATION 0322662 DATED 10-10-1966, EXPIRES 10-10-2016.
THE MARK CONSISTS OF A LOWER CASE LETTER "D" PARTIALLY INSIDE OF A CIRCLE.

CLASS 7—MACHINERY

FOR LOW-POWER DIRECT CURRENT, ALTERNATING CURRENT OR THREE-PHASE CURRENT ELECTRIC MOTORS AND GENERATORS, ESPECIALLY DIRECT AND ALTERNATING CURRENT MOTORS, PERMANENT MAGNET MOTORS, ASYNCHRONOUS MOTORS, SYNCHRONOUS MOTORS, CAPACITOR MOTORS, SHADED-POLE MOTORS, HYSTERESIS MOTORS, SERVO-MOTORS, TACHOMETRIC MOTORS, AND PARTS OF THE AFORESAID MOTORS AND ENGINES, ALL NOT FOR LAND VEHICLES; SPEED ADJUSTMENT APPARATUS, NAMELY, VARIABLE SPEED DRIVES FOR MOTORS AND ENGINES NOT FOR LAND VEHICLES; VARIABLE SPEED MECHANISMS, ESPECIALLY GOVERNORS AND GEARINGS (U.S. CLS. 13, 19, 21, 23, 31, 34 AND 35).

CLASS 11—ENVIRONMENTAL CONTROL APPARATUS

FOR SMALL APPARATUS FITTED WITH MOTORS NOT FOR LAND VEHICLES, NAMELY, VENTILATORS FOR AIR-CONDITIONING AND AIR COOLING, VENTILATORS FOR COMMERCIAL AND INDUSTRIAL USE, AND HAIR-DRYING APPARATUS (U.S. CLS. 13, 21, 23, 31 AND 34).

APRIL ROACH, EXAMINING ATTORNEY

SN 79-105,412. BERG + SCHMIDT GMBH & CO. KG, FED REP GERMANY, FILED 6-27-2011.

BERGABEST

THE MARK CONSISTS OF STANDARD CHARACTERS WITHOUT CLAIM TO ANY PARTICULAR FONT, STYLE, SIZE, OR COLOR.

OWNER OF INTERNATIONAL REGISTRATION 0793355 DATED 8-27-2002, EXPIRES 8-27-2012.

CLASS 1—CHEMICALS

FOR CHEMICALS USED IN INDUSTRY; CHEMICALS USED IN THE COSMETIC INDUSTRY; CHEMICALS USED IN THE FOOD INDUSTRY; FATTY ACID ESTERS FOR USE AS SOLUBILIZERS; FATTY ACID ESTERS FOR PRODUCING SOLUBILIZERS; CHEMICAL RELEASE AGENT PREPARATIONS USED IN THE BAKERY AND CONFECTIONERY INDUSTRIES; CHEMICAL SUPPORT SUBSTANCES FOR LIPOPHILIC SUBSTANCES USED IN THE FOOD INDUSTRY; CHEMICAL-BASED SURFACE TREATMENT AGENTS FOR STICKY PRODUCTS USED IN THE FOOD INDUSTRY; CHEMICAL-BASED HYDROPHOBIZING AGENTS USED IN THE FOOD INDUSTRY; CHEMICAL-BASED VISCOSITY REGULATORS USED IN THE FOOD INDUSTRY (U.S. CLS. 1, 5, 6, 10, 26 AND 46).

CLASS 4—LUBRICANTS AND FUELS

FOR LUBRICANTS, NAMELY, LUBRICATING GREASES, LUBRICATING OILS AND ALL PURPOSE LUBRICANTS; LUBRICANTS FOR THE FOOD INDUSTRY (U.S. CLS. 1, 6 AND 15).

JANICE KIM, EXAMINING ATTORNEY

SN 79-105,429. HUBERT BURDA: MEDIA HOLDING KOMMANDITGESELLSCHAFT, FED REP GERMANY, FILED 6-29-2011.



OWNER OF INTERNATIONAL REGISTRATION 0933841 DATED 6-18-2007, EXPIRES 6-18-2017.

THE COLOR(S) RED IS/ARE CLAIMED AS A FEATURE OF THE MARK.

THE MARK CONSISTS OF THE TERM "DLD" WITH A STAR BEHIND TO THE UPPER RIGHT PORTION OF THE SECOND "D", ALL IN RED.

CLASS 16—PAPER GOODS AND PRINTED MATTER

FOR PRINTED MATTER, NAMELY, PERIODICALS AND BOOKS IN THE FIELD OF ONLINE BUSINESS, ELECTRONICS, SOCIAL MEDIA, COMPUTER AND ONLINE TECHNOLOGY; PRINTED INSTRUCTIONAL AND TEACHING MATERIAL IN THE FIELD OF ONLINE BUSINESS, ELECTRONICS, SOCIAL MEDIA, COMPUTER AND ONLINE TECHNOLOGY (U.S. CLS. 2, 5, 22, 23, 29, 37, 38 AND 50).

CLASS 35—ADVERTISING AND BUSINESS

FOR ADVERTISING IN PRINT AND ON THE INTERNET, NAMELY, PROMOTING THE GOODS AND SERVICES, BRAND IDENTITY AND COMMERCIAL INFORMATION AND NEWS FOR THIRD PARTIES THROUGH PRINT AND ONLINE MEDIA; PUBLIC RELATIONS; ADVERTISING EVENTS, NAMELY, ARRANGING AND CONDUCTING SPECIAL EVENTS FOR COMMERCIAL, PROMOTIONAL OR ADVERTISING PURPOSES; DEMONSTRATION OF GOODS FOR THIRD PARTIES, NAMELY, DEMONSTRATION OF COMPUTERS, PRINTERS FOR USE WITH COMPUTERS, LOUD-SPEAKERS, SCANNERS, TELEPHONES, MOBILE TELEPHONES, HANDHELD POCKET COMPUTERS, PDAS, TELEVISION SETS, RADIOS, ALARM CLOCKS, STEREO APPARATUS, DOWNLOADABLE COMPUTER SOFTWARE, CDS, DVDS AND RECORDING MEDIA (U.S. CLS. 100, 101 AND 102).

CLASS 41—EDUCATION AND ENTERTAINMENT

FOR PUBLICATION OF PERIODICALS, BOOKS, PRINTED INSTRUCTIONAL AND TEACHING MATERIAL IN THE FIELD OF ONLINE BUSINESS, ELECTRONICS, SOCIAL MEDIA, COMPUTER AND ONLINE TECHNOLOGY; ENTERTAINMENT, IN THE NATURE OF VISUAL AND AUDIO PERFORMANCES; ORGANIZING TRAINING COURSES, NAMELY, ARRANGING PROFESSIONAL WORKSHOP AND TRAINING COURSES; ORGANIZING CULTURAL EVENTS (U.S. CLS. 100, 101 AND 107).

JANICE KIM, EXAMINING ATTORNEY

CLASS 42—SCIENTIFIC AND COMPUTER SERVICES

FOR PROVIDING COMPUTER PROGRAMMING SERVICES FOR ENABLING THE USE OF ON-LINE BOOKMARKS; COMPUTER SOFTWARE DESIGN, COMPUTER PROGRAMMING, OR MAINTENANCE OF COMPUTER SOFTWARE; COMPUTER SERVICES, NAMELY, PROVIDING TEMPORARY USE OF ONLINE, NON-DOWNLOADABLE COMPUTER PROGRAMS FOR INDEXING OF INFORMATION, SITES AND OTHER RESOURCES; CREATING OR MAINTAINING WEB SITES FOR OTHERS; RENTAL OF COMPUTERS; COMPUTER PROGRAMMING AND MAINTENANCE OF COMPUTER PROGRAMS; RENTAL OF WEB SERVERS; COMPUTER PROGRAMMING SERVICES FOR CREATING WEBSITES; COMPUTER PROGRAMMING SERVICES FOR BROWSING OF WEBSITES; PROVIDING METEOROLOGICAL INFORMATION; SERVICES FOR DESIGNING COMPUTER SOFTWARE; COMPUTER SERVICES, NAMELY, DESIGNING AND IMPLEMENTING NETWORK WEB PAGES FOR OTHERS; GRAPHIC ARTS DESIGNING; DESIGN OF WEBSITE; TECHNICAL ADVICE RELATING TO OPERATION AND PERFORMANCE OF COMPUTERS; TESTING, INSPECTION OR RESEARCH OF PHARMACEUTICALS, COSMETICS OR FOODSTUFF; TESTING, INSPECTION OR RESEARCH ON AGRICULTURE, LIVESTOCK BREEDING OR FISHERIES (U.S. CLS. 100 AND 101).

SN 79-105,612. GOURMET NAVIGATOR INCORPORATED, JAPAN, FILED 5-24-2011.

GURUNAVI

PRIORITY DATE OF 4-25-2011 IS CLAIMED.
OWNER OF INTERNATIONAL REGISTRATION 1097911 DATED 5-24-2011, EXPIRES 5-24-2021.
OWNER OF U.S. REG. NOS. 3,623,575 AND 3,824,208.
THE MARK CONSISTS OF THE WORDING "GURUNAVI" IN STYLIZED FONT.
THE WORDING "GURUNAVI" HAS NO MEANING IN A FOREIGN LANGUAGE.

CLASS 16—PAPER GOODS AND PRINTED MATTER

FOR HYGIENIC HAND TOWELS OF PAPER; FACE OR HAND TOWELS OF PAPER; TABLE NAPKINS OF PAPER; HAND TOWELS OF PAPER; HANDKERCHIEFS OF PAPER; TABLECLOTHS OF PAPER; PAPER AND CARDBOARD; STATIONERY AND STUDY MATERIALS, NAMELY, STUDY GUIDES; PRINTED MATTER, NAMELY, BOOKS, MANUALS, CURRICULUM, NEWSLETTERS, INFORMATIONAL CARDS AND BROCHURES IN THE FIELD OF RESTAURANTS AND FOODS; PRINTED TICKETS (U.S. CLS. 2, 5, 22, 23, 29, 37, 38 AND 50).

CLASS 35—ADVERTISING AND BUSINESS

FOR ADVERTISING AND PUBLICITY SERVICES; INTERNET ADVERTISING SERVICES; ASSISTANCE, ADVISORY SERVICES AND CONSULTANCY WITH REGARD TO BUSINESS PLANNING, BUSINESS ANALYSIS, BUSINESS MANAGEMENT, AND BUSINESS ORGANIZATION; MARKETING RESEARCH SERVICES; PROVIDING INFORMATION CONCERNING COMMERCIAL SALES; BUSINESS BROKERAGE OF CONTRACTS OF PRODUCT SALES; BUSINESS MANAGEMENT OF HOTELS FOR OTHERS; PUBLICITY MATERIAL RENTAL; EMPLOYMENT AGENCIES; PROVIDING BUSINESS MANAGEMENT ASSISTANCE IN THE OPERATION OF COMPUTERS, TYPEWRITERS, AND OTHER SIMILAR OFFICE MACHINES FOR OTHERS; IMPORT AND EXPORT AGENCIES; PROVIDING EMPLOYMENT INFORMATION (U.S. CLS. 100, 101 AND 102).

CLASS 43—HOTEL AND RESTAURANT SERVICES

FOR PROVIDING INFORMATION ON PROVIDING TEMPORARY ACCOMMODATION; PROVIDING INFORMATION ON ACCOMMODATION BUREAUX, NAMELY, BROKERING RESERVATIONS FOR TEMPORARY ACCOMMODATIONS; PROVIDING INFORMATION ON PROVIDING FOODS AND BEVERAGES, NAMELY, RESTAURANT SERVICES; PROVIDING INFORMATION ON PROVIDING TEMPORARY ACCOMMODATION FOR ANIMALS; PROVIDING INFORMATION ON DAY-NURSERIES, NAMELY, CRECHE SERVICES; PROVIDING RETIREMENT HOMES; PROVIDING INFORMATION ON RENTALS OF INDUSTRIAL COOKING EQUIPMENT, INDUSTRIAL DISH-DRYING MACHINES, OR INDUSTRIAL DISH-WASHING MACHINES; PROVIDING INFORMATION RELATING TO RESTAURANT SERVICES, INCLUDING LOCATION OF RESTAURANTS (U.S. CLS. 100 AND 101).

CLASS 45—PERSONAL AND LEGAL SERVICES

FOR INFORMATION RELATED TO CLOTHING RENTAL; PROVIDING INFORMATION ON NEWSPAPER ARTICLES, NAMELY, PROVIDING INFORMATION FROM NEWSPAPER ARTICLES IN THE FIELD OF MARRIAGE COUNSELING; MARRIAGE PARTNER INTRODUCTION OR DATING SERVICES; CONSULTANCY CONCERNING MARRIAGE PARTNER INTRODUCTION OR DATING SERVICES; ORGANIZATION OF WEDDING CEREMONY, NAMELY, PROVIDING FACILITIES FOR WEDDING CEREMONIES; FORTUNE-TELLING; PERSONAL LEGAL AFFAIRS CONSULTANCY; PROVIDING INFORMATION ABOUT FORTUNE-TELLING AND PERSONAL LEGAL AFFAIRS CONSULTANCY; PROVIDING INFORMATION RELATED TO CLOTHING RENTAL (U.S. CLS. 100 AND 101).

APRIL HESIK, EXAMINING ATTORNEY

SN 79-105,649. FAURECIA AUTOMOTIVE INDUSTRIE, FRANCE, FILED 9-30-2011.

FLAXPREG

THE MARK CONSISTS OF STANDARD CHARACTERS WITHOUT CLAIM TO ANY PARTICULAR FONT, STYLE, SIZE, OR COLOR.

PRIORITY DATE OF 4-7-2011 IS CLAIMED.

OWNER OF INTERNATIONAL REGISTRATION 1098026 DATED 9-30-2011, EXPIRES 9-30-2021.

CLASS 12—VEHICLES

FOR LAND VEHICLES AND AUTOMOBILES AND STRUCTURAL PARTS THEREFOR, NAMELY, FLOORS FOR VEHICLE TRUNKS, PASSENGER COMPARTMENTS FOR VEHICLES, SEPARATION BOARDS FITTED TO VEHICLES, VEHICLE TRUNKS, DOORS FOR VEHICLES, CAR WINDOW SHADES, AUTOMOTIVE WINDSHIELD SHADE SCREEN, FITTED VEHICLE COVERS AND VEHICLE SEAT COVERS, ALL OF THE AFORESAID GOODS MADE IN WHOLE OR IN SIGNIFICANT PART OF FLAX (U.S. CLS. 19, 21, 23, 31, 35 AND 44).

CLASS 17—RUBBER GOODS

FOR MATS AND PANELS OF FIBERS COMPRISING MAINLY CANVAS FOR USE IN THE PRODUCTION OF FLOORING OF TRUNKS AND PASSENGER COMPARTMENTS AND IN THE PRODUCTION OF SEPARATION BOARDS FITTED TO VEHICLES, TRUNKS AND PASSENGER COMPARTMENTS FOR VEHICLES; SEMI-PROCESSED CELLULOSE ACETATE, CANVAS HOSE PIPES, ARTIFICIAL AND SYNTHETIC RESINS, EPOXY AND POLYESTER IN ROLLS OR SHEETS FOR FURTHER MANUFACTURE, AND ALL OF THE AFORESAID GOODS MADE IN WHOLE OR COMBINED IN SIGNIFICANT PART WITH FLAX (U.S. CLS. 1, 5, 12, 13, 35 AND 50).

CLASS 22—CORDAGE AND FIBERS

FOR PANELS MADE OF FIBERS COMPRISING MAINLY CANVAS, TEXTILE FIBERS, RAW OR TREATED WOOL, WOOD WOOL, UPHOLSTERY WOOL, STUFFING MATERIALS NOT OF RUBBER, PAPER OR PLASTICS, WADDING FOR FILTERING, WADDING NOT OF RUBBER, PAPER OR PLASTIC FOR PADDING OR STUFFING UPHOLSTERY, FIBER OF RAMIE, HEMP, BAMBOO FIBER, RAW SILK, AND ALL OF THE AFORESAID GOODS MADE IN WHOLE OR COMBINED IN SIGNIFICANT PART WITH FLAX (U.S. CLS. 1, 2, 7, 19, 22, 42 AND 50).

JULIE WATSON, EXAMINING ATTORNEY

SN 79-105,791. YE JINXU, FUJIAN, CHINA, FILED 11-2-2011.

BluePower

THE MARK CONSISTS OF STANDARD CHARACTERS WITHOUT CLAIM TO ANY PARTICULAR FONT, STYLE, SIZE, OR COLOR.

OWNER OF INTERNATIONAL REGISTRATION 1098486 DATED 11-2-2011, EXPIRES 11-2-2021.

CLASS 18—LEATHER GOODS

FOR HANDBAGS; TRAVELLING BAGS; LEATHERWARE TRAVELLING SETS COMPRISED OF LUGGAGE, DUFFEL BAGS, SUITCASES, AND TRUNKS; HAVERSACKS; UMBRELLAS; WALKING STICKS; SADDLERY; PURSES; SCHOOL SATCHELS; BACKPACKS (U.S. CLS. 1, 2, 3, 22 AND 41).

CLASS 28—TOYS AND SPORTING GOODS

FOR GOLF CLUBS; GOLF CLUB HEADS; GOLF CLUB GRIPS; TOYS, NAMELY, PLUSH TOYS, ACTION FIGURE TOYS, TOY VEHICLES, DOLLS; FISHING TACKLE; GOLF GLOVES; BALLS FOR GAMES; GOLF BAGS, WITH OR WITHOUT WHEELS; BODY-BUILDING APPARATUS; PHYSICAL EXERCISE APPARATUS IN THE NATURE OF EXERCISE MACHINE; RACKETS (U.S. CLS. 22, 23, 38 AND 50).

JEAN IM, EXAMINING ATTORNEY

SN 79-105,955. WERBETECHNIK ART OF DISPLAY GMBH & CO. KG, FED REP GERMANY, FILED 8-3-2011.

dot

THE MARK CONSISTS OF STANDARD CHARACTERS WITHOUT CLAIM TO ANY PARTICULAR FONT, STYLE, SIZE, OR COLOR.

OWNER OF INTERNATIONAL REGISTRATION 1098579 DATED 8-3-2011, EXPIRES 8-3-2021.

CLASS 1—CHEMICALS

FOR ADHESIVES FOR FLOOR AND WALL BOARDS AND TILES, NOT OF METAL; ADHESIVES FOR FLOOR AND WALL BOARDS AND TILES, OF METAL; ADHESIVES FOR MIRRORED TILES; ADHESIVES FOR WOOD, CORK AND PLASTIC FLOOR AND WALL BOARDS (U.S. CLS. 1, 5, 6, 10, 26 AND 46).

CLASS 8—HAND TOOLS

FOR HAND TOOLS AND IMPLEMENTS, IN PARTICULAR FOR LAYING TILES AND BOARDS, NAMELY, TROWELS, MASONS' TROWELS, MASONS' EDGES, MASONS' GROOVERS, TILE CUTTERS, FILES, SAW, SQUARES, NIPPERS (U.S. CLS. 23, 28 AND 44).

CLASS 19—NON-METALLIC BUILDING MATERIALS

FOR TILES FOR FLOORING, NOT OF METAL; BOARDS AND TILES, NOT OF METAL, NAMELY, GLASS, CERAMIC, PLASTIC, EARTHENWARE; MORTAR, IN PARTICULAR TILE MORTAR; BOARDS OF WOOD; CORK BOARDS; MULTILAYER PLASTIC PANELS FOR USE IN BUILDING (U.S. CLS. 1, 12, 33 AND 50).

CLASS 20—FURNITURE AND ARTICLES NOT OTHERWISE CLASSIFIED

FOR MIRROR TILES (U.S. CLS. 2, 13, 22, 25, 32 AND 50).

CLASS 37—CONSTRUCTION AND REPAIR

FOR TILE LAYING (U.S. CLS. 100, 103 AND 106).

ALAIN LAPTER, EXAMINING ATTORNEY

SN 79-106,073. COLEXIO GMBH, FED REP GERMANY,
FILED 9-17-2011.

Colexio

THE MARK CONSISTS OF STANDARD CHARACTERS WITHOUT CLAIM TO ANY PARTICULAR FONT, STYLE, SIZE, OR COLOR.

OWNER OF INTERNATIONAL REGISTRATION 1098998 DATED 9-17-2011, EXPIRES 9-17-2021.

THE ENGLISH TRANSLATION OF "COLEXIO" IN THE MARK IS "SCHOOL".

CLASS 9—ELECTRICAL AND SCIENTIFIC APPARATUS

FOR COMPUTER SOFTWARE FOR COORDINATING THE USE OF VEHICLES AND FOR PLANNING THE EFFICIENT USE OF MEANS OF PUBLIC AND PRIVATE TRANSPORTATION (U.S. CLS. 21, 23, 26, 36 AND 38).

CLASS 39—TRANSPORTATION AND STORAGE

FOR PASSENGER TRANSPORT (U.S. CLS. 100 AND 105).

CLASS 42—SCIENTIFIC AND COMPUTER SERVICES

FOR COMPUTER SOFTWARE PROGRAMMING (U.S. CLS. 100 AND 101).
HEATHER BIDDULPH, EXAMINING ATTORNEY

SN 79-106,089. LONZA AG (LONZA LTD.), SWITZERLAND,
FILED 11-14-2011.



PRIORITY DATE OF 6-17-2011 IS CLAIMED.
OWNER OF INTERNATIONAL REGISTRATION 1099066 DATED 11-14-2011, EXPIRES 11-14-2021.

THE COLOR(S) PURPLE AND WHITE IS/ARE CLAIMED AS A FEATURE OF THE MARK.

THE MARK CONSISTS OF A PURPLE OVAL CONTAINING THE WORD "LORE" IN WHITE, AND A CIRCULAR PURPLE AND WHITE REPRESENTATION OF A DOG'S HEAD.

CLASS 1—CHEMICALS

FOR INDUSTRIAL CHEMICALS (U.S. CLS. 1, 5, 6, 10, 26 AND 46).

CLASS 5—PHARMACEUTICALS

FOR PESTICIDES (U.S. CLS. 6, 18, 44, 46, 51 AND 52).
BRIAN NEVILLE, EXAMINING ATTORNEY

SN 79-106,127. CATALYMEDIC INC., JAPAN, FILED 11-9-2011.

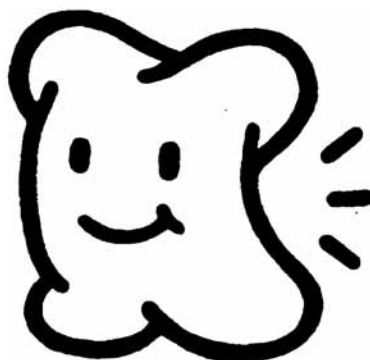

PRIORITY DATE OF 10-11-2011 IS CLAIMED.
OWNER OF INTERNATIONAL REGISTRATION 1099187 DATED 11-9-2011, EXPIRES 11-9-2021.

THE MARK CONSISTS OF A CARTOON DESIGN OF A BONE.

CLASS 10—MEDICAL APPARATUS

FOR ARTIFICIAL BONES FOR IMPLANTATION; ARTIFICIAL BONE FILLING MATERIALS, NAMELY, BONE VOID FILLERS CONSISTING OF ARTIFICIAL MATERIALS (U.S. CLS. 26, 39 AND 44).

CLASS 42—SCIENTIFIC AND COMPUTER SERVICES

FOR TESTING, INSPECTION OR RESEARCH OF PHARMACEUTICALS, COSMETICS OR FOODSTUFF (U.S. CLS. 100 AND 101).

CLASS 44—MEDICAL, BEAUTY AND AGRICULTURAL SERVICES

FOR PROVIDING MEDICAL INFORMATION (U.S. CLS. 100 AND 101).
ROBERT STRUCK, EXAMINING ATTORNEY

SN 79-106,128. CATALYMEDIC INC., JAPAN, FILED 11-9-2011.



PRIORITY DATE OF 10-11-2011 IS CLAIMED.
OWNER OF INTERNATIONAL REGISTRATION 1099188 DATED 11-9-2011, EXPIRES 11-9-2021.

THE MARK CONSISTS OF A CARTOON DESIGN OF A BONE WITH A STAR-SHAPED PATCH.

CLASS 10—MEDICAL APPARATUS

FOR ARTIFICIAL BONES FOR IMPLANTATION; ARTIFICIAL BONE FILLING MATERIALS, NAMELY, BONE VOID FILLERS CONSISTING OF ARTIFICIAL MATERIALS (U.S. CLS. 26, 39 AND 44).

CLASS 42—SCIENTIFIC AND COMPUTER SERVICES

FOR TESTING, INSPECTION OR RESEARCH OF PHARMACEUTICALS, COSMETICS OR FOODSTUFF (U.S. CLS. 100 AND 101).

CLASS 44—MEDICAL, BEAUTY AND AGRICULTURAL SERVICES

FOR PROVIDING MEDICAL INFORMATION (U.S. CLS. 100 AND 101).
ROBERT STRUCK, EXAMINING ATTORNEY

SN 79-106,271. GUANGZHOU FINE HORSE LEATHER; CO., LTD., CHINA, FILED 11-16-2011.



OWNER OF INTERNATIONAL REGISTRATION 1099602 DATED 11-16-2011, EXPIRES 11-16-2021.

THE MARK CONSISTS OF THE WORDING "GOODONNA" BELOW A DESIGN ELEMENT CONSISTING OF A POLYGON DISPLAYING TWO CANDLES THAT SHARE A SINGLE DIAMOND-SHAPED FLAME.

CLASS 18—LEATHER GOODS

FOR REUSABLE SHOPPING BAGS; HANDBAGS; RUCKSACKS; WALLETS; LEATHER PURSES; ATTACHE CASES; VALISES; SCHOOL BAGS; LEATHER LEADS; SUITCASES OF IMITATION LEATHER (U.S. CLS. 1, 2, 3, 22 AND 41).

CLASS 25—CLOTHING

FOR CLOTHING, NAMELY, TOPS, BOTTOMS, PANTS, SHIRTS, DRESSES, SHORTS, T-SHIRTS; CLOTHING FOR CHILDREN, NAMELY, TOPS, BOTTOMS, PANTS, SHIRTS, DRESSES, SHORTS, T-SHIRTS; FOOTWEAR; HEADWEAR; SOCKS AND STOCKINGS; GLOVES; NECKTIES; SCARVES AND SASHES FOR WEAR; BELTS; SWIMWEAR (U.S. CLS. 22 AND 39).
KAREN SEVERSON, EXAMINING ATTORNEY

SN 79-106,400. HILLS 100 COMPANY PTY LTD, AUSTRALIA, FILED 8-18-2011.

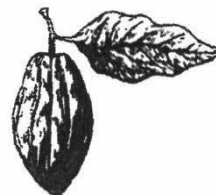
**KOKO BLACK**

PRIORITY DATE OF 8-17-2011 IS CLAIMED.
OWNER OF INTERNATIONAL REGISTRATION 1099699 DATED 8-18-2011, EXPIRES 8-18-2021.

NO CLAIM IS MADE TO THE EXCLUSIVE RIGHT TO USE "BLACK", APART FROM THE MARK AS SHOWN.

THE MARK CONSISTS OF THE DISTINCTIVE DESIGN OF A CACAO POD (FRUIT) AND LEAF PROTRUDING FROM THE STEM, ABOVE THE WORDING "KOKO BLACK".

CLASS 30—STAPLE FOODS

FOR CHOCOLATE; CHOCOLATE PRODUCTS, NAMELY, INDIVIDUAL HANDMADE CHOCOLATES, CHOCOLATE BARS, CHOCOLATE CANDIES, CHOCOLATE CARAMELS, CHOCOLATE DESSERTS; CHOCOLATE-BASED BEVERAGES; COCOA; TEA; COFFEE; ARTIFICIAL COFFEE; COFFEE-BASED BEVERAGES; BISCUITS; ICE CREAM; PASTRY AND CONFECTIONERY MADE OF SUGAR; CARAMELS; HARD CANDY (U.S. CL. 46).

CLASS 35—ADVERTISING AND BUSINESS

FOR WHOLESALE STORE, RETAIL STORE AND DISTRIBUTORSHIP SERVICES FEATURING CHOCOLATE, CHOCOLATE PRODUCTS, COCOA, TEA, COFFEE, ARTIFICIAL COFFEE, COFFEE-BASED BEVERAGES, BISCUITS, ICE CREAM, PASTRY AND CONFECTIONERY (U.S. CLS. 100, 101 AND 102).

CLASS 43—HOTEL AND RESTAURANT SERVICES

FOR PROVIDING FOOD AND DRINK; RESTAURANT SERVICES; CAFE SERVICES; COFFEE BAR SERVICES; CATERING SERVICES; FOOD PREPARATION; TAKE-OUT RESTAURANT SERVICES; ALL THE AFOREMENTIONED SERVICES PROVIDED AT VENUES THAT PRIMARILY SELL CHOCOLATE PRODUCTS (U.S. CLS. 100 AND 101).

DAVID HOFFMAN, EXAMINING ATTORNEY

SN 79-106,457. HANSOFT AB, SWEDEN, FILED 10-5-2011.



OWNER OF INTERNATIONAL REGISTRATION 1099843 DATED 10-5-2011, EXPIRES 10-5-2021.

THE COLOR(S) BLACK AND LIGHT BLUE IS/ARE CLAIMED AS A FEATURE OF THE MARK.

THE MARK CONSISTS OF THE WORD "HANSOFT" IN BLACK LETTERING WITH AN OVAL DESIGN TO THE LEFT OF THE WORD; THE LEFT HALF OF THE OVAL IS BLACK AND THE RIGHT HALF IS LIGHT BLUE; IN THE CENTER OF THE OVAL IS A STYLIZED PORTION OF THE LETTER "H" IN BLACK.

CLASS 9—ELECTRICAL AND SCIENTIFIC APPARATUS

FOR COMPUTER SOFTWARE FOR PROJECT AND QUALITY MANAGEMENT (U.S. CLS. 21, 23, 26, 36 AND 38).

CLASS 41—EDUCATION AND ENTERTAINMENT

FOR EDUCATION AND TRAINING SERVICES, NAMELY, TRAINING SERVICES IN THE FIELD OF PROJECT AND QUALITY MANAGEMENT SOFTWARE (U.S. CLS. 100, 101 AND 107).

MATTHEW MCDOWELL, EXAMINING ATTORNEY

CLASS 42—SCIENTIFIC AND COMPUTER SERVICES

FOR SCIENTIFIC AND INDUSTRIAL RESEARCH RELATING TO HEMOSTASIS; CONDUCTING CLINICAL TRIALS FOR OTHERS RELATING TO HEMOSTASIS (U.S. CLS. 100 AND 101).

AISHA SALEM, EXAMINING ATTORNEY

SN 79-106,482. FIVES STEIN, FRANCE, FILED 11-8-2011.

L.E.M.

THE MARK CONSISTS OF STANDARD CHARACTERS WITHOUT CLAIM TO ANY PARTICULAR FONT, STYLE, SIZE, OR COLOR.

OWNER OF INTERNATIONAL REGISTRATION 1099924 DATED 11-8-2011, EXPIRES 11-8-2021.

CLASS 7—MACHINERY

FOR INDUSTRIAL PLANTS, NAMELY, MACHINES FOR THE CONTINUOUS PROCESSING OF GLASS (U.S. CLS. 13, 19, 21, 23, 31, 34 AND 35).

CLASS 11—ENVIRONMENTAL CONTROL APPARATUS

FOR MELTING AND REFINING FURNACES FOR GLASS; THERMAL PLANTS FOR TREATING GLASS (U.S. CLS. 13, 21, 23, 31 AND 34).

CLASS 40—MATERIAL TREATMENT

FOR INDUSTRIAL, MECHANICAL AND THERMAL TREATMENT OF GLASS, NAMELY, PROCESSING AND FINISHING OF GLASS; HEAT TREATMENT AND COATING OF GLASS; GLASS POLISHING; GLASS BLOWING (U.S. CLS. 100, 103 AND 106).

BERNICE MIDDLETON, EXAMINING ATTORNEY

SN 79-106,488. LABORATOIRE FRANCAIS DU; FRACTIONNEMENT; ET DES BIOTECHNOLOGIES, F-91940 LES ULIS, FRANCE, FILED 10-28-2011.

ACTISEVEN

THE MARK CONSISTS OF STANDARD CHARACTERS WITHOUT CLAIM TO ANY PARTICULAR FONT, STYLE, SIZE, OR COLOR.

PRIORITY DATE OF 6-24-2011 IS CLAIMED.

OWNER OF INTERNATIONAL REGISTRATION 1099975 DATED 10-28-2011, EXPIRES 10-28-2021.

CLASS 5—PHARMACEUTICALS

FOR PHARMACEUTICAL PREPARATIONS FOR TREATING COAGULATION DISORDERS (U.S. CLS. 6, 18, 44, 46, 51 AND 52).

SN 79-106,605. ALTIFLEX APS, DENMARK, FILED 10-25-2011.

ALTIFLEX

THE MARK CONSISTS OF STANDARD CHARACTERS WITHOUT CLAIM TO ANY PARTICULAR FONT, STYLE, SIZE, OR COLOR.

OWNER OF INTERNATIONAL REGISTRATION 1100293 DATED 10-25-2011, EXPIRES 10-25-2021.

CLASS 6—METAL GOODS

FOR FLEXIBLE AND TELESCOPIC FRAMES OF METAL FOR TEMPORARILY COVERING WINDOW OR DOOR OPENINGS WITH A PLATE OF METAL; METAL WINDOWS, METAL DOORS, PARTITION WALLS OF METAL, METAL SCREWS, METAL BOLTS, METAL NUTS, METAL PROFILES, METAL SLEEVES FOR PIPE DUCTS AND VENTILATION (U.S. CLS. 2, 12, 13, 14, 23, 25 AND 50).

CLASS 19—NON-METALLIC BUILDING MATERIALS

FOR FLEXIBLE AND TELESCOPIC FRAMES FOR TEMPORARILY COVERING WINDOW OR DOOR OPENINGS WITH A PLATE OF WOOD, GLASS OR PLASTIC; NON-METAL WINDOWS, NON-METAL DOORS, NON-METAL PARTITION WALLS, RUBBER STRIPS FOR INSULATION AND SEALING (U.S. CLS. 1, 12, 33 AND 50).

CLASS 20—FURNITURE AND ARTICLES NOT OTHERWISE CLASSIFIED

FOR SCREWS, BOLTS, NUTS, NOT OF METAL (U.S. CLS. 2, 13, 22, 25, 32 AND 50).

CLASS 37—CONSTRUCTION AND REPAIR

FOR BUILDING CONSTRUCTION, REPAIR IN CONNECTION WITH BUILDING CONSTRUCTIONS, AND INSTALLATION SERVICES IN CONNECTION WITH BUILDING CONSTRUCTION, NAMELY, TEMPORARY SEALING OF BUILDINGS DURING CONSTRUCTION USING FLEXIBLE WINDOW AND DOOR MODULES, WHICH ARE MADE OF ALUMINUM AND SEMI-TRANSPARENT BREAKPROOF PLASTIC (U.S. CLS. 100, 103 AND 106).

SAMUEL E. SHARPER JR., EXAMINING ATTORNEY

SN 79-106,623. MYTRANSLATE AG, SWITZERLAND, FILED 11-11-2011.

SN 79-106,638. PSIPSIKAS GEORGE, GREECE, FILED 7-8-2011.

mytranslate

THE MARK CONSISTS OF STANDARD CHARACTERS WITHOUT CLAIM TO ANY PARTICULAR FONT, STYLE, SIZE, OR COLOR.

PRIORITY DATE OF 10-14-2011 IS CLAIMED.
OWNER OF INTERNATIONAL REGISTRATION 1100337 DATED 11-11-2011, EXPIRES 11-11-2021.

CLASS 35—ADVERTISING AND BUSINESS

FOR ADVERTISING; BUSINESS MANAGEMENT; BUSINESS ADMINISTRATION; OFFICE FUNCTIONS; ELECTRONIC COMMERCE SERVICES, NAMELY, ADVERTISING IN THE FORM OF DATA, TEXTS, IMAGES OR SOUNDS, ALONE OR IN COMBINATIONS, PROVIDED VIA COMPUTER NETWORKS, FOR THE SALE OF GOODS AND SERVICES OF ALL TYPES; COMPILATION AND SYSTEMIZATION OF DATA INTO COMPUTER DATABASES (U.S. CLS. 100, 101 AND 102).

CLASS 38—COMMUNICATION

FOR TELECOMMUNICATIONS SERVICES, NAMELY, THE PROVISION OF ACCESS TO INTERNET PLATFORMS THAT SUPPLY OFFERS OF LANGUAGE TRANSLATION SERVICES VIA ELECTRONICALLY AND INTERACTIVELY ACCESSIBLE DATABASES, WITH THE POSSIBILITY OF ORDERING DIRECTLY (U.S. CLS. 100, 101 AND 104).

CLASS 41—EDUCATION AND ENTERTAINMENT

FOR SERVICES IN THE FIELD OF ENTERTAINMENT, EDUCATION AND TRAINING, NAMELY, PROVIDING COURSES OF INSTRUCTION, GAMES, PUZZLES, COMPETITIONS, AND TRIVIA IN THE FIELD OF LANGUAGE TRANSLATION AND LINGUISTICS, PROVIDED ON-LINE FROM A COMPUTER, THE INTERNET OR OTHER ELECTRONIC NETWORKS; SPORTING AND CULTURAL ACTIVITIES, NAMELY, ORGANIZATION AND HOSTING OF CULTURAL SHOWS AND COMPETITIONS RELATING TO LANGUAGE TRANSLATION AND LINGUISTICS; ARRANGING AND CONDUCTING OF WORKSHOPS IN THE FIELD OF LANGUAGE TRANSLATION; EDUCATIONAL SERVICES, NAMELY, ARRANGING AND CONDUCTING OF SEMINARS, COLLOQUIUMS, CONFERENCES OR CONGRESSES IN THE FIELD OF LANGUAGE TRANSLATION; TRANSLATION; FOREIGN-LANGUAGE DUBBING (U.S. CLS. 100, 101 AND 107).

CLASS 42—SCIENTIFIC AND COMPUTER SERVICES

FOR SCIENTIFIC AND TECHNOLOGICAL SERVICES AND RESEARCH AND DESIGN RELATING THERETO, NAMELY, THE DEVELOPMENT OF COMPUTER-AIDED LANGUAGE TRANSLATION TOOLS; INDUSTRIAL ANALYSIS AND RESEARCH SERVICES IN THE FIELD OF LANGUAGE TRANSLATION; DESIGN AND DEVELOPMENT OF COMPUTERS AND SOFTWARE (U.S. CLS. 100 AND 101).

SHANNON TWOHIG, EXAMINING ATTORNEY



PRIORITY DATE OF 4-15-2011 IS CLAIMED.
OWNER OF INTERNATIONAL REGISTRATION 1100383 DATED 7-8-2011, EXPIRES 7-8-2021.

THE COLOR(S) WHITE, BLACK, AND GRAY IS/ARE CLAIMED AS A FEATURE OF THE MARK.

THE MARK CONSISTS OF TWO RINGS IN WHITE, BLACK, AND GRAY AND BENEATH THEM THE WORD "NANOBIONIC" IN BLACK AND GRAY WITH A GRAY REFLECTION BELOW; ALL ON A WHITE BACKGROUND.

CLASS 10—MEDICAL APPARATUS

FOR ORTHOPEDIC APPARATUS, NAMELY, MEDICAL ORTHOPEDIC SPLINTS (U.S. CLS. 26, 39 AND 44).

CLASS 25—CLOTHING

FOR CLOTHING, NAMELY, DRESSES, PANTS, SHIRTS, SHORTS, SOCKS, PANTIES, STOCKINGS, BRAS, TIGHTS AND UNDERSHIRTS; FOOTWEAR AND HEADWEAR (U.S. CLS. 22 AND 39).

MAYUR VAGHANI, EXAMINING ATTORNEY

SN 79-106,653. WILMAX LIMITED, UNITED KINGDOM, FILED 8-20-2011.

Wilmax England

THE MARK CONSISTS OF STANDARD CHARACTERS WITHOUT CLAIM TO ANY PARTICULAR FONT, STYLE, SIZE, OR COLOR.

OWNER OF INTERNATIONAL REGISTRATION 1100405 DATED 8-20-2011, EXPIRES 8-20-2021.

NO CLAIM IS MADE TO THE EXCLUSIVE RIGHT TO USE "ENGLAND", APART FROM THE MARK AS SHOWN.

CLASS 8—HAND TOOLS

FOR HAND TOOLS AND IMPLEMENTS, NAMELY, HAND-OPERATED KITCHEN APPLIANCES FOR DICING, MINCING, SLICING AND CHOPPING FOOD; ABRADING INSTRUMENTS, NAMELY, ABRADING TOOLS; HAND TOOLS, NAMELY, ADZES; AGRICULTURAL IMPLEMENTS, HAND-OPERATED, NAMELY, BROADFORKS, CIDER PRESSES, CHICKEN PLUCKERS; SIDE ARMS, NOT INCLUDING FIREARMS, NAMELY, HUNTING KNIVES, SWORDS; INSECTICIDE ATOMIZERS, NAMELY, HAND-OPERATED SPRAYERS FOR INSECTICIDE; HAND TOOLS, NAMELY, AUGERS; HAND TOOLS, NAMELY, AWLS; AXES; CUTTING BARS, NAMELY, METAL CUTTING SAWS, SAWS FOR CUTTING BRANCHES; BAYONETS; BEARD CLIPPERS; FIREPLACE BELLOWS; TOOL BELTS; BILL-HOOKS, NAMELY, GRASS HOOKS, HAND HOOKS; BITS, NAMELY, BITS FOR HAND DRILLS; BLADE SHARPENING INSTRUMENTS, NAMELY, KNIFE SHARPENERS, SHARPENING RODS, SHARPENING STONES; BLADES FOR KITCHEN KNIVES; BLUDGEONS; BORDER SHEARS; BOW SAWS; HAND TOOLS, NAMELY, BREAST DRILLS; BUDDING KNIVES; BUSHHAMMERS; HAND-OPERATED SKINNING APPLIANCES AND INSTRUMENTS, NAMELY, HAND-OPERATED SCRAPERS, HAND-OPERATED KNIVES, HAND-OPERATED PLIERS TO AID IN SKINNING AN ANIMAL FOR BUTCHERS' ANIMALS; CAN OPENERS, NON-ELEC-

TRIC; HAND TOOLS, NAMELY, CARPENTERS' AUGERS; RAZOR CASES; CATTLE MARKING TOOLS, NAMELY, BRANDING IRONS; HAND-OPERATED CATTLE SHEARERS; CAULKING IRONS, NAMELY, CAULKING GUNS; CENTRE PUNCHES; CHEESE SLICERS, NON-ELECTRIC; CHISELS; HAND-OPERATED CHOPPERS; CLAMPS FOR CARPENTERS OR COOPERS; CLEAVERS; HAND-OPERATED CRIMPING IRONS; CROW BARS; EYELASH CURLERS; CURLING TONGS, NAMELY, BUTTER CURLERS, NON-ELECTRIC CURLING IRONS; CUTICLE NIPPERS; CUTLERY, OTHER THAN SURGICAL CUTLERY; HAND-TOOLS, NAMELY, CUTTER BARS; CUTTERS, NAMELY, GLASS CUTTERS, WIRE CUTTERS; PIZZA CUTTERS, NON ELECTRIC; HAND-OPERATED CUTTING TOOLS; DAGGERS; HAND TOOL IMPLEMENTS FOR DECANTING LIQUIDS; DEPIILATION APPLIANCES, ELECTRIC AND NON-ELECTRIC; GLAZIERS' DIAMONDS BEING PARTS OF HAND TOOLS; PUNCHING DIES; DIGGERS, NAMELY, HAND-OPERATED POST HOLE DIGGERS AND WEED DIGGERS; DITCHERS, NAMELY, DITCHER DIGGING FORKS; DRAWING KNIVES; MANUAL DRILL HOLDERS; DRILLS, NAMELY, MANUAL DRILLS; EAR-PIERCING APPARATUS; HAND TOOLS, NAMELY, EARTH RAMMERS; EDGE TOOLS, NAMELY, HAND-OPERATED LAWN EDGERS; EGG SLICERS, NON-ELECTRIC; EMBOSSERS, NAMELY, HAND-OPERATED PRESS MACHINES FOR EMBOSSEING; EMERY GRINDING WHEELS, NAMELY, HAND TOOLS IN THE NATURE OF MANUALLY-OPERATED GRINDING WHEELS; ENGRAVING NEEDLES; HAND TOOLS, NAMELY, EXPANDERS; EXTENSION PIECES FOR BRACES FOR SCREWTAPS, NAMELY, EXTENSIONS FOR HAND TOOLS; NAIL EXTRACTORS, NAMELY, CARPENTERS' PINNERS; FARRIERS' KNIVES; FILES; FINGERNAIL POLISHERS, ELECTRIC OR NON-ELECTRIC; FIRE IRONS; FIREPLACE BELLOWS; HARPOONS FOR COMMERCIAL FISHING; FLAT IRONS, NON-ELECTRIC; FLESHING KNIVES; FORKS; HAND TOOLS, NAMELY, FOUNDRY LADLES; FRAMES FOR HANDSAWS; HAND TOOLS, NAMELY, FRUIT PICKERS; HAND TOOLS, NAMELY, FULLERS; GARDEN TOOLS, HAND-OPERATED, NAMELY, CULTIVATORS, TROWELS, WEEDING FORKS, SPADES, HOES; GIMLETS; GLAZING IRONS, NAMELY, FIRE IRONS, HAND TOOLS IN THE NATURE OF PRIMING IRONS; HAND TOOLS, NAMELY, ELECTRIC GOFFERING IRONS; HAND TOOLS, NAMELY, GOUGES; HAND TOOLS, NAMELY, GRAFTING TOOLS; HAND TOOLS, NAMELY, MANUALLY-OPERATED GRINDSTONES; GUNS, NAMELY, CAULKING GUNS; GUNS, HAND-OPERATED, FOR THE EXTRUSION OF MASTICS, NAMELY, MANUALLY OPERATED GREASE GUNS; HAINAULT SCYTHES; HAIR CLIPPERS FOR ANIMALS; HAIR CLIPPERS FOR PERSONAL USE, ELECTRIC AND NON-ELECTRIC; HAND-OPERATED HAIR CURLERS, NON-ELECTRIC; HAIR-REMOVING TWEEZERS; HAMMER SHARPENERS, NAMELY, SHARPENING RODS, SHARPENING STEELS; HAMMERS; HAND TOOLS, NAMELY, HAND DRILLS; HAND TOOLS, NAMELY, HAND-OPERATED PUMPS; HAND TOOLS, HAND-OPERATED, NAMELY, PICKS, REAMERS; HATCHETS; HOES; HOLING AXES; HOLLOWING BITS FOR HAND DRILLS; HOOP CUTTERS, NAMELY, HAND TOOLS IN THE NATURE OF PIPE CUTTERS, WIRE CUTTERS; HUNTING KNIVES; ICE PICKS; INSECTICIDE VAPORIZERS, NAMELY, HAND-OPERATED VAPORIZER SPRAYERS FOR INSECTICIDES; FLAT IRONS, NON-ELECTRIC; LIFTING JACKS, HAND-OPERATED; JIGSAWS, HAND-OPERATED; KNIVES; HAND-TO-HAND COMBAT WEAPONS, NAMELY, KNUCKLE DUSTERS; LADLES, NAMELY, LADLES FOR WINE; LASTS FOR SHOE-MAKING; LEATHER STROPS; HAND TOOLS, NAMELY, LEVERS; LIVESTOCK MARKING TOOLS, NAMELY, BRANDING IRONS; MACHETES; MALLETS; MANICURE SETS; MANICURE SETS, ELECTRIC; MASON'S HAMMERS; MATTOCKS; MEAT CHOPPERS, NAMELY, KITCHEN MEAT MALLETS; HAND TOOLS, NAMELY, METAL BAND STRETCHERS; HAND TOOLS, NAMELY, MILLING CUTTERS; MINCING KNIVES; HAND TOOLS, NAMELY, MITRE BOXES; MOLDING IRONS, NAMELY, HAND TOOLS IN THE NATURE OF CRIMPING IRONS; MORTARS FOR POUNDING; MORTISE AXES; MORTISE CHISELS; NAIL BUFFERS, ELECTRIC OR NON-ELECTRIC; NAIL CLIPPERS, ELECTRIC OR NON-ELECTRIC; NAIL DRAWERS, NAMELY, HAND TOOLS IN THE NATURE OF NAIL SETS; NAIL FILES; NAIL FILES, ELECTRIC; NAIL NIPPERS; HAND TOOLS, NAMELY, NAIL PUNCHES; HAND TOOLS,

NAMELY, NEEDLE FILES; NIPPERS; HAND TOOLS, NAMELY, NUMBERING PUNCHES; NUTCRACKERS; OYSTER OPENERS; PALETTE KNIVES; PARING IRONS; PARING KNIVES; PEDICURE SETS; PENKNIVES; PERFORATING TOOLS, NAMELY, SCISSORS; PESTLES FOR POUNDING; PICKAXES; PICKHAMMERS; HAND TOOLS, NAMELY, PICKS; EAR PIERCING APPARATUS; HAND TOOLS, NAMELY, PIN PUNCHES; HAND TOOLS, NAMELY, PINNERS; HAND TOOLS, NAMELY, PLANES IN THE NATURE OF PLANE IRONS; PLANES; PLIERS; POLICE BATONS; HAND TOOLS, NAMELY, PRIMING IRONS; PRUNING KNIVES; PRUNING SCISSORS; PRUNING SHEARS; PUNCH PLIERS; PUNCH RINGS, NAMELY, HAND-TO-HAND COMBAT WEAPONS IN THE NATURE OF KNUCKLE DUSTERS; HAND TOOLS, NAMELY, PUNCHES; RABBETING PLANES; RAKES, SAND TRAP RAKES; HAND TOOLS, NAMELY, RAMMERS; HAND TOOLS, NAMELY, RASPS; HAND TOOLS, NAMELY, RATCHET WRENCHES; RAZOR BLADES; RAZOR STROPS; RAZORS, ELECTRIC OR NON-ELECTRIC; REAMER SOCKETS SOLD AS AN INTEGRAL COMPONENT OF REAMERS; REAMERS; HAND TOOLS, NAMELY, RIVETERS; RIVETING HAMMERS; HAND SAW BLADES; HAND SAW HOLDERS; SAWS, NAMELY, PIT SAWS, METAL CUTTING SAWS; SCALING KNIVES; SCISSORS; HAND TOOLS, NAMELY, SCRAPERS; SCRAPING TOOLS, NAMELY, HAND TOOLS IN THE NATURE OF PAINT SCRAPERS; SCREW STOCKS, NAMELY, HAND TOOLS IN THE NATURE OF SCREW EXTRACTORS; EXTENSION PIECES FOR BRACES FOR HAND TOOLS IN THE NATURE OF SCREW TAPS; SCREWDRIVERS; HAND TOOLS, NAMELY, SCREW-THREAD CUTTERS; SCYTHE RINGS; SCYTHE STONES; SCYTHES; SECATEURS; SHARPENING INSTRUMENTS, NAMELY, SHARPENING RODS, SHARPENING STEELS; SHARPENING STONES; SHARPENING WHEELS; SHEAR BLADES; PAPER SHEARS; SHEARS; SHOVELS; SICKLES; SILVERWARE, NAMELY, FORKS, KNIVES AND SPOONS THAT ARE SILVER-PLATED; SLEDGEHAMMERS; SPADES; SPANNERS; HAND TOOLS, NAMELY, SPATULAS; SPOONS; HAND TOOLS, NAMELY, SQUARES; HAND TOOLS, NAMELY, STAMPING-OUT TOOLS; HAND TOOLS, NAMELY, STAMPS; STONE HAMMERS, NAMELY, BUSHHAMMERS; HAND TOOLS, NAMELY, STRETCHERS FOR WIRE AND METAL BANDS; STROPPING INSTRUMENTS, NAMELY, LEATHER STROPS, RAZOR STROPS; CATTLE STUNNING APPARATUS, NAMELY, HAND-OPERATED CATTLE PRODS; SUGAR TONGS; SWORDS; SYRINGES FOR SPRAYING INSECTICIDES, NAMELY, HAND-OPERATED SPRAYERS FOR INSECTICIDE; TABLE CUTLERY; TABLE FORKS; TABLEWARE, NAMELY, KNIVES, FORKS, AND SPOONS; TAP WRENCHES; HAND TOOLS, NAMELY, TAPS; APPARATUS FOR TATTOOING, NAMELY, TATTOO MACHINES; CAN OPENERS, NON-ELECTRIC; HAND TOOLS, NAMELY, TONGS; HAND TOOLS, NAMELY, TREE PRUNERS; TROWELS; GARDENING TROWELS; TUBE CUTTERS, NAMELY, HAND OPERATED PIPE CUTTERS; TWEEZERS; HAND OPERATED VEGETABLE CHOPPERS; VEGETABLE KNIVES; HAND OPERATED VEGETABLE SHREDDERS; VEGETABLE SLICERS; VICES; WEEDING FORKS; WHETSTONE HOLDERS; WHETSTONES; CANDLE WICK TRIMMERS; HAND TOOLS, NAMELY, WIRE STRETCHERS; WRENCHES (U.S. CLS. 23, 28 AND 44).

CLASS 21—HOUSEWARES AND GLASS

FOR HOUSEHOLD OR KITCHEN UTENSILS AND CONTAINERS, NAMELY, GRATERS, SPATULAS, GRILLS, SIEVES, SKIMMERS, POT SCRAPERS, CONTAINERS FOR HOUSEHOLD OR KITCHEN USE NOT OF PRECIOUS METAL, POURING AND STRAINING SPOUTS, KITCHEN TONGS, STRAINERS, WIRE BASKETS, TURNERS; COMBS AND SPONGES, NAMELY, BATH SPONGES, CLEANING SPONGES; BRUSHES EXCEPT PAINT BRUSHES, NAMELY, CLOTHES BRUSHES, BRUSHES FOR FOOTWEAR, FILE BRUSHES, DISHWASHING BRUSHES, CAKE BRUSHES, MUSHROOM BRUSHES, SCRAPING BRUSHES, SCRUBBING BRUSHES, FLOOR BRUSHES, BRUSHES FOR PETS; SHAVING BRUSHES; BRUSH-MAKING MATERIALS, NAMELY, FILAMENTS FOR MAKING BRUSHES; ARTICLES FOR CLEANING PURPOSES, NAMELY, CLEANING RAGS, CLEANING SPONGES, CLEANING CLOTHS, CLEANING COMBS, CLEANING COTTON, CLEANING PADS, METAL WOOL FOR CLEANING;

STEELWOOL; UNWORKED OR SEMI-WORKED GLASS EXCEPT GLASS USED IN BUILDING; GLASSWARE, NAMELY, GLASS STORAGE JARS, DRINKING GLASSES, FOOD PRESERVING JARS OF GLASS, GLASS BOWLS, GLASS DISHES, GLASS VASES, GLASS MUGS, GLASS PANS; PORCELAIN, NAMELY, PORCELAIN EGGS, PORCELAIN MUGS, PORCELAIN FLOWER POTS, PORCELAIN DISHES, PORCELAIN WORKS OF ART, PORCELAIN CAKE DECORATIONS; EARTHENWARE, NAMELY, EARTHENWARE MUGS, EARTHENWARE FIGURES, EARTHENWARE DISHES, EARTHENWARE BOWLS; ABRASIVE PADS FOR KITCHEN PURPOSES; ABRASIVE SPONGES FOR SCRUBBING THE SKIN; AEROSOL DISPENSERS, NOT FOR MEDICAL PURPOSES; INDOOR AQUARIA, AQUARIUM HOODS; AUTOCLAVES, NON-ELECTRIC; BABY BATHTUBS, PORTABLE; BOWLS; BASINS; BASKETS FOR DOMESTIC USE, NOT OF METAL; BASTING SPOONS, FOR KITCHEN USE; CARPET BEATERS, NOT BEING MACHINES; EGG BEATERS, NON-ELECTRIC; BEER MUGS; HEAT INSULATED CONTAINERS FOR BEVERAGES FOR DOMESTIC USE; DUST BINS; BIRD BATHS; BIRDCAGES; FOOD BLENDERS, NON-ELECTRIC, FOR HOUSEHOLD PURPOSES; BOOT-JACKS; BOOT TREES; BOTTLE GOURDS; BOTTLE OPENERS; BOTTLES, SOLD EMPTY; REFRIGERATING BOTTLES, SOLD EMPTY; GLASS BOWLS; BOXES OF GLASS; BOXES FOR SWEETMEATS; BOXES OF METAL, FOR DISPENSING PAPER TOWELS; SOAP BOXES; BREAD BASKETS, DOMESTIC; BREAD BINS; BREAD BOARDS; ANIMAL BRISTLES; BROOMS; ELECTRIC TOOTH BRUSHES, EXCEPT PARTS OF MACHINES; BRUSHES FOR CLEANING TANKS AND CONTAINERS, NAMELY, TOILET BOWL BRUSHES, SCRUBBING BRUSHES, FOR HOUSEHOLD USE; BUCKETS; BUCKSKIN CLOTHES FOR CLEANING; PERFUME BURNERS; BUSTS OF CHINA, TERRA-COTTA OR GLASS; BUTTER DISHES; BUTTER-DISH COVERS; BUTTON-HOOKS; TRAYS, NAMELY, SERVING TRAYS, TRAYS FOR DOMESTIC PURPOSES; CAGES FOR HOUSEHOLD PETS; CAKE MOLDS; CANDLESTICKS; CANDLE EXTINGUISHERS; CANDLE RINGS; CARBOYS, SOLD EMPTY FOR HOUSEHOLD PURPOSES; CARPET BEATERS; CARPET SWEEPERS; COMB CASES; CAULDRONS; CERAMIC FOR HOUSEHOLD PURPOSES, NAMELY, CERAMIC PULLS, CERAMIC FIGURINES, CERAMIC SCULPTURES, CERAMIC VASES, CERAMIC VESSELS, CERAMIC BOWLS, CERAMIC PLATES AND CERAMIC POTS; CHAMBER POTS; CHAMOIS LEATHER FOR CLEANING; CHEESE-DISH COVERS; CHINA ORNAMENTS; CHOPSTICKS; CINDER SIFTERS FOR HOUSEHOLD USE; CLEANING TOW, NAMELY, CLEANING PADS IN THE SHAPE OF ROPES; CLOSURES FOR POT LIDS, NAMELY, TENSION CLOSING DEVICES FOR POT LIDS; CLOTH FOR WASHING FLOORS; CLOTHES RACKS, FOR DRYING; CLOTHES PEGS; CLOTHES PINS; CLOTHING STRETCHERS; CLOTHS FOR CLEANING; COAL SCUTTLES; COASTERS, NOT OF PAPER AND OTHER THAN TABLE LINEN; COCKTAIL STIRRERS; COFFEE FILTERS NOT BEING PART OF NON-ELECTRIC COFFEE MAKERS; COFFEE GRINDERS, HAND-OPERATED; COFFEE PERCOLATORS, NON-ELECTRIC; COFFEE SERVICES; COFFEEPOTS, NON-ELECTRIC; PORTABLE COLDBOXES, NON-ELECTRIC; COMBS; CONFECTIONERS' DECORATING BAGS; CONTAINERS FOR HOUSEHOLD OR KITCHEN USE; COOKERY MOLDS; COOKIE CUTTERS; COOKIE JARS; COOKING POT SETS; COOKING POTS; COOKING SKEWERS, OF METAL; COOLERS, NAMELY, BUTTER COOLERS, CAVIAR COOLERS, COOLERS FOR WINE, PORTABLE COOLERS; FOOD COOLING DEVICES CONTAINING HEAT EXCHANGE FLUIDS IN THE FORM OF RECEPTACLES, FOR HOUSEHOLD PURPOSES; CORKSCREWS; COSMETIC UTENSILS, NAMELY, COSMETIC BRUSHES, DROPPERS SOLD EMPTY FOR COSMETIC PURPOSES, ELECTRICAL APPLICATORS FOR APPLYING COSMETICS TO THE SKIN; COVERS FOR DISHES; COVERS, NOT OF PAPER, FOR FLOWER POTS; CROCKERY, NAMELY, POTS, DISHES, DRINKING CUPS AND SAUCERS, BOWLS, SERVING BOWLS, TRAYS; CRUET STANDS FOR OIL AND VINEGAR; CRUMB TRAYS; CRYSTAL BEVERAGE GLASSWARE; CUPS; CUPS OF PAPER OR PLASTIC; CURRY COMBS; CUTTING BOARDS FOR THE KITCHEN; DECANTERS; DEEP FRYERS, NON-ELECTRIC; DEMIJOHNS; DISHES; DISHES FOR SOAP; SOAP DISPENSERS; METAL BOXES FOR DISPENSING PAPER TOWELS; DISPOSABLE TABLE PLATES; DOMESTIC GRINDERS, NON-ELECTRIC; DRINKING FLASKS

FOR TRAVELERS; DRINKING GLASSES; DRINKING TROUGHES; DRINKING VESSELS; DISH DRYING RACKS FOR WASHING; DUSTBINS; FURNITURE DUSTERS; DUSTING APPARATUS, NON-ELECTRIC, NAMELY, DUSTERS, DUSTING BRUSHES, DUST GLOVES; DUSTING CLOTHS; EGG CUPS; ENAMELLED GLASS; EPERGNES; EYEBROW BRUSHES; BUCKETS MADE OF WOVEN FABRICS; FEATHER-DUSTERS; HEATERS FOR FEEDING BOTTLES, NON-ELECTRIC; FEEDING TROUGHES; FEEDING TROUGHES FOR ANIMALS; FIBERGLASS OTHER THAN FOR INSULATION OR TEXTILE USE; FIBERGLASS THREAD, NOT FOR TEXTILE USE; FIGURINES OF PORCELAIN, TERRACOTTA OR GLASS; FLASKS; FLOSS FOR DENTAL PURPOSES; FLOWER POTS; FLOWER-POT COVERS, NOT OF PAPER; FLY CATCHERS; FLY SWATTERS; FRUIT CUPS SOLD EMPTY FOR HOLDING FRUIT; FRUIT PRESSES, NON-ELECTRIC, FOR HOUSEHOLD PURPOSES; FRYING PANS; FUNNELS; FUSED SILICA AS A SEMI-FINISHED PRODUCT, OTHER THAN FOR BUILDING, NAMELY, INGOTS, TUBES, RODS, DISCS, PLATES AND RINGS ALL FOR GENERAL INDUSTRIAL AND FURTHER MANUFACTURING USE; GARBAGE CANS; GARDENING GLOVES; GARLIC PRESSES; GLASS BULBS IN THE NATURE OF CONTAINERS FOR HOUSEHOLD USE; GLASS FLASKS; GLASS FOR VEHICLE WINDOWS; GLASS INCORPORATING FINE ELECTRICAL CONDUCTORS; OPAL GLASS; GLASS STOPPERS; GLASS, UNWORKED OR SEMI-WORKED, EXCEPT BUILDING GLASS; GLASS WOOL OTHER THAN FOR INSULATION; PAINTED BEVERAGE GLASSWARE; GLOVE STRETCHERS; GLOVES FOR HOUSEHOLD PURPOSES; POLISHING GLOVES; GLUEPOTS; GOBLETS; BOTTLE GOURDS; GRATERS, NAMELY, GRATERS FOR HOUSEHOLD PURPOSES; GRIDDLES; GRILLS; HEAT-INSULATED VESSELS; HOLDERS FOR FLOWERS AND PLANTS; TOILET PAPER HOLDERS; DRINKING HORNS; HORSE BRUSHES; HOT POTS, NOT ELECTRICALLY HEATED; ICE BUCKETS; ICE CUBE MOLDS; ICE PAILS; INDOOR TERRARIUMS; INSECT TRAPS; INSULATING FLASKS; IRONING BOARD COVERS, SHAPED; IRONING BOARDS; ISOTHERMIC BAGS, NAMELY, THERMAL INSULATED BAGS FOR FOOD OR BEVERAGES; JUGS; KETTLES, NON-ELECTRIC; KITCHEN CONTAINERS; KITCHEN FOOD MIXERS, NON-ELECTRIC; KNIFE RESTS FOR THE TABLE; KNOBS OF PORCELAIN; LAMP-GLASS BRUSHES; LAZY SUSANS; POLISHING LEATHER; LIQUEUR SETS, NAMELY, BEVERAGE GLASSWARE, FLASKS; LITTER BOXES FOR PETS; LUNCH BOXES; LYE WASHTUBS; MAJOLICA, NAMELY, EARTHENWARE MUGS, EARTHENWARE FIGURES, EARTHENWARE PLATES, EARTHENWARE POTS, EARTHENWARE DISHES, EARTHENWARE DRINKING CUPS; APPLIANCES FOR REMOVING MAKE-UP, NON-ELECTRIC, NAMELY, FACIAL CLEANSING SPONGES; MANGERS FOR ANIMALS; MANGERS FOR LIVESTOCK; MENU CARD HOLDERS; MESS-TINS; SALT MILLS FOR DOMESTIC PURPOSES, HAND-OPERATED; PEPPER MILLS FOR DOMESTIC PURPOSES, HAND-OPERATED; MIXING MACHINES, NON-ELECTRIC, FOR HOUSEHOLD PURPOSES, NAMELY, NON-ELECTRIC FOOD MIXERS; MIXING SPOONS; MOLDS, NAMELY, COOKERY MOLDS, PUDGING MOLDS, PASTRY MOLDS; MOPS; MOSAICS OF GLASS, NOT FOR BUILDING; MOUSE TRAPS; MUGS; NAIL BRUSHES; NAPKIN HOLDERS; NAPKIN RINGS; NEST EGGS, ARTIFICIAL; NOZZLES FOR LAWN SPRINKLER HOSE; PLASTIC NOZZLES FOR WATERING CANS; OIL CRUETS; PADS FOR CLEANING; PAILS; PEPPER MILLS, HAND-OPERATED; PEPPER POTS; PERFUME BURNERS; PERFUME SPRAYERS; PERFUME VAPORIZERS SOLD EMPTY; FITTED PIGNIC BASKETS, INCLUDING DISHES; PIE SERVERS; PIG BRISTLES; PIGGY BANKS, NOT OF METAL; COOKING PINS OF METAL, NAMELY, ROLLING PINS; PITCHERS; PLATE GLASS, NAMELY, GROUND PLATE GLASS, PLATE GLASS FOR CARDS, POLISHED PLATE GLASS; PAPER PLATES; PLATES TO PREVENT MILK BOILING OVER; PLUNGERS FOR CLEARING BLOCKED DRAINS; POLISHING APPARATUS AND MACHINES, FOR HOUSEHOLD PURPOSES, NON-ELECTRIC, NAMELY, POLISHING CLOTHS, POLISHING LEATHER, SHOE POLISHING MILS; POLISHING MATERIALS FOR MAKING SHINY, EXCEPT PREPARATIONS, NAMELY, POLISHING CLOTHS; POT LIDS; POTS; POTTERY, NAMELY, FLOWER VASES, VASES; POULTRY RINGS; POWDER COMPACTS; POWDER PUFFS; POWDERED GLASS FOR DECORATION; RAILS

AND RINGS FOR TOWELS; RAT TRAPS; REFRIGERATING BOTTLES, NAMELY, BOTTLES SOLD EMPTY, VACUUM BOTTLES; REFUSE BINS; ROLLING PINS, DOMESTIC; ROSES FOR WATERING CANS, NAMELY, A POURING SPOUT FOR HOUSEHOLD PURPOSES THAT CONTAINS HOLES FOR ALLOWING WATER TO BE SPRAYED ONTO FLOWERS AND POTS; SALT CELLARS, SALT SHAKERS; SAUCEPAN SCOURERS OF METAL; EARTHENWARE SAUCEPANS, SAUCERS; SCOOPS; SCOURING PADS; SERVICES, NAMELY, DISHES; SHAKERS, NAMELY, COCKTAIL SHAKERS, SALT SHAKERS; SHIRT STRETCHERS; SHOE BRUSHES; SHOE HORNS; SHOE STRETCHERS; SIEVES FOR HOUSEHOLD UTENSILS; SIFTERS, NAMELY, CINDER SIFTER FOR HOUSEHOLD PURPOSES, FLOUR SIFTERS, COOKING SIFTERS; UPRIGHT SIGNBOARDS OF PORCELAIN OR GLASS; SIPHONS FOR CARBONATED WATER, NAMELY, GAS PRESSURIZED BEVERAGE SIPHON CONTAINERS, NAMELY, CREAM WHIPPERS, CREAM PITCHERS AND SODA WATER HOLDERS AND GAS CARTRIDGES SOLD EMPTY; SKINS OF CHAMOIS FOR CLEANING; SOAP HOLDERS; SPICE SETS, NAMELY, SPICE RACKS, SPICE CONTAINER SETS FOR HOUSEHOLD USE SOLD EMPTY; SPONGE HOLDERS; SPONGES FOR HOUSEHOLD PURPOSES; KITCHEN UTENSILS IN THE NATURE OF POURING AND STRAINING SPOUTS; SPRINKLERS, NAMELY, GRASS SPRINKLER, LAWN SPRINKLER; SPRINKLERS FOR WATERING FLOWERS AND PLANTS; STANDS FOR SHAVING BRUSHES; STATUES OF PORCELAIN, TERRA-COTTA OR GLASS; STEEL WOOL FOR CLEANING; STEW-PANS; STRAINERS, NAMELY, COOKING STRAINERS, WINE STRAINERS; STRAINERS FOR HOUSEHOLD PURPOSES; STRETCHERS FOR CLOTHING; SUGAR BOWLS; SYRINGES FOR WATERING FLOWERS AND PLANTS; TABLE PLATES; TABLEWARE, OTHER THAN KNIVES, FORKS AND SPOONS, NAMELY, TEA SERVICES, COFFEE SERVICES; TANKARDS; TART SCOOPS; TEA BALLS; TEA CADDIES; TEA INFUSERS; TEA SERVICES; TEA STRAINERS; TEAPOTS; THERMALLY INSULATED CONTAINERS FOR FOOD FOR DOMESTIC PURPOSES; TIE PRESSES; TOILET BRUSHES; TOILET CASES, NAMELY, TOILET BRUSH HOLDERS, TOILET ROLL HOLDERS; TOILET SPONGES; TOOTHBRUSHES; TOOTHBRUSHES, ELECTRIC; TOOTHPICK HOLDERS; TOOTHPICKS; TRASH CANS; TRAYS FOR DOMESTIC PURPOSES; TRAYS FOR DOMESTIC PURPOSES, OF PAPER; TRIVETS; TROUGHS FOR LIVESTOCK; NON-ELECTRIC TROUSER PRESSES; TROUSER STRETCHERS; VACUUM BOTTLES; FITTED VANITY CASES; VASES; VEGETABLE DISHES FOR HOLDING VEGETABLES SOLD EMPTY; DRINKING VESSELS OF METAL FOR MAKING ICES AND ICED DRINKS; WAFFLE IRONS, NON-ELECTRIC; WASHING BOARDS; WASH-TUBS; WATER APPARATUS FOR CLEANING TEETH AND GUMS FOR HOME USE; WATERING CANS; WATERING DEVICES, NAMELY, WATERING CANS; WAX-POLISHING APPLIANCES, NON-ELECTRIC, FOR SHOES, NAMELY, SHOW POLISH APPLICATORS NOT CONTAINING SHOE POLISH; WINE TASTERS; WORKS OF ART, OF PORCELAIN, TERRA-COTTA OR GLASS (U.S. CLS. 2, 13, 23, 29, 30, 33, 40 AND 50).

MAYUR VAGHANI, EXAMINING ATTORNEY

SN 79-106,716, COMPANISTO GMBH, FED REP GERMANY, FILED 10-19-2011.

Companisto

THE MARK CONSISTS OF STANDARD CHARACTERS WITHOUT CLAIM TO ANY PARTICULAR FONT, STYLE, SIZE, OR COLOR.

OWNER OF INTERNATIONAL REGISTRATION 1100560 DATED 10-19-2011, EXPIRES 10-19-2021.

THE WORDING "COMPANISTO" HAS NO MEANING IN A FOREIGN LANGUAGE.

CLASS 35—ADVERTISING AND BUSINESS

FOR BUSINESS MANAGEMENT AND ORGANIZATION CONSULTANCY SERVICES; AUCTIONEERING; BUSINESS CONSULTANCY; ARRANGEMENT AND CONCLUSION OF TRADING TRANSACTIONS FOR THIRD PARTIES; ADVERTISING; BUSINESS ACQUISITION AND MERGER CONSULTATION (U.S. CLS. 100, 101 AND 102).

CLASS 36—INSURANCE AND FINANCIAL

FOR ELECTRONIC CASH TRANSACTIONS; FINANCING SERVICES; FINANCIAL SERVICES, NAMELY, BUSINESS FUNDRAISING PROVIDED OVER A COMPUTER NETWORK SUCH AS THE INTERNET; CAPITAL INVESTMENTS SERVICES; MUTUAL FUND INVESTMENT; CORPORATE FINANCING SERVICES; BROKERAGE OF SHARES OR STOCKS AND OTHER SECURITIES; CAPITAL INVESTMENT BROKERAGE; INVESTMENT BROKERAGE; ARRANGING INVESTMENTS, IN PARTICULAR CAPITAL INVESTMENTS, NAMELY, INVESTMENTS IN STARTUP COMPANIES; FINANCING SERVICES; BROKERAGE OF SECURITIES AND INVESTMENTS; ADVISORY SERVICES RELATING TO CORPORATE FINANCE; VENTURE CAPITAL FINANCING; VENTURE CAPITAL MANAGEMENT SERVICES; VENTURE CAPITAL INVESTMENT SERVICES; INVESTMENT TRUSTEESHIP REPRESENTATIVES; INVESTMENT ADVISORY SERVICES; CAPITAL INVESTMENT CONSULTATION SERVICES; FINANCIAL AND INVESTMENT CONSULTANCY SERVICES; INVESTMENT CONSULTATION (U.S. CLS. 100, 101 AND 102).

EVELYN BRADLEY, EXAMINING ATTORNEY

SN 79-106,806, SIEMENS AKTIENGESELLSCHAFT, FED REP GERMANY, FILED 11-14-2011.

Charge eMosphere

THE MARK CONSISTS OF STANDARD CHARACTERS WITHOUT CLAIM TO ANY PARTICULAR FONT, STYLE, SIZE, OR COLOR.

PRIORITY DATE OF 8-9-2011 IS CLAIMED.

OWNER OF INTERNATIONAL REGISTRATION 1100766 DATED 11-14-2011, EXPIRES 11-14-2021.

NO CLAIM IS MADE TO THE EXCLUSIVE RIGHT TO USE "CHARGE", APART FROM THE MARK AS SHOWN.

CLASS 9—ELECTRICAL AND SCIENTIFIC APPARATUS

FOR ELECTRICAL SIGNALING, MEASURING, METERING, REGISTERING, MONITORING, CONTROLLING, REGULATING AND SWITCHING APPARATUS, NAMELY, ELECTRIC METERS, ELECTRIC SWITCHES, ELECTRIC CONTROLLERS; ELECTRICAL DEVICES FOR INPUT, PROCESSING, TRANSMISSION, STORAGE AND OUTPUT OF DATA, NAMELY, COMPUTER HARDWARE, HARD DISC DRIVES; DATA-PROCESSING PROGRAMS, NAMELY, COMPUTER SOFTWARE FOR MANAGING, PROCESSING AND ANALYZING DATA RELATING TO ELECTRICAL VEHICLE CHARGING STATIONS AND NETWORKS AND FOR MONITORING AND CONTROLLING THE OPERATION OF ELECTRICAL CHARGING STATIONS AND NETWORKS, COMPUTER SOFTWARE FOR MANAGING CUSTOMER PAYMENTS AND ACCOUNTS AND FOR PROVIDING STATUS INFORMATION REGARDING AND ACCESS TO ELECTRICAL POWER SUPPLY NETWORKS FOR ELECTRIC VEHICLES (U.S. CLS. 21, 23, 26, 36 AND 38).

CLASS 42—SCIENTIFIC AND COMPUTER SERVICES

FOR DEVELOPMENT, GENERATION AND RENTING OF DATA PROCESSING PROGRAMS (U.S. CLS. 100 AND 101).

ERNEST SHOSHO, EXAMINING ATTORNEY

SN 79-107,094. CUSTOMDRINKS, S.L., SPAIN, FILED 10-28-2011.

SN 79-107,082. TUKAS GIDA; SANAYI VE TICARET ANONIM SIRKETI, TURKEY, FILED 7-18-2011.



OWNER OF INTERNATIONAL REGISTRATION 1101414 DATED 7-18-2011, EXPIRES 7-18-2021.

OWNER OF U.S. REG. NO. 3,329,785.

THE COLOR(S) BLACK, WHITE AND GREEN IS/ARE CLAIMED AS A FEATURE OF THE MARK.

THE MARK CONSISTS OF THE WORDING "TUKAS" IN WHITE, WITH TWO GREEN LEAVES EMANATING FROM THE TOP RIGHT OF THE LETTER "K", WITH THE WORDING "DOGAYA ÖZEN GÖSTERDİK" APPEARING IN WHITE UNDERNEATH; ALL OF THE WORDING AND LEAVES APPEAR ON A BLACK BACKGROUND.

THE ENGLISH TRANSLATION OF "DOGAYA ÖZEN GÖSTERDİK" IN THE MARK IS "WE HAVE TAKEN CARE OF NATURE". THE WORDING "TUKAS" HAS NO MEANING IN A FOREIGN LANGUAGE.

CLASS 29—MEATS AND PROCESSED FOODS

FOR MEAT, FISH; POULTRY AND GAME MEAT, AND PROCESSED MEAT, NAMELY, KIDNEYS, TURKEY, LAMB, LUNCHEON MEATS AND VEAL; DRIED LEGUMES; READY MADE SOUPS AND BOUILLON; PROCESSED OLIVES, PRESERVED OLIVES AND OLIVE PASTE; MILK AND MILK PRODUCTS, NAMELY, BUTTER, EVAPORATED MILK, AND MILK CURD; EDIBLE VEGETABLE OILS; DRIED, CANNED, FROZEN, COOKED, SMOKED, AND BRINED FRUITS AND VEGETABLES; DRIED FRUITS; HAZELNUT SPREAD AND PISTACHIO PASTES; SESAME SEED PASTE; EGGS; POWDERED EGGS; NON-MEDICAL FOODS USED FOR SUPPLEMENTARY PURPOSES, NAMELY, PROCESSED BEE POLLENS AS A FOODSTUFF; PROTEINS, NAMELY, TEXTURED VEGETABLE PROTEIN FOR USE AS A MEAT EXTENDER, PROTEIN MILK, FORMED TEXTURED VEGETABLE PROTEIN FOR USE AS A MEAT SUBSTITUTE, AND TOFU; NON-CARBOHYDRATE SUPPLEMENTS OTHER THAN FOR MEDICAL USE, NAMELY, NON-ALCOHOLIC FRUIT EXTRACTS FOR USE AS INGREDIENTS OF NUTRITIONAL SUPPLEMENTS AND VITAMINS, POTATO CHIPS (U.S. CL. 46).

CLASS 30—STAPLE FOODS

FOR COFFEE; COCOA; COFFEE SUBSTITUTES; COFFEE BASED BEVERAGES; COCOA BASED BEVERAGES; CHOCOLATE BASED BEVERAGES; PASTRY AND BAKERY PRODUCTS; BAKERY DESSERTS; HONEY; ROYAL JELLY FOR FOOD; PROPOLIS FOR FOOD PURPOSES; YEASTS; BAKING POWDER; CONDIMENTS FOR FOODSTUFF, NAMELY, PEPPER SAUCE, CHUTNEY, AND PICKLED GINGER, KETCHUP, AND MUSTARD; NATURAL SUBSTANCES FOR IMPROVING SHAPE AND COLOR OF BREAD AND RETARDING ITS PERIOD OF GETTING STALE, NAMELY, BREAD BASES, AND BAKING SODA; FLOUR; PROCESSED SEMOLINA; CORN STARCH; CRYSTALLISED SUGAR; CUBED SUGAR; POWDERED SUGAR; TEA; ICED TEA; CONFECTIONERY, NAMELY, FONDANTS, AND PASTILLES; BISCUITS; CRACKERS; WAFFLES; CHEWING GUMS; ICE CREAMS; FROZEN CREAMS, NAMELY, ICE CREAM, PASTRY CREAM, AND FROZEN DESSERTS CONSISTING OF CREAM; SALT; PROCESSED CEREALS AND PRODUCTS MADE FROM CEREALS, NAMELY, HIGH PROTEIN CEREAL BARS, CEREAL BASED ENERGY BARS, AND CEREAL BASED SNACK FOOD (U.S. CL. 46).

SHAILA SETTLES, EXAMINING ATTORNEY



OWNER OF INTERNATIONAL REGISTRATION 1101446 DATED 10-28-2011, EXPIRES 10-28-2021.

THE NAME(S), PORTRAIT(S), AND/OR SIGNATURE(S) SHOWN IN THE MARK DOES NOT IDENTIFY A PARTICULAR LIVING INDIVIDUAL.

THE COLOR(S) BLACK, WHITE AND RED IS/ARE CLAIMED AS A FEATURE OF THE MARK.

THE MARK CONSISTS OF THE WORDING "LA TITA RIVERA" IN STYLIZED WHITE FONT WITH BLACK OUTLINING. THE WORDING APPEARS BENEATH A BLACK AND WHITE PICTURE OF A WOMAN WEARING A RED APRON AND HOLDING TWO RED CANS WITH BLACK AND WHITE TOPS AND BOTTOMS. THE WOMAN APPEARS IN A BLACK CIRCLE WITH A WHITE CENTER.

THE ENGLISH TRANSLATION OF "LA TITA RIVERA" IN THE MARK IS "THE LITTLE AUNT RIVERA".

CLASS 32—LIGHT BEVERAGES

FOR BEERS; CONCENTRATES, SYRUP OR POWDERS USED IN THE PREPARATION OF SOFT DRINKS; FRUIT DRINKS; FRUIT JUICES; MALT SYRUP FOR BEVERAGES; MINERAL WATER; NON-ALCOHOLIC BEVERAGES CONTAINING FRUIT JUICES; NON-ALCOHOLIC COCKTAIL MIXES; NON-ALCOHOLIC FRUIT EXTRACTS USED IN THE PREPARATION OF BEVERAGES; NON-ALCOHOLIC MALT BEVERAGE; SPARKLING WATER; SYRUP FOR BEVERAGES; SYRUP FOR MAKING FRUIT DRINKS, SOFT DRINKS (U.S. CLS. 45, 46 AND 48).

CLASS 33—WINES AND SPIRITS

FOR ALCOHOLIC BEVERAGES EXCEPT BEERS (U.S. CLS. 47 AND 49).

CLASS 43—HOTEL AND RESTAURANT SERVICES

FOR SERVICES FOR PROVIDING FOOD AND DRINK; TEMPORARY ACCOMMODATION (U.S. CLS. 100 AND 101).

LIEF MARTIN, EXAMINING ATTORNEY

SN 79-107,228. ACCURE AB, GÖTEBORG, SWEDEN, FILED 11-15-2011.



PRIORITY DATE OF 5-16-2011 IS CLAIMED. OWNER OF INTERNATIONAL REGISTRATION 1101787 DATED 11-15-2011, EXPIRES 11-15-2021.

THE COLOR(S) ORANGE AND BLACK IS/ARE CLAIMED AS A FEATURE OF THE MARK.

THE MARK CONSISTS OF THE WORD "ACCURE" IN BLACK WITH A DESIGN TO THE RIGHT CONSISTING OF A LINE OF SIX DIAGONAL LINES AT THE TOP AND MIRRORED DIAGONAL LINES AT THE BOTTOM; THE FIRST SIX LINES - THREE TOP AND THREE BOTTOM - ARE ORANGE, THE NEXT TWO - TWO TOP AND TWO BOTTOM - WHICH MAKE AN "X" DESIGN ARE BLACK AND THE LAST ONE - ONE TOP AND ONE BOTTOM - IS ORANGE. THE COLOR WHITE REPRESENTS BACKGROUND AND IS NOT A PART OF THE MARK.

CLASS 9—ELECTRICAL AND SCIENTIFIC APPARATUS

FOR COMPUTER SOFTWARE AND PROGRAMS FOR ELECTRONIC ARCHIVING, DOCUMENT SOLUTIONS AND SYSTEM INTEGRATION; DATA PROCESSING EQUIPMENT AND COMPUTERS (U.S. CLS. 21, 23, 26, 36 AND 38).

CLASS 35—ADVERTISING AND BUSINESS

FOR ASSISTANCE AND CONSULTATION REGARDING BUSINESS MANAGEMENT, BUSINESS ADMINISTRATION AND BUSINESS ORGANIZATION (U.S. CLS. 100, 101 AND 102).

CLASS 42—SCIENTIFIC AND COMPUTER SERVICES

FOR CONSULTATION REGARDING IT; DESIGN AND DEVELOPMENT OF COMPUTER HARDWARE AND COMPUTER SOFTWARE (U.S. CLS. 100 AND 101).
MAYUR VAGHANI, EXAMINING ATTORNEY

SN 79-107,464. CONG TY CO PHAN DICH VU TONG HOP SAI GON, DBA SAVICO, HO CHI MINH CITY, VIETNAM, FILED 7-27-2011.



OWNER OF INTERNATIONAL REGISTRATION 1102366 DATED 7-27-2011, EXPIRES 7-27-2021.

NO CLAIM IS MADE TO THE EXCLUSIVE RIGHT TO USE "GROUP", APART FROM THE MARK AS SHOWN.

THE COLOR(S) RED AND WHITE IS/ARE CLAIMED AS A FEATURE OF THE MARK.

THE MARK CONSISTS OF THE LETTERS "S", "I", AND THE WORDS "SAVICO GROUP", ALL IN RED; A WHITE CIRCLE DESIGN IN THE MIDDLE OF THE STYLIZED "S" LETTER WITH THE "I" LETTER INSIDE; AND A LOZENGE SHAPE DESIGN IN WHITE WITH A RED BORDER.

THE WORDING "SAVICO" HAS NO MEANING IN A FOREIGN LANGUAGE.

CLASS 35—ADVERTISING AND BUSINESS

FOR COMMERCIAL SUPERMARKETS IN THE FIELDS OF GOODS, NAMELY FOODS AND FOODSTUFF, HANDICRAFTS, CRAFT INDUSTRY PRODUCTS, GARMENTS, FOOTWEAR, PAPER, LEATHER, PLASTIC AND PRODUCTS MADE OF PAPER, LEATHER, PLASTIC, INTERIOR DECORATION PRODUCTS, METALLIC PRODUCTS, ELECTRIC-MECHANICAL PRODUCTS AND SPARE PARTS THEREOF, ELECTRIC AND ELECTRONIC EQUIPMENTS AND THEIR SPARE PARTS, HOUSEHOLD COMMODITIES, CAMERAS, SPARE PARTS AND ACCESSORIES THEREOF, MUSIC INSTRUMENTS, WATCHES AND CLOCKS, EYE GLASSES AND SPARE PARTS THEREOF, TOYS FOR CHILDREN, PUBLICATIONS, OFFICE STATIONERY, OFFICE MACHINES AND EQUIPMENTS, COSMETICS, SPORT TOOLS, JEWELRY, WINE, BEER, SOFT DRINKS, TELEPHONES, FAX MACHINES, TELEPHONE CARDS, TELEPHONE EXCHANGERS AND OTHER POSTAL AND TELECOMMUNICATION EQUIPMENTS; RETAIL STORE SERVICES FEATURING AGRICULTURAL, FORESTAL, SEA AND AQUATIC PRODUCTS, FOODS AND FOODSTUFF, FINE ARTS AND HANDICRAFTS, CRAFT INDUSTRY PRODUCTS, GARMENTS, FOOTWEAR, PAPER, LEATHER, PLASTIC AND PRODUCTS MADE OF PAPER, LEATHER, PLASTIC, INDUSTRIAL PRODUCTS, MACHINES AND EQUIPMENTS AND SPARE PARTS, MATERIALS, CHEMICAL SUBSTANCES, RAW AND AUXILIARY MATERIALS SERVING FIELDS OF INDUSTRIAL PRODUCTIONS, MEDICAL TOOLS AND EQUIPMENTS, CONSTRUCTION MATERIALS, INTERIOR DECORATION PRODUCTS, MOTORCYCLES, CARS AND SPARE PARTS AND ACCESSORIES IN ALL KINDS THEREOF, ELECTRIC-FREEZING EQUIPMENTS, METALLIC PRODUCTS, ELECTRIC-MECHANICAL PRODUCTS AND SPARE PARTS THEREOF, ELECTRIC AND ELECTRONIC EQUIPMENTS AND THEIR SPARE PARTS, HOUSEHOLD COMMODITIES, COMPUTERS AND SPARE PARTS THEREOF, PERIPHERAL DEVICES, CAMERAS, SPARE PARTS AND ACCESSORIES THEREOF, PRODUCTS SERVING PHOTOGRAPH INDUSTRY, MUSIC INSTRUMENTS, WATCHES AND CLOCKS, EYE GLASSES AND SPARE PARTS THEREOF, TOYS FOR CHILDREN, PUBLICATIONS, OFFICE STATIONERY, OFFICE MACHINES AND EQUIPMENTS, COSMETICS, SPORT TOOLS, JEWELRY, GOLD, SILVER, PRECIOUS STONES, WINE, BEER, SOFT DRINKS, TELEPHONES, FAX MACHINES, TELEPHONE CARDS, TELEPHONE EXCHANGERS AND OTHER POSTAL AND TELECOMMUNICATION EQUIPMENTS; ADVERTISING SERVICES; RETAIL SERVICES BY DIRECT SOLICITATION BY SALES AGENTS IN THE FIELDS OF AGRICULTURAL, FORESTAL, SEA AND AQUATIC PRODUCTS, FOODS AND FOODSTUFF, FINE ARTS AND HANDICRAFTS, CRAFT INDUSTRY PRODUCTS, GARMENTS, FOOTWEAR, PAPER, LEATHER, PLASTIC AND PRODUCTS MADE OF PAPER, LEATHER, PLASTIC, INDUSTRIAL PRODUCTS, MACHINES AND EQUIPMENTS AND SPARE PARTS, MATERIALS, CHEMICAL SUBSTANCES, RAW AND AUXILIARY MATERIALS SERVING FIELDS OF INDUSTRIAL PRODUCTIONS, MEDICAL TOOLS AND EQUIPMENTS, CONSTRUCTION MATERIALS, INTERIOR DECORATION PRODUCTS, MOTORCYCLES, CARS AND SPARE PARTS AND ACCESSORIES IN ALL KINDS THEREOF, ELECTRIC-FREEZING EQUIPMENTS, METALLIC PRODUCTS, ELECTRIC-MECHANICAL PRODUCTS AND SPARE PARTS THEREOF, ELECTRIC AND ELECTRONIC EQUIPMENTS AND THEIR SPARE PARTS, HOUSEHOLD COMMODITIES, COMPUTERS AND SPARE PARTS THEREOF, PERIPHERAL DEVICES, CAMERAS, SPARE PARTS AND ACCESSORIES THEREOF, PRODUCTS SERVING PHOTOGRAPH INDUSTRY, MUSIC INSTRUMENTS, WATCHES AND CLOCKS, EYE GLASSES AND SPARE PARTS THEREOF, TOYS FOR CHILDREN, PUBLICATIONS, OFFICE STATIONERIES, OFFICE MACHINES AND EQUIPMENTS, COSMETICS, SPORT TOOLS, JEWELRY, GOLD, SILVER, PRECIOUS STONES, WINE, BEER, SOFT DRINKS, TELEPHONES, FAX MACHINES, TELEPHONE CARDS, TELEPHONE EXCHANGERS AND OTHER POSTAL AND TELECOMMUNICATION EQUIPMENTS; BUSINESS PROJECT MANAGEMENT; ESTIMATING CONTRACTING WORK, NAMELY, SERVICE OF MAKING GENERAL BUDGET ESTIMATES AND BUDGET ESTIMATES FOR CONSTRUCTION PROJECTS; BIDDING CONSULTANCY, NAMELY, ONLINE AUCTION BIDDING AND/OR BID-

DING QUOTATION; BIDDING SERVICE FOR OTHERS, NAMELY, ONLINE AUCTION BIDDING AND/OR BIDDING QUOTATION; AGENCY SERVICES OF EXPORT AND IMPORT OF GOODS (U.S. CLS. 100, 101 AND 102).

SN 79-107,968. BH SALON S.R.L., PONTECAGNANO (SA), ITALY, FILED 10-28-2011.

CLASS 36—INSURANCE AND FINANCIAL

FOR RENTAL OF REAL ESTATE, NAMELY, VACATION HOMES; REAL ESTATE BROKERAGES; REAL ESTATE AGENCIES; RENTAL OF HOUSES, OFFICES, APARTMENTS, AND BUILDINGS FOR WORKSHOPS AND TRADE CENTRES; CAPITAL INVESTMENTS IN FIELDS OF TRADING, REAL ESTATE AND FINANCE; REAL ESTATE CONSULTANCY; MORTGAGE SERVICES OF PROPERTIES FOR REFINANCING AND/OR LENDING (U.S. CLS. 100, 101 AND 102).

CLASS 39—TRANSPORTATION AND STORAGE

FOR ARRANGING OF DOMESTIC AND INTERNATIONAL TOURS; TRANSPORT OF PASSENGERS BY TAXI; SERVICES OF TRANSPORT OF GOODS AND/OR BY MAN-POWERED VEHICLES; STORAGE OF GOODS; RENTAL OF WAREHOUSES, PARKING PLACE RENTAL; CAR RENTAL (U.S. CLS. 100 AND 105).
TINA MAI, EXAMINING ATTORNEY



SN 79-107,758. LE CONTESSE S.R.L., ITALY, FILED 12-14-2011.



OWNER OF INTERNATIONAL REGISTRATION 1103150 DATED 12-14-2011. EXPIRES 12-14-2021.

THE MARK CONSISTS OF THE STYLIZED WORDING "LE CONTESSE". BEHIND THE WORDING IS A STYLIZED DESIGN OF A BUILDING AND A DOTTED LINE. ABOVE THE WORDING IS A STYLIZED CROWN AND A DOTTED LINE.

THE ENGLISH TRANSLATION OF "LE CONTESSE" IN THE MARK IS "COUNTESSSES".

CLASS 32—LIGHT BEVERAGES

FOR BEERS; MINERAL AND AERATED WATERS AND OTHER NON-ALCOHOLIC DRINKS, NAMELY, FRUIT DRINKS AND FRUIT JUICES; SYRUPS FOR MAKING BEVERAGES AND OTHER PREPARATIONS FOR MAKING BEVERAGES, NAMELY, FRUIT DRINKS (U.S. CLS. 45, 46 AND 48).

CLASS 33—WINES AND SPIRITS

FOR ALCOHOLIC BEVERAGES EXCEPT BEERS (U.S. CLS. 47 AND 49).
COLLEEN DOMBROW, EXAMINING ATTORNEY

PRIORITY DATE OF 9-29-2011 IS CLAIMED.

OWNER OF INTERNATIONAL REGISTRATION 1103800 DATED 10-28-2011. EXPIRES 10-28-2021.

THE MARK CONSIST OF MADE UP BY A CIRCLE; INSIDE, ARE PLACED THREE FANCY CHARACTER LETTERS "M" "U" "P" OVERLAPPED BETWEEN THEM; BELOW, THERE IS THE WORD "MASHUP" WHERE THE LETTERS "U" AND "P" ARE WRITTEN IN FANCY CURSIVE CHARACTER.

CLASS 3—COSMETICS AND CLEANING PREPARATIONS

FOR SOAPS FOR PERSONAL USE; PERFUMERY, ESSENTIAL OILS, COSMETICS, HAIR LOTIONS; DENTIFRICES (U.S. CLS. 1, 4, 6, 50, 51 AND 52).

CLASS 6—METAL GOODS

FOR COMMON METALS AND THEIR ALLOYS; TRANSPORTABLE BUILDINGS OF METAL; NON-ELECTRIC CABLES AND WIRES OF COMMON METAL (U.S. CLS. 2, 12, 13, 14, 23, 25 AND 50).

CLASS 14—JEWELRY

FOR PRECIOUS METALS AND THEIR ALLOYS; GOODS IN PRECIOUS METALS OR COATED, NAMELY, BOXES, JEWEL CASES, KEY HOLDERS; JEWELLERY, PRECIOUS STONES; HOROLOGICAL AND CHRONOMETRIC INSTRUMENTS (U.S. CLS. 2, 27, 28 AND 50).

CLASS 16—PAPER GOODS AND PRINTED MATTER

FOR PAPER, PAPER TOWELS, TISSUE PAPER, BATHROOM TISSUE PAPER, FACIAL TISSUE PAPER, TOILET PAPER; WRITING PAPER AND PADS, WRITING TABLETS AND WRITING INSTRUMENTS; CARDBOARD; STATIONERY, STATIONERY BOXES, STATIONERY FOLDERS; PENS; PENCILS; PAINT BRUSHES; BOOKS, MAGAZINES, BROCHURES IN THE FIELD OF BEAUTY, COSMETOLOGY EDUCATION, FASHION, HAIRDRESSING, HAIRSTYLING, MAKEUP ARTISTRY; CALENDARS; PHOTOGRAPHS; DIARIES, RUBBER STAMPS; STICKERS; TEMPORARY TATTOOS (U.S. CLS. 2, 5, 22, 23, 29, 37, 38 AND 50).

CLASS 18—LEATHER GOODS

FOR LEATHER AND IMITATIONS OF LEATHER AND GOODS MADE OF THESE MATERIALS, NAMELY, BAGS, HANDBAGS, SHOULDER BAGS; PURSES, WALLET, LUGGAGE, POUCHES; ATTACHE CASES, RUCKSACKS, BACKPACKS; SHOPPING BAGS; SCHOOL BAGS; SLING BAGS FOR CARRYING INFANTS; BAGS FOR SPORT; BEACH BAGS; MUSIC CASES; TOOL BAGS SOLD EMPTY; CASES; SHOULDER BELTS; COLLARS FOR ANIMAL AND PETS; CLOTHING FOR PETS; CREDIT CARD CASES; DOCUMENT CASES; KEY CASES; EMPTY COSMETIC CASES; EMPTY TOILETRY CASES, TRUNKS; TRAVELLING BAGS, TRAVELLING SETS; VALISES; VANITY CASES SOLD EMPTY; SUIT-CASES; BRIEFCASES; ANIMAL SKINS; HIDES; BEACH PARASOLS; PARASOLS; UMBRELLAS, UMBRELLA COVERS, UMBRELLA HANDLES; FRAMES FOR UMBRELLA OR PARASOLS; HARNESS AND SADDLERY (U.S. CLS. 1, 2, 3, 22 AND 41).

CLASS 20—FURNITURE AND ARTICLES NOT OTHERWISE CLASSIFIED

FOR FURNITURE, MIRRORS, PICTURE FRAMES (U.S. CLS. 2, 13, 22, 25, 32 AND 50).

CLASS 35—ADVERTISING AND BUSINESS

FOR ADVERTISING, MARKETING, MARKET RESEARCH AND MARKET STUDIES, BUSINESS MANAGEMENT, RELATING TO THE SALE OF GOODS BELONGING TO CLASSES 3, 6, 14, 16, 18, 20 MADE IN ANY WAY (U.S. CLS. 100, 101 AND 102).

CLASS 41—EDUCATION AND ENTERTAINMENT

FOR PROVISION OF EDUCATIONAL COURSES ABOUT HAIRDRESSING, MAKE-UP AND BEAUTY; PUBLICATION OF BOOKS, MAGAZINES, JOURNALS ABOUT HAIRDRESSING AND MAKE-UP; EDUCATION, NAMELY, PROVIDING CLASSES, WORKSHOPS, SEMINARS ABOUT HAIRDRESSING, MAKE-UP AND BEAUTY; PROVIDING TRAINING IN THE FIELD OF HAIRDRESSING, MAKE-UP AND BEAUTY; ORGANIZATION OF EDUCATION AND ENTERTAINMENT COMPETITIONS; ORGANIZATION OF EXHIBITIONS FOR EDUCATION PURPOSES (U.S. CLS. 100, 101 AND 107).

CLASS 44—MEDICAL, BEAUTY AND AGRICULTURAL SERVICES

FOR HEALTH CARE, HAIR SALON SERVICES, BEAUTY SALON SERVICES; PROVISION OF HAIRDRESSING SALON SERVICES; PROVISION OF INFORMATION AND ADVISORY SERVICES IN THE BEAUTY AND HAIR FIELD (U.S. CLS. 100 AND 101).
CHRIS WELLS, EXAMINING ATTORNEY

SN 79-108,180. TOWER IPCO COMPANY LIMITED, IRELAND, FILED 10-17-2011.

ELETILE

THE MARK CONSISTS OF STANDARD CHARACTERS WITHOUT CLAIM TO ANY PARTICULAR FONT, STYLE, SIZE, OR COLOR.
PRIORITY DATE OF 6-2-2011 IS CLAIMED.
OWNER OF INTERNATIONAL REGISTRATION 1104333 DATED 10-17-2011, EXPIRES 10-17-2021.

CLASS 19—NON-METALLIC BUILDING MATERIALS

FOR FLOOR BOARDS OF NON-METALLIC MATERIALS; NON-METALLIC FLOOR BOARDS; PARQUET FLOOR BOARDS; FLOOR TILES, NOT OF METAL; NON-METALLIC FLOORING TILES (U.S. CLS. 1, 12, 33 AND 50).

CLASS 27—FLOOR COVERINGS

FOR VINYL FLOOR COVERINGS; VINYL FLOOR COVERINGS FOR FORMING A FLOOR (U.S. CLS. 19, 20, 37, 42 AND 50).
TAMARA FRAZIER, EXAMINING ATTORNEY

SN 79-108,287. BOI TRADING COMPANY LTD., UNITED KINGDOM, FILED 8-2-2011.



PRIORITY DATE OF 7-26-2011 IS CLAIMED.
OWNER OF INTERNATIONAL REGISTRATION 1104561 DATED 8-2-2011, EXPIRES 8-2-2021.
OWNER OF U.S. REG. NO. 3,935,347.
THE MARK CONSISTS OF A THREE PRONGED ARROW AND AN ENCIRCLED CROWN DESIGN, FOLLOWED BY THE WORD "CROSSHATCH" IN STYLIZED FORMAT, ABOVE THE WORDS "FORWARD THINKING".

CLASS 3—COSMETICS AND CLEANING PREPARATIONS

FOR NON-MEDICATED TOILETRIES; AFTERSHAVE; PERFUME; COSMETICS; ESSENTIAL OILS; SOAPS; SHAMPOOS; DENTIFRICES; HAIR LOTIONS (U.S. CLS. 1, 4, 6, 50, 51 AND 52).

CLASS 18—LEATHER GOODS

FOR LEATHER AND IMITATIONS OF LEATHER; ANIMAL SKINS, HIDES; HANDBAGS; TRUNKS AND TRAVELLING BAGS; UMBRELLAS, PARASOLS AND WALKING STICKS (U.S. CLS. 1, 2, 3, 22 AND 41).

CLASS 25—CLOTHING

FOR CLOTHING, NAMELY, T-SHIRTS, TOPS, SHIRTS, JUMPERS, SWEATSHIRTS, JACKETS, TROUSERS, JEANS, PANTS, SWEAT PANTS, TEXTILE BELTS AND UNDERWEAR; FOOTWEAR, NAMELY, SHOES; AND HEADGEAR, NAMELY, CAPS AND HATS (U.S. CLS. 22 AND 39).
KELLY TRUSILO, EXAMINING ATTORNEY

SN 79-108,489. SRA INSTRUMENTS, MARCY L'ETOILE, FRANCE, FILED 8-19-2011.

ARCHIMODE

THE MARK CONSISTS OF STANDARD CHARACTERS WITHOUT CLAIM TO ANY PARTICULAR FONT, STYLE, SIZE, OR COLOR.
PRIORITY DATE OF 4-6-2011 IS CLAIMED.
OWNER OF INTERNATIONAL REGISTRATION 1105089 DATED 8-19-2011, EXPIRES 8-19-2021.

CLASS 9—ELECTRICAL AND SCIENTIFIC APPARATUS

FOR LABORATORY CHROMATOGRAPHS; CHROMATOGRAPHY APPARATUS FOR LABORATORY USE; AUTOMATIC SAMPLING SYSTEMS, CONSISTING OF PUMPS, FILTERS, VALVES, HEATERS, VAPORIZERS, PRESSURE REDUCERS, FLOW METERS AND SAFETY VALVES FOR CHROMATOGRAPHY APPARATUS INTENDED FOR LABORATORY USE OR ON-LINE ANALYZERS AS WELL AS RELATED SOFTWARE AND INTERFACING HARDWARE FOR CONTROLLING AND MONITORING; PHYSICO-CHEMICAL ANALYSIS APPARATUS INTENDED FOR INDUSTRIAL OR RESEARCH PURPOSES, NOT INTENDED FOR MEDICAL PURPOSES; GAS TESTING INSTRUMENTS; ON-LINE ANALYSIS APPARATUS, NAMELY, CHROMATOGRAPHS, MASS SPECTROMETERS, COMPUTERS AND ASSOCIATED SOFTWARE; SOFTWARE FOR CHROMATOGRAPHY APPARATUS, CHROMATOGRAPHS AND PHYSICO-CHEMICAL ANALYSIS APPARATUS (U.S. CLS. 21, 23, 26, 36 AND 38).

CLASS 11—ENVIRONMENTAL CONTROL APPARATUS

FOR INDUSTRIAL CHROMATOGRAPHS; CHROMATOGRAPHY APPARATUS FOR INDUSTRIAL PURPOSES (U.S. CLS. 13, 21, 23, 31 AND 34).

ALAIN LAPTER, EXAMINING ATTORNEY

SN 79-108,509. VANESSA DESTAING, FRANCE, FILED 12-2-2011.

WHERE ELSE . . .

OWNER OF INTERNATIONAL REGISTRATION 1105125 DATED 12-2-2011, EXPIRES 12-2-2021.

THE MARK CONSISTS OF THE WORDING "WHERE ELSE" FOLLOWED BY AN ELLIPSIS.

CLASS 14—JEWELRY

FOR JEWELRY; JEWELRY PRODUCTS, NAMELY, HAIR JEWELRY IN THE NATURE OF JEWELRY FOR USE IN THE HAIR, NECKLACES, RINGS, BROACHES, ORNAMENTAL PINS; PRECIOUS METALS AND THEIR ALLOYS JEWELRY CASES; BOXES OF PRECIOUS METAL; WATCH BANDS; KEY RINGS TRINKETS AND FOBS OF PRECIOUS METAL; CASES OR PRESENTATION CASES FOR TIMEPIECES; MEDALS (U.S. CLS. 2, 27, 28 AND 50).

CLASS 18—LEATHER GOODS

FOR LEATHER AND IMITATIONS OF LEATHER; ANIMAL SKINS; TRUNKS AND SUITCASES; UMBRELLAS, PARASOLS AND WALKING STICKS; WHIPS, HARNESSSES AND SADDLERY; WALLETS; PURSES; HANDBAGS, BACKPACKS, WHEELED BAGS; BAGS FOR CAMPERS IN THE NATURE OF BACKPACKS, TRAVELING BAGS, BEACH BAGS, SCHOOL BAGS; UNFITTED VANITY CASES; ANIMAL COLLARS; COVERS FOR ANIMALS; SHOPPING NETS IN THE NATURE OF BAGS MADE OF A MESH NET FOR USE IN SHOPPING AND SHOPPING BAGS; BAGS IN THE NATURE OF LEATHER ENVELOPES AND LEATHER POUCHES FOR PACKAGING (U.S. CLS. 1, 2, 3, 22 AND 41).

CLASS 25—CLOTHING

FOR CLOTHING, FOOTWEAR, AND HEADGEAR, NAMELY, SHIRTS, LEATHER OR IMITATION LEATHER CLOTHING, BELTS, FURS, GLOVES, SCARVES, NECKTIES; HOSIERY, SOCKS, SLIPPERS, BEACH, SKI OR SPORTS FOOTWEAR; BABIES' DIAPERS OF TEXTILE, AND UNDERWEAR (U.S. CLS. 22 AND 39).

JENNIFER WILLISTON, EXAMINING ATTORNEY

SN 79-108,696. SFS INTEC HOLDING AG, CH-9435 HEERBRUGG, SWITZERLAND, FILED 12-20-2011.

SOL-F

THE MARK CONSISTS OF STANDARD CHARACTERS WITHOUT CLAIM TO ANY PARTICULAR FONT, STYLE, SIZE, OR COLOR.

PRIORITY DATE OF 7-7-2011 IS CLAIMED.

OWNER OF INTERNATIONAL REGISTRATION 1105549 DATED 12-20-2011, EXPIRES 12-20-2021.

CLASS 6—METAL GOODS

FOR METAL HARDWARE, NAMELY, SCREWS, RIVETS, BOLTS; ARTICLES OF SMALL IRONWARE, NAMELY, BOLTS, NAILS, RIVETS, SCREWS; METAL CONSTRUCTION MATERIALS FOR SOLAR PANELS, NAMELY, BRACES, SUPPORTS, AND CLADDING; METAL ROOF COVERING MATERIALS, NAMELY, FLASHING, PANELS, AND TILES INCORPORATING METAL FRAMES FOR SOLAR PANELS; RETAINING SYSTEMS COMPRISED OF METAL CABLE WIRES AND METAL CANTILEVERED BRACKETS FOR SOLAR PANELS; GROUND SUPPORTS OF METAL FOR SOLAR PANELS; STEEL RODS FOR USE WITH SOLAR PANELS (U.S. CLS. 2, 12, 13, 14, 23, 25 AND 50).

CLASS 19—NON-METALLIC BUILDING MATERIALS

FOR NON-METAL ROOF CLADDING AND ROOFING ELEMENTS WITH INTEGRATED PHOTOVOLTAIC ELEMENTS, NAMELY, NON-METAL ROOFING PANELS, TILES, AND ROOF COVERINGS; STRUCTURAL COMPONENT PARTS OF THE AFOREMENTIONED GOODS; ROOFING, NOT OF METAL, INCORPORATING SOLAR CELLS (U.S. CLS. 1, 12, 33 AND 50).

CLASS 20—FURNITURE AND ARTICLES NOT OTHERWISE CLASSIFIED

FOR NON-METAL FASTENERS, NAMELY, SCREWS, RIVETS, AND BOLTS (U.S. CLS. 2, 13, 22, 25, 32 AND 50).

CLASS 37—CONSTRUCTION AND REPAIR

FOR INSTALLATION OF SOLAR ENERGY INSTALLATIONS (U.S. CLS. 100, 103 AND 106).

ADA HAN, EXAMINING ATTORNEY

SN 79-108,826. LINGOONA GMBH, FED REP GERMANY, FILED 6-22-2011.

LINGOONA

THE MARK CONSISTS OF STANDARD CHARACTERS WITHOUT CLAIM TO ANY PARTICULAR FONT, STYLE, SIZE, OR COLOR.

PRIORITY DATE OF 12-22-2010 IS CLAIMED.

OWNER OF INTERNATIONAL REGISTRATION 1105853 DATED 6-22-2011, EXPIRES 6-22-2021.

CLASS 9—ELECTRICAL AND SCIENTIFIC APPARATUS

FOR DOWNLOADABLE SOUND RECORDINGS, IMAGES, AND VIDEO RECORDINGS IN THE FIELD OF TRANSLATION AND LINGUISTIC ADAPTATION OF COMPUTER AND VIDEO GAMES AND SOFTWARE TO REGIONAL CUSTOMS AND CONVENTIONS, BEING DOWNLOADABLE TO COMPUTERS AND MOBILE COMMUNICATIONS APPARATUS; DOWNLOADABLE MUSICAL SOUND RECORDINGS, BEING DOWNLOADABLE TO COMPUTERS AND MOBILE COMMUNICATIONS APPARATUS; DOWNLOADABLE COMPUTER GAME PROGRAMS, BEING DOWNLOADABLE TO COMPUTERS AND MOBILE COMMUNICATIONS APPARATUS; COMPUTER SOFTWARE FOR TRANSLATION AND LINGUISTIC ADAPTATION OF COMPUTER AND VIDEO GAMES AND SOFTWARE TO REGIONAL CUSTOMS AND CONVENTIONS; TRANSLATIONS AND LOCALIZATION SOFTWARE FOR TRANSLATION AND LINGUISTIC ADAPTATION OF COMPUTER AND VIDEO GAMES AND SOFTWARE TO REGIONAL CUSTOMS AND CONVENTIONS, INTERACTIVE SOFTWARE, NAMELY, COMPUTER GAME SOFTWARE AND SOFTWARE FOR TRANSLATION AND LINGUISTIC ADAPTATION OF COMPUTER AND VIDEO GAMES AND SOFTWARE TO REGIONAL CUSTOMS AND CONVENTIONS; DOWNLOADABLE IMAGE FILES IN THE FIELD OF TRANSLATION AND LINGUISTIC ADAPTATION OF COMPUTER AND VIDEO GAMES AND SOFTWARE TO REGIONAL CUSTOMS AND CONVENTIONS; GAMES PROGRAMS FOR COMPUTERS, NAMELY, COMPUTER GAME PROGRAMS (U.S. CLS. 21, 23, 26, 36 AND 38).

CLASS 38—COMMUNICATION

FOR PROVIDING A VIDEO SHARING PORTAL, NAMELY, ELECTRONIC TRANSMISSION OF DIGITAL VIDEO FILES AMONG INTERNET USERS; TRANSMITTING NEWS, DATA AND CONTENT VIA THE INTERNET AND OTHER COMPUTER AND COMMUNICATION NETWORKS; TRANSMITTING ELECTRONIC MEDIA, MULTIMEDIA CONTENT, VIDEOS, MOVIES, IMAGES, TEXT, PHOTOS, GAMES, USER-GENERATED CONTENT, AUDIO CONTENT AND INFORMATION VIA THE INTERNET AND OTHER COMPUTER AND COMMUNICATION NETWORKS; PROVIDING ACCESS TO INFORMATION ON THE INTERNET, NAMELY, PROVISION OF ACCESS TO ELECTRONIC SITES; PROVIDING ACCESS TO DATA FILES VIA THE INTERNET, NAMELY, PROVIDING ACCESS TO ELECTRONICALLY STORED DATA FILES RELATING TO TRANSLATION AND LOCALIZATION SOFTWARE, VIDEOS, GAMES, VOICE MESSAGES, MUSIC AND PUBLICATIONS; PROVIDING ACCESS TO DATABASES IN COMPUTER NETWORKS (U.S. CLS. 100, 101 AND 104).

CLASS 41—EDUCATION AND ENTERTAINMENT

FOR PROVIDING INFORMATION ONLINE RELATING TO COMPUTER GAMES AND COMPUTER ENHANCEMENTS FOR GAMES; PROVIDING INFORMATION ONLINE IN THE FIELD OF TRANSLATION AND LOCALIZATION SERVICES RELATED TO COMPUTER AND VIDEO GAMES AND SOFTWARE, NAMELY, PROVIDING INFORMATION RELATING TO TRANSLATION AND LINGUISTIC ADAPTATION OF COMPUTER AND VIDEO GAMES AND SOFTWARE TO REGIONAL CUSTOMS AND CONVENTIONS; TRANSLATION AND LOCALIZATION SERVICES, NAMELY, TRANSLATION AND LINGUISTIC ADAPTATION OF COMPUTER AND VIDEO GAMES AND SOFTWARE TO REGIONAL CUSTOMS AND CONVENTIONS; TRANSLATION SERVICES (U.S. CLS. 100, 101 AND 107).

CLASS 42—SCIENTIFIC AND COMPUTER SERVICES

FOR DESIGN AND DEVELOPMENT OF COMPUTER HARDWARE, SOFTWARE AND DATABASES, IN PARTICULAR, DESIGN, DEVELOPMENT, AND UPDATING OF COMPUTER SOFTWARE; PROVIDING ONLINE, NONDOWNLOADABLE TRANSLATION AND LOCALIZATION SOFTWARE ON DATA NETWORKS FOR TRANSLATION AND LINGUISTIC ADAPTATION OF COMPUTER AND VIDEO GAMES AND SOFTWARE TO REGIONAL CUSTOMS AND CONVENTIONS; DESIGN OF TRANSLATION AND LOCALIZATION COMPUTER PROGRAMS (U.S. CLS. 100 AND 101).

LINDA LAVACHE, EXAMINING ATTORNEY

SN 79-109,009. PERFORMANCE MARINE GMBH, FED REP GERMANY, FILED 12-20-2011.



OWNER OF INTERNATIONAL REGISTRATION 1106450 DATED 12-20-2011, EXPIRES 12-20-2021.

NO CLAIM IS MADE TO THE EXCLUSIVE RIGHT TO USE "PERFORMANCE", APART FROM THE MARK AS SHOWN.

THE MARK CONSISTS OF THE WORDING "PERFORMANCE" APPEARING INSIDE OF AN OVAL, WITH THE STYLIZED DESIGN OF A MOTORBOAT APPEARING BEHIND THE LITERAL ELEMENT AND THE OVAL.

CLASS 12—VEHICLES

FOR SPORT MOTORBOATS AND REPLACEMENT PARTS THEREFOR (U.S. CLS. 19, 21, 23, 31, 35 AND 44).

CLASS 25—CLOTHING

FOR CLOTHING AND HEADGEAR, NAMELY, BATHING SUITS, SWIM SUITS, JACKETS, VESTS, T-SHIRTS, POLO SHIRTS, JERSEYS, TROUSERS, HATS AND CAPS (U.S. CLS. 22 AND 39).

SEAN CROWLEY, EXAMINING ATTORNEY

SN 79-109,308. OSRAM AG, AKA OSRAM AKTIENGESELLSCHAFT, MÜNCHEN, FED REP GERMANY, FILED 10-24-2011.

HPML

THE MARK CONSISTS OF STANDARD CHARACTERS WITHOUT CLAIM TO ANY PARTICULAR FONT, STYLE, SIZE, OR COLOR.

PRIORITY DATE OF 6-10-2011 IS CLAIMED.

OWNER OF INTERNATIONAL REGISTRATION 1107251 DATED 10-24-2011, EXPIRES 10-24-2021.

THE WORDING "HPML" HAS NO MEANING IN A FOREIGN LANGUAGE.

CLASS 9—ELECTRICAL AND SCIENTIFIC APPARATUS

FOR LIGHT CONTROL SYSTEMS, NAMELY, TRANSISTOR CIRCUITS FOR REGULATING CURRENT APPLIED TO DRIVE LIGHT-EMITTING DIODES; LIGHT-EMITTING DIODES; ORGANIC LIGHT-EMITTING DIODES; LIGHT-EMITTING DIODE MODULES, NAMELY, MODULES FOR EMITTING LIGHT, CONSTRUCTED FROM LIGHT-EMITTING DIODES; AND COMPONENT PARTS OF ALL THE AFORESAID GOODS (U.S. CLS. 21, 23, 26, 36 AND 38).

CLASS 11—ENVIRONMENTAL CONTROL APPARATUS

FOR APPARATUS FOR LIGHTING, NAMELY, ELECTRIC LAMPS AND LUMINAIRES; LUMINAIRES, USING LIGHT-EMITTING DIODES AS A LIGHT SOURCE, FOR STREET OR ROADWAY LIGHTING; LIGHTING APPARATUS AND SYSTEMS CONSTRUCTED FROM LIGHT-EMITTING DIODES (LEDS); LED LAMPS AND LED LUMINAIRES; AND COMPONENT PARTS OF ALL THE AFORESAID GOODS (U.S. CLS. 13, 21, 23, 31 AND 34).

KEVIN CORWIN, EXAMINING ATTORNEY

SN 79-109,474. JIANGMEN CITY RIYING STAINLESS; STEEL MATERIALS MANUFACTORY LIMITED, CHINA, FILED 12-8-2011.



OWNER OF INTERNATIONAL REGISTRATION 1107645 DATED 12-8-2011, EXPIRES 12-8-2021.

THE MARK CONSISTS OF THE STYLIZED BLOCK WORDING "M.P.T." APPEARING TO THE RIGHT OF A DESIGN COMPRISED OF A CENTRAL SPHERE DESIGN LARGELY ENCIRCLED BY THREE ROUGHLY TRIANGULAR SHAPES, WITH EACH HAVING TWO SLIGHTLY CURVED SIDES.

CLASS 7—MACHINERY

FOR TEA PROCESSING MACHINERY, NAMELY, CUTTING MACHINES, HARVEST DRYING MACHINES; PAPERMAKING MACHINES; LOCAL SPECIALTIES AND SUNDRY GOODS PROCESSING MACHINES, NAMELY, PACKAGING MACHINES, FILLING MACHINES; AERATED BEVERAGES MAKING MACHINES; BICYCLE ASSEMBLING MACHINES; WASHING MACHINES, NAMELY, CLOTHES WASHING MACHINES, DISH WASHING MACHINES, FLOOR WASHING MACHINES; PHARMACY PROCESSING MACHINES, NAMELY, MACHINES USED FOR PROCESS FILTRATION IN THE PHARMACEUTICAL INDUSTRY; ELEVATORS BEING LIFTS; GLASS CUTTING MACHINE; ROLLING MILLS (U.S. CLS. 13, 19, 21, 23, 31, 34 AND 35).

CLASS 8—HAND TOOLS

FOR KNIFE STEELS, NAMELY, KNIFE SHARPENERS; OYSTER OPENERS; APPLIANCES AND INSTRUMENTS FOR SLAUGHTERING BUTCHERS' ANIMALS, NAMELY, BUTCHER KNIVES, SLEDGE-HAMMERS; ELECTRIC AND NON-ELECTRIC RAZORS; HARPOONS FOR COMMERCIAL FISHING; HAND TOOLS AND INSTRUMENTS FOR WATCH MAKING, NAMELY, HAND TOOLS IN THE NATURE OF PRECISION SCREWDRIVERS, PLIERS, HAMMERS; THREE-JAW BEARING PULLER HAND TOOLS; DRILL TOOLS, NAMELY, MANUAL DRILLS; SIDE ARMS, OTHER THAN FIREARMS, NAMELY, SWORDS, HUNTING KNIVES; TABLE CUTLERY, NAMELY, KNIVES, FORKS AND SPOONS (U.S. CLS. 23, 28 AND 44).

CLASS 11—ENVIRONMENTAL CONTROL APPARATUS

FOR THEATRICAL AND FILM LIGHTING APPARATUS, NAMELY, STAGE LAMPS AND LANTERNS FOR LIGHTING; LIGHTS FOR VEHICLES; BAKERS' OVENS; REFRIGERATORS; HAIR DRYERS; ELECTRIC HEATING APPARATUS, NAMELY, ELECTRIC SPACE HEATERS, ELECTRIC RADIANT HEATERS FOR HOUSEHOLD PURPOSES; HOT WATER HEATING INSTALLATIONS, NAMELY, HOT WATER HEATERS; BATH INSTALLATIONS, NAMELY, SINKS INTEGRATED INTO COUNTERTOPS OR COUNTERTOPS, TOILETS, SHOWER ENCLOSURES; WATER PURIFYING APPARATUS AND MACHINES; RADIATORS, ELECTRIC (U.S. CLS. 13, 21, 23, 31 AND 34).

CLASS 20—FURNITURE AND ARTICLES NOT OTHERWISE CLASSIFIED

FOR TABLES, NAMELY, PLOT TABLES; TABLES OF METAL; KNIFE HANDLES NOT OF METAL; DISPLAY BOARDS; MOBILE BOARDING STAIRS, NOT OF METAL, FOR PASSENGERS; REELS, NOT OF METAL, NON-MECHANICAL, FOR FLEXIBLE HOSES, NAMELY, HAND-OPERATED NON-METAL GARDEN HOSE REELS; NON-METAL VALVES FOR CONTAINERS, NAMELY, NON-METAL BALL VALVES; INFLATABLE PUBLICITY OBJECTS; PILLOWS, NAMELY, MAGNETIC PILLOWS (U.S. CLS. 2, 13, 22, 25, 32 AND 50).

CLASS 21—HOUSEWARES AND GLASS

FOR KITCHEN UTENSILS, NAMELY, KITCHEN TONGS, SPLATTER SCREENS, POURING AND STRAINING SPOUTS; CRYSTAL HANDICRAFT, NAMELY, DECORATIVE CRYSTAL PRISMS, DESKTOP STATUARY MADE OF CRYSTAL, ORNAMENTS OF CRYSTAL; GLASSWARE OF CRYSTAL, NAMELY, BEVERAGE GLASSWARE; BRUSHES, NAMELY, BATH BRUSHES, CLOTHES BRUSHES, CLEANING BRUSHES FOR HOUSEHOLD USE; TOOTHBRUSHES, ELECTRIC; COSMETIC UTENSILS, NAMELY, COSMETIC BRUSHES, DROPPERS SOLD EMPTY FOR COSMETIC PURPOSES; COSMETIC SPATULAS FOR USE WITH DEPILATORY PREPARATIONS; INDOOR AQUARIA; VIVARIUMS BEING INDOOR TERRARIUMS; DRINKING TROUGHS; COSMETIC BRUSHES, NAMELY, CHEEK BRUSHES (U.S. CLS. 2, 13, 23, 29, 30, 33, 40 AND 50).

KEVIN CORWIN, EXAMINING ATTORNEY

SN 79-109,578. OLYMPUS EUROPA HOLDING GMBH, FED REP GERMANY, FILED 11-18-2011.



PRIORITY DATE OF 5-21-2011 IS CLAIMED.

OWNER OF INTERNATIONAL REGISTRATION 1107890 DATED 11-18-2011, EXPIRES 11-18-2021.

THE COLOR(S) YELLOW AND BLUE IS/ARE CLAIMED AS A FEATURE OF THE MARK.

THE MARK CONSISTS OF A YELLOW ARROW AND A BLUE ARROW. THE TIP OF THE YELLOW ARROW OVERLAPS THE TIP OF THE BLUE ARROW.

CLASS 16—PAPER GOODS AND PRINTED MATTER

FOR PRINTED MATTER, IN PARTICULAR, JOURNALS, MAGAZINES, PERIODICALS, PAMPHLETS, BROCHURES, PRINTED EDUCATIONAL MATERIALS, LEAFLETS, POSTERS, AND PLACARDS MADE OF PAPER OR CARDBOARD; PRINTED VISUALS IN THE NATURE OF PROMOTIONAL MATERIALS; PRINTED INSTRUCTIONAL AND TEACHING MATERIALS; ALL THE AFORESAID GOODS EXCLUSIVELY CONCERNING MEDICAL TOPICS (U.S. CLS. 2, 5, 22, 23, 29, 37, 38 AND 50).

CLASS 41—EDUCATION AND ENTERTAINMENT

FOR EDUCATIONAL SERVICES, NAMELY, CLASSES AND SEMINARS IN THE MEDICAL FIELD; MEDICAL TRAINING; ORGANIZATION AND CONDUCT OF SEMINARS, CONFERENCES, SYMPOSIA, WORKSHOPS AND TRAINING SESSIONS IN THE MEDICAL FIELD; PUBLICATION OF BOOKS AND MAGAZINES EXCLUSIVELY IN THE MEDICAL FIELD; ONLINE PUBLICATION OF ELECTRONIC BROCHURES AND MAGAZINES EXCLUSIVELY IN THE MEDICAL FIELD; CUSTOMER TRAINING, PARTICULARLY IN THE AREA OF APPLICATION AND USE OF MEDICAL DEVICES; WRITING OF TEXTS OTHER THAN ADVERTISING TEXTS, INFORMATION DOCUMENTS, NON-TECHNICAL DOCUMENTS, WRITTEN TRAINING MATERIALS, SCRIPTS AND INSTRUCTIONS, AND VIDEO PRODUCTION SERVICES, ALL THE AFORESAID SERVICES EXCLUSIVELY IN THE MEDICAL FIELD; WRITTEN TEXT EDITING IN PREPARATION OF PUBLICATION, NAMELY, EDITING MANUALS, OPERATING INSTRUCTIONS AND TECHNICAL DOCUMENTS, IN PARTICULAR, EDITING OF MANUALS AND OPERATION INSTRUCTIONS FOR MEDICAL APPARATUS AND INSTRUMENTS, MEDICAL IMAGING DEVICES AND DIAGNOSTIC DEVICES (U.S. CLS. 100, 101 AND 107).

BARBARA GAYNOR, EXAMINING ATTORNEY

SN 79-109,904. SALVATORE SANTORO, ITALY, FILED 12-15-2011.

b-used



OWNER OF INTERNATIONAL REGISTRATION 1108722 DATED 12-15-2011, EXPIRES 12-15-2021.

THE MARK CONSISTS OF SIX ASTERISKS TRAVERSED BY A THIN LINE AT A SLIGHT INCLINATION WITH THE NAME "B-USED" ABOVE, FORMED FROM THE LETTER "B" IN LOWER-CASE AND THE WORD "USED" IN LOWER-CASE.

CLASS 14—JEWELRY

FOR BANGLE BRACELETS, JEWELRY CASES OF PRECIOUS METAL (U.S. CLS. 2, 27, 28 AND 50).

CLASS 18—LEATHER GOODS

FOR LEATHER BAGS, SUITCASES AND WALLETS (U.S. CLS. 1, 2, 3, 22 AND 41).

CLASS 25—CLOTHING

FOR BOMBER JACKETS, LEATHER JACKETS, FUR COATS AND JACKETS (U.S. CLS. 22 AND 39).

BERNICE MIDDLETON, EXAMINING ATTORNEY

SN 79-110,018. OBSHCHESTVO S OGRANICHENNOY OTVETSTVENNOST'YU; "KORPORATSIYA "SIBIRSKOE ZDOROVIE", RUSSIAN FED., FILED 11-11-2011.



OWNER OF INTERNATIONAL REGISTRATION 1109137 DATED 11-11-2011, EXPIRES 11-11-2021.

OWNER OF U.S. REG. NO. 4,107,393.

THE COLOR(S) BLUE, GREEN, LIGHT BLUE AND DARK YELLOW IS/ARE CLAIMED AS A FEATURE OF THE MARK.

THE MARK CONSISTS OF AN APPLE TREE DESIGN WITHIN A SQUARE WITH ROUNDED CORNERS IN DARK BLUE. THE TREE AND APPLES APPEAR IN DARK YELLOW OUTLINED IN BLUE, BELOW THE TREE LINE IS GREEN AND THE LIGHT BLUE SKY SHOWS THROUGH THE BRANCHES.

CLASS 3—COSMETICS AND CLEANING PREPARATIONS

FOR AFTER-SHAVE LOTIONS; ANTIPERSPIRANTS; AROMATICS ESSENTIAL OILS; BATH SALTS, NOT FOR MEDICAL PURPOSES; BEAUTY MASKS; BREATH FRESHENING SPRAYS; CLEANSING MILK FOR TOILET PURPOSES; COSMETICS; COSMETIC CREAMS; COSMETIC HAIR DYES; COSMETIC MAKE UP KITS COMPRISED OF LIPSTICK, LIP GLOSS, MASCARA; COSMETIC PENCILS; COSMETIC PREPARATIONS FOR BATHS; COSMETIC PREPARATIONS FOR EYELASHES; COTTON STICKS FOR COSMETIC PURPOSES; PREPARATIONS FOR SLIMMING PURPOSES; COSMETIC PREPARATIONS FOR SKIN CARE; COTTON WOOL FOR COSMETIC PURPOSES; DENTAL BLEACHING GELS; DENTIFRICES; DEPILOYATORY PREPARATIONS; DEODORANTS FOR PERSONAL USE; EAU DE COLOGNE; EYEBROW COSMETICS; HAIR DYES; HAIR LOTIONS; HAIR SPRAY; HAIR WAVING PREPARATIONS; LOTIONS FOR COSMETIC PURPOSES; MAKE-UP POWDER; MAKE-UP REMOVING PREPARATIONS; MASCARA; MOUTH WASHES, NOT FOR MEDICAL PURPOSES; NAIL CARE PREPARATIONS; NAIL POLISH; OILS FOR COSMETIC PURPOSES; PERFUMERY; PERFUMES; POMADES FOR COSMETIC PURPOSES; POTPOURRI; AROMATIC POTPOURRI, SHAMPOOS; SHAVING PREPARATIONS; SOAP; TISSUES IMPREGNATED WITH COSMETIC LOTIONS; NON-MEDICAL TOILETRIES; TOILET WATER (U.S. CLS. 1, 4, 6, 50, 51 AND 52).

CLASS 5—PHARMACEUTICALS

FOR ADJUVANTS FOR MEDICAL PURPOSES; ALBUMINOUS FOODSTUFFS FOR MEDICAL PURPOSES; ALBUMINOUS PREPARATIONS FOR MEDICAL PURPOSES; BALMS FOR MEDICAL PURPOSES; BARK FOR PHARMACEUTICAL PURPOSES; BATH PREPARATIONS, MEDICATED; BATH SALTS FOR MEDICAL PURPOSES; BIOLOGICAL PREPARATIONS FOR MEDICAL PURPOSES, NAMELY, BIOACTIVE FOOD ADDITIVES; CANDY, MEDICATED; DENTAL LACQUER; DENTAL MASTICS; DIETETIC BEVERAGES ADAPTED FOR MEDICAL PURPOSES; DIETETIC FOODS ADAPTED FOR MEDICAL PURPOSES; DIETETIC SUBSTANCES ADAPTED FOR MEDICAL USE, NAMELY, BIOACTIVE FOOD ADDITIVES; DIGESTIVES FOR PHARMACEUTICAL PURPOSES; NON-NUTRITIVE EDIBLE DIETARY PLANT FIBERS TO AID NUTRITION; ENZYMES FOR MEDICAL PURPOSES; FOOD FOR BABIES; HERBS TEAS FOR MEDICINAL PURPOSES; LINIMENTS; ANTIBACTERIAL LOTIONS FOR PHARMACEUTICAL PURPOSES; MEDICINAL DRINKS; MEDICINAL HAIR GROWTH PREPARATIONS; MEDICINAL HERBS; HERBAL MUD PACKS FOR MEDICINAL PURPOSES; MEDICINAL OILS; MEDICINAL ROOTS; MINERAL FOOD-SUPPLEMENTS; MINERAL ENHANCED WATER FOR MEDICAL PURPOSES; MOUTHWASHES FOR MEDICAL PURPOSES; NUTRITIONAL ADDITIVES FOR MEDICAL PURPOSES USED IN FOODS AND DIETARY SUBSTANCES; SEA WATER FOR MEDICINAL BATHING; SANITARY TOWELS; VITAMIN PREPARATIONS (U.S. CLS. 6, 18, 44, 46, 51 AND 52).

CLASS 16—PAPER GOODS AND PRINTED MATTER

FOR PHOTO ALBUMS; ALMANACS; BAGS, NAMELY, ENVELOPES AND POUCHES OF PAPER OR PLASTICS, FOR PACKAGING; BOOKLETS AND BOOKS IN THE FIELD OF HEALTH CARE; CALENDARS; CATALOGUES IN THE FIELD OF HEALTH CARE; STATIONERY ENVELOPES; FORMS, PRINTED; GRAPHIC PRINTS; GREETING CARDS; PAPER; PRINTED PERIODICALS IN THE FIELD OF HEALTH CARE; POSTCARDS; POSTERS; PRINTED BUSINESS PROSPECTUSES; LABELS, NOT OF TEXTILE; NEWSLETTERS IN THE FIELD OF HEALTH CARE; NEWSPAPERS IN THE FIELD OF HEALTH CARE; BLANK NOTE BOOKS; SIGNBOARDS OF PAPER OR CARDBOARD; STATIONERY; STATIONERY STICKERS; PRINTED TEACHING MATERIALS IN THE FIELD OF HEALTH CARE; DESK SETS FOR WRITING; WRITING INSTRUMENTS (U.S. CLS. 2, 5, 22, 23, 29, 37, 38 AND 50).

CLASS 30—STAPLE FOODS

FOR BAKING POWDER; BREAD; BREAD ROLLS; BUNS; CEREAL-BASED SNACK FOOD; CEREAL PREPARATIONS, NAMELY, ENERGY BARS; CHEWING GUM, NOT FOR MEDICAL PURPOSES; CEREAL PRODUCTS, NAMELY, CONFECTIONERY CHIPS FOR BAKING; CHOCOLATE; CHOCOLATE-BASED BEVERAGES; CHOCOLATE BASED BEVERAGES WITH MILK; COCOA; COCOA-BASED BEVERAGES; COCOA BEVERAGES WITH MILK; COCOA BASED INGREDIENTS IN CONFECTIONERY PRODUCTS; COFFEE; COFFEE-BASED BEVERAGES; COFFEE BEVERAGES WITH MILK; CONDIMENTS, NAMELY, PEPPER SAUCE; CONFECTIONERY MADE OF SUGAR; COOKING SALT; CRACKERS; EDIBLE ICES; FARINACEOUS FOOD PASTES FOR HUMAN CONSUMPTION; FLOUR FOR FOOD; FLOUR-MILLING PRODUCTS, NAMELY, FLOUR BASED CHIPS; FRUIT JELLY CANDY; GARDEN HERBS, PRESERVED; GINGERBREAD; GRUEL, WITH A MILK BASE, NAMELY, PORRIDGE FOR FOOD; HONEY; ICE CREAM; MACARONI; MALT FOR HUMAN CONSUMPTION, NAMELY, FOOD PURPOSES; MUESLI; OAT-BASED FOOD, NAMELY, OAT FLAKES; PANCAKES; PASTRIES; PIZZAS; POPCORN; PROPOLIS FOR HUMAN CONSUMPTION; PUDDINGS; RAVIOLI; RICE-BASED SNACK FOOD; RUSKS; SANDWICHES; SEASONINGS; SPICES; STARCH FOR USE IN MANUFACTURING FOOD; SUGAR; SUSHI; SWEETMEATS; TARTS; TEA; TEA-BASED BEVERAGES; THICKENING AGENTS FOR COOKING FOODSTUFFS; VINEGAR; YEAST (U.S. CL. 46).

CLASS 32—LIGHT BEVERAGES

FOR APERITIFS, NON-ALCOHOLIC; BEER; COCKTAILS, NON-ALCOHOLIC; ESSENCES FOR MAKING BEVERAGES; FRUIT JUICES; FRUIT NECTARS, NON-ALCOHOLIC; ISOTONIC BEVERAGES; KVASS; NON-ALCOHOLIC BEVERAGES WITH TEA FLAVOR; NON-ALCOHOLIC FRUIT EXTRACTS USED IN THE PREPARATION OF BEVERAGES; SYRUPS FOR BEVERAGES; VEGETABLE JUICES; WATERS BEVERAGES (U.S. CLS. 45, 46 AND 48).

JASON TURNER, EXAMINING ATTORNEY

SN 79-110,442. INDENA SPA, ITALY, FILED 12-29-2011.

CASPEROME

THE MARK CONSISTS OF STANDARD CHARACTERS WITHOUT CLAIM TO ANY PARTICULAR FONT, STYLE, SIZE, OR COLOR.

PRIORITY DATE OF 11-8-2011 IS CLAIMED.

OWNER OF INTERNATIONAL REGISTRATION 1110144 DATED 12-29-2011, EXPIRES 12-29-2021.

CLASS 1—CHEMICALS

FOR CHEMICALS MADE FROM BOTANICAL EXTRACTS FOR USE IN THE PREPARATION OF PHARMACEUTICAL AND COSMETIC PRODUCTS, NUTRACEUTICALS AND FOODSTUFFS, WITH THE EXCEPTION OF PRODUCTS INTENDED FOR USE IN THE FLAVOR INDUSTRY (U.S. CLS. 1, 5, 6, 10, 26 AND 46).

CLASS 3—COSMETICS AND CLEANING PREPARATIONS

FOR BOTANICAL EXTRACTS, ESSENTIAL OILS EXCLUDED, FOR THE PREPARATION OF COSMETICS, NAMELY, FACE CREAMS, GELS, OINTMENTS, PRE-SUN BATH PRODUCTS, AFTER-SUN BATH PRODUCTS AND LIPSTICKS (U.S. CLS. 1, 4, 6, 50, 51 AND 52).

CLASS 5—PHARMACEUTICALS

FOR MEDICINAL PLANTS EXTRACTS FOR PHARMACEUTICAL USE, NAMELY, FOR THE TREATMENT OF INFLAMMATION, FOR THE TREATMENT OF IMMUNE SYSTEM DISEASES, RESPIRATORY SYSTEM DISEASES, CENTRAL NERVOUS SYSTEM DISEASES AND FOR THE TREATMENT OF SKIN DISEASES; MEDICINAL PLANT EXTRACTS FOR USE AS NUTRITIONAL SUPPLEMENTS (U.S. CLS. 6, 18, 44, 46, 51 AND 52).

CLASS 29—MEATS AND PROCESSED FOODS

FOR PLANT EXTRACTS, NAMELY, EXTRACTS FROM BOSWELLIA SERRATA, FOR USE AS FOOD (U.S. CL. 46).

JORDAN BAKER, EXAMINING ATTORNEY

SN 79-110,616. BUILMATEL CO., LTD., JAPAN, FILED 1-19-2012.

YUKIZNA

THE MARK CONSISTS OF STANDARD CHARACTERS WITHOUT CLAIM TO ANY PARTICULAR FONT, STYLE, SIZE, OR COLOR.

PRIORITY DATE OF 7-21-2011 IS CLAIMED.

OWNER OF INTERNATIONAL REGISTRATION 1110536
DATED 1-19-2012, EXPIRES 1-19-2022.

SN 79-112,231. CRIS CONF. S.P.A., ITALY, FILED 11-8-2011.

CLASS 18—LEATHER GOODS

FOR TANNED LEATHER; FOLDING BRIEFCASES; SHOULDER BAGS; GLADSTONE BAGS; BRIEFCASES; SUITCASES; CARRY-ON BAGS; TRAVELLING TRUNKS; HANDBAGS; BOSTON BAGS; TOTE BAGS; RUCKSACKS; PURSES; KEY CASES; POCKET WALLETS; BUSINESS CARD CASES (U.S. CLS. 1, 2, 3, 22 AND 41).

CLASS 25—CLOTHING

FOR JACKETS CLOTHING; SKIRTS AND DRESSES; OVERCOATS; TOPCOATS; CAPS HEADWEAR; HATS; BELTS CLOTHING; LEATHER SHOES; SANDAL SHOES; BEACH SHOES; LADIES' BOOTS (U.S. CLS. 22 AND 39).
PATRICIA EVANKO, EXAMINING ATTORNEY



PRIORITY DATE OF 6-30-2011 IS CLAIMED.
OWNER OF INTERNATIONAL REGISTRATION 1114184
DATED 11-8-2011, EXPIRES 11-8-2021.

THE MARK CONSISTS OF A SIGN DEPICTING THE WORDING UNIQUENESS IN FANCY CHARACTERS UNDERLINED CENTRALLY BY A STYLIZED HORIZONTAL BAND, ABOVE ALL OF WHICH ARE TWO U LETTERS PLACED VERTICALLY, REVERSED ONE WITH THE OTHER TO INTERSECT IN THE CURVED PARTS.

SN 79-111,327. SPIKY SNAIL LTD., ISRAEL, FILED 2-7-2012.

CLASS 18—LEATHER GOODS

FOR HANDBAGS; SHOULDER BAGS; CLUTCH BAGS (U.S. CLS. 1, 2, 3, 22 AND 41).

CLASS 25—CLOTHING

FOR DRESSING GOWNS; PULLOVERS; GLOVES BEING CLOTHING; CARDIGANS; JERSEYS BEING CLOTHING; FOULARDS BEING CLOTHING; SCARVES; MUFFS BEING CLOTHING; SWEATERS; TWIN SETS; TROUSERS; LEGGINGS; SKIRTS; JACKETS BEING CLOTHING; JERKINS; SHIRTS; DRESS SHIRTS; POLO SHIRTS; UNDERSHIRTS; VESTS; WAISTCOATS; JUMPERS; BLOUSES; JEANS; BERMUDA SHORTS; T-SHIRTS; SHAWLS; SUITS; DRESSES; CLOAKS; OVERCOATS; ANORAKS; COATS; BELTS BEING CLOTHING; SHOES; BOOTS; SANDALS; SNEAKERS; HATS; CAPS (U.S. CLS. 22 AND 39).

SETH A. RAPPAPORT, EXAMINING ATTORNEY

THE SPLATTERS

THE MARK CONSISTS OF STANDARD CHARACTERS WITHOUT CLAIM TO ANY PARTICULAR FONT, STYLE, SIZE, OR COLOR.

PRIORITY DATE OF 8-10-2011 IS CLAIMED.
OWNER OF INTERNATIONAL REGISTRATION 1112045
DATED 2-7-2012, EXPIRES 2-7-2022.

CLASS 9—ELECTRICAL AND SCIENTIFIC APPARATUS

FOR COMPUTER GAME SOFTWARE; VIDEO GAME PROGRAMS; DOWNLOADABLE COMPUTER GAME PROGRAMS; INTERACTIVE COMPUTER GAME PROGRAMS; DOWNLOADABLE GAME SOFTWARE FOR WIRELESS DEVICES; DOWNLOADABLE GAME SOFTWARE FOR CELLULAR TELEPHONES (U.S. CLS. 21, 23, 26, 36 AND 38).

CLASS 41—EDUCATION AND ENTERTAINMENT

FOR ENTERTAINMENT SERVICES, NAMELY, PROVIDING ON-LINE COMPUTER GAMES, ON-LINE GAME SERVICES, PROVISION OF ON-LINE INFORMATION IN THE FIELD OF COMPUTER GAMES; GAME SERVICES PROVIDED ON-LINE FROM A COMPUTER NETWORK OR MOBILE PHONE NETWORK (U.S. CLS. 100, 101 AND 107).

JASON BLAIR, EXAMINING ATTORNEY

SN 79-112,364. SEOUL SEMICONDUCTOR CO., LTD, REPUBLIC OF KOREA, FILED 12-16-2011.

UVRICH

THE MARK CONSISTS OF STANDARD CHARACTERS WITHOUT CLAIM TO ANY PARTICULAR FONT, STYLE, SIZE, OR COLOR.

PRIORITY DATE OF 9-30-2011 IS CLAIMED.
OWNER OF INTERNATIONAL REGISTRATION 1114583
DATED 12-16-2011, EXPIRES 12-16-2021.

CLASS 9—ELECTRICAL AND SCIENTIFIC APPARATUS

FOR DIODES; LIGHT EMITTING DIODES; TOP LIGHT EMITTING DIODES; POWER LIGHT EMITTING DIODES; CHIP LIGHT EMITTING DIODES; BIG TOP LIGHT EMITTING DIODES; HIGH FLUX LIGHT EMITTING DIODES; SIDE VIEW LIGHT EMITTING DIODES; ELECTROLUMINESCENCE DIODES; LASER DIODES; TRAFFIC SIGNAL DEVICES LUMINOUS OR MECHANICAL; TRAFFIC SIGNALING PANELS LUMINOUS OR MECHANICAL; ROAD SIGNS LUMINOUS OR MECHANICAL; SAFETY SIGNALING PANELS LUMINOUS OR MECHANICAL; SAFETY DISPLAY PANELS LUMINOUS OR MECHANICAL; SIGNALING PANELS LUMINOUS OR MECHANICAL; LUMINOUS SIGNS; LUMINOUS BEACONS; VEHICLE BREAKDOWN WARNING TRIANGLES LUMINOUS; INCUBATORS FOR BACTERIA CULTURE; CONSTANT-TEMPERATURE INCUBATORS FOR BACTERIA CULTURES; LIGHT EMITTING DIODE DISPLAYS (U.S. CLS. 21, 23, 26, 36 AND 38).

SN 85-019,024. BIG PICTURE GROUP USA, LLC, PICKERINGTON, OH. FILED 4-21-2010.



THE MARK CONSISTS OF THE WORD "SYNERGY" WITH A LINE BELOW CONNECTING THE 2 "Y" S IN THE WORD AND THE WORDS "SUBLIMATION IS SYNERGY" BELOW.

CLASS 9—ELECTRICAL AND SCIENTIFIC APPARATUS

FOR DIGITAL PRINTING SOFTWARE (U.S. CLS. 21, 23, 26, 36 AND 38).

CLASS 16—PAPER GOODS AND PRINTED MATTER

FOR DIGITAL PRINTING PAPER (U.S. CLS. 2, 5, 22, 23, 29, 37, 38 AND 50).

RAMONA ORTIGA, EXAMINING ATTORNEY

CLASS 11—ENVIRONMENTAL CONTROL APPARATUS

FOR LIGHTS FOR SHIPS; LAMPS FOR DIRECTIONAL SIGNALS OF SHIPS; LIGHT BULBS FOR DIRECTIONAL SIGNALS FOR SHIPS; HEADLIGHTS FOR SHIPS; LIGHTS FOR AIRCRAFTS; LAMPS FOR DIRECTIONAL SIGNALS OF AIRCRAFTS; LIGHT BULBS FOR DIRECTIONAL SIGNALS OF AIRCRAFTS; HEADLIGHTS FOR AIRCRAFTS; LIGHTS FOR RAILWAY VEHICLES; LAMPS FOR DIRECTIONAL SIGNALS OF RAILWAY VEHICLES; HEADLIGHTS FOR RAILWAY VEHICLES; CYCLE LIGHTS; AUTOMOBILE LIGHTS; LAMPS FOR DIRECTIONAL SIGNALS OF AUTOMOBILES; LIGHT BULBS FOR DIRECTIONAL SIGNALS OF AUTOMOBILES; HEADLIGHTS FOR AUTOMOBILES; BICYCLE LIGHTS; AIR PURIFYING APPARATUS AND MACHINES; AIR DEODORIZING APPARATUS, NAMELY, ELECTRIC ROOM DEODORIZING UNITS; WATER STERILIZERS; STREET LAMPS; GERMICIDAL LAMPS FOR PURIFYING AIR; ULTRAVIOLET RAY LAMPS FOR NON-MEDICAL PURPOSES; GERMICIDAL LAMPS NOT FOR MEDICAL PURPOSES; SPOTLIGHTS; DECORATIVE ELECTRIC LIGHTS, NAMELY, FAIRY LIGHTS; ELECTRIC TORCHES FOR LIGHTING; FAIRY LIGHTS FOR FESTIVE DECORATION; ELECTRIC LIGHTS FOR CHRISTMAS TREES; STANDARD LAMPS; ARTIFICIAL SOLAR LAMPS; FLUORESCENT LAMPS; WATER PURIFIERS FOR HOUSEHOLD PURPOSES; HUMIDIFIERS; ELECTRIC REFRIGERATORS; ELECTRIC KETTLES; LIGHT EMITTING DIODE LAMPS; DISH DISINFECTANT APPARATUS FOR HOUSEHOLD PURPOSES; FLASHLIGHTS; LIGHT EMITTING DIODES LIGHTING FIXTURES; LIGHT EMITTING DIODES LIGHTING FIXTURES FOR USE IN DISPLAY, COMMERCIAL, INDUSTRIAL, RESIDENTIAL, AND ARCHITECTURAL ACCENT LIGHTING APPLICATIONS; CRANK-POWERED PORTABLE LAMPS; LIGHT EMITTING DIODES LAMPS WHOSE LIGHT CAN BE TURNED IN ALL DIRECTIONS; LAMPS; OVERHEAD LAMPS; PROJECTOR LAMPS; SAFETY LAMPS FOR UNDERGROUND USE; SOLDERING LAMPS; SUN LAMPS NOT FOR MEDICAL PURPOSE; TANNING LAMPS; VEHICLE DYNAMO LAMPS; OUTDOOR LAMPS; FLASHLIGHTS WITH LIGHT EMITTING DIODES FOR USE IN PHOTOGRAPHY (U.S. CLS. 13, 21, 23, 31 AND 34).

DOMINICK J. SALEMI, EXAMINING ATTORNEY

SN 85-033,301. CAMOMILLA S.P.A., 20090 BUCCINASCO (MI), ITALY, FILED 5-7-2010.



THE MARK CONSISTS OF THE LETTER "C" BELOW WHICH IS A STYLIZED LOOP DESIGN, BOTH FORMED BY A SERIES OF DOTS.

CLASS 3—COSMETICS AND CLEANING PREPARATIONS

FOR BODY CARE PREPARATIONS, NAMELY, SOAPS, BATH FOAM AND BATH GEL; SHAMPOOS; SUNTAN CREAMS; BODY CREAMS; PERFUMERY; DEODORANTS FOR PERSONAL USE; NON-MEDICATED TOILETRIES; ESSENTIAL OILS; COSMETICS; LIPSTICK; NAIL VARNISH; MAKE-UP; HAIR LOTIONS; HAIR CARE PREPARATIONS; DENTIFRICES (U.S. CLS. 1, 4, 6, 50, 51 AND 52).

CLASS 4—LUBRICANTS AND FUELS

FOR PATIO TORCHES AND CANDLE TORCHES (U.S. CLS. 1, 6 AND 15).

CLASS 8—HAND TOOLS

FOR TABLEWARE, NAMELY, KNIVES, FORKS, SPOONS (U.S. CLS. 23, 28 AND 44).

CLASS 9—ELECTRICAL AND SCIENTIFIC APPARATUS

FOR SPECTACLES; PARTS AND ACCESSORIES THEREFOR, NAMELY, CHAINS FOR SPECTACLES, CORDS FOR SPECTACLES AND CASES FOR SPECTACLES; MOBILE TELEPHONE CASES; MOTORCYCLE HELMETS; RADIOS; PERSONAL STEREOs; CD AND DVD PLAYERS; SCALES; TIMERS; CALCULATING MACHINES (U.S. CLS. 21, 23, 26, 36 AND 38).

SN 85-061,577. UNIVERSITY OF NORTH TEXAS, DENTON, TX. FILED 6-13-2010.

CLASS 11—ENVIRONMENTAL CONTROL APPARATUS

FOR LAMPS AND CHANDELIERS; ELECTRIC TORCHES FOR LIGHTING; FLASH LIGHTS; ELECTRIC NIGHT LIGHTS; WATER DISPENSERS, NAMELY, WATER COOLERS (U.S. CLS. 13, 21, 23, 31 AND 34).

CLASS 14—JEWELRY

FOR COSTUME JEWELRY OF PRECIOUS AND NON-PRECIOUS MATERIALS; NECKLACES; EARRINGS; BRACELETS; RINGS; HOROLOGICAL AND CHRONOMETRIC INSTRUMENTS; WATCH STRAPS (U.S. CLS. 2, 27, 28 AND 50).

CLASS 18—LEATHER GOODS

FOR LEATHER AND IMITATION LEATHER; TRUNKS; TRAVELING BAGS; UMBRELLAS; RUCKSACKS; KEY CASES; BRIEFCASES; WALLETS; PURSES; BAGS, NAMELY, MAKE-UP BAGS SOLD EMPTY; UNFITTED VANITY CASES, ALL PURPOSE SPORT BAGS (U.S. CLS. 1, 2, 3, 22 AND 41).

CLASS 20—FURNITURE AND ARTICLES NOT OTHERWISE CLASSIFIED

FOR FURNITURE; MIRRORS AND MIRROR FRAMES; SOFAS; ARMCHAIRS; CHAIRS; TABLES; TEA TABLES; COFFEE TABLES (U.S. CLS. 2, 13, 22, 25, 32 AND 50).

CLASS 21—HOUSEWARES AND GLASS

FOR SOAP HOLDERS; COMBS; SPONGES FOR HOUSEHOLD PURPOSES; HAIR BRUSHES (U.S. CLS. 2, 13, 23, 29, 30, 33, 40 AND 50).

CLASS 24—FABRICS

FOR TEXTILE GOODS AND TEXTILE ACCESSORIES, NAMELY, BLANKETS, BEDSPREADS, SHEETS, CURTAINS, TOWELS, TABLECLOTHS, NAPKINS; HANDKERCHIEFS (U.S. CLS. 42 AND 50).

CLASS 26—FANCY GOODS

FOR HAIR CLIPS; RIBBONS FOR HAIR; HAIR BANDS; HAIR ELASTICS; HAT PINS FOR SECURING HATS; HAIR PINS (U.S. CLS. 37, 39, 40, 42 AND 50).

CLASS 27—FLOOR COVERINGS

FOR CARPETS; RUGS; NON-TEXTILE WALL HANGINGS; WALL COVERINGS OF TEXTILE AND PAPER (U.S. CLS. 19, 20, 37, 42 AND 50).

CLASS 28—TOYS AND SPORTING GOODS

FOR PARLOR GAMES; TOYS AND PLAYTHINGS, NAMELY, DOLLS (U.S. CLS. 22, 23, 38 AND 50).

CLASS 33—WINES AND SPIRITS

FOR WINE (U.S. CLS. 47 AND 49).
JERI J. FICKES, EXAMINING ATTORNEY

UNIVERSITY OF NORTH TEXAS

THE MARK CONSISTS OF STANDARD CHARACTERS WITHOUT CLAIM TO ANY PARTICULAR FONT, STYLE, SIZE, OR COLOR.

OWNER OF U.S. REG. NO. 3,780,422.
SEC. 2(F).

CLASS 16—PAPER GOODS AND PRINTED MATTER

FOR PAPER GOODS AND PRINTED MATERIALS, NAMELY, GREETING CARDS, NOTE CARDS, NOTEPADS, POST CARDS, STICKERS, PAPER LABELS, STATIONERY, BUSINESS CARDS, GRADUATION ANNOUNCEMENT CARDS; RUBBER STAMPS; PHOTO ALBUMS, SCRAPBOOKS AND ACCESSORIES, NAMELY, DECORATIVE PAPER; DECALS; AND MONEY CLIPS (U.S. CLS. 2, 5, 22, 23, 29, 37, 38 AND 50).
FIRST USE 4-0-2005; IN COMMERCE 4-0-2005.

CLASS 18—LEATHER GOODS

FOR BACKPACKS, FANNY PACKS, AND ATHLETIC BAGS (U.S. CLS. 1, 2, 3, 22 AND 41).
FIRST USE 4-0-2005; IN COMMERCE 4-0-2005.

CLASS 21—HOUSEWARES AND GLASS

FOR HOUSEWARES AND GLASS, NAMELY, CUPS, MUGS, STEINS, BEVERAGE GLASSWARE; BARWARE, NAMELY, FLASKS, TRIVETS, ALCOHOL AND WINE DECANTERS; WINE BOTTLE CHILLERS, NAMELY, ICE BUCKETS; CHINA, NAMELY, PLATES, CUPS, BOWLS AND SERVING DISHES; CRYSTAL, NAMELY, HIGH BALL GLASSES, SHOT GLASSES, BEVERAGE AND WINE GLASSES; COASTERS, NAMELY, COASTERS NOT OF PAPER AND OTHER THAN TABLE LINEN; COOLERS, NAMELY, PORTABLE BEVERAGE COOLERS, COOLERS FOR WINE, ICE COOLERS; TRAYS, NAMELY, BUTLER'S TRAYS, SERVING PLATTERS, CRUMB TRAYS AND SERVING TRAYS; BARWARE ACCESSORIES, NAMELY, WINE BOTTLE OPENERS, DRINK SHAKERS AND STIRRERS; AND CONCESSION CUPS MADE OF PAPER AND PLASTIC, AND SPORT BOTTLES SOLD EMPTY (U.S. CLS. 2, 13, 23, 29, 30, 33, 40 AND 50).
FIRST USE 4-0-2005; IN COMMERCE 4-0-2005.

CLASS 25—CLOTHING

FOR CLOTHING, NAMELY, MEN'S UNISEX T-SHIRTS; MEN'S AND UNISEX OUTERWEAR, NAMELY, RAINCOATS, OVERCOATS, JACKETS, SWEATERS, PULLOVERS, HEADWEAR; MEN'S AND UNISEX COMBO PACKAGES, NAMELY, SHIRTS AND PANTS; JERSEYS; UNIFORMS; INFANT AND TODDLER APPAREL, NAMELY, PAJAMAS, JACKETS, SHIRTS, SHORTS, PANTS, HATS, JUMPERS, ROMPERS, LAYETTES AND ONE-PIECE GARMENTS; YOUTH APPAREL, NAMELY, PAJAMAS, JACKETS, SHIRTS, SHORTS, PANTS, HATS AND JUMPERS; MEN'S FASHION APPAREL, NAMELY, COATS, JACKETS, SHIRTS, PANTS AND HATS; WOMEN'S APPAREL, NAMELY, PAJAMAS, COATS, JACKETS, SHIRTS, SHORTS, PANTS, SKIRTS AND HATS; MEN'S AND UNISEX FLEECE PULLOVERS, TOPS AND VESTS; MEN'S AND UNISEX LOUNGEWEAR AND SLEEPWEAR; MEN'S AND UNISEX PERFORMANCE APPAREL, NAMELY, SHORTS, SHIRTS, HATS, T-SHIRTS, SWEAT SHIRTS AND SWEAT PANTS; CLOTHING ACCESSORIES, NAMELY, SCARVES, SOCKS AND TIES; STRUCTURED CLOSED BACK HEADWEAR; STRUCTURED STRETCH FIT HEADWEAR; UNSTRUCTURED CLOSED BACK HEADWEAR; ADJUSTABLE WOOL BLEND HEADWEAR; AND ADJUSTABLE NON WOOL HEADWEAR (U.S. CLS. 22 AND 39).

FIRST USE 4-0-2005; IN COMMERCE 4-0-2005.

CLASS 28—TOYS AND SPORTING GOODS

FOR TOYS AND SPORTING GOODS, NAMELY, BASEBALL AND SOFTBALL ACCESSORIES, NAMELY, BASEBALLS, SOFTBALLS, BATTING TEES, GLOVES, MITTS, BATS AND BATTING GLOVES; BASKETBALL ACCESSORIES, NAMELY, BASKETBALLS AND BACKBOARDS; BOWLING ACCESSORIES, NAMELY, BOWLING BAGS, BALLS AND GLOVES; FISHING ACCESSORIES, NAMELY, TACKLE BOXES, ROD AND REELS AND ROD CASES; FOOTBALL ACCESSORIES, NAMELY, GLOVES, KNEE PADS, LEG PADS, SHOULDER PADS AND FOOTBALLS; GOLF ACCESSORIES, NAMELY, GOLF BALL TEES AND MARKERS, GLOVES AND DIVOT REPAIR TOOLS, GOLF BAGS, GOLF CLUBS, GOLF BALLS; BILLIARD ACCESSORIES, NAMELY, BALLS, RACKS AND CUES; COLLECTIBLE BALLS, NAMELY, FOOTBALLS, BASKETBALLS, BASEBALLS AND SOCCER BALLS; COMPETITION AND LEATHER SPORTS BALLS, NAMELY, RUBBER BALLS, FOAM BALLS; PUMPS FOR INFLATING SPORTS EQUIPMENT, NAMELY, FOOTBALLS, SOCCER BALLS, PLUSH SPORTS AND TOY BALLS, VINYL SPORTS AND TOY BALLS; DOLLS; PLUSH MASCOT TOYS; ACTION FIGURES; FLYING DISCS; GAMES, NAMELY, BOARD GAMES, PLAYING CARDS, PUZZLES, PARLOR AND MEMORY GAMES; STAND ALONE AND ARCADE-TYPE VIDEO GAME MACHINES; HAND-HELD MOBILE VIDEO GAMES WITH LIQUID CRYSTAL DISPLAYS; BALLOONS; TOY FOOTBALL HELMETS (U.S. CLS. 22, 23, 38 AND 50).

FIRST USE 4-0-2005; IN COMMERCE 4-0-2005.

CLASS 41—EDUCATION AND ENTERTAINMENT

FOR EDUCATIONAL SERVICES, NAMELY, PROVIDING COLLEGE AND GRADUATE LEVEL COURSES OF INSTRUCTION AND SEMINARS, AND EDUCATIONAL OPPORTUNITIES TO PARTICIPATE IN RESEARCH PROGRAMS; AND ENTERTAINMENT SERVICES, NAMELY, PROVIDING COLLEGE SPORT GAMES AND EVENTS, MUSICAL CONCERTS AND ENTERTAINMENT AND PERFORMANCES OF DRAMATIC WORKS (U.S. CLS. 100, 101 AND 107).

FIRST USE 4-0-2005; IN COMMERCE 4-0-2005.
THOMAS MANOR, EXAMINING ATTORNEY

SN 85-071,283. R&R APPAREL COMPANY, LLC, WILMINGTON, DE. FILED 6-24-2010.

Rock by Rock & Republic

THE MARK CONSISTS OF STANDARD CHARACTERS WITHOUT CLAIM TO ANY PARTICULAR FONT, STYLE, SIZE, OR COLOR.

OWNER OF U.S. REG. NOS. 3,732,871 AND 3,868,778.

CLASS 9—ELECTRICAL AND SCIENTIFIC APPARATUS

FOR EYEWEAR, NAMELY, READING GLASSES AND SUNGLASSES (U.S. CLS. 21, 23, 26, 36 AND 38).

CLASS 18—LEATHER GOODS

FOR PURSES, WALLETS, HANDBAGS, BACKPACKS, TOTE BAGS, SHOULDER BAGS, CREDIT CARD CASES, LUGGAGE, ATTACHE CASES, TRAVELING BAGS, CARRY-ON BAGS, SPORTS BAGS, BOOK BAGS, SUITCASES, DUFFLE BAGS, CLUTCHES, FANNY PACKS, RUCKSACKS, BEACH BAGS, GARMENT BAGS FOR TRAVEL, AND TOILETRY CASES SOLD EMPTY (U.S. CLS. 1, 2, 3, 22 AND 41).

SUSAN RICHARDS, EXAMINING ATTORNEY

SN 85-077,303. MARTELL & CO., COGNAC, FRANCE, FILED 7-2-2010.



PRIORITY CLAIMED UNDER SEC. 44(D) ON FRANCE APPLICATION NO. 103747740, FILED 6-21-2010, REG. NO. 103747740, DATED 6-21-2010, EXPIRES 6-21-2020.

PRIORITY CLAIMED UNDER SEC. 44(D) ON FRANCE APPLICATION NO. 103703300, FILED 1-8-2010, REG. NO. 103703300, DATED 1-8-2010, EXPIRES 1-8-2020.

OWNER OF U.S. REG. NOS. 3,127,066, 3,692,707 AND OTHERS.

THE COLOR(S) DARK BLUE, WHITE AND GOLD IS/ARE CLAIMED AS A FEATURE OF THE MARK.

THE MARK CONSISTS OF THE WORD "MARTELL" IN WHITE LETTERING WITH GOLD SHADOWS, WITH THE SILHOUETTE OF A BIRD IN GOLD ABOVE IT, ALL ON A DARK BLUE RECTANGULAR BACKGROUND.

CLASS 14—JEWELRY

FOR JEWELLERY, CUFF-LINKS, TIEPINS, BRACELETS, JEWELRY CHAINS, KEYRINGS OF PRECIOUS METALS, CLOCKS, WATCHES, JEWELLERY BOXES, BOXES MADE OF PRECIOUS METALS, CASES AND BOXES FOR CLOCKS AND WATCHES, MEDALS (U.S. CLS. 2, 27, 28 AND 50).

CLASS 16—PAPER GOODS AND PRINTED MATTER

FOR PRINTED MATTER, NAMELY, MAGAZINES FEATURING ALCOHOLIC BEVERAGES, BROCHURES FEATURING ALCOHOLIC BEVERAGES, NEWSPAPERS, PAMPHLETS ON THE SUBJECT OF ALCOHOLIC BEVERAGES, CATALOGS IN THE FIELD OF ALCOHOLIC BEVERAGES, PRINTED INSTRUCTIONAL AND TEACHING MATERIALS IN THE FIELDS OF ALCOHOLIC BEVERAGES, ART, ARCHITECTURE, AND INDUSTRIAL DESIGN; PHOTOGRAPHS, STATIONERY, OFFICE SUPPLIES EXCLUDING FURNITURE, NAMELY, BINDERS, PENS AND PENCILS, RULERS; ARTICLES MADE OF PAPER OR CARDBOARD, NAMELY, SIGNS AND SIGNBOARDS, LETTER PAPER, DIARIES, POUCHES FOR PACKAGING, PAPER ENVELOPES, PAPER OR CARDBOARD BOXES, CHECKBOOK HOLDERS, DOCUMENT FOLDERS, DOCUMENT FOLDERS IN THE FORM OF WALLETS, STATIONERY CASES FOR DIARIES, NOTEBOOKS, NOTEBOOK COVERS, FOLDERS, PAPER TABLECLOTHS, PAPER PARTY BANNERS, PAPER PARTY DECORATIONS, PAPER NAPKINS, NOTEPAPER, BANNERS; POSTERS; PHOTOGRAPH ALBUMS; CARDS, NAMELY, BLANK CARDS, PRINTED BUSINESS CARDS, PRINTED GREETING CARDS, AND POSTCARDS; BOOKS, NAMELY, ADDRESS BOOKS, BOOKS ABOUT ALCOHOLIC BEVERAGES, AND BOOKS ABOUT ART, ARCHITECTURE, AND INDUSTRIAL DESIGN; PRINTED BROCHURES IN THE FIELDS OF ALCOHOLIC BEVERAGES, ART, ARCHITECTURE, AND INDUSTRIAL DESIGN; CALENDARS; PRINTED MENUS; WRITING INSTRUMENTS; PAPER TABLE LINEN; CARDBOARD BOXES FOR PACKING; BAGS OF PAPER OR PLASTIC FOR WRAPPING; COASTERS OF PAPER AND CARDBOARD (U.S. CLS. 2, 5, 22, 23, 29, 37, 38 AND 50).

CLASS 18—LEATHER GOODS

FOR ARTICLES MADE OF LEATHER OR IMITATION LEATHER, NAMELY, BAGS, WALLETS, PURSES; HOLLARDS; TRAVEL BAGS; BEACH BAGS; VANITY CASES SOLD EMPTY; BAGS OR WALLETS MADE OF LEATHER FOR WRAPPING; UMBRELLAS AND PARASOLS; KEY CASES (U.S. CLS. 1, 2, 3, 22 AND 41).

CLASS 20—FURNITURE AND ARTICLES NOT OTHERWISE CLASSIFIED

FOR FURNITURE; MIRRORS; SHELVES; PLASTIC CONTAINERS FOR PACKING; SEATING FURNITURE; BOXES MADE OF WOOD OR PLASTIC; NOTICE BOARDS, NAMELY, BULLETIN BOARDS; PRESENTATION STANDS, NAMELY, DISPLAY STANDS (U.S. CLS. 2, 13, 22, 25, 32 AND 50).

CLASS 21—HOUSEWARES AND GLASS

FOR NON-ELECTRIC HOUSEHOLD OR KITCHEN UTENSILS OR CONTAINERS, NAMELY, NON-ELECTRIC JUICERS, NON-ELECTRIC FRUIT SQUEEZERS FOR HOUSEHOLD PURPOSES, ICE CUBE MOLDS, HEAT-INSULATED CONTAINERS ADAPTED FOR DISPENSING DRINKS, NAMELY, THERMAL INSULATED CONTAINERS FOR BEVERAGES; GLASSWARE, NAMELY, BEVERAGE GLASSWARE, WINE GLASSWARE, GLASS COCKTAIL SHAKERS, AND CONTAINERS OF GLASS, NAMELY, CARAFES, DECANTERS, JARS, AND VASES; PORCELAIN, NAMELY, SCULPTURES, FIGURES, FIGURINES, AND ORNAMENTS MADE OF PORCELAIN; EARTHENWARE, NAMELY, SCULPTURES, FIGURES, FIGURINES, AND ORNAMENTS MADE OF EARTHENWARE; BOTTLES SOLD EMPTY; FLASKS, ICE BUCKETS; JUGS; SERVING TRAYS; DRINKING MATS OR COASTERS NOT OF PAPER OR LINEN; DRIP PREVENTERS FOR BOTTLES, NAMELY, DRIP-FREE WINE POURERS; BOTTLE-OPENERS; NON-ELECTRIC COCKTAIL SHAKERS; COCKTAIL STIRRERS (U.S. CLS. 2, 13, 23, 29, 30, 33, 40 AND 50).

CLASS 25—CLOTHING

FOR ARTICLES OF CLOTHING, NAMELY, UPPER OUTER GARMENTS, NAMELY, JACKETS, PARKAS, SWEATERS, FLEECE VESTS, INSULATED VESTS, FLEECE PULLOVERS AND WIND-RESISTANT JACKETS, UPPER SPORTS GARMENTS, NAMELY, SWEAT-SHIRTS, JERSEYS, SPORTS VESTS AND WARM-UP JACKETS, PANTS, SPORTS PANTS, NAMELY, SWEAT-PANTS AND WARM-UP PANTS, WRISTBANDS, SCARVES, TIES, GLOVES, SOCKS, BELTS; FOOTWEAR AND HEADWEAR, NAMELY, HATS, CAPS AND HEADBANDS; APRONS (U.S. CLS. 22 AND 39).

CLASS 33—WINES AND SPIRITS

FOR ALCOHOLIC BEVERAGES, EXCEPT BEERS (U.S. CLS. 47 AND 49).

CLASS 41—EDUCATION AND ENTERTAINMENT

FOR EDUCATION AND TRAINING SERVICES, NAMELY, OFFERING OF WEB-BASED VIDEO AND CLASSROOM TRAINING FOR BARTENDERS AND OTHER SERVICE PROFESSIONALS IN THE ALCOHOLIC BEVERAGE INDUSTRY, AND INSTRUCTION AND TRAINING SERVICES RELATING TO SPORTS; EDUCATION AND ENTERTAINMENT SERVICES, NAMELY, ARRANGING AND CONDUCTING EXHIBITIONS, COLLOQUIA, CONFERENCES, CONGRESSES, SEMINARS, SYMPOSIA AND WORKSHOPS CONCERNING ALCOHOLIC BEVERAGES AND MODERATION IN DRINKING; EDUCATION AND ENTERTAINMENT SERVICES IN THE FIELD OF CULTURAL ACTIVITIES, NAMELY, ARRANGING AND CONDUCTING EXHIBITIONS, COLLOQUIA, CONFERENCES, CONGRESSES, SEMINARS, SYMPOSIA AND WORKSHOPS CONCERNING ART, ARCHITECTURE AND INDUSTRIAL DESIGN; ENTERTAINMENT SERVICES, NAMELY, PRESENTATION OF PROGRAMS ABOUT ALCOHOLIC BEVERAGES ACCESSIBLE BY RADIO, TELEVISION, VIDEO, FILM, AND COMPUTER NETWORKS; ENTERTAINMENT SERVICES, NAMELY, ARRANGING, ORGANIZING AND HOSTING AWARDS CEREMONIES, PARTY PLANNING; SPORTING AND CULTURAL ACTIVITIES, NAMELY, ORGANIZATION OF SOCCER, TENNIS, GOLF, CAR RACING, AND SAILING SPORTS COMPETITIONS AND TOURNAMENTS, PROVIDING SPORTS FACILITIES, PUBLICATION OF SPORTS MAGAZINES AND OTHER SPORTS-RELATED PRINTED MATTER, NAMELY, BOOKS (U.S. CLS. 100, 101 AND 107).

CLASS 43—HOTEL AND RESTAURANT SERVICES

FOR PROVIDING OF FOOD AND DRINK; PROVIDING TEMPORARY ACCOMMODATIONS (U.S. CLS. 100 AND 101).

TEJBIR SINGH, EXAMINING ATTORNEY

SN 85-090,605. THE ENERGY STORE INC., DBA THE ENERGY STORE, ETOBICOKE, ONTARIO, CANADA, FILED 7-22-2010.

THE ENERGY STORE

THE MARK CONSISTS OF STANDARD CHARACTERS WITHOUT CLAIM TO ANY PARTICULAR FONT, STYLE, SIZE, OR COLOR.

PRIORITY CLAIMED UNDER SEC. 44(D) ON CANADA APPLICATION NO. 1,483,218, FILED 6-1-2010, REG. NO. TMA822,992, DATED 4-26-2012, EXPIRES 4-26-2027.

NO CLAIM IS MADE TO THE EXCLUSIVE RIGHT TO USE "ENERGY", APART FROM THE MARK AS SHOWN.

CLASS 37—CONSTRUCTION AND REPAIR

FOR CONSULTING SERVICES IN THE FIELD OF INSTALLATION OF RENEWABLE ENERGY SYSTEMS; INSTALLATION, AND SERVICING OF RENEWABLE ENERGY SYSTEMS FOR PRIVATE HOMES, AND FOR COMMERCIAL, EDUCATIONAL AND RELIGIOUS INSTITUTIONAL BUILDINGS (U.S. CLS. 100, 103 AND 106).

CLASS 42—SCIENTIFIC AND COMPUTER SERVICES

FOR CONSULTING SERVICES IN THE FIELD OF ENVIRONMENTAL SITE ASSESSMENT, TECHNICAL PLANNING AND EVALUATION GOODS OF OTHERS FOR THE PURPOSE OF CERTIFICATION, ALL IN THE FIELD OF RENEWABLE ENERGY SYSTEMS (U.S. CLS. 100 AND 101).

BRIAN CALLAGHAN, EXAMINING ATTORNEY

SN 85-092,396. CASEY SORENSEN, SYLVAN LAKE, ALBERTA, CANADA, FILED 7-26-2010.

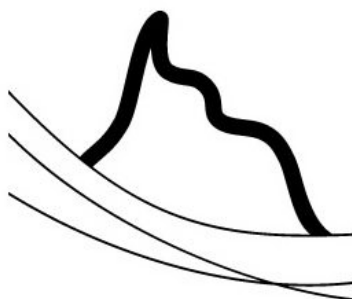

PRIORITY CLAIMED UNDER SEC. 44(D) ON CANADA APPLICATION NO. 1487243, FILED 7-2-2010, REG. NO. TMA817494, DATED 2-13-2012, EXPIRES 2-13-2027.

THE MARK CONSISTS OF AN ICEBERG DESIGN.

CLASS 18—LEATHER GOODS

FOR SPORTS BAGS, BEACH BAGS, ALL-PURPOSE CARRYING BAGS FOR CARRYING PORTABLE BEVERAGE COOLERS (U.S. CLS. 1, 2, 3, 22 AND 41).

CLASS 21—HOUSEWARES AND GLASS

FOR REFRIGERANT PACKS TO KEEP FOOD AND DRINK COLD; RE-USABLE, RE-FREEZABLE ICE PACKS, COLD PACKS AND ICE GEL PACKS TO KEEP FOODS AND DRINK COLD; NON-TOXIC, REUSABLE COLD PACKS CONTAINING ICE SUBSTITUTES USED TO KEEP FOOD AND DRINK COLD IN COOLERS; PORTABLE BEVERAGE COOLERS; BAGS SPECIALLY ADAPTED FOR CARRYING PORTABLE BEVERAGE COOLERS; THERMALLY INSULATING CONTAINERS FOR FOOD AND/OR BEVERAGES (U.S. CLS. 2, 13, 23, 29, 30, 33, 40 AND 50).

CLASS 35—ADVERTISING AND BUSINESS

FOR RETAIL STORE SERVICES AND ON-LINE RETAIL STORE SERVICES FEATURING REFRIGERANT PACKS, RE-USABLE, RE-FREEZABLE ICE PACKS, COLD PACKS AND ICE GEL PACKS, NON-TOXIC, REUSABLE ICE SUBSTITUTES USED IN COOLERS, PORTABLE BEVERAGE COOLERS, SPORTS BAGS, BEACH BAGS, BAGS FOR CARRYING PORTABLE BEVERAGE COOLERS AND THERMALLY INSULATING CONTAINERS FOR FOOD AND/OR BEVERAGES (U.S. CLS. 100, 101 AND 102).

ANDREW LEASER, EXAMINING ATTORNEY

SN 85-102,131. OLD DOMINION ELECTRIC COOPERATIVE, GLEN ALLEN, VA. FILED 8-6-2010.

The Electric Cooperatives
EnergizeEfficiently

NO CLAIM IS MADE TO THE EXCLUSIVE RIGHT TO USE "THE ELECTRIC COOPERATIVES", APART FROM THE MARK AS SHOWN.

CLASS 9—ELECTRICAL AND SCIENTIFIC APPARATUS

FOR DOWNLOADABLE PUBLICATIONS IN THE NATURE OF FORMS, BROCHURES, MANUALS, HAND-OUTS, GUIDELINES, EDUCATIONAL MATERIALS, REFERENCE MATERIALS, GLOSSARIES, INFORMATION BULLETINS, PRESENTATIONS, PHOTOGRAPHIC IMAGES, CHARTS, DIAGRAMS, TABLES, ILLUSTRATIONS AND GRAPHICS AND NEWSLETTERS IN THE FIELD OF ENERGY EFFICIENCY, CONSERVATION AND DEMAND RESPONSE (U.S. CLS. 21, 23, 26, 36 AND 38).

CLASS 35—ADVERTISING AND BUSINESS

FOR ENERGY USAGE MANAGEMENT; ENERGY USAGE AND DEMAND SIDE MANAGEMENT INFORMATION SERVICES; INFORMATION SERVICES IN THE FIELD OF ENERGY EFFICIENCY, CONSERVATION AND DEMAND RESPONSE; CONTENT, NAMELY, A WEBSITE IN THE FIELD OF ENERGY EFFICIENCY, CONSERVATION AND DEMAND RESPONSE (U.S. CLS. 100, 101 AND 102).

CLASS 41—EDUCATION AND ENTERTAINMENT

FOR CONSUMER EDUCATION AND ENTERTAINMENT SERVICES, NAMELY, PROVIDING PODCASTS, WEBCASTS, ONLINE NON-DOWNLOADABLE PUBLICATIONS IN THE NATURE OF FORMS, BROCHURES, MANUALS, HANDOUTS, GUIDELINES, EDUCATIONAL MATERIALS, REFERENCE MATERIALS, GLOSSARIES, INFORMATION BULLETINS, PRESENTATIONS, PHOTOGRAPHIC IMAGES, CHARTS, DIAGRAMS, TABLES, ILLUSTRATIONS AND GRAPHICS AND NEWSLETTERS IN THE FIELD OF ENERGY EFFICIENCY, CONSERVATION AND DEMAND RESPONSE (U.S. CLS. 100, 101 AND 107).

MARK RADEMACHER, EXAMINING ATTORNEY

CLASS 3—COSMETICS AND CLEANING PREPARATIONS

FOR BLEACHING PREPARATIONS AND OTHER SUBSTANCES IN THE NATURE OF DETERGENTS AND FABRIC SOFTENERS FOR LAUNDRY USE; CLEANING, POLISHING, SCOURING AND ABRASIVE PREPARATIONS; SOAPS; PERFUMERY, ESSENTIAL OILS, COSMETICS, HAIR LOTIONS; DENTIFRICES; DISINFECTANT SOAP; ALL OF THE AFOREMENTIONED GOODS BEING PERMISSIBLE UNDER ISLAMIC LAW, I.E., HALAL (U.S. CLS. 1, 4, 6, 50, 51 AND 52).

CLASS 5—PHARMACEUTICALS

FOR PHARMACEUTICAL PREPARATIONS IN THE NATURE OF MEDICINES FOR USE IN TREATMENT OF AILMENTS OF THE HEART, THE RESPIRATORY SYSTEM, THE DIGESTIVE SYSTEM, THE SKIN, THE HAIR, THE BONES AND THE TEETH, AND FOR TREATMENT OF COMMON COLD AND FEVER, FOR ORAL USE BY HUMAN BEINGS; VETERINARY PREPARATIONS, NAMELY, MEDICINES FOR USE IN TREATMENT OF AILMENTS OF THE HEART, THE RESPIRATORY SYSTEM, THE DIGESTIVE SYSTEM, THE SKIN, THE HAIR, THE BONES AND THE TEETH, AND FOR TREATMENT OF COMMON COLD AND FEVER; SANITARY PREPARATIONS FOR MEDICAL PURPOSES; DIETETIC SUBSTANCES IN THE NATURE OF FOOD AND BEVERAGES ADAPTED FOR MEDICAL USE, FOOD FOR BABIES; MEDICAL PLASTERS; MATERIALS FOR DRESSINGS, NAMELY, GAUZE; MATERIAL FOR STOPPING TEETH, DENTAL WAX; ALL PURPOSE DISINFECTANTS; PREPARATIONS FOR DESTROYING VERMIN; FUNGICIDES, HERBICIDES; ALL OF THE AFOREMENTIONED GOODS BEING PERMISSIBLE UNDER ISLAMIC LAW, I.E., HALAL (U.S. CLS. 6, 18, 44, 46, 51 AND 52).

SN 85-102,918. BRUNEI WAFIRAH HOLDINGS SDN. BHD., JALAN MENTERI BESAR, BRUNEI DARUSSALAM, FILED 8-9-2010.



NO CLAIM IS MADE TO THE EXCLUSIVE RIGHT TO USE "BRUNEI HALAL", APART FROM THE MARK AS SHOWN.

THE COLOR(S) BLACK, WHITE, GREEN AND YELLOW IS/ARE CLAIMED AS A FEATURE OF THE MARK.

THE MARK CONSISTS OF THE TERM "BRUNEIHALAL" WITH "BRUNEI" IN BLACK AND "HALAL" IN GREEN AND A DESIGN CONSISTING OF A BLACK SQUARE THAT COMES TO A POINT AT THE TOP AND INSIDE THE SQUARE IS ANOTHER SQUARE IN WHITE AND WITHIN THAT SQUARE IS ANOTHER SQUARE WITH THREE ROUNDED CORNERS AND A FOURTH CORNER THAT COMES TO A POINT WITH THE POINT FACING LEFT, WITH THE INTERNAL SQUARE GREEN ON ONE END AND GRADUALLY SHIFTING TO YELLOW ON THE END WITH THE POINT.

CLASS 1—CHEMICALS

FOR CHEMICALS USED IN INDUSTRY, SCIENCE AND PHOTOGRAPHY, AS WELL AS IN AGRICULTURE, HORTICULTURE AND FORESTRY EXCEPT FUNGICIDES, HERBICIDES, INSECTICIDES AND PARASITICIDES; CHEMICALS USED FOR THE PRESERVATION OF FOODS; UNPROCESSED ARTIFICIAL RESINS, UNPROCESSED PLASTICS; MANURES; FIRE EXTINGUISHING COMPOSITIONS; TEMPERING PREPARATIONS AND SOLDERING PREPARATIONS, NAMELY, SOLDERING CHEMICALS; CHEMICAL SUBSTANCES FOR PRESERVING FOODSTUFFS; TANNING AGENTS FOR USE IN THE MANUFACTURE OF LEATHER; ADHESIVES USED IN INDUSTRY; ALL OF THE AFOREMENTIONED GOODS BEING PERMISSIBLE UNDER ISLAMIC LAW, I.E., HALAL (U.S. CLS. 1, 5, 6, 10, 26 AND 46).

CLASS 29—MEATS AND PROCESSED FOODS

FOR MEAT, FISH, POULTRY AND GAME; MEAT EXTRACTS; PRESERVED, FROZEN, DRIED AND COOKED FRUITS AND VEGETABLES; JELLIES, JAMS, COMPOTES; EGGS, MILK AND MILK PRODUCTS EXCLUDING ICE CREAM, ICE MILK AND FROZEN YOGURT; EDIBLE OILS AND FATS PROCESSED EDIBLE SEEDS; ALL OF THE AFOREMENTIONED GOODS BEING PERMISSIBLE UNDER ISLAMIC LAW, I.E., HALAL (U.S. CL. 46).

CLASS 30—STAPLE FOODS

FOR COFFEE, TEA, COCOA, SUGAR, RICE, TAPIOCA, SAGO; ARTIFICIAL COFFEE; FLOUR; CEREAL-BASED SNACK FOOD AND PROCESSED CEREAL-BASED FOOD PRODUCTS TO BE USED AS BREAKFAST FOOD, SNACK FOOD OR INGREDIENT FOR MAKING OTHER FOODS, BREAD, PASTRY AND CONFECTIONERY, NAMELY, SWEETS AND CHOCOLATE, EDIBLE ICES; HONEY, TREACLE; YEAST, BAKING POWDER; SALT, MUSTARD; VINEGAR, SAUCES AS CONDIMENTS; SPICES; ICE; MALT FOR FOOD PROCESSES; PROCESSED GRAINS; ALL OF THE AFOREMENTIONED GOODS BEING PERMISSIBLE UNDER ISLAMIC LAW, I.E., HALAL (U.S. CL. 46).

CLASS 31—NATURAL AGRICULTURAL PRODUCTS

FOR UNPROCESSED EDIBLE GRAINS; LIVE ANIMALS; FRESH FRUITS AND VEGETABLES; FRUIT SEEDS; CROP SEEDS, NATURAL PLANTS AND FLOWERS; FOODSTUFFS FOR ANIMALS, MALT FOR BREWING AND DISTILLING; ALL OF THE AFOREMENTIONED GOODS BEING PERMISSIBLE UNDER ISLAMIC LAW, I.E., HALAL (U.S. CLS. 1 AND 46).

CLASS 32—LIGHT BEVERAGES

FOR MINERAL WATER; AERATED WATERS; FRUIT DRINKS; FRUIT JUICES; SYRUPS FOR MAKING BEVERAGES; ALL OF THE AFOREMENTIONED GOODS BEING PERMISSIBLE UNDER ISLAMIC LAW, I.E., HALAL (U.S. CLS. 45, 46 AND 48).

CLASS 39—TRANSPORTATION AND STORAGE

FOR LAND TRANSPORT BY CAR, TRUCK AND RAILWAY; FREIGHT SHIP TRANSPORT; AIR TRANSPORT; PACKAGING ARTICLES FOR TRANSPORTATION AND STORAGE OF GOODS; TRAVEL ARRANGEMENT, NAMELY, ORGANIZATION OF TRAVEL; ALL OF THE AFOREMENTIONED SERVICES BEING PERMISSIBLE UNDER ISLAMIC LAW, I.E., HALAL (U.S. CLS. 100 AND 105).

CLASS 43—HOTEL AND RESTAURANT SERVICES

FOR SERVICES FOR PROVIDING FOOD AND DRINK; PROVIDING TEMPORARY ACCOMMODATION; ALL OF THE AFOREMENTIONED SERVICES BEING PERMISSIBLE UNDER ISLAMIC LAW, I.E., HALAL (U.S. CLS. 100 AND 101).

CLASS 44—MEDICAL, BEAUTY AND AGRICULTURAL SERVICES

FOR MEDICAL SERVICES; VETERINARY SERVICES; HYGIENIC AND BEAUTY CARE FOR HUMAN BEINGS; GROOMING SERVICES THAT PROVIDE HYGIENIC AND BEAUTY CARE FOR ANIMALS; AGRICULTURAL AND FORESTRY SERVICES, NAMELY, PROVIDING ADVICE ON GROWTH, CULTIVATION AND HARVESTING OF CROPS AND VERMIN EXTERMINATION; HORTICULTURE SERVICES; ALL OF THE AFOREMENTIONED SERVICES BEING PERMISSIBLE UNDER ISLAMIC LAW, I.E., HALAL (U.S. CLS. 100 AND 101).
DAVID COLLIER, EXAMINING ATTORNEY

SN 85-111,594. CHILDREN'S MEDICAL CENTER CORPORATION, BOSTON, MA. FILED 8-19-2010.

KIDSMD

THE MARK CONSISTS OF STANDARD CHARACTERS WITHOUT CLAIM TO ANY PARTICULAR FONT, STYLE, SIZE, OR COLOR.

CLASS 38—COMMUNICATION

FOR WEB-BASED CONNECTIVITY BETWEEN THE PARENTS OF SICK CHILDREN, NAMELY, PROVIDING TELECOMMUNICATIONS CONNECTIVITY SERVICES FOR THE TRANSFER OF IMAGES, MESSAGES, AUDIO, VISUAL, AUDIOVISUAL AND MULTIMEDIA WORKS (U.S. CLS. 100, 101 AND 104).

CLASS 44—MEDICAL, BEAUTY AND AGRICULTURAL SERVICES

FOR PROVIDING A WEBSITE FEATURING PEDIATRIC CLINICAL, EDUCATIONAL AND DECISION-MAKING INFORMATION IN THE FIELDS OF INFANT, BABY, AND CHILDREN'S WELLNESS AND HEALTH-CARE (U.S. CLS. 100 AND 101).
JAMES STEIN, EXAMINING ATTORNEY

SN 85-128,107. CJ 4DPLEX CO., LTD., SEOUL, REPUBLIC OF KOREA, FILED 9-13-2010.

4DPLEX

THE MARK CONSISTS OF STANDARD CHARACTERS WITHOUT CLAIM TO ANY PARTICULAR FONT, STYLE, SIZE, OR COLOR.

PRIORITY CLAIMED UNDER SEC. 44(D) ON REPUBLIC OF KOREA APPLICATION NO. 40201047704, FILED 9-10-2010, REG. NO. 0914933, DATED 4-10-2012, EXPIRES 4-10-2022.

CLASS 7—MACHINERY

FOR EQUIPMENT FOR MOVIE AUDIENCE EFFECTS IN CINEMAS WITH SPECIAL EFFECTS SUCH AS WIND, MOTION, VIBRATION, BUBBLE, NAMELY, WIND-GENERATING MACHINES, VIBRATING AND MOTION-PRODUCING MACHINES, MECHANICAL BUBBLE MAKING MACHINES ALL FOR CREATING SPECIAL CINEMATIC EFFECTS; COMPRESSED AIR PUMPS; BLOWING MACHINES FOR THE COMPRESSION, EXHAUSTION AND TRANSPORT OF GASES; ELECTRIC MOTORS FOR MACHINES, OTHER THAN FOR VEHICLES; AUTOMATIC HANDLING MACHINES FOR USE IN CREATING SPECIAL CINEMATIC EFFECTS; INDUSTRIAL ROBOTS (U.S. CLS. 13, 19, 21, 23, 31, 34 AND 35).

CLASS 11—ENVIRONMENTAL CONTROL APPARATUS

FOR SMOKE AND MIST GENERATING MACHINES AND FLASHING STROBE LIGHT APPARATUS FOR CREATING SPECIAL CINEMATIC EFFECTS; ELECTRIC SCENT DISPENSERS FOR USE IN CREATING SPECIAL CINEMATIC EFFECTS (U.S. CLS. 13, 21, 23, 31 AND 34).
RON FAIRBANKS, EXAMINING ATTORNEY

SN 85-131,920. AYMERICH INVER, S.L., ELCHE (ALICANTE), SPAIN, FILED 9-17-2010.



PRIORITY CLAIMED UNDER SEC. 44(D) ON ERPNCMNTY TM OFC APPLICATION NO. 009339136, FILED 9-8-2010, REG. NO. 009339136, DATED 3-19-2012, EXPIRES 8-9-2020.

THE MARK CONSISTS OF THE LETTER "M" WITH A BLACK BACKGROUND AND THE LETTERS "MTNG" BELOW THE LETTER "M".

CLASS 18—LEATHER GOODS

FOR LEATHER AND IMITATION LEATHER; GOODS MADE OF LEATHER AND IMITATION LEATHER, NAMELY, HANDBAGS, WALLETS, AND BAGS IN THE NATURE OF ALL-PURPOSE CARRYING BAGS, ALL-PURPOSE SPORT BAGS, BELT BAGS, BAGS FOR UMBRELLAS, CLUTCH BAGS, DUFFEL BAGS, AND OVERNIGHT BAGS; ANIMALS SKINS AND HIDES; TRUNKS AND SUITCASES; UMBRELLAS, SUNSHADES IN THE NATURE OF PARASOLS AND SUN UMBRELLAS; WALKING STICKS, WHIPS, AND SADDLERY (U.S. CLS. 1, 2, 3, 22 AND 41).

CLASS 25—CLOTHING

FOR READY-MADE WEAR FOR WOMEN, MEN AND CHILDREN, NAMELY, BELTS, GLOVES, JACKETS, SWEATERS, MITTENS, OVERCOATS, SHIRTS, T-SHIRTS, PANTS, AND UNDERGARMENTS; FOOTWEAR, NAMELY, BOOTS, SHOES, AND SANDALS; HEADGEAR, NAMELY, HATS AND CAPS (U.S. CLS. 22 AND 39).

CLASS 35—ADVERTISING AND BUSINESS

FOR ADVERTISING AND BUSINESS MANAGEMENT; BUSINESS ADMINISTRATION AND OFFICE WORK, BUSINESS ADMINISTRATION AND MANAGEMENT, BUSINESS ADMINISTRATION CONSULTANCY; PROVIDING OFFICE FUNCTIONS (U.S. CLS. 100, 101 AND 102).

SUNG IN, EXAMINING ATTORNEY

SN 85-135,232. ESOZO LLC, FLEMINGTON, NJ. FILED 9-22-2010.

IT Made Easy

THE MARK CONSISTS OF STANDARD CHARACTERS WITHOUT CLAIM TO ANY PARTICULAR FONT, STYLE, SIZE, OR COLOR.

NO CLAIM IS MADE TO THE EXCLUSIVE RIGHT TO USE "IT", APART FROM THE MARK AS SHOWN.

CLASS 9—ELECTRICAL AND SCIENTIFIC APPARATUS

FOR COMPUTER HARDWARE AND PERIPHERALS; COMPUTER HARDWARE AND SOFTWARE FOR SETTING UP AND CONFIGURING LOCAL AREA NETWORKS; COMPUTER HARDWARE AND SOFTWARE USED FOR THE CONTROL OF VOICE CONTROLLED INFORMATION AND COMMUNICATION DEVICES; COMPUTER HARDWARE FOR COMMUNICATING AUDIO, VIDEO AND DATA BETWEEN COMPUTERS VIA A GLOBAL COMPUTER NETWORK, WIDE-AREA COMPUTER NETWORKS, AND PEER-TO-PEER COMPUTER NETWORKS; COMPUTER HARDWARE FOR UPLOAD, STORAGE, RETRIEVAL, DOWNLOAD, TRANSMISSION AND DELIVERY OF DIGITAL CONTENT; COMPUTER NETWORKING HARDWARE; COMPUTER PROGRAMS FOR CONNECTING REMOTELY TO COMPUTERS OR COMPUTER NETWORKS; COMPUTER SERVERS (U.S. CLS. 21, 23, 26, 36 AND 38).

FIRST USE 9-22-2010; IN COMMERCE 9-22-2010.

CLASS 42—SCIENTIFIC AND COMPUTER SERVICES

FOR COMPUTER SERVICES, NAMELY, COMPUTER SYSTEM ADMINISTRATION FOR OTHERS (U.S. CLS. 100 AND 101).

FIRST USE 9-22-2010; IN COMMERCE 9-22-2010.

DEZMONA MIZELLE, EXAMINING ATTORNEY

SN 85-143,650. PENSKE MEDIA CORPORATION, INGLEWOOD, CA. FILED 10-1-2010.

TVLINE

THE MARK CONSISTS OF STANDARD CHARACTERS WITHOUT CLAIM TO ANY PARTICULAR FONT, STYLE, SIZE, OR COLOR.

CLASS 9—ELECTRICAL AND SCIENTIFIC APPARATUS

FOR (BASED ON INTENT TO USE) DIGITAL AND ANALOG MEDIA FILES, NAMELY, DOWNLOADABLE ELECTRONIC PUBLICATIONS CONTAINING IMAGES, REVIEWS, COMMENTARY AND OPINIONS, ALL IN THE FIELD OF TELEVISION BUSINESS, PERSONALITIES, SHOWS, TELEVISION PRODUCTION COMPANIES, TELEVISION STUDIOS, THEATRES, EVENTS IN THE NATURE OF AWARD SHOWS, DOCUMENTARIES AND ENTERTAINMENT SHOWS, BROADCASTS AND OTHER ASPECTS OF THE TELEVISION INDUSTRY, NAMELY, TELEVISION BUSINESS (U.S. CLS. 21, 23, 26, 36 AND 38).

CLASS 16—PAPER GOODS AND PRINTED MATTER

FOR (BASED ON INTENT TO USE) MAGAZINES AND PRINTED MATTER, NAMELY, JOURNALS AND NEWSPAPERS, CONTAINING IMAGES, REVIEWS, COMMENTS AND OPINIONS, ALL IN THE FIELD OF BUSINESS, PERSONALITIES, SHOWS, PRODUCTION COMPANIES, STUDIOS, THEATRES, EVENTS, BROADCASTS AND OTHER ASPECTS OF THE TELEVISION INDUSTRY, NAMELY, TELEVISION BUSINESS (U.S. CLS. 2, 5, 22, 23, 29, 37, 38 AND 50).

CLASS 35—ADVERTISING AND BUSINESS

FOR (BASED ON USE IN COMMERCE) PROVIDING ADVERTISING SERVICES FOR BUSINESSES FOR DISSEMINATION VIA ANY MEDIUM (U.S. CLS. 100, 101 AND 102).

FIRST USE 7-1-2010; IN COMMERCE 7-1-2010.

CLASS 38—COMMUNICATION

FOR (BASED ON INTENT TO USE) PROVIDING ELECTRONIC TRANSMISSION OF VOICE, DATA, VIDEO, AND IMAGES VIA DIGITAL TRANSMISSION; INTERNET BROADCASTING SERVICES; CELLULAR TELEPHONE COMMUNICATION; COMPUTER SERVICES, NAMELY, PROVIDING ON-LINE FACILITIES FOR REAL-TIME INTERACTION WITH OTHER COMPUTER USERS CONCERNING TELEVISION; PROVIDING ON-LINE CHAT ROOMS, FORUMS AND ELECTRONIC BULLETIN BOARDS FOR TRANSMISSION OF MESSAGES AMONG COMPUTER USERS CONCERNING THE FIELD OF TELEVISION; PROVIDING E-MAIL AND INSTANT MESSAGING SERVICES (U.S. CLS. 100, 101 AND 104).

CLASS 39—TRANSPORTATION AND STORAGE

FOR (BASED ON INTENT TO USE) ON-LINE COMPUTER SERVICES IN THE NATURE OF PROVIDING A WEBSITE FOR THE ELECTRONIC STORAGE OF IMAGES, TEXT, AUDIO AND VIDEO DATA (U.S. CLS. 100 AND 105).

CLASS 41—EDUCATION AND ENTERTAINMENT

SN 85-161,464. LINEHAN, MARSHA M., SEATTLE, WA. FILED 10-26-2010.

FOR (BASED ON USE IN COMMERCE) PRODUCTION OF DIGITAL MEDIA, NAMELY, VIDEO, FILM AND AUDIO; ELECTRONIC PUBLISHING SERVICES, NAMELY, ELECTRONIC DESKTOP PUBLISHING; PROVIDING A WEBSITE FEATURING NON-DOWNLOADABLE PUBLICATIONS IN THE NATURE OF MAGAZINES, NEWSLETTERS, AND BLOGS, ALL FEATURING INFORMATION, COMMENTARY AND OPINION IN THE FIELDS OF FASHION, ENTERTAINMENT, SPORTS, POLITICS, BUSINESS, PERSONALITIES AND OTHER ASPECTS OF THE TELEVISION BUSINESS (U.S. CLS. 100, 101 AND 107).
FIRST USE 7-1-2010; IN COMMERCE 7-1-2010.

DBT

THE MARK CONSISTS OF STANDARD CHARACTERS WITHOUT CLAIM TO ANY PARTICULAR FONT, STYLE, SIZE, OR COLOR.

CLASS 42—SCIENTIFIC AND COMPUTER SERVICES

CLASS 41—EDUCATION AND ENTERTAINMENT

FOR (BASED ON INTENT TO USE) DIGITAL MEDIA AUTHORING SERVICES, NAMELY, ELECTRONIC SITE AUTHORING AND SOFTWARE AUTHORING; HOSTING ON-LINE SITES, NAMELY, HOSTING THE WEBSITES OF OTHERS ON A COMPUTER SERVER FOR A GLOBAL COMPUTER NETWORK (U.S. CLS. 100 AND 101).
JAMES STEIN, EXAMINING ATTORNEY

FOR EDUCATIONAL SERVICES, NAMELY, CONDUCTING CLASSES, SEMINARS, WORKSHOPS AND CONFERENCES IN THE FIELD OF CLINICAL PSYCHOLOGY AND DISTRIBUTION OF TRAINING AND COURSE MATERIALS IN CONNECTION THEREWITH (U.S. CLS. 100, 101 AND 107).
FIRST USE 3-31-1993; IN COMMERCE 3-31-1993.

SN 85-160,633. RADLO FOODS LLC, WATERTOWN, MA. FILED 10-25-2010.

CLASS 42—SCIENTIFIC AND COMPUTER SERVICES

BORN FREE FREE ROAMING

FOR RESEARCH AND DEVELOPMENT OF TREATMENTS IN THE FIELD OF CLINICAL PSYCHOLOGY; PROVIDING SCIENTIFIC INFORMATION IN THE FIELD OF CLINICAL TRIALS (U.S. CLS. 100 AND 101).
FIRST USE 3-31-1993; IN COMMERCE 3-31-1993.

THE MARK CONSISTS OF STANDARD CHARACTERS WITHOUT CLAIM TO ANY PARTICULAR FONT, STYLE, SIZE, OR COLOR.

CLASS 44—MEDICAL, BEAUTY AND AGRICULTURAL SERVICES

OWNER OF U.S. REG. NOS. 2,741,175 AND 3,767,370.
NO CLAIM IS MADE TO THE EXCLUSIVE RIGHT TO USE "FREE ROAMING", APART FROM THE MARK AS SHOWN.

FOR PSYCHOTHERAPY SERVICES (U.S. CLS. 100 AND 101).
FIRST USE 3-31-1993; IN COMMERCE 3-31-1993.
VIVIAN MICZNIK FIRST, EXAMINING ATTORNEY

SN 85-175,369. THE WHITE DOG, BELMAR, LLC, BELMAR, NJ. FILED 11-12-2010.

CLASS 29—MEATS AND PROCESSED FOODS

FOR EGGS, MEAT, FISH, POULTRY, GAME, AND DAIRY PRODUCTS EXCLUDING ICE CREAM, ICE MILK AND FROZEN YOGURT; FROZEN FOODS, NAMELY, OMELETS AND PRE-MADE MEALS CONSISTING PRIMARILY OF EGGS, TURKEY SAUSAGE, TURKEY BACON, CHEESE, VEGETABLES AND POTATOES; BREAKFAST PRODUCTS, NAMELY, OMELETS AND PRE-MADE MEALS CONSISTING PRIMARILY OF EGG PRODUCTS, TURKEY SAUSAGE, TURKEY BACON, CHEESE, VEGETABLES AND POTATOES; EGG SUBSTITUTES; DAIRY PRODUCTS, NAMELY, MILK, YOGURT, CHEESE, BUTTER AND CREAM; ALL THE FOREGOING MADE FROM OR WITH CAGE-FREE OR FREE RANGE ANIMALS (U.S. CL. 46).



CLASS 30—STAPLE FOODS

FOR DAIRY PRODUCTS, NAMELY, ICE CREAM, ICE MILK AND FROZEN YOGURT; FROZEN FOODS, NAMELY, PRE-MADE SANDWICHES CONSISTING PRIMARILY OF EGG PRODUCTS, TURKEY SAUSAGE, TURKEY BACON, CHEESE, VEGETABLES AND POTATOES; BREAKFAST PRODUCTS, NAMELY, PRE-MADE SANDWICHES CONSISTING PRIMARILY OF EGG PRODUCTS, TURKEY SAUSAGE, TURKEY BACON, CHEESE, VEGETABLES AND POTATOES; ALL THE FOREGOING MADE FROM OR WITH CAGE-FREE OR FREE RANGE ANIMALS (U.S. CL. 46).
FRANK LATTUCA, EXAMINING ATTORNEY

NO CLAIM IS MADE TO THE EXCLUSIVE RIGHT TO USE "BELMAR, NJ", APART FROM THE MARK AS SHOWN.

THE MARK CONSISTS OF A DOG WITH THE STYLIZED TEXT "THE WHITE DOG BELMAR, NJ".

CLASS 12—VEHICLES

FOR ANTI-SKID TEXTILE COVERS FOR TIRES (U.S. CLS. 19, 21, 23, 31, 35 AND 44).

CLASS 21—HOUSEWARES AND GLASS

FOR BEVERAGE GLASSWARE; COFFEE MUGS (U.S. CLS. 2, 13, 23, 29, 30, 33, 40 AND 50).
APRIL ROACH, EXAMINING ATTORNEY

CLASS 41—EDUCATION AND ENTERTAINMENT

FOR PROVIDING A WEB SITE THAT FEATURES INFORMAL INSTRUCTION ON CARDIOVASCULAR HEALTH (U.S. CLS. 100, 101 AND 107).
FIRST USE 1-31-2010; IN COMMERCE 1-31-2010.
JESSICA FATHY, EXAMINING ATTORNEY

SN 85-178,973. EDITIONS DE PARFUMS, PARIS, FRANCE,
FILED 11-17-2010.

SN 85-181,106. SANDVIKS HOP, INC., DANBURY, CT.
FILED 11-19-2010.

IRIS POUUDRE**HOOKED ON**

THE MARK CONSISTS OF STANDARD CHARACTERS WITHOUT CLAIM TO ANY PARTICULAR FONT, STYLE, SIZE, OR COLOR.

OWNER OF U.S. REG. NO. 2,668,283.
NO CLAIM IS MADE TO THE EXCLUSIVE RIGHT TO USE "POUDRE", APART FROM THE MARK AS SHOWN.
THE ENGLISH TRANSLATION OF "POUDRE" IN THE MARK IS "POWDER".

THE MARK CONSISTS OF STANDARD CHARACTERS WITHOUT CLAIM TO ANY PARTICULAR FONT, STYLE, SIZE, OR COLOR.

OWNER OF U.S. REG. NOS. 1,876,555, 2,591,385 AND OTHERS.

CLASS 3—COSMETICS AND CLEANING PREPARATIONS

FOR PERFUMERY, PERFUMES, ESSENTIAL OILS, COSMETICS, DEODORANTS FOR PERSONAL USE, OILS FOR PERFUMES; MAKEUP REMOVERS; SKIN-CARE PREPARATIONS, NAMELY, BODY WASH; HAIR CLEANING PREPARATIONS; INCENSE; ROOM FRAGRANCES FOR REFILLING FRAGRANCE DISPENSERS (U.S. CLS. 1, 4, 6, 50, 51 AND 52).

FIRST USE 0-0-2000; IN COMMERCE 8-30-2006.

CLASS 5—PHARMACEUTICALS

FOR AIR-FRESHENING PREPARATIONS (U.S. CLS. 6, 18, 44, 46, 51 AND 52).
BERYL GARDNER, EXAMINING ATTORNEY

CLASS 9—ELECTRICAL AND SCIENTIFIC APPARATUS

FOR PRE-RECORDED CDS, VIDEO TAPES, LASER DISKS AND DVDS FEATURING READING, WRITING, SPELLING, LANGUAGE ARTS, FOREIGN LANGUAGES, MATH, SCIENCE, TECHNOLOGY, SOCIAL SCIENCES, ARTS, HUMANITIES, RELIGION, MUSIC INSTRUCTION, TYPING, CHILD DEVELOPMENT, HOME SCHOOLING, HEALTH, FITNESS, AND NUTRITION, ALL OF THE ABOVE EXCLUDING MUSICAL ENTERTAINMENT (U.S. CLS. 21, 23, 26, 36 AND 38).
FIRST USE 7-27-2001; IN COMMERCE 7-27-2001.

SN 85-179,969. AMERICAN HEART ASSOCIATION, DALLAS, TX. FILED 11-18-2010.

My Life Check**CLASS 16—PAPER GOODS AND PRINTED MATTER**

FOR PACKAGED KITS COMPRISING PRINTED INSTRUCTIONAL, EDUCATIONAL, AND TEACHING MATERIALS FOR EDUCATIONAL ACTIVITIES IN THE FIELD OF READING, WRITING, SPELLING, LANGUAGE ARTS, FOREIGN LANGUAGES, MATH, SCIENCE, TECHNOLOGY, SOCIAL SCIENCES, ARTS, HUMANITIES, RELIGION, MUSIC, TYPING, CHILD DEVELOPMENT, HOME SCHOOLING, HEALTH, FITNESS, AND NUTRITION; PRINTED INSTRUCTIONAL, EDUCATIONAL, AND TEACHING MATERIALS IN THE FIELD OF READING, WRITING, SPELLING, LANGUAGE ARTS, FOREIGN LANGUAGES, MATH, SCIENCE, TECHNOLOGY, SOCIAL SCIENCES, ARTS, HUMANITIES, RELIGION, MUSIC INSTRUCTION, TYPING, CHILD DEVELOPMENT, HOME SCHOOLING, HEALTH, FITNESS, AND NUTRITION, ALL OF THE ABOVE EXCLUDING MUSIC ENTERTAINMENT (U.S. CLS. 2, 5, 22, 23, 29, 37, 38 AND 50).

FIRST USE 2-0-1987; IN COMMERCE 2-0-1987.
JAY FLOWERS, EXAMINING ATTORNEY

THE MARK CONSISTS OF STANDARD CHARACTERS WITHOUT CLAIM TO ANY PARTICULAR FONT, STYLE, SIZE, OR COLOR.

CLASS 16—PAPER GOODS AND PRINTED MATTER

FOR BROCHURES ABOUT CARDIOVASCULAR HEALTH; INFORMATIONAL FLYERS FEATURING CARDIOVASCULAR HEALTH; POSTERS (U.S. CLS. 2, 5, 22, 23, 29, 37, 38 AND 50).
FIRST USE 2-26-2010; IN COMMERCE 2-26-2010.

SN 85-181,472. HOME FOCUS DEVELOPMENT LIMITED, TORTOLA, BR. VIRGIN ISLANDS, FILED 11-19-2010.

FILLY

THE MARK CONSISTS OF STANDARD CHARACTERS WITHOUT CLAIM TO ANY PARTICULAR FONT, STYLE, SIZE, OR COLOR.

OWNER OF ERP N CMNTY TM OFC REG. NO. 004863999, DATED 1-17-2007, EXPIRES 1-27-2016.

CLASS 14—JEWELRY

FOR PRECIOUS METALS AND THEIR ALLOYS; GOODS MADE OF PRECIOUS METALS OR COATED THEREWITH, NAMELY, BUSTS OF PRECIOUS METALS, DECORATIVE BOXES MADE OF PRECIOUS METAL, DESKTOP STATUARY MADE OF PRECIOUS METAL, FIGURINES OF PRECIOUS METAL, JEWEL CASES OF PRECIOUS METAL, JEWELLERY CASES OF PRECIOUS METAL, KEY CHAINS OF PRECIOUS METAL, KEY HOLDERS OF PRECIOUS METALS, KEY RINGS OF PRECIOUS METALS, MODEL FIGURES MADE OF PRECIOUS METAL; JEWELLERY; PRECIOUS STONES; HOROLOGICAL AND CHRONOMETRIC INSTRUMENTS (U.S. CLS. 2, 27, 28 AND 50).

CLASS 25—CLOTHING

FOR CLOTHING AND FOOTWEAR, NAMELY, FOOTWEAR OF ALL KINDS; JACKETS, COATS, SHIRTS, BLOUSES, T-SHIRTS, SOCKS, SHORTS, SCARVES; SPORTSWEAR, NAMELY, SHORTS, UNDERWEAR, NIGHTWEAR, GLOVES, BATHROBES, APRONS, PANTS, HOSIERY, WINTERWEAR, NAMELY, LONG UNDERWEAR, RAINWEAR, VESTS, SWIMWEAR, BEACH PONCHOS; HEADWEAR OF ALL KINDS; CAPS (U.S. CLS. 22 AND 39).

JESSICA FATHY, EXAMINING ATTORNEY

SN 85-182,110. MARKUS M. HEISS, KOLN, FED REP GERMANY, FILED 11-22-2010.

WEBOP

THE MARK CONSISTS OF STANDARD CHARACTERS WITHOUT CLAIM TO ANY PARTICULAR FONT, STYLE, SIZE, OR COLOR.

PRIORITY CLAIMED UNDER SEC. 44(D) ON ERP N CMNTY TM OFC APPLICATION NO. 009162454, FILED 5-21-2010, REG. NO. 009162454, DATED 7-13-2010, EXPIRES 5-21-2020.

CLASS 35—ADVERTISING AND BUSINESS

FOR BUSINESS MANAGEMENT, BUSINESS CONSULTANCY, BUSINESS ADMINISTRATION, ALL OF THE FOREGOING RELATING TO AND IN THE NATURE OF PROVIDING SERVICES IN THE MEDICAL SECTOR (U.S. CLS. 100, 101 AND 102).

CLASS 38—COMMUNICATION

FOR TELECOMMUNICATIONS PROVIDED TO THE MEDICAL SECTOR, NAMELY, ELECTRONIC TRANSMISSION OF MEDICAL DATA (U.S. CLS. 100, 101 AND 104).

CLASS 44—MEDICAL, BEAUTY AND AGRICULTURAL SERVICES

FOR MEDICAL SERVICES; MEDICAL ANALYSIS SERVICES FOR THE DIAGNOSIS AND TREATMENT OF INDIVIDUALS; MEDICAL AND CLINICAL EXAMINATIONS OF INDIVIDUALS FOR MEDICAL DIAGNOSTIC PURPOSES (U.S. CLS. 100 AND 101).

BARBARA GAYNOR, EXAMINING ATTORNEY

SN 85-186,752. ASC UTAH LLC, PARK CITY, UT. FILED 11-29-2010.

AMAZING SIMPLICITY

THE MARK CONSISTS OF STANDARD CHARACTERS WITHOUT CLAIM TO ANY PARTICULAR FONT, STYLE, SIZE, OR COLOR.

CLASS 41—EDUCATION AND ENTERTAINMENT

FOR PROVIDING ENTERTAINMENT SERVICES, NAMELY, OPERATION OF SKI RESORTS; PROVIDING YEAR ROUND FACILITIES FOR RECREATIONAL ACTIVITIES, NAMELY, FACILITIES FOR SKIING, SNOWBOARDING, HIKING, MOUNTAIN BIKING, SIGHT-SEEING, AND ORGANIZING AND CONDUCTING SOCIAL EVENTS AND COMMUNITY FESTIVALS IN THE NATURE OF PARTIES, FAIRS, ART EXHIBITS, SPORTING EVENTS, NAMELY, MOUNTAIN BIKE, SKI AND SNOWBOARD COMPETITIONS; PROVIDING INSTRUCTION IN THE FIELD OF SKIING AND SNOWBOARDING; OPERATION OF A SKI RESORT; PROVIDING YEAR ROUND RECREATIONAL ACTIVITIES SERVICES, NAMELY, PROVIDING SKI SLOPES; RENTAL OF SKI EQUIPMENT; RENTAL OF SKIS; SKI INSTRUCTION; SKI RESORTS; SKI TUNING SERVICES; PROVIDING YEAR ROUND RECREATIONAL ACTIVITIES SERVICES, NAMELY, PROVIDING SNOWBOARDING SLOPES; RENTAL OF SNOWBOARDING EQUIPMENT; RENTAL OF SNOWBOARDS AND SNOWBOARD BOOTS; SNOWBOARDING INSTRUCTION; SNOWBOARDING RESORTS; SNOWBOARD TUNING SERVICES; PROVIDING SERVICES FOR YEAR-ROUND RECREATIONAL ACTIVITIES, NAMELY, PROVIDING FACILITIES FOR SKIING, SNOWBOARDING, HIKING, MOUNTAIN BIKING, SIGHT-SEEING, GOLF, HORSEBACK RIDING, TENNIS AND SWIMMING; ORGANIZING AND CONDUCTING SOCIAL EVENTS AND COMMUNITY FESTIVALS IN THE NATURE OF PARTIES, FAIRS, SPORTING EVENTS, NAMELY, MOUNTAIN BIKE, SKI AND SNOWBOARD COMPETITIONS AND ART EXHIBITS; PROVIDING INSTRUCTION IN THE FIELD OF SKIING AND SNOWBOARDING; PROVIDING SPORTS RELATED INFORMATION IN THE FIELD OF RECREATIONAL ACTIVITIES; ENTERTAINMENT SERVICES, NAMELY, PROVIDING AN ONLINE INTERACTIVE DATABASE OF VIDEOS IN THE FIELD OF OUTDOOR RECREATIONAL ACTIVITIES (U.S. CLS. 100, 101 AND 107).

CLASS 43—HOTEL AND RESTAURANT SERVICES

FOR RESORT LODGING AND RESTAURANT SERVICES (U.S. CLS. 100 AND 101).

TRACY WHITTAKER-BROWN, EXAMINING ATTORNEY

SN 85-187,377. KELLER WILLIAMS REALTY, INC., AUSTIN, TX. FILED 11-30-2010.

BOLD Leadership

THE MARK CONSISTS OF STANDARD CHARACTERS WITHOUT CLAIM TO ANY PARTICULAR FONT, STYLE, SIZE, OR COLOR.

NO CLAIM IS MADE TO THE EXCLUSIVE RIGHT TO USE "LEADERSHIP", APART FROM THE MARK AS SHOWN.

CLASS 36—INSURANCE AND FINANCIAL

FOR CONSULTING SERVICES FOR REAL ESTATE PROFESSIONALS IN THE FIELD OF REAL ESTATE BROKERAGE (U.S. CLS. 100, 101 AND 102).

CLASS 41—EDUCATION AND ENTERTAINMENT

FOR PROFESSIONAL EDUCATION AND DEVELOPMENT SERVICES, NAMELY, PROVIDING INSTRUCTION, TRAINING, COACHING AND ONE-ON-ONE MENTORING FOR REAL ESTATE PROFESSIONALS, ALL OF THE FOREGOING IN THE FIELD OF REAL ESTATE MARKETING AND SALES (U.S. CLS. 100, 101 AND 107).

NANCY CLARKE, EXAMINING ATTORNEY

SN 85-191,228. PERENNIAL INVESTMENT PARTNERS LIMITED, SYDNEY NEW SOUTH WALES, AUSTRALIA, FILED 12-6-2010.



NO CLAIM IS MADE TO THE EXCLUSIVE RIGHT TO USE "INVESTMENT PARTNERS", APART FROM THE MARK AS SHOWN.

THE MARK CONSISTS OF THE WORDS "PERENNIAL INVESTMENT PARTNERS" STACKED IN BETWEEN TWO PARALLEL HORIZONTAL LINES AND THE WORD "INVESTMENT" INSIDE OF A BLOCK, ALL TO THE RIGHT OF A SQUARE DESIGN WITH A CURVED WHITE STREAK.

CLASS 16—PAPER GOODS AND PRINTED MATTER

FOR PRINTED MATTER AND PUBLICATIONS RELATING TO FINANCIAL SERVICES AND FINANCIAL AFFAIRS, NAMELY, PRINTED PUBLIC OFFER DOCUMENTS, NAMELY, PROSPECTUSES, PRINTED ANNUAL REPORTS, NEWSLETTERS, PRODUCT DISCLOSURE STATEMENTS AND MEMORANDA, ALL IN THE FIELDS OF FUNDS MANAGEMENT SERVICES AND CAPITAL INVESTMENT, FINANCIAL EVALUATION AND FINANCIAL ANALYSIS SERVICES, FINANCIAL MANAGEMENT SERVICES, FINANCIAL INFORMATION SERVICES, INVESTMENT ADVISORY SERVICES, FINANCIAL CONSULTANCY SERVICES, FUND INVESTMENTS, MUTUAL FUNDS, TRUSTEESHIP, BROKERAGE, EXCHANGING MONEY (U.S. CLS. 2, 5, 22, 23, 29, 37, 38 AND 50).

CLASS 36—INSURANCE AND FINANCIAL

FOR FINANCIAL SERVICES, NAMELY, FUNDS MANAGEMENT SERVICES AND CAPITAL INVESTMENT; FINANCIAL EVALUATION AND FINANCIAL ANALYSIS SERVICES; FINANCIAL MANAGEMENT SERVICES; FINANCIAL INFORMATION SERVICES; INVESTMENT ADVISORY SERVICES; FINANCIAL CONSULTANCY SERVICES; FUND INVESTMENTS; MUTUAL FUNDS; TRUSTEESHIP, NAMELY, TRUSTEE SERVICES AND RESPONSIBLE ENTITY SERVICES, NAMELY, FIDUCIARY REPRESENTATIVE SERVICES; BROKERAGE, NAMELY, INVESTMENT BROKERAGE, MORTGAGE BROKERAGE, MUTUAL FUND BROKERAGE, REAL ESTATE BROKERAGE AND SECURITIES BROKERAGE; EXCHANGING MONEY (U.S. CLS. 100, 101 AND 102).

ROBIN CHOSID, EXAMINING ATTORNEY

SN 85-191,297. PERENNIAL INVESTMENT PARTNERS LIMITED, SYDNEY NEW SOUTH WALES, AUSTRALIA, FILED 12-6-2010.

PERENNIAL INVESTMENT PARTNERS

THE MARK CONSISTS OF STANDARD CHARACTERS WITHOUT CLAIM TO ANY PARTICULAR FONT, STYLE, SIZE, OR COLOR.

NO CLAIM IS MADE TO THE EXCLUSIVE RIGHT TO USE "INVESTMENT PARTNERS", APART FROM THE MARK AS SHOWN.

CLASS 16—PAPER GOODS AND PRINTED MATTER

FOR PRINTED MATTER AND PUBLICATIONS RELATING TO FINANCIAL SERVICES AND FINANCIAL AFFAIRS, NAMELY, PRINTED PUBLIC OFFER DOCUMENTS, NAMELY, PROSPECTUSES, PRINTED ANNUAL REPORTS, NEWSLETTERS, PRODUCT DISCLOSURE STATEMENTS AND MEMORANDA, ALL IN THE FIELDS OF FUNDS MANAGEMENT SERVICES AND CAPITAL INVESTMENT, FINANCIAL EVALUATION AND FINANCIAL ANALYSIS SERVICES, FINANCIAL MANAGEMENT SERVICES, FINANCIAL INFORMATION SERVICES, INVESTMENT ADVISORY SERVICES, FINANCIAL CONSULTANCY SERVICES, FUND INVESTMENTS, MUTUAL FUNDS, TRUSTEESHIP, BROKERAGE, EXCHANGING MONEY (U.S. CLS. 2, 5, 22, 23, 29, 37, 38 AND 50).

CLASS 36—INSURANCE AND FINANCIAL

FOR FINANCIAL SERVICES, NAMELY, FUNDS MANAGEMENT SERVICES AND CAPITAL INVESTMENT; FINANCIAL EVALUATION AND FINANCIAL ANALYSIS SERVICES; FINANCIAL MANAGEMENT SERVICES; FINANCIAL INFORMATION SERVICES; INVESTMENT ADVISORY SERVICES; FINANCIAL CONSULTANCY SERVICES; FUND INVESTMENTS; MUTUAL FUNDS; TRUSTEESHIP, NAMELY, TRUSTEE SERVICES AND RESPONSIBLE ENTITY SERVICES, NAMELY, FIDUCIARY REPRESENTATIVE SERVICES; BROKERAGE, NAMELY, INVESTMENT BROKERAGE, MORTGAGE BROKERAGE, MUTUAL FUND BROKERAGE, REAL ESTATE BROKERAGE AND SECURITIES BROKERAGE; EXCHANGING MONEY (U.S. CLS. 100, 101 AND 102).

ROBIN CHOSID, EXAMINING ATTORNEY

SN 85-192,961. TAHIRA SUZANNE KHAN, NEWTON, MA. FILED 12-8-2010.

SUGARHOUSE MEDIA

THE MARK CONSISTS OF STANDARD CHARACTERS WITHOUT CLAIM TO ANY PARTICULAR FONT, STYLE, SIZE, OR COLOR.

NO CLAIM IS MADE TO THE EXCLUSIVE RIGHT TO USE "MEDIA", APART FROM THE MARK AS SHOWN.

SN 85-191,338. PERENNIAL INVESTMENT PARTNERS LIMITED, SYDNEY NEW SOUTH WALES, AUSTRALIA, FILED 12-6-2010.

PERENNIAL REAL ESTATE

THE MARK CONSISTS OF STANDARD CHARACTERS WITHOUT CLAIM TO ANY PARTICULAR FONT, STYLE, SIZE, OR COLOR.

NO CLAIM IS MADE TO THE EXCLUSIVE RIGHT TO USE "REAL ESTATE", APART FROM THE MARK AS SHOWN.

CLASS 16—PAPER GOODS AND PRINTED MATTER

FOR PRINTED MATTER AND PUBLICATIONS RELATING TO FINANCIAL SERVICES AND FINANCIAL AFFAIRS, NAMELY, PRINTED PUBLIC OFFER DOCUMENTS, NAMELY, PROSPECTUSES, PRINTED ANNUAL REPORTS, NEWSLETTERS, PRODUCT DISCLOSURE STATEMENTS AND MEMORANDA, ALL IN THE FIELDS OF FUNDS MANAGEMENT SERVICES AND CAPITAL INVESTMENT, FINANCIAL EVALUATION AND FINANCIAL ANALYSIS SERVICES, FINANCIAL MANAGEMENT SERVICES, FINANCIAL INFORMATION SERVICES, INVESTMENT ADVISORY SERVICES, FINANCIAL CONSULTANCY SERVICES, FUND INVESTMENTS, MUTUAL FUNDS, TRUSTEESHIP, BROKERAGE, EXCHANGING MONEY (U.S. CLS. 2, 5, 22, 23, 29, 37, 38 AND 50).

CLASS 36—INSURANCE AND FINANCIAL

FOR FINANCIAL SERVICES, NAMELY, FUNDS MANAGEMENT SERVICES AND CAPITAL INVESTMENT; FINANCIAL EVALUATION AND FINANCIAL ANALYSIS SERVICES; FINANCIAL MANAGEMENT SERVICES; FINANCIAL INFORMATION SERVICES; INVESTMENT ADVISORY SERVICES; FINANCIAL CONSULTANCY SERVICES; FUND INVESTMENTS; MUTUAL FUNDS; TRUSTEESHIP, NAMELY, TRUSTEE SERVICES AND RESPONSIBLE ENTITY SERVICES, NAMELY, FIDUCIARY REPRESENTATIVE SERVICES; BROKERAGE, NAMELY, INVESTMENT BROKERAGE, MORTGAGE BROKERAGE, MUTUAL FUND BROKERAGE, REAL ESTATE BROKERAGE AND SECURITIES BROKERAGE; EXCHANGING MONEY (U.S. CLS. 100, 101 AND 102).

ROBIN CHOSID, EXAMINING ATTORNEY

CLASS 35—ADVERTISING AND BUSINESS

FOR ADVERTISING AND PUBLICITY SERVICES, NAMELY, PROMOTING THE GOODS, SERVICES, BRAND IDENTITY AND COMMERCIAL INFORMATION AND NEWS OF THIRD PARTIES THROUGH PRINT, AUDIO, VIDEO, DIGITAL AND ON-LINE MEDIUM; PREPARING ADVERTISEMENTS FOR OTHERS, NAMELY, PREPARING VIDEO ADVERTISING AND PROMOTIONAL VIDEOS FOR COMMERCIAL USE VIA THE INTERNET AND TELEVISION, DIGITAL CABLE AND VIDEO-ON-DEMAND OR DOWNLOAD; PREPARATION OF INSTRUCTIONAL AND TRAINING VIDEOS FOR OTHERS FOR USE VIA THE INTERNET AND TELEVISION, DIGITAL CABLE AND VIDEO-ON-DEMAND OR DOWNLOAD; PRODUCING PROMOTIONAL VIDEOTAPES, VIDEO DISCS, AND AUDIO VISUAL RECORDINGS; WRITING OF PUBLICITY TEXTS (U.S. CLS. 100, 101 AND 102).

CLASS 41—EDUCATION AND ENTERTAINMENT

FOR AUDIO AND VIDEO RECORDING SERVICES; FILM AND VIDEO RECORDING AND PRODUCTION SERVICES; FILM AND VIDEO PRODUCTION CONSULTING SERVICES; PHOTOGRAPHIC AND VIDEO SERVICES, NAMELY, PHOTOGRAPHIC AND VIDEO CAPTURE; PRODUCTION AND DISTRIBUTION OF ENTERTAINMENT AND EDUCATIONAL MOTION PICTURE FILMS ON A WIDE VARIETY OF THEMES; PRODUCTION AND DISTRIBUTION OF MOTION PICTURE FILMS FEATURING LIVE ACTION, NON-FICTION CONTENT, NEWS AND STORIES, MUSIC, COMEDY OR DRAMA; CUSTOM WRITING SERVICES (U.S. CLS. 100, 101 AND 107).

NAPOLEON SHARMA, EXAMINING ATTORNEY

SN 85-193,667. ARC PRODUCTS, INC., CLEVELAND, OH. FILED 12-8-2010.

AP AUTOMATION

THE MARK CONSISTS OF STANDARD CHARACTERS WITHOUT CLAIM TO ANY PARTICULAR FONT, STYLE, SIZE, OR COLOR.

NO CLAIM IS MADE TO THE EXCLUSIVE RIGHT TO USE "AUTOMATION", APART FROM THE MARK AS SHOWN.

CLASS 7—MACHINERY

FOR ELECTRIC WELDING MACHINES AND PARTS AND FITTINGS THEREOF; MACHINE PARTS FOR LINEAR MOVEMENT TECHNOLOGY APPARATUSES, NAMELY, EXTRUDED ALUMINUM U-CHANNELS USED TO CREATE THE BASE STRUCTURE FOR LINEAR GUIDES, LINEAR SLIDES AND CROSS SLIDES; MACHINES PARTS, NAMELY, PIPE ROLLERS AND ROTATORS USED TO HOLD ROTATING PIPE OR LARGE PRESSURE VESSELS WHILE WELDING; DRIVE UNITS USED TO ROTATE OR TURN PIPES AND LARGE PRESSURE VESSELS ON THE ROLLERS AND ROTATORS FOR WELDING EQUIPMENT AND MACHINERY; WELDING WIRE FEEDERS AND ELECTRIC WELDING GUIDES USED FOR POSITIONING THE TORCH OVER THE JOINT TO BE WELDED; WELDING HEADS; PARTS AND FITTINGS FOR ALL OF THE WELDING EQUIPMENT; REPLACEMENT PARTS FOR ALL OF THE WELDING EQUIPMENT (U.S. CLS. 13, 19, 21, 23, 31, 34 AND 35).

FIRST USE 5-23-2002; IN COMMERCE 5-23-2002.

CLASS 9—ELECTRICAL AND SCIENTIFIC APPARATUS

FOR ELECTRIC WELDING APPARATUS, NAMELY, ELECTRIC ARC WELDERS; ELECTRICAL CONTROLLERS FOR ELECTRICAL ARC WELDERS; ELECTRICAL CONTROLLERS FOR SEAM TRACKING SYSTEMS USED TO ACCURATELY TRACK THE SEAM BEING WELDED; ELECTRICAL CONTROLLERS FOR WELDING WIRE FEEDERS USED WITH ELECTRIC ARC WELDERS; MICRO-PROCESSOR, ELECTRONIC, ELECTRICAL AND COMPUTER-GENERATED CONTROLLERS FOR CONTROLLING, AUTOMATING AND MANAGING WELDING EQUIPMENT IN THE NATURE OF GAS TUNGSTEN ARC WELDERS, SUBMERGED ARC WELDERS AND GAS METAL ARC WELDERS; ELECTRICAL CONTROLLERS FOR PLASMA ARC WELDING PROCESSES, CYCLES AND PROGRAMS, NAMELY, AMP, VOLT, WIRE SPEED, AND TRAVEL SPEED PROGRAMS; HAND-HELD ELECTRONIC UNITS AND CABLES FOR CONTROLLING, AUTOMATING AND MANAGING WELDING EQUIPMENT IN THE NATURE OF GAS TUNGSTEN ARC WELDERS, SUBMERGED ARC WELDERS, AND GAS METAL ARC WELDERS AND FOR PLASMA ARC WELDING PROCESSES; HAND HELD ELECTRONIC UNITS AND CABLES FOR PLASMA ARC WELDING PROCESSES, CYCLES AND PROGRAMS, NAMELY, AMP, VOLT, WIRE SPEED, AND TRAVEL SPEED PROGRAMS; PROGRAMMABLE MICRO-PROCESSOR, ELECTRONIC, ELECTRICAL AND COMPUTER-GENERATED CONTROLLERS AND HAND-HELD ELECTRONIC UNITS AND CABLES FOR CONTROLLING, AUTOMATING AND MANAGING WELDING EQUIPMENT IN THE NATURE OF GAS TUNGSTEN ARC WELDERS, SUBMERGED ARC WELDERS AND GAS METAL ARC WELDERS; PROGRAMMABLE MICROPROCESSOR, ELECTRONIC, ELECTRICAL AND COMPUTER-GENERATED CONTROLLERS AND HAND-HELD ELECTRONIC UNITS AND CABLES FOR PLASMA ARC WELDING PROCESSES, CYCLES AND PROGRAMS, NAMELY, AMP, VOLT, WIRE SPEED, AND TRAVEL SPEED PROGRAMS FOR THE PURPOSE OF SEAM TRACKING, ARC VOLTAGE CONTROL, MAGNETIC ARC CONTROL, AND FEEDING WELDING WIRE; ELECTRIC SENSORS AND RELATED MOUNTING BRACKETS; TIP PARTS, NAMELY, A COMPUTER STYLUS FOR ELECTRIC SENSORS; MAGNETIC PROBES USED TO STABILIZE OR OSCILLATE A WELDING ARC; ELECTRICAL POWER DISTRIBUTION UNITS FOR PIPES AND LARGE PRESSURE VESSELS; ELECTRIC FOOT CONTROL SWITCHES USED TO ADJUST THE WELDING MACHINE; PARTS AND FITTINGS FOR ALL THE FOREGOING (U.S. CLS. 21, 23, 26, 36 AND 38).

FIRST USE 1-28-2002; IN COMMERCE 1-28-2002.
WENDY GOODMAN, EXAMINING ATTORNEY

SN 85-194,287. VÄLINGE PHOTOCATALYTIC AB, VIKEN SE-26040, SWEDEN, FILED 12-9-2010.



THE MARK CONSISTS OF THE STYLIZED WORDING "ACTiO2" APPEARING AT THE BOTTOM OF A SHADED SQUARE. UNDERNEATH THE LETTERS "ACTiO" IS A HORIZONTAL LINE. THE NUMBER "2" APPEARS AT THE END OF THE LINE AND BELOW AND TO THE RIGHT OF THE LETTER "O".

CLASS 2—PAINTS

FOR PAINTS, LACQUERS, AND RELATED PRODUCTS, NAMELY, VARNISHES, PRESERVATIVES AGAINST DETERIORATION OF WOOD, ADDITIVES FOR PAINTS, LACQUERS, VARNISHES AND COATINGS CONSISTING OF A LIQUID OF NANO PARTICLES FOR PHOTOCATALYTICAL FUNCTIONALIZATION OF SYNTHETIC MATERIALS, AND ADDITIVES FOR PAINTS, LACQUERS, VARNISHES AND COATINGS CONSISTING OF A LIQUID OF NANO PARTICLES FOR PHOTOCATALYTICAL FUNCTIONALIZATION OF NATURAL MATERIALS (U.S. CLS. 6, 11 AND 16).

CLASS 19—NON-METALLIC BUILDING MATERIALS

FOR BUILDING MATERIALS, NAMELY, NON-METALLIC FLOORS, FLOORING MATERIALS, FLOOR BOARDS AND FLOOR TILES; NON-METALLIC CEILING PANELS, CEILING BOARDS, CEILING TILES AND COVERINGS FOR CEILINGS; NON-METALLIC COVERINGS FOR WALLS, NAMELY, CORK TILES AND TILES OF CORK-BASED CONGLOMERATES FOR WALLS; NON-METALLIC DOOR, ROOFING AND WALL PANELS; DECORATIVE TILES FOR INTERIOR WALLS (U.S. CLS. 1, 12, 33 AND 50).

CLASS 42—SCIENTIFIC AND COMPUTER SERVICES

FOR TECHNOLOGICAL SERVICES AND RESEARCH AND DESIGN RELATING THERETO, NAMELY, DESIGN AND DEVELOPMENT OF FLOORS, FLOORING MATERIALS, FLOOR BOARDS AND FLOOR TILES, CEILINGS, COVERING FOR CEILINGS, COVERING FOR WALLS, PANELS, BUILDING MATERIALS AND FURNITURE (U.S. CLS. 100 AND 101).

CLASS 45—PERSONAL AND LEGAL SERVICES

FOR LICENSING OF INTELLECTUAL PROPERTY RIGHTS, LICENSING OF PATENTS (U.S. CLS. 100 AND 101).

JEFFREY LOOK, EXAMINING ATTORNEY

SN 85-195,714. DHYBRID, INC., ST. GEORGE, UT. FILED 12-10-2010.

ENERGY UNCOVERED

THE MARK CONSISTS OF STANDARD CHARACTERS WITHOUT CLAIM TO ANY PARTICULAR FONT, STYLE, SIZE, OR COLOR.

CLASS 7—MACHINERY

FOR COMPRESSED NATURAL GAS AND LIQUID FUEL BLENDING SYSTEMS COMPRISING SATELLITE COMMUNICATIONS EQUIPMENT, BATTERIES, BATTERY CHARGERS, ELECTRONIC MAPS AND MAPPING PROGRAMS, IGNITION DEVICES, TURBO CHARGERS, NATURAL GAS INFUSERS, REGULATORS BEING PARTS OF MACHINES, FUEL INJECTORS, AND STORAGE TANKS FOR USE IN COMBINATION WITH COMBUSTIBLE ENGINES AND COMPRESSION IGNITION ENGINES FOR MACHINES, LAND VEHICLES, LOCOMOTIVES, AND SHIPS; COMPONENTS AND PARTS FOR USE IN A COMPRESSED NATURAL GAS AND LIQUID FUEL BLENDING SYSTEMS USED IN COMBINATION WITH COMBUSTIBLE ENGINES AND COMPRESSION IGNITION ENGINES FOR MACHINES, LAND VEHICLES, LOCOMOTIVES, AND SHIPS, NAMELY, IGNITION DEVICES, NATURAL GAS INFUSERS, REGULATORS BEING PARTS OF MACHINES, FUEL INJECTORS; STRUCTURAL PARTS OF MACHINES FOR USE IN A COMPRESSED NATURAL GAS AND LIQUID FUEL BLENDING SYSTEMS USED IN COMBINATION WITH COMBUSTIBLE ENGINES AND COMPRESSION IGNITION ENGINES, NAMELY, FUEL STORAGE TANKS; REPLACEMENT PARTS FOR USE IN A COMPRESSED NATURAL GAS AND LIQUID FUEL BLENDING SYSTEMS USED IN COMBINATION WITH COMBUSTIBLE ENGINES AND COMPRESSION IGNITION ENGINES FOR MACHINES, LAND VEHICLES, LOCOMOTIVES, AND SHIPS; HYDRAULIC AND PNEUMATIC CONTROL UNITS FOR USE IN A COMPRESSED NATURAL GAS AND LIQUID FUEL BLENDING SYSTEMS USED IN COMBINATION WITH COMBUSTIBLE ENGINES AND COMPRESSION IGNITION ENGINES FOR MACHINES, LAND VEHICLES, LOCOMOTIVES, AND SHIPS; COMPONENTS AND PARTS FOR USE IN EXHAUST TREATMENT DEVICES USED ON COMBUSTIBLE ENGINES AND COMPRESSION IGNITION ENGINES FOR MACHINES, LAND VEHICLES, LOCOMOTIVES, AND SHIPS, NAMELY, FUEL FILTERS, AIR FILTERS; REPLACEMENT PARTS FOR USE IN EXHAUST TREATMENT DEVICES USED ON COMBUSTIBLE ENGINES AND COMPRESSION IGNITION ENGINES FOR MACHINES, LAND VEHICLES, LOCOMOTIVES, AND SHIPS (U.S. CLS. 13, 19, 21, 23, 31, 34 AND 35).

CLASS 9—ELECTRICAL AND SCIENTIFIC APPARATUS

FOR ELECTRONIC CONTROL UNITS FOR USE IN A COMPRESSED NATURAL GAS AND LIQUID FUEL BLENDING SYSTEMS USED IN COMBINATION WITH COMBUSTIBLE ENGINES AND COMPRESSION IGNITION ENGINES FOR MACHINES, LAND VEHICLES, LOCOMOTIVES, AND SHIPS; COMPONENTS AND PARTS FOR USE IN A COMPRESSED NATURAL GAS AND LIQUID FUEL BLENDING SYSTEMS USED IN COMBINATION WITH COMBUSTIBLE ENGINES AND COMPRESSION IGNITION ENGINES FOR MACHINES, LAND VEHICLES, LOCOMOTIVES, AND SHIPS AND FOR USE IN EXHAUST TREATMENT DEVICES USED ON COMBUSTIBLE ENGINES AND COMPRESSION IGNITION ENGINES FOR MACHINES, LAND VEHICLES, LOCOMOTIVES, AND SHIPS, NAMELY, SATELLITE TRANSCEIVERS, TRANSMITTERS AND RECEIVERS FOR RECEIVING ON-BOARD SATELLITE COMMUNICATIONS, DOWNLOADABLE ELECTRONIC MAPS AND COMPUTER SOFTWARE MAPPING PRO-

GRAMS; COMPONENTS AND PARTS FOR USE IN A COMPRESSED NATURAL GAS AND LIQUID FUEL BLENDING SYSTEMS USED IN COMBINATION WITH COMBUSTIBLE ENGINES AND COMPRESSION IGNITION ENGINES FOR MACHINES, LAND VEHICLES, LOCOMOTIVES, AND SHIPS AND FOR USE IN EXHAUST TREATMENT DEVICES USED ON COMBUSTIBLE ENGINES AND COMPRESSION IGNITION ENGINES FOR MACHINES, LAND VEHICLES, LOCOMOTIVES, AND SHIPS, NAMELY, VEHICLE TRACKING DEVICES COMPRISED OF CELLULAR RADIO MODULES, COMPUTER SOFTWARE AND COMPUTER HARDWARE, SENSORS, TRANSMITTERS, RECEIVERS AND GLOBAL POSITIONING SATELLITE RECEIVERS, ALL FOR USE IN CONNECTION WITH VEHICLE TRACKING AND VEHICLE MONITORING; COMPONENTS AND PARTS FOR USE IN A COMPRESSED NATURAL GAS AND LIQUID FUEL BLENDING SYSTEMS USED IN COMBINATION WITH COMBUSTIBLE ENGINES AND COMPRESSION IGNITION ENGINES FOR MACHINES, LAND VEHICLES, LOCOMOTIVES, AND SHIPS, NAMELY, SATELLITE COMMUNICATIONS EQUIPMENT IN THE NATURE OF SATELLITE TRANSMITTERS, SATELLITE RECEIVERS, AND SATELLITE TRANSCEIVERS, BATTERIES, BATTERY CHARGERS, DOWNLOADABLE ELECTRONIC MAPS AND MAPPING PROGRAMS; COMPONENTS AND PARTS FOR USE IN EXHAUST TREATMENT DEVICES USED ON COMBUSTIBLE ENGINES AND COMPRESSION IGNITION ENGINES FOR MACHINES, LAND VEHICLES, LOCOMOTIVES, AND SHIPS, NAMELY, EXHAUST SENSORS, TEMPERATURE SENSORS (U.S. CLS. 21, 23, 26, 36 AND 38).

WILLIAM P. SHANAHAN, EXAMINING ATTORNEY

SN 85-195,721. DHYBRID, INC., ST. GEORGE, UT. FILED 12-10-2010.

DHYBRID

THE MARK CONSISTS OF STANDARD CHARACTERS WITHOUT CLAIM TO ANY PARTICULAR FONT, STYLE, SIZE, OR COLOR.

CLASS 7—MACHINERY

FOR COMPRESSED NATURAL GAS AND LIQUID FUEL BLENDING SYSTEMS COMPRISING SATELLITE COMMUNICATIONS EQUIPMENT, BATTERIES, BATTERY CHARGERS, ELECTRONIC MAPS AND MAPPING PROGRAMS, IGNITION DEVICES, TURBO CHARGERS, NATURAL GAS INFUSERS, REGULATORS BEING PARTS OF MACHINES, FUEL INJECTORS, AND STORAGE TANKS FOR USE IN COMBINATION WITH COMBUSTIBLE ENGINES AND COMPRESSION IGNITION ENGINES FOR MACHINES, LAND VEHICLES, LOCOMOTIVES, AND SHIPS; COMPONENTS AND PARTS FOR USE IN A COMPRESSED NATURAL GAS AND LIQUID FUEL BLENDING SYSTEMS USED IN COMBINATION WITH COMBUSTIBLE ENGINES AND COMPRESSION IGNITION ENGINES FOR MACHINES, LAND VEHICLES, LOCOMOTIVES, AND SHIPS, NAMELY, IGNITION DEVICES, NATURAL GAS INFUSERS, REGULATORS BEING PARTS OF MACHINES, FUEL INJECTORS; STRUCTURAL PARTS OF MACHINES FOR USE IN A COMPRESSED NATURAL GAS AND LIQUID FUEL BLENDING SYSTEMS USED IN COMBINATION WITH COMBUSTIBLE ENGINES AND COMPRESSION IGNITION ENGINES, NAMELY, FUEL STORAGE TANKS; REPLACEMENT PARTS FOR USE IN A COMPRESSED NATURAL GAS AND LIQUID FUEL BLENDING SYSTEMS USED IN COMBINATION WITH COMBUSTIBLE ENGINES AND COMPRESSION IGNITION ENGINES FOR MACHINES, LAND VEHICLES, LOCOMOTIVES, AND SHIPS; HYDRAULIC AND PNEUMATIC CONTROL UNITS FOR USE IN A COMPRESSED NATURAL GAS AND LIQUID FUEL BLENDING SYSTEMS USED IN COMBINATION WITH COMBUSTIBLE ENGINES AND COMPRESSION IGNITION ENGINES FOR MACHINES, LAND VEHICLES, LOCOMOTIVES, AND SHIPS; COMPONENTS AND PARTS FOR USE IN EXHAUST TREATMENT DEVICES USED ON COMBUSTIBLE ENGINES AND COMPRESSION IGNITION ENGINES FOR MACHINES, LAND VEHICLES, LOCOMOTIVES, AND SHIPS, NAMELY, FUEL FILTERS, AIR FILTERS; REPLACEMENT PARTS FOR USE IN EXHAUST TREATMENT DEVICES USED ON COMBUSTIBLE ENGINES AND COMPRESSION IGNITION ENGINES FOR MACHINES, LAND VEHICLES, LOCOMOTIVES, AND SHIPS (U.S. CLS. 13, 19, 21, 23, 31, 34 AND 35).

CLASS 9—ELECTRICAL AND SCIENTIFIC APPARATUS

FOR ELECTRONIC CONTROL UNITS FOR USE IN A COMPRESSED NATURAL GAS AND LIQUID FUEL BLENDING SYSTEMS USED IN COMBINATION WITH COMBUSTIBLE ENGINES AND COMPRESSION IGNITION ENGINES FOR MACHINES, LAND VEHICLES, LOCOMOTIVES, AND SHIPS; COMPONENTS AND PARTS FOR USE IN A COMPRESSED NATURAL GAS AND LIQUID FUEL BLENDING SYSTEMS USED IN COMBINATION WITH COMBUSTIBLE ENGINES AND COMPRESSION IGNITION ENGINES FOR MACHINES, LAND VEHICLES, LOCOMOTIVES, AND SHIPS AND FOR USE IN EXHAUST TREATMENT DEVICES USED ON COMBUSTIBLE ENGINES AND COMPRESSION IGNITION ENGINES FOR MACHINES, LAND VEHICLES, LOCOMOTIVES, AND SHIPS, NAMELY, SATELLITE TRANSCIEVERS, TRANSMITTERS AND RECEIVERS FOR RECEIVING ON-BOARD SATELLITE COMMUNICATIONS, DOWNLOADABLE ELECTRONIC MAPS AND COMPUTER SOFTWARE MAPPING PROGRAMS; COMPONENTS AND PARTS FOR USE IN A COMPRESSED NATURAL GAS AND LIQUID FUEL BLENDING SYSTEMS USED IN COMBINATION WITH COMBUSTIBLE ENGINES AND COMPRESSION IGNITION ENGINES FOR MACHINES, LAND VEHICLES, LOCOMOTIVES, AND SHIPS AND FOR USE IN EXHAUST TREATMENT DEVICES USED ON COMBUSTIBLE ENGINES AND COMPRESSION IGNITION ENGINES FOR MACHINES, LAND VEHICLES, LOCOMOTIVES, AND SHIPS, NAMELY, VEHICLE TRACKING DEVICES COMPRISED OF CELLULAR RADIO MODULES, COMPUTER SOFTWARE AND COMPUTER HARDWARE, SENSORS, TRANSMITTERS, RECEIVERS AND GLOBAL POSITIONING SATELLITE RECEIVERS, ALL FOR USE IN CONNECTION WITH VEHICLE TRACKING AND VEHICLE MONITORING; COMPONENTS AND PARTS FOR USE IN A COMPRESSED NATURAL GAS AND LIQUID FUEL BLENDING SYS-

TEMS USED IN COMBINATION WITH COMBUSTIBLE ENGINES AND COMPRESSION IGNITION ENGINES FOR MACHINES, LAND VEHICLES, LOCOMOTIVES, AND SHIPS, NAMELY, SATELLITE COMMUNICATIONS EQUIPMENT IN THE NATURE OF SATELLITE TRANSMITTERS, SATELLITE RECEIVERS, AND SATELLITE TRANSCIEVERS, BATTERIES, BATTERY CHARGERS, DOWNLOADABLE ELECTRONIC MAPS AND MAPPING PROGRAMS; COMPONENTS AND PARTS FOR USE IN EXHAUST TREATMENT DEVICES USED ON COMBUSTIBLE ENGINES AND COMPRESSION IGNITION ENGINES FOR MACHINES, LAND VEHICLES, LOCOMOTIVES, AND SHIPS, NAMELY, EXHAUST SENSORS, TEMPERATURE SENSORS (U.S. CLS. 21, 23, 26, 36 AND 38).

WILLIAM P. SHANAHAN, EXAMINING ATTORNEY

SN 85-196,659. DENA CO., LTD., TOKYO, JAPAN, FILED 12-13-2010.

Mobage

PRIORITY CLAIMED UNDER SEC. 44(D) ON JAPAN APPLICATION NO. 2010-96496, FILED 12-13-2010, REG. NO. 5440507, DATED 9-22-2011, EXPIRES 9-22-2021.

THE MARK CONSISTS OF THE WORDING "MOBAGE" WITH A CAPITAL "M" AND LOWER CASE LETTERS FOLLOWING.

CLASS 9—ELECTRICAL AND SCIENTIFIC APPARATUS

FOR GAME PROGRAMS RUNNING ON MOBILE PHONES, INCLUDING DOWNLOADABLE GAME PROGRAMS; GAME PROGRAMS RUNNING ON PERSONAL COMPUTERS, INCLUDING DOWNLOADABLE GAME PROGRAMS; GAME PROGRAMS RUNNING ON HOME VIDEO GAME MACHINES FOR USE WITH EXTERNAL DISPLAY SCREEN OR MONITOR AS AN INTEGRAL COMPONENT THEREOF; DOWNLOADABLE DIGITAL IMAGES IN THE FIELD OF GAMES AND GAMING, GAME CHARACTERS, FICTIONAL CHARACTERS, USER-CREATED IMAGES, PHOTOGRAPHS, CONSUMER PRODUCTS, WEATHER AND CLIMATE, FORTUNE-TELLING AND CELEBRITIES, AND DOWNLOADABLE PICTURES IN THE FIELD OF GAMES AND GAMING, GAME CHARACTERS, FICTIONAL CHARACTERS, USER-CREATED PICTURES, PHOTOGRAPHS, CONSUMER PRODUCTS, WEATHER AND CLIMATE, FORTUNE-TELLING AND CELEBRITIES, AND MUSIC, DOWNLOADABLE TO MOBILE PHONES; ELECTRONIC MAGAZINES IN THE FIELD OF SOCIAL NETWORKING, GAMES AND GAMING DOWNLOADABLE TO MOBILE PHONES; AND OTHER DOWNLOADABLE ELECTRONIC PUBLICATIONS IN THE NATURE OF MAGAZINES, NEWSLETTERS, BOOKS, NOVELS, GRAPHIC NOVELS, COMIC BOOKS, SHORT STORIES AND POEMS IN THE FIELD OF FICTIONAL CHARACTERS IN GAMES, COMICS, DRAMATIC, FANTASY, HORROR, ACTION AND ADVENTURE SITUATIONS; COMPUTER PROGRAMS FOR CREATING SOFTWARE AND WEBSITES IN THE FIELD OF ELECTRONIC GAMES; COMPUTER APPLICATION SOFTWARE FOR MOBILE PHONES AND HANDHELD ELECTRONIC DEVICES USED FOR DATABASE MANAGEMENT AND ELECTRONIC STORAGE OF DATA; COMPUTER GAME PROGRAMS; COMPUTER GAME SOFTWARE; COMPUTER APPLICATION GAME SOFTWARE FOR MOBILE PHONES AND HANDHELD ELECTRONIC DEVICES (U.S. CLS. 21, 23, 26, 36 AND 38).

CLASS 16—PAPER GOODS AND PRINTED MATTER

FOR SERIES OF FICTION WORKS, NAMELY, NOVELS AND SHORT STORIES; PRINTED PUBLICATIONS, NAMELY, MAGAZINES IN THE FIELD OF SOCIAL NETWORKING, GAMES AND GAMING; PRINTED PUBLICATIONS IN THE NATURE OF MAGAZINES, NEWSLETTERS, BOOKS, NOVELS, GRAPHIC NOVELS, COMIC BOOKS, SHORT STORIES AND POEMS IN THE FIELD OF FICTIONAL CHARACTERS IN GAMES, COMICS, DRAMATIC, FANTASY, HORROR, ACTION AND ADVENTURE SITUATIONS (U.S. CLS. 2, 5, 22, 23, 29, 37, 38 AND 50).

CLASS 28—TOYS AND SPORTING GOODS

FOR GAME PROGRAMS RUNNING ON HOME STAND ALONE VIDEO GAME MACHINES AS INTEGRAL COMPONENTS THEREOF; GAME PROGRAMS RUNNING ON ARCADE GAME MACHINES AS INTEGRAL COMPONENTS THEREOF (U.S. CLS. 22, 23, 38 AND 50).

CLASS 35—ADVERTISING AND BUSINESS

FOR ADVERTISING SERVICES; AUCTIONEERING BY MEANS OF MOBILE PHONES AND COMPUTER NETWORKS; INTERMEDIATION FOR SALES/PURCHASE OF PRODUCTS, NAMELY, OPERATING AN ELECTRONIC MARKETPLACE VIA MOBILE PHONES AND COMPUTER NETWORKS; EMPLOYMENT AGENCIES; PROVIDING EMPLOYMENT INFORMATION; NEWS CLIPPING SERVICES; ADVERTISING SERVICES, NAMELY, PROMOTING THE COMPUTER APPLICATION SOFTWARE FOR MOBILE PHONES AND MOBILE DEVICES OF OTHERS; PROMOTING THE COMPUTER APPLICATION SOFTWARE FOR MOBILE PHONES AND MOBILE DEVICES OF OTHERS BY DISTRIBUTION OF DISCOUNT CARDS, DISCOUNT COUPONS, GIFT CERTIFICATES, NOVELTY ITEMS AND OTHER SALES SUPPORT MATERIAL; PROVIDING A WEBSITE FEATURING CONSUMER PRODUCT INFORMATION, NEWS, REVIEWS, PREVIEWS, RECOMMENDATIONS, RANKINGS, AND TRACKING OF COMPUTER APPLICATION SOFTWARE FOR MOBILE PHONES AND MOBILE DEVICES; PROVISION OF NEWS AND PRESS CUTTING AND MONITORING SERVICES (U.S. CLS. 100, 101 AND 102).

CLASS 38—COMMUNICATION

FOR ELECTRONIC BULLETIN BOARD SERVICES; ELECTRONIC MAIL SERVICES; ELECTRONIC, ELECTRIC, AND DIGITAL TRANSMISSION OF VOICE, DATA AND IMAGE; BROADCAST OF ON-GOING TELEVISION PROGRAMS AND OTHER PICTURES AND SOUNDS VIA MOBILE PHONES; SENDING OF NEWS; PROVIDING ONLINE FACILITIES AND TELECOMMUNICATION FACILITIES, NAMELY, PROVIDING ONLINE FACILITIES FOR REAL-TIME INTERACTION WITH OTHER COMPUTER USERS CONCERNING TOPICS OF GENERAL INTEREST; PROVIDING ON-LINE FORUMS VIA MOBILE PHONES AND MOBILE DEVICES FOR TRANSMISSION OF MESSAGES AMONG REGISTERED COMPUTER USERS FOR THE PURPOSE OF SHARING INFORMATION, FINDING FRIENDS, INVITING NEW USERS, ENGAGING IN SOCIAL NETWORKING AND SHARING INFORMATION ABOUT COMPUTER GAMES; PROVIDING ON-LINE FORUMS VIA MOBILE PHONES AND MOBILE DEVICES FOR THE TRANSMISSION OF MESSAGES AMONG COMPUTER USERS CONCERNING REVIEWS, RECOMMENDATIONS, RANKINGS, TRACKINGS, VOTES, NEWS, AND INFORMATION ALL RELATING TO ONLINE GAMES AND GAMES PLAYED VIA MOBILE PHONES AND MOBILE DEVICES; PROVIDING ON-LINE FORUMS VIA MOBILE PHONES AND MOBILE DEVICES FOR TRANSMISSION OF MESSAGES AMONG COMPUTER USERS CONCERNING ONLINE GAMES, COMPUTER APPLICATION SOFTWARE FOR MOBILE PHONES AND MOBILE DEVICES, AND GAMES PLAYED VIA MOBILE PHONES AND MOBILE DEVICES; PROVIDING E-MAIL NOTIFICATION ALERTS OF USER-DEFINED INFORMATION REGARDING COMPUTER APPLICATION SOFTWARE FOR MOBILE PHONES AND MOBILE

DEVICES; PROVIDING ONLINE FACILITIES AND TELECOMMUNICATION FACILITIES FOR REAL-TIME INTERACTION WITH OTHER COMPUTER USERS CONCERNING TOPICS OF GENERAL INTEREST; PROVIDING AN ONLINE COMMUNITY FORUM VIA MOBILE PHONES AND MOBILE DEVICES FOR REAL-TIME INTERACTION WITH OTHER COMPUTER USERS CONCERNING TOPICS OF GENERAL INTEREST; PROVIDING ONLINE COMMUNITY FORUM FOR REGISTERED USERS TO SHARE INFORMATION, FIND FRIENDS, INVITE NEW USERS, ENGAGE IN SOCIAL NETWORKING, PLAY COMPUTER GAMES, OBTAIN AND SHARE INFORMATION ON COMPUTER GAMES, TRACK POINTS, AND EXCHANGE POINTS EARNED FOR COUPONS, REBATES, DISCOUNTS OR SPECIAL OFFERINGS ON GOODS AND/OR SERVICES OF OTHERS (U.S. CLS. 100, 101 AND 104).

CLASS 39—TRANSPORTATION AND STORAGE

FOR TRAVEL ROUTE PLANNING SERVICES; TRAFFIC INFORMATION SERVICES; PROVIDING TRAVEL INFORMATION IN THE NATURE OF TRAFFIC INFORMATION ON MAPS (U.S. CLS. 100 AND 105).

CLASS 41—EDUCATION AND ENTERTAINMENT

FOR PLANNING AND PRODUCTION OF MASTER MATRIX FOR MUSIC, NAMELY, RECORD MASTER PRODUCTION; PLANNING, CONDUCTING AND ARRANGEMENT OF MUSIC CONCERTS OR MUSICAL PERFORMANCES; PLANNING, CONDUCTING AND ARRANGEMENT OF CONTESTS OR AUDITIONS RELATING TO MUSIC; PLANNING, CONDUCTING AND ARRANGEMENT OF CONTESTS RELATING TO NOVELS; PUBLICATION OF BOOKS; ENTERTAINMENT AND EDUCATION SERVICES, NAMELY, PROVIDING ONLINE GAMES AND CONTESTS VIA CELLULAR, AND WIRELESS COMMUNICATION, THE INTERNET, ELECTRONIC COMMUNICATIONS NETWORKS, AND COMPUTER NETWORKS; ONLINE SERVICES TO ENABLE PEOPLE TO LOCATE OTHER GAME PLAYERS AND PLAY GAMES OVER COMMUNICATIONS NETWORKS; ARRANGING AND CONDUCTING COMPETITIONS FOR VIDEO GAMES AND COMPUTER GAME PLAYERS; ONGOING ENTERTAINMENT PROGRAMS BROADCAST VIA CELLULAR, AND WIRELESS COMMUNICATION, THE INTERNET, ELECTRONIC COMMUNICATIONS NETWORKS, AND COMPUTER NETWORKS IN THE FIELDS OF GAMES, NEWS, WEATHER, SPORTS, TRAVEL, CURRENT EVENTS, REFERENCE INFORMATION, CAREER INFORMATION, COMPUTING, TECHNOLOGY, SHOPPING, AUCTIONS, MOVIES, THEATER, MUSIC, HEALTH, EDUCATION, SCIENCE, FINANCE, AND INVESTING; PROVIDING SPORTS INFORMATION VIA CELLULAR TELEPHONE, WIRELESS COMMUNICATION DEVICES, AND THE INTERNET; PROVIDING INFORMATION IN THE FIELD OF FITNESS, SPORTS, SPORTS SCORES, SPORTS STATISTICS, PLAYER STATISTICS, PLAY-BY-PLAY SPORTS COMMENTARY, AND SPORTS EDITORIAL COMMENTARY VIA CELLULAR TELEPHONE, WIRELESS COMMUNICATION DEVICES, AND THE INTERNET; MOVIE SCHEDULE AND LOCATION INFORMATION SERVICES; PROVIDING A WEBSITE FEATURING INFORMATION, LISTINGS, AND NEWS REGARDING TELEVISION PROGRAMMING AND ENTERTAINMENT; PROVIDING INFORMATION IN THE FIELDS OF NEWS AND ENTERTAINMENT, NAMELY, MOVIES, TELEVISION, MUSIC, SPORTS, AND CELEBRITY PERSONALITIES VIA CELLULAR TELEPHONE, WIRELESS COMMUNICATION DEVICES, AND COMPUTER NETWORKS; ENTERTAINMENT SERVICES IN THE FORM OF A CONTINUING NEWS SHOW DISTRIBUTED OVER CELLULAR TELEPHONE, WIRELESS COMMUNICATION DEVICES, AND COMPUTER NETWORKS; ORGANIZING AND CONDUCTING FANTASY SPORTS CONTESTS AND LEAGUES; PROVIDING ONLINE FANTASY SPORTS NEWS INFORMATION; PROVIDING INFORMATION RELATING TO ELECTRONIC AND COMPUTER GAMES; PRODUCTION OF MUSIC VIDEO PROGRAMS FOR BROADCAST ON CELLULAR TELEPHONE, WIRELESS COMMUNICATION DEVICES, AND COMPUTER NETWORKS; ENTERTAINMENT SERVICES, NAMELY, PROVIDING A WEB SITE FEATURING

TURING MUSICAL PERFORMANCES, MUSICAL VIDEOS, FILM CLIPS, CELEBRITY INTERVIEWS, TALK SHOWS, TELEVISION SHOW PREVIEWS, PHOTOGRAPHS, AND OTHER MULTIMEDIA MATERIALS; PROVIDING NON-DOWNLOADABLE PRERECORDED MUSIC, INFORMATION IN THE FIELD OF MUSIC, AND COMMENTARY AND ARTICLES ABOUT MUSIC, ALL VIA CELLULAR TELEPHONE, WIRELESS COMMUNICATION DEVICES, AND COMPUTER NETWORKS; PROVIDING INFORMATION REGARDING PHOTOGRAPHY; PROVIDING INFORMATION REGARDING LOTTERY RESULTS; ELECTRONIC PUBLISHING SERVICES, NAMELY, PUBLISHING OF ONLINE FICTIONAL WORKS OF OTHERS FEATURING USER-CREATED TEXT, AUDIO, VIDEO, AND GRAPHICS; PROVIDING ON-LINE JOURNALS AND WEB LOGS FEATURING USER-CREATED CONTENT IN THE FIELD OF GAMES AND GAMING, GAME CHARACTERS, FICTIONAL CHARACTERS, USER-CREATED PICTURES, PHOTOGRAPHS AND DIARIES, CONSUMER PRODUCTS, WEATHER AND CLIMATE, FORTUNE-TELLING AND CELEBRITIES; PROVIDING ON-LINE GAMES VIA MOBILE PHONES OR COMPUTER NETWORKS; PROVIDING ON-LINE GAMES VIA MOBILE PHONES OR COMPUTER NETWORKS; PROVIDING NON-DOWNLOADABLE ELECTRONIC MAGAZINES AND OTHER PUBLICATIONS IN THE NATURE OF NEWSLETTERS, BOOKS, NOVELS, GRAPHIC NOVELS, COMIC BOOKS, SHORT STORIES AND POEMS VIA MOBILE PHONES OR COMPUTER NETWORKS IN THE FIELD OF FICTIONAL CHARACTERS IN GAMES, COMICS, DRAMATIC, FANTASY, HORROR, ACTION AND ADVENTURE SITUATIONS; PROVIDING ONLINE NON-DOWNLOADABLE IMAGES AND PICTURES IN THE FIELD OF GAMES AND GAMING, GAME CHARACTERS, FICTIONAL CHARACTERS, USER-CREATED IMAGES, PHOTOGRAPHS, CONSUMER PRODUCTS, WEATHER AND CLIMATE, FORTUNE-TELLING AND CELEBRITIES, AND MUSIC, VIA MOBILE PHONES OR COMPUTER NETWORKS; NEWS REPORTER SERVICES; MULTIMEDIA PUBLISHING OF COMPUTER SOFTWARE FOR OTHERS; MULTIMEDIA PUBLISHING OF COMPUTER APPLICATION SOFTWARE FOR MOBILE PHONES AND MOBILE DEVICES FOR OTHERS; ENTERTAINMENT SERVICE, NAMELY, PROVIDING A WEBSITE THAT DISPLAYS VARIOUS REQUESTS, REVIEWS, RECOMMENDATIONS, RANKINGS, TRACKING VOTES, NEWS, AND INFORMATION RELATING TO ONLINE GAMES AND GAMES PLAYED VIA MOBILE PHONES AND MOBILE DEVICES, ALL EXCLUSIVELY FOR NON-BUSINESS AND NON-COMMERCIAL TRANSACTIONS AND PURPOSE; PUBLISHING COMPUTER APPLICATION SOFTWARE FOR MOBILE PHONES AND MOBILE DEVICES FOR OTHERS; PUBLISHING COMPUTER SOFTWARE FOR OTHERS; PROVIDING ONGOING TELEVISION PROGRAMS VIA MOBILE PHONES IN THE FIELD OF NEWS, COMEDY, COMMENTARY, GAMES AND GAMING; PROVIDING INFORMATION ON NEWSPAPER ARTICLES, NAMELY, PROVIDING ON-LINE NON-DOWNLOADABLE SUMMARIES AND EXCERPTS OF NEWSPAPER ARTICLES (U.S. CLS. 100, 101 AND 107).

CLASS 42—SCIENTIFIC AND COMPUTER SERVICES

FOR COMPUTER SERVICES, NAMELY, HOSTING ON-LINE WEB FACILITIES FOR OTHERS FOR ORGANIZING AND CONDUCTING ON-LINE MEETINGS, GATHERINGS, AND INTERACTIVE DISCUSSIONS; COMPUTER SERVICES IN THE NATURE OF CUSTOMIZED WEB PAGES FEATURING USER-DEFINED INFORMATION, PERSONAL PROFILES AND INFORMATION; APPLICATION SERVICE PROVIDER (ASP) FEATURING SOFTWARE TO ENABLE UPLOADING, POSTING, SHOWING, DISPLAYING, TAGGING, BLOGGING, SHARING OR OTHERWISE PROVIDING ELECTRONIC MEDIA OR INFORMATION OVER MOBILE PHONES, THE INTERNET OR OTHER COMMUNICATIONS NETWORKS; DESIGNING SERVICES, NAMELY, DESIGNING DIGITAL IMAGES RELATING TO HUMAN BEINGS FOR USE IN COMPUTER NETWORKS; PROVIDING INTERNET SEARCH ENGINES; PROVIDING WEATHER INFORMATION; PROVIDING USE OF ON-LINE NON-DOWNLOADABLE SOFTWARE DEVELOPMENT TOOLS FOR CREATING SOFTWARE AND WEBSITES IN THE FIELD OF ELECTRONIC GAMES; PROVIDING ON-LINE NON-DOWNLOADABLE

COMPUTER PROGRAMS FOR OTHERS TO CREATE SOFTWARE AND WEBSITES IN THE FIELD OF ELECTRONIC GAMES; RENTAL OF COMPUTER PROGRAMS FOR OTHERS TO CREATE SOFTWARE AND WEBSITES IN THE FIELD OF ELECTRONIC GAMES; ADVISORY SERVICES FOR OTHERS RELATED TO DEVELOPMENT AND MAINTENANCE OF SOFTWARE AND WEBSITES IN THE FIELD OF ELECTRONIC GAMES; DESIGN, DEVELOPMENT, MAINTENANCE AND UPDATING OF SOFTWARE AND WEBSITES IN THE FIELD OF ELECTRONIC GAMES; COMPUTER SERVICES, NAMELY, HOSTING AN ON-LINE COMMUNITY WEB SITE FOR REGISTERED USERS TO SHARE INFORMATION, FIND FRIENDS, INVITE NEW USERS, ENGAGE IN SOCIAL NETWORKING, PLAY COMPUTER GAMES, OBTAIN AND SHARE INFORMATION ON COMPUTER GAMES, TRACK POINTS AND EXCHANGE POINTS EARNED FOR COUPONS, REBATES, DISCOUNTS OR SPECIAL OFFERINGS ON GOODS AND/OR SERVICES OF OTHERS; COMPUTER SERVICES, NAMELY, CREATING AN ON-LINE COMMUNITY ACCESSIBLE VIA MOBILE PHONES AND MOBILE DEVICES FOR REGISTERED USERS TO PLAY COMPUTER GAMES, OBTAIN INFORMATION ON COMPUTER GAMES, AND TRACK POINTS AND EXCHANGE POINTS EARNED FOR COUPONS, REBATES, DISCOUNTS OR SPECIAL OFFERINGS ON GOODS AND/OR SERVICES OF OTHERS; COMPUTER SERVICES, NAMELY, CREATING AN ON-LINE COMMUNITY ACCESSIBLE VIA MOBILE PHONES AND MOBILE DEVICES FOR REGISTERED USERS TO PARTICIPATE IN COMPETITIONS, SHOWCASE THEIR SKILLS, GET FEEDBACK FROM THEIR PEERS, FORM VIRTUAL COMMUNITIES, ENGAGE IN SOCIAL NETWORKING AND IMPROVE THEIR TALENT; MAPPING, NAMELY, PROVIDING ELECTRONIC MAPS (U.S. CLS. 100 AND 101).

CLASS 45—PERSONAL AND LEGAL SERVICES

FOR INTERNET BASED INTRODUCTION AND SOCIAL NETWORKING SERVICES; ON-LINE SOCIAL NETWORKING SERVICES FEATURING PROFILES, DIARIES OR OTHER PERSONAL INFORMATION VIA ELECTRONIC BULLETIN BOARDS; INTERNET BASED DATING; INTRODUCING AND SOCIAL NETWORKING SERVICES; FORTUNE-TELLING SERVICES (U.S. CLS. 100 AND 101).

MARK RADEMACHER, EXAMINING ATTORNEY

SN 85-196,714, PRODIGY MUSIC GROUP LTD., VICTORIA, CANADA, FILED 12-13-2010.



NO CLAIM IS MADE TO THE EXCLUSIVE RIGHT TO USE "MUSIC GROUP", APART FROM THE MARK AS SHOWN.

THE COLOR(S) BLACK, WHITE, RED, AND GREY IS/ARE CLAIMED AS A FEATURE OF THE MARK.

THE MARK CONSISTS OF THE WORDS "PRODIGY MUSIC GROUP" WITH THE LETTER "I" OF "PRODIGY" BEING FORMED FROM A MICROPHONE DESIGN. ALL WORDING OF THE MARK IS BLACK EXCEPT FOR THE MICROPHONE LETTER I WHICH IS WHITE ON TOP WITH RED DOTS AND A GRAY SHADOW ON THE UPPER RIGHT AND LOWER LEFT. THE BOTTOM PORTION OF THE MICROPHONE IS BLACK.

CLASS 9—ELECTRICAL AND SCIENTIFIC APPARATUS

FOR PRE-RECORDED AUDIO TAPES, DISCS AND CASSETTES, VIDEO TAPES, DIGITAL AUDIO AND AUDIO VIDEO TAPES, CDS, DVDS, AND PHONOGRAPH RECORDS FEATURING MUSIC; MUSIC VIDEO RECORDINGS; DOWNLOADABLE RING TONES, MUSIC, MP3 FILES FEATURING MUSIC, GRAPHICS, GAME SOFTWARE, IMAGE FILES FEATURING MUSICIANS AND MUSIC VIDEOS FEATURING MUSICIANS FOR WIRELESS COMMUNICATION DEVICES; DOWNLOADABLE MUSIC, MP3 FILES FEATURING MUSIC, GRAPHICS, COMPUTER GAME SOFTWARE, IMAGE FILES IN THE FIELD OF MUSIC AND VIDEOS FEATURING MUSIC VIA A GLOBAL COMPUTER NETWORK (U.S. CLS. 21, 23, 26, 36 AND 38).

FIRST USE 11-19-2010; IN COMMERCE 12-12-2010.

CLASS 35—ADVERTISING AND BUSINESS

FOR DISTRIBUTORSHIP OF MUSICAL RECORDINGS; DISTRIBUTORSHIP OF MUSICAL AND NON-MUSICAL SOUND RECORDINGS AND VIDEO RECORDINGS; ADVERTISING AND PROMOTION SERVICES AND RELATED CONSULTING SERVICES; ADVERTISING AND PUBLICITY SERVICES; ASSOCIATION SERVICES, NAMELY, PROMOTING THE INTERESTS OF MUSICIANS, SINGERS, SONGWRITERS, MUSICAL PERFORMERS AND ARTISTS; COMPUTERIZED ONLINE ORDERING FEATURING GENERAL MERCHANDISE AND GENERAL CONSUMER GOODS; COMPUTERIZED ONLINE ORDERING SERVICES IN THE FIELD OF MUSICAL RECORDINGS, DVDS; COMPUTERIZED ONLINE RETAIL STORE SERVICES IN THE FIELD OF MUSICAL RECORDINGS, DVDS; ONLINE RETAIL STORE SERVICES FEATURING DOWNLOADABLE PRE-RECORDED MUSIC AND AUDIO-VISUAL CONTENT AND GENERAL MERCHANDISE; PREPARING AUDIO-VISUAL DISPLAYS IN THE FIELD OF MUSIC ADVERTISING; ARRANGING AND CONDUCTING FAIRS AND EXHIBITIONS FOR BUSINESS AND ADVERTISING PURPOSES; PROMOTING THE CONCERTS OF OTHERS; PROMOTING THE GOODS AND SERVICES OF OTHERS BY ARRANGING FOR SPONSORS TO AFFILIATE THEIR GOODS AND SERVICES WITH CONCERTS, MUSICAL AND SPORTS EVENTS; PROMOTING THE GOODS OF OTHERS BY PREPARING AND PLACING ADVERTISEMENTS IN AN ELECTRONIC MAGAZINE ACCESSED THROUGH A GLOBAL COMPUTER NETWORK; PROVIDING INFORMATION ABOUT THE GOODS AND SERVICES OF OTHERS VIA A GLOBAL COMPUTER NETWORK; RETAIL STORE SERVICES AVAILABLE THROUGH COMPUTER COMMUNICATIONS FEATURING CD'S, DVD'S, AND LICENSED CLOTHING MERCHANDISE; MANAGEMENT SERVICES FOR PROFESSIONAL PERFORMING AND RECORDING ARTISTS; TALENT AGENCY SERVICES; ADVERTISING, INCLUDING PROMOTION OF PRODUCTS AND SERVICES OF THIRD PARTIES THROUGH SPONSORING ARRANGEMENTS AND LICENSE AGREEMENTS RELATING TO MUSIC EVENTS; PROMOTING MUSIC COMPETITIONS AND EVENTS FOR OTHERS; PROMOTING GOODS AND SERVICES OF OTHERS BY ARRANGING FOR SPONSORS TO AFFILIATE THEIR GOODS AND SERVICES WITH MUSIC COMPETITIONS; PROMOTING THE INTERESTS OF PEOPLE INVOLVED AND CONCERNED WITH MUSIC; PROVIDING ONLINE REGISTRATION SERVICES FOR MUSIC COMPETITIONS (U.S. CLS. 100, 101 AND 102).

FIRST USE 11-19-2010; IN COMMERCE 12-12-2010.
BRENDAN MCCAULEY, EXAMINING ATTORNEY

SN 85-196,784. BIOTECH INTERNATIONAL CORPORATION, GLASTONBURY, CT. FILED 12-13-2010.

BIOTECH

THE MARK CONSISTS OF STANDARD CHARACTERS WITHOUT CLAIM TO ANY PARTICULAR FONT, STYLE, SIZE, OR COLOR.

OWNER OF U.S. REG. NO. 2,411,711.
SEC. 2(F).

CLASS 3—COSMETICS AND CLEANING PREPARATIONS

FOR BEAUTY CREAMS; BEAUTY LOTIONS; BEAUTY SERUMS; BODY CREAMS; BODY LOTIONS; CREAMS FOR CELLULITE REDUCTION; EYE CREAM; EYE LOTIONS; FACE AND BODY BEAUTY CREAMS; FACE AND BODY CREAMS; FACE AND BODY LOTIONS; FACE CREAMS; HAND CREAMS; HAND LOTIONS; LOTIONS FOR CELLULITE REDUCTION; SKIN CARE PRODUCTS, NAMELY, NON-MEDICATED SKIN SERUM; SKIN CREAMS; SKIN LOTIONS; TONING LOTION, FOR THE FACE, BODY AND HANDS (U.S. CLS. 1, 4, 6, 50, 51 AND 52).

FIRST USE 4-30-2002; IN COMMERCE 4-30-2002.

CLASS 5—PHARMACEUTICALS

FOR DIETARY AND NUTRITIONAL SUPPLEMENTS (U.S. CLS. 6, 18, 44, 46, 51 AND 52).

FIRST USE 9-30-1994; IN COMMERCE 9-30-1994.
TRACY FLETCHER, EXAMINING ATTORNEY

SN 85-196,806. EARTH NETWORKS, INC., GERMANTOWN, MD. FILED 12-13-2010.

EARTH NETWORKS

THE MARK CONSISTS OF STANDARD CHARACTERS WITHOUT CLAIM TO ANY PARTICULAR FONT, STYLE, SIZE, OR COLOR.

SEC. 2(F).

CLASS 9—ELECTRICAL AND SCIENTIFIC APPARATUS

FOR DOWNLOADABLE SOFTWARE FOR DISPLAYING WEATHER, CLIMATE AND ENVIRONMENTALLY RELATED INFORMATION AND IMAGES BY MEANS OF A GLOBAL COMPUTER NETWORK, MOBILE TELEPHONES OR OTHER WIRELESS NETWORK BASED DEVICES; COMPUTER SOFTWARE STORED ON ELECTRONIC MEDIA FOR RECORDING AND/OR DISPLAYING WEATHER RELATED INFORMATION AND IMAGES; ELECTRONIC PUBLICATIONS, NAMELY, MANUALS FEATURING INFORMATION ON THE SUBJECT OF INSTALLATION AND OPERATION OF WEATHER TRACKING STATIONS RECORDED ON ELECTRONIC MEDIA (U.S. CLS. 21, 23, 26, 36 AND 38).

CLASS 16—PAPER GOODS AND PRINTED MATTER

FOR PRINTED MANUALS PROVIDING INFORMATION IN CONNECTION WITH COMPUTER SOFTWARE, HARDWARE AND PERIPHERALS FOR RECORDING AND/OR DISPLAYING WEATHER, CLIMATE AND ENVIRONMENTALLY RELATED INFORMATION AND IMAGES; PRINTED MATERIALS, NAMELY, MANUALS FEATURING INFORMATION ON THE SUBJECT OF INSTALLATION AND OPERATION OF WEATHER TRACKING STATIONS (U.S. CLS. 2, 5, 22, 23, 29, 37, 38 AND 50).

CLASS 38—COMMUNICATION

FOR PROVIDING TRANSMISSION OF WEATHER, CLIMATE AND ENVIRONMENTAL IMPACT FROM CLIMATE CHANGE RELATED IMAGES BY MEANS OF A GLOBAL COMPUTER NETWORK; PROVIDING TRANSMISSION OF WEATHER RELATED IMAGES ACCESSIBLE BY BROADCAST TELEVISION, CABLE TELEVISION, MOBILE TELEPHONES OR OTHER WIRELESS NETWORK BASED DEVICES (U.S. CLS. 100, 101 AND 104).

CLASS 41—EDUCATION AND ENTERTAINMENT

FOR PROVIDING AN ON-LINE COMPUTER DATABASE FEATURING EDUCATIONAL LESSON PLANS IN THE FIELD OF WEATHER, CLIMATE AND ENVIRONMENTALLY RELATED CONDITIONS BY MEANS OF A GLOBAL COMPUTER NETWORK (U.S. CLS. 100, 101 AND 107).

CLASS 42—SCIENTIFIC AND COMPUTER SERVICES

FOR PROVIDING WEATHER, CLIMATE AND ENVIRONMENTAL IMPACT FROM CLIMATE CHANGE RELATED INFORMATION AND NON-DOWNLOADABLE IMAGES BY MEANS OF A GLOBAL COMPUTER NETWORK; PROVIDING WEATHER RELATED INFORMATION AND NON-DOWNLOADABLE IMAGES ACCESSIBLE BY BROADCAST TELEVISION, CABLE TELEVISION, MOBILE TELEPHONES OR OTHER WIRELESS NETWORK BASED DEVICES (U.S. CLS. 100 AND 101).

JENNIFER VASQUEZ, EXAMINING ATTORNEY

CLASS 9—ELECTRICAL AND SCIENTIFIC APPARATUS

FOR DOWNLOADABLE SOFTWARE FOR DISPLAYING WEATHER, CLIMATE AND ENVIRONMENTALLY RELATED INFORMATION AND IMAGES BY MEANS OF A GLOBAL COMPUTER NETWORK, MOBILE TELEPHONES OR OTHER WIRELESS NETWORK BASED DEVICES; COMPUTER SOFTWARE STORED ON ELECTRONIC MEDIA FOR RECORDING AND/OR DISPLAYING WEATHER RELATED INFORMATION AND IMAGES; ELECTRONIC PUBLICATIONS, NAMELY, MANUALS FEATURING INFORMATION ON THE SUBJECT OF INSTALLATION AND OPERATION OF WEATHER TRACKING STATIONS RECORDED ON ELECTRONIC MEDIA (U.S. CLS. 21, 23, 26, 36 AND 38).

CLASS 16—PAPER GOODS AND PRINTED MATTER

FOR PRINTED MANUALS PROVIDING INFORMATION IN CONNECTION WITH COMPUTER SOFTWARE, HARDWARE AND PERIPHERALS FOR RECORDING AND/OR DISPLAYING WEATHER, CLIMATE AND ENVIRONMENTALLY RELATED INFORMATION AND IMAGES; PRINTED MATERIALS, NAMELY, MANUALS FEATURING INFORMATION ON THE SUBJECT OF INSTALLATION AND OPERATION OF WEATHER TRACKING STATIONS (U.S. CLS. 2, 5, 22, 23, 29, 37, 38 AND 50).

CLASS 38—COMMUNICATION

FOR PROVIDING TRANSMISSION OF WEATHER, CLIMATE AND ENVIRONMENTAL IMPACT FROM CLIMATE CHANGE RELATED IMAGES BY MEANS OF A GLOBAL COMPUTER NETWORK; PROVIDING TRANSMISSION OF WEATHER RELATED IMAGES ACCESSIBLE BY BROADCAST TELEVISION, CABLE TELEVISION, MOBILE TELEPHONES OR OTHER WIRELESS NETWORK BASED DEVICES (U.S. CLS. 100, 101 AND 104).

CLASS 41—EDUCATION AND ENTERTAINMENT

FOR PROVIDING AN ON-LINE COMPUTER DATABASE FEATURING EDUCATIONAL LESSON PLANS IN THE FIELD OF WEATHER, CLIMATE AND ENVIRONMENTALLY RELATED CONDITIONS BY MEANS OF A GLOBAL COMPUTER NETWORK (U.S. CLS. 100, 101 AND 107).

CLASS 42—SCIENTIFIC AND COMPUTER SERVICES

FOR PROVIDING WEATHER, CLIMATE AND ENVIRONMENTAL IMPACT FROM CLIMATE CHANGE RELATED INFORMATION AND NON-DOWNLOADABLE IMAGES BY MEANS OF A GLOBAL COMPUTER NETWORK; PROVIDING WEATHER RELATED INFORMATION AND NON-DOWNLOADABLE IMAGES ACCESSIBLE BY BROADCAST TELEVISION, CABLE TELEVISION, MOBILE TELEPHONES OR OTHER WIRELESS NETWORK BASED DEVICES (U.S. CLS. 100 AND 101).

JENNIFER VASQUEZ, EXAMINING ATTORNEY

SN 85-197,493. EARTH NETWORKS, INC., GERMANTOWN, MD. FILED 12-14-2010.



THE MARK CONSISTS OF A STYLIZED DEPICTION OF THE WORDS "EARTH NETWORKS", WHICH INCLUDES A FANCIFUL DEPICTION OF THE DESIGN OF A GLOBE. SEC. 2(F) AS TO "EARTH NETWORKS".

SN 85-198,806. FREE SPIRIT RIDER, LLC, LOS ANGELES, CA. FILED 12-15-2010.

NAAKWAMA ANKRAH, EXAMINING ATTORNEY

FREE SPIRIT RIDER

THE MARK CONSISTS OF STANDARD CHARACTERS WITHOUT CLAIM TO ANY PARTICULAR FONT, STYLE, SIZE, OR COLOR.

CLASS 14—JEWELRY

FOR KEYCHAINS AS JEWELRY; JEWELRY (U.S. CLS. 2, 27, 28 AND 50).

CLASS 16—PAPER GOODS AND PRINTED MATTER

FOR PAPER PRODUCTS AND PAPER GOODS, NAMELY, STATIONERY, NOTEBOOKS, NOTEBOOK COVERS, POSTERS, GREETING CARDS, NOTE CARDS, BUSINESS CARDS, POSTCARDS; MEMORY BOXES, NAMELY, CARDBOARD BOXES CONTAINING CARDBOARD CARDS FOR DISPLAYING AND STORING KEEPSAKES; PENS AND PENCILS; BUMPER STICKERS; STICKERS; ADHESIVE BACKED STICKERS AND DECALS; DECORATIVE DECALS FOR VEHICLE WINDOWS; POSTERS, NOTEBOOK COVERS, STATIONERY; BOOKS, MAGAZINES, COMIC BOOKS, GRAPHIC NOVELS, PUBLICATIONS, PERIODICALS, PERIODICALS AND NEWSLETTERS, ALL OF THE FOREGOING IN THE FIELD OF FICTIONAL ENTERTAINMENT, WELLNESS, LIFESTYLE AND PERSONAL FULFILLMENT AND DEVELOPMENT; COMIC STRIPS, NEWSPAPERS (U.S. CLS. 2, 5, 22, 23, 29, 37, 38 AND 50).

CLASS 21—HOUSEWARES AND GLASS

FOR CUPS, MUGS, SHOT GLASSES (U.S. CLS. 2, 13, 23, 29, 30, 33, 40 AND 50).

CLASS 26—FANCY GOODS

FOR ORNAMENTAL NOVELTY BUTTONS AND PINS (U.S. CLS. 37, 39, 40, 42 AND 50).

CLASS 35—ADVERTISING AND BUSINESS

FOR BUSINESS CONSULTING SERVICES (U.S. CLS. 100, 101 AND 102).

CLASS 41—EDUCATION AND ENTERTAINMENT

FOR ENTERTAINMENT SERVICES, NAMELY, MOTION PICTURE FILM AND TELEVISION PRODUCTION AND DISTRIBUTION; SPECIAL EVENT PLANNING FOR SOCIAL ENTERTAINMENT PURPOSES; ENTERTAINMENT SERVICES, NAMELY, PERSONAL APPEARANCES BY A CELEBRITY; CONDUCTING ENTERTAINMENT EXHIBITIONS FEATURING LIVE PERFORMANCES BY MUSICAL, THEATRICAL, COMEDIC, AND DRAMATIC PERFORMERS; SCRIPTWRITING SERVICES FOR OTHERS; FAN CLUBS; PROVIDING A WEB SITE FEATURING INFORMATION ABOUT SOCIAL ISSUES, PUBLIC POLICY ISSUES; INTERNET-BASED TELEVISION AND ENTERTAINMENT PROGRAMMING, NAMELY, THE PRODUCTION AND DISTRIBUTION THEREOF; PROVIDING A WEB SITE FOR OTHERS FEATURING INFORMATION ABOUT POPULAR CULTURE; ORGANIZING EXHIBITIONS FOR SOCIAL POLICY ADVOCACY AND CULTURAL ENTERTAINMENT PURPOSES; PUBLIC SPEAKING SERVICES IN THE FIELDS OF WELLNESS, LIFESTYLE AND PERSONAL FULFILLMENT AND DEVELOPMENT (U.S. CLS. 100, 101 AND 107).

SN 85-199,010. VIVINT, INC., PROVO, UT. FILED 12-15-2010.

SIMPLY SMARTER

THE MARK CONSISTS OF STANDARD CHARACTERS WITHOUT CLAIM TO ANY PARTICULAR FONT, STYLE, SIZE, OR COLOR.

CLASS 16—PAPER GOODS AND PRINTED MATTER

FOR WRITING IMPLEMENTS; PRINTED INSTRUCTIONAL MATERIALS, NAMELY, INSTRUCTION BOOKLET, ALL OF THE AFOREMENTIONED IN THE FIELD OF BUILDING AUTOMATION UTILITY AND ALARM SYSTEM OPERATION (U.S. CLS. 2, 5, 22, 23, 29, 37, 38 AND 50).

CLASS 19—NON-METALLIC BUILDING MATERIALS

FOR NON-LUMINOUS, NON-MECHANICAL, YARD SIGNS MADE PRIMARILY NOT OF METAL (U.S. CLS. 1, 12, 33 AND 50).

KEVIN CORWIN, EXAMINING ATTORNEY

SN 85-201,757. ELDER CARE ALLIANCE, OAKLAND, CA. FILED 12-20-2010.



OWNER OF U.S. REG. NO. 2,613,315.

NO CLAIM IS MADE TO THE EXCLUSIVE RIGHT TO USE "ELDER CARE" AND "SENIOR HOUSING AND SERVICES", APART FROM THE MARK AS SHOWN.

THE MARK CONSISTS OF TWO CONCENTRIC HEARTS TO THE LEFT OF THE WORDING "ELDER CARE" WITH THE WORDING "ALLIANCE" CENTERED BELOW THE LETTERS "ERCARE" AND THE WORDING "SENIOR HOUSING AND SERVICES" CENTERED BELOW THE LETTERS "LLIANCE" IN THE WORD "ALLIANCE".

SEC. 2(F) AS TO "ELDER CARE ALLIANCE".

CLASS 41—EDUCATION AND ENTERTAINMENT

FOR SUPPORT SERVICES FOR SENIOR ADULTS AND THE ELDERLY, NAMELY, ORGANIZING PERSONAL FITNESS CLASSES AND CULTURAL, SOCIAL, AND ARTS EVENTS AND OUTINGS; EDUCATIONAL SERVICES IN THE NATURE OF PROVIDING COGNITIVE FITNESS PROGRAMS; HOSTING EDUCATIONAL SEMINARS AND WORKSHOPS FOR SENIOR ADULTS AND THE ELDERLY IN THE FIELD OF PHYSICAL HEALTH, MENTAL HEALTH, WELLNESS, FINANCIAL PLANNING, AND DEMENTIA (U.S. CLS. 100, 101 AND 107).

FIRST USE 11-30-1997; IN COMMERCE 11-30-1997.

CLASS 43—HOTEL AND RESTAURANT SERVICES

FOR PROVIDING ASSISTED LIVING FACILITIES; PROVIDING INDEPENDENT LIVING FACILITIES; SUPPORT SERVICES FOR SENIOR ADULTS AND THE ELDERLY, NAMELY, PROVIDING ASSISTANCE TO SENIOR ADULTS AND THE ELDERLY SEEKING TO DETERMINE ASSISTED LIVING FACILITIES APPROPRIATE FOR THEIR NEEDS; PROVIDING RESPITE CARE IN THE NATURE OF PROVIDING TEMPORARY ACCOMMODATION AND PROVIDING ELDER CARE FOR SENIOR ADULTS AND THE ELDERLY; PROVIDING MEALS FOR SENIOR ADULTS AND THE ELDERLY (U.S. CLS. 100 AND 101).
FIRST USE 11-30-1997; IN COMMERCE 11-30-1997.

CLASS 44—MEDICAL, BEAUTY AND AGRICULTURAL SERVICES

FOR SKILLED NURSING; ALZHEIMER'S AND DEMENTIA HEALTH CARE; PROVIDING NON-MEDICAL ASSISTED LIVING SERVICES FOR PERSONAL PURPOSES IN THE NATURE OF PROVIDING A BEAUTY SALON FOR ON-SITE RESIDENTS; SUPPORTIVE PROGRAMMING FOR DEMENTIA CARE, NAMELY, PROVIDING NON-MEDICAL ASSISTED LIVING SERVICES FOR PERSONAL PURPOSES IN THE NATURE OF PROVIDING A BEAUTY SALON FOR ON-SITE RESIDENTS (U.S. CLS. 100 AND 101).
FIRST USE 11-30-1997; IN COMMERCE 11-30-1997.

CLASS 45—PERSONAL AND LEGAL SERVICES

FOR SUPPORT SERVICES FOR SENIOR ADULTS AND THE ELDERLY, NAMELY, GERIATRIC CARE MANAGEMENT SERVICES IN THE NATURE OF THE COORDINATION OF NECESSARY SERVICES AND PERSONAL CARE FOR OLDER INDIVIDUALS AND ORGANIZING AND CONDUCTING SUPPORT GROUPS AND SOCIAL DISCUSSION GROUPS IN THE FIELD OF AGING, MENTAL HEALTH, AND DEMENTIA; PERSONAL CARE AND HOSPITALITY SERVICES, NAMELY, ASSISTANCE WITH ACTIVITIES OF DAILY LIVING, SUCH AS BATHING, GROOMING AND PERSONAL MOBILITY FOR SENIOR ADULTS, THE ELDERLY AND THOSE SUFFERING FROM DEMENTIA; PROVIDING NON-MEDICAL ASSISTED LIVING SERVICES FOR PERSONAL PURPOSES IN THE NATURE OF SCHEDULING APPOINTMENTS, MAIL SORTING, MAIL HANDLING, AND MAIL RECEIVING; SUPPORTIVE PROGRAMMING FOR DEMENTIA CARE, NAMELY, PROVIDING NON-MEDICAL ASSISTED LIVING SERVICES FOR PERSONAL PURPOSES IN THE NATURE OF SCHEDULING APPOINTMENTS, MAIL SORTING, MAIL HANDLING, AND MAIL RECEIVING; SECURITY SERVICES, NAMELY, PROVIDING DELAYED EGRESS IN THE NATURE OF PASSWORD-PROTECTED ACCESS TO THE BUILDING ENVIRONMENT FOR THOSE SUFFERING FROM DEMENTIA (U.S. CLS. 100 AND 101).
FIRST USE 11-30-1997; IN COMMERCE 11-30-1997.
TINA BROWN, EXAMINING ATTORNEY

SN 85-203,684. BUSINESS PROPERTIES OF MEXICO, S. DE R.L. DE C.V., NICOLAS DE LOS GZA, NL, MEXICO, FILED 12-22-2010.

AROMA

THE MARK CONSISTS OF STANDARD CHARACTERS WITHOUT CLAIM TO ANY PARTICULAR FONT, STYLE, SIZE, OR COLOR.

CLASS 9—ELECTRICAL AND SCIENTIFIC APPARATUS

FOR PRE-RECORDED CDS, VIDEO TAPES, LASER DISKS AND DVDS FEATURING MUSIC (U.S. CLS. 21, 23, 26, 36 AND 38).
FIRST USE 12-10-2010; IN COMMERCE 12-10-2010.

CLASS 41—EDUCATION AND ENTERTAINMENT

FOR ENTERTAINMENT IN THE NATURE OF LIVE PERFORMANCES BY A VOCAL AND INSTRUMENTAL MUSICAL GROUP (U.S. CLS. 100, 101 AND 107).
FIRST USE 12-10-2010; IN COMMERCE 12-10-2010.
CARYN GLASSER, EXAMINING ATTORNEY

SN 85-204,636. NORTHERN EDGE, INC., CHESTERFIELD, MO. FILED 12-23-2010.

NORTHERN EDGE

THE MARK CONSISTS OF STANDARD CHARACTERS WITHOUT CLAIM TO ANY PARTICULAR FONT, STYLE, SIZE, OR COLOR.

CLASS 25—CLOTHING

FOR CLOTHING, NAMELY, JERSEYS, JACKETS, COATS, HATS, STOCKING CAPS, T-SHIRTS, SWEAT SHIRTS, SWEAT PANTS, SHORTS, SHIRTS, PANTS, GLOVES, SOCKS (U.S. CLS. 22 AND 39).

CLASS 28—TOYS AND SPORTING GOODS

FOR ATHLETIC EQUIPMENT, SPORTING EQUIPMENT AND SPORTING GOODS, NAMELY, HOCKEY AND LACROSSE STICKS AND GLOVES (U.S. CLS. 22, 23, 38 AND 50).

CLASS 41—EDUCATION AND ENTERTAINMENT

FOR SPORTS TRAINING; SPORTS INSTRUCTION SERVICES (U.S. CLS. 100, 101 AND 107).
ANDREA BUTLER, EXAMINING ATTORNEY

SN 85-205,799. QUIIQ, LDA, PORTO, PORTUGAL, FILED 12-27-2010.



PRIORITY CLAIMED UNDER SEC. 44(D) ON ERPN CMNTY TM OFC APPLICATION NO. 9203589, FILED 6-25-2010, REG. NO. 9203589, DATED 12-6-2010, EXPIRES 6-25-2020.

NO CLAIM IS MADE TO THE EXCLUSIVE RIGHT TO USE "HOME APP MARKET", APART FROM THE MARK AS SHOWN.

THE MARK CONSISTS OF DESIGN DEPICTING A FRAMED COMPUTER MONITOR SHOWING APPLICATIONS ICONS, AND TO THE RIGHT OF THE DESIGN ARE THE WORDS "HOME APP MARKET".

CLASS 35—ADVERTISING AND BUSINESS

FOR (BASED ON 44(E)) WHOLESALE AND RETAIL STORE SERVICES FEATURING APPARATUS AND INSTRUMENTS FOR CONDUCTING, SWITCHING, TRANSFORMING, ACCUMULATING, REGULATING OR CONTROLLING ELECTRICITY, CASH REGISTERS, CALCULATING MACHINES, DATA PROCESSING EQUIPMENT, ALARM SYSTEMS, INTRUDER ALARM SYSTEMS AND THEFT ALARM SYSTEMS FOR DOMESTIC SECURITY, MOTION ALARMS, SMOKE, FIRE AND WATER DETECTORS, AUDIO AND VIDEO SPEAKERS, ACCESS DETECTORS AND WEATHER STATIONS (U.S. CLS. 100, 101 AND 102).

CLASS 38—COMMUNICATION

FOR (BASED ON INTENT TO USE) AND (BASED ON 44(E)) TELECOMMUNICATIONS SERVICES, NAMELY, CONSULTATION IN THE NATURE OF TECHNICAL CONSULTING IN THE FIELD OF AUDIO, TEXT AND VISUAL DATA TRANSMISSION AND COMMUNICATION IN THE FIELD OF CONTROLLING MUSIC, APPLIANCES, HEAT, AIR CONDITIONING, SECURITY, VIDEO, AND ENTERTAINMENT, IN THE HOME ENVIRONMENT (U.S. CLS. 100, 101 AND 104).

TRICIA SONNEBORN, EXAMINING ATTORNEY

SN 85-205,802. QUIIQ, LDA, PORTO, PORTUGAL, FILED 12-27-2010.



TV App Market

PRIORITY CLAIMED UNDER SEC. 44(D) ON ERPN CMNTY TM OFC APPLICATION NO. 9203555, FILED 6-25-2010, REG. NO. 9203555, DATED 12-6-2010, EXPIRES 6-25-2020.

NO CLAIM IS MADE TO THE EXCLUSIVE RIGHT TO USE "TV APP MARKET", APART FROM THE MARK AS SHOWN.

THE MARK CONSISTS OF A DESIGN DEPICTING A FRAMED COMPUTER MONITOR SHOWING APPLICATIONS ICONS AND TO THE RIGHT OF THE DESIGN ARE THE WORDS "TV APP MARKET".

CLASS 35—ADVERTISING AND BUSINESS

FOR (BASED ON 44(E)) WHOLESALE AND RETAIL STORE SERVICES FEATURING APPARATUS AND INSTRUMENTS FOR CONDUCTING, SWITCHING, TRANSFORMING, ACCUMULATING, REGULATING OR CONTROLLING ELECTRICITY, CASH REGISTERS, CALCULATING MACHINES, DATA PROCESSING EQUIPMENT, ALARM SYSTEMS, INTRUDER ALARM SYSTEMS AND THEFT ALARM SYSTEMS FOR DOMESTIC SECURITY, MOTION ALARMS, SMOKE, FIRE AND WATER DETECTORS, AUDIO AND VIDEO SPEAKERS, ACCESS DETECTORS AND WEATHER STATIONS (U.S. CLS. 100, 101 AND 102).

CLASS 38—COMMUNICATION

FOR (BASED ON INTENT TO USE) AND (BASED ON 44(E)) TELECOMMUNICATIONS SERVICES, NAMELY, CONSULTATION IN THE NATURE OF TECHNICAL CONSULTING IN THE FIELD OF AUDIO, TEXT AND VISUAL DATA TRANSMISSION AND COMMUNICATION IN THE FIELD OF CONTROLLING MUSIC, APPLIANCES, HEAT, AIR CONDITIONING, SECURITY, VIDEO, AND ENTERTAINMENT, IN THE HOME ENVIRONMENT (U.S. CLS. 100, 101 AND 104).

TRICIA SONNEBORN, EXAMINING ATTORNEY

SN 85-207,319. FIANDACA, ALFRED, NEW YORK, NY, FILED 12-29-2010.

FIANDACA

THE MARK CONSISTS OF STANDARD CHARACTERS WITHOUT CLAIM TO ANY PARTICULAR FONT, STYLE, SIZE, OR COLOR.

SEC. 2(F).

CLASS 25—CLOTHING

FOR WEARING APPAREL, NAMELY, BLOUSES, COATS, DRESSES, GOWNS, JACKETS, LOUNGEWEAR, PANTS, SKIRTS AND SUITS; ACCESSORIES, NAMELY, BELTS, GLOVES, SCARVES AND SHAWLS (U.S. CLS. 22 AND 39).

FIRST USE 5-1-1979; IN COMMERCE 5-1-1979.

CLASS 42—SCIENTIFIC AND COMPUTER SERVICES

FOR DESIGN FOR OTHERS OF WEARING APPAREL AND ACCESSORIES (U.S. CLS. 100 AND 101).

FIRST USE 5-1-1979; IN COMMERCE 5-1-1979.

H. M. FISHER, EXAMINING ATTORNEY

SN 85-208,669. SCOTCHWARE, INC., OLDSMAR, FL, FILED 12-31-2010.

ScotchWare

THE MARK CONSISTS OF STANDARD CHARACTERS WITHOUT CLAIM TO ANY PARTICULAR FONT, STYLE, SIZE, OR COLOR.

CLASS 9—ELECTRICAL AND SCIENTIFIC APPARATUS

FOR DOWNLOADABLE COMPUTER SOFTWARE FOR RECEIVING AND READING TEXT AND IMAGES AND SOUND THROUGH INTERNET ACCESS AND FOR DISPLAYING ELECTRONICALLY PUBLISHED MATERIALS, NAMELY, BOOKS, AUDIO BOOKS, VIDEOS, JOURNALS, NEWSPAPERS, MAGAZINES, AND MULTIMEDIA PRESENTATIONS, ALL FOR USE ON COMPUTERS AND MOBILE DEVICES, NAMELY, PERSONAL COMPUTERS, WEB BROWSERS, MOBILE PHONES AND MOBILE COMPUTERS FOR INDIVIDUAL AND BUSINESS SOLUTIONS; DOWNLOADABLE COMPUTER SOFTWARE FOR DISPLAYING ELECTRONICALLY PUBLISHED MATERIALS IN THE FIELD OF ELEARNING, NAMELY, BOOKS, AUDIO BOOKS, VIDEOS, PRACTICE TESTS, JOURNALS, NEWSPAPERS, MAGAZINES, AND MULTIMEDIA PRESENTATIONS, ALL FOR USE ON COMPUTERS AND MOBILE DEVICES, NAMELY, PERSONAL COMPUTERS, WEB BROWSERS, MOBILE PHONES AND MOBILE COMPUTERS FOR INDIVIDUAL AND BUSINESS SOLUTIONS; COMPUTER SOFTWARE IN THE FIELD OF TEXT, IMAGE AND SOUND TRANSMISSION AND DISPLAY FOR INDIVIDUAL AND BUSINESS SOLUTIONS (U.S. CLS. 21, 23, 26, 36 AND 38).

CLASS 35—ADVERTISING AND BUSINESS

FOR ADVERTISING, MARKETING AND PROMOTION SERVICES FOR COMPUTER APPLICATIONS SOFTWARE (U.S. CLS. 100, 101 AND 102).

CLASS 41—EDUCATION AND ENTERTAINMENT

FOR MULTI-MEDIA PUBLISHING OF COMPUTER SOFTWARE, NAMELY, PUBLICATION OF THIRD PARTY DOWNLOADABLE COMPUTER SOFTWARE FOR RECEIVING AND READING TEXT AND IMAGES AND SOUND THROUGH WIRELESS INTERNET ACCESS AND FOR DISPLAYING ELECTRONICALLY PUBLISHED MATERIALS, NAMELY, BOOKS, AUDIO BOOKS, VIDEOS, JOURNALS, NEWSPAPERS, MAGAZINES, AND MULTIMEDIA PRESENTATIONS, ALL FOR USE ON COMPUTERS AND MOBILE DEVICES, NAMELY, PERSONAL COMPUTERS, WEB BROWSERS, MOBILE PHONES AND MOBILE COMPUTERS FOR INDIVIDUAL AND BUSINESS SOLUTIONS; PUBLICATION OF ELECTRONICALLY PUBLISHED MATERIALS, NAMELY, BOOKS, AUDIO BOOKS, VIDEOS, JOURNALS, NEWSPAPERS, MAGAZINES, AND MULTIMEDIA PRESENTATIONS FOR MOBILE DEVICES, ONLINE WEB BROWSER APPLICATIONS AND PERSONAL AND BUSINESS COMPUTER APPLICATIONS (U.S. CLS. 100, 101 AND 107).

CLASS 42—SCIENTIFIC AND COMPUTER SERVICES

FOR PROVIDING ONLINE NON-DOWNLOADABLE SOFTWARE FOR RECEIVING AND READING TEXT AND IMAGES AND SOUND THROUGH INTERNET ACCESS AND FOR DISPLAYING ELECTRONICALLY PUBLISHED MATERIALS, NAMELY, BOOKS, AUDIO BOOKS, VIDEOS, JOURNALS, NEWSPAPERS, MAGAZINES, AND MULTIMEDIA PRESENTATIONS, ALL FOR USE ON COMPUTERS AND MOBILE DEVICES, NAMELY, PERSONAL COMPUTERS, WEB BROWSERS, MOBILE PHONES AND MOBILE COMPUTERS FOR INDIVIDUAL AND BUSINESS SOLUTIONS; CUSTOMIZED COMPUTER SOFTWARE DEVELOPMENT SERVICES FOR MOBILE DEVICES, ONLINE WEB BROWSER APPLICATIONS, AND PERSONAL COMPUTER APPLICATIONS; INDIVIDUAL AND BUSINESS TECHNOLOGY COMPUTER SOFTWARE CONSULTATION; COMPUTER SOFTWARE DEVELOPMENT; DEVELOPING, DESIGNING, AND WRITING OF COMPUTER APPLICATION SOFTWARE (U.S. CLS. 100 AND 101).

CHARLOTTE CORWIN, EXAMINING ATTORNEY

SN 85-209,785. CIVICSCIENCE INC., PITTSBURGH, PA. FILED 1-4-2011.

CIVICSCIENCE

THE MARK CONSISTS OF STANDARD CHARACTERS WITHOUT CLAIM TO ANY PARTICULAR FONT, STYLE, SIZE, OR COLOR.

CLASS 9—ELECTRICAL AND SCIENTIFIC APPARATUS

FOR DOWNLOADABLE ELECTRONIC DATA FILES AND DATABASES, NAMELY, DATA FROM PUBLIC OPINION POLLS, VIA THE INTERNET (U.S. CLS. 21, 23, 26, 36 AND 38).

CLASS 35—ADVERTISING AND BUSINESS

FOR CONDUCTING PUBLIC OPINION POLLS; CONDUCTING PUBLIC OPINION POLL SURVEYS FOR BUSINESS PURPOSES IN THE FIELDS OF DEMOGRAPHICS, POLITICS, CONSUMER HABITS, AND ATTITUDES TOWARD BRANDS AND PRODUCTS; ANALYZING PUBLIC OPINION POLL DATA FOR BUSINESS PURPOSES IN THE FIELDS OF DEMOGRAPHICS, POLITICS, CONSUMER HABITS, AND ATTITUDES TOWARD BRANDS AND PRODUCTS; SUPPLYING OPINION-POLL QUESTIONS AND RESULTS FOR USE BY OTHERS ON WEBSITES (U.S. CLS. 100, 101 AND 102).

KATHRYN COWARD, EXAMINING ATTORNEY

SN 85-210,200. ORNAMENT CENTRAL, LLC, GARDNER, MA. FILED 1-4-2011.



THE MARK CONSISTS OF AN IMAGE OF A SMILING FACE WITH TWO LARGE CIRCLES FOR CHEEKS.

CLASS 9—ELECTRICAL AND SCIENTIFIC APPARATUS

FOR DECORATIVE MAGNETS (U.S. CLS. 21, 23, 26, 36 AND 38).

CLASS 20—FURNITURE AND ARTICLES NOT OTHERWISE CLASSIFIED

FOR ORNAMENTS OF RESIN (U.S. CLS. 2, 13, 22, 25, 32 AND 50).

CLASS 28—TOYS AND SPORTING GOODS

FOR CHRISTMAS TREE ORNAMENTS (U.S. CLS. 22, 23, 38 AND 50).

SAIMA MAKHDOOM, EXAMINING ATTORNEY

SN 85-210,246. ORNAMENT CENTRAL, LLC, GARDNER, MA. FILED 1-4-2011.



THE MARK CONSISTS OF AN IMAGE OF A SMILING FACE WITH TWO LARGE CIRCLES FOR CHEEKS AND FOUR EYELASHES.

CLASS 9—ELECTRICAL AND SCIENTIFIC APPARATUS

FOR DECORATIVE MAGNETS (U.S. CLS. 21, 23, 26, 36 AND 38).

CLASS 20—FURNITURE AND ARTICLES NOT OTHERWISE CLASSIFIED

FOR ORNAMENTS OF RESIN (U.S. CLS. 2, 13, 22, 25, 32 AND 50).

CLASS 28—TOYS AND SPORTING GOODS

FOR CHRISTMAS TREE ORNAMENTS (U.S. CLS. 22, 23, 38 AND 50).
SAIMA MAKHDOOM, EXAMINING ATTORNEY

SN 85-210,860. BJU INTERNATIONAL, LONDON, UNITED KINGDOM, FILED 1-5-2011.

BJU INTERNATIONAL

THE MARK CONSISTS OF STANDARD CHARACTERS WITHOUT CLAIM TO ANY PARTICULAR FONT, STYLE, SIZE, OR COLOR.

PRIORITY CLAIMED UNDER SEC. 44(D) ON ERP N CMNTY TM OFC APPLICATION NO. 009276767, FILED 7-27-2010, REG. NO. 009276767, DATED 3-6-2011, EXPIRES 7-27-2020.

NO CLAIM IS MADE TO THE EXCLUSIVE RIGHT TO USE "INTERNATIONAL", APART FROM THE MARK AS SHOWN.

CLASS 9—ELECTRICAL AND SCIENTIFIC APPARATUS

FOR NON-PRINTED, ELECTRONIC AND DOWNLOADABLE PUBLICATIONS, NAMELY, BOOKS, JOURNALS, JOURNAL SUPPLEMENTS, ARTICLES, NEWSLETTERS, PODCASTS, SLIDE PRESENTATIONS, AUDIO AND VIDEO, ALL ON THE SUBJECT OF UROLOGY AND MEN'S HEALTH; NON-PRINTED, ELECTRONIC AND DOWNLOADABLE PUBLICATIONS, NAMELY, BOOKS, JOURNALS, JOURNAL SUPPLEMENTS, ARTICLES, NEWSLETTERS, PODCASTS, SLIDE PRESENTATIONS, AUDIO AND VIDEO, ALL RELATING TO CONTINUED PROFESSIONAL DEVELOPMENT, RESEARCH AND EDUCATION ON THE SUBJECT OF UROLOGY AND MEN'S HEALTH (U.S. CLS. 21, 23, 26, 36 AND 38).

CLASS 16—PAPER GOODS AND PRINTED MATTER

FOR PRINTED PUBLICATIONS, NAMELY, BOOKS, JOURNALS, SUPPLEMENTS, ARTICLES, NEWSLETTERS, ALL ON THE SUBJECT OF UROLOGY AND MEN'S HEALTH; PRINTED PUBLICATIONS, NAMELY, BOOKS, JOURNALS, SUPPLEMENTS, ARTICLES, NEWSLETTERS, ALL RELATING TO CONTINUED PROFESSIONAL DEVELOPMENT, RESEARCH AND EDUCATION ON THE SUBJECT OF UROLOGY AND MEN'S HEALTH (U.S. CLS. 2, 5, 22, 23, 29, 37, 38 AND 50).

CLASS 41—EDUCATION AND ENTERTAINMENT

FOR EDUCATION AND TEACHING ON THE SUBJECT OF UROLOGY AND MEN'S HEALTH, NAMELY, ARRANGING AND CONDUCTING PROGRAMS, WORKSHOPS, COURSES, CLASSES, LECTURES, SEMINARS, TUTORIALS, CONFERENCES AND EXHIBITIONS, AND DISTRIBUTING COURSE MATERIAL IN CONNECTION THEREWITH; TRAINING IN THE FIELD OF UROLOGY AND MEN'S HEALTH, AND DISTRIBUTING COURSE MATERIAL IN CONNECTION THEREWITH; PRODUCTION OF AUDIO TAPES, AUDIO DISCS, VIDEO TAPES AND VIDEO DISCS, ALL ON THE SUBJECT OF UROLOGY AND MEN'S HEALTH; PROVISION OF EDUCATIONAL, TRAINING AND TEACHING INFORMATION RELATING TO THE SUBJECT OF MEN'S HEALTH AND OTHER RELATED AREAS; PUBLICATION OF BOOKS, TEXTS AND PRINTED MATTER RELATING TO THE SUBJECT OF UROLOGY; PUBLICATION OF EDUCATIONAL PRINTED MATTER RELATING TO THE SUBJECT OF UROLOGY; PROVISION OF CONTINUING PROFESSIONAL DEVELOPMENT PROGRAMMES, PROVISION OF INTERACTIVE CONTINUING PROFESSIONAL DEVELOPMENT PROGRAMMES (U.S. CLS. 100, 101 AND 107).

BRIDGETT SMITH, EXAMINING ATTORNEY

SN 85-211,242. ORNAMENT CENTRAL LLC, GARDNER, MA. FILED 1-5-2011.



THE MARK CONSISTS OF A SMILING FACE WITH TWO LARGE CIRCLES FOR CHEEKS AND THREE EYELASHES.

CLASS 9—ELECTRICAL AND SCIENTIFIC APPARATUS

FOR DECORATIVE MAGNETS (U.S. CLS. 21, 23, 26, 36 AND 38).

CLASS 20—FURNITURE AND ARTICLES NOT OTHERWISE CLASSIFIED

FOR 3D ORNAMENTS MADE FROM PLASTIC; HOLIDAY ORNAMENTS OF PLASTIC (U.S. CLS. 2, 13, 22, 25, 32 AND 50).

CLASS 28—TOYS AND SPORTING GOODS

FOR CHRISTMAS TREE ORNAMENTS AND DECORATIONS (U.S. CLS. 22, 23, 38 AND 50).
SAIMA MAKHDOOM, EXAMINING ATTORNEY

SN 85-211,312. ORNAMENT CENTRAL LLC, GARDNER, MA. FILED 1-5-2011.

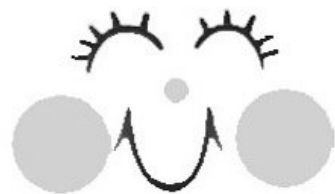

THE MARK CONSISTS OF AN IMAGE OF A SMILING FACE WITH TWO LARGE CIRCLES FOR CHEEKS AND FIVE EYELASHES.

CLASS 9—ELECTRICAL AND SCIENTIFIC APPARATUS

FOR DECORATIVE MAGNETS (U.S. CLS. 21, 23, 26, 36 AND 38).

CLASS 20—FURNITURE AND ARTICLES NOT OTHERWISE CLASSIFIED

FOR 3D ORNAMENTS MADE FROM PLASTIC; HOLIDAY ORNAMENTS OF PLASTIC (U.S. CLS. 2, 13, 22, 25, 32 AND 50).

CLASS 28—TOYS AND SPORTING GOODS

FOR CHRISTMAS TREE ORNAMENTS AND DECORATIONS (U.S. CLS. 22, 23, 38 AND 50).
SAIMA MAKHDOOM, EXAMINING ATTORNEY

SN 85-211,707. GLO SCIENCE LLC, NEW YORK, NY. FILED 1-6-2011.

GLO Brilliant

THE MARK CONSISTS OF STANDARD CHARACTERS WITHOUT CLAIM TO ANY PARTICULAR FONT, STYLE, SIZE, OR COLOR.
OWNER OF U.S. REG. NO. 3,873,849.

CLASS 3—COSMETICS AND CLEANING PREPARATIONS

FOR DENTAL BLEACHING GELS; TEETH WHITENING KITS; TEETH BLEACHING PREPARATIONS; TEETH CLEANING PREPARATIONS; TEETH WHITENING GELS; TEETH WHITENING PREPARATIONS (U.S. CLS. 1, 4, 6, 50, 51 AND 52).
FIRST USE 5-25-2010; IN COMMERCE 5-25-2010.

CLASS 5—PHARMACEUTICALS

FOR PRE-FILLED CONTAINERS FOR APPLYING TEETH BLEACHING PREPARATIONS AND BLEACHING GELS (U.S. CLS. 6, 18, 44, 46, 51 AND 52).
FIRST USE 5-25-2010; IN COMMERCE 5-25-2010.

CLASS 10—MEDICAL APPARATUS

FOR TEETH WHITENING DEVICES, NAMELY, MOUTHGUARDS (U.S. CLS. 26, 39 AND 44).
FIRST USE 5-25-2010; IN COMMERCE 5-25-2010.
GISELLE AGOSTO, EXAMINING ATTORNEY

SN 85-214,137. NATURA INVICTA - IMPORTACAO E EXPORTACAO DE BRINDES, LDA., RIO DE MOURO, PORTUGAL, FILED 1-10-2011.

SHAANTI & DOSTEE

THE MARK CONSISTS OF STANDARD CHARACTERS WITHOUT CLAIM TO ANY PARTICULAR FONT, STYLE, SIZE, OR COLOR.

PRIORITY CLAIMED UNDER SEC. 44(D) ON PORTUGAL APPLICATION NO. 476745, FILED 12-31-2010, REG. NO. 476745, DATED 3-14-2011, EXPIRES 3-14-2021.

THE ENGLISH TRANSLATION OF "SHAANTI" IN THE MARK IS "PEACE". THE ENGLISH TRANSLATION OF "DOSTEE" IS "FRIENDSHIP".

CLASS 14—JEWELRY

FOR PRECIOUS METALS; JEWELRY; BIJOUTERIE, NAMELY, COSTUME JEWELRY; WATCHES (U.S. CLS. 2, 27, 28 AND 50).

CLASS 18—LEATHER GOODS

FOR LEATHER AND IMITATION LEATHER; SADDLERY; TRAVEL GOODS, NAMELY, LUGGAGE, CARRY-ON BAGS, GARMENT BAGS FOR TRAVEL, TRAVEL BAGGAGE, TRAVEL BAGS AND TRAVEL CASES; UMBRELLAS AND PARASOLS (U.S. CLS. 1, 2, 3, 22 AND 41).

CLASS 25—CLOTHING

FOR CLOTHING, NAMELY, SHIRTS, PANTS AND JACKETS; FOOTWEAR; HEADGEAR, NAMELY, HEADWEAR, HATS AND CAPS (U.S. CLS. 22 AND 39).
LOURDES AYALA, EXAMINING ATTORNEY

SN 85-216,716. EUREKA SPORTS LAB LLC, NEW YORK, NY. FILED 1-13-2011.

WORLD CHAMPIONSHIP OF PING
PONG

THE MARK CONSISTS OF STANDARD CHARACTERS WITHOUT CLAIM TO ANY PARTICULAR FONT, STYLE, SIZE, OR COLOR.

CLASS 9—ELECTRICAL AND SCIENTIFIC APPARATUS

FOR COMPUTER GAME DISCS; COMPUTER GAME PROGRAMS; COMPUTER GAME SOFTWARE; ELECTRONIC VIDEO GAME DISCS; ELECTRONIC VIDEO GAME PROGRAMS; ELECTRONIC VIDEO GAME SOFTWARE; INTERACTIVE ELECTRONIC GAME DISCS; INTERACTIVE ELECTRONIC GAME PROGRAMS; INTERACTIVE ELECTRONIC GAME SOFTWARE; INTERACTIVE VIDEO GAME DISCS; INTERACTIVE VIDEO GAME PROGRAMS; INTERACTIVE VIDEO GAME SOFTWARE; VIDEO GAME DISCS; VIDEO GAME PROGRAMS; VIDEO GAME SOFTWARE; VIDEO GAME SOFTWARE APPLICATIONS FOR MOBILE PHONES, HAND-HELD DEVICES, AND COMPUTERS (U.S. CLS. 21, 23, 26, 36 AND 38).

CLASS 41—EDUCATION AND ENTERTAINMENT

FOR ENTERTAINMENT SERVICES, NAMELY, PROVIDING ONLINE VIDEO GAMES; ENTERTAINMENT SERVICES, NAMELY, PROVIDING ONLINE ELECTRONIC GAMES (U.S. CLS. 100, 101 AND 107).
JORDAN BAKER, EXAMINING ATTORNEY

SN 85-218,050. BLUEBONNET ELECTRIC COOPERATIVE, INC., BASTROP, TX. FILED 1-14-2011.

NET ENERGY MARKET

THE MARK CONSISTS OF STANDARD CHARACTERS WITHOUT CLAIM TO ANY PARTICULAR FONT, STYLE, SIZE, OR COLOR.

NO CLAIM IS MADE TO THE EXCLUSIVE RIGHT TO USE "NET ENERGY", APART FROM THE MARK AS SHOWN.

CLASS 35—ADVERTISING AND BUSINESS

FOR ENERGY USAGE MANAGEMENT; PROVIDING ENERGY USAGE MANAGEMENT SERVICES, NAMELY, REDUCING ENERGY CONSUMPTION BY REMOTELY INTERACTING WITH AND CONTROLLING SMART APPLIANCES AND SMART PLUGS; ENERGY USAGE MANAGEMENT SERVICES, NAMELY, ENERGY DEMAND MANAGEMENT SERVICES; ENERGY USAGE MANAGEMENT INFORMATION SERVICES; HOME ENERGY ASSESSMENT SERVICES FOR THE PURPOSE OF DETERMINING ENERGY EFFICIENCY OR USAGE MANAGEMENT; PROVIDING INFORMATION IN THE FIELD OF ENERGY EFFICIENCY; PROVIDING INFORMATION ON THE ENVIRONMENTAL IMPACT OF CONSUMERS' ONGOING ENERGY USAGE; PROVIDING INFORMATION TO CONSUMERS ABOUT THE EFFICIENT USE OF RENEWABLE ENERGY, ELECTRICITY, AND OTHER UTILITY SERVICES (U.S. CLS. 100, 101 AND 102).

FIRST USE 5-27-2010; IN COMMERCE 5-27-2010.

CLASS 40—MATERIAL TREATMENT

FOR PROVIDING INFORMATION TO CONSUMERS ABOUT RENEWABLE ENERGY GENERATION (U.S. CLS. 100, 103 AND 106).

FIRST USE 5-27-2010; IN COMMERCE 5-27-2010.
JASON LOTT, EXAMINING ATTORNEY

SN 85-218,095. RHOMANIA LLC, PITTSBURGH, PA. FILED 1-14-2011.



THE MARK CONSISTS OF THE TEXT "RHOMANIA" WITH THE TEXT "SENSE ABILITY" POSITIONED DIRECTLY UNDERNEATH THE "RHOMANIA" TEXT AND THE GREEK LETTER RHO POSITIONED IN A CIRCLE DIRECTLY ABOVE THE "RHOMANIA" TEXT.

CLASS 9—ELECTRICAL AND SCIENTIFIC APPARATUS

FOR DOWNLOADABLE COMPUTER APPLICATION SOFTWARE IN THE FIELD OF WINE SELECTION AND RECOMMENDATIONS VIA THE INTERNET AND WIRELESS DEVICES (U.S. CLS. 21, 23, 26, 36 AND 38).

CLASS 35—ADVERTISING AND BUSINESS

FOR PROVIDING A WEBSITE WHERE USERS CAN POST RATINGS, REVIEWS AND RECOMMENDATIONS ON LIQUOR, BEER, WINE AND FOOD/BEVERAGE PAIRINGS FOR COMMERCIAL PURPOSES; PROVIDING INFORMATION TO RESTAURANTS AND WHOLESALE PURCHASERS OF LIQUOR, BEER AND WINE TO ASSIST WITH PURCHASES OF LIQUOR, BEER AND WINE INVENTORY (U.S. CLS. 100, 101 AND 102).

CLASS 43—HOTEL AND RESTAURANT SERVICES

FOR PROVIDING A WEBSITE WHERE USERS CAN POST RATINGS, REVIEWS AND RECOMMENDATIONS ON WINE FOR THE PURPOSE OF CREATING AN INDIVIDUALIZED PROFILE; PROVIDING A WEBSITE FOR USERS WITH SPECIFIC INFORMED RECOMMENDATIONS OF WINE CHARACTERISTICS VALIDATED BY THE USERS' INPUTTED PREFERENCES AND SOCIAL NETWORK (U.S. CLS. 100 AND 101).

NAAKWAMA ANKRAH, EXAMINING ATTORNEY

SN 85-220,407. MARCH JR., GLENVILLE A., LOS ANGELES, CA. AND MARCH, CABRINI T., LOS ANGELES, CA. FILED 1-18-2011.

MARCH

SN 85-218,238. RHOMANIA LLC, PITTSBURGH, PA. FILED 1-14-2011.

Grail

THE MARK CONSISTS OF STANDARD CHARACTERS WITHOUT CLAIM TO ANY PARTICULAR FONT, STYLE, SIZE, OR COLOR.

CLASS 9—ELECTRICAL AND SCIENTIFIC APPARATUS

FOR DOWNLOADABLE COMPUTER APPLICATION SOFTWARE IN THE FIELD OF WINE SELECTION AND RECOMMENDATIONS VIA THE INTERNET AND WIRELESS DEVICES (U.S. CLS. 21, 23, 26, 36 AND 38).

CLASS 35—ADVERTISING AND BUSINESS

FOR PROVIDING A WEBSITE WHERE USERS CAN POST RATINGS, REVIEWS AND RECOMMENDATIONS ON LIQUOR, BEER, WINE AND FOOD/BEVERAGE PAIRINGS FOR COMMERCIAL PURPOSES; PROVIDING INFORMATION TO RESTAURANTS AND WHOLESALE PURCHASERS OF LIQUOR, BEER AND WINE TO ASSIST WITH PURCHASES OF LIQUOR, BEER AND WINE INVENTORY (U.S. CLS. 100, 101 AND 102).

CLASS 43—HOTEL AND RESTAURANT SERVICES

FOR PROVIDING A WEBSITE WHERE USERS CAN POST RATINGS, REVIEWS AND RECOMMENDATIONS ON WINE FOR THE PURPOSE OF CREATING AN INDIVIDUALIZED PROFILE; PROVIDING A WEBSITE FOR USERS WITH SPECIFIC INFORMED RECOMMENDATIONS OF WINE CHARACTERISTICS VALIDATED BY THE USERS' INPUTTED PREFERENCES AND SOCIAL NETWORK (U.S. CLS. 100 AND 101).

NAAKWAMA ANKRAH, EXAMINING ATTORNEY

THE MARK CONSISTS OF STANDARD CHARACTERS WITHOUT CLAIM TO ANY PARTICULAR FONT, STYLE, SIZE, OR COLOR.

CLASS 9—ELECTRICAL AND SCIENTIFIC APPARATUS

FOR ELECTRONIC DOWNLOADABLE PUBLICATIONS, NAMELY, NEWSLETTERS, FACT SHEETS, AND BROCHURES IN THE FIELDS OF VISION CARE AND PATIENT OUTREACH SERVICES REGARDING POTENTIAL OR ACTUAL HEALTH ISSUES, NUTRITION, WEIGHT LOSS, OBESITY, WEIGHT MANAGEMENT, SMOKING CESSATION, CHRONIC DISEASE MANAGEMENT, DISEASE PREVENTION, MEDICAL CARE, ACCESS TO MEDICAL CARE, HEALTH SERVICES, HEALTH RISK FACTORS, HEALTH STATUS, HEALTH PLAN INFORMATION, AND HEALTH CARE SERVICES OFFERED BY THIRD PARTIES, EXPRESSLY EXCLUDING SUCH PUBLICATIONS IN THE FIELD OF MEDICAL FITNESS (U.S. CLS. 21, 23, 26, 36 AND 38).

FIRST USE 12-15-2005; IN COMMERCE 12-15-2005.

CLASS 16—PAPER GOODS AND PRINTED MATTER

FOR PRINT PUBLICATIONS, NAMELY, NEWSLETTERS, FACT SHEETS, AND BROCHURES IN THE FIELDS OF VISION CARE AND PATIENT OUTREACH SERVICES REGARDING POTENTIAL OR ACTUAL HEALTH ISSUES, NUTRITION, WEIGHT LOSS, OBESITY, WEIGHT MANAGEMENT, SMOKING CESSATION, CHRONIC DISEASE MANAGEMENT, DISEASE PREVENTION, MEDICAL CARE, ACCESS TO MEDICAL CARE, HEALTH SERVICES, HEALTH RISK FACTORS, HEALTH STATUS, HEALTH PLAN INFORMATION, AND HEALTH CARE SERVICES OFFERED BY THIRD PARTIES, EXPRESSLY EXCLUDING SUCH PUBLICATIONS IN THE FIELD OF MEDICAL FITNESS (U.S. CLS. 2, 5, 22, 23, 29, 37, 38 AND 50).

FIRST USE 12-15-2005; IN COMMERCE 12-15-2005.

CLASS 35—ADVERTISING AND BUSINESS

FOR BUSINESS MANAGEMENT AND CONSULTING SERVICES FOR THE HEALTH CARE INDUSTRY, EXPRESSLY EXCLUDING SUCH SERVICES IN THE FIELD OF MEDICAL FITNESS; MEDICAL CLAIMS MANAGEMENT SERVICES, NAMELY, RECEIVING, DATA ENTERING, AND RE-PRICING OF TRANSACTIONS THAT ARE ORIGINATED BY PHYSICIANS, HOSPITALS, AND ANCILLARY MEDICAL CARE PROVIDERS; MARKETING SERVICES, NAMELY, PROMOTING HEALTH BENEFIT PLANS OF OTHERS (U.S. CLS. 100, 101 AND 102).

FIRST USE 6-17-2005; IN COMMERCE 6-17-2005.

CLASS 36—INSURANCE AND FINANCIAL

FOR CLAIMS ADJUSTMENT IN THE FIELD OF INSURANCE; CLAIMS ADMINISTRATION SERVICES IN THE FIELD OF HEALTH INSURANCE; ELECTRONIC PROCESSING OF INSURANCE CLAIMS AND PAYMENT DATA; UNDERWRITING AND ISSUING HEALTH INSURANCE, PREPAID BENEFIT PLANS, AND DISCOUNT PLANS; UNDERWRITING, ISSUING, UNDERWRITING, AND ADMINISTERING VISION CARE INSURANCE, PREPAID BENEFIT PLANS, AND DISCOUNT PLANS; PROVIDING INFORMATION VIA TELEPHONE AND WEBSITES IN THE FIELDS OF HEALTH INSURANCE PLANS; MEDICAL CLAIMS MANAGEMENT SERVICES, NAMELY, ADMINISTERING, PROCESSING, ASSESSING, ADJUSTING, AND PAYING HEALTH INSURANCE CLAIMS; OUTREACH SERVICES IN THE NATURE OF PROVIDING INSURANCE INFORMATION WITH PATIENTS REGARDING HEALTH PLANS VIA TELEPHONE, MAIL, TEXT, INSTANT MESSAGING AND OTHER COMMUNICATIONS METHODS, EXPRESSLY EXCLUDING SUCH SERVICES IN THE FIELD OF MEDICAL FITNESS (U.S. CLS. 100, 101 AND 102).

FIRST USE 4-6-2005; IN COMMERCE 4-6-2005.

CLASS 41—EDUCATION AND ENTERTAINMENT

FOR EDUCATIONAL SERVICES, NAMELY, PROVIDING INFORMATION VIA SEMINARS, CONFERENCES, CONTINUING EDUCATION COURSES, AND NON-DOWNLOADABLE ELECTRONIC NEWSLETTERS, FACT SHEETS AND BROCHURES, ALL IN THE FIELDS OF VISION CARE AND PATIENT OUTREACH SERVICES REGARDING POTENTIAL OR ACTUAL HEALTH ISSUES, NUTRITION, WEIGHT LOSS, OBESITY, WEIGHT MANAGEMENT, SMOKING CESSATION, CHRONIC DISEASE MANAGEMENT, DISEASE PREVENTION, MEDICAL CARE, ACCESS TO MEDICAL CARE, HEALTH SERVICES, HEALTH RISK FACTORS, HEALTH STATUS, HEALTH PLAN INFORMATION, AND HEALTH CARE SERVICES OFFERED BY THIRD PARTIES, EXPRESSLY EXCLUDING SUCH SERVICES IN THE FIELD OF MEDICAL FITNESS; VISION CARE SERVICES FOR PATIENTS, NAMELY, PROVIDING EDUCATION SERVICES IN THE NATURE OF CLASSES, SEMINARS, AND WORKSHOPS IN THE FIELD OF EYE DISEASES AND CONDITIONS (U.S. CLS. 100, 101 AND 107).

FIRST USE 12-31-1996; IN COMMERCE 12-31-1996.

CLASS 44—MEDICAL, BEAUTY AND AGRICULTURAL SERVICES

FOR MEDICAL SERVICES, EXPRESSLY EXCLUDING SUCH SERVICES IN THE FIELD OF MEDICAL FITNESS; HEALTH CARE SERVICES, EXCLUDING SUCH SERVICES IN THE FIELD OF MEDICAL FITNESS; VISION CARE SERVICES, NAMELY, THE DIAGNOSIS, TREATMENT, REHABILITATION, AND MANAGEMENT OF EYE DISEASES AND CONDITIONS; PROVIDING INFORMATION VIA TELEPHONE, WEBSITES, AND GLOBAL INFORMATION AND COMPUTER NETWORKS IN THE FIELDS OF HEALTH, EYE HEALTH, NUTRITION, WEIGHT LOSS AND WEIGHT MANAGEMENT, OBESITY, SMOKING CESSATION, CHRONIC DISEASE MANAGEMENT, DISEASE PREVENTION, MEDICAL CARE, HEALTH AND WELLNESS INCLUDING HEALTH STATUS AND HEALTH RISK FACTORS, AND HEALTH CARE SERVICES OFFERED BY THIRD PARTIES, EXPRESSLY EXCLUDING SUCH INFORMATION SERVICES IN THE FIELD OF MEDICAL FITNESS; OUTREACH SERVICES IN THE NATURE OF PROVIDING HEALTH CARE INFORMATION TO PATIENTS REGARDING POTENTIAL OR ACTUAL HEALTH IS-

SUES, NUTRITION, WEIGHT LOSS, OBESITY, WEIGHT MANAGEMENT, SMOKING CESSATION, CHRONIC DISEASE MANAGEMENT, DISEASE PREVENTION, MEDICAL CARE, ACCESS TO MEDICAL CARE, HEALTH SERVICES, HEALTH RISK FACTORS, HEALTH STATUS, AND HEALTH CARE SERVICES OFFERED BY THIRD PARTIES IN PERSON AND VIA TELEPHONE, MAIL, TEXT, INSTANT MESSAGING AND OTHER COMMUNICATIONS METHODS, EXPRESSLY EXCLUDING SUCH INFORMATION SERVICES IN THE FIELD OF MEDICAL FITNESS (U.S. CLS. 100 AND 101).

FIRST USE 12-31-1996; IN COMMERCE 12-31-1996.

ANDREW LEASER, EXAMINING ATTORNEY

SN 85-221,136. WOOT SERVICES LLC, CARROLLTON, TX. FILED 1-19-2011.

WOOT!

THE MARK CONSISTS OF STANDARD CHARACTERS WITHOUT CLAIM TO ANY PARTICULAR FONT, STYLE, SIZE, OR COLOR.

OWNER OF U.S. REG. NOS. 3,397,587 AND 3,811,816.

CLASS 35—ADVERTISING AND BUSINESS

FOR TRANSPORTATION LOGISTICS SERVICES, NAMELY, ARRANGING THE TRANSPORTATION AND SHIPPING OF GOODS FOR OTHERS, ARRANGING EXPEDITED PARCEL AND AIR FREIGHT SHIPPING FOR OTHERS, ARRANGING EXPEDITED SHIPPING OF GOODS FOR OTHERS AND ARRANGING FOR DELIVERY OF GOODS FOR OTHERS (U.S. CLS. 100, 101 AND 102).

CLASS 39—TRANSPORTATION AND STORAGE

FOR PACKAGING ARTICLES FOR TRANSPORTATION; PACKAGING GOODS FOR TRANSPORTATION; STORAGE OF GOODS; ELECTRONIC STORAGE OF MESSAGES AND DATA; STORAGE OF ELECTRONIC MEDIA, NAMELY, IMAGES, TEXT AND AUDIO DATA; PROVIDING A WEBSITE FOR ELECTRONIC STORAGE OF DIGITAL PHOTOGRAPHS AND VIDEOS (U.S. CLS. 100 AND 105).

CLASS 42—SCIENTIFIC AND COMPUTER SERVICES

FOR PROVIDING ON-LINE SOFTWARE FOR SELECTING DESTINATION LOCATIONS FOR THE TRANSPORTATION OF GOODS; PROVIDING AN ON-LINE WEBSITE FEATURING SOFTWARE WHICH AFFORD CUSTOMERS THE ABILITY TO SELECT A DISTRIBUTION POINT FOR GOODS PURCHASED ON THE INTERNET; RENTAL OF CLOUD COMPUTING SOFTWARE AND HARDWARE FOR STORING AND ARCHIVING DATA (U.S. CLS. 100 AND 101).

GENE MACIOL, EXAMINING ATTORNEY

SN 85-222,167. THE BEDA GROUP, LLC, BROOKLYN, NY.
FILED 1-20-2011.

BARZEL

THE MARK CONSISTS OF STANDARD CHARACTERS WITHOUT CLAIM TO ANY PARTICULAR FONT, STYLE, SIZE, OR COLOR.

THE ENGLISH TRANSLATION OF "BARZEL" IN THE MARK IS "IRON".

CLASS 7—MACHINERY

FOR SNOW THROWER, LAWN MOWER, POWER-OPERATED GRASS TRIMMER, POWER-OPERATED HEDGE TRIMMER (U.S. CLS. 13, 19, 21, 23, 31, 34 AND 35).

FIRST USE 11-30-2010; IN COMMERCE 11-30-2010.

CLASS 8—HAND TOOLS

FOR HAND-OPERATED ICE CHOPPER (U.S. CLS. 23, 28 AND 44).

FIRST USE 11-1-2010; IN COMMERCE 11-1-2010.

ANNE E. GUSTASON, EXAMINING ATTORNEY

SN 85-222,181. IPSCO TUBULARS INC., DOWNERS GROVE, IL. FILED 1-20-2011.



OWNER OF U.S. REG. NO. 2,478,141.

THE MARK CONSISTS OF THE LETTERS "TMK" APPEARING IN THE LOWER LEFT SIDE OF A SHADED SQUARE AND TO THE LEFT OF AN ARC DESIGN WITH THE TERM "IPSCO" APPEARING UNDERNEATH THE SQUARE IN A BACKGROUND WITH AN IN THE OUTLINE OF THE RECTANGLE.

CLASS 6—METAL GOODS

FOR METAL PIPES; METAL OIL AND GAS DRILL PIPES FOR USE IN WELL BORING; METAL OIL AND GAS WELL CASINGS; METAL OIL AND GAS WELL TUBING; METAL OIL AND GAS WELL PIPES; CUSTOMIZED MANUFACTURED METAL PIPES MADE TO CUSTOMER SPECIFICATIONS FEATURING PATENTED THREADS UTILIZED FOR FASTENING PIPE SECTIONS; METAL HOLLOW STRUCTURAL SECTIONS FOR CONSTRUCTION, STRUCTURAL AND HIGH-STRENGTH APPLICATIONS; METAL STRUCTURAL TUBING; AND METAL PIPE CONNECTIONS (U.S. CLS. 2, 12, 13, 14, 23, 25 AND 50).

FIRST USE 11-0-2009; IN COMMERCE 11-0-2009.

CLASS 40—MATERIAL TREATMENT

FOR CUSTOM MANUFACTURING OF PIPE AND PIPE CONNECTIONS; CUSTOM PIPE THREADING SERVICES (U.S. CLS. 100, 103 AND 106).

FIRST USE 11-0-2009; IN COMMERCE 11-0-2009.

ANNE E. GUSTASON, EXAMINING ATTORNEY

SN 85-222,724. CORVEL CORPORATION, IRVINE, CA.
FILED 1-20-2011.

CORVEL

THE MARK CONSISTS OF STANDARD CHARACTERS WITHOUT CLAIM TO ANY PARTICULAR FONT, STYLE, SIZE, OR COLOR.

OWNER OF U.S. REG. NOS. 1,796,491, 2,720,818 AND 2,868,502.

CLASS 9—ELECTRICAL AND SCIENTIFIC APPARATUS

FOR DOWNLOADABLE SOFTWARE FOR USE ON MOBILE DEVICES THAT ENABLES EMPLOYEES OF CLIENTS TO REMOTELY ACCESS INFORMATION ABOUT AND SCHEDULE APPOINTMENTS FOR HEALTH CARE SERVICES, WORKER'S COMPENSATION SERVICES, MEDICAL DIAGNOSTIC AND TREATMENT SERVICES, AND DISABILITY MANAGEMENT SERVICES; DOWNLOADABLE SOFTWARE FOR USE ON MOBILE DEVICES THAT ENABLES EMPLOYERS TO TRACK AND OBTAIN REPORTS ON EMPLOYEE INSURANCE CLAIMS AND WORKER'S COMPENSATION CLAIMS; DOWNLOADABLE SOFTWARE USED FOR REPORTING PHYSICAL INJURIES, REQUESTING HEALTH CARE SERVICES THROUGH AN ONLINE REQUEST FORM, AND SCHEDULING MEDICAL, DIAGNOSTIC AND THERAPY APPOINTMENTS, FOR MEDICAL AND LEGAL BILL REVIEW THROUGH AN ONLINE REQUEST FORM, ADJUDICATION OF MEDICAL AND WORKER'S COMPENSATION CLAIMS VIA AN ONLINE DATABASE PLATFORM AND AUDITING OF MEDICAL AND WORKER'S COMPENSATION CLAIMS VIA AN ONLINE DATABASE PLATFORM, FOR MEDICAL CLAIMS INFORMATION MANAGEMENT, AND FOR MANAGING MEDICAL CARE AND TREATMENT BY ENABLING CLIENTS TO REPORT INCIDENTS OR INJURIES AND TO OBTAIN AND SCHEDULE MEDICAL CARE AND TREATMENT VIA AN ONLINE DATA PLATFORM; DOWNLOADABLE SOFTWARE USED FOR ACCESSING A DATABASE FEATURING INFORMATION ON HEALTH CARE PROVIDER CREDENTIALS, PARTICIPATING HEALTH CARE PROVIDERS, HEALTH CARE NETWORK INFORMATION, AND PHARMACIES OFFERING DISCOUNT PRESCRIPTIONS (U.S. CLS. 21, 23, 26, 36 AND 38).

FIRST USE 9-20-2010; IN COMMERCE 9-20-2010.

CLASS 35—ADVERTISING AND BUSINESS

FOR HEALTH CARE COST REVIEW, NAMELY, MEDICAL PROVIDER REIMBURSEMENT REVIEW SERVICES; PROVIDING MEDICAL REFERRALS, PATIENT FILE MANAGEMENT, AND MEDICAL COST VERIFICATION SERVICES; PROVIDING REFERRALS FOR DISABILITY SERVICES; REVIEW OF UTILIZATION OF DISABILITY SERVICES; SCHEDULING OF APPOINTMENTS FOR MEDICAL CARE, EXAMS, TREATMENTS AND THERAPY SERVICES; COORDINATING ORDERS AND DELIVERY OF AND BILLING FOR RENTAL MEDICAL EQUIPMENT FROM PREFERRED DISTRIBUTORS THROUGH WEB-BASED SCHEDULING AND CALL CENTERS FOR CLIENTS; PATIENT CARE MANAGEMENT SERVICES, NAMELY, MEDICAL COST MANAGEMENT, MEDICAL REFERRALS, HEALTH CARE UTILIZATION AND REVIEW, EMPLOYMENT

TIONAL INTERNSHIPS, OFF CAMPUS EDUCATIONAL INTERNSHIPS, ON CAMPUS EDUCATIONAL PROFESSIONAL INTERNSHIPS, ON CAMPUS EDUCATIONAL FELLOWSHIPS, OFF CAMPUS EDUCATIONAL FELLOWSHIPS, STUDY ABROAD EDUCATIONAL OPPORTUNITIES, UNDERGRADUATE RESEARCH EDUCATIONAL OPPORTUNITIES, UNDERGRADUATE RESEARCH OPPORTUNITIES, COMMUNITY OUTREACH OPPORTUNITIES, COMMUNITY EDUCATIONAL SERVICE OPPORTUNITIES, AND COMMUNITY SERVICE OPPORTUNITIES; PROVIDING CONSULTING SERVICES AND INFORMATION AND ONLINE INFORMATION RELATING TO GRANTS, SCHOLARSHIPS, FINANCIAL AID, FINANCIAL ASSISTANCE AND FUNDING FOR UNIVERSITY STUDENTS IN THE FIELDS OF ENHANCED LEARNING AND EDUCATIONAL OPPORTUNITIES BEYOND THE CLASSROOM, ON CAMPUS EDUCATIONAL OPPORTUNITIES, OFF CAMPUS EDUCATIONAL OPPORTUNITIES, ON CAMPUS PART-TIME WORK STUDY EDUCATIONAL EXPERIENCES, ON CAMPUS EDUCATIONAL INTERNSHIPS, OFF CAMPUS EDUCATIONAL INTERNSHIPS, ON CAMPUS EDUCATIONAL PROFESSIONAL INTERNSHIPS, ON CAMPUS EDUCATIONAL FELLOWSHIPS, OFF CAMPUS EDUCATIONAL FELLOWSHIPS, STUDY ABROAD EDUCATIONAL OPPORTUNITIES, UNDERGRADUATE RESEARCH EDUCATIONAL OPPORTUNITIES, UNDERGRADUATE RESEARCH OPPORTUNITIES, COMMUNITY OUTREACH OPPORTUNITIES, COMMUNITY EDUCATIONAL SERVICE OPPORTUNITIES, AND COMMUNITY SERVICE OPPORTUNITIES; PROVIDING COUNSELING, CONSULTING, INFORMATION AND ONLINE INFORMATION IN THE AREA OF IMPROVED SERVICES FOR UNIVERSITY STUDENTS IN THE FIELD OF EDUCATIONAL FINANCIAL OPTIONS; AND PROVIDING COUNSELING, CONSULTING, INFORMATION AND ONLINE INFORMATION IN THE AREA OF IMPROVED SERVICES FOR UNIVERSITY STUDENTS IN THE FIELDS OF CAMPUS RESIDENTIAL LIVING IN THE FORM OF RENTAL OF STUDENT HOUSING (U.S. CLS. 100, 101 AND 102).

CLASS 41—EDUCATION AND ENTERTAINMENT

FOR DEVELOPING METHODS AND MEANS OF ENHANCING THE EDUCATIONAL EXPERIENCE OF UNIVERSITY STUDENTS ON CAMPUS AND OFF CAMPUS, NAMELY, PROVIDING AND ARRANGING CONFERENCES, MEETINGS, INTERVIEWS AND SURVEYS FOR STUDENTS AND OTHERS, FOR THE BENEFIT OF STUDENTS AND OTHERS, TO PROVIDE INPUT REGARDING METHODS AND MEANS OF ENHANCING THE EDUCATIONAL EXPERIENCE OF UNIVERSITY STUDENTS; DEVELOPING, OFFERING, PROVIDING AND MAKING AVAILABLE, FOR UNIVERSITY STUDENTS (A) ON CAMPUS AND OFF CAMPUS ENHANCED LEARNING AND EDUCATIONAL OPPORTUNITIES, NAMELY, DEVELOPING, OFFERING, PROVIDING AND MAKING AVAILABLE CONFERENCES, SEMINARS, CLASSES, TRAINING, ORIENTATIONS, TUTORIALS, LECTURES, WEBINARS, WORKSHOPS, DEMONSTRATIONS, EXHIBITS, LIBRARY RESOURCES, FIELD TRIPS, TOURS, PROGRAMS, HONORS PROGRAMS, ACTIVITIES IN THE NATURE OF FINE ARTS PRESENTATIONS AND PRODUCTIONS, FILMS, DANCE RECITALS, THEATRICAL PERFORMANCES AND OTHER CAMPUS SPONSORED CULTURAL EVENTS, SERVICE PROJECTS IN THE NATURE OF EDUCATIONAL CHARITABLE SERVICE PROJECTS INVOLVING UNIVERSITY STUDENTS IN THE FIELDS OF HOUSING AND BASIC HUMAN NEEDS FOR THE BENEFIT OF THE COMMUNITY, RESEARCH, MEDIA IN THE NATURE OF MAKING VIDEOTAPED CONFERENCES, SPEECHES, SEMINARS AND NEWS STORIES AVAILABLE OVER THE INTERNET, CONTESTS, COUNSELING, TUTORING, MENTORING AND PROVIDING EDUCATIONAL MATERIALS THEREWITH, ALL IN THE FIELDS OF EDUCATION, UNIVERSITY CURRICULUM AND UNIVERSITY EDUCATIONAL SUBJECT MATTER AND MAJORS, (B) ON CAMPUS EDUCATIONAL INTERNSHIPS, (C) OFF CAMPUS EDUCATIONAL INTERNSHIPS, (D) ON CAMPUS EDUCATIONAL PROFESSIONAL INTERNSHIPS, (E) ON CAMPUS EDUCATIONAL FELLOWSHIPS, (F) STUDY ABROAD EDUCATIONAL OPPORTUNITIES, NAMELY, TEMPORARY

EDUCATIONAL STUDIES IN A FOREIGN COUNTRY, (G) UNDERGRADUATE RESEARCH OPPORTUNITIES AND UNDERGRADUATE RESEARCH EDUCATIONAL OPPORTUNITIES, NAMELY, PERFORMING EDUCATIONAL RESEARCH AS AN UNDERGRADUATE WITH SUPERVISION FROM OTHERS, AND (H) COMMUNITY OUTREACH OPPORTUNITIES, COMMUNITY EDUCATIONAL SERVICE OPPORTUNITIES AND COMMUNITY SERVICE OPPORTUNITIES, NAMELY, ORGANIZING AND PROVIDING EDUCATIONAL CHARITABLE SERVICE PROJECTS INVOLVING UNIVERSITY STUDENTS IN THE FIELDS OF HOUSING AND OTHER BASIC HUMAN NEEDS FOR THE BENEFIT OF THE COMMUNITY; PROVIDING COUNSELING, CONSULTING, INFORMATION AND ONLINE INFORMATION TO UNIVERSITY STUDENTS IN THE FIELDS OF (A) ON CAMPUS AND OFF CAMPUS ENHANCED LEARNING AND EDUCATIONAL OPPORTUNITIES, NAMELY, CONFERENCES, SEMINARS, CLASSES, TRAINING, TUTORIALS, LECTURES, WEBINARS, WORKSHOPS, DEMONSTRATIONS, EXHIBITS, FIELD TRIPS, TOURS, PROGRAMS, ACTIVITIES, EVENTS, COUNSELING, TUTORING, MENTORING, AND EDUCATIONAL MATERIALS, ALL IN THE FIELDS OF EDUCATION, UNIVERSITY CURRICULUM AND UNIVERSITY EDUCATIONAL SUBJECT MATTER AND MAJORS, (B) ON CAMPUS PART-TIME WORK STUDY EDUCATIONAL EXPERIENCES, (C) ON CAMPUS EDUCATIONAL INTERNSHIPS, (D) OFF CAMPUS EDUCATIONAL INTERNSHIPS, (E) ON CAMPUS EDUCATIONAL PROFESSIONAL INTERNSHIPS, (F) ON CAMPUS EDUCATIONAL FELLOWSHIPS, (G) OFF CAMPUS EDUCATIONAL FELLOWSHIPS, (H) EDUCATIONAL EXTERNSHIPS, (I) EDUCATIONAL EXCHANGE STUDENT PROGRAMS, (J) STUDY ABROAD EDUCATIONAL OPPORTUNITIES, NAMELY, TEMPORARY EDUCATIONAL STUDIES IN A FOREIGN LAND, (K) UNDERGRADUATE RESEARCH OPPORTUNITIES AND UNDERGRADUATE RESEARCH EDUCATIONAL OPPORTUNITIES, NAMELY, PERFORMING EDUCATIONAL RESEARCH AS AN UNDERGRADUATE WITH SUPERVISION FROM OTHERS, (L) AND COMMUNITY OUTREACH OPPORTUNITIES, COMMUNITY EDUCATIONAL SERVICE OPPORTUNITIES AND COMMUNITY SERVICE OPPORTUNITIES, NAMELY, ORGANIZING AND PROVIDING EDUCATIONAL CHARITABLE SERVICE PROJECTS INVOLVING UNIVERSITY STUDENTS IN THE FIELDS OF HOUSING AND OTHER BASIC HUMAN NEEDS FOR THE BENEFIT OF THE COMMUNITY; DEVELOPING, OFFERING, PROVIDING AND MAKING AVAILABLE, FOR UNIVERSITY STUDENTS, ENHANCED LEARNING AND EDUCATIONAL OPPORTUNITIES THROUGH CURRICULUM DEVELOPMENT AND IMPROVEMENT, COURSE DEVELOPMENT AND IMPROVEMENT, AND CLASS DEVELOPMENT AND IMPROVEMENT, NAMELY, PROVIDING AND ARRANGING CONFERENCES, MEETINGS, INTERVIEWS AND SURVEYS FOR STUDENTS AND OTHERS TO PROVIDE INPUT REGARDING CURRICULUM DEVELOPMENT AND IMPROVEMENT, COURSE DEVELOPMENT AND IMPROVEMENT, AND CLASS DEVELOPMENT AND IMPROVEMENT; PROVIDING COUNSELING, CONSULTING, INFORMATION AND ONLINE INFORMATION IN THE FIELDS OF ENHANCED LEARNING AND EDUCATIONAL OPPORTUNITIES RELATING TO CURRICULUM DEVELOPMENT AND IMPROVEMENT, COURSE DEVELOPMENT AND IMPROVEMENT, AND CLASS DEVELOPMENT AND IMPROVEMENT; DEVELOPING, OFFERING, PROVIDING AND MAKING AVAILABLE WORKSHOPS, TRAINING, SEMINARS, CLASSES AND LIVE DISCUSSION GROUPS AT THE UNIVERSITY LEVEL IN THE FIELDS OF EDUCATIONAL INSTRUCTION AND TEACHING, IMPROVING EDUCATIONAL INSTRUCTION AND TEACHING, AND TECHNIQUES FOR IMPROVING EDUCATIONAL INSTRUCTION AND TEACHING; PROVIDING COUNSELING, CONSULTING, INFORMATION AND ONLINE INFORMATION RELATING TO WORKSHOPS, TRAINING, SEMINARS, CLASSES AND LIVE DISCUSSION GROUPS AT THE UNIVERSITY LEVEL IN THE FIELDS OF EDUCATIONAL INSTRUCTION AND TEACHING, IMPROVING EDUCATIONAL INSTRUCTION AND TEACHING, AND TECHNIQUES FOR IMPROVING EDUCATIONAL INSTRUCTION AND TEACHING; DEVELOPING, OFFERING, PROVIDING AND MAKING AVAILABLE IMPROVED SERVICES FOR UNIVERSITY STUDENTS, NAMELY, RANGING AND PROVIDING CONFERENCES, MEETINGS, INTERVIEWS AND SURVEYS FOR STUDENTS AND OTHERS TO PROVIDE

INPUT REGARDING STUDENT SERVICES IN THE FIELDS OF UNIVERSITY EDUCATION, EDUCATIONAL OPTIONS, EDUCATIONAL ENHANCEMENT OPTIONS, EDUCATIONAL CURRICULUM, EDUCATIONAL COURSE OPTIONS, EDUCATIONAL GRADUATION REQUIREMENTS, EDUCATIONAL FINANCIAL OPTIONS, EDUCATIONAL TECHNOLOGICAL SUPPORT, STUDENT ADVISING, STUDENT COUNSELING, CAMPUS RESIDENTIAL LIVING, CAMPUS ACTIVITIES AND CAMPUS ENTERTAINMENT; PROVIDING COUNSELING, CONSULTING, INFORMATION AND ONLINE INFORMATION IN THE AREA OF IMPROVED SERVICES FOR UNIVERSITY STUDENTS IN THE FIELDS OF UNIVERSITY EDUCATION, EDUCATIONAL OPTIONS, EDUCATIONAL ENHANCEMENT OPTIONS, EDUCATIONAL CURRICULUM, EDUCATIONAL COURSE OPTIONS, EDUCATIONAL GRADUATION REQUIREMENTS, EDUCATIONAL FINANCIAL OPTIONS, EDUCATIONAL TECHNOLOGICAL SUPPORT, STUDENT ADVISING, STUDENT COUNSELING, CAMPUS PARKING, CAMPUS RESIDENTIAL LIVING, CAMPUS ACTIVITIES AND CAMPUS ENTERTAINMENT; AND PROVIDING COUNSELING, CONSULTING, INFORMATION AND ONLINE INFORMATION IN THE AREA OF IMPROVED SERVICES FOR UNIVERSITY STUDENTS IN THE FIELDS OF CAMPUS ENTERTAINMENT, NAMELY, PLAYS, MUSICALS, THEATRICAL EVENTS, BAND PERFORMANCES, ORCHESTRA PERFORMANCES, LECTURES, AND MOVIES (U.S. CLS. 100, 101 AND 107).

EUGENIA MARTIN, EXAMINING ATTORNEY

CLASS 38—COMMUNICATION

FOR SECURED TELECOMMUNICATION SERVICES, NAMELY, PROVIDING SECURED ACCESS TO TELECOMMUNICATION NETWORKS; MOBILE AND FIXED TELECOMMUNICATION SERVICES, NAMELY, PROVIDING CELLULAR AND FIXED TELEPHONE NETWORKS; VIDEO TELECOMMUNICATION TRANSMISSION SERVICES; INTERNET AND COMPUTER COMMUNICATION SERVICES, NAMELY, PROVIDING COMMUNICATION NETWORKS BY MEANS OF WIRELESS NETWORK; PROVIDING VOICE OVER INTERNET PROTOCOL (VOIP) COMMUNICATION SERVICES; MOBILE AND FIXED TELECOMMUNICATIONS NETWORK SERVICES; INTERNET ACCESS SERVICES; DATA COMMUNICATION SERVICES BY ELECTRONIC MAIL; ELECTRONIC DATA TRANSMISSION SERVICES; TRANSMISSION OF EMAIL, TEXT MESSAGING, AUDIO, VIDEO AND IMAGES BY TELEPHONE AND THE INTERNET; INSTANT MESSAGING SERVICES; MOBILE AND FIXED TELEPHONE CONFERENCING SERVICES; VIDEO CONFERENCING SERVICES; CONFERENCING SERVICES PROVIDED VIA A COMPUTER NETWORK; WEB CONFERENCING SERVICES; HOSTING, JOINING, MANAGING, SCHEDULING AND STREAMING VOICE, VIDEO AND AUDIO-VISUAL CONTENT BETWEEN USERS VIA A COMMUNICATIONS NETWORK; INFORMATION AND ADVISORY SERVICES RELATING TO ALL THE AFORESAID SERVICES; DOWNLOADABLE COMPUTER SOFTWARE FOR THE TRANSMISSION OF DATA, EMAIL, TEXT MESSAGING, AUDIO, VIDEO AND IMAGES (U.S. CLS. 100, 101 AND 104).

SN 85-224,125. SEECRYPT GROUP INC, GRAND CAYMAN, CAYMAN ISLANDS, FILED 1-24-2011.

SEECRYPT

THE MARK CONSISTS OF STANDARD CHARACTERS WITHOUT CLAIM TO ANY PARTICULAR FONT, STYLE, SIZE, OR COLOR.

OWNER OF ERPN CMNTY TM OFC REG. NO. 009677436, DATED 7-22-2011, EXPIRES 1-31-2021.

CLASS 9—ELECTRICAL AND SCIENTIFIC APPARATUS

FOR COMPUTER SOFTWARE TO ENABLE VIDEO AND VOICE TELEPHONY AND COMMUNICATIONS; COMPUTER SOFTWARE FOR THE TRANSMISSION OF DATA, EMAIL, TEXT MESSAGING, AUDIO, VIDEO AND IMAGES; COMPUTER SOFTWARE FOR INSTANT MESSAGING; COMPUTER SOFTWARE FOR MAKING CONFERENCE CALLS VIA MOBILE TELEPHONE, FIXED TELEPHONE, INTERNET AND COMPUTER NETWORKS; DOWNLOADABLE COMPUTER SOFTWARE TO ENABLE VIDEO AND VOICE TELEPHONY AND COMMUNICATIONS; DOWNLOADABLE COMPUTER SOFTWARE FOR INSTANT MESSAGING; DOWNLOADABLE COMPUTER SOFTWARE FOR MAKING CONFERENCE CALLS VIA MOBILE TELEPHONE, FIXED TELEPHONE, INTERNET AND COMPUTER NETWORKS (U.S. CLS. 21, 23, 26, 36 AND 38).

CLASS 42—SCIENTIFIC AND COMPUTER SERVICES

FOR DESIGN AND DEVELOPMENT OF COMPUTER HARDWARE AND SOFTWARE; PROVIDING COMPUTER NON-DOWNLOADABLE SOFTWARE TO ENABLE VIDEO AND VOICE TELEPHONY AND COMMUNICATIONS; PROVIDING ONLINE NON-DOWNLOADABLE COMPUTER SOFTWARE TO ENABLE VIDEO AND VOICE TELEPHONY AND COMMUNICATIONS; PROVIDING NON-DOWNLOADABLE COMPUTER SOFTWARE TO ENABLE SECURED VIDEO AND VOICE TELEPHONY AND COMMUNICATIONS; PROVIDING ONLINE NON-DOWNLOADABLE COMPUTER SOFTWARE TO ENABLE SECURED VIDEO AND VOICE TELEPHONY AND COMMUNICATIONS; PROVIDING NON-DOWNLOADABLE COMPUTER SOFTWARE FOR THE TRANSMISSION OF DATA, EMAIL, TEXT MESSAGING, AUDIO, VIDEO AND IMAGES; PROVIDING ONLINE NON-DOWNLOADABLE COMPUTER SOFTWARE FOR THE TRANSMISSION OF DATA, EMAIL, TEXT MESSAGING, AUDIO, VIDEO AND IMAGES; PROVIDING NON-DOWNLOADABLE COMPUTER SOFTWARE FOR INSTANT MESSAGING; PROVIDING ONLINE AND DOWNLOADABLE COMPUTER SOFTWARE FOR INSTANT MESSAGING; PROVIDING NON-DOWNLOADABLE COMPUTER SOFTWARE FOR MAKING CONFERENCE CALLS VIA MOBILE TELEPHONE, FIXED TELEPHONE, INTERNET AND COMPUTER NETWORKS; PROVIDING NON-DOWNLOADABLE COMPUTER SOFTWARE FOR MAKING CONFERENCE CALLS VIA MOBILE TELEPHONE, FIXED TELEPHONE, INTERNET AND COMPUTER NETWORKS; DATA HOSTING SERVICES, NAMELY, HOSTING DIGITAL DATA RELATING TO MOBILE AND TELECOMMUNICATIONS (U.S. CLS. 100 AND 101).

MARILYN IZZI, EXAMINING ATTORNEY

SN 85-224,682. MOBOTIX AG, WINNWEILER, FED REP GERMANY, FILED 1-24-2011.

IPupilla

THE MARK CONSISTS OF STANDARD CHARACTERS WITHOUT CLAIM TO ANY PARTICULAR FONT, STYLE, SIZE, OR COLOR.

PRIORITY CLAIMED UNDER SEC. 44(D) ON ERP NCNTY TM OFC APPLICATION NO. 009374844, FILED 8-27-2010, REG. NO. 9374844, DATED 6-16-2011, EXPIRES 8-27-2020.

CLASS 9—ELECTRICAL AND SCIENTIFIC APPARATUS

FOR APPARATUS AND INSTRUMENTS FOR CONDUCTING, SWITCHING, TRANSFORMING, ACCUMULATING, REGULATING OR CONTROLLING ELECTRICITY, NAMELY, ELECTRICAL CONNECTORS, ELECTRICAL CABLES, AND ELECTRONIC SWITCHES FOR USE IN DATA TRANSMISSION NETWORKS; CAMERAS, IN PARTICULAR HEMISPHERICAL CAMERAS, WEBCAMS FOR DIRECT CONNECTION TO AT LEAST ONE MOBILE TELEPHONE, WEBCAMS FOR DIRECT CONNECTION TO AT LEAST ONE FIXED NETWORK, AND WEBCAMS FOR DIRECT CONNECTION TO AT LEAST ONE IP NETWORK; MONITORING CAMERAS; WEATHERPROOF NETWORK CAMERAS, IN PARTICULAR WITH INTEGRATED RECORDER FUNCTIONS; VIDEOPHONES; VIDEO SENSOR SYSTEMS COMPRISING VIDEO CAMERAS, CHIPS, MICRO-PROCESSORS AND PROGRAMS, COMPUTER SOFTWARE AND MICROPHONES; VIDEO SENSOR SYSTEMS COMPRISING VIDEO CAMERAS, CHIPS, MICRO-PROCESSORS AND PROGRAMS, COMPUTER SOFTWARE AND MICROPHONES AND AUDIO AMPLIFIERS; APPARATUS FOR RECORDING, TRANSMISSION OR REPRODUCTION OF SOUND OR IMAGES; DATA PROCESSORS AND COMPUTERS; BLANK DATA CARRIERS; PRERECORDED DATA CARRIERS FEATURING DRIVERS FOR ELECTRONIC DEVICES AND PROGRAMS FOR HANDLING OF VIDEO DATA AND AUTOMATED SURVEILLANCE; DISTANCE MEASURING APPARATUS; GPS SYSTEMS; DIGITAL VIDEO MANAGEMENT SYSTEMS FOR MANAGEMENT OF VIDEO CAMERAS, COMPRISING COMPUTER SOFTWARE AND COMPUTER HARDWARE FOR PROCESSING, ARCHIVING AND MINING OF VIDEO DATA AND DIGITAL IMAGES, AND VIDEO MONITORS FOR USE IN SURVEILLANCE; DIGITAL VIDEO SYSTEMS FOR SECURITY, SURVEILLANCE AND ACCESS CONTROL, NAMELY, DIGITAL VIDEO CAMERAS, SWITCHES, MONITORS, MICROPHONES, AND RECORDERS; DIGITAL VIDEO SYSTEMS FOR MONITORING THE OUTPUT AND QUALITY OF INDUSTRIAL PROCESSES, NAMELY, DIGITAL VIDEO CAMERAS, SWITCHES, MONITORS, MICROPHONES, AND RECORDERS; ELECTRONIC CONTROLS FOR DIGITAL CAMERAS USED FOR SECURITY, SURVEILLANCE AND ACCESS CONTROL; ELECTRONIC CONTROLS FOR DIGITAL CAMERAS USED FOR MONITORING THE OUTPUT AND QUALITY OF INDUSTRIAL PROCESSES; ELECTRIC APPARATUS AND INSTRUMENTS FOR ACCESS CHECKING AND CONTROL AT ENTRANCES AND EXITS; ELECTRONIC DOOR OPENING AND CLOSING SYSTEMS; ELECTRIC AND ELECTRONIC DOOR BELLS; INTERCOMS; DEVICES FOR THE STORAGE AND PROCESSING OF AUDIO AND VISUAL DATA, NAMELY, FLASH DRIVES, OPTICAL DISK DRIVES, AND COMPUTER MEMORIES; OPTICAL DISK DRIVES; NETWORK ATTACHED STORAGE, NAMELY, COMPUTER HARDWARE FOR DATA STORAGE CONNECTED TO A COMPUTER NETWORK; SOFTWARE FOR DATA COMPRESSION, FOR VIDEO MANAGEMENT, FOR IMAGE PROCESSING, FOR PATTERN RECOGNITION FOR ROBOT CONTROL, FOR PROCESS CONTROL, FOR CONTROL OF AUTOMATION DEVICES, FOR REMOTE ACCESS TO CAMERAS, FOR VIDEOPHONES, FOR DISTANCE MEASURING APPA-

RATUS AND FOR NAVIGATION SYSTEMS, FOR DOOR OPENING AND CLOSING SYSTEMS, FOR DOOR BELLS AND INTERCOMS, FOR DEVICES FOR THE STORAGE AND PROCESSING OF AUDIO AND VISUAL DATA (U.S. CLS. 21, 23, 26, 36 AND 38).

CLASS 38—COMMUNICATION

FOR RENTAL OF TELECOMMUNICATIONS EQUIPMENT; TELECOMMUNICATION SERVICES, NAMELY, PROVIDING ACCESS TO PICTURES, VIDEO, ALARM STATUS, BUILDING PLANS AND OTHER BUILDING AND SECURITY INFORMATION AT A REMOTE STATION (U.S. CLS. 100, 101 AND 104).

CLASS 42—SCIENTIFIC AND COMPUTER SERVICES

FOR COMPUTER PROGRAMMING FOR OTHERS IN THE FIELDS OF DATA TRANSMISSION AND REMOTE CONTROL OF ELECTRONIC DEVICES; DESIGN AND DEVELOPMENT OF COMPUTER HARDWARE AND SOFTWARE (U.S. CLS. 100 AND 101).

CLASS 45—PERSONAL AND LEGAL SERVICES

FOR SECURITY CONSULTANCY, NIGHT GUARDS, IN PARTICULAR WITH REGARD TO THE CENTRAL EVALUATION OF LIVE IMAGES (U.S. CLS. 100 AND 101).

DORITT L. CARROLL, EXAMINING ATTORNEY

SN 85-225,962. AULD D'ALEO INC., NEW YORK, NY. FILED 1-25-2011.



THE MARK CONSISTS OF A TWO-DIMENSIONAL OUTLINE OF A CAPITAL LETTER "G" THE EXTERIOR OF WHICH CAPITAL "G" IS ALSO A THREE-DIMENSIONAL REPRESENTATION OF A CIRCULAR TRAY ABOVE WHICH IS THE OUTLINE OF THE LIP OF A DRINKING GLASS VIEWED FROM ABOVE AND WITHIN WHICH THREE-DIMENSIONAL DRINKING GLASS IS THE WORD "GELUS" IN LOWER CASE TYPE POSITIONED ABOVE THE HORIZONTAL BAR OF THE CAPITAL "G".

CLASS 1—CHEMICALS

FOR CHEMICAL ADDITIVES IN THE FORM OF SODIUM ALGINATE ACTIVATED BY A CALCIUM-BASED SOLUTION FOR USE IN THE MANUFACTURE OF AN INGESTIBLE, SEMI-SOLID SPHERICAL SHAPE WITH A LIQUID CENTER FOR USE WITH ALCOHOLIC AND NON-ALCOHOLIC BEVERAGES (U.S. CLS. 1, 5, 6, 10, 26 AND 46).

CLASS 29—MEATS AND PROCESSED FOODS

FOR SODIUM ALGINATE AND CALCIUM-BASED SOLUTION THAT INSTANTANEOUSLY TURNS INTO AN INGESTIBLE, SEMI-SOLID SPHERICAL SHAPE WITH A LIQUID CENTER FOR MAKING ALCOHOLIC AND NON-ALCOHOLIC BEVERAGES (U.S. CL. 46).

CLASS 32—LIGHT BEVERAGES

FOR NON-ALCOHOLIC COCKTAIL CONCENTRATES AND POWDERS THAT INSTANTANEOUSLY TURNS INTO AN INGESTIBLE, SEMI-SOLID SPHERICAL SHAPE WITH A LIQUID CENTER FOR USE IN THE PREPARATION OF BEER AND NON-ALCOHOLIC COCKTAILS (U.S. CLS. 45, 46 AND 48).

CLASS 33—WINES AND SPIRITS

FOR ALCOHOLIC COCKTAIL MIXER THAT INSTANTANEOUSLY TURNS INTO AN INGESTIBLE, SEMI-SOLID SPHERICAL SHAPE WITH A LIQUID CENTER FOR USE WITH ALCOHOLIC BEVERAGES (U.S. CLS. 47 AND 49).

DANNEAN HETZEL, EXAMINING ATTORNEY

SN 85-225,967. AULD D'ALEO INC., NEW YORK, NY. FILED 1-25-2011.

GELUS

THE MARK CONSISTS OF STANDARD CHARACTERS WITHOUT CLAIM TO ANY PARTICULAR FONT, STYLE, SIZE, OR COLOR.

CLASS 1—CHEMICALS

FOR CHEMICAL ADDITIVES IN THE FORM OF SODIUM ALGINATE ACTIVATED BY A CALCIUM-BASED SOLUTION FOR USE IN THE MANUFACTURE OF AN INGESTIBLE, SEMI-SOLID SPHERICAL SHAPE WITH A LIQUID CENTER FOR USE WITH ALCOHOLIC AND NON-ALCOHOLIC BEVERAGES (U.S. CLS. 1, 5, 6, 10, 26 AND 46).

CLASS 29—MEATS AND PROCESSED FOODS

FOR SODIUM ALGINATE AND CALCIUM-BASED SOLUTION THAT INSTANTANEOUSLY TURNS INTO AN INGESTIBLE, SEMI-SOLID SPHERICAL SHAPE WITH A LIQUID CENTER FOR MAKING ALCOHOLIC AND NON-ALCOHOLIC BEVERAGES (U.S. CL. 46).

CLASS 32—LIGHT BEVERAGES

FOR NON-ALCOHOLIC COCKTAIL CONCENTRATES AND POWDERS THAT INSTANTANEOUSLY TURNS INTO AN INGESTIBLE, SEMI-SOLID SPHERICAL SHAPE WITH A LIQUID CENTER FOR USE IN THE PREPARATION OF BEER AND NON-ALCOHOLIC COCKTAILS (U.S. CLS. 45, 46 AND 48).

CLASS 33—WINES AND SPIRITS

FOR ALCOHOLIC COCKTAIL MIXER THAT INSTANTANEOUSLY TURNS INTO AN INGESTIBLE, SEMI-SOLID SPHERICAL SHAPE WITH A LIQUID CENTER FOR USE WITH ALCOHOLIC BEVERAGES (U.S. CLS. 47 AND 49).

DANNEAN HETZEL, EXAMINING ATTORNEY

SN 85-226,669. VISION CRITICAL COMMUNICATIONS INC., VANCOUVER, BC, CANADA, FILED 1-26-2011.

SPRINGBOARD

THE MARK CONSISTS OF STANDARD CHARACTERS WITHOUT CLAIM TO ANY PARTICULAR FONT, STYLE, SIZE, OR COLOR.

CLASS 35—ADVERTISING AND BUSINESS

FOR DATA PROCESSING FOR OTHERS IN THE REALMS OF MARKET RESEARCH, AND INDUSTRIAL, COMMERCIAL, ECONOMIC, POLITICAL, SOCIOLOGICAL AND ECONOMIC RESEARCH; PROCESSING ONLINE DATA FOR OTHERS IN THE FIELDS OF ONLINE SURVEYS, POLLS, AND OPINION PANELS FOR MARKET RESEARCH PURPOSES AND FOR INDUSTRIAL, COMMERCIAL, ECONOMIC, POLITICAL, SOCIOLOGICAL AND ECONOMIC RESEARCH PURPOSES; PROVIDING MARKET RESEARCH, NAMELY, CONDUCTING SURVEYS, POLLING AND OPINION SURVEYS FOR OTHERS IN THE FIELD OF INDUSTRIAL, COMMERCIAL, ECONOMIC, POLITICAL, SOCIOLOGICAL AND ECONOMIC RESEARCH; MARKET RESEARCH, NAMELY, CONDUCTING AND MANAGING THE CONDUCT OF SURVEYS, POLLING, AND OPINION-GATHERING ON BEHALF OF OTHERS AND MANAGING RESPONSES FROM SURVEYS; ALL OF THE AFOREMENTIONED NOT INCLUDING SERVICES IN THE AREA OF CORPORATE AND BUSINESS AWARENESS OF PEOPLE WITH DISABILITIES, DISABILITY ETIQUETTE, WORKPLACE DIVERSITY, WORKPLACE INITIATIVES, PUBLIC RELATIONS, ADVERTISING, AND MARKETING OF THE GOODS AND SERVICES OF OTHERS TO PEOPLE WITH DISABILITIES AND THEIR FAMILIES (U.S. CLS. 100, 101 AND 102).

FIRST USE 8-0-2009; IN COMMERCE 8-0-2009.

CLASS 42—SCIENTIFIC AND COMPUTER SERVICES

FOR HOSTED COMPUTING SERVICES, NAMELY, HOSTING DIGITAL CONTENT ON THE GLOBAL COMPUTER NETWORK AND HOSTING COMPUTER SOFTWARE APPLICATIONS OF OTHERS IN THE REALMS OF MARKET RESEARCH, AND INDUSTRIAL, COMMERCIAL, ECONOMIC, POLITICAL, SOCIOLOGICAL AND ECONOMIC RESEARCH (U.S. CLS. 100 AND 101).

FIRST USE 8-0-2009; IN COMMERCE 8-0-2009.

KAREN SEVERSON, EXAMINING ATTORNEY

SN 85-227,137. RETAIL INNOVATION GROUP INC., PORTLAND, OR. FILED 1-26-2011.

THE CLYMB

THE MARK CONSISTS OF STANDARD CHARACTERS WITHOUT CLAIM TO ANY PARTICULAR FONT, STYLE, SIZE, OR COLOR.

CLASS 25—CLOTHING

FOR APPAREL INTENDED FOR USE IN OUTDOOR ACTIVITIES, NAMELY, CLOTHING FOR CYCLING, HIKING, SKIING, AND ALL-AROUND FITNESS ACTIVITIES AND TECHNICAL OUTDOOR APPAREL, NAMELY, RAINWEAR, SKIWEAR, SWIMWEAR, UNDERWEAR, JACKETS, COATS, RAINCOATS, PARKAS, SNOWSUITS, PULLOVERS, VESTS, SWEATERS, SWEATSHIRTS WITH AND WITHOUT HOODS, SHIRTS, T-SHIRTS, SPORTS BRAS, BELTS, PANTS, SHORTS, SKIRTS, SWEATPANTS, TIGHTS, FOOTWEAR, BOOTS, SHOES, SOCKS, SCARVES, BANDANAS, GAITERS AND SUSPENDERS, GLOVES, AND MITTENS; HEADGEAR, NAMELY, HEADWEAR, HATS, AND CAPS (U.S. CLS. 22 AND 39).

CLASS 39—TRANSPORTATION AND STORAGE

FOR TRAVEL AGENCY SERVICES, NAMELY, MAKING RESERVATIONS AND BOOKINGS FOR TRANSPORTATION; TRAVEL AND TOUR INFORMATION SERVICES (U.S. CLS. 100 AND 105).
STEVEN JACKSON, EXAMINING ATTORNEY

SN 85-227,880. INTELLECTUAL SOLUTIONS, INC., EATONTOWN, NJ. FILED 1-27-2011.

HAPPY HOUR

THE MARK CONSISTS OF STANDARD CHARACTERS WITHOUT CLAIM TO ANY PARTICULAR FONT, STYLE, SIZE, OR COLOR.

CLASS 16—PAPER GOODS AND PRINTED MATTER

FOR PAPER PARTY FAVORS; BAR RELATED PRODUCTS, NAMELY, PAPER COCKTAIL UMBRELLAS, PAPER NAPKINS, PAPER MATS, PAPER COASTERS, PAPER TABLECLOTHS (U.S. CLS. 2, 5, 22, 23, 29, 37, 38 AND 50).

CLASS 20—FURNITURE AND ARTICLES NOT OTHERWISE CLASSIFIED

FOR PORTABLE BARS, AND STRUCTURAL PARTS THEREFOR SOLD AS A UNIT, NAMELY, SHELVING, BUCKETS, GLASS HANGERS AND SINK UNITS (U.S. CLS. 2, 13, 22, 25, 32 AND 50).
WON TEAK OH, EXAMINING ATTORNEY

SN 85-229,148. SCREENLIFE, LLC, SEATTLE, WA. FILED 1-28-2011.

TRIVIA WITH A TWIST

THE MARK CONSISTS OF STANDARD CHARACTERS WITHOUT CLAIM TO ANY PARTICULAR FONT, STYLE, SIZE, OR COLOR.

NO CLAIM IS MADE TO THE EXCLUSIVE RIGHT TO USE "TRIVIA", APART FROM THE MARK AS SHOWN.

CLASS 9—ELECTRICAL AND SCIENTIFIC APPARATUS

FOR GAME SOFTWARE FOR PLAYING DOWNLOADABLE GAMES ON MOBILE PLATFORMS (U.S. CLS. 21, 23, 26, 36 AND 38).

CLASS 28—TOYS AND SPORTING GOODS

FOR BOARD OR PARLOR GAMES (U.S. CLS. 22, 23, 38 AND 50).

CLASS 41—EDUCATION AND ENTERTAINMENT

FOR ONLINE ELECTRONIC GAMES; ENTERTAINMENT SERVICES, NAMELY, PROVIDING ONLINE INTERACTIVE ELECTRONIC GAMES ACCESSED THROUGH A TELEVISION (U.S. CLS. 100, 101 AND 107).
WON TEAK OH, EXAMINING ATTORNEY

SN 85-229,192. SCREENLIFE, LLC, SEATTLE, WA. FILED 1-28-2011.

SCENE IT? SPOTLIGHT

THE MARK CONSISTS OF STANDARD CHARACTERS WITHOUT CLAIM TO ANY PARTICULAR FONT, STYLE, SIZE, OR COLOR.

OWNER OF U.S. REG. NOS. 2,751,317, 3,399,351 AND OTHERS.

CLASS 9—ELECTRICAL AND SCIENTIFIC APPARATUS

FOR GAME SOFTWARE FOR PLAYING DOWNLOADABLE GAMES ON MOBILE PLATFORMS (U.S. CLS. 21, 23, 26, 36 AND 38).

CLASS 28—TOYS AND SPORTING GOODS

FOR BOARD OR PARLOR GAMES (U.S. CLS. 22, 23, 38 AND 50).

CLASS 41—EDUCATION AND ENTERTAINMENT

FOR ONLINE ELECTRONIC GAMES; ENTERTAINMENT SERVICES, NAMELY, PROVIDING ONLINE INTERACTIVE ELECTRONIC GAMES ACCESSED THROUGH A TELEVISION (U.S. CLS. 100, 101 AND 107).
WON TEAK OH, EXAMINING ATTORNEY

SN 85-230,181. VINUM DESIGN INC., MONTREAL, QUEBEC, CANADA, FILED 1-31-2011.

SN 85-235,998. ATLAS DATABASE SOFTWARE CORP., CALABASAS, CA. FILED 2-7-2011.



PRIORITY CLAIMED UNDER SEC. 44(D) ON CANADA APPLICATION NO. 1490494, FILED 7-29-2010.

NO CLAIM IS MADE TO THE EXCLUSIVE RIGHT TO USE "VINUM DESIGN", APART FROM THE MARK AS SHOWN.

THE MARK CONSISTS OF A LEAF DESIGN TO THE LEFT OF THE WORDS "VINUM DESIGN", WHICH ARE STYLIZED.

THE ENGLISH TRANSLATION OF "VINUM" IN THE MARK IS "WINE".

CLASS 21—HOUSEWARES AND GLASS

FOR ACCESSORIES FOR WINE CONSUMPTION, NAMELY, CORKSCREWS, ALCOHOL DISPENSERS, COCKTAIL SHAKERS, POURERS, CLOTHS FOR CLEANING AND WIPING GLASSWARE; BOTTLE STOPPERS SPECIALLY ADAPTED FOR USE WITH WINE BOTTLES (U.S. CLS. 2, 13, 23, 29, 30, 33, 40 AND 50).

CLASS 35—ADVERTISING AND BUSINESS

FOR RETAIL STORE AND ON-LINE RETAIL STORE SERVICES FEATURING WINE ACCESSORIES (U.S. CLS. 100, 101 AND 102).

JAMES GRIFFIN, EXAMINING ATTORNEY

SN 85-230,449. GLOBAL RESEARCH MEDIA, INC., BOULDER, CO. FILED 1-31-2011.

MUG SHOT JUNKIE

THE MARK CONSISTS OF STANDARD CHARACTERS WITHOUT CLAIM TO ANY PARTICULAR FONT, STYLE, SIZE, OR COLOR.

NO CLAIM IS MADE TO THE EXCLUSIVE RIGHT TO USE "MUG SHOT", APART FROM THE MARK AS SHOWN.

CLASS 16—PAPER GOODS AND PRINTED MATTER

FOR NEWSPAPERS (U.S. CLS. 2, 5, 22, 23, 29, 37, 38 AND 50).

CLASS 45—PERSONAL AND LEGAL SERVICES

FOR INFORMATION SERVICES, NAMELY, PROVIDING A WEB SITE FEATURING PHOTOGRAPHIC, VIDEO AND PROSE PRESENTATIONS FEATURING A COMPILATION OF CRIME OCCURRENCE INFORMATION (U.S. CLS. 100 AND 101).

SARA BENJAMIN, EXAMINING ATTORNEY

ANYWARE

THE MARK CONSISTS OF STANDARD CHARACTERS WITHOUT CLAIM TO ANY PARTICULAR FONT, STYLE, SIZE, OR COLOR.

OWNER OF U.S. REG. NO. 3,781,669.

CLASS 9—ELECTRICAL AND SCIENTIFIC APPARATUS

FOR COMPUTER SOFTWARE AND MANUALS THEREFORE, FOR USE IN FACILITATING SYSTEM INTEGRATION AND INTEROPERABILITY AMONG SOFTWARE APPLICATIONS USED WITHIN A LOCAL NETWORK OR ACROSS NETWORKS, INCLUDING THE INTERNET (U.S. CLS. 21, 23, 26, 36 AND 38).

CLASS 42—SCIENTIFIC AND COMPUTER SERVICES

FOR APPLICATION SERVICE PROVIDER FEATURING COMPUTER SOFTWARE AND MANUALS THEREFORE, FOR USE IN FACILITATING SYSTEM INTEGRATION AND INTEROPERABILITY AMONG SOFTWARE APPLICATIONS USED WITHIN A LOCAL NETWORK OR ACROSS NETWORKS, INCLUDING THE INTERNET (U.S. CLS. 100 AND 101).

JENNY PARK, EXAMINING ATTORNEY

SN 85-236,910. BIRDS EYE FOODS LLC, MOUNTAIN LAKES, NJ. FILED 2-8-2011.

CHEF'S FAVORITES

THE MARK CONSISTS OF STANDARD CHARACTERS WITHOUT CLAIM TO ANY PARTICULAR FONT, STYLE, SIZE, OR COLOR.

OWNER OF U.S. REG. NO. 1,926,620.

CLASS 29—MEATS AND PROCESSED FOODS

FOR FROZEN VEGETABLES; PROCESSED VEGETABLES; FROZEN AND PREPARED MEALS AND SIDE DISHES COMPRISED PRIMARILY OF VEGETABLES AND ONE OR MORE OF SAUCE, SEASONING, RICE OR PASTA; FROZEN VEGETABLES WITH SAUCE; FROZEN VEGETABLES WITH SEASONING (U.S. CL. 46).

CLASS 30—STAPLE FOODS

FOR FROZEN AND PREPARED MEALS AND SIDE DISHES COMPRISED PRIMARILY OF RICE OR PASTA AND ONE OR MORE OF VEGETABLES, SAUCE OR SEASONING (U.S. CL. 46).

MARK SHINER, EXAMINING ATTORNEY

SN 85-238,367. ENCORE LEGAL SOLUTIONS, LOS ANGELES, CA. FILED 2-9-2011.

eMax

THE MARK CONSISTS OF STANDARD CHARACTERS WITHOUT CLAIM TO ANY PARTICULAR FONT, STYLE, SIZE, OR COLOR.

CLASS 41—EDUCATION AND ENTERTAINMENT

FOR PROVIDING INTERACTIVE ON-LINE TRAINING SERVICES RELATING TO WEB-BASED LITIGATION SUPPORT APPLICATIONS (U.S. CLS. 100, 101 AND 107).

CLASS 42—SCIENTIFIC AND COMPUTER SERVICES

FOR PROVIDING A WEB-BASED SYSTEM IN THE FIELD OF LEGAL SUPPORT SERVICES FEATURING ON-LINE NON-DOWNLOADABLE SOFTWARE THAT ENABLES CLIENTS AND OTHER USERS TO ACCESS AND MANAGE PROJECT INFORMATION, NAMELY, DOCUMENTATION, USER RELATED INFORMATION, PROJECT MANAGEMENT INFORMATION, PROJECT CALCULATORS, MILESTONES, PROJECT COSTS, PROJECT DURATION, DATA MANAGEMENT, COMMUNICATIONS, DEADLINES, WORK ORDERS, TASK AND SUPPORT REQUESTS, STATUS UPDATES, REPORTS, BUDGETS, STATEMENTS AND INVOICES; COMPUTER SERVICES, NAMELY, HOSTING AND MAINTAINING AN ONLINE WEB SITE FOR OTHERS TO ADMINISTER AND CONTROL PROJECT INFORMATION DURING LITIGATION; PROVIDING A WEB-BASED SERVICE FEATURING TECHNOLOGY THAT ENABLES USERS TO MANAGE DISCOVERY AND DOCUMENT PRODUCTION; COMPUTER TECHNOLOGY SUPPORT SERVICES, NAMELY, HELP DESK SERVICES RELATING TO WEB-BASED LITIGATION SUPPORT APPLICATIONS (U.S. CLS. 100 AND 101).

KIM MONINGHOFF, EXAMINING ATTORNEY

SN 85-238,373. ENCORE LEGAL SOLUTIONS, INC., LOS ANGELES, CA. FILED 2-9-2011.



OWNER OF U.S. REG. NO. 3,680,790.

NO CLAIM IS MADE TO THE EXCLUSIVE RIGHT TO USE "VIRTUAL PROJECT MANAGER ASSISTANT", APART FROM THE MARK AS SHOWN.

THE MARK CONSISTS OF A STYLIZED LETTER "E" IN A CIRCLE AND THE WORD "MAX" ABOVE THE WORDS "VIRTUAL PROJECT MANAGER ASSISTANT" IN A RECTANGLE.

CLASS 41—EDUCATION AND ENTERTAINMENT

FOR PROVIDING INTERACTIVE ON-LINE TRAINING SERVICES RELATING TO WEB-BASED LITIGATION SUPPORT APPLICATIONS (U.S. CLS. 100, 101 AND 107).

CLASS 42—SCIENTIFIC AND COMPUTER SERVICES

FOR PROVIDING A WEB-BASED SYSTEM IN THE FIELD OF LEGAL SUPPORT SERVICES FEATURING ON-LINE NON-DOWNLOADABLE SOFTWARE THAT ENABLES CLIENTS AND OTHER USERS TO ACCESS AND MANAGE PROJECT INFORMATION, NAMELY, DOCUMENTATION, USER RELATED INFORMATION, PROJECT MANAGEMENT INFORMATION, PROJECT CALCULATORS, MILESTONES, PROJECT COSTS, PROJECT DURATION, DATA MANAGEMENT, COMMUNICATIONS, DEADLINES, WORK ORDERS, TASK AND SUPPORT REQUESTS, STATUS UPDATES, REPORTS, BUDGETS, STATEMENTS AND INVOICES; COMPUTER SERVICES, NAMELY, HOSTING AND MAINTAINING AN ONLINE WEB SITE FOR OTHERS TO ADMINISTER AND CONTROL PROJECT INFORMATION DURING LITIGATION; PROVIDING A WEB-BASED SERVICE FEATURING TECHNOLOGY THAT ENABLES USERS TO MANAGE DISCOVERY AND DOCUMENT PRODUCTION; COMPUTER TECHNOLOGY SUPPORT SERVICES, NAMELY, HELP DESK SERVICES RELATING TO WEB-BASED LITIGATION SUPPORT APPLICATIONS (U.S. CLS. 100 AND 101).

KIM MONINGHOFF, EXAMINING ATTORNEY

SN 85-239,814. GEIER ASSET MANAGEMENT, INC., MARIOTTSTVILLE, MD. FILED 2-11-2011.

GEIER FUNDS

THE MARK CONSISTS OF STANDARD CHARACTERS WITHOUT CLAIM TO ANY PARTICULAR FONT, STYLE, SIZE, OR COLOR.

NO CLAIM IS MADE TO THE EXCLUSIVE RIGHT TO USE "FUNDS", APART FROM THE MARK AS SHOWN. SEC. 2(F).

CLASS 9—ELECTRICAL AND SCIENTIFIC APPARATUS

FOR ELECTRONIC DOWNLOADABLE PUBLICATIONS, NAMELY, NEWSLETTERS, MAGAZINES, ARTICLES, REPORTS, GUIDES, CHARTS AND GRAPHS, WORKSHEETS, FORMS, INSTRUCTIONAL MATERIALS, EDUCATIONAL MATERIALS, BULLETINS, PAMPHLETS, BOOKLETS, VIDEO RECORDINGS IN THE INVESTMENT, INVESTMENT BROKERAGE, ASSET MANAGEMENT AND FINANCIAL FIELD; DOWNLOADABLE VIDEO RECORDINGS FEATURING PRESENTATIONS IN THE INVESTMENT, INVESTMENT BROKERAGE, ASSET MANAGEMENT AND FINANCIAL FIELD (U.S. CLS. 21, 23, 26, 36 AND 38).

FIRST USE 4-0-2011; IN COMMERCE 4-0-2011.

CLASS 16—PAPER GOODS AND PRINTED MATTER

FOR PUBLICATIONS, NAMELY, NEWSLETTERS, MAGAZINES, ARTICLES, REPORTS, GUIDES, CHARTS AND GRAPHS, WORKSHEETS, FORMS, INSTRUCTIONAL MATERIALS, EDUCATIONAL MATERIALS, BULLETINS, PAMPHLETS, BOOKLETS IN THE INVESTMENT, INVESTMENT BROKERAGE, ASSET MANAGEMENT AND FINANCIAL FIELD (U.S. CLS. 2, 5, 22, 23, 29, 37, 38 AND 50).

FIRST USE 4-0-2011; IN COMMERCE 4-0-2011.

CLASS 36—INSURANCE AND FINANCIAL

FOR MUTUAL FUND INVESTMENT; INVESTMENT BROKERAGE; INVESTMENT MANAGEMENT; FINANCIAL ASSET MANAGEMENT; INVESTMENT ADVICE; INVESTMENT CONSULTATION; FINANCIAL RESEARCH; FINANCIAL ANALYSIS IN THE FIELD OF TAXATION; BANKING; FINANCIAL PLANNING FOR RETIREMENT; FINANCIAL ADMINISTRATION OF RETIREMENT PLANS; FINANCIAL PLANNING FOR EDUCATIONAL EXPENSES; FINANCIAL PLANNING SERVICES, NAMELY, DEVELOPING AND MANAGING CHARITABLE GIVING PROGRAMS ON BEHALF OF WEALTHY INDIVIDUALS OR FAMILIES (U.S. CLS. 100, 101 AND 102).

FIRST USE 4-0-2011; IN COMMERCE 4-0-2011.

ROBERT C. CLARK JR., EXAMINING ATTORNEY

SN 85-242,244. NOVO SOLUTIONS, MD, LLC, PARADISE VALLEY, AZ. FILED 2-15-2011.

NOVO SOLUTIONS MD

THE MARK CONSISTS OF STANDARD CHARACTERS WITHOUT CLAIM TO ANY PARTICULAR FONT, STYLE, SIZE, OR COLOR.

NO CLAIM IS MADE TO THE EXCLUSIVE RIGHT TO USE "SOLUTIONS MD", APART FROM THE MARK AS SHOWN.

CLASS 3—COSMETICS AND CLEANING PREPARATIONS

FOR COSMETICS; FACIAL MAKEUP, CONCEALERS, BLUSHERS, FACIAL POWDERS, FOUNDATION MAKEUP, EYE MAKEUP, EYE PENCILS, EYEBROW PENCILS, MASCARA, FALSE EYELASHES, FACE AND BODY GLITTER, COSMETIC COMPACTS, COSMETIC PENCILS, LIPSTICK, LIPSTICK CASES, LIPSTICK HOLDERS, LIP GLOSS, LIP POMADES, LIP PENCILS, MAKEUP REMOVERS, MAKEUP APPLICATORS IN THE NATURE OF COTTON SWABS FOR COSMETIC PURPOSES, EYE CREAMS, FACIAL CLEANSERS, TONERS, FACIAL EXFOLIANTS AND SCRUBS, FACIAL CREAMS, FACIAL MOISTURIZERS, FACIAL LOTIONS AND NON-MEDICATED FACIAL TREATMENTS IN THE NATURE OF FACIAL EMULSIONS, WRINKLE REMOVING SKIN CARE PREPARATIONS, NAIL POLISHES, NAIL POLISH BASE COAT, NAIL POLISH TOP COAT, NAIL STRENGTHENERS, NAIL HARDENERS, NAIL POLISH REMOVERS, NAIL CREAMS, CUTICLE REMOVING PREPARATIONS, NAIL TIPS, AND NAIL BUFFING PREPARATIONS; BEAUTY MILKS, SKIN MOISTURIZERS AND SKIN MOISTURIZER MASKS, SKIN CONDITIONERS, HAND CREAMS, MASSAGE OILS, ESSENTIAL OILS FOR PERSONAL USE, TALCUM POWDER, PERFUMED POWDERS, BATH BEADS, BATH CRYSTALS, BATH FOAM, BATH GELS, BATH OILS, BATH POWDERS, BATH SALTS, FACE WASH, SKIN CLEANSERS, SKIN HIGHLIGHTER, BODY SCRUBS, BODY FRAGRANCES, FRAGRANCES FOR PERSONAL USE, BODY AND HAND LOTIONS, BODY GELS, SHOWER GELS, BODY OILS, BODY

POWDERS, BODY EXFOLIANTS, BODY MASKS, BODY MASK CREAMS AND LOTIONS, SHAVING PREPARATIONS, AFTER SHAVE LOTIONS, SHAVING BALM, SHAVING CREAM, SHAVING GEL, SKIN ABRASIVE PREPARATIONS, NON-MEDICATED SKIN CREAMS AND SKIN LOTIONS FOR RELIEVING RAZOR BURNS, NON-MEDICATED LIP CARE PREPARATIONS, LIP CREAM, SUNSCREEN PREPARATIONS, SUNTANNING PREPARATIONS AND AFTER-SUN LOTIONS; COSMETIC SUN-PROTECTING PREPARATIONS; SUN TAN OILS; SELF-TANNING PREPARATIONS, NAMELY, SELF TANNING MILK AND CREAM, ACCELERATED TANNING CREAM, SELF-TANNING LOTIONS, GELS AND SPRAYS; NON-MEDICATED OINTMENTS FOR THE TREATMENT OF SUNBURNS; NON-MEDICATED TOILETRIES; PERFUME, PERFUME OILS, COLOGNE, EAU DE TOILETTE, EAU DE PERFUME, EAU DE COLOGNE AND TOILETTE WATER; TOOTHPASTE, DEODORANT AND ANTIPERSPIRANT; COSMETIC SOAPS, PERFUMED SOAPS, LIQUID SOAPS, HAND, FACIAL AND BATH SOAPS, DEODORANT SOAPS, SHAVING SOAPS, SOAP POWDER, TOILET SOAPS, SOAPS FOR BODY CARE, AND SOAPS FOR PERSONAL USE; COSMETIC PADS, PRE-MOISTENED COSMETIC WIPES, PRE-MOISTENED COSMETIC TISSUES AND TOWELETTES; COTTON STICKS FOR COSMETIC PURPOSES; ALL PURPOSE COTTON SWABS FOR PERSONAL USE AND COSMETIC PURPOSES; NON-MEDICATED TOPICAL SKIN CREAMS, GELS, TONERS, AND LOTIONS; TOPICAL SKIN SPRAYS FOR COSMETIC PURPOSES; NON-MEDICATED AROMATHERAPY CREAMS, LOTIONS AND OILS; HAIR CARE PRODUCTS, NAMELY, SHAMPOOS, CONDITIONERS, MOUSSE, GELS, FROSTS, CREAMS, RINSES, SPRAYS, HAIR COLOR, HAIR WAVING LOTION, PERMANENT WAVE PREPARATIONS, HAIR LIGHTENERS, HAIR DYES, HAIR EMOLLIENTS, HAIR MASCARA, HAIR POMADES, HAIR COLOR REMOVERS, HAIR RELAXING PREPARATIONS, HAIR STYLING PREPARATIONS, HAIR REMOVING CREAM, AND HAIR CARE PREPARATIONS; ASTRINGENTS FOR COSMETIC PURPOSES; BABY WIPES; DISPOSABLE WIPES IMPREGNATED WITH CHEMICALS OR COMPOUNDS FOR PERSONAL HYGIENE AND HOUSEHOLD USE; INCENSE; ROOM FRAGRANCES; FRAGRANCE EMITTING WICKS FOR ROOM FRAGRANCES; SACHETS; SACHET-LIKE EYE PILLOWS CONTAINING FRAGRANCES; SCENTED CERAMIC STONES; SCENTED LINEN SPRAYS AND SCENTED ROOM SPRAYS; SCENTED OILS USED TO PRODUCE AROMAS WHEN HEATED; SCENTED PINE CONES; POTPOURRI; NON-MEDICATED AROMATHERAPY PILLOWS COMPRISING POTPOURRI IN FABRIC CONTAINERS FOR BATH, HAIR AND BODY CARE (U.S. CLS. 1, 4, 6, 50, 51 AND 52).

CLASS 5—PHARMACEUTICALS

FOR AROMATHERAPY PILLOWS COMPRISING POTPOURRI IN FABRIC CONTAINERS FOR RELAXATION, ENERGIZING, IMPROVING RESPIRATION, MENTAL POWER AND MENTAL ALACRITY, PAIN RELIEF, FITNESS, STRESS RELIEF, AIR PURIFICATION, AMBIANCE, SENSUALITY, CELEBRATION, MEDITATION, MIND CLEARANCE, SPATIAL CLEANSING AND SPIRITUALITY (U.S. CLS. 6, 18, 44, 46, 51 AND 52).

EMILY CARLSEN, EXAMINING ATTORNEY

SN 85-245,892. K. HOV IP, II, INC., RED BANK, NJ. FILED 2-18-2011.



NO CLAIM IS MADE TO THE EXCLUSIVE RIGHT TO USE "NATURE TECHNOLOGY EFFICIENCY", APART FROM THE MARK AS SHOWN.

THE MARK CONSISTS OF THE WORDS "NATURE TECHNOLOGY EFFICIENCY" BELOW A CURVED ARROW POINTING RIGHT AND ABOVE A CURVED ARROW POINTING LEFT.

CLASS 35—ADVERTISING AND BUSINESS

FOR PROVIDING INFORMATION, ADVICE AND CONSULTANCY IN THE FIELD OF ENERGY EFFICIENCY, WATER CONSERVATION, AND AIR QUALITY; PROVIDING INFORMATION REGARDING ENERGY EFFICIENCY, CONSERVATION BENEFITS, AIR QUALITY, AND ENERGY SAVING RESOURCES OF RESIDENTIAL PROPERTIES; REAL ESTATE MARKETING SERVICES, NAMELY, PROVIDING AN INTERACTIVE WEBSITE WHICH PROMOTES RESIDENTIAL PROPERTIES THROUGH PROVISION OF MAPS, LOCATIONS, AND ENERGY SAVING RESOURCES OF RESIDENTIAL PROPERTIES; ADVERTISING SERVICES, NAMELY, PROMOTING THE BRANDS, GOODS AND SERVICES OF OTHERS (U.S. CLS. 100, 101 AND 102).
FIRST USE 1-6-2011; IN COMMERCE 1-6-2011.

CLASS 42—SCIENTIFIC AND COMPUTER SERVICES

FOR PROVIDING A WEBSITE THAT GIVES USERS THE ABILITY TO SUBMIT QUESTIONS IN THE FIELD OF ENERGY EFFICIENCY, WATER CONSERVATION, AIR QUALITY, AND ENERGY SAVING RESOURCES (U.S. CLS. 100 AND 101).

FIRST USE 1-6-2011; IN COMMERCE 1-6-2011.
KIMBERLY PERRY, EXAMINING ATTORNEY

SN 85-249,519. GRAY DEVELOPMENT GROUP L.L.C., PHOENIX, AZ. FILED 2-23-2011.

BLUE SKY

THE MARK CONSISTS OF STANDARD CHARACTERS WITHOUT CLAIM TO ANY PARTICULAR FONT, STYLE, SIZE, OR COLOR.

CLASS 36—INSURANCE AND FINANCIAL

FOR LEASING, NAMELY, APARTMENTS (U.S. CLS. 100, 101 AND 102).

CLASS 37—CONSTRUCTION AND REPAIR

FOR REAL ESTATE DEVELOPMENT (U.S. CLS. 100, 103 AND 106).
ALLISON HOLTZ, EXAMINING ATTORNEY

SN 85-250,641. COMIC RELIEF LIMITED, LONDON, UNITED KINGDOM, FILED 2-24-2011.

RED NOSE DAY

THE MARK CONSISTS OF STANDARD CHARACTERS WITHOUT CLAIM TO ANY PARTICULAR FONT, STYLE, SIZE, OR COLOR.

OWNER OF U.S. REG. NOS. 3,223,730, 3,317,061 AND 3,913,503.

CLASS 29—MEATS AND PROCESSED FOODS

FOR MEAT, FISH, POULTRY AND GAME; PREPARED AND PROCESSED ENTREES CONSISTING PRIMARILY OF THE AFORESAID; PRESERVED, DRIED AND COOKED FRUIT AND VEGETABLES; PREPARED AND PROCESSED ENTREES CONSISTING PRIMARILY OF THE AFORESAID; EGGS, MILK AND DAIRY PRODUCTS EXCLUDING ICE CREAM, ICE MILK AND FROZEN YOGURT; EDIBLE OILS AND FATS (U.S. CL. 46).

CLASS 30—STAPLE FOODS

FOR COFFEE, TEA, COCOA, SUGAR; FLOUR AND PREPARATIONS MADE FROM FLOUR, NAMELY, PASTA, PANCAKES, TORTILLAS; CEREALS; BREADS; PASTRY; CONFECTIONARY MADE OF SUGAR; FLAVORED ICES; SPICES; SAUCES; CONDIMENTS BEING SALT AND PEPPER (U.S. CL. 46).

CLASS 31—NATURAL AGRICULTURAL PRODUCTS

FOR FRESH FRUIT AND VEGETABLES; SEEDS FOR HORTICULTURAL PURPOSES; LIVE PLANTS AND FLOWERS (U.S. CLS. 1 AND 46).

CLASS 32—LIGHT BEVERAGES

FOR BEERS; NON-ALCOHOLIC BEVERAGES, NAMELY, CARBONATED BEVERAGES, FRUIT JUICES; MINERAL WATER; SYRUPS AND NON-ALCOHOLIC CORDIALS FOR MAKING BEVERAGES (U.S. CLS. 45, 46 AND 48).

CLASS 33—WINES AND SPIRITS

FOR ALCOHOLIC CORDIALS FOR MAKING BEVERAGES (U.S. CLS. 47 AND 49).
JESSICA A. POWERS, EXAMINING ATTORNEY

SN 85-254,268. WILLIAM GRANT & SONS LIMITED, SCOTLAND, UNITED KINGDOM, FILED 3-1-2011.



OWNER OF ERPN CMNTY TM OFC REG. NO. 009549189, DATED 5-10-2011, EXPIRES 11-24-2020.

NO CLAIM IS MADE TO THE EXCLUSIVE RIGHT TO USE "TALES" IN INTERNATIONAL CLASS 41, APART FROM THE MARK AS SHOWN.

THE MARK CONSISTS OF THE WORDING "TRUE TALES" WHERE THE TERM "TRUE" PERPENDICULARLY PRECEDES THE TERM "TALES".

CLASS 33—WINES AND SPIRITS

FOR ALCOHOLIC BEVERAGES EXCEPT BEERS (U.S. CLS. 47 AND 49).

CLASS 41—EDUCATION AND ENTERTAINMENT

FOR ENTERTAINMENT SERVICES, NAMELY, PRESENTATION OF LIVE SHOW PERFORMANCES IN THE FIELD OF DRAMATIC MONOLOGUES AND COMEDY FOR EDUCATIONAL, CULTURAL OR ENTERTAINMENT PURPOSES; ORGANIZATION OF EXHIBITION EVENTS FOR CULTURAL OR EDUCATIONAL PURPOSES; ARRANGING AND CONDUCTING SPECIAL EVENTS FOR SOCIAL ENTERTAINMENT PURPOSES; PRESENTATION OF LIVE SHOW PERFORMANCES IN THE NATURE OF COMPETITIONS, AWARD CEREMONIES, CONTESTS, GAME SHOWS, QUIZ SHOWS, FUN DAY SHOWS, ENTERTAINMENT EXHIBITIONS AND SHOWS, ROAD SHOWS, STAGED EVENTS, THEATRICAL PERFORMANCES, LIVE CONCERTS, LIVE PERFORMANCES AND PARTICIPATION EVENTS IN THE FIELD OF DRAMATIC MONOLOGUES AND COMEDY FOR EDUCATIONAL, CULTURAL OR ENTERTAINMENT PURPOSES, ALL EXCLUDING SUBJECTS OF INTEREST TO CHILDREN (U.S. CLS. 100, 101 AND 107).
ANDREW RHIM, EXAMINING ATTORNEY

SN 85-254,988. MOD JEWELRY, INC., COSTA MESA, CA. FILED 3-1-2011.



OWNER OF U.S. REG. NO. 2,525,569.
THE MARK CONSISTS OF THE LETTERING "MOD" WITH THE LETTER "O" SHOWN AS A RING LINKING THE LETTERS "M" AND "D" TOGETHER.

CLASS 14—JEWELRY

FOR JEWELRY (U.S. CLS. 2, 27, 28 AND 50).
FIRST USE 12-0-2004; IN COMMERCE 12-0-2004.

CLASS 35—ADVERTISING AND BUSINESS

FOR ON-LINE RETAIL STORE SERVICES FEATURING JEWELRY (U.S. CLS. 100, 101 AND 102).
FIRST USE 1-0-2007; IN COMMERCE 1-0-2007.
KATHERINE STOIDES, EXAMINING ATTORNEY

SN 85-256,676. HILMAN, INC., MARLBORO, NJ. FILED 3-3-2011.



NO CLAIM IS MADE TO THE EXCLUSIVE RIGHT TO USE "ROLLERS", APART FROM THE MARK AS SHOWN.

THE MARK CONSISTS OF A STYLIZED LETTER "H" ABOVE A DESIGN CONSISTING OF TWELVE CIRCLES SURROUNDING A HORIZONTAL BAR SHAPE, AND THE WORDS "HILMAN ROLLERS" ON THE RIGHT SIDE OF THE STYLIZED LETTER "H" AND THE CIRCLES AND BAR DESIGN.

CLASS 7—MACHINERY

FOR POWER-OPERATED MOVING AND LIFTING EQUIPMENT, NAMELY, CENTRAL CONTROLLER MACHINES IN THE NATURE OF MACHINES WITH WHEELS TO CONTROL LOAD-BEARING PLATFORMS, AND HEAVY LOAD-CARRYING MODULAR MOTORIZED CRAWLING DEVICES IN THE NATURE OF MACHINE OPERATED LOAD-BEARING PLATFORMS; HYDRAULIC JACKS (U.S. CLS. 13, 19, 21, 23, 31, 34 AND 35).

FIRST USE 4-0-2008; IN COMMERCE 4-0-2008.

CLASS 12—VEHICLES

FOR NON-MOTORIZED LOAD CARRYING DEVICES, NAMELY, ROLLER MECHANISMS IN THE NATURE OF DOLLIES AND WHEELED PLATFORMS WITH NON-MOTORIZED WHEELS FOR MOVING MACHINERY AND OTHER HEAVY OBJECTS; DOLLIES FOR MOVING LOADS (U.S. CLS. 19, 21, 23, 31, 35 AND 44).

FIRST USE 0-0-1980; IN COMMERCE 0-0-1980.
ROBIN MITTLER, EXAMINING ATTORNEY

SN 85-256,830. CRAMARO TARPAULIN SYSTEMS, INC., NEWARK, DE. FILED 3-3-2011.



NO CLAIM IS MADE TO THE EXCLUSIVE RIGHT TO USE "TARP", APART FROM THE MARK AS SHOWN.

THE MARK CONSISTS OF THE STYLIZED WORDING "TARP WORKS" WITH A CURVED ARROW DESIGN EXTENDING FROM THE LETTER "T" UP OVER THE WORD "TARP" AND POINTING DOWN TO A HORIZONTAL STRAIGHT ARROW DESIGN EXTENDING FROM THE LETTER "W".

CLASS 12—VEHICLES

FOR FITTED TARPAULIN COVERS FOR LAND VEHICLES, AND MOUNTING HARDWARE FOR FITTED TARPAULIN COVERS FOR LAND VEHICLES, ALL SOLD AS A UNIT (U.S. CLS. 19, 21, 23, 31, 35 AND 44).

CLASS 22—CORDAGE AND FIBERS

FOR UNFITTED TARPAULIN COVERS FOR LAND VEHICLES, AND MOUNTING HARDWARE FOR UNFITTED TARPAULIN COVERS FOR LAND VEHICLES, ALL SOLD AS A UNIT (U.S. CLS. 1, 2, 7, 19, 22, 42 AND 50).

ANDREW RHIM, EXAMINING ATTORNEY

SN 85-258,482. CELLCO PARTNERSHIP, DBA VERIZON WIRELESS, BASKING RIDGE, NJ. FILED 3-4-2011.

UHOPELINE

THE MARK CONSISTS OF STANDARD CHARACTERS WITHOUT CLAIM TO ANY PARTICULAR FONT, STYLE, SIZE, OR COLOR.

OWNER OF U.S. REG. NOS. 1,831,587 AND 2,931,104.

CLASS 36—INSURANCE AND FINANCIAL

FOR CHARITABLE SERVICES, NAMELY, PROVIDING GRANTS TO CHARITABLE, NON-PROFIT AND COMMUNITY ORGANIZATIONS THAT SUPPORT THE PREVENTION OF DOMESTIC VIOLENCE, VIOLENCE ON CAMPUSES OF COLLEGES AND UNIVERSITIES AND VICTIMS OF SUCH VIOLENCE (U.S. CLS. 100, 101 AND 102).

CLASS 38—COMMUNICATION

FOR CELLULAR TELEPHONE SERVICES; CHARITABLE SERVICES, NAMELY, DONATION OF CELLULAR TELEPHONES AND CELLULAR TELEPHONE AIRTIME TO VICTIMS OF DOMESTIC VIOLENCE AND DOMESTIC VIOLENCE ADVOCACY GROUPS AND ORGANIZATIONS THAT SUPPORT THE PREVENTION OF DOMESTIC VIOLENCE, VIOLENCE ON CAMPUSES OF COLLEGES AND UNIVERSITIES AND VICTIMS OF SUCH VIOLENCE (U.S. CLS. 100, 101 AND 104).

GRETCHEN ULRICH, EXAMINING ATTORNEY

SN 85-259,678. VIAJES IBEROJET, S.A., PALMA DE MALORCA, SPAIN, FILED 3-7-2011.



PRIORITY CLAIMED UNDER SEC. 44(D) ON ERPNTY TM OFC APPLICATION NO. 009765587, FILED 2-25-2011, REG. NO. 009765587, DATED 7-28-2011, EXPIRES 2-25-2021.

OWNER OF U.S. REG. NO. 3,482,916.

NO CLAIM IS MADE TO THE EXCLUSIVE RIGHT TO USE "AIRLINES", APART FROM THE MARK AS SHOWN.

THE COLOR(S) TEAL, WHITE, GRAY, NAVY, LILAC, PURPLE AND SEA FOAM IS/ARE CLAIMED AS A FEATURE OF THE MARK.

THE MARK CONSISTS OF THE WORD "ORBEST" IN TEAL ABOVE THE WORD "ORIZONIA" IN GRAY, AND TO THE RIGHT THE WORD "AIRLINES" IN GRAY; BETWEEN THE WORDS "ORBEST" AND "AIRLINES" IS A GRAY VERTICAL LINE, TO THE LEFT OF THE WORD "ORBEST" ARE SIX OVALS OF DIFFERENT SIZES STACKED VERTICALLY, THE COLORS FROM TOP TO BOTTOM ARE TEAL, LILAC, NAVY, PURPLE, SEA FOAM AND TEAL, ALL ON A WHITE BACKGROUND.

CLASS 16—PAPER GOODS AND PRINTED MATTER

FOR PRINTED PUBLICATIONS, NAMELY, TOURIST LEAFLETS AND BROCHURES IN THE FIELD OF TRAVEL (U.S. CLS. 2, 5, 22, 23, 29, 37, 38 AND 50).

CLASS 39—TRANSPORTATION AND STORAGE

FOR PROVIDING TRAVEL ARRANGEMENTS, AIRCRAFT TRANSPORT OF PASSENGERS, GROUND TRANSPORT OF PASSENGERS, STORAGE OF GOODS, PACKAGING OF GOODS FOR TRANSPORT PURPOSES, TICKET RESERVATION FOR THE AFORESAID MEANS OF TRANSPORT, HIRING OF VEHICLES, NAMELY, ARRANGING VEHICLE RENTAL FOR PASSENGERS (U.S. CLS. 100 AND 105).

CLASS 43—HOTEL AND RESTAURANT SERVICES

FOR PROVIDING RESERVATION OF TEMPORARY ACCOMMODATIONS, SERVICES FOR PROVIDING FOOD AND DRINK; HOTEL RESERVATION SERVICES (U.S. CLS. 100 AND 101).

CHRISTINA SOBRAL, EXAMINING ATTORNEY

SN 85-262,594. ZUMBACH'S GOURMET COFFEE, NEW CANAAN, CT. FILED 3-9-2011.

CAFFEINE & CARBURETORS

THE MARK CONSISTS OF STANDARD CHARACTERS WITHOUT CLAIM TO ANY PARTICULAR FONT, STYLE, SIZE, OR COLOR.

CLASS 21—HOUSEWARES AND GLASS

FOR BEVERAGEWARE, NAMELY, DRINKING GLASSES, MUGS AND CUPS (U.S. CLS. 2, 13, 23, 29, 30, 33, 40 AND 50).

CLASS 25—CLOTHING

FOR CLOTHING, NAMELY, SHIRTS, SWEATSHIRTS, SWEATERS, JACKETS AND HATS (U.S. CLS. 22 AND 39).

CLASS 36—INSURANCE AND FINANCIAL

FOR CHARITABLE FUNDRAISING SERVICES, NAMELY, ORGANIZING AND CONDUCTING ENTERTAINMENT AND RECREATIONAL SERVICES IN THE NATURE OF AUTOMOBILE DEMONSTRATIONS AND EXHIBITIONS, AND SOCIAL EVENTS FEATURING AUTOMOBILES, TO RAISE FUNDS (U.S. CLS. 100, 101 AND 102).

CLASS 41—EDUCATION AND ENTERTAINMENT

FOR ARRANGING AND CONDUCTING EVENTS FOR SOCIAL ENTERTAINMENT PURPOSES RELATED TO AUTOMOBILES; ENTERTAINMENT AND RECREATIONAL SERVICES IN THE NATURE OF AUTOMOBILE DEMONSTRATIONS AND EXHIBITIONS, AND SOCIAL EVENTS FEATURING AUTOMOBILES (U.S. CLS. 100, 101 AND 107).

CLASS 42—SCIENTIFIC AND COMPUTER SERVICES

FOR CREATING AN ON-LINE COMMUNITY FOR USERS TO PARTICIPATE IN DISCUSSIONS, FORM VIRTUAL COMMUNITIES, AND ENGAGE IN SOCIAL EVENTS FEATURING AUTOMOBILES (U.S. CLS. 100 AND 101).

TIMOTHY FINNEGAN, EXAMINING ATTORNEY

SN 85-263,192. ASPHALT SYSTEMS, INC., SALT LAKE CITY, UT. FILED 3-10-2011.

ASI

THE MARK CONSISTS OF STANDARD CHARACTERS WITHOUT CLAIM TO ANY PARTICULAR FONT, STYLE, SIZE, OR COLOR.

CLASS 19—NON-METALLIC BUILDING MATERIALS

FOR ASPHALT-BASED SEALANTS FOR USE ON PAVEMENTS (U.S. CLS. 1, 12, 33 AND 50).
FIRST USE 4-11-1975; IN COMMERCE 4-11-1975.

CLASS 35—ADVERTISING AND BUSINESS

FOR ON-LINE RETAIL STORE SERVICES FEATURING ASPHALT SEALANTS, HAND TOOLS AND SEAL-COATING SUPPLIES (U.S. CLS. 100, 101 AND 102).
FIRST USE 4-11-1975; IN COMMERCE 4-11-1975.
DAWN HAN, EXAMINING ATTORNEY

SN 85-266,365. HEARING CARE RESOURCES, LLC, GLOVERSVILLE, NY. FILED 3-14-2011.



NO CLAIM IS MADE TO THE EXCLUSIVE RIGHT TO USE "HEARING CARE RESOURCES", APART FROM THE MARK AS SHOWN.

THE MARK CONSISTS OF THE LITERAL ELEMENT "HEARING CARE RESOURCES" AND A DESIGN ELEMENT CONSISTING OF A PROFILE OF A PERSON'S FACE WITH WAVE LINES ADJACENT THE EAR. A LINE SEPARATES THE WORDING "HEARING CARE" AND THE WORD "RESOURCES".

CLASS 10—MEDICAL APPARATUS

FOR HEARING AIDS, HEARING INSTRUMENTS, HEARING ASSIST DEVICES, NAMELY, ELECTRICALLY OPERATED HEARING AIDS, WIRELESS SYSTEMS TO CONNECT TELEPHONES AND OTHER SOUND SOURCES TO HEARING AID(S), TELEPHONE AMPLIFIERS, TELEVISION AMPLIFIERS, DATA STREAMING DEVICES TO WIRELESSLY TRANSMIT DATA TO HEARING AIDS OR SOUND REPRODUCTION DEVICES, WIRELESS TRANSMITTERS THAT CREATE AMPLIFIED SOUND NEAR THE EAR(S); HEARING ACCESSORIES, NAMELY, WIRELESS TRANSMITTERS AND RECEIVERS FOR USE WITH HEARING AIDS; HEARING AID BATTERIES, BRUSHES FOR CLEANING HEARING AIDS AND HEARING DEVICES, WAX REMOVAL TOOLS, DRYING DEVICES TO REMOVE MOISTURE FROM HEARING AIDS, DESICCANTS TO REMOVE MOISTURE FROM HEARING AIDS, RETENTION CLIPS AND DEVICES TO KEEP HEARING AIDS ATTACHED TO THE BODY AND IN PROPER POSITION FOR OPERATION, MOISTURE COVERS FOR HEARING AIDS, SWEAT PROTECTION COVERS FOR HEARING AIDS, CUSTOM COVERS TO PROTECT HEARING AIDS; EAR MOLDS, CUSTOM EAR MOLDS FOR HOUSING HEARING AID COMPONENTS; HEARING PROTECTION DEVICES, NAMELY, CERUMEN PROTECTION SYSTEMS, WAX GUARDS, HEARING PROTECTING EAR MUFFS; TINNITUS TREATMENT DEVICES, NAMELY, TINNITUS MASKING DEVICES; TINNITUS MASKING DEVICES INTEGRATED INTO HEARING AIDS, SOUND GENERATORS (EAR LEVEL), SOUND GENERATORS (FOR A ROOM); DEVICES INTENDED TO ASSIST THE HEARING IMPAIRED, NAMELY, WIRELESS TRANSMITTERS AND RECEIVERS FOR USE WITH HEARING AIDS (U.S. CLS. 26, 39 AND 44).

FIRST USE 9-23-2009; IN COMMERCE 10-1-2010.

CLASS 35—ADVERTISING AND BUSINESS

FOR RETAIL STORE SERVICES FEATURING HEARING AIDS, HEARING INSTRUMENTS, HEARING ASSIST DEVICES, NAMELY, ELECTRICALLY OPERATED HEARING AIDS, WIRELESS SYSTEMS TO CONNECT TELEPHONES AND OTHER SOUND SOURCES TO HEARING AID(S), TELEPHONE AMPLIFIERS, TELEVISION AMPLIFIERS, DATA STREAMING DEVICES TO WIRELESSLY TRANSMIT DATA TO HEARING AIDS OR SOUND REPRODUCTION DEVICES, WIRELESS TRANSMITTERS THAT CREATE AMPLIFIED SOUND NEAR THE EAR(S), HEARING ACCESSORIES, NAMELY, WIRELESS TRANSMITTERS AND RECEIVERS FOR USE WITH HEARING AIDS, HEARING AID BATTERIES, BRUSHES FOR CLEANING HEARING AIDS AND HEARING DEVICES, WAX REMOVAL TOOLS, DRYING DEVICES TO REMOVE MOISTURE FROM HEARING AIDS, DESICCANTS TO REMOVE MOISTURE FROM HEARING AIDS, RETENTION CLIPS AND DEVICES TO KEEP HEARING AIDS ATTACHED TO THE BODY AND IN PROPER POSITION FOR OPERATION, MOISTURE COVERS FOR HEARING AIDS, SWEAT PROTECTION COVERS FOR HEARING AIDS, CUSTOM COVERS TO PROTECT HEARING AIDS, EAR MOLDS, CUSTOM EAR MOLDS FOR HOUSING HEARING AID COMPONENTS, HEARING PROTECTION DEVICES, NAMELY, CERUMEN PROTECTION SYSTEMS, WAX GUARDS, HEARING PROTECTING EAR MUFFS, TINNITUS TREATMENT DEVICES, NAMELY, TINNITUS MASKING DEVICES, TINNITUS MASKING DEVICES INTEGRATED INTO HEARING AIDS, SOUND GENERATORS (EAR LEVEL), SOUND GENERATORS (FOR A ROOM), DEVICES INTENDED TO ASSIST THE HEARING IMPAIRED, NAMELY, WIRELESS TRANSMITTERS AND RECEIVERS FOR USE WITH HEARING AIDS; DEALERSHIPS IN THE FIELD OF HEARING AIDS; THE BRINGING TOGETHER, FOR THE BENEFIT OF OTHERS, HEARING AIDS AND HEARING AID-RELATED INSTRUMENTS, ENABLING CUSTOMERS TO CONVENIENTLY VIEW AND PURCHASE THOSE GOODS; RETAIL STORE SERVICES FEATURING BATTERY PLANS FOR HEARING AIDS, NAMELY, PLANS FOR PROVIDING REPLACEMENT BATTERIES TO CUSTOMERS AT REGULAR INTERVALS; DEMONSTRATION OF HEARING AIDS AND HEARING ASSIST DEVICES (U.S. CLS. 100, 101 AND 102).

FIRST USE 9-23-2009; IN COMMERCE 3-3-2011.

CLASS 44—MEDICAL, BEAUTY AND AGRICULTURAL SERVICES

FOR HEARING TESTING FOR AUDIOLOGICAL DIAGNOSTIC PURPOSES; CONSULTING SERVICES IN THE FIELD OF AUDIOLOGICAL DIAGNOSTIC HEARING TESTING; AUDIOLOGICAL SERVICES, NAMELY, CERUMEN REMOVAL SERVICES, MIDDLE EAR EVALUATIONS INCLUDING TYMPANOMETRY TESTING, ACOUSTIC REFLEX TESTING, DIAGNOSTIC HEARING EVALUATIONS AND TINNITUS TREATMENT, AUDITORY EVOKE POTENTIAL TESTING, BALANCE TESTING, OTOACOUSTIC EMISSION TESTING; HEARING AID SERVICES; AUDIOLOGICAL SERVICES, NAMELY, PROVIDING AUDIOLOGIST SERVICES, PROVIDING AUDIOMETRIC MEASUREMENT(S); FITTING OF HEARING AIDS (U.S. CLS. 100 AND 101).

FIRST USE 9-23-2009; IN COMMERCE 3-3-2011.
PAUL MORENO, EXAMINING ATTORNEY

SN 85-268,450. THE VANGUARD GROUP, INC., MALVERN, PA. FILED 3-16-2011.

Vanguard Flagship Community

THE MARK CONSISTS OF STANDARD CHARACTERS WITHOUT CLAIM TO ANY PARTICULAR FONT, STYLE, SIZE, OR COLOR.

OWNER OF U.S. REG. NOS. 1,617,920, 1,784,435 AND OTHERS.

NO CLAIM IS MADE TO THE EXCLUSIVE RIGHT TO USE "COMMUNITY", APART FROM THE MARK AS SHOWN.

CLASS 9—ELECTRICAL AND SCIENTIFIC APPARATUS

FOR DOWNLOADABLE ELECTRONIC PUBLICATIONS IN THE NATURE OF NEWSLETTERS, REPORTS, GUIDES, CHARTS, WORKSHEETS, FORMS, INSTRUCTIONAL MATERIALS, EDUCATIONAL MATERIALS, PRESENTATIONS, BULLETINS, PAMPHLETS, AND BOOKLETS IN THE FIELDS OF FINANCE, SAVING, INVESTING, INVESTMENTS, INVESTMENT BROKERAGE, AND ASSET MANAGEMENT; COMPUTER SOFTWARE FOR USE IN OBTAINING ACCESS TO, AND ENHANCING THE USER'S EXPERIENCE OF, AN INTERNET WEB SITE WHICH PROVIDES NEWS AND INFORMATION AND A PLATFORM FOR INTERACTIVE DISCUSSIONS, PARTICIPATING IN POLLS AND SURVEYS, AND SOCIAL-NETWORKING (U.S. CLS. 21, 23, 26, 36 AND 38).

FIRST USE 2-15-2011; IN COMMERCE 2-15-2011.

CLASS 35—ADVERTISING AND BUSINESS

FOR PROVIDING AN INTERACTIVE WEBSITE FOR CLIENT FEEDBACK AND COLLABORATION WHERE CLIENTS CAN ANALYZE AN IDEA OR PROTOTYPE SUCH AS AN ADVERTISEMENT, BROCHURE, PAMPHLET IN ORDER FOR CLIENTS TO PROVIDE FEEDBACK FOR FUTURE MATERIALS DIRECTED TO CLIENTS (U.S. CLS. 100, 101 AND 102).

FIRST USE 2-15-2011; IN COMMERCE 2-15-2011.

CLASS 36—INSURANCE AND FINANCIAL

FOR FINANCIAL SERVICES, NAMELY, INVESTMENT MANAGEMENT SERVICES, FINANCIAL PLANNING SERVICES, MUTUAL FUND INVESTMENT SERVICES, SECURITIES BROKERAGE SERVICES AND FINANCIAL INFORMATION PROVIDED BY ELECTRONIC MEANS; PROVIDING INFORMATION IN THE FINANCIAL AND INVESTMENT FIELDS; PROVIDING AN INTERACTIVE WEBSITE IN THE FIELDS OF INVESTING, FINANCE, SAVING, FINANCIAL PLANNING, FINANCIAL NEWS, FINANCIAL INFORMATION, ANALYSIS IN THE FIELDS OF INVESTING, FINANCE, AND FINANCIAL PLANNING, FINANCIAL PORTFOLIO MANAGEMENT, FINANCIAL DECISION MAKING, INVESTMENT RESEARCH, MONITORING INVESTMENT VALUE AND PERFORMANCE OF INVESTMENTS, ANALYZING INVESTMENT PERFORMANCE, EVALUATING ASSET ALLOCATION, RISK TOLERANCE, FINANCIAL ALTERNATIVE PLANS AND INVESTMENT TIME FRAMES; RESEARCH IN THE FIELDS OF FINANCE, SAVING, INVESTING, INVESTMENTS, INVESTMENT BROKERAGE, AND ASSET MANAGEMENT (U.S. CLS. 100, 101 AND 102).

FIRST USE 2-15-2011; IN COMMERCE 2-15-2011.

CLASS 41—EDUCATION AND ENTERTAINMENT

FOR EDUCATIONAL SERVICES, NAMELY, PROVIDING ONLINE PUBLICATIONS IN THE NATURE OF NEWSLETTERS, REPORTS, GUIDES, CHARTS, WORKSHEETS, FORMS, INSTRUCTIONAL MATERIALS, EDUCATIONAL MATERIALS, PRESENTATIONS, BULLETINS, PAMPHLETS, AND BOOKLETS IN THE FIELDS OF FINANCE, SAVING, INVESTING, INVESTMENTS, INVESTMENT BROKERAGE, AND ASSET MANAGEMENT; PROVIDING INFORMATION IN THE FIELD OF FINANCIAL EDUCATION TO CLIENTS BY MEANS OF AN INTERACTIVE INTERNET WEB SITE (U.S. CLS. 100, 101 AND 107).

FIRST USE 2-15-2011; IN COMMERCE 2-15-2011.

CLASS 42—SCIENTIFIC AND COMPUTER SERVICES

FOR COMPUTER SERVICES, NAMELY, CREATING AN ONLINE COMMUNITY FOR REGISTERED USERS TO PARTICIPATE IN DISCUSSIONS, GET FEEDBACK FROM THEIR PEERS, AND FORM VIRTUAL COMMUNITIES; PROVIDING USE OF ON-LINE NON-DOWNLOADABLE SOFTWARE IN THE FIELDS OF CLIENT COLLABORATION, NAMELY, THE SHARING AND COMMUNICATION OF IDEAS, INSIGHT, AND FEEDBACK BETWEEN CLIENTS AND FINANCIAL EXPERTS, AND SOCIAL NETWORKING; PROVIDING AN ONLINE COMMUNITY FOR USERS TO ENGAGE IN CLIENT COLLABORATION, NAMELY, THE SHARING AND COMMUNICATION OF IDEAS, INSIGHT, AND FEEDBACK BETWEEN COMPANIES AND THEIR CUSTOMERS, AND TO ENGAGE IN SOCIAL NETWORKING RELATED TO THE ONLINE CUSTOMER COLLABORATION COMMUNITY (U.S. CLS. 100 AND 101).

FIRST USE 2-15-2011; IN COMMERCE 2-15-2011.

ALLISON HOLTZ, EXAMINING ATTORNEY

SN 85-268,869. MOVIE GRILL CONCEPTS TRADEMARK HOLDINGS, LLC, DALLAS, TX. FILED 3-16-2011.

STUDIO
MOVIE GRILL
EAT · DRINK · MOVIES

OWNER OF U.S. REG. NO. 2,963,249.

NO CLAIM IS MADE TO THE EXCLUSIVE RIGHT TO USE "MOVIE GRILL" AND "EAT DRINK MOVIES", APART FROM THE MARK AS SHOWN.

THE MARK CONSISTS OF THE WORD "STUDIO" ABOVE THE WORDS "MOVIE GRILL" ABOVE THE WORDS "EAT", "DRINK" AND "MOVIES", EACH OF WHICH ARE SEPARATED BY A DOT, AS WELL AS THREE PARALLEL LINES ON EITHER SIDE OF "STUDIO" AND "MOVIE GRILL".

CLASS 41—EDUCATION AND ENTERTAINMENT

FOR MOVIE THEATERS; PROVIDING FACILITIES FOR MOVIES, PRERECORDED VIDEOS, MOVIE PREMIERS AND OTHER AUDIO-VISUAL PRESENTATIONS FOR ENTERTAINMENT PURPOSES; PROVIDING FACILITIES FOR LIVE ENTERTAINMENT IN THE NATURE OF THEATER SHOWS, PLAYS, MUSICAL PERFORMANCES AND SHOW PERFORMANCES; DINER THEATER SERVICES (U.S. CLS. 100, 101 AND 107).
FIRST USE 3-0-2009; IN COMMERCE 3-0-2009.

CLASS 43—HOTEL AND RESTAURANT SERVICES

FOR BAR AND RESTAURANT SERVICES; PROVISION OF FACILITIES FOR CONFERENCES AND MEETINGS (U.S. CLS. 100 AND 101).
FIRST USE 3-0-2009; IN COMMERCE 3-0-2009.
CHRIS WELLS, EXAMINING ATTORNEY

SN 85-269,923, CARTIHEAL (2009) LTD., ARIEL, ISRAEL, FILED 3-17-2011.

Agili-C

PRIORITY CLAIMED UNDER SEC. 44(D) ON ISRAEL APPLICATION NO. 233094, FILED 10-10-2010, REG. NO. 233094, DATED 4-4-2012, EXPIRES 10-10-2020.

THE MARK CONSISTS OF "AGILI-C" IN STYLIZED LETTERS, BEGINNING IN A CAPITAL LETTER "A" AND ENDING IN A CAPITAL LETTER "C", WITH A DASH BETWEEN "AGILI" AND "C".

CLASS 5—PHARMACEUTICALS

FOR MEDICAL IMPLANTS, NAMELY, BONE AND CARTILAGE IMPLANTS MADE OF BIOLOGICAL MATERIALS; SPINAL IMPLANTS MADE OF BIOLOGICAL MATERIALS (U.S. CLS. 6, 18, 44, 46, 51 AND 52).

CLASS 10—MEDICAL APPARATUS

FOR SURGICAL, MEDICAL, DENTAL AND VETERINARY APPARATUS AND INSTRUMENTS; ARTIFICIAL LIMBS, EYES AND TEETH, ORTHOPEDIC ARTICLES, NAMELY, BRACES, JOINT IMPLANTS, SHOE INSERTS, WRIST, NECK, BACK, ANKLE, KNEE AND ELBOW SUPPORTERS, PROTECTORS AND SPLINTS, PROSTHESIS; SURGICAL IMPLANTS COMPRISING ARTIFICIAL MATERIAL; MEDICAL IMPLANTS, NAMELY, BONE AND CARTILAGE IMPLANTS MADE OF ARTIFICIAL MATERIALS; SPINAL IMPLANTS MADE OF ARTIFICIAL MATERIALS; SUTURE MATERIALS; PARTS AND ACCESSORIES FOR THE AFOREMENTIONED GOODS (U.S. CLS. 26, 39 AND 44).

SAMUEL E. SHARPER JR., EXAMINING ATTORNEY

SN 85-272,674, WINET AG, 9440 VADUZ, LIECHTENSTEIN, FILED 3-21-2011.



OWNER OF ERPN CMNTY TM OFC REG. NO. 008724049, DATED 12-23-2010, EXPIRES 12-1-2019.

NO CLAIM IS MADE TO THE EXCLUSIVE RIGHT TO USE "PROMOGAMES", APART FROM THE MARK AS SHOWN.

THE MARK CONSISTS OF THE WORDING "PROMOGAMES" UNDERNEATH THE DESIGN OF FOUR CARDS. FROM LEFT TO RIGHT, THE CARDS DISPLAY A HEART, SPADE, DIAMOND, AND CLUB.

CLASS 9—ELECTRICAL AND SCIENTIFIC APPARATUS

FOR COMPUTER SOFTWARE AND COMPUTER PROGRAMS FEATURING GAMES, CASINO STYLE GAMES, CARD STYLE GAMES; COMPUTER SOFTWARE AND COMPUTER PROGRAMS DOWNLOADABLE FROM THE INTERNET FEATURING GAMES, CASINO STYLE GAMES, CARD STYLE GAMES; COMPUTER HARDWARE; ELECTRONIC PUBLICATIONS DOWNLOADABLE FROM THE INTERNET, NAMELY, INSTRUCTION SHEETS FEATURING RULES AND REGULATIONS PERTAINING TO CASINO GAMING AND LOTTERY AND SWEEPSTAKES PROMOTIONS; MAGNETIC ENCODED CARDS AND CARD CONTAINING AN INTEGRATED CIRCUIT CHIP ("SMART CARDS"), NAMELY, CASH CARDS AND STORED VALUE CARDS AND PAY CARDS THAT ALLOW USERS TO ACCESS VENDING MACHINES; MAGNETIC ENCODED CARD READERS; CREDIT CARD READERS; GAMES AND AMUSEMENT APPARATUS, NAMELY, VIDEO GAME CONSOLES ADAPTED FOR USE WITH AN EXTERNAL DISPLAY SCREEN OR MONITOR, VIDEO LOTTERY TERMINALS AND SLOT MACHINES; STANDALONE GAMING MACHINES BUILT WITH RETAIL HARDWARE COMPONENTS IN THE NATURE OF MOTHERBOARDS, HARD DISK DRIVES, POWER SUPPLIES, TOUCH SCREENS, BILL ACCEPTORS, SMART CARD READERS, AND PRINTERS (U.S. CLS. 21, 23, 26, 36 AND 38).

CLASS 28—TOYS AND SPORTING GOODS

FOR STANDALONE VIDEO GAME MACHINES BUILT WITH RETAIL HARDWARE COMPONENTS IN THE NATURE OF MOTHERBOARDS, HARD DISK DRIVES, POWER SUPPLIES, TOUCH SCREENS, BILL ACCEPTORS, SMART CARD READERS, AND PRINTERS (U.S. CLS. 22, 23, 38 AND 50).

CLASS 35—ADVERTISING AND BUSINESS

FOR ORGANIZATION, ADMINISTRATION AND MANAGEMENT OF THE ENTERTAINMENT EVENTS, SPORTING ACTIVITIES, CULTURAL ACTIVITIES, TOURNAMENTS, COMPETITIONS, CONTESTS, GAMES, GAME SHOWS, GAMBLING SERVICES, BETTING SERVICES, CASINO SERVICES, CARD GAME SERVICES, AMUSEMENT GAMES, AND POKER GAMES SERVICES OF THIRD PARTIES (U.S. CLS. 100, 101 AND 102).

CLASS 41—EDUCATION AND ENTERTAINMENT

FOR ENTERTAINMENT SERVICES PROVIDED BY MEANS OF THE INTERNET, NAMELY, PROVIDING A WEB SITE FEATURING NON-DOWNLOADABLE MULTIMEDIA MATERIALS FEATURING CASINO GAMING, AMUSEMENT AND SKILL GAMES, CASINO STYLE GAMING; PROVIDING A FREE ENTERTAINMENT WEBSITE FEATURING CASINO GAMING AND CARD GAMES, PROVIDING A WEBSITE FEATURING LOCAL AND GLOBAL CURRENT EVENT NEWS, PROVIDING ONLINE SWEEPSTAKES SERVICES FEATURING CASINO STYLE GAMES RESEMBLING SLOT MACHINES, CARD GAMES, AND OTHER SIMILAR GAMES; CARD GAMES SERVICES PROVIDED BY MEANS OF THE INTERNET; PROVIDING ONLINE COMPUTER GAMES, CARD GAMES, AND CASINO-TYPE GAMES; INFORMATION AND ADVISORY SERVICES RELATING TO THE AFORESAID SERVICES; PROVIDING ON-LINE, NON-DOWNLOADABLE ELECTRONIC PUBLICATIONS, NAMELY, ON PURPOSE NEWSLETTERS IN THE FIELD OF SWEEPSTAKES PROMOTIONS; ONLINE GAMING SERVICES, NAMELY, PROVIDING VIRTUAL MULTI-PLAYER CARD ROOMS (U.S. CLS. 100, 101 AND 107).

CLASS 42—SCIENTIFIC AND COMPUTER SERVICES

FOR DESIGN AND DEVELOPMENT OF COMPUTER HARDWARE AND SOFTWARE; DESIGNING, CREATING, AND MAINTAINING WEB PAGES FOR OTHERS; INSTALLATION AND MAINTENANCE OF COMPUTER SOFTWARE; INFORMATION AND ADVISORY SERVICES RELATING TO THE AFORESAID SERVICES (U.S. CLS. 100 AND 101).

CLASS 43—HOTEL AND RESTAURANT SERVICES

FOR (BASED ON INTENT TO USE) RESTAURANT, CAFE, SNACK BAR, COFFEE BAR, CARRY OUT RESTAURANT SERVICES, COCKTAIL LOUNGE SERVICES (U.S. CLS. 100 AND 101).

CLASS 45—PERSONAL AND LEGAL SERVICES

FOR PROVIDING A SOCIAL NETWORKING WEBSITE FOR ENTERTAINMENT PURPOSES (U.S. CLS. 100 AND 101).

KIMBERLY FRYE, EXAMINING ATTORNEY

SN 85-274,302. UNICON SYSTEMS PTY LTD, EPPING NSW 2121, AUSTRALIA, FILED 3-23-2011.



NO CLAIM IS MADE TO THE EXCLUSIVE RIGHT TO USE "SYSTEMS", APART FROM THE MARK AS SHOWN. THE MARK CONSISTS OF A STYLIZED "U" IN A BOX NEXT TO THE WORDING "UNICON SYSTEMS".

CLASS 6—METAL GOODS

FOR CHANNELS OF METAL FOR CASTING INTO CONCRETE; DEVICES OF METAL, IN THE NATURE OF REINFORCING BARS, RODS AND MESHES FOR USE IN REINFORCING CONCRETE; DISPLACEMENT BODIES OF METAL IN THE NATURE OF RECESS FORMERS FOR MAKING CAVITIES IN CONCRETE PARTS; METAL FORMWORK FOR CONCRETE; LIFTING LOOPS IN THE NATURE OF ANCHORS, CABLES AND SHACKLES OF METAL FOR HANDLING CONCRETE ELEMENTS; LINERS OF METAL FOR CONCRETE FORMS; METAL FABRIC IN THE NATURE OF WIRE MESH FOR USE IN THE REINFORCEMENT OF CONCRETE; METAL MATERIALS IN THE NATURE OF MOLDS FOR USE IN CONCRETE FORMING; METALLIC BANDS FOR REINFORCING CONCRETE; METAL PRE-RINSE, WASH DOWN SPRAY NOZZLES FOR HOSES USED IN SPRAYING CONCRETE FOR COMMERCIAL AND INDUSTRIAL USE; METALLIC SHUTTERING FOR CONCRETE; MOLDS OF METAL FOR FORMING CONCRETE FABRICATIONS; REINFORCEMENT ELEMENTS OF METAL FOR PRE-CAST CONCRETE; REINFORCEMENT OF METAL FOR CONCRETE; REINFORCING BARS OF METAL FOR USE IN CONCRETE; REINFORCING MATERIALS OF METAL FOR CONCRETE; REINFORCING RODS OF METAL FOR CONCRETE; ROUND METAL BARS FOR USE IN REINFORCING CONCRETE; SHUTTERING OF METAL FOR CONCRETE; SPLICES OF METAL FOR CONNECTING REINFORCING BARS IN CONCRETE COLUMNS; STAINLESS STEEL REINFORCING RODS FOR CONCRETE BUILDING WORKS; STEEL DECK SHUTTERING FOR USE IN THE CONSTRUCTION OF CONCRETE FLOORS; STEEL REINFORCEMENT FOR USE IN THE CONSTRUCTION OF CONCRETE FLOORS; STEEL SHUTTERING FOR USE IN THE CONSTRUCTION OF CONCRETE FLOORS (U.S. CLS. 2, 12, 13, 14, 23, 25 AND 50).

CLASS 19—NON-METALLIC BUILDING MATERIALS

FOR FLOOR PATCHING MATERIALS, NAMELY, CONCRETE SEALERS; NON-METALLIC FORMS FOR CONCRETE; NON-METALLIC FORMWORK FOR CONCRETE; NON-METALLIC LINERS FOR CONCRETE FORMS; NON-METALLIC MATERIALS FOR USE IN CONCRETE FORMING IN THE NATURE OF LUMBER, BOARDS OF WOOD AND SLATS OF TIMBER; NON-METALLIC MATERIALS ARE USED IN THE MANUFACTURE OF CONCRETE IN THE NATURE OF SAND, CEMENT AGGREGATE AND CEMENT; NON-METALLIC SHEETING TO USE IN MAKING CONCRETE COMPONENTS IN THE NATURE OF PLYWOOD; NON-METALLIC SPLICES AND JOINERS FOR CONNECTING REINFORCING BARS IN CONCRETE COLUMNS; PRODUCTS IN THE NATURE OF CEMENTS FOR THE REPAIR OF CONCRETE; PRODUCTS IN THE NATURE OF MORTARS FOR THE REPAIR OF CONCRETE; REINFORCEMENTS OF NON-METALLIC MATERIALS FOR CONCRETE; REINFORCING BARS, NOT OF METAL FOR USE IN CONCRETE; BUILDING MATERIALS, NAMELY, NON-METALLIC SUPPORT PROFILES IN PLASTIC FOR HOLDING REINFORCEMENT IN CONCRETE AND NON-METALLIC PROFILES OF PLASTIC FOR POSITIONING REINFORCEMENT IN CONCRETE (U.S. CLS. 1, 12, 33 AND 50).

DAVID TAYLOR, EXAMINING ATTORNEY

SN 85-275,100. NATURAL PACK, INC., SANTA BARBARA, CA. FILED 3-23-2011.

PROFLORA

THE MARK CONSISTS OF STANDARD CHARACTERS WITHOUT CLAIM TO ANY PARTICULAR FONT, STYLE, SIZE, OR COLOR.

CLASS 1—CHEMICALS

FOR POTTING SOIL; SOIL AMENDMENTS; SOIL MIXTURES COMPRISED OF ONE OR MORE OF THE FOLLOWING FLOWER, VEGETABLE, HERB AND GRASS SEEDS, MANURE, COMPOST, COCONUT PITH, PEAT MOSS, AND SLOW RELEASE, POWDER AND GRANULAR FERTILIZER; HYDROPONIC GROWING MEDIA FOR PLANTS; FERTILIZERS; PLANT GROWTH NUTRIENTS (U.S. CLS. 1, 5, 6, 10, 26 AND 46).
FIRST USE 12-27-2009; IN COMMERCE 12-27-2009.

CLASS 21—HOUSEWARES AND GLASS

FOR FLORIST AND GARDEN SUPPLIES, NAMELY, DECORATIVE POTS, PLANT BASKETS, AND PLANT BASKET LINERS (U.S. CLS. 2, 13, 23, 29, 30, 33, 40 AND 50).
FIRST USE 12-27-2009; IN COMMERCE 12-27-2009.

CLASS 31—NATURAL AGRICULTURAL PRODUCTS

FOR MULCH; COCONUT HUSK, COIR AND BARK FOR USE AS MULCH; PEAT MOSS; LIVING LICHEN; MOSSES, NAMELY, NATURAL DECORATIVE MOSSES SOLD DRIED, DYED AND PRESERVED FOR USE WITH FLORAL ARRANGEMENTS, ARTS, CRAFTS, AND HOBBY (U.S. CLS. 1 AND 46).
FIRST USE 12-27-2009; IN COMMERCE 12-27-2009.
CHRIS WELLS, EXAMINING ATTORNEY

SN 85-275,257. STRICTLY HODAKA, LLC, SANDGATE, VT. FILED 3-24-2011.



OWNER OF U.S. REG. NOS. 3,566,479 AND 3,614,388.
NO CLAIM IS MADE TO THE EXCLUSIVE RIGHT TO USE "MOTORCYCLES", APART FROM THE MARK AS SHOWN.

THE MARK CONSISTS OF TWO CONCENTRIC CIRCLES WITH A TRIANGLE DESIGN INSIDE THE INNER CIRCLE. THE WORDS "HODAKA" AND "MOTORCYCLES" ARE WRITTEN BETWEEN THE CIRCLES, AND THE LETTER "H" IS WRITTEN WITHIN THE INNER TRIANGLE DESIGN.

THE WORD(S) "HODAKA" HAS NO MEANING IN A FOREIGN LANGUAGE.

CLASS 25—CLOTHING

FOR SHIRTS; HATS (U.S. CLS. 22 AND 39).
FIRST USE 0-0-1990; IN COMMERCE 0-0-1990.

CLASS 35—ADVERTISING AND BUSINESS

FOR RETAIL STORE SERVICES AND ON-LINE RETAIL STORE SERVICES FEATURING VINTAGE MOTORCYCLES, MOTORCYCLE PARTS, AND MOTORCYCLE ACCESSORIES; WEBSITE FEATURING CONSUMER INFORMATION IN THE FIELD OF VINTAGE MOTORCYCLES, MOTORCYCLE PARTS, AND MOTORCYCLE ACCESSORIES (U.S. CLS. 100, 101 AND 102).
FIRST USE 0-0-1986; IN COMMERCE 7-0-1990.
JAMES STEIN, EXAMINING ATTORNEY

SN 85-275,361. R.O.B.A. INTERACTIVE, LLC, MIAMI, FL. FILED 3-24-2011.

TOUCH THE MUSIC

THE MARK CONSISTS OF STANDARD CHARACTERS WITHOUT CLAIM TO ANY PARTICULAR FONT, STYLE, SIZE, OR COLOR.

CLASS 9—ELECTRICAL AND SCIENTIFIC APPARATUS

FOR (BASED ON INTENT TO USE) COMPUTER APPLICATION SOFTWARE FOR MOBILE PHONES, COMPUTERS, HANDHELD ELECTRONIC DEVICES, STANDALONE DEVICES, TELEVISION-STYLE DEVICES, PORTABLE DEVICES, TABLETS AND COMPUTERS, NAMELY, SOFTWARE FOR MUSIC, MUSIC HISTORY, INTERVIEWS, MUSIC NEWS, CONCERT FOOTAGE, ARCHIVAL FOOTAGE, EDUCATIONAL ELEMENTS, NAMELY, TESTS, QUIZZES AND EDUCATIONAL GAMES, AND MUSIC-CREATION; DIGITAL MEDIA, NAMELY, HARD DRIVES, FLASH DRIVES, DIGITAL CHIPS, DOWNLOADABLE SOFTWARE, CLOUD-BASED SOFTWARE, PRE-RECORDED DVDS, DOWNLOADABLE AUDIO AND VIDEO RECORDINGS, AND CDS PROMOTING AND FEATURING MUSIC, MUSIC HISTORY, INTERVIEWS, MUSIC NEWS, CONCERT FOOTAGE, ARCHIVAL FOOTAGE, EDUCATIONAL ELEMENTS, NAMELY, TESTS, QUIZZES AND EDUCATIONAL GAMES, AND MUSIC-CREATION; PRE-RECORDED CDS, VIDEO TAPES, LASER DISKS AND DVDS FEATURING MUSIC, MUSIC HISTORY, INTERVIEWS, MUSIC NEWS, CONCERT FOOTAGE, ARCHIVAL FOOTAGE, EDUCATIONAL ELEMENTS, NAMELY, TESTS, QUIZZES AND EDUCATIONAL GAMES, AND MUSIC-CREATION (U.S. CLS. 21, 23, 26, 36 AND 38).

CLASS 35—ADVERTISING AND BUSINESS

FOR (BASED ON USE IN COMMERCE) ADVERTISING AND MARKETING CONSULTANCY; ADVERTISING AND MARKETING SERVICES, NAMELY, PROMOTING THE GOODS AND SERVICES OF OTHERS; ADVERTISING, MARKETING AND PROMOTION SERVICES; CONSULTATION SERVICES, NAMELY, CREATIVE AND STRATEGIC CONSULTATION REGARDING DEVELOPMENT AND PRODUCTION OF MARKETING CAMPAIGNS FOR OTHERS; CONSULTING SERVICES IN THE FIELD OF INTERNET MARKETING; ENTERTAINMENT MARKETING SERVICES, NAMELY, MARKETING, PROMOTION AND ADVERTISING FOR INDEPENDENT RECORDING ARTISTS; ENTERTAINMENT MARKETING SERVICES, NAMELY, MARKETING, PROMOTION AND ADVERTISING FOR RECORDING AND PERFORMING ARTISTS (U.S. CLS. 100, 101 AND 102).

FIRST USE 9-21-2010; IN COMMERCE 3-10-2011.

CLASS 42—SCIENTIFIC AND COMPUTER SERVICES

FOR (BASED ON USE IN COMMERCE) PROVIDING A WEBSITE ALLOWING USERS TO DOWNLOAD MUSIC AND MUSIC VIDEOS; PROVIDING A WEBSITE FEATURING NON-DOWNLOADABLE SOFTWARE FOR VIEWING MUSIC, MUSIC HISTORY, INTERVIEWS, MUSIC NEWS, CONCERT FOOTAGE, ARCHIVAL FOOTAGE, EDUCATIONAL ELEMENTS, NAMELY, TESTS, QUIZZES AND EDUCATIONAL GAMES, AND MUSIC-CREATION; PROVIDING A WEBSITE FEATURING TECHNOLOGY THAT ENABLES USERS TO VIEW, RATE, REVIEW AND DISCUSS MUSIC, MUSIC HISTORY, INTERVIEWS, MUSIC NEWS, CONCERT FOOTAGE, ARCHIVAL FOOTAGE, EDUCATIONAL ELEMENTS, NAMELY, TESTS, QUIZZES AND EDUCATIONAL GAMES, AND MUSIC-CREATION (U.S. CLS. 100 AND 101).

FIRST USE 9-21-2010; IN COMMERCE 3-10-2011.
TIMOTHY FINNEGAN, EXAMINING ATTORNEY

SN 85-279,450. PRO ATM, LLC, SLIPPERY ROCK, PA. FILED 3-29-2011.

PRO ATM

THE MARK CONSISTS OF STANDARD CHARACTERS WITHOUT CLAIM TO ANY PARTICULAR FONT, STYLE, SIZE, OR COLOR.

NO CLAIM IS MADE TO THE EXCLUSIVE RIGHT TO USE "ATM", APART FROM THE MARK AS SHOWN.

CLASS 35—ADVERTISING AND BUSINESS

FOR RETAIL STORE SERVICES AND WHOLESALE DISTRIBUTORSHIP SERVICES FEATURING AUTOMATED TELLER MACHINES AND CASH DISPENSERS AND PROVIDING AUTOMATED TELLER MACHINE AND CASH DISPENSER SUPPLIES TO OTHERS (U.S. CLS. 100, 101 AND 102).

FIRST USE 0-0-2009; IN COMMERCE 0-0-2009.

CLASS 36—INSURANCE AND FINANCIAL

FOR AUTOMATED TELLER MACHINE AND CASH DISPENSER SERVICES IN THE NATURE OF AUTOMATED TELLER MACHINE MANAGEMENT, AUTOMATED TELLER MACHINE ACCOUNT MANAGEMENT, AUTOMATED TELLER MACHINE CASH MANAGEMENT, AUTOMATED TELLER MACHINE PROCESSING AND AUTOMATED TELLER MACHINE FEE COLLECTION AND PAYMENT SERVICES; RENTAL OF AUTOMATED TELLER MACHINES AND CASH DISPENSERS (U.S. CLS. 100, 101 AND 102).

FIRST USE 0-0-2009; IN COMMERCE 0-0-2009.

CLASS 37—CONSTRUCTION AND REPAIR

FOR AUTOMATED TELLER MACHINE AND CASH DISPENSER MAINTENANCE SERVICES (U.S. CLS. 100, 103 AND 106).

FIRST USE 0-0-2009; IN COMMERCE 0-0-2009.

SAIMA MAKHDOOM, EXAMINING ATTORNEY

SN 85-284,542. DESIRE2LEARN INCORPORATED, KITCHENER, ON, CANADA, FILED 4-2-2011.

PLEARN

THE MARK CONSISTS OF STANDARD CHARACTERS WITHOUT CLAIM TO ANY PARTICULAR FONT, STYLE, SIZE, OR COLOR.

CLASS 9—ELECTRICAL AND SCIENTIFIC APPARATUS

FOR COMPUTER SOFTWARE AND COMPUTER PROGRAM PLATFORMS FOR CREATING AND CONDUCTING EDUCATIONAL COURSES AND SEMINARS, FOR GENERATING COURSE AND RELATED INSTRUCTIONAL MATERIAL FOR ONLINE USE AT ALL LEARNING LEVELS, FOR ENABLING PAYMENT, REGISTRATION, SELF ASSESSMENT, COURSE ADMINISTRATION, EXPERIENCE AND STUDENT EVALUATIONS, INTERACTIVE COMMUNICATIONS AND FOR TRAINING USERS ON THE USE AND OPERATION OF THE FOREGOING (U.S. CLS. 21, 23, 26, 36 AND 38).

CLASS 42—SCIENTIFIC AND COMPUTER SERVICES

FOR COMPUTER SERVICES, NAMELY, HOSTING ONLINE WEB FACILITIES FOR OTHERS FOR ORGANIZING AND CONDUCTING ONLINE GATHERINGS AND INTERACTIVE DISCUSSIONS; COMPUTER SERVICES, NAMELY, INTERACTIVE HOSTING SERVICES WHICH ALLOW USERS TO PUBLISH AND SHARE THEIR OWN CONTENT AND IMAGES ONLINE, INCLUDING ELECTRONIC LEARNING PROGRAMS AND PLATFORMS; DESIGN AND DEVELOPMENT OF COMPUTER HARDWARE AND SOFTWARE FOR ELECTRONIC LEARNING PROGRAMS AND PLATFORMS (U.S. CLS. 100 AND 101).

IRA J. GOODSaid, EXAMINING ATTORNEY

SN 85-287,475. COLOCATION.FR, 75008 PARIS, FRANCE,
FILED 4-6-2011.

SN 85-290,000. SANOFI, PARIS, FRANCE, FILED 4-8-2011.

COBRUNCHING

THE MARK CONSISTS OF STANDARD CHARACTERS WITHOUT CLAIM TO ANY PARTICULAR FONT, STYLE, SIZE, OR COLOR.

CLASS 35—ADVERTISING AND BUSINESS

FOR ADVERTISING; ONLINE ADVERTISING ON A COMPUTER NETWORK; ADVERTISING SERVICES, NAMELY, PROMOTING THE GOODS AND SERVICES OF OTHERS VIA COMPUTER AND COMMUNICATION NETWORKS; PUBLICATION OF PUBLICITY TEXTS IN THE NATURE OF PAMPHLETS, SHEETS, AND NEWSLETTERS RELATING TO CULINARY TOPICS AND ORGANIZATION OF EVENTS; RENTAL OF ADVERTISING SPACE; RENTAL OF ADVERTISING TIME ON COMMUNICATION MEDIA, NAMELY, THE COMPUTER NETWORK; DATABASE MANAGEMENT; COMPILATION IN COMPUTER DATABASES OF INFORMATION IDENTIFYING INDIVIDUALS AND EATING ESTABLISHMENTS AND RELATED CULINARY INFORMATION; PUBLIC RELATIONS (U.S. CLS. 100, 101 AND 102).

CLASS 41—EDUCATION AND ENTERTAINMENT

FOR ENTERTAINMENT, NAMELY, ARRANGING, ORGANIZING AND CONDUCTING MEETINGS RELATING TO CULINARY TOPICS AT RESTAURANTS, BARS AND CAFES FOR SOCIAL ENTERTAINMENT PURPOSES; PUBLISHING OF ELECTRONIC PUBLICATIONS FEATURING RESTAURANTS, BARS AND CAFES; ONLINE PUBLICATION OF NEWSLETTERS AND ARTICLES FEATURING CULINARY TOPICS, RESTAURANTS, BARS AND CAFES; PROVIDING COMPUTER, ELECTRONIC AND ONLINE DATABASES IN THE FIELD OF ORGANIZING CULINARY MEETINGS AT RESTAURANTS, BARS AND CAFES FOR SOCIAL ENTERTAINMENT PURPOSES (U.S. CLS. 100, 101 AND 107).

CLASS 43—HOTEL AND RESTAURANT SERVICES

FOR BAR AND RESTAURANT SERVICES; PROVIDING ON-LINE REVIEWS OF RESTAURANTS, BARS AND CAFES; RESTAURANTS, BARS AND CAFES RESERVATION SERVICES; PROVIDING A WEB SITE FEATURING INFORMATION ON RESTAURANTS, BARS AND CAFES (U.S. CLS. 100 AND 101).

CLASS 45—PERSONAL AND LEGAL SERVICES

FOR ONLINE SOCIAL NETWORKING IN THE FIELD OF RESTAURANTS, BARS AND CAFES; ONLINE SOCIAL NETWORKING SERVICES IN THE FIELD OF ORGANIZING MEETINGS AT RESTAURANTS, BARS AND CAFES PROVIDED VIA A WEBSITE; PROVIDING ON-LINE COMPUTER DATABASES AND ON-LINE SEARCHABLE DATABASES IN THE FIELD OF SOCIAL NETWORKING (U.S. CLS. 100 AND 101).

THOMAS MANOR, EXAMINING ATTORNEY

BGSTAR LEGATO

THE MARK CONSISTS OF STANDARD CHARACTERS WITHOUT CLAIM TO ANY PARTICULAR FONT, STYLE, SIZE, OR COLOR.

OWNER OF FRANCE REG. NO. 11/3821184, DATED 4-6-2011, EXPIRES 4-6-2021.

OWNER OF U.S. REG. NO. 3,787,454.

CLASS 5—PHARMACEUTICALS

FOR BLOOD GLUCOSE MONITORING KITS COMPRISING STRIPS FOR MEASURING BLOOD GLUCOSE CONCENTRATIONS, LANCETS AND CONTROL SOLUTION, ALL OF THE FOREGOING SOLD TO PATIENTS (U.S. CLS. 6, 18, 44, 46, 51 AND 52).

CLASS 9—ELECTRICAL AND SCIENTIFIC APPARATUS

FOR SOFTWARE INTENDED FOR DIABETIC PATIENTS FOR RECORDING BLOOD TEST RESULTS FROM A BLOOD GLUCOSE MONITOR, SOLD TO PATIENTS (U.S. CLS. 21, 23, 26, 36 AND 38).

CLASS 10—MEDICAL APPARATUS

FOR BLOOD GLUCOSE MONITORS, AND BLOOD GLUCOSE MONITORS SOLD AS A UNIT WITH BLOOD GLUCOSE MONITORING KITS COMPRISING STRIPS FOR MEASURING BLOOD GLUCOSE CONCENTRATIONS, LANCETS AND CONTROL SOLUTION, ALL OF THE FOREGOING SOLD TO PATIENTS (U.S. CLS. 26, 39 AND 44).

FRED CARL, EXAMINING ATTORNEY

SN 85-297,025. SANKAR-ZHU, LISA, DBA LISA SANKAR-ZHU, ZHENGZHOU, HENAN, CHINA, FILED 4-16-2011.

Golden Mushroom Cartoon

THE MARK CONSISTS OF STANDARD CHARACTERS WITHOUT CLAIM TO ANY PARTICULAR FONT, STYLE, SIZE, OR COLOR.

NO CLAIM IS MADE TO THE EXCLUSIVE RIGHT TO USE "CARTOON", APART FROM THE MARK AS SHOWN.

CLASS 9—ELECTRICAL AND SCIENTIFIC APPARATUS

FOR VIDEOTAPES AND VIDEO DISKS RECORDED WITH ANIMATIONS, NAMELY, VIDEO, TV, FILM, AND COMPUTER ANIMATIONS (U.S. CLS. 21, 23, 26, 36 AND 38).

CLASS 41—EDUCATION AND ENTERTAINMENT

FOR VIDEO, TV, FILM, AND COMPUTER ANIMATION SERVICES, NAMELY, SPECIAL EFFECTS ANIMATION SERVICES FOR FILM AND VIDEO (U.S. CLS. 100, 101 AND 107).

CLASS 42—SCIENTIFIC AND COMPUTER SERVICES

FOR VIDEO, TV, FILM, AND COMPUTER ANIMATION SERVICES, NAMELY, ANIMATION DESIGN FOR OTHERS (U.S. CLS. 100 AND 101).

LIEF MARTIN, EXAMINING ATTORNEY

SN 85-303,840. LION CAPITAL LLP, LONDON SW1X 7HF, UNITED KINGDOM, FILED 4-25-2011.

LION
CAPITAL

SN 85-297,791. BSN SPORTS, INC., FARMERS BRANCH, TX, FILED 4-18-2011.

BSN SPORTS

THE MARK CONSISTS OF STANDARD CHARACTERS WITHOUT CLAIM TO ANY PARTICULAR FONT, STYLE, SIZE, OR COLOR.

OWNER OF U.S. REG. NOS. 1,198,106 AND 2,473,322.

NO CLAIM IS MADE TO THE EXCLUSIVE RIGHT TO USE "SPORTS", APART FROM THE MARK AS SHOWN.

CLASS 16—PAPER GOODS AND PRINTED MATTER

FOR CALENDARS, DAY PLANNERS, BINDERS, FOLDERS, PENS (U.S. CLS. 2, 5, 22, 23, 29, 37, 38 AND 50).

CLASS 18—LEATHER GOODS

FOR LEATHER KEY CHAINS; SPORTS BAGS, ATHLETIC BAGS, CARRY-ALL BAGS, GYM BAGS, TRAVEL BAGS (U.S. CLS. 1, 2, 3, 22 AND 41).

CLASS 25—CLOTHING

FOR CLOTHING, NAMELY, CAPS, BEANIES, HATS, VISORS, T-SHIRTS, POLO SHIRTS, SWEATSHIRTS AND HOODED SWEATSHIRTS, SWEATPANTS, JACKETS, PANTS, SHOES (U.S. CLS. 22 AND 39).

CLASS 35—ADVERTISING AND BUSINESS

FOR MAIL ORDER CATALOG SERVICES, ONLINE RETAIL STORE SERVICES, AND WHOLESALE DISTRIBUTORSHIP SERVICES ALL IN THE FIELDS OF SPORTING AND ATHLETIC GOODS, EQUIPMENT AND SUPPLIES, PHYSICAL FITNESS AND EXERCISE EQUIPMENT, AND RECREATIONAL EQUIPMENT, SUPPLIES AND ACCESSORIES (U.S. CLS. 100, 101 AND 102).

FIRST USE 0-0-1984; IN COMMERCE 0-0-1984.
BARBARA RUTLAND, EXAMINING ATTORNEY

PRIORITY CLAIMED UNDER SEC. 44(D) ON ERPN CMNTY TM OFC APPLICATION NO. 009813131, FILED 3-15-2011, REG. NO. 009813131, DATED 8-25-2011, EXPIRES 3-15-2021.

NO CLAIM IS MADE TO THE EXCLUSIVE RIGHT TO USE "CAPITAL", APART FROM THE MARK AS SHOWN.

THE MARK CONSISTS OF THE WORDS "LION" AND "CAPITAL", WITH THE WORD "LION" APPEARING ABOVE THE WORD "CAPITAL" AND BOTH HAVING A RIGHT JUSTIFICATION.

CLASS 16—PAPER GOODS AND PRINTED MATTER

FOR PRINTED MATTER, NAMELY, MAGAZINES, BOOKS, NEWSLETTERS AND PAMPHLETS RELATING TO FINANCE, INVESTMENT OR ASSET MANAGEMENT; BROCHURES IN RELATION TO FINANCE, INVESTMENT OR ASSET MANAGEMENT; INVESTMENT BRIEFING PACKS (U.S. CLS. 2, 5, 22, 23, 29, 37, 38 AND 50).

CLASS 35—ADVERTISING AND BUSINESS

FOR ADVICE RELATING TO BUSINESS MANAGEMENT; BUSINESS ADVICE AND INFORMATION; GATHERING AND PROVIDING BUSINESS INFORMATION RELATING TO COMPANY ACTIVITIES; BUSINESS ACQUISITIONS CONSULTANCY AND ADVISORY SERVICES; BUSINESS MANAGEMENT AND ADMINISTRATION RELATING TO THE FIELD OF INVESTMENT AND FINANCIAL AFFAIRS; BUSINESS CONSULTANCY; ADVISORY, CONSULTANCY AND INFORMATION SERVICES RELATING TO ALL THE AFORESAID SERVICES (U.S. CLS. 100, 101 AND 102).

CLASS 36—INSURANCE AND FINANCIAL

FOR FINANCIAL AFFAIRS AND MONETARY AFFAIRS, NAMELY, FINANCIAL AND MONETARY INFORMATION, MANAGEMENT AND ANALYSIS SERVICES; FINANCIAL SERVICES, NAMELY, FINANCIAL AND INVESTMENT PLANNING AND RESEARCH, FINANCIAL CONSULTATION AND ASSISTING OTHERS WITH THE COMPLETION OF FINANCIAL TRANSACTIONS FOR STOCKS, BONDS, SECURITIES AND EQUITIES; CORPORATE FINANCE SERVICES, NAMELY, CONSULTATION IN THE FIELD OF ASSET ACQUISITIONS AND SALES AND CAPITAL STRUCTURE; PRIVATE EQUITY FUND INVESTMENT SERVICES; INVESTMENT CONSULTANCY AND ADVISORY SERVICES; CAPITAL, FUNDS AND TRUST INVESTMENT SERVICES; INVESTMENT MANAGEMENT SERVICES; OPERATION AND MANAGEMENT OF HEDGE FUNDS AND OTHER COLLECTIVE INVESTMENT VEHICLES; FINANCIAL AND INVESTMENT PLANNING AND RESEARCH; FUND RAISING, NAMELY, BUSINESS FUND-RAISING FOR OTHERS AND FUND-RAISING FOR OTHERS FOR THE PURPOSE OF PURCHASING COMPANIES; RAISING OF FINANCE AND FINANCING, NAMELY, RAISING DEBT AND EQUITY CAPITAL FOR OTHERS AND RAISING MONEY FOR THE HEDGE FUND OF OTHERS; ADVISORY, CONSULTANCY AND INFORMATION SERVICES RELATING TO ALL THE AFORESAID SERVICES (U.S. CLS. 100, 101 AND 102).

STEVEN R. FINE, EXAMINING ATTORNEY

SN 85-304,509. THE CHARLOTTE-MECKLENBURG HOSPITAL AUTHORITY, CHARLOTTE, NC. FILED 4-26-2011.

SN 85-307,900. BSN SPORTS, INC., FARMERS BRANCH, TX. FILED 4-28-2011.

CAROLINAS HEALTHCARE SYSTEM

THE MARK CONSISTS OF STANDARD CHARACTERS WITHOUT CLAIM TO ANY PARTICULAR FONT, STYLE, SIZE, OR COLOR.

NO CLAIM IS MADE TO THE EXCLUSIVE RIGHT TO USE "HEALTHCARE SYSTEM", APART FROM THE MARK AS SHOWN.
SEC. 2(F).



CLASS 16—PAPER GOODS AND PRINTED MATTER

FOR PRINTED INSTRUCTIONAL, EDUCATIONAL, AND TEACHING MATERIALS IN THE FIELD OF HEALTH, WELLNESS, FITNESS, EXERCISE, SCIENTIFIC AND MEDICAL RESEARCH, HEALTHCARE CAREERS, AND HEALTH SURVEYS, QUESTIONNAIRES AND REPORTS (U.S. CLS. 2, 5, 22, 23, 29, 37, 38 AND 50).
FIRST USE 12-31-1996; IN COMMERCE 12-31-1996.

CLASS 35—ADVERTISING AND BUSINESS

FOR RETAIL PHARMACY SERVICES (U.S. CLS. 100, 101 AND 102).
FIRST USE 12-31-2003; IN COMMERCE 12-31-2003.
LINDA LAVACHE, EXAMINING ATTORNEY

OWNER OF U.S. REG. NOS. 1,198,106 AND 2,473,322.
NO CLAIM IS MADE TO THE EXCLUSIVE RIGHT TO USE "SPORTS", APART FROM THE MARK AS SHOWN.

THE MARK CONSISTS OF THE WORDS "BSN SPORTS" WITH A STYLIZED ARROW DESIGN ABOVE, AND THE WORDS "FEEL THE STRENGTH" ON A TRAPEZOIDAL FIGURE, ALL AGAINST A CONTRASTING RECTANGULAR BACKGROUND.

CLASS 16—PAPER GOODS AND PRINTED MATTER

FOR DRY MARKERS; CALENDARS, DAY PLANNERS, BINDERS, FOLDERS, PENS (U.S. CLS. 2, 5, 22, 23, 29, 37, 38 AND 50).

CLASS 18—LEATHER GOODS

FOR LEATHER KEY CHAINS; SPORTS BAGS, ATHLETIC BAGS, CARRY-ALL BAGS, GYM BAGS, TRAVEL BAGS (U.S. CLS. 1, 2, 3, 22 AND 41).

CLASS 25—CLOTHING

FOR CLOTHING, NAMELY, CAPS, BEANIES, HATS, VISORS, T-SHIRTS, POLO SHIRTS, SWEATSHIRTS AND HOODED SWEATSHIRTS, SWEATPANTS, JACKETS, PANTS, SHOES (U.S. CLS. 22 AND 39).

CLASS 28—TOYS AND SPORTING GOODS

FOR SPORTS EQUIPMENT, NAMELY, BUCKET CADDY FOR CARRYING, STORING AND TRANSPORTING BALLS AND OTHER SPORTS EQUIPMENT, SOCCER GOALS, STRESS RELIEF BALLS FOR HAND EXERCISE, STRESS RELIEF CUBES FOR HAND EXERCISE (U.S. CLS. 22, 23, 38 AND 50).

CLASS 35—ADVERTISING AND BUSINESS

FOR MAIL ORDER CATALOG SERVICES, ONLINE RETAIL STORE SERVICES, AND WHOLESALE DISTRIBUTORSHIP SERVICES ALL IN THE FIELDS OF SPORTING AND ATHLETIC GOODS, EQUIPMENT AND SUPPLIES, PHYSICAL FITNESS AND EXERCISE EQUIPMENT, AND RECREATIONAL EQUIPMENT, SUPPLIES AND ACCESSORIES (U.S. CLS. 100, 101 AND 102).

BARBARA RUTLAND, EXAMINING ATTORNEY

SN 85-306,594. SMARTORGANICS LLC, LAFARGE, WI. FILED 4-27-2011.

SMARTORGANICS

THE MARK CONSISTS OF STANDARD CHARACTERS WITHOUT CLAIM TO ANY PARTICULAR FONT, STYLE, SIZE, OR COLOR.

CLASS 5—PHARMACEUTICALS

FOR BABY FOOD, NAMELY, REFRIGERATED, FROZEN, AND SHELF STABLE FOOD; BABY BEVERAGES, NAMELY, FORMULA AND NUTRITIONALLY FORTIFIED BEVERAGES; ALL AFOREMENTIONED GOODS CONTAINING AT LEAST 95% ORGANIC INGREDIENTS (U.S. CLS. 6, 18, 44, 46, 51 AND 52).

CLASS 29—MEATS AND PROCESSED FOODS

FOR DAIRY-BASED FOOD AND BEVERAGE PRODUCTS, NAMELY, MILK, YOGURT, CHEESE, ALL CONTAINING AT LEAST 95% ORGANIC INGREDIENTS (U.S. CL. 46).

JAMES STEIN, EXAMINING ATTORNEY

SN 85-307,904. BSN SPORTS, INC., FARMERS BRANCH, TX.
FILED 4-28-2011.



THE MARK CONSISTS OF A STYLIZED ARROW DESIGN.

CLASS 16—PAPER GOODS AND PRINTED MATTER

FOR DRY MARKERS; CALENDARS, DAY PLANNERS, BINDERS, FOLDERS, PENS (U.S. CLS. 2, 5, 22, 23, 29, 37, 38 AND 50).

CLASS 18—LEATHER GOODS

FOR LEATHER KEY CHAINS; SPORTS BAGS, ATHLETIC BAGS, CARRY-ALL BAGS, GYM BAGS, TRAVEL BAGS (U.S. CLS. 1, 2, 3, 22 AND 41).

CLASS 25—CLOTHING

FOR CLOTHING, NAMELY, CAPS, BEANIES, HATS, VISORS, T-SHIRTS, POLO SHIRTS, SWEATSHIRTS AND HOODED SWEATSHIRTS, SWEATPANTS, JACKETS, PANTS, SHOES (U.S. CLS. 22 AND 39).

CLASS 28—TOYS AND SPORTING GOODS

FOR SPORTS EQUIPMENT, NAMELY, BUCKET CADDY FOR CARRYING, STORING AND TRANSPORTING BALLS AND OTHER SPORTS EQUIPMENT, SOCCER GOALS, STRESS RELIEF BALLS FOR HAND EXERCISE, STRESS RELIEF CUBES FOR HAND EXERCISE (U.S. CLS. 22, 23, 38 AND 50).

CLASS 35—ADVERTISING AND BUSINESS

FOR MAIL ORDER CATALOG SERVICES, ONLINE RETAIL STORE SERVICES, AND WHOLESALE DISTRIBUTORSHIP SERVICES ALL IN THE FIELDS OF SPORTING AND ATHLETIC GOODS, EQUIPMENT AND SUPPLIES, PHYSICAL FITNESS AND EXERCISE EQUIPMENT, AND RECREATIONAL EQUIPMENT, SUPPLIES AND ACCESSORIES (U.S. CLS. 100, 101 AND 102).

BARBARA RUTLAND, EXAMINING ATTORNEY

SN 85-310,894. IQOR TECHNOLOGIES, INC., NEW YORK, NY. FILED 5-3-2011.

QUANTUMATCH

THE MARK CONSISTS OF STANDARD CHARACTERS WITHOUT CLAIM TO ANY PARTICULAR FONT, STYLE, SIZE, OR COLOR.

CLASS 9—ELECTRICAL AND SCIENTIFIC APPARATUS

FOR SOFTWARE USING ALGORITHMS FOR CREATING MODELS, RATINGS AND CATEGORIZATION OF CONSUMER ACCOUNTS, DATA AND INFORMATION; SOFTWARE FOR CREATING SEARCHABLE DATABASES CONTAINING INFORMATION AND DATA RELATING TO MODELS, RATINGS AND CATEGORIZATION OF CONSUMER ACCOUNTS, DATA AND INFORMATION (U.S. CLS. 21, 23, 26, 36 AND 38).

CLASS 35—ADVERTISING AND BUSINESS

FOR PROVIDING A SEARCHABLE COMPUTER-ACCESSIBLE DATABASE OF CONSUMER ACCOUNT INFORMATION AND DATA, FOR THE PURPOSE OF MARKETING AND ADVERTISING, TO ALLOW MATCHING OF THE SEARCH CRITERIA ABOUT A PARTICULAR USER OR SET OF USERS AGAINST A COLLECTED AND STORED DATA CONCERNING CONSUMER ACCOUNTS, DEMOGRAPHICS, PAYMENT HISTORY AND OTHER CONSUMER-RELATED DATA ASSEMBLED AND STORED IN THE DATABASE (U.S. CLS. 100, 101 AND 102).

CLASS 36—INSURANCE AND FINANCIAL

FOR PROVIDING A SEARCHABLE COMPUTER-ACCESSIBLE DATABASE OF CONSUMER ACCOUNT INFORMATION AND DATA, FOR THE PURPOSE OF ASSESSING CREDIT RATINGS, TO ALLOW MATCHING OF THE SEARCH CRITERIA ABOUT A PARTICULAR USER OR SET OF USERS AGAINST A COLLECTED AND STORED DATA CONCERNING CONSUMER ACCOUNTS, DEMOGRAPHICS, PAYMENT HISTORY AND OTHER CONSUMER-RELATED DATA ASSEMBLED AND STORED IN THE DATABASE; CREDIT RATING SERVICES; PROVIDING FINANCIAL ACCOUNTING INFORMATION IN CONNECTION WITH CREDIT RATING MANAGEMENT AND SERVICES (U.S. CLS. 100, 101 AND 102).

KATHLEEN LORENZO, EXAMINING ATTORNEY

SN 85-310,993. IQOR TECHNOLOGIES, INC., NEW YORK, NY. FILED 5-3-2011.

MIQOR

THE MARK CONSISTS OF STANDARD CHARACTERS WITHOUT CLAIM TO ANY PARTICULAR FONT, STYLE, SIZE, OR COLOR.

CLASS 36—INSURANCE AND FINANCIAL

FOR ADMINISTRATION OF EMPLOYEE WELFARE BENEFIT PLANS CONCERNING INSURANCE AND FINANCE AND FINANCIAL BENEFIT PLANS (U.S. CLS. 100, 101 AND 102).

CLASS 42—SCIENTIFIC AND COMPUTER SERVICES

FOR APPLICATION SERVICE PROVIDER, NAMELY, PROVIDING, HOSTING, MANAGING, DEVELOPING, RESEARCHING, ANALYZING, REPORTING AND MAINTAINING APPLICATIONS, SOFTWARE, WEB SITES AND DATABASES OF OTHERS IN THE FIELDS OF HEALTHCARE, BENEFITS PROGRAMS, EMPLOYEE PRODUCTIVITY AND RISK MANAGEMENT (U.S. CLS. 100 AND 101).

KATHLEEN LORENZO, EXAMINING ATTORNEY

SN 85-311,033. FRANCE PUBLICATIONS, INC., ATLANTA, GA. FILED 5-3-2011.

France Media

THE MARK CONSISTS OF STANDARD CHARACTERS WITHOUT CLAIM TO ANY PARTICULAR FONT, STYLE, SIZE, OR COLOR.

OWNER OF U.S. REG. NOS. 3,886,484 AND 3,894,052. NO CLAIM IS MADE TO THE EXCLUSIVE RIGHT TO USE "MEDIA", APART FROM THE MARK AS SHOWN.

CLASS 35—ADVERTISING AND BUSINESS

FOR ADVERTISING AND COMMERCIAL INFORMATION SERVICES, VIA THE INTERNET (U.S. CLS. 100, 101 AND 102).

FIRST USE 4-1-2011; IN COMMERCE 4-1-2011.

CLASS 41—EDUCATION AND ENTERTAINMENT

FOR BUSINESS TRAINING (U.S. CLS. 100, 101 AND 107).

FIRST USE 4-1-2011; IN COMMERCE 4-1-2011.
KYLE PEETE, EXAMINING ATTORNEY

CLASS 9—ELECTRICAL AND SCIENTIFIC APPARATUS

FOR COMPUTER GAMING SOFTWARE; DOWNLOADABLE COMPUTER GAMING SOFTWARE; COMPUTER GAMING PROGRAMS; DOWNLOADABLE COMPUTER GAMING PROGRAMS; SOFTWARE FOR CASINO MANAGEMENT, NAMELY, COMPUTER SOFTWARE FOR CONDUCTING AND PROCESSING FINANCIAL TRANSACTIONS, CASINO GAME AND VENUE PERFORMANCE ANALYSIS AND REPORTING, MONITORING AND COMPARING CASINO SITE, FLOOR, MACHINE, AND GAME PERFORMANCE, CONTROLLING ACCESS TO CASINO GAMES, CONDUCTING CASINO PLAYER TRACKING, CONDUCTING CASINO AUDITING, COLLECTING USER INFORMATION AND DATA FOR USE WITH CASINO MARKETING AND CASINO CUSTOMER RELATIONS, AND CONTROLLING AND MONITORING CASINO MACHINES, CASINO FLOORS, AND CASINO GAMING SOFTWARE (U.S. CLS. 21, 23, 26, 36 AND 38).

CLASS 28—TOYS AND SPORTING GOODS

FOR GAMBLING MACHINES FOR USE WITH AN EXTERNAL DISPLAY SCREEN OR MONITOR CONTAINING SOFTWARE WHICH ENABLES GAMBLING MACHINES TO RUN; STAND ALONE OR SERVER LINKED GAMBLING MACHINES, OTHER THAN THOSE FOR USE WITH AN EXTERNAL DISPLAY SCREEN OR MONITOR (U.S. CLS. 22, 23, 38 AND 50).

CLASS 41—EDUCATION AND ENTERTAINMENT

FOR ENTERTAINMENT SERVICES, NAMELY, THE PROVISION OF LIVE GAMBLING SERVICES AND THE PROVISION OF ONLINE GAMBLING SERVICES (U.S. CLS. 100, 101 AND 107).

MICHAEL TANNER, EXAMINING ATTORNEY

SN 85-311,121. WATERLEAF LIMITED, DOUGLAS, ISLE OF MAN, FILED 5-3-2011.



OWNER OF U.S. REG. NOS. 3,199,542, 3,562,644 AND OTHERS.

THE MARK CONSISTS OF TWO CURVED BANDS FORMING THE SHAPE OF THE LETTER "X" APPEARING ABOVE THE STYLIZED WORDING "XGS" WHICH APPEARS ABOVE THE STYLIZED WORDING "BETSTONE".

SN 85-315,626. THE SWIFT COLLECTIVE, INC., DBA THE SWIFT COLLECTIVE, PORTLAND, OR. FILED 5-9-2011.

The Swift Collective

THE MARK CONSISTS OF STANDARD CHARACTERS WITHOUT CLAIM TO ANY PARTICULAR FONT, STYLE, SIZE, OR COLOR.

NO CLAIM IS MADE TO THE EXCLUSIVE RIGHT TO USE "COLLECTIVE", APART FROM THE MARK AS SHOWN.

CLASS 35—ADVERTISING AND BUSINESS

FOR MARKETING STRATEGY DEVELOPMENT AND IMPLEMENTATION INCLUDING EMAIL MARKETING, ONLINE ADVERTISING, SEARCH ENGINE OPTIMIZATION, SEARCH ENGINE MARKETING, MULTI-CHANNEL CAMPAIGNS, AND SOCIAL MEDIA CAMPAIGN DEVELOPMENT AND EXECUTION; AND WEBSITE MEASUREMENT VIA USER TESTING, SURVEYS, AND ANALYTICS, NAMELY, TRACKING WEB SITE USAGE TO PROVIDE DETAILS ABOUT USER TRAFFIC AND SPECIFIC PAGE VISITS (U.S. CLS. 100, 101 AND 102).

CLASS 42—SCIENTIFIC AND COMPUTER SERVICES

FOR DESIGN, CREATION, AND MAINTENANCE OF INTERNET SITES FOR THIRD PARTIES; DESIGNING AND DEVELOPING WEB PAGES ON THE INTERNET; COMPUTER SERVICES, NAMELY, DESIGNING AND IMPLEMENTING WEB SITES FOR OTHERS; DESIGN OF HOME PAGES, COMPUTER SOFTWARE AND WEB SITES; ELABORATION AND MAINTENANCE OF WEB SITES FOR THIRD PARTIES; AND WEBSITE DEVELOPMENT FOR OTHERS; WEBSITE AND MOBILE APPLICATION DESIGN AND DEVELOPMENT SERVICES INCLUDING USER EXPERIENCE STRATEGY, INFORMATION ARCHITECTURE, GRAPHIC DESIGN, FRONT-END DEVELOPMENT AND BACK-END DEVELOPMENT, SYSTEMS INTEGRATION; SEARCH ENGINE OPTIMIZATION (U.S. CLS. 100 AND 101).

ANDREW LEASER, EXAMINING ATTORNEY

SN 85-316,601. AVOCENT HUNTSVILLE CORP., HUNTSVILLE, AL. FILED 5-10-2011.



THE MARK CONSISTS OF THE WORD "TRELLIS" NEXT TO THE STYLIZED REPRESENTATION OF A SERIES OF STACKED PLATFORMS.

CLASS 6—METAL GOODS

FOR DOOR PANELS OF METAL AS COMPONENT PARTS OF DATA CENTER AND COMPUTER ROOM MANAGEMENT SYSTEMS (U.S. CLS. 2, 12, 13, 14, 23, 25 AND 50).

CLASS 9—ELECTRICAL AND SCIENTIFIC APPARATUS

FOR DATA CENTER INFRASTRUCTURE MANAGEMENT SOFTWARE; PHYSICAL ASSET TRACKING SOFTWARE; IMPACT AND UTILIZATION ANALYSIS SOFTWARE; INVENTORY AND PLANNING REPORTING SOFTWARE; ASSET AUTOMATION AND MONITORING SOFTWARE; VISUAL MODELING SOFTWARE; COMPUTER HARDWARE; TELECOMMUNICATIONS HARDWARE, NAMELY, HARDWARE FOR ACCESSING A COMPUTER OVER THE INTERNET, KEYBOARD VIDEO AND MOUSE OVER IP SWITCHES AND KEYBOARD VIDEO AND MOUSE OVER IP SERVERS; COMPUTER FIRMWARE FOR PROCESS MANAGEMENT, FOR USE IN OPERATING CONTROL SYSTEMS, FOR ALARMING, CONTROLLING, EVENTING AND ACCESSING DATA CENTER AND COMPUTER ROOM EQUIPMENT; COMPUTER SWITCHES; COMPUTER PERIPHERALS; POWER TRANSFER SWITCHES; POWER SUPPLIES; UNINTERRUPTIBLE POWER SUPPLIES (UPS); COOLING SYSTEMS, NAMELY, CPU COOLERS; COOLING SYSTEMS CONSISTING OF THERMOSTATS FOR COOLING EQUIPMENT, A PROGRAMMABLE LOGIC CONTROLLER (PLC) AND ELECTRONIC CONTROLLERS; VOLTAGE SURGE SUPPRESSORS; MOUNTING RACKS FOR COMPUTER HARDWARE AND TELECOMMUNICATIONS HARDWARE; COMMUNICATIONS SERVERS; COMPUTER SERVERS; NETWORK SERVERS; BLADE SERVERS; VIRTUAL SERVER SOFTWARE; NETWORK ACCESS SERVER HARDWARE, NAMELY, SERVER RACKS; BATTERIES; ELECTRICAL POWER DISTRIBUTION UNITS (PDUS); POWER CONTROLLERS; ELECTRICAL CONTROLLERS; ELECTRIC FIRE PUMP CONTROLLERS; CONTROL CABINETS SPECIFICALLY ADAPTED FOR COMPUTER HARDWARE AND TELECOMMUNICATIONS EQUIPMENT; CABINETS FOR COMPUTER

HARDWARE AND TELECOMMUNICATIONS EQUIPMENT; ELECTRIC DISTRIBUTION CONSOLES; LIQUID CRYSTAL DISPLAY (LCD) CONSOLES; INFORMATION MANAGEMENT SYSTEMS COMPRISED OF COMPUTER HARDWARE AND MANAGEMENT SOFTWARE; INTEGRATED CIRCUIT MODULES; MODULES FOR MONITORING ELECTRIC CURRENT AND ELECTRIC SIGNALS; SOFTWARE MODULES FOR INVENTORY AND ASSET MANAGEMENT, FOR PROCESS MANAGEMENT, FOR USE IN OPERATING CONTROL SYSTEMS, FOR ALARMING, CONTROLLING, EVENTING AND ACCESSING DATA CENTER AND COMPUTER ROOM EQUIPMENT; STORAGE APPLICATION MODULES; VOLTAGE MONITOR MODULES; VOLTAGE REGULATORS FOR ELECTRIC POWER; COOLING SYSTEMS FOR COMPUTER ROOMS AND DATA CENTERS; FAN CONTROLS, NAMELY, ELECTRONIC CONTROLLERS FOR CPU FANS; PANEL DOORS FOR CONTROL CABINETS FOR COMPUTER HARDWARE AND TELECOMMUNICATIONS EQUIPMENT; COMPUTER MONITORS; VOLTAGE SURGE PROTECTORS; ELECTRIC SURGE PROTECTORS; DATA CENTER INFORMATION MANAGEMENT SYSTEMS COMPRISED OF COMPUTERS, COMPUTER HARDWARE AND SOFTWARE, HEATING, VENTILATION, AIR CONDITIONING AND REFRIGERATION (HVAC/R) SYSTEMS FOR USE WITH DATA CENTERS AND COMPUTER ROOMS, SERVER HARDWARE AND SOFTWARE, FIRMWARE, SWITCHES, TRANSFER SWITCHES, SURGE SUPPRESSORS, POWER SYSTEMS, UNINTERRUPTIBLE POWER SUPPLIES (UPS), CABINETS, RACKS, BATTERIES, CONTROLLERS, FIRE PUMP CONTROLLERS, POWER DISTRIBUTION UNITS, LCD CONSOLES (U.S. CLS. 21, 23, 26, 36 AND 38).

CLASS 11—ENVIRONMENTAL CONTROL APPARATUS

FOR HEATING, VENTILATION, AIR CONDITIONING AND REFRIGERATION (HVAC/R) UNITS; HEATING, VENTILATION, AIR CONDITIONING AND REFRIGERATION (HVAC/R) SYSTEMS COMPRISED OF COMPUTER ROOM AIR CONDITIONER (CRAC) UNITS, COMPUTER ROOM AIR HANDLING (CRAH) UNITS, PANEL BOARDS, FILLER PANELS, AIR MOVERS, CHILLERS AND PUMPS; ENVIRONMENTAL CONTROL APPARATUS FOR REGULATING AND CONTROLLING TEMPERATURE AND HUMIDITY, NAMELY, FANS, FILTERS FOR COOLING UNITS, DUST COLLECTORS, VENTILATORS, DEHUMIDIFIERS; REFRIGERATOR CONDENSERS; AIR CONDITIONING CONDENSING UNITS; REFRIGERANT COMPRESSORS; DRY COOLERS, NAMELY, EVAPORATIVE AIR COOLERS; AIR CONDITIONERS (U.S. CLS. 13, 21, 23, 31 AND 34).

CLASS 19—NON-METALLIC BUILDING MATERIALS

FOR DOOR PANELS, NOT OF METAL, AS COMPONENT PARTS OF DATA CENTER AND COMPUTER ROOM MANAGEMENT SYSTEMS (U.S. CLS. 1, 12, 33 AND 50).

CLASS 20—FURNITURE AND ARTICLES NOT OTHERWISE CLASSIFIED

FOR CABINETS AS COMPONENT PARTS OF DATA CENTER AND COMPUTER ROOM MANAGEMENT SYSTEMS (U.S. CLS. 2, 13, 22, 25, 32 AND 50).

CLASS 35—ADVERTISING AND BUSINESS

FOR DISTRIBUTORSHIPS IN THE FIELD OF COMPUTER SOFTWARE; DATA PROCESSING SERVICES; BUSINESS CONSULTATION IN THE FIELD OF TELECOMMUNICATIONS; BUSINESS CONSULTATION IN THE FIELD OF IT EQUIPMENT (U.S. CLS. 100, 101 AND 102).

CLASS 37—CONSTRUCTION AND REPAIR

FOR MAINTENANCE AND REPAIR OF NETWORK, FACILITY AND BUILDING INFRASTRUCTURE AND DATA CENTER SYSTEMS AND EQUIPMENT; CONSULTING IN THE FIELD OF MAINTENANCE AND REPAIR OF TELECOMMUNICATIONS NETWORKS, APPARATUS AND INSTRUMENTS; MAINTENANCE AND REPAIR OF TELECOMMUNICATIONS NETWORKING HARDWARE, APPARATUS AND INSTRUMENTS (U.S. CLS. 100, 103 AND 106).

SN 85-316,734. LUMESSE (UK) LTD., LONDON EC1N 8SJ, UNITED KINGDOM, FILED 5-10-2011.

Lumesse

THE MARK CONSISTS OF STANDARD CHARACTERS WITHOUT CLAIM TO ANY PARTICULAR FONT, STYLE, SIZE, OR COLOR.

PRIORITY CLAIMED UNDER SEC. 44(D) ON ERPN CMNTY TM OFC APPLICATION NO. 009595571, FILED 12-14-2010, REG. NO. 009595571, DATED 5-23-2011, EXPIRES 12-14-2020.

CLASS 38—COMMUNICATION

FOR TELECOMMUNICATIONS CONSULTATION IN THE NATURE OF TECHNICAL CONSULTING IN THE FIELD OF AUDIO, TEXT AND VISUAL DATA TRANSMISSION AND COMMUNICATION; TELECOMMUNICATIONS CONSULTATION; TELECOMMUNICATION SERVICES, NAMELY, PROVIDING MULTIPLE-USER ACCESS TO A GLOBAL COMPUTER NETWORK; TRANSFER OF DATA BY TELECOMMUNICATIONS; TRANSMISSION OF DATABASE INFORMATION VIA TELECOMMUNICATIONS NETWORKS (U.S. CLS. 100, 101 AND 104).

CLASS 9—ELECTRICAL AND SCIENTIFIC APPARATUS

FOR COMPUTER SOFTWARE AND COMPUTER DATABASE MANAGEMENT SOFTWARE; COMPUTER-READABLE ELECTRONIC DATABASES; COMPUTER HARDWARE AND COMPUTER SOFTWARE FOR DATABASE MANAGEMENT, FOR DATA SEARCHES, FOR CONNECTION TO DATABASES AND TO THE INTERNET, FOR DATABASE INTEGRATION APPLICATIONS, FOR IMAGE PROCESSING, FOR DOCUMENT MANAGEMENT, FOR PRINTING MANAGEMENT, FOR NETWORK TRANSMISSION AND RECEIVING, FOR DOCUMENT CREATIONS, FOR DATABASE MANAGEMENT AND FOR DOCUMENT AND IMAGE PROCESSING; ELECTRONIC DATABASES RECORDED ON COMPUTER MEDIA; APPARATUS AND INSTRUMENTS FOR RECORDING, REPRODUCING, PROCESSING, MANIPULATING, TRANSMITTING, BROADCASTING, RETRIEVING AND MUSIC, SOUNDS, IMAGES, TEXT, SIGNALS, SOFTWARE, INFORMATION, DATA AND CODE; DIGITAL MEDIA, NAMELY, PRE-RECORDED DVDS, DOWNLOADABLE AUDIO AND VIDEO RECORDINGS, AND CDS; MUSICAL SOUND RECORDINGS AND VIDEO AND DATA RECORDINGS; COMPUTER PROGRAMS STORED ON DATA CARRIERS, INCLUDING MAGNETIC DATA CARRIERS; PRE-RECORDED DATA CARRIERS FOR USE WITH COMPUTERS; DOWNLOADABLE PLUG-INS, APPLETS, RING TONES FOR MOBILE PHONES, MP3 FILES, GRAPHIC AND VIDEO FILES FOR COMPUTERS, COMPUTER PROGRAMS FOR WIRELESS COMMUNICATION APPARATUS, NAMELY, MOBILE PHONES, CORDLESS PHONES, PERSONAL COMPUTERS AND PERSONAL COMPUTER TABLETS, MOBILE TELEPHONES; INTERFACES FOR COMPUTERS; ALL THE AFORESAID SOFTWARE PRODUCTS FOR USE IN THE FIELD OF PERSONNEL AND CANDIDATE ATTRACTION, PERSONNEL AND CANDIDATE SELECTION, IN THE FIELD OF PERSONNEL RECRUITMENT AND INTEGRATION, NAMELY, ONBOARDING, PERSONNEL MANAGEMENT, PERSONNEL-RELATED PERFORMANCE MANAGEMENT, PERSONNEL-RELATED COMPENSATION MANAGEMENT AND PERSONNEL-RELATED SKILL AND COMPETENCE MANAGEMENT, AND FOR CAREER AND SUCCESSION PLANNING, AND IN THE FIELD OF FURTHER TRAINING MANAGEMENT AND FOR THE DRAWING UP OF ORGANIZATIONAL CHARTS (U.S. CLS. 21, 23, 26, 36 AND 38).

CLASS 39—TRANSPORTATION AND STORAGE

FOR DISTRIBUTION SERVICES, NAMELY, THE DELIVERY OF COMPUTER SOFTWARE (U.S. CLS. 100 AND 105).

CLASS 42—SCIENTIFIC AND COMPUTER SERVICES

FOR TECHNICAL COMPUTER NETWORK INFRASTRUCTURE MONITORING, MEASUREMENT AND MANAGEMENT; ENERGY MONITORING, MANAGEMENT AND MEASUREMENT; TECHNICAL COMPUTER DATA CENTER MONITORING AND MANAGEMENT; COMPUTER SERVICES, NAMELY, TECHNICAL COMPUTER ROOM, BUILDING AND FACILITIES SITE MONITORING, COMPUTER EQUIPMENT MONITORING, COMPUTER SYSTEM MONITORING; SPATIAL MAPPING AND INFORMATION AND TECHNOLOGIES SERVICES IN THE FIELD OF INFORMATION AND TELECOMMUNICATIONS TECHNOLOGY; CONSULTATION SERVICES IN THE FIELD OF DATA CENTER INFRASTRUCTURE MANAGEMENT; CONSULTATION AND PHYSICAL MAINTENANCE OF IT EQUIPMENT AND FACILITIES; COMPUTER CONSULTATION; COMPUTER SOFTWARE CONSULTATION; CONSULTATION IN THE FIELD OF ENVIRONMENTAL ENGINEERING; INFORMATION TECHNOLOGY CONSULTATION; COMPUTER SERVICES, NAMELY, SOFTWARE AS A SERVICE FEATURING NON-DOWNLOADABLE SOFTWARE FOR USE IN DATA CENTER INFRASTRUCTURE MANAGEMENT, IT EQUIPMENT AND PHYSICAL INFRASTRUCTURE MANAGEMENT; PROVIDING USE OF ON-LINE, NON-DOWNLOADABLE DATA CENTER INFRASTRUCTURE MANAGEMENT SOFTWARE, PHYSICAL ASSET TRACKING SOFTWARE, IMPACT AND UTILIZATION ANALYSIS SOFTWARE, INVENTORY AND PLANNING REPORTING SOFTWARE, AUTOMATION AND MONITORING SOFTWARE AND VISUAL MODELING SOFTWARE; CONSULTING IN THE FIELD OF TELECOMMUNICATIONS TECHNOLOGY; MONITORING VIRTUAL SERVERS (U.S. CLS. 100 AND 101).

FRANK LATTUCA, EXAMINING ATTORNEY

CLASS 35—ADVERTISING AND BUSINESS

FOR COMPOSITION, SYSTEMIZATION, AND COLLECTION OF DATA IN COMPUTER DATABASES, COMPUTERIZED FILE MANAGEMENT AND COLLATING OF DATA IN COMPUTER DATABASES, NAMELY, IN THE FIELD OF PERSONNEL RECRUITMENT, PERSONNEL EMPLOYMENT, PERSONNEL MANAGEMENT, PERSONNEL PLACEMENT; ORGANIZATIONAL PROJECT MANAGEMENT IN THE FIELD OF ELECTRONIC DATA PROCESSING FOR OTHERS; COMPILATION OF STATISTICS FOR BUSINESS PURPOSES AND PROFESSIONAL BUSINESS EXPERTISE ADVICE AND APPRAISALS; MARKET RESEARCH; PUBLIC RELATIONS; ADVERTISING ON THE INTERNET, FOR OTHERS; BUSINESS DEVELOP-

MENT SERVICES; BUSINESS INFORMATION SERVICES PROVIDED ONLINE FROM A GLOBAL COMPUTER NETWORK, COMPUTER DATABASE OR THE INTERNET; CONSULTANCY WITH REGARD TO BUSINESS ORGANIZATIONAL MATTERS AND BUSINESS MANAGEMENT, WITH AND WITHOUT THE AID OF ELECTRONIC DATABASES AND WEB-BASED SOFTWARE; ALL THE AFORESAID SERVICES FOR THE HUMAN RESOURCES SECTOR, NAMELY, FOR THE FIELD OF PERSONNEL AND CANDIDATE ATTRACTION, PERSONNEL AND CANDIDATE SELECTION, THE FIELD OF PERSONNEL RECRUITMENT AND INTEGRATION, NAMELY, ONBOARDING, PERSONNEL MANAGEMENT, PERSONNEL-RELATED PERFORMANCE MANAGEMENT, PERSONNEL-RELATED COMPENSATION MANAGEMENT AND PERSONNEL-RELATED SKILL AND COMPETENCE MANAGEMENT, AND FOR CAREER AND SUCCESSION PLANNING, AND FOR THE FIELD OF FURTHER TRAINING MANAGEMENT AND FOR THE DRAWING UP OF ORGANIZATIONAL CHARTS; PROVIDING PORTALS ON THE INTERNET IN THE FIELD OF PERSONNEL MANAGEMENT (U.S. CLS. 100, 101 AND 102).

CLASS 38—COMMUNICATION

FOR TELECOMMUNICATIONS, IN PARTICULAR MOBILE TELECOMMUNICATIONS, NAMELY, WIRELESS MOBILE TELEPHONE CALLING PLANS; ELECTRIC TRANSMISSION OF COMPUTER PROGRAMS, PLUG-INS, APPLETS, RING TONE, VOICE, MUSIC, MP3, GRAPHICS AND VIDEO IMAGE FILES AND OF INFORMATION AND MESSAGES BY MEANS OF WIRELESS UPLOADING AND DOWNLOADING VIA GLOBAL COMPUTER NETWORKS ON COMPUTER AND ON WIRELESS COMMUNICATIONS DEVICES, NAMELY, MOBILE PHONES; BROADCAST COMMUNICATION SERVICES, NAMELY, TRANSMITTING, IN PARTICULAR SENDING AND RECEIVING VOICE AND TEXT MESSAGES BETWEEN WIRELESS MOBILE TELECOMMUNICATIONS DEVICES; RADIO BROADCASTING PROVIDING ACCESS TO SOFTWARE ON DATA NETWORKS FOR INTERNET ACCESS; PROVIDING PORTALS ON THE INTERNET, NAMELY, PROVIDING MULTIPLE-USER ACCESS TO INFORMATION IN THE FIELD OF PERSONNEL MANAGEMENT; PROVIDING CHATLINES, CHATROOMS AND ELECTRONIC ONLINE FORUMS FOR PERSONNEL MANAGEMENT PROFESSIONALS (U.S. CLS. 100, 101 AND 104).

CLASS 42—SCIENTIFIC AND COMPUTER SERVICES

FOR COMPUTER PROGRAMMING; DESIGN, INSTALLATION, UPDATING AND MAINTENANCE OF SOFTWARE AND COMPUTER PROGRAMS; PROVISION OF SEARCH ENGINES FOR THE INTERNET; RENTAL OF COMPUTER SOFTWARE; DEVELOPMENT AND MAINTENANCE OF INTRANETS, AND IMPLEMENTATION OF SOFTWARE IN EXISTING COMPUTER NETWORKS AND APPLICATIONS; RENTAL AND MAINTENANCE OF MEMORY SPACE FOR WEBSITES, FOR OTHERS; PROVIDING A WEBSITE FEATURING NON-DOWNLOADABLE WEB-BASED SOFTWARE, FOR OTHERS; PROVIDING TEMPORARY USE OF ON-LINE NON-DOWNLOADABLE CUSTOMIZED DATABASE SOFTWARE, FOR OTHERS; RESEARCH, DEVELOPMENT AND PROJECT ANALYSIS, IN PARTICULAR IN THE FIELD OF INFORMATION TECHNOLOGY AND OTHER COMPUTER-RELATED TECHNOLOGIES; SECURITY SERVICES FOR PROTECTION AGAINST ILLEGAL NETWORK ACCESS; ALL THE AFORESAID SERVICES FOR THE HUMAN RESOURCES SECTOR, NAMELY, FOR THE FIELD OF PERSONNEL AND CANDIDATE ATTRACTION, PERSONNEL AND CANDIDATE SELECTION, THE FIELD OF PERSONNEL RECRUITMENT AND INTEGRATION, NAMELY, ONBOARDING, PERSONNEL MANAGEMENT, PERSONNEL-RELATED PERFORMANCE MANAGEMENT,

PERSONNEL-RELATED COMPENSATION MANAGEMENT AND PERSONNEL-RELATED SKILL AND COMPETENCE MANAGEMENT, AND FOR CAREER AND SUCCESSION PLANNING, AND FOR THE FIELD OF FURTHER TRAINING MANAGEMENT AND FOR THE DRAWING UP OF ORGANIZATIONAL CHARTS; PROVIDING AN E-COMMERCE WEB HOSTING PLATFORM ON THE INTERNET FOR PROVIDING PORTALS ON THE INTERNET IN THE FIELD OF PERSONNEL MANAGEMENT; PROVIDING WEB HOSTING PLATFORMS ON THE INTERNET IN THE FIELD OF PERSONNEL MANAGEMENT (U.S. CLS. 100 AND 101).
NAKIA HENRY, EXAMINING ATTORNEY

SN 85-318,136. BRANSON ULTRASONICS CORPORATION, DANBURY, CT. FILED 5-11-2011.



THE MARK CONSISTS OF THE LETTERS "DCX", THE LETTERS "DC" IN FRONT OF A LARGE "X".

CLASS 7—MACHINERY

FOR ULTRASONIC WELDING MACHINES; ULTRASONIC SOLDERING MACHINES; ELECTRIC ULTRASONIC SOLDERING APPARATUS (U.S. CLS. 13, 19, 21, 23, 31, 34 AND 35).

CLASS 9—ELECTRICAL AND SCIENTIFIC APPARATUS

FOR POWER SUPPLIES; ELECTRONIC CONTROL SYSTEMS FOR ULTRASONIC CLEANING, SOLDERING AND WELDING MACHINES, EXCLUDING DIRECT CURRENT MOTOR CONTROLLERS; WELDERS, NAMELY, ULTRASONIC WELDING DEVICES (U.S. CLS. 21, 23, 26, 36 AND 38).
TAMARA FRAZIER, EXAMINING ATTORNEY

SN 85-320,991. HAUK CUSTOM POOLS, CELINA, TX. FILED 5-13-2011.

HAUK CUSTOM POOLS

THE MARK CONSISTS OF STANDARD CHARACTERS WITHOUT CLAIM TO ANY PARTICULAR FONT, STYLE, SIZE, OR COLOR.

NO CLAIM IS MADE TO THE EXCLUSIVE RIGHT TO USE "CUSTOM POOLS", APART FROM THE MARK AS SHOWN.

SEC. 2(F).

CLASS 37—CONSTRUCTION AND REPAIR

FOR CONSTRUCTION, REMODELING AND MAINTENANCE OF SWIMMING POOLS; CONSTRUCTION OF OUTDOOR LIVING AREAS (U.S. CLS. 100, 103 AND 106).
FIRST USE 5-10-2001; IN COMMERCE 5-10-2001.

CLASS 42—SCIENTIFIC AND COMPUTER SERVICES

FOR DESIGN OF SWIMMING POOLS; DESIGN OF OUTDOOR LIVING AREAS (U.S. CLS. 100 AND 101).
FIRST USE 5-10-2001; IN COMMERCE 5-10-2001.
ZHALEH DELANEY, EXAMINING ATTORNEY

CLASS 38—COMMUNICATION

FOR PROVIDING ON-LINE ELECTRONIC BULLETIN BOARDS AND FORUMS FOR TRANSMISSION OF MESSAGES AMONG USERS IN THE FIELD OF EDUCATION; PROVIDING E-MAIL SERVICES (U.S. CLS. 100, 101 AND 104).
FIRST USE 3-18-2004; IN COMMERCE 3-18-2004.

CLASS 41—EDUCATION AND ENTERTAINMENT

FOR PROVIDING A WEBSITE IN THE FIELD OF EDUCATION; PROVIDING BLOGS IN THE FIELD OF EDUCATION AND MARKETING; PROVIDING INFORMATION CONCERNING EDUCATION; COMPUTER TRAINING, ONLINE AND IN PERSON (U.S. CLS. 100, 101 AND 107).
FIRST USE 3-18-2004; IN COMMERCE 3-18-2004.

SN 85-323,982. UNITED STATES POLO ASSOCIATION, INC., LEXINGTON, KY. FILED 5-18-2011.



NO CLAIM IS MADE TO THE EXCLUSIVE RIGHT TO USE "TEAM", APART FROM THE MARK AS SHOWN.
THE MARK CONSISTS OF THE WORDS "TEAM USPA" AND A DESIGN OF TWO POLO PLAYERS AND HORSES DISPOSED BELOW THE WORDS.

CLASS 42—SCIENTIFIC AND COMPUTER SERVICES

FOR HOSTING OF WEBSITES VIA THE INTERNET; SOFTWARE AS A SERVICE (SAAS) SERVICES FEATURING SOFTWARE FOR PROVIDING ACCESS TO EDUCATIONAL WEBSITES, ONLINE CLASSROOM TOOLS AND CLASSROOM MANAGEMENT TOOLS AND MANAGING STUDENT ELECTRONIC COMMUNICATIONS; TECHNICAL SUPPORT SERVICES, NAMELY, TROUBLESHOOTING OF COMPUTER SOFTWARE PROBLEMS; GRAPHIC DESIGN SERVICES; WEB PUBLISHING, NAMELY, CREATING AN EDUCATIONAL WEBSITE AND UPLOADING IT ONTO AN INTERNET SERVER (U.S. CLS. 100 AND 101).
FIRST USE 3-18-2004; IN COMMERCE 3-18-2004.
MICHELE SWAIN, EXAMINING ATTORNEY

CLASS 25—CLOTHING

FOR CLOTHING, NAMELY, TOPS, BOTTOMS, JACKETS, BLAZERS, HEADWEAR, AND SHIRTS (U.S. CLS. 22 AND 39).

SN 85-330,450. LATINA MEDIA VENTURES LLC, NEW YORK, NY. FILED 5-25-2011.

CLASS 41—EDUCATION AND ENTERTAINMENT

FOR ENTERTAINMENT SERVICES, NAMELY, ORGANIZING AND CONDUCTING POLO TOURNAMENTS (U.S. CLS. 100, 101 AND 107).
ANNE MADDEN, EXAMINING ATTORNEY

GOOD LIVING BY LATINA

SN 85-329,764. INTRAFINITY INC., TORONTO, CANADA, FILED 5-25-2011.

SHARPSCHOOL

THE MARK CONSISTS OF STANDARD CHARACTERS WITHOUT CLAIM TO ANY PARTICULAR FONT, STYLE, SIZE, OR COLOR.
THE ENGLISH TRANSLATION OF "LATINA" IN THE MARK IS "LATIN OR LATIN WOMAN".

CLASS 8—HAND TOOLS

FOR CITRUS ZESTERS AND MUDDLERS (U.S. CLS. 23, 28 AND 44).

THE MARK CONSISTS OF STANDARD CHARACTERS WITHOUT CLAIM TO ANY PARTICULAR FONT, STYLE, SIZE, OR COLOR.
PRIORITY CLAIMED UNDER SEC. 44(D) ON CANADA APPLICATION NO. 1516305, FILED 2-22-2011.

CLASS 9—ELECTRICAL AND SCIENTIFIC APPARATUS

FOR JIGGERS (U.S. CLS. 21, 23, 26, 36 AND 38).

CLASS 21—HOUSEWARES AND GLASS

FOR KITCHENWARE, NAMELY, ELECTRIC AND NON-ELECTRIC QUESADILLA MAKERS, ELECTRIC AND NON-ELECTRIC TORTILLA PRESSES, ELECTRIC AND NON-ELECTRIC TORTILLA WARMERS, SPICE RACKS, FLAN MOLDS, ELECTRIC AND NON-ELECTRIC PALETA MAKERS, CANISTERS, ELECTRIC AND NON-ELECTRIC EMPANADA CUTTERS, ROASTING PANS, CUTTING BOARDS, ELECTRIC AND NON-ELECTRIC CITRUS JUICERS, CAKE PANS, CAKE STANDS, PANS, SERVINGWARE FOR SERVING FOOD AND DRINKS, SOUP TUREENS, LADLES, DISHES AND PLATES, DECORATIVE CENTERPIECES (OF EARTHENWARE, GLASS, PORCELAIN, CERAMIC), SALT AND PEPPER SHAKERS AND BOWLS, BARWARE, NAMELY, PITCHERS, BEVERAGE GLASSWARE, CHARMS FOR ATTACHMENT TO BEVERAGE GLASSWARE FOR IDENTIFICATION PURPOSES, COASTERS NOT OF PAPER, SHOT GLASSES, COCKTAIL SHAKERS, STRAINERS, COCKTAIL STIRRERS AND BAR UTENSILS, NAMELY, COCKTAIL SHAKERS, STIRRERS, AND STRAINERS, HOME DÉCOR, NAMELY, CANDLE HOLDERS, VASES, AND BASKETS FOR DOMESTIC USE, NOT OF METAL (U.S. CLS. 2, 13, 23, 29, 30, 33, 40 AND 50).

STEPHANIE ALI, EXAMINING ATTORNEY

CLASS 9—ELECTRICAL AND SCIENTIFIC APPARATUS

FOR APPLICATION PROGRAMMING INTERFACE (API) COMPUTER SOFTWARE WHICH FACILITATES ONLINE SERVICES FOR SOCIAL NETWORKING, BUILDING SOCIAL NETWORKING APPLICATIONS AND FOR ALLOWING DATA RETRIEVAL, UPLOAD, DOWNLOAD, ACCESS AND MANAGEMENT; COMPUTER SOFTWARE TO ENABLE UPLOADING, DOWNLOADING, ACCESSING, POSTING, DISPLAYING, TAGGING, BLOGGING, STREAMING, LINKING, SHARING OR OTHERWISE PROVIDING ELECTRONIC MEDIA OR INFORMATION VIA COMPUTER AND COMMUNICATION NETWORKS; COMPUTER SOFTWARE, NAMELY, SOFTWARE THAT ALLOWS WEB PUBLISHERS TO CREATE, MANAGE, DISTRIBUTE AND MONETIZE TEXTUAL, GRAPHICAL AND AUDIO CONTENT OVER A GLOBAL COMMUNICATIONS NETWORK; DOWNLOADABLE SOFTWARE AND SOFTWARE RECORDED ON COMPUTER MEDIA FEATURING PORTABLE COMPUTER CODE CAPABLE OF BEING EMBEDDED WITHIN A WEB PAGE; COMPUTER SOFTWARE DEVELOPMENT TOOLS; APPLICATION PROGRAMMING INTERFACE (API) COMPUTER SOFTWARE FOR SOFTWARE DEVELOPMENT, FOR THIRD-PARTY APPLICATIONS USED ON AND ACROSS MULTIPLE NETWORKS, FOR SOFTWARE AND ONLINE SERVICES RELATING TO SOCIAL NETWORKING, AND FOR DEVELOPING SOCIAL NETWORKING APPLICATIONS; COMPUTER SOFTWARE FOR ACCESSING, BROWSING, SHARING, AND COMMUNICATING INFORMATION OVER COMPUTER NETWORKS AND SECURE PRIVATE NETWORKS; COMPUTER SOFTWARE FOR USE IN CONNECTING TO AND SEARCHING THE CONTENTS OF REMOTE COMPUTERS, COMPUTER NETWORKS, AND SECURE PRIVATE NETWORKS; COMPUTER SOFTWARE FOR ASSISTING USERS IN NAVIGATING THROUGH COMPUTER NETWORKS AND SECURE PRIVATE NETWORKS; COMPUTER SOFTWARE FOR RUNNING WEB APPLICATIONS; COMPUTER SOFTWARE FOR USE IN DATABASE MANAGEMENT; COMPUTER E-COMMERCE SOFTWARE TO ALLOW USERS TO PERFORM ELECTRONIC BUSINESS TRANSACTIONS VIA A GLOBAL COMPUTER NETWORK; COMPUTER SEARCH ENGINE SOFTWARE; COMPUTER SOFTWARE WHICH ENABLES DISTRIBUTION OF DIGITAL CONTENT ON WEBSITES; COMPUTER SOFTWARE THAT ALLOWS THE VIEWING AND SHARING OF VIDEO STRAIGHT OUT OF INSTANT MESSAGING SYSTEMS (IMS); COMPUTER SOFTWARE FOR SEARCHING AND RETRIEVING INFORMATION, WEBSITES, FILES, AND DOCUMENTS, ESPECIALLY THOSE RELATED TO ENTERTAINMENT, ON COMPUTER NETWORKS; ELECTRONIC AND DIGITAL PUBLICATIONS, NAMELY, BOOKS, MAGAZINES AND NEWSLETTERS FEATURING INFORMATION ON TELEVISION PROGRAMS AND MOVIES RECORDED ON COMPUTER MEDIA; DOWNLOADABLE SOFTWARE AND SOFTWARE RECORDED ON COMPUTER MEDIA IN THE NATURE OF A MULTI-MEDIA WEB PLATFORM; DOWNLOADABLE SOFTWARE AND SOFTWARE RECORDED ON COMPUTER MEDIA IN THE NATURE OF A WEB CONTENT DELIVERY SYSTEM (U.S. CLS. 21, 23, 26, 36 AND 38).

SN 85-332,911. WOVEN DIGITAL, LLC, SANTA BARBARA, CA. FILED 5-27-2011.

WOVEN CUBE**CLASS 35—ADVERTISING AND BUSINESS**

FOR FACILITATING THE EXCHANGE AND SALE OF SERVICES AND PRODUCTS OF THIRD PARTIES BY MATCHING POTENTIAL ADVERTISING BUYERS AND SELLERS, CONNECTING SOCIAL NETWORK USERS TO RETAILERS VIA COMPUTER AND COMMUNICATION NETWORKS; CONSULTING SERVICES IN THE FIELD OF ADVERTISING, MULTIMEDIA ADVERTISING, AND PROMOTION FOR ONLINE PUBLISHERS AND ADVERTISERS; COMPUTERIZED DATA BASE MANAGEMENT, AND DATA PROCESSING SERVICES, NAMELY, DATA COLLECTION AND ANALYSIS FOR OTHERS; COMPILATION AND SYSTEMIZATION OF DATA RELATED TO BUSINESS INFORMATION IN COMPUTERIZED DATA BANKS; PROVIDING COMMERCIAL INFORMATION SERVICES IN THE FIELD OF ADVERTISING, MARKETING, MULTIMEDIA ADVERTISING, AND PROMOTION VIA THE INTERNET (U.S. CLS. 100, 101 AND 102).

THE MARK CONSISTS OF STANDARD CHARACTERS WITHOUT CLAIM TO ANY PARTICULAR FONT, STYLE, SIZE, OR COLOR.

CLASS 38—COMMUNICATION

FOR AUDIO, TEXT AND VIDEO BROADCASTING SERVICES OVER COMPUTER OR OTHER COMMUNICATION NETWORKS, NAMELY, UPLOADING, POSTING, DISPLAYING, TAGGING, AND ELECTRONICALLY TRANSMITTING DATA, INFORMATION, AUDIO AND VIDEO IMAGES; PROVIDING MULTIPLE-USER ACCESS TO A GLOBAL COMPUTER INFORMATION NETWORK, NAMELY, A NETWORK WHICH ASSISTS ADVERTISERS IN BUYING MEDIA SPACE; TELECOMMUNICATION SERVICES, NAMELY, PROVIDING ONLINE WEBSITES FOR REAL-TIME INTERACTION BETWEEN AND AMONG USERS OF COMPUTERS, MOBILE AND HANDHELD COMPUTERS, AND WIRED AND WIRELESS COMMUNICATION DEVICES CONCERNING ADVERTISING, MARKETING, MULTIMEDIA ADVERTISING, BROADCAST MEDIA, AND PROMOTION; PROVIDING ON-LINE COMMUNICATIONS LINKS THAT TRANSFER A WEBSITE USER TO OTHER LOCAL AND GLOBAL WEB PAGES (U.S. CLS. 100, 101 AND 104).

CLASS 42—SCIENTIFIC AND COMPUTER SERVICES

FOR COMPUTER SERVICES, NAMELY, PROVIDING A WEB-BASED SYSTEM AND ONLINE PORTAL FEATURING ON-LINE NON-DOWNLOADABLE SOFTWARE THAT ENABLES USERS TO ACCESS TRAINING, EDUCATION, TESTING AND CERTIFICATION MATERIALS IN THE FIELD OF COMPUTER SOFTWARE; PROVIDING A WEBSITE FEATURING RESOURCES, NAMELY, NON-DOWNLOADABLE SOFTWARE FOR USE IN DATABASE MANAGEMENT; APPLICATION SERVICE PROVIDER (ASP) FEATURING SOFTWARE TO ENABLE UPLOADING, POSTING, SHOWING, DISPLAYING, TAGGING, BLOGGING, SHARING OR OTHERWISE PROVIDING ELECTRONIC MEDIA OR INFORMATION OVER THE INTERNET, BROADCAST MEDIA NETWORKS, OR OTHER COMMUNICATIONS NETWORK; PROVIDING TEMPORARY ONLINE USE OF NON-DOWNLOADABLE SOFTWARE IN THE NATURE OF A MULTIMEDIA WEB PLATFORM; PROVIDING TEMPORARY ONLINE USE OF NON-DOWNLOADABLE SOFTWARE IN THE NATURE OF A WEB CONTENT DELIVERY SYSTEM; PROVIDING ONLINE WEBPAGES FEATURING TECHNOLOGY THAT ALLOWS USERS OF COMPUTERS, MOBILE AND HANDHELD COMPUTERS, AND WIRED AND WIRELESS COMMUNICATIONS DEVICES TO INTERACT IN REAL TIME (U.S. CLS. 100 AND 101).

REBECCA EISINGER, EXAMINING ATTORNEY

SN 85-335,406, BLUKIT METALURGICA LTDA, SANTA CATARINA, BRAZIL, FILED 6-1-2011.

BLUKIT

THE MARK CONSISTS OF STANDARD CHARACTERS WITHOUT CLAIM TO ANY PARTICULAR FONT, STYLE, SIZE, OR COLOR.

CLASS 6—METAL GOODS

FOR DRAIN PIPES OF METAL; PIPES OF METAL; TUBES OF METAL; JUNCTIONS OF METAL FOR PIPES; PIPEWORK OF METAL; WATER-PIPE VALVES OF METAL NOT BEING PARTS OF MACHINES; WATER-PIPES OF METAL; ELBOWS OF METAL FOR PIPES; BRANCHING PIPES OF METAL; HARDWARE OF METAL, NAMELY, SMALL WASH DOWN SPRAY NOZZLES FOR COMMERCIAL AND INDUSTRIAL USE OF METAL, VALVES OF METAL, OTHER THAN PARTS OF MACHINES AND WASHERS OF METAL (U.S. CLS. 2, 12, 13, 14, 23, 25 AND 50).

CLASS 11—ENVIRONMENTAL CONTROL APPARATUS

FOR REGULATING AND SAFETY ACCESSORIES FOR WATER APPARATUS, NAMELY, METERED VALVES; REGULATING ACCESSORIES FOR WATER OR GAS APPARATUS AND PIPES; FLUSHING APPARATUS, NAMELY, FLUSHMETERS, FLUSH ACTUATORS AND FLUSH LEVERS; PIPES AND WATER PIPES BEING PARTS OF SANITARY FACILITIES; REGULATING ACCESSORIES FOR WATER SUPPLY, NAMELY, METERED VALVES; TAPS, COCKS AND SPIGOTS; FAUCETS FOR PIPES; REGULATING ACCESSORIES FOR WATER SUPPLY, NAMELY, METERED VALVES IN THE FORM OF LEVEL CONTROLLING TAPS IN TANKS; BATH PLUMBING FIXTURES, NAMELY, SINK TRAPS AND SHOWER SPRAYERS; PLUMBING FITTINGS, NAMELY, WATER-PIPE VALVES, NOT OF METAL OR PLASTIC (U.S. CLS. 13, 21, 23, 31 AND 34).

CLASS 17—RUBBER GOODS

FOR RINGS OF RUBBER FOR USE AS WATER-TIGHT PIPE CONNECTION SEALS; WASHERS OF RUBBER OR VULCANIZED FIBER; INSULATING TAPE AND BAND; PIPE GASKETS; NON-METAL GASKETS FOR PLUMBING USE; FLEXIBLE PIPES, NOT OF METAL; PIPE JACKETS, NOT OF METAL FOR USE WITH PLUMBING PIPES; JOINT PACKING FOR PLUMBING PIPES; WATER CONDUITS INSTALLATIONS IN THE NATURE OF PLASTIC CONDUIT FOR PLUMBING USE; PLASTIC WASHERS FOR WATER TAPS (U.S. CLS. 1, 5, 12, 13, 35 AND 50).

CLASS 19—NON-METALLIC BUILDING MATERIALS

FOR WATER-PIPES, NOT OF METAL; DRAIN PIPES, NOT OF METAL MADE OF PLASTIC; RIGID PIPES, NOT OF METAL FOR BUILDING, JUNCTIONS, NOT OF METAL, FOR WATER PIPES (U.S. CLS. 1, 12, 33 AND 50).
KIMBERLY PERRY, EXAMINING ATTORNEY

SN 85-335,450, BLUKIT METALURGICA LTDA, SANTA CATARINA, BRAZIL, FILED 6-1-2011.

BLUKIT PLASTICOS

THE MARK CONSISTS OF STANDARD CHARACTERS WITHOUT CLAIM TO ANY PARTICULAR FONT, STYLE, SIZE, OR COLOR.

NO CLAIM IS MADE TO THE EXCLUSIVE RIGHT TO USE "PLASTICOS", APART FROM THE MARK AS SHOWN. THE ENGLISH TRANSLATION OF "PLASTICOS" IN THE MARK IS "PLASTICS".

CLASS 11—ENVIRONMENTAL CONTROL APPARATUS

FOR REGULATING AND SAFETY ACCESSORIES FOR WATER APPARATUS, NAMELY, METERED VALVES; REGULATING ACCESSORIES FOR WATER OR GAS APPARATUS AND PIPES; FLUSHING APPARATUS, NAMELY, FLUSHMETERS, FLUSH ACTUATORS AND FLUSH LEVERS; PIPES AND WATER PIPES BEING PARTS OF SANITARY FACILITIES; REGULATING ACCESSORIES FOR WATER SUPPLY, NAMELY, METERED VALVES; TAPS, COCKS AND SPIGOTS; FAUCETS FOR PIPES; REGULATING ACCESSORIES FOR WATER SUPPLY, NAMELY, METERED VALVES IN THE FORM OF LEVEL CONTROLLING TAPS IN TANKS; BATH PLUMBING FIXTURES, NAMELY, SINK TRAPS AND SHOWER SPRAYERS; PLUMBING FITTINGS, NAMELY, WATER-PIPE VALVES, NOT OF METAL OR PLASTIC (U.S. CLS. 13, 21, 23, 31 AND 34).

CLASS 17—RUBBER GOODS

FOR RINGS OF RUBBER FOR USE AS WATER-TIGHT PIPE CONNECTION SEALS; WASHERS OF RUBBER OR VULCANIZED FIBER; INSULATING TAPE AND BAND; PIPE GASKETS; NON-METAL GASKETS FOR PLUMBING USE; FLEXIBLE PIPES, NOT OF METAL; PIPE JACKETS, NOT OF METAL FOR USE WITH PLUMBING PIPES; JOINT PACKING FOR PLUMBING PIPES; WATER CONDUITS INSTALLATIONS IN THE NATURE OF PLASTIC CONDUIT FOR PLUMBING USE; PLASTIC WASHERS FOR WATER TAPS (U.S. CLS. 1, 5, 12, 13, 35 AND 50).

CLASS 19—NON-METALLIC BUILDING MATERIALS

FOR WATER-PIPES, NOT OF METAL; DRAIN PIPES, NOT OF METAL MADE OF PLASTIC; RIGID PIPES, NOT OF METAL FOR BUILDING, JUNCTIONS, NOT OF METAL, FOR WATER PIPES (U.S. CLS. 1, 12, 33 AND 50).
KIMBERLY PERRY, EXAMINING ATTORNEY

CLASS 42—SCIENTIFIC AND COMPUTER SERVICES

FOR TECHNICAL DESIGN SERVICES FOR OTHERS IN THE FIELD OF ARCHITECTURE; INTERIOR DESIGN SERVICES; LANDSCAPE ARCHITECTURAL DESIGN SERVICES; CONCEPT DESIGN DEVELOPMENT, NAMELY, THE DEVELOPMENT OF CONCEPT DESIGNS IN THE FIELDS OF ARCHITECTURE AND INTERIOR DESIGN; INTERIOR DESIGN SERVICES, NAMELY, SPACE PLANNING; ARCHITECTURAL CONSULTANCY AND ADVISORY SERVICES; ARCHITECTURAL SERVICES; ARCHITECTURAL PLANNING SERVICES; ARCHITECTURAL DESIGN SERVICES; PREPARATION OF ARCHITECTURAL PLANS AND REPORTS IN CONNECTION WITH ARCHITECTURAL CONSULTATION; CIVIL ENGINEERING ADVISORY AND CONSULTANCY SERVICES; STRUCTURAL ENGINEERING ADVISORY AND CONSULTANCY SERVICES; CIVIL ENGINEERING SERVICES; CIVIL ENGINEERING DESIGN SERVICES; CIVIL ENGINEERING DRAWING SERVICES; CIVIL ENGINEERING PLANNING SERVICES; TECHNICAL CONSULTATION IN THE FIELD OF CIVIL ENGINEERING; STRUCTURAL ENGINEERING SERVICES; SURVEYING; CONSULTANCY AND ADVISORY SERVICES RELATING TO BUILDING DESIGN FOR OTHERS; ELECTRICAL ENGINEERING SERVICES; SCIENTIFIC AND TECHNOLOGICAL SERVICES, NAMELY, SCIENTIFIC RESEARCH IN THE FIELDS OF ARCHITECTURE, INTERIOR DESIGN AND ENGINEERING; INDUSTRIAL RESEARCH IN THE FIELDS OF ARCHITECTURE, INTERIOR DESIGN AND ENGINEERING; DESIGN AND DEVELOPMENT OF COMPUTER HARDWARE AND SOFTWARE (U.S. CLS. 100 AND 101).

CLASS 44—MEDICAL, BEAUTY AND AGRICULTURAL SERVICES

FOR LANDSCAPE DESIGN SERVICES (U.S. CLS. 100 AND 101).
LINDA M. KING, EXAMINING ATTORNEY

SN 85-337,485. MOGGLIDEN AB, SE-904 36 UMEÅ, SWEDEN, FILED 6-3-2011.

SN 85-336,317. AEDAS LTD., QUARRY BAY, HONG KONG, FILED 6-2-2011.

THE GIRL WITH THE DRAGON TATTOO

THE MARK CONSISTS OF STANDARD CHARACTERS WITHOUT CLAIM TO ANY PARTICULAR FONT, STYLE, SIZE, OR COLOR.

NO CLAIM IS MADE TO THE EXCLUSIVE RIGHT TO USE "TATTOO" IN CL. 44 ONLY, APART FROM THE MARK AS SHOWN.

CLASS 3—COSMETICS AND CLEANING PREPARATIONS

FOR BLEACHING PREPARATIONS FOR LAUNDRY USE; CLEANING, POLISHING AND SCOURING PREPARATIONS; SOAPS; PERFUMERY; ESSENTIAL OILS; COSMETICS; HAIR LOTIONS; AND DENTIFRICES (U.S. CLS. 1, 4, 6, 50, 51 AND 52).

OWNER OF HONG KONG REG. NO. 301930365, DATED 5-27-2011, EXPIRES 5-26-2021.

THE MARK CONSISTS OF A CHEVRON DESIGN ON THE LEFT AND THE WORDS "VIEWVANTAGE" ON THE RIGHT.

CLASS 9—ELECTRICAL AND SCIENTIFIC APPARATUS

FOR APPARATUS FOR RECORDING, TRANSMISSION OR REPRODUCTION OF SOUND OR IMAGES; COMPUTER OR VIDEO GAME CONSOLES FOR USE WITH AN EXTERNAL DISPLAY SCREEN OR MONITOR; COMPUTER GAME PROGRAMS; EXPOSED CAMERA FILMS, EXPOSED CINEMATOGRAPHIC FILMS, PRERECORDED VIDEO CASSETTES, DIGITAL VIDEO DISCS, DIGITAL VERSATILE DISCS, HIGH DEFINITION DIGITAL DISCS, OR TAPES, FEATURING ENTERTAINMENT FILM; PRERECORDED MAGNETIC DATA CARRIERS FEATURING MUSIC AND/OR ENTERTAINMENT FILMS, PRERECORDED DIGITAL VIDEO DISCS FEATURING MUSIC AND/OR ENTERTAINMENT FILMS; PRERECORDED COMPACT DISCS FEATURING MUSIC; AUDIO BOOKS RECORDED ON DISCS; AUTOMATIC VENDING MACHINES AND MECHANISMS FOR COIN-OPERATED APPARATUS; CASH REGISTERS, CALCULATING MACHINES, DATA PROCESSING EQUIPMENT AND COMPUTERS; FIRE EXTINGUISHING APPARATUS (U.S. CLS. 21, 23, 26, 36 AND 38).

CLASS 16—PAPER GOODS AND PRINTED MATTER

FOR PAPER AND CARDBOARD; PRINTED MATTER, NAMELY, BOOKS AND MAGAZINES CONTAINING IMAGINATIVE LITERATURE; BOOKBINDING MATERIALS; PHOTOGRAPHS; STATIONERY; ADHESIVES FOR STATIONERY OR HOUSEHOLD PURPOSES; ARTISTS' MATERIALS, NAMELY, ARTISTS' BRUSHES, ARTISTS' PASTELS AND PENCILS AND ARTISTS PENS; PAINT BRUSHES; TYPEWRITERS; PLASTIC BAGS FOR PACKAGING AND PLASTIC BUBBLE PACKS FOR WRAPPING OR PACKAGING; PRINTERS' TYPE; PRINTING BLOCKS (U.S. CLS. 2, 5, 22, 23, 29, 37, 38 AND 50).

CLASS 25—CLOTHING

FOR CLOTHING, NAMELY, JACKETS, SHIRTS, DRESSES, COATS, PANTS, SWEATERS, NIGHT GOWNS, T-SHIRTS, VESTS, GLOVES, UNDERWEAR, BELTS, SCARVES; FOOTWEAR, HEADWEAR (U.S. CLS. 22 AND 39).

CLASS 28—TOYS AND SPORTING GOODS

FOR GAMES AND PLAYTHINGS, NAMELY, ELECTRONIC GAMES OTHER THAN THOSE ADAPTED FOR USE WITH TELEVISION RECEIVERS ONLY, HANDHELD GAMES WITH LIQUID CRYSTAL DISPLAYS, ARCADE GAMES, CARD GAMES, DICE GAMES, ORDINARY PLAYING CARDS, CHESS GAMES, MEMORY GAMES, BALLS FOR GAMES, GYMNASIAC AND SPORTING ARTICLES NOT INCLUDED IN OTHER CLASSES, NAMELY, BOXING GLOVES; CHRISTMAS TREE DECORATIONS (U.S. CLS. 22, 23, 38 AND 50).

CLASS 41—EDUCATION AND ENTERTAINMENT

FOR EDUCATION, NAMELY, PROVIDING SEMINARS AND WORKSHOPS IN THE FIELD OF WRITING AND COMPOSING; PROVIDING OF PHYSICAL FITNESS TRAINING OF INDIVIDUALS AND GROUPS; ENTERTAINMENT, NAMELY, PROVISION OF NON-DOWNLOADABLE FILMS AND TELEVISION PROGRAMS VIA A VIDEO-ON-DEMAND SERVICE; PUBLICATION OF BOOKS, NEWSPAPERS AND MAGAZINES; PRODUCTION TELEVISION PROGRAMS; FILM AND VIDEO PRODUCTION; RECORDING STUDIOS (U.S. CLS. 100, 101 AND 107).

CLASS 44—MEDICAL, BEAUTY AND AGRICULTURAL SERVICES

FOR HYGIENIC AND BEAUTY CARE FOR HUMAN BEINGS OR ANIMALS; TATTOOING (U.S. CLS. 100 AND 101).

SUSAN RICHARDS, EXAMINING ATTORNEY

SN 85-338,481. KAILOS GENETICS, INC, HUNTSVILLE, AL.
FILED 6-6-2011.

Epigenetic PatchPCR

THE MARK CONSISTS OF STANDARD CHARACTERS WITHOUT CLAIM TO ANY PARTICULAR FONT, STYLE, SIZE, OR COLOR.

NO CLAIM IS MADE TO THE EXCLUSIVE RIGHT TO USE "EPIGENETIC", APART FROM THE MARK AS SHOWN.

CLASS 42—SCIENTIFIC AND COMPUTER SERVICES

FOR SCIENTIFIC RESEARCH IN THE FIELD OF MOLECULAR BASED GENE SEQUENCES AND MUTATIONS (U.S. CLS. 100 AND 101).

CLASS 44—MEDICAL, BEAUTY AND AGRICULTURAL SERVICES

FOR GENETIC TESTING FOR MEDICAL PURPOSES IN THE FIELD OF IDENTIFICATION OF GENE SEQUENCES AND MUTATIONS (U.S. CLS. 100 AND 101).

CAROLINE WOOD, EXAMINING ATTORNEY

SN 85-338,547. SPYDER LYNK, LLC, DENVER, CO. FILED 6-6-2011.

SNAPTAG

THE MARK CONSISTS OF STANDARD CHARACTERS WITHOUT CLAIM TO ANY PARTICULAR FONT, STYLE, SIZE, OR COLOR.

CLASS 16—PAPER GOODS AND PRINTED MATTER

FOR GRAPHIC EMBLEMS, NAMELY, PRINTED AND PAPER EMBLEMS THAT MAY BE APPLIED TO A FLAT SURFACE FOR MOBILE MARKETING PURPOSE TO IDENTIFY THE SOURCE FOR INFORMATION ABOUT A PARTICULAR GOOD OR SERVICE (U.S. CLS. 2, 5, 22, 29, 37, 38 AND 50).

FIRST USE 6-1-2008; IN COMMERCE 8-5-2008.

CLASS 35—ADVERTISING AND BUSINESS

FOR MARKETING, PROMOTION AND ADVERTISING SERVICES; PROVIDING INFORMATION ABOUT THE GOODS OR SERVICES OF OTHERS VIA THE INTERNET OR OTHER COMPUTER OR COMMUNICATIONS NETWORKS BASED ON IMAGE RECOGNITION TECHNOLOGY; PROVIDING CONSUMER PRODUCT INFORMATION VIA THE INTERNET AND OTHER COMMUNICATIONS NETWORKS FOR ADVERTISING AND SALES PROMOTION PURPOSES (U.S. CLS. 100, 101 AND 102).

FIRST USE 6-1-2008; IN COMMERCE 8-5-2008.

ESTHER BELENKER, EXAMINING ATTORNEY

SN 85-339,467. MEDALLOCATORS, INC., DULUTH, GA.
FILED 6-7-2011.

MEDALLOCATORS

THE MARK CONSISTS OF STANDARD CHARACTERS WITHOUT CLAIM TO ANY PARTICULAR FONT, STYLE, SIZE, OR COLOR.

CLASS 35—ADVERTISING AND BUSINESS

FOR HEALTH CARE COST CONTAINMENT SERVICES IN THE WORKPLACE AND DISABILITY MARKETPLACE; HEALTH CARE COST REVIEW; COST ASSESSMENT SERVICES (U.S. CLS. 100, 101 AND 102).
FIRST USE 7-0-2005; IN COMMERCE 7-0-2005.

CLASS 36—INSURANCE AND FINANCIAL

FOR INSURANCE SERVICES, NAMELY, MEDICAL INSURANCE CASE AND UTILIZATION REVIEW AND INSURANCE CLAIM ADJUSTMENT SERVICES FOR HEALTHCARE AND WORKERS COMPENSATION PURCHASERS, PAYORS, PROVIDERS AND MEDICARE SECONDARY PAYER (MSP) BENEFICIARIES; FINANCIAL ANALYSIS AND REPORTING IN THE FIELD OF MEDICARE SET ASIDE ARRANGEMENTS AND MEDICARE LIENS IN CONNECTION WITH THE SETTLEMENT OF LEGAL CLAIMS (U.S. CLS. 100, 101 AND 102).
FIRST USE 7-0-2005; IN COMMERCE 7-0-2005.

CLASS 45—PERSONAL AND LEGAL SERVICES

FOR LEGAL NURSE REVIEWS IN THE DISABILITY INSURANCE FIELD, NAMELY, PROVIDING LEGAL CONSULTATION IN THE AREA OF HEALTH ISSUES BY A LEGAL NURSE FOR BOTH PLAINTIFFS AND DEFENDANTS OF CLAIM SETTLEMENT LITIGATION (U.S. CLS. 100 AND 101).
FIRST USE 7-0-2005; IN COMMERCE 7-0-2005.
ROBIN CHOSID, EXAMINING ATTORNEY

SN 85-339,771. PETEDGE, INC., BEVERLY, MA. FILED 6-7-2011.



NO CLAIM IS MADE TO THE EXCLUSIVE RIGHT TO USE "PET" AND "GIFTS FOR PETS & PET PEOPLE", APART FROM THE MARK AS SHOWN.

THE MARK CONSISTS OF A FANCIFUL DRAWING OF A DOG WITH A BERET ON ITS HEAD, A COLLAR AROUND ITS NECK, WITH A DRAWING OF A BOX WITH RIBBON AND BOW HELD BY THE RIBBON IN THE DOG'S TEETH WITH CURVED LINES AROUND THE TAIL INDICATING 'WAGGING' WITH THE WORDS "PET STUDIO GIFTS FOR PETS & PET PEOPLE!" BELOW THE DOG.

CLASS 6—METAL GOODS

FOR METAL KEY CHAINS (U.S. CLS. 2, 12, 13, 14, 23, AND 50).
FIRST USE 3-0-2005; IN COMMERCE 3-0-2005.

CLASS 20—FURNITURE AND ARTICLES NOT OTHERWISE CLASSIFIED

FOR WIND CHIMES, METAL PICTURE FRAMES, PET FURNITURE, PET CRATES, PET STAIRS AND RAMPS (U.S. CLS. 2, 13, 22, 25, 32 AND 50).
FIRST USE 3-0-2005; IN COMMERCE 3-0-2005.

CLASS 21—HOUSEWARES AND GLASS

FOR PET FEEDING AND DRINKING BOWLS (U.S. CLS. 2, 13, 23, 29, 30, 33, 40 AND 50).
FIRST USE 3-0-2005; IN COMMERCE 3-0-2005.

CLASS 27—FLOOR COVERINGS

FOR DOOR MATS AND RUGS (U.S. CLS. 19, 20, 37, 42 AND 50).
FIRST USE 3-0-2005; IN COMMERCE 3-0-2005.
SUE LAWRENCE, EXAMINING ATTORNEY

SN 85-341,097. HYDRO-QUEBEC, MONTREAL, QUEBEC, CANADA, FILED 6-8-2011.



PRIORITY CLAIMED UNDER SEC. 44(D) ON CANADA APPLICATION NO. 1512704, FILED 1-26-2011, REG. NO. 821408, DATED 4-3-2012, EXPIRES 4-3-2027.

OWNER OF U.S. REG. NOS. 1,651,729 AND 1,975,711.
THE MARK CONSISTS OF A CIRCLE WITH LIGHTNING OF ELECTRICITY FORMING A "Q".

CLASS 35—ADVERTISING AND BUSINESS

FOR RETAIL ENERGY PROVIDER SERVICES, NAMELY, PROVIDING A SERVICE THAT ALLOWS CUSTOMERS TO PURCHASE ENERGY, NAMELY, ELECTRICITY AND RENEWABLE ENERGY (U.S. CLS. 100, 101 AND 102).

CLASS 39—TRANSPORTATION AND STORAGE

FOR UTILITY SERVICES, NAMELY, TRANSMISSION AND DISTRIBUTION OF ELECTRICITY AND ENERGY (U.S. CLS. 100 AND 105).

CLASS 40—MATERIAL TREATMENT

FOR GENERATION OF ELECTRICITY; GENERATION OF ENERGY (U.S. CLS. 100, 103 AND 106).
JASON TURNER, EXAMINING ATTORNEY

SN 85-342,535. NETAPP, INC., SUNNYVALE, CA. FILED 6-9-2011.

NETAPP

THE MARK CONSISTS OF STANDARD CHARACTERS WITHOUT CLAIM TO ANY PARTICULAR FONT, STYLE, SIZE, OR COLOR.

OWNER OF U.S. REG. NOS. 2,088,731, 2,844,772 AND 3,771,053.
SEC. 2(F).

CLASS 36—INSURANCE AND FINANCIAL

FOR FINANCING SERVICES (U.S. CLS. 100, 101 AND 102).
FIRST USE 3-0-2008; IN COMMERCE 3-0-2008.

CLASS 42—SCIENTIFIC AND COMPUTER SERVICES

FOR SOFTWARE AS A SERVICE (SAAS) SERVICES FEATURING SOFTWARE FOR MANAGEMENT, STORAGE, TROUBLESHOOTING, OPTIMIZATION, AND ANALYSIS OF NETWORK DATA (U.S. CLS. 100 AND 101).
FIRST USE 3-0-2008; IN COMMERCE 3-0-2008.
JAY BESCH, EXAMINING ATTORNEY

SN 85-343,387. JJCK LLC, FRISCO, TX. FILED 6-10-2011.



THE MARK CONSISTS OF A DESIGN OF A SHIELD AND BANNER WITH A RAISED ARM AND HAND WEARING AN ELECTRONIC DEVICE WITH THE WORDING "OPERATION EMPACT" APPEARING ON THE SHIELD AND BANNER.

CLASS 35—ADVERTISING AND BUSINESS

FOR ADMINISTRATION OF PROGRAM FOR LAW ENFORCEMENT AGENCIES TO TRACK, LOCATE, AND MONITOR INDIVIDUALS THROUGH CELLULAR TELEPHONE INFRASTRUCTURE AND NETWORK (U.S. CLS. 100, 101 AND 102).
FIRST USE 5-1-2011; IN COMMERCE 5-1-2011.

CLASS 41—EDUCATION AND ENTERTAINMENT

FOR TRAINING SERVICES IN THE FIELD OF USING ELECTRONIC DEVICES, NAMELY, TRANSCEIVERS WORN BY INDIVIDUALS WITH PHYSICAL AND/OR COGNITIVE DISABILITIES OR IMPAIRMENTS IN THE NATURE OF ALZHEIMER'S DISEASE, AUTISM, AND DOWN SYNDROME TO TRACK, LOCATE AND MONITOR SUCH INDIVIDUALS THROUGH CELLULAR TELEPHONE INFRASTRUCTURE AND NETWORK (U.S. CLS. 100, 101 AND 107).
FIRST USE 5-1-2011; IN COMMERCE 5-1-2011.
DARRYL SPRUILL, EXAMINING ATTORNEY

SN 85-343,394. JJCK LLC, FRISCO, TX. FILED 6-10-2011.

OPERATION EMPACT

THE MARK CONSISTS OF STANDARD CHARACTERS WITHOUT CLAIM TO ANY PARTICULAR FONT, STYLE, SIZE, OR COLOR.

CLASS 35—ADVERTISING AND BUSINESS

FOR ADMINISTRATION OF PROGRAM FOR LAW ENFORCEMENT AGENCIES TO TRACK, LOCATE, AND MONITOR INDIVIDUALS THROUGH CELLULAR TELEPHONE INFRASTRUCTURE AND NETWORK (U.S. CLS. 100, 101 AND 102).
FIRST USE 5-1-2011; IN COMMERCE 5-1-2011.

CLASS 41—EDUCATION AND ENTERTAINMENT

FOR TRAINING SERVICES IN THE FIELD OF USING ELECTRONIC DEVICES, NAMELY, TRANSCEIVERS WORN BY INDIVIDUALS WITH PHYSICAL AND/OR COGNITIVE DISABILITIES OR IMPAIRMENTS IN THE NATURE OF ALZHEIMER'S DISEASE, AUTISM, AND DOWN SYNDROME TO TRACK, LOCATE AND MONITOR SUCH INDIVIDUALS THROUGH CELLULAR TELEPHONE INFRASTRUCTURE AND NETWORK (U.S. CLS. 100, 101 AND 107).
FIRST USE 5-1-2011; IN COMMERCE 5-1-2011.
DARRYL SPRUILL, EXAMINING ATTORNEY

SN 85-343,849. NIMBLE, INC., SANTA MONICA, CA. FILED 6-11-2011.

More Customers. Less Work.

THE MARK CONSISTS OF STANDARD CHARACTERS WITHOUT CLAIM TO ANY PARTICULAR FONT, STYLE, SIZE, OR COLOR.

CLASS 9—ELECTRICAL AND SCIENTIFIC APPARATUS

FOR COMPUTER SOFTWARE FOR USE IN CUSTOMER RELATIONSHIP MANAGEMENT (CRM) (U.S. CLS. 21, 23, 26, 36 AND 38).
FIRST USE 1-0-2010; IN COMMERCE 1-0-2010.

CLASS 42—SCIENTIFIC AND COMPUTER SERVICES

FOR COMPUTER SOFTWARE DEVELOPMENT IN THE FIELD OF CUSTOMER RELATIONSHIP MANAGEMENT; PROVIDING ON-LINE NON-DOWNLOADABLE SOFTWARE FOR USE IN CUSTOMER RELATIONSHIP MANAGEMENT (U.S. CLS. 100 AND 101).

FIRST USE 1-0-2010; IN COMMERCE 1-0-2010.
ALLISON HOLTZ, EXAMINING ATTORNEY

CLASS 41—EDUCATION AND ENTERTAINMENT

FOR DEVELOPMENT AND DISSEMINATION OF EDUCATIONAL MATERIALS OF OTHERS IN THE FIELD OF CHRISTIANITY, THEOLOGY, CHRISTIAN DOCTRINE, BIBLE STUDY, EVANGELISM, RELIGIOUS MISSIONS, SOCIAL JUSTICE, RACIAL HARMONY, WORSHIP MUSIC, CHRISTIAN DISCIPLESHIP AND CHRISTIAN LIVING; EDUCATION SERVICES, NAMELY, PROVIDING RELIGIOUS INSTRUCTION, CLASSES, SEMINARS, WORKSHOPS, AND GROUP COACHING AND DISTRIBUTING COURSE MATERIALS IN CONNECTION THERE, ALL IN THE FIELD OF CHRISTIANITY, THEOLOGY, CHRISTIAN DOCTRINE, BIBLE STUDY, EVANGELISM, RELIGIOUS MISSIONS, SOCIAL JUSTICE, RACIAL HARMONY, WORSHIP MUSIC, CHRISTIAN DISCIPLESHIP AND CHRISTIAN LIVING; MUSIC COMPOSITION AND TRANSCRIPTION FOR OTHERS; MUSIC PRODUCTION SERVICES; PRESENTATION OF MUSICAL PERFORMANCE; PRODUCTION OF SOUND AND MUSIC VIDEO RECORDINGS; PROVIDING FACILITIES FOR MOVIES, SHOWS, PLAYS, MUSIC OR EDUCATIONAL TRAINING; RELIGIOUS INSTRUCTION SERVICES (U.S. CLS. 100, 101 AND 107).

FIRST USE 4-15-2007; IN COMMERCE 4-15-2007.

SN 85-345,417. WORD OF GOD CHURCH & MINISTRIES, AKA WORD OF GOD, COLUMBIA, SC. FILED 6-14-2011.

**CLASS 45—PERSONAL AND LEGAL SERVICES**

FOR COUNSELING SERVICES IN THE FIELD OF CHRISTIAN CONDUCT IN PERSONAL RELATIONSHIPS; EVANGELISTIC AND MINISTERIAL SERVICES; GRIEF COUNSELING; MARRIAGE COUNSELING; RELIGIOUS AND SPIRITUAL SERVICES, NAMELY, CONDUCTING RELIGIOUS WORSHIP, MARRIAGE CEREMONIES, BAPTISMAL CEREMONIES, BABY DEDICATIONS, BEREAVEMENT CEREMONIES, AND RELIGIOUS COUNSELING (U.S. CLS. 100 AND 101).

FIRST USE 9-10-2001; IN COMMERCE 9-10-2001.
DAWN HAN, EXAMINING ATTORNEY

NO CLAIM IS MADE TO THE EXCLUSIVE RIGHT TO USE "WORD OF GOD CHURCH & MINISTRIES", APART FROM THE MARK AS SHOWN.

THE MARK CONSISTS OF THE STYLIZED WORDING "WORD OF GOD CHURCH & MINISTRIES" AND THE DESIGN OF A SWORD INTERLOCKED THROUGH THE MIDDLE OF THE THREE "O" LETTERS IN "WORD OF GOD" AND UNDER THE "&" AMPERSAND. THERE IS A DESIGN OF A CONTINENT AND MERIDIAN AND PARALLEL LINES INSIDE THE LETTER "O" OF THE WORDING "OF".

SN 85-346,611. BRASSTECH, INC., SANTA ANA, CA. FILED 6-15-2011.

CLASS 9—ELECTRICAL AND SCIENTIFIC APPARATUS

FOR DIGITAL MEDIA, NAMELY, CDS, DVDS, DOWNLOADABLE AUDIO AND VIDEO RECORDINGS FEATURING INFORMATIONAL, INSTRUCTIONAL, AND EDUCATIONAL CONTENT FOR RELIGIOUS, EDUCATIONAL, EVANGELISTIC AND MINISTERIAL TRAINING, EXHORTATION AND INSTRUCTION (U.S. CLS. 21, 23, 26, 36 AND 38).

FIRST USE 9-10-2001; IN COMMERCE 9-10-2001.

METRO

THE MARK CONSISTS OF STANDARD CHARACTERS WITHOUT CLAIM TO ANY PARTICULAR FONT, STYLE, SIZE, OR COLOR.

OWNER OF U.S. REG. NO. 3,077,483.

CLASS 16—PAPER GOODS AND PRINTED MATTER

FOR PRINTED INSTRUCTIONAL, EDUCATIONAL, AND TEACHING MATERIALS IN THE FIELD OF RELIGIOUS, MINISTERIAL, EVANGELISTIC AND EDUCATIONAL TRAINING AND INSTRUCTION; INFORMATIONAL LETTERS CONCERNING CHURCH EVENTS, NEWS AND CHURCH LIFE; INFORMATIONAL SHEETS ABOUT CHURCH DOCTRINE, VALUES, CHARACTERISTICS AND CHURCH LIFE (U.S. CLS. 2, 5, 22, 23, 29, 37, 38 AND 50).

FIRST USE 9-10-2001; IN COMMERCE 9-10-2001.

CLASS 11—ENVIRONMENTAL CONTROL APPARATUS

FOR PLUMBING PRODUCTS, NAMELY, FAUCETS, SHOWERHEADS, HANDHELD SHOWERS AND BATH FAUCETS (U.S. CLS. 13, 21, 23, 31 AND 34).

CLASS 21—HOUSEWARES AND GLASS

FOR BATHROOM ACCESSORIES, NAMELY, TOWEL BARS, TOWEL RINGS AND TOILET TISSUE HOLDERS (U.S. CLS. 2, 13, 23, 29, 30, 33, 40 AND 50).

TRACY CROSS, EXAMINING ATTORNEY

SN 85-346,769. BRASSTECH, INC., SANTA ANA, CA. FILED 6-15-2011.

FAIRLYNN

THE MARK CONSISTS OF STANDARD CHARACTERS WITHOUT CLAIM TO ANY PARTICULAR FONT, STYLE, SIZE, OR COLOR.

CLASS 11—ENVIRONMENTAL CONTROL APPARATUS

FOR PLUMBING PRODUCTS, NAMELY, FAUCETS, SHOWER HEADS, HANDHELD SHOWERS AND BATH FAUCETS (U.S. CLS. 13, 21, 23, 31 AND 34).

CLASS 21—HOUSEWARES AND GLASS

FOR BATHROOM ACCESSORIES, NAMELY, TOWEL BARS, TOWEL RINGS AND TOILET TISSUE HOLDERS (U.S. CLS. 2, 13, 23, 29, 30, 33, 40 AND 50). TRACY CROSS, EXAMINING ATTORNEY

SN 85-346,929. BRASSTECH, INC., SANTA ANA, CA. FILED 6-15-2011.

ANISE

THE MARK CONSISTS OF STANDARD CHARACTERS WITHOUT CLAIM TO ANY PARTICULAR FONT, STYLE, SIZE, OR COLOR.

CLASS 11—ENVIRONMENTAL CONTROL APPARATUS

FOR PLUMBING PRODUCTS, NAMELY, FAUCETS, SHOWERHEADS, HANDHELD SHOWERS AND BATH FAUCETS (U.S. CLS. 13, 21, 23, 31 AND 34).

CLASS 21—HOUSEWARES AND GLASS

FOR BATHROOM ACCESSORIES, NAMELY, TOWEL BARS, TOWEL RINGS AND TOILET TISSUE HOLDERS (U.S. CLS. 2, 13, 23, 29, 30, 33, 40 AND 50). TRACY CROSS, EXAMINING ATTORNEY

SN 85-348,693. BARTLEY GROUP, INC., THE, SAN JUAN CAPISTRANO, CA. FILED 6-17-2011.

COMMITTED TO LIFE SAFETY

THE MARK CONSISTS OF STANDARD CHARACTERS WITHOUT CLAIM TO ANY PARTICULAR FONT, STYLE, SIZE, OR COLOR.

CLASS 19—NON-METALLIC BUILDING MATERIALS

FOR NON-METALLIC BUILDING MATERIALS, NAMELY, CADMIUM FREE STRETCH PVC MEMBRANES FOR WALLS AND CEILINGS; NON-METAL COVERINGS FOR CEILINGS, NAMELY, LUMINOUS STRETCH CEILING SYSTEMS; ACOUSTICAL STRETCH FABRIC SYSTEMS FOR WALLS AND CEILINGS; WALL PANELS NOT OF METAL, NAMELY, WOOD VENEER PANELS FOR WALLS AND CEILINGS, PERFORATED WOODEN PANELS (U.S. CLS. 1, 12, 33 AND 50).

CLASS 24—FABRICS

FOR FABRICS, NAMELY, FIRE RESISTANT FABRICS FOR USE AS AN OVERLAY ON WALL AND CEILING PANELS; WINDOW COVERINGS, NAMELY, CURTAINS, DRAPERIES, SHEERS, SWAGS AND VALANCES; DRAPERY - ALL STYLES; WINDOW COVERINGS, NAMELY, SWAGS, FABRIC CASCADES; BEDSPREADS; COVERLETS; COMFORTERS; BED SKIRTS; DUVETS; PILLOW SHAMS; TABLECLOTHS OF TEXTILE; DECORATIVE SHOWER CURTAINS; SHOWER CURTAINS; SHOWER CURTAIN LINERS (U.S. CLS. 42 AND 50). HELENE LIWINSKI, EXAMINING ATTORNEY

SN 85-349,125. DEXTER & CHANEY, INC., SEATTLE, WA. FILED 6-17-2011.

VENTURE

THE MARK CONSISTS OF STANDARD CHARACTERS WITHOUT CLAIM TO ANY PARTICULAR FONT, STYLE, SIZE, OR COLOR.

CLASS 9—ELECTRICAL AND SCIENTIFIC APPARATUS

FOR COMPUTER SOFTWARE FOR BID MANAGEMENT AND PROJECT MANAGEMENT FOR THE CONSTRUCTION INDUSTRY FOR USE DURING PRE-CONSTRUCTION AND LIVE CONSTRUCTION OPERATIONS (U.S. CLS. 21, 23, 26, 36 AND 38).

CLASS 42—SCIENTIFIC AND COMPUTER SERVICES

FOR SOFTWARE AS A SERVICE (SAAS) SERVICES FEATURING SOFTWARE FOR BID MANAGEMENT AND PROJECT MANAGEMENT FOR THE CONSTRUCTION INDUSTRY FOR USE DURING PRE-CONSTRUCTION AND LIVE CONSTRUCTION OPERATIONS (U.S. CLS. 100 AND 101). NELSON SNYDER, EXAMINING ATTORNEY

SN 85-349,430. HACHETTE FILIPACCHI PRESSE, LEVAL-LOIS-PERRET, FRANCE, FILED 6-17-2011.

ELLE

THE MARK CONSISTS OF STANDARD CHARACTERS WITHOUT CLAIM TO ANY PARTICULAR FONT, STYLE, SIZE, OR COLOR.

OWNER OF U.S. REG. NOS. 758,137, 3,745,516 AND OTHERS.

THE ENGLISH TRANSLATION OF "ELLE" IN THE MARK IS "SHE".

CLASS 3—COSMETICS AND CLEANING PREPARATIONS

FOR BEAUTY AND COSMETIC PRODUCTS, NAMELY, SUN-TANNING PREPARATIONS, COSMETIC AND EYEBROW PENCILS, MAKE-UP REMOVING PREPARATIONS, DENTIFRICE, DEPILETORY MILK FOR TOILET PURPOSES, MAKE-UP, MAKE-UP POWDERS, MAKE-UP PREPARATIONS, BEAUTY MASKS, NAIL CARE PREPARATIONS, NAIL VARNISHES, FALSE-NAILS, COSMETIC PREPARATIONS FOR SLIMMING PURPOSES IN THE FORM OF OILS, LOTIONS, CREAMS AND GELS; OILS FOR COSMETIC PURPOSES, POMADES FOR COSMETIC PURPOSES, DEODORANTS FOR PERSONAL USE, COTTON STICKS AND COTTON WOOL FOR COSMETIC PURPOSES, COSMETIC KITS, NAMELY, A SMALL BAG, BOX OR CASE CONTAINING LIP-STICK, BLUSH, MASCARA, COSMETIC PENCILS AND EYE-SHADOW; COSMETIC PREPARATIONS FOR BATHS, COSMETIC PREPARATIONS FOR EYELASHES, EYEBROW COSMETICS, DECORATIVE TRANSFERS FOR COSMETICS PURPOSES; FIRING, AND REJUVENATING, FACIAL AND BODY SCRUBS, FOOT LOTIONS; CUTICLE PRODUCTS, NAMELY, CUTICLE CONDITIONERS, CREAMS AND CUTICLE REMOVING PREPARATIONS; NAIL ENAMEL AND MAKEUP REMOVER, NAIL ENAMEL TOP AND BASE COATS; PRE MOISTENED COSMETIC WIPES; NAIL EMERY BOARDS (U.S. CLS. 1, 4, 6, 50, 51 AND 52).

CLASS 8—HAND TOOLS

FOR TWEEZERS, EYELASH CURLERS, NAIL FILES AND CLIPPERS; EYE BROW TRIMMER, NAIL SCOOP HAND IMPLEMENTS FOR REMOVING MATTER UNDER FINGERNAILS AND TOENAILS, HAND IMPLEMENTS NAIL CLEANER FOR USE REMOVING MATTER UNDER FINGERNAILS AND TOENAILS, NAIL SCISSORS, CUTICLE TRIMMER, PEDICURE HAND AND NAIL BUFFERS, PEDICURE KITS, NAMELY, NAIL FILES, CLIPPERS, CUTICLE PUSHERS, TWEEZERS, SCISSORS, FOAM TOES SEPARATORS, CUTICLE CONDITIONERS, AND CUTICLE REMOVING PREPARATIONS, SOLD TOGETHER AS A SET (U.S. CLS. 23, 28 AND 44).

CLASS 9—ELECTRICAL AND SCIENTIFIC APPARATUS

FOR MOBILE TELEPHONES AND THEIR ACCESSORIES, NAMELY, MOBILE PHONE CASES, STRAPS, HAND-FREE KITS FOR MOBILE PHONES FOR USE IN CARS; CARS KITS FOR MOBILE PHONES COMPRISING BATTERY CHARGERS, HANDS FREE KITS, ELECTRICAL CONNECTOR HOUSING, AND CELL PHONES COVERS; MAGNIFYING GLASSES; ELECTRIC ROLLER APPLICATORS USED TO APPLY MAKEUP TO THE SKIN AND EYELASHES (U.S. CLS. 21, 23, 26, 36 AND 38).

CLASS 18—LEATHER GOODS

FOR BACKPACKS (U.S. CLS. 1, 2, 3, 22 AND 41).

CLASS 20—FURNITURE AND ARTICLES NOT OTHERWISE CLASSIFIED

FOR TOE AND FINGER SEPARATOR BLOCKS FOR USE IN MANICURES AND PEDICURES; FOAM TOE SPACERS TO SEPARATE TOES IN PEDICURES (U.S. CLS. 2, 13, 22, 25, 32 AND 50).

CLASS 21—HOUSEWARES AND GLASS

FOR NAIL BRUSHES, EYEBROW BRUSHES, HAIR COMBS, NON-WOVEN FABRIC COSMETIC WIPES, POWDER PUFFS AND PERFUME SPRAYERS SOLD EMPTY; FOAM AND PLASTIC ROLLER APPLICATORS USED TO APPLY MAKEUP TO THE SKIN AND EYELASHES (U.S. CLS. 2, 13, 23, 29, 30, 33, 40 AND 50).

JUDITH HELFMAN, EXAMINING ATTORNEY

SN 85-350,186. BENNY BREEZE BRAND, LLC, LOUISVILLE, KY. FILED 6-20-2011.

BENNY BREEZE

THE MARK CONSISTS OF STANDARD CHARACTERS WITHOUT CLAIM TO ANY PARTICULAR FONT, STYLE, SIZE, OR COLOR.

CLASS 35—ADVERTISING AND BUSINESS

FOR PROMOTING PUBLIC AWARENESS OF SOCIAL AND POLITICAL ISSUES (U.S. CLS. 100, 101 AND 102).

CLASS 41—EDUCATION AND ENTERTAINMENT

FOR MULTIMEDIA ENTERTAINMENT SERVICES IN THE NATURE OF RECORDING, PRODUCTION AND POST-PRODUCTION SERVICES IN THE FIELDS OF VIDEO AND FILMS (U.S. CLS. 100, 101 AND 107).

JOHN KELLY, EXAMINING ATTORNEY

SN 85-351,785. ARROWEYE SOLUTIONS, INC., CHICAGO, IL. FILED 6-21-2011.

ARROWEYE

THE MARK CONSISTS OF STANDARD CHARACTERS WITHOUT CLAIM TO ANY PARTICULAR FONT, STYLE, SIZE, OR COLOR.

CLASS 35—ADVERTISING AND BUSINESS

FOR MARKETING FOR OTHERS OF GREETING CARDS, CARRIERS AND FINANCIAL TRANSACTION CARDS, NAMELY, CUSTOMIZED PLASTIC GIFT, INCENTIVE AND PAYMENT CARDS, PREPAID AND STORED VALUE CARD, CREDIT AND DEBIT CARDS, AND REWARD CARD; ON-LINE ART GALLERIES (U.S. CLS. 100, 101 AND 102).

FIRST USE 6-0-2007; IN COMMERCE 6-0-2007.

CLASS 36—INSURANCE AND FINANCIAL

FOR ADMINISTERING WEB BASED FINANCIAL TRANSACTIONS CARD PROGRAMS, NAMELY, PROVIDING SECURE COMMERCIAL TRANSACTIONS AND PAYMENT OPTIONS (U.S. CLS. 100, 101 AND 102).
FIRST USE 6-0-2007; IN COMMERCE 6-0-2007.

CLASS 39—TRANSPORTATION AND STORAGE

FOR PROVIDING WEBSITES FOR THE ELECTRONIC STORAGE OF CARD DESIGNS AND IMAGES FOR OTHERS (U.S. CLS. 100 AND 105).
FIRST USE 6-0-2007; IN COMMERCE 6-0-2007.

CLASS 40—MATERIAL TREATMENT

FOR PERSONALIZED GIFTING SOLUTIONS FOR OTHERS, NAMELY, CREATION AND ON-DEMAND PRINTING OF CUSTOMIZED MATERIALS, INCLUDING GREETING CARDS, VALUE ADDED CARDS, ADVERTISEMENTS AND CATALOGS; PRODUCTION AND MANUFACTURING SERVICES FOR OTHERS OF GREETING CARDS, CARRIERS AND FINANCIAL TRANSACTION CARDS, NAMELY, CUSTOMIZED PLASTIC GIFT, INCENTIVE AND PAYMENT CARDS, PREPAID AND STORED VALUE CARD, CREDIT AND DEBIT CARDS, AND REWARD CARDS (U.S. CLS. 100, 103 AND 106).
FIRST USE 6-0-2007; IN COMMERCE 6-0-2007.

CLASS 42—SCIENTIFIC AND COMPUTER SERVICES

FOR TEMPORARY USE OF ON-LINE, NON-DOWNLOADABLE COMPUTER SOFTWARE FOR USE IN CREATING, PERSONALIZING AND MANAGING GREETING CARDS, GIFT CARDS, AND FINANCIAL TRANSACTION CARDS, CARD DESIGNS, CARD PROGRAMS, AND CUSTOM CARD TEMPLATES; ADMINISTERING WEB BASED DESIGN SERVICES FOR OTHERS, NAMELY, SERVICES FOR THE CREATION OF GREETING CARD AND GIFT CARDS; PROVIDING A WEBSITE THAT GIVES USERS THE ABILITY TO REVIEW VARIOUS PRINT, PHOTOGRAPHIC, GRAPHIC IMAGE, AND AUDIO AND VIDEO CONTENT AND UTILIZE A CUSTOM TEMPLATES IN THE CREATION OF GREETING CARDS AND GIFT CARDS (U.S. CLS. 100 AND 101).
FIRST USE 6-0-2007; IN COMMERCE 6-0-2007.
RONALD AIKENS, EXAMINING ATTORNEY

CLASS 9—ELECTRICAL AND SCIENTIFIC APPARATUS

FOR MEASURING SPOON SETS AND MEASURING CUP SETS (U.S. CLS. 21, 23, 26, 36 AND 38).
FIRST USE 5-4-2010; IN COMMERCE 5-4-2010.

CLASS 14—JEWELRY

FOR WALL CLOCK (U.S. CLS. 2, 27, 28 AND 50).
FIRST USE 5-20-2010; IN COMMERCE 5-20-2010.

CLASS 18—LEATHER GOODS

FOR INSULATED TOTE BAGS (U.S. CLS. 1, 2, 3, 22 AND 41).
FIRST USE 5-27-2009; IN COMMERCE 5-27-2009.

CLASS 20—FURNITURE AND ARTICLES NOT OTHERWISE CLASSIFIED

FOR HOSTESS TABLE (U.S. CLS. 2, 13, 22, 25, 32 AND 50).
FIRST USE 11-18-2010; IN COMMERCE 11-18-2010.

CLASS 21—HOUSEWARES AND GLASS

FOR TRAVEL MUGS; SERVING TRAY; UTENSIL SETS SOLD AS A UNIT CONSISTING OF KITCHEN TONGS, SPATULAS, SERVING SPOONS, SERVING FORKS, SERVING LADLES, SERVING TONGS, FORKS, KNIVES AND SPOONS; SALAD BOWL W/SERVING TONGS; COOKIE JAR; PORTABLE BEVERAGE DISPENSER; BREAD BOX; CREAM AND SUGAR SET; SALT AND PEPPER SHAKER SET, SPICE HOLDER, NAMELY, SPICE RACK AND CONTAINERS FOR HOLDING SPICES; PAPER TOWEL HOLDER (U.S. CLS. 2, 13, 23, 29, 30, 33, 40 AND 50).
FIRST USE 5-27-2009; IN COMMERCE 5-27-2009.

CLASS 24—FABRICS

FOR KITCHEN TOWELS; PLACEMATS NOT MADE OF PAPER; CLOTH NAPKINS; TABLECLOTH NOT MADE OF PAPER; OVEN MITTS (U.S. CLS. 42 AND 50).
FIRST USE 8-14-2009; IN COMMERCE 8-14-2009.
MATTHEW EINSTEIN, EXAMINING ATTORNEY

SN 85-354,560. TEMP-TATIONS, LLC, EXTON, PA. FILED 6-23-2011.

SN 85-356,612. MORPHOSYS AG, MARTINSRIED-PLA-NEGG, FED REP GERMANY, FILED 6-27-2011.

TEMP-TATIONS

THE MARK CONSISTS OF STANDARD CHARACTERS WITHOUT CLAIM TO ANY PARTICULAR FONT, STYLE, SIZE, OR COLOR.
OWNER OF U.S. REG. NOS. 3,145,875 AND 3,529,117.

CLASS 8—HAND TOOLS

FOR FLATWARE; UTENSIL SETS SOLD AS A UNIT CONSISTING OF FORKS, KNIVES, SPOONS, KITCHEN TONGS, SPATULAS, SERVING SPOONS, SERVING FORKS, SERVING LADLES, AND SERVING TONGS (U.S. CLS. 23, 28 AND 44).
FIRST USE 11-5-2009; IN COMMERCE 11-5-2009.

**FIFTY BILLION HIGH
POTENTIALS**

THE MARK CONSISTS OF STANDARD CHARACTERS WITHOUT CLAIM TO ANY PARTICULAR FONT, STYLE, SIZE, OR COLOR.
PRIORITY CLAIMED UNDER SEC. 44(D) ON ERPN CMNTY TM OFC APPLICATION NO. 010074839, FILED 6-24-2011, REG. NO. 010074839, DATED 1-25-2012, EXPIRES 6-24-2021.

CLASS 1—CHEMICALS

FOR CHEMICAL, BIOCHEMICAL, BIOLOGICAL AND BIOTECHNOLOGICAL PREPARATIONS, NAMELY, ANTIBODIES AND FRAGMENTS OF ANTIBODIES FOR USE IN THE DEVELOPMENT OR MANUFACTURE OF IMMUNOLOGICAL REAGENTS USED IN INDUSTRY AND SCIENCE; BIOLOGICAL PREPARATIONS, NAMELY, ANTIBODIES AND FRAGMENTS OF ANTIBODIES FOR LABORATORIES, DIAGNOSTICS AND ANALYTICS FOR SCIENTIFIC OR RESEARCH USE (U.S. CLS. 1, 5, 6, 10, 26 AND 46).

CLASS 5—PHARMACEUTICALS

FOR BIOLOGICAL SUBSTANCES, NAMELY, ANTIBODIES AND FRAGMENTS OF ANTIBODIES FOR HUMAN MEDICAL DIAGNOSTICS AND ANALYSIS; PHARMACEUTICAL PREPARATIONS, NAMELY, ANTIBODIES AND FRAGMENTS OF ANTIBODIES FOR THE TREATMENT OF METABOLIC DISORDERS, INFECTIOUS DISEASES, CANCER, INFLAMMATORY DISEASES, ALZHEIMER, SEPSIS, AND RESTENOSIS; SANITARY PREPARATIONS FOR MEDICAL USE (U.S. CLS. 6, 18, 44, 46, 51 AND 52).

CLASS 42—SCIENTIFIC AND COMPUTER SERVICES

FOR SCIENTIFIC, BIOLOGICAL, PHARMACEUTICAL AND MEDICAL RESEARCH SERVICES; LABORATORY RESEARCH IN THE FIELD OF ANALYTICAL CHEMISTRY, BIOCHEMISTRY, MEDICINAL CHEMISTRY, DRUG DEVELOPMENT, BIOTECHNOLOGY, MICROBIOLOGY AND MOLECULAR BIOLOGY; CHEMICAL, BIOCHEMICAL AND BIOTECHNOLOGICAL ANALYSIS (U.S. CLS. 100 AND 101).

BENJAMIN OKEKE, EXAMINING ATTORNEY

SN 85-356,997. JOHN VASILAKIS, EAST MEADOW, NY. FILED 6-27-2011.

718 Coverage

THE MARK CONSISTS OF STANDARD CHARACTERS WITHOUT CLAIM TO ANY PARTICULAR FONT, STYLE, SIZE, OR COLOR.

CLASS 37—CONSTRUCTION AND REPAIR

FOR REAL ESTATE PROPERTY CLEANING, REPAIR AND MAINTENANCE SERVICES (U.S. CLS. 100, 103 AND 106).

CLASS 42—SCIENTIFIC AND COMPUTER SERVICES

FOR CONSULTING SERVICES IN THE FIELD OF DESIGN, SELECTION, IMPLEMENTATION AND USE OF COMPUTER HARDWARE AND SOFTWARE SYSTEMS FOR OTHERS; INSTALLATION, MAINTENANCE AND REPAIR OF COMPUTER SOFTWARE (U.S. CLS. 100 AND 101).

JEAN IM, EXAMINING ATTORNEY

SN 85-357,339. VT IDIRECT, INC., HERNDON, VA. FILED 6-27-2011.

iDIRECT GOVERNMENT TECHNOLOGIES

THE MARK CONSISTS OF STANDARD CHARACTERS WITHOUT CLAIM TO ANY PARTICULAR FONT, STYLE, SIZE, OR COLOR.

NO CLAIM IS MADE TO THE EXCLUSIVE RIGHT TO USE "GOVERNMENT TECHNOLOGIES", APART FROM THE MARK AS SHOWN.

CLASS 35—ADVERTISING AND BUSINESS

FOR PROCUREMENT OF CONTRACTS FOR THE PURCHASE AND SALE OF GOODS, NAMELY, GOVERNMENT CONTRACTS TO GOVERNMENT AGENCIES AND MILITARY ORGANIZATIONS OF HARDWARE AND SOFTWARE, FOR SATELLITE COMMUNICATIONS NETWORKS FOR THE TRANSMISSION OF VOICE, VIDEO AND DATA; ELECTRONIC COMMERCE SERVICES, NAMELY, PROVIDING INFORMATION ABOUT HARDWARE AND SOFTWARE FOR SATELLITE COMMUNICATIONS NETWORKS FOR THE TRANSMISSION OF VOICE, VIDEO AND DATA VIA TELECOMMUNICATIONS NETWORKS FOR ADVERTISING AND SALES PURPOSES TO GOVERNMENT AGENCIES AND MILITARY ORGANIZATIONS; RETAIL SERVICES BY DIRECT SOLICITATION OF GOVERNMENT AGENCIES AND MILITARY ORGANIZATIONS IN THE FIELD OF HARDWARE AND SOFTWARE FOR SATELLITE COMMUNICATIONS NETWORKS FOR THE TRANSMISSION OF VOICE, VIDEO AND DATA (U.S. CLS. 100, 101 AND 102).

CLASS 41—EDUCATION AND ENTERTAINMENT

FOR PROVIDING TRAINING SERVICES FOR MAINTAINING SATELLITE COMMUNICATIONS NETWORKS FOR THE TRANSMISSION OF VOICE, VIDEO AND DATA (U.S. CLS. 100, 101 AND 107).

CLASS 42—SCIENTIFIC AND COMPUTER SERVICES

FOR TECHNICAL SUPPORT SERVICES, NAMELY, TROUBLESHOOTING IN THE NATURE OF DIAGNOSING HARDWARE AND SOFTWARE FOR SATELLITE COMMUNICATIONS NETWORKS FOR THE TRANSMISSION OF VOICE, VIDEO AND DATA (U.S. CLS. 100 AND 101).

MATTHEW KLINE, EXAMINING ATTORNEY

SN 85-357,360. VT IDIRECT, INC., HERNDON, VA. FILED 6-27-2011.

iGT

THE MARK CONSISTS OF STANDARD CHARACTERS WITHOUT CLAIM TO ANY PARTICULAR FONT, STYLE, SIZE, OR COLOR.

CLASS 35—ADVERTISING AND BUSINESS

FOR PROCUREMENT OF CONTRACTS FOR THE PURCHASE AND SALE OF GOODS, NAMELY, GOVERNMENT CONTRACTS TO GOVERNMENT AGENCIES AND MILITARY ORGANIZATIONS OF HARDWARE AND SOFTWARE, FOR SATELLITE COMMUNICATIONS NETWORKS FOR THE TRANSMISSION OF VOICE, VIDEO AND DATA; ELECTRONIC COMMERCE SERVICES, NAMELY, PROVIDING INFORMATION ABOUT HARDWARE AND SOFTWARE FOR SATELLITE COMMUNICATIONS NETWORKS FOR THE TRANSMISSION OF VOICE, VIDEO AND DATA VIA TELECOMMUNICATIONS NETWORKS FOR ADVERTISING AND SALES PURPOSES TO GOVERNMENT AGENCIES AND MILITARY ORGANIZATIONS; RETAIL SERVICES BY DIRECT SOLICITATION OF GOVERNMENT AGENCIES AND MILITARY ORGANIZATIONS IN THE FIELD OF HARDWARE AND SOFTWARE FOR SATELLITE COMMUNICATIONS NETWORKS FOR THE TRANSMISSION OF VOICE, VIDEO AND DATA (U.S. CLS. 100, 101 AND 102).

CLASS 41—EDUCATION AND ENTERTAINMENT

FOR PROVIDING TRAINING SERVICES TO GOVERNMENT AGENCIES AND MILITARY ORGANIZATIONS FOR MAINTAINING SATELLITE COMMUNICATIONS NETWORKS FOR THE TRANSMISSION OF VOICE, VIDEO AND DATA (U.S. CLS. 100, 101 AND 107).

CLASS 42—SCIENTIFIC AND COMPUTER SERVICES

FOR TECHNICAL SUPPORT SERVICES RENDERED TO GOVERNMENT AGENCIES AND MILITARY ORGANIZATIONS, NAMELY, TROUBLESHOOTING IN THE NATURE OF DIAGNOSING HARDWARE AND SOFTWARE FOR SATELLITE COMMUNICATIONS NETWORKS FOR THE TRANSMISSION OF VOICE, VIDEO AND DATA (U.S. CLS. 100 AND 101).

MATTHEW KLINE, EXAMINING ATTORNEY

SN 85-357,423. SCHOOL OF DNA THETA HEALING, INC., LAS VEGAS, NV. FILED 6-27-2011.



THE MARK CONSISTS OF A SWIRL.

CLASS 3—COSMETICS AND CLEANING PREPARATIONS

FOR (BASED ON INTENT TO USE) ESSENTIAL OILS; NON-MEDICATED SKIN CARE PREPARATIONS; HAIR CARE PRODUCTS, NAMELY, HAIR SHampoos, CONDITIONERS AND HAIR CARE PREPARATIONS (U.S. CLS. 1, 4, 6, 50, 51 AND 52).

CLASS 5—PHARMACEUTICALS

FOR (BASED ON USE IN COMMERCE) HOMEOPATHIC MEDICINE FOR THE TREATMENT OF DISORDERS OF THE SKELETON SYSTEM, ENDOCRINE SYSTEM, HORMONE SYSTEM, DIGESTIVE SYSTEM, RESPIRATORY SYSTEM, CIRCULATORY SYSTEM, EXCRETORY SYSTEM, SEXUAL SYSTEM, MUSCULAR SYSTEM, NERVOUS SYSTEM, SKIN SYSTEM, EYES, BRAIN, AND EARS; HOLISTIC ALTERNATIVE HOMEOPATHIC, DIETARY, FOOD, NUTRITIONAL, AND HERBAL SUPPLEMENTS; HORMONE TESTING PRODUCTS, NAMELY, MEDICAL DIAGNOSTIC REAGENTS FOR THE TESTING OF HORMONE LEVELS, PARASITE TESTING PRODUCTS, NAMELY, MEDICAL DIAGNOSTIC REAGENTS FOR DETECTING PARASITES; MEDICATED SKIN CARE PREPARATIONS (U.S. CLS. 6, 18, 44, 46, 51 AND 52).

FIRST USE 3-2-2011; IN COMMERCE 3-2-2011.

CLASS 41—EDUCATION AND ENTERTAINMENT

FOR (BASED ON USE IN COMMERCE) LIFE COACHING SERVICES IN THE FIELD OF PERSONAL DEVELOPMENT, PROFESSIONAL DEVELOPMENT, AND PERFORMANCE; EDUCATION SERVICES, NAMELY, PROVIDING MENTORING, TUTORING, CLASSES, SEMINARS AND WORKSHOPS IN THE FIELD OF HEALTH, HEALING, ENERGY HEALING, ENERGY MEDICINE, WELLNESS, SPIRITUALITY, RELIGION AND METAPHYSICS (U.S. CLS. 100, 101 AND 107).

FIRST USE 3-2-2011; IN COMMERCE 3-2-2011.

CLASS 44—MEDICAL, BEAUTY AND AGRICULTURAL SERVICES

FOR (BASED ON USE IN COMMERCE) ALTERNATIVE MEDICINE THERAPY IN THE FIELD OF ENERGY HEALING AND ENERGY HEALING CONSULTATION SERVICES (U.S. CLS. 100 AND 101).

FIRST USE 3-2-2011; IN COMMERCE 3-2-2011.

KATHRYN COWARD, EXAMINING ATTORNEY

SN 85-357,777. T.F.H. PUBLICATIONS, INC., NEPTUNE CITY, NJ. FILED 6-28-2011.

DENTA-C

THE MARK CONSISTS OF STANDARD CHARACTERS WITHOUT CLAIM TO ANY PARTICULAR FONT, STYLE, SIZE, OR COLOR.

CLASS 3—COSMETICS AND CLEANING PREPARATIONS

FOR NON-MEDICATED DENTAL HEALTH ITEMS FOR PETS, NAMELY, TOOTHPASTE, TARTAR REMOVAL PASTE AND PRE-MOISTENED DENTAL WIPES IMPREGNATED WITH TEETH CLEANING PREPARATIONS (U.S. CLS. 1, 4, 6, 50, 51 AND 52).

CLASS 28—TOYS AND SPORTING GOODS

FOR NON-EDIBLE CHEWABLE DOG TOYS WHICH AID IN IMPROVING DOG TEETH (U.S. CLS. 22, 23, 38 AND 50).

CLASS 31—NATURAL AGRICULTURAL PRODUCTS

FOR EDIBLE PET CHEWS (U.S. CLS. 1 AND 46).

JEFFERY COWARD, EXAMINING ATTORNEY

SN 85-358,449. NOBLE EXPERIMENT, DBA NOBLE EXPERIMENT, MIAMI, FL. FILED 6-28-2011.

NOBLE EXPERIMENT

THE MARK CONSISTS OF STANDARD CHARACTERS WITHOUT CLAIM TO ANY PARTICULAR FONT, STYLE, SIZE, OR COLOR.

CLASS 25—CLOTHING

FOR MEN'S AND WOMEN'S CLOTHING APPAREL, NAMELY, SHIRTS, SHIRT ACCESSORIES IN THE NATURE OF POCKET SQUARES, T-SHIRTS, TANK TOPS, DRESS SHIRTS, COLLARED SHIRTS, RUGBY SHIRTS, KNIT SHIRTS, BLOUSES, SWEATERS, SWEATSHIRTS, SHORTS, JEANS, PANTS, TROUSERS, SLACKS, SWEATPANTS, SUITS, COATS, JACKETS, BLAZERS, VESTS, WAISTCOATS, FROCKS, DRESSES, SKIRTS, HATS, CAPS, FOOTWEAR, BELTS, SUSPENDERS, GLOVES, SOCKS, STOCKINGS, SCARVES, NECKTIES, BOW TIES, ASCOT, KERCHIEFS, UNDERGARMENTS, SLEEPWEAR, SWIMWEAR (U.S. CLS. 22 AND 39).
FIRST USE 2-1-2011; IN COMMERCE 2-1-2011.

CLASS 40—MATERIAL TREATMENT

FOR TAILORING; CUSTOM MANUFACTURE OF WEARABLE APPAREL (U.S. CLS. 100, 103 AND 106).
FIRST USE 2-1-2011; IN COMMERCE 2-1-2011.

CLASS 42—SCIENTIFIC AND COMPUTER SERVICES

FOR CUSTOM DESIGN OF WEARABLE APPAREL (U.S. CLS. 100 AND 101).
FIRST USE 2-1-2011; IN COMMERCE 2-1-2011.
NICHOLAS COLEMAN, EXAMINING ATTORNEY

SN 85-359,320. THE PROCTER & GAMBLE COMPANY, CINCINNATI, OH. FILED 6-29-2011.

NO CLAIM IS MADE TO THE EXCLUSIVE RIGHT TO USE "CAR", APART FROM THE MARK AS SHOWN.
THE MARK CONSISTS OF THE LETTERS "C", "A" AND "R", WHEREIN THE LETTER "A" APPEARS AS THE IMAGE OF THE FRONT OF AN AUTOMOBILE.

CLASS 3—COSMETICS AND CLEANING PREPARATIONS

FOR AIR FRESHENER (U.S. CLS. 1, 4, 6, 50, 51 AND 52).

CLASS 5—PHARMACEUTICALS

FOR AIR DEODORIZER (U.S. CLS. 6, 18, 44, 46, 51 AND 52).

CLASS 11—ENVIRONMENTAL CONTROL APPARATUS

FOR BATTERY-POWERED OR ELECTRIC-OPERATED AIR FRESHENING AND DEODORIZATION DEVICES FOR USE IN AUTOMOBILES (U.S. CLS. 13, 21, 23, 31 AND 34).

JOHN DALIER, EXAMINING ATTORNEY

SN 85-359,560. STICHTING HAPPY GLOBALLY FOUNDATION, AMSTERDAM, NETHERLANDS, FILED 6-29-2011.

HAPPY

THE MARK CONSISTS OF STANDARD CHARACTERS WITHOUT CLAIM TO ANY PARTICULAR FONT, STYLE, SIZE, OR COLOR.

CLASS 35—ADVERTISING AND BUSINESS

FOR CHARITABLE SERVICES, NAMELY, PROMOTING PUBLIC AWARENESS OF CARDIOVASCULAR DISEASE AND GENETIC RISK FACTORS THEREFOR (U.S. CLS. 100, 101 AND 102).

CLASS 41—EDUCATION AND ENTERTAINMENT

FOR EDUCATIONAL SERVICES IN THE NATURE OF OFFERING CLASSES, SEMINARS, CONFERENCES, WORKSHOPS, AND PROGRAMS IN THE FIELD OF CARDIOVASCULAR DISEASE AND GENETIC RISK FACTORS THEREFOR (U.S. CLS. 100, 101 AND 107).

CLASS 42—SCIENTIFIC AND COMPUTER SERVICES

FOR MEDICAL RESEARCH SERVICES IN THE FIELD OF CARDIOVASCULAR DISEASE AND ASSOCIATED GENETIC RISK FACTORS (U.S. CLS. 100 AND 101).
ZHALEH DELANEY, EXAMINING ATTORNEY

SN 85-359,856. ANNE TAYLOR COMMUNICATIONS, LLC, CHICAGO, IL. FILED 6-29-2011.



NO CLAIM IS MADE TO THE EXCLUSIVE RIGHT TO USE "TRAVEL", APART FROM THE MARK AS SHOWN.
THE MARK CONSISTS OF CONSISTS OF FLOWING AND SWIRLING LINES WITH THE WORDS "HIP TRAVEL MAMA" AND PICTURES OF A SUITCASE, CAR, BOAT, CAMERA AND AIRPLANE.

CLASS 39—TRANSPORTATION AND STORAGE

FOR TRAVEL INFORMATION SERVICES; ARRANGING TRAVEL TOURS AND TRAVEL EVENTS IN THE NATURE OF ARRANGING TRAVEL EXCURSION, ARRANGING WEEKEND TRAVEL GETAWAYS AND RETREAT TRAVEL ARRANGEMENT; ONLINE TRIP AND TRAVEL RESERVATION SERVICES, NAMELY, ARRANGING RESERVATIONS FOR TRAVEL AND TOUR TICKET RESERVATION SERVICES FOR TRAVEL EXCURSIONS, GETAWAYS AND RETREATS; PROVIDING A WEBSITE FEATURING TRAVEL INFORMATION AND COMMENTARY; TRAVEL CLUB SERVICES; PROVIDING AN ONLINE WEBSITE FEATURING INFORMATION ON FAMILY TRAVEL, LUXURY TRAVEL, TRAVEL TIPS AND COMMENTARY; CITY TRAVEL GUIDE SERVICES (U.S. CLS. 100 AND 105).
FIRST USE 9-14-2010; IN COMMERCE 9-14-2010.

CLASS 45—PERSONAL AND LEGAL SERVICES

FOR PROVIDING A WEB SITE FEATURING INFORMATION ON FASHION AND LIFESTYLE FOR FAMILIES, MEN, WOMEN AND CHILDREN AND INFORMATION ON ISSUES RELATING TO MOTHERHOOD, NAMELY, INFORMATION IN THE FIELD OF PARENTING AND PARENTAL WORK AND LIFE BALANCE (U.S. CLS. 100 AND 101).
FIRST USE 2-14-2009; IN COMMERCE 2-14-2009.
ANDREA K. NADELMAN, EXAMINING ATTORNEY

CLASS 42—SCIENTIFIC AND COMPUTER SERVICES

FOR COMPUTER HARDWARE AND SOFTWARE CONSULTING SERVICES; COMPUTER HARDWARE AND SOFTWARE DESIGN; COMPUTER SERVICES, NAMELY, REMOTE AND ON-SITE MANAGEMENT OF THE INFORMATION TECHNOLOGY (IT) CLOUD COMPUTING SYSTEMS OF OTHERS OF OTHERS; PREPARATION, UPDATE, INSTALLATION AND MAINTENANCE OF COMPUTER SOFTWARE; PROFESSIONAL COMPUTER SERVICES, NAMELY, NETWORK ANALYSIS, LAN/WAN DESIGN, WIRELESS ENGINEERING, VIRTUALIZATION AND COMPUTER PROJECT MANAGEMENT; PROGRAMMING OF COMPUTER SOFTWARE FOR OTHERS (U.S. CLS. 100 AND 101).
SEAN CROWLEY, EXAMINING ATTORNEY

SN 85-360,149. STRATODESK SOFTWARE, GMBH, KLAGENFURT, AUSTRIA, FILED 6-30-2011.

NoTouch Desktop

SN 85-360,146. STRATODESK SOFTWARE, GMBH, KLAGENFURT, AUSTRIA, FILED 6-30-2011.

THE MARK CONSISTS OF STANDARD CHARACTERS WITHOUT CLAIM TO ANY PARTICULAR FONT, STYLE, SIZE, OR COLOR.
NO CLAIM IS MADE TO THE EXCLUSIVE RIGHT TO USE "DESKTOP", APART FROM THE MARK AS SHOWN.

No Touch

THE MARK CONSISTS OF STANDARD CHARACTERS WITHOUT CLAIM TO ANY PARTICULAR FONT, STYLE, SIZE, OR COLOR.

CLASS 9—ELECTRICAL AND SCIENTIFIC APPARATUS

FOR COMPUTER HARDWARE AND SOFTWARE FOR SETTING UP AND CONFIGURING LOCAL AREA NETWORKS; COMPUTER SOFTWARE AND FIRMWARE FOR OPERATING SYSTEM PROGRAMS; COMPUTER SOFTWARE FOR ADMINISTRATION OF COMPUTER LOCAL AREA NETWORKS; COMPUTER SOFTWARE FOR COMPUTER SYSTEM AND APPLICATION DEVELOPMENT, DEPLOYMENT AND MANAGEMENT; COMPUTER SOFTWARE FOR CONTROLLING AND MANAGING ACCESS SERVER APPLICATIONS; COMPUTER SOFTWARE FOR CONTROLLING SELF-SERVICE TERMINALS; COMPUTER SOFTWARE TO MAINTAIN AND OPERATE COMPUTER SYSTEM; COMPUTER TERMINALS (U.S. CLS. 21, 23, 26, 36 AND 38).

CLASS 9—ELECTRICAL AND SCIENTIFIC APPARATUS

FOR COMPUTER HARDWARE AND SOFTWARE FOR SETTING UP AND CONFIGURING LOCAL AREA NETWORKS; COMPUTER SOFTWARE AND FIRMWARE FOR OPERATING SYSTEM PROGRAMS; COMPUTER SOFTWARE FOR ADMINISTRATION OF COMPUTER LOCAL AREA NETWORKS; COMPUTER SOFTWARE FOR COMPUTER SYSTEM AND APPLICATION DEVELOPMENT, DEPLOYMENT AND MANAGEMENT; COMPUTER SOFTWARE FOR CONTROLLING AND MANAGING ACCESS SERVER APPLICATIONS; COMPUTER SOFTWARE FOR CONTROLLING SELF-SERVICE TERMINALS; COMPUTER SOFTWARE TO MAINTAIN AND OPERATE COMPUTER SYSTEM; COMPUTER TERMINALS (U.S. CLS. 21, 23, 26, 36 AND 38).

CLASS 42—SCIENTIFIC AND COMPUTER SERVICES

FOR COMPUTER HARDWARE AND SOFTWARE CONSULTING SERVICES; COMPUTER HARDWARE AND SOFTWARE DESIGN; COMPUTER SERVICES, NAMELY, REMOTE AND ON-SITE MANAGEMENT OF THE INFORMATION TECHNOLOGY (IT) CLOUD COMPUTING SYSTEMS OF OTHERS OF OTHERS; PREPARATION, UPDATE, INSTALLATION AND MAINTENANCE OF COMPUTER SOFTWARE; PROFESSIONAL COMPUTER SERVICES, NAMELY, NETWORK ANALYSIS, LAN/WAN DESIGN, WIRELESS ENGINEERING, VIRTUALIZATION AND COMPUTER PROJECT MANAGEMENT; PROGRAMMING OF COMPUTER SOFTWARE FOR OTHERS (U.S. CLS. 100 AND 101).
SEAN CROWLEY, EXAMINING ATTORNEY

SN 85-360,150. STRATODESK SOFTWARE, GMBH, KLAGENFURT, AUSTRIA, FILED 6-30-2011.

NoTouch Receiver

THE MARK CONSISTS OF STANDARD CHARACTERS WITHOUT CLAIM TO ANY PARTICULAR FONT, STYLE, SIZE, OR COLOR.

NO CLAIM IS MADE TO THE EXCLUSIVE RIGHT TO USE "RECEIVER", APART FROM THE MARK AS SHOWN.

CLASS 9—ELECTRICAL AND SCIENTIFIC APPARATUS

FOR COMPUTER HARDWARE AND SOFTWARE FOR SETTING UP AND CONFIGURING LOCAL AREA NETWORKS; COMPUTER SOFTWARE AND FIRMWARE FOR OPERATING SYSTEM PROGRAMS; COMPUTER SOFTWARE FOR ADMINISTRATION OF COMPUTER LOCAL AREA NETWORKS; COMPUTER SOFTWARE FOR COMPUTER SYSTEM AND APPLICATION DEVELOPMENT, DEPLOYMENT AND MANAGEMENT; COMPUTER SOFTWARE FOR CONTROLLING AND MANAGING ACCESS SERVER APPLICATIONS; COMPUTER SOFTWARE FOR CONTROLLING SELF-SERVICE TERMINALS; COMPUTER SOFTWARE TO MAINTAIN AND OPERATE COMPUTER SYSTEM; COMPUTER TERMINALS (U.S. CLS. 21, 23, 26, 36 AND 38).

CLASS 42—SCIENTIFIC AND COMPUTER SERVICES

FOR COMPUTER HARDWARE AND SOFTWARE CONSULTING SERVICES; COMPUTER HARDWARE AND SOFTWARE DESIGN; COMPUTER SERVICES, NAMELY, REMOTE AND ON-SITE MANAGEMENT OF THE INFORMATION TECHNOLOGY (IT) CLOUD COMPUTING SYSTEMS OF OTHERS; PREPARATION, UPDATE, INSTALLATION AND MAINTENANCE OF COMPUTER SOFTWARE; PROFESSIONAL COMPUTER SERVICES, NAMELY, NETWORK ANALYSIS, LAN/WAN DESIGN, WIRELESS ENGINEERING, VIRTUALIZATION AND COMPUTER PROJECT MANAGEMENT; PROGRAMMING OF COMPUTER SOFTWARE FOR OTHERS (U.S. CLS. 100 AND 101).

SEAN CROWLEY, EXAMINING ATTORNEY

SN 85-360,152. STRATODESK SOFTWARE, GMBH, KLAGENFURT, AUSTRIA, FILED 6-30-2011.

NoTouch Center

THE MARK CONSISTS OF STANDARD CHARACTERS WITHOUT CLAIM TO ANY PARTICULAR FONT, STYLE, SIZE, OR COLOR.

NO CLAIM IS MADE TO THE EXCLUSIVE RIGHT TO USE "CENTER", APART FROM THE MARK AS SHOWN.

CLASS 9—ELECTRICAL AND SCIENTIFIC APPARATUS

FOR COMPUTER HARDWARE AND SOFTWARE FOR SETTING UP AND CONFIGURING LOCAL AREA NETWORKS; COMPUTER SOFTWARE AND FIRMWARE FOR OPERATING SYSTEM PROGRAMS; COMPUTER SOFTWARE FOR ADMINISTRATION OF COMPUTER LOCAL AREA NETWORKS; COMPUTER SOFTWARE FOR COMPUTER SYSTEM AND APPLICATION DEVELOPMENT, DEPLOYMENT AND MANAGEMENT; COMPUTER SOFTWARE FOR CONTROLLING AND MANAGING ACCESS SERVER APPLICATIONS; COMPUTER SOFTWARE FOR CONTROLLING SELF-SERVICE TERMINALS; COMPUTER SOFTWARE TO MAINTAIN AND OPERATE COMPUTER SYSTEM; COMPUTER TERMINALS (U.S. CLS. 21, 23, 26, 36 AND 38).

CLASS 42—SCIENTIFIC AND COMPUTER SERVICES

FOR COMPUTER HARDWARE AND SOFTWARE CONSULTING SERVICES; COMPUTER HARDWARE AND SOFTWARE DESIGN; COMPUTER SERVICES, NAMELY, REMOTE AND ON-SITE MANAGEMENT OF THE INFORMATION TECHNOLOGY (IT) CLOUD COMPUTING SYSTEMS OF OTHERS; PREPARATION, UPDATE, INSTALLATION AND MAINTENANCE OF COMPUTER SOFTWARE; PROFESSIONAL COMPUTER SERVICES, NAMELY, NETWORK ANALYSIS, LAN/WAN DESIGN, WIRELESS ENGINEERING, VIRTUALIZATION AND COMPUTER PROJECT MANAGEMENT; PROGRAMMING OF COMPUTER SOFTWARE FOR OTHERS (U.S. CLS. 100 AND 101).

SEAN CROWLEY, EXAMINING ATTORNEY

SN 85-360,153. STRATODESK SOFTWARE, GMBH, KLAGENFURT, AUSTRIA, FILED 6-30-2011.

NoTouch Cloud

THE MARK CONSISTS OF STANDARD CHARACTERS WITHOUT CLAIM TO ANY PARTICULAR FONT, STYLE, SIZE, OR COLOR.

NO CLAIM IS MADE TO THE EXCLUSIVE RIGHT TO USE "CLOUD", APART FROM THE MARK AS SHOWN.

CLASS 9—ELECTRICAL AND SCIENTIFIC APPARATUS

FOR COMPUTER HARDWARE AND SOFTWARE FOR SETTING UP AND CONFIGURING LOCAL AREA NETWORKS; COMPUTER SOFTWARE AND FIRMWARE FOR OPERATING SYSTEM PROGRAMS; COMPUTER SOFTWARE FOR ADMINISTRATION OF COMPUTER LOCAL AREA NETWORKS; COMPUTER SOFTWARE FOR COMPUTER SYSTEM AND APPLICATION DEVELOPMENT, DEPLOYMENT AND MANAGEMENT; COMPUTER SOFTWARE FOR CONTROLLING AND MANAGING ACCESS SERVER APPLICATIONS; COMPUTER SOFTWARE FOR CONTROLLING SELF-SERVICE TERMINALS; COMPUTER SOFTWARE TO MAINTAIN AND OPERATE COMPUTER SYSTEM; COMPUTER TERMINALS (U.S. CLS. 21, 23, 26, 36 AND 38).

CLASS 42—SCIENTIFIC AND COMPUTER SERVICES

FOR COMPUTER HARDWARE AND SOFTWARE CONSULTING SERVICES; COMPUTER HARDWARE AND SOFTWARE DESIGN; COMPUTER SERVICES, NAMELY, REMOTE AND ON-SITE MANAGEMENT OF THE INFORMATION TECHNOLOGY (IT) CLOUD COMPUTING SYSTEMS OF OTHERS; PREPARATION, UPDATE, INSTALLATION AND MAINTENANCE OF COMPUTER SOFTWARE; PROFESSIONAL COMPUTER SERVICES, NAMELY, NETWORK ANALYSIS, LAN/WAN DESIGN, WIRELESS ENGINEERING, VIRTUALIZATION AND COMPUTER PROJECT MANAGEMENT; PROGRAMMING OF COMPUTER SOFTWARE FOR OTHERS (U.S. CLS. 100 AND 101).

SEAN CROWLEY, EXAMINING ATTORNEY

SN 85-361,080. FOX FACTORY, INC., WATSONVILLE, CA. FILED 6-30-2011.



OWNER OF U.S. REG. NOS. 2,321,069, 3,669,224 AND OTHERS.

NO CLAIM IS MADE TO THE EXCLUSIVE RIGHT TO USE "RACING SHOCKS", APART FROM THE MARK AS SHOWN.

THE MARK CONSISTS OF THE STYLIZED WORD "FOX" FEATURING A STYLIZED BUSHY FOX TAIL THROUGH THE LETTER "O" OVER THE WORDING "RACING SHOX".

SN 85-361,037. FOXEN VINEYARD, INC., SANTA BARBARA, CA. FILED 6-30-2011.

FOXEN

THE MARK CONSISTS OF STANDARD CHARACTERS WITHOUT CLAIM TO ANY PARTICULAR FONT, STYLE, SIZE, OR COLOR.

OWNER OF U.S. REG. NO. 2,076,681.

CLASS 25—CLOTHING

FOR HEADWEAR, AND APPAREL, NAMELY SHIRTS, SWEATSHIRTS, TANK TOPS, JACKETS, FLEECE JACKETS, AND HATS (U.S. CLS. 22 AND 39).

CLASS 35—ADVERTISING AND BUSINESS

FOR RETAIL STORE SERVICES AND ONLINE RETAIL STORE SERVICES, BOTH FEATURING WINE, APPAREL, CLOTHING, MERCHANDISE, AND GIFT ITEMS; PROVIDING A WEBSITE FEATURING PRODUCT RATINGS AND REVIEWS IN THE FIELD OF WINE FOR COMMERCIAL PURPOSES; ADVERTISING SERVICES, NAMELY, PROMOTING THE FOOD AND WINE OF OTHERS; RETAIL DELICATESSEN SERVICES; ON-LINE RETAIL STORE SERVICES FEATURING WINE; WHOLESALE AND RETAIL STORE SERVICES AND ON-LINE RETAIL AND WHOLESALE STORE SERVICES FEATURING WINE, APPAREL, CLOTHING, AND GIFT ITEMS (U.S. CLS. 100, 101 AND 102).

CLASS 39—TRANSPORTATION AND STORAGE

FOR MAIL ORDER WINE CLUB SERVICES FEATURING PERIODIC SHIPMENTS OF WINE TO MEMBERS; WINE CLUB SERVICES FEATURING PERIODIC SHIPMENTS OF WINE TO MEMBERS (U.S. CLS. 100 AND 105).

HANNO RITTNER, EXAMINING ATTORNEY

CLASS 12—VEHICLES

FOR SUSPENSION SYSTEMS FOR VEHICLES, NAMELY, BICYCLES AND LAND MOTOR VEHICLES; VEHICLE PARTS, NAMELY, SHOCK ABSORBERS (U.S. CLS. 19, 21, 23, 31, 35 AND 44).

FIRST USE 1-31-1983; IN COMMERCE 1-31-1983.

CLASS 35—ADVERTISING AND BUSINESS

FOR ADVERTISING, MARKETING AND PROMOTIONAL SERVICES FOR DEALERS AND DISTRIBUTORS OF VEHICLE SUSPENSION SYSTEMS INCLUDING SHOCK ABSORBERS FOR VEHICLES (U.S. CLS. 100, 101 AND 102).

FIRST USE 1-31-1983; IN COMMERCE 1-31-1983.

DOMINIC J. FERRAIUOLO, EXAMINING ATTORNEY

SN 85-361,941. ADVANCE EDUCATION, INC., DBA ADVANCED, ALPHARETTA, GA. FILED 7-1-2011.

ASSIST

THE MARK CONSISTS OF STANDARD CHARACTERS WITHOUT CLAIM TO ANY PARTICULAR FONT, STYLE, SIZE, OR COLOR.

CLASS 9—ELECTRICAL AND SCIENTIFIC APPARATUS

FOR COMPUTER SOFTWARE PLATFORMS FOR KNOWLEDGE MANAGEMENT OF DATA AND DIAGNOSTIC TOOLS FOR USE IN SCHOOL IMPROVEMENT, ACCREDITATION AND COMPLIANCE PROCESSES TO DRIVE QUALITY EDUCATION AND STUDENT PERFORMANCE (U.S. CLS. 21, 23, 26, 36 AND 38).

FIRST USE 7-1-2009; IN COMMERCE 5-21-2010.

CLASS 42—SCIENTIFIC AND COMPUTER SERVICES

FOR APPLICATION SERVICE PROVIDER (ASP) FEATURING SOFTWARE FOR USE BY EDUCATIONAL INSTITUTIONS TO MERGE PROCESS, CONTENT, DATA AND TECHNOLOGY INTO A WEB-BASED PLATFORM THAT SUPPORTS END TO END MANAGEMENT OF SCHOOL IMPROVEMENT, ACCREDITATION PROCESSES AND COMPLIANCE MONITORING; COMPUTER SERVICES, NAMELY, ACTING AS AN APPLICATION SERVICE PROVIDER IN THE FIELD OF KNOWLEDGE MANAGEMENT TO HOST COMPUTER APPLICATION SOFTWARE FOR THE PURPOSE OF SCHOOL IMPROVEMENT, ACCREDITATION SERVICES AND COMPLIANCE MONITORING; CONSULTING ON ROOT CAUSE ANALYSIS IN THE FIELD OF SCHOOL IMPROVEMENT; SOFTWARE AS A SERVICE (SAAS) SERVICES FEATURING SOFTWARE IN THE FIELD OF SCHOOL IMPROVEMENT, ACCREDITATION PROCESSES AND COMPLIANCE MONITORING (U.S. CLS. 100 AND 101).

FIRST USE 7-1-2009; IN COMMERCE 5-21-2010.
RAUL CORDOVA, EXAMINING ATTORNEY

SN 85-361,964. VALMONT INDUSTRIES, INC., OMAHA, NE. FILED 7-1-2011.

VALMONT WEST COAST ENGINEERING

THE MARK CONSISTS OF STANDARD CHARACTERS WITHOUT CLAIM TO ANY PARTICULAR FONT, STYLE, SIZE, OR COLOR.

OWNER OF U.S. REG. NOS. 846,915 AND 1,151,459.
NO CLAIM IS MADE TO THE EXCLUSIVE RIGHT TO USE "ENGINEERING", APART FROM THE MARK AS SHOWN.

SEC. 2(F) AS TO "WEST COAST ENGINEERING".

CLASS 6—METAL GOODS

FOR METAL POLES; METAL BOLLARDS; METAL CASTINGS; METAL LAMP POSTS; METAL SIGN BRIDGES; METAL OUTDOOR LIGHTING STRUCTURES; POLE ACCESSORIES MADE OF METAL, NAMELY, ANCHOR BOLTS, NUT COVERS AND POLE TOP CAPS; METAL POLE BASES; METAL LADDERS; METAL HAND HOLE COVERS; MONOPOLES WITH PINWHEEL ANTENNA MOUNTING BRACKETS (U.S. CLS. 2, 12, 13, 14, 23, 25 AND 50).

FIRST USE 2-0-2008; IN COMMERCE 2-0-2008.

SN 85-361,958. VALMONT INDUSTRIES, INC., OMAHA, NE. FILED 7-1-2011.

WEST COAST ENGINEERING

THE MARK CONSISTS OF STANDARD CHARACTERS WITHOUT CLAIM TO ANY PARTICULAR FONT, STYLE, SIZE, OR COLOR.

NO CLAIM IS MADE TO THE EXCLUSIVE RIGHT TO USE "ENGINEERING", APART FROM THE MARK AS SHOWN.

SEC. 2(F).

CLASS 17—RUBBER GOODS

FOR POLE ACCESSORIES MADE OF PLASTIC, NAMELY, ANCHOR BOLT NUT COVERS AND POLE TOP CAPS; PLASTIC POLE BASE COVERS (U.S. CLS. 1, 5, 12, 13, 35 AND 50).

FIRST USE 2-0-2008; IN COMMERCE 2-0-2008.

CLASS 6—METAL GOODS

FOR METAL POLES; METAL BOLLARDS; METAL CASTINGS; METAL LAMP POSTS; METAL SIGN BRIDGES; METAL OUTDOOR LIGHTING STRUCTURES; POLE ACCESSORIES MADE OF METAL, NAMELY, ANCHOR BOLTS, NUT COVERS AND POLE TOP CAPS; METAL POLE BASE COVERS; METAL POLE BASES; METAL LADDERS; METAL HAND HOLE COVERS; MONOPOLES WITH PINWHEEL ANTENNA MOUNTING BRACKETS (U.S. CLS. 2, 12, 13, 14, 23, 25 AND 50).

FIRST USE 0-0-1992; IN COMMERCE 0-0-1996.

CLASS 20—FURNITURE AND ARTICLES NOT OTHERWISE CLASSIFIED

FOR COMPOSITE POLES MADE PRIMARILY OF RESIN (U.S. CLS. 2, 13, 22, 25, 32 AND 50).

FIRST USE 2-0-2008; IN COMMERCE 2-0-2008.

JANICE L. MCMORROW, EXAMINING ATTORNEY

CLASS 17—RUBBER GOODS

FOR POLE ACCESSORIES MADE OF PLASTIC, NAMELY, ANCHOR BOLT NUT COVERS AND POLE TOP CAPS; PLASTIC POLE BASE COVERS (U.S. CLS. 1, 5, 12, 13, 35 AND 50).

FIRST USE 0-0-1992; IN COMMERCE 0-0-1996.

SN 85-362,681. DATA RX MANAGEMENT, INCORPORATED, CUMMING, GA. FILED 7-4-2011.

DataRx**CLASS 20—FURNITURE AND ARTICLES NOT OTHERWISE CLASSIFIED**

FOR COMPOSITE POLES MADE PRIMARILY OF RESIN (U.S. CLS. 2, 13, 22, 25, 32 AND 50).

FIRST USE 0-0-1992; IN COMMERCE 0-0-1996.

JANICE L. MCMORROW, EXAMINING ATTORNEY

THE MARK CONSISTS OF STANDARD CHARACTERS WITHOUT CLAIM TO ANY PARTICULAR FONT, STYLE, SIZE, OR COLOR.

CLASS 35—ADVERTISING AND BUSINESS

FOR BUSINESS MANAGEMENT CONSULTATION, NAMELY, ASSISTING PHARMACIES IN NEGOTIATING PRICING AND REIMBURSEMENT LEVELS, DISPENSING FEES AND OTHER CONTRACTUAL TERMS WITH PHARMACY BENEFIT MANAGERS; ASSISTING PHARMACIES IN NEGOTIATING PRICING WITH PHARMACEUTICAL WHOLESALERS; PROVIDING CLAIM RECONCILIATION SERVICES IN THE NATURE OF PROVIDING INSURANCE/PAYOR CLAIMS AUDITING INFORMATION TO PHARMACIES PERTAINING TO PAYMENTS FROM INSURANCE CARRIERS AND OTHER PAYORS VIA A WORLDWIDE COMMUNICATIONS NETWORK; ADMINISTRATION OF PRESCRIPTION DISCOUNT DRUG PROGRAMS; PROMOTING THE GOODS AND SERVICES OF OTHERS BY PROVIDING HYPERTEXT LINKS TO THE WEB SITES OF OTHERS; INSURANCE PLAN RECONCILIATION FOR OTHERS; PROVIDING AN ONLINE DATABASE FEATURING CUSTOMER ORDER STATUS INFORMATION (U.S. CLS. 100, 101 AND 102).

FIRST USE 7-1-2005; IN COMMERCE 7-1-2005.

CLASS 36—INSURANCE AND FINANCIAL

FOR PROVIDING PHARMACY BENEFIT MANAGEMENT SERVICES TO EMPLOYER GROUPS; PROVIDING FINANCIAL CONSULTING SERVICES TO PHARMACIES AND OTHERS; PROVIDING PRESCRIPTION CLAIMS AGGREGATION SERVICES TO PHARMACIES; PROVIDING INFORMATION IN THE FIELD OF INSURANCE PLAN INFORMATION ALL VIA A GLOBAL COMPUTER NETWORK; INSURANCE CONSULTATION SERVICES, NAMELY, PRE-SCREENING PHARMACY CLAIMS FOR COMPLIANCE WITH INSURANCE PLAN REQUIREMENTS; INSURANCE MANAGEMENT SERVICES, NAMELY, INSURANCE PLAN FACTORING FOR OTHERS (U.S. CLS. 100, 101 AND 102).

FIRST USE 7-1-2008; IN COMMERCE 7-1-2008.

CLASS 38—COMMUNICATION

FOR TELECOMMUNICATION SERVICES, NAMELY, DATA SWITCHING SERVICES FOR USE IN TRANSMITTING MEDICAL PRESCRIPTIONS BETWEEN PHARMACIES AND INSURANCE PROVIDERS AND PROVIDING MULTIPLE USER ACCESS TO THE INTERNET FOR PHARMACIES AND INSURANCE PROVIDERS FOR USE IN AUTHORIZING AND FILLING PRESCRIPTIONS AND PRESCRIPTION REFILLS; PROVIDING ACCESS TO DATABASES (U.S. CLS. 100, 101 AND 104).

FIRST USE 7-1-1998; IN COMMERCE 7-1-1998.
JAMES GRIFFIN, EXAMINING ATTORNEY

SN 85-362,726. DATA RX MANAGEMENT, INCORPORATED, CUMMING, GA. FILED 7-5-2011.

RxSense

THE MARK CONSISTS OF STANDARD CHARACTERS WITHOUT CLAIM TO ANY PARTICULAR FONT, STYLE, SIZE, OR COLOR.

CLASS 35—ADVERTISING AND BUSINESS

FOR BUSINESS MANAGEMENT CONSULTATION, NAMELY, ASSISTING PHARMACIES IN NEGOTIATING PRICING AND REIMBURSEMENT LEVELS, DISPENSING FEES AND OTHER CONTRACTUAL TERMS WITH PHARMACY BENEFIT MANAGERS; ASSISTING PHARMACIES IN NEGOTIATING PRICING WITH PHARMACEUTICAL WHOLESALERS; PROVIDING CLAIM RECONCILIATION SERVICES IN THE NATURE OF PROVIDING INSURANCE/PAYOR CLAIMS AUDITING INFORMATION TO PHARMACIES PERTAINING TO PAYMENTS FROM INSURANCE CARRIERS AND OTHER PAYORS VIA A WORLDWIDE COMMUNICATIONS NETWORK; INSURANCE PLAN RECONCILIATION FOR OTHERS (U.S. CLS. 100, 101 AND 102).

FIRST USE 12-31-2004; IN COMMERCE 12-31-2004.

CLASS 36—INSURANCE AND FINANCIAL

FOR PROVIDING PHARMACY BENEFIT MANAGEMENT SERVICES TO EMPLOYER GROUPS; PROVIDING FINANCIAL CONSULTING SERVICES TO PHARMACIES AND OTHERS; PROVIDING PRESCRIPTION CLAIMS AGGREGATION SERVICES TO PHARMACIES; PROVIDING INFORMATION IN THE FIELD OF INSURANCE PLAN INFORMATION ALL VIA A GLOBAL COMPUTER NETWORK; INSURANCE CONSULTATION SERVICES, NAMELY, PRE-SCREENING PHARMACY CLAIMS FOR COMPLIANCE WITH INSURANCE PLAN REQUIREMENTS; INSURANCE MANAGEMENT SERVICES, NAMELY, INSURANCE PLAN FACTORING FOR OTHERS (U.S. CLS. 100, 101 AND 102).

FIRST USE 12-31-2004; IN COMMERCE 12-31-2004.
JAMES GRIFFIN, EXAMINING ATTORNEY

SN 85-362,794. THE WRITE GURU, LTD., SEATTLE, WA. FILED 7-5-2011.

WRITE GURU

THE MARK CONSISTS OF STANDARD CHARACTERS WITHOUT CLAIM TO ANY PARTICULAR FONT, STYLE, SIZE, OR COLOR.

SEC. 2(F).

CLASS 41—EDUCATION AND ENTERTAINMENT

FOR CUSTOM WRITING SERVICES FOR OTHERS; CUSTOM WRITING SERVICES FOR OTHERS, NAMELY, WRITING AN INDEX FOR PRINTED PUBLICATIONS AND ONLINE PUBLICATIONS; WRITING OF ARTICLES FOR PERIODICALS OTHER THAN FOR ADVERTISING OR PUBLICITY FOR OTHERS; WRITING OF TEXTS FOR OTHERS (U.S. CLS. 100, 101 AND 107).

FIRST USE 12-23-1994; IN COMMERCE 1-31-1995.

CLASS 42—SCIENTIFIC AND COMPUTER SERVICES

FOR WEBSITE DESIGN AND DEVELOPMENT FOR OTHERS; TECHNICAL WRITING FOR OTHERS (U.S. CLS. 100 AND 101).

FIRST USE 12-23-1994; IN COMMERCE 1-31-1995.
KIM MONINGHOFF, EXAMINING ATTORNEY

SN 85-363,327. KNIGHT OIL TOOLS, LLC, LAFAYETTE, LA.
FILED 7-5-2011.

SN 85-363,377. I.V.A.S. INDUSTRIA VERNICI S.P.A., SAN
MAURO PASCOLI (FC), ITALY, FILED 7-5-2011.



NO CLAIM IS MADE TO THE EXCLUSIVE RIGHT TO USE "OIL TOOLS", APART FROM THE MARK AS SHOWN. THE COLOR(S) BLUE, GRAY AND WHITE IS/ARE CLAIMED AS A FEATURE OF THE MARK.

THE MARK CONSISTS OF THE WORD "KNIGHT OIL TOOLS" IN BLUE COLOR POSITIONED TO THE RIGHT OF A SHIELD BORDERED IN BLUE WITH A GRAY INTERIOR AND WITH A KNIGHT'S HELMET SUPERIMPOSED ON THE SHIELD IN WHITE AND BLUE.

CLASS 37—CONSTRUCTION AND REPAIR

FOR (BASED ON USE IN COMMERCE) RENTAL OF TOOLS USED IN THE FIELD OF OIL AND GAS WELL DRILLING, COMPLETION, WELL CONTROL AND WORKOVER; (BASED ON INTENT TO USE) FISHING SERVICES IN THE FIELD OF OIL AND GAS EXPLORATION, DRILLING AND PRODUCTION, NAMELY, RECOVERING LOST OR STUCK EQUIPMENT IN THE WELLBORE; OIL AND GAS WELL PLUGGING AND ABANDONMENT SERVICES; CLEANING AND COATING OF DRILL PIPES FOR OIL AND GAS; REFACING DRILL COLLARS FOR USE IN DRILLING OIL AND GAS WELLS; CONSULTING IN THE FIELD OF OIL AND GAS CONSTRUCTION (U.S. CLS. 100, 103 AND 106).

FIRST USE 2-25-1985; IN COMMERCE 2-25-1985.

CLASS 40—MATERIAL TREATMENT

FOR (BASED ON INTENT TO USE) MANUFACTURE OF TOOLS AND EQUIPMENT IN THE FIELD OF OIL AND GAS WELL DRILLING AND WORKOVER OPERATIONS TO THE ORDER AND SPECIFICATION OF OTHERS; METAL TREATMENT SERVICES, NAMELY, HARBANDING OF DRILL COLLARS FOR USE IN DRILLING OIL AND GAS WELLS; CONSULTING IN THE FIELD OF OIL AND GAS PRODUCTION (U.S. CLS. 100, 103 AND 106).

CLASS 41—EDUCATION AND ENTERTAINMENT

FOR (BASED ON INTENT TO USE) SAFETY TRAINING IN THE FIELD OF OIL AND GAS EXPLORATION AND PRODUCTION, HEALTHCARE, AND CONSTRUCTION (U.S. CLS. 100, 101 AND 107).

CLASS 42—SCIENTIFIC AND COMPUTER SERVICES

FOR (BASED ON INTENT TO USE) OILFIELD EQUIPMENT INSPECTION; CONSULTING IN THE FIELD OF OIL AND GAS EXPLORATION (U.S. CLS. 100 AND 101).

CLASS 44—MEDICAL, BEAUTY AND AGRICULTURAL SERVICES

FOR (BASED ON INTENT TO USE) CONSULTING IN THE FIELD OF HEALTHCARE (U.S. CLS. 100 AND 101).
ESTHER BELENKER, EXAMINING ATTORNEY

METROPOLIS

THE MARK CONSISTS OF STANDARD CHARACTERS WITHOUT CLAIM TO ANY PARTICULAR FONT, STYLE, SIZE, OR COLOR.

CLASS 1—CHEMICALS

FOR VINYLIC RESINS SOLD IN FORM OF LIQUIDS, MEDIUM VISCOUS LIQUID, PASTES AND PSEUDO PLASTIC PASTES; EPOXY RESINS SOLD IN FORM OF LIQUIDS, MEDIUM VISCOUS LIQUID, PASTES AND PSEUDO PLASTIC PASTES; POLYURETHANE RESINS WITH ALIPHATIC ISOCYANATE IN FORM OF LIQUIDS, MEDIUM VISCOUS LIQUID, PASTES AND PSEUDO PLASTIC PASTES; ACRYLIC RESINS SOLD IN FORM OF LIQUIDS, MEDIUM VISCOUS LIQUID, PASTES AND PSEUDO PLASTIC PASTES, ALL THE FOREMENTIONED GOODS FOR USE IN DECORATING AND COATING WALLS AND CREATING AND COATING FLOORINGS (U.S. CLS. 1, 5, 6, 10, 26 AND 46).

CLASS 2—PAINTS

FOR BINDING PREPARATIONS FOR PAINTS, COATING PAINTS, COLORANTS, TITANIUM DIOXIDE, ENAMELS FOR PAINTING, ENAMELS USED AS VARNISHES, PAINTS, ENAMEL PAINTS, THINNERS FOR PAINTS, PRIMERS, THICKENERS FOR PAINTS, THINNERS FOR LACQUERS, VARNISHES, FIXATIVES FOR WATERCOLORS, WOOD COATING PAINTS, WOOD STAINS, DISTEMPERS, LACQUERS, NATURAL RESINS (U.S. CLS. 6, 11 AND 16).

CLASS 17—RUBBER GOODS

FOR INSULATING PAINTS (U.S. CLS. 1, 5, 12, 13, 35 AND 50).

ANTHONY RINKER, EXAMINING ATTORNEY

SN 85-364,629. HLD GLOBAL LIMITED, KOWLOON, HONG KONG, FILED 7-6-2011.

MOOD CUBES

THE MARK CONSISTS OF STANDARD CHARACTERS WITHOUT CLAIM TO ANY PARTICULAR FONT, STYLE, SIZE, OR COLOR.

NO CLAIM IS MADE TO THE EXCLUSIVE RIGHT TO USE "CUBES", APART FROM THE MARK AS SHOWN.

CLASS 12—VEHICLES

FOR METAL ROLLING CARTS USED PRIMARILY TO MOVE, AS WELL AS TO CONTAIN, HOUSEHOLD AND CLOSET STORAGE BINS; PLASTIC ROLLING CARTS USED PRIMARILY TO MOVE, AS WELL AS TO CONTAIN, HOUSEHOLD AND CLOSET STORAGE BINS (U.S. CLS. 19, 21, 23, 31, 35 AND 44).

CLASS 20—FURNITURE AND ARTICLES NOT OTHERWISE CLASSIFIED

FOR WOODEN SHELVING UNITS FOR CLOSETS AND STORAGE SHELVING; FURNITURE, NAMELY, METAL ROLLING CARTS USED PRIMARILY TO CONTAIN, AS WELL AS TO MOVE, HOUSEHOLD AND CLOSET STORAGE BINS; FURNITURE, NAMELY, PLASTIC ROLLING CARTS USED PRIMARILY TO CONTAIN, AS WELL AS TO MOVE, HOUSEHOLD AND CLOSET STORAGE BINS (U.S. CLS. 2, 13, 22, 25, 32 AND 50).

CLASS 21—HOUSEWARES AND GLASS

FOR HOME STORAGE AND ORGANIZING PRODUCTS, NAMELY, FOLDABLE FABRIC STORAGE BINS (U.S. CLS. 2, 13, 23, 29, 30, 33, 40 AND 50).

REBECCA EISINGER, EXAMINING ATTORNEY

SN 85-367,236. WORLD SPORTS HOLDINGS, LLC, MORGANTOWN, WV. FILED 7-9-2011.



NO CLAIM IS MADE TO THE EXCLUSIVE RIGHT TO USE "AMERICAN MOTOCROSS CHAMPIONSHIP" AND "MX SPORTS", APART FROM THE MARK AS SHOWN.

THE COLOR(S) RED, WHITE, BLUE, AND BLACK IS/ARE CLAIMED AS A FEATURE OF THE MARK.

THE MARK CONSISTS OF THE WORDS "AMERICAN" AND "MOTOCROSS" IN RED LETTERING WITH THE "A" AND "M" IN LARGER UPPERCASE LETTERS AND THE REMAINING LETTERS IN SMALLER LOWERCASE WITH THE WORD "CHAMPIONSHIP" RUNNING HORIZONTALLY BENEATH BEING IN ALL BLUE UPPERCASE LETTERS WITH ALL OF THOSE WORDS TO THE LEFT OF THE "MX SPORTS" LOGO BEING "MX" IN BLUE ITALICIZED FONT OVER THE WORD "SPORTS" IN SMALLER BLUE LETTERS ITALICIZED SET AGAINST A WHITE BACKGROUND ALL BEING LOCATED ABOVE A PENTAGONAL OBJECT HAVING A 5-POINTED WHITE STAR IN ITS CENTER WITH A BLUE HORIZONTAL BAR ABOVE THE STAR AND SURROUNDING THE UPPERMOST POINT AND A RED V-SHAPED BAR BELOW AND TO THE SIDES OF THE STAR, THE ENTIRE OBJECT BEING ENCLOSED WITHIN A 10-SIDED BLACK LINE.

SN 85-364,943. CANTERBURY PARK HOLDING CORPORATION, SHAKOPEE, MN. FILED 7-7-2011.



OWNER OF U.S. REG. NO. 2,093,394.

NO CLAIM IS MADE TO THE EXCLUSIVE RIGHT TO USE "FILLIES RACE", APART FROM THE MARK AS SHOWN.

THE COLOR(S) WHITE, TAN, LIGHT PINK AND DARK PINK IS/ARE CLAIMED AS A FEATURE OF THE MARK.

THE MARK CONSISTS OF A LIGHT AND DARK PINK RIBBON IN THE SHAPE OF A HORSE'S HEAD AND NECK APPEARING ABOVE THE WORDS "FILLIES RACE FOR" IN TAN AND THE WORD "HOPE" IN DARK PINK BELOW THE RIBBON; "CANTERBURY PARK" IN WHITE INSIDE A TAN BOX.

CLASS 25—CLOTHING

FOR CLOTHING, NAMELY, T-SHIRTS AND HATS (U.S. CLS. 22 AND 39).

FIRST USE 9-30-2010; IN COMMERCE 9-30-2010.

CLASS 36—INSURANCE AND FINANCIAL

FOR CHARITABLE FUNDRAISING SERVICES, NAMELY, RAISING FUNDS FOR FINANCIAL SUPPORT OF INDIVIDUALS AND THEIR FAMILIES THAT SUFFER FROM CANCER BY MEANS OF HORSE RACING EVENTS (U.S. CLS. 100, 101 AND 102).

FIRST USE 9-30-2010; IN COMMERCE 9-30-2010.
ANTHONY RINKER, EXAMINING ATTORNEY

CLASS 16—PAPER GOODS AND PRINTED MATTER

FOR BINDERS; BOOK COVERS; BOOK MARKERS; BOOK MARKS; CALENDARS; CHILDREN'S ACTIVITY BOOKS; COLORING BOOKS; COMIC BOOKS; COMIC STRIPS; FOLDERS; MAGAZINES IN THE FIELD OF MOTOCROSS AND STORIES IN ILLUSTRATED FORM; NOTEBOOKS; NOTEPADS; POSTERS; STICKERS AND STICKER ALBUMS; THREE-RING BINDERS; TRADING CARDS (U.S. CLS. 2, 5, 22, 23, 29, 37, 38 AND 50).

CLASS 25—CLOTHING

FOR CAPS; HEADGEAR, NAMELY, CAPS AND HATS; POLO SHIRTS; SHIRTS; SWEAT SHIRTS; T-SHIRTS (U.S. CLS. 22 AND 39).

CLASS 28—TOYS AND SPORTING GOODS

FOR TOY VEHICLES (U.S. CLS. 22, 23, 38 AND 50).

CLASS 41—EDUCATION AND ENTERTAINMENT

FOR ELECTRONIC GAMES SERVICES PROVIDED BY MEANS OF THE INTERNET; ENTERTAINMENT IN THE NATURE OF MOTOCROSS RACES, ACTIVITIES, COMPETITIONS AND EVENTS; ENTERTAINMENT IN THE NATURE OF PROVIDING ONLINE MOTOCROSS RACING VIDEO GAMES; ENTERTAINMENT IN THE NATURE OF MOTOCROSS RACES; ENTERTAINMENT SERVICES, NAMELY, ARRANGING AND CONDUCTING OF COMPETITIONS FOR MOTOCROSS; ENTERTAINMENT SERVICES, NAMELY, PROVIDING ONLINE ELECTRONIC GAMES; ENTERTAINMENT SERVICES, NAMELY, PROVIDING ONLINE VIDEO GAMES (U.S. CLS. 100, 101 AND 107).

DANIEL CAPSHAW, EXAMINING ATTORNEY

SN 85-367,249. DESIGN WORKS, NASHVILLE, TN. FILED 7-9-2011.

DESIGN WORKS

THE MARK CONSISTS OF STANDARD CHARACTERS WITHOUT CLAIM TO ANY PARTICULAR FONT, STYLE, SIZE, OR COLOR.

NO CLAIM IS MADE TO THE EXCLUSIVE RIGHT TO USE "DESIGN", APART FROM THE MARK AS SHOWN.

CLASS 35—ADVERTISING AND BUSINESS

FOR RETAIL AND WHOLESALE DISTRIBUTORSHIP SERVICES FEATURING COUNTERTOPS (U.S. CLS. 100, 101 AND 102).

FIRST USE 8-1-2009; IN COMMERCE 8-1-2009.

CLASS 40—MATERIAL TREATMENT

FOR CUSTOM FABRICATION OF COUNTERTOPS TO WHOLESALE AND RETAIL CUSTOMERS (U.S. CLS. 100, 103 AND 106).

FIRST USE 8-1-2009; IN COMMERCE 8-1-2009.
AHSEN KHAN, EXAMINING ATTORNEY

SN 85-367,689. AVG TECHNOLOGIES CZ, S.R.O., BRNO, CZECH REPUBLIC, FILED 7-11-2011.

MULTIMI

THE MARK CONSISTS OF STANDARD CHARACTERS WITHOUT CLAIM TO ANY PARTICULAR FONT, STYLE, SIZE, OR COLOR.

CLASS 9—ELECTRICAL AND SCIENTIFIC APPARATUS

FOR DOWNLOADABLE SOFTWARE INTERFACES AVAILABLE OVER A COMPUTER NETWORK IN ORDER TO CREATE A PERSONALIZED ON-LINE INFORMATION SERVICE; DOWNLOADABLE SOFTWARE ALLOWING USERS TO UPLOAD, POST, DISPLAY, ORGANIZE AND CUSTOMIZE ELECTRONIC MEDIA AND INFORMATION IN THE NATURE OF WEB PAGES, VIDEO, MUSIC AND PHOTOS; DOWNLOADABLE SOFTWARE DEVELOPMENT TOOLS AND APPLICATION PROGRAM INTERFACES (API), NAMELY, DOWNLOADABLE SOFTWARE TO ENGAGE IN SECURITY RELATED ACCESS TO ON-LINE AND FILE STORAGE SERVICES (U.S. CLS. 21, 23, 26, 36 AND 38).

CLASS 38—COMMUNICATION

FOR PROVIDING ELECTRONIC MAIL AND WORK-GROUP COMMUNICATIONS SERVICES OVER COMPUTER NETWORKS; PROVIDING MULTIPLE USER ACCESS TO PROPRIETARY COLLECTIONS OF INFORMATION BY MEANS OF GLOBAL COMPUTER INFORMATION NETWORKS; ELECTRONIC MESSAGING SYSTEM, NAMELY, ELECTRONIC QUEUING OR AGGREGATING OF ELECTRONIC MAIL ADDRESSES AND TRANSMISSION OR FORWARDING OF SAME TO AN AGGREGATE ELECTRONIC MAIL ADDRESS; INSTANT MESSAGING SERVICES (U.S. CLS. 100, 101 AND 104).

CLASS 42—SCIENTIFIC AND COMPUTER SERVICES

FOR PROVIDING A WEBSITE ALLOWING USERS TO UPLOAD, POST, DISPLAY, ORGANIZE AND CUSTOMIZE ELECTRONIC MEDIA AND INFORMATION IN THE NATURE OF WEB PAGES, VIDEOS, MUSIC AND PHOTOS; PROVIDING CUSTOMIZED ONLINE WEB PAGES FEATURING USER DEFINED INFORMATION, WHICH INCLUDES ONLINE LINKS TO OTHER WEB PAGES, VIDEOS, MUSIC AND PHOTOS; APPLICATION SERVICE PROVIDER (ASP), NAMELY, HOSTING COMPUTER SOFTWARE APPLICATIONS OF OTHERS; APPLICATION SERVICE PROVIDER (ASP) FEATURING SOFTWARE TO ENABLE UPLOADING, POSTING, SHOWING, DISPLAYING, TAGGING, BLOGGING, SHARING OR PROVIDING ELECTRONIC MEDIA OR INFORMATION OVER THE INTERNET OR OTHER COMMUNICATIONS NETWORK; COMPUTER SERVICES, NAMELY, PROVIDING A SEARCH ENGINE TO ALLOW USERS TO PREVIEW, ORDER AND DOWNLOAD BOOKS, SEARCH FULL TEXTS OF BOOKS, FIND REVIEWS AND OTHER INFORMATION ON BOOKS, SEARCH FOR MAGAZINE CONTENT, FIND REFERENCE BOOKS ON OTHER WEB SITES AND BLOGS ON A VARIETY OF TOPICS; AND PROVIDING ONLINE NON-DOWNLOADABLE SOFTWARE FOR AGGREGATING AND ORGANIZING MULTIPLE ELECTRONIC MAIL ADDRESSES; PROVIDING CUSTOMIZED SEARCH ENGINES FOR OTHERS; PROVIDING A WEB SITE THAT ENABLES USERS TO STORE, ORGANIZE, TRACK, MONITOR, AND SHARE HEALTH AND MEDICAL INFORMATION; PROVIDING TECHNICAL INFORMATION IN THE FIELD OF COMPUTER SOFTWARE DEVELOPMENT (U.S. CLS. 100 AND 101).

CLASS 45—PERSONAL AND LEGAL SERVICES

FOR ON-LINE SOCIAL NETWORKING SERVICES (U.S. CLS. 100 AND 101).

DOUGLAS LEE, EXAMINING ATTORNEY

SN 85-367,772. BROADRIDGE FINANCIAL SOLUTIONS, INC., JERSEY CITY, NJ. FILED 7-11-2011.

FOREFIELD

THE MARK CONSISTS OF STANDARD CHARACTERS WITHOUT CLAIM TO ANY PARTICULAR FONT, STYLE, SIZE, OR COLOR.

CLASS 9—ELECTRICAL AND SCIENTIFIC APPARATUS

FOR PROVIDING ELECTRONIC DOWNLOADABLE PUBLICATIONS IN THE NATURE OF BROCHURES, BOOKLETS, AND ARTICLES IN THE FIELDS OF FINANCIAL AND INVESTMENT MANAGEMENT, SECURITIES AND INVESTMENT BROKERAGE, INSURANCE BROKERAGE, BANKING AND FINANCE, ESTATE PLANNING (U.S. CLS. 21, 23, 26, 36 AND 38).

CLASS 41—EDUCATION AND ENTERTAINMENT

FOR CONTINUING EDUCATION SERVICES, NAMELY, PROVIDING ON-LINE COURSES IN THE FIELDS OF FINANCIAL AND INVESTMENT MANAGEMENT, SECURITIES AND INVESTMENT BROKERAGE, INSURANCE BROKERAGE, BANKING AND FINANCE, ESTATE PLANNING, AND EDUCATIONAL PLANNING, NAMELY, SAVINGS FOR COLLEGE; DEVELOPMENT AND DISSEMINATION OF EDUCATIONAL MATERIALS OF OTHERS IN THE FIELDS OF FINANCIAL AND INVESTMENT MANAGEMENT, SECURITIES AND INVESTMENT BROKERAGE, INSURANCE BROKERAGE, BANKING AND FINANCE, ESTATE PLANNING; ON-LINE ELECTRONIC PUBLISHING OF THE TEXT AND GRAPHIC WORKS OF OTHERS FEATURING INFORMATION IN THE FIELDS OF FINANCIAL AND INVESTMENT MANAGEMENT, SECURITIES AND INVESTMENT BROKERAGE, INSURANCE BROKERAGE, BANKING AND FINANCE, ESTATE PLANNING (U.S. CLS. 100, 101 AND 107).

KAREN BRACEY, EXAMINING ATTORNEY

SN 85-367,969. NUK USA LLC, WILMINGTON, DE. FILED 7-11-2011.



The logo for Freshfoods features the word "Freshfoods" in a stylized, lowercase font. The letters "F", "r", "e", "s", "h", "f", "o", "o", "d", "s" are in green, while the letter "e" is in pink. A small green leaf design is positioned above the letter "e".

THE COLOR(S) GREEN AND PINK IS/ARE CLAIMED AS A FEATURE OF THE MARK.

THE MARK CONSISTS OF THE STYLIZED WORDING "FRESHFOODS" IN GREEN, EXCEPT FOR THE LETTER "E" WHICH IS PINK, AND A SMALL LEAF DESIGN IN GREEN ABOVE THAT LETTER.

CLASS 7—MACHINERY

FOR ELECTRIC MIXERS FOR HOUSEHOLD PURPOSES (U.S. CLS. 13, 19, 21, 23, 31, 34 AND 35).

CLASS 11—ENVIRONMENTAL CONTROL APPARATUS

FOR APPARATUS FOR STEAM GENERATING AND COOKING, NAMELY, ELECTRIC FOOD STEAMERS (U.S. CLS. 13, 21, 23, 31 AND 34).

CLASS 21—HOUSEWARES AND GLASS

FOR HOUSEHOLD CONTAINERS FOR STORING FOOD; INSULATED CONTAINERS FOR BEVERAGES FOR DOMESTIC USE (U.S. CLS. 2, 13, 23, 29, 30, 33, 40 AND 50).

BRIAN CALLAGHAN, EXAMINING ATTORNEY

SN 85-367,968. UHS OF DELAWARE, INC., KING OF PRUSSIA, PA. FILED 7-11-2011.



THE HEART AND
VASCULAR CENTER
OF DOCTORS HOSPITAL

SN 85-368,860. INTERNATIONAL FLORA TECHNOLOGIES LTD., CHANDLER, AZ. FILED 7-12-2011.

Cedar, Jojoba, and Seven Miles of Silk

OWNER OF U.S. REG. NOS. 2,446,048, 2,777,011 AND 3,266,768.

NO CLAIM IS MADE TO THE EXCLUSIVE RIGHT TO USE "THE HEART AND VASCULAR CENTER OF DOCTORS HOSPITAL", APART FROM THE MARK AS SHOWN.

THE MARK CONSISTS OF A GENERALLY CIRCULAR DESIGN ELEMENT DIVIDED INTO FOUR SHADED QUADRANTS, WITH EACH QUADRANT HAVING AN INDENTATION IN ITS EXTERIOR EDGE, AND WITH THE INTERIOR EDGES OF THE QUADRANTS DEFINING THE HOLLOW PORTION IN THE IMAGE OF A HEART. WITHIN THE HOLLOW PORTION IS A SHADED DESIGN IN THE SHAPE OF A HEART. TO THE RIGHT OF THE DESIGN ELEMENT ARE THE WORDS "THE HEART AND VASCULAR CENTER OF DOCTORS HOSPITAL", WITH A HORIZONTAL LINE IN BETWEEN "VASCULAR CENTER" AND "OF DOCTORS HOSPITAL".

CLASS 41—EDUCATION AND ENTERTAINMENT

FOR EDUCATION SERVICES, NAMELY, PROVIDING CLASSES, WORKSHOPS AND SEMINARS IN THE FIELD OF HEALTHCARE (U.S. CLS. 100, 101 AND 107).

CLASS 44—MEDICAL, BEAUTY AND AGRICULTURAL SERVICES

FOR HEALTHCARE; MEDICAL SERVICES (U.S. CLS. 100 AND 101).

MATTHEW KLINE, EXAMINING ATTORNEY

THE MARK CONSISTS OF STANDARD CHARACTERS WITHOUT CLAIM TO ANY PARTICULAR FONT, STYLE, SIZE, OR COLOR.

NO CLAIM IS MADE TO THE EXCLUSIVE RIGHT TO USE "CEDAR JOJOBA", APART FROM THE MARK AS SHOWN.

CLASS 1—CHEMICALS

FOR BOTANICAL AND BOTANICALLY-DERIVED EXTRACTS OF JOJOBA AND CEDAR FOR USE IN THE MANUFACTURE OF PERSONAL CARE PRODUCTS AND COSMETICS (U.S. CLS. 1, 5, 6, 10, 26 AND 46).

CLASS 3—COSMETICS AND CLEANING PREPARATIONS

FOR BOTANICAL AND BOTANICALLY-DERIVED EXTRACTS OF JOJOBA AND CEDAR SOLD AS COMPONENT INGREDIENTS OF COSMETICS, SKIN CARE PREPARATIONS, AND HAIR CARE PREPARATIONS (U.S. CLS. 1, 4, 6, 50, 51 AND 52).

DAWN FELDMAN, EXAMINING ATTORNEY

SN 85-369,272. THE TRAVELERS INDEMNITY COMPANY, HARTFORD, CT. FILED 7-12-2011.

TRAVELERS CLICK

THE MARK CONSISTS OF STANDARD CHARACTERS WITHOUT CLAIM TO ANY PARTICULAR FONT, STYLE, SIZE, OR COLOR.

OWNER OF U.S. REG. NOS. 1,611,053, 3,494,648 AND OTHERS.

CLASS 36—INSURANCE AND FINANCIAL

FOR PROPERTY AND CASUALTY INSURANCE AND SURETY SERVICES, NAMELY, RATING, QUOTING, UNDERWRITING, BINDING, AND ISSUING INSURANCE COVERAGE AND SURETY BONDS VIA AN ONLINE, NON-DOWNLOADABLE INTERFACE SOFTWARE PORTAL (U.S. CLS. 100, 101 AND 102).

CLASS 42—SCIENTIFIC AND COMPUTER SERVICES

FOR PROVIDING USE OF ONLINE, NON-DOWNLOADABLE SOFTWARE FOR RATING, QUOTING, UNDERWRITING, BINDING, AND ISSUING INSURANCE COVERAGE AND SURETY BONDS IN THE FIELD OF PROPERTY AND CASUALTY INSURANCE, AND THAT ALLOWS INSURANCE AGENTS TO MANAGE THEIR CUSTOMERS AND ACCOUNTS (U.S. CLS. 100 AND 101).

ANDREW LEASER, EXAMINING ATTORNEY

SN 85-369,376. QUALTET NA, INC., WOBURN, MA. FILED 7-12-2011.

SOCIAL WEBFORCE

THE MARK CONSISTS OF STANDARD CHARACTERS WITHOUT CLAIM TO ANY PARTICULAR FONT, STYLE, SIZE, OR COLOR.

NO CLAIM IS MADE TO THE EXCLUSIVE RIGHT TO USE "SOCIAL", APART FROM THE MARK AS SHOWN.

CLASS 9—ELECTRICAL AND SCIENTIFIC APPARATUS

FOR COMPUTER SOFTWARE DEVELOPMENT TOOLS; COMPUTER SOFTWARE FOR USE AS AN APPLICATION PROGRAMMING INTERFACE (API) FOR BUILDING SOFTWARE APPLICATIONS; APPLICATION PROGRAMMING INTERFACE (API) FOR COMPUTER SOFTWARE WHICH FACILITATES ONLINE SERVICES FOR SOCIAL NETWORKING, BUILDING SOCIAL NETWORKING APPLICATIONS AND FOR ALLOWING DATA RETRIEVAL, UPLOAD, DOWNLOAD, ACCESS AND MANAGEMENT; COMPUTER SOFTWARE TO ENABLE UPLOADING, DOWNLOADING, ACCESSING, POSTING, DISPLAYING, TAGGING, BLOGGING, STREAMING, LINKING, SHARING OR OTHERWISE PROVIDING ELECTRONIC MEDIA OR INFORMATION VIA COMPUTER AND COMMUNICATION NETWORKS (U.S. CLS. 21, 23, 26, 36 AND 38).

CLASS 35—ADVERTISING AND BUSINESS

FOR PROVIDING ONLINE BUSINESS NETWORKING SERVICES, FEATURING VIRTUAL BUSINESSES; ADVERTISING AND INFORMATION DISTRIBUTION SERVICES, NAMELY, PROVIDING CLASSIFIED ADVERTISING SPACE VIA THE GLOBAL COMPUTER NETWORK; PROMOTING THE GOODS AND SERVICES OF OTHERS OVER THE INTERNET; PROVIDING ON-LINE COMPUTER DATABASES AND ON-LINE SEARCHABLE DATABASES IN THE FIELD OF CLASSIFIED ADVERTISING; PROVIDING ON-LINE COMPUTER DATABASES AND ON-LINE SEARCHABLE DATABASES IN THE FIELD OF BUSINESS INFORMATION, ADVICE, CONSULTING, AND BUSINESS NETWORKING (U.S. CLS. 100, 101 AND 102).

CLASS 38—COMMUNICATION

FOR PROVIDING ONLINE CHAT ROOMS, FORUMS AND ELECTRONIC BULLETIN BOARDS FOR REGISTERED USERS FOR TRANSMISSION OF MESSAGES, COMMENTARY AND EXCHANGE OF IDEAS CONCERNING GENERAL BUSINESS INTERESTS (U.S. CLS. 100, 101 AND 104).

CLASS 42—SCIENTIFIC AND COMPUTER SERVICES

FOR COMPUTER SERVICES, NAMELY, HOSTING ONLINE WEB FACILITIES FOR OTHERS FOR ORGANIZING AND CONDUCTING ONLINE MEETINGS, GATHERINGS, AND INTERACTIVE DISCUSSIONS; COMPUTER SERVICES IN THE NATURE OF CUSTOMIZED WEB PAGES FEATURING USER-DEFINED INFORMATION, PERSONAL PROFILES AND INFORMATION; COMPUTER SERVICES, NAMELY, CREATING AN ONLINE BUSINESS COMMUNITY FOR REGISTERED USERS TO PARTICIPATE IN DISCUSSION, GET FEEDBACK FROM THEIR PEERS, FORM VIRTUAL BUSINESS NETWORKS AND ACTIVITIES, AND ENGAGE IN BUSINESS NETWORKING AND ON-LINE COLLABORATION (U.S. CLS. 100 AND 101).

REBECCA EISINGER, EXAMINING ATTORNEY

SN 85-369,379. QUALTET NA, INC., WOBURN, MA. FILED 7-12-2011.



NO CLAIM IS MADE TO THE EXCLUSIVE RIGHT TO USE "SOCIAL", APART FROM THE MARK AS SHOWN.

THE MARK CONSISTS OF THE WORD "SOCIAL" IN LOWERCASE LETTERS ABOVE THE WORD "WEBFORCE" IN CAPITALIZED LETTERS, WITH A DESIGN APPEARING ABOVE THE WORD "SOCIAL" THAT CONSISTS OF OPAQUE DOTS SLIGHTLY ABOVE OPAQUE CYLINDRICAL SHAPES WITH STRAIGHT OR SQUARED OFF BOTTOM EDGES.

CLASS 9—ELECTRICAL AND SCIENTIFIC APPARATUS

FOR COMPUTER SOFTWARE DEVELOPMENT TOOLS; COMPUTER SOFTWARE FOR USE AS AN APPLICATION PROGRAMMING INTERFACE (API) FOR BUILDING SOFTWARE APPLICATIONS; APPLICATION PROGRAMMING INTERFACE (API) FOR COMPUTER SOFTWARE WHICH FACILITATES ONLINE SERVICES FOR SOCIAL NETWORKING, BUILDING SOCIAL NETWORKING APPLICATIONS AND FOR ALLOWING DATA RETRIEVAL, UPLOAD, DOWNLOAD, ACCESS AND MANAGEMENT; COMPUTER SOFTWARE TO ENABLE UPLOADING, DOWNLOADING, ACCESSING, POSTING, DISPLAYING, TAGGING, BLOGGING, STREAMING, LINKING, SHARING OR OTHERWISE PROVIDING ELECTRONIC MEDIA OR INFORMATION VIA COMPUTER AND COMMUNICATION NETWORKS (U.S. CLS. 21, 23, 26, 36 AND 38).

CLASS 35—ADVERTISING AND BUSINESS

FOR PROVIDING ONLINE BUSINESS NETWORKING SERVICES, FEATURING VIRTUAL BUSINESSES; ADVERTISING AND INFORMATION DISTRIBUTION SERVICES, NAMELY, PROVIDING CLASSIFIED ADVERTISING SPACE VIA THE GLOBAL COMPUTER NETWORK; PROMOTING THE GOODS AND SERVICES OF OTHERS OVER THE INTERNET; PROVIDING ONLINE COMPUTER DATABASES AND ON-LINE SEARCHABLE DATABASES IN THE FIELD OF CLASSIFIED ADVERTISING; PROVIDING ON-LINE COMPUTER DATABASES AND ON-LINE SEARCHABLE DATABASES IN THE FIELD OF BUSINESS INFORMATION, ADVICE, CONSULTING, AND BUSINESS NETWORKING (U.S. CLS. 100, 101 AND 102).

CLASS 38—COMMUNICATION

FOR PROVIDING ONLINE CHAT ROOMS, FORUMS AND ELECTRONIC BULLETIN BOARDS FOR REGISTERED USERS FOR TRANSMISSION OF MESSAGES, COMMENTARY AND EXCHANGE OF IDEAS CONCERNING GENERAL BUSINESS INTERESTS (U.S. CLS. 100, 101 AND 104).

CLASS 42—SCIENTIFIC AND COMPUTER SERVICES

FOR COMPUTER SERVICES, NAMELY, HOSTING ONLINE WEB FACILITIES FOR OTHERS FOR ORGANIZING AND CONDUCTING ONLINE MEETINGS, GATHERINGS, AND INTERACTIVE DISCUSSIONS; COMPUTER SERVICES IN THE NATURE OF CUSTOMIZED WEB PAGES FEATURING USER-DEFINED INFORMATION, PERSONAL PROFILES AND INFORMATION; COMPUTER SERVICES, NAMELY, CREATING AN ONLINE BUSINESS COMMUNITY FOR REGISTERED USERS TO PARTICIPATE IN DISCUSSION, GET FEEDBACK FROM THEIR PEERS, FORM VIRTUAL BUSINESS NETWORKS AND ACTIVITIES, AND ENGAGE IN BUSINESS NETWORKING AND ONLINE COLLABORATION (U.S. CLS. 100 AND 101).

REBECCA EISINGER, EXAMINING ATTORNEY

SN 85-369,486. ANUNCIOS EN DIRECTORIOS, S.A. DE C.V., MEXICO, D.F., MEXICO, FILED 7-12-2011.



NO CLAIM IS MADE TO THE EXCLUSIVE RIGHT TO USE "LLAMADAS", APART FROM THE MARK AS SHOWN.

THE COLOR(S) RED, BLACK, WHITE, AND YELLOW IS/ ARE CLAIMED AS A FEATURE OF THE MARK.

THE MARK CONSISTS OF A RED TAG WITH A BLACK STRING ON THE LEFT SIDE. THE TOP LEFT CORNER OF THE TAG HAS A BLACK BACKGROUND WITH THE WORDING "SECCION" IN A WHITE STYLIZED FONT. THE WORDING "AHORROS" IS PRESENTED ACROSS THE CENTER OF THE TAG IN A STYLIZED YELLOW FONT OUTLINED IN BLACK, WITH BLACK SCISSORS CUTTING OUT THE CENTER OF THE SECOND LETTER "O". THERE IS A BLACK STRIPE ACROSS THE BOTTOM OF THE TAG WITH THE WORDING "LLAMADAS" IN A WHITE STYLIZED FONT.

THE ENGLISH TRANSLATION OF "SECCION", "AHORROS" AND "LLAMADAS" IN THE MARK IS "SECTION", "SAVINGS" AND "CALLS".

CLASS 16—PAPER GOODS AND PRINTED MATTER

FOR TELEPHONE CALLING CARDS, NOT MAGNETICALLY ENCODED (U.S. CLS. 2, 5, 22, 23, 29, 37, 38 AND 50).

CLASS 35—ADVERTISING AND BUSINESS

FOR ADVERTISING SERVICES; RETAIL STORE AND ON-LINE RETAIL STORE SERVICES FEATURING CALLING CARDS; MAIL ORDER SERVICES FEATURING CALLING CARDS (U.S. CLS. 100, 101 AND 102).

CLASS 38—COMMUNICATION

FOR LOCAL AND LONG DISTANCE TELEPHONE SERVICES; FIXED AND MOBILE TELEPHONE SERVICES; COMMUNICATIONS BY TELEPHONE; COMMUNICATION BY MOBILE TELEPHONE; TELEPHONE TELECOMMUNICATIONS SERVICES PROVIDED VIA PREPAID TELEPHONE CALLING CARDS (U.S. CLS. 100, 101 AND 104).

CLASS 41—EDUCATION AND ENTERTAINMENT

FOR EDUCATIONAL SERVICES, NAMELY, CONDUCTING SEMINARS, CONFERENCES, AND WORKSHOPS IN THE FIELD OF TELECOMMUNICATIONS SERVICES; ENTERTAINMENT, NAMELY, CONDUCTING RAFFLE CONTESTS AND COMPETITIONS IN THE FIELD OF CULTURE AND SPORTS; ENTERTAINMENT SERVICES, NAMELY, NON-DOWNLOADABLE RING TONES, WALLPAPER GRAPHICS, IMAGES AND PHOTOGRAPHS PRESENTED TO MOBILE COMMUNICATIONS DEVICES VIA A GLOBAL COMPUTER NETWORK AND WIRELESS NETWORKS; PROVIDING NEWS IN THE FIELD OF ENTERTAINMENT (U.S. CLS. 100, 101 AND 107).

TINA MAI, EXAMINING ATTORNEY

SN 85-370,434. SUPER DUPER INC., DBA SUPER DUPER PUBLICATIONS, GREENVILLE, SC. FILED 7-13-2011.

Navi-Gator

THE MARK CONSISTS OF STANDARD CHARACTERS WITHOUT CLAIM TO ANY PARTICULAR FONT, STYLE, SIZE, OR COLOR.

CLASS 9—ELECTRICAL AND SCIENTIFIC APPARATUS

FOR COMPUTER APPLICATION SOFTWARE FOR MOBILE PHONES AND HAND HELD COMPUTERS, NAMELY, SOFTWARE FOR USE IN ELECTRONIC STORAGE OF DATA FROM A PICTURE MAPPING BASED BEHAVIORAL PROGRAM (U.S. CLS. 21, 23, 26, 36 AND 38).

CLASS 16—PAPER GOODS AND PRINTED MATTER

FOR A PRINTED PICTURE MAPPING BASED BEHAVIORAL PROGRAM CONSISTING OF A PRINTED PICTURE MAPPING BOOK AND AN INSTRUCTIONAL MANUAL FOR USE BY EDUCATORS AND PARENTS IN THE INSTRUCTION OF CHILDREN TO IMPROVE THEIR SOCIAL, LISTENING, EXPRESSIVE, AND RECEPTIVE LANGUAGE, AND WORKING MEMORY SKILLS (U.S. CLS. 2, 5, 22, 23, 29, 37, 38 AND 50).

CLASS 41—EDUCATION AND ENTERTAINMENT

FOR EDUCATIONAL SERVICES, NAMELY, PROVIDING WORKSHOPS IN THE AREA OF ADULT LEARNING, BOTH TO INDIVIDUALS AND INSTITUTIONS, INCLUDING COLLEGES AND UNIVERSITIES, COMMUNITY COLLEGES, SCHOOLS, AND INDEPENDENT AND COMMUNITY GROUPS IN THE AREA OF SPEECH, LANGUAGE, AND BEHAVIOR (U.S. CLS. 100, 101 AND 107).

APRIL ROACH, EXAMINING ATTORNEY

SN 85-370,532. CEJKA SEARCH, INC., CREVE COEUR, MO. FILED 7-13-2011.



NO CLAIM IS MADE TO THE EXCLUSIVE RIGHT TO USE "PHYSICIANS", APART FROM THE MARK AS SHOWN.

THE MARK CONSISTS OF THE TERM "CONTACT" IN UPPERCASE LETTERS ABOVE THE TERM "PHYSICIANS" IN UPPERCASE LETTERS, ALL TO THE RIGHT OF A STYLIZED LETTER "X", WITH SEVERAL CIRCLES OUTLINING THE "X".

CLASS 35—ADVERTISING AND BUSINESS

FOR PROVIDING AN ON-LINE COMPUTER DATABASE IN THE FIELD OF BUSINESS CONTACTS CONCERNING PHYSICIANS, RESIDENT PHYSICIANS, AND PHYSICIAN GRADUATES (U.S. CLS. 100, 101 AND 102). FIRST USE 2-1-2011; IN COMMERCE 2-1-2011.

CLASS 44—MEDICAL, BEAUTY AND AGRICULTURAL SERVICES

FOR PROVIDING A WEBSITE FEATURING INFORMATION IN THE FIELD OF MEDICAL RECORDS (U.S. CLS. 100 AND 101).

FIRST USE 2-1-2011; IN COMMERCE 2-1-2011. TEJBIR SINGH, EXAMINING ATTORNEY

SN 85-372,261. NSPHERE, INC., FORMERLY DIRECTORY M, INC., BOSTON, MA. FILED 7-15-2011.

NSPHERE

THE MARK CONSISTS OF STANDARD CHARACTERS WITHOUT CLAIM TO ANY PARTICULAR FONT, STYLE, SIZE, OR COLOR.

CLASS 35—ADVERTISING AND BUSINESS

FOR ADVERTISING SERVICES; COMPILATION OF BUSINESS DIRECTORIES; ON-LINE BUSINESS DIRECTORIES FEATURING HEALTH, LAW, AUTO AND EDUCATION; PROVIDING ONLINE ADVERTISEMENTS; PROVIDING CONSUMER PRODUCT INFORMATION VIA THE INTERNET; PROMOTING THE GOODS AND SERVICES OF OTHERS THROUGH SEARCH ENGINE REFERRAL TRAFFIC ANALYSIS AND REPORTING (U.S. CLS. 100, 101 AND 102).

FIRST USE 5-11-2011; IN COMMERCE 5-11-2011.

CLASS 42—SCIENTIFIC AND COMPUTER SERVICES

FOR PROVISION OF INTERNET SEARCH ENGINES TO LOCATE VENDORS AND PRODUCTS, IN PARTICULAR BY ASSOCIATING MEDIA BRANDS AND RELEVANT EXPERT INFORMATION AND BUYING GUIDES WITH LOCAL SERVICE PROVIDERS, TRADE SHOW ORGANIZERS, EVENT PLANNERS AND RETAILERS AND OTHER LOCAL INFORMATION SOURCES WITH PARTICULAR LOCAL CONSUMER NEEDS (U.S. CLS. 100 AND 101).

FIRST USE 5-11-2011; IN COMMERCE 5-11-2011.

CLASS 45—PERSONAL AND LEGAL SERVICES

FOR PROVIDING ON-LINE INFORMATION ON LAWS AND REGULATIONS IN THE FIELD OF GENERAL LAW (U.S. CLS. 100 AND 101).

FIRST USE 5-11-2011; IN COMMERCE 5-11-2011.

TARAH HARDY, EXAMINING ATTORNEY

SN 85-372,287. NSPHERE, INC., FORMERLY DIRECTORY M, INC., BOSTON, MA. FILED 7-15-2011.



nSphere

THE MARK CONSISTS OF A CIRCLE WITH FUZZY BORDERS AS MIGHT RESULT FROM INK SPLATTER, SURROUNDING A CIRCULAR WHITE SPACE, WITH THE WORD "NSPHERE" APPEARING BELOW.

CLASS 35—ADVERTISING AND BUSINESS

FOR ADVERTISING SERVICES; COMPILATION OF BUSINESS DIRECTORIES; ON-LINE BUSINESS DIRECTORIES FEATURING HEALTH, LAW, AUTO AND EDUCATION; PROVIDING ONLINE ADVERTISEMENTS; PROVIDING CONSUMER PRODUCT INFORMATION VIA THE INTERNET; PROMOTING THE GOODS AND SERVICES OF OTHERS THROUGH SEARCH ENGINE REFERRAL TRAFFIC ANALYSIS AND REPORTING (U.S. CLS. 100, 101 AND 102).
FIRST USE 5-11-2011; IN COMMERCE 5-11-2011.

CLASS 42—SCIENTIFIC AND COMPUTER SERVICES

FOR PROVISION OF INTERNET SEARCH ENGINES TO LOCATE VENDORS AND PRODUCTS, IN PARTICULAR BY ASSOCIATING MEDIA BRANDS AND RELEVANT EXPERT INFORMATION AND BUYING GUIDES WITH LOCAL SERVICE PROVIDERS, TRADE SHOW ORGANIZERS, EVENT PLANNERS AND RETAILERS AND OTHER LOCAL INFORMATION SOURCES WITH PARTICULAR LOCAL CONSUMER NEEDS (U.S. CLS. 100 AND 101).
FIRST USE 5-11-2011; IN COMMERCE 5-11-2011.

CLASS 45—PERSONAL AND LEGAL SERVICES

FOR PROVIDING ON-LINE INFORMATION ON LAWS AND REGULATIONS IN THE FIELD OF GENERAL LAW (U.S. CLS. 100 AND 101).
FIRST USE 5-11-2011; IN COMMERCE 5-11-2011.
TARAH HARDY, EXAMINING ATTORNEY

SN 85-372,401. LIFE CREDIT UNION, NASHVILLE, TN. FILED 7-15-2011.



NO CLAIM IS MADE TO THE EXCLUSIVE RIGHT TO USE "CREDIT UNION", APART FROM THE MARK AS SHOWN.

THE MARK CONSISTS OF A LEAF DESIGN WHICH CONSISTS OF FOUR LEAVES THAT COME TOGETHER INTO A BURST OF LIGHT IN THE CENTER FORMING A CROSS FORMATION SHINING FROM THE CENTER OF THE FOUR LEAVES. THE WORD "LIFE" APPEARS TO THE RIGHT OF THE LEAF DESIGN AND THE WORDS "CREDIT UNION" APPEAR BELOW THE WORD "LIFE". THE WORDS "CREDIT UNION" HAVE LINE ABOVE AND BELOW THEM.

CLASS 9—ELECTRICAL AND SCIENTIFIC APPARATUS

FOR DOWNLOADABLE ELECTRONIC NEWSLETTERS DELIVERED BY E-MAIL IN THE FIELD OF CREDIT UNION SERVICES (U.S. CLS. 21, 23, 26, 36 AND 38).
FIRST USE 4-16-2010; IN COMMERCE 4-16-2010.

CLASS 16—PAPER GOODS AND PRINTED MATTER

FOR NEWSLETTERS IN THE FIELD OF CREDIT UNION SERVICES (U.S. CLS. 2, 5, 22, 23, 29, 37, 38 AND 50).
FIRST USE 4-16-2010; IN COMMERCE 4-16-2010.

CLASS 18—LEATHER GOODS

FOR TOTE BAGS; UMBRELLAS (U.S. CLS. 1, 2, 3, 22 AND 41).
FIRST USE 4-16-2010; IN COMMERCE 4-16-2010.

CLASS 21—HOUSEWARES AND GLASS

FOR CUPS AND MUGS (U.S. CLS. 2, 13, 23, 29, 30, 33, 40 AND 50).
FIRST USE 4-16-2010; IN COMMERCE 4-16-2010.

CLASS 25—CLOTHING

FOR JACKETS; LONG-SLEEVED SHIRTS; POLO SHIRTS; WEARABLE GARMENTS AND CLOTHING, NAMELY, SHIRTS (U.S. CLS. 22 AND 39).
FIRST USE 4-16-2010; IN COMMERCE 4-16-2010.

CLASS 35—ADVERTISING AND BUSINESS

FOR DIRECT MARKETING (U.S. CLS. 100, 101 AND 102).
FIRST USE 4-16-2010; IN COMMERCE 4-16-2010.

CLASS 36—INSURANCE AND FINANCIAL

FOR CREDIT UNION SERVICES; CREDIT UNIONS (U.S. CLS. 100, 101 AND 102).
FIRST USE 4-16-2010; IN COMMERCE 4-16-2010.

CLASS 38—COMMUNICATION

FOR DATA COMMUNICATION BY ELECTRONIC MAIL; ELECTRONIC MAIL (U.S. CLS. 100, 101 AND 104).
FIRST USE 4-16-2010; IN COMMERCE 4-16-2010.
PATRICIA EVANKO, EXAMINING ATTORNEY

SN 85-372,911. HPE DESIGN, LLC, DBA HENNESSEY PERFORMANCE ENGINEERING, SEALY, TX. FILED 7-15-2011.

VelociRaptor

THE MARK CONSISTS OF STANDARD CHARACTERS WITHOUT CLAIM TO ANY PARTICULAR FONT, STYLE, SIZE, OR COLOR.

CLASS 12—VEHICLES

FOR AUTOMOBILES AND AUTOMOTIVE VEHICLE PARTS, NAMELY, BRAKE CYLINDERS, TRANSMISSIONS, AUTOMOBILE ENGINES, SHOCK ABSORBERS, SWAY BARS, WHEEL SPACERS WITH STUDS, BRAKES, STEERING WHEELS AND PARTS THEREOF, NAMELY, COMPONENT PARTS OF STEERING WHEELS, DIFFERENTIALS, FITTED LEATHER CONVERTIBLE TOP COVERS, FOOT RESTS, CLUTCH PRESSURE PLATES AND CLUTCH DISCS, SHORT THROW SHIFTERS, SHOCK TOWER BRACES, GAS PEDALS, GAS PEDAL LINKAGE, FRONT SPOILERS, CLUTCH CABLES, SPOILER GRILLES, LEATHER HEADLINERS, SUN VISORS, DOOR HANDLES, MAP POCKETS, LEATHER COVERED CONSOLE WITH BRAKE HANDLE, HEATED WINDSHIELDS, PLASTIC AND METAL DECORATIVE EXTERIOR TRIMS, AUTOMOTIVE PRODUCTS FOR HIGH PERFORMANCE MODIFICATION RELATING TO ENGINE TUNING, DRIVELINE TUNING, CHASSIS TUNING, AND COMPREHENSIVE TUNING OF MOTOR VEHICLES, NAMELY, SUSPENSION SYSTEMS, BRAKES AND BRAKE HARDWARE ALL FOR INCREASED POWER, FASTER ACCELERATION AND IMPROVED HANDLING; AND INSTRUMENT PANELS FOR AUTOMOBILES, NAMELY, DASHBOARDS (U.S. CLS. 19, 23, 31, 35 AND 44).

FIRST USE 7-1-2003; IN COMMERCE 7-1-2003.

CLASS 37—CONSTRUCTION AND REPAIR

FOR CUSTOMIZING AND MODIFYING AUTOMOTIVE VEHICLES TO CUSTOMERS' SPECIFICATIONS (U.S. CLS. 100, 103 AND 106).

FIRST USE 7-1-2003; IN COMMERCE 7-1-2003.

TINA BROWN, EXAMINING ATTORNEY

SN 85-373,902. T2 BIOSYSTEMS, INC., LEXINGTON, MA. FILED 7-18-2011.



OWNER OF U.S. REG. NOS. 3,839,317, 3,911,373 AND OTHERS.

THE MARK CONSISTS OF SIX (6) CIRCLES AND "T2" IN STYLIZED FORM.

CLASS 1—CHEMICALS

FOR ASSAYS FOR USE IN BIOLOGICAL AND CHEMICAL RESEARCH (U.S. CLS. 1, 5, 6, 10, 26 AND 46).

CLASS 5—PHARMACEUTICALS

FOR DIAGNOSTIC REAGENTS FOR MEDICAL USE; MEDICAL DIAGNOSTIC ASSAYS FOR TESTING BIOLOGICAL FLUIDS; ASSAYS FOR USE IN MEDICAL AND CLINICAL DIAGNOSTICS (U.S. CLS. 6, 18, 44, 46, 51 AND 52).

CLASS 10—MEDICAL APPARATUS

FOR MEDICAL DIAGNOSTIC EQUIPMENT, NAMELY, PORTABLE NUCLEAR MAGNETIC RESONANCE INSTRUMENTS FOR IN VITRO DIAGNOSTICS (U.S. CLS. 26, 39 AND 44).

CLASS 44—MEDICAL, BEAUTY AND AGRICULTURAL SERVICES

FOR MEDICAL DIAGNOSTIC SERVICES (U.S. CLS. 100 AND 101).

TEJBIR SINGH, EXAMINING ATTORNEY

SN 85-373,935. OVERHEAD DOOR CORPORATION, LEWISVILLE, TX. FILED 7-18-2011.



THE COLOR(S) GREEN IS/ARE CLAIMED AS A FEATURE OF THE MARK.

THE MARK CONSISTS OF A GREEN IRREGULAR SHAPED THREE-PRONGED DESIGN COMPRISED OF THREE IRREGULAR SHAPED CIRCLES OF UNEQUAL SIZE WHICH ARE CENTRALLY CONNECTED. TWO IRREGULAR SHAPED CIRCLES APPEAR ON THE TOP AND BOTTOM LEFT OF THE DESIGN AND A THIRD IRREGULAR SHAPED CIRCLE IS ON THE RIGHT BETWEEN THE TWO LEFT CIRCLES.

CLASS 6—METAL GOODS

FOR RESIDENTIAL METAL GARAGE DOORS; DOORS FOR INDUSTRIAL AND COMMERCIAL USE, NAMELY, METAL AUTOMATIC SLIDING DOORS SOLD TOGETHER WITH INTEGRATED ELECTRIC DOOR OPENERS AND CLOSERS, METAL MANUAL SLIDING DOORS SOLD TOGETHER WITH INTEGRATED ELECTRIC DOOR OPENERS AND CLOSERS, METAL AUTOMATIC SWINGING DOORS SOLD TOGETHER WITH INTEGRATED ELECTRIC DOOR OPENERS AND CLOSERS, METAL AUTOMATIC REVOLVING DOORS, METAL MANUAL REVOLVING DOORS, METAL AUTOMATIC SECURITY REVOLVING DOORS SOLD TOGETHER WITH INTEGRATED ELECTRIC DOOR OPENERS AND CLOSERS, METAL MANUAL SECURITY REVOLVING DOORS, METAL AUTOMATIC BIFOLDING DOORS SOLD TOGETHER WITH INTEGRATED ELECTRIC DOOR OPENERS AND CLOSERS; WINDOWS FOR INDUSTRIAL AND COMMERCIAL USE, NAMELY, METAL AUTOMATIC WINDOWS SOLD TOGETHER WITH INTEGRATED ELECTRIC OPENERS AND CLOSERS, METAL MANUAL WINDOWS; METAL DOORS AND STRUCTURAL PARTS THEREOF FOR FREIGHT CARGO CONTAINERS, SAID CONTAINERS TO BE MOUNTED ON TRUCK TRAILERS AND RAILWAY FLAT CARS (U.S. CLS. 2, 12, 13, 14, 23, 25 AND 50).

CLASS 7—MACHINERY

FOR PNEUMATIC DOOR OPERATORS FOR INDUSTRIAL AND COMMERCIAL USE (U.S. CLS. 13, 19, 21, 23, 31, 34 AND 35).

CLASS 9—ELECTRICAL AND SCIENTIFIC APPARATUS

FOR ELECTRONIC RESIDENTIAL AND COMMERCIAL DOOR OPENERS AND OPERATORS, NAMELY, ELECTRONIC DOOR OPERATORS FOR SLIDING DOORS AND ELECTRONIC OPENERS AND CLOSERS FOR WINDOWS, AND ELECTRONIC OPENERS AND CLOSERS FOR SWINGING, REVOLVING AND UPWARD ACTING SECTIONAL AND ROLL-UP DOORS; ELECTRONIC DOOR OPERATORS FOR FIRE DOORS (U.S. CLS. 21, 23, 26, 36 AND 38).

CLASS 12—VEHICLES

FOR DOOR PANELS AND STRUCTURAL PARTS THEREOF FOR LAND VEHICLES, NAMELY, TRUCKS, TRAILERS, APPARATUS FOR OPERATING DOORS FOR VEHICLES, NAMELY, TRUCK DOORS; SKYLIGHTS IN THE NATURE OF AUTOMOBILE SUNROOFS; DOORS FOR INSTALLATION IN OR ON VEHICLES, NAMELY, TRUCKS AND TRAILERS (U.S. CLS. 19, 21, 23, 31, 35 AND 44).

CLASS 19—NON-METALLIC BUILDING MATERIALS

FOR NON-METAL UPWARD ACTING SECTIONAL DOORS FOR GARAGES AND TRUCKS; NON-METAL UPWARD ACTING BARRIERS, NAMELY, ROLLING GRILLES; NON-METAL GARAGE DOORS; NON-METAL DOORS FOR INDUSTRIAL AND COMMERCIAL USE, NAMELY, NON-METAL AUTOMATIC SLIDING DOORS SOLD TOGETHER WITH INTEGRATED ELECTRIC DOOR OPENERS AND CLOSERS, NON-METAL AUTOMATIC SWINGING DOORS SOLD TOGETHER WITH INTEGRATED ELECTRIC DOOR OPENERS AND CLOSERS, NON-METAL AUTOMATIC REVOLVING DOORS SOLD TOGETHER WITH INTEGRATED ELECTRIC DOOR OPENERS AND CLOSERS, NON-METAL MANUAL REVOLVING DOORS, NON-METAL AUTOMATIC SECURITY REVOLVING DOORS SOLD TOGETHER WITH INTEGRATED ELECTRIC DOOR OPENERS AND CLOSERS, NON-METAL MANUAL SECURITY REVOLVING DOORS, NON-METAL AUTOMATIC BIFOLDING DOORS SOLD TOGETHER WITH INTEGRATED ELECTRIC DOOR OPENERS AND CLOSERS; WINDOWS FOR INDUSTRIAL AND COMMERCIAL USE, NAMELY, NON-METAL AUTOMATIC WINDOWS SOLD TOGETHER WITH INTEGRATED ELECTRIC OPENERS AND CLOSERS, NON-METAL MANUAL WINDOWS; NON-METAL DOORS AND STRUCTURAL PARTS THEREOF FOR FREIGHT CARGO CONTAINERS TO BE MOUNTED ON TRUCK TRAILERS AND RAILWAY FLAT CARS; NON-METAL DOORS AND STRUCTURAL PARTS THEREOF FOR FREIGHT CARGO CONTAINERS, SAID CONTAINERS TO BE MOUNTED ON TRUCK TRAILERS AND RAILWAY FLAT CARS (U.S. CLS. 1, 12, 33 AND 50).
JENNIFER WILLISTON, EXAMINING ATTORNEY

SN 85-374,409. JEFFREY RAYMOND HENSON, AUSTIN, TX. FILED 7-18-2011.

MEGANAUT

THE MARK CONSISTS OF STANDARD CHARACTERS WITHOUT CLAIM TO ANY PARTICULAR FONT, STYLE, SIZE, OR COLOR.

CLASS 9—ELECTRICAL AND SCIENTIFIC APPARATUS

FOR AUDIO AND VIDEO RECORDINGS FEATURING MUSIC AND ARTISTIC PERFORMANCES; COMPACT DISCS FEATURING MUSIC; DOWNLOADABLE MUSICAL SOUND RECORDINGS; DOWNLOADABLE RING TONES FOR MOBILE PHONES; DOWNLOADABLE RING TONES, GRAPHICS AND MUSIC VIA A GLOBAL COMPUTER NETWORK AND WIRELESS DEVICES (U.S. CLS. 21, 23, 26, 36 AND 38).
FIRST USE 3-25-2006; IN COMMERCE 3-25-2006.

CLASS 41—EDUCATION AND ENTERTAINMENT

FOR ENTERTAINMENT IN THE NATURE OF VISUAL AND AUDIO PERFORMANCES BY A MUSICAL BAND; ENTERTAINMENT SERVICES IN THE NATURE OF LIVE MUSICAL PERFORMANCES; ENTERTAINMENT SERVICES IN THE NATURE OF RECORDING, PRODUCTION AND POST-PRODUCTION SERVICES IN THE FIELD OF MUSIC (U.S. CLS. 100, 101 AND 107).
FIRST USE 3-25-2006; IN COMMERCE 3-25-2006.
ALLISON SCHRODY, EXAMINING ATTORNEY

SN 85-374,827. DAIMLER AG, STUTTGART, FED REP GERMANY, FILED 7-19-2011.

THE ESSENCE OF PERFORMANCE

THE MARK CONSISTS OF STANDARD CHARACTERS WITHOUT CLAIM TO ANY PARTICULAR FONT, STYLE, SIZE, OR COLOR.

PRIORITY CLAIMED UNDER SEC. 44(D) ON FED REP GERMANY APPLICATION NO. 302011006610, FILED 2-4-2011.

CLASS 12—VEHICLES

FOR AUTOMOBILES AND THEIR STRUCTURAL PARTS (U.S. CLS. 19, 21, 23, 31, 35 AND 44).

CLASS 35—ADVERTISING AND BUSINESS

FOR ADVERTISING SERVICES (U.S. CLS. 100, 101 AND 102).
DAWN FELDMAN, EXAMINING ATTORNEY

SN 85-374,984. THANK GOD FOR LIFE, LLC, GREENVILLE, SC. FILED 7-19-2011.

THANK GOD FOR LIFE

THE MARK CONSISTS OF STANDARD CHARACTERS WITHOUT CLAIM TO ANY PARTICULAR FONT, STYLE, SIZE, OR COLOR.

CLASS 14—JEWELRY

FOR JEWELRY, NAMELY, NECKLACES, BRACELETS, RINGS AND CHARMS, PLASTIC BRACELETS, PENDANTS, EARRINGS, LOCKETS (U.S. CLS. 2, 27, 28 AND 50).

CLASS 18—LEATHER GOODS

FOR TOTE BAGS, BACKPACKS, CARRYING CASES, LEATHER BAGS (U.S. CLS. 1, 2, 3, 22 AND 41).

CLASS 25—CLOTHING

FOR T-SHIRTS, POLO SHIRTS, CASUAL SHIRTS, DRESS SHIRTS, SWEATSHIRTS, SWEAT PANTS, TOPS, PANTS, SHORTS, GYM SHORTS, HATS, VISORS, PULL-OVERS; ONE PIECE GARMENT FOR INFANTS AND TODDLERS; CLOTH BIBS (U.S. CLS. 22 AND 39).

KEVIN DINALLO, EXAMINING ATTORNEY

CLASS 21—HOUSEWARES AND GLASS

FOR MUGS, PLASTIC WATER BOTTLES SOLD EMPTY, TOWELS, CORKSCREWS (U.S. CLS. 2, 13, 23, 29, 30, 33, 40 AND 50).

CLASS 25—CLOTHING

FOR MEN'S AND WOMEN'S CLOTHING, NAMELY, SHIRTS, T-SHIRTS, TANK TOPS, SWEATSHIRTS, SWEATPANTS, WARM-UP SUITS, JACKETS, HATS, AND SCARVES (U.S. CLS. 22 AND 39).

CLASS 26—FANCY GOODS

FOR ORNAMENTAL BUTTONS (U.S. CLS. 37, 39, 40, 42 AND 50).

CLASS 28—TOYS AND SPORTING GOODS

FOR BEACH BALLS (U.S. CLS. 22, 23, 38 AND 50).

CLASS 35—ADVERTISING AND BUSINESS

FOR RETAIL PHARMACY SERVICES (U.S. CLS. 100, 101 AND 102).

CLASS 44—MEDICAL, BEAUTY AND AGRICULTURAL SERVICES

FOR MEDICAL AND DENTAL SERVICES, ADDICTION TREATMENT SERVICES, PSYCHIATRIC SERVICES, MEDICAL COUNSEL AND TESTING SERVICES FOR DIAGNOSTIC OR TREATMENT PURPOSES (U.S. CLS. 100 AND 101).

CLASS 45—PERSONAL AND LEGAL SERVICES

FOR LEGAL CONSULTATION SERVICES (U.S. CLS. 100 AND 101).

KIMBERLY PERRY, EXAMINING ATTORNEY

SN 85-375,084, WHITMAN-WALKER CLINIC, INC., WASHINGTON, DC. FILED 7-19-2011.



OWNER OF U.S. REG. NOS. 3,720,522 AND 3,720,526.

NO CLAIM IS MADE TO THE EXCLUSIVE RIGHT TO USE "HEALTH", APART FROM THE MARK AS SHOWN.

THE MARK CONSISTS OF THE WORDING "WHITMAN-WALKER HEALTH" WITH THE WORDING "COMMUNITY. CARING. QUALITY." UNDERNEATH AND THE DESIGN OF INTERLOCKING TRIANGLES REPRESENTING TWO STYLIZED "W" S ON THE LEFT SIDE OF THE WORDING.

CLASS 9—ELECTRICAL AND SCIENTIFIC APPARATUS

FOR COMPUTER STORAGE DEVICES, NAMELY, BLANK USB FLASH DRIVES; DECORATIVE MAGNETS (U.S. CLS. 21, 23, 26, 36 AND 38).

CLASS 14—JEWELRY

FOR LAPEL PINS (U.S. CLS. 2, 27, 28 AND 50).

CLASS 16—PAPER GOODS AND PRINTED MATTER

FOR PAMPHLETS AND BROCHURES IN THE FIELD OF HEALTH CARE, PAPER BANNERS, POSTERS, STICKERS, BODY TATTOOS, PENS, PICTURES, NOTECARDS, PRINTED EVENT PROGRAMS AND ANNUAL REPORTS, AND CALENDARS (U.S. CLS. 2, 5, 22, 23, 29, 37, 38 AND 50).

CLASS 18—LEATHER GOODS

FOR BRIEFCASE-TYPE PORTFOLIOS (U.S. CLS. 1, 2, 3, 22 AND 41).

CLASS 20—FURNITURE AND ARTICLES NOT OTHERWISE CLASSIFIED

FOR NON-METAL AND NON-LEATHER KEY CHAINS; VINYL BANNERS (U.S. CLS. 2, 13, 22, 25, 32 AND 50).

SN 85-375,746. SUTIONO, EDWIN, PATI, CENTRAL JAVA, INDONESIA, FILED 7-20-2011.



THE COLOR(S) RED, BLACK, WHITE AND GREEN IS/ ARE CLAIMED AS A FEATURE OF THE MARK.

THE MARK CONSISTS OF A RED RABBIT WITH BLACK AND WHITE FEATURES AND A WHITE RABBIT OUTLINED IN BLACK POSITIONED ON TOP OF A BLACK AND WHITE PEANUT, IN FRONT OF A GREEN AND BLACK TREED LANDSCAPE HORIZON AND RED SETTING SUN, OVER TWO RED AND WHITE JUMPING FISH AND INSIDE A RED CIRCLE CONTAINING A WHITE BACKGROUND, OVER THE RED WORDS "DOUBLE-RABBIT" IN STYLIZED SCRIPT.

CLASS 29—MEATS AND PROCESSED FOODS

FOR SECTION 1(B): FRUIT CHIPS; VEGETABLE CHIPS; POTATO CHIPS; POTATO CRISPS; PRESERVED PEAS; PRESERVED FRUITS AND VEGETABLES; PROCESSED FRUITS AND VEGETABLES; PRESERVED FRUIT PEEL; SALTED FRUITS; SALTED VEGETABLES; SALTED FISH; SALTED MEATS; PRESERVED MEATS; PRESERVED FISH; POTATO-BASED SNACK FOODS; NUT-BASED SNACK FOODS, NAMELY, NUT CRISPS; NUT-BASED-SNACK FOODS, NAMELY, NUT CLUSTERS; SECTION 1(A): PROCESSED NUTS; ROASTED NUTS; SALTED NUTS; NUT-BASED SNACK FOODS (U.S. CL. 46).

FIRST USE 0-0-2006; IN COMMERCE 0-0-2006.

CLASS 30—STAPLE FOODS

FOR TAPIOCA CRISPS; CORN-BASED SNACK FOODS (U.S. CL. 46).

TOBY BULLOFF, EXAMINING ATTORNEY

CLASS 36—INSURANCE AND FINANCIAL

FOR ENERGY BROKERAGE SERVICES, NAMELY, ELECTRICITY AND NATURAL GAS; ELECTRICITY BROKERAGE, NAMELY, THE BROKERAGE OF ELECTRIC POWER, BOTH GENERATED INTERNALLY AND PURCHASED FROM ELECTRIC UTILITIES AND FROM OTHER ELECTRIC POWER PRODUCERS, SUPPLIERS AND SOURCES, FOR TRANSFER TO OTHERS; PROVIDING VARIOUS PAYMENT PLANS FOR THE PURCHASE OF ELECTRICITY, NAMELY, ELECTRICITY RATE PLANS; OFFERING SERVICE SUPPORT FOR ELECTRICITY CUSTOMERS, NAMELY, BILL PAYMENT SERVICES, NAMELY, BILL PAYMENT SERVICES; PROVIDING FINANCIAL INFORMATION REGARDING THE ENERGY INDUSTRY AND ENERGY COMMODITIES (U.S. CLS. 100, 101 AND 102).

FIRST USE 9-12-2011; IN COMMERCE 9-12-2011.

CLASS 42—SCIENTIFIC AND COMPUTER SERVICES

FOR PROVIDING TECHNOLOGY INFORMATION REGARDING THE ENERGY INDUSTRY AND ENERGY COMMODITIES (U.S. CLS. 100 AND 101).

FIRST USE 9-12-2011; IN COMMERCE 9-12-2011.

SUE LAWRENCE, EXAMINING ATTORNEY

SN 85-376,261. RELIANT ENERGY RETAIL HOLDINGS, LLC, HOUSTON, TX. FILED 7-20-2011.

SN 85-376,915. R. E. SCHAUB ENTERPRISES, INC., GRAND RAPIDS, MI. FILED 7-21-2011.



OWNER OF U.S. REG. NOS. 2,666,766, 4,029,969 AND OTHERS.

NO CLAIM IS MADE TO THE EXCLUSIVE RIGHT TO USE "COMPANY", APART FROM THE MARK AS SHOWN.

THE MARK CONSISTS OF THE WORD "RELIANT" WITH A DESIGN OF CROSSES LOCATED IN THE UPPER RIGHT CORNER ABOVE THE LETTER "T" AND THE WORDS "AN NRG COMPANY" DIRECTLY BELOW.

CLASS 35—ADVERTISING AND BUSINESS

FOR ENERGY MANAGEMENT SERVICES, NAMELY, PROVIDING A SERVICE THAT ALLOWS CUSTOMERS TO PURCHASE ENERGY; BILLING SERVICES; PROVIDING INFORMATION RESOURCES THAT ASSIST IN REDUCING ENERGY USAGE; PROVIDING INFORMATION REGARDING ENERGY EFFICIENCY AND ENERGY USAGE; COMMERCIAL AND INDUSTRIAL MANAGEMENT ASSISTANCE, NAMELY, CONTROLLING AND MANAGING OF ENERGY USAGE FOR COMMERCIAL, INDUSTRIAL, AND INSTITUTIONAL CUSTOMERS; PROVIDING ON-LINE INFORMATION IN THE FIELD OF ENERGY EFFICIENCY; PROVIDING BUSINESS INFORMATION REGARDING THE ENERGY INDUSTRY AND ENERGY COMMODITIES; PROMOTING PUBLIC AWARENESS OF THE NEED FOR ENVIRONMENTALLY FRIENDLY ENERGY; PROMOTING PUBLIC AWARENESS OF ALTERNATIVE ENERGY GENERATION ALTERNATIVES (U.S. CLS. 100, 101 AND 102).

FIRST USE 9-12-2011; IN COMMERCE 9-12-2011.



THE NAME(S), PORTRAIT(S), AND/OR SIGNATURE(S) SHOWN IN THE MARK IDENTIFIES ROBERT E. "SCHAUB", WHOSE CONSENT(S) TO REGISTER IS MADE OF RECORD.

THE MARK CONSISTS OF A DESIGN COMPRISED OF INTERLOCKING OPPOSING ARCS CONTAINED WITH A RECTANGLE UNDER WHICH THE WORD "SCHAUB" IN STYLIZED FONT IS CENTERED.

CLASS 6—METAL GOODS

FOR CABINET, FURNITURE AND APPLIANCE HARDWARE OF METAL, NAMELY, KNOBS, PULLS, HANDLES, BACKPLATES AND HINGES (U.S. CLS. 2, 12, 13, 14, 23, 25 AND 50).

FIRST USE 1-0-2002; IN COMMERCE 1-0-2002.

CLASS 20—FURNITURE AND ARTICLES NOT OTHERWISE CLASSIFIED

FOR NON-METAL CABINET AND FURNITURE HARDWARE, NAMELY, KNOBS, PULLS AND HANDLES; PRODUCT DISPLAY MERCHANDISERS, TOWERS AND BOARDS (U.S. CLS. 2, 13, 22, 25, 32 AND 50).

FIRST USE 1-0-2002; IN COMMERCE 1-0-2002.

ZACHARY BELLO, EXAMINING ATTORNEY

SN 85-377,281. ABT ASSOCIATES INC., CAMBRIDGE, MA.
FILED 7-21-2011.



OWNER OF U.S. REG. NOS. 3,597,457 AND 3,605,158.
NO CLAIM IS MADE TO THE EXCLUSIVE RIGHT TO USE "ASSOCIATES", APART FROM THE MARK AS SHOWN.

THE COLOR(S) RED AND GRAY IS/ARE CLAIMED AS A FEATURE OF THE MARK.

THE MARK CONSISTS OF THE WORDS "ABT ASSOCIATES" IN RED ENCAPSULATED BY A CIRCULAR SPIRAL COMPRISED OF FOUR BOXES, ONE OF WHICH IS IN RED AND THE REMAINING THREE ARE IN GRAY, THE WORDING "BOLD THINKERS DRIVING REAL-WORLD IMPACT" ARE TO THE RIGHT OF THE BOXES IN GRAY. THE COLOR WHITE IS NOT PART OF THE MARK AND REPRESENTS BACKGROUND OR TRANSPARENT AREAS.

CLASS 35—ADVERTISING AND BUSINESS

FOR BUSINESS CONSULTING AND BUSINESS RESEARCH CONSULTING IN THE FIELDS OF SOCIAL, ECONOMIC, ENVIRONMENTAL AND HEALTH POLICY AND INTERNATIONAL DEVELOPMENT; PUBLIC POLICY CONSULTANCY SERVICES IN THE FIELDS OF ECONOMIC, ENVIRONMENTAL AND HEALTH POLICY AND INTERNATIONAL DEVELOPMENT (U.S. CLS. 100, 101 AND 102).

FIRST USE 5-18-2011; IN COMMERCE 6-13-2011.

CLASS 41—EDUCATION AND ENTERTAINMENT

FOR EDUCATION SERVICES, NAMELY, PROVIDING SEMINARS, WORKSHOPS, CONFERENCES IN THE FIELDS OF HEALTH, SOCIAL AND ENVIRONMENTAL POLICY, INTERNATIONAL DEVELOPMENT, AND SCIENTIFIC RESEARCH (U.S. CLS. 100, 101 AND 107).

FIRST USE 5-18-2011; IN COMMERCE 6-13-2011.

CLASS 42—SCIENTIFIC AND COMPUTER SERVICES

FOR SCIENTIFIC RESEARCH, TECHNICAL CONSULTING IN RELATION TO SCIENTIFIC RESEARCH, AND SCIENTIFIC RESEARCH CONSULTING IN THE FIELDS OF SOCIAL, ECONOMIC, HEALTH POLICY, AND INTERNATIONAL DEVELOPMENT (U.S. CLS. 100 AND 101).

FIRST USE 5-18-2011; IN COMMERCE 6-13-2011.
DEIRDRE ROBERTSON, EXAMINING ATTORNEY

SN 85-378,341. DCVW ACQUISITION CORPORATION, PROVO, UT. FILED 7-22-2011.

FASHION À LA CARTE

THE MARK CONSISTS OF STANDARD CHARACTERS WITHOUT CLAIM TO ANY PARTICULAR FONT, STYLE, SIZE, OR COLOR.

NO CLAIM IS MADE TO THE EXCLUSIVE RIGHT TO USE "FASHION", APART FROM THE MARK AS SHOWN.

CLASS 14—JEWELRY

FOR COSTUME JEWELRY; COSTUME NECKLACES; COSTUME BRACELETS; COSTUME EAR RINGS; COSTUME PENDANTS; COSTUME CHARMS, ALL SOLD IN ARTS AND CRAFT STORES (U.S. CLS. 2, 27, 28 AND 50).

CLASS 16—PAPER GOODS AND PRINTED MATTER

FOR APPLIQUES IN THE NATURE OF STICKERS; IRON-ON DECALS; IRON-ON TRANSFERS (U.S. CLS. 2, 5, 22, 23, 29, 37, 38 AND 50).

CLASS 26—FANCY GOODS

FOR HAIR ACCESSORIES, NAMELY, DECORATIVE CRAFT COMPONENTS IN THE NATURE OF DECORATIVE EMBELLISHMENTS AND ATTACHMENT BANDS USED IN THE FORMATION OF CUSTOMIZED HAIR ORNAMENTS; HAIR CLIPS; HAIR ELASTICS; HAIR BANDS; HAIR ORNAMENTS; HAIR ORNAMENT ACCESSORIES USED IN THE FORMATION OF CUSTOMIZED HAIR ORNAMENTS, NAMELY, ELASTIC BANDS, DECORATIVE ORNAMENTS CONFIGURED TO BE MOUNTED ON ELASTIC BANDS, AND NON-PRECIOUS JEWELS CONFIGURED TO BE MOUNTED ON DECORATIVE ORNAMENTS; HAIR ORNAMENT ACCESSORIES, NAMELY, ARTIFICIAL FLOWERS, CHARMS CONFIGURED TO BE MOUNTED ON ARTIFICIAL FLOWERS, DECORATIVE FABRIC EMBELLISHMENTS, FEATHERS, JEWELS, DECORATIVE ACRYLIC AND METAL CENTERPIECES OR FOCAL PIECES TO BE MOUNTED ON ARTIFICIAL FLOWERS, ATTACHMENT BANDS, AND ELASTIC RIBBON (U.S. CLS. 37, 39, 40, 42 AND 50).

MARK SHINER, EXAMINING ATTORNEY

SN 85-378,447. PRIEFERT MFG. CO., INC., MOUNT PLEASANT, TX. FILED 7-22-2011.



THE MARK CONSISTS OF THE WORD "PRIEFERT" IN STYLIZED FONT WITH A DIAMOND SHAPE OVER THE LETTER "I" AND WHICH IS ABOVE A TRIANGLE DESIGN AND THE WORD "3-POINT" WITH THE NUMBER "3" INSIDE OF THE TRIANGLE.

CLASS 7—MACHINERY

FOR AGRICULTURAL EQUIPMENT TOWED BY OR ATTACHED TO TRACTORS OR ATVS, NAMELY, HARROWS, PLOWS, GROOMERS, TILLERS, GRADERS, SCRAPES, LANDSCAPE RAKES, SEED SPREADERS, SUB SOILERS, CULTIVATORS, MOWERS, SEED PACKERS, BOOM POLES, PALLET FORKS; AGRICULTURAL MACHINERY, NAMELY, PLOWS, HARROWS, GROOMERS, GRADERS, SCRAPES, LANDSCAPE RAKES TOWED BY TRACTORS, TILLERS TOWED BY TRACTORS, CULTIVATORS, MOWERS, SEED PACKERS, DIRT SCOOPERS, ROUND BALE MOVERS, BALE SPIKES, BALE FORKS; PLOWS; HARROWS; POWER-OPERATED LOG SPLITTERS; CHAIN SAWS (U.S. CLS. 13, 19, 21, 23, 31, 34 AND 35).

FIRST USE 5-0-2009; IN COMMERCE 5-0-2009.

CLASS 12—VEHICLES

FOR TRAILER HITCHES; DOLLIES (U.S. CLS. 19, 21, 23, 31, 35 AND 44).

FIRST USE 5-0-2009; IN COMMERCE 5-0-2009.
MICHAEL SOUDERS, EXAMINING ATTORNEY

SN 85-378,459. PRIEFERT MFG. CO., INC., MOUNT PLEASANT, TX. FILED 7-22-2011.

SN 85-380,043. SCORES HOLDING COMPANY INC., NEW YORK, NY. FILED 7-25-2011.

Priefert

THE MARK CONSISTS OF THE WORD "PRIEFERT" IN STYLIZED FONT WITH A DIAMOND SHAPE OVER THE LETTER "I".

CLASS 6—METAL GOODS

FOR METAL LIVESTOCK AND EQUINE HANDLING EQUIPMENT, NAMELY, METAL SQUEEZE CHUTES, CALF TABLES, LOADING CHUTES, CHUTES, STALLS, HEAD GATES, STOCKS, PANELS, PENS, ALLEYS, SWEEPS, BUCKING CHUTES, ROPING CHUTES; METAL LIVESTOCK HANDLING EQUIPMENT, NAMELY, FENCE AND CORRAL PANELS, GATES, TUBULAR FENCING, FENCE POSTS, PLATFORMS, STAIRS, STALLS AND SHELTERS; METAL LIVESTOCK CHUTES AND SWEEPS FOR MOVING AND SORTING CATTLE; METAL CALF TABLES; METAL LIVESTOCK PENS; METAL CORRALS; METAL ARENA KITS COMPRISING METAL SWEEPS, CHUTES, PANELS, PENS, ALLEYS, GATES, FENCES, PANELS, BUCKING CHUTES, ROPING CHUTES; METAL STOCK TURN AND TRAP KITS COMPRISING METAL PENS, ALLEYS AND SWEEPS; METAL CATTLE GUARDS; WIRE FENCES; METAL HORSE STOCKS, NAMELY, NARROW STALLS; ARCHITECTURAL METALWORK; METAL STORAGE SHEDS; HORSE BARN AND SHELTER KITS COMPRISING METAL WALLS, FRAMES, ROOFS, WINDOWS, DOORS, STALLS, STALL DIVIDERS, STALL PANELS, STALL FRONTS, AISLES, FEEDERS, TACK ROOMS, OFFICES, WASH BAYS, AWNINGS, PENS; HORSE ARENA KITS COMPRISING METAL WALL PANELS, PENS, POSTS, GATES AND CHUTES (U.S. CLS. 2, 12, 13, 14, 23, 25 AND 50).

FIRST USE 9-0-1999; IN COMMERCE 9-0-1999.

CLASS 7—MACHINERY

FOR MECHANIZED HORSE WALKERS; MECHANIZED BULL AND HORSE WALKER (U.S. CLS. 13, 19, 21, 23, 31, 34 AND 35).

FIRST USE 7-0-2003; IN COMMERCE 10-0-2003.

CLASS 19—NON-METALLIC BUILDING MATERIALS

FOR HORSE STALL KICK WALLS; NON-METAL FENCE PANELS; NON-METAL GATES AND FENCES (U.S. CLS. 1, 12, 33 AND 50).

FIRST USE 9-0-1999; IN COMMERCE 9-0-1999.

CLASS 20—FURNITURE AND ARTICLES NOT OTHERWISE CLASSIFIED

FOR DOG KENNELS; METAL PET KENNELS (U.S. CLS. 2, 13, 22, 25, 32 AND 50).

FIRST USE 9-0-1999; IN COMMERCE 9-0-1999.

CLASS 21—HOUSEWARES AND GLASS

FOR NON-MECHANIZED ANIMAL FEEDERS; ANIMAL ACTIVATED ANIMAL FEEDERS; ANIMAL ACTIVATED LIVESTOCK FEEDERS (U.S. CLS. 2, 13, 23, 29, 30, 33, 40 AND 50).

FIRST USE 1-0-1990; IN COMMERCE 1-0-1990.

MICHAEL SOUDERS, EXAMINING ATTORNEY



OWNER OF U.S. REG. NOS. 1,830,135, 1,855,829 AND OTHERS.

NO CLAIM IS MADE TO THE EXCLUSIVE RIGHT TO USE "NEW YORK", APART FROM THE MARK AS SHOWN.

THE COLOR(S) RED, TAN, BEIGE AND BLACK IS/ARE CLAIMED AS A FEATURE OF THE MARK.

THE MARK CONSISTS OF THE WORDS "SCORES NEW YORK" WITH THE BLACK SILHOUETTE OF A FEMALE DANCING ON A RED POLE ON TOP OF THE WORD "SCORES". THE WORD "SCORES" APPEARS IN THREE DIMENSIONAL LETTERING WITH TAN AND BEIGE LETTERING AND RED AND BLACK SHADOWING, THE WORDS "NEW YORK" APPEAR IN BLACK.

CLASS 41—EDUCATION AND ENTERTAINMENT

FOR ARRANGING AND CONDUCTING SPECIAL EVENTS FOR SOCIAL ENTERTAINMENT PURPOSES; CONSULTATION IN THE FIELD OF SPECIAL EVENT PLANNING FOR SOCIAL ENTERTAINMENT PURPOSES; ENTERTAINMENT IN THE NATURE OF DANCE PERFORMANCES; ENTERTAINMENT IN THE NATURE OF CONDUCTING TELEVISION VIEWING PARTIES; ENTERTAINMENT SERVICES, NAMELY, CONDUCTING PARTIES; PARTY PLANNING; PARTY PLANNING CONSULTATION (U.S. CLS. 100, 101 AND 107).

CLASS 43—HOTEL AND RESTAURANT SERVICES

FOR BAR AND RESTAURANT SERVICES; COCKTAIL LOUNGE SERVICES (U.S. CLS. 100 AND 101).

CHRISTINA SOBRAL, EXAMINING ATTORNEY

SN 85-380,087. SCORES HOLDING COMPANY INC., NEW YORK, NY. FILED 7-25-2011.



OWNER OF U.S. REG. NOS. 1,830,135, 1,855,829 AND OTHERS.

NO CLAIM IS MADE TO THE EXCLUSIVE RIGHT TO USE "NEW YORK", APART FROM THE MARK AS SHOWN. THE COLOR(S) RED, TAN, BEIGE AND BLACK IS/ARE CLAIMED AS A FEATURE OF THE MARK.

THE MARK CONSISTS OF THE WORDS "SCORES NEW YORK" WITH THE BLACK SILHOUETTE OF A FEMALE DANCING ON A RED POLE TO THE RIGHT OF THE WORDING. THE WORD "SCORES" APPEARS IN THREE DIMENSIONAL LETTERING WITH TAN AND BEIGE LETTERING AND RED AND BLACK SHADOWING, THE WORDS "NEW YORK" APPEAR IN BLACK.

CLASS 41—EDUCATION AND ENTERTAINMENT

FOR ARRANGING AND CONDUCTING SPECIAL EVENTS FOR SOCIAL ENTERTAINMENT PURPOSES; CONSULTATION IN THE FIELD OF SPECIAL EVENT PLANNING FOR SOCIAL ENTERTAINMENT PURPOSES; ENTERTAINMENT IN THE NATURE OF DANCE PERFORMANCES; ENTERTAINMENT IN THE NATURE OF CONDUCTING TELEVISION VIEWING PARTIES; ENTERTAINMENT SERVICES, NAMELY, CONDUCTING PARTIES; PARTY PLANNING; PARTY PLANNING CONSULTATION (U.S. CLS. 100, 101 AND 107).

CLASS 43—HOTEL AND RESTAURANT SERVICES

FOR BAR AND RESTAURANT SERVICES; COCKTAIL LOUNGE SERVICES (U.S. CLS. 100 AND 101).
CHRISTINA SOBRAL, EXAMINING ATTORNEY

SN 85-380,191. 350 FINANCE, LLC, NEW YORK, NY. FILED 7-25-2011.

350 FINANCE

THE MARK CONSISTS OF STANDARD CHARACTERS WITHOUT CLAIM TO ANY PARTICULAR FONT, STYLE, SIZE, OR COLOR.

NO CLAIM IS MADE TO THE EXCLUSIVE RIGHT TO USE "FINANCE", APART FROM THE MARK AS SHOWN.

CLASS 35—ADVERTISING AND BUSINESS

FOR BUSINESS MANAGEMENT SERVICES IN THE FIELD OF RENEWABLE ENERGY (U.S. CLS. 100, 101 AND 102).

CLASS 36—INSURANCE AND FINANCIAL

FOR FINANCIAL SERVICES, NAMELY, INVESTMENT ADVICE, INVESTMENT MANAGEMENT, INVESTMENT CONSULTATION, AND INVESTMENT OF FUNDS FOR OTHERS IN THE FIELD OF RENEWABLE ENERGY; THE PROVISION OF LOANS AND VENTURE CAPITAL FUNDING TO RENEWABLE ENERGY PROJECTS (U.S. CLS. 100, 101 AND 102).

LINDA MICKLEBURGH, EXAMINING ATTORNEY

SN 85-380,728. LAKELAND FINANCE, LLC, CHARLOTTESVILLE, VA. FILED 7-26-2011.



THE MARK CONSISTS OF A CAPITAL "H" WITH ITS HORIZONTAL ELEMENT EXTENDING AND SLIGHTLY CURVING BEYOND THE VERTICAL ELEMENTS.

CLASS 39—TRANSPORTATION AND STORAGE

FOR TRAVEL SERVICES, NAMELY, ARRANGING TOURS, GUIDE SERVICES, ARRANGING FOR TRAVEL DOCUMENTS FOR PERSONS TRAVELING ABROAD AND DOMESTICALLY, TRAVEL BOOKING AGENCY, MAKING RESERVATIONS AND BOOKINGS FOR TRANSPORTATION, PROVIDING TRAVEL INFORMATION, ARRANGING EDUCATIONAL TRIPS FOR STUDENTS, CLUBS, AND ORGANIZATIONS (U.S. CLS. 100 AND 105).

CLASS 41—EDUCATION AND ENTERTAINMENT

FOR EDUCATIONAL SERVICES, NAMELY, ARRANGING AND CONDUCTING PROGRAMS, SEMINARS, WORKSHOPS, COURSES, AND DISTANCE LEARNING PROGRAMS IN THE FIELDS OF SCIENCE, CULTURE, HERITAGE, HISTORY, RELIGION, AND ARTS, OF TRAVEL DESTINATIONS FOR STUDENTS, CLUBS, AND ORGANIZATIONS (U.S. CLS. 100, 101 AND 107).

PRISCILLA MILTON, EXAMINING ATTORNEY

SN 85-380,909. LAKELAND FINANCE, LLC, CHARLOTTESVILLE, VA. FILED 7-26-2011.



THE MARK CONSISTS OF THE UPPER END OF A COLUMN HAVING A HORIZONTAL ARC PASSING THROUGH JUST BELOW THE CAP.

CLASS 39—TRANSPORTATION AND STORAGE

FOR TRAVEL SERVICES, NAMELY, ARRANGING TOURS, GUIDE SERVICES, ARRANGING FOR TRAVEL DOCUMENTS FOR PERSONS TRAVELING ABROAD AND DOMESTICALLY, TRAVEL BOOKING AGENCY, MAKING RESERVATIONS AND BOOKINGS FOR TRANSPORTATION, PROVIDING TRAVEL INFORMATION, ARRANGING EDUCATIONAL TRIPS FOR STUDENTS, CLUBS, AND ORGANIZATIONS (U.S. CLS. 100 AND 105).

CLASS 41—EDUCATION AND ENTERTAINMENT

FOR EDUCATIONAL SERVICES, NAMELY, ARRANGING AND CONDUCTING PROGRAMS, SEMINARS, WORKSHOPS, COURSES, AND DISTANCE LEARNING PROGRAMS IN THE FIELDS OF SCIENCE, CULTURE, HERITAGE, HISTORY, RELIGION, AND ARTS, OF TRAVEL DESTINATIONS FOR STUDENTS, CLUBS, AND ORGANIZATIONS (U.S. CLS. 100, 101 AND 107).
PRISCILLA MILTON, EXAMINING ATTORNEY

SN 85-381,602. ZYNGA INC., SAN FRANCISCO, CA. FILED 7-26-2011.

POKERCON

THE MARK CONSISTS OF STANDARD CHARACTERS WITHOUT CLAIM TO ANY PARTICULAR FONT, STYLE, SIZE, OR COLOR.

CLASS 9—ELECTRICAL AND SCIENTIFIC APPARATUS

FOR COMPUTER GAME SOFTWARE; VIDEO GAME PROGRAMS; AND COMPUTER SOFTWARE PLATFORMS FOR SOCIAL NETWORKING; INTERACTIVE VIDEO GAME PROGRAMS; DOWNLOADABLE ELECTRONIC GAME PROGRAMS AND COMPUTER SOFTWARE PLATFORMS FOR SOCIAL NETWORKING THAT MAY BE ACCESSED VIA THE INTERNET, COMPUTERS AND WIRELESS DEVICES; COMPUTER SOFTWARE TO ENABLE UPLOADING, POSTING, SHOWING, DISPLAYING, TAGGING, BLOGGING, SHARING OR OTHERWISE PROVIDING ELECTRONIC MEDIA OR INFORMATION IN THE FIELDS OF VIRTUAL COMMUNITIES, ELECTRONIC GAMING, ENTERTAINMENT, AND GENERAL INTEREST VIA THE INTERNET OR OTHER COMMUNICATIONS NETWORKS WITH THIRD PARTIES (U.S. CLS. 21, 23, 26, 36 AND 38).

CLASS 41—EDUCATION AND ENTERTAINMENT

FOR ENTERTAINMENT SERVICES, NAMELY, PROVIDING ONLINE COMPUTER AND ELECTRONIC GAMES, ENHANCEMENTS WITHIN ONLINE COMPUTER AND ELECTRONIC GAMES, AND GAME APPLICATIONS WITHIN ONLINE COMPUTER AND ELECTRONIC GAMES; ENTERTAINMENT REVIEWS OF COMPUTER GAMES PROVIDED ONLINE AND INFORMATION RELATING TO COMPUTER GAMES PROVIDED ONLINE; ENTERTAINMENT SERVICES PROVIDED VIA VIRTUAL ENVIRONMENTS IN WHICH USERS CAN INTERACT THROUGH SOCIAL GAMES FOR RECREATIONAL, LEISURE OR ENTERTAINMENT PURPOSES (U.S. CLS. 100, 101 AND 107).
PAUL E. FAHRENKOPF, EXAMINING ATTORNEY

SN 85-382,338. INTERNATIONAL AUTOMOTIVE COMPONENTS GROUP, S.A., LUXEMBOURG, LUXEMBOURG, FILED 7-27-2011.

IAC

THE MARK CONSISTS OF STANDARD CHARACTERS WITHOUT CLAIM TO ANY PARTICULAR FONT, STYLE, SIZE, OR COLOR.
PRIORITY CLAIMED UNDER SEC. 44(D) ON BENELUX APPLICATION NO. 1229765, FILED 7-25-2011, REG. NO. 908672, DATED 1-10-2012, EXPIRES 1-10-2022.

CLASS 12—VEHICLES

FOR INTERIOR TRIM FOR VEHICLES, NAMELY, DECORATIVE AND PROTECTIVE TRIM PIECES; INTERIOR PANELS FOR VEHICLES, NAMELY, DOOR PANELS, OVERHEAD PANELS, BODY PANELS, DASHBOARD PANELS, INSTRUMENT PANELS AND FLOORING PANELS; FITTED DASHBOARD COVERS FOR VEHICLES; FITTED LINERS FOR THE CARGO AREA OF VEHICLES; CARGO STORAGE BINS SPECIALLY ADAPTED FOR USE IN MOTOR VEHICLES; SEMI-FINISHED INJECTION MOLDED PRODUCTS OF PLASTIC FOR USE IN VEHICLES, NAMELY, FLUID RECOVERY BOTTLES, WASHER FLUID BOTTLES, HVAC DUCTS; PLASTIC PARTS FOR VEHICLES, NAMELY, AUTOMOTIVE DECORATIVE AND PROTECTIVE TRIM; UPHOLSTERY FOR VEHICLES (U.S. CLS. 19, 21, 23, 31, 35 AND 44).

CLASS 27—FLOOR COVERINGS

FOR RUBBER MATS, CARPETS, FLOOR MATS, FLOOR COVERINGS, BACKING LAYERS FOR FLOOR MATS, ALL OF THE FORGOING FOR VEHICLES (U.S. CLS. 19, 20, 37, 42 AND 50).

CLASS 40—MATERIAL TREATMENT

FOR MANUFACTURE OF VEHICLE PARTS AND ACCESSORIES FOR OTHERS; PROTOTYPE FABRICATION OF NEW PRODUCTS AND AUTOMOTIVE PARTS AND ACCESSORIES FOR OTHERS; INJECTION MOLDING OF PLASTIC FOR OTHERS; TECHNICAL CONSULTANCY IN THE NATURE OF PROVIDING ADVICE ABOUT HOW TO MANUFACTURE MACHINED GOODS (U.S. CLS. 100, 103 AND 106).

JEFFREY LOOK, EXAMINING ATTORNEY

SN 85-383,315. WILLIAMS, NICOLE, LANSDOWNE, PA. FILED 7-28-2011.



NO CLAIM IS MADE TO THE EXCLUSIVE RIGHT TO USE "EYECARE" AS TO CLASSES 35 AND 44, APART FROM THE MARK AS SHOWN.

THE MARK CONSISTS OF AN "EYE" WITH THE WORD "VIVID" UNDERNEATH, AND "EYECARE" BELOW "VIVID".

SN 85-383,046. NOVOMATIC AG, GUMPOLDSKIRCHEN, AUSTRIA, FILED 7-28-2011.



NO CLAIM IS MADE TO THE EXCLUSIVE RIGHT TO USE "AMERICAN POKER", APART FROM THE MARK AS SHOWN.

THE COLOR(S) RED, WHITE, YELLOW, BLUE, BLACK, DARK RED, BROWN AND GREY IS/ARE CLAIMED AS A FEATURE OF THE MARK.

THE MARK CONSISTS OF THE WORDS "AMERICAN POKER" IN YELLOW WITH BLACK OUTLINE AND SHADOWS, BLUE EDGES, AND WHITE HIGHLIGHTS. IN THE CENTER OF THE MARK IS THE HEAD OF AN EAGLE WITH WHITE, GREY AND BROWN FEATHERS, BLACK AND YELLOW EYE, BLACK AND YELLOW BEAK, AND BLACK SHADOW. UNDERNEATH THE EAGLE IS DISPLAYED A STYLIZED US FLAG IN RED, WHITE AND BLUE, AND DIAMONDS IN THE FORM OF DROPS IN BLUE AND WHITE WITH WHITE STAR-SHAPED HIGHLIGHTS. THE WORDS AND THE EAGLE WITH FLAG ARE FRAMED BY A YELLOW LINE SET WITH FOUR BLUE AND WHITE DIAMONDS SURROUNDED BY YELLOW WITH WHITE HIGHLIGHTS, AND THE BACKGROUND IS A SHIMMERING RED AND DARK RED RECTANGLE.

CLASS 9—ELECTRICAL AND SCIENTIFIC APPARATUS

FOR COMPUTER GAME SOFTWARE FOR GAMES AND GAMING MACHINES, NAMELY, SLOT MACHINES WITH OR WITHOUT VIDEO OUTPUT (U.S. CLS. 21, 23, 26, 36 AND 38).

CLASS 28—TOYS AND SPORTING GOODS

FOR ARCADE GAME MACHINES FOR AMUSEMENT ARCADES; GAMING MACHINES; GAMING MACHINES FOR CASINOS (U.S. CLS. 22, 23, 38 AND 50).

ROBIN MITTLER, EXAMINING ATTORNEY

CLASS 18—LEATHER GOODS

FOR TOTE BAGS (U.S. CLS. 1, 2, 3, 22 AND 41). FIRST USE 9-1-2009; IN COMMERCE 9-1-2009.

CLASS 25—CLOTHING

FOR CLOTHING, NAMELY, SHIRTS AND HATS (U.S. CLS. 22 AND 39). FIRST USE 9-1-2009; IN COMMERCE 9-1-2009.

CLASS 35—ADVERTISING AND BUSINESS

FOR RETAIL OPTICAL STORE SERVICES, MAIL ORDER CATALOG SERVICES, TELEPHONE ORDER SERVICES, AND ONLINE RETAIL OPTICAL STORE SERVICES FEATURING EYEWEAR PRODUCTS, PRESCRIPTION AND NON-PRESCRIPTION EYEGLASSES AND SUNGLASSES, AND CONTACT LENSES AND RELATED PRODUCTS (U.S. CLS. 100, 101 AND 102). FIRST USE 9-1-2009; IN COMMERCE 9-1-2009.

CLASS 44—MEDICAL, BEAUTY AND AGRICULTURAL SERVICES

FOR OPTOMETRY SERVICES (U.S. CLS. 100 AND 101). FIRST USE 9-1-2009; IN COMMERCE 9-1-2009.

PRISCILLA MILTON, EXAMINING ATTORNEY

SN 85-384,210. ELECTRONIC CHECK CLEARING HOUSE ORGANIZATION, DALLAS, TX. FILED 7-29-2011.

ECCHO

THE MARK CONSISTS OF STANDARD CHARACTERS WITHOUT CLAIM TO ANY PARTICULAR FONT, STYLE, SIZE, OR COLOR.

CLASS 9—ELECTRICAL AND SCIENTIFIC APPARATUS

FOR DOWNLOADABLE ELECTRONIC PUBLICATIONS IN THE NATURE OF WHITE PAPERS, SLIDE PRESENTATIONS, PRESENTATION NOTES, DOCUMENT SUMMARIES, AND INFORMATIONAL COURSE MATERIALS, ALL ON THE TOPICS OF FREQUENTLY ASKED QUESTIONS ON THE CHECK PAYMENT INDUSTRY, DESCRIPTIONS AND EXPLANATIONS OF CHECK CLEARING FOR THE 21ST CENTURY ACT AND REGULATION CC, ECCHO RULES, ACTIVITIES AND DECISIONS OF OPERATIONS COMMITTEE, ENDORSEMENT CONSIDERATIONS FOR CHECKS, RETURN CHECK HIERARCHY DECISION STANDARDS, DETECTING AND AVOIDING DUPLICATE PAYMENTS, CHECK 21 ACT SUBSTITUTE CHECK HANDLING, CHECK 21 EXPEDITED RECREDIT REQUIREMENTS AND CONSIDERATIONS, MINIMUM CHECK 21 COMPLIANCE REQUIREMENTS, PROCESSING QUALITY STANDARDS, GREY SCALE AND BLACK AND WHITE IMAGES FOR SUBSTITUTE CHECK STANDARDS, TIFF TAG DISCUSSIONS, BANKING PRACTICES AGREEMENTS, AND INDUSTRY PERSPECTIVES ON CHECK IMAGE EXCHANGE (U.S. CLS. 21, 23, 26, 36 AND 38).

FIRST USE 9-24-1997; IN COMMERCE 9-24-1997.

CLASS 16—PAPER GOODS AND PRINTED MATTER

FOR PRINTED MATERIALS, NAMELY, WHITE PAPERS, HARD COPIES OF SLIDE PRESENTATIONS, PRESENTATION NOTES, INFORMATIONAL COURSE MATERIALS AND DOCUMENT SUMMARIES, ALL ON THE TOPICS OF FREQUENTLY ASKED QUESTIONS ON THE CHECK PAYMENT INDUSTRY, DESCRIPTIONS AND EXPLANATIONS OF CHECK CLEARING FOR THE 21ST CENTURY ACT AND REGULATION CC, ECCHO RULES, ACTIVITIES AND DECISIONS OF OPERATIONS COMMITTEE, ENDORSEMENT CONSIDERATIONS FOR CHECKS, RETURN CHECK HIERARCHY DECISION STANDARDS, DETECTING AND AVOIDING DUPLICATE PAYMENTS, CHECK 21 ACT SUBSTITUTE CHECK HANDLING, CHECK 21 EXPEDITED RECREDIT REQUIREMENTS AND CONSIDERATIONS, MINIMUM CHECK 21 COMPLIANCE REQUIREMENTS, PROCESSING QUALITY STANDARDS, GREY SCALE AND BLACK AND WHITE IMAGES FOR SUBSTITUTE CHECK STANDARDS, TIFF TAG DISCUSSIONS, BANKING PRACTICES AGREEMENTS, AND INDUSTRY PERSPECTIVES ON CHECK IMAGE EXCHANGE (U.S. CLS. 2, 5, 22, 23, 29, 37, 38 AND 50).

FIRST USE 3-3-1992; IN COMMERCE 3-3-1992.

CLASS 35—ADVERTISING AND BUSINESS

FOR BUSINESS CONSULTATION SERVICES ABOUT DEVELOPMENT AND MAINTENANCE OF UNIFORM COMMERCIAL CODE CLEARINGHOUSE RULES TO ALLOCATE LIABILITIES AMONG MEMBER FINANCIAL INSTITUTIONS ENGAGED IN THE INTERBANK COLLECTION, RETURN AND ADJUSTMENT OF CHECK IMAGES; CONSENSUS BUILDING, NAMELY, PROMOTING AWARENESS OF BEST PRACTICES, STANDARDS AND RULES FOR CHECK IMAGES, AMONG ITS MEMBERS, FINANCIAL SERVICES ORGANIZATIONS AND OTHER CHECK PAYMENT INDUSTRY ORGANIZATIONS; PUBLIC ADVOCACY FOR STATUTORY AND REGULATORY CHANGES AT THE STATE AND NATIONAL LEVELS; PROMOTING INDUSTRY AWARENESS IN THE FINANCIAL SERVICES INDUSTRY ON THE ISSUE OF ENHANCED EFFICIENCIES AND REDUCED RISKS IN THE CHECK PAYMENT SYSTEM (U.S. CLS. 100, 101 AND 102).

FIRST USE 3-5-1990; IN COMMERCE 3-5-1990.

CLASS 41—EDUCATION AND ENTERTAINMENT

FOR DEVELOPMENT OF INDUSTRY FILE AND FORMAT STANDARDS FOR THE EXCHANGE OF CHECK IMAGES AND CHECK PAYMENTS (U.S. CLS. 100, 101 AND 107).

FIRST USE 3-3-1992; IN COMMERCE 3-3-1992.
HANNO RITTNER, EXAMINING ATTORNEY

SN 85-384,212. ELECTRONIC CHECK CLEARING HOUSE ORGANIZATION, DALLAS, TX. FILED 7-29-2011.



THE MARK CONSISTS OF THE WORD "ECCHO" APPEARING ABOVE A HEART BEAT SYMBOL WHICH IS SUPERIMPOSED OVER A DIAMOND SHAPE.

CLASS 9—ELECTRICAL AND SCIENTIFIC APPARATUS

FOR DOWNLOADABLE ELECTRONIC PUBLICATIONS IN THE NATURE OF WHITE PAPERS, SLIDE PRESENTATIONS, PRESENTATION NOTES, DOCUMENT SUMMARIES, AND INFORMATIONAL COURSE MATERIALS, ALL ON THE TOPICS OF FREQUENTLY ASKED QUESTIONS ON THE CHECK PAYMENT INDUSTRY, DESCRIPTIONS AND EXPLANATIONS OF CHECK CLEARING FOR THE 21ST CENTURY ACT AND REGULATION CC, ECCHO RULES, ACTIVITIES AND DECISIONS OF OPERATIONS COMMITTEE, ENDORSEMENT CONSIDERATIONS FOR CHECKS, RETURN CHECK HIERARCHY DECISION STANDARDS, DETECTING AND AVOIDING DUPLICATE PAYMENTS, CHECK 21 ACT SUBSTITUTE CHECK HANDLING, CHECK 21 EXPEDITED RECREDIT REQUIREMENTS AND CONSIDERATIONS, MINIMUM CHECK 21 COMPLIANCE REQUIREMENTS, PROCESSING QUALITY STANDARDS, GREY SCALE AND BLACK AND WHITE IMAGES FOR SUBSTITUTE CHECK STANDARDS, TIFF TAG DISCUSSIONS, BANKING PRACTICES AGREEMENTS, AND INDUSTRY PERSPECTIVES ON CHECK IMAGE EXCHANGE (U.S. CLS. 21, 23, 26, 36 AND 38).

FIRST USE 9-24-1997; IN COMMERCE 9-24-1997.

CLASS 16—PAPER GOODS AND PRINTED MATTER

FOR PRINTED MATERIALS, NAMELY, WHITE PAPERS, HARD COPIES OF SLIDE PRESENTATIONS, PRESENTATION NOTES, INFORMATIONAL COURSE MATERIALS AND DOCUMENT SUMMARIES, ALL ON THE TOPICS OF FREQUENTLY ASKED QUESTIONS ON THE CHECK PAYMENT INDUSTRY, DESCRIPTIONS AND EXPLANATIONS OF CHECK CLEARING FOR THE 21ST CENTURY ACT AND REGULATION CC, ECCHO RULES, ACTIVITIES AND DECISIONS OF OPERATIONS COMMITTEE, ENDORSEMENT CONSIDERATIONS FOR CHECKS, RETURN CHECK HIERARCHY DECISION STANDARDS, DETECTING AND AVOIDING DUPLICATE PAYMENTS, CHECK 21 ACT SUBSTITUTE CHECK HANDLING, CHECK 21 EXPEDITED RECREDIT REQUIREMENTS AND CONSIDERATIONS, MINIMUM CHECK 21 COMPLIANCE REQUIREMENTS, PROCESSING QUALITY STANDARDS, GREY SCALE AND BLACK AND WHITE IMAGES FOR SUBSTITUTE CHECK STANDARDS, TIFF TAG DISCUSSIONS, BANKING PRACTICES AGREEMENTS, AND INDUSTRY PERSPECTIVES ON CHECK IMAGE EXCHANGE (U.S. CLS. 2, 5, 22, 23, 29, 37, 38 AND 50).

FIRST USE 3-3-1992; IN COMMERCE 3-3-1992.

CLASS 35—ADVERTISING AND BUSINESS

FOR BUSINESS CONSULTATION SERVICES ABOUT DEVELOPMENT AND MAINTENANCE OF UNIFORM COMMERCIAL CODE CLEARINGHOUSE RULES TO ALLOCATE LIABILITIES AMONG MEMBER FINANCIAL INSTITUTIONS ENGAGED IN THE INTERBANK COLLECTION, RETURN AND ADJUSTMENT OF CHECK IMAGES; CONSENSUS BUILDING, NAMELY, PROMOTING AWARENESS OF BEST PRACTICES, STANDARDS AND RULES FOR CHECK IMAGES, AMONG ITS MEMBERS, FINANCIAL SERVICES ORGANIZATIONS AND OTHER CHECK PAYMENT INDUSTRY ORGANIZATIONS; PUBLIC ADVOCACY FOR STATUTORY AND REGULATORY CHANGES AT THE STATE AND NATIONAL LEVELS; PROMOTING INDUSTRY AWARENESS IN THE FINANCIAL SERVICES INDUSTRY ON THE ISSUE OF ENHANCED EFFICIENCIES AND REDUCED RISKS IN THE CHECK PAYMENT SYSTEM (U.S. CLS. 100, 101 AND 102).

FIRST USE 2-14-1991; IN COMMERCE 2-14-1991.

CLASS 41—EDUCATION AND ENTERTAINMENT

FOR DEVELOPMENT OF INDUSTRY FILE AND FORMAT STANDARDS FOR THE EXCHANGE OF CHECK IMAGES AND CHECK PAYMENTS (U.S. CLS. 100, 101 AND 107).

FIRST USE 3-3-1992; IN COMMERCE 3-3-1992.
HANNO RITTNER, EXAMINING ATTORNEY

SN 85-384,868. MONIER ROOFING COMPONENTS GMBH, OBERURSEL, FED REP GERMANY, FILED 7-29-2011.

EASYFLASH

THE MARK CONSISTS OF STANDARD CHARACTERS WITHOUT CLAIM TO ANY PARTICULAR FONT, STYLE, SIZE, OR COLOR.

OWNER OF ERPN CMNTY TM OFC REG. NO. 009578147, DATED 5-13-2011, EXPIRES 12-7-2020.

CLASS 6—METAL GOODS

FOR METAL BUILDING MATERIALS FOR ROOFING, NAMELY, FLASHING FOR METAL AND NON-METAL ROOFING (U.S. CLS. 2, 12, 13, 14, 23, 25 AND 50).

CLASS 19—NON-METALLIC BUILDING MATERIALS

FOR NON-METALLIC BUILDING MATERIALS FOR ROOFING, NAMELY, FLASHING FOR METAL AND NON-METAL ROOFING (U.S. CLS. 1, 12, 33 AND 50).
JIM RINGLE, EXAMINING ATTORNEY

SN 85-384,897. FIRST CLASS CARE, INC., NORTHBROOK, IL. FILED 7-29-2011.



OWNER OF U.S. REG. NO. 3,464,553.

NO CLAIM IS MADE TO THE EXCLUSIVE RIGHT TO USE "PROFESSIONAL TRAINING FOR DOMESTIC STAFF IN CHICAGO", APART FROM THE MARK AS SHOWN.

THE MARK CONSISTS OF THREE SILHOUETTES ON AN UPWARD ANGLE WITH A STAR AT THE TIP OF THE THIRD SILHOUETTE AND THE WORDS "FIRST CLASS CARE ACADEMY PROFESSIONAL TRAINING FOR DOMESTIC STAFF IN CHICAGO" NEXT TO THE SILHOUETTES.

CLASS 35—ADVERTISING AND BUSINESS

FOR DOMESTIC PLACEMENT SERVICES, NAMELY, JOB PLACEMENT OF CHILDCARE PROFESSIONALS, NANNIES, HOUSEKEEPERS, HOUSE MANAGERS, PERSONAL CHEFS AND OTHER HOUSEHOLD EMPLOYEES (U.S. CLS. 100, 101 AND 102).

CLASS 41—EDUCATION AND ENTERTAINMENT

FOR TRAINING SERVICES IN THE FIELD OF CHILDCARE, COOKING, HOUSEKEEPING, AND CPR (U.S. CLS. 100, 101 AND 107).

ZACHARY BELLO, EXAMINING ATTORNEY

SN 85-386,050. T FARM, LLC, MADISON, WI. FILED 8-1-2011.



NO CLAIM IS MADE TO THE EXCLUSIVE RIGHT TO USE "FARM", "LLC" OR "TOMATOES", APART FROM THE MARK AS SHOWN.

THE MARK CONSISTS OF A SYMBOL OF A TOMATO WITH A SPACE AND RING LABELED "T · FARM LLC", WITH "LLC" ABOVE THE "M", AND A BANNER ACROSS THE BOTTOM CONTAINING THE WORDS "TOMATOES WITH TASTE".

CLASS 29—MEATS AND PROCESSED FOODS

FOR CANNED TOMATOES; DICED TOMATOES; PEELED TOMATOES; TINNED TOMATOES; TOMATO EXTRACTS; TOMATO PASTE; TOMATO PRESERVES; TOMATO PUREE; DRIED TOMATOES; PRESERVED TOMATOES IN VINEGAR (U.S. CL. 46).

FIRST USE 1-28-2011; IN COMMERCE 1-28-2011.

CLASS 30—STAPLE FOODS

FOR TOMATO SAUCE; TOMATO-BASED SALSA; DRIED HERBS; HERBS PRESERVED IN VINEGAR (U.S. CL. 46).

FIRST USE 1-28-2011; IN COMMERCE 1-28-2011.

CLASS 31—NATURAL AGRICULTURAL PRODUCTS

FOR FRESH HERBS; RAW HERBS; FRESH GRAPE CHERRY TOMATOES; FRESH TOMATOES; RAW TOMATOES; UNPROCESSED TOMATOES (U.S. CLS. 1 AND 46).

FIRST USE 1-28-2011; IN COMMERCE 1-28-2011.

CLASS 32—LIGHT BEVERAGES

FOR TOMATO JUICE (U.S. CLS. 45, 46 AND 48).

FIRST USE 1-28-2011; IN COMMERCE 1-28-2011.

MATTHEW PAPPAS, EXAMINING ATTORNEY

SN 85-386,082. M DIAS BRANCO S,A. INDÚSTRIA E COMÉRCIO DE ALIMENTOS, EUSEBIO, CE, BRAZIL, FILED 8-1-2011.



THE COLOR(S) BLACK, WHITE, GOLD, RED, BROWN AND GRAY IS/ARE CLAIMED AS A FEATURE OF THE MARK.

THE MARK CONSISTS OF THE LETTERS "RICHESTER" IN WHITE LETTERS WITH GRAY SHADING AND HAVING A BLACK AND GOLD OUTLINE, SUPERIMPOSED ON A PAIR OF OVERLAPPING HEARTS, NAMELY, A RED HEART HAVING A BLACK AND GOLD BORDER, AND A BROWN HEART HAVING A BLACK AND GOLD BORDER, ALL CONTAINING WHITE SHADING.

CLASS 29—MEATS AND PROCESSED FOODS

FOR POTATO-BASED SNACK FOODS (U.S. CL. 46).

CLASS 30—STAPLE FOODS

FOR BISCUITS; COOKIES; MACARONI; NOODLES; PASTA; RUSKS (U.S. CL. 46).

MATTHEW PAPPAS, EXAMINING ATTORNEY

SN 85-386,224. SIFTEO, INC., SAN FRANCISCO, CA. FILED 8-1-2011.

Blok 9

THE MARK CONSISTS OF STANDARD CHARACTERS WITHOUT CLAIM TO ANY PARTICULAR FONT, STYLE, SIZE, OR COLOR.

CLASS 9—ELECTRICAL AND SCIENTIFIC APPARATUS

FOR MULTIPLE DISTRIBUTED TANGIBLE COMPUTER HARDWARE DEVICES THAT INTERFACE AND RESPOND TO A USER'S PHYSICAL MANIPULATION AND ACT IN CONCERT TO FORM A SINGLE INTERFACE (U.S. CLS. 21, 23, 26, 36 AND 38).

FIRST USE 9-0-2011; IN COMMERCE 9-0-2011.

CLASS 28—TOYS AND SPORTING GOODS

FOR ELECTRONIC TOY COMPRISING MULTIPLE DISTRIBUTED TANGIBLE COMPUTER INTERFACES THAT ARE RESPONSIVE TO A USER'S PHYSICAL MANIPULATION AND ACT IN CONCERT TO FORM A SINGLE INTERFACE; ELECTRONIC ACTION TOY, NAMELY, ELECTRONIC BLOCKS ACTING IN CONCERT TO FORM A COMPUTER INTERFACE; ELECTRONIC LEARNING TOY, NAMELY, ELECTRONIC BLOCKS ACTING IN CONCERT TO FORM A COMPUTER INTERFACE (U.S. CLS. 22, 23, 38 AND 50).

FIRST USE 9-0-2011; IN COMMERCE 9-0-2011.

EDWARD NELSON, EXAMINING ATTORNEY

SN 85-386,275. SIFTEO, INC., SAN FRANCISCO, CA. FILED 8-1-2011.

Booker the Penguin

THE MARK CONSISTS OF STANDARD CHARACTERS WITHOUT CLAIM TO ANY PARTICULAR FONT, STYLE, SIZE, OR COLOR.

CLASS 9—ELECTRICAL AND SCIENTIFIC APPARATUS

FOR MULTIPLE DISTRIBUTED TANGIBLE COMPUTER HARDWARE DEVICES THAT INTERFACE AND RESPOND TO A USER'S PHYSICAL MANIPULATION THAT ACT IN CONCERT TO FORM A SINGLE INTERFACE (U.S. CLS. 21, 23, 26, 36 AND 38).

FIRST USE 9-0-2011; IN COMMERCE 9-0-2011.

CLASS 28—TOYS AND SPORTING GOODS

FOR ELECTRONIC GAME COMPRISING MULTIPLE DISTRIBUTED TANGIBLE COMPUTER INTERFACES THAT ARE RESPONSIVE TO USER PHYSICAL MANIPULATION AND ACT IN CONCERT TO FORM A SINGLE INTERFACE; ELECTRONIC LEARNING TOY, NAMELY, MULTIPLE DISTRIBUTED TANGIBLE COMPUTER INTERFACES IN THE FORM OF BLOCKS; ELECTRONIC ACTION TOY, NAMELY, MULTIPLE DISTRIBUTED TANGIBLE COMPUTER INTERFACES IN THE FORM OF BLOCKS (U.S. CLS. 22, 23, 38 AND 50).

FIRST USE 9-0-2011; IN COMMERCE 9-0-2011.

EDWARD NELSON, EXAMINING ATTORNEY

SN 85-386,369. SIFTEO, INC., SAN FRANCISCO, CA. FILED 8-1-2011.

Do the Sift

THE MARK CONSISTS OF STANDARD CHARACTERS WITHOUT CLAIM TO ANY PARTICULAR FONT, STYLE, SIZE, OR COLOR.

OWNER OF U.S. REG. NO. 4,016,490.

CLASS 9—ELECTRICAL AND SCIENTIFIC APPARATUS

FOR MULTIPLE DISTRIBUTED TANGIBLE COMPUTER HARDWARE DEVICES THAT INTERFACE AND RESPOND TO A USER'S PHYSICAL MANIPULATION AND ACT IN CONCERT TO FORM A SINGLE INTERFACE (U.S. CLS. 21, 23, 26, 36 AND 38).

FIRST USE 9-0-2011; IN COMMERCE 9-0-2011.

CLASS 28—TOYS AND SPORTING GOODS

FOR ELECTRONIC TOY COMPRISING MULTIPLE DISTRIBUTED TANGIBLE COMPUTER INTERFACES THAT ARE RESPONSIVE TO A USER'S PHYSICAL MANIPULATION AND ACT IN CONCERT TO FORM A SINGLE INTERFACE; ELECTRONIC ACTION TOY, NAMELY, MULTIPLE DISTRIBUTED COMPUTER INTERFACES IN THE FORM OF INDIVIDUAL CUBES; ELECTRONIC LEARNING TOY, NAMELY, MULTIPLE DISTRIBUTED COMPUTER INTERFACES IN THE FORM OF INDIVIDUAL CUBES (U.S. CLS. 22, 23, 38 AND 50).

FIRST USE 9-0-2011; IN COMMERCE 9-0-2011.
EDWARD NELSON, EXAMINING ATTORNEY

SN 85-386,409. SIFTEO, INC., SAN FRANCISCO, CA. FILED 8-1-2011.

Gopher Run

THE MARK CONSISTS OF STANDARD CHARACTERS WITHOUT CLAIM TO ANY PARTICULAR FONT, STYLE, SIZE, OR COLOR.

NO CLAIM IS MADE TO THE EXCLUSIVE RIGHT TO USE "GOPHER", APART FROM THE MARK AS SHOWN.

CLASS 9—ELECTRICAL AND SCIENTIFIC APPARATUS

FOR MULTIPLE DISTRIBUTED TANGIBLE COMPUTER HARDWARE DEVICES THAT INTERFACE AND RESPOND TO A USER'S PHYSICAL MANIPULATION AND ACT IN CONCERT TO FORM A SINGLE INTERFACE (U.S. CLS. 21, 23, 26, 36 AND 38).

FIRST USE 9-0-2011; IN COMMERCE 9-0-2011.

CLASS 28—TOYS AND SPORTING GOODS

FOR ELECTRONIC TOY COMPRISING MULTIPLE DISTRIBUTED TANGIBLE COMPUTER INTERFACES THAT ARE RESPONSIVE TO A USER'S PHYSICAL MANIPULATION AND ACT IN CONCERT TO FORM A SINGLE INTERFACE; ELECTRONIC ACTION TOY, NAMELY, ELECTRONIC BLOCKS ACTING IN CONCERT TO FORM A COMPUTER INTERFACE; ELECTRONIC LEARNING TOY, NAMELY, ELECTRONIC BLOCKS ACTING IN CONCERT TO FORM A COMPUTER INTERFACE (U.S. CLS. 22, 23, 38 AND 50).

FIRST USE 9-0-2011; IN COMMERCE 9-0-2011.
EDWARD NELSON, EXAMINING ATTORNEY

SN 85-386,641. SIFTEO, INC., SAN FRANCISCO, CA. FILED 8-2-2011.

No Evil Monkeys

THE MARK CONSISTS OF STANDARD CHARACTERS WITHOUT CLAIM TO ANY PARTICULAR FONT, STYLE, SIZE, OR COLOR.

CLASS 9—ELECTRICAL AND SCIENTIFIC APPARATUS

FOR MULTIPLE DISTRIBUTED TANGIBLE COMPUTER INTERFACES RESPONSIVE TO A USER'S PHYSICAL MANIPULATION THAT ACT IN CONCERT TO FORM A SINGLE INTERFACE (U.S. CLS. 21, 23, 26, 36 AND 38).

FIRST USE 9-0-2011; IN COMMERCE 9-0-2011.

CLASS 28—TOYS AND SPORTING GOODS

FOR ELECTRONIC GAME COMPRISING MULTIPLE DISTRIBUTED TANGIBLE COMPUTER INTERFACES RESPONSIVE TO USER PHYSICAL MANIPULATION OF ONE OR MORE OF SAID USER INTERFACES; ELECTRONIC TOY COMPRISING MULTIPLE DISTRIBUTED TANGIBLE COMPUTER INTERFACES THAT RESPONSIVE TO A USER'S PHYSICAL MANIPULATION ACT IN CONCERT TO FORM A SINGLE INTERFACE (U.S. CLS. 22, 23, 38 AND 50).

FIRST USE 9-0-2011; IN COMMERCE 9-0-2011.
EDWARD NELSON, EXAMINING ATTORNEY

SN 85-386,645. SIFTEO, INC., SAN FRANCISCO, CA. FILED 8-2-2011.

Oogor's Day

THE MARK CONSISTS OF STANDARD CHARACTERS WITHOUT CLAIM TO ANY PARTICULAR FONT, STYLE, SIZE, OR COLOR.

CLASS 9—ELECTRICAL AND SCIENTIFIC APPARATUS

FOR MULTIPLE DISTRIBUTED TANGIBLE COMPUTER HARDWARE DEVICES THAT INTERFACE AND RESPOND TO A USER'S PHYSICAL MANIPULATION AND ACT IN CONCERT TO FORM A SINGLE INTERFACE (U.S. CLS. 21, 23, 26, 36 AND 38).

FIRST USE 9-0-2011; IN COMMERCE 9-0-2011.

CLASS 28—TOYS AND SPORTING GOODS

FOR ELECTRONIC TOY COMPRISING MULTIPLE DISTRIBUTED TANGIBLE COMPUTER INTERFACES THAT ARE RESPONSIVE TO A USER'S PHYSICAL MANIPULATION AND ACT IN CONCERT TO FORM A SINGLE INTERFACE; ELECTRONIC ACTION TOY, NAMELY, AN ELECTRONIC BLOCKS ACTING IN CONCERT TO FORM A COMPUTER INTERFACE IN THE FORM OF A STORYTELLING AND ADVENTURE GAME (U.S. CLS. 22, 23, 38 AND 50).

FIRST USE 9-0-2011; IN COMMERCE 9-0-2011.
EDWARD NELSON, EXAMINING ATTORNEY

SN 85-388,169. RECOLOGY INC., SAN FRANCISCO, CA. FILED 8-3-2011.

為明天廢盡其用

THE MARK CONSISTS OF THE CHINESE CHARACTERS WHICH FORM THE WORDS "MAXIMIZE THE POTENTIAL OF WASTE FOR TOMORROW".

THE NON-LATIN CHARACTERS IN THE MARK TRANSLITERATE TO "WEI MING TIAN FEI JIN QI YONG" AND THIS MEANS "MAXIMIZE THE POTENTIAL OF WASTE FOR TOMORROW" IN ENGLISH.

CLASS 37—CONSTRUCTION AND REPAIR

FOR SOLID WASTE MANAGEMENT, NAMELY, WASTE DISPOSAL; WASTE DISPOSAL FOR OTHERS; TRASH COLLECTION, REFUSE CLEAN-UP (U.S. CLS. 100, 103 AND 106).

CLASS 39—TRANSPORTATION AND STORAGE

FOR TRANSPORTING WASTE BY TRUCK; GARBAGE COLLECTION AND TRANSPORT BY TRUCK; RENTAL OF DUMPSTERS (U.S. CLS. 100 AND 105).

CLASS 40—MATERIAL TREATMENT

FOR WASTE MANAGEMENT, NAMELY, RECYCLING AND WASTE TREATMENT SERVICES; SORTING OF WASTE AND RECYCLABLE MATERIAL; RECYCLING; SORTING PLASTICS, PAPER, CARDBOARD, GLASS AND METAL; RECYCLING OF WASTE AND TRASH (U.S. CLS. 100, 103 AND 106).

CLASS 41—EDUCATION AND ENTERTAINMENT

FOR DEVELOPING AND CONDUCTING EDUCATIONAL PROGRAMS FOR USE BY OTHERS IN PROMOTING ENVIRONMENTAL AWARENESS AND RECYCLING ISSUES DIRECTED TO THE COMMUNITY, BUSINESSES AND SCHOOLS (U.S. CLS. 100, 101 AND 107).

LINDA ESTRADA, EXAMINING ATTORNEY

SN 85-389,486. THE BEST OF ORGANIC LLC, WEST BLOOMFIELD, MI. FILED 8-4-2011.

SKINNYSMART

THE MARK CONSISTS OF STANDARD CHARACTERS WITHOUT CLAIM TO ANY PARTICULAR FONT, STYLE, SIZE, OR COLOR.

CLASS 9—ELECTRICAL AND SCIENTIFIC APPARATUS

FOR DIGITAL MEDIA, NAMELY, PRE-RECORDED VIDEO CASSETTES, DIGITAL VIDEO DISCS, DIGITAL VERSATILE DISCS, DOWNLOADABLE AUDIO AND VIDEO RECORDINGS, DVDS, AND HIGH DEFINITION DIGITAL DISCS FEATURING HEALTH, NUTRITION AND LIFESTYLE INFORMATION AND INSTRUCTION (U.S. CLS. 21, 23, 26, 36 AND 38).

CLASS 16—PAPER GOODS AND PRINTED MATTER

FOR BOOKS IN THE FIELD OF HEALTH, NUTRITION, AND LIFESTYLE (U.S. CLS. 2, 5, 22, 23, 29, 37, 38 AND 50).

CLASS 44—MEDICAL, BEAUTY AND AGRICULTURAL SERVICES

FOR PROVIDING A WEBSITE FEATURING INFORMATION ABOUT HEALTH AND WELLNESS, NAMELY, HEALTH, NUTRITION, AND LIFESTYLE WELLNESS INFORMATION (U.S. CLS. 100 AND 101).

SUSAN LESLIE DUBOIS, EXAMINING ATTORNEY

SN 85-390,040. KANGLE FOOD INC., FLUSHING, NY. FILED 8-4-2011.



THE COLOR(S) DARK GREEN, LIGHT GREEN AND WHITE IS/ARE CLAIMED AS A FEATURE OF THE MARK.

THE MARK CONSISTS OF CONCENTRIC CIRCLES OF VARYING THICKNESS AND PATTERN; A BANNER COVERING THE LOWER PART OF THE CONCENTRIC CIRCLES. THE BANNER IS LIGHT AND DARK GREEN, AND CONSISTS OF TWO WHITE LINES, ONE NEAR THE TOP EDGE AND THE OTHER NEAR THE BOTTOM EDGE; IN THE CENTER OF THE BANNER LIES TWO TRADITIONAL CHINESE CHARACTERS IN WHITE; THE BANNER ENTIRELY COVERS THE BOTTOM PARTS OF THE INNER MOST TWO CIRCLES, AND PARTIALLY COVERS THE BOTTOM PARTS OF THE OUTER FOUR CIRCLES. THE OUTER MOST CIRCLE CONSISTS OF A LIGHT GREEN

ZIGZAG EDGE; THE SECOND CIRCLE CONSISTS OF A DARK GREEN THIN LINE; THE THIRD CIRCLE CONSISTS OF A WHITE THICK LINE; THE FOURTH CIRCLE CONSISTS OF A THICK DARK GREEN BAND; THE FIFTH CIRCLE CONSISTS OF A THIN WHITE LINE THAT IS THICKER THAN THE THIRD WHITE CIRCLE; THE SIXTH CIRCLE CONSISTS OF A LIGHT GREEN LINE THAT IS THE SAME THICKNESS WITH THE THIRD WHITE CIRCLE. IN THE TOP PART OF THE FOURTH CIRCLE LIES A WORD "KANGLE" AND TWO LEAVES ON BOTH ENDS OF "KANGLE"; "KANGLE" IS WHITE AND ITS BOTTOM EDGE COMPLETELY ATTACHES TO THE TOP EDGE OF THE FIFTH CIRCLE; THE LEAVES ARE WHITE WITH DARK GREEN CENTER LINE. WITHIN THE SIXTH CIRCLE IS WHITE BACKGROUND. IN THE CENTER OF SUCH WHITE BACKGROUND, AND ON TOP OF THE BANNER, LIES A VEGETABLE ICON THAT IS DARK GREEN, LIGHT GREEN AND WHITE.

THE NON-LATIN CHARACTERS IN THE MARK TRANSLITERATE TO "KANGLE" AND THIS MEANS HEALTHY, HAPPY IN ENGLISH.

CLASS 29—MEATS AND PROCESSED FOODS

FOR PROCESSED SOY BEANS (U.S. CL. 46).

CLASS 30—STAPLE FOODS

FOR BEAN-STARCH NOODLES (HARUSAME, UNCOOKED); CHINESE RICE NOODLES (BIFUN, UNCOOKED); PROCESSED CORN (U.S. CL. 46).
PAUL MORENO, EXAMINING ATTORNEY

SN 85-390,306. GLEBAR COMPANY, INC, FRANKLIN LAKES, NJ. FILED 8-5-2011.

Glebar

THE MARK CONSISTS OF STANDARD CHARACTERS WITHOUT CLAIM TO ANY PARTICULAR FONT, STYLE, SIZE, OR COLOR.

CLASS 7—MACHINERY

FOR CENTRIFUGAL GRINDING MACHINES; COMPONENTS FOR MACHINES AND MACHINE TOOLS, GRINDING MACHINES, MATERIAL HANDLING MACHINES, FOOD PROCESSING MACHINES, CHEMISTRY PROCESSING MACHINES AND TEXTILE INDUSTRY MACHINES, NAMELY, SAND, CHEMICAL AND REVERSE OSMOSIS FILTERS; GRINDING AND POLISHING MACHINES; GRINDING MACHINES; GRINDING MACHINES FOR THE TREATMENT OF CERAMICS AND METAL; GRINDING MACHINES FOR MEDICAL DEVICE EQUIPMENT DESIGNED FOR MEDICAL DEVICE PRECISION GRINDING AND GAUGING, GLASS MATERIAL PRODUCTION GRINDING, METAL WORKING, CERAMIC MATERIAL FORMING AND FINISHING; COMPOSITE MATERIAL PRECISION FORMING AND FINISHING; RUBBER MATERIAL PRECISION FORMING AND FINISHING; WOOD PRECISION FORM GRINDING; PLASTIC MATERIALS PRECISION GRINDING AND FINISHING MACHINES; GRINDING MACHINES WITH SPIRAL BEVEL GEARS; GRINDING TOOLS FOR GRINDING MACHINES; INTERNAL GRINDING MACHINES; INVOLUTE GRINDING MACHINES; POLISHING MACHINES FOR USE IN GRINDING AND POLISHING METAL, WOOD, CERAMICS AND PLASTICS; POLISHING SYSTEM FOR USE IN SINGLE-HEAD MACHINES COMPRISING GRINDING AND POLISHING DISCS FOR STONE PROFILING AND EDGES; POWER-OPERATED GRINDING WHEELS; POWER-OPERATED GRINDING WHEELS FOR OPTICAL LENS GRINDING; WOOD GRINDING MACHINES (U.S. CLS. 13, 19, 21, 23, 31, 34 AND 35).

FIRST USE 4-1-1958; IN COMMERCE 4-1-1958.

CLASS 40—MATERIAL TREATMENT

FOR APPLYING FINISHES TO METAL, CERAMIC, WOOD, RUBBER, COMPOSITE MATERIALS, GLASS AND MEDICAL DEVICES.; CUSTOM BUILDING OF TOOLS AND COMPONENTS FOR METAL, CERAMIC, WOOD, RUBBER, COMPOSITE MATERIALS, GLASS AND MEDICAL DEVICE MANUFACTURE AND WORKING; CUSTOM FABRICATION AND PRODUCTION OF METAL, CERAMIC, WOOD, RUBBER, COMPOSITE MATERIALS, GLASS AND MEDICAL DEVICES; CUSTOM MANUFACTURE OF TOOLS AND COMPONENTS FOR METAL, CERAMIC, WOOD, RUBBER, COMPOSITE MATERIALS, GLASS AND MEDICAL DEVICE MANUFACTURE AND WORKING; GRINDING; MANUFACTURE OF TOOLS AND COMPONENTS FOR METAL, CERAMIC, WOOD, RUBBER, COMPOSITE MATERIALS, GLASS AND MEDICAL DEVICES; GLASS AND MEDICAL DEVICE MANUFACTURE AND WORKING TO ORDER AND/OR SPECIFICATION OF OTHERS; MANUFACTURING SERVICES FOR OTHERS IN THE FIELD OF TOOLS AND COMPONENTS FOR METAL, CERAMIC, WOOD, RUBBER, COMPOSITE MATERIALS, GLASS AND MEDICAL DEVICE MANUFACTURE AND WORKING; METAL FABRICATION AND FINISHING SERVICES (U.S. CLS. 100, 103 AND 106).

FIRST USE 4-1-1958; IN COMMERCE 4-1-1958.

CLASS 42—SCIENTIFIC AND COMPUTER SERVICES

FOR ENGINEERING SERVICES IN THE FIELD OF DEVELOPMENT OF TOOLS AND COMPONENTS FOR METAL, CERAMIC, WOOD, RUBBER, COMPOSITE MATERIALS, GLASS AND MEDICAL DEVICE MANUFACTURE AND WORKING; ENGINEERING SERVICES, NAMELY, ENGINEERING FOR THE DEVELOPMENT OF TOOLS AND COMPONENTS FOR METAL, CERAMIC, WOOD, RUBBER, COMPOSITE MATERIALS, GLASS AND MEDICAL DEVICE MANUFACTURE AND WORKING; PRODUCT DEVELOPMENT AND ENGINEERING SERVICES FOR OTHERS; TESTING, ANALYSIS AND EVALUATION OF METAL TOOLS, MACHINERY AND FABRICATION EQUIPMENT; TOOL DESIGN; TOOL MANAGEMENT SYSTEMS DESIGN SERVICES (U.S. CLS. 100 AND 101).

FIRST USE 4-1-1958; IN COMMERCE 4-1-1958.
FONG HSU, EXAMINING ATTORNEY

SN 85-390,739. DIMENSIONU, INC., LONG ISLAND CITY, NY. FILED 8-5-2011.

EDCREDS

THE MARK CONSISTS OF STANDARD CHARACTERS WITHOUT CLAIM TO ANY PARTICULAR FONT, STYLE, SIZE, OR COLOR.

CLASS 36—INSURANCE AND FINANCIAL

FOR PROVIDING FANTASY VIRTUAL MONEY FOR USE BY MEMBERS OF AN ONLINE COMMUNITY IN CONNECTION WITH A DESIGNATED WEBSITE FEATURING ONLINE GAMES (U.S. CLS. 100, 101 AND 102).

CLASS 41—EDUCATION AND ENTERTAINMENT

FOR ENTERTAINMENT SERVICES, NAMELY, PROVIDING ONLINE COMPUTER GAMES (U.S. CLS. 100, 101 AND 107).
TRACY WHITTAKER-BROWN, EXAMINING ATTORNEY

SN 85-393,074. FX INITIATIVE, LLC, CHICAGO, IL. FILED 8-9-2011.

FX Initiative

THE MARK CONSISTS OF STANDARD CHARACTERS WITHOUT CLAIM TO ANY PARTICULAR FONT, STYLE, SIZE, OR COLOR.

NO CLAIM IS MADE TO THE EXCLUSIVE RIGHT TO USE "FX", APART FROM THE MARK AS SHOWN.

CLASS 36—INSURANCE AND FINANCIAL

FOR PROVIDING FINANCIAL SERVICES IN THE FIELD OF FOREIGN EXCHANGE RISK MANAGEMENT, NAMELY, PROVIDING INFORMATION ABOUT THE RISK INVOLVED WITH THE FLUCTUATION OF FOREIGN EXCHANGE RATES AND CONSULTING WITH OTHERS REGARDING FOREIGN EXCHANGE TRANSACTIONS, THE FOREGOING FOR THE PURPOSE OF ENABLING INDIVIDUALS, BUSINESSES, AND GOVERNMENTS TO UNDERSTAND, ANALYZE, AND MITIGATE FOREIGN CURRENCY RISK (U.S. CLS. 100, 101 AND 102).

CLASS 41—EDUCATION AND ENTERTAINMENT

FOR PROVIDING A WEBSITE FEATURING EDUCATIONAL CONTENT IN THE NATURE OF WEBINARS AND CLASSES IN THE FIELD OF FOREIGN EXCHANGE RISK MANAGEMENT (U.S. CLS. 100, 101 AND 107).

CLASS 42—SCIENTIFIC AND COMPUTER SERVICES

FOR PROVIDING CALCULATION AND ANALYSIS TOOLS IN THE FIELD OF FOREIGN EXCHANGE RISK MANAGEMENT, NAMELY, PROVIDING TEMPORARY USE OF NON-DOWNLOADABLE COMPUTER SOFTWARE THAT ALLOWS USERS TO CALCULATE AND ANALYZE FOREIGN EXCHANGE RATES AND DATA, THE FOREGOING FOR THE PURPOSE OF ENABLING INDIVIDUALS, BUSINESSES, AND GOVERNMENTS TO UNDERSTAND, ANALYZE, AND MITIGATE FOREIGN CURRENCY RISK (U.S. CLS. 100 AND 101).

NANCY CLARKE, EXAMINING ATTORNEY

SN 85-393,117. REAL ESTATE CENTERS OF AMERICA LLC, FORMERLY REAL ESTATE CENTER, INC., SPEARFISH, SD. FILED 8-9-2011.



NO CLAIM IS MADE TO THE EXCLUSIVE RIGHT TO USE "THE REAL ESTATE CENTER", APART FROM THE MARK AS SHOWN.

THE COLOR(S) GREEN, YELLOW, WHITE, AND LIGHT GREEN IS/ARE CLAIMED AS A FEATURE OF THE MARK.

THE MARK CONSISTS OF A WHITE STRUCTURE THAT HAS PILLARS WITH A WHITE ROOF. WITHIN THE STRUCTURE IS A GREEN BACKGROUND WITH YELLOW LETTERING THAT READS "THE REAL ESTATE CENTER". EVERYTHING LISTED ABOVE IS SURROUNDED BY A LIGHT GREEN BOX WITH THE PEAK OF THE ROOF FROM THE STRUCTURE SLIGHTLY GOING ABOVE THE LIGHT GREEN BOX.

CLASS 35—ADVERTISING AND BUSINESS

FOR ADVERTISING OF COMMERCIAL OR RESIDENTIAL REAL ESTATE; MATCHING CONSUMERS WITH REAL ESTATE PROFESSIONALS IN THE FIELD OF REAL ESTATE SERVICES VIA COMPUTER NETWORK; NEGOTIATION AND RENEGOTIATION FOR OTHERS OF LEASES AND SUBLEASES AND REAL ESTATE PURCHASE AGREEMENTS; PROVIDING AN INTERACTIVE REAL ESTATE WEBSITE WHICH PROMOTES HOUSING AND APARTMENT PROPERTIES THROUGH OFFERING PROSPECTIVE TENANTS VIDEO WALK THROUGHS, PROPERTY DESCRIPTIONS, TEXT, PRICE, LOCATION, MAPS AND OTHER INFORMATION THAT WOULD BE INFLUENTIAL TO A PROSPECTIVE TENANT IN MAKING A RENTAL DECISION; PROVIDING BUSINESS PLANNING AND MARKETING SOLUTIONS FOR REAL ESTATE PROFESSIONALS; PROVIDING REAL ESTATE LEADS FOR PROSPECTIVE PURCHASERS; PROVIDING REAL ESTATE VIDEO TOURS FOR MARKETING PURPOSES; REAL ESTATE ADVERTISING SERVICES; REAL ESTATE MARKETING ANALYSIS; REAL ESTATE MARKETING SERVICES IN THE FIELD OF RESIDENTIAL, COMMERCIAL, AND LAND; REAL ESTATE MARKETING SERVICES, NAMELY, ON-LINE SERVICES FEATURING TOURS OF RESIDENTIAL AND COMMERCIAL REAL ESTATE; REAL ESTATE SALES MANAGEMENT (U.S. CLS. 100, 101 AND 102).

FIRST USE 2-14-1992; IN COMMERCE 2-14-1992.

CLASS 36—INSURANCE AND FINANCIAL

FOR COMMERCIAL AND RESIDENTIAL REAL ESTATE AGENCY SERVICES; EVALUATION OF REAL PROPERTY; FINANCIAL VALUATION OF PERSONAL PROPERTY AND REAL ESTATE; LAND ACQUISITION, NAMELY, REAL ESTATE BROKERAGE; PROVIDING A DATABASE OF INFORMATION ABOUT RESIDENTIAL REAL ESTATE LISTINGS IN DIFFERENT NEIGHBORHOODS AND COMMUNITIES; PROVIDING A DATABASE OF RESIDENTIAL REAL ESTATE LISTINGS WITHIN NEIGHBORHOODS AND COMMUNITIES SPECIFICALLY IDENTIFIED BY USERS; PROVIDING AN INTERNET WEBSITE PORTAL OFFERING INFORMATION IN THE FIELDS OF REAL ESTATE CONCERNING THE PURCHASE AND SALE OF NEW AND RESALE HOMES AND CONDOS; PROVIDING INFORMATION IN THE FIELD OF REAL ESTATE BY MEANS OF LINKING THE WEB SITE TO OTHER WEB SITES FEATURING REAL ESTATE INFORMATION; PROVIDING INFORMATION IN THE FIELD OF REAL ESTATE VIA THE INTERNET; PROVIDING REAL ESTATE LISTINGS AND REAL ESTATE INFORMATION VIA THE INTERNET; PROVIDING REAL ESTATE LISTINGS VIA THE INTERNET; REAL ESTATE ACQUISITION SERVICES; REAL ESTATE AGENCIES; REAL ESTATE APPRAISAL AND VALUATION; REAL ESTATE BROKERAGE; REAL ESTATE CONSULTANCY; REAL ESTATE CONSULTATION; REAL ESTATE ESCROW SERVICES; REAL ESTATE FINANCING SERVICES; REAL ESTATE INVESTMENT SERVICES IN THE NATURE OF PURCHASING AND SELLING OF REAL ESTATE FOR OTHERS; REAL ESTATE LISTING; REAL ESTATE MANAGEMENT SERVICES; REAL ESTATE MULTIPLE LISTING SERVICES; REAL ESTATE RENTAL SERVICES, NAMELY, RENTAL OF RESIDENTIAL HOUSING; REAL ESTATE SERVICES IN THE FORM OF PROVIDING PHYSICAL ACCESS TO AVAILABLE PROPERTIES VIA A REMOTE CALL-IN LOCKING DEVICE; REAL ESTATE SERVICES, NAMELY, RENTAL, BROKERAGE, LEASING AND MANAGEMENT OF COMMERCIAL PROPERTY, OFFICES AND OFFICE SPACE; REAL ESTATE VALUATION SERVICES; REAL ESTATE VALUATIONS; RESIDENTIAL REAL ESTATE AGENCY SERVICES; VALUATIONS IN REAL ESTATE MATTERS (U.S. CLS. 100, 101 AND 102).

FIRST USE 2-14-1992; IN COMMERCE 2-14-1992.
ROBERT STRUCK, EXAMINING ATTORNEY

SN 85-393,969. TUNG CHUN (IP) HOLDINGS LIMITED,
CENTRAL, HONG KONG, FILED 8-10-2011.

TONG ZHEN

THE MARK CONSISTS OF STANDARD CHARACTERS WITHOUT CLAIM TO ANY PARTICULAR FONT, STYLE, SIZE, OR COLOR.

PRIORITY CLAIMED UNDER SEC. 44(D) ON HONG KONG APPLICATION NO. 301992718, FILED 8-3-2011.

OWNER OF HONG KONG REG. NO. 301992718, DATED 8-3-2011, EXPIRES 8-3-2021.

THE ENGLISH TRANSLATION OF THE INDIVIDUAL TERM "TONG" IN THE MARK IS SAME AND THE ENGLISH TRANSLATION OF THE INDIVIDUAL TERM "ZHEN" IN THE MARK IS TREASURE.

CLASS 29—MEATS AND PROCESSED FOODS

FOR MEAT, FISH, POULTRY AND GAME; MEAT EXTRACTS; PRESERVED PRUNE; PROCESSED SALTED LEMON; PROCESSED SALTED BLACK BEANS; PRESERVED SWEET WHITE CUCUMBER; PICKLED ONION; PICKLED PLUMS; PICKLED PEACH; PICKLES; PRESERVED, PROCESSED, FROZEN, DRIED AND COOKED FRUITS AND VEGETABLES, INSTANT PREPARED VEGETABLES, PROCESSED NUTS; JELLIES, JAMS, COMPOTES; EGGS, MILK AND MILK PRODUCTS EXCLUDING ICE CREAM, ICE MILK AND FROZEN YOGURT; OLIVE OIL; SESAME OIL; EDIBLE OILS AND FATS; CANNED SEAFOOD; CANNED BEANS, FISH, FRUITS AND PORK; BEAN CURD; FERMENTED BEAN CURD; RED BEAN CURD; PRODUCTS MADE FROM BEAN CURD, NAMELY, BEAN AND JELLY, BEAN CURD IN SHEET AND STICK FORM, SOUPS; INSTANT SOUP; SOUP MIXES; FRUIT PUREE SAUCES, NAMELY, APPLESAUCE, CRANBERRY SAUCE; FRUIT-BASED PUREE SAUCES, NAMELY, APPLESAUCE, CRANBERRY SAUCE; SHRIMP SLICES; SHRIMP PASTE; CHICKEN POWDER FOR HUMAN CONSUMPTION FOR USE AS A FOOD ADDITIVE; SHRIMP CHIPS (U.S. CL. 46).

CLASS 30—STAPLE FOODS

FOR CHOW CHOW IN SYRUP; PICKLED GINGER; PRESERVED RED GINGER; PRESERVED SWEET MIXED GINGER; PRESERVED STEM GINGER; CRYSTALLIZED STEM GINGER; CHILI OIL FOR USE AS A SEASONING OR CONDIMENT; GARLIC SESAME OIL FOR USE AS A SEASONING OR CONDIMENT; COFFEE; TEA; COCOA; SUGAR; RICE; TAPIOCA; SAGO; ARTIFICIAL COFFEE; FLOUR; PREPARATIONS MADE FROM CEREALS, NAMELY, BREAKFAST CEREALS AND CEREAL BASED ENERGY BARS FOR USE AS A MEAL REPLACEMENT; BREAD; PASTRY AND CONFECTIONERY MADE OF SUGAR; ICE; ICES; HONEY; TREATLE; YEAST; BAKING-POWDER; ICE CREAM; FROZEN ICE CREAMS; DUMPLINGS; CORN FLOUR; CORN STARCH; POTATO STARCH; POTATO FLOUR AND STARCH FOR FOOD; TASTE AND FLAVOR ENHANCERS USED IN FOOD PRODUCTS, OTHER THAN ESSENTIAL OILS; PASTA; NOODLES; INSTANT NOODLES; COOKED RICE CONGEE AND PORRIDGE IN THE NATURE OF BREAKFAST CEREALS; FROZEN RICE CONGEE AND PORRIDGE IN THE NATURE OF BREAKFAST CEREALS; INSTANT RICE CONGEE AND PORRIDGE IN THE NATURE OF BREAKFAST CEREALS; SALT; MUSTARD; PREPARED WASABI; FIVE SPICE POWDER IN THE NATURE OF A SPICE; CURRY POWDER; CURRY SAUCE; CURRY PASTE; CHUTNEYS OR RELISH; BLACK VINEGAR; SWEETENED BLACK RICE VINEGAR; CHINESE VINEGAR; SPICE VINEGAR; WHITE VINEGAR; VINEGAR SAUCE; SOY SAUCE; DARK SOY SAUCE; THIN SOY SAUCE; THICK SOY SAUCE; SWEET SOY SAUCE; FISH SOY SAUCE; OYSTER SAUCE; MAYONNAISE; MEAT GRAVIES; MARINADE SAUCE; CHILI SAUCE; CHILI GARLIC SAUCE; SWEET SAUCE; PASTA SAUCE; SAUCES MIXES; KETCHUP; SALAD DRESSINGS; PEPPER; PEPPER SAUCE; PEPPER DRESSINGS, NAMELY, PEPPER SALAD DRESSINGS AND PEPPER MARINADE; SPICY BAKING SAUCE; SHRIMP SAUCE; STEAK SAUCE; WORCESTERSHIRE SAUCE; SAUCE FOR RICE; FISH SAUCE; TERIYAKI SAUCE, JAPANESE SAUCE; CHICKEN SAUCE; SESAME SAUCE; GROUND BEAN SAUCE; WHOLE BEAN SAUCE; FERMENTED SOY BEAN SAUCE; BEAN SAUCE; CHILI BEAN SAUCE; BLACK BEAN SAUCE; BLACK BEAN GARLIC SAUCE; SOY BEAN BARBECUE SAUCE; SPICY BEAN SAUCE; BARBECUE SAUCE; HOISIN SAUCE, SEAFOOD SAUCE; PLUM SAUCE; LEMON SAUCE; SWEET AND SOUR SAUCE; CHU HOU SAUCE, CHINESE SOY SAUCE; CHINESE BARBECUE SAUCE; SATAY SAUCES; PEKING DUCK SAUCE; CHOCOLATE SAUCE; SAUCES; SPICES; SEASONINGS; CONDIMENTS, NAMELY, CHUTNEYS, PICKLED GINGER, PREPARED HORSE-RADISH, SOYA BEAN PASTE; VINEGAR; FLAVORINGS FOR FOODSTUFFS; LYE WATER, NON-MEDICATED ADDITIVES FOR FOODSTUFFS, NAMELY, FOOD ADDITIVES FOR NON-NUTRITIONAL PURPOSES FOR USE AS A FLAVORING; PRAWN CRACKER; CHOCOLATE WITH LIQUID FILLINGS, IN PARTICULAR OF

WINES AND SPIRITS; CHOCOLATE COVERED NUTS; CHOCOLATE; DIM SUMS, NAMELY, DUMPLINGS AND NOODLES (U.S. CL. 46).

BRENDAN MCCAULEY, EXAMINING ATTORNEY

SN 85-394,136. CAPLIN & DRYSDALE, CHARTERED, WASHINGTON, DC. FILED 8-10-2011.

CoveredOfficials.com

THE MARK CONSISTS OF STANDARD CHARACTERS WITHOUT CLAIM TO ANY PARTICULAR FONT, STYLE, SIZE, OR COLOR.

CLASS 36—INSURANCE AND FINANCIAL

FOR PROVIDING AN ONLINE SEARCHABLE DATABASE FEATURING INFORMATION RELATING TO PUBLIC PENSION AND RETIREMENT FUNDS; PROVIDING A WEBSITE FEATURING INFORMATION IN THE FIELDS OF PUBLIC PENSION AND RETIREMENT FUNDS (U.S. CLS. 100, 101 AND 102).

CLASS 45—PERSONAL AND LEGAL SERVICES

FOR PROVIDING AN ONLINE SEARCHABLE DATABASE FEATURING INFORMATION RELATING TO GOVERNING LAWS AND REGULATIONS IN THE FIELDS OF PUBLIC PENSION AND RETIREMENT FUNDS (U.S. CLS. 100 AND 101).

ZACHARY BELLO, EXAMINING ATTORNEY

SN 85-394,142. VALSPAR SOURCING, INC., MINNEAPOLIS, MN. FILED 8-10-2011.

STOP CLEANING. START CARING

THE MARK CONSISTS OF STANDARD CHARACTERS WITHOUT CLAIM TO ANY PARTICULAR FONT, STYLE, SIZE, OR COLOR.

CLASS 2—PAINTS

FOR SCRATCH COVERING PREPARATIONS FOR WOOD SURFACES, NAMELY, FELT-TIP APPLICATORS CONTAINING STAINS AND DYES FOR USE IN COLORING AND COVERING SCRATCHES AND DAMAGE ON WOOD SURFACES (U.S. CLS. 6, 11 AND 16).

CLASS 3—COSMETICS AND CLEANING PREPARATIONS

FOR CLEANERS FOR USE ON FABRIC, WOOD AND LEATHER; FURNITURE AND WOOD POLISH; STAIN REMOVERS; CLEANING AND CONDITIONING PREPARATIONS FOR USE ON LEATHER; LEATHER CONDITIONER MOUSSE; INK REMOVER WIPES IMPREGNATED WITH CLEANING PREPARATIONS; CLEANING, DUSTING AND POLISHING CLOTHS FOR HOUSEHOLD USE AND IMPREGNATED WITH CLEANING CHEMICALS AND COMPOUNDS; IMPREGNATED CLEANING, DUSTING OR POLISHING CLOTHS (U.S. CLS. 1, 4, 6, 50, 51 AND 52).

CLASS 37—CONSTRUCTION AND REPAIR

FOR PROFESSIONAL REPAIR SERVICES, NAMELY, FURNITURE REPAIR; ON-SITE REPAIR AND REFINISHING OF RESIDENTIAL AND COMMERCIAL FURNITURE (U.S. CLS. 100, 103 AND 106).

SUZANNE BLANE, EXAMINING ATTORNEY

SN 85-397,206. A G CONSULTING, LLC, SAN JUAN CAPISTRANO, CA. FILED 8-12-2011.

SAPPHIRE AT SCHOOL

THE MARK CONSISTS OF STANDARD CHARACTERS WITHOUT CLAIM TO ANY PARTICULAR FONT, STYLE, SIZE, OR COLOR.

OWNER OF U.S. REG. NO. 3,445,876.

NO CLAIM IS MADE TO THE EXCLUSIVE RIGHT TO USE "AT SCHOOL", APART FROM THE MARK AS SHOWN.

CLASS 41—EDUCATION AND ENTERTAINMENT

FOR EDUCATION SERVICES, NAMELY, PROVIDING CLASSES, SEMINARS, WORKSHOPS, TUTORING, AND MENTORING IN THE FIELD OF CULINARY ART FOR SCHOOLS, CHILDREN, PARENTS, AND INDIVIDUAL GROUPS (U.S. CLS. 100, 101 AND 107).

CLASS 43—HOTEL AND RESTAURANT SERVICES

FOR CONSULTANCY SERVICES IN THE FIELD OF MENU PREPARATION IN THE NATURE OF MENU PLANNING, REGARDING NUTRITIONAL LEVELS FOR SCHOOL LUNCH PROGRAMS; CATERING SERVICES FOR SCHOOLS; PROVIDING HEALTHY LIFESTYLE AND NUTRITION SERVICES, NAMELY, CONSULTING SERVICES IN NUTRITION FOR SCHOOLS AND SCHOOL CHILDREN AND LIFESTYLE WELLNESS (U.S. CLS. 100 AND 101).

ALICE BENMAMAN, EXAMINING ATTORNEY

SN 85-397,678. NYSE GROUP, INC., NEW YORK, NY. FILED 8-15-2011.

IT'S BRIGHTER UP HERE

THE MARK CONSISTS OF STANDARD CHARACTERS WITHOUT CLAIM TO ANY PARTICULAR FONT, STYLE, SIZE, OR COLOR.

CLASS 36—INSURANCE AND FINANCIAL

FOR PROVIDING FINANCIAL INFORMATION SERVICES IN THE FIELD OF MARKET TRADING, NAMELY, PROVIDING REAL TIME AND HISTORICAL MARKET TRADING DATA, SECURITIES QUOTATIONS, COMMODITY QUOTATIONS, AND FINANCIAL ANALYSIS; FINANCIAL INFORMATION SERVICES PROVIDED ON-LINE FROM A COMPUTER DATABASES OR A GLOBAL COMPUTER NETWORK IN THE FIELD OF SECURITIES MARKET INFORMATION (U.S. CLS. 100, 101 AND 102).

FIRST USE 5-31-2011; IN COMMERCE 5-31-2011.

CLASS 42—SCIENTIFIC AND COMPUTER SERVICES

FOR COMPUTER SERVICES, NAMELY, CLOUD HOSTING PROVIDER SERVICES; PROVIDING VIRTUAL COMPUTER SYSTEMS AND VIRTUAL COMPUTER ENVIRONMENTS THROUGH CLOUD COMPUTING; COMPUTER SERVICES, NAMELY, DESIGNING, INSTALLING, UPGRADING, MAINTAINING OF COMPUTER SOFTWARE PLATFORMS; COMPUTER MONITORING SERVICE WHICH TRACKS APPLICATION SOFTWARE PERFORMANCE, PERFORMS PERIODIC MAINTENANCE AND PROVIDES REPORTS AND ALERTS CONCERNING SUCH PERFORMANCE; DEVELOPMENT OF SOFTWARE FOR SECURE NETWORK OPERATIONS; COMPUTER SERVICES, NAMELY, PROVIDING VIRTUAL AND NON-VIRTUAL PRIVATE APPLICATION SERVERS, FILE SERVERS, CO-LOCATION SERVERS AND DATABASE SERVERS OF VARIABLE CAPACITY TO THIRD PARTY COMPUTING AND DATA STORAGE FACILITIES (U.S. CLS. 100 AND 101).

FIRST USE 5-31-2011; IN COMMERCE 5-31-2011.

CHRISIE B. KING, EXAMINING ATTORNEY

SN 85-397,702. GEMS GROUP, INC., MIAMI, FL. FILED 8-15-2011.

PURA VIDA

THE MARK CONSISTS OF STANDARD CHARACTERS WITHOUT CLAIM TO ANY PARTICULAR FONT, STYLE, SIZE, OR COLOR.

OWNER OF U.S. REG. NO. 3,404,289.

THE ENGLISH TRANSLATION OF "PURA VIDA" IN THE MARK IS PURE LIFE.

CLASS 31—NATURAL AGRICULTURAL PRODUCTS

FOR LIVE FLOWERS, CUT FLOWERS, FLOWER BULBS; FLOWER SEEDS; LIVE PLANTS (U.S. CLS. 1 AND 46).

FIRST USE 8-1-2006; IN COMMERCE 8-1-2006.

CLASS 35—ADVERTISING AND BUSINESS

FOR WHOLESALE DISTRIBUTORSHIPS, WHOLESALE AND RETAIL STORE SERVICES, AND MAIL ORDER CATALOGUE SERVICES FEATURING FLOWERS AND LIVE PLANTS; PROVIDING MARKETING AND SALES METHOD INFORMATION ON FLOWERS AND LIVE PLANTS TO THOSE IN THE FLOWER INDUSTRY, NAMELY, RETAILERS, WHOLESALERS, AND GROWERS; BUSINESS SERVICES, NAMELY, FLORAL CLEARING HOUSE; ADVERTISING, MARKETING, AND PROMOTION SERVICES IN THE FIELD OF FLOWERS; ONLINE WHOLESALE AND RETAIL STORE SERVICES, AND MAIL ORDER CATALOGUE SERVICES FEATURING FLOWERS AND LIVE PLANTS (U.S. CLS. 100, 101 AND 102).

FIRST USE 8-1-2006; IN COMMERCE 8-1-2006.

CAROLINE WOOD, EXAMINING ATTORNEY

SN 85-399,003. KARL STORZ GMBH & CO. KG, TUTTLINGEN, FED REP GERMANY, FILED 8-16-2011.

TENTACLE

THE MARK CONSISTS OF STANDARD CHARACTERS WITHOUT CLAIM TO ANY PARTICULAR FONT, STYLE, SIZE, OR COLOR.

PRIORITY CLAIMED UNDER SEC. 44(D) ON FED REP GERMANY APPLICATION NO. 302011015186, FILED 3-12-2011.

OWNER OF FED REP GERMANY REG. NO. 302011015186, DATED 10-12-2011, EXPIRES 3-31-2021.

CLASS 10—MEDICAL APPARATUS

FOR MEDICAL APPARATUS AND INSTRUMENTS, NAMELY, SURGICAL INSTRUMENTS AND APPARATUS CONSISTING OF AN ILLUMINATED MODULAR RETRACTOR FOR MINIMALLY INVASIVE SPINAL SURGERY (U.S. CLS. 26, 39 AND 44).

CLASS 16—PAPER GOODS AND PRINTED MATTER

FOR PRINTED MATERIAL, NAMELY, CATALOGUES, MAGAZINES, JOURNALS, BROCHURES AND INFORMATIONAL FLYERS, LETTERS AND SHEETS IN THE FIELD OF MEDICAL TECHNOLOGY RELATED TO AN ILLUMINATED MODULAR RETRACTOR FOR MINIMALLY INVASIVE SPINAL SURGERY; PRINTED TEACHING AND INSTRUCTIONAL MANUALS IN THE FIELD OF MEDICAL TECHNOLOGY RELATED TO AN ILLUMINATED MODULAR RETRACTOR FOR MINIMALLY INVASIVE SPINAL SURGERY; BINDERS; PHOTOGRAPHS (U.S. CLS. 2, 5, 22, 23, 29, 37, 38 AND 50).

JOHN DWYER, EXAMINING ATTORNEY

SN 85-399,815. HORN GMBH & CO. KG, FLENSBURG, FED REP GERMANY, FILED 8-17-2011.



PRIORITY CLAIMED UNDER SEC. 44(D) ON ERPN CMNTY TM OFC APPLICATION NO. 009745282, FILED 2-17-2011, REG. NO. 009745282, DATED 10-7-2011, EXPIRES 2-17-2021.

THE COLOR(S) LIGHT GREEN AND WHITE IS/ARE CLAIMED AS A FEATURE OF THE MARK.

THE MARK CONSISTS OF A LIGHT GREEN SQUARE WITH THE UPPER RIGHT AND LOWER LEFT CORNERS REMOVED. A WHITE LETTER "T" APPEARS IN THE CENTER OF THE SQUARE.

CLASS 6—METAL GOODS

FOR IRONMONGERY AND SMALL ITEMS OF METAL HARDWARE, NAMELY, PIPES, PIPEWORK AND CONNECTORS AND CONNECTING PARTS FOR PIPES ALL FORMED OF METAL; FLEXIBLE TUBES, HOSE ASSEMBLIES AND CONNECTIONS, AND CONNECTION PARTS FOR FLEXIBLE TUBES, ALL FORMED OF METAL; CONTAINERS OF METAL AND PRESSURIZED CONTAINERS OF METAL FOR VISCOUS, LIQUID AND GASEOUS MEDIA, SOLD EMPTY; AND METAL CLOSURES FOR CONTAINERS (U.S. CLS. 2, 12, 13, 14, 23, 25 AND 50).

CLASS 7—MACHINERY

FOR MACHINES AND MECHANICAL EQUIPMENT AND INSTALLATIONS CONSTRUCTED THEREOF FOR CONVEYING, DELIVERING, PROPORTIONING, EXTRACTION, RECEIVING, COLLECTING AND STORAGE OF VISCOUS, LIQUID AND GASEOUS MEDIA, NAMELY, COMBUSTION FUEL OIL, GREASE LUBRICANTS, SEALING PREPARATIONS, FUEL VAPOR AND UREA SOLUTIONS, NAMELY, ELECTRIC PUMPS, PNEUMATIC PUMPS, CENTRIFUGAL PUMPS, VANE PUMPS, GEAR PUMPS, AND HYBRID PUMPS, NAMELY, CENTRIFUGAL AND POSITIVE DISPLACEMENT PUMPS, PUMPS AS PARTS OF MACHINES, ELECTRIC MOTORS AND ENGINES, ELECTRIC MIXERS, COMPRESSED AIR PUMPS, POWER-OPERATED DISPENSERS, TIRE INFLATORS, NAMELY, ELECTRICALLY OPERATED INFLATION MACHINES NOT FOR USE WITH VEHICLES, POWER-OPERATED WASTE OIL DRAINERS, AND TANKS AS PART OF MACHINES FOR STORAGE OF FUEL, OIL AND UREA SOLUTIONS (U.S. CLS. 13, 19, 21, 23, 31, 34 AND 35).

CLASS 8—HAND TOOLS

FOR MANUALLY-OPERATED TOOLS, NAMELY, HAND-OPERATED DEVICES FOR CONVEYING, DELIVERING, PROPORTIONING, EXTRACTION, RECEIVING, COLLECTING AND STORAGE OF VISCOUS, LIQUID, AND GASEOUS MEDIA, NAMELY, COMBUSTION FUEL, OIL, GREASE, LUBRICANTS, SEALING PREPARATIONS, FUEL VAPOR AND UREA SOLUTIONS, NAMELY, HAND-OPERATED CARTRIDGE PUMPS (U.S. CLS. 23, 28 AND 44).

CLASS 9—ELECTRICAL AND SCIENTIFIC APPARATUS

FOR ELECTRIC AND ELECTRONIC EQUIPMENT FOR RECORDING OF FILLING PROCESS PARAMETERS AND FLUID LEVELS; ELECTRIC AND ELECTRONIC DEVICES FOR USE IN CONTROL, REGULATING, PRE-SELECTION, STORAGE, PROPORTIONING, FILLING, COLLECTING, OPERATING AND DATA INPUT FOR VISCOUS, LIQUID AND GASEOUS MEDIA, NAMELY, COMBUSTION FUEL, OIL, GREASE, LUBRICANTS, SEALING PREPARATIONS, FUEL VAPOR AND UREA SOLUTIONS, NAMELY, ELECTRONIC LIQUID LEVEL SENSORS, ELECTRONIC FLOW METERS, MECHANICAL ROLLER COUNTERS, FILLING STATIONS FOR COMBUSTION FUEL AND UREA SOLUTIONS, DISPENSING STATIONS FOR COMBUSTION FUEL, OIL AND UREA SOLUTIONS, AND ELECTRIC TIRE INFLATORS NOT FOR VEHICLES (U.S. CLS. 21, 23, 26, 36 AND 38).

CLASS 17—RUBBER GOODS

FOR FLEXIBLE PIPES, HOSE ASSEMBLIES AND CONNECTIONS AND CONNECTION PARTS FOR FLEXIBLE PARTS, NOT FORMED OF METAL; PIPES, PIPEWORK AND CONNECTIONS AND CONNECTING PARTS FOR PIPES, NOT FORMED OF METAL; NON-METAL COMPONENTS FOR CONVEYING, DELIVERING, PROPORTIONING, EXTRACTING, RECEIVING, COLLECTING AND STORAGE OF VISCOUS, LIQUID AND GASEOUS MEDIA, NAMELY, COMBUSTION FUEL, OIL, GREASE, LUBRICANTS, SEALING PREPARATIONS, FUEL VAPOR AND UREA SOLUTIONS, NAMELY, NON-METAL HOSE AND PIPE FITTINGS (U.S. CLS. 1, 5, 12, 13, 35 AND 50).

ALYSSA STEEL, EXAMINING ATTORNEY

SN 85-401,152. BIZEQUITY, LLC, WILMINGTON, DE. FILED 8-18-2011.

BIZEQUITY SCORE

THE MARK CONSISTS OF STANDARD CHARACTERS WITHOUT CLAIM TO ANY PARTICULAR FONT, STYLE, SIZE, OR COLOR.

NO CLAIM IS MADE TO THE EXCLUSIVE RIGHT TO USE "SCORE", APART FROM THE MARK AS SHOWN.

CLASS 35—ADVERTISING AND BUSINESS

FOR BUSINESS DATA ANALYSIS; BUSINESS DATA ANALYSIS, NAMELY, PROVIDING INFORMATION REGARDING A COMPANY'S ABILITY TO GROW, INNOVATE, AND BE A MARKET LEADER BASED ON DATA PROVIDED ONLINE (U.S. CLS. 100, 101 AND 102).

CLASS 42—SCIENTIFIC AND COMPUTER SERVICES

FOR PROVIDING ONLINE TEMPORARY USE OF NON-DOWNLOADABLE SOFTWARE USED IN PERFORMING BUSINESS VALUATIONS (U.S. CLS. 100 AND 101).

JILL PRATER, EXAMINING ATTORNEY

SN 85-401,161. BIZEQUITY, LLC, WILMINGTON, DE. FILED 8-18-2011.

B SCORE

THE MARK CONSISTS OF STANDARD CHARACTERS WITHOUT CLAIM TO ANY PARTICULAR FONT, STYLE, SIZE, OR COLOR.

NO CLAIM IS MADE TO THE EXCLUSIVE RIGHT TO USE "SCORE", APART FROM THE MARK AS SHOWN.

CLASS 35—ADVERTISING AND BUSINESS

FOR BUSINESS DATA ANALYSIS; BUSINESS DATA ANALYSIS, NAMELY, PROVIDING INFORMATION REGARDING A COMPANY'S ABILITY TO GROW, INNOVATE, AND BE A MARKET LEADER BASED ON DATA PROVIDED ONLINE (U.S. CLS. 100, 101 AND 102).

CLASS 42—SCIENTIFIC AND COMPUTER SERVICES

FOR PROVIDING ONLINE TEMPORARY USE OF NON-DOWNLOADABLE SOFTWARE USED IN PERFORMING BUSINESS VALUATIONS (U.S. CLS. 100 AND 101).

JILL PRATER, EXAMINING ATTORNEY

SN 85-403,965. NATIONAL ASSOCIATION OF TOURNAMENT DIRECTORS, LLC, FLEMINGTON, NJ. FILED 8-22-2011.



NO CLAIM IS MADE TO THE EXCLUSIVE RIGHT TO USE "NATIONAL ASSOCIATION OF TOURNAMENT DIRECTORS", APART FROM THE MARK AS SHOWN.

THE COLOR(S) ORANGE AND BLUE IS/ARE CLAIMED AS A FEATURE OF THE MARK.

THE MARK CONSISTS OF A HALF OVAL STRETCHING FROM THE BOTTOM LEFT HAND CORNER TO THE UPPER RIGHT HAND CORNER. THE HALF OVAL IS THE COLOR BLUE. ABOVE THE HALF OVAL STRETCHING FROM THE BOTTOM LEFT HAND CORNER TO HALF WAY UP THE HALF OVAL IS THE GRAPHIC "V" SHAPE REACHING FROM THE BOTTOM LEFT HAND CORNER INTO THE TOP LEFT HAND CORNER WITH A CIRCLE AT THE POINT IN THE "V", BOTH OF WHICH ARE THE COLOR ORANGE. FROM THE MID POINT IN THE HALF OVAL TO THE UPPER RIGHT HAND CORNER IS A LINE, ENDING IN A STAR. TO THE RIGHT OF THE STAR ARE FOUR SMALL STARS. THIS LINE AND THE STARS ARE THE COLOR ORANGE. PARALLEL TO AND ABOVE THIS ORANGE LINE IS ANOTHER LINE WHICH IS THE COLOR BLUE. BELOW THE HALF OVAL LINE ARE THE CAPITAL LETTERS "NATD" IN THE COLOR BLUE, WITH THE CROSS IN THE LETTER "A" CONSISTING OF A BLUE LINE AND AN ORANGE LINE. BELOW THE LETTERS "NATD" ARE THE WORDS "NATIONAL ASSOCIATION OF TOURNAMENT DIRECTORS", WHICH WORDS ARE IN THE COLOR BLUE.

CLASS 16—PAPER GOODS AND PRINTED MATTER

FOR PRINTED MATERIALS, NAMELY, MANUALS, PERIODICALS, NEWSLETTERS, AND INSTRUCTIONAL AND TEACHING MATERIALS IN THE FIELD OF DIRECTING AND ORGANIZING AMATEUR SPORTS TOURNAMENTS (U.S. CLS. 2, 5, 22, 23, 29, 37, 38 AND 50).

FIRST USE 8-22-2011; IN COMMERCE 8-22-2011.

CLASS 35—ADVERTISING AND BUSINESS

FOR ASSOCIATION SERVICES, NAMELY, PROMOTING THE INTERESTS OF AMATEUR SPORTS TOURNAMENT DIRECTORS; PROVISION OF CONSULTING AND ADVICE IN THE FIELD OF DIRECTING AND ORGANIZING AMATEUR SPORTS TOURNAMENTS (U.S. CLS. 100, 101 AND 102).

FIRST USE 8-22-2011; IN COMMERCE 8-22-2011.

CLASS 41—EDUCATION AND ENTERTAINMENT

FOR CONDUCTING AND ARRANGING EDUCATIONAL SEMINARS AND CONFERENCES IN THE FIELD OF THE DIRECTING AND ORGANIZING OF AMATEUR SPORTS TOURNAMENTS (U.S. CLS. 100, 101 AND 107).

FIRST USE 8-22-2011; IN COMMERCE 8-22-2011.

HEATHER BIDDULPH, EXAMINING ATTORNEY

SN 85-404,078. ROY YAMAGUCHI, HONOLULU, HI. FILED 8-22-2011.

CHEF ROY YAMAGUCHI

THE MARK CONSISTS OF STANDARD CHARACTERS WITHOUT CLAIM TO ANY PARTICULAR FONT, STYLE, SIZE, OR COLOR.

NO CLAIM IS MADE TO THE EXCLUSIVE RIGHT TO USE "CHEF", APART FROM THE MARK AS SHOWN.

THE NAME "ROY YAMAGUCHI" IDENTIFIES A LIVING INDIVIDUAL WHOSE CONSENT IS OF RECORD.

CLASS 29—MEATS AND PROCESSED FOODS

FOR FRESH OR FROZEN FOOD PRODUCTS, NAMELY, MEAT, SEAFOOD, FISH, SHRIMP, PORK RIBS, OR PROCESSED VEGETABLES; FRESH OR FROZEN PREPARED ENTREES CONSISTING PRIMARILY OF MEAT, SEAFOOD, FISH, SHRIMP, PORK RIBS, OR PROCESSED VEGETABLES; FRESH OR FROZEN PREPARED MEALS CONSISTING PRIMARILY OF MEAT, SEAFOOD, FISH, SHRIMP, PORK RIBS, OR PROCESSED VEGETABLES WITH ONE OR MORE OF THE FOLLOWING: RICE, FRIED RICE, STIR FRY NOODLES, GYOZA, POTSTICKERS, EGG ROLLS, PROCESSED POTATOES, OR PASTA (U.S. CL. 46).

CLASS 30—STAPLE FOODS

FOR RICE, FRIED RICE, STIR FRY NOODLES, GYOZA, POTSTICKERS, EGG ROLLS, PASTA; FRESH OR FROZEN PREPARED ENTREES CONSISTING PRIMARILY OF RICE, FRIED RICE, STIR FRY NOODLES, GYOZA, POTSTICKERS, EGG ROLLS, OR PASTA; FRESH OR FROZEN PREPARED MEALS CONSISTING PRIMARILY OF RICE, FRIED RICE, STIR FRY NOODLES, GYOZA, POTSTICKERS, EGG ROLLS, OR PASTA; ICE CREAM, FROZEN YOGURT, FROZEN FRUIT PIES, CHEESECAKE, DESSERT PIES PRIMARILY CONSISTING OF PUDDINGS OR CUSTARD; CAKE; DESSERT SOUFFLES; SALAD DRESSINGS; DIPPING SAUCES, MARINADES, SAUCES AND GLAZES FOR FISH, MEAT AND POULTRY; SEASONING MIXES (U.S. CL. 46).

ARETHA SOMERVILLE, EXAMINING ATTORNEY

SN 85-404,697. PHI IOTA ALPHA FRATERNITY, INC., BROOKLYN, NY. FILED 8-23-2011.

PHIOTA

THE MARK CONSISTS OF STANDARD CHARACTERS WITHOUT CLAIM TO ANY PARTICULAR FONT, STYLE, SIZE, OR COLOR.

OWNER OF U.S. REG. NO. 3,725,006.

CLASS 16—PAPER GOODS AND PRINTED MATTER

FOR MAGAZINES FEATURING NEWS AND INFORMATION ABOUT FRATERNITIES (U.S. CLS. 2, 5, 22, 23, 29, 37, 38 AND 50).

FIRST USE 8-1-1994; IN COMMERCE 8-1-1994.

CLASS 25—CLOTHING

FOR SHIRTS; BASEBALL JERSEYS (U.S. CLS. 22 AND 39).

FIRST USE 8-1-1994; IN COMMERCE 8-1-1994.
MICHELLE DUBOIS, EXAMINING ATTORNEY

SN 85-404,739. PHI IOTA ALPHA FRATERNITY, INC., NEW YORK, NY. FILED 8-23-2011.



OWNER OF U.S. REG. NO. 3,725,006.

THE MARK CONSISTS OF AN IMAGE OF A TWELVE LEAVES, SIX ON THE LEFT, SIX ON THE RIGHT ATTACHED TO A SEVEN POINT BASE WHICH HAS A SMALL FASCE WITH A X SHAPED DESIGN ON TOP OF

THE BASE. RESTING ON THIS FASCE IS A DOUBLE HEADED AX WITH A SPEAR HEAD PROTRUDING OUT OF THE AX HEAD. BELOW IS A KNIGHT'S ARMOR WITH THE FACE MASK SLIGHTLY OPENED. ATTACHED AT THE SHOULDER OF THE ARMOR IS A OLD SHIELD WITH THE SYMBOL OF PHI IOTA ALPHA WRITTEN IN GREEK SYMBOLS, JUST BELOW IS A PORTRAIT FRAME MADE OF TWENTY-ONE LINK CHAIN WITH A NON GEOGRAPHIC BOUNDARY MAP OF LATIN AMERICA. TWO BANDS POSITIONED ON AN ANGLE WITH THREE STARS ON EACH SIDE CONNECT THE CHAINED PORTRAIT AND THE EDGES OF THE SHIELD. BELOW THE CHAIN LINKED PORTRAIT IS A PHRYGIAN. THERE ARE TWO RAMPANT GRIFFINS ON EITHER SIDE HOLDING THE CREST AND FACING INWARD, TOWARDS THE CREST, THEY ARE SHOWING THEIR TONGUES. THE CREST AND THE GRIFFINS ARE ON TOP OF A BANNER WHICH HAS THE WORDS "SEMPER PARATI SEMPER JUNCTI" IN LATIN WRITTEN ACROSS IT.

THE ENGLISH TRANSLATION OF "SEMPER PARATI SEMPER JUNCTI" IN THE MARK IS ALWAYS PREPARED, ALWAYS TOGETHER.

CLASS 14—JEWELRY

FOR JEWELRY; NECKLACES; JEWELRY, NAMELY, DOG TAGS FOR WEAR BY HUMANS FOR DECORATIVE PURPOSES (U.S. CLS. 2, 27, 28 AND 50).

FIRST USE 1-1-1938; IN COMMERCE 1-1-1938.

CLASS 21—HOUSEWARES AND GLASS

FOR MUGS (U.S. CLS. 2, 13, 23, 29, 30, 33, 40 AND 50).

FIRST USE 1-1-1938; IN COMMERCE 1-1-1938.

CLASS 25—CLOTHING

FOR JACKETS (U.S. CLS. 22 AND 39).

FIRST USE 1-1-1938; IN COMMERCE 1-1-1938.

CLASS 35—ADVERTISING AND BUSINESS

FOR ASSOCIATION SERVICES, NAMELY, ORGANIZING CHAPTERS OF A FRATERNITY AND PROMOTING THE INTERESTS OF THE MEMBERS THEREOF (U.S. CLS. 100, 101 AND 102).

FIRST USE 1-1-1938; IN COMMERCE 1-1-1938.

MICHELLE DUBOIS, EXAMINING ATTORNEY

SN 85-405,576. FENWAY GROUP, LLC, DALLAS, TX. FILED 8-24-2011.



THE COLOR(S) WHITE, NAVY BLUE, AND APPLE GREEN IS/ARE CLAIMED AS A FEATURE OF THE MARK. THE MARK CONSISTS OF A SQUARE THAT IS ONE VERTICAL HALF NAVY BLUE, THE OTHER VERTICAL HALF APPLE GREEN, ALMOST FILLING THIS SQUARE ARE THE STYLIZED LETTERS "FG" IN WHITE.

CLASS 9—ELECTRICAL AND SCIENTIFIC APPARATUS

FOR COMPUTER APPLICATION SOFTWARE FOR MOBILE PHONES, NAMELY, SOFTWARE FOR PROVIDING LINKS TO SERVICES BASED USER LOCATION, MOBILE SEARCH AND BROWSING, MOBILE HEALTH MONITORING, MOBILE PAYMENTS, NEAR FIELD COMMUNICATIONS, MOBILE ADVERTISING, HUMAN AUGMENTATION, SPEECH RECOGNITION, LOCATION AWARE APPLICATIONS FOR CREATING AND MAINTAINING PUBLIC VIRTUAL WORLDS, MICROBLOGGING, ELECTRONIC PAPER, CLOUD COMPUTING, DATA STORAGE AND RETRIEVAL, AND OPERATING MOBILE ROBOTS; COMPUTER APPLICATION SOFTWARE FOR DATA STORAGE AND RETRIEVAL IN THE FIELD OF, OR FOR USE WITH, ECOMMERCE, DASHBOARDS, ERP, CRM, TICKETING SYSTEMS, ENTERPRISE SOFTWARE, ACCOUNTING SOFTWARE, OFFICE SUITES, GRAPHICS SOFTWARE, MIDDLEWARE, BUSINESS WORKFLOW, DATABASE MANAGEMENT SYSTEMS, DIGITAL ASSET MANAGEMENT, DOCUMENT MANAGEMENT, SALES READINESS SOFTWARE, SIMULATION SOFTWARE, IMAGE EDITING SOFTWARE, WEB DEVELOPMENT SOFTWARE, FINITE ELEMENT ANALYSIS, INTEGRATED DEVELOPMENT ENVIRONMENTS; COMPUTER E-COMMERCE SOFTWARE TO ALLOW USERS TO PERFORM ELECTRONIC BUSINESS TRANSACTIONS VIA A GLOBAL COMPUTER NETWORK; COMPUTER SOFTWARE THAT PROVIDES REAL-TIME, INTEGRATED BUSINESS MANAGEMENT INTELLIGENCE BY COMBINING INFORMATION FROM VARIOUS DATABASES AND PRESENTING IT IN AN EASY-TO-UNDERSTAND USER INTERFACE; COMPUTER SOFTWARE, NAMELY, AN APPLICATION ALLOWING SALES AND FIELD SERVICE EMPLOYEES TO UPDATE AND RECEIVE DATA STORED IN AN ENTERPRISE'S COMPUTER DATABASES IN REAL TIME, USING A MOBILE DEVICE, WITH FULL TELEPHONY INTEGRATION WITH THE TELEPHONE AND/OR SOFTWARE FEATURES OF THE MOBILE DEVICE; COMPUTER SOFTWARE, NAMELY, SOFTWARE DEVELOPMENT TOOLS FOR THE CREATION OF MOBILE INTERNET APPLICATIONS AND CLIENT INTERFACES, DOWNLOADABLE SOFTWARE IN THE NATURE OF A MOBILE APPLICATION FOR PROVIDING LINKS TO SERVICES BASED USER LOCATION, MOBILE SEARCH AND BROWSING, MOBILE HEALTH MONITORING, MOBILE PAYMENTS, NEAR FIELD COMMUNICATIONS, MOBILE ADVERTISING, HUMAN AUGMENTATION, SPEECH RECOGNITION, LOCATION AWARE APPLICATIONS FOR CREATING AND MAINTAINING PUBLIC VIRTUAL WORLDS, MICROBLOGGING, ELECTRONIC PAPER, CLOUD COMPUTING, DATA STORAGE AND RETRIEVAL, AND OPERATING MOBILE ROBOTS; ENTERPRISE SOFTWARE IN THE NATURE OF A DATABASE FOR NON-TRANSACTIONAL DATA AND A SEARCH ENGINE FOR DATABASE CONTENT (U.S. CLS. 21, 23, 26, 36 AND 38).

FIRST USE 2-14-2002; IN COMMERCE 2-14-2002.

CLASS 35—ADVERTISING AND BUSINESS

FOR BUSINESS CONSULTATION SERVICES, NAMELY, BUSINESS PROCESS IMPROVEMENT AND ENTERPRISE ARCHITECTURE DESIGN; BUSINESS CONSULTING SERVICES IN THE FIELD OF ORGANIZATIONAL CHANGE MANAGEMENT; BUSINESS CONSULTING SERVICES RELATING TO THE INTEGRATION OF THE AREAS OF BUSINESS PROCESS TECHNOLOGY, ORGANIZATIONAL LEARNING, CHANGE MANAGEMENT, AND OPERATIONAL SUSTAINABILITY; BUSINESS CONSULTING SERVICES, NAMELY, PROVIDING A TURNKEY BUSINESS SOLUTION FOR REVIEWING PRODUCTS AND SERVICES, PLANNING DOCUMENTATION AND WORKFLOW, HIRING TECHNICAL WRITERS, MANAGING PROJECTS FOR BUSINESS PURPOSES, TRACKING USER SATISFACTION, AND RUNNING USABILITY STUDIES FOR BUSINESS PURPOSES; BUSINESS CONSULTING

SERVICES, NAMELY, PROVIDING A TURNKEY SOLUTION FOR REVIEWING PRODUCT AND SERVICE DOCUMENTATION AND WORKFLOW, MANAGING PROJECTS FOR BUSINESS PURPOSES, TRACKING USER SATISFACTION, AND RUNNING USABILITY STUDIES FOR BUSINESS PURPOSES; BUSINESS MANAGEMENT AND CONSULTATION IN THE FIELD OF CASE MANAGEMENT, INTEGRATED JUSTICE, DATA CONVERSIONS, AND BUSINESS INTELLIGENCE; PROMOTING THE USE OF THE SECURITY ASSURANCE BEST PRACTICES OF OTHERS IN THE FIELD OF CLOUD COMPUTING (U.S. CLS. 100, 101 AND 102).

FIRST USE 2-14-2002; IN COMMERCE 2-14-2002.

CLASS 41—EDUCATION AND ENTERTAINMENT

FOR BUSINESS TRAINING; BUSINESS TRAINING CONSULTANCY SERVICES; COMPUTER EDUCATION TRAINING; COMPUTER EDUCATION TRAINING SERVICES; EDUCATION SERVICES, NAMELY, MENTORING IN THE FIELD OF CUSTOM AND COMMERCIAL APPLICATION DEVELOPMENT; EDUCATION SERVICES, NAMELY, ONE-ON-ONE MENTORING IN THE FIELDS OF CUSTOM AND COMMERCIAL APPLICATION DEVELOPMENT; PROVIDING EDUCATIONAL MENTORING SERVICES AND PROGRAMS IN THE FIELD OF CUSTOM AND COMMERCIAL APPLICATION DEVELOPMENT; TRAINING IN THE USE AND OPERATION OF SOFTWARE DEVELOPMENT TOOLS, LANGUAGES, PROCESSES AND METHODOLOGIES (U.S. CLS. 100, 101 AND 107).

FIRST USE 2-14-2002; IN COMMERCE 2-14-2002.

CLASS 42—SCIENTIFIC AND COMPUTER SERVICES

FOR APPLICATION SERVICE PROVIDER, NAMELY, HOSTING, MANAGING, DEVELOPING, AND MAINTAINING APPLICATIONS, SOFTWARE, AND WEB SITES, IN THE FIELDS OF PERSONAL PRODUCTIVITY, WIRELESS COMMUNICATION, MOBILE INFORMATION ACCESS, AND REMOTE DATA MANAGEMENT FOR WIRELESS DELIVERY OF CONTENT TO HANDHELD COMPUTERS, LAPTOPS AND MOBILE ELECTRONIC DEVICES; CLOUD COMPUTING FEATURING SOFTWARE FOR USE IN THE DELIVERY OF TRADITIONAL APPLICATION DEVELOPMENT SERVICES; COMPUTER SERVICES, NAMELY, CLOUD HOSTING PROVIDER SERVICES; COMPUTER SERVICES, NAMELY, INTEGRATION OF PRIVATE AND PUBLIC CLOUD COMPUTING ENVIRONMENTS; COMPUTER SERVICES, NAMELY, REMOTE AND ON-SITE MANAGEMENT OF THE INFORMATION TECHNOLOGY (IT) CLOUD COMPUTING SYSTEMS OF OTHERS; COMPUTER SERVICES, NAMELY, REMOTE MANAGEMENT OF THE INFORMATION TECHNOLOGY (IT) SYSTEMS OF OTHERS; COMPUTER SOFTWARE DEVELOPMENT IN THE FIELD OF MOBILE APPLICATIONS; COMPUTER TECHNICAL SUPPORT SERVICES, NAMELY, 24/7 SERVICE DESK/HELP DESK SERVICES FOR IT INFRASTRUCTURE, OPERATING SYSTEMS, DATABASE SYSTEMS, AND WEB APPLICATIONS; COMPUTER TECHNOLOGY SUPPORT SERVICES, NAMELY, HELP DESK SERVICES; CONSULTING SERVICES IN THE FIELD OF CLOUD COMPUTING; DEVELOPING AND HOSTING A SERVER ON A GLOBAL COMPUTER NETWORK FOR THE PURPOSE OF FACILITATING E-COMMERCE VIA SUCH A SERVER; DEVELOPING AND MANAGING APPLICATION SOFTWARE AND DATABASES FOR DELIVERY OF MULTIMEDIA CONTENT PROVIDED BY MUSEUMS AND OTHER TOUR VENUES FOR USE ON MULTIPLE TYPES OF WIRELESS MOBILE DEVICES; PROVIDING A WEBSITE THAT ENABLES USERS TO SUBSCRIBE TO COACHING, MENTORING, AND/OR EDUCATIONAL SERVICES AND TO ENABLE USERS TO AUTHOR AND PUBLISH INSTRUCTIONAL CONTENT FOR OTHERS; PROVIDING VIRTUAL COMPUTER SYSTEMS AND VIRTUAL COMPUTER ENVIRONMENTS THROUGH CLOUD COMPUTING; TECHNICAL CONSULTING SERVICES IN THE FIELDS OF DATACENTER ARCHITECTURE, PUBLIC AND PRIVATE CLOUD COMPUTING SOLUTIONS, AND EVALUATION AND IMPLEMENTATION OF INTERNET TECHNOLOGY AND SERVICES; TECHNICAL SUPPORT SERVICES, NAMELY, REMOTE AND ON-SITE INFRASTRUCTURE MANAGEMENT SER-

VICES FOR MONITORING, ADMINISTRATION AND MANAGEMENT OF PUBLIC AND PRIVATE CLOUD COMPUTING IT AND APPLICATION SYSTEMS; WEBSITE USABILITY TESTING SERVICES (U.S. CLS. 100 AND 101).

FIRST USE 2-14-2002; IN COMMERCE 2-14-2002.

CLASS 45—PERSONAL AND LEGAL SERVICES

FOR PROVIDING USER AUTHENTICATION SERVICES IN E-COMMERCE TRANSACTIONS (U.S. CLS. 100 AND 101).

FIRST USE 2-14-2002; IN COMMERCE 2-14-2002.

ELI HELLMAN, EXAMINING ATTORNEY

SN 85-406,318. OTC MARKETS GROUP INC., NEW YORK, NY. FILED 8-24-2011.

OTCM

THE MARK CONSISTS OF STANDARD CHARACTERS WITHOUT CLAIM TO ANY PARTICULAR FONT, STYLE, SIZE, OR COLOR.

OWNER OF U.S. REG. NOS. 3,813,947, 4,043,582 AND OTHERS.

CLASS 36—INSURANCE AND FINANCIAL

FOR PROVIDING FINANCIAL INFORMATION IN THE NATURE OF MARKET QUOTATIONS AND ORDERS THROUGH A WEBSITE; COLLECTING, ORGANIZING, PROCESSING AND DISSEMINATING FINANCIAL AND SECURITIES INFORMATION THROUGH A WEBSITE; PROVIDING AN ON-LINE COMPUTER DATABASE FEATURING FINANCIAL INVESTMENT INFORMATION; FINANCIAL SERVICES IN THE NATURE OF PROVIDING FINANCIAL INFORMATION TO BROKER DEALERS TO TRADE SECURITIES; PROVIDING SECURITIES EXCHANGE QUOTATION INFORMATION; PROVIDING SECURITIES INFORMATION, NAMELY, COMPANY NAME, IDENTIFYING NUMBERS FOR STOCKS, BONDS AND OTHER SECURITIES AND TRADING VENUE; PROVIDING COMPANY FINANCIAL NEWS; AND OBJECTIVELY RATING SECURITIES (U.S. CLS. 100, 101 AND 102).

CLASS 42—SCIENTIFIC AND COMPUTER SERVICES

FOR ANALYSIS AND EVALUATION OF THE STOCKS AND SECURITIES OF OTHERS FOR THE PURPOSE OF CERTIFICATION (U.S. CLS. 100 AND 101).

JAMES LOVELACE, EXAMINING ATTORNEY

SN 85-406,350. OTC MARKETS GROUP INC., NEW YORK, NY. FILED 8-24-2011.

OTCMG

THE MARK CONSISTS OF STANDARD CHARACTERS WITHOUT CLAIM TO ANY PARTICULAR FONT, STYLE, SIZE, OR COLOR.

OWNER OF U.S. REG. NOS. 3,813,947, 4,043,582 AND OTHERS.

CLASS 36—INSURANCE AND FINANCIAL

FOR PROVIDING FINANCIAL INFORMATION IN THE NATURE OF MARKET QUOTATIONS AND ORDERS THROUGH A WEBSITE; COLLECTING, ORGANIZING, PROCESSING AND DISSEMINATING FINANCIAL AND SECURITIES INFORMATION THROUGH A WEBSITE; PROVIDING AN ON-LINE COMPUTER DATABASE FEATURING FINANCIAL INVESTMENT INFORMATION; FINANCIAL SERVICES IN THE NATURE OF PROVIDING FINANCIAL INFORMATION TO BROKER DEALERS TO TRADE SECURITIES; PROVIDING SECURITIES EXCHANGE QUOTATION INFORMATION; PROVIDING SECURITIES INFORMATION, NAMELY, COMPANY NAME, IDENTIFYING NUMBERS FOR STOCKS, BONDS AND OTHER SECURITIES AND TRADING VENUE; PROVIDING COMPANY FINANCIAL NEWS; AND OBJECTIVELY RATING SECURITIES (U.S. CLS. 100, 101 AND 102).

CLASS 42—SCIENTIFIC AND COMPUTER SERVICES

FOR ANALYSIS AND EVALUATION OF THE STOCKS AND SECURITIES OF OTHERS FOR THE PURPOSE OF CERTIFICATION (U.S. CLS. 100 AND 101).

JAMES LOVELACE, EXAMINING ATTORNEY

SN 85-406,889. CONSERVAL ENGINEERING INC., TORONTO, ONTARIO, CANADA, FILED 8-25-2011.

SOLARWALL

THE MARK CONSISTS OF STANDARD CHARACTERS WITHOUT CLAIM TO ANY PARTICULAR FONT, STYLE, SIZE, OR COLOR.

OWNER OF U.S. REG. NOS. 1,294,112 AND 3,724,240. SEC. 2(F).

CLASS 6—METAL GOODS

FOR METAL HEATING DUCTS; METAL STRUCTURES FOR MOUNTING SOLAR PANELS; SOLAR PANEL MOUNTS MADE OF METAL; SUBSTRATES PRIMARILY OF METAL FOR SUPPORTING SOLAR CELLS, PHOTOVOLTAIC CELLS AND SOLAR COLLECTORS (U.S. CLS. 2, 12, 13, 14, 23, 25 AND 50).

FIRST USE 1-1-1988; IN COMMERCE 1-1-1988.

CLASS 9—ELECTRICAL AND SCIENTIFIC APPARATUS

FOR APPARATUS FOR CONVERTING ELECTRONIC RADIATION TO ELECTRICAL ENERGY, NAMELY, PHOTOVOLTAIC CLADDING PANELS; APPARATUS FOR CONVERTING ELECTRONIC RADIATION TO ELECTRICAL ENERGY, NAMELY, PHOTOVOLTAIC ROOFING MEMBERS; APPARATUS FOR CONVERTING ELECTRONIC RADIATION TO ELECTRICAL ENERGY, NAMELY, PHOTOVOLTAIC SOLAR HYBRID MODULES; APPARATUS FOR CONVERTING ELECTRONIC RADIATION TO ELECTRICAL ENERGY, NAMELY, PHOTOVOLTAIC SOLAR MODULES; APPARATUS FOR CONVERTING ELECTRONIC RADIATION TO ELECTRICAL ENERGY, NAMELY, PHOTOVOLTAIC THERMAL HYBRID MODULE; APPARATUS FOR CONVERTING ELECTRONIC RADIATION TO ELECTRICAL ENERGY, NAMELY, PHOTOVOLTAIC THERMAL MODULE; APPARATUS FOR CONVERTING ELECTRONIC RADIATION TO ELECTRICAL ENERGY, NAMELY, PVT (PHOTOVOLTAIC THERMAL) MODULE; PHOTOVOLTAIC CELLS ALSO INCLUDING A SOLAR THERMAL COLLECTOR SOLD AS A UNIT (U.S. CLS. 21, 23, 26, 36 AND 38).

FIRST USE 7-1-1995; IN COMMERCE 7-1-1995.

CLASS 37—CONSTRUCTION AND REPAIR

FOR CONSULTING IN THE FIELD OF BUILDING CONSTRUCTION; TECHNICAL CONSULTATION IN THE FIELD OF BUILDING CONSTRUCTION (U.S. CLS. 100, 103 AND 106).

FIRST USE 1-1-1988; IN COMMERCE 1-1-1988.

CLASS 42—SCIENTIFIC AND COMPUTER SERVICES

FOR ENGINEERING SERVICES IN THE FIELD OF ENERGY EFFICIENCY; ENGINEERING SERVICES IN THE FIELD OF SOLAR ENERGY (U.S. CLS. 100 AND 101).

FIRST USE 1-1-1988; IN COMMERCE 1-1-1988.
ANNE FARRELL, EXAMINING ATTORNEY

SN 85-407,265. BELLAMY, WERTEN, JENKINTOWN, PA. FILED 8-25-2011.

ALL RELATIONSHIPS START
WITH HELLO

THE MARK CONSISTS OF STANDARD CHARACTERS WITHOUT CLAIM TO ANY PARTICULAR FONT, STYLE, SIZE, OR COLOR.

CLASS 16—PAPER GOODS AND PRINTED MATTER

FOR STICKERS (U.S. CLS. 2, 5, 22, 23, 29, 37, 38 AND 50).

CLASS 21—HOUSEWARES AND GLASS

FOR MUGS (U.S. CLS. 2, 13, 23, 29, 30, 33, 40 AND 50).

CLASS 25—CLOTHING

FOR APPAREL, NAMELY, SHIRTS, PANTS, SHORTS, DRESSES, SKIRTS, BLOUSES, HATS, SCARVES, AND SHOES (U.S. CLS. 22 AND 39).

CLASS 35—ADVERTISING AND BUSINESS

FOR RETAIL CLOTHING STORE SERVICES (U.S. CLS. 100, 101 AND 102).
JILL PRATER, EXAMINING ATTORNEY

SN 85-407,464. BIG FISH, LLC, LA MESA, CA. FILED 8-25-2011.

Shortest Distance to
Revenue

THE MARK CONSISTS OF STANDARD CHARACTERS WITHOUT CLAIM TO ANY PARTICULAR FONT, STYLE, SIZE, OR COLOR.

CLASS 35—ADVERTISING AND BUSINESS

FOR ASSISTANCE, ADVISORY SERVICES AND CONSULTANCY WITH REGARD TO BUSINESS DEVELOPMENT AND CORPORATE STRATEGIC PLANNING (U.S. CLS. 100, 101 AND 102).

FIRST USE 3-15-2010; IN COMMERCE 3-15-2010.

CLASS 36—INSURANCE AND FINANCIAL

FOR ASSISTANCE, ADVISORY SERVICES AND CONSULTANCY SERVICES IN THE FIELD OF FINANCIAL FORECASTING IN THE NATURE OF BUDGET REVENUE AND REVENUE BUILDING (U.S. CLS. 100, 101 AND 102).

FIRST USE 3-15-2012; IN COMMERCE 3-15-2012.
DANNEAN HETZEL, EXAMINING ATTORNEY

SN 85-408,001. NOVEDA TECHNOLOGIES, INC., BRANCBURG, NJ. FILED 8-26-2011.

IQUATIC

THE MARK CONSISTS OF STANDARD CHARACTERS WITHOUT CLAIM TO ANY PARTICULAR FONT, STYLE, SIZE, OR COLOR.

CLASS 9—ELECTRICAL AND SCIENTIFIC APPARATUS

FOR DATA COLLECTION SYSTEM COMPOSED OF COMPUTER HARDWARE AND SOFTWARE FOR MEASURING, MONITORING, ANALYZING, RECORDING, TRANSMITTING, AND DISPLAYING WATER USE AND WATER LEAKAGE DATA (U.S. CLS. 21, 23, 26, 36 AND 38).

CLASS 35—ADVERTISING AND BUSINESS

FOR PROVIDING INFORMATION REGARDING ENERGY USE, NAMELY, PROVIDING ENERGY USE MANAGEMENT INFORMATION SERVICES VIA THE INTERNET (U.S. CLS. 100, 101 AND 102).

CLASS 37—CONSTRUCTION AND REPAIR

FOR INSTALLING AND MAINTENANCE OF SYSTEMS FOR MEASURING, MONITORING, ANALYZING, RECORDING, TRANSMITTING, AND DISPLAYING WATER USE AND WATER LEAKAGE DATA (U.S. CLS. 100, 103 AND 106).

CLASS 42—SCIENTIFIC AND COMPUTER SERVICES

FOR PROVIDING INFORMATION REGARDING WATER USE AND LEAKAGE DATA VIA THE INTERNET, NAMELY, WATER METER READING AND DATA ANALYSIS; DESIGN AND DEVELOPMENT OF SYSTEMS FOR MEASURING, MONITORING, ANALYZING, RECORDING, TRANSMITTING, AND DISPLAYING WATER USE AND WATER LEAKAGE DATA (U.S. CLS. 100 AND 101).

LINDA ESTRADA, EXAMINING ATTORNEY

SN 85-408,007. NOVEDA TECHNOLOGIES, INC., BRANCBURG, NJ. FILED 8-26-2011.

ENGAGE. ENABLE. EDUCATE.
EMPOWER.

THE MARK CONSISTS OF STANDARD CHARACTERS WITHOUT CLAIM TO ANY PARTICULAR FONT, STYLE, SIZE, OR COLOR.

CLASS 9—ELECTRICAL AND SCIENTIFIC APPARATUS

FOR DATA COLLECTION SYSTEM COMPOSED OF COMPUTER HARDWARE AND SOFTWARE FOR MEASURING, MONITORING, ANALYZING, RECORDING, TRANSMITTING, AND DISPLAYING WATER USE AND WATER LEAKAGE DATA (U.S. CLS. 21, 23, 26, 36 AND 38).

CLASS 35—ADVERTISING AND BUSINESS

FOR PROVIDING INFORMATION REGARDING ENERGY USE, NAMELY, PROVIDING ENERGY USE MANAGEMENT INFORMATION SERVICES VIA THE INTERNET (U.S. CLS. 100, 101 AND 102).

CLASS 37—CONSTRUCTION AND REPAIR

FOR INSTALLATION AND MAINTENANCE OF SYSTEMS FOR MEASURING, MONITORING, ANALYZING, RECORDING, TRANSMITTING, AND DISPLAYING ENERGY AND WATER USE DATA (U.S. CLS. 100, 103 AND 106).

CLASS 42—SCIENTIFIC AND COMPUTER SERVICES

FOR PROVIDING INFORMATION REGARDING WATER USE VIA THE INTERNET, NAMELY, WATER METER READING AND DATA ANALYSIS; DESIGN AND DEVELOPMENT OF SYSTEMS FOR MEASURING, MONITORING, ANALYZING, RECORDING, TRANSMITTING, AND DISPLAYING ENERGY AND WATER USE DATA; COMPUTER SERVICES, NAMELY, CREATING AN ON-LINE COMMUNITY FOR USERS TO PARTICIPATE IN DISCUSSIONS, GET FEEDBACK FROM THEIR PEERS, FORM VIRTUAL COMMUNITIES, AND ENGAGE IN SOCIAL NETWORKING SERVICES IN THE FIELD OF WATER AND ENERGY USE (U.S. CLS. 100 AND 101).

LINDA ESTRADA, EXAMINING ATTORNEY

SN 85-408,820. GOODSEARCH, LLC, LOS ANGELES, CA. FILED 8-26-2011.

GOODAPP

THE MARK CONSISTS OF STANDARD CHARACTERS WITHOUT CLAIM TO ANY PARTICULAR FONT, STYLE, SIZE, OR COLOR.

OWNER OF U.S. REG. NOS. 3,424,170, 3,743,390 AND OTHERS.

CLASS 9—ELECTRICAL AND SCIENTIFIC APPARATUS

FOR COMPUTER SOFTWARE, NAMELY, DOWNLOADABLE COMPUTER SOFTWARE FOR OPERATING SEARCH ENGINES THROUGH A HOSTED CUSTOMIZED BROWSER TOOLBAR; COMPUTER SOFTWARE, NAMELY, DOWNLOADABLE INTERNET BROWSER SOFTWARE WITH A TOOLBAR FOR MANAGING OTHER SOFTWARE APPLICATIONS AND SEARCHING CAPABILITIES; COMPUTER SOFTWARE, NAMELY, DOWNLOADABLE COMPUTER SOFTWARE, NAMELY, COMMUNICATION SOFTWARE FOR PROVIDING ACCESS TO INFORMATION, NEWS, WEATHER, ONLINE AND DOWNLOADABLE GAMES, SEARCH ENGINES AND THIRD-PARTY WEB SITES ON THE INTERNET THROUGH A CUSTOMIZED BROWSER TOOLBAR; COMPUTER SOFTWARE, NAMELY, COMPUTER SEARCH ENGINE SOFTWARE; GRAPHICAL USER INTERFACE SOFTWARE, NAMELY, TOOLBAR SOFTWARE FOR USE WITH SEARCH ENGINE SOFTWARE AND WEBSITES; COMPUTER SOFTWARE THAT MAY BE DOWNLOADED FROM A GLOBAL COMPUTER NETWORK FOR CONSUMERS, USERS, NONPROFIT ENTITIES, AND BUSINESSES TO ENGAGE IN SOCIAL NETWORKING, EDUCATION, ADVERTISING, AND SHOPPING SERVICES; DOWNLOADABLE COMPUTER SOFTWARE IN THE NATURE OF A MOBILE APPLICATION FOR CONSUMERS, USERS, NONPROFIT ENTITIES, AND BUSINESSES TO ENGAGE IN SOCIAL NETWORKING, EDUCATION, ADVERTISING, AND SHOPPING SERVICES; COMPUTER SOFTWARE FOR MOBILE PHONES, PERSONAL DIGITAL ASSISTANTS, SMART PHONES, AND HANDHELD MOBILE DIGITAL ELECTRONIC DEVICES AND OTHER CONSUMER ELECTRONICS DOWNLOADABLE FROM THE INTERNET AND OTHER COMPUTER, ELECTRONIC AND COMMUNICATIONS NETWORKS FOR RECORDING, ORGANIZING, TRANSMITTING, MANIPULATING AND REVIEWING TEXT, DATA, AUDIO, IMAGE AND VIDEO FILES; COMPUTER SOFTWARE FOR MOBILE PHONES, PERSONAL DIGITAL ASSISTANTS, SMART PHONES, AND HANDHELD MOBILE DIGITAL ELECTRONIC DEVICES AND OTHER CONSUMER ELECTRONICS DOWNLOADABLE FROM THE INTERNET AND OTHER COMPUTER, ELECTRONIC AND COMMUNICATIONS NETWORKS, NAMELY, SOFTWARE FOR USE IN SEARCHING DATABASES OF GEOLOCATED INFORMATION; COMPUTER SOFTWARE FOR MOBILE PHONES, PERSONAL DIGITAL ASSISTANTS, SMART PHONES, AND HANDHELD MOBILE DIGITAL ELECTRONIC DEVICES AND OTHER CONSUMER ELECTRONICS DOWNLOADABLE FROM THE INTERNET AND OTHER COMPUTER, ELECTRONIC AND COMMUNICATIONS NETWORKS, NAMELY, TO FACILITATE ONLINE SHOPPING; COMPUTER SOFTWARE FOR MOBILE PHONES, PERSONAL DIGITAL ASSISTANTS, SMART PHONES, AND HANDHELD MOBILE DIGITAL ELECTRONIC DEVICES AND OTHER CONSUMER ELECTRONICS DOWNLOADABLE FROM THE INTERNET AND OTHER COMPUTER, ELECTRONIC AND COMMUNICATIONS NETWORKS THAT ENABLES USERS TO DOWNLOAD, SHARE, AND SEND TEXT, PHOTOGRAPHS, GRAPHICS FILES, AND DATA TO OTHER USERS OF MOBILE PHONES; DOWNLOADABLE RING TONES, MUSIC, AND ELECTRONIC GAMES VIA THE INTERNET AND WIRELESS DEVICES; DOWNLOADABLE SOFTWARE FOR RECORDING, ORGANIZING, TRANSMITTING, MANIPULATING AND

REVIEWING TEXT, DATA, AUDIO, IMAGE AND VIDEO FILES VIA THE INTERNET AND WIRELESS DEVICES; DOWNLOADABLE COMPUTER GAME PROGRAMS; DOWNLOADABLE COMPUTER GAME SOFTWARE VIA A GLOBAL COMPUTER NETWORK AND WIRELESS DEVICES; COMPUTER SOFTWARE PLATFORM AND COMPUTER SOFTWARE DEVELOPMENT TOOLS USED FOR DEVELOPING SOFTWARE FOR MOBILE PHONES, PERSONAL DIGITAL ASSISTANTS, SMART PHONES, AND HANDHELD MOBILE DIGITAL ELECTRONIC DEVICES AND OTHER CONSUMER ELECTRONICS; SOFTWARE FOR DEVELOPMENT OF SOFTWARE FOR MOBILE PHONES, PERSONAL DIGITAL ASSISTANTS, SMART PHONES, AND HANDHELD MOBILE DIGITAL ELECTRONIC DEVICES; DOWNLOADABLE SEARCH SOFTWARE TO ALLOW USERS TO PERFORM ELECTRONIC BUSINESS TRANSACTIONS VIA A GLOBAL COMPUTER NETWORK, NAMELY, TO ALLOW USERS TO RESEARCH AND IDENTIFY COMPUTER SOFTWARE AND TO ALLOW USERS TO PURCHASE AND/OR DOWNLOAD COMPUTER SOFTWARE (U.S. CLS. 21, 23, 26, 36 AND 38).

CLASS 35—ADVERTISING AND BUSINESS

FOR ON-LINE RETAIL STORE SERVICES FEATURING A WIDE VARIETY OF CONSUMER GOODS OF OTHERS; ON-LINE RETAIL STORE SERVICES FEATURING DOWNLOADABLE SOFTWARE APPLICATIONS; ON-LINE RETAIL STORE SERVICES FEATURING COMPUTER SOFTWARE FOR USE ON HANDHELD MOBILE DIGITAL ELECTRONIC DEVICES AND OTHER CONSUMER ELECTRONICS; ON-LINE RETAIL STORE SERVICES FEATURING COMPUTER SOFTWARE PROVIDED VIA THE INTERNET AND OTHER COMPUTER AND ELECTRONIC COMMUNICATION NETWORKS; RETAIL STORE SERVICES FEATURING COMPUTER SOFTWARE; RETAIL STORE SERVICES FEATURING COMPUTER SOFTWARE PROVIDED VIA THE INTERNET AND OTHER COMPUTER, ELECTRONIC AND COMMUNICATIONS NETWORKS; RETAIL STORE SERVICES FEATURING COMPUTER SOFTWARE FOR USE ON MOBILE PHONES, PERSONAL DIGITAL ASSISTANTS, SMART PHONES, AND HANDHELD MOBILE DIGITAL ELECTRONIC DEVICES AND OTHER CONSUMER ELECTRONICS; ON-LINE RETAIL STORE SERVICES FEATURING DOWNLOADABLE PRE-RECORDED MUSIC AND VIDEO AND SOFTWARE; RETAIL STORE SERVICES FEATURING DOWNLOADABLE PRE-RECORDED MUSIC AND VIDEO AND SOFTWARE PROVIDED VIA THE INTERNET AND OTHER COMPUTER, ELECTRONIC AND COMMUNICATIONS NETWORKS; ON-LINE RETAIL STORE SERVICES FEATURING DOWNLOADABLE RING TONES; RETAIL STORE SERVICES FEATURING DOWNLOADABLE RING TONES PROVIDED VIA THE INTERNET AND OTHER COMPUTER, ELECTRONIC AND COMMUNICATIONS NETWORKS; RETAIL STORE SERVICES IN THE FIELD OF ENTERTAINMENT, INCLUDING, AUDIO, AUDIOVISUAL, MUSIC, MULTIMEDIA, SOFTWARE, AND VIDEO CONTENT PROVIDED VIA THE INTERNET AND OTHER COMPUTER AND ELECTRONIC COMMUNICATION NETWORKS; OPERATING ON-LINE MARKETPLACES FEATURING DOWNLOADABLE RING TONES, DOWNLOADABLE PRE-RECORDED MUSIC AND VIDEO; OPERATING ON-LINE MARKETPLACES FEATURING DOWNLOADABLE SOFTWARE AND SOFTWARE PROGRAMS; OPERATING ONLINE MARKETPLACES FOR SELLERS AND LICENSORS OF COMPUTER SOFTWARE (U.S. CLS. 100, 101 AND 102).

CLASS 36—INSURANCE AND FINANCIAL

FOR CHARITABLE FUNDRAISING SERVICES; CHARITABLE FUNDRAISING SERVICES BY MEANS OF COLLECTING PROCEEDS FROM PURCHASES OF SOFTWARE AND DONATING A PORTION OR PERCENTAGE OF THE PROCEEDS TO CHARITIES, NOT-FOR-PROFIT AND PHILANTHROPIC ORGANIZATIONS AND ASSOCIATIONS, SCHOOLS, AND CIVIC GROUPS; CHARITABLE FUND RAISING SERVICES, NAMELY, FACILITATING CHARITABLE DONATIONS ON BEHALF OF THIRD PARTIES THROUGH DONATING A PORTION OR PERCENTAGE OF REVENUES COLLECTED TO CHARITIES, NOT-FOR-PROFIT AND PHILANTHROPIC ORGANIZATIONS AND ASSOCIATIONS,

SCHOOLS, AND CIVIC GROUPS; CHARITABLE FUNDRAISING SERVICES, NAMELY, DONATING A PORTION OR PERCENTAGE OF THE SALE OF SOFTWARE AND SOFTWARE PROGRAMS TO CHARITIES, NOT-FOR-PROFIT AND PHILANTHROPIC ORGANIZATIONS AND ASSOCIATIONS, SCHOOLS, AND CIVIC GROUPS; CHARITABLE FUNDRAISING SERVICES, NAMELY, SHARING PROFITS OR PROCEEDS FROM ONLINE PURCHASES, ONLINE TRANSACTIONS AND COMMERCIAL WEBSITES; CHARITABLE FUNDRAISING SERVICES, NAMELY, RAISING FUNDS THROUGH ONLINE SHOPPING; ON-LINE CHARITABLE FUNDRAISING SERVICES; FUNDRAISING SERVICES, NAMELY, SHARING PROFITS FROM THE SALE OF SOFTWARE AND SOFTWARE PROGRAMS WITH CHARITIES, NOT-FOR-PROFIT AND PHILANTHROPIC ORGANIZATIONS AND ASSOCIATIONS, SCHOOLS, AND CIVIC GROUPS; CHARITABLE FUNDRAISING, NAMELY, RAISING MONIES FOR CHARITIES, NOT-FOR-PROFIT AND PHILANTHROPIC ORGANIZATIONS AND ASSOCIATIONS, SCHOOLS, AND CIVIC GROUPS; CHARITABLE FUNDRAISING, NAMELY, SHARING PROFITS FROM THE SALE OF RESTAURANT SERVICES WITH CHARITIES, NOT-FOR-PROFIT AND PHILANTHROPIC ORGANIZATIONS AND ASSOCIATIONS, SCHOOLS, AND CIVIC GROUPS; CHARITABLE FUNDRAISING SERVICES FOR CHARITIES, NOT-FOR-PROFIT AND PHILANTHROPIC ORGANIZATIONS AND ASSOCIATIONS, SCHOOLS, AND CIVIC GROUPS (U.S. CLS. 100, 101 AND 102).

CLASS 38—COMMUNICATION

FOR TELECOMMUNICATION SERVICES, NAMELY, ELECTRONIC TRANSMISSION OF STREAMED AND DOWNLOADABLE DATA, AUDIO AND VIDEO FILES, AND SOFTWARE VIA COMPUTER AND OTHER COMMUNICATIONS NETWORKS; PROVISION OF CONNECTIVITY SERVICES AND ACCESS TO ELECTRONIC COMMUNICATIONS NETWORKS, FOR TRANSMISSION OR RECEPTION OF DATA, AUDIO AND VIDEO FILES, AND SOFTWARE; ELECTRONIC TRANSMISSION OF COMPUTER SOFTWARE AND SOFTWARE PROGRAMS VIA THE INTERNET AND OTHER COMPUTER AND ELECTRONIC COMMUNICATION NETWORKS AND WIRELESS DEVICES; TELECOMMUNICATION SERVICES, NAMELY, PROVIDING ONLINE AND TELECOMMUNICATION FACILITIES FOR REAL-TIME INTERACTION BETWEEN AND AMONG USERS OF COMPUTERS, MOBILE AND HANDHELD COMPUTERS, AND WIRED AND WIRELESS COMMUNICATION DEVICES; ENABLING INDIVIDUALS TO SEND AND RECEIVE MESSAGES VIA EMAIL, INSTANT MESSAGING OR A WEBSITE ON THE INTERNET IN THE FIELD OF GENERAL INTEREST; PROVIDING ON-LINE CHAT ROOMS AND ELECTRONIC BULLETIN BOARDS FOR TRANSMISSION OF MESSAGES AMONG USERS IN THE FIELD OF GENERAL INTEREST; PROVIDING AN ONLINE COMMUNITY FORUM FOR REGISTERED USERS TO SHARE INFORMATION, PHOTOS, AUDIO AND VIDEO CONTENT ABOUT THEMSELVES, THEIR LIKES AND DISLIKES AND DAILY ACTIVITIES, TO GET FEEDBACK FROM THEIR PEERS, TO FORM VIRTUAL COMMUNITIES, AND TO ENGAGE IN SOCIAL NETWORKING (U.S. CLS. 100, 101 AND 104).

CLASS 42—SCIENTIFIC AND COMPUTER SERVICES

FOR COMPUTER SERVICES, NAMELY, HOSTING AND MAINTAINING AN ONLINE WEBSITE FOR OTHERS TO BUILD AND MANAGE THEIR BUSINESS PARTNER RELATIONSHIPS; COMPUTER SERVICES, NAMELY, APPLICATION SERVICE PROVIDER SERVICES, NAMELY, HOSTING MANAGING, DEVELOPING, ANALYZING, AND MAINTAINING ENTERPRISE APPLICATIONS, SOFTWARE, AND WEB SITES, OF OTHERS; COMPUTER SERVICES, NAMELY, PROVIDING AN INTERACTIVE WEBSITE FEATURING TECHNOLOGY THAT ALLOWS USERS TO MANAGE THEIR ONLINE PHOTOGRAPH AND SOCIAL NETWORKING ACCOUNTS; COMPUTER SERVICES, NAMELY, PROVIDING SEARCH ENGINES FOR OBTAINING DATA AND INFORMATION ON A GLOBAL COMPUTER NETWORK; COMPUTER SERVICES, NAMELY, CREATING INDEXES OF INFORMATION, WEB SITES AND OTHER

RESOURCES AVAILABLE ON GLOBAL COMPUTER NETWORKS; COMPUTER SERVICES, NAMELY, CREATING AN ON-LINE COMMUNITY FOR REGISTERED USERS TO PARTICIPATE IN DISCUSSIONS, GET FEEDBACK FROM THEIR PEERS, FORM VIRTUAL COMMUNITIES, AND ENGAGE IN SOCIAL NETWORKING SERVICES IN THE FIELD OF CONSUMER GOODS AND SERVICES; COMPUTER SERVICES, NAMELY, PROVIDING A SOCIAL NETWORKING WEBSITE WHICH FEATURES TECHNOLOGY THAT ENABLES USERS TO GIVE CHARITABLE FINANCIAL GIFTS TO OTHERS; COMPUTER SERVICES, NAMELY, PROVIDING SEARCH ENGINES FOR OBTAINING DATA ON A GLOBAL COMPUTER NETWORK; COMPUTER SERVICES, NAMELY, DEVELOPMENT OF SEARCHABLE INDEXES FOR WEBSITES AND WEB SERVICES, NAMELY, FOR PROVIDING INFORMATION FROM SEARCHABLE INDEXES AND DATABASES OF INFORMATION, INCLUDING TEXT, ELECTRONIC DOCUMENTS, AND DATABASES ON COMPUTER AND COMMUNICATION NETWORKS; SOFTWARE AS A SERVICE (SAAS) SERVICES FEATURING SOFTWARE FOR SEARCHING AND SHOPPING FOR THE GOODS AND SERVICES OF OTHERS; ON-LINE SERVICES, NAMELY, PEER-TO-BROWSER PHOTO SHARING SERVICES, NAMELY, PROVIDING A WEBSITE FEATURING TECHNOLOGY ENABLING USERS TO UPLOAD, VIEW, AND DOWNLOAD DIGITAL PHOTOS; ON-LINE SERVICES, NAMELY, PROVIDING INFORMATION AT THE SPECIFIC REQUEST OF END-USERS BY MEANS OF GLOBAL COMPUTER NETWORKS; ON-LINE SERVICES, NAMELY, PROVIDING ON-LINE NON-DOWNLOADABLE SEARCH ENGINE PORTALS IN THE FORM OF SEARCH BARS; ON-LINE SERVICES, NAMELY, PROVIDING CUSTOMIZED ON-LINE WEB PAGES FEATURING USER-DEFINED INFORMATION, WHICH INCLUDES SEARCH ENGINES AND ON-LINE WEB LINKS TO OTHER WEB SITES; ON-LINE SERVICES, NAMELY, PROVIDING ON-LINE NON-DOWNLOADABLE EMBEDDABLE COMPUTER SOFTWARE FOR USE IN PROVIDING A WEBSITE TOOLBAR WHICH ALLOWS THE USER TO DELIVER MESSAGES AND PROVIDE WEB LINKS TO OTHER WEB PAGES THAT PROMOTE GOODS AND SERVICES; ON-LINE SERVICES, NAMELY, PROVIDING CUSTOMIZED ON-LINE WEB PAGES FEATURING USER-DEFINED INFORMATION, WHICH INCLUDES SEARCH ENGINES AND ON-LINE WEB LINKS TO OTHER WEBSITES; ON-LINE SERVICES, NAMELY, PROVIDING TEMPORARY USE OF A WEB-BASED SOFTWARE APPLICATION FOR SEARCHING AND SHOPPING FOR THE GOODS AND SERVICES OF OTHERS; WEBSITE SERVICES, NAMELY, PROVIDING A WEB SITE FEATURING TECHNOLOGY THAT ENABLES INTERNET USERS TO CREATE, BOOKMARK, ANNOTATE, AND PUBLICLY SHARE DATA; WEBSITE SERVICES, NAMELY, PROVIDING A WEB SITE THAT GIVES USERS THE ABILITY TO UPLOAD PHOTOGRAPHS; COMPUTER SERVICES, NAMELY, ACTING AS AN APPLICATION SERVICE PROVIDER TO HOST THE APPLICATIONS OF OTHERS; SOFTWARE AS A SERVICE (SAAS) SERVICES FEATURING SOFTWARE ENABLING USERS TO DOWNLOAD SOFTWARE AND SOFTWARE PROGRAMS; PROVIDING ON-LINE FACILITIES, VIA A GLOBAL COMPUTER NETWORK, TO ENABLE USERS TO DOWNLOAD SOFTWARE AND SOFTWARE PROGRAMS; CONSULTING SERVICES IN THE FIELD CONSULTING SERVICES IN THE FIELD OF DESIGN, SELECTION, IMPLEMENTATION AND USE OF COMPUTER HARDWARE AND SOFTWARE SYSTEMS FOR OTHERS; CONSULTING SERVICES IN THE FIELD OF HOSTING COMPUTER SOFTWARE APPLICATIONS; COMPUTER CONSULTING SERVICES RELATING TO CREATING A BRANDED SEARCH PAGE OR A TOOLBAR FOR A SEARCH PAGE FOR DIRECTING INTERNET SEARCH TRAFFIC AND RELATING TO THE REDIRECTED INTERNET SEARCH TRAFFIC; MAINTENANCE AND UPDATING OF COMPUTER SOFTWARE; PROVIDING INFORMATION CONCERNING COMPUTER SOFTWARE VIA THE INTERNET AND OTHER COMPUTER AND ELECTRONIC COMMUNICATION NETWORKS; PROVIDING TEMPORARY USE OF COMPUTER SOFTWARE AND ONLINE FACILITIES TO ENABLE USERS TO ACCESS AND DOWNLOAD COMPUTER SOFTWARE; PLATFORM AS A SERVICE (PAAS) FEATURING COMPUTER SOFTWARE PLATFORMS FOR CREATING SOFTWARE AND SOFTWARE PROGRAMS; SOFTWARE AS A SERVICE (SAAS) SERVICES FEATURING SOFTWARE FOR CREATING SOFTWARE

AND SOFTWARE PROGRAMS; COMPUTER SERVICES, NAMELY, CREATING AN ON-LINE COMMUNITY FOR REGISTERED USERS TO PARTICIPATE IN DISCUSSIONS, GET FEEDBACK FROM THEIR PEERS, FORM VIRTUAL COMMUNITIES, AND ENGAGE IN SOCIAL NETWORKING SERVICES IN THE FIELD OF SOFTWARE AND SOFTWARE PROGRAMS; COMPUTER SERVICES, NAMELY, CREATING AN ON-LINE COMMUNITY FOR REGISTERED USERS TO PARTICIPATE IN RANKING SOFTWARE AND SOFTWARE PROGRAMS; COMPUTER SERVICES, NAMELY, PROVIDING SEARCH ENGINES FOR OBTAINING DATA AND SEARCHING FOR SOFTWARE AND SOFTWARE PROGRAMS; SOFTWARE AS A SERVICE (SAAS) SERVICES, NAMELY, HOSTING SOFTWARE AND SOFTWARE PROGRAMS FOR USE BY OTHERS; PROVIDING SEARCH ENGINES FOR OBTAINING DATA VIA COMMUNICATIONS NETWORKS; PROVIDING TEMPORARY USE OF ONLINE, NON-DOWNLOADABLE COMPUTER SOFTWARE TO ENABLE USERS TO PROGRAM, ORGANIZE AND ACCESS AUDIO, VIDEO, TEXT, MULTIMEDIA CONTENT AND THIRD-PARTY COMPUTER SOFTWARE PROGRAMS; INTERNET COMPUTER SERVICES, NAMELY, CREATING INDEXES OF INFORMATION, SITES, AND OTHER RESOURCES AVAILABLE ON GLOBAL COMPUTER NETWORKS FOR OTHERS; SEARCHING, BROWSING AND RETRIEVING INFORMATION, SITES, AND OTHER RESOURCES AVAILABLE ON GLOBAL COMPUTER NETWORKS AND OTHER COMMUNICATION NETWORKS FOR OTHERS; TECHNOLOGICAL SERVICES IN THE FIELDS OF MAINTENANCE, REPAIR AND UPDATING OF COMPUTER SOFTWARE; PROVIDING TEMPORARY USE OF ON-LINE NON-DOWNLOADABLE SOFTWARE FOR DOWNLOADING, UPLOADING, TRANSFERRING, SHARING, RANKING, EVALUATING, CRITIQUING, EMAILING, EVALUATING, AND STORING COMPUTER SOFTWARE AND SOFTWARE PROGRAMS; APPLICATION SERVICE PROVIDER FEATURING INTERACTIVE SOFTWARE FOR DOWNLOADING, UPLOADING, TRANSFERRING, SHARING, RANKING, EVALUATING, CRITIQUING, EMAILING, EVALUATING, AND STORING COMPUTER SOFTWARE AND SOFTWARE PROGRAMS; PROVIDING TEMPORARY USE OF NON-DOWNLOADABLE COMPUTER SOFTWARE FOR ENTERTAINMENT AND EDUCATIONAL PURPOSES, NAMELY, FOR USE IN OBTAINING REVIEWS, RECOMMENDATIONS, RANKINGS AND INFORMATION RELATED TO COMPUTER SOFTWARE AND SOFTWARE PROGRAMS; PROVIDING A WEBSITE FOR OBTAINING REVIEWS, RECOMMENDATIONS, RANKINGS AND INFORMATION RELATED TO COMPUTER SOFTWARE AND SOFTWARE PROGRAMS; PROVIDING TEMPORARY USE OF NON-DOWNLOADABLE COMPUTER SOFTWARE FOR USE IN POSTING, TRANSMITTING, RECEIVING, RETRIEVING, ORGANIZING, SEARCHING AND REVIEWING COMPUTER SOFTWARE AND SOFTWARE PROGRAMS VIA COMPUTERS, MOBILE AND HANDHELD COMPUTING DEVICES, AND WIRED AND WIRELESS COMMUNICATION DEVICES; APPLICATION SERVICE PROVIDER (ASP) SERVICES FEATURING SOFTWARE USED FOR THE DISSEMINATION, DISTRIBUTION AND REVIEW OF COMPUTER SOFTWARE AND SOFTWARE PROGRAMS; APPLICATION SERVICE PROVIDER (ASP) SERVICES FEATURING SOFTWARE FOR RESEARCHING, DEVELOPING, DESIGNING, AND UPGRADING OF COMPUTER SOFTWARE; PROVIDING TEMPORARY USE OF COMPUTER SOFTWARE AND ONLINE FACILITIES FOR RESEARCHING, DEVELOPING, DESIGNING, AND UPGRADING OF COMPUTER SOFTWARE; APPLICATION SERVICE PROVIDER, NAMELY, HOSTING, MANAGING, DEVELOPING, AND MAINTAINING COMPUTER SOFTWARE APPLICATIONS OF OTHERS FOR USE WITH MOBILE COMMUNICATIONS DEVICES; DESIGNING AND DEVELOPING SOFTWARE AND COMPONENTS FOR INDIVIDUALS AND BUSINESSES FOR USE WITH MOBILE AND STATIONERY CONSUMER ELECTRONIC DEVICES, NAMELY, MOBILE PHONES, PERSONAL DIGITAL ASSISTANTS, SMART PHONES, AND HANDHELD MOBILE DIGITAL ELECTRONIC DEVICES AND OTHER CONSUMER ELECTRONICS (U.S. CLS. 100 AND 101).

CLASS 45—PERSONAL AND LEGAL SERVICES

FOR INTERNET-BASED SOCIAL NETWORKING SERVICES; ONLINE SOCIAL NETWORKING SERVICES PROVIDED THROUGH A COMMUNITY WEBSITE; ONLINE SOCIAL NETWORKING SERVICES IN THE FIELD OF CHARITABLE GIVING AND PHILANTHROPIC ORGANIZATIONS PROVIDED VIA A WEBSITE; ON-LINE SOCIAL NETWORKING SERVICES; PROVIDING A SOCIAL NETWORKING WEBSITE FOR ENTERTAINMENT PURPOSES; PROVIDING A WEBSITE ON THE INTERNET FOR THE PURPOSE OF SOCIAL NETWORKING (U.S. CLS. 100 AND 101).

JANICE L. MCMORROW, EXAMINING ATTORNEY

CLASS 36—INSURANCE AND FINANCIAL

FOR PROVIDING FINANCIAL SERVICES THROUGH A WEBSITE FOR MOBILE DEVICES, NAMELY, ELECTRONIC CHECK CONVERSION AND REMOTE DEPOSIT, ELECTRONIC TRANSFER OF MONEY, ELECTRONIC PAYMENT, VIEWING BANK AND INVESTMENT ACCOUNT INFORMATION, INVESTMENT PORTFOLIO MANAGEMENT, ELECTRONIC TRADING OF SECURITIES, PERFORMING FINANCIAL AND INVESTMENT RESEARCH AND ANALYSIS, PROVIDING FINANCIAL AND INVESTMENT INFORMATION AND NEWS, PROVIDING FINANCIAL AND INVESTMENT ADVISORY AND CONSULTANCY SERVICES VIA E-MAIL AND TEXT MESSAGES, PROVIDING FINANCIAL AND INVESTMENT ADVISORY AND CONSULTANCY SERVICES, FINANCIAL NEWS, FINANCIAL RESEARCH, FINANCIAL PLANNING, AND INVESTMENT STRATEGY ONLINE (U.S. CLS. 100, 101 AND 102).

CLASS 39—TRANSPORTATION AND STORAGE

FOR PROVIDING CUSTOMIZED DRIVING OR WALKING DIRECTIONS, NAMELY, ENABLING USERS TO LOCATE AND RECEIVE NAVIGATIONAL DIRECTIONS TO LOCATIONS AT WHICH FINANCIAL SERVICES ARE PROVIDED (U.S. CLS. 100 AND 105).

JOHN DALIER, EXAMINING ATTORNEY

SN 85-409,492. CHARLES SCHWAB & CO., INC., SAN FRANCISCO, CA. FILED 8-29-2011.

SCHWAB

SN 85-409,507. CHARLES SCHWAB & CO., INC., SAN FRANCISCO, CA. FILED 8-29-2011.

THE MARK CONSISTS OF STANDARD CHARACTERS WITHOUT CLAIM TO ANY PARTICULAR FONT, STYLE, SIZE, OR COLOR.

OWNER OF U.S. REG. NOS. 2,706,554 AND 3,597,849. SEC. 2(F).

CLASS 9—ELECTRICAL AND SCIENTIFIC APPARATUS

FOR DOWNLOADABLE SOFTWARE IN THE NATURE OF A MOBILE APPLICATION FOR ELECTRONIC CHECK CONVERSION AND REMOTE DEPOSIT SERVICES, ELECTRONIC TRANSFER OF MONEY, ELECTRONIC BILL PAYMENT, VIEWING BANK AND INVESTMENT ACCOUNT INFORMATION, INVESTMENT PORTFOLIO MANAGEMENT, ELECTRONIC TRADING OF SECURITIES, PERFORMING FINANCIAL AND INVESTMENT RESEARCH AND ANALYSIS, AND OBTAINING FINANCIAL AND INVESTMENT INFORMATION AND NEWS; DOWNLOADABLE SOFTWARE IN THE NATURE OF A MOBILE APPLICATION FOR DELIVERING STREAMING FINANCIAL AND INVESTMENT INFORMATION AND NEWS; DOWNLOADABLE SOFTWARE IN THE NATURE OF A MOBILE APPLICATION WHICH ENABLES USERS TO LOCATE, AND RECEIVE NAVIGATIONAL DIRECTIONS TO, LOCATIONS AT WHICH FINANCIAL SERVICES ARE PROVIDED; DOWNLOADABLE SOFTWARE IN THE NATURE OF A MOBILE APPLICATION THAT ALLOWS USERS TO COMMUNICATE WITH FINANCIAL SERVICES PROFESSIONALS THROUGH E-MAIL, TEXT, AND AUDIO AND AUDIOVISUAL MEANS; DOWNLOADABLE SOFTWARE IN THE NATURE OF A MOBILE APPLICATION FOR VIEWING VIDEOS PERTAINING TO NEWS, RESEARCH, INVESTMENTS, FINANCE, FINANCIAL PLANNING, AND INVESTMENT STRATEGY (U.S. CLS. 21, 23, 26, 36 AND 38).



OWNER OF U.S. REG. NOS. 3,124,831 AND 3,576,109. THE MARK CONSISTS OF THE WORDS "TALK TO CHUCK" ENCLOSED IN A RECTANGULAR QUOTE.

CLASS 9—ELECTRICAL AND SCIENTIFIC APPARATUS

FOR DOWNLOADABLE SOFTWARE IN THE NATURE OF A MOBILE APPLICATION FOR ELECTRONIC CHECK CONVERSION AND REMOTE DEPOSIT SERVICES, ELECTRONIC TRANSFER OF MONEY, ELECTRONIC BILL PAYMENT, VIEWING BANK AND INVESTMENT ACCOUNT INFORMATION, INVESTMENT PORTFOLIO MANAGEMENT, ELECTRONIC TRADING OF SECURITIES, PERFORMING FINANCIAL AND INVESTMENT RESEARCH AND ANALYSIS, AND OBTAINING FINANCIAL AND INVESTMENT INFORMATION AND NEWS; DOWNLOADABLE SOFTWARE IN THE NATURE OF A MOBILE APPLICATION FOR DELIVERING STREAMING FINANCIAL AND INVESTMENT INFORMATION AND NEWS; DOWNLOADABLE SOFTWARE IN THE NATURE OF A MOBILE APPLICATION WHICH ENABLES USERS TO LOCATE, AND RECEIVE NAVIGATIONAL DIRECTIONS TO, LOCATIONS AT WHICH FINANCIAL SERVICES ARE PROVIDED; DOWNLOADABLE SOFTWARE IN THE NATURE OF A MOBILE APPLICATION THAT ALLOWS USERS TO COMMUNICATE WITH FINANCIAL SERVICES PROFESSIONALS THROUGH EMAIL, TEXT, AND AUDIO AND AUDIOVISUAL MEANS; DOWNLOADABLE SOFTWARE IN THE NATURE OF A MOBILE APPLICATION FOR VIEWING VIDEOS PERTAINING TO NEWS, RESEARCH, INVESTMENTS, FINANCE, FINANCIAL PLANNING, AND INVESTMENT STRATEGY (U.S. CLS. 21, 23, 26, 36 AND 38).

CLASS 36—INSURANCE AND FINANCIAL

FOR PROVIDING FINANCIAL SERVICES THROUGH A WEBSITE FOR MOBILE DEVICES, NAMELY, ELECTRONIC CHECK CONVERSION AND REMOTE DEPOSIT, ELECTRONIC TRANSFER OF MONEY, ELECTRONIC PAYMENT, VIEWING BANK AND INVESTMENT ACCOUNT INFORMATION, INVESTMENT PORTFOLIO MANAGEMENT, ELECTRONIC TRADING OF SECURITIES, PERFORMING FINANCIAL AND INVESTMENT RESEARCH AND ANALYSIS, PROVIDING FINANCIAL AND INVESTMENT INFORMATION AND NEWS, PROVIDING FINANCIAL AND INVESTMENT ADVISORY AND CONSULTANCY SERVICES VIA EMAIL AND TEXT MESSAGES, PROVIDING FINANCIAL AND INVESTMENT ADVISORY AND CONSULTANCY SERVICES, FINANCIAL NEWS, FINANCIAL RESEARCH, FINANCIAL PLANNING, AND INVESTMENT STRATEGY ONLINE (U.S. CLS. 100, 101 AND 102).

CLASS 39—TRANSPORTATION AND STORAGE

FOR PROVIDING CUSTOMIZED DRIVING OR WALKING DIRECTIONS, NAMELY, ENABLING USERS TO LOCATE AND RECEIVE NAVIGATIONAL DIRECTIONS TO LOCATIONS AT WHICH FINANCIAL SERVICES ARE PROVIDED (U.S. CLS. 100 AND 105).
JOHN DALIER, EXAMINING ATTORNEY

SN 85-409,510. CHARLES SCHWAB & CO., INC., SAN FRANCISCO, CA. FILED 8-29-2011.

charles SCHWAB

OWNER OF U.S. REG. NOS. 1,930,549, 2,501,268 AND OTHERS.

THE NAME(S), PORTRAIT(S), AND/OR SIGNATURE(S) SHOWN IN THE MARK IDENTIFIES A LIVING INDIVIDUAL, WHOSE CONSENT(S) TO REGISTER IS MADE OF RECORD.

THE MARK CONSISTS OF THE NAME "CHARLES" IN LOWER-CASE ITALICS FOLLOWED BY THE NAME "SCHWAB" IN CAPITALIZED LETTERS.

CLASS 9—ELECTRICAL AND SCIENTIFIC APPARATUS

FOR DOWNLOADABLE SOFTWARE IN THE NATURE OF A MOBILE APPLICATION FOR ELECTRONIC CHECK CONVERSION AND REMOTE DEPOSIT SERVICES, ELECTRONIC TRANSFER OF MONEY, ELECTRONIC PAYMENT, VIEWING BANK AND INVESTMENT ACCOUNT INFORMATION, INVESTMENT PORTFOLIO MANAGEMENT, ELECTRONIC TRADING OF SECURITIES, PERFORMING FINANCIAL AND INVESTMENT RESEARCH AND ANALYSIS, AND OBTAINING FINANCIAL AND INVESTMENT INFORMATION AND NEWS; DOWNLOADABLE SOFTWARE IN THE NATURE OF A MOBILE APPLICATION FOR VIEWING, SEARCHING AND SHARING FIXED CONTENT, INTERACTIVE CONTENT, AND ARTICLES FROM PERIODICAL PUBLICATIONS, ALL OF THE FOREGOING PERTAINING TO NEWS, RESEARCH, INVESTMENTS, FINANCE, FINANCIAL PLANNING, AND INVESTMENT STRATEGY; DOWNLOADABLE SOFTWARE IN THE NATURE OF A MOBILE APPLICATION FOR DELIVERING STREAMING FINANCIAL AND INVESTMENT INFORMATION AND NEWS; DOWNLOADABLE SOFTWARE IN THE NATURE OF A MOBILE APPLICATION WHICH ENABLES USERS TO LOCATE, AND RECEIVE NAVIGATIONAL DIRECTIONS TO, LOCATIONS AT WHICH FINANCIAL SERVICES ARE PROVIDED; DOWNLOADABLE SOFTWARE IN THE NATURE OF A MOBILE APPLICATION THAT ALLOWS USERS TO COMMUNICATE WITH FINANCIAL SERVICES PROFESSIONALS THROUGH EMAIL, TEXT, AND AUDIO AND AUDIOVISUAL MEANS; DOWNLOADABLE SOFTWARE IN THE NATURE OF A MOBILE APPLICATION FOR VIEWING VIDEOS PERTAINING TO NEWS, RESEARCH, INVESTMENTS, FINANCE, FINANCIAL PLANNING, AND INVESTMENT STRATEGY (U.S. CLS. 21, 23, 26, 36 AND 38).

CLASS 36—INSURANCE AND FINANCIAL

FOR PROVIDING FINANCIAL SERVICES THROUGH A WEBSITE FOR MOBILE DEVICES, NAMELY, ELECTRONIC CHECK CONVERSION AND REMOTE DEPOSIT, ELECTRONIC TRANSFER OF MONEY, ELECTRONIC PAYMENT, VIEWING BANK AND INVESTMENT ACCOUNT INFORMATION, INVESTMENT PORTFOLIO MANAGEMENT, ELECTRONIC TRADING OF SECURITIES, PERFORMING FINANCIAL AND INVESTMENT RESEARCH AND ANALYSIS, PROVIDING FINANCIAL AND INVESTMENT INFORMATION AND NEWS, PROVIDING FINANCIAL AND INVESTMENT ADVISORY AND CONSULTANCY SERVICES VIA EMAIL AND TEXT MESSAGES, PROVIDING FINANCIAL AND INVESTMENT ADVISORY AND CONSULTANCY SERVICES, FINANCIAL NEWS, FINANCIAL RESEARCH, FINANCIAL PLANNING, AND INVESTMENT STRATEGY ONLINE (U.S. CLS. 100, 101 AND 102).

CLASS 39—TRANSPORTATION AND STORAGE

FOR PROVIDING CUSTOMIZED DRIVING OR WALKING DIRECTIONS, NAMELY, ENABLING USERS TO LOCATE AND RECEIVE NAVIGATIONAL DIRECTIONS TO LOCATIONS AT WHICH FINANCIAL SERVICES ARE PROVIDED (U.S. CLS. 100 AND 105).
JOHN DALIER, EXAMINING ATTORNEY

SN 85-409,513. CHARLES SCHWAB & CO., INC., SAN FRANCISCO, CA. FILED 8-29-2011.

CHARLES SCHWAB

THE MARK CONSISTS OF STANDARD CHARACTERS WITHOUT CLAIM TO ANY PARTICULAR FONT, STYLE, SIZE, OR COLOR.

OWNER OF U.S. REG. NOS. 1,930,549, 2,501,268 AND OTHERS.

THE NAME(S), PORTRAIT(S), AND/OR SIGNATURE(S) SHOWN IN THE MARK IDENTIFIES A LIVING INDIVIDUAL, WHOSE CONSENT(S) TO REGISTER IS MADE OF RECORD.

CLASS 9—ELECTRICAL AND SCIENTIFIC APPARATUS

FOR DOWNLOADABLE SOFTWARE IN THE NATURE OF A MOBILE APPLICATION FOR ELECTRONIC CHECK CONVERSION AND REMOTE DEPOSIT SERVICES; ELECTRONIC TRANSFER OF MONEY; ELECTRONIC BILL PAYMENT; VIEWING BANK AND INVESTMENT ACCOUNT INFORMATION; INVESTMENT PORTFOLIO MANAGEMENT; ELECTRONIC TRADING OF SECURITIES; PERFORMING FINANCIAL AND INVESTMENT RESEARCH AND ANALYSIS; AND OBTAINING FINANCIAL AND INVESTMENT INFORMATION AND NEWS; DOWNLOADABLE SOFTWARE IN THE NATURE OF A MOBILE APPLICATION FOR VIEWING, SEARCHING AND SHARING FIXED CONTENT, INTERACTIVE CONTENT, AND ARTICLES FROM PERIODICAL PUBLICATIONS, ALL OF THE FOREGOING PERTAINING TO NEWS, RESEARCH, INVESTMENTS, FINANCE, FINANCIAL PLANNING, AND INVESTMENT STRATEGY; DOWNLOADABLE SOFTWARE IN THE NATURE OF A MOBILE APPLICATION FOR DELIVERING STREAMING FINANCIAL AND INVESTMENT INFORMATION AND NEWS; DOWNLOADABLE SOFTWARE IN THE NATURE OF A MOBILE APPLICATION WHICH ENABLES USERS TO LOCATE, AND RECEIVE NAVIGATIONAL DIRECTIONS TO, LOCATIONS AT WHICH FINANCIAL SERVICES ARE PROVIDED; DOWNLOADABLE SOFTWARE IN THE NATURE OF A MOBILE APPLICATION THAT ALLOWS USERS TO COMMUNICATE WITH FINANCIAL SERVICES PROFESSIONALS THROUGH EMAIL, TEXT, AND AUDIO AND AUDIOVISUAL MEANS; DOWNLOADABLE SOFTWARE IN THE NATURE OF A MOBILE APPLICATION FOR VIEWING VIDEOS PERTAINING TO NEWS, RESEARCH, INVESTMENTS, FINANCE, FINANCIAL PLANNING, AND INVESTMENT STRATEGY (U.S. CLS. 21, 23, 26, 36 AND 38).

CLASS 36—INSURANCE AND FINANCIAL

FOR PROVIDING FINANCIAL SERVICES THROUGH A WEBSITE FOR MOBILE DEVICES, NAMELY, ELECTRONIC CHECK CONVERSION AND REMOTE DEPOSIT, ELECTRONIC TRANSFER OF MONEY, ELECTRONIC PAYMENT, VIEWING BANK AND INVESTMENT ACCOUNT INFORMATION, INVESTMENT PORTFOLIO MANAGEMENT, ELECTRONIC TRADING OF SECURITIES, PERFORMING FINANCIAL AND INVESTMENT RESEARCH AND ANALYSIS, PROVIDING FINANCIAL AND INVESTMENT INFORMATION AND NEWS, PROVIDING FINANCIAL AND INVESTMENT ADVISORY AND CONSULTANCY SERVICES VIA EMAIL AND TEXT MESSAGES, PROVIDING FINANCIAL AND INVESTMENT ADVISORY AND CONSULTANCY SERVICES, FINANCIAL NEWS, FINANCIAL RESEARCH, FINANCIAL PLANNING, AND INVESTMENT STRATEGY ONLINE (U.S. CLS. 100, 101 AND 102).

CLASS 39—TRANSPORTATION AND STORAGE

FOR PROVIDING CUSTOMIZED DRIVING OR WALKING DIRECTIONS, NAMELY, ENABLING USERS TO LOCATE AND RECEIVE NAVIGATIONAL DIRECTIONS TO LOCATIONS AT WHICH FINANCIAL SERVICES ARE PROVIDED (U.S. CLS. 100 AND 105).

JOHN DALIER, EXAMINING ATTORNEY

SN 85-409,924. ADASIM INC., CULVER CITY, CA. FILED 8-29-2011.

MOBILE GENIUS

THE MARK CONSISTS OF STANDARD CHARACTERS WITHOUT CLAIM TO ANY PARTICULAR FONT, STYLE, SIZE, OR COLOR.

NO CLAIM IS MADE TO THE EXCLUSIVE RIGHT TO USE "MOBILE", APART FROM THE MARK AS SHOWN.

CLASS 41—EDUCATION AND ENTERTAINMENT

FOR EDUCATIONAL SERVICES, NAMELY, PROVIDING ON-LINE INSTRUCTION IN THE FIELD OF ADVERTISING AND SELLING PRODUCTS ON MOBILE TELEPHONES (U.S. CLS. 100, 101 AND 107).

CLASS 42—SCIENTIFIC AND COMPUTER SERVICES

FOR SOFTWARE AS A SERVICE (SAAS) SERVICES FEATURING SOFTWARE FOR USE IN BUSINESS MANAGEMENT AND BUSINESS DEVELOPMENT (U.S. CLS. 100 AND 101).

GIANCARLO CASTRO, EXAMINING ATTORNEY

SN 85-410,136. HUMAN INTELLECT LAB, LLC, WEST SACRAMENTO, CA. FILED 8-30-2011.

MYNE

THE MARK CONSISTS OF STANDARD CHARACTERS WITHOUT CLAIM TO ANY PARTICULAR FONT, STYLE, SIZE, OR COLOR.

CLASS 9—ELECTRICAL AND SCIENTIFIC APPARATUS

FOR COMPUTER SOFTWARE FOR PROVIDING AN ON-LINE DATABASE IN THE FIELD OF TRANSACTION PROCESSING TO UPLOAD TRANSACTIONAL DATA, PROVIDE STATISTICAL ANALYSIS, AND PRODUCE NOTIFICATIONS AND REPORTS; COMPUTER SOFTWARE FOR THE COLLECTION, EDITING, ORGANIZING, MODIFYING, BOOK MARKING, TRANSMISSION, STORAGE AND SHARING OF DATA AND INFORMATION; COMPUTER SOFTWARE FOR THE FIELD OF WAREHOUSING AND DISTRIBUTION, TO MANAGE TRANSACTIONAL DATA, PROVIDE STATISTICAL ANALYSIS, AND PRODUCE NOTIFICATIONS AND REPORTS; COMPUTER SOFTWARE PLATFORMS FOR EXCHANGE OF USER COMPUTER OR DEVICE USAGE DATA (U.S. CLS. 21, 23, 26, 36 AND 38).

CLASS 35—ADVERTISING AND BUSINESS

FOR AD SERVING, NAMELY, PLACING ADVERTISEMENTS ON WEBSITES FOR OTHERS USING SPECIALIZED COMPUTER SOFTWARE; ONLINE MEDIA MONITORING SERVICES USING COMPUTER SOFTWARE TO AUTOMATICALLY MONITOR INTERNET WEBSITES AND ONLINE PUBLICATIONS FOR CUSTOMER-SPECIFIED TOPICS AND TO CAPTURE RELEVANT CONTENT ON THOSE TOPICS, AND PROVIDING DOCUMENTATION AND ANALYSIS OF THAT ONLINE CONTENT TO OTHERS FOR BUSINESS PURPOSES; OPERATING ON-LINE MARKETPLACES FEATURING EXCHANGE OF PERSONAL DATA BETWEEN SELLERS AND BUYERS; PROVIDING A WEBSITE FEATURING AN ONLINE MARKETPLACE FOR EXCHANGING GOODS AND SERVICES WITH OTHER USERS (U.S. CLS. 100, 101 AND 102).

TRACY CROSS, EXAMINING ATTORNEY

SN 85-411,807. ACA ENTERPRISES, CLYDE, OH. FILED 8-31-2011.

KNUCKLE BUSTER

THE MARK CONSISTS OF STANDARD CHARACTERS WITHOUT CLAIM TO ANY PARTICULAR FONT, STYLE, SIZE, OR COLOR.

CLASS 3—COSMETICS AND CLEANING PREPARATIONS

FOR IMPREGNATED CLEANING, DUSTING, AND POLISHING CLOTHS (U.S. CLS. 1, 4, 6, 50, 51 AND 52).
FIRST USE 1-1-2010; IN COMMERCE 1-1-2010.

CLASS 21—HOUSEWARES AND GLASS

FOR HOOK AND LOOP-TYPE WET FLAT MOPS, HOOK AND LOOP-TYPE DUST MOPS, POCKET DUST MOPS WITH CANVAS BACK, WET MOPS, MICROFIBER FLAT MOPS, MICROFIBER STRING MOPS, MICROFIBER STRIP MOPS, MOP HANDLES, MOP BASES; BUCKETS; DUSTERS; MITTEN-SHAPED MICROFIBER CLEANING CLOTHS; COTTON RAGS, AND FABRIC AUTOMOTIVE WIPES NOT IMPREGNATED WITH CHEMICALS (U.S. CLS. 2, 13, 23, 29, 30, 33, 40 AND 50).
FIRST USE 1-1-2010; IN COMMERCE 1-10-2010.

CLASS 24—FABRICS

FOR MULTI-PURPOSE TOWELS, SHOP TOWELS, TERRY TOWELS, MICROFIBER TOWELS, AND MICROFIBER BAR TOWELS; BED SHEETS AND PILLOW CASES (U.S. CLS. 42 AND 50).

FIRST USE 1-1-2010; IN COMMERCE 1-1-2010.

ROBIN CHOSID, EXAMINING ATTORNEY

SN 85-412,036. FOODSIES.COM, LLC, BAY HARBOR ISLANDS, FL. FILED 8-31-2011.

FOODSIES

THE MARK CONSISTS OF STANDARD CHARACTERS WITHOUT CLAIM TO ANY PARTICULAR FONT, STYLE, SIZE, OR COLOR.

CLASS 35—ADVERTISING AND BUSINESS

FOR ADVERTISING AND MARKETING SERVICES, NAMELY, PROMOTING THE GOODS AND SERVICES OF OTHERS; PROMOTING THE GOODS AND SERVICES OF OTHERS BY PROVIDING A WEBSITE FOR CUSTOMERS TO SEARCH FOR, COMPARE, AND REVIEW FOOD AND DRINK OFFERED BY OTHERS (U.S. CLS. 100, 101 AND 102).

CLASS 41—EDUCATION AND ENTERTAINMENT

FOR EDUCATIONAL SERVICES, NAMELY, PROVIDING ONLINE INSTRUCTION IN THE FIELD OF CULINARY ARTS; EDUCATIONAL SERVICES, NAMELY, PROVIDING INSTRUCTION IN THE FIELD OF CULINARY ARTS (U.S. CLS. 100, 101 AND 107).

CLASS 42—SCIENTIFIC AND COMPUTER SERVICES

FOR PROVIDING A WEBSITE THAT GIVES USERS THE ABILITY TO CREATE CUSTOMIZED WEB PAGES FEATURING USER-DEFINED PROFILES; PROVIDING A WEBSITE THAT GIVES USERS THE ABILITY TO CREATE CUSTOMIZED WEB PAGES FEATURING USER-DEFINED PROFILES FEATURING INGREDIENTS, FOODS, DRINKS, RESTAURANTS, DINING, COOKING, RECIPES, AND FOOD AND DRINK CRITICISM (U.S. CLS. 100 AND 101).

CLASS 43—HOTEL AND RESTAURANT SERVICES

FOR PROVIDING A WEBSITE FEATURING INFORMATION ABOUT INGREDIENTS, FOODS, DRINKS, RESTAURANTS, DINING, COOKING, RECIPES, AND FOOD AND DRINK CRITICISM; PROVIDING A DATABASE IN THE FIELD OF FOOD AND DRINK; PROVIDING A DATABASE IN THE FIELD OF FOOD AND DRINK THAT STORES USERS; BIOGRAPHICAL DATA AND THE USERS; PREFERENCES DATA FOR INGREDIENTS, FOODS, DRINKS, RESTAURANTS, DINING, COOKING, AND FOOD AND DRINK CRITICISM; PROVIDING AN ONLINE COMPUTER DATABASE CONCERNING INGREDIENTS, FOODS, DRINKS, RESTAURANTS, DINING, RECIPES, AND FOOD AND DRINK CRITICISM; PROVIDING ON-LINE REVIEWS OF INGREDIENTS, FOOD, DRINKS, RESTAURANTS, DINING, COOKING, AND RECIPES; PROVIDING REVIEWS OF INGREDIENTS, FOOD, DRINKS RESTAURANTS, DINING COOKING, AND RECIPES (U.S. CLS. 100 AND 101).

CLASS 44—MEDICAL, BEAUTY AND AGRICULTURAL SERVICES

FOR DIETARY AND NUTRITIONAL GUIDANCE (U.S. CLS. 100 AND 101).

CLASS 45—PERSONAL AND LEGAL SERVICES

FOR INTERNET-BASED SOCIAL NETWORKING SERVICES; ONLINE SOCIAL NETWORKING SERVICES BASED ON SHARED INTEREST IN INGREDIENTS, FOODS, DRINKS, RESTAURANTS, DINING, COOKING, RECIPES, AND FOOD AND DRINK CRITICISM PROVIDED VIA A WEBSITE (U.S. CLS. 100 AND 101).

DAVID I, EXAMINING ATTORNEY

CLASS 9—ELECTRICAL AND SCIENTIFIC APPARATUS

FOR COMPUTER HARDWARE AND COMPUTER SOFTWARE FOR THE REPRODUCTION, PROCESSING AND STREAMING OF AUDIO, VIDEO, IMAGES AND OTHER MULTIMEDIA CONTENT; COMPUTER HARDWARE AND SOFTWARE FOR CONTROLLING THE OPERATION OF AUDIO AND VIDEO DEVICES AND FOR VIEWING, SEARCHING AND/OR PLAYING AUDIO, VIDEO, IMAGES AND OTHER MULTIMEDIA CONTENT; COMPUTER HARDWARE AND SOFTWARE TO ENABLE USERS TO PROGRAM, DISTRIBUTE, TRANSMIT AND RECEIVE AUDIO, VIDEO, IMAGES AND OTHER MULTIMEDIA CONTENT VIA COMMUNICATIONS NETWORKS; COMPUTERS; COMPUTER SOFTWARE THAT ENABLES THE SHARING OF DIGITAL MEDIA BETWEEN CONSUMER DEVICES SUCH AS COMPUTERS, TELEVISIONS, PRINTERS, CAMERAS, CELL PHONES, SMART PHONES, LOUDSPEAKERS AND OTHER MULTIMEDIA DEVICES AND THE PLAYBACK OF SUCH MEDIA ON SUCH DEVICES; COMPUTER PERIPHERAL DEVICES; HANDHELD COMPUTERS; TABLET COMPUTERS; HANDHELD DIGITAL ELECTRONIC DEVICES COMPRISING A TABLET COMPUTER, ELECTRONIC BOOK READER, DIGITAL AUDIO AND VIDEO PLAYER, CAMERA, PERSONAL DIGITAL ASSISTANT AND GLOBAL POSITIONING SYSTEM (GPS) DEVICE AND WHICH IS CAPABLE OF PROVIDING ACCESS TO GLOBAL COMMUNICATIONS NETWORKS AND MOBILE COMMUNICATIONS NETWORKS PRINTERS; TELEPHONES; MOBILE PHONES; SMARTPHONES; PERSONAL DIGITAL ASSISTANTS; TELEVISIONS; TELEVISION MONITORS; VIDEO MONITORS; TELEVISION SET TOP BOXES; RADIOS; APPARATUS FOR RECORDING, TRANSMISSION OR REPRODUCTION OF SOUND OR IMAGES; AUDIO SPEAKERS; HOME THEATER SYSTEMS CONSISTING OF OPTICAL DISC PLAYERS AND RECORDERS, AUDIO AMPLIFIERS, AUDIO SPEAKERS, DOCK AUDIO SPEAKERS AND SUBWOOFERS; OPTICAL DISC PLAYERS AND RECORDERS; DIGITAL AUDIO RECORDERS AND PLAYERS; DIGITAL VIDEO RECORDERS AND PLAYERS; NETWORK PLAYERS IN THE NATURE OF SET TOP BOXES; MP3 AND OTHER DIGITAL FORMAT AUDIO PLAYERS; NETWORK AUDIO SPEAKERS; ACTIVE AUDIO SPEAKERS; DOCK AUDIO SPEAKERS; AMPLIFIERS; UNIVERSAL REMOTE CONTROLS FOR MULTIPLE DEVICES, NAMELY, TELEVISIONS, OPTICAL DISC PLAYERS, OPTICAL DISC RECORDERS, OPTICAL DISC PLAYERS AND RECORDERS, AND LOUDSPEAKERS CONNECTED TO A COMPUTER NETWORK; HEADPHONES; MICROPHONES; CAMERAS; DIGITAL STILL CAMERAS; CAMCORDERS; AMUSEMENT APPARATUS FOR GAMES ADAPTED FOR USE WITH TELEVISION RECEIVERS; COMPUTER GAMING MACHINES; ELECTRONIC READERS (U.S. CLS. 21, 23, 26, 36 AND 38).

SN 85-412,247. SONY CORPORATION, TOKYO, JAPAN, FILED 8-31-2011.



CLASS 28—TOYS AND SPORTING GOODS

FOR ELECTRONIC HAND-HELD GAMES OTHER THAN THOSE ADAPTED FOR USE WITH AN EXTERNAL DISPLAY SCREEN OR MONITOR (U.S. CLS. 22, 23, 38 AND 50).

BRIAN PINO, EXAMINING ATTORNEY

SN 85-412,283. FOODSIES.COM, LLC, BAY HARBOR ISLANDS, FL. FILED 8-31-2011.

FoodDNA

THE MARK CONSISTS OF A DESIGN OF A DARK RECTANGLE WITH A LIGHT DOT CENTERED IN THE TOP OF THE RECTANGLE, A DARK DOT ABOVE THE OUTSIDE OF THE RECTANGLE, AND A DARK TRIANGULAR ELEMENT APPEARING ABOVE THE DARK DOT.

THE MARK CONSISTS OF STANDARD CHARACTERS WITHOUT CLAIM TO ANY PARTICULAR FONT, STYLE, SIZE, OR COLOR.

CLASS 35—ADVERTISING AND BUSINESS

FOR ADVERTISING AND MARKETING SERVICES, NAMELY, PROMOTING THE GOODS AND SERVICES OF OTHERS; PROMOTING THE GOODS AND SERVICES OF OTHERS BY PROVIDING A WEBSITE FOR CUSTOMERS TO SEARCH FOR, COMPARE, AND REVIEW FOOD AND DRINK OFFERED BY OTHERS (U.S. CLS. 100, 101 AND 102).

CLASS 41—EDUCATION AND ENTERTAINMENT

FOR EDUCATIONAL SERVICES, NAMELY, PROVIDING ONLINE INSTRUCTION IN THE FIELD OF CULINARY ARTS; EDUCATIONAL SERVICES, NAMELY, PROVIDING INSTRUCTION IN THE FIELD OF CULINARY ARTS (U.S. CLS. 100, 101 AND 107).

CLASS 42—SCIENTIFIC AND COMPUTER SERVICES

FOR PROVIDING A WEBSITE THAT GIVES USERS THE ABILITY TO CREATE CUSTOMIZED WEB PAGES FEATURING USER-DEFINED PROFILES; PROVIDING A WEBSITE THAT GIVES USERS THE ABILITY TO CREATE CUSTOMIZED WEB PAGES FEATURING USER-DEFINED PROFILES FEATURING INTERESTS IN INGREDIENTS, FOODS, DRINKS, RESTAURANTS, DINING, COOKING, RECIPES, AND FOOD AND DRINK CRITICISM (U.S. CLS. 100 AND 101).

CLASS 43—HOTEL AND RESTAURANT SERVICES

FOR PROVIDING A WEBSITE FEATURING INFORMATION ABOUT INGREDIENTS, FOODS, DRINKS, RESTAURANTS, DINING, COOKING, RECIPES, AND FOOD AND DRINK CRITICISM; PROVIDING A DATABASE IN THE FIELD OF FOOD AND DRINK; PROVIDING A DATABASE IN THE FIELD OF FOOD AND DRINK THAT STORES USERS; BIOGRAPHICAL DATA AND THE USERS; PREFERENCES DATA FOR INGREDIENTS, FOODS, DRINKS, RESTAURANTS, DINING, COOKING, AND FOOD AND DRINK CRITICISM; PROVIDING AN ONLINE COMPUTER DATABASE STORING DATA CONCERNING INGREDIENTS, FOODS, DRINKS, RESTAURANTS, DINING, RECIPES, AND FOOD AND DRINK CRITICISM; PROVIDING ON-LINE REVIEWS OF INGREDIENTS, FOOD, DRINKS, RESTAURANTS, DINING, COOKING, AND RECIPES; PROVIDING REVIEWS OF INGREDIENTS, FOOD, DRINKS RESTAURANTS, DINING COOKING, AND RECIPES (U.S. CLS. 100 AND 101).

CLASS 44—MEDICAL, BEAUTY AND AGRICULTURAL SERVICES

FOR DIETARY AND NUTRITIONAL GUIDANCE (U.S. CLS. 100 AND 101).

CLASS 45—PERSONAL AND LEGAL SERVICES

FOR INTERNET-BASED SOCIAL NETWORKING SERVICES; ONLINE SOCIAL NETWORKING SERVICES BASED ON SHARED INTEREST IN INGREDIENTS, FOODS, DRINKS, RESTAURANTS, DINING, COOKING, RECIPES, AND FOOD AND DRINK CRITICISM PROVIDED VIA A WEBSITE (U.S. CLS. 100 AND 101).

DAVID I. EXAMINING ATTORNEY

SN 85-413,523. FOODSIES.COM, LLC, BAY HARBOR ISLANDS, FL. FILED 9-1-2011.



THE MARK CONSISTS OF "FOODSIES" IN LARGER SANS SARIF FONT WITH "LET'S EAT!" IN A SMALLER ITALICIZED SCRIPT BENEATH. ALL OF THE WORDS ARE ENCLOSED IN A WORD BUBBLE (I.E. LIKE A COMIC STRIP).

CLASS 35—ADVERTISING AND BUSINESS

FOR ADVERTISING AND MARKETING SERVICES, NAMELY, PROMOTING THE GOODS AND SERVICES OF OTHERS; PROMOTING THE GOODS AND SERVICES OF OTHERS BY PROVIDING A WEBSITE FOR CUSTOMERS TO SEARCH FOR, COMPARE, AND REVIEW FOOD AND DRINK OFFERED BY OTHERS (U.S. CLS. 100, 101 AND 102).

CLASS 41—EDUCATION AND ENTERTAINMENT

FOR EDUCATIONAL SERVICES, NAMELY, PROVIDING ONLINE INSTRUCTION IN THE FIELD OF CULINARY ARTS; EDUCATIONAL SERVICES, NAMELY, PROVIDING INSTRUCTION IN THE FIELD OF CULINARY ARTS (U.S. CLS. 100, 101 AND 107).

CLASS 42—SCIENTIFIC AND COMPUTER SERVICES

FOR PROVIDING A WEBSITE THAT GIVES USERS THE ABILITY TO CREATE CUSTOMIZED WEB PAGES FEATURING USER-DEFINED PROFILES; PROVIDING A WEBSITE THAT GIVES USERS THE ABILITY TO CREATE CUSTOMIZED WEB PAGES FEATURING USER-DEFINED PROFILES FEATURING INTERESTS IN INGREDIENTS, FOODS, DRINKS, RESTAURANTS, DINING, COOKING, RECIPES, AND FOOD AND DRINK CRITICISM (U.S. CLS. 100 AND 101).

CLASS 43—HOTEL AND RESTAURANT SERVICES

FOR PROVIDING A WEBSITE FEATURING INFORMATION ABOUT INGREDIENTS, FOODS, DRINKS, RESTAURANTS, DINING, COOKING, RECIPES, AND FOOD AND DRINK CRITICISM; PROVIDING A DATABASE IN THE FIELD OF FOOD AND DRINK; PROVIDING A DATABASE IN THE FIELD OF FOOD AND DRINK THAT STORES USERS; BIOGRAPHICAL DATA AND THE USERS; PREFERENCES DATA FOR INGREDIENTS, FOODS, DRINKS, RESTAURANTS, DINING, COOKING, AND FOOD AND DRINK CRITICISM; PROVIDING AN ONLINE COMPUTER DATABASE STORING DATA CONCERNING INGREDIENTS, FOODS, DRINKS, RESTAURANTS, DINING, RECIPES, AND FOOD AND DRINK CRITICISM; PROVIDING ON-LINE REVIEWS OF INGREDIENTS, FOOD, DRINKS, RESTAURANTS, DINING, COOKING, AND RECIPES; PROVIDING REVIEWS OF INGREDIENTS, FOOD, DRINKS RESTAURANTS, DINING COOKING, AND RECIPES (U.S. CLS. 100 AND 101).

CLASS 44—MEDICAL, BEAUTY AND AGRICULTURAL SERVICES

FOR DIETARY AND NUTRITIONAL GUIDANCE (U.S. CLS. 100 AND 101).

CLASS 45—PERSONAL AND LEGAL SERVICES

FOR INTERNET-BASED SOCIAL NETWORKING SERVICES; ONLINE SOCIAL NETWORKING SERVICES BASED ON SHARED INTEREST IN INGREDIENTS, FOODS, DRINKS, RESTAURANTS, DINING, COOKING, RECIPES, AND FOOD AND DRINK CRITICISM PROVIDED VIA A WEBSITE; PROVIDING A WEBSITE FOR USERS WITH SPECIFIC INFORMED RECOMMENDATIONS OF SPECIFIC CONSUMER PRODUCTS AND SERVICES VALIDATED BY THE USERS' INPUTTED PREFERENCES AND SOCIAL NETWORK; PROVIDING A FOOD-THEMED WEBSITE FOR USERS WITH SPECIFIC INFORMED RECOMMENDATIONS OF SPECIFIC CONSUMER PRODUCTS AND SERVICES VALIDATED BY THE USERS' INPUTTED PREFERENCES AND SOCIAL NETWORK (U.S. CLS. 100 AND 101).
DAVID I, EXAMINING ATTORNEY

SN 85-414,677. WOODMAN, CYNTHIA, PASADENA, CA. FILED 9-2-2011.

WHAT A GIRL EATS

THE MARK CONSISTS OF STANDARD CHARACTERS WITHOUT CLAIM TO ANY PARTICULAR FONT, STYLE, SIZE, OR COLOR.

CLASS 43—HOTEL AND RESTAURANT SERVICES

FOR EDUCATIONAL AND ENTERTAINMENT SERVICES, NAMELY, PROVIDING INFORMATION IN THE FIELDS OF FOOD PREPARATION, COOKING, AND RESTAURANTS VIA WIRED AND WIRELESS GLOBAL COMPUTER NETWORKS (U.S. CLS. 100 AND 101).
FIRST USE 5-29-2011; IN COMMERCE 5-29-2011.

CLASS 44—MEDICAL, BEAUTY AND AGRICULTURAL SERVICES

FOR EDUCATIONAL AND ENTERTAINMENT SERVICES, NAMELY, PROVIDING INFORMATION IN THE FIELDS OF NUTRITION AND DIET VIA WIRED AND WIRELESS GLOBAL COMPUTER NETWORKS (U.S. CLS. 100 AND 101).
FIRST USE 5-29-2011; IN COMMERCE 5-29-2011.
SUNG IN, EXAMINING ATTORNEY

SN 85-415,385. PRO EQUINE GROUP, INC., DEERFIELD, IL. FILED 9-6-2011.

CACTUS GEAR

THE MARK CONSISTS OF STANDARD CHARACTERS WITHOUT CLAIM TO ANY PARTICULAR FONT, STYLE, SIZE, OR COLOR.
OWNER OF U.S. REG. NOS. 2,259,342, 3,898,707 AND OTHERS.
NO CLAIM IS MADE TO THE EXCLUSIVE RIGHT TO USE "GEAR", APART FROM THE MARK AS SHOWN.

CLASS 10—MEDICAL APPARATUS

FOR COMPRESSION BANDAGES FOR HORSES (U.S. CLS. 26, 39 AND 44).

CLASS 18—LEATHER GOODS

FOR PROTECTIVE HORSE BOOTS FOR THE LEGS AND HOOVES, FLY MASKS FOR HORSES, PROTECTIVE LEG WRAPS FOR HORSES, HORSE BLANKETS AND CLOTHING FOR HORSES, NAMELY, FLY SHEETS, STABLE SHEETS, TURNOUT SHEETS; SADDLERY, NAMELY, CINCHES; HAY AND FEED BAGS; AND RIDING BOOT TOTE BAGS (U.S. CLS. 1, 2, 3, 22 AND 41).

GENE MACIOL, EXAMINING ATTORNEY

SN 85-415,712. FENWAY GROUP, LLC, DALLAS, TX. FILED 9-6-2011.

Fenway Group

THE MARK CONSISTS OF STANDARD CHARACTERS WITHOUT CLAIM TO ANY PARTICULAR FONT, STYLE, SIZE, OR COLOR.
NO CLAIM IS MADE TO THE EXCLUSIVE RIGHT TO USE "GROUP", APART FROM THE MARK AS SHOWN.

CLASS 9—ELECTRICAL AND SCIENTIFIC APPARATUS

FOR COMPUTER APPLICATION SOFTWARE FOR MOBILE PHONES, NAMELY, SOFTWARE FOR PROVIDING LINKS TO SERVICES BASED USER LOCATION, MOBILE SEARCH AND BROWSING, MOBILE HEALTH MONITORING, MOBILE PAYMENTS, NEAR FIELD COMMUNICATIONS, MOBILE ADVERTISING, HUMAN AUGMENTATION, SPEECH RECOGNITION, LOCATION AWARE APPLICATIONS FOR CREATING AND MAINTAINING PUBLIC VIRTUAL WORLDS, MICROBLOGGING, ELECTRONIC PAPER, CLOUD COMPUTING, DATA STORAGE AND RETRIEVAL, AND OPERATING MOBILE ROBOTS; COMPUTER APPLICATION SOFTWARE FOR DATA STORAGE AND RETRIEVAL IN THE FIELD OF, OR FOR USE WITH, ECOMMERCE, DASHBOARDS, ERP, CRM, TICKETING SYSTEMS, ENTERPRISE SOFTWARE, ACCOUNTING SOFTWARE, OFFICE SUITES, GRAPHICS SOFTWARE, MIDDLEWARE, BUSINESS WORKFLOW, DATABASE MANAGEMENT SYSTEMS, DIGITAL ASSET MANAGEMENT, DOCUMENT MANAGEMENT, SALES READINESS SOFTWARE, SIMULATION SOFTWARE, IMAGE EDITING SOFTWARE, WEB DEVELOPMENT SOFTWARE, FINITE ELEMENT ANALYSIS, INTEGRATED DEVELOPMENT ENVIRONMENTS; COMPUTER ECOMMERCE SOFTWARE TO ALLOW USERS TO PERFORM ELECTRONIC BUSINESS TRANSACTIONS VIA A GLOBAL COMPUTER NETWORK; COMPUTER SOFTWARE THAT PROVIDES REAL-TIME, INTEGRATED BUSINESS MANAGEMENT INTELLIGENCE BY COMBINING INFORMATION FROM VARIOUS DATABASES AND PRESENTING IT IN AN EASY-TO-UNDERSTAND USER INTERFACE; COMPUTER SOFTWARE, NAMELY, AN APPLICATION ALLOWING SALES AND FIELD SERVICE EMPLOYEES TO UPDATE AND RECEIVE DATA STORED IN AN ENTERPRISE'S COMPUTER DATABASES IN REAL TIME, USING A MOBILE DEVICE, WITH FULL TELEPHONY INTEGRATION WITH THE TELEPHONE AND/OR SOFTWARE FEATURES OF THE MOBILE DEVICE; COMPUTER SOFTWARE, NAMELY, SOFTWARE DEVELOPMENT TOOLS FOR THE CREATION OF MOBILE INTERNET APPLICATIONS AND CLIENT INTERFACES, DOWNLOADABLE SOFTWARE IN THE NATURE OF A MOBILE APPLICATION FOR PROVIDING LINKS TO SERVICES BASED USER LOCATION, MOBILE SEARCH AND BROWSING,

MOBILE HEALTH MONITORING, MOBILE PAYMENTS, NEAR FIELD COMMUNICATIONS, MOBILE ADVERTISING, HUMAN AUGMENTATION, SPEECH RECOGNITION, LOCATION AWARE APPLICATIONS FOR CREATING AND MAINTAINING PUBLIC VIRTUAL WORLDS, MICROBLOGGING, ELECTRONIC PAPER, CLOUD COMPUTING, DATA STORAGE AND RETRIEVAL, AND OPERATING MOBILE ROBOTS; ENTERPRISE SOFTWARE IN THE NATURE OF A DATABASE FOR NON-TRANSACTIONAL DATA AND A SEARCH ENGINE FOR DATABASE CONTENT (U.S. CLS. 21, 23, 26, 36 AND 38).

FIRST USE 2-14-2002; IN COMMERCE 2-14-2002.

CLASS 35—ADVERTISING AND BUSINESS

FOR BUSINESS CONSULTATION SERVICES, NAMELY, BUSINESS PROCESS IMPROVEMENT AND ENTERPRISE ARCHITECTURE DESIGN; BUSINESS CONSULTING SERVICES IN THE FIELD OF ORGANIZATIONAL CHANGE MANAGEMENT; BUSINESS CONSULTING SERVICES RELATING TO THE INTEGRATION OF THE AREAS OF BUSINESS PROCESS TECHNOLOGY, ORGANIZATIONAL LEARNING, CHANGE MANAGEMENT, AND OPERATIONAL SUSTAINABILITY; BUSINESS CONSULTING SERVICES, NAMELY, PROVIDING A TURNKEY BUSINESS SOLUTION FOR REVIEWING PRODUCTS AND SERVICES, PLANNING DOCUMENTATION AND WORKFLOW, HIRING TECHNICAL WRITERS, MANAGING PROJECTS FOR BUSINESS PURPOSES, TRACKING USER SATISFACTION, AND RUNNING USABILITY STUDIES FOR BUSINESS PURPOSES; BUSINESS CONSULTING SERVICES, NAMELY, PROVIDING A TURNKEY SOLUTION FOR REVIEWING PRODUCT AND SERVICE DOCUMENTATION AND WORKFLOW, MANAGING PROJECTS FOR BUSINESS PURPOSES, TRACKING USER SATISFACTION, AND RUNNING USABILITY STUDIES FOR BUSINESS PURPOSES; BUSINESS MANAGEMENT AND CONSULTATION IN THE FIELD OF CASE MANAGEMENT, INTEGRATED JUSTICE, DATA CONVERSIONS, AND BUSINESS INTELLIGENCE; PROMOTING THE USE OF THE SECURITY ASSURANCE BEST PRACTICES OF OTHERS IN THE FIELD OF CLOUD COMPUTING (U.S. CLS. 100, 101 AND 102).

FIRST USE 2-14-2002; IN COMMERCE 2-14-2002.

CLASS 41—EDUCATION AND ENTERTAINMENT

FOR BUSINESS TRAINING; BUSINESS TRAINING CONSULTANCY SERVICES; COMPUTER EDUCATION TRAINING; COMPUTER EDUCATION TRAINING SERVICES; EDUCATION SERVICES, NAMELY, MENTORING IN THE FIELD OF CUSTOM AND COMMERCIAL APPLICATION DEVELOPMENT; EDUCATION SERVICES, NAMELY, ONE-ON-ONE MENTORING IN THE FIELDS OF CUSTOM AND COMMERCIAL APPLICATION DEVELOPMENT; PROVIDING EDUCATIONAL MENTORING SERVICES AND PROGRAMS IN THE FIELD OF CUSTOM AND COMMERCIAL APPLICATION DEVELOPMENT; TRAINING IN THE USE AND OPERATION OF SOFTWARE DEVELOPMENT TOOLS, LANGUAGES, PROCESSES AND METHODOLOGIES (U.S. CLS. 100, 101 AND 107).

FIRST USE 2-14-2002; IN COMMERCE 2-14-2002.

CLASS 42—SCIENTIFIC AND COMPUTER SERVICES

FOR APPLICATION SERVICE PROVIDER, NAMELY, HOSTING, MANAGING, DEVELOPING, AND MAINTAINING APPLICATIONS, SOFTWARE, AND WEB SITES, IN THE FIELDS OF PERSONAL PRODUCTIVITY, WIRELESS COMMUNICATION, MOBILE INFORMATION ACCESS, AND REMOTE DATA MANAGEMENT FOR WIRELESS DELIVERY OF CONTENT TO HANDHELD COMPUTERS, LAPTOPS AND MOBILE ELECTRONIC DEVICES; CLOUD COMPUTING FEATURING SOFTWARE FOR USE IN THE DELIVERY OF TRADITIONAL APPLICATION DEVELOPMENT SERVICES; COMPUTER SERVICES, NAMELY, CLOUD HOSTING PROVIDER SERVICES; COMPUTER SERVICES, NAMELY, INTEGRATION OF PRIVATE AND PUBLIC CLOUD COMPUTING ENVIRONMENTS; COMPUTER SERVICES, NAMELY, REMOTE AND ON-SITE MAN-

AGEMENT OF THE INFORMATION TECHNOLOGY (IT) CLOUD COMPUTING SYSTEMS OF OTHERS; COMPUTER SERVICES, NAMELY, REMOTE MANAGEMENT OF THE INFORMATION TECHNOLOGY (IT) SYSTEMS OF OTHERS; COMPUTER SOFTWARE DEVELOPMENT IN THE FIELD OF MOBILE APPLICATIONS; COMPUTER TECHNICAL SUPPORT SERVICES, NAMELY, 24/7 SERVICE DESK/HELP DESK SERVICES FOR IT INFRASTRUCTURE, OPERATING SYSTEMS, DATABASE SYSTEMS, AND WEB APPLICATIONS.; COMPUTER TECHNOLOGY SUPPORT SERVICES, NAMELY, HELP DESK SERVICES; CONSULTING SERVICES IN THE FIELD OF CLOUD COMPUTING; DEVELOPING AND HOSTING A SERVER ON A GLOBAL COMPUTER NETWORK FOR THE PURPOSE OF FACILITATING E-COMMERCE VIA SUCH A SERVER; DEVELOPING AND MANAGING APPLICATION SOFTWARE AND DATABASES FOR DELIVERY OF MULTIMEDIA CONTENT PROVIDED BY MUSEUMS AND OTHER TOUR VENUES FOR USE ON MULTIPLE TYPES OF WIRELESS MOBILE DEVICES; PROVIDING A WEBSITE THAT ENABLES USERS TO SUBSCRIBE TO COACHING, MENTORING, AND/OR EDUCATIONAL SERVICES AND TO ENABLE USERS TO AUTHOR AND PUBLISH INSTRUCTIONAL CONTENT FOR OTHERS; PROVIDING VIRTUAL COMPUTER SYSTEMS AND VIRTUAL COMPUTER ENVIRONMENTS THROUGH CLOUD COMPUTING, TECHNICAL CONSULTING SERVICES IN THE FIELDS OF DATACENTER ARCHITECTURE, PUBLIC AND PRIVATE CLOUD COMPUTING SOLUTIONS, AND EVALUATION AND IMPLEMENTATION OF INTERNET TECHNOLOGY AND SERVICES; TECHNICAL SUPPORT SERVICES, NAMELY, REMOTE AND ON-SITE INFRASTRUCTURE MANAGEMENT SERVICES FOR MONITORING, ADMINISTRATION AND MANAGEMENT OF PUBLIC AND PRIVATE CLOUD COMPUTING IT AND APPLICATION SYSTEMS; WEBSITE USABILITY TESTING SERVICES (U.S. CLS. 100 AND 101).

FIRST USE 2-14-2002; IN COMMERCE 2-14-2002.

CLASS 45—PERSONAL AND LEGAL SERVICES

FOR PROVIDING USER AUTHENTICATION SERVICES IN E-COMMERCE TRANSACTIONS (U.S. CLS. 100 AND 101).

FIRST USE 2-14-2002; IN COMMERCE 2-14-2002.

ELI HELLMAN, EXAMINING ATTORNEY

SN 85-416,839. SYLVAN ENERGY, LLC, PITTSBURGH, PA. FILED 9-7-2011.



NO CLAIM IS MADE TO THE EXCLUSIVE RIGHT TO USE "ENERGY", APART FROM THE MARK AS SHOWN.

THE MARK CONSISTS OF THE WORDS "SYLVAN ENERGY" FOLLOWED BY A STYLIZED TREE HAVING A BOTTOM TRUNK PORTION RESEMBLING AN OIL DERICK AND A TOP PORTION RESEMBLING LEAVES, THE LITERAL AND DESIGN ELEMENTS ARE POSITIONED ABOVE A HORIZONTAL LINE.

CLASS 40—MATERIAL TREATMENT

FOR OIL AND GAS PRODUCTION (U.S. CLS. 100, 103 AND 106).

FIRST USE 10-9-2007; IN COMMERCE 10-9-2007.

CLASS 42—SCIENTIFIC AND COMPUTER SERVICES

FOR OIL AND GAS EXPLORATION (U.S. CLS. 100 AND 101).
FIRST USE 10-9-2007; IN COMMERCE 10-9-2007.
ANTHONY RINKER, EXAMINING ATTORNEY

SN 85-416,882. SYLVAN ENERGY, LLC, PITTSBURGH, PA.
FILED 9-7-2011.

SYLVAN ENERGY

THE MARK CONSISTS OF STANDARD CHARACTERS WITHOUT CLAIM TO ANY PARTICULAR FONT, STYLE, SIZE, OR COLOR.
NO CLAIM IS MADE TO THE EXCLUSIVE RIGHT TO USE "ENERGY", APART FROM THE MARK AS SHOWN.

CLASS 40—MATERIAL TREATMENT

FOR OIL AND GAS PRODUCTION (U.S. CLS. 100, 103 AND 106).
FIRST USE 10-9-2007; IN COMMERCE 10-9-2007.

CLASS 42—SCIENTIFIC AND COMPUTER SERVICES

FOR OIL AND GAS EXPLORATION (U.S. CLS. 100 AND 101).
FIRST USE 10-9-2007; IN COMMERCE 10-9-2007.
ANTHONY RINKER, EXAMINING ATTORNEY

SN 85-419,527. EIEIO, INC., AUSTIN, TX. FILED 9-10-2011.

Magicow

THE MARK CONSISTS OF STANDARD CHARACTERS WITHOUT CLAIM TO ANY PARTICULAR FONT, STYLE, SIZE, OR COLOR.
OWNER OF U.S. REG. NO. 3,016,060.

CLASS 11—ENVIRONMENTAL CONTROL APPARATUS

FOR TEMPERATURE-CONTROLLED FOOD AND BEVERAGE DISPENSERS, AND COMPONENTS THEREOF (U.S. CLS. 13, 21, 23, 31 AND 34).
FIRST USE 3-28-2000; IN COMMERCE 1-1-2002.

CLASS 29—MEATS AND PROCESSED FOODS

FOR COFFEE CREAMER (U.S. CL. 46).
FIRST USE 3-28-2000; IN COMMERCE 1-1-2002.

CLASS 30—STAPLE FOODS

FOR FLAVORINGS FOR BEVERAGES (U.S. CL. 46).
FIRST USE 3-28-2000; IN COMMERCE 1-1-2002.
ROBIN CHOSID, EXAMINING ATTORNEY

SN 85-420,352. UNITEDHEALTH GROUP INCORPORATED,
MINNETONKA, MN. FILED 9-12-2011.

LIFEPRINT

THE MARK CONSISTS OF STANDARD CHARACTERS WITHOUT CLAIM TO ANY PARTICULAR FONT, STYLE, SIZE, OR COLOR.

CLASS 36—INSURANCE AND FINANCIAL

FOR INSURANCE CLAIMS PROCESSING (U.S. CLS. 100, 101 AND 102).
FIRST USE 2-0-2011; IN COMMERCE 2-0-2011.

CLASS 41—EDUCATION AND ENTERTAINMENT

FOR EDUCATIONAL SERVICES, NAMELY, CONDUCTING PROGRAMS AND CLASSES IN THE FIELDS OF HEALTH, WELLNESS, NUTRITION, AND HEALTHY LIFESTYLE; PROVIDING A CENTER FOR EDUCATIONAL CLASSES IN THE FIELD OF HEALTH, WELLNESS, NUTRITION, AND HEALTHY LIFESTYLES (U.S. CLS. 100, 101 AND 107).
FIRST USE 2-0-2011; IN COMMERCE 2-0-2011.

CLASS 43—HOTEL AND RESTAURANT SERVICES

FOR PROVIDING COMMUNITY CENTERS FOR SOCIAL GATHERINGS (U.S. CLS. 100 AND 101).
FIRST USE 2-0-2011; IN COMMERCE 2-0-2011.

CLASS 44—MEDICAL, BEAUTY AND AGRICULTURAL SERVICES

FOR HEALTHCARE SERVICES, NAMELY, ESTABLISHING A NETWORK OF PHYSICIANS; MANAGED HEALTHCARE SERVICES; MEDICAL CLINICS; HEALTHCARE SERVICES; COUNSELING SERVICES IN THE FIELDS OF HEALTH, WELLNESS, NUTRITION AND HEALTHY LIFESTYLE; CONDUCTING PERSONAL HEALTH, WELLNESS, NUTRITION AND LIFESTYLE ASSESSMENTS (U.S. CLS. 100 AND 101).
FIRST USE 2-0-2011; IN COMMERCE 2-0-2011.
ESTHER A. BORSUK, EXAMINING ATTORNEY

SN 85-420,653. COOLWAY INC., TARZANA, CA. FILED 9-12-2011.

°Coolway

THE MARK CONSISTS OF A DEGREE CELSIUS SYMBOL FORMING PART OF LETTER "C" IN THE LITERAL ELEMENT "COOLWAY".

CLASS 3—COSMETICS AND CLEANING PREPARATIONS

FOR HAIR CARE AND STYLING PREPARATIONS, NAMELY, SHAMPOO, CONDITIONER, HAIR CREAM, NON-MEDICATED HAIR SERUM, HAIR STYLING SPRAY, AND HAIR SMOOTHING SPRAY (U.S. CLS. 1, 4, 6, 50, 51 AND 52).

CLASS 8—HAND TOOLS

FOR ELECTRIC HAIR TOOLS, NAMELY, SMOOTHING IRONS, HAND-HELD HAIR STYLING IRONS AND, HAIR CURLERS (U.S. CLS. 23, 28 AND 44).

CLASS 11—ENVIRONMENTAL CONTROL APPARATUS

FOR ELECTRIC HAIR TOOLS, NAMELY, HAIR DRYERS (U.S. CLS. 13, 21, 23, 31 AND 34).
JENNY PARK, EXAMINING ATTORNEY

SN 85-420,664. COOLWAY INC., TARZANA, CA. FILED 9-12-2011.

COOLWAY

THE MARK CONSISTS OF STANDARD CHARACTERS WITHOUT CLAIM TO ANY PARTICULAR FONT, STYLE, SIZE, OR COLOR.

CLASS 3—COSMETICS AND CLEANING PREPARATIONS

FOR HAIR CARE AND STYLING PREPARATIONS, NAMELY, SHAMPOO, CONDITIONER, HAIR CREAM, NON-MEDICATED HAIR SERUM, HAIR STYLING SPRAY, AND HAIR SMOOTHING SPRAY (U.S. CLS. 1, 4, 6, 50, 51 AND 52).

CLASS 8—HAND TOOLS

FOR ELECTRIC HAIR TOOLS, NAMELY, SMOOTHING IRONS, HAND-HELD HAIR STYLING IRONS AND, HAIR CURLERS (U.S. CLS. 23, 28 AND 44).

CLASS 11—ENVIRONMENTAL CONTROL APPARATUS

FOR ELECTRIC HAIR TOOLS, NAMELY, HAIR DRYERS (U.S. CLS. 13, 21, 23, 31 AND 34).
JENNY PARK, EXAMINING ATTORNEY

SN 85-420,671. COOLWAY INC., TARZANA, CA. FILED 9-12-2011.

THE LOW HEAT REVOLUTION

THE MARK CONSISTS OF STANDARD CHARACTERS WITHOUT CLAIM TO ANY PARTICULAR FONT, STYLE, SIZE, OR COLOR.

NO CLAIM IS MADE TO THE EXCLUSIVE RIGHT TO USE "LOW HEAT", APART FROM THE MARK AS SHOWN.

CLASS 3—COSMETICS AND CLEANING PREPARATIONS

FOR HAIR CARE AND STYLING PREPARATIONS, NAMELY, SHAMPOO, CONDITIONER, HAIR CREAM, NON-MEDICATED HAIR SERUM, HAIR STYLING SPRAY, AND HAIR SMOOTHING SPRAY (U.S. CLS. 1, 4, 6, 50, 51 AND 52).

CLASS 8—HAND TOOLS

FOR ELECTRIC HAIR TOOLS, NAMELY, SMOOTHING IRONS, HAND-HELD HAIR STYLING IRONS AND, HAIR CURLERS (U.S. CLS. 23, 28 AND 44).

CLASS 11—ENVIRONMENTAL CONTROL APPARATUS

FOR ELECTRIC HAIR TOOLS, NAMELY, HAIR DRYERS (U.S. CLS. 13, 21, 23, 31 AND 34).
JENNY PARK, EXAMINING ATTORNEY

SN 85-421,142. DYNACRAFT BSC, INC., AMERICAN CANYON, CA. FILED 9-13-2011.

BLING IT

THE MARK CONSISTS OF STANDARD CHARACTERS WITHOUT CLAIM TO ANY PARTICULAR FONT, STYLE, SIZE, OR COLOR.

CLASS 12—VEHICLES

FOR BICYCLES, TRICYCLES, SCOOTERS, WAGONS, UNICYCLES, HANDLEBAR BAGS (U.S. CLS. 19, 21, 23, 31, 35 AND 44).

CLASS 16—PAPER GOODS AND PRINTED MATTER

FOR BICYCLES ACCESSORIES, NAMELY, KITS COMPRISING MARKERS, PAPER STICKERS AND GEMS FOR DECORATING BICYCLES (U.S. CLS. 2, 5, 22, 23, 29, 37, 38 AND 50).

CLASS 28—TOYS AND SPORTING GOODS

FOR THREE-WHEELED, NON MOTORIZED RIDE ON TOY (U.S. CLS. 22, 23, 38 AND 50).
JOSETTE BEVERLY, EXAMINING ATTORNEY

SN 85-422,045. HARCO CO. LTD., MISSISSAUGA, ONTARIO, CANADA, FILED 9-14-2011.



PRIORITY CLAIMED UNDER SEC. 44(D) ON CANADA APPLICATION NO. 1521068, FILED 3-28-2011, REG. NO. TMA822160, DATED 4-16-2012, EXPIRES 4-16-2027.

NO CLAIM IS MADE TO THE EXCLUSIVE RIGHT TO USE "LAUNDRY SYSTEMS", APART FROM THE MARK AS SHOWN.

THE MARK CONSISTS OF THE STYLIZED LETTERING OF THE WORD "HARCO" FOLLOWED BY THE SWIRLING EDDY DESIGN THAT APPEARS AGAINST THE BACKGROUND OF TWO EQUAL SIZED PARALLELOGRAMS, THE LEFT ONE DARKER THAN THE RIGHT ONE. BELOW THE LETTER "A" IN "HARCO" APPEARS THE PHRASE "LEADERS IN LAUNDRY SYSTEMS".

CLASS 7—MACHINERY

FOR LAUNDRY AND DRY CLEANING MACHINE SYSTEMS, NAMELY, WASHERS, EXTRACTORS, DRY TUMBLERS, FLATWORK IRONERS, FOLDERS, CROSS FOLDERS, SPREADER FEEDERS, SMALL PIECE FOLDERS, TUNNEL WASHERS, DRY CLEANING UNITS, SHIRT FINISHING SYSTEMS, UTILITY PRESSES, BOILERS AND HEATERS; TEXTILE MACHINES, NAMELY, WASHERS, DRYERS AND IRONING MACHINES; LAUNDRY AND DRY CLEANING SYSTEMS, NAMELY, COMBINED CLOTHES WASHERS AND DRYERS AND ACCESSORIES AND PARTS THEREFORE (U.S. CLS. 13, 19, 21, 23, 31, 34 AND 35).

CLASS 9—ELECTRICAL AND SCIENTIFIC APPARATUS

FOR ENCODED SMART CARDS CONTAINING PROGRAMMING USED TO ACCESS LAUNDRY MACHINES AND DRY CLEANING SYSTEMS (U.S. CLS. 21, 23, 26, 36 AND 38).

CLASS 22—CORDAGE AND FIBERS

FOR LAUNDRY BAGS (U.S. CLS. 1, 2, 7, 19, 22, 42 AND 50).

CLASS 35—ADVERTISING AND BUSINESS

FOR WHOLESALE DISTRIBUTORSHIP SERVICES FEATURING LAUNDRY AND DRY CLEANING MACHINE SYSTEMS; BUSINESS CONSULTATION SERVICES IN THE LAUNDRY AND DRY CLEANING INDUSTRY, NAMELY, WORK FLOW PLANNING, LABOR, OPERATING AND COST ANALYSIS, EQUIPMENT SELECTION AND PROCUREMENT, INVENTORY MANAGEMENT AND CONTROL CONSULTATION (U.S. CLS. 100, 101 AND 102).

CLASS 36—INSURANCE AND FINANCIAL

FOR PROVISION OF WARRANTIES FOR LAUNDRY AND DRY CLEANING SYSTEMS FOR THIRD PARTIES (U.S. CLS. 100, 101 AND 102).

CLASS 37—CONSTRUCTION AND REPAIR

FOR APPLIANCE INSTALLATION, REPAIR AND MAINTENANCE SERVICES, NAMELY, INSTALLATION, REPAIR, CONSULTATION AND MAINTENANCE SERVICES RELATED TO LAUNDRY AND DRY CLEANING SYSTEMS; APPLIANCE CONSULTATION SERVICES, NAMELY, CONSULTATION SERVICES IN THE FIELD OF LAUNDRY AND DRY CLEANING MACHINE INSTALLATION, MAINTENANCE AND REPAIR SYSTEMS; LAUNDRY AND DRY CLEANING MACHINERY MAINTENANCE CONSULTATION SERVICES; PROVISION OF LEASING SERVICES FOR LAUNDRY AND DRY CLEANING SYSTEMS (U.S. CLS. 100, 103 AND 106).

CLASS 39—TRANSPORTATION AND STORAGE

FOR STORAGE CONSULTATION, NAMELY, WAREHOUSING CONSULTATION IN THE FIELD OF THE LAUNDRY AND DRY CLEANING INDUSTRY (U.S. CLS. 100 AND 105).

CLASS 41—EDUCATION AND ENTERTAINMENT

FOR EDUCATION CONSULTATION IN THE FIELD OF OPERATOR TRAINING IN THE LAUNDRY AND DRY CLEANING INDUSTRY (U.S. CLS. 100, 101 AND 107).

CLASS 42—SCIENTIFIC AND COMPUTER SERVICES

FOR DESIGN CONSULTING SERVICES, NAMELY, DESIGN ENGINEERING CONSULTATION IN THE FIELD OF LAUNDRY AND DRY CLEANING INDUSTRY MACHINERY (U.S. CLS. 100 AND 101).

AMY C. KEAN, EXAMINING ATTORNEY

SN 85-422,049. HARCO CO. LTD., MISSISSAUGA, ONTARIO, CANADA, FILED 9-14-2011.



PRIORITY CLAIMED UNDER SEC. 44(D) ON CANADA APPLICATION NO. 1521195, FILED 3-28-2011, REG. NO. TMA821980, DATED 4-11-2012, EXPIRES 4-11-2027.

THE MARK CONSISTS OF A SWIRLING EDDY DESIGN THAT APPEARS AGAINST THE BACKGROUND OF TWO EQUAL SIZED PARALLELOGRAMS, THE LEFT ONE DARKER THAN THE RIGHT ONE.

CLASS 7—MACHINERY

FOR LAUNDRY AND DRY CLEANING MACHINE SYSTEMS, NAMELY, WASHERS, EXTRACTORS, DRY TUMBLERS, FLATWORK IRONERS, FOLDERS, CROSS FOLDERS, SPREADER FEEDERS, SMALL PIECE FOLDERS, TUNNEL WASHERS, DRY CLEANING UNITS, SHIRT FINISHING SYSTEMS, UTILITY PRESSES, BOILERS AND HEATERS; TEXTILE MACHINES, NAMELY, WASHERS, DRYERS AND IRONING MACHINES; LAUNDRY AND DRY CLEANING SYSTEMS, NAMELY, COMBINED CLOTHES WASHERS AND DRYERS AND ACCESSORIES AND PARTS THEREFORE (U.S. CLS. 13, 19, 21, 23, 31, 34 AND 35).

CLASS 9—ELECTRICAL AND SCIENTIFIC APPARATUS

FOR ENCODED SMART CARDS CONTAINING PROGRAMMING USED TO ACCESS LAUNDRY MACHINES AND DRY CLEANING SYSTEMS (U.S. CLS. 21, 23, 26, 36 AND 38).

CLASS 22—CORDAGE AND FIBERS

FOR LAUNDRY BAGS (U.S. CLS. 1, 2, 7, 19, 22, 42 AND 50).

CLASS 35—ADVERTISING AND BUSINESS

FOR WHOLESALE DISTRIBUTORSHIP SERVICES FEATURING LAUNDRY AND DRY CLEANING MACHINE SYSTEMS; BUSINESS CONSULTATION SERVICES IN THE LAUNDRY AND DRY CLEANING INDUSTRY, NAMELY, WORK FLOW PLANNING, LABOR, OPERATING AND COST ANALYSIS, EQUIPMENT SELECTION AND PROCUREMENT, INVENTORY MANAGEMENT AND CONTROL CONSULTATION (U.S. CLS. 100, 101 AND 102).

CLASS 36—INSURANCE AND FINANCIAL

FOR PROVISION OF WARRANTIES FOR LAUNDRY AND DRY CLEANING SYSTEMS FOR THIRD PARTIES (U.S. CLS. 100, 101 AND 102).

CLASS 37—CONSTRUCTION AND REPAIR

FOR APPLIANCE INSTALLATION, REPAIR AND MAINTENANCE SERVICES, NAMELY, INSTALLATION, REPAIR, CONSULTATION AND MAINTENANCE SERVICES RELATED TO LAUNDRY AND DRY CLEANING SYSTEMS; APPLIANCE CONSULTATION SERVICES, NAMELY CONSULTATION SERVICES IN THE FIELD OF LAUNDRY AND DRY CLEANING MACHINE INSTALLATION, MAINTENANCE AND REPAIR SYSTEMS; LAUNDRY AND DRY CLEANING MACHINERY MAINTENANCE CONSULTATION SERVICES; PROVISION OF LEASING SERVICES FOR LAUNDRY AND DRY CLEANING SYSTEMS (U.S. CLS. 100, 103 AND 106).

CLASS 39—TRANSPORTATION AND STORAGE

FOR STORAGE CONSULTATION, NAMELY, WAREHOUSING CONSULTATION IN THE FIELD OF THE LAUNDRY AND DRY CLEANING INDUSTRY (U.S. CLS. 100 AND 105).

CLASS 41—EDUCATION AND ENTERTAINMENT

FOR EDUCATION CONSULTATION IN THE FIELD OF OPERATOR TRAINING IN THE LAUNDRY AND DRY CLEANING INDUSTRY (U.S. CLS. 100, 101 AND 107).

CLASS 42—SCIENTIFIC AND COMPUTER SERVICES

FOR DESIGN CONSULTING SERVICES, NAMELY, DESIGN ENGINEERING CONSULTATION IN THE FIELD OF LAUNDRY AND DRY CLEANING INDUSTRY MACHINERY (U.S. CLS. 100 AND 101).
AMY C. KEAN, EXAMINING ATTORNEY

SN 85-422,488. AES CORPORATION, PEABODY, MA. FILED 9-14-2011.



NO CLAIM IS MADE TO THE EXCLUSIVE RIGHT TO USE "ONLINE", APART FROM THE MARK AS SHOWN.

THE MARK CONSISTS OF THE WORDS "SECURITY VISION ONLINE" WITH THE WORD "ONLINE" APPEARING BELOW "SECURITY VISION" AND A HORIZONTAL LINE APPEARING IN FRONT OF THE WORD "ONLINE". THE LETTER "I" IN "SECURITY" IS DOTTED WITH A CIRCLE WHICH IS SURROUNDED BY THREE ARCS, THE SMALLEST FACING LEFT, THE LARGER TWO FACING RIGHT.

CLASS 35—ADVERTISING AND BUSINESS

FOR PROVIDING A WEB-BASED, ON-LINE PORTAL TO INDUSTRIES THAT PROVIDE CUSTOMERS ACCESS TO THEIR ALARM SYSTEM AND ALARM SYSTEM CONTROLS, TO THEIR VEHICLE TRACKING SYSTEM, TO THEIR HOME AUTOMATION SYSTEM, TO THEIR VIDEO MONITORING SYSTEM AND TO OTHER INDUSTRIES WHICH PROVIDE REMOTE CONTROL EQUIPMENT AND SERVICES FOR THE PURPOSE OF CUSTOMER ACCOUNT BUSINESS MANAGEMENT (U.S. CLS. 100, 101 AND 102).

FIRST USE 3-18-2011; IN COMMERCE 3-18-2011.

CLASS 42—SCIENTIFIC AND COMPUTER SERVICES

FOR PROVIDING A WEB-BASED, ON-LINE PORTAL FOR INSTALLERS FEATURING TECHNOLOGY ENABLING THE INSTALLERS TO SERVICE AND MODIFY THE ALARMS IN ALARM SYSTEMS AND ALARM SYSTEM CONTROLS, VEHICLE TRACKING SYSTEMS, HOME AUTOMATION SYSTEMS AND VIDEO MONITORING SYSTEMS (U.S. CLS. 100 AND 101).

FIRST USE 3-18-2011; IN COMMERCE 3-18-2011.
TRACY FLETCHER, EXAMINING ATTORNEY

SN 85-422,985. VIETNAM NATIONAL COAL, MINERAL INDUSTRIES HOLDING CORPORATION LIMITED, DONG DA DIST., HANOI, VIETNAM, FILED 9-14-2011.



PRIORITY CLAIMED UNDER SEC. 44(D) ON VIETNAM APPLICATION NO. 4-2011-11952, FILED 6-16-2011, REG. NO. 183600, DATED 4-23-2012, EXPIRES 6-16-2021.

THE COLOR(S) WHITE, RED, BLUE, BROWN, YELLOW, AND BLACK IS/ARE CLAIMED AS A FEATURE OF THE MARK.

THE MARK CONSISTS OF THE STYLIZED TEXT "VINA-COMIN", WITH THE LETTERS "V", "C", AND "M" IN RED, AND THE LETTERS, "I", "N", "A", "O", "I", AND "N", IN BLACK; A RED "V" IS LOCATED ABOVE THE TEXT, WITH A YELLOW STAR LOCATED IN THE SPACE IN THE "V", TWO BLUE CONCENTRIC CIRCLES WITH A BLUE LINE IN THE MIDDLE LOCATED BEHIND THE "V", TWO BROWN TRIANGLES LOCATED ON EACH SIDE OF THE "V", AND A WHITE CIRCLE AND WHITE LINE LOCATED INSIDE THE "V".

CLASS 4—LUBRICANTS AND FUELS

FOR CHARCOAL AS FUEL; OILS AND GREASES FOR INDUSTRIAL PURPOSES; MINERAL FUEL (U.S. CLS. 1, 6 AND 15).

CLASS 6—METAL GOODS

FOR ALUMINUM ALLOYS; COPPER ORES; ZINC ORES; CHROMIUM; IRONS AND STEELS (U.S. CLS. 2, 12, 13, 14, 23, 25 AND 50).

CLASS 37—CONSTRUCTION AND REPAIR

FOR CONSTRUCTION AND INSTALLATION SERVICES FOR INDUSTRIAL ELECTRICITY POWER PROJECTS, NAMELY, PLANT CONSTRUCTION, MAINTENANCE AND CONSTRUCTION PROJECT MANAGEMENT SERVICES FOR BUSINESSES IN THE ENERGY PRODUCTION AND TRANSMISSION SECTOR, INSTALLATION OF RENEWABLE ENERGY GENERATION EQUIPMENT, CONSTRUCTION OF NUCLEAR AND COAL-FIRED POWER PLANTS; MINING EXTRACTION; REPAIR OF MINING MACHINES AND APPARATUS (U.S. CLS. 100, 103 AND 106).
NICHOLAS COLEMAN, EXAMINING ATTORNEY

SN 85-426,226. FUNDHUB, LLC, FALLS CHURCH, VA.
FILED 9-19-2011.

fundhub

THE MARK CONSISTS OF STANDARD CHARACTERS WITHOUT CLAIM TO ANY PARTICULAR FONT, STYLE, SIZE, OR COLOR.

CLASS 35—ADVERTISING AND BUSINESS

FOR WHOLESALE SUPPLIER SERVICES AND ONLINE WHOLESALE SUPPLIER SERVICES FEATURING FUNDRAISING ITEMS IN THE NATURE OF HOME GOODS, APPAREL, NOVELTY ITEMS, AND GIFTS; DEVELOP FUNDRAISING PROGRAM AND CAMPAIGNS FOR OTHERS; BUSINESS CONSULTATION SERVICES TO ASSIST NON-PROFIT ORGANIZATIONS IN PLANNING, MANAGING, AND CONDUCTING FUNDRAISING ACTIVITIES; MANUFACTURERS' REPRESENTATIVES IN THE FIELD OF GENERAL MERCHANDISE FOR FUNDRAISING PURPOSES; PROVIDE A WEB BASED SYSTEM AND ONLINE PORTAL IN THE FIELD OF FUNDRAISING USED TO ORGANIZE, MANAGE, AND COMMUNICATE WITHIN FUNDRAISING CAMPAIGNS IN ALL TERRITORIES; PROVIDE AN ONLINE PORTAL FOR REGISTRATION FOR ATHLETICS AND FUNDRAISING EVENTS (U.S. CLS. 100, 101 AND 102).

CLASS 36—INSURANCE AND FINANCIAL

FOR CHARITABLE FUNDRAISING SERVICES; FUNDRAISING SERVICES, NAMELY, ORGANIZING, ARRANGING AND CONDUCTING FUNDRAISING PROGRAMS FOR SCHOOLS AND OTHER GROUPS; ONLINE BUSINESS FUNDRAISING SERVICES (U.S. CLS. 100, 101 AND 102).

ALAIN LAPTER, EXAMINING ATTORNEY

SN 85-429,165. HOTEL JV SERVICES, LLC, DALLAS, TX.
FILED 9-22-2011.

ROOM KEY

THE MARK CONSISTS OF STANDARD CHARACTERS WITHOUT CLAIM TO ANY PARTICULAR FONT, STYLE, SIZE, OR COLOR.

CLASS 39—TRANSPORTATION AND STORAGE

FOR PROVIDING A WEBSITE FEATURING INFORMATION IN THE FIELD OF TRAVEL, CRUISES, VACATION PACKAGES, TOURS, AND TRANSPORTATION; PROVIDING ONLINE REVIEWS OF TRAVEL SERVICE PROVIDERS, AIRLINES, CRUISE LINES, VACATION PACKAGES, TOURS, TRANSPORTATION PROVIDERS, AND CAR RENTAL AGENCIES; RESERVATIONS AND BOOKINGS FOR TRAVEL, CRUISES, VACATION PACKAGES, TOURS, AND TRANSPORTATION (U.S. CLS. 100 AND 105).

CLASS 41—EDUCATION AND ENTERTAINMENT

FOR PROVIDING A WEBSITE FEATURING INFORMATION IN THE FIELD OF ENTERTAINMENT, SPORTING, AND CULTURAL EVENTS AND VENUES, AMUSEMENT PARKS, TOURIST ATTRACTIONS, TOURIST DESTINATIONS, AND RECREATIONAL ACTIVITIES; PROVIDING ONLINE REVIEWS OF ENTERTAINMENT, SPORTING, AND CULTURAL EVENTS AND VENUES, AMUSEMENT PARKS, TOURIST ATTRACTIONS, TOURIST DESTINATIONS, AND RECREATIONAL ACTIVITIES; TICKET RESERVATION AND BOOKING SERVICES FOR ENTERTAINMENT, SPORTING AND CULTURAL EVENTS AND VENUES, AMUSEMENT PARKS, TOURIST ATTRACTIONS, AND RECREATIONAL ACTIVITIES (U.S. CLS. 100, 101 AND 107).

CLASS 43—HOTEL AND RESTAURANT SERVICES

FOR PROVIDING ONLINE REVIEWS OF HOTELS AND TEMPORARY ACCOMMODATIONS (U.S. CLS. 100 AND 101).

JAMES GRIFFIN, EXAMINING ATTORNEY

SN 85-430,164. AMPLIFY SOCIAL, INC., SAN FRANCISCO, CA. FILED 9-23-2011.

AMPLIFY SOCIAL

THE MARK CONSISTS OF STANDARD CHARACTERS WITHOUT CLAIM TO ANY PARTICULAR FONT, STYLE, SIZE, OR COLOR.

NO CLAIM IS MADE TO THE EXCLUSIVE RIGHT TO USE "SOCIAL", APART FROM THE MARK AS SHOWN.

CLASS 35—ADVERTISING AND BUSINESS

FOR ADVERTISING AND PUBLICITY SERVICES, NAMELY, PROMOTING THE GOODS, SERVICES, CONTENT, BRAND IDENTITY AND COMMERCIAL INFORMATION AND NEWS OF THIRD PARTIES THROUGH DIGITAL AND ON-LINE MEDIUM; ADVERTISING AND MARKETING SERVICES PROVIDED BY MEANS OF INDIRECT METHODS OF MARKETING COMMUNICATIONS, NAMELY, THE DISSEMINATION OF SOCIAL MEDIA, SEARCH ENGINE MARKETING, INQUIRY MARKETING, INTERNET MARKETING, MOBILE MARKETING, BLOGGING AND OTHER FORMS OF PASSIVE, SHARABLE OR VIRAL COMMUNICATIONS CHANNELS (U.S. CLS. 100, 101 AND 102).
FIRST USE 5-1-2011; IN COMMERCE 5-1-2011.

CLASS 38—COMMUNICATION

FOR ELECTRONIC TRANSMISSION OF THIRD PARTY CONTENT, NAMELY, THE DISTRIBUTION OF TEXT, GRAPHICS, VIDEO, AND AUDIO FOR PUBLICATION ON MULTIPLE WEBSITES AND OTHER DIGITAL AND ONLINE MEDIUM (U.S. CLS. 100, 101 AND 104).
FIRST USE 5-1-2011; IN COMMERCE 5-1-2011.

CLASS 41—EDUCATION AND ENTERTAINMENT

FOR ONLINE SYNDICATION OF THIRD PARTY NEWS AND INFORMATIONAL CONTENT, NAMELY, TEXT, GRAPHICS, VIDEO AND AUDIO FEATURING ATHLETES (U.S. CLS. 100, 101 AND 107).
FIRST USE 5-1-2011; IN COMMERCE 5-1-2011.
JENNIFER VASQUEZ, EXAMINING ATTORNEY

SN 85-430,171. AMPLIFY SOCIAL, INC., SAN FRANCISCO, CA. FILED 9-23-2011.



THE COLOR(S) ORANGE AND BLACK IS/ARE CLAIMED AS A FEATURE OF THE MARK.

THE MARK CONSISTS OF THE WORD "AMPLIFY" IN BLACK AND "SOCIAL" IN ORANGE TO THE RIGHT OF A GROUPING OF SEVERAL ORANGE CIRCLES.

CLASS 35—ADVERTISING AND BUSINESS

FOR ADVERTISING AND PUBLICITY SERVICES, NAMELY, PROMOTING THE GOODS, SERVICES, CONTENT, BRAND IDENTITY AND COMMERCIAL INFORMATION AND NEWS OF THIRD PARTIES THROUGH DIGITAL AND ON-LINE MEDIUM; ADVERTISING AND MARKETING SERVICES PROVIDED BY MEANS OF INDIRECT METHODS OF MARKETING COMMUNICATIONS, NAMELY, THE DISSEMINATION OF SOCIAL MEDIA, SEARCH ENGINE MARKETING, INQUIRY MARKETING, INTERNET MARKETING, MOBILE MARKETING, BLOGGING AND OTHER FORMS OF PASSIVE, SHARABLE OR VIRAL COMMUNICATIONS CHANNELS (U.S. CLS. 100, 101 AND 102).
FIRST USE 9-5-2011; IN COMMERCE 9-25-2011.

CLASS 38—COMMUNICATION

FOR ELECTRONIC TRANSMISSION OF THIRD PARTY CONTENT, NAMELY, THE DISTRIBUTION OF TEXT, GRAPHICS, VIDEO, AND AUDIO FOR PUBLICATION ON MULTIPLE WEBSITES AND OTHER DIGITAL AND ONLINE MEDIUM (U.S. CLS. 100, 101 AND 104).
FIRST USE 9-5-2011; IN COMMERCE 9-25-2011.

CLASS 41—EDUCATION AND ENTERTAINMENT

FOR ONLINE SYNDICATION OF THIRD PARTY NEWS AND INFORMATIONAL CONTENT, NAMELY, TEXT, GRAPHICS, VIDEO AND AUDIO FEATURING ATHLETES (U.S. CLS. 100, 101 AND 107).
FIRST USE 9-5-2001; IN COMMERCE 9-25-2001.
JENNIFER VASQUEZ, EXAMINING ATTORNEY

SN 85-430,967. BETTINARDI, ROBERT J., TINLEY PARK, IL. FILED 9-23-2011.

Studio B

THE MARK CONSISTS OF STANDARD CHARACTERS WITHOUT CLAIM TO ANY PARTICULAR FONT, STYLE, SIZE, OR COLOR.

CLASS 25—CLOTHING

FOR ATHLETIC APPAREL, NAMELY, SHIRTS, PANTS, JACKETS, FOOTWEAR, HATS AND CAPS, ATHLETIC UNIFORMS; ATHLETIC FOOTWEAR; ATHLETIC SHOES; BUTTON DOWN SHIRTS; CARGO PANTS; COLLARED SHIRTS; DENIMS; GOLF CAPS; GOLF CLEATS; GOLF PANTS, SHIRTS AND SKIRTS; GOLF SHIRTS; GOLF SHOES; GOLF SHORTS; GOLF SPIKES; GOLF TROUSERS; GYM PANTS; HOODED SWEAT SHIRTS; JOGGING PANTS; KNIT SHIRTS; LONG-SLEEVED SHIRTS; LOUNGE PANTS; OPEN-NECKED SHIRTS; PANTS; PIQUE SHIRTS; POLO SHIRTS; SHIRTS; SPORTS PANTS; SPORTS SHIRTS; SPORTS SHIRTS WITH SHORT SLEEVES; SWEAT BANDS; SWEAT JACKETS; SWEAT PANTS; SWEAT SHIRTS; SWEAT SHORTS; T-SHIRTS (U.S. CLS. 22 AND 39).
FIRST USE 1-1-2006; IN COMMERCE 1-1-2006.

CLASS 28—TOYS AND SPORTING GOODS

FOR COVERS FOR GOLF CLUBS; DISCS FOR PLAYING DISC GOLF; DIVOT REPAIR TOOLS; DRIVING PRACTICE MATS; FITTED COVERS FOR NON-MOTORIZED GOLF CARTS; FITTED HEAD COVERS FOR GOLF CLUBS; GLOVES FOR GOLF; GOLF ACCESSORIES, NAMELY, CARRIERS AND DISPENSERS FOR GOLF BALLS; GOLF ACCESSORIES, NAMELY, HOLDERS SPECIALLY ADAPTED FOR HOLDING GOLF BALL MARKERS; GOLF ACCESSORY POUCHES; GOLF ACCESSORY, NAMELY, SUPPORT FOR HOLDING A GOLF CLUB; GOLF BAG COVERS; GOLF BAG PEGS; GOLF BAG TAGS; GOLF BAGS; GOLF BAGS WITH OR WITHOUT WHEELS; GOLF BALL MARKERS; GOLF BALL RETRIEVERS; GOLF BALL SLEEVES; GOLF BALLS; GOLF CLUB BAGS; GOLF CLUB COVERS; GOLF CLUB GRIPS; GOLF CLUB HEADS; GOLF CLUB HOLDERS FOR USE ON A DRIVING RANGE OR GOLF COURSE; GOLF CLUB INSERTS; GOLF CLUB SHAFTS; GOLF CLUB SWING AIDS, NAMELY, TARGET LASER AND LIGHTS; GOLF CLUB SWING AIDS, NAMELY, GOLF CLUB BALANCING SCALES AND SCALE PARTS THEREOF, TO ANALYZE, FIT AND/OR MAKE GOLF CLUBS; GOLF CLUBS; GOLF FLAGS; GOLF GLOVES; GOLF IRONS; GOLF PRACTICE NETS; GOLF PUTTER COVERS; GOLF PUTTERS; GOLF TEE MARKERS; GOLF TEES; GOLF TOWEL CLIPS FOR ATTACHMENT TO GOLF BAGS; GOLF TRAINING APPARATUS, NAMELY, DEVICES USED TO HELP GROOVE A REPETITIVE PUTTING STROKE; GOLF TRAINING APPARATUS, NAMELY, GOLF PRACTICE PLATFORMS; GOLF TRAINING EQUIPMENT, NAMELY, A GOLF TRAINING CAGE; GOLF TRAINING EQUIPMENT, NAMELY, A MOTORIZED GOLF CHIPPING PRACTICE AID; HAND GRIPS FOR GOLF CLUBS; HEAD COVERS FOR GOLF CLUBS; IMPACT MARKERS IN THE NATURE OF PRESSURE SENSITIVE REUSABLE IMPACT LABELS FOR ATTACHMENT TO THE HEAD OF A GOLF CLUB TO INDICATE WHERE THE CLUB HITS THE BALL; MODULAR FOAM PREFABRICATED MINIATURE GOLF COURSES AND PUTTING SURFACES; PUTTING PRACTICE MATS; STANDS SPECIALLY ADAPTED FOR HOLDING GOLF CLUBS; TROLLEY BAGS FOR GOLF EQUIPMENT (U.S. CLS. 22, 23, 38 AND 50).

FIRST USE 1-1-2006; IN COMMERCE 1-1-2006.
JAY FLOWERS, EXAMINING ATTORNEY

SN 85-431,215. HEINTZ, JOHN, LOS ANGELES, CA. FILED 9-24-2011.

GETDOWN

THE MARK CONSISTS OF STANDARD CHARACTERS WITHOUT CLAIM TO ANY PARTICULAR FONT, STYLE, SIZE, OR COLOR.

CLASS 9—ELECTRICAL AND SCIENTIFIC APPARATUS

FOR COMPACT DISCS FEATURING MUSIC; DVDS FEATURING MUSIC VIDEOS; DIGITAL MUSIC DOWNLOADABLE FROM THE INTERNET (U.S. CLS. 21, 23, 26, 36 AND 38).

CLASS 41—EDUCATION AND ENTERTAINMENT

FOR MULTIMEDIA ENTERTAINMENT SERVICES IN THE NATURE OF RECORDING, PRODUCTION, AND POST-PRODUCTION SERVICES IN THE FIELDS OF MUSIC, VIDEO, AND FILMS; ENTERTAINMENT, NAMELY, LIVE MUSIC CONCERTS (U.S. CLS. 100, 101 AND 107).

DAVID TAYLOR, EXAMINING ATTORNEY

SN 85-432,039. SPIN CONCEPTS, INC., OVERLAND PARK, KS. FILED 9-26-2011.



OWNER OF U.S. REG. NOS. 3,163,808 AND 3,172,270.
THE MARK CONSISTS OF A REPRESENTATION OF A MAN BENT AT THE WAIST AND RIDING A BICYCLE WITH ONE ARM STRETCHED UP TOWARD A SPIRAL DESIGN, THE MAN'S MOUTH IS OPEN AND HE IS WEARING A BALL CAP WITH THE BILL POSITIONED UPWARD, THE TWO CIRCLES ON EITHER SIDE OF THE MAN REPRESENT THE BICYCLE.

CLASS 30—STAPLE FOODS

FOR PREPARED FOODS FOR CONSUMPTION ON AND OFF THE PREMISES, NAMELY, PIZZA, PANINI, GELATO, DELI SANDWICHES, AND COFFEE AND TEA BEVERAGES (U.S. CL. 46).

FIRST USE 5-1-2005; IN COMMERCE 5-1-2005.

CLASS 43—HOTEL AND RESTAURANT SERVICES

FOR RESTAURANT AND RESTAURANT CARRY-OUT SERVICES, FEATURING PIZZA, PANINI, GELATO, DELI SANDWICHES, SOUPS AND SALADS, AND COFFEE AND TEA BEVERAGES; BAR SERVICES; CATERING SERVICES; WINE BAR SERVICES (U.S. CLS. 100 AND 101).

FIRST USE 5-1-2005; IN COMMERCE 5-1-2005.
APRIL ROACH, EXAMINING ATTORNEY

SN 85-433,406. MILFORD HOLDING CO., WILMINGTON, DE. FILED 9-27-2011.

CLARION FINANCIAL

THE MARK CONSISTS OF STANDARD CHARACTERS WITHOUT CLAIM TO ANY PARTICULAR FONT, STYLE, SIZE, OR COLOR.

NO CLAIM IS MADE TO THE EXCLUSIVE RIGHT TO USE "FINANCIAL", APART FROM THE MARK AS SHOWN.

CLASS 35—ADVERTISING AND BUSINESS

FOR LEASING OF OFFICE EQUIPMENT; AND LEASING OF OFFICE FURNITURE (U.S. CLS. 100, 101 AND 102).

FIRST USE 1-0-2003; IN COMMERCE 1-0-2003.

CLASS 36—INSURANCE AND FINANCIAL

FOR FINANCING SERVICES FOR DENTAL PRACTICES IN THE NATURE OF EQUIPMENT FINANCING SERVICES; VENTURE CAPITAL SERVICES IN THE NATURE OF PROVIDING FINANCING TO DENTAL PRACTICES; BUSINESS FINANCE PROCUREMENT SERVICES; BUSINESS LIQUIDATION SERVICES; DEBT CONSOLIDATION SERVICES; LEASE-PURCHASE FINANCING SERVICES; REFINANCING SERVICES AND PROVIDING WORKING CAPITAL LOANS (U.S. CLS. 100, 101 AND 102).

FIRST USE 1-0-2003; IN COMMERCE 1-0-2003.

CLASS 44—MEDICAL, BEAUTY AND AGRICULTURAL SERVICES

FOR LEASING SERVICES IN THE NATURE OF LEASING OF DENTAL EQUIPMENT (U.S. CLS. 100 AND 101).

FIRST USE 1-0-2003; IN COMMERCE 1-0-2003.
ZACHARY BELLO, EXAMINING ATTORNEY

SN 85-434,340. MCCUTCHEON, DAVID, SOUTH DAYTONA, FL. FILED 9-28-2011.

Puppy Jock

THE MARK CONSISTS OF STANDARD CHARACTERS WITHOUT CLAIM TO ANY PARTICULAR FONT, STYLE, SIZE, OR COLOR.

NO CLAIM IS MADE TO THE EXCLUSIVE RIGHT TO USE "PUPPY", APART FROM THE MARK AS SHOWN.

CLASS 5—PHARMACEUTICALS

FOR VITAMINS FOR DOGS (U.S. CLS. 6, 18, 44, 46, 51 AND 52).

CLASS 31—NATURAL AGRICULTURAL PRODUCTS

FOR DIGESTIBLE CHEWING BONES FOR DOGS; DRY DOG FOOD, NAMELY, DOG BISCUITS; CANNED DOG FOOD; EDIBLE DOG TREATS; DRINKING WATER FOR DOGS; EDIBLE DOG TREATS, NAMELY, CHEWS FOR DOGS (U.S. CLS. 1 AND 46).

JASON TURNER, EXAMINING ATTORNEY

SN 85-434,981. TB PROPRIETARY CORPORATION, WILMINGTON, DE. FILED 9-29-2011.

THE TOLL BROTHERS GREEN COMMITMENT

THE MARK CONSISTS OF STANDARD CHARACTERS WITHOUT CLAIM TO ANY PARTICULAR FONT, STYLE, SIZE, OR COLOR.

NO CLAIM IS MADE TO THE EXCLUSIVE RIGHT TO USE "BROTHERS" AND "GREEN", APART FROM THE MARK AS SHOWN.

CLASS 35—ADVERTISING AND BUSINESS

FOR REAL ESTATE SALES MANAGEMENT (U.S. CLS. 100, 101 AND 102).

FIRST USE 10-27-2010; IN COMMERCE 10-27-2010.

CLASS 37—CONSTRUCTION AND REPAIR

FOR LAND DEVELOPMENT AND CONSTRUCTION SERVICES, NAMELY, PLANNING, LAYING OUT AND CUSTOM CONSTRUCTION OF RESIDENTIAL COMMUNITIES; CONSTRUCTION OF ENVIRONMENTALLY FRIENDLY RESIDENTIAL COMMUNITIES (U.S. CLS. 100, 103 AND 106).

FIRST USE 10-27-2010; IN COMMERCE 10-27-2010.
CARYN GLASSER, EXAMINING ATTORNEY

SN 85-437,032. ENDURANCE EVOLUTION, INC., COLORADO SPRINGS, CO. FILED 9-30-2011.

EnduroBites

THE MARK CONSISTS OF STANDARD CHARACTERS WITHOUT CLAIM TO ANY PARTICULAR FONT, STYLE, SIZE, OR COLOR.

CLASS 5—PHARMACEUTICALS

FOR DIETARY AND NUTRITIONAL SUPPLEMENTS, DIETARY AND NUTRITIONAL SUPPLEMENTS FORMED AND PACKAGED AS BARS, DIETARY SUPPLEMENTAL DRINKS, DIETARY SUPPLEMENTS, MEAL REPLACEMENT BARS AND SHAKES ADAPTED FOR MEDICAL USE; POWDERED NUTRITIONAL SUPPLEMENT DRINK MIXES (U.S. CLS. 6, 18, 44, 46, 51 AND 52).

CLASS 25—CLOTHING

FOR CLOTHING AND SPORTING CLOTHING APPAREL, NAMELY, T-SHIRTS, SHIRTS, PANTS, SWEATSHIRTS, SWEATPANTS, SOCKS, HATS AND CAPS (U.S. CLS. 22 AND 39).

ODESSA BIBBINS, EXAMINING ATTORNEY

SN 85-437,149. LOGICATION, LLC, NEW YORK, NY. FILED 10-1-2011.

HACKERSHIELD

THE MARK CONSISTS OF STANDARD CHARACTERS WITHOUT CLAIM TO ANY PARTICULAR FONT, STYLE, SIZE, OR COLOR.

CLASS 42—SCIENTIFIC AND COMPUTER SERVICES

FOR ENGINEERING SERVICES COMPRISING TESTING AND ANALYSIS, AND CONSULTING SERVICES IN THE TECHNOLOGY FIELD OF SECURITY, ACCESS, AUTHORIZATION, AUTHENTICATION ENCRYPTION, AND IDENTIFICATION SYSTEMS FOR COMPUTERS, COMPUTER HARDWARE AND COMPUTER NETWORKS; DEVELOPMENT, INTEGRATION AND OPERATION OF COMPUTER SYSTEMS TO SUPPORT ISSUANCE AND MANAGEMENT OF DIGITAL CERTIFICATES; CREATION AND IMPLEMENTATION OF PROCEDURES AND PRACTICES FOR ISSUANCE AND MANAGEMENT OF DIGITAL CERTIFICATES; ENTERPRISE SOFTWARE INTEGRATION, NAMELY, INTEGRATION OF COMPUTER SOFTWARE INTO MULTIPLE SYSTEMS AND NETWORKS; COMPUTER SERVICES, NAMELY, PROVIDING A WEB SITE FEATURING NON-DOWNLOADABLE SOFTWARE THAT ENABLES USERS OF THE INTERNET TO DELIVER INFORMATION ABOUT THEMSELVES AND, IF APPLICABLE, THEIR BUSINESSES, PRODUCTS OR SERVICES, AND TO REGISTER THEIR UNIVERSAL RESOURCE LOCATORS (URLS), WITH ON-LINE CATALOGUES, DIRECTORIES, SEARCH ENGINES AND WEB SITES, VIA THE INTERNET AND OTHER COMPUTER NETWORKS; ON-LINE TECHNICAL SUPPORT SERVICES, NAMELY, TROUBLESHOOTING OF COMPUTER HARDWARE AND SOFTWARE PROBLEMS; COMPUTER CONSULTATION REGARDING COMPUTER NETWORKS AND INTERNAL COMPUTER NETWORKS, SECURITY SERVICES FOR COMPUTER NETWORKS AND INTERNAL COMPUTER NETWORKS, NAMELY, INSTALLATION, DESIGN AND CUSTOMIZATION OF INTERNET AND NETWORK FIREWALL SOFTWARE FOR OTHERS; COMPUTER CONSULTING SERVICES IN THE FIELD OF SECURITY INTEGRATION, NETWORK SECURITY, NETWORK ARCHITECTURE, ENCRYPTION TECHNOLOGY AND COMPUTER SECURITY; SECURITY VERIFICATION OF COMPUTER NETWORK FIREWALLS, SERVERS AND OTHER NETWORK DEVICES FROM UNAUTHORIZED ACCESS, NAMELY, ANALYZING GLOBAL COMPUTER INFORMATION NETWORK AND INTERNAL COMPUTER NETWORK VULNERABILITY; COMPUTER SOFTWARE CONSULTATION SERVICES FOR THE DEVELOPMENT OF SOFTWARE APPLICATIONS; DESIGNING AND PROGRAMMING COMPUTER CONTROLLED COMMUNICATIONS SYSTEMS; DATA AUTOMATION AND COLLECTION SERVICE USING PROPRIETARY SOFTWARE TO EVALUATE, ANALYZE, AND COLLECT SERVICE DATA; DATA CONVERSION OF COMPUTER PROGRAM DATA OR INFORMATION; APPLICATION SERVICE PROVIDER (ASP), NAMELY, HOSTING COMPUTER SOFTWARE APPLICATIONS FOR OTHERS; HOSTING OF WEB SITES; CONSULTING IN THE FIELD OF COMPUTERS AND COMPUTER NETWORKS, NAMELY, COMPUTERS AND COMPUTER NETWORKS FEATURING TURN KEY E-COMMERCE SERVICES; PROVIDING TEMPORARY USE OF ONLINE NON-DOWNLOADABLE COMPUTER PROGRAMS FOR NETWORK SECURITY AUTHENTICATION FOR COMPUTER NETWORKS USING THE ELECTRONIC PRODUCT CODE (EPC); COMPUTER CONSULTATION IN THE FIELD OF COMPUTER SECURITY (U.S. CLS. 100 AND 101).

FIRST USE 1-1-2011; IN COMMERCE 1-1-2011.

CLASS 45—PERSONAL AND LEGAL SERVICES

FOR PROVIDING USER AUTHENTICATION SERVICES IN E-COMMERCE TRANSACTIONS; COMPUTER SERVICES, NAMELY, PROVIDING ON-LINE LEGAL INFORMATION IN THE FIELD OF DOMAIN NAME DISPUTES; REGISTRATION OF DOMAIN NAMES FOR IDENTIFICATION OF USERS ON A GLOBAL COMPUTER NETWORK; ISSUANCE OF DIGITAL CERTIFICATES FOR AUTHENTICATION; MONITORING OF COMPUTER SYSTEMS FOR SECURITY PURPOSES; COMPUTER RELATED SERVICES, NAMELY, MANAGED COMPUTER NETWORK AND INTERNET SECURITY SERVICES, NAMELY, PUBLIC KEY INFRASTRUCTURE (PKI) VERIFICATION, AUTHENTICATION, DISTRIBUTION AND MANAGEMENT; DIGITAL CERTIFICATE ISSUANCE, VERIFICATION AND MANAGEMENT (U.S. CLS. 100 AND 101).

FIRST USE 1-1-2011; IN COMMERCE 1-1-2011.
MICHAEL LITZAU, EXAMINING ATTORNEY

SN 85-438,384. ESSELTE CORPORATION, MELVILLE, NY.
FILED 10-4-2011.



OWNER OF U.S. REG. NOS. 1,646,819, 2,521,532 AND 3,046,273.

THE MARK CONSISTS OF THE STYLIZED WORD "ESSELTE" TO THE RIGHT OF A CIRCLE DESIGN, WITH THREE BANDS EMANATING FROM THE BOTTOM LEFT OF THE CIRCLE RESEMBLING PIECES OF PAPER.

CLASS 6—METAL GOODS

FOR FILE DRAWER FRAMES, NAMELY, METAL FRAMES FOR HOLDING HANGING FILES (U.S. CLS. 2, 12, 13, 14, 23, 25 AND 50).

CLASS 7—MACHINERY

FOR EMBOSSING MACHINES (U.S. CLS. 13, 19, 21, 23, 31, 34 AND 35).

CLASS 8—HAND TOOLS

FOR HAND-OPERATED PRESS MACHINES FOR EMBOSSING AND LAMINATING; ROTARY CUTTING TOOL, NAMELY, HAND-OPERATED CUTTING TOOLS (U.S. CLS. 23, 28 AND 44).

CLASS 16—PAPER GOODS AND PRINTED MATTER

FOR PRINTING PAPER, CARDBOARD, ARCHIVE STORAGE BOXES OF PAPER OR CARDBOARD, PAPER LABELS, ENVELOPES, WRITING PADS, BLANK JOURNALS, FOLDERS, PAPER EXPANDING FILES, HANGING FOLDERS, END TAB LABELS, DOCUMENT FOLDERS IN THE FORM OF WALLETS, DESKTOP AND PERSONAL ORGANIZERS, FILE BOXES FOR STORAGE OF BUSINESS AND PERSONAL RECORDS, INSERTABLE REINFORCED STATIONERY AND MARKING TABS, FILE POCKETS, ALPHABETICAL LETTERING GUIDES, PAPER FILE FASTENERS, BLANK JOURNAL BOOKS WITH COLUMNS, ACCOUNTING BOOKS, NOTEBOOKS, INDEX CARDS, INDEX CARD BOXES, FILE TRAYS, BINDERS, PRESENTATION BINDERS, PRESENTATION FOLDERS, PROTECTIVE COVERS FOR DOCUMENTS, DISPENSERS FOR PROTECTIVE COVERS FOR DOCUMENTS FOR STATIONERY OR HOUSEHOLD PURPOSES, CARRY CASES SPECIALLY ADAPTED FOR HOLDING AND CARRYING DOCUMENT FILES, EXPANDING ORGANIZERS, PAPER FILE CRATES, CARDBOARD STORAGE BOXES, STORAGE FILES FOR STORAGE OF BUSINESS AND PERSONAL DOCUMENTS, INSERTABLE TAB DIVIDERS, CARDBOARD SUBJECT DIVIDERS, DESKTOP BUSINESS CARD HOLDERS, PAPER ID BADGES AND CLIPS FOR USE THEREWITH, MAGAZINE COVERS, MAGAZINE BINDERS, CATALOGUE BINDERS, PAPER CLIPS, POLY FOLDERS WITH WRITE ON TABS, 3 HOLE PUNCH, 2 HOLE PUNCH, STAPLERS, STAPLES, REPLACEMENT STAPLE CARTRIDGE, LIQUID ADHESIVE PENS FOR STATIONERY OR HOUSEHOLD PURPOSES, LIQUID ADHESIVE BOTTLES FOR STATIONERY OR HOUSEHOLD PURPOSES, GLUE STICKS FOR STATIONERY OR HOUSEHOLD PURPOSES, MAGNET TAPE DISPENSERS FOR STATIONERY OR HOUSEHOLD PURPOSES, PHOTO CORNER DISPENSERS, LIQUID ADHESIVE DISPENSERS FOR STATIONERY OR HOUSEHOLD PURPOSES, ADHESIVE ERASERS, PHOTO AND SCRAPBOOK ALBUMS, LAMINATION PAGES, PAGE PROTECTORS, ADHESIVE APPLICATION MACHINES FOR HOME AND OFFICE USE, LAMINATION MACHINES FOR HOME AND HOUSEHOLD USE AND CARTRIDGES THEREFOR, TAPE DISPENSERS FOR STATIONERY OR HOUSEHOLD USE, AND ADHESIVE DISPENSERS FOR OFFICE USE (U.S. CLS. 2, 5, 22, 23, 29, 37, 38 AND 50).

CLASS 20—FURNITURE AND ARTICLES NOT OTHERWISE CLASSIFIED

FOR PLASTIC FILE CRATES; PLASTIC OR WOOD DISPLAYS IN THE FORM OF A FRAME OR HOLDER FOR DISPLAYING DIPLOMAS, PLASTIC OR WOOD DISPLAYS IN THE FORM OF A FRAME OR HOLDER FOR DISPLAYING CERTIFICATES (U.S. CLS. 2, 13, 22, 25, 32 AND 50).

JAMES GRIFFIN, EXAMINING ATTORNEY

SN 85-438,983. UNITEDHEALTH GROUP INCORPORATED, MINNETONKA, MN. FILED 10-4-2011.

**LIFEPRIENT HEALTH CARE
BUILT AROUND YOU**

THE MARK CONSISTS OF STANDARD CHARACTERS WITHOUT CLAIM TO ANY PARTICULAR FONT, STYLE, SIZE, OR COLOR.

CLASS 36—INSURANCE AND FINANCIAL

FOR INSURANCE CLAIMS PROCESSING (U.S. CLS. 100, 101 AND 102).
FIRST USE 2-0-2011; IN COMMERCE 2-0-2011.

CLASS 41—EDUCATION AND ENTERTAINMENT

FOR EDUCATIONAL SERVICES, NAMELY, CONDUCTING PROGRAMS AND CLASSES IN THE FIELDS OF HEALTH, WELLNESS, NUTRITION, AND HEALTHY LIFESTYLE; PROVIDING A CENTER FOR EDUCATIONAL CLASSES IN THE FIELD OF HEALTH, WELLNESS, NUTRITION, AND HEALTHY LIFESTYLES (U.S. CLS. 100, 101 AND 107).

FIRST USE 2-0-2011; IN COMMERCE 2-0-2011.

CLASS 43—HOTEL AND RESTAURANT SERVICES

FOR PROVIDING COMMUNITY CENTERS FOR SOCIAL GATHERINGS (U.S. CLS. 100 AND 101).

FIRST USE 2-0-2011; IN COMMERCE 2-0-2011.

CLASS 44—MEDICAL, BEAUTY AND AGRICULTURAL SERVICES

FOR PROVIDING INFORMATION IN THE FIELD OF HEALTH CARE; HEALTHCARE SERVICES, NAMELY, ESTABLISHING A NETWORK OF PHYSICIANS; MANAGED HEALTHCARE SERVICES (U.S. CLS. 100 AND 101).

FIRST USE 2-0-2011; IN COMMERCE 2-0-2011.

ESTHER A. BORSUK, EXAMINING ATTORNEY

SN 85-440,433. LIGHT IN THE BOX LIMITED, HONG KONG, HONG KONG, FILED 10-6-2011.

THREE SEASONS

THE MARK CONSISTS OF STANDARD CHARACTERS WITHOUT CLAIM TO ANY PARTICULAR FONT, STYLE, SIZE, OR COLOR.

CLASS 9—ELECTRICAL AND SCIENTIFIC APPARATUS

FOR AMUSEMENT APPARATUS ADAPTED FOR USE WITH AN EXTERNAL DISPLAY SCREEN OR MONITOR; CAMCORDERS; CAMERAS; COMPUTER HARDWARE AND COMPUTER PERIPHERAL DEVICES; CONTACT LENSES; EYEGLASS CASES; EYEGLASS FRAMES; EYEGLASSES; RECONFIGURABLE PROCESSORS FOR USE IN WIRELESS COMMUNICATION HANDSETS AND NETWORK EQUIPMENT IN THE FIELD OF WIDEBAND COMMUNICATIONS; SUNGLASSES (U.S. CLS. 21, 23, 26, 36 AND 38).

CLASS 14—JEWELRY

FOR BOXES OF PRECIOUS METAL; BRACELETS; BROOCHES; CHARMS; EARRINGS; KEY RINGS OF PRECIOUS METAL; NECKLACES; ORNAMENTS OF PRECIOUS METAL IN THE NATURE OF JEWELRY; RINGS; WRISTWATCHES (U.S. CLS. 2, 27, 28 AND 50).

CLASS 18—LEATHER GOODS

FOR ANIMAL SKINS; BACKPACKS; BAGS FOR SPORTS; FURS SOLD IN BULK; HANDBAGS; HAVERSACKS; PURSES; TRAVELLING BAGS; UMBRELLAS (U.S. CLS. 1, 2, 3, 22 AND 41).

CLASS 35—ADVERTISING AND BUSINESS

FOR ADVERTISING AGENCIES; BUSINESS INFORMATION AND INQUIRIES; COMMERCIAL AND INDUSTRIAL MANAGEMENT ASSISTANCE; ON-LINE ADVERTISING ON COMPUTER COMMUNICATION NETWORKS; ON-LINE WHOLESALE AND RETAIL STORE SERVICES FEATURING JEWELRY, GLASSES AND BAGS; PRESENTATION OF GOODS ON COMMUNICATION MEDIA FOR RETAIL PURPOSES; PROCUREMENT, NAMELY, PURCHASING JEWELRY, GLASSES AND BAGS FOR OTHERS; RELOCATION SERVICES FOR BUSINESS; SALES PROMOTION FOR OTHERS PROVIDED THROUGH THE DISTRIBUTION AND THE ADMINISTRATION OF PRIVILEGED USER CARDS; SPONSORSHIP SEARCH (U.S. CLS. 100, 101 AND 102).

ANDREW RHIM, EXAMINING ATTORNEY

SN 85-440,793. THE URBAN MUSE, LLC, DENVER, NJ. FILED 10-6-2011.



THE MARK CONSISTS OF A CRESCENT MOON WITH A SIMPLE TREE PARTIALLY OVERLAPPING THE MOON.

CLASS 35—ADVERTISING AND BUSINESS

FOR RETAIL STORE SERVICES FEATURING CANDLES, HANDBAGS, BODY CARE PRODUCTS, PRE-RECORDED MUSIC CD'S, BOOKS, CLOTHING AND CLOTHING ACCESSORIES (U.S. CLS. 100, 101 AND 102).
FIRST USE 10-22-2004; IN COMMERCE 10-22-2004.

CLASS 44—MEDICAL, BEAUTY AND AGRICULTURAL SERVICES

FOR DAY SPA SERVICES, NAMELY, NAIL CARE, MANICURES, PEDICURES AND NAIL ENHANCEMENTS; HEALTH SPA SERVICES, NAMELY, COSMETIC BODY CARE SERVICES; MASSAGE THERAPY SERVICES; BODY WAXING SERVICES; SALON SERVICES, NAMELY, FACIALS, MANICURES AND MESSAGES THAT ARE PROVIDED IN A TRAILER OUTFITTED WITH CHAIR, TABLE AND SINK ACCESSORIES (U.S. CLS. 100 AND 101).

FIRST USE 10-22-2004; IN COMMERCE 12-24-2004.
ANTHONY RINKER, EXAMINING ATTORNEY

SN 85-440,958. GREEN MOUNTAIN COFFEE ROASTERS, INC., WATERBURY, VT. FILED 10-6-2011.



OWNER OF U.S. REG. NOS. 1,631,794, 3,755,361 AND OTHERS.

NO CLAIM IS MADE TO THE EXCLUSIVE RIGHT TO USE "FOUNDATION" AND "COFFEE ROASTERS, INC.", APART FROM THE MARK AS SHOWN.

THE MARK CONSISTS OF THE WORD ELEMENTS "BREWING A BETTER WORLD" FEATURED ABOVE THE WORD ELEMENTS "FOUNDATION GREEN MOUNTAIN COFFEE ROASTERS, INC.", BOTH FEATURED NEXT TO A DESIGN OF A STYLIZED COFFEE CUP WITH STYLIZED RISING STEAM. THE STYLIZED CUP DESIGN INCLUDES A GLOBE DISPLAYING NORTH AND SOUTH AMERICA. WAVES ARE FEATURED BELOW THE CUP. THE CUP AND WAVES ARE DISPLAYED INSIDE A CIRCLE. THE WORD ELEMENTS "FOUNDATION GREEN MOUNTAIN COFFEE ROASTERS, INC." ARE FEATURED INSIDE A PARTIAL RECTANGLE.

CLASS 35—ADVERTISING AND BUSINESS

FOR CHARITABLE SERVICES, NAMELY, ORGANIZING, CONDUCTING AND SPONSORING COMMUNITY OUTREACH PROJECTS (U.S. CLS. 100, 101 AND 102).

CLASS 36—INSURANCE AND FINANCIAL

FOR CHARITABLE FUNDRAISING SERVICES; PROVIDING GRANTS FOR CHARITABLE PURPOSES; ELEEMOSYNARY SERVICES IN THE FIELD OF MONETARY DONATIONS (U.S. CLS. 100, 101 AND 102).

TOBY BULLOFF, EXAMINING ATTORNEY

SN 85-441,147. FULLCIRCLE SOCIAL NETWORKS, INC., BETHESDA, MD. FILED 10-6-2011.

fullcircle

THE MARK CONSISTS OF STANDARD CHARACTERS WITHOUT CLAIM TO ANY PARTICULAR FONT, STYLE, SIZE, OR COLOR.

CLASS 9—ELECTRICAL AND SCIENTIFIC APPARATUS

FOR COMPUTER APPLICATION SOFTWARE FOR MOBILE PHONES, NAMELY, SOFTWARE FOR SOCIAL INTRODUCTION, NETWORKING AND SOCIAL NETWORKING (U.S. CLS. 21, 23, 26, 36 AND 38).
FIRST USE 9-30-2011; IN COMMERCE 9-30-2011.

CLASS 45—PERSONAL AND LEGAL SERVICES

FOR INTERNET BASED INTRODUCTION, NETWORKING AND SOCIAL NETWORKING SERVICES (U.S. CLS. 100 AND 101).

FIRST USE 9-30-2011; IN COMMERCE 9-30-2011.
JAY FLOWERS, EXAMINING ATTORNEY

SN 85-442,633. ALIMENTOS SELECTOS SOCIEDAD ANÓNIMA, MIXCO, GUATEMALA, FILED 10-7-2011.

SN 85-445,450. UPMC, PITTSBURGH, PA. FILED 10-12-2011.

CARIBBEAN CRUNCH

THE MARK CONSISTS OF STANDARD CHARACTERS WITHOUT CLAIM TO ANY PARTICULAR FONT, STYLE, SIZE, OR COLOR.

CLASS 29—MEATS AND PROCESSED FOODS

FOR SNACK MIX CONSISTING PRIMARILY OF PROCESSED FRUITS, PROCESSED NUTS AND/OR RAISINS (U.S. CL. 46).

CLASS 31—NATURAL AGRICULTURAL PRODUCTS

FOR FRESH NUTS; RAW NUTS; UNPROCESSED NUTS (U.S. CLS. 1 AND 46).
SHAUNIA CARLYLE, EXAMINING ATTORNEY

SN 85-444,384. EVOLENT HEALTH, INC., ARLINGTON, VA. FILED 10-11-2011.

EVOLENT

THE MARK CONSISTS OF STANDARD CHARACTERS WITHOUT CLAIM TO ANY PARTICULAR FONT, STYLE, SIZE, OR COLOR.

CLASS 35—ADVERTISING AND BUSINESS

FOR BUSINESS CONSULTING TO THIRD PARTIES IN THE NATURE OF PROVIDING ANALYTICS ON THE INSURED, HEALTH PLAN AND NETWORK DESIGN AND ESTABLISHING WELLNESS AND BENEFIT PROGRAMS FOR INSURED; PROVIDING AN IN-PERSON BUSINESS FORUM FOR CONDUCTING EXECUTIVE RESEARCH IN THE FIELDS OF HEALTH CARE ADMINISTRATION AND HEALTH INSURANCE (U.S. CLS. 100, 101 AND 102).

CLASS 36—INSURANCE AND FINANCIAL

FOR HEALTH INSURANCE SERVICES, THIRD PARTY ADMINISTRATOR, UNDERWRITING AND CLAIM PROCESSING SERVICES FOR HEALTH BENEFIT PLANS AND HEALTH INSURANCE (U.S. CLS. 100, 101 AND 102).
JOHN E. MICHOS, EXAMINING ATTORNEY

Life Changing Medicine

THE MARK CONSISTS OF STANDARD CHARACTERS WITHOUT CLAIM TO ANY PARTICULAR FONT, STYLE, SIZE, OR COLOR.

OWNER OF U.S. REG. NO. 4,032,796.
NO CLAIM IS MADE TO THE EXCLUSIVE RIGHT TO USE "MEDICINE", APART FROM THE MARK AS SHOWN.

CLASS 35—ADVERTISING AND BUSINESS

FOR BUSINESS MANAGEMENT AND CONSULTING SERVICES FOR THE HEALTHCARE INDUSTRY, NAMELY, PROVIDING INDUSTRY EXPERTISE AND SUPPLIER PARTNERSHIPS; HOSPITAL MANAGEMENT; NEW BUSINESS VENTURE DEVELOPMENT AND FORMATION CONSULTING SERVICES (U.S. CLS. 100, 101 AND 102).

FIRST USE 7-24-2011; IN COMMERCE 7-24-2011.

CLASS 36—INSURANCE AND FINANCIAL

FOR ADMINISTRATION AND UNDERWRITING OF HEALTH, MEDICAL, PHARMACEUTICAL AND PRESCRIPTION DRUG INSURANCE PLANS (U.S. CLS. 100, 101 AND 102).

FIRST USE 7-24-2011; IN COMMERCE 7-24-2011.

CLASS 41—EDUCATION AND ENTERTAINMENT

FOR EDUCATIONAL SERVICES, NAMELY, PROVIDING CLASSES, SEMINARS AND WORKSHOPS FOR THE GENERAL PUBLIC IN THE FIELD OF HEALTH AND DISSEMINATION OF RELATED EDUCATIONAL MATERIALS, AND PROVIDING CLASSES AND SEMINARS FOR MEDICAL STUDENTS AND HEALTH CARE PROFESSIONALS' CONTINUING MEDICAL EDUCATION IN THE FIELD OF HEALTH CARE AND CURRENT MEDICAL ISSUES (U.S. CLS. 100, 101 AND 107).

FIRST USE 7-24-2011; IN COMMERCE 7-24-2011.

CLASS 42—SCIENTIFIC AND COMPUTER SERVICES

FOR MEDICAL RESEARCH (U.S. CLS. 100 AND 101).
FIRST USE 7-24-2011; IN COMMERCE 7-24-2011.

CLASS 44—MEDICAL, BEAUTY AND AGRICULTURAL SERVICES

FOR HEALTHCARE; PHYSICIAN SERVICES; HOSPITALS; PROVIDING MEDICAL INFORMATION (U.S. CLS. 100 AND 101).

FIRST USE 7-24-2011; IN COMMERCE 7-24-2011.
CIMMERIAN COLEMAN, EXAMINING ATTORNEY

SN 85-446,085. CHARLES PARSONS (HOLDINGS) PTY LIMITED, SYDNEY, NSW 2000, AUSTRALIA, FILED 10-12-2011.

CHARLES PARSONS

THE MARK CONSISTS OF STANDARD CHARACTERS WITHOUT CLAIM TO ANY PARTICULAR FONT, STYLE, SIZE, OR COLOR.

PRIORITY CLAIMED UNDER SEC. 44(D) ON NEW ZEALAND APPLICATION NO. 844267, FILED 6-21-2011, REG. NO. 844267, DATED 1-9-2012, EXPIRES 6-21-2021.

THE NAME(S), PORTRAIT(S), AND/OR SIGNATURE(S) SHOWN IN THE MARK DOES NOT IDENTIFY A PARTICULAR LIVING INDIVIDUAL.

CLASS 24—FABRICS

FOR TEXTILES AND TEXTILE GOODS, NAMELY, FABRICS FOR TEXTILE USE, COTTON FABRIC FOR USE AS A TEXTILE, CURTAINS OF TEXTILE, TAPETRIES OF TEXTILE; HOUSEHOLD LINEN, BED LINEN, BED BLANKETS, BED BLANKETS MADE OF COTTON, BED BLANKETS MADE OF MAN-MADE FIBERS, BED BLANKETS MADE OF WOOL, QUILTED BED BLANKETS, TEXTILE FABRICS FOR MAKING INTO BLANKETS, BED QUILTS, CONTINENTAL QUILTS, QUILTS, BEDSPREADS, COVERLETS, BEDSHEETS, TEXTILE BED SHEETS, VALANCE BED SHEETS, VALANCED BED SHEETS, PILLOWCASES, BATH SHEETS, TOWELS, BATH TOWELS, FACE TOWELS OF TEXTILE, KITCHEN TOWELS, BEACH TOWELS, TOWELS, TOWELS OF TEXTILE, APPAREL FABRICS, FABRICS FOR TEXTILE USE FOR THE MANUFACTURE OF BEDROOM LINENS, BREATHABLE WATERPROOF FABRIC FOR MANUFACTURING CLOTHING, FURNITURE AND AUTOMOBILE UPHOLSTERY, AND LUGGAGE, BROAD WOVEN INDUSTRIAL FABRICS, CHEMICAL KNIT MIXED FABRICS, CHEMICAL FIBER LOOP KNOT FABRICS, CHENILLE FABRIC, COTTON FABRICS, CREPE FABRICS, CURTAIN FABRICS, EMBROIDERY FABRIC, FABRIC, NAMELY, FABRICS FOR TEXTILE USE, FABRICS FOR TEXTILE USE COATED WITH RUBBER OR PLASTICS, UNFITTED FABRIC FURNITURE COVERS, FABRIC FOR USE IN THE MANUFACTURE OF CLOTHING, FABRIC PLACE MATS, FABRICS BEING TEXTILE GOODS IN ROLL FORM, FABRICS FOR FURNITURE, FABRICS FOR TEXTILE USE FOR INTERIOR DECORATING, FABRICS FOR MAKING CURTAINS, FABRICS FOR TEXTILE USE, FURNISHING FABRICS, MIXED AND SYNTHETIC FABRICS, RAYON FABRIC, SILK FABRICS FOR FURNITURE, TEXTILE FABRICS FOR MAKING INTO CLOTHING, TEXTILE FABRICS FOR MAKING INTO LINENS, TEXTILE FABRICS FOR MAKING UP INTO HOUSEHOLD TEXTILE ARTICLES, TEXTILE FABRICS FOR USE IN THE MANUFACTURE OF BEDDING, TEXTILES IN THE NATURE OF FABRICS FOR TEXTILE USE, TEXTILE FABRICS FOR USE IN THE MANUFACTURE OF CURTAINS, TEXTILE FABRICS FOR USE IN THE MANUFACTURE OF FURNITURE, TEXTILE FABRICS FOR USE IN THE MANUFACTURE OF TOWELS, TEXTILE FABRICS IN THE PIECE, UPHOLSTERY FABRICS, WINDOW FURNISHING FABRICS, WOOLEN FABRICS, WOVEN FABRICS FOR FURNITURE, WOVEN FURNISHING FABRICS, WOVEN LINEN FABRICS, WOVEN SILK FABRICS, PLACE MATS (NOT OF PAPER), TEXTILE PLACE MATS, TEXTILE DINNER NAPKINS, TABLE NAPKINS OF TEXTILE, TEXTILE NAPKINS, TABLE LINEN, DRAPERIES, CURTAINS, COTTON FABRICS FOR USE AS A TEXTILE IN THE MANUFACTURE OF WINDOW BLINDS, COVERS FOR CUSHIONS, WOVEN FABRICS FOR CUSHIONS, CANVAS FOR TAPESTRY, CANVAS FOR TAPESTRY OR EMBROIDERY, TAPESTRY AND WALL HANGINGS OF TEXTILE (U.S. CLS. 42 AND 50).

CLASS 35—ADVERTISING AND BUSINESS

FOR RETAIL AND WHOLESALE STORE SERVICES FEATURING TEXTILES AND TEXTILE GOODS, FABRICS, CURTAINS AND DRAPES, AND ALSO INCLUDING CURTAINS MADE OF PLASTIC, BLINDS MADE OF TEXTILE MATERIAL, COVERS FOR CUSHIONS, BEDDING INCLUDING QUILTS, DUVETS, BLANKETS, SHEETS, PILLOWCASES, HOUSEHOLD LINEN, AND TOWELS (U.S. CLS. 100, 101 AND 102).

CHARLOTTE CORWIN, EXAMINING ATTORNEY

SN 85-446,177. CUNNINGHAM, KRISTEN, DBA HIPLASH, MONTROSE, CA. FILED 10-13-2011.

Hiplash

THE MARK CONSISTS OF STANDARD CHARACTERS WITHOUT CLAIM TO ANY PARTICULAR FONT, STYLE, SIZE, OR COLOR.

CLASS 35—ADVERTISING AND BUSINESS

FOR RETAIL SERVICES THROUGH DIRECT SOLICITATION BY SALESPERSONS DIRECTED TO END-USERS FEATURING DANCE CLOTHING AND ACCESSORIES (U.S. CLS. 100, 101 AND 102).

FIRST USE 8-3-1999; IN COMMERCE 8-3-1999.

CLASS 41—EDUCATION AND ENTERTAINMENT

FOR CONDUCTING FITNESS CLASSES; DANCE INSTRUCTION; EDUCATION SERVICES, NAMELY, PROVIDING CLASSES AND INSTRUCTION IN THE FIELD OF DANCE; ENTERTAINMENT IN THE NATURE OF DANCE PERFORMANCES; ORGANIZATION OF DANCING EVENTS; PHYSICAL FITNESS INSTRUCTION; PHYSICAL FITNESS TRAINING OF INDIVIDUALS AND GROUPS (U.S. CLS. 100, 101 AND 107).

FIRST USE 8-3-1999; IN COMMERCE 8-3-1999.

TASHIA BUNCH, EXAMINING ATTORNEY

SN 85-446,377. LIGHT IN THE BOX LIMITED, HONG KONG, HONG KONG, FILED 10-13-2011.

3 Seasons

THE MARK CONSISTS OF STANDARD CHARACTERS WITHOUT CLAIM TO ANY PARTICULAR FONT, STYLE, SIZE, OR COLOR.

CLASS 9—ELECTRICAL AND SCIENTIFIC APPARATUS

FOR AMUSEMENT APPARATUS ADAPTED FOR USE WITH AN EXTERNAL DISPLAY SCREEN OR MONITOR; CAMCORDERS; CAMERAS; COMPUTER HARDWARE AND COMPUTER PERIPHERAL DEVICES; CONTACT LENSES; EYEGLASS CASES; EYEGLASS FRAMES; EYEGLASSES; RECONFIGURABLE PROCESSORS FOR USE IN WIRELESS COMMUNICATION HANDSETS AND NETWORK EQUIPMENT IN THE FIELD OF WIDEBAND COMMUNICATIONS; SUNGLASSES (U.S. CLS. 21, 23, 26, 36 AND 38).

CLASS 14—JEWELRY

FOR BOXES OF PRECIOUS METAL; BRACELETS; BROOCHES; CHARMS; EARRINGS; KEY RINGS OF PRECIOUS METALS; NECKLACES; ORNAMENTS OF PRECIOUS METAL IN THE NATURE OF JEWELRY; RINGS; WRISTWATCHES (U.S. CLS. 2, 27, 28 AND 50).

CLASS 18—LEATHER GOODS

FOR ANIMAL SKINS; BACKPACKS; BAGS FOR SPORTS; FURS SOLD IN BULK; HANDBAGS; HAVERSACKS; PURSES; TRAVELLING BAGS; UMBRELLAS (U.S. CLS. 1, 2, 3, 22 AND 41).

CLASS 35—ADVERTISING AND BUSINESS

FOR ADVERTISING AGENCIES; BUSINESS INFORMATION AND INQUIRIES; COMMERCIAL AND INDUSTRIAL MANAGEMENT ASSISTANCE; ON-LINE ADVERTISING ON COMPUTER COMMUNICATION NETWORKS; ON-LINE WHOLESALE AND RETAIL STORE SERVICES FEATURING JEWELRY, GLASSES AND BAGS; PRESENTATION OF GOODS ON COMMUNICATION MEDIA FOR RETAIL PURPOSES; PROCUREMENT, NAMELY, PURCHASING JEWELRY, GLASSES AND BAGS FOR OTHERS; RELOCATION SERVICES FOR BUSINESS; SALES PROMOTION FOR OTHERS PROVIDED THROUGH THE DISTRIBUTION AND THE ADMINISTRATION OF PRIVILEGED USER CARDS; SPONSORSHIP SEARCH (U.S. CLS. 100, 101 AND 102).

ANDREW RHIM, EXAMINING ATTORNEY

SN 85-446,528. MCCOY GROUP, INC., DUBUQUE, IA. FILED 10-13-2011.

DRIVING EXCELLENCE

THE MARK CONSISTS OF STANDARD CHARACTERS WITHOUT CLAIM TO ANY PARTICULAR FONT, STYLE, SIZE, OR COLOR.

CLASS 35—ADVERTISING AND BUSINESS

FOR BUSINESS MANAGEMENT SERVICES IN THE FIELD OF MANAGING DISTRIBUTION AND TRANSPORTATION OF BULK FREIGHT MATERIALS TRANSPORTED BY TRUCK; BUSINESS MANAGEMENT SERVICES IN THE FIELD OF ORGANIZING THE DELIVERY AND TRANSPORTING OF BULK FREIGHT MATERIALS TRANSPORTED BY TRUCK; AND TRUCK DEALERSHIP SERVICES (U.S. CLS. 100, 101 AND 102).

FIRST USE 7-31-2005; IN COMMERCE 7-31-2005.

CLASS 37—CONSTRUCTION AND REPAIR

FOR SERVICING AND REPAIR OF TRUCKS (U.S. CLS. 100, 103 AND 106).
FIRST USE 7-31-2005; IN COMMERCE 7-31-2005.

CLASS 39—TRANSPORTATION AND STORAGE

FOR TRUCKING SERVICES, NAMELY, HAULING OF BULK LIQUID AND BULK DRY MATERIALS; FREIGHT TRANSPORTATION OF BULK MATERIALS BY TRUCK (U.S. CLS. 100 AND 105).
FIRST USE 7-31-2005; IN COMMERCE 7-31-2005.
PAUL MORENO, EXAMINING ATTORNEY

SN 85-447,518. EASTERN METAL SUPPLY INC., LAKE WORTH, FL. FILED 10-14-2011.

EASTERN ARCHITECTURAL SYSTEMS

THE MARK CONSISTS OF STANDARD CHARACTERS WITHOUT CLAIM TO ANY PARTICULAR FONT, STYLE, SIZE, OR COLOR.

NO CLAIM IS MADE TO THE EXCLUSIVE RIGHT TO USE "ARCHITECTURAL SYSTEMS", APART FROM THE MARK AS SHOWN.

CLASS 6—METAL GOODS

FOR DOORS AND WINDOWS OF METAL (U.S. CLS. 2, 12, 13, 14, 23, 25 AND 50).
FIRST USE 5-19-2011; IN COMMERCE 5-19-2011.

CLASS 19—NON-METALLIC BUILDING MATERIALS

FOR NON-METAL WINDOWS AND DOORS (U.S. CLS. 1, 12, 33 AND 50).
FIRST USE 5-19-2011; IN COMMERCE 5-19-2011.
CHRISTINA SOBRAL, EXAMINING ATTORNEY

SN 85-447,787. COLLINS, WILLIAM E., CINCINNATI, OH. FILED 10-14-2011.

Bootzilla

THE MARK CONSISTS OF STANDARD CHARACTERS WITHOUT CLAIM TO ANY PARTICULAR FONT, STYLE, SIZE, OR COLOR.

CLASS 25—CLOTHING

FOR ATHLETIC APPAREL, NAMELY, SHIRTS, PANTS, JACKETS, FOOTWEAR, HATS AND CAPS, ATHLETIC UNIFORMS; CAMP SHIRTS; FOOTWEAR; HOODED SWEAT SHIRTS; POLO SHIRTS; SHORT-SLEEVED OR LONG-SLEEVED T-SHIRTS; T-SHIRTS FOR FASHION (U.S. CLS. 22 AND 39).

CLASS 41—EDUCATION AND ENTERTAINMENT

FOR CONDUCTING ENTERTAINMENT EXHIBITIONS IN THE NATURE OF MUSIC FESTIVALS; EDUCATIONAL AND ENTERTAINMENT SERVICES FOR CHILDREN, NAMELY, PROVIDING INTERACTIVE PLAY AREAS, INSTRUCTIONAL CLASSES IN THE FIELD OF MUSIC AND SOCIAL GATHERINGS FOR CHILDREN; ENTERTAINMENT IN THE NATURE OF LIVE PERFORMANCES BY MUSICAL BANDS; ENTERTAINMENT IN THE NATURE OF LIVE STAGE PERFORMANCES IN THE NATURE OF MUSIC CONCERTS OR LECTURE FOR HIRE IN THE FIELD OF MUSIC BY AN INDIVIDUAL; ENTERTAINMENT IN THE NATURE OF VISUAL AND AUDIO PERFORMANCES BY MUSICAL BANDS; ENTERTAINMENT IN THE NATURE OF VISUAL AND AUDIO PERFORMANCES, NAMELY, MUSICAL BAND, ROCK GROUP, GYMNASTIC, DANCE, AND BALLET PERFORMANCES; ENTERTAINMENT IN THE NATURE OF LIVE MUSICAL PERFORMANCES; ENTERTAINMENT INFORMATION SERVICES, NAMELY, PROVIDING INFORMATION AND NEWS RELEASES ABOUT A MUSICAL ARTIST; ENTERTAINMENT SERVICES BY A MUSICAL ARTIST AND PRODUCER, NAMELY, MUSICAL COMPOSITION FOR OTHERS AND PRODUCTION OF MUSICAL SOUND RECORDINGS; ENTERTAINMENT SERVICES IN THE NATURE OF LIVE MUSICAL PERFORMANCES; ENTERTAINMENT SERVICES IN THE NATURE OF PRESENTING LIVE MUSICAL PERFORMANCES; ENTERTAINMENT SERVICES IN THE NATURE OF RECORDING, PRODUCTION AND POST-PRODUCTION SERVICES IN THE FIELD OF MUSIC; ENTERTAINMENT SERVICES IN THE NATURE OF MUSIC PERFORMANCES; ENTERTAINMENT, NAMELY, LIVE MUSIC CONCERTS; ENTERTAINMENT, NAMELY, LIVE PERFORMANCES BY MUSICAL BANDS; ENTERTAINMENT, NAMELY, PRODUCTION OF MUSIC; ORGANIZATION OF EXHIBITIONS FOR MUSICAL ENTERTAINMENT; ORGANIZING MUSIC EXHIBITIONS FOR ENTERTAINMENT PURPOSES; PROVIDING A WEBSITE FEATURING INFORMATION IN THE FIELD OF MUSIC AND ENTERTAINMENT (U.S. CLS. 100, 101 AND 107).

COLLEEN DOMBROW, EXAMINING ATTORNEY

SN 85-448,071. MAIONICA, MOISES, WESTON, FL. FILED 10-14-2011.



THE MARK CONSISTS OF A SOLID RECTANGLE CARRYING A BILLFISH ABOVE THE LETTERS "OFL".

CLASS 25—CLOTHING

FOR CLOTHING, NAMELY, T-SHIRTS, SHIRTS, SWEATSHIRTS, SWIMWEAR, SHORTS, PANTS, HATS, CAPS, FOOTWEAR, JACKETS (U.S. CLS. 22 AND 39).

CLASS 28—TOYS AND SPORTING GOODS

FOR FISHING EQUIPMENT, NAMELY, FISHING LURES; FISHING POLES; FISHING REELS; FISHING TACKLE (U.S. CLS. 22, 23, 38 AND 50).

CLASS 35—ADVERTISING AND BUSINESS

FOR ONLINE ADVERTISING PROMOTIONAL SERVICES FOR FISHING TOURNAMENTS; MANAGING FISHING TOURNAMENTS, NAMELY, PROVIDING ONLINE REGISTRATION SERVICES FOR FISHING TOURNAMENTS (U.S. CLS. 100, 101 AND 102).

CLASS 41—EDUCATION AND ENTERTAINMENT

FOR ENTERTAINMENT SERVICES, NAMELY, ORGANIZING AND CONDUCTING FISHING TOURNAMENTS IN OPEN WATERS; TELEVISION PROGRAM SERIES FEATURING FISHING TOURNAMENTS; PROVIDING ENTERTAINMENT WEBCASTS IN THE FIELD OF FISHING TOURNAMENTS (U.S. CLS. 100, 101 AND 107).

SANDRA BUJA, EXAMINING ATTORNEY

SN 85-448,082. MAIONICA, MOISES, WESTON, FL. FILED 10-14-2011.



NO CLAIM IS MADE TO THE EXCLUSIVE RIGHT TO USE "OFFSHORE FISHING LEAGUE", APART FROM THE MARK AS SHOWN.

THE MARK CONSISTS OF THE ACRONYM "OFL" IN LARGE CAPITAL FONT WITH A BILLFISH IN THE LETTER "O", ALL ABOVE THE WORDING "OFFSHORE FISHING LEAGUE" IN TITLE CASE FONT.

CLASS 25—CLOTHING

FOR CLOTHING, NAMELY, T-SHIRTS, SHIRTS, SWEATSHIRTS, SWIMWEAR, SHORTS, PANTS, HATS, CAPS, FOOTWEAR, JACKETS (U.S. CLS. 22 AND 39).

CLASS 28—TOYS AND SPORTING GOODS

FOR FISHING EQUIPMENT, NAMELY, FISHING LURES; FISHING POLES; FISHING REELS; FISHING TACKLE (U.S. CLS. 22, 23, 38 AND 50).

CLASS 35—ADVERTISING AND BUSINESS

FOR ONLINE ADVERTISING PROMOTIONAL SERVICES FOR FISHING TOURNAMENTS; MANAGING FISHING TOURNAMENTS, NAMELY, PROVIDING ONLINE REGISTRATION SERVICES FOR FISHING TOURNAMENTS (U.S. CLS. 100, 101 AND 102).

CLASS 41—EDUCATION AND ENTERTAINMENT

FOR ENTERTAINMENT SERVICES, NAMELY, ORGANIZING AND CONDUCTING FISHING TOURNAMENTS IN OPEN WATERS; TELEVISION PROGRAM SERIES FEATURING FISHING TOURNAMENTS; PROVIDING ENTERTAINMENT WEBCASTS IN THE FIELD OF FISHING TOURNAMENTS (U.S. CLS. 100, 101 AND 107).

SANDRA BUJA, EXAMINING ATTORNEY

SN 85-449,377. WHO LET THE DOGS OUT, LLC, DBA WHO LET THE DOGS OUT, SAN FRANCISCO, CA. FILED 10-17-2011.

Who Let the Dogs Out!

THE MARK CONSISTS OF STANDARD CHARACTERS WITHOUT CLAIM TO ANY PARTICULAR FONT, STYLE, SIZE, OR COLOR.

CLASS 41—EDUCATION AND ENTERTAINMENT

FOR DOG TRAINING; KENNEL SERVICES, NAMELY, DOG TRAINING SERVICES (U.S. CLS. 100, 101 AND 107).

FIRST USE 1-1-2004; IN COMMERCE 1-1-2004.

CLASS 44—MEDICAL, BEAUTY AND AGRICULTURAL SERVICES

FOR DOG WALKING SERVICES; PET CARE SERVICES, NAMELY, DOG WALKING, DOG BATHING AND NON-MEDICATED PET GROOMING (U.S. CLS. 100 AND 101).

FIRST USE 1-1-2004; IN COMMERCE 1-1-2004.
LESLIE RICHARDS, EXAMINING ATTORNEY

SN 85-450,694. ACTELIS NETWORKS INC., FREMONT, CA. FILED 10-19-2011.



OWNER OF U.S. REG. NOS. 2,643,401 AND 3,980,803.
NO CLAIM IS MADE TO THE EXCLUSIVE RIGHT TO USE "NETWORKS", "BROADBAND" AND "COMPANY", APART FROM THE MARK AS SHOWN.

THE COLOR(S) BLUE AND BLACK IS/ARE CLAIMED AS A FEATURE OF THE MARK.

THE MARK CONSISTS OF THE WORDS "ACTELIS NETWORKS" OVER THE WORDS "THE BROADBAND ACCELERATION COMPANY", ALL IN BLACK, WITH A BLUE ORBIT DESIGN THROUGH THE TERM "ACTELIS".

CLASS 9—ELECTRICAL AND SCIENTIFIC APPARATUS

FOR COMPUTER HARDWARE FOR TELECOMMUNICATIONS AND DATA COMMUNICATIONS APPLICATIONS; EMBEDDED COMPUTER SOFTWARE FOR PROVIDING COMMUNICATIONS LINKS AND PROTOCOLS, FOR OPTIMIZING TRANSMISSION PERFORMANCE, FOR MANAGING SYSTEM CONFIGURATION AND SYSTEM COMPONENTS AND FOR MONITORING SYSTEM PERFORMANCE; COMPUTER AND TELECOMMUNICATIONS HARDWARE, NAMELY, ETHERNET AGGREGATION SWITCHES, REPEATERS AND ACCESS APPARATUS, AND INSTRUCTIONAL MANUALS, SOLD AS A UNIT (U.S. CLS. 21, 23, 26, 36 AND 38).

CLASS 42—SCIENTIFIC AND COMPUTER SERVICES

FOR COMPUTER TECHNOLOGY CONSULTING SERVICES, NAMELY, CONSULTING SERVICES IN THE FIELDS OF DESIGN, SELECTION, IMPLEMENTATION AND USE OF COMPUTER HARDWARE, COMPUTER SOFTWARE, COMPUTER NETWORKING AND ETHERNET TECHNOLOGY FOR OTHERS (U.S. CLS. 100 AND 101).

GINA HAYES, EXAMINING ATTORNEY

SN 85-450,779. FONTEIN, JOHN, BROOKLYN, NY. FILED 10-19-2011.

re:label

THE MARK CONSISTS OF STANDARD CHARACTERS WITHOUT CLAIM TO ANY PARTICULAR FONT, STYLE, SIZE, OR COLOR.

CLASS 9—ELECTRICAL AND SCIENTIFIC APPARATUS

FOR PRE-RECORDED CDS, DVDS, OPTICAL DISCS, LPS AND DOWNLOADABLE MP3 FILES AND MP3 RECORDINGS ALL FEATURING MUSIC OR MUSICAL PERFORMANCES; SUNGLASSES; DOWNLOADABLE COMPUTER ENTERTAINMENT SOFTWARE CONTAINING MUSIC OR MUSICAL PERFORMANCES (U.S. CLS. 21, 23, 26, 36 AND 38).

CLASS 14—JEWELRY

FOR JEWELRY; PRECIOUS STONES, PRECIOUS METALS AND THEIR ALLOYS; GOODS IN PRECIOUS METALS OR COATED THEREWITH, NAMELY, RINGS, NECKLACES, BRACELETS, EARRINGS, BROOCHES, PENDANTS AND PINS (U.S. CLS. 2, 27, 28 AND 50).

CLASS 25—CLOTHING

FOR CLOTHING, NAMELY, FOOTWEAR, HEADWEAR, SHIRTS, SWEATERS, JACKETS, HATS, SWEATSHIRTS, SHORTS, JEANS, SOCKS, UNDERWEAR, T-SHIRTS, SHOES AND SANDALS (U.S. CLS. 22 AND 39).

CLASS 35—ADVERTISING AND BUSINESS

FOR BUSINESS MANAGEMENT, BUSINESS ADMINISTRATION, ADVERTISING AND PUBLICITY; MARKETING AND BUSINESS MANAGEMENT CONSULTANCY; BUSINESS OPERATION, BUSINESS ADMINISTRATION AND OFFICE FUNCTIONS; PROVIDING MANAGEMENT, ADMINISTRATION, PROMOTION, ADVERTISING, AND BUSINESS CONSULTATION, FOR THE BENEFIT OF MUSIC PRODUCERS, SONG WRITERS, DJS, MUSICIANS, ARTISTS, MODELS, PHOTOGRAPHERS, VIDEOGRAPHERS AND CINEMATOGRAPHERS; MANAGEMENT OF PERFORMING AND RECORDING ARTISTS; TALENT AGENCY SERVICES (U.S. CLS. 100, 101 AND 102).

CLASS 38—COMMUNICATION

FOR STREAMING OF AUDIO, VISUAL AND AUDIOVISUAL MATERIAL VIA A GLOBAL COMPUTER NETWORK; TRANSMISSION SERVICES VIA THE INTERNET, FEATURING MP3 FILES AND MUSIC VIDEOS (U.S. CLS. 100, 101 AND 104).

CLASS 41—EDUCATION AND ENTERTAINMENT

FOR ENTERTAINMENT SERVICES, NAMELY, AN ON-GOING SERIES FEATURING MUSIC PROVIDED THROUGH MOBILE COMPUTER APPLICATIONS IS AMENDED TO ENTERTAINMENT SERVICES, NAMELY, AN ON-GOING SERIES FEATURING NON-DOWNLOADABLE MUSIC PROVIDED THROUGH MOBILE COMPUTER APPLICATIONS (U.S. CLS. 100, 101 AND 107).

WILLIAM P. SHANAHAN, EXAMINING ATTORNEY

SN 85-451,212. GHODGESHOLDINGS, LLC, DENVER, CO. FILED 10-19-2011.



NO CLAIM IS MADE TO THE EXCLUSIVE RIGHT TO USE "RACING", APART FROM THE MARK AS SHOWN. THE MARK CONSISTS OF THE WORDING "G22 RACING" IN STYLIZED FONT.

CLASS 25—CLOTHING

FOR CLOTHING, NAMELY, SWEATSHIRTS, POLO SHIRTS, T-SHIRTS, TANK TOPS, JERSEYS, JACKETS, COATS, HATS, CAPS, BANDANAS, VISORS, BELTS; INFANT WEAR (U.S. CLS. 22 AND 39).

CLASS 41—EDUCATION AND ENTERTAINMENT

FOR ENTERTAINMENT SERVICES IN THE NATURE OF PARTICIPATING IN PROFESSIONAL AUTOMOBILE RACES AND AUTO RACING EXHIBITIONS (U.S. CLS. 100, 101 AND 107).

DANIEL CAPSHAW, EXAMINING ATTORNEY

SN 85-451,092. FTS INTERNATIONAL SERVICES, LLC, FORT WORTH, TX. FILED 10-19-2011.



THE COLOR(S) GREEN AND YELLOW IS/ARE CLAIMED AS A FEATURE OF THE MARK.

THE MARK CONSISTS OF A STYLIZED LETTER "F" THAT IS FORMED BY INTERLOCKING AND OUTLINED AND CURVED RECTANGULAR DESIGN ELEMENTS. THE OUTLINE OF THE DESIGN ELEMENTS IS IN YELLOW AND THE INSIDE OF THE OUTLINED PORTIONS IS IN GREEN.

CLASS 1—CHEMICALS

FOR PROPPANT FOR USE IN OIL WELL AND GAS WELL HYDRAULIC FRACTURING OPERATIONS; CHEMICALS AND CHEMICAL ADDITIVES FOR DRILLING FLUID USED IN OIL AND GAS DRILLING AND ENHANCED RECOVERY OPERATIONS (U.S. CLS. 1, 5, 6, 10, 26 AND 46).

FIRST USE 6-15-2010; IN COMMERCE 6-15-2010.

CLASS 40—MATERIAL TREATMENT

FOR OIL AND GAS WELL TREATMENT (U.S. CLS. 100, 103 AND 106).

FIRST USE 6-15-2010; IN COMMERCE 6-15-2010.
NAPOLEON SHARMA, EXAMINING ATTORNEY

SN 85-451,772. FUGRO N.V., LEIDSCHEMENDAM, NETHERLANDS, FILED 10-20-2011.

FUGRO SMARTPIPE

THE MARK CONSISTS OF STANDARD CHARACTERS WITHOUT CLAIM TO ANY PARTICULAR FONT, STYLE, SIZE, OR COLOR.

OWNER OF BENELUX REG. NO. 0817127, DATED 2-8-2007, EXPIRES 1-18-2017.

OWNER OF U.S. REG. NOS. 3,752,515, 3,960,716 AND OTHERS.

CLASS 9—ELECTRICAL AND SCIENTIFIC APPARATUS

FOR GEOTECHNICAL APPARATUS AND INSTRUMENTS FOR USE IN UNDERSEA MEASURING OF PIPE-SOIL INTERACTIONS, NAMELY, APPARATUS AND INSTRUMENTS FOR MEASURING SOIL PARAMETERS, PIPE FORCES, PIPE DISPLACEMENTS AND PORE WATER PRESSURE CHANGES; GEOTECHNICAL APPARATUS AND INSTRUMENTS FOR USE IN SOIL MODELING, NAMELY, GEOTECHNICAL MODELING COMPUTER SOFTWARE AND HARDWARE FOR USE IN SOIL MODELING (U.S. CLS. 21, 23, 26, 36 AND 38).

CLASS 42—SCIENTIFIC AND COMPUTER SERVICES

FOR GEOTECHNICAL ENGINEERING SERVICES (U.S. CLS. 100 AND 101).

MAUREEN DALL, EXAMINING ATTORNEY

SN 85-456,341. MARTINGALE & COMPANY, BOTHELL, WA.
FILED 10-26-2011.

SN 85-456,582. AMERI-KART CORP., BRISTOL, IN. FILED
10-26-2011.

CREATE WITH CONFIDENCE

THE MARK CONSISTS OF STANDARD CHARACTERS WITHOUT CLAIM TO ANY PARTICULAR FONT, STYLE, SIZE, OR COLOR.

CLASS 9—ELECTRICAL AND SCIENTIFIC APPARATUS

FOR DOWNLOADABLE BOOKS AND PATTERNS IN THE FIELDS OF CRAFTS, SEWING, QUILTING, KNITTING AND OTHER HOBBIES VIA INTERNET WEBSITE (U.S. CLS. 21, 23, 26, 36 AND 38).

FIRST USE 3-7-2012; IN COMMERCE 3-7-2012.

CLASS 16—PAPER GOODS AND PRINTED MATTER

FOR BOOKS IN THE FIELDS OF CRAFTS, SEWING, QUILTING, KNITTING AND OTHER HOBBIES; CATALOGS IN THE FIELDS OF CRAFTS, SEWING, QUILTING, KNITTING AND OTHER HOBBIES; PATTERNS FOR SEWING, QUILTING, KNITTING AND OTHER HOBBIES (U.S. CLS. 2, 5, 22, 23, 29, 37, 38 AND 50).

FIRST USE 2-27-2012; IN COMMERCE 2-27-2012.

CLASS 35—ADVERTISING AND BUSINESS

FOR RETAIL STORE SERVICES IN THE FIELDS OF CRAFTS, SEWING, QUILTING, KNITTING AND OTHER HOBBIES, ACCESSIBLE ONLINE OR VIA MAIL ORDER AND TELEPHONE; PROVIDING A WEBSITE FEATURING INFORMATION FOR CONSUMERS IN THE FIELDS OF CRAFTS, SEWING, QUILTING, KNITTING AND OTHER HOBBIES (U.S. CLS. 100, 101 AND 102).

FIRST USE 3-7-2012; IN COMMERCE 3-7-2012.

KATINA MISTER, EXAMINING ATTORNEY

SN 85-456,457. NEXSTAGE, INC., MARTINSVILLE, IN.
FILED 10-26-2011.

IGNITE YOUR PASSION FOR BARBEQUE!

THE MARK CONSISTS OF STANDARD CHARACTERS WITHOUT CLAIM TO ANY PARTICULAR FONT, STYLE, SIZE, OR COLOR.

CLASS 30—STAPLE FOODS

FOR SAUCES (U.S. CL. 46).

FIRST USE 10-1-2011; IN COMMERCE 10-1-2011.

CLASS 43—HOTEL AND RESTAURANT SERVICES

FOR RESTAURANT AND CATERING SERVICES (U.S. CLS. 100 AND 101).

FIRST USE 4-1-2011; IN COMMERCE 4-1-2011.

JEFF DEFORD, EXAMINING ATTORNEY

AMERI-KART

THE MARK CONSISTS OF STANDARD CHARACTERS WITHOUT CLAIM TO ANY PARTICULAR FONT, STYLE, SIZE, OR COLOR.

CLASS 12—VEHICLES

FOR STRUCTURAL PARTS OF MARINE VESSELS, NAMELY, FUEL TANKS; STRUCTURAL PARTS OF MARINE VESSELS, NAMELY, COOLERS AND STORAGE BOXES; STRUCTURAL PARTS OF MARINE VESSELS, NAMELY, LIVEWELLS AND BAITWELLS; STRUCTURAL PARTS OF MARINE VESSELS, NAMELY, SEAT SHELLS; WATER TANKS FOR MARINE VESSELS AND RECREATIONAL VEHICLES, NAMELY, MARINE VESSEL, TOWABLE TRAILER AND MOTOR HOME STRUCTURAL PARTS, NAMELY WATER STORAGE TANKS; HOLDING TANKS FOR MARINE VESSELS AND RECREATIONAL VEHICLES, NAMELY, WASTE HOLDING TANKS FOR HOLDING HUMAN WASTE OR WATER WASTE IN THE NATURE OF STRUCTURAL PARTS OF MARINE VESSELS AND RECREATIONAL VEHICLES; STRUCTURAL PARTS OF TOWABLE TRAILER AND MOTOR HOME, NAMELY, FENDERS; STRUCTURAL PARTS OF RECREATIONAL VEHICLES, NAMELY, SHOWER PANS; VACUUM FORMED PLASTIC STRUCTURAL PARTS FOR TOWABLE TRAILERS AND MOTOR HOMES, NAMELY, FAUCET BEZELS, PROPANE TANK COVERS, SINKS, AND TRIM PIECES; MOLDED PLASTIC STRUCTURAL PARTS FOR TOWABLE TRAILERS AND MOTOR HOMES, NAMELY, COMPARTMENT LINERS, CONVENIENCE CENTERS, RANGE HOLDERS, BATTERY BOXES, DRAWERS, SLIDES, AND WHEEL WELLS; MARINE VESSEL PARTS, NAMELY, AN EVAPORATIVE EMISSION CONTROL DEVICE CONSISTING PRIMARILY OF A DECK FITTING FOR FILLING FUEL AND A FUEL VENT; MARINE VESSEL PARTS, NAMELY, A FUEL OVERFILL PREVENTION SYSTEM CONSISTING PRIMARILY OF A DECK FITTING FOR FILLING FUEL AND A FUEL SENSOR; PLASTIC GOODS HANDLING CARTS (U.S. CLS. 19, 21, 23, 31, 35 AND 44).

FIRST USE 5-31-1992; IN COMMERCE 5-31-1992.

CLASS 20—FURNITURE AND ARTICLES NOT OTHERWISE CLASSIFIED

FOR PLASTIC STORAGE CONTAINERS FOR INDUSTRIAL USE; PLASTIC TANKS, NAMELY, HYDRAULIC AND FUEL TANKS, NAMELY, NON-METAL FLUID STORAGE TANKS; PLASTIC STORAGE TANKS FOR AGRICULTURAL USE; PLASTIC WATER TANKS FOR INDUSTRIAL AND AGRICULTURAL PURPOSES; NON-METAL AND NON-PAPER CONTAINERS FOR INDUSTRIAL, COMMERCIAL, OR AGRICULTURAL STORAGE USE; PLASTIC BINS AND PACKAGING CONTAINERS FOR HOUSEHOLD, INDUSTRIAL, OR COMMERCIAL USE; PLASTIC BINS AND PACKAGING CONTAINERS FOR HANDLING OF WASTE, SCRAP, AND RECYCLABLES (U.S. CLS. 2, 13, 22, 25, 32 AND 50).

FIRST USE 5-31-1992; IN COMMERCE 5-31-1992.

CLASS 21—HOUSEWARES AND GLASS

FOR TRASH CANS (U.S. CLS. 2, 13, 23, 29, 30, 33, AND 50).

FIRST USE 10-31-1989; IN COMMERCE 10-31-1989.

CLASS 40—MATERIAL TREATMENT

FOR PARTS MOLDING; ROTATIONAL MOLDING OF PLASTIC FOR OTHERS; VACUUM FORMING OF PLASTIC FOR OTHERS, NAMELY, CUSTOM MOLDING OF PLASTICS; CUSTOM PLASTICS MOLDING SERVICES AND CUSTOM MANUFACTURE OF PLASTIC PARTS, COMPONENT ASSEMBLIES, AND FINISHED PLASTICS FOR A WIDE VARIETY OF INDUSTRIES; CUSTOM MANUFACTURE OF MOLDS FOR USE IN THE PLASTICS INDUSTRY; ASSEMBLY OF PLASTIC PRODUCTS FOR OTHERS; CONSULTING SERVICES PROVIDED WITH THE FOREGOING (U.S. CLS. 100, 103 AND 106).

FIRST USE 5-31-1992; IN COMMERCE 5-31-1992.
ROBERT STRUCK, EXAMINING ATTORNEY

SN 85-457,141. MIRANDA INDUSTRIES, INC., DAMASCUS, OR. FILED 10-26-2011.

REDI POUR

THE MARK CONSISTS OF STANDARD CHARACTERS WITHOUT CLAIM TO ANY PARTICULAR FONT, STYLE, SIZE, OR COLOR.

NO CLAIM IS MADE TO THE EXCLUSIVE RIGHT TO USE "POUR", APART FROM THE MARK AS SHOWN.

CLASS 37—CONSTRUCTION AND REPAIR

FOR CONSTRUCTION SERVICES, NAMELY, CONSULTING CONCERNING CONCRETE STRUCTURES (U.S. CLS. 100, 103 AND 106).

FIRST USE 10-21-2011; IN COMMERCE 10-21-2011.

CLASS 42—SCIENTIFIC AND COMPUTER SERVICES

FOR DESIGNING CONCRETE STRUCTURES, AND BUILDING CONCRETE STRUCTURES (U.S. CLS. 100 AND 101).

FIRST USE 10-21-2011; IN COMMERCE 10-21-2011.
MICHELE SWAIN, EXAMINING ATTORNEY

SN 85-457,516. STROH AUSTRIA GESELLSCHAFT MBH, AM WÖRTHERSEE, AUSTRIA, FILED 10-27-2011.

STROHKOLADE

THE MARK CONSISTS OF STANDARD CHARACTERS WITHOUT CLAIM TO ANY PARTICULAR FONT, STYLE, SIZE, OR COLOR.

OWNER OF ERPN CMNTY TM OFC REG. NO. 009820481, DATED 7-28-2011, EXPIRES 3-18-2021.

CLASS 29—MEATS AND PROCESSED FOODS

FOR MILK AND MILK PRODUCTS EXCLUDING ICE CREAM, ICE MILK AND FROZEN YOGURT; MILK PREDOMINATING BEVERAGES, NAMELY, MILKSHAKES, WHEY; WHIPPING CREAM; SOYA MILK (U.S. CL. 46).

CLASS 30—STAPLE FOODS

FOR COFFEE, TEA, COCOA, COFFEE BEVERAGES WITH MILK, COCOA BEVERAGES WITH MILK, MILK CHOCOLATE, COCOA-BASED BEVERAGES, CHOCOLATE-BASED BEVERAGES, COFFEE BASED BEVERAGES; FLAVORINGS, OTHER THAN ESSENTIAL OILS, FOR BEVERAGES; COFFEE FLAVORINGS; COCOA-BASED INGREDIENT IN CONFECTIONERY PRODUCTS; CHOCOLATE; PASTRIES AND COOKIES, EDIBLE ICES, ICE CREAM (U.S. CL. 46).

CLASS 33—WINES AND SPIRITS

FOR ALCOHOLIC BEVERAGES EXCEPT BEERS (U.S. CLS. 47 AND 49).

STEVEN JACKSON, EXAMINING ATTORNEY

SN 85-457,804. PALLET LOGISTICS & UNIT LOAD SOLUTIONS, INC., PRINCETON, MA. FILED 10-27-2011.

9BLOC

THE MARK CONSISTS OF STANDARD CHARACTERS WITHOUT CLAIM TO ANY PARTICULAR FONT, STYLE, SIZE, OR COLOR.

CLASS 35—ADVERTISING AND BUSINESS

FOR COMPUTERIZED MONITORING OF GOODS IN TRANSIT THROUGH THE USE OF RADIO-FREQUENCY IDENTIFICATION, BAR CODES, THE INTERNET AND WIRELESS AND ELECTRONIC MEANS OF TRANSFERRING DATA; MONITORING OF SHIPMENTS OF GOODS THROUGH THE USE OF A GLOBAL COMPUTER NETWORK, INTERNET, BAR CODES OR RADIO-FREQUENCY IDENTIFICATION; COMPUTERIZED TRACKING OF LEASED PALLETS; TRACKING PALLETS BY MEANS OF RADIO-FREQUENCY IDENTIFICATION, BAR CODES, THE INTERNET AND WIRELESS AND ELECTRONIC MEANS (U.S. CLS. 100, 101 AND 102).

CLASS 37—CONSTRUCTION AND REPAIR

FOR REPAIR AND MAINTENANCE OF PALLETS (U.S. CLS. 100, 103 AND 106).

CLASS 39—TRANSPORTATION AND STORAGE

FOR PALLET POOLING SERVICES, NAMELY, CREATING A POOL OF PALLETS FOR TRANSPORTING AND PACKAGING OF GOODS FOR OTHERS; PALLET POOLING SERVICES, NAMELY, THE LEASING, RENTING, PURCHASING SELLING AND EXCHANGING OWNERSHIP OF PALLETS ON A POOLING BASIS INVOLVING THE CIRCULATION OF PALLETS BY AND BETWEEN DIFFERENT USERS, FOR TRANSPORTING AND PACKAGING OF GOODS FOR OTHERS; TRANSPORTING PALLETS BY TRUCK, TRAIN, AND AIR; WAREHOUSING AND STORING THE GOODS OF OTHERS; AND TRANSFERRING OWNERSHIP WITHIN THE POOL; LEASING AND RENTING OF PALLETS (U.S. CLS. 100 AND 105).

MICHAEL ENGEL, EXAMINING ATTORNEY

SN 85-458,112. POLO GEAR INTELLECTUAL PROPERTIES, INC., PARKMAN, WY. FILED 10-27-2011.

SN 85-459,330. JODA ENTERPRISES, INC., CHICAGO, IL. FILED 10-28-2011.



THE MARK CONSISTS OF A DARK RING WITH THE WORD "POLOGEAR" LOCATED INSIDE THE UPPER PORTION OF THE RING IN WHITE; WHITE STARS ARE DISPOSED INSIDE THE DARK RING WITH THREE STARS ON THE RIGHT AND THREE STARS ON THE LEFT SIDE OF THE WORD "POLOGEAR"; AN IMAGE OF A HORSE AND RIDER IS LOCATED INSIDE THE DARK RING WITH THE RIDER STRIKING A BALL WITH A Mallet.

SEC. 2(F) AS TO "POLO GEAR" .

CLASS 18—LEATHER GOODS

FOR SADDLES, HORSE TACK, NAMELY, BRIDLES, REINS, LEADS, BITS, STIRRUP LEATHERS, GIRTH STRAPS, LUNGE LINES, HALTERS, BAGS FOR SPORTS, SPATS AND KNEE BANDAGES FOR HORSES, KNEE GUARDS FOR HORSES, EQUINE LEG WRAPS, HORSE FLANKS AND SHANKS, NAMELY, HORSE PROTECTIVE PADDING, BRACES, AND LEG BOOTS FOR THE FLANKS AND LEGS, LEGGINGS FOR ANIMALS, GAITERS, NAMELY, JUMPING BOOTS FOR HORSES, HARNESS FITTINGS OF IRON, WHIPS, PADS FOR HORSE SADDLES, EXERCISE SHEETS FOR HORSES, HORSE BLANKETS AND SADDLE BLANKETS, ALL FOR USE IN EQUESTRIAN ACTIVITIES (U.S. CLS. 1, 2, 3, 22 AND 41).

FIRST USE 12-31-1995; IN COMMERCE 12-31-1995.

CLASS 25—CLOTHING

FOR CLOTHING FOR WEAR IN EQUESTRIAN ACTIVITIES, NAMELY, ATHLETIC UNIFORMS, PANTS, SHORTS, SHIRTS, UNDERWEAR, SOCKS, BOOTS, SHOES, BELTS, SUSPENDERS, GLOVES, HATS, AND CAPS (U.S. CLS. 22 AND 39).

FIRST USE 12-31-1995; IN COMMERCE 12-31-1995.
MIDGE BUTLER, EXAMINING ATTORNEY



OWNER OF U.S. REG. NOS. 2,111,455 AND 3,858,677.
NO CLAIM IS MADE TO THE EXCLUSIVE RIGHT TO USE "TOOLS", APART FROM THE MARK AS SHOWN.
THE MARK CONSISTS OF A KNIGHT ON A HORSE STANDING ON ITS TWO HIND LEGS. THE KNIGHT CARRYING A SHIELD WITH A DESIGN ON THE SHIELD OF A SLENDER OVAL WITH A HOOK AT THE TOP OPENING TO THE LEFT AND A HOOK AT THE BOTTOM OPENING TO THE RIGHT, THE KNIGHT ALSO CARRYING A FLAG BEARING THE WORDS "LINK TOOLS".

CLASS 7—MACHINERY

FOR POWER TOOLS, NAMELY, POWERED TORQUE-TRANSMITTING DRIVE TOOLS, INCLUDING SPECIFICALLY TORQUE-TRANSMITTING POWER TOOLS, NAMELY, POWER-OPERATED DRILLS AND UNIVERSAL DRIVERS, SCREW DRIVERS, RATCHET WRENCHES, IMPACT WRENCHES, CLUTCH WRENCHES, TORQUE WRENCHES, SPEEDER WRENCHES, SPINNER WRENCHES, AND ACCESSORIES THEREFOR, NAMELY, ALL TORQUE-TRANSMITTING ATTACHMENTS AND END TOOLS IN THE NATURE OF ADAPTERS, EXTENSION BARS, UNIVERSAL JOINTS, SOCKETS, CROW-FOOT WRENCHES, SOCKET-MOUNTED BITS, SOCKET BITS, BITS, AND ATTACHMENTS THAT TRANSMIT TORQUE TO SCREWS, BOLTS AND OTHER FASTENERS (U.S. CLS. 13, 19, 21, 23, 31, 34 AND 35).

CLASS 8—HAND TOOLS

FOR HAND TOOLS, NAMELY, HAND-OPERATED TORQUE-TRANSMITTING DRIVE TOOLS, NAMELY, RATCHET WRENCHES, TORQUE WRENCHES, CLUTCH WRENCHES, FLEX HANDLE WRENCHES, T-BAR WRENCHES, PALM WRENCHES, SPEEDER WRENCHES, BRACE-STYLE SPEEDER WRENCHES, FLAT WRENCHES, SPINNER WRENCHES, AND ALL ATTACHMENTS THEREFOR, NAMELY, ALL TORQUE-TRANSMITTING ATTACHMENTS AND END TOOLS FOR HAND-OPERATED TOOLS, NAMELY, ADAPTERS, EXTENSION BARS, UNIVERSAL JOINTS, SOCKETS, CROW-FOOT WRENCHES, SOCKET-MOUNTED BITS, SOCKET BITS, BITS, AND ATTACHMENTS THAT TRANSMIT TORQUE TO SCREWS, BOLTS AND OTHER FASTENERS (U.S. CLS. 23, 28 AND 44).

JUSTINE D. PARKER, EXAMINING ATTORNEY

SN 85-459,399. DIVERSIFIED PROJECT MANAGEMENT, INC., NEWTON, MA. FILED 10-28-2011.

DIVERSIFIED PROJECT MANAGEMENT

THE MARK CONSISTS OF STANDARD CHARACTERS WITHOUT CLAIM TO ANY PARTICULAR FONT, STYLE, SIZE, OR COLOR.

NO CLAIM IS MADE TO THE EXCLUSIVE RIGHT TO USE "PROJECT MANAGEMENT", APART FROM THE MARK AS SHOWN.

CLASS 35—ADVERTISING AND BUSINESS

FOR BUSINESS PROJECT MANAGEMENT, NAMELY, CONSULTING, PLANNING, AND SUPERVISING FACILITIES OPERATIONS MANAGEMENT FOR BUSINESSES AND ORGANIZATIONS; AND REPRESENTING BUSINESS OWNERS IN ARRANGING CONTRACTUAL SERVICES WITH THIRD PARTIES (U.S. CLS. 100, 101 AND 102).

FIRST USE 5-31-1994; IN COMMERCE 5-31-1994.

CLASS 37—CONSTRUCTION AND REPAIR

FOR CONSTRUCTION MANAGEMENT, NAMELY, CONSULTING, PLANNING, AND SUPERVISING PRE-CONSTRUCTION, AND CONSTRUCTION FOR BUSINESSES AND ORGANIZATIONS (U.S. CLS. 100, 103 AND 106).

FIRST USE 5-31-1994; IN COMMERCE 5-31-1994.

CLASS 39—TRANSPORTATION AND STORAGE

FOR CONSULTATION REGARDING COORDINATED MOVING AND RELOCATION SERVICES FOR BUSINESSES AND ORGANIZATIONS (U.S. CLS. 100 AND 105).

FIRST USE 5-31-1994; IN COMMERCE 5-31-1994.
VERNA BETH RIRIE, EXAMINING ATTORNEY

SN 85-460,014. O'NEILL, AISLINN, HUNTINGDON, UNITED KINGDOM, FILED 10-31-2011.

KYNESKA

THE MARK CONSISTS OF STANDARD CHARACTERS WITHOUT CLAIM TO ANY PARTICULAR FONT, STYLE, SIZE, OR COLOR.

OWNER OF UNITED KINGDOM REG. NO. 2586846, DATED 10-21-2011, EXPIRES 7-6-2021.

THE WORDING "KYNESKA" HAS NO MEANING IN A FOREIGN LANGUAGE.

CLASS 9—ELECTRICAL AND SCIENTIFIC APPARATUS

FOR MUSICAL SOUND RECORDING AND MUSICAL VIDEO RECORDINGS IN ALL MEDIA; MOTION PICTURE FILMS ABOUT MUSICAL BANDS; PRERECORDED VIDEO DISCS, COMPACT DISCS, AUDIO CASSETTES, VIDEO CASSETTES, EXPOSED SLIDE FILMS AND PHOTOGRAPHIC SLIDE TRANSPARENCIES FEATURING PERFORMANCES BY A MUSICAL GROUP, THEATRICAL, ORCHESTRAL, VOCAL, CHORAL, CHOREOGRAPHIC, CINEMATIC PRESENTATIONS IN THE NATURE OF FILMS FEATURING MEMBERS OF A MUSICAL GROUP, AND MULTI-MEDIA PRESENTATIONS IN THE NATURE OF COMPUTER BASED FILMS FEATURING MEMBERS OF A MUSICAL GROUP; EYEGLASSES, SPECTACLES, SPECTACLE FRAMES, SUNGLASSES; EYEGLASSES CASES; MUSICAL SOUND AND VIDEO RECORDINGS; DIGITAL MUSIC DOWNLOADABLE FROM THE INTERNET; DIGITAL MUSIC DOWNLOADABLE PROVIDED FROM MP3 WEB SITES ON THE INTERNET; PRERECORDED VIDEO TAPES FEATURING MUSIC; DOWNLOADABLE RING TONES FOR MOBILE PHONES; CINEMATOGRAPHIC FILMS FEATURING MUSIC FOR ENTERTAINMENT EXHIBITIONS; PHONOGRAPH RECORDS FEATURING MUSIC; PRERECORDED AUDIO AND VIDEO TAPES, VIDEO AND AUDIO CASSETTES, COMPACT DISCS AND DVDS FEATURING MUSIC; MUSICAL SOUND AND VIDEO RECORDINGS; APPARATUS FOR RECORDING, TRANSMISSION OR REPRODUCTION OF SOUND; DOWNLOADABLE AUDIO AND VIDEO RECORDINGS FEATURING MUSIC; MOUSE PADS; DECORATIVE MAGNETS; PARTS AND FITTINGS FOR ALL THE AFORESAID GOODS (U.S. CLS. 21, 23, 26, 36 AND 38).

CLASS 41—EDUCATION AND ENTERTAINMENT

FOR ENTERTAINMENT SERVICES, NAMELY, PROVIDING ADVICE AND INFORMATION FOR MUSIC, VIDEO AND FILM CONCEPT AND SCRIPT DEVELOPMENT; ENTERTAINMENT IN THE NATURE OF VISUAL AND AUDIO PERFORMANCES BY A MUSICAL BAND; LIVE PERFORMANCES BY A MUSICAL GROUP; LIVE ENTERTAINMENT SERVICES IN THE NATURE OF MUSICAL CONCERTS; ENTERTAINMENT SERVICES, NAMELY, THE PROVISION OF CONTINUING PROGRAMS FEATURING COMEDY DELIVERED BY TELEVISION; ENTERTAINMENT, NAMELY, LIVE PERFORMANCES BY A MUSICAL BAND; ENTERTAINMENT, NAMELY, LIVE MUSICAL CONCERTS; PRODUCTION OF SOUND RECORDING, FILM AND VIDEO PRODUCTION AND DISTRIBUTION OF MOTION PICTURE FILMS; PRODUCTION OF RADIO AND TELEVISION PROGRAMS; TELEVISION SHOW PRODUCTION; PRODUCTION OF MUSICAL VIDEOS; ARRANGING AND CONDUCTING CONCERTS; AUDIO RECORDING AND PRODUCTION SERVICES; FAN CLUBS; PROVIDING EDUCATION COURSES IN THE FIELD OF MUSIC OFFERED THROUGH ONLINE, NON-DOWNLOADABLE VIDEOS AND INSTRUCTOR ASSISTANCE (U.S. CLS. 100, 101 AND 107).

CHRISIE B. KING, EXAMINING ATTORNEY

SN 85-461,313. INTERNATIONAL ALLIANCE SOLUTIONS, LLC, CONGERS, NY. FILED 11-1-2011.

CODESMART

THE MARK CONSISTS OF STANDARD CHARACTERS WITHOUT CLAIM TO ANY PARTICULAR FONT, STYLE, SIZE, OR COLOR.

CLASS 35—ADVERTISING AND BUSINESS

FOR PROVIDING AUDITING AND ONLINE AUDITING SERVICES IN THE FIELD OF ICD-10 MEDICAL CODING IN THE NATURE OF BUSINESS REVIEW AND ANALYSIS OF MEDICAL CODING IN RECORDS FOR HOSPITALS, DOCTOR'S OFFICES, SPECIALTY CLINICS (U.S. CLS. 100, 101 AND 102).

CLASS 41—EDUCATION AND ENTERTAINMENT

FOR EDUCATIONAL SERVICES, NAMELY, CONDUCTING ONLINE TRAINING FOR NEW AND EXISTING MEDICAL CODERS AND CLINICIANS IN THE FIELD OF ICD-10 MEDICAL CODING (U.S. CLS. 100, 101 AND 107).

JULIE GUTTADAURO, EXAMINING ATTORNEY

SN 85-462,622. EMPOWER ENNOVATION, LLC, DBA ENNOVATE, ATLANTA, GA. FILED 11-2-2011.

ENNOVATE

THE MARK CONSISTS OF STANDARD CHARACTERS WITHOUT CLAIM TO ANY PARTICULAR FONT, STYLE, SIZE, OR COLOR.

CLASS 35—ADVERTISING AND BUSINESS

FOR CONSULTING SERVICES IN THE FIELDS OF ENERGY CONSUMPTION AND USAGE CONSERVATION TO IMPROVE ENERGY EFFICIENCY; CONDUCTING ENERGY AUDITS OF ENERGY AND WATER CONSERVATION PROJECTS FOR THE PURPOSE OF IMPROVING ENERGY EFFICIENCY; BUSINESS MANAGEMENT IN THE FIELDS OF ENERGY MANAGEMENT SYSTEMS, LIGHTING RETROFIT, BOILER AND HEATING, VENTILATION AND AIR CONDITIONING (HVAC) CONTROLS, WATER CONSERVATION, POWER MANAGEMENT AND RENEWABLE ENERGY EQUIPMENT (U.S. CLS. 100, 101 AND 102).

FIRST USE 9-15-2011; IN COMMERCE 9-15-2011.

CLASS 36—INSURANCE AND FINANCIAL

FOR PROVIDING VENTURE CAPITAL, DEVELOPMENT CAPITAL, PRIVATE EQUITY AND INVESTMENT FUNDING IN THE FIELDS OF ENERGY MANAGEMENT SYSTEMS, LIGHTING RETROFIT, BOILER AND HEATING, VENTILATION AND AIR CONDITIONING (HVAC) CONTROLS, WATER CONSERVATION, POWER MANAGEMENT AND RENEWABLE ENERGY EQUIPMENT (U.S. CLS. 100, 101 AND 102).

FIRST USE 9-15-2011; IN COMMERCE 9-15-2011.

CLASS 37—CONSTRUCTION AND REPAIR

FOR INSTALLATION OF ENERGY MANAGEMENT SYSTEMS, LIGHTING RETROFIT, BOILER AND HEATING, VENTILATION AND AIR CONDITIONING (HVAC) CONTROLS, WATER CONSERVATION, POWER MANAGEMENT AND RENEWABLE ENERGY EQUIPMENT (U.S. CLS. 100, 103 AND 106).

FIRST USE 9-15-2011; IN COMMERCE 9-15-2011.

TINA L. SNAPP, EXAMINING ATTORNEY

SN 85-461,820. BOSLEY, INC., BEVERLY HILLS, CA. FILED 11-1-2011.

BOSLEY ENHANCE

THE MARK CONSISTS OF STANDARD CHARACTERS WITHOUT CLAIM TO ANY PARTICULAR FONT, STYLE, SIZE, OR COLOR.

OWNER OF U.S. REG. NOS. 2,422,933, 3,966,917 AND OTHERS.

NO CLAIM IS MADE TO THE EXCLUSIVE RIGHT TO USE "ENHANCE", APART FROM THE MARK AS SHOWN.

CLASS 3—COSMETICS AND CLEANING PREPARATIONS

FOR HAIR CARE PREPARATIONS, NAMELY, SHAMPOOS, CONDITIONERS, HAIR GELS, HAIR SPRAYS (U.S. CLS. 1, 4, 6, 50, 51 AND 52).

CLASS 5—PHARMACEUTICALS

FOR MEDICATED HAIR CARE PREPARATIONS, NAMELY, MINOXYDIL LIQUID TOPICAL APPLICATIONS (U.S. CLS. 6, 18, 44, 46, 51 AND 52).

CLASS 44—MEDICAL, BEAUTY AND AGRICULTURAL SERVICES

FOR MEDICAL SERVICES RELATING TO THE HAIR AND SCALP, HAIR REPLACEMENT AND RESTORATION SERVICES; MEDICAL SERVICES, NAMELY, HAIR GROWING SERVICES; HAIR IMPLANTATION; PERFORMING MEDICAL DIAGNOSTIC TESTING OF HAIR; PROVIDING MEDICAL HAIR INCREASING TREATMENT FOR HAIR LOSS DISEASE; PROVIDING MEDICAL INFORMATION ABOUT HAIR LOSS PROTECTION, HAIR GROWTH, HAIR INCREASING, AND HAIR IMPLANTATION; PROVIDING MEDICAL ADVICE AND INFORMATION ON HAIR LOSS PROTECTION, HAIR GROWTH, HAIR INCREASING, AND HAIR IMPLANTATION; PROVIDING MEDICAL ADVICE AND INFORMATION ON SCALP HEALTH (U.S. CLS. 100 AND 101).

ODESSA BIBBINS, EXAMINING ATTORNEY

SN 85-462,718. STEVEN JEFFERIES, DBA NEO CHIA, HOUSTON, TX. FILED 11-2-2011.

NEO CHIA

THE MARK CONSISTS OF STANDARD CHARACTERS WITHOUT CLAIM TO ANY PARTICULAR FONT, STYLE, SIZE, OR COLOR.

NO CLAIM IS MADE TO THE EXCLUSIVE RIGHT TO USE "CHIA", APART FROM THE MARK AS SHOWN.

CLASS 3—COSMETICS AND CLEANING PREPARATIONS

FOR BODY AND BEAUTY CARE COSMETICS; COSMETIC CREAMS FOR SKIN CARE; COSMETIC HAND CREAMS; COSMETIC MASKS; COSMETIC NOURISHING CREAMS; COSMETIC OILS; COSMETIC OILS FOR THE EPIDERMIS; COSMETIC PREPARATIONS FOR BATH AND SHOWER; COSMETIC PREPARATIONS FOR BODY CARE; COSMETIC PREPARATIONS FOR SKIN CARE; COSMETIC PREPARATIONS FOR SKIN RENEWAL; COSMETIC PREPARATIONS FOR THE HAIR AND SCALP; COSMETIC PREPARATIONS, NAMELY, FIRMING CREAMS; COSMETIC PREPARATIONS, NAMELY, FIRMING LOTIONS; COSMETIC SOAPS; COSMETICS AND MAKE-UP; COSMETICS, NAMELY, LIP REPAIRERS; FACE CREAMS FOR COSMETIC USE; LOTIONS FOR COSMETIC PURPOSES; NUTRITIONAL OILS FOR COSMETIC PURPOSES; OILS FOR COSMETIC PURPOSES; PLANT AND HERB EXTRACTS SOLD AS COMPONENTS OF COSMETICS; PRIVATE LABEL COSMETICS; SKIN AND BODY TOPICAL LOTIONS, CREAMS AND OILS FOR COSMETIC USE; TOPICAL SKIN SPRAYS FOR COSMETIC PURPOSES (U.S. CLS. 1, 4, 6, 50, 51 AND 52).

CLASS 30—STAPLE FOODS

FOR TEA-BASED BEVERAGES; TEA-BASED BEVERAGES WITH FRUIT FLAVORING (U.S. CL. 46).

CLASS 32—LIGHT BEVERAGES

FOR COCONUT-BASED BEVERAGES; FRUIT BEVERAGES; ISOTONIC BEVERAGES; NON-ALCOHOLIC BEVERAGES CONTAINING FRUIT JUICES; NON-ALCOHOLIC BEVERAGES WITH TEA FLAVOR; NON-ALCOHOLIC FRUIT JUICE BEVERAGES (U.S. CLS. 45, 46 AND 48).

STEVEN JACKSON, EXAMINING ATTORNEY

SN 85-462,812. THE COLLEGE OF AMERICAN PATHOLOGISTS, NORTHFIELD, IL. FILED 11-2-2011.

CAP QMAP

THE MARK CONSISTS OF STANDARD CHARACTERS WITHOUT CLAIM TO ANY PARTICULAR FONT, STYLE, SIZE, OR COLOR.

OWNER OF U.S. REG. NOS. 3,479,635 AND 3,819,547.

CLASS 41—EDUCATION AND ENTERTAINMENT

FOR EDUCATIONAL SERVICES, NAMELY, DEVELOPING, ARRANGING, AND CONDUCTING EDUCATIONAL CONFERENCES AND PROGRAMS AND PROVIDING COURSES OF INSTRUCTION IN THE FIELDS OF PATHOLOGY AND LABORATORY SERVICES (U.S. CLS. 100, 101 AND 107).

CLASS 42—SCIENTIFIC AND COMPUTER SERVICES

FOR QUALITY ASSESSMENT SERVICES FOR MEDICAL LABORATORIES (U.S. CLS. 100 AND 101).

RON FAIRBANKS, EXAMINING ATTORNEY

SN 85-462,852. SPORTS LEGACY INSTITUTE, INC., BOSTON, MA. FILED 11-2-2011.

EVERY HIT COUNTS

THE MARK CONSISTS OF STANDARD CHARACTERS WITHOUT CLAIM TO ANY PARTICULAR FONT, STYLE, SIZE, OR COLOR.

CLASS 9—ELECTRICAL AND SCIENTIFIC APPARATUS

FOR ACCESSORIES, NAMELY, ELECTRONIC DEVICES THAT RECORD, TRACK AND TRANSMIT DATA REGARDING PHYSICAL IMPACTS AMONG PLAYERS FOR SPORTS PARTICIPANTS, NAMELY, FOOTBALL, BASEBALL, BASKETBALL, HOCKEY, SOCCER, AND WRESTLING (U.S. CLS. 21, 23, 26, 36 AND 38).

CLASS 36—INSURANCE AND FINANCIAL

FOR CHARITABLE FUNDRAISING SERVICES (U.S. CLS. 100, 101 AND 102).

CLASS 41—EDUCATION AND ENTERTAINMENT

FOR EDUCATION SERVICES, NAMELY, PROVIDING CLASSES, SEMINARS AND WORKSHOPS IN THE FIELD OF REPETITIVE BRAIN INJURIES (U.S. CLS. 100, 101 AND 107).

ARETHA SOMERVILLE, EXAMINING ATTORNEY

SN 85-462,858. SPORTS LEGACY INSTITUTE, INC., BOSTON, MA. FILED 11-2-2011.

HIT COUNT

THE MARK CONSISTS OF STANDARD CHARACTERS WITHOUT CLAIM TO ANY PARTICULAR FONT, STYLE, SIZE, OR COLOR.

CLASS 9—ELECTRICAL AND SCIENTIFIC APPARATUS

FOR ACCESSORIES, NAMELY, ELECTRONIC DEVICES THAT RECORD, TRACK AND TRANSMIT DATA REGARDING PHYSICAL IMPACTS AMONG PLAYERS FOR SPORTS PARTICIPANTS, NAMELY, FOOTBALL, BASEBALL, BASKETBALL, HOCKEY, SOCCER, AND WRESTLING (U.S. CLS. 21, 23, 26, 36 AND 38).

CLASS 36—INSURANCE AND FINANCIAL

FOR CHARITABLE FUNDRAISING SERVICES (U.S. CLS. 100, 101 AND 102).

CLASS 41—EDUCATION AND ENTERTAINMENT

FOR EDUCATION SERVICES, NAMELY, PROVIDING CLASSES, SEMINARS AND WORKSHOPS IN THE FIELD OF REPETITIVE BRAIN INJURIES (U.S. CLS. 100, 101 AND 107).
ARETHA SOMERVILLE, EXAMINING ATTORNEY

CLASS 9—ELECTRICAL AND SCIENTIFIC APPARATUS

FOR COMPUTER PROGRAM FOR INTEGRATING LEGAL RESEARCH APPLICATIONS; COMPUTER SOFTWARE APPLICATIONS, NAMELY, DOWNLOADABLE APPLICATIONS TO ACCESS LEGAL BUSINESS AND NEWS AND TO STORE, ANNOTATE AND SHARE DOCUMENTS ALL PROVIDED ONLINE AND BY MOBILE DEVICES (U.S. CLS. 21, 23, 26, 36 AND 38).
FIRST USE 10-4-2010; IN COMMERCE 10-4-2010.

SN 85-462,862. SPORTS LEGACY INSTITUTE, INC., BOSTON, MA. FILED 11-2-2011.

CLASS 38—COMMUNICATION

FOR PROVIDING MULTIPLE USER ACCESS TO A GLOBAL COMPUTER NETWORK (U.S. CLS. 100, 101 AND 104).
FIRST USE 10-4-2010; IN COMMERCE 10-4-2010.

HITS COUNT SO COUNT HITS

THE MARK CONSISTS OF STANDARD CHARACTERS WITHOUT CLAIM TO ANY PARTICULAR FONT, STYLE, SIZE, OR COLOR.

CLASS 41—EDUCATION AND ENTERTAINMENT

FOR PROVIDING NEWS AND INFORMATION IN THE FIELD OF LAW AND BUSINESS (U.S. CLS. 100, 101 AND 107).
FIRST USE 10-4-2010; IN COMMERCE 10-4-2010.

CLASS 9—ELECTRICAL AND SCIENTIFIC APPARATUS

FOR ACCESSORIES, NAMELY, ELECTRONIC DEVICES THAT RECORD, TRACK AND TRANSMIT DATA REGARDING PHYSICAL IMPACTS AMONG PLAYERS FOR SPORTS PARTICIPANTS, NAMELY, FOOTBALL, BASEBALL, BASKETBALL, HOCKEY, SOCCER, AND WRESTLING (U.S. CLS. 21, 23, 26, 36 AND 38).

CLASS 42—SCIENTIFIC AND COMPUTER SERVICES

FOR PROVIDING TEMPORARY USE OF ONLINE NONDOWNLOADABLE COMPUTER SOFTWARE FOR INTEGRATING LEGAL RESEARCH APPLICATIONS; COMPUTER SOFTWARE APPLICATIONS; AND, PROVIDING TEMPORARY USE OF COMPUTER SOFTWARE APPLICATIONS, NAMELY, LAW NEWS AND GENERAL BUSINESS INFORMATION TO STORE, ANNOTATE AND SHARE DOCUMENTS ALL PROVIDED ONLINE AND BY MOBILE DEVICES (U.S. CLS. 100 AND 101).
FIRST USE 10-4-2010; IN COMMERCE 10-4-2010.

CLASS 36—INSURANCE AND FINANCIAL

FOR CHARITABLE FUNDRAISING SERVICES (U.S. CLS. 100, 101 AND 102).

CLASS 45—PERSONAL AND LEGAL SERVICES

FOR PUBLIC RECORD INVESTIGATION SERVICES (U.S. CLS. 100 AND 101).
FIRST USE 10-4-2010; IN COMMERCE 10-4-2010.
MATTHEW KLINE, EXAMINING ATTORNEY

CLASS 41—EDUCATION AND ENTERTAINMENT

FOR EDUCATION SERVICES, NAMELY, PROVIDING CLASSES, SEMINARS AND WORKSHOPS IN THE FIELD OF REPETITIVE BRAIN INJURIES (U.S. CLS. 100, 101 AND 107).
ARETHA SOMERVILLE, EXAMINING ATTORNEY

SN 85-463,751. MEZCAL DE AMOR, S.A.P.I. DE C.V., DISTRITO FEDERAL, MEXICO, FILED 11-3-2011.

SN 85-463,604. REED ELSEVIER PROPERTIES INC., WILMINGTON, DE. FILED 11-3-2011.

LEXIS ADVANCE

THE MARK CONSISTS OF STANDARD CHARACTERS WITHOUT CLAIM TO ANY PARTICULAR FONT, STYLE, SIZE, OR COLOR.
OWNER OF U.S. REG. NOS. 1,020,214, 1,128,529 AND 1,274,298.

**- M E Z C A L -
A M O R E S**



NO CLAIM IS MADE TO THE EXCLUSIVE RIGHT TO USE "MEZCAL", APART FROM THE MARK AS SHOWN.
THE MARK CONSISTS OF THE WORD "MEZCAL" WITH A DASH ON BOTH SIDES OF THE TERM "MEZCAL" ABOVE THE WORD "AMORES" ALL ABOVE RAYS DEPICTED IN A CIRCULAR DESIGN WITH THE DEPICTION OF AN "MA" INSIDE OF THE CIRCLE.
THE ENGLISH TRANSLATION OF "AMORES" IN THE MARK IS "LOVES".

CLASS 33—WINES AND SPIRITS

FOR DISTILLED BEVERAGES, NAMELY, MEZCAL (U.S. CLS. 47 AND 49).

CLASS 35—ADVERTISING AND BUSINESS

FOR ADVERTISING, ADVERTISING AGENCIES, BUSINESS INVESTIGATIONS, BUSINESS RESEARCH, COMMERCIAL INFORMATION AND ADVICE FOR CONSUMERS, COST PRICE ANALYSIS, DEMONSTRATION OF GOODS, ORGANIZATION OF EXHIBITIONS FOR COMMERCIAL OR ADVERTISING PURPOSES, MARKETING RESEARCH, MARKETING STUDIES, PUBLICATION OF PUBLICITY TEXTS AND WRITING OF PUBLICITY TEXTS (U.S. CLS. 100, 101 AND 102).
BRIDGETT SMITH, EXAMINING ATTORNEY

SN 85-464,028. J.M. TEST SYSTEMS, INC., BATON ROUGE, LA. FILED 11-3-2011.



NO CLAIM IS MADE TO THE EXCLUSIVE RIGHT TO USE "TEST SYSTEMS", APART FROM THE MARK AS SHOWN.

THE COLOR(S) LIGHT YELLOW, DARK YELLOW, AND BLACK IS/ARE CLAIMED AS A FEATURE OF THE MARK.

THE COLOR BLACK APPEARS IN THE WORDING "JM TEST SYSTEMS"; THE COLORS LIGHT YELLOW AND DARK YELLOW APPEAR AS ALTERNATING LINES BEHIND THE TEXT.

CLASS 9—ELECTRICAL AND SCIENTIFIC APPARATUS

FOR ELECTRICAL EDDY CURRENT TEST EQUIPMENT (U.S. CLS. 21, 23, 26, 36 AND 38).
FIRST USE 6-1-2007; IN COMMERCE 6-1-2007.

CLASS 37—CONSTRUCTION AND REPAIR

FOR RENTAL OF CONSTRUCTION EQUIPMENT (U.S. CLS. 100, 103 AND 106).
FIRST USE 6-1-2007; IN COMMERCE 6-1-2007.

CLASS 42—SCIENTIFIC AND COMPUTER SERVICES

FOR CALIBRATION OF CONSTRUCTION TESTING EQUIPMENT (U.S. CLS. 100 AND 101).
FIRST USE 6-1-2007; IN COMMERCE 6-1-2007.
AISHA SALEM, EXAMINING ATTORNEY

SN 85-464,394. CONCHETTA, INC., TA CLUB RISQUE ON THE DELAWARE, PHILADELPHIA, PA. FILED 11-4-2011.



NO CLAIM IS MADE TO THE EXCLUSIVE RIGHT TO USE "CLUB", APART FROM THE MARK AS SHOWN.

THE MARK CONSISTS OF THE WORDING "CLUB" OVER A DESIGN OF HUMAN LIPS THAT IS CONNECTED TO THE LETTER "R" IN THE WORDING "RISQUE".

CLASS 41—EDUCATION AND ENTERTAINMENT

FOR ARRANGING AND CONDUCTING NIGHTCLUB ENTERTAINMENT EVENTS (U.S. CLS. 100, 101 AND 107).
FIRST USE 1-31-1997; IN COMMERCE 1-31-1997.

CLASS 43—HOTEL AND RESTAURANT SERVICES

FOR BAR SERVICES (U.S. CLS. 100 AND 101).
FIRST USE 1-31-1997; IN COMMERCE 1-31-1997.
JANET LEE, EXAMINING ATTORNEY

SN 85-464,479. THE IMPRESSION LLC, WESTPORT, CT. FILED 11-4-2011.

THE IMPRESSION

THE MARK CONSISTS OF STANDARD CHARACTERS WITHOUT CLAIM TO ANY PARTICULAR FONT, STYLE, SIZE, OR COLOR.

CLASS 9—ELECTRICAL AND SCIENTIFIC APPARATUS

FOR COMPUTER SOFTWARE FOR ACCESSING, VIEWING, INTERACTING WITH AND DOWNLOADING CONTENT AND INFORMATION FROM VARIOUS MEDIA, NAMELY, WEBSITES AND ONLINE MAGAZINES IN THE FIELDS OF LIFESTYLE, FASHION, STYLE, CELEBRITIES, INTERIORS AND BEAUTY (U.S. CLS. 21, 23, 26, 36 AND 38).

CLASS 41—EDUCATION AND ENTERTAINMENT

FOR PROVIDING A WEBSITE FEATURING ONLINE JOURNALS, NAMELY, BLOGS IN THE FIELD OF CELEBRITIES, NON-DOWNLOADABLE PHOTOGRAPHS AND VIDEOS, AND INFORMATION IN THE FIELD OF CELEBRITIES (U.S. CLS. 100, 101 AND 107).

CLASS 45—PERSONAL AND LEGAL SERVICES

FOR PROVIDING A WEBSITE FEATURING INFORMATION ON LIFESTYLES, FASHION AND STYLE (U.S. CLS. 100 AND 101).
ASMAT KHAN, EXAMINING ATTORNEY

SN 85-464,518. CONCHETTA, INC., TA CLUB RISQUE ON THE DELAWARE, PHILADELPHIA, PA. FILED 11-4-2011.

SN 85-466,531. GREGG, STEPHEN, LAKE FOREST, CA. FILED 11-7-2011.

Club Risque



THE MARK CONSISTS OF STANDARD CHARACTERS WITHOUT CLAIM TO ANY PARTICULAR FONT, STYLE, SIZE, OR COLOR.

NO CLAIM IS MADE TO THE EXCLUSIVE RIGHT TO USE "CLUB", APART FROM THE MARK AS SHOWN.

CLASS 41—EDUCATION AND ENTERTAINMENT

FOR ARRANGING AND CONDUCTING NIGHTCLUB ENTERTAINMENT EVENTS (U.S. CLS. 100, 101 AND 107).

FIRST USE 1-31-1997; IN COMMERCE 1-31-1997.

CLASS 43—HOTEL AND RESTAURANT SERVICES

FOR BAR SERVICES (U.S. CLS. 100 AND 101).

FIRST USE 1-31-1997; IN COMMERCE 1-31-1997.
JANET LEE, EXAMINING ATTORNEY

SN 85-464,765. SAN DIEGO ARMED SERVICES YMCA, SAN DIEGO, CA. FILED 11-4-2011.

Making Military Life Easier

THE MARK CONSISTS OF STANDARD CHARACTERS WITHOUT CLAIM TO ANY PARTICULAR FONT, STYLE, SIZE, OR COLOR.

CLASS 35—ADVERTISING AND BUSINESS

FOR CHARITABLE SERVICES, NAMELY, ORGANIZING AND CONDUCTING VOLUNTEER PROGRAMS AND COMMUNITY SERVICE PROJECTS AIMED AT INCREASING SUPPORT AND MORALE OF FAMILIES OF DECEASED WAR VETERANS, WAR VETERANS, CURRENT MEMBERS AND FUTURE MEMBERS OF THE U.S. MILITARY; CHARITABLE SERVICES, NAMELY, ORGANIZING AND CONDUCTING VOLUNTEER PROGRAMS AND COMMUNITY SERVICE PROJECTS AIMED AT INCREASING SUPPORT AND MORALE OF MEMBERS OF THE U.S. MILITARY (U.S. CLS. 100, 101 AND 102).

FIRST USE 9-15-2011; IN COMMERCE 9-15-2011.

CLASS 36—INSURANCE AND FINANCIAL

FOR ACCEPTING AND ADMINISTERING MONETARY CHARITABLE CONTRIBUTIONS TO ASSIST UNITED STATES SERVICE PERSONS SERVING IN COMBAT ZONES OR WOUNDED AND IN MILITARY HOSPITALS (U.S. CLS. 100, 101 AND 102).

FIRST USE 9-15-2011; IN COMMERCE 9-15-2011.
KATHERINE CHANG, EXAMINING ATTORNEY

NO CLAIM IS MADE TO THE EXCLUSIVE RIGHT TO USE "WEEKLY" AND "REPORT", APART FROM THE MARK AS SHOWN.

THE COLOR(S) RED, WHITE AND GRAY IS/ARE CLAIMED AS A FEATURE OF THE MARK.

THE MARK CONSISTS OF A CIRCLE IN RED WITH TWO WHITE CHECK MARKS WITH WHITE DOTS IN THE ELBOW OF THE CHECK MARKS FOLLOWED BY THE WORD "WEEKLY" IN GRAY FOLLOWED BY THE WORD "SUCCESS" IN RED AND THE WORD "REPORT" IN GRAY UNDERNEATH THE WORD "SUCCESS" AND JUSTIFIED TO THE RIGHT OF THE WORD "SUCCESS."

CLASS 9—ELECTRICAL AND SCIENTIFIC APPARATUS

FOR COMPUTER APPLICATION SOFTWARE FOR PERSONAL COMPUTERS, HANDHELD DEVICES, AND CELL PHONES, NAMELY, SOFTWARE FOR TRACKING SALES AND SALES ACTIVITY INFORMATION (U.S. CLS. 21, 23, 26, 36 AND 38).

FIRST USE 6-14-2011; IN COMMERCE 6-14-2011.

CLASS 16—PAPER GOODS AND PRINTED MATTER

FOR BOOKLETS FOR RECORDING SALES AND SALES ACTIVITY INFORMATION (U.S. CLS. 2, 5, 22, 23, 29, 37, 38 AND 50).

FIRST USE 6-14-2011; IN COMMERCE 6-14-2011.
JENNY PARK, EXAMINING ATTORNEY

SN 85-466,832. SENIOR INFORMATION CENTERS, INC., BOCA RATON, FL. FILED 11-8-2011.



NO CLAIM IS MADE TO THE EXCLUSIVE RIGHT TO USE THE DESIGN OF THE "CADUCEUS", APART FROM THE MARK AS SHOWN.

THE MARK CONSISTS OF A SHIELD SEPARATED INTO FOUR PARTS, EACH PART CONTAINING A DIFFERENT IMAGE, NAMELY, A GAVEL IN THE TOP LEFT PART, A CADUCEUS IN THE TOP RIGHT PART, A DOLLAR SIGN WITH AN ARROW THROUGH IT IN THE BOTTOM LEFT PART, AND A 1040 TAX FORM IN THE BOTTOM RIGHT PART.

CLASS 35—ADVERTISING AND BUSINESS

FOR PROVIDING REFERRAL SERVICES TO PROFESSIONAL SERVICE PROVIDERS IN THE FIELDS OF LAW, ACCOUNTING, MEDICINE AND FINANCE (U.S. CLS. 100, 101 AND 102).

FIRST USE 5-0-2009; IN COMMERCE 5-0-2009.

CLASS 36—INSURANCE AND FINANCIAL

FOR INFORMATIONAL SERVICES, NAMELY, PROVIDING A WEBSITE FEATURING ESTATE PLANNING INFORMATION FOR THE ELDERLY IN THE FIELDS OF LAW, TAX, MEDICINE AND FINANCE (U.S. CLS. 100, 101 AND 102).

FIRST USE 5-0-2009; IN COMMERCE 5-0-2009.
ODESSA BIBBINS, EXAMINING ATTORNEY

CLASS 5—PHARMACEUTICALS

FOR DIETARY SUPPLEMENTS, DIETARY AND NUTRITIONAL SUPPLEMENTS, DIETARY FOOD SUPPLEMENTS, MEDICATED TOPICAL PREPARATIONS, NAMELY, GELS AND CREAMS FOR SKIN CARE (U.S. CLS. 6, 18, 44, 46, 51 AND 52).

ALAIN LAPTER, EXAMINING ATTORNEY

SN 85-468,620. 8TH STREET E. SONOMA HOLDINGS, WINERY LLC, DBA CONJURE WINERY, LAFAYETTE, CA. FILED 11-9-2011.

Conjure Wines

THE MARK CONSISTS OF STANDARD CHARACTERS WITHOUT CLAIM TO ANY PARTICULAR FONT, STYLE, SIZE, OR COLOR.

NO CLAIM IS MADE TO THE EXCLUSIVE RIGHT TO USE "WINES", APART FROM THE MARK AS SHOWN.

CLASS 40—MATERIAL TREATMENT

FOR WINERY SERVICES (U.S. CLS. 100, 103 AND 106).

CLASS 44—MEDICAL, BEAUTY AND AGRICULTURAL SERVICES

FOR VINEYARD AND WINERY SERVICES, NAMELY, THE CULTIVATION OF GRAPES FOR OTHERS (U.S. CLS. 100 AND 101).

JOHN GARTNER, EXAMINING ATTORNEY

SN 85-469,235. WATER PURE, INC., DBA PURITY PRODUCTS, PLAINVIEW, NY. FILED 11-10-2011.

ASTADERM

THE MARK CONSISTS OF STANDARD CHARACTERS WITHOUT CLAIM TO ANY PARTICULAR FONT, STYLE, SIZE, OR COLOR.

CLASS 3—COSMETICS AND CLEANING PREPARATIONS

FOR SKIN AND BODY TOPICAL LOTIONS, CREAMS AND OILS FOR COSMETIC USE (U.S. CLS. 1, 4, 6, 50, 51 AND 52).

SN 85-470,314. ESIONIC HOLDINGS, LLC, MENLO PARK, CA. FILED 11-11-2011.

ESIONIC

THE MARK CONSISTS OF STANDARD CHARACTERS WITHOUT CLAIM TO ANY PARTICULAR FONT, STYLE, SIZE, OR COLOR.

CLASS 1—CHEMICALS

FOR MOLECULAR MEMORIES FOR SCIENTIFIC OR LABORATORY PURPOSES THAT USE THE TRANSFER OF ELECTRICAL CHARGES TO STORE AND RELAY DATA WHEREIN MOLECULES ARE USED TO STORE OR RELAY DATA; CHEMICAL PREPARATIONS FOR USE IN THE MANUFACTURE OF SOLAR CELLS AND ELECTRONIC COMPONENTS; CHEMICAL PREPARATIONS IN THE NATURE OF ELECTROLYTES FOR BATTERIES, CAPACITORS, AND ELECTRIC DOUBLE-LAYER CAPACITORS, ENERGY STORAGE DEVICES AND FOR USE IN GAS SEPARATION; MOLECULAR MEMORIES FOR SCIENTIFIC OR LABORATORY PURPOSES WHICH INCORPORATE THE USE OF ELECTRICAL CHARGE AS THE STORAGE MECHANISM WHEREIN MOLECULES ARE USED TO STORE OR RELAY DATA (U.S. CLS. 1, 5, 6, 10, 26 AND 46).

CLASS 9—ELECTRICAL AND SCIENTIFIC APPARATUS

FOR SEMICONDUCTOR MEMORIES FOR SCIENTIFIC OR LABORATORY PURPOSES THAT USE THE TRANSFER OF ELECTRICAL CHARGES TO STORE AND RELAY DATA; ELECTRIC DOUBLE-LAYER CAPACITORS; CAPACITORS (U.S. CLS. 21, 23, 26, 36 AND 38).

CLASS 42—SCIENTIFIC AND COMPUTER SERVICES

FOR RESEARCH, DESIGN AND DEVELOPMENT OF MOLECULAR MEMORIES WHICH INCORPORATE THE USE OF ELECTRICAL CHARGE AS THE STORAGE MECHANISM; SCIENTIFIC RESEARCH, TECHNICAL CONSULTATION AND DESIGN FOR OTHERS IN THE FIELD OF MOLECULAR INTERFACE AND MOLECULAR ELECTRONICS (U.S. CLS. 100 AND 101).

CLASS 45—PERSONAL AND LEGAL SERVICES

FOR LICENSING OF INTELLECTUAL PROPERTY (U.S. CLS. 100 AND 101).

MELISSA VALLILLO, EXAMINING ATTORNEY

SN 85-470,641. EMPOWER ENNOVATION, LLC, DBA ENNOVATE, ATLANTA, GA. FILED 11-11-2011.



THE MARK CONSISTS OF A LOOSE INTERPRETATION OF A STYLIZED LOWER CASE "E" THAT CREATES A SWIRL AROUND AND INTERSECTS A SPHERE.

CLASS 35—ADVERTISING AND BUSINESS

FOR CONSULTING SERVICES IN THE FIELDS OF ENERGY CONSUMPTION AND USAGE CONSERVATION TO IMPROVE ENERGY EFFICIENCY; CONDUCTING ENERGY AUDITS OF ENERGY AND WATER CONSERVATION PROJECTS FOR THE PURPOSE OF IMPROVING ENERGY EFFICIENCY; BUSINESS MANAGEMENT IN THE FIELDS OF ENERGY MANAGEMENT SYSTEMS, LIGHTING RETROFIT, BOILER AND HEATING, VENTILATION AND AIR CONDITIONING (HVAC) CONTROLS, WATER CONSERVATION, POWER MANAGEMENT AND RENEWABLE ENERGY EQUIPMENT (U.S. CLS. 100, 101 AND 102).

FIRST USE 9-15-2011; IN COMMERCE 9-15-2011.

CLASS 36—INSURANCE AND FINANCIAL

FOR PROVIDING VENTURE CAPITAL, DEVELOPMENT CAPITAL, PRIVATE EQUITY AND INVESTMENT FUNDING IN THE FIELDS OF ENERGY MANAGEMENT SYSTEMS, LIGHTING RETROFIT, BOILER AND HEATING, VENTILATION AND AIR CONDITIONING (HVAC) CONTROLS, WATER CONSERVATION, POWER MANAGEMENT AND RENEWABLE ENERGY EQUIPMENT (U.S. CLS. 100, 101 AND 102).

FIRST USE 9-15-2011; IN COMMERCE 9-15-2011.

CLASS 37—CONSTRUCTION AND REPAIR

FOR INSTALLATION OF ENERGY MANAGEMENT SYSTEMS, LIGHTING RETROFIT, BOILER AND HEATING, VENTILATION AND AIR CONDITIONING (HVAC) CONTROLS, WATER CONSERVATION, POWER MANAGEMENT AND RENEWABLE ENERGY EQUIPMENT (U.S. CLS. 100, 103 AND 106).

FIRST USE 9-15-2011; IN COMMERCE 9-15-2011.

TINA L. SNAPP, EXAMINING ATTORNEY

SN 85-472,491. SONS DESIGN & MANUFACTURING, INC., AKA SDMI, CITY OF INDUSTRY, CA. FILED 11-15-2011.

SDMI

THE MARK CONSISTS OF STANDARD CHARACTERS WITHOUT CLAIM TO ANY PARTICULAR FONT, STYLE, SIZE, OR COLOR.

OWNER OF U.S. REG. NO. 4,055,310.

CLASS 40—MATERIAL TREATMENT

FOR CUSTOM CONSTRUCTION OF ELECTRONIC OR ELECTRICAL EQUIPMENT, PLASTICS, METAL AND STONE; CUSTOM FABRICATION AND PRODUCTION OF ELECTRONIC OR ELECTRICAL EQUIPMENT, PLASTICS, METAL AND STONE; CUSTOM FABRICATION OF COUNTER TOPS; CUSTOM MANUFACTURE OF ELECTRONIC OR ELECTRICAL EQUIPMENT, PLASTICS, METAL AND STONE; MANUFACTURE OF GENERAL PRODUCT LINES IN THE FIELD OF STEEL PIPE AND TUBING TO ORDER AND/OR SPECIFICATION OF OTHERS; CUSTOM MANUFACTURE OF TUNNELING EQUIPMENT; CUTTING OF PLASTICS, METAL AND STONE; MANUFACTURE OF GENERAL PRODUCT LINES IN THE FIELD OF ELECTRONIC OR ELECTRICAL EQUIPMENT, PLASTICS, METAL AND STONE TO THE ORDER AND SPECIFICATION OF OTHERS; MANUFACTURING SERVICES FOR OTHERS IN THE FIELD OF ELECTRONIC OR ELECTRICAL EQUIPMENT, PLASTICS, METAL, AND STONE; METAL CASTING; METAL FABRICATION AND FINISHING SERVICES; METAL LAMINATING; METAL PLATING; METAL PLATING AND LAMINATING; METAL RECLAMATION SERVICES; METAL REFINING SERVICES, NAMELY, ALL METALS IN THE NATURE OF STEEL, ALUMINUM, CHROMIUM, COBALT, COPPER, GOLD, IRON, LEAD, MAGNESIUM, MANGANESE, MERCURY, NICKEL, PLATINUM, SILVER, TIN, TITANIUM, TUNGSTEN AND ZINC; METAL STAMPING; METAL TEMPERING; METAL TREATING; METAL TREATMENT; METALIZING; OIL PRODUCTION SERVICES; TREATMENT OF MATERIALS BY LASER BEAM; AND TREATMENT OF METAL (U.S. CLS. 100, 103 AND 106).

FIRST USE 12-31-2002; IN COMMERCE 12-31-2002.

CLASS 42—SCIENTIFIC AND COMPUTER SERVICES

FOR DESIGN AND DEVELOPMENT OF AUTOMATED HOME CONTROLLER SYSTEMS, NAMELY, TEMPERATURE, HUMIDITY, AND ELECTRICAL CONTROLLERS; DESIGN AND DEVELOPMENT OF AUTOMATED CONTROLLER SYSTEMS, NAMELY, TEMPERATURE, HUMIDITY AND ELECTRICAL CONTROLLERS; DESIGN AND TESTING FOR NEW PRODUCT DEVELOPMENT; DESIGN AND TESTING OF NEW PRODUCTS FOR OTHERS; DESIGN OF ENGINEERING PRODUCTS; DESIGN OF MECHANICAL AND MICROMECHANICAL COMPONENTS; DESIGN OF MECHANICAL, ELECTROMECHANICAL AND OPTOELECTRONIC APPARATUS AND INSTRUMENTS; DESIGN OF OPTICAL AND MICRO-OPTICAL COMPONENTS; DESIGN, DEVELOPMENT, AND CONSULTING SERVICES IN THE FIELD OF HOME AND WORKPLACE AUTOMATION HARDWARE AND SOFTWARE; DEVELOPMENT OF TECHNOLOGIES FOR THE FABRICATION OF CIRCUITS FOR WIRELESS COMMUNICATION, ELECTRONIC DATA PROCESSING, CONSUMER ELECTRONICS, AUTOMOTIVE ELECTRONICS; DRAFTING; DRAFTING OF PLANS AND ENGINEERING DRAWINGS FOR OTHERS; ENGINEERING; ENGINEERING AND SYSTEM ANALYSIS IN THE FIELD OF HOME SECURITY SYSTEMS; ENGINEERING SERVICES FOR BUILDING AND PROPERTY CONDITION ASSESSMENT, FACILITY MANAGEMENT, REPAIR, RESTORATION AND BUILDING INSTRUMENTATION, BUILDING MONITORING AND ENVIRONMENTAL CONSULTING; HOME INSPECTION SERVICES FOR PURPOSES OF HOME REPAIR AND RESTORATION; INDUSTRIAL DESIGN; INDUSTRIAL DESIGN SERVICES; MACHINE PART DESIGN SERVICES; MATERIAL TESTING; MATERIALS TESTING AND ANALYZING; MATERIALS TESTING AND EVALUATION; MECHANICAL ENGINEERING; MECHANICAL RESEARCH; MONITORING OF STREAM WATER QUALITY; NEW PRODUCT DESIGN SERVICES; OIL EXPLORATION; PRODUCT DESIGN AND DEVELOPMENT IN THE FIELD OF ELECTRONIC OR ELECTRICAL EQUIPMENT, METAL, STONE OR OTHER SOLID MATERIALS; PRODUCT DEVELOPMENT; PRODUCT DEVELOPMENT FOR OTHERS; PRODUCT DEVELOPMENT CONSULTATION; PRODUCT DEVELOPMENT AND ENGINEERING SERVICES FOR OTHERS; PRODUCT DEVELOPMENT IN THE FIELD OF ELECTRONIC OR ELECTRICAL EQUIPMENT, METAL, STONE OR OTHER SOLID MATERIALS; PRODUCT RESEARCH; PRODUCT RESEARCH AND DEVELOPMENT; RESEARCH AND DEVELOPMENT OF NEW

PRODUCTS; RESEARCH, DEVELOPMENT, ENGINEERING AND TESTING SERVICES IN THE FIELDS OF CUTTING, WELDING AND MATERIAL JOINING; TESTING, ANALYSIS AND EVALUATION OF THE GOODS AND SERVICES OF OTHERS FOR THE PURPOSE OF CERTIFICATION; TESTING, ANALYSIS AND EVALUATION OF MATERIALS, NAMELY, METAL, PLASTIC AND NYLON; TESTING, ANALYSIS AND EVALUATION OF METAL TOOLS, MACHINERY AND FABRICATION EQUIPMENT; TOOL DESIGN (U.S. CLS. 100 AND 101).

FIRST USE 12-31-2002; IN COMMERCE 12-31-2002.
CHRISTOPHER SIDOTI, EXAMINING ATTORNEY

SN 85-474,907. AMERICAN NEWLAND COMMUNITIES, LP, SAN DIEGO, CA. FILED 11-17-2011.

TEHALEH

SN 85-474,205. GRAND VALLEY STATE UNIVERSITY, ALLENDALE, MI. FILED 11-16-2011.



OWNER OF U.S. REG. NOS. 2,800,257 AND 2,897,055.
THE MARK CONSISTS OF THE WORD "LAKER" UNDERLINED WITH A WIDE BAR THAT CONTAINS THE WORDS "FOR A LIFETIME". ALL POSITIONED ABOVE A STYLIZED "GV" AND THE WORDS "GRAND VALLEY STATE UNIVERSITY".

CLASS 36—INSURANCE AND FINANCIAL

FOR CHARITABLE FUNDRAISING SERVICES TO RAISE FUNDS FOR EDUCATION AND/OR ALUMNI ORGANIZATIONS; CHARITABLE FUNDRAISING SERVICES, NAMELY, RAISING FUNDS FOR COLLEGE EDUCATION COSTS; CHARITABLE SERVICES, NAMELY, ORGANIZING FUNDRAISING SERVICES AND EVENTS TO RAISE FUNDS IN THE FIELD OF EDUCATION; FUNDRAISING SERVICES, NAMELY, ORGANIZING, ARRANGING AND CONDUCTING FUNDRAISING PROGRAMS FOR THE BENEFIT OF SCHOOLS AND NON-PROFIT ORGANIZATIONS; CHARITABLE FUNDRAISING SERVICES, NAMELY, SOLICITING AND MANAGING DONATIONS TO PROMOTE THE INTERESTS OF THE UNIVERSITY, ITS STUDENTS, AND ALUMNI (U.S. CLS. 100, 101 AND 102).

CLASS 41—EDUCATION AND ENTERTAINMENT

FOR PROVIDING ON-LINE NEWSLETTERS IN THE FIELD OF CHARITABLE FUNDRAISING SERVICES TO RAISE FUNDS FOR EDUCATION AND/OR ALUMNI ORGANIZATIONS (U.S. CLS. 100, 101 AND 107).

CLASS 45—PERSONAL AND LEGAL SERVICES

FOR ON-LINE SOCIAL NETWORKING SERVICES IN THE FIELD OF CHARITABLE FUNDRAISING SERVICES TO RAISE FUNDS FOR EDUCATION AND/OR ALUMNI ORGANIZATIONS (U.S. CLS. 100 AND 101).
CHRISTOPHER LAW, EXAMINING ATTORNEY

THE MARK CONSISTS OF STANDARD CHARACTERS WITHOUT CLAIM TO ANY PARTICULAR FONT, STYLE, SIZE, OR COLOR.

THE ENGLISH TRANSLATION OF "TEHALEH" IN THE MARK IS "HIGH GROUND", "SUPERIOR LAND" OR "LAND OF THE GODS" IN CHINOOK JARGON.

CLASS 35—ADVERTISING AND BUSINESS

FOR HOMEOWNER ASSOCIATION SERVICES, NAMELY, PROMOTING THE INTERESTS OF HOMEOWNERS IN A SPECIFIC COMMUNITY; ONLINE INFORMATION SERVICES IN THE FIELD OF REAL ESTATE, NAMELY, REAL ESTATE SALES MANAGEMENT; PROVIDING WEBSITES IN THE FIELD OF REAL ESTATE, NAMELY, REAL ESTATE SALES MANAGEMENT (U.S. CLS. 100, 101 AND 102).

CLASS 36—INSURANCE AND FINANCIAL

FOR REAL ESTATE SERVICES, NAMELY, REAL ESTATE AGENCIES, REAL ESTATE MANAGEMENT, REAL ESTATE LISTING, REAL ESTATE BROKERAGE, ONLINE INFORMATION SERVICES IN THE FIELD OF REAL ESTATE AND REAL ESTATE INVESTMENT; PROVIDING WEBSITES IN THE FIELD OF REAL ESTATE AND REAL ESTATE INVESTMENT (U.S. CLS. 100, 101 AND 102).

CLASS 37—CONSTRUCTION AND REPAIR

FOR REAL ESTATE DEVELOPMENT; LAND DEVELOPMENT SERVICES, NAMELY, PLANNING AND LAYING OUT OF RESIDENTIAL AND/OR COMMERCIAL COMMUNITIES; MASTER PLAN COMMUNITY SERVICES, NAMELY, PLANNING, DEVELOPING, AND CONSTRUCTION OF MASTER PLAN COMMUNITIES; CONSTRUCTION PLANNING; CONSTRUCTION MANAGEMENT; ONLINE INFORMATION SERVICES IN THE FIELDS OF REAL ESTATE DEVELOPMENT, NAMELY, THE DEVELOPMENT OF PLANNED COMMUNITIES, AND RESIDENTIAL AND/OR COMMERCIAL DEVELOPMENTS; PROVIDING MAINTENANCE OF RECREATIONAL AREAS, POOL FACILITIES, SPA FACILITIES, COUNTRY CLUB FACILITIES, PHYSICAL FITNESS FACILITIES, CLUB ROOM FACILITIES, TENNIS COURT FACILITIES; STREET MAINTENANCE; COMMERCIAL AND RESIDENTIAL WASTE DISPOSAL SERVICES FOR OTHERS; BUILDING CONSTRUCTION, REPAIR, MAINTENANCE, AND RENOVATION SERVICES, CONSTRUCTION AND MAINTENANCE OF ROADS AND OTHER INFRASTRUCTURE (U.S. CLS. 100, 103 AND 106).

WANDA KAY PRICE, EXAMINING ATTORNEY

SN 85-475,632. HEAL THE OCEAN, INC., SANTA BARBARA, CA. FILED 11-17-2011.

SN 85-476,246. LA CENTRO AMERICANA CORP., BAY SHORE, NY. FILED 11-18-2011.

HEAL THE OCEAN

THE MARK CONSISTS OF STANDARD CHARACTERS WITHOUT CLAIM TO ANY PARTICULAR FONT, STYLE, SIZE, OR COLOR.

OWNER OF U.S. REG. NO. 2,566,735.

CLASS 42—SCIENTIFIC AND COMPUTER SERVICES

FOR RESEARCH SERVICES IN THE FIELD OF WATER RECLAMATION, WASTEWATER TRACKING, WASTEWATER DISCHARGE, GROUNDWATER CONTAMINATION, TRACKING POLLUTION LEVELS IN COASTAL WATERS, DNA TESTING TO DETERMINE SOURCES OF POLLUTION, CHECKING FOR HUMAN WASTE IN CREEKS, STORM DRAINS, AND OCEANS, ENVIRONMENTAL CONSERVATION; PROVIDING ENVIRONMENTAL INFORMATION DEDICATED TO THE PRESERVATION, PROTECTION, AND ENHANCEMENT OF THE WORLD'S OCEANS AND BEACHES; PROVIDING ENVIRONMENTAL INFORMATION ON OCEAN WATER QUALITY VIA THE INTERNET; PROVIDING A WEBSITE FEATURING ENVIRONMENTAL INFORMATION ABOUT GROUNDWATER CONTAMINATION, THE DANGERS OF SWIMMING IN POLLUTED OCEAN WATER, UNLINED LANDFILLS WHICH CONTAMINATE THE ENVIRONMENT, AND FEASIBILITY STUDIES OF WASTEWATER TREATMENT PLANTS; RESEARCH IN THE FIELD OF ENVIRONMENTAL PROTECTION; OCEAN HABITAT PRESERVATION SERVICES, NAMELY, MONITORING, TESTING AND ANALYZING ECOLOGICAL SUCCESS IN THE FIELD OF ENVIRONMENTALLY SENSITIVE COASTAL WATERS; PROVIDING A WEBSITE FEATURING ENVIRONMENTAL INFORMATION, NAMELY, NON-DOWNLOADABLE PHOTOGRAPHIC, AUDIO, AND VIDEO PRESENTATIONS IN THE FIELD OF POLLUTION DETECTION, GROUNDWATER CONTAMINATION, AND ENVIRONMENTAL CONSERVATION; RESEARCH ON PREVENTION OF POLLUTION; PROVIDING A WEBSITE FEATURING ENVIRONMENTAL INFORMATION IN THE FIELD OF POLLUTION CONTROL, GROUNDWATER CONTAMINATION, AND ENVIRONMENTAL CONSERVATION, MARINE ECOSYSTEMS; TESTING OR RESEARCH ON PREVENTION OF WATER POLLUTION; ANALYSIS OF OCEAN WATER QUALITY; ENVIRONMENTAL ENFORCEMENT, NAMELY, ENGINEERING SERVICES IN THE FIELD OF ENVIRONMENTAL COMPLIANCE (U.S. CLS. 100 AND 101).

FIRST USE 8-25-1998; IN COMMERCE 8-25-1998.

CLASS 45—PERSONAL AND LEGAL SERVICES

FOR TRACKING AND MONITORING REGULATORY REQUIREMENTS IN THE FIELD OF POLLUTION LEVELS FOR REGULATORY COMPLIANCE PURPOSES IN COASTAL WATERS; PROVIDING NEWS REPORTING SERVICES FOR POLLUTION LEVEL MONITORING FOR REGULATORY COMPLIANCE PURPOSES IN COASTAL WATERS; PROVIDING WEBSITE FEATURING ENVIRONMENTAL INFORMATION ABOUT TRACKING AND MONITORING WASTEWATER FOR REGULATORY COMPLIANCE PURPOSES, PROVIDING A WEBSITE FEATURING ENVIRONMENTAL INFORMATION, NON-DOWNLOADABLE PHOTOGRAPHIC, AUDIO, AND VIDEO PRESENTATIONS ABOUT TRACKING AND MONITORING WASTEWATER FOR REGULATORY COMPLIANCE PURPOSES (U.S. CLS. 100 AND 101).

FIRST USE 8-25-1998; IN COMMERCE 8-25-1998.

LOURDES AYALA, EXAMINING ATTORNEY

LOS LENCAS

THE MARK CONSISTS OF STANDARD CHARACTERS WITHOUT CLAIM TO ANY PARTICULAR FONT, STYLE, SIZE, OR COLOR.

THE WORDING "LOS LENCAS" HAS NO MEANING IN A FOREIGN LANGUAGE.

CLASS 29—MEATS AND PROCESSED FOODS

FOR DRY BEANS, PROCESSED FROZEN BANANA LEAVES AND FROZEN ANNATTO FRUIT (U.S. CL. 46).

CLASS 30—STAPLE FOODS

FOR TORTILLAS, CORN CHIPS, CORN CURLS, WHOLE CINNAMON, TOSTADOS, SALSA, COOKIES, RELISH, BROWN SUGAR, BARLEY FLOUR IN POWDER AND NECTAR FORM, RICE, TAMALES MIX, CORN-BASED SNACK FOOD, NAMELY, CORN STICKS, FROZEN BANANA LEAVES AND FROZEN ANNATTO FLAVORING (U.S. CL. 46).

CHRISTINA SOBRAL, EXAMINING ATTORNEY

SN 85-476,486. DESIGNS AROUND YOU, INC., MILWAUKEE, WI. FILED 11-18-2011.

Designs Around You

THE MARK CONSISTS OF STANDARD CHARACTERS WITHOUT CLAIM TO ANY PARTICULAR FONT, STYLE, SIZE, OR COLOR.

OWNER OF U.S. REG. NO. 2,522,019.

CLASS 41—EDUCATION AND ENTERTAINMENT

FOR DESKTOP AND ELECTRONIC DESKTOP PUBLISHING FOR OTHERS; DESKTOP AND ELECTRONIC DESKTOP PUBLISHING FOR OTHERS FOR ADVERTISING PURPOSES; PROVIDING INDIVIDUAL INSTRUCTION AS TO THE DESIGN AND IMPLEMENTATION OF WEBSITE ADVERTISING AND WEB DESIGN, MULTIMEDIA DESIGN, COMMERCIAL ART DESIGN, GRAPHIC ART DESIGN, AND DESKTOP AND ELECTRONIC PUBLISHING FOR OTHERS (U.S. CLS. 100, 101 AND 107).

FIRST USE 1-1-1995; IN COMMERCE 1-1-1995.

CLASS 42—SCIENTIFIC AND COMPUTER SERVICES

FOR PROVIDING WEBPAGE DESIGN SERVICES FOR ADVERTISING PURPOSES; PROVIDING MULTIMEDIA DESIGN SERVICES FOR THE PURPOSE OF PROMOTING THE GOODS AND SERVICES OF OTHERS; COMMERCIAL ART DESIGN FOR ADVERTISING PURPOSES; GRAPHIC ART DESIGN FOR ADVERTISING PURPOSES; COMPUTER SERVICES, NAMELY, CREATING AND MAINTAINING WEB SITES FOR OTHERS, DESIGNING AND IMPLEMENTING WEBSITES FOR OTHERS; PROVIDING MULTIMEDIA DESIGN SERVICES FOR THE PURPOSE OF PROMOTING THE GOODS AND SERVICES OF OTHERS; COMMERCIAL ART DESIGN; GRAPHIC ART DESIGN (U.S. CLS. 100 AND 101).

FIRST USE 1-1-1995; IN COMMERCE 1-1-1995.
MARK SPARACINO, EXAMINING ATTORNEY

SN 85-477,114. JEFFREY FRIEDMAN, PLEASANTON, CA. FILED 11-19-2011.

BOSOM BUDDIES

THE MARK CONSISTS OF STANDARD CHARACTERS WITHOUT CLAIM TO ANY PARTICULAR FONT, STYLE, SIZE, OR COLOR.

CLASS 25—CLOTHING

FOR CAPS; LINGERIE EXCLUDING MATERNITY AND NURSING WEAR; SHIRTS EXCLUDING MATERNITY AND NURSING WEAR (U.S. CLS. 22 AND 39).

CLASS 33—WINES AND SPIRITS

FOR DISTILLED SPIRITS; WINES AND LIQUEURS (U.S. CLS. 47 AND 49).
JUSTINE D. PARKER, EXAMINING ATTORNEY

SN 85-476,761. GORADIO, LLC, NEW YORK, NY. FILED 11-18-2011.

GO RADIO

THE MARK CONSISTS OF STANDARD CHARACTERS WITHOUT CLAIM TO ANY PARTICULAR FONT, STYLE, SIZE, OR COLOR.

NO CLAIM IS MADE TO THE EXCLUSIVE RIGHT TO USE "RADIO", APART FROM THE MARK AS SHOWN.

CLASS 38—COMMUNICATION

FOR INTERNET BROADCASTING SERVICES; INTERNET RADIO BROADCASTING SERVICES; RADIO BROADCASTING SERVICES; STREAMING OF AUDIO AND VIDEO MATERIAL ON THE INTERNET, ON MOBILE TELEPHONES OR ON OTHER ELECTRONIC OR DIGITAL COMMUNICATIONS NETWORKS; PROVIDING AN INTERNET WEBSITE PORTAL FOR INTERNET RADIO BROADCASTING SERVICES (U.S. CLS. 100, 101 AND 104).

CLASS 41—EDUCATION AND ENTERTAINMENT

FOR ENTERTAINMENT SERVICES, NAMELY, PROVIDING CONTINUING AUDIO PROGRAMS FEATURING MUSIC, SPORTS, TALK, NEWS AND DATA VIA SATELLITE, GLOBAL COMPUTER NETWORK, TELECOMMUNICATION NETWORK, WIRELESS COMMUNICATION NETWORK, OR OTHER ELECTRONIC OR DIGITAL COMMUNICATIONS NETWORK OR DIGITAL COMMUNICATIONS DEVICE; PROVIDING AN INTERNET WEBSITE PORTAL IN THE FIELD OF INTERNET MUSIC AND ENTERTAINMENT; PROVIDING A WEBSITE FEATURING INFORMATION AND CONTENT IN THE FIELD OF MUSIC AND ENTERTAINMENT (U.S. CLS. 100, 101 AND 107).

SANDRA BUJA, EXAMINING ATTORNEY

SN 85-478,732. OLD CELL PHONE COMPANY, LLC, PALM CITY, FL. FILED 11-22-2011.



Innovate and Inspire Your Voice

THE COLOR(S) BLUE, WHITE AND RED IS/ARE CLAIMED AS A FEATURE OF THE MARK.

THE MARK CONSISTS OF A GLOBE IN DIFFERENT SHADES OF BLUE WITH HORIZONTAL AND VERTICAL LINES, NORTH AND SOUTH AMERICA IN WHITE AND THE WORDS "I VOX SOLUTIONS" TO THE RIGHT OF THE GLOBE. THE "I" IN "I VOX" IS IN DARK BLUE AND THE "VOX" IS IN RED. THE WORD "SOLUTIONS" IS IN DARK BLUE UNDERNEATH THE "O" AND "X" IN "VOX." THE WORDS "INNOVATE AND INSPIRE YOUR VOICE" ARE UNDERNEATH BOTH THE GLOBE AND THE WORDS "I VOX SOLUTIONS" IN DARK BLUE.

CLASS 35—ADVERTISING AND BUSINESS

FOR ORDER FULFILLMENT SERVICES; MANAGEMENT AND OPERATION OF A CALL CENTER FOR OTHERS (U.S. CLS. 100, 101 AND 102).

FIRST USE 11-16-2011; IN COMMERCE 11-16-2011.

CLASS 39—TRANSPORTATION AND STORAGE

FOR WHOLESALE DISTRIBUTION OF CELLULAR PHONES; SERVICES CONNECTED WITH THE PACKAGING AND PARCELING OF GOODS FOR OTHERS BEFORE DISPATCH (U.S. CLS. 100 AND 105).

FIRST USE 11-16-2011; IN COMMERCE 11-16-2011.
LUCY ARANT, EXAMINING ATTORNEY

SN 85-478,946. COLUMBIA HELICOPTERS, INC., AURORA, OR. FILED 11-22-2011.

SN 85-482,719. SANSHA ELECTRIC MANUFACTURING COMPANY, LIMITED, OSAKA-FU, JAPAN, FILED 11-29-2011.

COLUMBIA HELICOPTERS

THE MARK CONSISTS OF STANDARD CHARACTERS WITHOUT CLAIM TO ANY PARTICULAR FONT, STYLE, SIZE, OR COLOR.

NO CLAIM IS MADE TO THE EXCLUSIVE RIGHT TO USE "HELICOPTERS", APART FROM THE MARK AS SHOWN.

CLASS 37—CONSTRUCTION AND REPAIR

FOR HELICOPTER MAINTENANCE OR REPAIR; HELICOPTER REPAIR AND MAINTENANCE; FUELING SERVICES FOR HELICOPTERS; INFORMATION WITH RELATION TO HELICOPTER CONSTRUCTION, REPAIR AND MAINTENANCE; OUTER AND INNER CLEANING OF HELICOPTERS; REPAIR AND MAINTENANCE OF HELICOPTERS; TECHNICAL SUPPORT SERVICES, NAMELY, PROVIDING TECHNICAL ADVICE IN THE FIELD OF HELICOPTER ENGINE AND REPAIR (U.S. CLS. 100, 103 AND 106).

FIRST USE 1-1-1958; IN COMMERCE 1-1-1958.

CLASS 39—TRANSPORTATION AND STORAGE

FOR HELICOPTER TRANSPORT; RENTAL OF HELICOPTER; CHARTERING OF HELICOPTERS (U.S. CLS. 100 AND 105).

FIRST USE 1-1-1958; IN COMMERCE 1-1-1958.
JENNIFER MARTIN, EXAMINING ATTORNEY



THE COLOR(S) BLUE AND GRAY IS/ARE CLAIMED AS A FEATURE OF THE MARK.

THE MARK CONSISTS OF NINE STYLIZED DIAMONDS SHOWN IN THE COLOR BLUE ABOVE NINE GRAY-COLORED DIAMONDS TO CREATE AN APPEARANCE OF SHADOWING ALL AGAINST THE COLOR WHITE, WHICH REPRESENTS BACKGROUND ONLY AND IS NOT PART OF THE MARK.

CLASS 7—MACHINERY

FOR SOLAR POWER GENERATING SYSTEMS COMPRISED OF SOLAR-POWERED ELECTRICITY GENERATORS (U.S. CLS. 13, 19, 21, 23, 31, 34 AND 35).

CLASS 9—ELECTRICAL AND SCIENTIFIC APPARATUS

FOR INVERTERS; POWER LINE CONDITIONERS (U.S. CLS. 21, 23, 26, 36 AND 38).

DAVID YONTEF, EXAMINING ATTORNEY

SN 85-479,658. U MARKETING, LLC, LOMBARD, IL. FILED 11-23-2011.

THE ACCOUNTABLE COMMUNICATIONS COMPANY

THE MARK CONSISTS OF STANDARD CHARACTERS WITHOUT CLAIM TO ANY PARTICULAR FONT, STYLE, SIZE, OR COLOR.

NO CLAIM IS MADE TO THE EXCLUSIVE RIGHT TO USE "COMMUNICATIONS COMPANY", APART FROM THE MARK AS SHOWN.

CLASS 35—ADVERTISING AND BUSINESS

FOR BUSINESS MARKETING SERVICES, NAMELY, RESEARCH, PRINT PRODUCTION MANAGEMENT, MARKET DATA MANAGEMENT AND ANALYSIS, AND PHOTOCOPYING SERVICES FOR PREPARATION OF GRAPHICS (U.S. CLS. 100, 101 AND 102).

CLASS 42—SCIENTIFIC AND COMPUTER SERVICES

FOR PREPARATION OF DESIGN COPY OF GRAPHICS, INCLUDING ONLINE AND DIGITAL MARKETING, NAMELY, GRAPHIC DESIGN SERVICES (U.S. CLS. 100 AND 101).

KEVIN CORWIN, EXAMINING ATTORNEY

SN 85-482,873. ASA PROPERTIES, LLC, NEW BRAUNFELS, TX. FILED 11-29-2011.



THE COLOR(S) BROWN, DARK GREEN, LIGHT GREEN, AND BLUE IS/ARE CLAIMED AS A FEATURE OF THE MARK.

THE MARK CONSISTS OF A LARGE BROWN "V" THROUGH WHICH THREE WAVE-LIKE SHAPES ARE WOVEN TO REPRESENT THE ROLLING HILLS AND THE RIVER SURROUNDING THE COMMUNITY. THE "V" IS IN BROWN. THE TOP WAVE SHAPE IS DARK GREEN, THE MIDDLE AND LARGEST ONE IS LIGHT GREEN, AND THE BOTTOM ONE IS BLUE. UNDER THE "V", THE WORD "VERAMENDI" IN BROWN. BENEATH THE WORD "VERAMENDI", THE PHRASE "TRUE TEXAS HILL COUNTRY LIVING" APPEARS IN BLUE IN ALL CAPITAL LETTERS.

CLASS 35—ADVERTISING AND BUSINESS

FOR REAL ESTATE MARKETING SERVICES IN THE FIELD OF MIXED USE DEVELOPMENT, RETAIL, PLANNED COMMUNITY (U.S. CLS. 100, 101 AND 102).

FIRST USE 5-1-2011; IN COMMERCE 5-1-2011.

CLASS 37—CONSTRUCTION AND REPAIR

FOR CONSTRUCTION SERVICES, NAMELY, PLANNING, LAYING OUT AND CONSTRUCTION OF A PLANNED RESIDENTIAL COMMUNITY (U.S. CLS. 100, 103 AND 106).

FIRST USE 5-1-2011; IN COMMERCE 5-1-2011.
GRETTA YAO, EXAMINING ATTORNEY

SN 85-483,662. ROBERTS, ANANDA, DBA NFOCUS SOLUTIONS, PHOENIX, AZ. FILED 11-30-2011.



OWNER OF U.S. REG. NOS. 3,597,730, 4,059,913 AND OTHERS.

NO CLAIM IS MADE TO THE EXCLUSIVE RIGHT TO USE "SOLUTIONS", APART FROM THE MARK AS SHOWN.

THE COLOR(S) ORANGE, LIME GREEN, NAVY BLUE AND GRAY IS/ARE CLAIMED AS A FEATURE OF THE MARK.

THE MARK CONSISTS OF SIX CIRCLES TO THE LEFT AND OVER THE TOP OF THE LOWER CASE LETTER "N", THE LARGE ORANGE CIRCLE WITH FIVE LIME GREEN CIRCLES GRADUATING IN SIZE ABOVE. THE WORD "NFOCUS" IN NAVY BLUE AND THE WORD "SOLUTIONS" BELOW IN THE COLOR GRAY AND THE WORDS, "BRIDGING THE GAP", BELOW IN NAVY BLUE.

CLASS 9—ELECTRICAL AND SCIENTIFIC APPARATUS

FOR COMPUTER SOFTWARE FOR USE IN DATA COLLECTION, TRACKING, AND IMPACT/OUTCOME MEASUREMENT FOR THE PUBLIC SECTOR (U.S. CLS. 21, 23, 26, 36 AND 38).

FIRST USE 10-28-2011; IN COMMERCE 11-18-2011.

CLASS 42—SCIENTIFIC AND COMPUTER SERVICES

FOR TECHNOLOGY SERVICES, NAMELY, PROVIDING TEMPORARY USE OF ON-LINE NON-DOWNLOADABLE SOFTWARE FOR TRACKING AND MEASURING THE IMPACT OF PROGRAMS AND SERVICES OFFERED BY PUBLIC SCHOOLS, NONPROFIT ORGANIZATIONS, AND GOVERNMENT AGENCIES (U.S. CLS. 100 AND 101).

FIRST USE 10-28-2011; IN COMMERCE 11-18-2011.
MARGERY A. TIERNEY, EXAMINING ATTORNEY

SN 85-483,691. FXI, INC., MEDIA, PA. FILED 11-30-2011.



NO CLAIM IS MADE TO THE EXCLUSIVE RIGHT TO USE "BED BUG", APART FROM THE MARK AS SHOWN.

THE MARK CONSISTS OF "BED BUG DEFENSE SHIELD" WITH PROFILE OF INSECT SURROUNDED BY TWO CONCENTRIC CIRCLES AND A VERTICAL LINE AND HORIZONTAL LINE FORMING CROSS.

CLASS 5—PHARMACEUTICALS

FOR INSECT REPELLENTS IN THE FORM OF PESTICIDE-TREATED LINERS FOR DRAWERS AND SUITCASES AND PESTICIDE-TREATED POLYURETHANE FOAM PADS AND COVERS FOR MATTRESSES, CRIB MATTRESSES AND BASSINET MATTRESSES (U.S. CLS. 6, 18, 44, 46, 51 AND 52).

CLASS 22—CORDAGE AND FIBERS

FOR INSECT PROTECTION NETS (U.S. CLS. 1, 2, 7, 19, 22, 42 AND 50).

LINDA M. KING, EXAMINING ATTORNEY

SN 85-483,697. FXI, INC., MEDIA, PA. FILED 11-30-2011.

BED BUG DEFENSE SHIELD

THE MARK CONSISTS OF STANDARD CHARACTERS WITHOUT CLAIM TO ANY PARTICULAR FONT, STYLE, SIZE, OR COLOR.

NO CLAIM IS MADE TO THE EXCLUSIVE RIGHT TO USE "BED BUG", APART FROM THE MARK AS SHOWN.

CLASS 5—PHARMACEUTICALS

FOR INSECT REPELLENTS IN THE FORM OF PESTICIDE-TREATED LINERS FOR DRAWERS AND SUITCASES AND PESTICIDE-TREATED POLYURETHANE FOAM PADS AND COVERS FOR MATTRESSES, CRIB MATTRESSES AND BASSINET MATTRESSES (U.S. CLS. 6, 18, 44, 46, 51 AND 52).

CLASS 22—CORDAGE AND FIBERS

FOR INSECT PROTECTION NETS (U.S. CLS. 1, 2, 7, 19, 22, 42 AND 50).

LINDA M. KING, EXAMINING ATTORNEY

SN 85-485,553. PAYLOGIX LLC, WESTBURY, NY. FILED 12-2-2011.

PRO-ENROLL

THE MARK CONSISTS OF STANDARD CHARACTERS WITHOUT CLAIM TO ANY PARTICULAR FONT, STYLE, SIZE, OR COLOR.

CLASS 36—INSURANCE AND FINANCIAL

FOR PROVIDING A WEBSITE FEATURING EDUCATIONAL INFORMATION REGARDING FINANCE, INSURANCE AND HEALTHCARE BENEFIT OPTIONS FOR EMPLOYEES AND A MEANS FOR EMPLOYEES TO EFFECT BENEFIT ELECTIONS (U.S. CLS. 100, 101 AND 102).

FIRST USE 10-10-2011; IN COMMERCE 10-10-2011.

CLASS 42—SCIENTIFIC AND COMPUTER SERVICES

FOR APPLICATION SERVICE PROVIDER (ASP) FEATURING SOFTWARE FOR EMPLOYEES TO ACCESS EMPLOYER SPONSORED HEALTH AND WELFARE BENEFIT OPTIONS (U.S. CLS. 100 AND 101).

FIRST USE 10-10-2011; IN COMMERCE 10-10-2011.

MARLENE BELL, EXAMINING ATTORNEY

CLASS 9—ELECTRICAL AND SCIENTIFIC APPARATUS

FOR DOWNLOADABLE SOFTWARE THAT PROVIDES ACCESS TO A COMPREHENSIVE PROPRIETARY COLLECTION OF MARKETING-RELATED RESOURCES AND PRE-RECORDED AUDIO AND VIDEO MESSAGES RELATING TO MARKETING (U.S. CLS. 21, 23, 26, 36 AND 38).

CLASS 35—ADVERTISING AND BUSINESS

FOR PROVIDING A WEB SITE FEATURING EDUCATIONAL RESOURCES AND INFORMATION IN THE FIELD OF MARKETING (U.S. CLS. 100, 101 AND 102).

GIANCARLO CASTRO, EXAMINING ATTORNEY

SN 85-486,155. MARK G. ANDERSON CONSULTANTS, INC., WASHINGTON, DC. FILED 12-2-2011.

SN 85-487,400. RHODE ISLAND EMPLOYEE ASSISTANCE PROGRAM, WARWICK, RI. FILED 12-5-2011.

MGAC

THE MARK CONSISTS OF STANDARD CHARACTERS WITHOUT CLAIM TO ANY PARTICULAR FONT, STYLE, SIZE, OR COLOR.

CLASS 35—ADVERTISING AND BUSINESS

FOR BUSINESS MANAGEMENT CONSULTING SERVICES IN THE FIELD OF BUILDING DESIGN AND CONSTRUCTION; PROVIDING CONSULTATION SERVICES IN PROCUREMENT, NAMELY, PROCURING CONTRACTS AND PURCHASING GOODS AND SERVICES FOR OTHERS IN THE FIELD OF BUILDING DESIGN AND CONSTRUCTION; BUSINESS SERVICES, NAMELY, FACILITIES MANAGEMENT OF TECHNICAL OPERATIONS; PROJECT MANAGEMENT FOR BUSINESS PURPOSES IN THE FIELD OF BUILDING DESIGN (U.S. CLS. 100, 101 AND 102).

FIRST USE 11-1-2011; IN COMMERCE 11-1-2011.

CLASS 37—CONSTRUCTION AND REPAIR

FOR PROJECT MANAGEMENT IN THE FIELD OF CONSTRUCTION (U.S. CLS. 100, 103 AND 106).

FIRST USE 11-1-2011; IN COMMERCE 11-1-2011.

AMY KELLY, EXAMINING ATTORNEY

SN 85-487,276. GLAZER-KENNEDY INSIDER'S CIRCLE, LLC, AKA GKIC, CHICAGO, IL. FILED 12-5-2011.

iMarket

THE MARK CONSISTS OF STANDARD CHARACTERS WITHOUT CLAIM TO ANY PARTICULAR FONT, STYLE, SIZE, OR COLOR.

COASTLINE EAP

THE MARK CONSISTS OF STANDARD CHARACTERS WITHOUT CLAIM TO ANY PARTICULAR FONT, STYLE, SIZE, OR COLOR.

NO CLAIM IS MADE TO THE EXCLUSIVE RIGHT TO USE "EAP", APART FROM THE MARK AS SHOWN.

CLASS 36—INSURANCE AND FINANCIAL

FOR EMPLOYEE ASSISTANCE PROGRAMS FOR EMPLOYEES AND THEIR DEPENDENTS, NAMELY, CASE MANAGEMENT, CONSULTATION, ASSESSMENT AND REFERRAL SERVICES IN THE FIELDS OF FINANCIAL PLANNING (U.S. CLS. 100, 101 AND 102).

CLASS 44—MEDICAL, BEAUTY AND AGRICULTURAL SERVICES

FOR EMPLOYEE ASSISTANCE PROGRAMS FOR EMPLOYEES AND THEIR DEPENDENTS, NAMELY, CASE MANAGEMENT, CONSULTATION, ASSESSMENT AND REFERRAL SERVICES IN THE FIELDS OF SUBSTANCE ABUSE, ALCOHOL AND DRUG DEPENDENCY, EMOTIONAL AND BEHAVIORAL DISORDERS (U.S. CLS. 100 AND 101).

CLASS 45—PERSONAL AND LEGAL SERVICES

FOR EMPLOYEE ASSISTANCE PROGRAMS FOR EMPLOYEES AND THEIR DEPENDENTS, NAMELY, CASE MANAGEMENT, CONSULTATION, ASSESSMENT AND REFERRAL SERVICES IN THE FIELDS OF PERSONAL RELATIONSHIP DISCORD. EMPLOYEE ASSISTANCE PROGRAMS FOR EMPLOYEES AND THEIR DEPENDENTS, NAMELY, CASE MANAGEMENT, CONSULTATION, ASSESSMENT AND REFERRAL SERVICES IN THE FIELDS OF LEGAL AFFAIRS (U.S. CLS. 100 AND 101).

CURTIS FRENCH, EXAMINING ATTORNEY

SN 85-487,771. O'SHEA, KATHERINE, DENVER, CO. FILED 12-6-2011.

SN 85-488,168. STEARCLEAR LLC, WYCKOFF, NJ. FILED 12-6-2011.



NO CLAIM IS MADE TO THE EXCLUSIVE RIGHT TO USE "LADIES BEER CLUB", APART FROM THE MARK AS SHOWN.

THE COLOR(S) GREEN, BLACK, AND ORANGE IS/ARE CLAIMED AS A FEATURE OF THE MARK.

THE MARK CONSISTS OF THE LITERAL ELEMENTS "CRAFTY LADIES BEER CLUB", WRITTEN IN STYLIZED FORM, WHEREIN THE WORDS "CRAFTY LADIES" ARE WRITTEN IN BLACK COLOR AND THE WORDS "BEER CLUB" ARE WRITTEN IN GREEN COLOR BENEATH THE WORDS "CRAFTY LADIES". ABOVE THE WORDING APPEARS A DESIGN CONSISTING OF TWO WHEAT STICKS AND TWO SORGHUM STICKS. BOTH THE WHEAT AND THE SORGHUM SHOW WHITE ELEMENTS, WHICH ARE MEANT TO SHOW A TRANSPARENT AREA IN THE DESIGN. THE WHEAT ALSO HAS ORANGE ELEMENTS AND THE SORGHUM ALSO HAS GREEN ELEMENTS. THE WHEAT AND THE SORGHUM APPEAR IN A CIRCLE HAVING ORANGE BACKGROUND WITH TRANSPARENT AND GREEN COLORED OUTLINES. THE BACKGROUND OF THE MARK IS TRANSPARENT.

CLASS 21—HOUSEWARES AND GLASS

FOR DRINKING PINT GLASSES; MUGS; BOTTLE OPENERS; COASTERS NOT OF PAPER AND NOT BEING TABLE LINEN (U.S. CLS. 2, 13, 23, 29, 30, 33, 40 AND 50).

CLASS 25—CLOTHING

FOR CLOTHING, NAMELY, TOPS, BOTTOMS, T-SHIRTS, HATS (U.S. CLS. 22 AND 39).

CLASS 35—ADVERTISING AND BUSINESS

FOR CLUB SERVICES, NAMELY, PROMOTING THE INTERESTS OF BEER ENTHUSIASTS (U.S. CLS. 100, 101 AND 102).

CLASS 39—TRANSPORTATION AND STORAGE

FOR ARRANGING, ORGANIZING, AND CONDUCTING BEER-RELATED FIELD TRIPS; ARRANGING OF BREWERY TOURS (U.S. CLS. 100 AND 105).
ANDREA HACK, EXAMINING ATTORNEY

STEAR CLEAR

THE MARK CONSISTS OF STANDARD CHARACTERS WITHOUT CLAIM TO ANY PARTICULAR FONT, STYLE, SIZE, OR COLOR.

CLASS 9—ELECTRICAL AND SCIENTIFIC APPARATUS

FOR E-COMMERCE SOFTWARE TO ALLOW USERS TO PERFORM ELECTRONIC BUSINESS TRANSACTIONS VIA A GLOBAL COMPUTER NETWORK (U.S. CLS. 21, 23, 26, 36 AND 38).

CLASS 39—TRANSPORTATION AND STORAGE

FOR PASSENGER TRANSPORT; TRANSPORT AND DELIVERY OF GOODS (U.S. CLS. 100 AND 105).
JOSETTE BEVERLY, EXAMINING ATTORNEY

SN 85-488,208. PLANT & PIPELINE SPECIALTIES, INC., ROCKPORT, TX. FILED 12-6-2011.

"WE DON'T....DRIP, DRIBBLE OR PASS GAS"

THE MARK CONSISTS OF STANDARD CHARACTERS WITHOUT CLAIM TO ANY PARTICULAR FONT, STYLE, SIZE, OR COLOR.

CLASS 6—METAL GOODS

FOR METAL PIPE FITTINGS IN THE NATURE OF LINE STOPS AND PRESSURE TAPS FOR GAS AND LIQUID LINES (U.S. CLS. 2, 12, 13, 14, 23, 25 AND 50).

CLASS 40—MATERIAL TREATMENT

FOR PIPE TAPPING SERVICES, NAMELY, DRILLING OR CUTTING HOLES IN PRESSURIZED PIPES WITHOUT DRAINING OR SPILLING THE CONTENTS OF THE PIPES (U.S. CLS. 100, 103 AND 106).
JEFFERY COWARD, EXAMINING ATTORNEY

SN 85-489,060. N2IT CONTAINERS, HOUSTON, TX. FILED 12-7-2011.

N2IT

THE MARK CONSISTS OF STANDARD CHARACTERS WITHOUT CLAIM TO ANY PARTICULAR FONT, STYLE, SIZE, OR COLOR.

CLASS 16—PAPER GOODS AND PRINTED MATTER

FOR CORRUGATED BOARD CONTAINERS (U.S. CLS. 2, 5, 22, 23, 29, 37, 38 AND 50).
FIRST USE 1-0-2000; IN COMMERCE 1-0-2000.

CLASS 20—FURNITURE AND ARTICLES NOT OTHERWISE CLASSIFIED

FOR CONTAINERS, NOT OF METAL, FOR COMMERCIAL AND INDUSTRIAL USE (U.S. CLS. 2, 13, 22, 25, 32 AND 50).
FIRST USE 1-0-2000; IN COMMERCE 1-0-2000.

CLASS 35—ADVERTISING AND BUSINESS

FOR DISTRIBUTORSHIP SERVICES IN THE FIELD OF CONTAINERS FOR COMMERCIAL AND INDUSTRIAL USE (U.S. CLS. 100, 101 AND 102).
FIRST USE 1-0-2000; IN COMMERCE 1-0-2000.

CLASS 40—MATERIAL TREATMENT

FOR CUSTOM MANUFACTURE OF CONTAINERS (U.S. CLS. 100, 103 AND 106).
FIRST USE 1-0-2000; IN COMMERCE 1-0-2000.
JULIE WATSON, EXAMINING ATTORNEY

SN 85-490,283. CMC ONLINE S.R.O., PRAHA 6, CZECH REPUBLIC, FILED 12-8-2011.

MAHEE

THE MARK CONSISTS OF STANDARD CHARACTERS WITHOUT CLAIM TO ANY PARTICULAR FONT, STYLE, SIZE, OR COLOR.

PRIORITY CLAIMED UNDER SEC. 44(D) ON ERPNTY CMNTY TM OFC APPLICATION NO. 010444586, FILED 11-24-2011, REG. NO. 010444586, DATED 4-12-2012, EXPIRES 11-24-2021.

CLASS 9—ELECTRICAL AND SCIENTIFIC APPARATUS

FOR COMPUTER GAME PROGRAMMES DOWNLOADABLE VIA THE INTERNET; COMPUTER GAME SOFTWARE; COMPUTER GAME SOFTWARE FOR USE ON MOBILE AND CELLULAR PHONES; INTERACTIVE VIDEO GAME PROGRAMS; INTERNET SERVERS (U.S. CLS. 21, 23, 26, 36 AND 38).

CLASS 35—ADVERTISING AND BUSINESS

FOR ADVERTISEMENT FOR OTHERS ON THE INTERNET; ADVERTISING SERVICES; DIRECT MAIL ADVERTISING SERVICES; INTERNET ADVERTISING SERVICES; ONLINE ADVERTISEMENTS (U.S. CLS. 100, 101 AND 102).

CLASS 38—COMMUNICATION

FOR DATA COMMUNICATION BY ELECTRONIC MAIL; PROVIDING INTERNET CHATROOMS; TRANSMISSION AND DISTRIBUTION OF DATA OR AUDIO VISUAL IMAGES VIA A GLOBAL COMPUTER NETWORK OR THE INTERNET; VIDEO BROADCASTING SERVICES OVER THE INTERNET OR OTHER COMMUNICATIONS NETWORK, NAMELY, ELECTRONICALLY TRANSMITTING VIDEO CLIPS (U.S. CLS. 100, 101 AND 104).

CLASS 41—EDUCATION AND ENTERTAINMENT

FOR ELECTRONIC GAMES SERVICES PROVIDED BY MEANS OF THE INTERNET; ENTERTAINMENT SERVICES, NAMELY, PROVIDING ON-LINE COMPUTER GAMES; PROVISION OF INFORMATION RELATING TO ELECTRONIC COMPUTER GAMES PROVIDED VIA THE INTERNET (U.S. CLS. 100, 101 AND 107).

CLASS 42—SCIENTIFIC AND COMPUTER SERVICES

FOR COMPUTER PROGRAMMING OF COMPUTER GAMES; DESIGNING AND DEVELOPING COMPUTER GAME SOFTWARE AND VIDEO GAME SOFTWARE FOR USE WITH COMPUTERS, VIDEO GAME PROGRAM SYSTEMS AND COMPUTER NETWORKS; DESIGNING AND MODIFYING COMPUTER PROGRAMS AND VIDEO GAMES FOR OTHERS; WEB PUBLISHING, NAMELY, CREATING A WEBSITE AND UPLOADING IT ONTO AN INTERNET SERVER (U.S. CLS. 100 AND 101).

CHRIS WELLS, EXAMINING ATTORNEY

SN 85-489,615. SMOKESTACK BARBECUE RESTAURANT, INC., KANSAS CITY, MO. FILED 12-7-2011.

SMOKESTACK

THE MARK CONSISTS OF STANDARD CHARACTERS WITHOUT CLAIM TO ANY PARTICULAR FONT, STYLE, SIZE, OR COLOR.
OWNER OF U.S. REG. NO. 2,110,643.

CLASS 29—MEATS AND PROCESSED FOODS

FOR MEATS AND PREPARED FOODS, NAMELY, PREPARED MEAT, PROCESSED FRUITS AND VEGETABLES, CUT FRUITS AND VEGETABLES, PREPARED MEALS CONSISTING PRIMARILY OF MEAT OR VEGETABLES, AND OTHER FOOD DISHES FOR HUMAN CONSUMPTION, NAMELY, PREPARED MEALS CONSISTING PRIMARILY OF FISH OR POULTRY, BAKED BEANS, COOKED FRUITS AND VEGETABLES, FOOD PACKAGE COMBINATIONS CONSISTING PRIMARILY OF CHEESE, MEAT AND/OR PROCESSED FRUIT, FRUIT AND VEGETABLE SALADS, AND POTATO SALAD (U.S. CL. 46).

CLASS 30—STAPLE FOODS

FOR FOOD DISHES FOR HUMAN CONSUMPTION, NAMELY, SANDWICHES, PREPARED ENTREES CONSISTING PRIMARILY OF PASTA OR RICE, MACARONI SALAD; SAUCES; SEASONINGS; CONDIMENTS, NAMELY, CHUTNEYS, PREPARED HORSERADISH, KETCHUP, MUSTARD, MAYONNAISE, HOT SAUCE, BARBECUE SAUCE (U.S. CL. 46).
KATHERINE CONNOLLY, EXAMINING ATTORNEY

SN 85-490,305. BOYD, MICHAEL, SUN VALLEY, CA. FILED 12-8-2011.



NO CLAIM IS MADE TO THE EXCLUSIVE RIGHT TO USE "BASEBALL", APART FROM THE MARK AS SHOWN.

THE MARK CONSISTS OF A FIGURE OF A BASEBALL PLAYER HOLDING A BAT OVER HIS HEAD TO THE RIGHT IN A HITTING STANCE WITH LEGS SLIGHTLY MORE THAN SHOULDER WIDTH APART WEARING A BASEBALL UNIFORM AND A BASEBALL CAP STANDING IN THE CENTER OF A BASEBALL WITH BASEBALL STITCHES WITH CLOCK-LIKE NUMERALS IN BLACK ALONG THE OUTER CIRCUMFERENCE LIKE A STOP WATCH WITH THE NUMBERS "5, 10, 15, 20, 25, 30, 35, 40, 45, 50, 55 AND 60" DISPLAYED WITH FOUR DASHES IN BETWEEN EACH OF THE NUMBERS OUTLINED BY A BLACK CIRCLE WHICH IS OUTLINED BY A LARGER CIRCLE FILLED IN WITH LIGHT CONTAINING THE WORD "STANDSTILL" IN BLACK CURVED ACROSS THE TOP OF THE CIRCLE AND THE WORD "BASEBALL" IN BLACK CURVED ACROSS THE BOTTOM OF THE CIRCLE.

CLASS 25—CLOTHING

FOR CLOTHING, NAMELY, T-SHIRTS, SWEATSHIRTS, TANK TOPS, WOVEN SHIRTS, SWEATERS, JACKETS, PANTS, SWEATPANTS, SHORTS, HATS, CAPS, COATS, SHOES, SOCKS, SKIRTS, DRESSES, BLOUSES (U.S. CLS. 22 AND 39).

FIRST USE 4-0-2002; IN COMMERCE 4-0-2002.

CLASS 41—EDUCATION AND ENTERTAINMENT

FOR ENTERTAINMENT SERVICES IN THE NATURE OF BASEBALL TYPE GAMES (U.S. CLS. 100, 101 AND 107).

FIRST USE 4-0-2002; IN COMMERCE 4-0-2002.

ANNE MADDEN, EXAMINING ATTORNEY

SN 85-490,337. RICHARD MARTIN DYSON JENSEN, SAO PAULO-SP 01046-911, BRAZIL, FILED 12-8-2011.

GO 4 THE WORLD

THE MARK CONSISTS OF STANDARD CHARACTERS WITHOUT CLAIM TO ANY PARTICULAR FONT, STYLE, SIZE, OR COLOR.

CLASS 39—TRANSPORTATION AND STORAGE

FOR ARRANGING EXCURSIONS FOR TOURISTS; ARRANGING OF TOURS; ORGANIZATION, BOOKING AND ARRANGEMENT OF EXCURSIONS, DAY TRIPS AND SIGHTSEEING TOURS; TRANSPORTATION OF PASSENGERS AND/OR GOODS BY BUS, BOAT, RAIL, AND AIR; TRAVEL AGENCY SERVICES, NAMELY, MAKING RESERVATIONS AND BOOKINGS FOR TRANSPORTATION (U.S. CLS. 100 AND 105).

CLASS 43—HOTEL AND RESTAURANT SERVICES

FOR HOTEL ACCOMMODATION SERVICES; TRAVEL AGENCY SERVICES, NAMELY, MAKING RESERVATIONS AND BOOKING FOR TEMPORARY LODGING (U.S. CLS. 100 AND 101).

HAI-LY LAM, EXAMINING ATTORNEY

SN 85-492,122. ROBERT P. FORES, MODESTO, CA. FILED 12-9-2011.

RIDE FOR MOM

THE MARK CONSISTS OF STANDARD CHARACTERS WITHOUT CLAIM TO ANY PARTICULAR FONT, STYLE, SIZE, OR COLOR.

CLASS 36—INSURANCE AND FINANCIAL

FOR CHARITABLE FUNDRAISING; CHARITABLE FUNDRAISING SERVICES BY MEANS OF ORGANIZING, PROMOTING, AND CONDUCTING ENTERTAINMENT AND SPORTING EVENTS; CHARITABLE FUNDRAISING SERVICES BY MEANS OF BICYCLE RIDING EVENTS; CHARITABLE FUNDRAISING SERVICES BY MEANS OF ORGANIZING AND CONDUCTING EVENTS TO PROMOTE AWARENESS OF HEALTH AND DISEASE TREATMENT AND PREVENTION (U.S. CLS. 100, 101 AND 102).

CLASS 41—EDUCATION AND ENTERTAINMENT

FOR ORGANIZING, PROMOTING, AND CONDUCTING SPORTING EVENTS, NAMELY, BICYCLE RIDES; PROVIDING INFORMATION RELATING TO SPORTS AND SPORTING EVENTS (U.S. CLS. 100, 101 AND 107).

CLASS 44—MEDICAL, BEAUTY AND AGRICULTURAL SERVICES

FOR PROVIDING INFORMATION ABOUT HEALTH, NAMELY, HEALTH AND DISEASE AWARENESS, DIAGNOSIS AND INFORMATION ABOUT DISEASE SCREENING AND TREATMENT (U.S. CLS. 100 AND 101).

HANNO RITTNER, EXAMINING ATTORNEY

SN 85-492,745. BEDLOO, LLC, THOUSAND OAKS, CA.
FILED 12-12-2011.

SN 85-492,898. NATIONAL PARKINSON FOUNDATION,
INC., MIAMI, FL. FILED 12-12-2011.

BEDLOO



THE MARK CONSISTS OF STANDARD CHARACTERS WITHOUT CLAIM TO ANY PARTICULAR FONT, STYLE, SIZE, OR COLOR.

CLASS 9—ELECTRICAL AND SCIENTIFIC APPARATUS

FOR COMPUTER SOFTWARE DEVELOPMENT TOOLS; COMPUTER SOFTWARE FOR USE AS AN APPLICATION PROGRAMMING INTERFACE (API); COMPUTER SOFTWARE TO ENABLE UPLOADING, DOWNLOADING, ACCESSING, POSTING, DISPLAYING, TAGGING, BLOGGING, STREAMING, LINKING, SHARING AND OTHERWISE PROVIDING ELECTRONIC MEDIA OR INFORMATION VIA COMPUTER AND COMMUNICATIONS NETWORKS (U.S. CLS. 21, 23, 26, 36 AND 38).

CLASS 35—ADVERTISING AND BUSINESS

FOR INTERNET BASED BUSINESS AND SALES RELATED NETWORKING SERVICES; INTERNET BASED DECISION MAKING SERVICES LIMITED TO MAKING CHOICES BETWEEN ALTERNATIVES PRESENTED FOR BUSINESS AND SALES RELATED PURPOSES (U.S. CLS. 100, 101 AND 102).

CLASS 38—COMMUNICATION

FOR COMMUNICATION SERVICES, NAMELY, TRANSMISSION OF VOICE, AUDIO, VISUAL IMAGES AND DATA BY TELECOMMUNICATIONS NETWORKS, WIRELESS COMMUNICATION NETWORKS, THE INTERNET, INFORMATION SERVICES NETWORKS AND DATA NETWORKS (U.S. CLS. 100, 101 AND 104).

CLASS 42—SCIENTIFIC AND COMPUTER SERVICES

FOR APPLICATION SERVICE PROVIDER FEATURING APPLICATION PROGRAMMING INTERFACE (API) SOFTWARE WHICH FACILITATES ONLINE SERVICES FOR SOCIAL NETWORKING, BUILDING SOCIAL NETWORKING APPLICATIONS AND FOR ALLOWING DATA RETRIEVAL, UPLOAD, DOWNLOAD, ACCESS AND MANAGEMENT (U.S. CLS. 100 AND 101).

CLASS 45—PERSONAL AND LEGAL SERVICES

FOR INTERNET BASED SOCIAL NETWORKING AND INTRODUCTION SERVICES; INTERNET BASED DECISION MAKING SERVICES LIMITED TO MAKING CHOICES BETWEEN ALTERNATIVES PRESENTED FOR SOCIAL NETWORKING AND INTRODUCTION PURPOSES (U.S. CLS. 100 AND 101).

PAUL E. FAHRENKOPF, EXAMINING ATTORNEY

NO CLAIM IS MADE TO THE EXCLUSIVE RIGHT TO USE "PARKINSON'S DISEASE" AND "PARKINSON FOUNDATION", APART FROM THE MARK AS SHOWN.

THE COLOR(S) BLUE, WHITE AND BLACK IS/ARE CLAIMED AS A FEATURE OF THE MARK.

THE MARK CONSISTS OF A STYLIZED LETTER "P" WITHIN A CIRCULAR DESIGN, WITH THE WORDING "AWARE IN CARE" AND "PARKINSON'S DISEASE" SET FORTH ABOVE AND BELOW THE "P", RESPECTIVELY. THE WORDING "NATIONAL PARKINSON FOUNDATION" IS TO THE RIGHT OF THE CIRCLE WITHIN STYLIZED LETTERING. THE WORD "NATIONAL" IS PLACED IN A VERTICAL POSITION NEXT TO THE WORDING "PARKINSON FOUNDATION". THE STYLIZED "P" AND THE WORDING "AWARE IN CARE" AND "PARKINSON'S DISEASE" ARE WHITE. THE WORD "PARKINSON" AND THE CIRCLE DESIGN ARE BLUE. THE WORDING "NATIONAL" AND "FOUNDATION" ARE BLACK.

SEC. 2(F) AS TO "NATIONAL PARKINSON FOUNDATION".

CLASS 35—ADVERTISING AND BUSINESS

FOR CHARITABLE SERVICES, NAMELY, PROMOTING AND SUPPORTING PUBLIC AWARENESS OF PARKINSON'S DISEASE THROUGH BASIC SCIENTIFIC RESEARCH ABOUT PARKINSON'S DISEASE, THROUGH SUPPORT GROUPS, THROUGH AN ON-LINE COMPUTER WEBSITE AND THROUGH THE DISTRIBUTION OF INFORMATIONAL KITS INCLUDING PRINTED PAMPHLETS, NOTECARDS, BOOKLETS, NOTEPADS, NEWSLETTERS, BROCHURES AND INFORMATIONAL FLYERS IN THE FIELDS OF TREATMENT, MEDICINE AND CAREGIVING WITH RESPECT TO PARKINSON'S DISEASE (U.S. CLS. 100, 101 AND 102).

CLASS 41—EDUCATION AND ENTERTAINMENT

FOR PROVIDING EDUCATIONAL SEMINARS, WORKSHOPS, ON-LINE SEMINARS, CONFERENCES AND COURSES FOR GOVERNMENT MEDICAL RESEARCH DECISION MAKERS, PATIENTS, CARE GIVERS, AND THE PUBLIC IN THE FIELD OF PARKINSON'S DISEASE; CONDUCTING MEDICAL, NURSING, CARE-GIVER AND PATIENT PANEL DISCUSSIONS, CONGRESSES, SYMPOSIA, CLASSES, SEMINARS, CONFERENCES AND WORKSHOPS ABOUT PARKINSON'S DISEASE; PUBLISHING OF ELECTRONIC PUBLICATIONS AND PRINTED MATTER, NAMELY, PAMPHLETS, BOOKS, NEWSLETTERS AND BROCHURES ABOUT PARKINSON'S DISEASE; CONDUCTING CONFERENCES, WORKSHOPS AND ON-LINE SEMINARS FOR PARKINSON'S DISEASE PATIENTS AND THEIR CAREGIVERS (U.S. CLS. 100, 101 AND 107).

ELLEN B. AWRICH, EXAMINING ATTORNEY

SN 85-493,637. DANIA BEACH COMMUNITY REDEVELOPMENT AGENCY, DANIA BEACH, FL. FILED 12-13-2011.



NO CLAIM IS MADE TO THE EXCLUSIVE RIGHT TO USE "DANIA BEACH", APART FROM THE MARK AS SHOWN.

THE COLOR(S) RED, ORANGE, BROWN, GREEN, BLUE, BLACK AND WHITE IS/ARE CLAIMED AS A FEATURE OF THE MARK.

THE MARK CONSISTS OF THE STYLIZED TERMS "DANIA BEACH" APPEARING IN BLACK ABOVE THE LARGER STYLIZED TERM "PATCH" IN BLACK CAPITAL LETTERS; TO THE LEFT OF THESE TERMS IS A DESIGN OF A FLOWER COMPRISED OF A BROWN FIGURE OF A MAN WITH OUTSTRETCHED ARMS AND LEGS AT THE CENTER OF FOUR COLORED LEAF, THE BOTTOM LEFT LEAF IS RED AND WHITE, THE TOP LEFT LEAF IS ORANGE AND WHITE AND IS CONNECTED TO THE MAN'S RIGHT ARM, THE TOP RIGHT LEAF IS BLUE AND WHITE AND CONNECTED TO THE MAN'S LEFT ARM, THE BOTTOM RIGHT LEAF IS GREEN AND WHITE; CENTERED UNDERNEATH THESE TERMS AND DESIGN ARE THE SMALLER STYLIZED BLACK TERMS "PEOPLE'S ACCESS TO COMMUNITY HORTICULTURE"

CLASS 31—NATURAL AGRICULTURAL PRODUCTS

FOR FRESH FRUIT AND VEGETABLES (U.S. CLS. 1 AND 46).

CLASS 44—MEDICAL, BEAUTY AND AGRICULTURAL SERVICES

FOR AGRICULTURAL ADVICE (U.S. CLS. 100 AND 101).

ANTHONY RINKER, EXAMINING ATTORNEY

SN 85-493,870. RHEE BROS., INC., HANOVER, MD. FILED 12-13-2011.



THE MARK CONSISTS OF THE STYLIZED TERM "YISSINE", TWO LARGE CHINESE CHARACTERS AND TWO SMALL KOREAN CHARACTERS, ALL WITHIN A RECTANGLE; THE TERM "YISSINE" APPEARS AT THE BOTTOM IN A SHADED PORTION OF THE RECTANGLE.

THE NON-LATIN CHARACTERS IN THE MARK TRANSLITERATE TO "YISSINE" AND THIS HAS NO MEANING IN A FOREIGN LANGUAGE.

CLASS 29—MEATS AND PROCESSED FOODS

FOR ROASTED SHEETS OF LAYER; DRIED EDIBLE SEAWEED; PICKLED RADISHES; FISH SAUCE, NAMELY, SALTY SHRIMP SAUCE; PROCESSED FISH ROE; FISH CAKE; CRAB MEAT MADE FROM FISH PASTE; HOT PEPPER PASTE; SAUSAGES (U.S. CL. 46).
FIRST USE 11-9-1994; IN COMMERCE 11-9-1994.

CLASS 30—STAPLE FOODS

FOR PROCESSED GRAINS; MIXES FOR MAKING BATTERS FOR FRIED FOOD; NOODLES; RICE CAKE; COOKED BEEF DUMPLINGS; DUMPLING WRAPPERS; SOYBEAN PASTE (U.S. CL. 46).
FIRST USE 11-9-1994; IN COMMERCE 11-9-1994.

CLASS 31—NATURAL AGRICULTURAL PRODUCTS

FOR FRESH PEARS (U.S. CLS. 1 AND 46).
FIRST USE 11-13-2010; IN COMMERCE 11-13-2010.
HOWARD B. LEVINE, EXAMINING ATTORNEY

SN 85-494,191. FOREST LABORATORIES, INC., NEW YORK, NY. FILED 12-13-2011.



NO CLAIM IS MADE TO THE EXCLUSIVE RIGHT TO USE "LABORATORIES, INC.", APART FROM THE MARK AS SHOWN.

THE COLOR(S) GREEN IS/ARE CLAIMED AS A FEATURE OF THE MARK.

THE MARK CONSISTS OF A SLANTED "F", FOLLOWED BY A SLANTED "NBL" AND ANOTHER LINE SLANTED LEFT, FOLLOWED BY A SPHERE CONTAINING THREE CURVED HORIZONTAL AND THREE CURVED VERTICAL LINES, FOLLOWED BY THE WORDING "FOREST LABORATORIES, INC." ALL IN THE COLOR GREEN.

CLASS 42—SCIENTIFIC AND COMPUTER SERVICES

FOR INTERNET WEBSITE PROVIDING INFORMATION ON CLINICAL TRIALS FOR EXISTING AND PROSPECTIVE PHARMACEUTICAL PRODUCTS (U.S. CLS. 100 AND 101).

FIRST USE 2-8-2005; IN COMMERCE 2-8-2005.

CLASS 44—MEDICAL, BEAUTY AND AGRICULTURAL SERVICES

FOR MEDICAL INFORMATION SERVICES, NAMELY, PROVIDING MEDICAL INFORMATION TO PATIENTS AND THE GENERAL PUBLIC REGARDING VARIOUS PROSPECTIVE AND AVAILABLE MEDICINES VIA A GLOBAL COMPUTER NETWORK (U.S. CLS. 100 AND 101).

FIRST USE 11-18-2004; IN COMMERCE 11-18-2004.
MICHELE SWAIN, EXAMINING ATTORNEY

SN 85-495,248. AVICII MUSIC AB, 111 60 STOCKHOLM, SWEDEN, FILED 12-14-2011.

AVICII

THE MARK CONSISTS OF STANDARD CHARACTERS WITHOUT CLAIM TO ANY PARTICULAR FONT, STYLE, SIZE, OR COLOR.

OWNER OF ERP/N CMNTY TM OFC REG. NO. 010477181, DATED 5-3-2012, EXPIRES 12-8-2021.

THE NAME(S), PORTRAIT(S), AND/OR SIGNATURE(S) SHOWN IN THE MARK IDENTIFIES THE PROFESSIONAL NAME OF TIM BERGLING, WHOSE CONSENT(S) TO REGISTER IS MADE OF RECORD.

CLASS 9—ELECTRICAL AND SCIENTIFIC APPARATUS

FOR MUSICAL SOUND RECORDINGS AND AUDIOVISUAL RECORDINGS FEATURING MUSIC AND ENTERTAINMENT; SOUND RECORDINGS AND AUDIOVISUAL RECORDINGS, FEATURING MOTION PICTURE FILMS, TELEVISION PROGRAMS, TELEVISION FILMS, MUSIC VIDEOS, DOCUMENTARIES AND ANIMATION; SUNGLASSES; CASES FOR SUNGLASSES SOLD EMPTY; DECORATIVE MAGNETS; CELL PHONE CASES AND COVERS; ELECTRIC SIGNS; COMPUTER MOUSEPADS; LAPTOP CASES, STORAGE CASES FOR COMPACT DISCS, DVDS AND COMPUTER DISCS (U.S. CLS. 21, 23, 26, 36 AND 38).

CLASS 25—CLOTHING

FOR CLOTHING, NAMELY, SHIRTS, TROUSERS, JEANS, TOPS, BOTTOMS, SHORTS, SKIRTS, DRESSES, JACKETS, COATS, RAINWEAR, NECKWEAR, SLEEPWEAR, LOUNGEWEAR, UNDERWEAR, SWIMWEAR, GLOVES, SOCKS, HOSIERY, BELTS, FOOTWEAR AND HEADWEAR (U.S. CLS. 22 AND 39).

CLASS 41—EDUCATION AND ENTERTAINMENT

FOR ENTERTAINMENT SERVICES, NAMELY, LIVE MUSICAL AND VOCAL PERFORMANCES BY A DJ, SOLO RECORDING ARTIST OR MUSICAL GROUP; PROVIDING A WEB SITE FEATURING PRE-RECORDED MUSICAL AUDIO AND AUDIOVISUAL CLIPS, PHOTOGRAPHS, NEWS, REVIEWS AND OTHER MULTIMEDIA ARTICLES IN CONNECTION WITH A SOLO RECORDING ARTIST AND MUSICAL GROUP; FAN CLUB SERVICES; PRODUCTION OF TELEVISION PROGRAMS; ONLINE MAGAZINES IN THE FIELDS OF MUSIC AND ENTERTAINMENT; ENTERTAINMENT SERVICES IN THE NATURE OF ONGOING TELEVISION PROGRAMS IN THE FIELD OF MUSIC; TELEVISION PRODUCTION, THEATRICAL PRODUCTION AND MOTION PICTURE FILM PRODUCTION; MUSIC PRODUCTION AND PRODUCTION OF LYRICS TO MUSIC (U.S. CLS. 100, 101 AND 107).

RON FAIRBANKS, EXAMINING ATTORNEY

SN 85-495,278. HEALTHSOUTH CORPORATION, BIRMINGHAM, AL. FILED 12-14-2011.

HEALTHSOUTH

OWNER OF U.S. REG. NO. 2,144,242. THE MARK CONSISTS OF "HEALTHSOUTH" IN A SLANTED POSITION AND BLOCK LETTERS.

CLASS 41—EDUCATION AND ENTERTAINMENT

FOR EDUCATIONAL SERVICES, NAMELY, CONDUCTING CLASSES, SEMINARS, AND CONFERENCES IN THE FIELD OF HEALTH CARE (U.S. CLS. 100, 101 AND 107).

FIRST USE 12-1-2005; IN COMMERCE 12-1-2005.

CLASS 44—MEDICAL, BEAUTY AND AGRICULTURAL SERVICES

FOR HEALTH CARE SERVICES, NAMELY, IN-PATIENT AND OUT-PATIENT PHYSICAL REHABILITATION SERVICES AND HOME HEALTH CARE (U.S. CLS. 100 AND 101).

FIRST USE 12-1-2005; IN COMMERCE 12-1-2005.

SANJEEV VOHRA, EXAMINING ATTORNEY

SN 85-495,528. ORIGINAL JUAN SPECIALTY FOODS, INC., KANSAS CITY, KS. FILED 12-14-2011.

MOST WANTED

THE MARK CONSISTS OF STANDARD CHARACTERS WITHOUT CLAIM TO ANY PARTICULAR FONT, STYLE, SIZE, OR COLOR.

CLASS 30—STAPLE FOODS

FOR SAUCE; HOT SAUCE; HOT WING SAUCE; STEAK SAUCE; BARBEQUE SAUCE; AND MUSTARD (U.S. CL. 46).

FIRST USE 4-30-2010; IN COMMERCE 4-30-2010.

CLASS 32—LIGHT BEVERAGES

FOR NON-ALCOHOLIC COCKTAIL MIXES (U.S. CLS. 45, 46 AND 48).

FIRST USE 12-9-2011; IN COMMERCE 12-9-2011.

ADA HAN, EXAMINING ATTORNEY

SN 85-495,568. VIPER CONSULTING, LLC, PHOENIX, AZ. FILED 12-14-2011.

VeriSearch

THE MARK CONSISTS OF STANDARD CHARACTERS WITHOUT CLAIM TO ANY PARTICULAR FONT, STYLE, SIZE, OR COLOR.

CLASS 35—ADVERTISING AND BUSINESS

FOR ADVICE IN THE FIELD OF BUSINESS MANAGEMENT AND MARKETING; BUSINESS ADVISORY SERVICES, CONSULTANCY AND INFORMATION; PROVIDING A WEB SITE FEATURING BUSINESS INFORMATION IN THE FORM OF AUDIO AND VIDEO INTERVIEWS, TRANSCRIPTS AND OTHER EDUCATIONAL MATERIALS (U.S. CLS. 100, 101 AND 102).

FIRST USE 4-28-2011; IN COMMERCE 5-7-2011.

CLASS 41—EDUCATION AND ENTERTAINMENT

FOR EDUCATIONAL SERVICES, NAMELY, CONDUCTING SEMINARS, LECTURES, AND WORKSHOPS IN THE FIELDS OF MARKETING, ONLINE TRAFFIC, LOCAL SEARCH ADVERTISING, MOBILE SEARCH ADVERTISING, SEARCH ENGINE OPTIMIZATION, AND REPUTATION MANAGEMENT AND DISTRIBUTION OF TRAINING MATERIALS IN CONNECTION THEREWITH (U.S. CLS. 100, 101 AND 107).

FIRST USE 4-28-2011; IN COMMERCE 5-7-2011.
DOUGLAS LEE, EXAMINING ATTORNEY

SN 85-495,968. 10GEN, INC., NEW YORK, NY. FILED 12-15-2011.

10GEN

THE MARK CONSISTS OF STANDARD CHARACTERS WITHOUT CLAIM TO ANY PARTICULAR FONT, STYLE, SIZE, OR COLOR.

CLASS 41—EDUCATION AND ENTERTAINMENT

FOR EDUCATIONAL SERVICES, NAMELY, CONDUCTING CLASSES AND COURSES IN THE FIELDS OF DATABASE DEVELOPMENT, MAINTENANCE, AND MANAGEMENT AND DISTRIBUTION OF TRAINING MATERIALS IN CONNECTION THEREWITH (U.S. CLS. 100, 101 AND 107).

FIRST USE 1-0-2010; IN COMMERCE 1-0-2010.

CLASS 42—SCIENTIFIC AND COMPUTER SERVICES

FOR DATABASE DESIGN AND DEVELOPMENT; IT CONSULTING SERVICES; TECHNICAL SUPPORT SERVICES, NAMELY, TROUBLESHOOTING OF COMPUTER SOFTWARE PROBLEMS (U.S. CLS. 100 AND 101).

FIRST USE 1-0-2010; IN COMMERCE 1-0-2010.
JERI J. FICKES, EXAMINING ATTORNEY

SN 85-495,770. SMITH, CAMILLA, SOUTH SURREY, CANADA, FILED 12-15-2011.

ACCENTPRO

THE MARK CONSISTS OF STANDARD CHARACTERS WITHOUT CLAIM TO ANY PARTICULAR FONT, STYLE, SIZE, OR COLOR.

CLASS 9—ELECTRICAL AND SCIENTIFIC APPARATUS

FOR COMPUTER APPLICATION SOFTWARE FOR MOBILE PHONES AND HANDHELD COMPUTERS, NAMELY, EDUCATIONAL SOFTWARE FEATURING INSTRUCTION IN THE FIELD OF LANGUAGE, NAMELY, ACCULTURATED SPEECH, ACCENTS, PRONUNCIATION, AND VERBAL COMMUNICATION SKILLS (U.S. CLS. 21, 23, 26, 36 AND 38).

FIRST USE 11-0-2010; IN COMMERCE 11-0-2010.

CLASS 41—EDUCATION AND ENTERTAINMENT

FOR EDUCATIONAL SERVICES, NAMELY, PROVIDING IN PERSON TRAINING AND PERSONAL COACHING IN THE FIELD OF LANGUAGE, NAMELY, ACCULTURATED SPEECH, ACCENTS, PRONUNCIATION, AND VERBAL PRESENTATION AND COMMUNICATION SKILLS; EDUCATIONAL SERVICES, NAMELY, PROVIDING COURSES VIA THE INTERNET AND TELEPHONE IN THE FIELD OF LANGUAGE, NAMELY, ACCULTURATED SPEECH, ACCENTS, PRONUNCIATION, AND VERBAL PRESENTATION AND COMMUNICATION SKILLS; EDUCATIONAL SERVICES, NAMELY, DEVELOPING CONTEXTUALIZED CURRICULA AND SYLLABI IN THE FIELD OF LANGUAGE, NAMELY, ACCULTURATED SPEECH, ACCENTS, PRONUNCIATION, AND VERBAL PRESENTATION AND COMMUNICATION SKILLS (U.S. CLS. 100, 101 AND 107).

FIRST USE 9-0-2007; IN COMMERCE 9-0-2007.
JIM RINGLE, EXAMINING ATTORNEY

SN 85-495,973. 10GEN, INC., NEW YORK, NY. FILED 12-15-2011.

THE MARK CONSISTS OF THE WORDING "10GEN" BELOW FOUR CIRCLES.

CLASS 41—EDUCATION AND ENTERTAINMENT

FOR EDUCATIONAL SERVICES, NAMELY, CONDUCTING CLASSES AND COURSES IN THE FIELDS OF DATABASE DEVELOPMENT, MAINTENANCE, AND MANAGEMENT AND DISTRIBUTION OF TRAINING MATERIALS IN CONNECTION THEREWITH (U.S. CLS. 100, 101 AND 107).

FIRST USE 1-0-2010; IN COMMERCE 1-0-2010.

CLASS 42—SCIENTIFIC AND COMPUTER SERVICES

FOR DATABASE DESIGN AND DEVELOPMENT; IT CONSULTING SERVICES; TECHNICAL SUPPORT SERVICES, NAMELY, TROUBLESHOOTING OF COMPUTER SOFTWARE PROBLEMS (U.S. CLS. 100 AND 101).

FIRST USE 1-0-2010; IN COMMERCE 1-0-2010.
JERI J. FICKES, EXAMINING ATTORNEY

SN 85-496,997. HAGER WORLDWIDE, INC., HICKORY, NC.
FILED 12-16-2011.

BULL FROG

THE MARK CONSISTS OF STANDARD CHARACTERS WITHOUT CLAIM TO ANY PARTICULAR FONT, STYLE, SIZE, OR COLOR.

CLASS 10—MEDICAL APPARATUS

FOR DENTAL INSTRUMENTS, NAMELY, SALIVA EJECTORS IN THE NATURE OF MANUAL VALVES USED WITH A SUCTION VACUUM, AND ACCESSORIES THEREFORE, NAMELY, HAND PIECES AND EJECTOR TIPS (U.S. CLS. 26, 39 AND 44).

FIRST USE 12-31-1985; IN COMMERCE 12-31-1985.

CLASS 37—CONSTRUCTION AND REPAIR

FOR MOTOR REPAIR AND MAINTENANCE SERVICES FOR EQUIPMENT USED IN DENTAL OFFICES, NAMELY, VACUUM PUMPS AND CARTRIDGES, COMPRESSORS, VACUUMS, TURBINES, SEPARATORS, COLLECTORS, GAUGES, VALVES, SWITCHES AND REGULATORS (U.S. CLS. 100, 103 AND 106).

FIRST USE 12-31-1985; IN COMMERCE 12-31-1985.

DAVID ELTON, EXAMINING ATTORNEY

SN 85-497,311. DANNI ASHE, INC., BOCA RATON, FL.
FILED 12-16-2011.

DANNI

THE MARK CONSISTS OF STANDARD CHARACTERS WITHOUT CLAIM TO ANY PARTICULAR FONT, STYLE, SIZE, OR COLOR.

OWNER OF U.S. REG. NOS. 2,698,825, 3,302,408 AND OTHERS.

CLASS 38—COMMUNICATION

FOR PROVIDING ONLINE CHAT ROOMS ON THE TOPIC OF ADULT ENTERTAINMENT; PROVIDING ACCESS TO AN ONLINE COMPUTER BULLETIN BOARD DEALING WITH ADULT ENTERTAINMENT; PROVIDING ONLINE ELECTRONIC BULLETIN BOARDS FOR TRANSMISSION OF MESSAGES AMONG COMPUTER USERS CONCERNING ADULT ENTERTAINMENT; PROVIDING ONLINE FACILITIES FOR REAL TIME INTERACTION WITH OTHER COMPUTER USERS CONCERNING ADULT ENTERTAINMENT (U.S. CLS. 100, 101 AND 104).

CLASS 41—EDUCATION AND ENTERTAINMENT

FOR ENTERTAINMENT SERVICES IN THE NATURE OF PROVIDING A WEBSITE ON THE GLOBAL COMPUTER NETWORKS FEATURING INFORMATION IN THE FIELD OF ADULT ENTERTAINMENT; PROVIDING AN ONLINE WEBSITE OF INFORMATION COMPRISING ADULT MATERIAL AND VIEWING THEREOF, AND OTHER ADULT ENTERTAINMENT RELATED NEWS, FACTS, TRIVIA AND HUMOR; COMPUTER SERVICES, NAMELY, PROVIDING ON-LINE MAGAZINE AND COLUMNS IN THE FIELD OF ADULT ENTERTAINMENT (U.S. CLS. 100, 101 AND 107).

RUDY R. SINGLETON, EXAMINING ATTORNEY

SN 85-497,367. TECMARK, INC., SAINT PAUL, MN. FILED
12-16-2011.

SimpliConnect

THE MARK CONSISTS OF STANDARD CHARACTERS WITHOUT CLAIM TO ANY PARTICULAR FONT, STYLE, SIZE, OR COLOR.

CLASS 35—ADVERTISING AND BUSINESS

FOR ADVERTISING AND MARKETING SERVICES, NAMELY, ADMINISTRATION OF CUSTOMER LOYALTY, INCENTIVE AWARD AND DATABASE MARKETING PROGRAMS, PROVIDING ACCOUNT STATEMENTS, PROMOTIONAL MATERIALS, MAIL AND ORDER FULFILLMENT SERVICES; PROCESSING, REPORTING AND ANALYSIS OF CUSTOMER LOYALTY DATA (U.S. CLS. 100, 101 AND 102).

FIRST USE 2-1-2012; IN COMMERCE 2-1-2012.

CLASS 42—SCIENTIFIC AND COMPUTER SERVICES

FOR SOFTWARE AS A SERVICES (SAAS) SERVICES FEATURING SOFTWARE FOR STORING, MANAGING, TRACKING, ANALYZING AND REPORTING DATA IN THE FIELDS OF MARKETING, PROMOTION, SALES, CUSTOMER INFORMATION, CUSTOMER RELATIONSHIP MANAGEMENT, SALES SUPPORT, AND EMPLOYEE EFFICIENCY, AND FOR USE IN ADMINISTERING AND MANAGING CUSTOMER LOYALTY, INCENTIVE AWARD, CUSTOMER REWARDS AND PROMOTIONAL MARKETING PROGRAMS; PROVIDING ON-LINE, NON-DOWNLOADABLE SOFTWARE FOR STORING, MANAGING, TRACKING, ANALYZING AND REPORTING DATA IN THE FIELDS OF MARKETING, PROMOTION, SALES, CUSTOMER INFORMATION, CUSTOMER RELATIONSHIP MANAGEMENT, SALES SUPPORT, AND EMPLOYEE EFFICIENCY, AND FOR USE IN ADMINISTERING AND MANAGING CUSTOMER LOYALTY, INCENTIVE AWARD, CUSTOMER REWARDS AND PROMOTIONAL MARKETING PROGRAMS (U.S. CLS. 100 AND 101).

FIRST USE 2-1-2012; IN COMMERCE 2-1-2012.

ARETHA SOMERVILLE, EXAMINING ATTORNEY

SN 85-497,969. ALBERTMING INC., BERKELEY, CA. FILED 12-16-2011.

ALBERTMING

THE MARK CONSISTS OF STANDARD CHARACTERS WITHOUT CLAIM TO ANY PARTICULAR FONT, STYLE, SIZE, OR COLOR.

THE NAME "ALBERTMING" DOES NOT IDENTIFY A LIVING INDIVIDUAL. THE MARK IS A COMBINATION OF THE TWO FOUNDERS' GIVEN NAMES. BOTH FOUNDERS HAVE SIGNED THE APPLICATION.

CLASS 25—CLOTHING

FOR CLOTHING, NAMELY, SHIRTS, SUITS, PANTS, AND JACKETS (U.S. CLS. 22 AND 39).

FIRST USE 12-8-2011; IN COMMERCE 12-8-2011.

CLASS 35—ADVERTISING AND BUSINESS

FOR RETAIL AND ONLINE STORES FEATURING CLOTHING (U.S. CLS. 100, 101 AND 102).

FIRST USE 12-8-2011; IN COMMERCE 12-8-2011.
EUGENIA MARTIN, EXAMINING ATTORNEY

SN 85-498,096. RR HOLDINGS LLC, BETHESDA, MD. FILED 12-17-2011.

BERKELEY POINT

THE MARK CONSISTS OF STANDARD CHARACTERS WITHOUT CLAIM TO ANY PARTICULAR FONT, STYLE, SIZE, OR COLOR.

CLASS 35—ADVERTISING AND BUSINESS

FOR MARKET RESEARCH (U.S. CLS. 100, 101 AND 102).

FIRST USE 1-11-2012; IN COMMERCE 1-11-2012.

CLASS 36—INSURANCE AND FINANCIAL

FOR REAL ESTATE DEBT, EQUITY, AND MEZZANINE LOAN FINANCING AND LOAN SERVICING; FINANCIAL SERVICES RELATING TO COMMERCIAL AND MULTI-FAMILY MORTGAGE BANKING, LOAN SERVICING, AND MORTGAGE BROKERAGE SERVICES; ORIGINATING MULTIFAMILY, SENIORS HOUSING, HEALTH CARE FACILITIES, OR MANUFACTURED HOUSING COMMERCIAL LOANS UNDER U.S. GOVERNMENT, GOVERNMENT SPONSORED ENTERPRISE AND STATE AGENCY PROGRAMS; FINANCIAL ANALYSIS AND CONSULTATION RELATING TO COMMERCIAL AND MULTIFAMILY REAL ESTATE; FINANCIAL ADVISORY SERVICES REGARDING COMMERCIAL AND MULTIFAMILY REAL ESTATE; REAL ESTATE CAPITAL INVESTMENT CONSULTATION SERVICES; CONSULTATION AND MANAGEMENT OF INVESTMENT FUNDS RELATING TO REAL ESTATE, REAL ESTATE DEBT AND REAL ESTATE SECURITIES; COMMERCIAL AND MULTIFAMILY REAL ESTATE APPRAISAL, BROKERAGE, INVESTMENT, INVESTMENT SALES AND MANAGEMENT SERVICES; FINANCIAL RESEARCH IN THE AREA OF COMMERCIAL AND MULTIFAMILY REAL ESTATE; AND COMMERCIAL AND MULTIFAMILY REAL ESTATE INVESTMENT AND PROPERTY MANAGEMENT (U.S. CLS. 100, 101 AND 102).

FIRST USE 1-11-2012; IN COMMERCE 1-11-2012.
BRIDGETT SMITH, EXAMINING ATTORNEY

SN 85-498,765. UNITED SOYBEAN BOARD, CHESTERFIELD, MO. AND NATIONAL CORN GROWERS ASSOCIATION, CHESTERFIELD, MO. FILED 12-19-2011.



THE MARK CONSISTS OF A FANCIFUL LANDSCAPE SUGGESTING A FARM ON THE LEFT SIDE, A FIELD IN THE MIDDLE, AND A CITY ON THE RIGHT SIDE WITH A CLOUDY SKY ABOVE AND THE WORD "COMMONGROUND" BELOW.

CLASS 35—ADVERTISING AND BUSINESS

FOR ASSOCIATION SERVICES, NAMELY, PROMOTING GREATER PUBLIC AWARENESS OF MODERN AGRICULTURE (U.S. CLS. 100, 101 AND 102).

FIRST USE 2-28-2011; IN COMMERCE 2-28-2011.

CLASS 38—COMMUNICATION

FOR PROVIDING AN ONLINE FORUM FOR TRANSMISSION OF MESSAGES AMONG COMPUTER USERS CONCERNING MODERN AGRICULTURE (U.S. CLS. 100, 101 AND 104).

FIRST USE 2-28-2011; IN COMMERCE 2-28-2011.
H. M. FISHER, EXAMINING ATTORNEY

SN 85-498,860. UNITED SOYBEAN BOARD, CHESTERFIELD, MO. AND NATIONAL CORN GROWERS ASSOCIATION, CHESTERFIELD, MO. FILED 12-19-2011.

SN 85-500,276. LABEL INNOVATORS, INC., LIVERMORE, CA. FILED 12-20-2011.

commonground



THE MARK CONSISTS OF STANDARD CHARACTERS WITHOUT CLAIM TO ANY PARTICULAR FONT, STYLE, SIZE, OR COLOR.

NO CLAIM IS MADE TO THE EXCLUSIVE RIGHT TO USE "PURE", APART FROM THE MARK AS SHOWN.

CLASS 35—ADVERTISING AND BUSINESS

THE MARK CONSISTS OF A DEPICTION OF A PET WATER BOWL WITH THE STYLIZED LITERAL ELEMENT "PURE" APPEARING ABOVE THE STYLIZED LITERAL ELEMENT "MUGZ" APPEARING OVER THE LITERAL ELEMENT "HYDRATE YOUR OWNER" PRINTED OVER THE DEPICTION OF THE BOWL.

FOR ASSOCIATION SERVICES, NAMELY, PROMOTING GREATER PUBLIC AWARENESS OF MODERN AGRICULTURE (U.S. CLS. 100, 101 AND 102).
FIRST USE 2-28-2011; IN COMMERCE 2-28-2011.

CLASS 31—NATURAL AGRICULTURAL PRODUCTS

CLASS 38—COMMUNICATION

FOR PROVIDING AN ONLINE FORUM FOR TRANSMISSION OF MESSAGES AMONG COMPUTER USERS CONCERNING MODERN AGRICULTURE (U.S. CLS. 100, 101 AND 104).
FIRST USE 2-28-2011; IN COMMERCE 2-28-2011.
H. M. FISHER, EXAMINING ATTORNEY

FOR BOTTLED WATER FOR PETS; ELECTROLYTE WATER BEVERAGE FOR PETS AND NOT FOR MEDICAL PURPOSES (U.S. CLS. 1 AND 46).

CLASS 32—LIGHT BEVERAGES

FOR BOTTLED DRINKING WATER; ELECTROLYTE WATER BEVERAGE FOR PEOPLE AND NOT FOR MEDICAL PURPOSES (U.S. CLS. 45, 46 AND 48).
THOMAS MANOR, EXAMINING ATTORNEY

SN 85-500,259. LABEL INNOVATORS, INC., LIVERMORE, CA. FILED 12-20-2011.

SN 85-500,393. RR HOLDINGS LLC, BETHESDA, MD. FILED 12-20-2011.

PURE MUGZ



THE MARK CONSISTS OF STANDARD CHARACTERS WITHOUT CLAIM TO ANY PARTICULAR FONT, STYLE, SIZE, OR COLOR.

NO CLAIM IS MADE TO THE EXCLUSIVE RIGHT TO USE "PURE", APART FROM THE MARK AS SHOWN.

CLASS 31—NATURAL AGRICULTURAL PRODUCTS

THE MARK CONSISTS OF THREE CONSECUTIVE, OVERLAPPING FOUR-SIDED SHAPES WITH ARCS ENDING IN POINTS AT THE TOP OF EACH SHAPE ABOVE THE WORDS "BERKELEY POINT".

FOR BOTTLED WATER FOR PETS; ELECTROLYTE WATER BEVERAGE FOR PETS AND NOT FOR MEDICAL PURPOSES (U.S. CLS. 1 AND 46).

CLASS 32—LIGHT BEVERAGES

FOR BOTTLED DRINKING WATER; ELECTROLYTE WATER BEVERAGE FOR PEOPLE AND NOT FOR MEDICAL PURPOSES (U.S. CLS. 45, 46 AND 48).
THOMAS MANOR, EXAMINING ATTORNEY

CLASS 35—ADVERTISING AND BUSINESS

FOR MARKET RESEARCH (U.S. CLS. 100, 101 AND 102).
FIRST USE 1-11-2012; IN COMMERCE 1-11-2012.

CLASS 36—INSURANCE AND FINANCIAL

FOR REAL ESTATE DEBT, EQUITY, AND MEZZANINE LOAN FINANCING AND LOAN SERVICING; FINANCIAL SERVICES RELATING TO COMMERCIAL AND MULTI-FAMILY MORTGAGE BANKING, LOAN SERVICING, AND MORTGAGE BROKERAGE SERVICES; ORIGINATING MULTIFAMILY, SENIORS HOUSING, HEALTH CARE FACILITIES, OR MANUFACTURED HOUSING COMMERCIAL LOANS UNDER U.S. GOVERNMENT, GOVERNMENT SPONSORED ENTERPRISE AND STATE AGENCY PROGRAMS; FINANCIAL ANALYSIS AND CONSULTATION RELATING TO COMMERCIAL AND MULTIFAMILY REAL ESTATE; FINANCIAL ADVISORY SERVICES REGARDING COMMERCIAL AND MULTIFAMILY REAL ESTATE; REAL ESTATE CAPITAL INVESTMENT CONSULTATION SERVICES; CONSULTATION AND MANAGEMENT OF INVESTMENT FUNDS RELATING TO REAL ESTATE, REAL ESTATE DEBT AND REAL ESTATE SECURITIES; COMMERCIAL AND MULTIFAMILY REAL ESTATE APPRAISAL, BROKERAGE, INVESTMENT, INVESTMENT SALES AND MANAGEMENT SERVICES; FINANCIAL RESEARCH IN THE AREA OF COMMERCIAL AND MULTIFAMILY REAL ESTATE; AND COMMERCIAL AND MULTIFAMILY REAL ESTATE INVESTMENT AND PROPERTY MANAGEMENT (U.S. CLS. 100, 101 AND 102).

FIRST USE 1-11-2012; IN COMMERCE 1-11-2012.
BRIDGETT SMITH, EXAMINING ATTORNEY

CLASS 36—INSURANCE AND FINANCIAL

FOR REAL ESTATE DEBT, EQUITY, AND MEZZANINE LOAN FINANCING AND LOAN SERVICING; FINANCIAL SERVICES RELATING TO COMMERCIAL AND MULTIFAMILY MORTGAGE BANKING, LOAN SERVICING, AND MORTGAGE BROKERAGE SERVICES; ORIGINATING MULTIFAMILY, SENIORS HOUSING, HEALTH CARE FACILITIES, OR MANUFACTURED HOUSING COMMERCIAL LOANS UNDER U.S. GOVERNMENT, GOVERNMENT SPONSORED ENTERPRISE AND STATE AGENCY PROGRAMS; FINANCIAL ANALYSIS AND CONSULTATION RELATING TO COMMERCIAL AND MULTIFAMILY REAL ESTATE; FINANCIAL ADVISORY SERVICES REGARDING COMMERCIAL AND MULTIFAMILY REAL ESTATE; REAL ESTATE CAPITAL INVESTMENT CONSULTATION SERVICES; CONSULTATION AND MANAGEMENT OF INVESTMENT FUNDS RELATING TO REAL ESTATE, REAL ESTATE DEBT AND REAL ESTATE SECURITIES; COMMERCIAL AND MULTIFAMILY REAL ESTATE APPRAISAL, BROKERAGE, INVESTMENT, INVESTMENT SALES AND MANAGEMENT SERVICES; FINANCIAL RESEARCH IN THE AREA OF COMMERCIAL AND MULTIFAMILY REAL ESTATE; AND COMMERCIAL AND MULTIFAMILY REAL ESTATE INVESTMENT AND PROPERTY MANAGEMENT (U.S. CLS. 100, 101 AND 102).

BRIDGETT SMITH, EXAMINING ATTORNEY

SN 85-500,397. RR HOLDINGS LLC, BETHESDA, MD. FILED 12-20-2011.

SN 85-500,891. BELGRAVE OIL AND GAS CORP., CALGARY, ALBERTA, CANADA, FILED 12-21-2011.

IOR EDGE



THE MARK CONSISTS OF STANDARD CHARACTERS WITHOUT CLAIM TO ANY PARTICULAR FONT, STYLE, SIZE, OR COLOR.

NO CLAIM IS MADE TO THE EXCLUSIVE RIGHT TO USE "IOR", APART FROM THE MARK AS SHOWN.

THE MARK CONSISTS OF THREE CONSECUTIVE, OVERLAPPING FOUR-SIDED SHAPES EACH HAVING AN ARC FORMING A POINT AT THE TOP.

CLASS 35—ADVERTISING AND BUSINESS

FOR MARKET RESEARCH (U.S. CLS. 100, 101 AND 102).

FIRST USE 1-11-2012; IN COMMERCE 1-11-2012.

CLASS 35—ADVERTISING AND BUSINESS

FOR PROVIDING AN ONLINE DIRECTORY INFORMATION SERVICE FEATURING INFORMATION REGARDING IMPROVED OIL RECOVERY AND ENHANCED OIL RECOVERY PROFESSIONALS; PROVIDING ADVERTISING ON BEHALF OF OTHERS USING THE INTERNET OR OTHER COMMUNICATION NETWORKS; PROVIDING ADVERTISING SPACE VIA GLOBAL COMPUTER NETWORKS; PROMOTING THE GOODS AND SERVICES OF OTHERS VIA THE INTERNET (U.S. CLS. 100, 101 AND 102).

CLASS 37—CONSTRUCTION AND REPAIR

FOR PROVIDING INFORMATION IN THE FIELD OF IMPROVED OIL RECOVERY AND ENHANCED OIL RECOVERY; PROVIDING AN ONLINE COMPUTER DATABASE FEATURING TECHNICAL INFORMATION ABOUT IMPROVED OIL RECOVERY AND ENHANCED OIL RECOVERY (U.S. CLS. 100, 103 AND 106).

CLASS 42—SCIENTIFIC AND COMPUTER SERVICES

FOR COMPUTER SERVICES, NAMELY, CREATING AN ON-LINE COMMUNITY FOR REGISTERED USERS TO PARTICIPATE IN DISCUSSIONS, GET FEEDBACK FROM THEIR PEERS, FORM VIRTUAL COMMUNITIES, AND ENGAGE IN SOCIAL NETWORKING SERVICES IN THE FIELD OF THE OIL AND GAS EXTRACTION INDUSTRIES; PROVIDING A WEBSITE FEATURING TECHNOLOGY THAT ENABLES USERS TO UPLOAD, POST, SHOW, DISPLAY, TAG AND ELECTRONICALLY TRANSMIT INFORMATION, AUDIO AND VIDEO CLIPS (U.S. CLS. 100 AND 101).

MARIA-VICTORIA SUAREZ, EXAMINING ATTORNEY

SN 85-500,953. BELGRAVE OIL AND GAS CORP., CALGARY, ALBERTA, CANADA, FILED 12-21-2011.



THE MARK CONSISTS OF A DEPICTION OF A RAIN-DROP AND THE TERM "IOREDGE" APPEARING IN A FANCIFUL FONT.

CLASS 35—ADVERTISING AND BUSINESS

FOR PROVIDING AN ONLINE DIRECTORY INFORMATION SERVICE FEATURING INFORMATION REGARDING IMPROVED OIL RECOVERY AND ENHANCED OIL RECOVERY PROFESSIONALS; PROVIDING ADVERTISING ON BEHALF OF OTHERS USING THE INTERNET OR OTHER COMMUNICATION NETWORKS; PROVIDING ADVERTISING SPACE VIA GLOBAL COMPUTER NETWORKS; PROMOTING THE GOODS AND SERVICES OF OTHERS VIA THE INTERNET (U.S. CLS. 100, 101 AND 102).

SN 85-500,915. BELGRAVE OIL AND GAS CORP., CALGARY, ALBERTA, CANADA, FILED 12-21-2011.

IOREDGE

THE MARK CONSISTS OF STANDARD CHARACTERS WITHOUT CLAIM TO ANY PARTICULAR FONT, STYLE, SIZE, OR COLOR.

CLASS 35—ADVERTISING AND BUSINESS

FOR PROVIDING AN ONLINE DIRECTORY INFORMATION SERVICE FEATURING INFORMATION REGARDING IMPROVED OIL RECOVERY AND ENHANCED OIL RECOVERY PROFESSIONALS; PROVIDING ADVERTISING ON BEHALF OF OTHERS USING THE INTERNET OR OTHER COMMUNICATION NETWORKS; PROVIDING ADVERTISING SPACE VIA GLOBAL COMPUTER NETWORKS; PROMOTING THE GOODS AND SERVICES OF OTHERS VIA THE INTERNET (U.S. CLS. 100, 101 AND 102).

CLASS 37—CONSTRUCTION AND REPAIR

FOR PROVIDING INFORMATION IN THE FIELD OF IMPROVED OIL RECOVERY AND ENHANCED OIL RECOVERY; PROVIDING AN ONLINE COMPUTER DATABASE FEATURING TECHNICAL INFORMATION ABOUT IMPROVED OIL RECOVERY AND ENHANCED OIL RECOVERY (U.S. CLS. 100, 103 AND 106).

CLASS 42—SCIENTIFIC AND COMPUTER SERVICES

FOR COMPUTER SERVICES, NAMELY, CREATING AN ON-LINE COMMUNITY FOR REGISTERED USERS TO PARTICIPATE IN DISCUSSIONS, GET FEEDBACK FROM THEIR PEERS, FORM VIRTUAL COMMUNITIES, AND ENGAGE IN SOCIAL NETWORKING SERVICES IN THE FIELD OF THE OIL AND GAS EXTRACTION INDUSTRIES; PROVIDING A WEBSITE FEATURING TECHNOLOGY THAT ENABLES USERS TO UPLOAD, POST, SHOW, DISPLAY, TAG AND ELECTRONICALLY TRANSMIT INFORMATION, AUDIO AND VIDEO CLIPS (U.S. CLS. 100 AND 101).

MARIA-VICTORIA SUAREZ, EXAMINING ATTORNEY

CLASS 37—CONSTRUCTION AND REPAIR

FOR PROVIDING INFORMATION IN THE FIELD OF IMPROVED OIL RECOVERY AND ENHANCED OIL RECOVERY; PROVIDING AN ONLINE COMPUTER DATABASE FEATURING TECHNICAL INFORMATION ABOUT IMPROVED OIL RECOVERY AND ENHANCED OIL RECOVERY (U.S. CLS. 100, 103 AND 106).

CLASS 42—SCIENTIFIC AND COMPUTER SERVICES

FOR COMPUTER SERVICES, NAMELY, CREATING AN ON-LINE COMMUNITY FOR REGISTERED USERS TO PARTICIPATE IN DISCUSSIONS, GET FEEDBACK FROM THEIR PEERS, FORM VIRTUAL COMMUNITIES, AND ENGAGE IN SOCIAL NETWORKING SERVICES IN THE FIELD OF THE OIL AND GAS EXTRACTION INDUSTRIES; PROVIDING A WEBSITE FEATURING TECHNOLOGY THAT ENABLES USERS TO UPLOAD, POST, SHOW, DISPLAY, TAG AND ELECTRONICALLY TRANSMIT INFORMATION, AUDIO AND VIDEO CLIPS (U.S. CLS. 100 AND 101).

MARIA-VICTORIA SUAREZ, EXAMINING ATTORNEY

SN 85-501,135. L&L WINGS, INC., NEW YORK, NY. FILED 12-21-2011.



OWNER OF U.S. REG. NO. 3,458,144.

THE MARK CONSISTS OF THE WORD "WINGS" IN A DOUBLE BAND OVAL WITH TWO HIBISCUS FLOWERS CUTTING INTO THE LOWER RIGHT CORNER OF THE OVAL.

CLASS 24—FABRICS

FOR BEACH TOWELS (U.S. CLS. 42 AND 50).
FIRST USE 2-9-2008; IN COMMERCE 2-9-2008.

SN 85-501,730. FIRST DATA CORPORATION, GREENWOOD VILLAGE, CO. FILED 12-22-2011.

CLASS 25—CLOTHING

FOR MEN'S, WOMEN'S AND CHILDREN'S CLOTHING, NAMELY, SWEAT PANTS, SWEATSHIRTS, TEE SHIRTS, TANK TOPS, SHIRTS, SHORTS, DRESSES, SKIRTS, PANTS, JACKETS, SWEATERS, SWIMSUITS, SWIMSUIT COVER-UPS, AND PAREOS; BEACH SHOES, NAMELY, SANDALS, THONGS AND SLIPPERS; SOCKS, NAMELY, AQUA SOCKS; HEAD WEAR, NAMELY, SWIM CAPS, HATS, CAPS, HEADBANDS, BANDANAS, AND KERCHIEFS; ACCESSORIES, NAMELY, WRISTBANDS, VESTS, SHAWLS, SCARVES AND BELTS (U.S. CLS. 22 AND 39).

FIRST USE 2-9-2008; IN COMMERCE 2-9-2008.

PCI RAPID COMPLY

THE MARK CONSISTS OF STANDARD CHARACTERS WITHOUT CLAIM TO ANY PARTICULAR FONT, STYLE, SIZE, OR COLOR.

NO CLAIM IS MADE TO THE EXCLUSIVE RIGHT TO USE "PCI" AND "COMPLY", APART FROM THE MARK AS SHOWN.

CLASS 35—ADVERTISING AND BUSINESS

FOR RETAIL STORE SERVICES FEATURING BODY BOARDS, SWIM BOARDS, SWIM FLOATS, BEACH UMBRELLAS, BEACH TOWELS, SCUBA DIVING EQUIPMENT, SWIM GOGGLES, BEACH MATS, COSTUME JEWELRY, SOUVENIRS, GIFT ITEMS, CANDY AND BOTTLED WATER (U.S. CLS. 100, 101 AND 102).

FIRST USE 2-9-2008; IN COMMERCE 2-9-2008.

COLLEEN DOMBROW, EXAMINING ATTORNEY

CLASS 42—SCIENTIFIC AND COMPUTER SERVICES

FOR PROVIDING A WEB SITE FEATURING TECHNOLOGY THAT ENABLES USERS TO FULFILL PAYMENT CARD INDUSTRY SECURITY STANDARD REPORTING REQUIREMENTS AND MANAGE, MONITOR, AND GENERATE INFORMATION AND REPORTS REGARDING MERCHANT REQUIREMENTS IN ACCORDANCE WITH THE PAYMENT CARD INDUSTRY SECURITY STANDARDS (U.S. CLS. 100 AND 101).

SN 85-501,439. GYRENE BURGER COMPANY, AVE MARIA, FL. FILED 12-21-2011.

CLASS 45—PERSONAL AND LEGAL SERVICES

FOR TRACKING AND MONITORING REGULATORY REQUIREMENTS IN THE FIELD OF MERCHANT PAYMENT CARD REQUIREMENTS FOR REGULATORY COMPLIANCE PURPOSES (U.S. CLS. 100 AND 101).

MICHELE SWAIN, EXAMINING ATTORNEY

GYRENE BURGER COMPANY

THE MARK CONSISTS OF STANDARD CHARACTERS WITHOUT CLAIM TO ANY PARTICULAR FONT, STYLE, SIZE, OR COLOR.

NO CLAIM IS MADE TO THE EXCLUSIVE RIGHT TO USE "BURGER COMPANY", APART FROM THE MARK AS SHOWN.

SN 85-502,528. WHITSONS FOOD SERVICE CORP., ISLANDIA, NY. FILED 12-22-2011.

WHITSONS**CLASS 30—STAPLE FOODS**

FOR HAMBURGER SANDWICHES (U.S. CL. 46).

THE MARK CONSISTS OF STANDARD CHARACTERS WITHOUT CLAIM TO ANY PARTICULAR FONT, STYLE, SIZE, OR COLOR.

OWNER OF U.S. REG. NO. 3,139,864.

SEC. 2(F).

CLASS 35—ADVERTISING AND BUSINESS

FOR FRANCHISING, NAMELY, OFFERING BUSINESS MANAGEMENT ASSISTANCE IN THE ESTABLISHMENT AND/OR OPERATION OF GOURMET HAMBURGER STORES; RESTAURANT FRANCHISING, NAMELY, OFFERING BUSINESS MANAGEMENT ASSISTANCE IN THE ESTABLISHMENT AND/OR OPERATION OF RESTAURANTS (U.S. CLS. 100, 101 AND 102).

CLASS 29—MEATS AND PROCESSED FOODS

FOR FROZEN AND FRESH PREPARED AND PACKAGED MEALS CONSISTING PRIMARILY OF MEAT, FISH, POULTRY OR VEGETABLES (U.S. CL. 46).

FIRST USE 1-0-1979; IN COMMERCE 1-0-1979.

CLASS 43—HOTEL AND RESTAURANT SERVICES

FOR RESTAURANT AND CATERING SERVICES (U.S. CLS. 100 AND 101).

THEODORE MCBRIDE, EXAMINING ATTORNEY

CLASS 30—STAPLE FOODS

FOR FROZEN AND FRESH PREPARED AND PACKAGED MEALS CONSISTING PRIMARILY OF PASTA OR RICE (U.S. CL. 46).

FIRST USE 1-0-1979; IN COMMERCE 1-0-1979.

CHERYL CLAYTON, EXAMINING ATTORNEY

SN 85-502,770. JIAXING MBAOBAO NETWORK TECHNOLOGY CO., LTD., JIAXING CITY, CHINA, FILED 12-22-2011.

CLASS 9—ELECTRICAL AND SCIENTIFIC APPARATUS

FOR FUEL CELL ELECTRIC POWER GENERATORS, IN THE NATURE OF A FUEL CELL (U.S. CLS. 21, 23, 26, 36 AND 38).

PRISCILLA MILTON, EXAMINING ATTORNEY

Mbaobao

SN 85-503,240. EDUCARE LEARNING NETWORK LLC, CHICAGO, IL. FILED 12-23-2011.

EDUCARE LEARNING NETWORK

THE MARK CONSISTS OF STYLIZED WORD "MBAO-BAO".

CLASS 18—LEATHER GOODS

FOR BACKPACKS; BRIEFCASES; CREDIT CARD HOLDERS; HANDBAGS; KEY CASES; NAME CARD CASES; PURSES; TRAVELLING BAGS; TRAVELLING TRUNKS; UMBRELLAS; WALLETS INCLUDING CARD HOLDERS (U.S. CLS. 1, 2, 3, 22 AND 41).

FIRST USE 8-27-2007; IN COMMERCE 8-27-2007.

CLASS 35—ADVERTISING AND BUSINESS

FOR ACCOUNTING SERVICES; ADVERTISING SERVICES; BUSINESS ORGANISATION AND MANAGEMENT CONSULTING SERVICES; COMMERCIAL BUSINESS MANAGEMENT; COMPILING OF INFORMATION INTO COMPUTER DATABASES; ON-LINE RETAIL STORE SERVICES FEATURING BAGS; ONLINE ADVERTISING VIA A COMPUTER COMMUNICATIONS NETWORK; ORGANISATION OF EXHIBITIONS AND EVENTS FOR COMMERCIAL OR ADVERTISING PURPOSES; PERSONNEL MANAGEMENT CONSULTATION; RELOCATION SERVICES FOR BUSINESS; RENTAL OF VENDING MACHINES; SALES PROMOTION SERVICES (U.S. CLS. 100, 101 AND 102).

FIRST USE 9-14-2007; IN COMMERCE 9-14-2007.

FRANK LATTUCA, EXAMINING ATTORNEY

THE MARK CONSISTS OF STANDARD CHARACTERS WITHOUT CLAIM TO ANY PARTICULAR FONT, STYLE, SIZE, OR COLOR.

OWNER OF U.S. REG. NO. 2,868,355.

NO CLAIM IS MADE TO THE EXCLUSIVE RIGHT TO USE "LEARNING NETWORK", APART FROM THE MARK AS SHOWN.

CLASS 35—ADVERTISING AND BUSINESS

FOR PUBLIC ADVOCACY VIA A VARIETY OF COMMUNICATIONS TOOLS AND STRATEGIES TO PROMOTE AWARENESS OF THE IMPORTANCE OF INVESTING IN QUALITY EARLY CARE AND LEARNING PROGRAMS FOR AT-RISK CHILDREN FROM BIRTH TO AGE FIVE; ASSOCIATION SERVICES, NAMELY, PROMOTING PUBLIC INTEREST AND AWARENESS IN THE IMPORTANCE OF INVESTING IN QUALITY EARLY CARE AND LEARNING PROGRAMS FOR AT-RISK CHILDREN FROM BIRTH TO AGE FIVE (U.S. CLS. 100, 101 AND 102).

FIRST USE 0-0-2003; IN COMMERCE 0-0-2003.

CLASS 41—EDUCATION AND ENTERTAINMENT

FOR EDUCATIONAL SERVICES, NAMELY, DEVELOPING CURRICULUM FOR OTHERS IN THE FIELD OF EARLY CHILDHOOD EDUCATION AND DEVELOPMENT; EDUCATIONAL SERVICES, NAMELY, TEACHER TRAINING IN THE FIELDS OF EARLY CHILDHOOD EDUCATION AND DEVELOPMENT PROVIDED ON A REAL-TIME BASIS DURING CLASSROOM INSTRUCTION; EDUCATIONAL SERVICES, NAMELY, TEACHER TRAINING IN THE FIELDS OF EARLY CHILDHOOD EDUCATION AND DEVELOPMENT; RESEARCH IN THE FIELD OF EDUCATION; CONSULTING SERVICES IN THE FIELD OF TRAINING FOR EDUCATIONAL ADMINISTRATORS AND TEACHERS IN EARLY CHILDHOOD EDUCATION (U.S. CLS. 100, 101 AND 107).

FIRST USE 0-0-2003; IN COMMERCE 0-0-2003.

DAWN HAN, EXAMINING ATTORNEY

SN 85-503,137. POINT SOURCE POWER, INC., ALAMEDA, CA. FILED 12-23-2011.

VOTO

SN 85-503,622. REVEL8 LLC, SANDY, UT. FILED 12-24-2011.

THE MARK CONSISTS OF STANDARD CHARACTERS WITHOUT CLAIM TO ANY PARTICULAR FONT, STYLE, SIZE, OR COLOR.

CLASS 7—MACHINERY

FOR FUEL CELL ELECTRIC POWER GENERATORS, IN THE NATURE OF A GENERATOR (U.S. CLS. 13, 19, 21, 23, 31, 34 AND 35).

NUVI

THE MARK CONSISTS OF STANDARD CHARACTERS WITHOUT CLAIM TO ANY PARTICULAR FONT, STYLE, SIZE, OR COLOR.

THE WORDING "NUVI" HAS NO MEANING IN A FOREIGN LANGUAGE.

CLASS 35—ADVERTISING AND BUSINESS

FOR BUSINESS ANALYSIS, NAMELY, BUSINESS DATA ANALYSIS; CONSULTING SERVICES IN THE FIELD OF TRACKING AND ANALYZING SOCIAL MEDIA, WEB SITES AND APPLICATIONS AND DATABASES OF OTHERS TO PROVIDE VISUAL INTELLIGENCE, ENGAGEMENT AND INTERACTION, RESEARCH, STRATEGY, INSIGHT, OPTIMIZATION, MARKETING, SALES, OPERATION, AND PRODUCT DESIGN, PARTICULARLY SPECIALIZING IN THE USE OF ANALYTIC AND STATISTIC MODELS AND VISUALIZATIONS FOR THE UNDERSTANDING AND PREDICTING INTENT OF CONSUMERS, BUSINESSES, AND MARKET TRENDS AND ACTIONS IN THE FIELD OF SOCIAL MEDIA, CUSTOMER RELATIONSHIP, REPUTATION AND BRAND MANAGEMENT, POLITICAL DIALOGUE, FINANCIAL MANAGEMENT, NEWS MEDIA AND JOURNALISM; CONSULTING SERVICES IN THE FIELD OF INTERNET AND SOCIAL MEDIA MARKETING (U.S. CLS. 100, 101 AND 102).

FIRST USE 7-1-2011; IN COMMERCE 10-10-2011.

CLASS 42—SCIENTIFIC AND COMPUTER SERVICES

FOR ONLINE, NON-DOWNLOADABLE SOFTWARE FOR TRACKING AND ANALYZING BUSINESS DATA, NAMELY, SOCIAL MEDIA, WEB SITES AND APPLICATIONS AND DATABASES OF OTHERS TO PROVIDE VISUAL INTELLIGENCE, ENGAGEMENT AND INTERACTION, RESEARCH, STRATEGY, MARKET TRENDS, CONSUMER INTENT PREDICTIONS, STATISTICAL MODELS, INSIGHT, OPTIMIZATION, MARKETING, SALES, OPERATION, AND PRODUCT DESIGN, FOR USE IN THE FIELDS OF SOCIAL MEDIA, CUSTOMER RELATIONSHIP, REPUTATION AND BRAND MANAGEMENT, POLITICAL DIALOGUE, FINANCIAL MANAGEMENT, NEWS MEDIA AND JOURNALISM (U.S. CLS. 100 AND 101).

FIRST USE 7-1-2011; IN COMMERCE 10-10-2011.

WARREN L. OLANDRIA, EXAMINING ATTORNEY

SN 85-504,286. PROPEX OPERATING COMPANY LLC, CHATTANOOGA, TN. FILED 12-27-2011.

THE EVOLUTION OF INFRASTRUCTURE

THE MARK CONSISTS OF STANDARD CHARACTERS WITHOUT CLAIM TO ANY PARTICULAR FONT, STYLE, SIZE, OR COLOR.

CLASS 17—RUBBER GOODS

FOR PACKAGING PRODUCTS, NAMELY, HOUSE WRAP BUILDING INSULATION IN THE NATURE OF WOVEN, COATED AND LAMINATED FABRICS MADE OF MAN-MADE MATERIALS OR SHEETS OF WOVEN, COATED AND LAMINATED FABRICS MADE OF MAN-MADE MATERIALS USED AS AN INSULATING INFILTRATION BARRIER IN BUILDING CONSTRUCTION; CONCRETE CONSTRUCTION PRODUCTS IN THE NATURE OF FIBERS OF POLYPROPYLENE AND STEEL FOR USE IN IMPARTING REINFORCEMENT AND OTHER PROPERTIES TO CONCRETE (U.S. CLS. 1, 5, 12, 13, 35 AND 50).

CLASS 18—LEATHER GOODS

FOR TEXTILE SHOPPING BAGS; MESH FABRIC SHOPPING BAGS FOR RETAIL PACKAGING OF PRODUCE AND FOOD ITEMS; REUSABLE TEXTILE PRODUCE BAGS TO CARRY PRODUCE FROM GROCERY STORES AND FARMER'S MARKETS (U.S. CLS. 1, 2, 3, 22 AND 41).

CLASS 19—NON-METALLIC BUILDING MATERIALS

FOR BUILDING PRODUCTS, NAMELY, WOVEN, COATED AND LAMINATED ROOFING FABRICS AND WOVEN, COATED AND LAMINATED FABRICS BEING SHEATHING; GEOSYNTHETIC PRODUCTS, NAMELY, WOVEN, NON-WOVEN, STITCH-BONDED, COMPOSITE, TEXTILES COMPRISING MAN-MADE AND NATURAL MATERIALS FOR USE IN SOIL STABILIZATION, SOIL SEPARATION, SOIL DRAINAGE, PAVING, SOIL REINFORCEMENT, SEDIMENT CONTROL, LANDFILL LINING SYSTEMS, EROSION CONTROL AND VEGETATIVE ESTABLISHMENT; RECREATION PRODUCTS, NAMELY, WOVEN PRODUCTS MADE OF MAN-MADE FABRICS IN THE NATURE OF FITTED SWIMMING POOL COVERS; WOVEN AND NON-WOVEN AGRICULTURAL FABRICS MADE OF MAN-MADE MATERIALS FOR USE IN VEGETATIVE CONTAINMENT (U.S. CLS. 1, 12, 33 AND 50).

CLASS 22—CORDAGE AND FIBERS

FOR PACKAGING PRODUCTS, NAMELY, WOVEN FABRIC BAGS FOR THE TRANSPORTATION OR STORAGE OF MATERIALS IN BULK, INCLUDING THE PACKAGING OF BALED COTTON; FLOORING PRODUCTS, NAMELY, WOVEN AND NON-WOVEN, COMPOSITE FIBERS FOR USE IN THE MANUFACTURE OF CARPET BACKING, CARPETS AND RUGS; RECREATION PRODUCTS, NAMELY, WOVEN PRODUCTS MADE OF MAN-MADE FABRICS IN THE NATURE OF UNFITTED SWIMMING POOL COVERS (U.S. CLS. 1, 2, 7, 19, 22, 42 AND 50).

CLASS 24—FABRICS

FOR NON-WOVEN AND WOVEN FABRICS MADE OF MAN-MADE AND NATURAL MATERIALS FOR USE IN THE MANUFACTURE OF FILTRATION MEDIA; NON-WOVEN AND WOVEN FABRICS MADE OF MANMADE MATERIALS FOR USE IN THE MANUFACTURE OF AUTOMOTIVE COMPONENTS; WOVEN, COATED AND LAMINATED FABRICS MADE OF MAN-MADE MATERIALS FOR USE IN THE MANUFACTURE OF HOUSE WRAP, ROOFING AND SHEATHING; NON-WOVEN COATED AND LAMINATED FABRICS MADE OF MAN-MADE MATERIALS FOR USE IN MANUFACTURING FURNITURE AND BEDDING COMPONENTS (U.S. CLS. 42 AND 50).

CLASS 28—TOYS AND SPORTING GOODS

FOR RECREATION PRODUCTS, NAMELY, WOVEN PRODUCTS MADE OF MAN-MADE FABRICS IN THE NATURE OF TRAMPOLINE COVERS (U.S. CLS. 22, 23, 38 AND 50).

JENNIFER MARTIN, EXAMINING ATTORNEY

SN 85-505,384. PRESS ENTER, L.L.P., RIVER FALLS, WI.
FILED 12-29-2011.

SN 85-505,513. MCLANAHAN CORPORATION, HOLLI-
DAYSBURG, PA. FILED 12-29-2011.

PRESSENTER



THE MARK CONSISTS OF STANDARD CHARACTERS WITHOUT CLAIM TO ANY PARTICULAR FONT, STYLE, SIZE, OR COLOR.

OWNER OF U.S. REG. NOS. 2,601,032 AND 3,292,906.

CLASS 9—ELECTRICAL AND SCIENTIFIC APPARATUS

FOR DOWNLOADABLE ELECTRONIC NEWSLETTER FEATURING NEWS AND INFORMATION ABOUT THE INTERNET (U.S. CLS. 21, 23, 26, 36 AND 38).

CLASS 35—ADVERTISING AND BUSINESS

FOR PROCUREMENT, NAMELY, RECOMMENDING AND PURCHASING COMPUTER HARDWARE AND SOFTWARE AND COMPUTER NETWORKS FOR OTHERS (U.S. CLS. 100, 101 AND 102).

CLASS 37—CONSTRUCTION AND REPAIR

FOR INSTALLATION, MAINTENANCE AND REPAIR OF COMPUTER HARDWARE AND COMPUTER NETWORKS (U.S. CLS. 100, 103 AND 106).

CLASS 38—COMMUNICATION

FOR TELECOMMUNICATIONS, NAMELY, PROVIDING TELECOMMUNICATIONS CONNECTIONS AND MULTIPLE-USER ACCESS TO THE INTERNET AND ISDN SERVICES (U.S. CLS. 100, 101 AND 104).

CLASS 42—SCIENTIFIC AND COMPUTER SERVICES

FOR COMPUTER SERVICES, NAMELY, DESIGNING, MANAGING AND IMPLEMENTING WEB SITES FOR OTHERS; INFORMATION TECHNOLOGY CONSULTING SERVICES; TECHNICAL SUPPORT SERVICES, NAMELY, TROUBLESHOOTING IN THE NATURE OF DIAGNOSING COMPUTER HARDWARE AND SOFTWARE AND COMPUTER NETWORK PROBLEMS; INSTALLATION, MAINTENANCE AND REPAIR OF COMPUTER SOFTWARE (U.S. CLS. 100 AND 101).

CHERYL CLAYTON, EXAMINING ATTORNEY

THE COLOR(S) RED AND WHITE IS/ARE CLAIMED AS A FEATURE OF THE MARK.

THE MARK CONSISTS OF A RED SPHERE WITH FOUR WHITE, CURVED BANDS CONTAINED THEREIN.

CLASS 7—MACHINERY

FOR BULK MATERIAL HANDLING APPARATUS, NAMELY, CRUSHING MACHINES, WASHING AND CLASSIFYING MACHINES, FEEDERS, SCRUBBERS, SCRUBBERS AND SCREENS, ROTARY SCREENS, VIBRATING SCREENS, SHAKING SCREENS, PUG MILLS, BLENDERS, MIXERS, SAND DRAGS, JIGS, GRIZZLIES, SAMPLING MACHINES, CASTINGS, ROTARY COAL AND SINTER BREAKERS, CONCRETE WASHOUT APPARATUS AND SAND MANURE PROCESSING MACHINES; BULK MATERIAL HANDLING APPARATUS USED IN THE MINERAL PROCESSING, AGGREGATE PROCESSING, FARMING AND MINING INDUSTRIES AND PARTS THEREFOR, NAMELY, ROTARY PUMPS AND REPLACEABLE WEAR LINERS FOR ROTARY PUMPS, HYDROCYCLONE SEPARATORS AND REPLACEABLE WEAR LINERS FOR HYDROCYCLONE SEPARATORS, REPLACEABLE PROTECTIVE LINERS FOR CRUSHERS, REPLACEABLE WEAR MEDIA, NAMELY, SCREEN MEDIA, SCREEN SIDE LINERS, SCREEN FEED LINERS, SCREEN DISCHARGE LINERS, SPRAY DEFLECTOR NOZZLES, CHUTE AND HOPPER LININGS, SPRAY PIPE SEALS, LOG WASHER PADDLES, AND TANK AND HOPPER LINERS, REPLACEABLE WEAR MEDIA FOR CONVEYOR TRANSFER POINTS, NAMELY, IMPACT LINERS, SKIRT BOARD LINERS, BELT CLEANER INSERTS, BUCKETS, AND FUGITIVE MATERIAL SEALS, WEAR PARTS FOR FINE MATERIAL RECOVERY SYSTEMS, NAMELY, PIPES, HOSES, SAND TANK VALVES, SAND SCREW SHOES, DOWNSPOUTS, DISCHARGE ELBOWS, FLUME LINING, PINCH VALVE INSERTS, MIXER LINERS, AND FLOTATION CELL AGITATORS AND BAFFLES, AND TROMMEL AND SCRUBBER WEAR PARTS, NAMELY, SCREEN PANELS, LIFTER BARS, KICKER PADDLES, SPIRAL FLIGHTS, BAFFLE PLATES, AND FEED, DISCHARGE, AND SHELL LINERS, ALL OF THE FOREGOING BEING MACHINES AND STRUCTURAL PARTS THEREFOR (U.S. CLS. 13, 19, 21, 23, 31, 34 AND 35).

CLASS 37—CONSTRUCTION AND REPAIR

FOR MAINTENANCE AND REPAIR OF BULK MATERIAL HANDLING APPARATUS, NAMELY, CRUSHING MACHINES, WASHING AND CLASSIFYING MACHINES, FEEDERS, SCRUBBERS, SCRUBBERS AND SCREENS, ROTARY SCREENS, VIBRATING SCREENS, SHAKING SCREENS, PUG MILLS, BLENDERS, MIXERS, SAND DRAGS, JIGS, GRIZZLIES, SAMPLING MACHINES, CASTINGS, ROTARY COAL AND SINTER BREAKERS, CONCRETE WASHOUT SYSTEMS AND SAND MANURE PROCESSING MACHINES FOR OTHERS; MAINTENANCE AND REPAIR OF BULK MATERIAL HANDLING APPARATUS, NAMELY, PUMPS, PUMP LINERS, HYDROCYCLONES, HYDROCYCLONE LINERS, CRUSHER LINERS, ELBOWS, PIPES, HOSES, FINES HANDLING, SCREEN MEDIA, CHUTE AND HOPPER LININGS, SAND TANK VALVES, SAND SCREW SHOES, WATER MANAGEMENT EQUIPMENT, LOG WASHER PADDLES, TROMMELS, SCRUBBER LINERS, URETHANE COMPONENTS, RUBBER COMPONENTS AND CERAMIC COMPONENTS FOR THE AFORESAID GOODS (U.S. CLS. 100, 103 AND 106).
NANCY CLARKE, EXAMINING ATTORNEY

SN 85-507,883. PALLET LOGISTICS & UNIT LOAD SOLUTIONS, INC., PRINCETON, MA. FILED 1-3-2012.



SN 85-506,007. WOODRUFF, MICHAEL, JACKSON, CA. AND NOSLER, MARK, JACKSON, CA. FILED 12-29-2011.

THE MARK CONSISTS OF THE NUMBER "9" WITH STRAIGHT EDGES AND SQUARED CORNERS IN BOLD TEXT AND THE LETTERS "BLOC" IN ALL CAPITALS AND IN BOLD TEXT. THE LETTERS "BLOC" ARE SURROUNDED BY A SQUARED-OFF BORDER WITH THE TOP EDGE OF THE BORDER BEING FORMED BY THE BOTTOM EDGE OF THE NUMBER "9".

RIVEN

THE MARK CONSISTS OF STANDARD CHARACTERS WITHOUT CLAIM TO ANY PARTICULAR FONT, STYLE, SIZE, OR COLOR.

CLASS 9—ELECTRICAL AND SCIENTIFIC APPARATUS

FOR AUDIO AND VIDEO RECORDINGS FEATURING MUSIC AND ARTISTIC PERFORMANCES BY A MUSICAL BAND (U.S. CLS. 21, 23, 26, 36 AND 38).

CLASS 41—EDUCATION AND ENTERTAINMENT

FOR ENTERTAINMENT SERVICES, NAMELY, LIVE PERFORMANCES BY A MUSICAL BAND (U.S. CLS. 100, 101 AND 107).
BARBARA BROWN, EXAMINING ATTORNEY

CLASS 35—ADVERTISING AND BUSINESS

FOR COMPUTERIZED MONITORING OF GOODS IN TRANSIT THROUGH THE USE OF RADIO-FREQUENCY IDENTIFICATION, BAR CODES, THE INTERNET AND WIRELESS AND ELECTRONIC MEANS OF TRANSFERRING DATA; MONITORING OF SHIPMENTS OF GOODS THROUGH THE USE OF A GLOBAL COMPUTER NETWORK, INTERNET, BAR CODES OR RADIO-FREQUENCY IDENTIFICATION; COMPUTERIZED TRACKING OF LEASED PALLETS; TRACKING PALLETS BY MEANS OF RADIO-FREQUENCY IDENTIFICATION, BAR CODES, THE INTERNET AND WIRELESS AND ELECTRONIC MEANS (U.S. CLS. 100, 101 AND 102).

CLASS 37—CONSTRUCTION AND REPAIR

FOR REPAIR AND MAINTENANCE OF PALLETS (U.S. CLS. 100, 103 AND 106).

CLASS 39—TRANSPORTATION AND STORAGE

FOR PALLET POOLING SERVICES, NAMELY, CREATING A POOL OF PALLETS FOR TRANSPORTING AND PACKAGING OF GOODS FOR OTHERS; PALLET POOLING SERVICES, NAMELY, THE LEASING, RENTING, PURCHASING SELLING AND EXCHANGING OWNERSHIP OF PALLETS ON A POOLING BASIS INVOLVING THE CIRCULATION OF PALLETS BY AND BETWEEN DIFFERENT USERS, FOR TRANSPORTING AND PACKAGING OF GOODS FOR OTHERS; TRANSPORTING PALLETS BY TRUCK, TRAIN, AND AIR; WAREHOUSING AND STORING THE GOODS OF OTHERS; AND TRANSFERRING OWNERSHIP WITHIN THE POOL; LEASING AND RENTING OF PALLETS (U.S. CLS. 100 AND 105).
MICHAEL ENGEL, EXAMINING ATTORNEY

SN 85-508,202. GOODWILL COMMUNITY FOUNDATION, INC., DURHAM, NC. FILED 1-4-2012.

SN 85-508,351. AUSTRALIAN SHEPHERD CLUB OF AMERICA, INC., BRYAN, TX. FILED 1-4-2012.



THE MARK CONSISTS OF STYLIZED IMAGE OF A GIRL, BISECTED BY A VERTICAL LINE, WITH ONE SIDE OF THE FIGURE SHADED DARKER THAN THE OTHER, WITH THE WORD "GOOD" TO THE RIGHT OF THE FIGURE.

CLASS 35—ADVERTISING AND BUSINESS

FOR CHARITABLE SERVICES, NAMELY, COORDINATION OF NON-MONETARY CONTRIBUTIONS TO CHARITIES AND NON-PROFITS; CHARITABLE SERVICES, NAMELY, ORGANIZING AND DEVELOPING PROJECTS THAT AIM TO IMPROVE THE LIVES OF UNDERPRIVILEGED AND IMPOVERISHED PEOPLE; CHARITABLE SERVICES, NAMELY, PROVIDING OFFICE EQUIPMENT TO THOSE IN NEED; PROVIDING BUSINESS CONSULTING RELATING TO CHARITABLE FUNDRAISING TO NON-PROFIT ORGANIZATIONS (U.S. CLS. 100, 101 AND 102).

FIRST USE 6-24-2002; IN COMMERCE 6-24-2002.

CLASS 36—INSURANCE AND FINANCIAL

FOR CHARITABLE FUNDRAISING; CHARITABLE FUNDRAISING SERVICES BY MEANS OF COLLECTING AND REDEEMING RECYCLABLES FOR DONATION OF REDEMPTION PROCEEDS TO CHARITABLE ORGANIZATIONS; CHARITABLE FUNDRAISING SERVICES BY MEANS OF ORGANIZING AND CONDUCTING SPECIAL EVENTS; CHARITABLE FUNDRAISING SERVICES BY MEANS OF COLLECTING AND REDEEMING RECYCLABLES FOR DONATION OF REDEMPTION PROCEEDS TO NON-PROFIT CHARITABLE ORGANIZATIONS; CHARITABLE FUNDRAISING SERVICES BY MEANS OF PROVIDING GRANTS TO NON-PROFIT CHARITABLE ORGANIZATIONS; PROVIDING PHILANTHROPY AND FINANCIAL CONSULTING RELATING TO CHARITABLE FUNDRAISING TO NON-PROFIT ORGANIZATIONS; CHARITABLE FUNDRAISING TO SUPPORT EDUCATION, EMPLOYMENT AND LIFE ENRICHMENT OPPORTUNITIES FOR PERSONS WITH DISABILITIES OR OTHER DISADVANTAGING CIRCUMSTANCES (U.S. CLS. 100, 101 AND 102).

FIRST USE 6-24-2002; IN COMMERCE 6-24-2002.
LAURIE MAYES, EXAMINING ATTORNEY



THE MARK CONSISTS OF STYLIZED REPRESENTATION OF AN AUSTRALIAN SHEPHERD DOG WITH A CIRCLE BORDER.
SEC. 2(F).

CLASS 35—ADVERTISING AND BUSINESS

FOR MAINTAINING A REGISTRY OF BREEDS IN THE FIELD OF DOGS (U.S. CLS. 100, 101 AND 102).
FIRST USE 10-10-1979; IN COMMERCE 10-10-1979.

CLASS 41—EDUCATION AND ENTERTAINMENT

FOR DOG SHOWS (U.S. CLS. 100, 101 AND 107).
FIRST USE 10-10-1979; IN COMMERCE 10-10-1979.
KAPIL BHANOT, EXAMINING ATTORNEY

SN 85-508,704. DANGEROUS GOODS TRAINERS ASSOCIATION, INC., AKA DGTA, SAN LEANDRO, CA. FILED 1-4-2012.



NO CLAIM IS MADE TO THE EXCLUSIVE RIGHT TO USE "DANGEROUS GOODS TRAINERS ASSOCIATION", APART FROM THE MARK AS SHOWN.

THE COLOR(S) LIGHT GRAY, GRAY, WHITE, ORANGE, BLUE AND DARK BLUE IS/ARE CLAIMED AS A FEATURE OF THE MARK.

THE MARK CONSISTS OF A SHIELD WITH FOUR DIAMOND IN LIGHT GRAY AND GRAY OVER A BLUE AND DARK BLUE BACK GROUND ABOVE A DIAGONAL WHITE WAVY BAR AND ORANGE BACKGROUND AT THE BOTTOM OF THE SHIELD. THE SHIELD HAS A GRAY INNER BORDER AND BLUE AND DARK BLUE OUTER BORDER. THE LETTERS "D", "G", "T", "A" IN BLUE WITH UNDERLINED IN GRAY IS ABOVE THE WORDING "DANGEROUS GOODS TRAINERS ASSOCIATION" IN ORANGE ALL TO THE RIGHT OF THE SHIELD DESIGN.

CLASS 16—PAPER GOODS AND PRINTED MATTER

FOR PRINTED ANSWER SHEETS IN THE FIELD OF DANGEROUS GOODS TRANSPORTATION; PRINTED AWARD CERTIFICATES; PRINTED AWARDS; PRINTED EDUCATIONAL MATERIALS IN THE FIELD OF DANGEROUS GOODS TRANSPORTATION; PRINTED INSTRUCTIONAL, EDUCATIONAL, AND TEACHING MATERIALS IN THE FIELD OF DANGEROUS GOODS TRANSPORTATION; PRINTED MATERIALS, NAMELY, CURRICULA IN THE FIELD OF DANGEROUS GOODS TRANSPORTATION; PRINTED MATERIALS, NAMELY, WRITTEN ARTICLES IN THE FIELD OF DANGEROUS GOODS TRANSPORTATION; PRINTED NEWS RELEASES IN THE FIELD OF DANGEROUS GOODS TRANSPORTATION; PRINTED TEACHING MATERIALS IN THE FIELD OF DANGEROUS GOODS TRANSPORTATION; PRINTED TEACHING MATERIALS IN THE FIELD OF DANGEROUS GOODS TRANSPORTATION; PRINTED TRAINING MATERIALS IN THE FIELD OF DANGEROUS GOODS TRANSPORTATION (U.S. CLS. 2, 5, 22, 23, 29, 37, 38 AND 50).

FIRST USE 6-1-2009; IN COMMERCE 6-1-2009.

CLASS 41—EDUCATION AND ENTERTAINMENT

FOR EDUCATIONAL EXAMINATION SERVICES; EDUCATIONAL SERVICES IN THE NATURE OF DANGEROUS GOODS TRANSPORTATION TRAINING SCHOOLS; EDUCATIONAL SERVICES, NAMELY, CONDUCTING CLASSES, SEMINARS, WORKSHOPS, FORUMS AND CONFERENCES IN THE FIELDS OF DANGEROUS GOODS TRANSPORTATION AND DISTRIBUTION OF TRAINING MATERIALS IN CONNECTION THEREWITH; EDUCATIONAL SERVICES, NAMELY, CONDUCTING CLASSES, SEMINARS, WORKSHOPS, FORUMS AND CONFERENCES IN THE FIELD OF DANGEROUS GOODS TRANSPORTATION; EDUCATIONAL SERVICES, NAMELY, CONDUCTING CLASSES, SEMINARS, WORKSHOPS, FORUMS AND CONFERENCES IN THE FIELD OF DANGEROUS GOODS TRANSPORTATION; PUBLICATION OF BROCHURES; PUBLICATION OF DOCUMENTS IN THE FIELD OF TRAINING, SCIENCE, PUBLIC LAW AND SOCIAL AFFAIRS; PUBLICATION OF JOURNALS; PUBLICATION OF LEAFLETS; PUBLICATION OF MATTERS AFFECTING DANGEROUS GOODS TRANSPORTATION PROFESSIONALS, EDUCATIONAL MATERIALS, ARTICLES AND LEAFLETS ON DANGEROUS GOODS TRANSPORTATION AND EXAMINATION MATERIALS FOR TRAINERS IN THE FIELD OF DANGEROUS GOODS TRANSPORTATION (U.S. CLS. 100, 101 AND 107).

FIRST USE 6-1-2009; IN COMMERCE 6-1-2009.
SALLY SHIH, EXAMINING ATTORNEY

SN 85-508,916. STARMER JR, CHARLES F, PLANT CITY, FL. FILED 1-4-2012.

curiosity@work

THE MARK CONSISTS OF STANDARD CHARACTERS WITHOUT CLAIM TO ANY PARTICULAR FONT, STYLE, SIZE, OR COLOR.

OWNER OF U.S. REG. NO. 3,056,118.

CLASS 9—ELECTRICAL AND SCIENTIFIC APPARATUS

FOR COMPUTER PROGRAMS FOR USING THE INTERNET AND THE WORLD WIDE WEB; COMPUTER PROGRAMS FOR USING THE INTERNET AND THE WORLDWIDE WEB; COMPUTER SOFTWARE FOR THE COLLECTION, EDITING, ORGANIZING, MODIFYING, BOOK MARKING, TRANSMISSION, STORAGE AND SHARING OF DATA AND INFORMATION; COMPUTER SOFTWARE THAT PROVIDES WEB-BASED ACCESS TO APPLICATIONS AND SERVICES THROUGH A WEB OPERATING SYSTEM OR PORTAL INTERFACE (U.S. CLS. 21, 23, 26, 36 AND 38).

FIRST USE 5-1-2003; IN COMMERCE 12-1-2011.

CLASS 42—SCIENTIFIC AND COMPUTER SERVICES

FOR COMPUTER SERVICES, NAMELY, CREATING AN ON-LINE COMMUNITY FOR REGISTERED USERS TO PARTICIPATE IN DISCUSSIONS, GET FEEDBACK FROM THEIR PEERS, FORM VIRTUAL COMMUNITIES, AND ENGAGE IN SOCIAL NETWORKING SERVICES IN THE FIELD OF LEARNING AND INSTRUCTION; COMPUTER SERVICES, NAMELY, CREATING AN ON-LINE COMMUNITY FOR REGISTERED USERS TO LEARN, ACQUIRE ACCREDITATION, SHARE INSIGHTS; COMPUTER SERVICES, NAMELY, HOSTING AN INTERACTIVE WEB SITE THAT ALLOWS EARNING (U.S. CLS. 100 AND 101).

FIRST USE 12-1-2011; IN COMMERCE 12-1-2011.
JENNIFER VASQUEZ, EXAMINING ATTORNEY

SN 85-509,009. TABUE TECHNOLOGIES, L.P., DBA SHIBUE COUTURE, INC, HUNTINGTON BEACH, CA. FILED 1-5-2012.

Sex-a-Peel,

THE MARK CONSISTS OF STANDARD CHARACTERS WITHOUT CLAIM TO ANY PARTICULAR FONT, STYLE, SIZE, OR COLOR.

CLASS 25—CLOTHING

FOR DISPOSABLE UNDERWEAR; LADIES' UNDERWEAR; LINGERIE; LINGERIE ACCESSORIES, NAMELY, REMOVABLE SILICONE BREAST ENHANCER PADS USED IN A BRA; MEN'S UNDERWEAR; PARTS OF CLOTHING, NAMELY, GUSSETS FOR TIGHTS, GUSSETS FOR STOCKINGS, GUSSETS FOR BATHING SUITS, GUSSETS FOR UNDERWEAR, GUSSETS FOR LEOTARDS AND GUSSETS FOR FOOTLETS; THONGS; UNDERWEAR; WOMEN'S UNDERWEAR (U.S. CLS. 22 AND 39).

CLASS 45—PERSONAL AND LEGAL SERVICES

FOR PROVIDING FASHION INFORMATION IN THE FIELD OF DURABILITY, FIT AND STYLE OF LINGERIE PRODUCTS VIA THE INTERNET (U.S. CLS. 100 AND 101).

FRED CARL, EXAMINING ATTORNEY

SN 85-509,059. SCALETTA MOLONEY ARMORING CORP., DBA SCALETTA ARMORING, BEDFORD PARK, IL. FILED S.R. 1-5-2012; AM. P.R. 4-18-2012.

SN 85-510,479. GOODWILL COMMUNITY FOUNDATION, INC., DURHAM, NC. FILED 1-6-2012.



NO CLAIM IS MADE TO THE EXCLUSIVE RIGHT TO USE "ARMORING", APART FROM THE MARK AS SHOWN.

THE COLOR(S) BLACK, BLUE, WHITE IS/ARE CLAIMED AS A FEATURE OF THE MARK.

THE MARK CONSISTS OF THE FOLLOWING: THE WORD "SCALETТА" IN BLACK BLOCK LETTERS ABOVE THE WORD "ARMORING" IN ITALICIZED BLUE CAPITAL LETTERS, BOTH ABOVE THE WORDS "BUILT FOR LIFE" DEPICTED IN THE COLOR BLACK ALL TO THE LEFT A STYLIZED BLUE AND WHITE GLOBE DESIGN.

CLASS 12—VEHICLES

FOR ARMORED PASSENGER AND CARGO VEHICLES (U.S. CLS. 19, 21, 23, 31, 35 AND 44).

FIRST USE 10-15-2010; IN COMMERCE 3-15-2011.

CLASS 40—MATERIAL TREATMENT

FOR CUSTOM MANUFACTURING OF ARMORED PASSENGER AND CARGO VEHICLES (U.S. CLS. 100, 103 AND 106).

FIRST USE 10-15-2010; IN COMMERCE 3-15-2011.

CLASS 42—SCIENTIFIC AND COMPUTER SERVICES

FOR DESIGN AND ENGINEERING OF ARMORED PASSENGER AND CARGO VEHICLES (U.S. CLS. 100 AND 101).

FIRST USE 10-15-2010; IN COMMERCE 3-15-2011. BRIDGETT SMITH, EXAMINING ATTORNEY

SN 85-510,161. RIOT GAMES, INC., SANTA MONICA, CA. FILED 1-6-2012.

PENTAKILL

THE MARK CONSISTS OF STANDARD CHARACTERS WITHOUT CLAIM TO ANY PARTICULAR FONT, STYLE, SIZE, OR COLOR.

CLASS 9—ELECTRICAL AND SCIENTIFIC APPARATUS

FOR COMPUTER AND VIDEO GAME SOFTWARE (U.S. CLS. 21, 23, 26, 36 AND 38).

FIRST USE 10-27-2009; IN COMMERCE 10-27-2009.

CLASS 41—EDUCATION AND ENTERTAINMENT

FOR ENTERTAINMENT SERVICES, NAMELY, PROVIDING ON-LINE COMPUTER GAMES (U.S. CLS. 100, 101 AND 107).

FIRST USE 10-27-2009; IN COMMERCE 10-27-2009. ALEX KEAM, EXAMINING ATTORNEY



THE MARK CONSISTS OF STYLIZED IMAGE OF A GIRL, BISECTED BY A VERTICAL LINE, WITH ONE SIDE OF THE FIGURE SHADED DARKER THAN THE OTHER.

CLASS 35—ADVERTISING AND BUSINESS

FOR CHARITABLE SERVICES, NAMELY, COORDINATION OF NON-MONETARY CONTRIBUTIONS TO CHARITIES AND NON-PROFITS; CHARITABLE SERVICES, NAMELY, ORGANIZING AND DEVELOPING PROJECTS THAT AIM TO IMPROVE THE LIVES OF UNDERPRIVILEGED AND IMPOVERISHED PEOPLE; CHARITABLE SERVICES, NAMELY, PROVIDING OFFICE EQUIPMENT TO THOSE IN NEED; PROVIDING BUSINESS CONSULTING RELATING TO CHARITABLE FUNDRAISING TO NON-PROFIT ORGANIZATIONS (U.S. CLS. 100, 101 AND 102).

FIRST USE 6-24-2002; IN COMMERCE 6-24-2002.

CLASS 36—INSURANCE AND FINANCIAL

FOR CHARITABLE FUNDRAISING; CHARITABLE FUNDRAISING SERVICES BY MEANS OF COLLECTING AND REDEEMING RECYCLABLES FOR DONATION OF REDEMPTION PROCEEDS TO CHARITABLE ORGANIZATIONS; CHARITABLE FUNDRAISING SERVICES BY MEANS OF ORGANIZING AND CONDUCTING SPECIAL EVENTS; CHARITABLE FUNDRAISING SERVICES BY MEANS OF COLLECTING AND REDEEMING RECYCLABLES FOR DONATION OF REDEMPTION PROCEEDS TO NON-PROFIT CHARITABLE ORGANIZATIONS; CHARITABLE FUNDRAISING SERVICES BY MEANS OF PROVIDING GRANTS TO NON-PROFIT CHARITABLE ORGANIZATIONS; PROVIDING PHILANTHROPY AND FINANCIAL CONSULTING RELATING TO CHARITABLE FUNDRAISING TO NON-PROFIT ORGANIZATIONS; CHARITABLE FUNDRAISING TO SUPPORT EDUCATION, EMPLOYMENT AND LIFE ENRICHMENT OPPORTUNITIES FOR PERSONS WITH DISABILITIES OR OTHER DISADVANTAGING CIRCUMSTANCES (U.S. CLS. 100, 101 AND 102).

FIRST USE 6-24-2002; IN COMMERCE 6-24-2002. LAURIE MAYES, EXAMINING ATTORNEY

SN 85-510,652. ROSINK GMBH + CO. KG MASCHINEN-FABRIK, NORDHORD, FED REP GERMANY, FILED 1-6-2012.

SN 85-510,653. AXEL LTD. CO., IVENESS, FL. FILED 1-6-2012.



OWNER OF FED REP GERMANY REG. NO. 302010020390, DATED 10-26-2010, EXPIRES 5-31-2020.

THE MARK CONSISTS OF THE WORD "ROSINK" FEATURING A SQUARE BOX, HAVING A LIGHTER COLORED CIRCULAR DISK TOUCHING THE WALLS OF THE BOX AND A LIGHT COLORED COIL IN THE CIRCULAR DISK, OFF CENTERED TOWARD THE BOTTOM OF THE DISK.

CLASS 7—MACHINERY

FOR TEXTILE MACHINES FOR PROCESSING YARN, FIBERS AND TEXTILE THREADS, NAMELY, YARN BUNDLING MACHINES, YARN REELING MACHINES, YARN SLIVERING AND COMBINING MACHINES, YARN WINDING MACHINES; GRINDING MACHINES FOR MACHINING SPINNING ROLLS; CLEANING MACHINES FOR CLEANING INDUSTRIAL MANUFACTURED PARTS; PAINT REMOVING MACHINES; STEEL ROLLERS FOR USE IN TEXTILE MACHINES AND PRINTING MACHINES, DYEING MACHINES, CALENDARS AND WASHING MACHINES (U.S. CLS. 13, 19, 21, 23, 31, 34 AND 35).

CLASS 11—ENVIRONMENTAL CONTROL APPARATUS

FOR FINNED TUBES FOR THE PURPOSE OF HEAT TRANSFER SOLD AS AN INTEGRAL COMPONENT OF HEAT EXCHANGERS, NOT BEING PARTS OF MACHINES (U.S. CLS. 13, 21, 23, 31 AND 34).

CLASS 20—FURNITURE AND ARTICLES NOT OTHERWISE CLASSIFIED

FOR FURNITURE (U.S. CLS. 2, 13, 22, 25, 32 AND 50).

CLASS 42—SCIENTIFIC AND COMPUTER SERVICES

FOR CONSULTANCY IN THE FIELD OF INTERIOR AND ARCHITECTURAL DESIGN AND FURNISHING (U.S. CLS. 100 AND 101).

KEVIN DINALLO, EXAMINING ATTORNEY

IMORE

THE MARK CONSISTS OF STANDARD CHARACTERS WITHOUT CLAIM TO ANY PARTICULAR FONT, STYLE, SIZE, OR COLOR.

CLASS 35—ADVERTISING AND BUSINESS

FOR MARKETING SERVICES, NAMELY, PROVIDING INFORMATIONAL WEB PAGES DESIGNED TO GENERATE SALES TRAFFIC VIA HYPERLINKS TO OTHER WEB SITES; ON-LINE RETAIL STORE SERVICES FEATURING DOWNLOADABLE RING TONES; ONLINE RETAIL STORE SERVICES FEATURING CONSUMER ELECTRONICS AND TELECOMMUNICATION PRODUCTS AND ACCESSORIES; PROVIDING ON-LINE DIRECTORY INFORMATION SERVICES ALSO FEATURING HYPERLINKS TO OTHER WEB SITES (U.S. CLS. 100, 101 AND 102).

FIRST USE 1-5-2012; IN COMMERCE 1-5-2012.

CLASS 42—SCIENTIFIC AND COMPUTER SERVICES

FOR COMPUTER SERVICES, NAMELY, CREATING AN ONLINE COMMUNITY FOR REGISTERED USERS TO ENGAGE IN SOCIAL NETWORKING, GIVE AND RECEIVE PEER-TO-PEER HELP AND FEEDBACK FOR SKILL AND KNOWLEDGE BUILDING, AND SHOWCASE THEIR TALENTS; COMPUTER SERVICES, NAMELY, REDIRECTING ELECTRONIC MAIL TO CHANGED PERSONAL ELECTRONIC ADDRESS (U.S. CLS. 100 AND 101).

FIRST USE 1-5-2012; IN COMMERCE 1-5-2012.

EDWARD NELSON, EXAMINING ATTORNEY

SN 85-511,090. KOBER, JAMES, HAUPPAUGE, NY. FILED 1-7-2012.

ASSETSHIELD

THE MARK CONSISTS OF STANDARD CHARACTERS WITHOUT CLAIM TO ANY PARTICULAR FONT, STYLE, SIZE, OR COLOR.

CLASS 35—ADVERTISING AND BUSINESS

FOR BUSINESS SERVICES, NAMELY, CATALOGING ONE'S ASSETS WITHIN THEIR HOME VIA PROFESSIONAL PHOTOGRAPHS AND VIDEOGRAPHY, NAMELY, COMPILATION AND SYSTEMIZATION OF INFORMATION INTO COMPUTER DATABASES; AND PROVIDING AN ASSET INVENTORY IN THE EVENT OF FIRE, THEFT, NATURAL DISASTER OR DIVORCE, NAMELY, INVENTORY CONTROL AND INVENTORY MANAGEMENT (U.S. CLS. 100, 101 AND 102).

CLASS 45—PERSONAL AND LEGAL SERVICES

FOR PROVIDING AN ASSET INVENTORY IN THE EVENT OF FIRE, THEFT, NATURAL DISASTER OR DIVORCE, NAMELY, COMPILING INVENTORIES OF PERSONAL ITEMS FOR OTHERS FOR INSURANCE OR SECURITY PURPOSES (U.S. CLS. 100 AND 101).

ROBERT STRUCK, EXAMINING ATTORNEY

SN 85-511,822. INDUSTRIALIZADORA INTEGRAL DEL AGAVE S.A. DE C.V., TLAQUEPAQUE, JALISCO, MEXICO, FILED 1-9-2012.



THE MARK CONSISTS OF THE WORD "SWITTER" IN SPECIAL HANDWRITING, UNDERLINED BY A CURVED LINE. THE SECOND LETTER "T" HAS ON THE TOP THE DESIGN OF LEAVES.

THE WORDING "SWITTER" HAS NO MEANING IN A FOREIGN LANGUAGE.

CLASS 5—PHARMACEUTICALS

FOR DIETETIC SUGAR FOR MEDICAL USE; DIETETIC SUGAR SUBSTITUTES FOR MEDICAL USE; MEDICAL DIAGNOSTIC REAGENTS AND ASSAYS FOR TESTING BODY FLUIDS FOR MICROORGANISMS; SUGAR REPLACEMENT FOR MEDICINAL OR THERAPEUTIC PURPOSES (U.S. CLS. 6, 18, 44, 46, 51 AND 52).

CLASS 30—STAPLE FOODS

FOR NATURAL SWEETENER (U.S. CL. 46).
ELI HELLMAN, EXAMINING ATTORNEY

SN 85-512,097. 900 FILMS, INC., VISTA, CA. FILED 1-9-2012.



THE COLOR(S) BLACK, WHITE AND RED IS/ARE CLAIMED AS A FEATURE OF THE MARK.

THE MARK CONSISTS OF A WHITE "R" AND A RED TRIANGLE INSIDE A BLACK SQUARE WITH ROUNDED CORNERS.

CLASS 38—COMMUNICATION

FOR AUDIO-VIDEO BROADCASTING SERVICES OVER CABLE, THE INTERNET AND OTHER COMMUNICATIONS NETWORKS, NAMELY, SHOWING, DISPLAYING AND ELECTRONICALLY TRANSMITTING INFORMATION, AUDIO-VIDEO CLIPS; SATELLITE TELEVISION BROADCASTING; BROADCASTING OVER THE INTERNET; AUDIO-VIDEO BROADCASTING TO TELEPHONES, MOBILE ELECTRONIC DEVICES; AUDIO-VIDEO BROADCASTING TO HANDHELD ELECTRONIC DEVICES (U.S. CLS. 100, 101 AND 104).

CLASS 41—EDUCATION AND ENTERTAINMENT

FOR ENTERTAINMENT IN THE NATURE OF PROVIDING AN INFORMATIONAL AND ENTERTAINMENT WEBSITE IN THE FIELDS OF CELEBRITY NEWS, CURRENT EVENTS NEWS, INTERVIEWS, MUSIC AND SPORTS; ENTERTAINMENT SERVICES, NAMELY, PROVIDING A WEBSITE FEATURING NON-DOWNLOADABLE AUDIO-VIDEO CLIPS, INTERVIEWS, MUSICAL PERFORMANCES, MUSICAL VIDEOS, FILM CLIPS, PHOTOGRAPHS, OTHER MULTIMEDIA MATERIALS, IN THE FIELD OF ENTERTAINMENT; ON-LINE JOURNALS, NAMELY, BLOGS FEATURING CELEBRITY NEWS, CURRENT EVENTS NEWS, INTERVIEWS, MUSIC, AND SPORTS; ENTERTAINMENT SERVICES, NAMELY, CONTINUING PROGRAMS ABOUT CELEBRITY NEWS, INTERVIEWS, MUSIC, MUSICIANS, CURRENT EVENTS NEWS AND SPORTS ACCESSIBLE BY SATELLITE AND COMPUTER NETWORKS; TELEVISION PROGRAM SYNDICATION; PRODUCTION OF DVDS FEATURING CELEBRITY NEWS, CURRENT EVENTS NEWS AND SPORTS; PRODUCTION OF TELEVISION PROGRAMS; PRODUCTION OF CONTENT FOR ENTERTAINMENT WEBSITES (U.S. CLS. 100, 101 AND 107).

JAMES GRIFFIN, EXAMINING ATTORNEY

SN 85-512,758. AMERISOURCEBERGEN DRUG CORPORATION, CHESTERBROOK, PA. FILED 1-10-2012.



OWNER OF U.S. REG. NOS. 723,984, 3,512,962 AND OTHERS.

NO CLAIM IS MADE TO THE EXCLUSIVE RIGHT TO USE THE PRESCRIPTION SYMBOL "RX" AND "PHARMACY", APART FROM THE MARK AS SHOWN.

THE COLOR(S) RED AND BLUE IS/ARE CLAIMED AS A FEATURE OF THE MARK.

THE MARK CONSISTS OF A BLUE MORTAR AND PESTLE AND PRESCRIPTION SYMBOL, AND THE WORDING "GOOD NEIGHBOR PHARMACY" IN RED. THE PRESCRIPTION SYMBOL AND THE OUTLINE OF THE MORTAR AND PESTLE ARE OF A LIGHT BLUE COLOR. THE MARK ALSO HAS A RECTANGULAR DARK BLUE BORDER EXTENDING AROUND THE WORDS AND OTHER DESIGN ELEMENTS. THE COLOR WHITE INSIDE THE RECTANGULAR BORDER IS TRANSPARENT AS BACKGROUND AND IS NOT CLAIMED AS A FEATURE OF THE MARK.

CLASS 16—PAPER GOODS AND PRINTED MATTER

FOR PRINTED PUBLICATIONS, NAMELY, FLYERS AND BROCHURES FEATURING INFORMATION, NEWS AND COMMENTARY IN THE FIELD OF HEALTH AND WELLNESS RELATING TO HEALTHY DIETS AND ACTIVITIES FOR MALE AND FEMALE INFANTS, CHILDREN, TEENAGERS, ADULTS AND SENIORS AND TO ILLNESSES AND TREATMENTS AFFECTING THEM (U.S. CLS. 2, 5, 22, 23, 29, 37, 38 AND 50).

FIRST USE 9-30-2011; IN COMMERCE 9-30-2011.

CLASS 20—FURNITURE AND ARTICLES NOT OTHERWISE CLASSIFIED

FOR PLASTIC VIALS IN THE NATURE OF CONTAINERS FOR MEDICATIONS SOLD EMPTY FOR COMMERCIAL USE AND PLASTIC CAPS FOR USE THEREON (U.S. CLS. 2, 13, 22, 25, 32 AND 50).

FIRST USE 9-30-2011; IN COMMERCE 9-30-2011.

CLASS 35—ADVERTISING AND BUSINESS

FOR RETAIL DRUG STORE SERVICES (U.S. CLS. 100, 101 AND 102).

FIRST USE 9-30-2011; IN COMMERCE 9-30-2011.

CLASS 44—MEDICAL, BEAUTY AND AGRICULTURAL SERVICES

FOR PROVIDING ON-LINE INFORMATION, NEWS AND COMMENTARY IN THE FIELD OF HEALTH AND WELLNESS RELATING TO HEALTHY DIETS AND ACTIVITIES FOR MALE AND FEMALE INFANTS, CHILDREN, TEENAGERS, ADULTS AND SENIORS AND TO ILLNESSES AND TREATMENTS AFFECTING THEM (U.S. CLS. 100 AND 101).

FIRST USE 9-30-2011; IN COMMERCE 9-30-2011.

KIMBERLY PERRY, EXAMINING ATTORNEY

CLASS 9—ELECTRICAL AND SCIENTIFIC APPARATUS

FOR COMPUTER HARDWARE, NAMELY, MOTHERBOARDS; COMPUTER SERVERS FOR USE WITH COMPUTER NETWORKS AND COMPUTER WORKSTATIONS; COMPUTER SYSTEM COMPRISED OF CLUSTERING MULTIPLE SERVERS MOTHERBOARDS AND COMPUTER MEMORIES SOLD TOGETHER AS A UNIT; COMPUTER SERVER SYSTEMS CONSISTING OF MOTHERBOARDS, CHASSIS, CENTRAL PROCESSING UNITS, MEMORY MODULES, MEMORY CARDS, HARD DRIVES, POWER SUPPLIES AND SYSTEM COOLING FANS, SOLD TOGETHER AS A UNIT; COMPUTER OPERATING PROGRAMS WITH ACCOMPANYING DOCUMENTATION DISTRIBUTED THEREWITH; COMPUTER SOFTWARE FOR PROVIDING AND MANAGING ACCESS TO COMPUTER SOFTWARE AND HARDWARE ON OTHER SERVERS AMONG MULTIPLE COMPUTER SERVERS; COMPUTER SOFTWARE FOR MONITORING, MANAGING, MAINTAINING, CONFIGURING AND PREVENTING AND REACTING TO FAILURE OF COMPUTER SERVERS; A COMPUTER SYSTEM, NAMELY, A CHASSIS WITH A POWER SUPPLY SUBSYSTEM AND A COOLING SUBSYSTEM; MOUNTING HOUSINGS, CAGES, RACKS AND FRAMES FOR MOUNTING MULTIPLE SERVERS; COMPUTER CHASSIS; COMPUTER SOFTWARE, NAMELY, COMPUTER OPERATING PROGRAMS WITH ACCOMPANYING DOCUMENTATION DISTRIBUTED THEREWITH; COMPUTER PROGRAMS FOR PROVIDING AND MANAGING ACCESS TO COMPUTER SOFTWARE AND HARDWARE ON OTHER SERVERS AMONG MULTIPLE COMPUTER SERVERS; COMPUTER PROGRAMS FOR MONITORING, MANAGING, MAINTAINING, CONFIGURING AND PREVENTING AND REACTING TO FAILURE OF COMPUTER SERVERS; COMPUTER UTILITY PROGRAMS FOR SERVER SYSTEMS WITH ACCOMPANYING DOCUMENTATION DISTRIBUTED THEREWITH; COMPUTER HARDWARE; COMPUTER SERVERS; COMPUTER SEMICONDUCTOR CHIPS (U.S. CLS. 21, 23, 26, 36 AND 38).

CLASS 37—CONSTRUCTION AND REPAIR

FOR MAINTENANCE OF COMPUTER HARDWARE; TECHNICAL SUPPORT SERVICES, NAMELY, TROUBLESHOOTING AND REPAIR OF COMPUTER HARDWARE (U.S. CLS. 100, 103 AND 106).

CLASS 42—SCIENTIFIC AND COMPUTER SERVICES

FOR GLOBAL COMPUTER NETWORK AND COMPUTER CONSULTING SERVICES; MAINTENANCE OF COMPUTER SOFTWARE; TECHNICAL SUPPORT SERVICES, NAMELY, TROUBLESHOOTING OF COMPUTER SOFTWARE PROBLEMS (U.S. CLS. 100 AND 101).

EDWARD NELSON, EXAMINING ATTORNEY

SN 85-513,022. SUPER MICRO COMPUTER, INC., SAN JOSE, CA. FILED 1-10-2012.

SN 85-513,026. SUPER MICRO COMPUTER, INC., SAN JOSE, CA. FILED 1-10-2012.

SMCI

FATTWIN

THE MARK CONSISTS OF STANDARD CHARACTERS WITHOUT CLAIM TO ANY PARTICULAR FONT, STYLE, SIZE, OR COLOR.

THE MARK CONSISTS OF STANDARD CHARACTERS WITHOUT CLAIM TO ANY PARTICULAR FONT, STYLE, SIZE, OR COLOR.

OWNER OF U.S. REG. NOS. 3,788,239 AND 3,862,733.

CLASS 9—ELECTRICAL AND SCIENTIFIC APPARATUS

FOR COMPUTER HARDWARE, NAMELY, MOTHERBOARDS; COMPUTER SERVERS FOR USE WITH COMPUTER NETWORKS AND COMPUTER WORKSTATIONS; COMPUTER SYSTEM COMPRISED OF CLUSTERING MULTIPLE SERVERS MOTHERBOARDS AND COMPUTER MEMORIES SOLD TOGETHER AS A UNIT; COMPUTER SERVER SYSTEMS CONSISTING OF MOTHERBOARDS, CHASSIS, CENTRAL PROCESSING UNITS, MEMORY MODULES, MEMORY CARDS, HARD DRIVES, POWER SUPPLIES AND SYSTEM COOLING FANS, SOLD TOGETHER AS A UNIT; COMPUTER OPERATING PROGRAMS WITH ACCOMPANYING DOCUMENTATION DISTRIBUTED THEREWITH; COMPUTER SOFTWARE FOR PROVIDING AND MANAGING ACCESS TO COMPUTER SOFTWARE AND HARDWARE ON OTHER SERVERS AMONG MULTIPLE COMPUTER SERVERS; COMPUTER SOFTWARE FOR MONITORING, MANAGING, MAINTAINING, CONFIGURING AND PREVENTING AND REACTING TO FAILURE OF COMPUTER SERVERS; A COMPUTER SYSTEM, NAMELY, A CHASSIS WITH A POWER SUPPLY SUBSYSTEM AND A COOLING SUBSYSTEM; MOUNTING HOUSINGS, CAGES, RACKS AND FRAMES FOR MOUNTING MULTIPLE SERVERS; COMPUTER CHASSIS; COMPUTER SOFTWARE, NAMELY, COMPUTER OPERATING PROGRAMS WITH ACCOMPANYING DOCUMENTATION DISTRIBUTED THEREWITH; COMPUTER PROGRAMS FOR PROVIDING AND MANAGING ACCESS TO COMPUTER SOFTWARE AND HARDWARE ON OTHER SERVERS AMONG MULTIPLE COMPUTER SERVERS; COMPUTER PROGRAMS FOR MONITORING, MANAGING, MAINTAINING, CONFIGURING AND PREVENTING AND REACTING TO FAILURE OF COMPUTER SERVERS; COMPUTER UTILITY PROGRAMS FOR SERVER SYSTEMS WITH ACCOMPANYING DOCUMENTATION DISTRIBUTED THEREWITH; COMPUTER HARDWARE; COMPUTER SERVERS; COMPUTER SEMICONDUCTOR CHIPS (U.S. CLS. 21, 23, 26, 36 AND 38).

CLASS 9—ELECTRICAL AND SCIENTIFIC APPARATUS

FOR COMPUTER HARDWARE, NAMELY, MOTHERBOARDS; COMPUTER SERVERS FOR USE WITH COMPUTER NETWORKS AND COMPUTER WORKSTATIONS; COMPUTER SYSTEM COMPRISED OF CLUSTERING MULTIPLE SERVERS MOTHERBOARDS AND COMPUTER MEMORIES SOLD TOGETHER AS A UNIT; COMPUTER SERVER SYSTEMS CONSISTING OF MOTHERBOARDS, CHASSIS, CENTRAL PROCESSING UNITS, MEMORY MODULES, MEMORY CARDS, HARD DRIVES, POWER SUPPLIES AND SYSTEM COOLING FANS, SOLD TOGETHER AS A UNIT; COMPUTER OPERATING PROGRAMS WITH ACCOMPANYING DOCUMENTATION DISTRIBUTED THEREWITH; COMPUTER SOFTWARE FOR PROVIDING AND MANAGING ACCESS TO COMPUTER SOFTWARE AND HARDWARE ON OTHER SERVERS AMONG MULTIPLE COMPUTER SERVERS; COMPUTER SOFTWARE FOR MONITORING, MANAGING, MAINTAINING, CONFIGURING AND PREVENTING AND REACTING TO FAILURE OF COMPUTER SERVERS; A COMPUTER SYSTEM, NAMELY, A CHASSIS WITH A POWER SUPPLY SUBSYSTEM AND A COOLING SUBSYSTEM; MOUNTING HOUSINGS, CAGES, RACKS AND FRAMES FOR MOUNTING MULTIPLE SERVERS; COMPUTER CHASSIS; COMPUTER SOFTWARE, NAMELY, COMPUTER OPERATING PROGRAMS WITH ACCOMPANYING DOCUMENTATION DISTRIBUTED THEREWITH; COMPUTER PROGRAMS FOR PROVIDING AND MANAGING ACCESS TO COMPUTER SOFTWARE AND HARDWARE ON OTHER SERVERS AMONG MULTIPLE COMPUTER SERVERS; COMPUTER PROGRAMS FOR MONITORING, MANAGING, MAINTAINING, CONFIGURING AND PREVENTING AND REACTING TO FAILURE OF COMPUTER SERVERS; COMPUTER UTILITY PROGRAMS FOR SERVER SYSTEMS WITH ACCOMPANYING DOCUMENTATION DISTRIBUTED THEREWITH; COMPUTER HARDWARE; COMPUTER SERVERS; COMPUTER SEMICONDUCTOR CHIPS (U.S. CLS. 21, 23, 26, 36 AND 38).

CLASS 37—CONSTRUCTION AND REPAIR

FOR MAINTENANCE OF COMPUTER HARDWARE; TECHNICAL SUPPORT SERVICES, NAMELY, TROUBLESHOOTING AND REPAIR OF COMPUTER HARDWARE (U.S. CLS. 100, 103 AND 106).

CLASS 37—CONSTRUCTION AND REPAIR

FOR MAINTENANCE OF COMPUTER HARDWARE; TECHNICAL SUPPORT SERVICES, NAMELY, TROUBLESHOOTING AND REPAIR OF COMPUTER HARDWARE (U.S. CLS. 100, 103 AND 106).

CLASS 42—SCIENTIFIC AND COMPUTER SERVICES

FOR GLOBAL COMPUTER NETWORK AND COMPUTER CONSULTING SERVICES; MAINTENANCE OF COMPUTER SOFTWARE; TECHNICAL SUPPORT SERVICES, NAMELY, TROUBLESHOOTING OF COMPUTER SOFTWARE PROBLEMS (U.S. CLS. 100 AND 101).
EDWARD NELSON, EXAMINING ATTORNEY

CLASS 42—SCIENTIFIC AND COMPUTER SERVICES

FOR GLOBAL COMPUTER NETWORK AND COMPUTER CONSULTING SERVICES; MAINTENANCE OF COMPUTER SOFTWARE; TECHNICAL SUPPORT SERVICES, NAMELY, TROUBLESHOOTING OF COMPUTER SOFTWARE PROBLEMS (U.S. CLS. 100 AND 101).
EDWARD NELSON, EXAMINING ATTORNEY

SN 85-513,032. SUPER MICRO COMPUTER, INC., SAN JOSE, CA. FILED 1-10-2012.

SN 85-513,041. SUPER MICRO COMPUTER, INC., SAN JOSE, CA. FILED 1-10-2012.

FSMCI

FFAT TWIN

THE MARK CONSISTS OF STANDARD CHARACTERS WITHOUT CLAIM TO ANY PARTICULAR FONT, STYLE, SIZE, OR COLOR.

THE MARK CONSISTS OF STANDARD CHARACTERS WITHOUT CLAIM TO ANY PARTICULAR FONT, STYLE, SIZE, OR COLOR.
OWNER OF U.S. REG. NOS. 3,788,239 AND 3,862,733.

CLASS 9—ELECTRICAL AND SCIENTIFIC APPARATUS

FOR COMPUTER HARDWARE, NAMELY, MOTHERBOARDS; COMPUTER SERVERS FOR USE WITH COMPUTER NETWORKS AND COMPUTER WORKSTATIONS; COMPUTER SYSTEM COMPRISED OF CLUSTERING MULTIPLE SERVERS MOTHERBOARDS AND COMPUTER MEMORIES SOLD TOGETHER AS A UNIT; COMPUTER SERVER SYSTEMS CONSISTING OF MOTHERBOARDS, CHASSIS, CENTRAL PROCESSING UNITS, MEMORY MODULES, MEMORY CARDS, HARD DRIVES, POWER SUPPLIES AND SYSTEM COOLING FANS, SOLD TOGETHER AS A UNIT; COMPUTER OPERATING PROGRAMS WITH ACCOMPANYING DOCUMENTATION DISTRIBUTED THEREWITH; COMPUTER SOFTWARE FOR PROVIDING AND MANAGING ACCESS TO COMPUTER SOFTWARE AND HARDWARE ON OTHER SERVERS AMONG MULTIPLE COMPUTER SERVERS; COMPUTER SOFTWARE FOR MONITORING, MANAGING, MAINTAINING, CONFIGURING AND PREVENTING AND REACTING TO FAILURE OF COMPUTER SERVERS; A COMPUTER SYSTEM, NAMELY, A CHASSIS WITH A POWER SUPPLY SUBSYSTEM AND A COOLING SUBSYSTEM; MOUNTING HOUSINGS, CAGES, RACKS AND FRAMES FOR MOUNTING MULTIPLE SERVERS; COMPUTER CHASSIS; COMPUTER SOFTWARE, NAMELY, COMPUTER OPERATING PROGRAMS WITH ACCOMPANYING DOCUMENTATION DISTRIBUTED THEREWITH; COMPUTER PROGRAMS FOR PROVIDING AND MANAGING ACCESS TO COMPUTER SOFTWARE AND HARDWARE ON OTHER SERVERS AMONG MULTIPLE COMPUTER SERVERS; COMPUTER PROGRAMS FOR MONITORING, MANAGING, MAINTAINING, CONFIGURING AND PREVENTING AND REACTING TO FAILURE OF COMPUTER SERVERS; COMPUTER UTILITY PROGRAMS FOR SERVER SYSTEMS WITH ACCOMPANYING DOCUMENTATION DISTRIBUTED THEREWITH (U.S. CLS. 21, 23, 26, 36 AND 38).

CLASS 37—CONSTRUCTION AND REPAIR

FOR MAINTENANCE OF COMPUTER HARDWARE; TECHNICAL SUPPORT SERVICES, NAMELY, TROUBLESHOOTING AND REPAIR OF COMPUTER HARDWARE (U.S. CLS. 100, 103 AND 106).

CLASS 42—SCIENTIFIC AND COMPUTER SERVICES

FOR GLOBAL COMPUTER NETWORK AND COMPUTER CONSULTING SERVICES; MAINTENANCE OF COMPUTER SOFTWARE; TECHNICAL SUPPORT SERVICES, NAMELY, TROUBLESHOOTING OF COMPUTER SOFTWARE PROBLEMS (U.S. CLS. 100 AND 101).

EDWARD NELSON, EXAMINING ATTORNEY

SN 85-513,344. 40K GLOBAL, LLC, KINGWOOD, TX. FILED 1-10-2012.

4 Our KIDS Learning Academy

THE MARK CONSISTS OF STANDARD CHARACTERS WITHOUT CLAIM TO ANY PARTICULAR FONT, STYLE, SIZE, OR COLOR.

NO CLAIM IS MADE TO THE EXCLUSIVE RIGHT TO USE "KIDS" OR "LEARNING ACADEMY", APART FROM THE MARK AS SHOWN.

CLASS 41—EDUCATION AND ENTERTAINMENT

FOR EDUCATION SERVICES, NAMELY, PROVIDING KINDERGARTEN CLASSROOM INSTRUCTION (U.S. CLS. 100, 101 AND 107).

CLASS 43—HOTEL AND RESTAURANT SERVICES

FOR CHILD CARE SERVICES; PRESCHOOLER AND INFANT CARE AT DAYCARE CENTERS; PROVIDING CHILD CARE CENTERS; PROVIDING DAY CARE CENTERS (U.S. CLS. 100 AND 101).

JEFFREY LOOK, EXAMINING ATTORNEY

SN 85-513,365. 40K GLOBAL, LLC, KINGWOOD, TX. FILED 1-10-2012.



NO CLAIM IS MADE TO THE EXCLUSIVE RIGHT TO USE "KIDS" OR "LEARNING ACADEMY", APART FROM THE MARK AS SHOWN.

THE COLOR(S) DARK PURPLE, LIGHT PURPLE, DARK YELLOW, LIGHT YELLOW, RED, DARK GREEN, LIGHT GREEN, BLACK AND WHITE IS/ARE CLAIMED AS A FEATURE OF THE MARK.

THE MARK CONSISTS OF FOUR VERTICALLY SUCCESSIVE LINES OF TEXT ON A WHITE BACKGROUND. THE FIRST LINE CONSISTS OF AN ARABIC NUMERAL "4", WHICH IS FORMED BY A VERTICAL DARK PURPLE CRAYON, A HORIZONTAL DARK GREEN CRAYON AND A DIAGONAL DARK YELLOW CRAYON, AND WHICH IS FOLLOWED BY THE WORD "OUR" IN A PLAIN BLACK FONT. THE SECOND LINE CONSISTS OF THE WORD "KIDS", AND APPEARS TO BE FORMED OF CHILDREN'S ALPHABET BLOCKS, EACH LETTER BEING SURROUNDED BY WHITE SPACE AND ENCLOSED WITHIN A RECTANGULAR FRAME, AND THE SUCCESSIVE BLOCKS ALTERNATE IN VERTICAL POSITION. THE LETTER "K" AND ITS FRAME ARE LIGHT PURPLE, THE LETTER "I" AND ITS FRAME ARE LIGHT YELLOW, THE LETTER "D" AND ITS FRAME ARE RED, AND THE LETTER "S" AND ITS FRAME ARE LIGHT GREEN. THE THIRD LINE CONSISTS OF THE WORDS "LEARNING ACADEMY" IN A BLACK FONT. THE FOURTH LINE CONSISTS OF THE WORDS "WHERE KIDS COME FIRST" IN QUOTATION MARKS, IN AN ITALICIZED BLACK FONT.

CLASS 41—EDUCATION AND ENTERTAINMENT

FOR EDUCATION SERVICES, NAMELY, PROVIDING KINDERGARTEN CLASSROOM INSTRUCTION (U.S. CLS. 100, 101 AND 107).

CLASS 43—HOTEL AND RESTAURANT SERVICES

FOR CHILD CARE SERVICES; PRESCHOOLER AND INFANT CARE AT DAYCARE CENTERS; PROVIDING CHILD CARE CENTERS; PROVIDING DAY CARE CENTERS (U.S. CLS. 100 AND 101).

JEFFREY LOOK, EXAMINING ATTORNEY

SN 85-514,310. ENGAGE HEALTHCARE COMMUNICATIONS, LLC, MONROE TOWNSHIP, NJ. FILED 1-11-2012.

SN 85-514,375. TIM HORTONS USA INC., DUBLIN, OH. FILED 1-11-2012.

PROCESS IMPROVEMENTS TO ENHANCE PATIENT CARE

THE MARK CONSISTS OF STANDARD CHARACTERS WITHOUT CLAIM TO ANY PARTICULAR FONT, STYLE, SIZE, OR COLOR.

NO CLAIM IS MADE TO THE EXCLUSIVE RIGHT TO USE "PROCESS IMPROVEMENTS" OR "PATIENT CARE", APART FROM THE MARK AS SHOWN.

CLASS 9—ELECTRICAL AND SCIENTIFIC APPARATUS

FOR PROVIDING DOWNLOADABLE ELECTRONIC MAGAZINES, JOURNALS, NEWSLETTERS, FEATURE REPORTS, MONOGRAPHS AND ELECTRONIC SUPPLEMENTS TO THE FOREGOING IN THE FIELDS OF MEDICINE, HEALTHCARE, MEDICAL PRACTICE MANAGEMENT, PATIENT CARE COORDINATION, AND NURSING ADMINISTRATION (U.S. CLS. 21, 23, 26, 36 AND 38).

FIRST USE 8-1-2010; IN COMMERCE 4-1-2011.

CLASS 16—PAPER GOODS AND PRINTED MATTER

FOR PRINTED PUBLICATIONS, NAMELY, PEER REVIEWED MEDICAL MAGAZINES, JOURNALS, NEWSLETTERS, FEATURE REPORTS, MONOGRAPHS, AND PRINTED SUPPLEMENTS TO THE FOREGOING IN THE FIELDS OF MEDICINE, HEALTHCARE, MEDICAL PRACTICE MANAGEMENT, PATIENT CARE COORDINATION, AND NURSING ADMINISTRATION (U.S. CLS. 2, 5, 22, 23, 29, 37, 38 AND 50).

FIRST USE 8-1-2010; IN COMMERCE 4-1-2011.

CLASS 35—ADVERTISING AND BUSINESS

FOR ADVERTISING SERVICES, NAMELY, PROVIDING ADVERTISING SPACE IN MAGAZINES, JOURNALS, NEWSLETTERS, FEATURE REPORTS AND MAGAZINE SUPPLEMENTS TO NEWSPAPERS THAT CONCERN INFORMATION IN THE FIELDS OF HEMATOLOGY AND ONCOLOGY; ADVERTISING SERVICES, NAMELY, PROVIDING SPACE AT A WEB SITE FOR THE ADVERTISEMENT OF THE GOODS AND SERVICES OF OTHERS CONCERNING INFORMATION IN THE FIELDS OF HEMATOLOGY AND ONCOLOGY (U.S. CLS. 100, 101 AND 102).

FIRST USE 8-1-2010; IN COMMERCE 4-1-2011.

CLASS 41—EDUCATION AND ENTERTAINMENT

FOR ONLINE EDUCATIONAL SERVICES, NAMELY, PROVIDING CONTINUING EDUCATION COURSES AND EXAMS IN THE FIELDS OF MEDICINE, HEALTHCARE, MEDICAL PRACTICE MANAGEMENT, PATIENT CARE COORDINATION, AND NURSING ADMINISTRATION VIA A GLOBAL COMPUTER INFORMATION NETWORK (U.S. CLS. 100, 101 AND 107).

FIRST USE 8-1-2010; IN COMMERCE 4-1-2011.
DAWN HAN, EXAMINING ATTORNEY

WHERE QUALITY MEETS VALUE

THE MARK CONSISTS OF STANDARD CHARACTERS WITHOUT CLAIM TO ANY PARTICULAR FONT, STYLE, SIZE, OR COLOR.

CLASS 29—MEATS AND PROCESSED FOODS

FOR SOUPS, CHILI, FRUIT SALADS, VEGETABLE SALADS; HASH BROWN POTATOES; MILK-BASED COLD BEVERAGES, NAMELY, SHAKES AND ICED SHAKES (U.S. CL. 46).

CLASS 30—STAPLE FOODS

FOR PREPARED FOODS, NAMELY, DONUTS, DONUT HOLES, MUFFINS, COOKIES, PASTRIES, CAKES, TEA BISCUITS, CROISSANTS, BAGELS, PIES, SANDWICHES, NON-ALCOHOLIC BEVERAGES, NAMELY, COFFEE, ESPRESSO, CAPPUCCINO, TEA, HOT CHOCOLATE; MILK-BASED HOT AND COLD BEVERAGES, NAMELY, CAFE LATTE, AND ICE CREAM FLOATS; COFFEE-BASED HOT AND COLD BEVERAGES, NAMELY, CAFE MOCHA, ICED CAPPUCCINO, ICED MOCHA CAPPUCCINO AND ICED COFFEE; COFFEE BEANS AND GROUND COFFEE BEANS; CEREAL, NAMELY, OATMEAL (U.S. CL. 46).

CLASS 32—LIGHT BEVERAGES

FOR FRUIT JUICES, VEGETABLE JUICES, SOFT DRINKS, BOTTLED WATER, ICED LEMONADE, FRUIT SMOOTHIES, AND SLUSH TYPE SOFT DRINKS (U.S. CLS. 45, 46 AND 48).

RAUL CORDOVA, EXAMINING ATTORNEY

SN 85-515,672. BARDACH, NOAH ARTHUR, SANTA MONICA, CA. FILED 1-13-2012.

GO FER IT!

THE MARK CONSISTS OF STANDARD CHARACTERS WITHOUT CLAIM TO ANY PARTICULAR FONT, STYLE, SIZE, OR COLOR.

CLASS 35—ADVERTISING AND BUSINESS

FOR TRANSPORTATION LOGISTICS SERVICES, NAMELY, ARRANGING AND COORDINATING THE TRANSPORTATION AND DELIVERY OF GOODS FOR OTHERS AND FACILITATING COMMERCIAL TRANSACTIONS BETWEEN COURIERS AND THOSE SEEKING COURIER SERVICES (U.S. CLS. 100, 101 AND 102).

CLASS 39—TRANSPORTATION AND STORAGE

FOR COURIER SERVICES (U.S. CLS. 100 AND 105).
JULIE GUTTADAURO, EXAMINING ATTORNEY

SN 85-515,677. ROHM AND HAAS COMPANY, PHILADELPHIA, PA. FILED 1-13-2012.

SN 85-517,623. YELLOW PLUM, INC, CHICAGO, IL. FILED 1-17-2012.

NANOTRACE

THE MARK CONSISTS OF STANDARD CHARACTERS WITHOUT CLAIM TO ANY PARTICULAR FONT, STYLE, SIZE, OR COLOR.

OWNER OF U.S. REG. NOS. 1,712,912, 2,317,129 AND 2,404,547.

CLASS 1—CHEMICALS

FOR CHEMICALS AND CHEMICAL PREPARATIONS FOR USE IN INDUSTRY, NAMELY, CHEMICALS AND CHEMICAL MARKERS USED IN LIQUIDS IN THE PETROLEUM INDUSTRY FOR REGULATORY, QUALITY AND BRAND PURPOSES (U.S. CLS. 1, 5, 6, 10, 26 AND 46).

CLASS 2—PAINTS

FOR DYES FOR GENERAL INDUSTRIAL USE, NAMELY, DYES USED IN LIQUIDS IN THE PETROLEUM INDUSTRY FOR REGULATORY, QUALITY AND BRAND PURPOSES; COLORANTS, NAMELY, MARKING COLORANTS USED IN LIQUIDS IN THE PETROLEUM INDUSTRY FOR REGULATORY, QUALITY AND BRAND PURPOSES (U.S. CLS. 6, 11 AND 16).

ROBERT C. CLARK JR., EXAMINING ATTORNEY

SN 85-515,718. THE UPTICK GROUP, LLC, PEMBROKE PARK, FL. FILED 1-13-2012.

The Uptick Group

THE MARK CONSISTS OF STANDARD CHARACTERS WITHOUT CLAIM TO ANY PARTICULAR FONT, STYLE, SIZE, OR COLOR.

NO CLAIM IS MADE TO THE EXCLUSIVE RIGHT TO USE "GROUP", APART FROM THE MARK AS SHOWN.

CLASS 35—ADVERTISING AND BUSINESS

FOR ACCOUNTING SERVICES; BUSINESS ADVISORY SERVICES, CONSULTANCY AND INFORMATION; BUSINESS ASSISTANCE, MANAGEMENT AND INFORMATION SERVICES; BUSINESS PROCESS OUTSOURCING SERVICES IN THE FIELD OF ACCOUNTING, SUPPLY CHAIN MANAGEMENT AND FULFILLMENT; GOODS IMPORT-EXPORT AGENCIES; SUPPLY CHAIN MANAGEMENT SERVICES (U.S. CLS. 100, 101 AND 102).

FIRST USE 1-5-2012; IN COMMERCE 1-5-2012.

CLASS 41—EDUCATION AND ENTERTAINMENT

FOR ADVISORY AND CONSULTING SERVICES IN THE FIELD OF MANAGEMENT COACHING AND BUSINESS TRAINING FOCUSED ON BUSINESS STRATEGY, SALES, OPERATIONS AND DIRECT IMPORTING (U.S. CLS. 100, 101 AND 107).

FIRST USE 1-5-2012; IN COMMERCE 1-5-2012.
MARY ROSSMAN, EXAMINING ATTORNEY

YELLOW PLUM

THE MARK CONSISTS OF STANDARD CHARACTERS WITHOUT CLAIM TO ANY PARTICULAR FONT, STYLE, SIZE, OR COLOR.

CLASS 25—CLOTHING

FOR CLOTHING FOR WOMEN, NAMELY, COATS, JACKETS, VESTS, CAPES, BLAZERS, SWEATERS, SWEATSHIRTS, SOCKS, TIGHTS, LEGGINGS, SHIRTS, T-SHIRTS, BLOUSES, PANTS, JEANS, LINGERIE, DRESSES, SKIRTS, SWIM WEAR, BELTS OF LEATHER AND IMITATION LEATHER; FOOTWEAR INCLUDING SHOES, BOOTS, SANDALS; AND ACCESSORIES, NAMELY, SCARVES, HATS, AND GLOVES; CLOTHING FOR MEN, NAMELY, COATS, JACKETS, BLAZERS, CASUAL AND DRESS SHOES, SHIRTS, JEANS, PANTS, NECK TIES, SCARVES, HATS, AND BELTS (U.S. CLS. 22 AND 39).

CLASS 35—ADVERTISING AND BUSINESS

FOR RETAIL STORE AND ONLINE RETAIL STORE SERVICES FEATURING MEN'S AND WOMEN'S FOOTWEAR, CLOTHING, AND ACCESSORIES, NAMELY, BAGS, WATCHES, SCARVES, HOSIERY, SUNGLASSES, HATS, AND HAIR ACCESSORIES (U.S. CLS. 100, 101 AND 102).

GENE MACIOL, EXAMINING ATTORNEY

SN 85-517,799. A E STRUTHERS LIMITED, GLENROTHES, UNITED KINGDOM, FILED 1-17-2012.



PRIORITY CLAIMED UNDER SEC. 44(D) ON UNITED KINGDOM APPLICATION NO. 2588870, FILED 7-22-2011.

THE MARK CONSISTS OF THE LITERAL ELEMENT "RYAN & O'DONNELL" APPEARING IN A STYLIZED SCRIPT WITH A STYLIZED DESIGNED ELEMENT CONSISTING OF A SILHOUETTE OF A FEMALE FIGURE DANCING.

CLASS 25—CLOTHING

FOR CLOTHING, NAMELY, DANCE COSTUMES, TIGHTS; HEADWEAR, FOOTWEAR, DANCE SHOES, DANCE PUMPS, SANDALS (U.S. CLS. 22 AND 39).

CLASS 35—ADVERTISING AND BUSINESS

FOR ONLINE RETAIL STORE SERVICES AND MAIL ORDER CATALOG SERVICES FEATURING CLOTHING, NAMELY, DANCE COSTUMES, TIGHTS; ONLINE RETAIL STORE SERVICES AND MAIL ORDER CATALOG SERVICES FEATURING HEADGEAR, FOOTWEAR, DANCE SHOES, DANCE PUMPS (U.S. CLS. 100, 101 AND 102).

GENE MACIOL, EXAMINING ATTORNEY

SN 85-517,868. ANCESTRY.COM OPERATIONS INC., PROVO, UT. FILED 1-17-2012.

SN 85-517,869. ANCESTRY.COM OPERATIONS INC., PROVO, UT. FILED 1-17-2012.

Ancestry.ca

Ancestry.co.uk

THE MARK CONSISTS OF STANDARD CHARACTERS WITHOUT CLAIM TO ANY PARTICULAR FONT, STYLE, SIZE, OR COLOR.

OWNER OF U.S. REG. NOS. 3,566,509, 3,852,700 AND OTHERS.

SEC. 2(F).

THE MARK CONSISTS OF STANDARD CHARACTERS WITHOUT CLAIM TO ANY PARTICULAR FONT, STYLE, SIZE, OR COLOR.

OWNER OF U.S. REG. NOS. 3,566,509, 3,852,700 AND OTHERS.

SEC. 2(F).

CLASS 42—SCIENTIFIC AND COMPUTER SERVICES

FOR APPLICATION SERVICE PROVIDER SERVICES FEATURING SOFTWARE FOR USE IN CREATING, DISPLAYING, SHARING AND STORING MULTIMEDIA PRESENTATIONS THAT INCLUDE PHOTOGRAPHS AND SOUND, ALL IN THE FIELD OF GENEALOGY AND FAMILY HISTORY; PROVIDING TEMPORARY USE OF NON-DOWNLOADABLE COMPUTER SOFTWARE FOR USE IN CREATING, DISPLAYING, SHARING AND STORING MULTIMEDIA PRESENTATIONS THAT INCLUDE PHOTOGRAPHS AND SOUND, ALL IN THE FIELD OF GENEALOGY AND FAMILY HISTORY; PROVIDING TEMPORARY USE OF NON-DOWNLOADABLE COMPUTER SOFTWARE THAT ENABLES FAMILY GROUPS TO CREATE AND MAINTAIN PERSONALIZED WEBSITES FOR THE PURPOSE OF SHARING INFORMATION REGARDING FAMILY MEMBERS; HOSTING OF DIGITAL CONTENT ON THE INTERNET, NAMELY, HOSTING ON-LINE JOURNALS AND BLOGS IN THE FIELD OF GENEALOGY AND FAMILY HISTORY; COMPUTER SERVICES, NAMELY, HOSTING AND MAINTAINING AN ONLINE WEBSITE FOR OTHERS TO ACCESS PHOTO ALBUMS AND CALENDARS; PROVIDING TEMPORARY USE OF NON-DOWNLOADABLE COMPUTER SOFTWARE FOR USE IN THE CREATION AND PUBLICATION OF ON-LINE JOURNALS AND BLOGS IN THE FIELD OF GENEALOGY AND FAMILY HISTORY (U.S. CLS. 100 AND 101).

FIRST USE 6-0-2006; IN COMMERCE 6-0-2006.

CLASS 45—PERSONAL AND LEGAL SERVICES

FOR PROVISION OF GENEALOGICAL INFORMATION, NAMELY, PROVISION OF EDUCATIONAL, RESEARCH AND HISTORICAL TABLES OF GENEALOGICAL INFORMATION; PROVIDING GENEALOGICAL INFORMATION, NAMELY, FAMILY HISTORY INFORMATION SERVICES, NAMELY, RETRIEVING, RECORDING AND REVIEWING ANCESTRAL DATA VIA THE GLOBAL COMPUTER NETWORK; CONSULTANCY, INFORMATION AND ADVISORY SERVICES RELATING TO THE AFORESAID; AND PROVIDING AN ON-LINE COMPUTER DATABASE IN THE FIELD OF GENEALOGY INFORMATION AND FAMILY HISTORY INFORMATION; GENEALOGICAL SERVICES, NAMELY, GENEALOGY RESEARCH, PROVIDED IN PERSON AND VIA THE INTERNET (U.S. CLS. 100 AND 101).

FIRST USE 6-0-2006; IN COMMERCE 6-0-2006.

LEIGH CAROLINE CASE, EXAMINING ATTORNEY

CLASS 42—SCIENTIFIC AND COMPUTER SERVICES

FOR APPLICATION SERVICE PROVIDER SERVICES FEATURING SOFTWARE FOR USE IN CREATING, DISPLAYING, SHARING AND STORING MULTIMEDIA PRESENTATIONS THAT INCLUDE PHOTOGRAPHS AND SOUND, ALL IN THE FIELD OF GENEALOGY AND FAMILY HISTORY; PROVIDING TEMPORARY USE OF NON-DOWNLOADABLE COMPUTER SOFTWARE FOR USE IN CREATING, DISPLAYING, SHARING AND STORING MULTIMEDIA PRESENTATIONS THAT INCLUDE PHOTOGRAPHS AND SOUND, ALL IN THE FIELD OF GENEALOGY AND FAMILY HISTORY; PROVIDING TEMPORARY USE OF NON-DOWNLOADABLE COMPUTER SOFTWARE THAT ENABLES FAMILY GROUPS TO CREATE AND MAINTAIN PERSONALIZED WEBSITES FOR THE PURPOSE OF SHARING INFORMATION REGARDING FAMILY MEMBERS; HOSTING OF DIGITAL CONTENT ON THE INTERNET, NAMELY, HOSTING ON-LINE JOURNALS AND BLOGS IN THE FIELD OF GENEALOGY AND FAMILY HISTORY; COMPUTER SERVICES, NAMELY, HOSTING AND MAINTAINING AN ONLINE WEBSITE FOR OTHERS TO ACCESS PHOTO ALBUMS AND CALENDARS; PROVIDING TEMPORARY USE OF NON-DOWNLOADABLE COMPUTER SOFTWARE FOR USE IN THE CREATION AND PUBLICATION OF ON-LINE JOURNALS AND BLOGS IN THE FIELD OF GENEALOGY AND FAMILY HISTORY (U.S. CLS. 100 AND 101).

FIRST USE 0-0-2002; IN COMMERCE 0-0-2002.

CLASS 45—PERSONAL AND LEGAL SERVICES

FOR PROVISION OF GENEALOGICAL INFORMATION, NAMELY, PROVISION OF EDUCATIONAL, RESEARCH AND HISTORICAL TABLES OF GENEALOGICAL INFORMATION; PROVIDING GENEALOGICAL INFORMATION, NAMELY, FAMILY HISTORY INFORMATION SERVICES, NAMELY, RETRIEVING, RECORDING AND REVIEWING ANCESTRAL DATA VIA THE GLOBAL COMPUTER NETWORK; CONSULTANCY, INFORMATION AND ADVISORY SERVICES RELATING TO THE AFORESAID; AND PROVIDING AN ON-LINE COMPUTER DATABASE IN THE FIELD OF GENEALOGY INFORMATION AND FAMILY HISTORY INFORMATION; GENEALOGICAL SERVICES, NAMELY, GENEALOGY RESEARCH, PROVIDED IN PERSON AND VIA THE INTERNET (U.S. CLS. 100 AND 101).

FIRST USE 0-0-2002; IN COMMERCE 0-0-2002.

LEIGH CAROLINE CASE, EXAMINING ATTORNEY

SN 85-518,367. MYLAWSUIT.COM, INC, WOODSIDE, CA.
FILED 1-17-2012.

MyLawsuit.com

THE MARK CONSISTS OF STANDARD CHARACTERS WITHOUT CLAIM TO ANY PARTICULAR FONT, STYLE, SIZE, OR COLOR.

CLASS 35—ADVERTISING AND BUSINESS

FOR BUSINESS SERVICES, NAMELY, PROVIDING AN ONLINE NETWORK FOR LEGAL SERVICES CONTRACTORS TO RECEIVE LEADS AND BIDDING OPPORTUNITIES BY MEANS OF AN ONLINE MARKETPLACE FOR THE PURPOSE OF DEVELOPING BUSINESS IN THE LEGAL SERVICES INDUSTRY; COMPUTERIZED ON-LINE RETAIL STORE SERVICES IN THE FIELD OF LEGAL OFFICE SUPPLIES, OFFICE EQUIPMENT, INCLUDING ENVELOPES, INDEX BOOKS, INDEX CARDS, INDEX DIVIDERS, LEGAL FORMS, PAPER FILING SUPPLIES, NAMELY, FILE JACKETS, FILING POCKETS, NON-LEATHER FILING WALLETS, FOLDERS, BINDERS AND MINUTE BOOKS (U.S. CLS. 100, 101 AND 102).

FIRST USE 10-10-2007; IN COMMERCE 12-3-2007.

CLASS 45—PERSONAL AND LEGAL SERVICES

FOR PROVIDING AN ON-LINE INTERACTIVE DATABASE FEATURING LEGAL INFORMATION (U.S. CLS. 100 AND 101).

FIRST USE 10-10-2007; IN COMMERCE 12-3-2007.

JEAN IM, EXAMINING ATTORNEY

SN 85-518,404. DARLING, JUDY ANN, BELLEVILLE, MI.
FILED 1-17-2012.

**TRANSFORMING TEACHERS
ABOVE AND BEYOND**

THE MARK CONSISTS OF STANDARD CHARACTERS WITHOUT CLAIM TO ANY PARTICULAR FONT, STYLE, SIZE, OR COLOR.

OWNER OF U.S. REG. NO. 3,175,504.

NO CLAIM IS MADE TO THE EXCLUSIVE RIGHT TO USE "TEACHERS", APART FROM THE MARK AS SHOWN.

CLASS 41—EDUCATION AND ENTERTAINMENT

FOR EDUCATIONAL SERVICES, NAMELY, PROVIDING WORKSHOPS AND SEMINARS, ONSITE IN THE CHILD CARE FACILITY SETTING, FOR PARENTS AND TEACHERS IN THE FIELDS OF EARLY CHILDHOOD DEVELOPMENT AND EDUCATION, MOTIVATION AND INSPIRATION; GROUP, PROFESSIONAL AND PERSONAL COACHING TO PROVIDE EDUCATIONAL SUPPORT FOR PARENTS AND TEACHERS IN THE FIELD OF EARLY CHILDHOOD DEVELOPMENT AND EDUCATION, MOTIVATION AND INSPIRATION (U.S. CLS. 100, 101 AND 107).

CLASS 45—PERSONAL AND LEGAL SERVICES

FOR PROVIDING EMOTIONAL COUNSELING SERVICES TO PROVIDE EMOTIONAL SUPPORT FOR PARENTS AND TEACHERS IN THE FIELDS OF EARLY CHILDHOOD DEVELOPMENT AND EDUCATION, MOTIVATION, AND INSPIRATION; ORGANIZING AND CONDUCTING SUPPORT GROUPS TO PROVIDE EMOTIONAL SUPPORT FOR PARENTS AND TEACHERS IN THE FIELDS OF EARLY CHILDHOOD DEVELOPMENT AND EDUCATION, MOTIVATION AND INSPIRATION (U.S. CLS. 100 AND 101).

ELLEN B. AWRICH, EXAMINING ATTORNEY

SN 85-518,552. TATE TECHNOLOGY, LLC, DBA TATE TECHNOLOGY, LLC, PACIFIC PALISADES, CA. FILED 1-17-2012.

TATE TECHNOLOGY, LLC



NO CLAIM IS MADE TO THE EXCLUSIVE RIGHT TO USE "TECHNOLOGY, LLC", APART FROM THE MARK AS SHOWN.

THE COLOR(S) BLACK, WHITE, RED, GREY AND GOLD IS/ARE CLAIMED AS A FEATURE OF THE MARK.

THE MARK CONSISTS OF THE WORDING "TATE TECHNOLOGY, LLC" IN BLACK LOCATED DIRECTLY OVER A CREST OR COAT OF ARMS DESIGN COMPRISING A SHIELD OF SIX BOXES ALTERNATING IN RED AND WHITE WITH A BLACK BIRD IN EACH OF THE WHITE BOXES, AND ABOVE THE SHIELD IS HELMET IN WHITE, GREY, AND BLACK WITH A BRAID AND FEATHERS IN WHITE AND RED, AND FOUR STYLIZED LEAVES IN RED AND WHITE EMANATING FROM THE HELMET WITH GOLD TASSELS AT THE END OF EACH LEAF, AND ON THE BOTTOM IS THE WORDING "TATE" IN BLACK FEATURED INSIDE A WHITE BANNER OUTLINED IN BLACK.

CLASS 9—ELECTRICAL AND SCIENTIFIC APPARATUS

FOR PROTECTION AND SAFETY APPARATUS, NAMELY, INFLATABLE FLOTATION DEVICES; PROTECTIVE HELMETS FOR SPORTS; PROTECTIVE SPORTS HELMET ACCESSORIES THAT ATTACH TO THE HELMETS, NAMELY, MOUTH GUARDS, EAR PADS, THROAT PROTECTORS, CHIN STRAPS, FACE MASKS, JAW PADS AND EYE SHIELDS; SAFETY HELMETS; SPORTS HELMETS (U.S. CLS. 21, 23, 26, 36 AND 38).

CLASS 28—TOYS AND SPORTING GOODS

FOR CHEST PROTECTORS WORN BY HUMANS FOR SPORTS, SPECIFICALLY FOOTBALL, MOTOCROSS, HOCKEY, SKIING; FACE MASKS FOR FOOTBALL, MOTOCROSS, HOCKEY, SKIING; PROTECTIVE PADDING FOR PLAYING CONTACT AND NON-CONTACT SPORTS REQUIRING OR USING PADDING, SPECIFICALLY FOOTBALL, MOTOCROSS, HOCKEY, SKIING; PROTECTIVE PADDING FOR SHOULDERS AND ELBOWS USED SPECIFICALLY IN FOOTBALL, MOTOCROSS, HOCKEY, SKIING (U.S. CLS. 22, 23, 38 AND 50).
AMY KELLY, EXAMINING ATTORNEY

SKILLSHARKS

SN 85-518,853. ESI INTERNATIONAL, INC., ARLINGTON, VA. FILED 1-18-2012.

THE MARK CONSISTS OF STANDARD CHARACTERS WITHOUT CLAIM TO ANY PARTICULAR FONT, STYLE, SIZE, OR COLOR.

CLASS 9—ELECTRICAL AND SCIENTIFIC APPARATUS

FOR COMPUTER SOFTWARE FOR TRAINING IN THE FIELDS OF PROJECT MANAGEMENT, BUSINESS ANALYSIS, BUSINESS SKILLS, AND CONTRACT MANAGEMENT (U.S. CLS. 21, 23, 26, 36 AND 38).

CLASS 16—PAPER GOODS AND PRINTED MATTER

FOR PRINTED PUBLICATIONS, NAMELY, TRAINING MATERIALS, INSTRUCTIONAL MANUALS, TESTING MATERIALS, BOOKS, NEWSLETTERS, PAMPHLETS AND BROCHURES IN THE FIELDS OF PROJECT MANAGEMENT, BUSINESS ANALYSIS, BUSINESS SKILLS, CONTRACT MANAGEMENT, COMPUTER SOFTWARE MANAGEMENT, AND GOVERNMENT RELATIONS (U.S. CLS. 2, 5, 22, 23, 29, 37, 38 AND 50).

CLASS 35—ADVERTISING AND BUSINESS

FOR CONSULTING SERVICES IN THE FIELD OF BUSINESS, BUSINESS PROJECT MANAGEMENT, BUSINESS SKILLS, AND PUBLIC ADMINISTRATION (U.S. CLS. 100, 101 AND 102).

CLASS 41—EDUCATION AND ENTERTAINMENT

FOR EDUCATIONAL TRAINING SERVICES IN THE FIELDS OF PROJECT MANAGEMENT, BUSINESS ANALYSIS, BUSINESS SKILLS, CONTRACT MANAGEMENT, COMPUTER SOFTWARE MANAGEMENT, AND GOVERNMENT RELATIONS (U.S. CLS. 100, 101 AND 107).
DOMINIC FATHY, EXAMINING ATTORNEY

SN 85-519,237. DIRTT ENVIRONMENTAL SOLUTIONS, LTD, CALGARY, CANADA, FILED 1-18-2012.

DIRTT

THE MARK CONSISTS OF STANDARD CHARACTERS WITHOUT CLAIM TO ANY PARTICULAR FONT, STYLE, SIZE, OR COLOR.
OWNER OF U.S. REG. NO. 3,176,427.

CLASS 6—METAL GOODS

FOR METAL BUILDING MATERIALS, NAMELY, MODULAR WALLS, WINDOWS, FLOORING, DOOR FRAMES, WINDOW FRAMES AND WALL FRAMES (U.S. CLS. 2, 12, 13, 14, 23, 25 AND 50).

CLASS 19—NON-METALLIC BUILDING MATERIALS

FOR NON-METAL BUILDING MATERIALS, NAMELY, MODULAR WALLS, WINDOWS, FLOORING, AND CORRESPONDING FRAMES, ALL PRIMARILY MADE OF NON-METAL (U.S. CLS. 1, 12, 33 AND 50).

CLASS 20—FURNITURE AND ARTICLES NOT OTHERWISE CLASSIFIED

FOR OFFICE INTERIORS, NAMELY, OFFICE FURNITURE, MOVEABLE PARTITIONS AND FREE STANDING PARTITIONS (U.S. CLS. 2, 13, 22, 25, 32 AND 50).
DAVID MURRAY, EXAMINING ATTORNEY

SN 85-519,336. SALA, ENRIC, WASHINGTON, DC. FILED 1-18-2012.

FISH BANKS

THE MARK CONSISTS OF STANDARD CHARACTERS WITHOUT CLAIM TO ANY PARTICULAR FONT, STYLE, SIZE, OR COLOR.

NO CLAIM IS MADE TO THE EXCLUSIVE RIGHT TO USE "FISH", APART FROM THE MARK AS SHOWN.

CLASS 35—ADVERTISING AND BUSINESS

FOR BUSINESS CONSULTING IN THE FIELD OF ENVIRONMENTAL MANAGEMENT, NAMELY, ADVISING BUSINESSES AND INDIVIDUALS ON ISSUES OF ENVIRONMENTAL IMPACT, CONSERVATION, PRESERVATION AND PROTECTION, AND ECONOMIC ANALYSIS FOR BUSINESS PURPOSES (U.S. CLS. 100, 101 AND 102).

CLASS 36—INSURANCE AND FINANCIAL

FOR FINANCIAL INVESTMENT IN THE FIELD OF OCEAN AND COASTAL COMMUNITY CONSERVATION (U.S. CLS. 100, 101 AND 102).
EMILY CARLSEN, EXAMINING ATTORNEY

SN 85-519,411. MARCOS AURELIO MUÑOZ TORRES, LEÓN, GUANAJUATO, MEXICO, FILED 1-18-2012.



THE MARK CONSISTS OF AN IMAGE OF AN INKED ANIMAL PAW ENCLOSED IN A CIRCLE.

CLASS 25—CLOTHING

FOR CLOTHING, NAMELY, SHIRTS, T-SHIRTS, PANTS, SHORTS, AND SWEATSHIRTS; SHOES (U.S. CLS. 22 AND 39).

CLASS 35—ADVERTISING AND BUSINESS

FOR RETAIL STORE SERVICES FEATURING CLOTHING AND SHOES (U.S. CLS. 100, 101 AND 102).
KAPIL BHANOT, EXAMINING ATTORNEY

SN 85-519,464. DREAMWORKS ANIMATION L.L.C., GLENDALE, CA. FILED 1-18-2012.



OWNER OF U.S. REG. NOS. 2,326,951, 3,370,649 AND OTHERS.

THE COLOR(S) BLACK, GRAY, BLUE, GREEN, RED, WHITE AND BROWN IS/ARE CLAIMED AS A FEATURE OF THE MARK.

THE MARK CONSISTS OF AN IMAGE OF A DRAGON ABOVE AND TO THE LEFT OF AN IMAGE OF A BOY SITTING AND FISHING ON THE MOON. THE BOY SITTING AND FISHING ON THE MOON IS TO THE LEFT OF THE WORD "DREAMWORKS". BOTH THE BOY AND THE WORD "DREAMWORKS" ARE CENTERED ABOVE THE LARGER WORD "DRAGONS". THE LETTERS "D", "R" AND PART OF THE LETTER "A" OF THE WORD "DRAGONS" ARE IN FRONT OF THE IMAGE OF THE DRAGON. THE DRAGON'S RIGHT FOOT IS RESTING ON THE LETTER "D" AND ITS LEFT FOOT IS RESTING ON THE LETTER "R". THE DRAGON'S TAIL HANGS CENTERED AND CURVED BELOW THE WORD "DRAGONS". THE COLOR BLACK APPEARS IN THE EYES, HEAD, BODY, LEGS, WINGS AND TAIL OF THE DRAGON, IN THE SHADING AROUND THE WORD "DRAGONS". IN THE BOY SITTING AND FISHING ON THE MOON AND THE WORD "DREAMWORKS"; THE COLOR GRAY APPEARS IN THE HEAD, BODY, LEGS, WINGS AND TAIL OF THE

DRAGON AND IN THE SHADING AROUND THE WORD "DRAGONS"; THE COLOR BLUE APPEARS IN THE HEAD, BODY, LEGS, WINGS AND TAIL OF THE DRAGON; THE COLOR GREEN APPEARS IN THE DRAGON'S EYES, THE COLOR RED APPEARS IN THE WORD "DRAGONS" AND IN THE TAIL OF THE DRAGON; THE COLOR WHITE APPEARS IN THE SKIN, TEETH AND NAILS OF THE DRAGON AND IN THE SHADING AROUND THE WORD "DRAGONS"; THE COLOR BROWN APPEARS IN THE TAIL OF THE DRAGON.

CLASS 9—ELECTRICAL AND SCIENTIFIC APPARATUS

FOR COMPUTER GAME SOFTWARE FOR WIRELESS AND ELECTRONIC MOBILE DEVICES, MOBILE PHONES AND HAND-HELD ELECTRONIC DEVICES; COMPUTER GAME SOFTWARE, ELECTRONIC GAME PROGRAMS, ELECTRONIC GAME SOFTWARE FOR HANDHELD ELECTRONIC DEVICES; VIDEO GAME SOFTWARE; COMPUTER GAME DISCS; VIDEO GAME CARTRIDGES, VIDEO GAME DISCS; PRERECORDED CDS FEATURING MUSIC AND MOTION PICTURE SOUND TRACKS; PRERECORDED VIDEO DISKS AND DVDS FEATURING ANIMATED MOTION PICTURES; PRERECORDED OPTICAL AND MAGNETO-OPTICAL DISCS FEATURING MUSIC AND ANIMATED MOTION PICTURES; MULTIMEDIA SOFTWARE RECORDED ON CD ROM FEATURING MUSIC, MOTION PICTURE SOUNDTRACKS AND ANIMATED MOTION PICTURES; INTERACTIVE MULTIMEDIA SOFTWARE PROGRAMS CONTAINING ANIMATED MOTION PICTURES FOR ENTERTAINMENT; INTERACTIVE MULTI-MEDIA SOFTWARE FOR PLAYING GAMES; MAGNETS AND SUNGLASSES; HAND-HELD UNIT FOR PLAYING ELECTRONIC GAMES ADAPTED FOR USE WITH AN EXTERNAL DISPLAY SCREEN OR MONITOR; ANIMATED CARTOONS RECORDED ON DVDS; EXPOSED CINEMATOGRAPHIC FILM (U.S. CLS. 21, 23, 26, 36 AND 38).

CLASS 16—PAPER GOODS AND PRINTED MATTER

FOR PAPER PARTY DECORATIONS; PAPER PARTY SUPPLIES, NAMELY, PAPER NAPKINS, PAPER PLACE MATS, GIFTWRAPPING PAPER AND PAPER GIFT WRAPPING RIBBONS, PAPER GIFT WRAP BOWS, PAPER TABLE CLOTHS AND PAPER PARTY BAGS; CHILDREN'S ACTIVITY BOOKS, CHILDREN'S STORYBOOKS, COMIC BOOKS, COLORING BOOKS, BOOK MARKS, LOOSE LEAF BINDERS, STATIONERY-TYPE PORTFOLIOS, WIRE-BOUND NOTEBOOKS, NOTE PADS OR WRITING PADS, DIARIES, DAILY PLANNERS, CALENDARS, SCRAPBOOK ALBUMS, SKETCHBOOK ALBUMS, PHOTOGRAPH ALBUMS, STICKER ALBUMS, STICKERS, DECALS, STAMP PADS OR INKING PADS, RUBBER STAMPS, HEAT APPLIED APPLIQUES IN THE FORM OF DECALS MADE OF PAPER, TEMPORARY TATTOOS, SLATEBOARDS FOR WRITING, PENCILS, PENS, PENCIL ERASERS, DECORATIVE PENCIL-TOP ORNAMENTS, PEN CASES AND PENCIL CASES, PEN BOXES AND PENCIL BOXES, PENCIL SHARPENERS, CHALK, MARKERS, POSTERS, POSTCARDS, TRADING CARDS, GREETING CARDS, PENNANTS MADE OF PAPER, PAINTING SETS FOR CHILDREN; ARTS AND CRAFTS PAINT KITS; STUDY KITS, CONSISTING OF PENCIL ERASERS, DRAWING RULERS, PENCIL SHARPENERS AND PENCIL CASE; STATIONERY PACKS CONSISTING OF WRITING PAPER, ENVELOPES, MARKERS, AND STENCILS; AND ACTIVITY KITS CONSISTING OF STICKERS AND RUBBER STAMPS (U.S. CLS. 2, 5, 22, 23, 29, 37, 38 AND 50).

CLASS 25—CLOTHING

FOR SHIRTS AND TOPS, DRESSES, SKIRTS, PANTS, TROUSERS, JEANS, SHORTS, ROMPERS, OVERALLS, SWEATSHIRTS AND SWEAT PANTS, SWEATSUITS, CAPS AND HATS, GLOVES, SUSPENDERS, TIES, COATS AND JACKETS, HOSIERY, SHOES, BOOTS, SLIPPERS, PAJAMAS, ROBES, SLEEPSHIRTS, SLEEPWEAR, UNDERWEAR, HALLOWEEN COSTUMES, AND CLOTH BABY BIBS (U.S. CLS. 22 AND 39).

CLASS 28—TOYS AND SPORTING GOODS

FOR ACTION FIGURES AND ACCESSORIES THEREFOR, BATHTUB TOYS, KITES, TOY BUILDING BLOCKS, BOARD GAMES, COSTUME MASKS, HAND-HELD UNIT FOR PLAYING ELECTRONIC GAMES OTHER THAN THOSE ADAPTED FOR USE WITH AN EXTERNAL DISPLAY SCREEN OR MONITOR, DIE CAST MINIATURE TOY VEHICLES, DOLLS, DOLL ACCESSORIES, DOLL CLOTHING, BEAN BAG DOLLS, BENDABLE PLAY FIGURES, FLYING DISCS, INFLATABLE VINYL PLAY FIGURES, JIGSAW PUZZLES, MARBLES, PLUSH TOYS, PUPPETS, RIDE-ON TOYS, SKATEBOARDS, BALLOONS, ROLLERSKATES, TOY BANKS, WATER SQUIRTING TOYS, STUFFED TOYS, TOY VEHICLES, CHRISTMAS TREE ORNAMENTS; PINBALL MACHINES; AND PLAYING CARDS (U.S. CLS. 22, 23, 38 AND 50).

GIANCARLO CASTRO, EXAMINING ATTORNEY

CLASS 45—PERSONAL AND LEGAL SERVICES

FOR SOCIAL SERVICE, NAMELY, COMPANIONSHIP SERVICES FOR INFANTS, CHILDREN, THE ELDERLY, AND DISABLED; IN-HOME SUPPORT SERVICES TO SENIOR PERSONS, NAMELY, GERIATRIC CARE MANAGEMENT SERVICES AND PERSONAL AFFAIRS MANAGEMENT SERVICES IN THE NATURE OF THE COORDINATION OF NECESSARY SERVICES AND CARE FOR OLDER INDIVIDUALS; PROVIDING NON-MEDICAL PERSONAL ASSISTANT SERVICES FOR OTHERS IN THE NATURE OF PLANNING, ORGANIZING, COORDINATING, ARRANGING AND ASSISTING INDIVIDUALS TO PERFORM DAILY TASKS; PROVIDING NON-MEDICAL ASSISTED LIVING SERVICES FOR PERSONAL PURPOSES IN THE NATURE OF SCHEDULING APPOINTMENTS, ANSWERING THE TELEPHONE, CHECKING MESSAGES, MAIL SORTING, HANDLING AND RECEIVING, AND SECRETARIAL AND CLERICAL SERVICES; PERSONAL CARE ASSISTANCE OF ACTIVITIES OF DAILY LIVING, SUCH AS BATHING, GROOMING AND PERSONAL MOBILITY FOR MENTALLY AND PHYSICALLY CHALLENGED PEOPLE, THE ELDERLY, AND INFANTS AND CHILDREN; RUNNING ERRANDS FOR OTHERS; PERSONAL SHOPPING FOR OTHERS; PROVIDING PERSONAL SUPPORT SERVICES FOR FAMILIES OF PATIENTS WITH LIFE THREATENING DISORDERS AND OTHER ILLNESSES AND FAMILIES OF MENTALLY AND PHYSICALLY CHALLENGED INDIVIDUALS, NAMELY, COMPANIONSHIP, HELP WITH MEDICAL FORMS, COUNSELING AND EMOTIONAL SUPPORT; PERSONAL CONCIERGE SERVICES FOR OTHERS COMPRISING MAKING REQUESTED PERSONAL ARRANGEMENTS AND RESERVATIONS, RUNNING ERRANDS AND PROVIDING CUSTOMER SPECIFIC INFORMATION TO MEET INDIVIDUAL NEEDS, ALL RENDERED IN BUSINESS ESTABLISHMENTS AND HOMES (U.S. CLS. 100 AND 101).

KAREN K. BUSH, EXAMINING ATTORNEY

SN 85-519,477. 24-7 BRIGHT STAR HEALTHCARE, LLC, GURNEE, IL. FILED 1-18-2012.

**BRIGHTSTAR CLINICAL
PATHWAYS**

THE MARK CONSISTS OF STANDARD CHARACTERS WITHOUT CLAIM TO ANY PARTICULAR FONT, STYLE, SIZE, OR COLOR.

OWNER OF U.S. REG. NOS. 3,608,700, 3,608,702 AND OTHERS.

NO CLAIM IS MADE TO THE EXCLUSIVE RIGHT TO USE "CLINICAL PATHWAYS", APART FROM THE MARK AS SHOWN.

CLASS 35—ADVERTISING AND BUSINESS

FOR MEDICAL AND NURSING PERSONNEL PLACEMENT, RECRUITING AND STAFFING (U.S. CLS. 100, 101 AND 102).

CLASS 39—TRANSPORTATION AND STORAGE

FOR TRANSPORTATION SERVICES PROVIDED TO INDIVIDUALS (U.S. CLS. 100 AND 105).

CLASS 43—HOTEL AND RESTAURANT SERVICES

FOR CHILDCARE SERVICES; PROVIDING DAY CARE SERVICES FOR ADULTS AND CHILDREN, NAMELY, PROVIDING ELDER CARE SERVICES FOR ADULTS AND DISABLED INDIVIDUALS; PROVIDING CHILD CARE SERVICES FOR CHILDREN AND DISABLED INDIVIDUALS; PROVIDING ASSISTED LIVING FACILITIES (U.S. CLS. 100 AND 101).

CLASS 44—MEDICAL, BEAUTY AND AGRICULTURAL SERVICES

FOR HOME HEALTH CARE SERVICES; HOSPICE CARE SERVICES PROVIDED IN EITHER THE HOME OR IN FACILITIES (U.S. CLS. 100 AND 101).

SN 85-519,546. INDUSTRIAL PROPERTIES, LLC, CHICAGO, IL. FILED 1-18-2012.

PNEU FAST

THE MARK CONSISTS OF STANDARD CHARACTERS WITHOUT CLAIM TO ANY PARTICULAR FONT, STYLE, SIZE, OR COLOR.

CLASS 6—METAL GOODS

FOR NAILS SOLD IN BULK, COLLATED NAILS, METAL STAPLES FOR CONSTRUCTION OR INDUSTRIAL USE AND COLLATED METAL STAPLES FOR CONSTRUCTION OR INDUSTRIAL USE; METAL FASTENERS, NAMELY, NAILS, COLLATED NAILS, METAL STAPLES FOR CONSTRUCTION OR INDUSTRIAL USE AND COLLATED METAL STAPLES FOR CONSTRUCTION OR INDUSTRIAL USE (U.S. CLS. 2, 12, 13, 14, 23, 25 AND 50).

FIRST USE 0-0-1981; IN COMMERCE 0-0-1981.

CLASS 7—MACHINERY

FOR HAND-OPERATED PNEUMATIC TOOLS, NAMELY, NAIL AND STAPLE GUNS AND REPLACEMENT PARTS THEREFORE (U.S. CLS. 13, 19, 21, 23, 31, 34 AND 35).

FIRST USE 0-0-1981; IN COMMERCE 0-0-1981.
GENE MACIOL, EXAMINING ATTORNEY

SN 85-519,652. INDUSTRIAL PROPERTIES, LLC, CHICAGO, IL. FILED 1-18-2012.

SN 85-519,970. FREEBIES2DEALS INC, LEHI, UT. FILED 1-19-2012.



THE MARK CONSISTS OF STYLIZED CHARACTERS SPELLING "PNEU FAST" WITH A THREE-SIDED GEOMETRIC GRAPHIC BETWEEN THE WORDS "PNEU" AND "FAST".

CLASS 6—METAL GOODS

FOR NAILS SOLD IN BULK, COLLATED NAILS, METAL STAPLES FOR CONSTRUCTION OR INDUSTRIAL USE AND COLLATED METAL STAPLES FOR CONSTRUCTION OR INDUSTRIAL USE; METAL FASTENERS, NAMELY, NAILS, COLLATED NAILS, METAL STAPLES FOR CONSTRUCTION OR INDUSTRIAL USE AND COLLATED METAL STAPLES FOR CONSTRUCTION OR INDUSTRIAL USE (U.S. CLS. 2, 12, 13, 14, 23, 25 AND 50).

FIRST USE 0-0-1981; IN COMMERCE 0-0-1981.

CLASS 7—MACHINERY

FOR HAND-OPERATED PNEUMATIC TOOLS, NAMELY, NAIL AND STAPLE GUNS AND REPLACEMENT PARTS THEREFOR (U.S. CLS. 13, 19, 21, 23, 31, 34 AND 35).

FIRST USE 0-0-1981; IN COMMERCE 0-0-1981.
GENE MACIOL, EXAMINING ATTORNEY

SN 85-519,745. FRAT HOUSE BAR, LLC, GREENWOOD VILLAGE, CO. FILED 1-19-2012.

FRAT HOUSE BAR

THE MARK CONSISTS OF STANDARD CHARACTERS WITHOUT CLAIM TO ANY PARTICULAR FONT, STYLE, SIZE, OR COLOR.

NO CLAIM IS MADE TO THE EXCLUSIVE RIGHT TO USE "BAR", APART FROM THE MARK AS SHOWN. THE WORDING "FRAT HOUSE" HAS NO MEANING IN A FOREIGN LANGUAGE.

CLASS 41—EDUCATION AND ENTERTAINMENT

FOR ARRANGING AND CONDUCTING NIGHTCLUB ENTERTAINMENT EVENTS (U.S. CLS. 100, 101 AND 107).

CLASS 43—HOTEL AND RESTAURANT SERVICES

FOR BAR SERVICES; RESTAURANT SERVICES (U.S. CLS. 100 AND 101).
VIVIAN MICZNIK FIRST, EXAMINING ATTORNEY

FREEBIES2DEALS

THE MARK CONSISTS OF STANDARD CHARACTERS WITHOUT CLAIM TO ANY PARTICULAR FONT, STYLE, SIZE, OR COLOR.

CLASS 35—ADVERTISING AND BUSINESS

FOR PROMOTING THE GOODS AND SERVICES OF OTHERS THROUGH A WEBSITE FEATURING DEALS, FREEBIES, COUPONS, GIVEAWAYS, PRODUCT REVIEWS AND DISCOUNT INFORMATION OF VARIOUS STORES AND GROCERY MARKETS (U.S. CLS. 100, 101 AND 102).

CLASS 36—INSURANCE AND FINANCIAL

FOR PROVIDING FINANCIAL INFORMATION ON SAVING MONEY, SHOPPING TECHNIQUES, AND PROVIDING FOR YOUR FAMILY ON A BUDGET; PROVIDING A WEBSITE DIRECTING OTHERS HOW TO SAVE MONEY WITH IN-STORE AND ONLINE PURCHASES (U.S. CLS. 100, 101 AND 102).

CLASS 41—EDUCATION AND ENTERTAINMENT

FOR PROVIDING ONLINE AND IN-PERSON WORKSHOPS AND CLASSES TEACHING OTHERS HOW TO USE COUPONS, SAVE MONEY AND BUILD A FOOD STORAGE ON A BUDGET (U.S. CLS. 100, 101 AND 107).
ROSELLE HERRERA, EXAMINING ATTORNEY

SN 85-520,524. FIRST BOSTON FINANCIAL, LLC, CHEYENNE, WY. FILED 1-19-2012.

POLITICALB

THE MARK CONSISTS OF STANDARD CHARACTERS WITHOUT CLAIM TO ANY PARTICULAR FONT, STYLE, SIZE, OR COLOR.

CLASS 35—ADVERTISING AND BUSINESS

FOR PROVIDING ON-LINE COMPUTER DATABASES AND ON-LINE SEARCHABLE DATABASES IN THE FIELD OF POLITICS (U.S. CLS. 100, 101 AND 102).

CLASS 45—PERSONAL AND LEGAL SERVICES

FOR ONLINE SOCIAL NETWORKING SERVICES; PROVIDING A SOCIAL NETWORKING WEBSITE FOR ENTERTAINMENT PURPOSES (U.S. CLS. 100 AND 101).
FIRST USE 12-20-2011; IN COMMERCE 12-20-2011.
SAMUEL E. SHARPER JR., EXAMINING ATTORNEY

SN 85-520,639. CORBETT, ROBERT, HERMOSA BEACH, CA.
FILED 1-19-2012.

THE GROOVE WORKOUT

THE MARK CONSISTS OF STANDARD CHARACTERS WITHOUT CLAIM TO ANY PARTICULAR FONT, STYLE, SIZE, OR COLOR.

NO CLAIM IS MADE TO THE EXCLUSIVE RIGHT TO USE "WORKOUT", APART FROM THE MARK AS SHOWN.

CLASS 25—CLOTHING

FOR ATHLETIC APPAREL, NAMELY, SHIRTS, PANTS, JACKETS, FOOTWEAR, HATS AND CAPS, ATHLETIC UNIFORMS (U.S. CLS. 22 AND 39).

FIRST USE 7-8-2011; IN COMMERCE 7-8-2011.

CLASS 41—EDUCATION AND ENTERTAINMENT

FOR CONDUCTING FITNESS CLASSES; CONSULTING SERVICES IN THE FIELDS OF FITNESS AND EXERCISE; COUNSELING SERVICES IN THE FIELD OF PHYSICAL FITNESS; HEALTH CLUB SERVICES, NAMELY, PROVIDING INSTRUCTION AND EQUIPMENT IN THE FIELD OF PHYSICAL EXERCISE; PERSONAL FITNESS TRAINING SERVICES AND CONSULTANCY; PERSONAL FITNESS TRAINING SERVICES FEATURING AEROBIC AND ANAEROBIC ACTIVITIES COMBINED WITH RESISTANCE AND FLEXIBILITY TRAINING; PERSONAL TRAINING PROVIDED IN CONNECTION WITH WEIGHT LOSS AND EXERCISE PROGRAMS; PHYSICAL FITNESS CONDITIONING CLASSES; PHYSICAL FITNESS INSTRUCTION; PHYSICAL FITNESS TRAINING OF INDIVIDUALS AND GROUPS; PHYSICAL FITNESS TRAINING SERVICES; PROVIDING A WEBSITE FEATURING INFORMATION ON EXERCISE AND FITNESS; PROVIDING AN INTERACTIVE WEBSITE FEATURING INFORMATION AND LINKS RELATING TO FITNESS; PROVIDING ASSISTANCE, PERSONAL TRAINING AND PHYSICAL FITNESS CONSULTATION TO CORPORATE CLIENTS TO HELP THEIR EMPLOYEES MAKE PHYSICAL FITNESS, STRENGTH, CONDITIONING, AND EXERCISE ALTERATIONS IN THEIR DAILY LIVING; PROVIDING ASSISTANCE, PERSONAL TRAINING AND PHYSICAL FITNESS CONSULTATION TO INDIVIDUALS TO HELP THEM MAKE PHYSICAL FITNESS, STRENGTH, CONDITIONING, AND EXERCISE IMPROVEMENT IN THEIR DAILY LIVING; PROVIDING INFORMATION IN THE FIELD OF EXERCISE TRAINING; PROVIDING INFORMATION ON PHYSICAL EXERCISE (U.S. CLS. 100, 101 AND 107).

FIRST USE 7-8-2011; IN COMMERCE 7-8-2011.

BILL DAWE, EXAMINING ATTORNEY

SN 85-520,695. ZYNGA INC., SAN FRANCISCO, CA. FILED
1-19-2012.

ZYNGA BINGO

THE MARK CONSISTS OF STANDARD CHARACTERS WITHOUT CLAIM TO ANY PARTICULAR FONT, STYLE, SIZE, OR COLOR.

NO CLAIM IS MADE TO THE EXCLUSIVE RIGHT TO USE "BINGO", APART FROM THE MARK AS SHOWN.

CLASS 9—ELECTRICAL AND SCIENTIFIC APPARATUS

FOR COMPUTER GAME SOFTWARE; COMPUTER GAME PROGRAMS; ELECTRONIC GAME PROGRAMS; INTERACTIVE VIDEO GAME PROGRAMS; COMPUTER SOFTWARE PLATFORMS FOR SOCIAL NETWORKING; COMPUTER SOFTWARE TO ENABLE UPLOADING, POSTING, SHOWING, DISPLAYING, TAGGING, BLOGGING, SHARING OR OTHERWISE PROVIDING ELECTRONIC MEDIA OR INFORMATION IN THE FIELDS OF VIRTUAL COMMUNITIES, ELECTRONIC GAMING, ENTERTAINMENT, AND GENERAL INTEREST VIA THE INTERNET OR OTHER COMMUNICATIONS NETWORKS WITH THIRD PARTIES; MAGNETIC ENCODED GIFT CARDS (U.S. CLS. 21, 23, 26, 36 AND 38).

CLASS 41—EDUCATION AND ENTERTAINMENT

FOR COMPUTER AND ELECTRONIC GAMES PROVIDED ONLINE AND ENHANCEMENTS WITHIN ONLINE COMPUTER AND ELECTRONIC GAMES; INFORMATION RELATING TO COMPUTER GAMES PROVIDED ONLINE; VIRTUAL ENVIRONMENTS IN WHICH USERS CAN INTERACT THROUGH SOCIAL GAMES FOR RECREATIONAL, LEISURE OR ENTERTAINMENT PURPOSES (U.S. CLS. 100, 101 AND 107).

SUSAN LESLIE DUBOIS, EXAMINING ATTORNEY

SN 85-521,059. CHAN, ALBERT W., NEW YORK, NY. FILED
1-20-2012.

鴻昌
Hung Chong

OWNER OF U.S. REG. NOS. 2,148,909 AND 2,148,910.

THE MARK CONSISTS OF TWO CHINESE CHARACTERS. THE WORDS "HUNG CHONG" APPEAR BELOW THE CHINESE CHARACTERS.

THE CHINESE CHARACTERS IN THE MARK TRANSLITERATE TO "HUNG CHONG" AND THIS MEANS "GREAT PROSPERITY" IN ENGLISH.

CLASS 29—MEATS AND PROCESSED FOODS

FOR FROZEN, PROCESSED, PRESERVED AND DRIED MEATS AND POULTRY; SAUSAGES CONTAINING MEATS AND POULTRY; FROZEN MEALS CONSISTING PRIMARILY OF PROCESSED MEATS, SEAFOOD, POULTRY AND VEGETABLES (U.S. CL. 46).

CLASS 30—STAPLE FOODS

FOR FROZEN DIM SUMS CONSISTING PRIMARILY OF PROCESSED MEATS, SEAFOOD, POULTRY AND VEGETABLES ENROBED IN WHEAT OR RICE FLOUR WRAPPERS; FROZEN DUMPLINGS CONTAINING PROCESSED MEATS, SEAFOOD, POULTRY AND VEGETABLES IN WHEAT OR RICE FLOUR WRAPPINGS; FROZEN BUNS, BREADS OR ROLLS CONTAINING PROCESSED MEATS, POULTRY AND VEGETABLES IN WHEAT OR RICE FLOUR WRAPPINGS (U.S. CL. 46).

CARYN GLASSER, EXAMINING ATTORNEY

SN 85-521,738. ECHELON TITLE LLC, PHILADELPHIA, PA.
FILED 1-20-2012.



NO CLAIM IS MADE TO THE EXCLUSIVE RIGHT TO USE "TOWN CENTER", APART FROM THE MARK AS SHOWN.

THE MARK CONSISTS OF AN IMAGE OF A STYLIZED "X" WITH THE STYLIZED WORDING "VOORHEES" ABOVE THE STYLIZED WORDING "TOWN CENTER" ALL SET TO THE RIGHT OF THE IMAGE OF THE "X".

SEC. 2(F) AS TO "VOORHEES TOWN CENTER".

CLASS 35—ADVERTISING AND BUSINESS

FOR BUSINESS MANAGEMENT SERVICES IN THE FIELD OF SHOPPING CENTERS, NAMELY, OPERATING SHOPPING CENTER SPACE FOR SELLERS AND CONSUMERS OF GOODS AND SERVICES, AND PROMOTING THE GOODS AND SERVICES OF LESSEES OF SHOPPING CENTERS THROUGH THE DISTRIBUTION OF PRINTED, AUDIO AND VISUAL PROMOTIONAL MATERIALS AND THROUGH A VARIETY OF MEANS AND BY RENDERING SALES PROMOTION ADVICE (U.S. CLS. 100, 101 AND 102).

FIRST USE 1-30-2007; IN COMMERCE 1-30-2007.

CLASS 36—INSURANCE AND FINANCIAL

FOR SHOPPING CENTER SERVICES, NAMELY, LEASING AND MANAGEMENT OF SHOPPING CENTER SPACE; REAL ESTATE SERVICES, NAMELY, LEASING AND MANAGEMENT OF OFFICE AND RESIDENTIAL SPACE (U.S. CLS. 100, 101 AND 102).

FIRST USE 1-30-2007; IN COMMERCE 1-30-2007.

DANIEL CAPSHAW, EXAMINING ATTORNEY

SN 85-522,428. SELECT BIOSCIENCES, LTD., SUDBURY,
UNITED KINGDOM, FILED 1-23-2012.

SELECT BIOSCIENCES

THE MARK CONSISTS OF STANDARD CHARACTERS WITHOUT CLAIM TO ANY PARTICULAR FONT, STYLE, SIZE, OR COLOR.

NO CLAIM IS MADE TO THE EXCLUSIVE RIGHT TO USE "BIOSCIENCES", APART FROM THE MARK AS SHOWN.

CLASS 35—ADVERTISING AND BUSINESS

FOR PROVIDING BUSINESS ANALYSIS AND BUSINESS STRATEGIC PLANNING SERVICES IN THE SCIENTIFIC AND TECHNOLOGY INDUSTRY; BUSINESS CONSULTATION SERVICES IN THE FIELD OF COMPANY, BUSINESS SECTOR AND INDUSTRY DATA AND RESEARCH; PROVIDING BUSINESS INFORMATION IN THE FIELD OF LIFE SCIENCE AND DRUG RESEARCH INDUSTRY (U.S. CLS. 100, 101 AND 102).

FIRST USE 0-0-1994; IN COMMERCE 0-0-1994.

CLASS 41—EDUCATION AND ENTERTAINMENT

FOR ARRANGING AND CONDUCTING CONFERENCES IN THE FIELDS OF SCIENCE, LIFE SCIENCE AND DRUG RESEARCH; PROVIDING EDUCATIONAL SERVICES, NAMELY, TRAINING COURSES IN THE FIELDS OF SCIENCE, LIFE SCIENCE AND DRUG RESEARCH (U.S. CLS. 100, 101 AND 107).

FIRST USE 0-0-1994; IN COMMERCE 0-0-1994.

JANICE L. MCMORROW, EXAMINING ATTORNEY

SN 85-522,568. NOVARTIS AG, BASEL, SWITZERLAND,
FILED 1-23-2012.

NEPHROSCORE

THE MARK CONSISTS OF STANDARD CHARACTERS WITHOUT CLAIM TO ANY PARTICULAR FONT, STYLE, SIZE, OR COLOR.

CLASS 5—PHARMACEUTICALS

FOR ANTI-INFLAMMATORIES; ANTIBACTERIAL PHARMACEUTICALS; ANTIBIOTICS; ANTIFUNGAL PREPARATIONS; ANTIVIRALS; CARDIOVASCULAR PHARMACEUTICALS; PHARMACEUTICAL PREPARATIONS ACTING ON THE CENTRAL NERVOUS SYSTEM; PHARMACEUTICAL PREPARATIONS AND SUBSTANCES FOR THE TREATMENT OF GASTRO-INTESTINAL DISEASES; PHARMACEUTICAL PREPARATIONS FOR THE TREATMENT AND PREVENTION OF DISEASES AND DISORDERS OF THE AUTOIMMUNE SYSTEM, THE METABOLIC SYSTEM, THE MUSCULOSKELETAL SYSTEM AND THE GENITOURINARY SYSTEM; PHARMACEUTICAL PREPARATIONS FOR USE IN HEMATOLOGY AND IN TISSUE AND ORGAN TRANSPLANTATION; PHARMACEUTICAL PREPARATIONS FOR THE TREATMENT OF EYE DISEASES AND CONDITIONS; PHARMACEUTICAL PREPARATIONS FOR THE TREATMENT OF HEART RHYTHM DISORDERS; PHARMACEUTICAL PREPARATIONS FOR THE TREATMENT OF IMMUNE SYSTEM RELATED DISEASES AND DISORDERS; PHARMACEUTICAL PREPARATIONS FOR THE TREATMENT OF KIDNEY DISEASES; PHARMACEUTICAL PREPARATIONS FOR TREATING DIABETES; PHARMACEUTICAL PREPARATIONS FOR USE IN DERMATOLOGY; PHARMACEUTICAL PRODUCTS FOR OPHTHALMOLOGICAL USE; PHARMACEUTICAL PRODUCTS FOR THE PREVENTION AND TREATMENT OF CANCER; PHARMACEUTICAL PRODUCTS FOR THE TREATMENT OF BONE DISEASES; PHARMACEUTICAL PRODUCTS FOR TREATING RESPIRATORY DISEASES; PHARMACEUTICAL PRODUCTS FOR TREATING RESPIRATORY DISEASES AND ASTHMA; PHARMACEUTICALS, NAMELY, ANTI-INFECTIVES; DIAGNOSTIC PREPARATIONS FOR MEDICAL PURPOSES; DIAGNOSTIC REAGENTS FOR MEDICINAL USE (U.S. CLS. 6, 18, 44, 46, 51 AND 52).

CLASS 10—MEDICAL APPARATUS

FOR MEDICAL APPARATUS AND INSTRUMENTS FOR DIAGNOSTIC PURPOSES IN THE AREA OF NEPHROLOGY, KIDNEY INJURY AND KIDNEY DISEASES (U.S. CLS. 26, 39 AND 44).

CHRISTINE MARTIN, EXAMINING ATTORNEY

SN 85-522,605. CRESCENT REAL ESTATE EQUITIES LIMITED PARTNERSHIP, FORT WORTH, TX. FILED 1-23-2012.

SN 85-523,172. E-Z LINE PIPE SUPPORT COMPANY, LLC, MANVEL, TX. FILED 1-23-2012.

CRESCENT PLAZA

THE MARK CONSISTS OF STANDARD CHARACTERS WITHOUT CLAIM TO ANY PARTICULAR FONT, STYLE, SIZE, OR COLOR.

OWNER OF U.S. REG. NOS. 2,103,239 AND 3,155,420.
NO CLAIM IS MADE TO THE EXCLUSIVE RIGHT TO USE "PLAZA", APART FROM THE MARK AS SHOWN.

CLASS 36—INSURANCE AND FINANCIAL

FOR MANAGEMENT AND LEASING OF REAL ESTATE FACILITIES (U.S. CLS. 100, 101 AND 102).

CLASS 37—CONSTRUCTION AND REPAIR

FOR REAL ESTATE DEVELOPMENT (U.S. CLS. 100, 103 AND 106).
LESLIE RICHARDS, EXAMINING ATTORNEY

SN 85-522,696. SIERRA FLOORING, INC, MCDONOUGH, GA. FILED 1-23-2012.



NO CLAIM IS MADE TO THE EXCLUSIVE RIGHT TO USE "FLOORS", APART FROM THE MARK AS SHOWN.

THE COLOR(S) LIGHT GREEN AND DARK GREEN IS/ARE CLAIMED AS A FEATURE OF THE MARK.

THE MARK CONSISTS OF THE WORDS "SIERRA FLOORS" IN DARK GREEN AND THE DESIGN OF A LEAF IN LIGHT AND DARK GREEN.

CLASS 19—NON-METALLIC BUILDING MATERIALS

FOR CORK TILES AND TILES OF CORK-BASED CONGLOMERATES FOR FLOOR, WALL AND CEILING COVERINGS; ENGINEERED HARDWOOD FLOORING; FLOORING UNDERLAYMENTS; HARD WOOD FLOORING; HARDWOOD FLOORING; LAMINATE FLOORING; RUBBER FLOORING; VINYL FLOORING (U.S. CLS. 1, 12, 33 AND 50).

CLASS 27—FLOOR COVERINGS

FOR CARPET TILES; CARPETING; CARPETS; CARPETS AND RUGS; FLOOR COVERINGS; VINYL FLOOR COVERINGS (U.S. CLS. 19, 20, 37, 42 AND 50).
MIDGE BUTLER, EXAMINING ATTORNEY

E-Z LINE

THE MARK CONSISTS OF STANDARD CHARACTERS WITHOUT CLAIM TO ANY PARTICULAR FONT, STYLE, SIZE, OR COLOR.

CLASS 6—METAL GOODS

FOR METAL PIPE SUPPORTS; METAL PIPE GUIDES; METAL PIPE CLAMPS; METAL PIPE SHOES; METAL SHIM BLOCKS AND ASSEMBLIES (U.S. CLS. 2, 12, 13, 14, 23, 25 AND 50).

FIRST USE 0-0-1952; IN COMMERCE 0-0-1952.

CLASS 40—MATERIAL TREATMENT

FOR CUSTOM STEEL FABRICATION TO THE ORDER AND SPECIFICATION OF OTHERS (U.S. CLS. 100, 103 AND 106).

FIRST USE 0-0-1989; IN COMMERCE 0-0-1989.

JEFF DEFORD, EXAMINING ATTORNEY

SN 85-523,250. ISCA TECHNOLOGIES, INC., RIVERSIDE, CA. FILED 1-23-2012.

OIKOS

THE MARK CONSISTS OF STANDARD CHARACTERS WITHOUT CLAIM TO ANY PARTICULAR FONT, STYLE, SIZE, OR COLOR.

THE ENGLISH TRANSLATION OF "OIKOS" IN THE MARK IS "HOUSE" OR "HOME".

CLASS 5—PHARMACEUTICALS

FOR INSECTICIDES AND INSECT ATTRACTANTS, NAMELY, CHEMICAL COMPOSITIONS TO ATTRACT INSECTS FOR PEST CONTROL PURPOSES (U.S. CLS. 6, 18, 44, 46, 51 AND 52).

CLASS 21—HOUSEWARES AND GLASS

FOR INSECT TRAPS; INSECT TRAPS WITH INSECT LURES FOR PEST CONTROL PURPOSES SOLD AS A UNIT (U.S. CLS. 2, 13, 23, 29, 30, 33, 40 AND 50).
WILLIAM VERHOSEK, EXAMINING ATTORNEY

SN 85-523,294. BRAND CENTRAL LLC, LOS ANGELES, CA.
FILED 1-23-2012.

GEEK CHIC

THE MARK CONSISTS OF STANDARD CHARACTERS WITHOUT CLAIM TO ANY PARTICULAR FONT, STYLE, SIZE, OR COLOR.

CLASS 9—ELECTRICAL AND SCIENTIFIC APPARATUS

FOR CASES FOR EYEGLASSES AND SUNGLASSES; EYEGLOSS CHAINS AND CORDS; EYEGLOSS FRAMES; EYEGLOSS LENSES; EYEGLASSES; SUNGLASS CHAINS AND CORDS; SUNGLASS LENSES; SUNGLASSES (U.S. CLS. 21, 23, 26, 36 AND 38).

CLASS 18—LEATHER GOODS

FOR BACKPACKS; BEACH BAGS; COIN PURSES; COSMETIC BAGS SOLD EMPTY; DUFFLE BAGS; HANDBAGS; KEYCASES; LUGGAGE; PURSES; SUITCASES; TOILETRY BAGS SOLD EMPTY; TOTE BAGS; UMBRELLAS; WALLETS (U.S. CLS. 1, 2, 3, 22 AND 41).
SHANNON TWOHIG, EXAMINING ATTORNEY

SN 85-523,312. AVATAR PROPERTIES, INC., POINCIANA, FL. FILED 1-23-2012.

AV HOMES

THE MARK CONSISTS OF STANDARD CHARACTERS WITHOUT CLAIM TO ANY PARTICULAR FONT, STYLE, SIZE, OR COLOR.

NO CLAIM IS MADE TO THE EXCLUSIVE RIGHT TO USE "HOMES", APART FROM THE MARK AS SHOWN.

CLASS 36—INSURANCE AND FINANCIAL

FOR REAL ESTATE AGENCY SERVICES AND REAL ESTATE BROKERAGE (U.S. CLS. 100, 101 AND 102).

CLASS 37—CONSTRUCTION AND REPAIR

FOR REAL ESTATE DEVELOPMENT SERVICES; LAND DEVELOPMENT SERVICES, NAMELY, PLANNING AND LAYING OUT OF RESIDENTIAL COMMUNITIES, RECREATIONAL FACILITIES, SOCIAL AND COMMUNITY FACILITIES, OFFICE COMPLEXES, SHOPPING CENTERS AND MEETING AND CONVENTION CENTERS; CONSTRUCTION SERVICES, NAMELY, PLANNING, LAYING OUT, AND CONSTRUCTION OF RESIDENCES, RECREATIONAL FACILITIES, SOCIAL AND COMMUNITY FACILITIES AND COMMERCIAL BUILDINGS (U.S. CLS. 100, 103 AND 106).

CLASS 41—EDUCATION AND ENTERTAINMENT

FOR PROVIDING RECREATIONAL FACILITIES, NAMELY, TENNIS COURTS, SWIMMING FACILITIES, AND FITNESS AND EXERCISE FACILITIES (U.S. CLS. 100, 101 AND 107).

SHARON MEIER, EXAMINING ATTORNEY

SN 85-523,346. OM-POWERED LLC, SAN FRANCISCO, CO.
FILED 1-23-2012.

OMpower

THE MARK CONSISTS OF STANDARD CHARACTERS WITHOUT CLAIM TO ANY PARTICULAR FONT, STYLE, SIZE, OR COLOR.

CLASS 18—LEATHER GOODS

FOR MESSENGER BAGS; ATHLETIC BAGS; GENERAL PURPOSE BAGS FOR CARRYING YOGA EQUIPMENT; TOTE BAGS (U.S. CLS. 1, 2, 3, 22 AND 41).

CLASS 25—CLOTHING

FOR CLOTHING, NAMELY, T-SHIRTS, TANK TOPS, LONG SLEEVED SHIRTS, JACKETS, HATS, CYCLING SHORTS, CYCLING JERSEYS, YOGA PANTS, YOGA SHIRTS (U.S. CLS. 22 AND 39).

CLASS 41—EDUCATION AND ENTERTAINMENT

FOR PROVIDING FITNESS AND EXERCISE FACILITIES AND CLASSES; ON-LINE JOURNALS, NAMELY, BLOGS IN THE FIELD OF SELF-IMPROVEMENT; PROVIDING ON-LINE NON-DOWNLOADABLE PUBLICATIONS IN THE NATURE OF ARTICLES IN THE FIELD OF SELF IMPROVEMENT; ENTERTAINMENT SERVICES, NAMELY, PROVIDING PODCASTS IN THE FIELD OF SELF-IMPROVEMENT (U.S. CLS. 100, 101 AND 107).

ELLEN B. AWRICH, EXAMINING ATTORNEY

SN 85-523,348. OM-POWERED LLC, SAN FRANCISCO, CO.
FILED 1-23-2012.



THE MARK CONSISTS OF AN INTERPRETATION OF A PORTION OF THE OM SYMBOL SURROUNDED BY THREE CIRCLES.

CLASS 18—LEATHER GOODS

FOR MESSENGER BAGS; ATHLETIC BAGS; GENERAL PURPOSE BAGS FOR CARRYING YOGA EQUIPMENT; TOTE BAGS (U.S. CLS. 1, 2, 3, 22 AND 41).

CLASS 25—CLOTHING

FOR CLOTHING, NAMELY, T-SHIRTS, TANK TOPS, LONG SLEEVED SHIRTS, JACKETS, HATS, CYCLING SHORTS, CYCLING JERSEYS, YOGA PANTS, YOGA SHIRTS (U.S. CLS. 22 AND 39).

CLASS 41—EDUCATION AND ENTERTAINMENT

FOR PROVIDING FITNESS AND EXERCISE FACILITIES AND CLASSES; ON-LINE JOURNALS, NAMELY, BLOGS IN THE FIELD OF SELF-IMPROVEMENT; PROVIDING ON-LINE NON-DOWNLOADABLE PUBLICATIONS IN THE NATURE OF ARTICLES IN THE FIELD OF SELF IMPROVEMENT; ENTERTAINMENT SERVICES, NAMELY, PROVIDING PODCASTS IN THE FIELD OF SELF-IMPROVEMENT (U.S. CLS. 100, 101 AND 107).

ELLEN B. AWRICH, EXAMINING ATTORNEY

SN 85-523,540. TRANSITIONS OPTICAL, INC., PINELLAS PARK, FL. FILED 1-24-2012.

TRANSITIONS HEALTHY SIGHT
FOR LIFE

THE MARK CONSISTS OF STANDARD CHARACTERS WITHOUT CLAIM TO ANY PARTICULAR FONT, STYLE, SIZE, OR COLOR.

OWNER OF U.S. REG. NOS. 1,576,217, 3,336,227 AND 3,986,171.

NO CLAIM IS MADE TO THE EXCLUSIVE RIGHT TO USE "SIGHT", APART FROM THE MARK AS SHOWN.

CLASS 36—INSURANCE AND FINANCIAL

FOR PROVIDING SCHOLARSHIPS AND GRANTS IN THE FIELD OF EYE CARE AND EYE HEALTH EDUCATION (U.S. CLS. 100, 101 AND 102).

FIRST USE 1-31-2007; IN COMMERCE 1-31-2007.

CLASS 41—EDUCATION AND ENTERTAINMENT

FOR EDUCATIONAL SERVICES, NAMELY, CONDUCTING CLASSES, SEMINARS, AND WORKSHOPS IN THE FIELD OF EYE CARE AND EYE HEALTH AND THE DISTRIBUTION OF COURSE MATERIAL FOR USE IN CONNECTION THEREWITH (U.S. CLS. 100, 101 AND 107).

FIRST USE 1-31-2007; IN COMMERCE 1-31-2007.

BRIDGETT SMITH, EXAMINING ATTORNEY

SN 85-523,651. NETVOYAGE CORP., OREM, UT. FILED 1-24-2012.

NetDocuments

THE MARK CONSISTS OF STANDARD CHARACTERS WITHOUT CLAIM TO ANY PARTICULAR FONT, STYLE, SIZE, OR COLOR.

SEC. 2(F).

CLASS 9—ELECTRICAL AND SCIENTIFIC APPARATUS

FOR COMPUTER SOFTWARE USED FOR ON-LINE STORAGE, ORGANIZATION, RETRIEVAL, MANAGEMENT VIA THE GLOBAL COMPUTER NETWORK OF A COLLECTION OF ONE OR MORE FILES FOR ESTABLISHING A DESIGNATED SET OF USERS HAVING ACCESS TO SUCH COLLECTION FOR CONTROL AND TRACKING OF CHANGES BY MEMBERS OF SAID SET OF USERS AND FOR AUTOMATICALLY NOTIFYING MEMBERS OF THE DESIGNATED SET OF USERS WHEN EACH MEMBER IS DESIGNATED AS A MEMBER OF SAID SET OF DESIGNATED USERS, WHEN FILES ARE ADDED TO OR REMOVED FROM THE COLLECTION, OR WHEN FILES WITHIN THE COLLECTION ARE MODIFIED (U.S. CLS. 21, 23, 26, 36 AND 38).

FIRST USE 2-26-1999; IN COMMERCE 2-26-1999.

CLASS 42—SCIENTIFIC AND COMPUTER SERVICES

FOR CONSULTATION SERVICES IN THE NATURE OF ESTABLISHING COLLECTIONS OF FILES STORED, ORGANIZED AND MANAGED AND RETRIEVED ON-LINE VIA THE GLOBAL COMPUTER NETWORK FOR ESTABLISHING A DESIGNATED SET OF USERS HAVING ACCESS TO EACH SUCH COLLECTION FOR CONTROLLING AND TRACKING OF CHANGES BY MEMBERS OF SAID SET OF USERS TO FILES IN SAID COLLECTION AND FOR AUTOMATICALLY NOTIFYING EACH OF THE MEMBERS OF THE DESIGNATED SET OF USERS WHEN SAID MEMBER IS ADDED TO THE SET OF DESIGNATED AS A MEMBER OF SAID SET, WHEN FILES ARE ADDED TO OR REMOVED FROM THE COLLECTION, OR WHEN FILES WITHIN THE COLLECTION ARE MODIFIED (U.S. CLS. 100 AND 101).

FIRST USE 2-26-1999; IN COMMERCE 2-26-1999.

JAY FLOWERS, EXAMINING ATTORNEY

SN 85-523,652. SCIESENT LLC, WAKEFIELD, MA. FILED 1-24-2012.

MEDMAP

THE MARK CONSISTS OF STANDARD CHARACTERS WITHOUT CLAIM TO ANY PARTICULAR FONT, STYLE, SIZE, OR COLOR.

CLASS 35—ADVERTISING AND BUSINESS

FOR ASSISTANCE, ADVISORY SERVICES AND CONSULTANCY WITH REGARD TO BUSINESS PLANNING, MARKET ASSESSMENT AND ANALYSIS, AND COMMERCIAL DEVELOPMENT, LAUNCH, AND EXPLOITATION OF MEDICAL DEVICES, MEDICAL EQUIPMENT, MEDICAL APPARATUS AND MEDICAL UTENSILS; ASSISTANCE, ADVISORY SERVICES AND CONSULTANCY PERTAINING TO REGULATORY APPROVAL AND REGULATORY SUBMISSION MANAGEMENT, NAMELY, PREPARATION, FILING AND PROCESSING OF APPLICATIONS FOR APPROVALS IN THE FIELD OF MEDICAL DEVICES, MEDICAL EQUIPMENT, MEDICAL APPARATUS AND MEDICAL UTENSILS (U.S. CLS. 100, 101 AND 102).

FIRST USE 5-4-2010; IN COMMERCE 5-4-2010.

CLASS 42—SCIENTIFIC AND COMPUTER SERVICES

FOR DESIGN, ENGINEERING, RESEARCH, DEVELOPMENT AND TESTING SERVICES IN THE FIELD OF MEDICAL DEVICES, MEDICAL APPARATUS, MEDICAL EQUIPMENT, AND MEDICAL UTENSILS; DESIGN, ENGINEERING, RESEARCH, DEVELOPMENT AND TESTING SERVICES IN THE FIELD OF ANTIMICROBIAL, ANTIFUNGAL, ANTIBACTERIAL POLYMERS AND POLYMERIC MATERIALS, COATINGS, TREATMENTS AND MATERIALS CUSTOMIZATION FOR MEDICAL, SCIENTIFIC, AND TECHNOLOGICAL APPLICATIONS (U.S. CLS. 100 AND 101).

FIRST USE 5-4-2010; IN COMMERCE 5-4-2010.
JAY FLOWERS, EXAMINING ATTORNEY

SN 85-523,672. MASTERCARD INTERNATIONAL INCORPORATED, PURCHASE, NY. FILED 1-24-2012.

THAT'S MASTERCARD. THAT'S
PRICELESS

THE MARK CONSISTS OF STANDARD CHARACTERS WITHOUT CLAIM TO ANY PARTICULAR FONT, STYLE, SIZE, OR COLOR.

OWNER OF U.S. REG. NOS. 1,186,117, 2,370,508 AND OTHERS.

CLASS 35—ADVERTISING AND BUSINESS

FOR PROMOTING THE SALE OF THE GOODS AND SERVICES OF OTHERS BY MEANS OF ADVERTISEMENTS AND PROMOTIONS IN CONNECTION WITH THE USE OF CREDIT AND DEBIT CARDS (U.S. CLS. 100, 101 AND 102).

FIRST USE 9-7-2011; IN COMMERCE 9-7-2011.

CLASS 36—INSURANCE AND FINANCIAL

FOR FINANCIAL SERVICES, NAMELY, BANKING SERVICES; PROVIDING CREDIT CARD AND DEBIT CARD SERVICES; PROVIDING ELECTRONIC FUNDS AND CURRENCY TRANSFER SERVICES, ELECTRONIC PAYMENTS SERVICES, CASH DISBURSEMENT SERVICES AND TRANSACTION AUTHORIZATION AND SETTLEMENT SERVICES; TRAVEL INSURANCE SERVICES; FINANCIAL SERVICES, NAMELY, BANKING AND PAYMENT CARD SERVICES PROVIDED BY MEANS OF A GLOBAL COMPUTER NETWORK OR THE INTERNET (U.S. CLS. 100, 101 AND 102).

FIRST USE 9-7-2011; IN COMMERCE 9-7-2011.
SUNG IN, EXAMINING ATTORNEY

SN 85-524,009. GRUMA CORPORATION, IRVING, TX. FILED 1-24-2012.

A LITTLE PIECE OF MEXICO

THE MARK CONSISTS OF STANDARD CHARACTERS WITHOUT CLAIM TO ANY PARTICULAR FONT, STYLE, SIZE, OR COLOR.

OWNER OF U.S. REG. NOS. 2,591,406, 4,006,294 AND OTHERS.

CLASS 29—MEATS AND PROCESSED FOODS

FOR CHICHARRON (U.S. CL. 46).

CLASS 30—STAPLE FOODS

FOR TORTILLAS, TOSTADAS, TORTILLA CHIPS, GORDITAS, SOPE, WHEAT BASED SNACK FOODS (U.S. CL. 46).

MAUREEN DALL, EXAMINING ATTORNEY

SN 85-524,225. THE BURCHARD GROUP LLC, PORTLAND, OR. FILED 1-24-2012.

Millionaire Marketing
Formulas

THE MARK CONSISTS OF STANDARD CHARACTERS WITHOUT CLAIM TO ANY PARTICULAR FONT, STYLE, SIZE, OR COLOR.

OWNER OF U.S. REG. NO. 4,079,963.

NO CLAIM IS MADE TO THE EXCLUSIVE RIGHT TO USE "MARKETING FORMULAS", APART FROM THE MARK AS SHOWN.

CLASS 9—ELECTRICAL AND SCIENTIFIC APPARATUS

FOR AUDIO DISCS FEATURING MARKETING, BRAND POSITIONING, BUSINESS, LEADERSHIP, AND TECHNOLOGY INSTRUCTION; DOWNLOADABLE VIDEO RECORDINGS FEATURING MARKETING, BRAND POSITIONING, BUSINESS, LEADERSHIP, AND TECHNOLOGY INSTRUCTION; ELECTRONIC PUBLICATIONS, NAMELY, ARTICLES AND BOOKS FEATURING MARKETING, BRAND POSITIONING, BUSINESS, LEADERSHIP, AND TECHNOLOGY INSTRUCTION RECORDED ON COMPUTER MEDIA; VIDEO DISCS FEATURING MARKETING, BRAND POSITIONING, BUSINESS, LEADERSHIP, AND TECHNOLOGY INSTRUCTION (U.S. CLS. 21, 23, 26, 36 AND 38).

FIRST USE 8-1-2010; IN COMMERCE 8-1-2010.

CLASS 16—PAPER GOODS AND PRINTED MATTER

FOR A SERIES OF BOOKS, WRITTEN ARTICLES, HANDOUTS AND WORKSHEETS IN THE FIELD OF BUSINESS, NAMELY MARKETING, BRAND POSITIONING, BUSINESS, LEADERSHIP, HOW-TO ADVICE, AND TECHNOLOGY; BOOKS IN THE FIELD OF BUSINESS, NAMELY, MARKETING, BRAND POSITIONING, BUSINESS, LEADERSHIP, AND TECHNOLOGY (U.S. CLS. 2, 5, 22, 23, 29, 37, 38 AND 50).

FIRST USE 8-1-2010; IN COMMERCE 8-1-2010.

CLASS 41—EDUCATION AND ENTERTAINMENT

FOR EDUCATIONAL SERVICES, NAMELY, CONDUCTING SEMINARS, LECTURES, AND WORKSHOPS IN THE FIELD OF MARKETING, BRAND POSITIONING, BUSINESS, LEADERSHIP, HOW-TO ADVICE, AND TECHNOLOGY AND DISTRIBUTION OF COURSE MATERIAL IN CONNECTION THEREWITH (U.S. CLS. 100, 101 AND 107).

FIRST USE 5-1-2010; IN COMMERCE 5-1-2010.

KATHERINE E. HALMEN, EXAMINING ATTORNEY

SN 85-524,262. AMAZING SHINE NAILS, INC., SANTA FE SPRINGS, CA. FILED 1-24-2012.

SPEEDYGEL

THE MARK CONSISTS OF STANDARD CHARACTERS WITHOUT CLAIM TO ANY PARTICULAR FONT, STYLE, SIZE, OR COLOR.

OWNER OF U.S. REG. NOS. 3,823,830 AND 3,986,878.

CLASS 3—COSMETICS AND CLEANING PREPARATIONS

FOR NAIL CARE PREPARATIONS; NAIL POLISH; NAIL POLISH KITS CONTAINING NAIL POLISH AND NAIL CLEANSERS (U.S. CLS. 1, 4, 6, 50, 51 AND 52).
FIRST USE 7-0-2011; IN COMMERCE 7-0-2011.

CLASS 11—ENVIRONMENTAL CONTROL APPARATUS

FOR ULTRAVIOLET LAMPS NOT FOR MEDICAL PURPOSES (U.S. CLS. 13, 21, 23, 31 AND 34).
FIRST USE 7-0-2011; IN COMMERCE 7-0-2011.
NATALIE POLZER, EXAMINING ATTORNEY

SN 85-524,274. PRECISION FOODS, INC., ST. LOUIS, MO. FILED 1-24-2012.

FOOTHILL FARMS

THE MARK CONSISTS OF STANDARD CHARACTERS WITHOUT CLAIM TO ANY PARTICULAR FONT, STYLE, SIZE, OR COLOR.

OWNER OF U.S. REG. NO. 1,941,004.

CLASS 29—MEATS AND PROCESSED FOODS

FOR SOUP BASES AND SOUP MIXES; VEGETABLE CHOP SUEY; MEAT AND POULTRY PRODUCTS, NAMELY, CHICKEN CHOP SUEY, MEAT BALLS, CORNED BEEF HASH, AND CHICKEN A LA KING; LOW SODIUM SOUPS (U.S. CL. 46).

CLASS 30—STAPLE FOODS

FOR MIXES FOR THE PREPARATION OF FROZEN CONFECTIONS, WATER ICE, ICE MILK, FROZEN YOGURT, SMOOTHIES, AND SHAKES; MIXES FOR THE PREPARATION OF BAKERY GOODS, MOUSSE, CHEESECAKE, COBBLER, BREAD PUDDING, AND MERINGUE; CRUST MIXES; GELATIN AND PUDDING MIXES; GELATIN DESSERT AND CONSOMME POWDERS; GRAVY MIXES; MEAT FLAVORED DRY BASE FOR SOUPS AND GRAVY; MEATLESS AND MEAT FLAVORED SAUCES FOR MEATS, FISH, VEGETABLES, AND ALIMENTARY PASTE PRODUCTS; DRY BASES FOR MATZO BALLS AND POTATO PANCAKES; PANCAKE SYRUP; FOOD FLAVORING SALTS AND CONCENTRATES; NOODLES AND SEASONING MIXES COMBINED IN UNITARY PACKAGING FOR MAKING CASSEROLES; CONDIMENTAL SAUCES, NAMELY, BARBEQUE, DILL, STEAK, TARTAR, AND SPAGHETTI SAUCES; FOOD FLAVORINGS AND SEASONINGS, NAMELY, GARLIC SALT, BEEF FLAVORING, GARLIC SEASONING, FLAVORED CHARCOAL SEASONING, AND GARLIC SPREAD; BREADING MIXES; DRY BASES FOR MAKING HOT CHOCOLATE; SPAGHETTI SAUCE WITH MEAT; SPECIAL DIETARY FOODS, NAMELY, LACTOSE-FREE FROZEN CONFECTIONS AND LOW SODIUM SALAD DRESSINGS (U.S. CL. 46).
KELLY TRUSILO, EXAMINING ATTORNEY

SN 85-524,447. WORLD GOLF TOUR, INC., SAN FRANCISCO, CA. FILED 1-24-2012.

TKO Boxing

THE MARK CONSISTS OF STANDARD CHARACTERS WITHOUT CLAIM TO ANY PARTICULAR FONT, STYLE, SIZE, OR COLOR.

NO CLAIM IS MADE TO THE EXCLUSIVE RIGHT TO USE "BOXING", APART FROM THE MARK AS SHOWN.

CLASS 9—ELECTRICAL AND SCIENTIFIC APPARATUS

FOR DOWNLOADABLE INTERACTIVE GAME SOFTWARE (U.S. CLS. 21, 23, 26, 36 AND 38).

CLASS 41—EDUCATION AND ENTERTAINMENT

FOR ENTERTAINMENT SERVICES, NAMELY, PROVIDING TEMPORARY USE OF NON-DOWNLOADABLE INTERACTIVE GAMES (U.S. CLS. 100, 101 AND 107).
BILL DAWE, EXAMINING ATTORNEY

SN 85-524,529. EBC BREWERY, LLC, RALEIGH, NC. FILED 1-25-2012.

BIG BOSS BREWING COMPANY

THE MARK CONSISTS OF STANDARD CHARACTERS WITHOUT CLAIM TO ANY PARTICULAR FONT, STYLE, SIZE, OR COLOR.

NO CLAIM IS MADE TO THE EXCLUSIVE RIGHT TO USE "BREWING COMPANY" FOR INTERNATIONAL CLASSES 6 AND 33 AND "COMPANY" FOR INTERNATIONAL CLASS 30, APART FROM THE MARK AS SHOWN.

CLASS 6—METAL GOODS

FOR METAL BOTTLE CAPS (U.S. CLS. 2, 12, 13, 14, 23, 25 AND 50).

CLASS 30—STAPLE FOODS

FOR CONDIMENTS, NAMELY, BARBECUE SAUCE, BARBECUE DRY RUB, AND HOT SAUCE (U.S. CL. 46).

CLASS 33—WINES AND SPIRITS

FOR ALCOHOLIC BEVERAGES EXCEPT BEER (U.S. CLS. 47 AND 49).
MIDGE BUTLER, EXAMINING ATTORNEY

SN 85-524,534. ARES GAMES S.R.L., CAPEZZANO PIANORE, ITALY, FILED 1-25-2012.

Wings of Glory

THE MARK CONSISTS OF STANDARD CHARACTERS WITHOUT CLAIM TO ANY PARTICULAR FONT, STYLE, SIZE, OR COLOR.

CLASS 9—ELECTRICAL AND SCIENTIFIC APPARATUS

FOR COMPUTER GAME PROGRAMS; COMPUTER GAME SOFTWARE; DOWNLOADABLE COMPUTER GAME PROGRAMS; DOWNLOADABLE ELECTRONIC GAME PROGRAMS; ELECTRONIC GAME PROGRAMS; ELECTRONIC GAME SOFTWARE FOR CELLULAR TELEPHONES; ELECTRONIC GAME SOFTWARE FOR HANDHELD ELECTRONIC DEVICES; GAME SOFTWARE; INTERACTIVE MULTIMEDIA COMPUTER GAME PROGRAM; VIDEO GAME SOFTWARE (U.S. CLS. 21, 23, 26, 36 AND 38).

CLASS 28—TOYS AND SPORTING GOODS

FOR BOARD GAMES; CARD GAMES; GAME CARDS; GAME TABLES; PLAYING PIECES IN THE NATURE OF MINIATURE ACTION FIGURES AND TOY MODEL VEHICLES FOR USE WITH TABLE TOP HOBBY BATTLE GAMES IN THE NATURE OF BATTLE, WAR AND SKIRMISH GAMES, AND FANTASY GAMES; PROMOTIONAL GAME MATERIALS; ROLE PLAYING GAMES; SCALE MODEL AIRCRAFT; SCALE MODEL AIRPLANES; SCALE MODEL VEHICLES; TABLETOP GAMES; TABLETOP HOBBY BATTLE GAMES IN THE NATURE OF BATTLE, WAR AND SKIRMISH GAMES, AND FANTASY GAMES, AND PLAYING EQUIPMENT SOLD AS A UNIT THEREWITH (U.S. CLS. 22, 23, 38 AND 50).

FIRST USE 8-0-2011; IN COMMERCE 1-0-2012.
DEBORAH LOBO, EXAMINING ATTORNEY

SN 85-524,537. CERPOK, MICHAEL L., FOUNTAIN HILLS, AZ. FILED 1-25-2012.

OFFICIAL SABAKIBALL

THE MARK CONSISTS OF STANDARD CHARACTERS WITHOUT CLAIM TO ANY PARTICULAR FONT, STYLE, SIZE, OR COLOR.

NO CLAIM IS MADE TO THE EXCLUSIVE RIGHT TO USE "OFFICIAL", APART FROM THE MARK AS SHOWN. THE ENGLISH TRANSLATION OF "SABAKI" IS "TO MOVE".

CLASS 28—TOYS AND SPORTING GOODS

FOR SPORTS EQUIPMENT, NAMELY, BALLS, BACKBOARDS, AND BALL GAME PINS (U.S. CLS. 22, 23, 38 AND 50).

FIRST USE 3-3-2010; IN COMMERCE 3-3-2010.

CLASS 41—EDUCATION AND ENTERTAINMENT

FOR ENTERTAINMENT SERVICES, NAMELY, ORGANIZING LEAGUES FOR PLAYING BALL GAMES (U.S. CLS. 100, 101 AND 107).

FIRST USE 3-3-2010; IN COMMERCE 1-24-2012.
MELISSA VALLILLO, EXAMINING ATTORNEY

SN 85-524,571. THE UPTICK GROUP, LLC, PEMBROKE PARK, FL. FILED 1-25-2012.

NO CLAIM IS MADE TO THE EXCLUSIVE RIGHT TO USE "GROUP", APART FROM THE MARK AS SHOWN.

THE MARK CONSISTS OF "UPTICK" IN BOLD FACE SEPARATED BY VERTICAL LINE WITH "THE UPTICK GROUP" TO THE RIGHT OF THE VERTICAL LINE.

CLASS 35—ADVERTISING AND BUSINESS

FOR ACCOUNTING SERVICES; BUSINESS ADVISORY SERVICES; CONSULTANCY AND INFORMATION; BUSINESS ASSISTANCE, MANAGEMENT AND INFORMATION SERVICES; BUSINESS PROCESS OUTSOURCING SERVICES IN THE FIELD OF ACCOUNTING, SUPPLY CHAIN MANAGEMENT AND FULFILLMENT; GOODS IMPORT-EXPORT AGENCIES; SUPPLY CHAIN MANAGEMENT SERVICES (U.S. CLS. 100, 101 AND 102).

FIRST USE 1-5-2012; IN COMMERCE 1-5-2012.

CLASS 41—EDUCATION AND ENTERTAINMENT

FOR ADVISORY AND CONSULTING SERVICES IN THE FIELD OF MANAGEMENT COACHING AND BUSINESS TRAINING FOCUSED ON BUSINESS STRATEGY, SALES, OPERATIONS AND DIRECT IMPORTING (U.S. CLS. 100, 101 AND 107).

FIRST USE 1-5-2012; IN COMMERCE 1-5-2012.
MARY ROSSMAN, EXAMINING ATTORNEY

SN 85-524,732. CNA INTERNATIONAL, INC., WOOD DALE, IL. FILED 1-25-2012.

SN 85-524,749. GOYA FOODS, INC., SECAUCUS, NJ. FILED 1-25-2012.

MAGIC CHEF

THE MARK CONSISTS OF STANDARD CHARACTERS WITHOUT CLAIM TO ANY PARTICULAR FONT, STYLE, SIZE, OR COLOR.

OWNER OF U.S. REG. NOS. 1,055,942, 3,379,669 AND OTHERS.

CLASS 7—MACHINERY

FOR ELECTRIC MEAT GRINDERS AND ELECTRIC MEAT SLICERS (U.S. CLS. 13, 19, 21, 23, 31, 34 AND 35). FIRST USE 12-27-2011; IN COMMERCE 12-27-2011.

CLASS 11—ENVIRONMENTAL CONTROL APPARATUS

FOR ELECTRIC BUFFET SERVERS, ELECTRIC DEEP FRYERS AND ELECTRIC GRILLS (U.S. CLS. 13, 21, 23, 31 AND 34).

FIRST USE 12-22-2011; IN COMMERCE 12-22-2011.
EMILY CARLSEN, EXAMINING ATTORNEY

SN 85-524,738. CNA INTERNATIONAL, INC., WOOD DALE, IL. FILED 1-25-2012.



OWNER OF U.S. REG. NOS. 1,055,942, 3,379,669 AND OTHERS.

THE MARK CONSISTS OF A DESIGN OF A CHEF TO THE LEFT OF THE STYLIZED WORDS "MAGIC CHEF".

CLASS 7—MACHINERY

FOR ELECTRIC MEAT GRINDERS AND ELECTRIC MEAT SLICERS (U.S. CLS. 13, 19, 21, 23, 31, 34 AND 35). FIRST USE 12-27-2011; IN COMMERCE 12-27-2011.

CLASS 11—ENVIRONMENTAL CONTROL APPARATUS

FOR ELECTRIC BUFFET SERVERS, ELECTRIC DEEP FRYERS AND ELECTRIC GRILLS (U.S. CLS. 13, 21, 23, 31 AND 34).

FIRST USE 12-22-2011; IN COMMERCE 12-22-2011.
EMILY CARLSEN, EXAMINING ATTORNEY

EL MUNDO DE GOYA KID

THE MARK CONSISTS OF STANDARD CHARACTERS WITHOUT CLAIM TO ANY PARTICULAR FONT, STYLE, SIZE, OR COLOR.

OWNER OF U.S. REG. NOS. 764,033, 966,178 AND OTHERS.

NO CLAIM IS MADE TO THE EXCLUSIVE RIGHT TO USE "KID", APART FROM THE MARK AS SHOWN.

THE ENGLISH TRANSLATION OF "EL MUNDO DE" IN THE MARK IS THE WORLD OF.

CLASS 41—EDUCATION AND ENTERTAINMENT

FOR ENTERTAINMENT SERVICES, NAMELY, PROVIDING A WEBSITE FEATURING GAMES AND PUZZLES; ENTERTAINMENT SERVICES, NAMELY, PROVIDING ON-LINE COMPUTER GAMES (U.S. CLS. 100, 101 AND 107).

FIRST USE 7-0-2010; IN COMMERCE 7-0-2010.

CLASS 44—MEDICAL, BEAUTY AND AGRICULTURAL SERVICES

FOR PROVIDING A WEB SITE THAT FEATURES INFORMATION ON CHILDREN'S NUTRITION (U.S. CLS. 100 AND 101).

FIRST USE 7-0-2010; IN COMMERCE 7-0-2010.

KATHLEEN LORENZO, EXAMINING ATTORNEY

SN 85-524,936. STERLING ENGAGEMENTS, INC., AGOURA HILLS, CA. FILED 1-25-2012.

STERLING ENGAGEMENTS

THE MARK CONSISTS OF STANDARD CHARACTERS WITHOUT CLAIM TO ANY PARTICULAR FONT, STYLE, SIZE, OR COLOR.

NO CLAIM IS MADE TO THE EXCLUSIVE RIGHT TO USE "ENGAGEMENTS", APART FROM THE MARK AS SHOWN.

CLASS 35—ADVERTISING AND BUSINESS

FOR ARRANGING AND CONDUCTING SPECIAL EVENTS FOR BUSINESS PURPOSES; ARRANGING AND CONDUCTING SPECIAL EVENTS FOR COMMERCIAL, PROMOTIONAL OR ADVERTISING PURPOSES; EVENT PLANNING AND MANAGEMENT FOR MARKETING, BRANDING, PROMOTING OR ADVERTISING THE GOODS AND SERVICES OF OTHERS (U.S. CLS. 100, 101 AND 102).

FIRST USE 9-21-2005; IN COMMERCE 9-21-2005.

CLASS 41—EDUCATION AND ENTERTAINMENT

FOR PARTY AND WEDDING PLANNING, COORDINATION AND CONSULTATION SERVICES; PROVIDING INFORMATION IN THE FIELD OF WEDDING PARTY PLANNING (U.S. CLS. 100, 101 AND 107).

FIRST USE 9-21-2005; IN COMMERCE 9-21-2005.

KIM MONINGHOFF, EXAMINING ATTORNEY

SN 85-525,487. BAD DONKEY SOCIAL, LLC, MADISON, WI.
FILED 1-25-2012.



THE MARK CONSISTS OF THE WORDING "BUZZ" AND "MSG". ABOVE THE WORDING "MSG" IS A PACK OF EIGHT WATERCOLOR DOTS. THE DOTS ARE ALL DIFFERENT SIZES AND THEY ALL HAVE A GRADIENT AFFECT. THE LARGEST THREE DOTS ARE ON THE OUTER RIGHT AND THE SMALLER DOTS ARE ON THE LEFT. THE DOTS RESEMBLE FLOATING BALLOONS.

CLASS 35—ADVERTISING AND BUSINESS

FOR ADVERTISING, PROMOTION AND MARKETING SERVICES PROVIDED BY MEANS OF THE INTERNET AND TELECOMMUNICATIONS NETWORKS, NAMELY, TEXT MESSAGES, EMAILS, INSTANT MESSAGES OR SOCIAL MEDIA (U.S. CLS. 100, 101 AND 102).

CLASS 38—COMMUNICATION

FOR COMMUNICATION SERVICES, NAMELY, TRANSMISSION OF VOICE, AUDIO, VIDEO, VISUAL IMAGES, GRAPHICS, PICTURES, PHOTOGRAPHS, DATA AND TEXT BY TELECOMMUNICATIONS NETWORKS, WIRELESS COMMUNICATIONS NETWORKS, THE INTERNET, INFORMATION SERVICES NETWORKS AND DATA NETWORKS (U.S. CLS. 100, 101 AND 104).

MICHAEL KEATING, EXAMINING ATTORNEY

SN 85-525,641. EASTERN STATES VETERINARY ASSOCIATION, INC., DBA NORTH AMERICAN VETERINARY CONFERENCE, GAINESVILLE, FL. FILED 1-26-2012.



OWNER OF U.S. REG. NOS. 3,333,122, 3,550,575 AND 4,008,346.

NO CLAIM IS MADE TO THE EXCLUSIVE RIGHT TO USE "EXPEDITIONS", APART FROM THE MARK AS SHOWN.

THE COLOR(S) DARK BLUE, ORANGE, LIGHT BLUE, YELLOW AND WHITE IS/ARE CLAIMED AS A FEATURE OF THE MARK.

THE MARK CONSISTS OF THE WORDING "NAVC" AND "EXPEDITIONS" BETWEEN TWO CONCENTRIC DARK BLUE CIRCLE OUTLINES WHICH FEATURE IN THE CENTER A LETTER "V" IN BLUE WITH THE WORDING "NAVC" IN YELLOW, LIGHT BLUE WAVES AND A YELLOW AND ORANGE SUN, ALL OVER A WHITE BACKGROUND.

CLASS 39—TRANSPORTATION AND STORAGE

FOR ORGANIZATION OF EXCURSIONS, SIGHTSEEING TOURS, HOLIDAYS, TOURS AND TRAVEL (U.S. CLS. 100 AND 105).

FIRST USE 10-28-2010; IN COMMERCE 10-28-2010.

CLASS 41—EDUCATION AND ENTERTAINMENT

FOR CONTINUING EDUCATION SERVICES, NAMELY, PROVIDING LIVE AND ON-LINE CONTINUING PROFESSIONAL EDUCATION SEMINARS IN THE FIELD OF VETERINARY MEDICINE (U.S. CLS. 100, 101 AND 107).

FIRST USE 10-28-2010; IN COMMERCE 10-28-2010.

JULIE VEPPUMTHARA, EXAMINING ATTORNEY

SN 85-525,945. DOSKOCIL MANUFACTURING COMPANY, INC., ARLINGTON, TX. FILED 1-26-2012.

FurPlus

THE MARK CONSISTS OF STANDARD CHARACTERS WITHOUT CLAIM TO ANY PARTICULAR FONT, STYLE, SIZE, OR COLOR.

OWNER OF U.S. REG. NOS. 3,442,122 AND 3,690,604.

CLASS 8—HAND TOOLS

FOR GROOMING TOOLS FOR PETS, NAMELY, NAIL CLIPPERS (U.S. CLS. 23, 28 AND 44).

CLASS 21—HOUSEWARES AND GLASS

FOR GROOMING TOOLS FOR PETS, NAMELY, BRUSHES AND COMBS; AND HOME AND CAR ANIMAL HAIR REMOVAL BRUSH (U.S. CLS. 2, 13, 23, 29, 30, 33, 40 AND 50).

BRIAN PINO, EXAMINING ATTORNEY

SN 85-526,520. MAJOR LEAGUE BASEBALL PLAYERS ASSOCIATION, NEW YORK, NY. FILED 1-26-2012.

PLAYERS CHOICE ACADEMY

THE MARK CONSISTS OF STANDARD CHARACTERS WITHOUT CLAIM TO ANY PARTICULAR FONT, STYLE, SIZE, OR COLOR.

OWNER OF U.S. REG. NOS. 2,537,150, 2,929,068 AND OTHERS.

NO CLAIM IS MADE TO THE EXCLUSIVE RIGHT TO USE "ACADEMY", APART FROM THE MARK AS SHOWN.

CLASS 9—ELECTRICAL AND SCIENTIFIC APPARATUS

FOR VIDEO GAME CARTRIDGES, COMPUTER GAME PROGRAMS; VIDEO GAME PROGRAMS RELATED TO BASEBALL, COMPUTER GAME PROGRAMS RELATED TO BASEBALL; COMPUTER HARDWARE AND SOFTWARE USED FOR TRAINING AND INSTRUCTION RELATED TO BASEBALL AND SOFTBALL SKILLS (U.S. CLS. 21, 23, 26, 36 AND 38).

SN 85-526,540. SWITCHFLY, INC., SAN FRANCISCO, CA. FILED 1-26-2012.

CLASS 16—PAPER GOODS AND PRINTED MATTER

FOR TRADING CARDS, NAMELY, PAPER AND CARDBOARD TRADING CARDS; PHOTOGRAPHS, NAMELY, MOUNTED AND UN-MOUNTED PHOTOGRAPHS; STICKERS, POSTERS, DECALS, POSTCARDS, STATIONERY, CALENDARS, PAPER PENNANTS, NEWSLETTERS FEATURING BASEBALL, MAGAZINES IN THE FIELD OF BASEBALL; BOOKS IN THE FIELD OF BASEBALL AND OTHER PRINTED MATTER, NAMELY, NEWSLETTERS AND BULLETINS FEATURING BASEBALL AND BASEBALL CARDS; PENS, NAMELY, BALL-POINT, ROLLER BALL, FOUNTAIN, HIGHLIGHTERS, FIBER-TIP PEN AND PENCIL BOX SETS, PENCIL AND PEN BOX SETS, PEN BOX SETS, PENCIL BOX SETS, PEN AND PENCIL HOLDERS (U.S. CLS. 2, 5, 22, 23, 29, 37, 38 AND 50).

SWITCHFLY

THE MARK CONSISTS OF STANDARD CHARACTERS WITHOUT CLAIM TO ANY PARTICULAR FONT, STYLE, SIZE, OR COLOR.

CLASS 25—CLOTHING

FOR CLOTHING, NAMELY, T-SHIRTS, SWEATSHIRTS, SWEATPANTS, PANTS, TANK TOPS, SHORTS, JERSEYS, WARM-UP SUITS, JACKETS, SPORT SHIRTS, SHOES, SOCKS, WRIST BANDS, POLO SHIRTS AND HEADGEAR, NAMELY, CAPS AND HATS (U.S. CLS. 22 AND 39).

CLASS 35—ADVERTISING AND BUSINESS

FOR CUSTOMER LOYALTY SERVICES AND CUSTOMER CLUB SERVICES FOR COMMERCIAL, PROMOTIONAL AND ADVERTISING PURPOSES; CONDUCTING CUSTOMER LOYALTY, REWARD, AFFINITY AND INCENTIVE PROGRAMS FOR COMMERCIAL PROMOTION AND ADVERTISING PURPOSES; BUSINESS CONSULTING SERVICES IN THE FIELD OF TRAVEL AND OPERATION OF TRAVEL-RELATED BUSINESSES; ADVERTISING SERVICES, NAMELY, PROMOTING AND MARKETING THE GOODS AND SERVICES OF OTHERS VIA ELECTRONIC AND OPTICAL COMMUNICATIONS NETWORKS (U.S. CLS. 100, 101 AND 102).

CLASS 28—TOYS AND SPORTING GOODS

FOR HANDHELD UNITS FOR PLAYING VIDEO GAMES RELATED TO BASEBALL, HANDHELD UNITS FOR PLAYING ELECTRONIC GAMES RELATED TO BASEBALL, TOYS AND GAMES DEPICTING BASEBALL PLAYERS IN THE GAME OF BASEBALL, NAMELY, ACTION FIGURES, DOLLS, STUFFED TOYS, JIGSAW PUZZLES, BOARD GAMES RELATED TO BASEBALL, PLAYING CARDS, BASEBALL TRAINING APPARATUS USED FOR INSTRUCTION IN AND DEVELOPMENT OF BASEBALL AND SOFTBALL SKILLS (U.S. CLS. 22, 23, 38 AND 50).

CLASS 42—SCIENTIFIC AND COMPUTER SERVICES

FOR COMPUTER SOFTWARE DESIGN AND MAINTENANCE OF COMPUTER SOFTWARE FOR THE TRAVEL INDUSTRY, NAMELY, APPLICATION SUPPORT OF SOFTWARE FOR CREATING DYNAMIC PACKAGING AND FACILITATING INDIVIDUAL SALE OF TRAVEL PRODUCTS, INCLUDING AIR, ROOM, CAR, TRAVEL ACTIVITIES AND CRUISES AND ADMINISTERING NETWORK CONNECTIVITY BETWEEN SUPPLIERS AND DISTRIBUTORS OF TRAVEL PRODUCTS; PROVIDING TEMPORARY USE OF NONDOWNLOADABLE COMPUTER SOFTWARE FOR CONDUCTING CUSTOMER LOYALTY, REWARD, AFFINITY AND INCENTIVE PROGRAMS; PROVIDING TEMPORARY USE OF NONDOWNLOADABLE COMPUTER SOFTWARE FOR PROMOTING AND MARKETING THE GOODS AND SERVICES OF OTHERS VIA ELECTRONIC AND OPTICAL COMMUNICATIONS NETWORKS; PROVIDING TEMPORARY USE OF NONDOWNLOADABLE COMPUTER SOFTWARE FOR ENABLING CONSUMERS TO ENGAGE IN SOCIAL NETWORKING AND BUSINESS NETWORKING; PROVIDING TEMPORARY USE OF NONDOWNLOADABLE SOFTWARE APPLICATIONS FOR TRANSMISSION OF AUDIO, VIDEO, PHOTOGRAPHIC IMAGES, TEXT, GRAPHICS, DATA AND USER-GENERATED CONTENT; PROVIDING TEMPORARY USE OF NONDOWNLOADABLE COMPUTER SOFTWARE FOR MANAGING AND USING VIRTUAL CURRENCY OR REWARDS POINTS FOR PURCHASING GOODS AND SERVICES ON ELECTRONIC OR OPTICAL COMMUNICATIONS NETWORKS (U.S. CLS. 100 AND 101).

CLASS 35—ADVERTISING AND BUSINESS

FOR RETAIL OUTLETS FEATURING BASEBALL-RELATED PRODUCTS (U.S. CLS. 100, 101 AND 102).

CLASS 41—EDUCATION AND ENTERTAINMENT

FOR PROVIDING RECREATIONAL FACILITIES, INSTRUCTION, TRAINING, CAMPS, LEAGUES, TEAMS, CLINICS, SPORTING EVENTS AND ENTERTAINMENT SERVICES, NAMELY, PARTIES AND GAMES, ALL RELATED TO BASEBALL AND/OR SOFTBALL (U.S. CLS. 100, 101 AND 107).

ALICIA COLLINS, EXAMINING ATTORNEY

KRISTIN DAHLING, EXAMINING ATTORNEY

SN 85-526,544. SWITCHFLY, INC., SAN FRANCISCO, CA. FILED 1-26-2012.

SN 85-526,581. EVANS, TYRONE F., MALDEN, MA. FILED 1-26-2012.

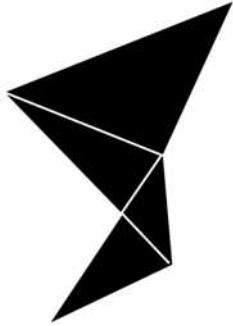

THE MARK CONSISTS OF A STYLIZED FOLDED LETTER "S" COMPRISED OF A GEOMETRIC DESIGN OF FOUR TRIANGLES.

CLASS 35—ADVERTISING AND BUSINESS

FOR CUSTOMER LOYALTY SERVICES AND CUSTOMER CLUB SERVICES FOR COMMERCIAL, PROMOTIONAL AND ADVERTISING PURPOSES; CONDUCTING CUSTOMER LOYALTY, REWARD, AFFINITY AND INCENTIVE PROGRAMS FOR COMMERCIAL PROMOTION AND ADVERTISING PURPOSES; BUSINESS CONSULTING SERVICES IN THE FIELD OF TRAVEL AND OPERATION OF TRAVEL-RELATED BUSINESSES; ADVERTISING SERVICES, NAMELY, PROMOTING AND MARKETING THE GOODS AND SERVICES OF OTHERS VIA ELECTRONIC AND OPTICAL COMMUNICATIONS NETWORKS (U.S. CLS. 100, 101 AND 102).

CLASS 42—SCIENTIFIC AND COMPUTER SERVICES

FOR COMPUTER SOFTWARE DESIGN AND MAINTENANCE OF COMPUTER SOFTWARE FOR THE TRAVEL INDUSTRY, NAMELY, APPLICATION SUPPORT OF SOFTWARE FOR CREATING DYNAMIC PACKAGING AND FACILITATING INDIVIDUAL SALE OF TRAVEL PRODUCTS, INCLUDING AIR, ROOM, CAR, TRAVEL ACTIVITIES AND CRUISES AND ADMINISTERING NETWORK CONNECTIVITY BETWEEN SUPPLIERS AND DISTRIBUTORS OF TRAVEL PRODUCTS; PROVIDING TEMPORARY USE OF NONDOWNLOADABLE COMPUTER SOFTWARE FOR CONDUCTING CUSTOMER LOYALTY, REWARD, AFFINITY AND INCENTIVE PROGRAMS; PROVIDING TEMPORARY USE OF NONDOWNLOADABLE COMPUTER SOFTWARE FOR PROMOTING AND MARKETING THE GOODS AND SERVICES OF OTHERS VIA ELECTRONIC AND OPTICAL COMMUNICATIONS NETWORKS; PROVIDING TEMPORARY USE OF NONDOWNLOADABLE COMPUTER SOFTWARE FOR ENABLING CONSUMERS TO ENGAGE IN SOCIAL NETWORKING AND BUSINESS NETWORKING; PROVIDING TEMPORARY USE OF NONDOWNLOADABLE SOFTWARE APPLICATIONS FOR TRANSMISSION OF AUDIO, VIDEO, PHOTOGRAPHIC IMAGES, TEXT, GRAPHICS, DATA AND USER-GENERATED CONTENT; PROVIDING TEMPORARY USE OF NONDOWNLOADABLE COMPUTER SOFTWARE FOR MANAGING AND USING VIRTUAL CURRENCY OR REWARDS POINTS FOR PURCHASING GOODS AND SERVICES ON ELECTRONIC OR OPTICAL COMMUNICATIONS NETWORKS (U.S. CLS. 100 AND 101).

KRISTIN DAHLING, EXAMINING ATTORNEY

All In 4 Jesus

THE MARK CONSISTS OF STANDARD CHARACTERS WITHOUT CLAIM TO ANY PARTICULAR FONT, STYLE, SIZE, OR COLOR.

CLASS 25—CLOTHING

FOR T-SHIRTS; HATS, SHORTS, UNDERWEAR, SOCKS, HEAD BANDS, EAR MUFFS, SWEAT PANTS, SNEAKERS, SLIPPERS, PULL OVERS, SWEAT SHIRTS AND SHOES (U.S. CLS. 22 AND 39).

FIRST USE 12-14-2011; IN COMMERCE 12-14-2011.

CLASS 41—EDUCATION AND ENTERTAINMENT

FOR ENTERTAINMENT SERVICES IN THE NATURE OF LIVE TALENT SHOWS (U.S. CLS. 100, 101 AND 107). FIRST USE 12-14-2011; IN COMMERCE 12-14-2011. DAVID H. STINE, EXAMINING ATTORNEY

SN 85-526,890. AUDI AG, INGOLSTADT, FED REP GERMANY, FILED 1-27-2012.



THE MARK CONSISTS OF STANDARD CHARACTERS WITHOUT CLAIM TO ANY PARTICULAR FONT, STYLE, SIZE, OR COLOR.

OWNER OF FED REP GERMANY REG. NO. 302011041044, DATED 9-15-2011, EXPIRES 7-31-2021.

CLASS 12—VEHICLES

FOR AUTOMOBILES AND THEIR STRUCTURAL PARTS (U.S. CLS. 19, 21, 23, 31, 35 AND 44).

CLASS 18—LEATHER GOODS

FOR LEATHER AND IMITATION OF LEATHER AND GOODS MADE OF THESE MATERIALS, NAMELY, TRUNKS AND TRAVELING BAGS, PURSES, WALLETS, BAGS, KEY CHAINS, UMBRELLAS (U.S. CLS. 1, 2, 3, 22 AND 41).

CLASS 28—TOYS AND SPORTING GOODS

FOR GAMES AND PLAYTHINGS, NAMELY, MODEL CARS, PLUSH CARS, CHILDREN'S PEDAL CARS, PLAYING CARDS (U.S. CLS. 22, 23, 38 AND 50). ANDREA K. NADELMAN, EXAMINING ATTORNEY

SN 85-526,909. HENDON GROUP, INC., LINDENHURST, IL. FILED 1-27-2012.

BETTER PLANNING. BETTER LEADERSHIP. BETTER OUTCOMES.

THE MARK CONSISTS OF STANDARD CHARACTERS WITHOUT CLAIM TO ANY PARTICULAR FONT, STYLE, SIZE, OR COLOR.

CLASS 35—ADVERTISING AND BUSINESS

FOR BUSINESS CONSULTING SERVICES IN THE FIELD OF PROJECT, PROGRAM AND PORTFOLIO MANAGEMENT (U.S. CLS. 100, 101 AND 102).

CLASS 42—SCIENTIFIC AND COMPUTER SERVICES

FOR TECHNOLOGICAL PLANNING AND CONSULTING SERVICES IN THE FIELD OF PROJECT, PROGRAM AND PORTFOLIO MANAGEMENT (U.S. CLS. 100 AND 101).

CHRIS WELLS, EXAMINING ATTORNEY

CLASS 3—COSMETICS AND CLEANING PREPARATIONS

FOR 3-IN-1 ORGANIC SOAP BARS FOR USE AS SOAP, SHAMPOO AND CONDITIONER; ALMOND SOAPS; ANTI-BACTERIAL SOAP; ANTIBACTERIAL SKIN SOAPS; ANTIBACTERIAL SOAP; AROMATIC BODY CARE PRODUCTS, NAMELY, BODY LOTION, SHOWER GEL, CUTICLE CREAM, SHAMPOO, CONDITIONER, NON-MEDICATED LIP BALM, SOAP, BODY POLISH, BODY AND FOOT SCRUB AND NON-MEDICATED FOOT CREAM; BABY HAND SOAP; BAR SOAP; BATH SOAPS; BATH SOAPS IN LIQUID, SOLID OR GEL FORM; BEAUTY SOAP; BODY CREAM SOAP; CAKES OF TOILET SOAP; COSMETIC SOAPS; CREAM SOAPS; DEODORANT SOAP; DETERGENT SOAP; DISINFECTANT SOAPS; DISINFECTING PERFUMED SOAPS; GRANULATED SOAPS; HAND SOAPS; HANDMADE SOAP BARS; INDUSTRIAL SOAP; LAUNDRY SOAP; LIQUID BATH SOAPS; LIQUID SOAP; LIQUID SOAP USED IN FOOT BATH; LIQUID SOAPS; LIQUID SOAPS FOR HANDS AND FACE; LIQUID SOAPS FOR HANDS, FACE AND BODY; LOOFAH SOAPS; MEDICATED SOAP; MEDICATED SOAPS; NATURAL COCOA BUTTER BASED PERSONAL CARE PRODUCTS, NAMELY, BODY LOTION, SHOWER GEL, SOAP, BODY POLISH, BODY AND FOOT SCRUB AND NON-MEDICATED SKIN CREAMS; NATURAL SOAP BARS; NATURALLY HANDMADE SOAP BARS; ORGANIC SOAP BARS; PERFUMED SOAP; PERFUMED SOAPS; SCENT ELIMINATING SHAMPOO AND SOAP FOR USE ASSOCIATED WITH HUNTING AND OUTDOOR RECREATION; SHAVING SOAP; SHAVING SOAPS; SKIN SOAP; SOAP IN THE FORM OF BATH TOYS; SOAP POWDER; SOAPS; SOAPS AND DETERGENTS; SOAPS FOR BODY CARE; SOAPS FOR HOUSEHOLD USE; SOAPS FOR PERSONAL USE; SOAPS FOR TOILET PURPOSES; TOILET SOAP; TOILET SOAPS; WATERLESS SOAP (U.S. CLS. 1, 4, 6, 50, 51 AND 52).

CLASS 35—ADVERTISING AND BUSINESS

FOR RETAIL STORE SERVICES FEATURING BATH AND BEAUTY PRODUCTS (U.S. CLS. 100, 101 AND 102). ADA HAN, EXAMINING ATTORNEY

SN 85-528,329. MTS MEDICATION TECHNOLOGIES, INC., ST. PETERSBURG, FL. FILED 1-30-2012.

easyBLIST

THE MARK CONSISTS OF STANDARD CHARACTERS WITHOUT CLAIM TO ANY PARTICULAR FONT, STYLE, SIZE, OR COLOR.

CLASS 9—ELECTRICAL AND SCIENTIFIC APPARATUS

FOR COMPUTER SOFTWARE FOR THE IDENTIFICATION, ADMINISTRATION, AND MANAGEMENT OF PATIENT RECORDS AND MEDICATIONS (U.S. CLS. 21, 23, 26, 36 AND 38).

CLASS 16—PAPER GOODS AND PRINTED MATTER

FOR PACKAGING, NAMELY, BLISTER CARDS; PRINTED PRODUCTS, NAMELY, CUSTOMIZED CARDBOARD MEDICINE PACKAGES (U.S. CLS. 2, 5, 22, 23, 29, 37, 38 AND 50).

SN 85-527,282. SPRIZZARE SOAP CAFE, L.L.C., NORTH LAS VEGAS, NV. FILED 1-27-2012.

SWEET BUBBLE

THE MARK CONSISTS OF STANDARD CHARACTERS WITHOUT CLAIM TO ANY PARTICULAR FONT, STYLE, SIZE, OR COLOR.

OWNER OF U.S. REG. NO. 3,961,796.

CLASS 42—SCIENTIFIC AND COMPUTER SERVICES

FOR SOFTWARE AS A SERVICE FOR THE IDENTIFICATION, ADMINISTRATION, AND MANAGEMENT OF PATIENT RECORDS AND MEDICATIONS (U.S. CLS. 100 AND 101).

JANICE KIM, EXAMINING ATTORNEY

CLASS 18—LEATHER GOODS

FOR ALL-PURPOSE CARRYING BAGS; EVENING BAGS; HUNTERS' GAME BAGS; LEATHER BAGS AND WALLETS; LEATHER BAGS, SUITCASES AND WALLETS; MESSENGER BAGS; TOTE BAGS (U.S. CLS. 1, 2, 3, 22 AND 41).

LINDA ESTRADA, EXAMINING ATTORNEY

SN 85-528,725. YOUNG, CHRISTOPHER MILLER, DBA SKULLBOY, BRICK, NJ. FILED 1-30-2012.

Skullboy

THE MARK CONSISTS OF STANDARD CHARACTERS WITHOUT CLAIM TO ANY PARTICULAR FONT, STYLE, SIZE, OR COLOR.

CLASS 16—PAPER GOODS AND PRINTED MATTER

FOR PAINTINGS; PRINTS; STICKERS; SKETCHES (U.S. CLS. 2, 5, 22, 23, 29, 37, 38 AND 50).

FIRST USE 3-1-2002; IN COMMERCE 3-1-2002.

CLASS 25—CLOTHING

FOR HATS; JACKETS; PANTS; SHOES; SWEAT SHIRTS; T-SHIRTS; UNDERWEAR; BATHING SUITS; VESTS (U.S. CLS. 22 AND 39).

FIRST USE 1-10-2004; IN COMMERCE 1-10-2004.
WILLIAM VERHOSEK, EXAMINING ATTORNEY

SN 85-528,995. GREWAL GARY, TRACY, CA. FILED 1-30-2012.

TOTARE

THE MARK CONSISTS OF STANDARD CHARACTERS WITHOUT CLAIM TO ANY PARTICULAR FONT, STYLE, SIZE, OR COLOR.

THE WORDING "TOTARE" HAS NO MEANING IN A FOREIGN LANGUAGE.

CLASS 9—ELECTRICAL AND SCIENTIFIC APPARATUS

FOR BAGS AND CASES SPECIALLY ADAPTED FOR HOLDING OR CARRYING PORTABLE TELEPHONES AND TELEPHONE EQUIPMENT AND ACCESSORIES; BAGS FOR CAMERAS AND PHOTOGRAPHIC EQUIPMENT; COMPUTER BAGS; MESSENGER BAGS ESPECIALLY ADAPTED FOR HOLDING ELECTRONIC BOOK READERS; MESSENGER BAGS ESPECIALLY ADAPTED FOR HOLDING LAPTOPS (U.S. CLS. 21, 23, 26, 36 AND 38).

SN 85-529,067. MCGRAW, JORDAN, BEVERLY HILLS, CA. FILED 1-30-2012.



THE MARK CONSISTS OF A STAR WITH A LIGHTNING BOLT THAT APPEARS ABOVE THE STYLIZED LETTERS "SNS" AND CONTAINING SPLATTER MARKINGS.

CLASS 9—ELECTRICAL AND SCIENTIFIC APPARATUS

FOR MUSICAL SOUND RECORDINGS; MUSICAL VIDEO AND AUDIO RECORDINGS; PRERECORDED AUDIO AND VISUAL TAPES, PRERECORDED PHONOGRAPH RECORDS AND PRERECORDED COMPACT DISCS AND DVDS ALL FEATURING MUSIC (U.S. CLS. 21, 23, 26, 36 AND 38).

CLASS 16—PAPER GOODS AND PRINTED MATTER

FOR PRINTED MATTER FOR PUBLICITY AND PROMOTIONAL MATERIALS, NAMELY, POSTERS; STICKERS; POSTCARDS, MOUNTED AND UNMOUNTED PHOTOGRAPHS AND PHOTOGRAPHIC PRINTS; NEWSLETTERS IN THE FIELDS OF MUSIC AND ENTERTAINMENT; CALENDARS; DECALS; PRINTED CONCERT TICKETS; PRINTED BACKSTAGE PASSES; SOUVENIR PROGRAMS CONCERNING MUSIC AND ENTERTAINMENT EVENTS; BOOKS AND MAGAZINES ALL IN THE FIELD OF MUSIC AND ENTERTAINMENT (U.S. CLS. 2, 5, 22, 23, 29, 37, 38 AND 50).

CLASS 25—CLOTHING

FOR CLOTHING, NAMELY, SHIRTS, T-SHIRTS, HATS, CAPS, AND SWEATSHIRTS (U.S. CLS. 22 AND 39).

CLASS 41—EDUCATION AND ENTERTAINMENT

FOR ENTERTAINMENT SERVICES, NAMELY, LIVE PERFORMANCES AND APPEARANCES BY A VOCAL AND INSTRUMENTAL GROUP, AND LIVE PERFORMANCES AND APPEARANCES FEATURING PRERECORDED MUSIC BY A VOCAL AND INSTRUMENTAL GROUP; FAN CLUB SERVICES; PROVIDING A WEBSITE FEATURING ENTERTAINMENT INFORMATION, NAMELY, REVIEWS, ARTICLES, INTERVIEWS, MUSIC VIDEOS, MUSIC CHARTS, PERSONAL BIOGRAPHIES, DIARIES, INFORMATION ON MUSIC INSTRUMENTS, TOUR DATES, GAMES, TRIVIA, ACCESS TO MEMORABILIA, PHOTOGRAPHS, VIDEO CLIPS, AND AUDIO CLIPS, ALL AVAILABLE VIA A GLOBAL COMPUTER NETWORK (U.S. CLS. 100, 101 AND 107).

EDWARD NELSON, EXAMINING ATTORNEY

SN 85-529,367. WICKED BEAN, LLC, PONTE VEDRA BEACH, FL. FILED 1-31-2012.



THE MARK CONSISTS OF A CAPITAL "W" AND CAPITAL "B" INSIDE OF A BEAN. THE "W" IS IN THE UPPER LEFT CORNER OF THE BEAN AND THE "B" IS IN THE LOWER RIGHT CORNER OF THE BEAN. IN THE LOWER LEFT CORNER IS THE SHAPE OF A WAVE. ALSO STARTING IN THE LOWER LEFT CORNER CONTINUING UP TO THE UPPER RIGHT CORNER IS THE SHAPE OF A TREE WHICH IS ALL IN THE BACKGROUND BEHIND THE "W", "B" AND WAVE.

CLASS 16—PAPER GOODS AND PRINTED MATTER

FOR DECALS (U.S. CLS. 2, 5, 22, 23, 29, 37, 38 AND 50).

CLASS 25—CLOTHING

FOR LONG-SLEEVED SHIRTS; SHIRTS; SHIRTS AND SHORT-SLEEVED SHIRTS; SHORT-SLEEVED OR LONG-SLEEVED T-SHIRTS; SHORT-SLEEVED SHIRTS; T-SHIRTS (U.S. CLS. 22 AND 39).

LOURDES AYALA, EXAMINING ATTORNEY

SN 85-530,455. IMPARATO, LAUREN, DBA I.AM.YOU. STUDIO, NEW YORK, NY. FILED 1-31-2012.

I.AM.YOU.

THE MARK CONSISTS OF STANDARD CHARACTERS WITHOUT CLAIM TO ANY PARTICULAR FONT, STYLE, SIZE, OR COLOR.

CLASS 41—EDUCATION AND ENTERTAINMENT

FOR YOGA INSTRUCTION (U.S. CLS. 100, 101 AND 107).
FIRST USE 4-0-2009; IN COMMERCE 4-0-2009.

CLASS 44—MEDICAL, BEAUTY AND AGRICULTURAL SERVICES

FOR COUNSELING SERVICES IN THE FIELDS OF HEALTH, NUTRITION AND LIFESTYLE WELLNESS; DIETARY AND NUTRITIONAL GUIDANCE; NUTRITION COUNSELING; NUTRITIONAL THERAPY SERVICES; PROVIDING A WEBSITE FEATURING INFORMATION ABOUT HEALTH, WELLNESS AND NUTRITION; PROVIDING HEALTHY LIFESTYLE AND NUTRITION SERVICES, NAMELY, PERSONAL ASSESSMENTS, PERSONALIZED ROUTINES, MAINTENANCE SCHEDULES, AND COUNSELING; PROVIDING INFORMATION ABOUT DIETARY SUPPLEMENTS AND NUTRITION (U.S. CLS. 100 AND 101).

FIRST USE 4-0-2009; IN COMMERCE 4-0-2009.
JAY FLOWERS, EXAMINING ATTORNEY

SN 85-530,465. IMPARATO, LAUREN, DBA I.AM.YOU. STUDIO, NEW YORK, NY. FILED 1-31-2012.

DETOX TO RETOX

THE MARK CONSISTS OF STANDARD CHARACTERS WITHOUT CLAIM TO ANY PARTICULAR FONT, STYLE, SIZE, OR COLOR.

CLASS 41—EDUCATION AND ENTERTAINMENT

FOR YOGA INSTRUCTION (U.S. CLS. 100, 101 AND 107).
FIRST USE 5-0-2009; IN COMMERCE 5-0-2009.

CLASS 44—MEDICAL, BEAUTY AND AGRICULTURAL SERVICES

FOR COUNSELING SERVICES IN THE FIELDS OF HEALTH, NUTRITION AND LIFESTYLE WELLNESS; NUTRITION COUNSELING; NUTRITIONAL THERAPY SERVICES; PROVIDING A WEBSITE FEATURING INFORMATION ABOUT HEALTH, WELLNESS AND NUTRITION; PROVIDING AN ON-LINE COMPUTER DATABASE FEATURING INFORMATION REGARDING HEALTH AND NUTRITION; PROVIDING ASSISTANCE, FITNESS EVALUATION AND CONSULTATION TO INDIVIDUALS TO HELP THEM MAKE HEALTH, WELLNESS AND NUTRITIONAL CHANGES IN THEIR DAILY LIVING TO IMPROVE HEALTH; PROVIDING HEALTHY LIFESTYLE AND NUTRITION SERVICES, NAMELY, PERSONAL ASSESSMENTS, PERSONALIZED ROUTINES, MAINTENANCE SCHEDULES, AND COUNSELING; PROVIDING INFORMATION ABOUT DIETARY SUPPLEMENTS AND NUTRITION (U.S. CLS. 100 AND 101).

FIRST USE 5-0-2009; IN COMMERCE 5-0-2009.
JAY FLOWERS, EXAMINING ATTORNEY

SN 85-530,475. ANDREW REISMAN, CHICAGO, IL. FILED 1-31-2012.

SN 85-530,586. MEDICAL RECOVERY SERVICES, LLC., IDAHO FALLS, ID. FILED 2-1-2012.

ESPI

THE MARK CONSISTS OF STANDARD CHARACTERS WITHOUT CLAIM TO ANY PARTICULAR FONT, STYLE, SIZE, OR COLOR.

CLASS 9—ELECTRICAL AND SCIENTIFIC APPARATUS

FOR COMPUTER SOFTWARE FOR PERFORMING PREDICTIVE CODING AND COMPUTER ASSISTED REVIEW OF ELECTRONIC DOCUMENTS (U.S. CLS. 21, 23, 26, 36 AND 38).

CLASS 45—PERSONAL AND LEGAL SERVICES

FOR LITIGATION SUPPORT SERVICES (U.S. CLS. 100 AND 101).
TIMOTHY FINNEGAN, EXAMINING ATTORNEY

SN 85-530,568. MINISTRY OF SOUND GROUP LIMITED, LONDON, UNITED KINGDOM, FILED 2-1-2012.

HED KANDI

THE MARK CONSISTS OF STANDARD CHARACTERS WITHOUT CLAIM TO ANY PARTICULAR FONT, STYLE, SIZE, OR COLOR.

OWNER OF ERP N CMNTY TM OFC REG. NO. 005259262, DATED 7-26-2007, EXPIRES 8-16-2016.

CLASS 25—CLOTHING

FOR CLOTHING, NAMELY JACKETS, SHIRTS, TEE SHIRTS, SHORTS, TRACKSUITS, SKIRTS, SCARVES, DRESSES, TROUSERS, SWEATSHIRTS, TRACK PANTS, VESTS, BLOUSES; FOOTWEAR, NAMELY SHOES, SLIPPERS AND SANDALS; HEADGEAR, NAMELY HATS AND CAPS (U.S. CLS. 22 AND 39).

CLASS 43—HOTEL AND RESTAURANT SERVICES

FOR BARS, RESTAURANTS AND HOTELS; PROVISION OF TEMPORARY ACCOMMODATION SERVICES AND CATERING SERVICES; MAKING RESERVATIONS AND BOOKINGS FOR RESTAURANTS AND TEMPORARY VACATION LODGING; SERVICES FOR PROVIDING FOOD AND DRINK (U.S. CLS. 100 AND 101).
LINDA MICKLEBURGH, EXAMINING ATTORNEY

MEDICAL RECOVERY SERVICES

THE MARK CONSISTS OF STANDARD CHARACTERS WITHOUT CLAIM TO ANY PARTICULAR FONT, STYLE, SIZE, OR COLOR.

OWNER OF U.S. REG. NO. 3,143,758.
NO CLAIM IS MADE TO THE EXCLUSIVE RIGHT TO USE "RECOVERY SERVICES", APART FROM THE MARK AS SHOWN.
SEC. 2(F).

CLASS 36—INSURANCE AND FINANCIAL

FOR COLLECTION AGENCIES; COLLECTION OF DEBTS; DEBT RECOVERY AND COLLECTION AGENCIES (U.S. CLS. 100, 101 AND 102).
FIRST USE 9-23-2003; IN COMMERCE 9-23-2003.

CLASS 45—PERSONAL AND LEGAL SERVICES

FOR LEGAL SERVICES (U.S. CLS. 100 AND 101).
FIRST USE 9-23-2003; IN COMMERCE 9-23-2003.
WILLIAM P. SHANAHAN, EXAMINING ATTORNEY

SN 85-530,662. LIMITED BRANDS SERVICE COMPANY, LLC, COLUMBUS, OH. FILED 2-1-2012.

EASTON

THE MARK CONSISTS OF STANDARD CHARACTERS WITHOUT CLAIM TO ANY PARTICULAR FONT, STYLE, SIZE, OR COLOR.

CLASS 36—INSURANCE AND FINANCIAL

FOR REAL ESTATE SERVICES, NAMELY, RENTAL, BROKERAGE, LEASING AND MANAGEMENT OF COMMERCIAL PROPERTY, OFFICES AND OFFICE SPACE; LEASING OF SHOPPING MALL SPACE (U.S. CLS. 100, 101 AND 102).
FIRST USE 6-30-1999; IN COMMERCE 6-30-1999.

CLASS 37—CONSTRUCTION AND REPAIR

FOR REAL ESTATE DEVELOPMENT AND CONSTRUCTION OF COMMERCIAL, RESIDENTIAL AND HOTEL PROPERTIES (U.S. CLS. 100, 103 AND 106).
FIRST USE 6-30-1999; IN COMMERCE 6-30-1999.
HANNO RITTNER, EXAMINING ATTORNEY

SN 85-530,677. ELSEVIER INC., NEW YORK, NY. FILED 2-1-2012.

CLINICALKEY

THE MARK CONSISTS OF STANDARD CHARACTERS WITHOUT CLAIM TO ANY PARTICULAR FONT, STYLE, SIZE, OR COLOR.

CLASS 42—SCIENTIFIC AND COMPUTER SERVICES

FOR PROVIDING A SECURED-ACCESS, MEMBERS ONLY WEBSITE FEATURING TECHNOLOGY THAT GIVES MEMBERS THE ABILITY TO SEARCH, RETRIEVE, AND REVIEW JOURNAL ARTICLES, REPORTS, BOOKS, MONOGRAPHS, VIDEOS, IMAGES AND OTHER RESEARCH MATERIALS IN THE FIELDS OF SCIENCE, MEDICINE, HEALTH, BIOMEDICINE, PHARMACOLOGY, BIOLOGY AND PHYSICS; COMPUTER ASSISTED RESEARCH SERVICES IN THE FIELDS OF SCIENCE, MEDICINE, HEALTH, BIOMEDICINE, PHARMACOLOGY, BIOLOGY AND PHYSICS; CONVERSION OF DATA OR DOCUMENTS FROM PHYSICAL TO ELECTRONIC MEDIA IN THE FIELDS OF SCIENCE, MEDICINE, HEALTH, BIOMEDICINE, PHARMACOLOGY, BIOLOGY AND PHYSICS; COMPILING DATA FOR RESEARCH PURPOSES IN THE FIELD OF MEDICAL SCIENCE; PROVIDING DATABASES AND WEBSITES FEATURING INFORMATION IN THE FIELDS OF SCIENCE (U.S. CLS. 100 AND 101).

CLASS 44—MEDICAL, BEAUTY AND AGRICULTURAL SERVICES

FOR PROVIDING DATABASES AND WEBSITES FEATURING INFORMATION IN THE FIELDS OF MEDICINE, HEALTH, BIOMEDICINE, AND PHARMACOLOGY (U.S. CLS. 100 AND 101).
ANTHONY RINKER, EXAMINING ATTORNEY

SN 85-530,705. SOC, PARIS, FRANCE, FILED 2-1-2012.

PAD

THE MARK CONSISTS OF STANDARD CHARACTERS WITHOUT CLAIM TO ANY PARTICULAR FONT, STYLE, SIZE, OR COLOR.

CLASS 16—PAPER GOODS AND PRINTED MATTER

FOR PRINTED MATTER, NAMELY, PAPER SIGNS, BOOKS, MANUALS, CURRICULUM, NEWSLETTERS, INFORMATIONAL CARDS AND BROCHURES IN THE FIELD OF CULTURAL MATTERS (U.S. CLS. 2, 5, 22, 23, 29, 37, 38 AND 50).
FIRST USE 11-7-2011; IN COMMERCE 11-7-2011.

CLASS 41—EDUCATION AND ENTERTAINMENT

FOR ORGANIZATION OF CULTURAL SHOWS; ORGANIZATION OF EXHIBITIONS FOR CULTURAL OR EDUCATIONAL PURPOSES (U.S. CLS. 100, 101 AND 107).

FIRST USE 11-7-2011; IN COMMERCE 11-7-2011.
LINDA MICKLEBURGH, EXAMINING ATTORNEY

SN 85-530,723. SOC, PARIS, FRANCE, FILED 2-1-2012.



THE COLOR(S) ORANGE IS/ARE CLAIMED AS A FEATURE OF THE MARK.

THE MARK CONSISTS OF THE LITERAL ELEMENT "PAD" IN A SANS-SERIF FONT IN THE COLOR ORANGE.

CLASS 16—PAPER GOODS AND PRINTED MATTER

FOR PRINTED MATTER, NAMELY, NEWSPAPERS, PHOTOGRAPHS, MAGAZINES, BOOKS, PRINTED PERIODICALS, NEWSLETTERS, AND BROCHURES ALL IN THE FIELDS OF SECURITIES, OPTIONS AND OTHER FINANCIAL INSTRUMENTS (U.S. CLS. 2, 5, 22, 23, 29, 37, 38 AND 50).

FIRST USE 11-7-2011; IN COMMERCE 11-7-2011.

CLASS 41—EDUCATION AND ENTERTAINMENT

FOR ORGANIZATION OF CULTURAL SHOWS; ORGANIZING EXHIBITIONS FOR CULTURAL PURPOSES (U.S. CLS. 100, 101 AND 107).

FIRST USE 11-7-2011; IN COMMERCE 11-7-2011.
LINDA MICKLEBURGH, EXAMINING ATTORNEY

SN 85-530,727. SOC, PARIS, FRANCE, FILED 2-1-2012.



THE COLOR(S) ORANGE AND WHITE IS/ARE CLAIMED AS A FEATURE OF THE MARK.

THE MARK CONSISTS OF THE LITERAL ELEMENT "PAD" IN WHITE AND A SANS-SERIF FONT AGAINST AN ORANGE BACKGROUND.

CLASS 16—PAPER GOODS AND PRINTED MATTER

FOR PRINTED MATTER, NAMELY, PAPER SIGNS, BOOKS, MANUALS, CURRICULUM, NEWSLETTERS, INFORMATIONAL CARDS AND BROCHURES IN THE FIELD OF CULTURAL MATTERS (U.S. CLS. 2, 5, 22, 23, 29, 37, 38 AND 50).

FIRST USE 11-7-2011; IN COMMERCE 11-7-2011.

CLASS 41—EDUCATION AND ENTERTAINMENT

FOR ORGANIZATION OF CULTURAL SHOWS; ORGANIZING EXHIBITIONS FOR CULTURAL PURPOSES (U.S. CLS. 100, 101 AND 107).

FIRST USE 11-7-2011; IN COMMERCE 11-7-2011.

LINDA MICKLEBURGH, EXAMINING ATTORNEY

SN 85-530,795. MEDTECH PRODUCTS INC., IRVINGTON, NY. FILED 2-1-2012.

Everything they need.
Nothing they don't.

THE MARK CONSISTS OF STANDARD CHARACTERS WITHOUT CLAIM TO ANY PARTICULAR FONT, STYLE, SIZE, OR COLOR.

CLASS 3—COSMETICS AND CLEANING PREPARATIONS

FOR NON-MEDICATED DIAPER RASH PREPARATIONS; NON-MEDICATED SKIN CREAM FOR TREATING ECZEMA AND LOTION FOR TREATING CRADLE CAP; NON-MEDICATED ANTI-ALLERGIC PREPARATION APPLIED AS A TOPICAL OINTMENT OR GEL (U.S. CLS. 1, 4, 6, 50, 51 AND 52).

CLASS 5—PHARMACEUTICALS

FOR NASAL SPRAY AND DROP PREPARATIONS FOR THE RELIEF OF COLD SYMPTOMS; SALINE SOLUTIONS FOR RELIEF OF STUFFY OR DRY NOSES; STUFFY NOSE KITS CONSISTING OF SALINE SOLUTIONS AND NASAL ASPIRATORS; PREPARATIONS FOR TREATING COUGH AND COLD SYMPTOMS; DECONGESTANTS AND PREPARATIONS FOR COUGHS AND SORE THROATS; PREPARATIONS FOR RELIEF OF FEVER, ACHES AND PAINS; THROAT POPS FOR RELIEF OF SORE THROATS; CHEST RUB TO CLEAR CONGESTION, COUGH, AND REDUCE BODY INFLAMMATION; MEDICATED DIAPER RASH PREPARATIONS, AND GRIPE WATER PREPARATIONS FOR TREATMENT OF INTESTINAL GAS, STOMACH DISCOMFORT AND CONSTIPATION; ORAL PAIN RELIEF PREPARATIONS; EAR DROPS FOR DRYING WATER IN THE EARS AND RELIEVING EAR DISCOMFORT CAUSED BY WATER IN THE EARS; MEDICATED SKIN CREAM FOR TREATING ECZEMA AND MEDICATED LOTION FOR TREATING CRADLE CAP; AEROSOL ANESTHETIC PREPARATION FOR THE RELIEF OF SURFACE PAIN; SYRUP CONTAINING HONEY FOR SOOTHING SORE THROATS AND IRRITATION CAUSED BY COUGHING; MEDICATED ANTI-ALLERGIC PREPARATION APPLIED AS A TOPICAL OINTMENT OR GEL; TREATMENT FOR POISONS IN THE NATURE OF POISON ANTIDOTES (U.S. CLS. 6, 18, 44, 46, 51 AND 52).

ZACHARY BELLO, EXAMINING ATTORNEY

SN 85-530,811. CASE MANAGEMENT SOCIETY OF AMERICA, INC., LITTLE ROCK, AR. FILED 2-1-2012.

CMSA Today

THE MARK CONSISTS OF STANDARD CHARACTERS WITHOUT CLAIM TO ANY PARTICULAR FONT, STYLE, SIZE, OR COLOR.

OWNER OF U.S. REG. NOS. 2,087,728 AND 2,106,882.

CLASS 9—ELECTRICAL AND SCIENTIFIC APPARATUS

FOR DOWNLOADABLE ELECTRONIC PUBLICATIONS IN THE NATURE OF MAGAZINES IN THE FIELD OF HEALTH CARE CASE MANAGEMENT (U.S. CLS. 21, 23, 26, 36 AND 38).

FIRST USE 5-19-2011; IN COMMERCE 5-19-2011.

CLASS 16—PAPER GOODS AND PRINTED MATTER

FOR MAGAZINES IN THE FIELD OF HEALTH CARE CASE MANAGEMENT (U.S. CLS. 2, 5, 22, 23, 29, 37, 38 AND 50).

FIRST USE 6-14-2011; IN COMMERCE 6-14-2011.

WILLIAM JACKSON, EXAMINING ATTORNEY

SN 85-530,833. LEGAL SYNC INC., MIAMI, FL. FILED 2-1-2012.

LegalSync

THE MARK CONSISTS OF STANDARD CHARACTERS WITHOUT CLAIM TO ANY PARTICULAR FONT, STYLE, SIZE, OR COLOR.

CLASS 35—ADVERTISING AND BUSINESS

FOR BUSINESS ADVISORY SERVICES, CONSULTANCY AND INFORMATION; NEW BUSINESS VENTURE DEVELOPMENT AND FORMATION CONSULTING SERVICES (U.S. CLS. 100, 101 AND 102).

FIRST USE 1-31-2012; IN COMMERCE 1-31-2012.

CLASS 45—PERSONAL AND LEGAL SERVICES

FOR LEGAL DOCUMENT PREPARATION AND RESEARCH SERVICES FOR ATTORNEYS; LEGAL SERVICES (U.S. CLS. 100 AND 101).

FIRST USE 1-31-2012; IN COMMERCE 1-31-2012.

KELLY BOULTON, EXAMINING ATTORNEY

SN 85-530,836. QSL INTELLECTUAL PROPERTIES CORP., SHARON, PA. FILED 2-1-2012.

SN 85-530,876. DIETZ, WILLIAM C., SEATTLE, WA. FILED 2-1-2012.

BAR JAR

THE MARK CONSISTS OF STANDARD CHARACTERS WITHOUT CLAIM TO ANY PARTICULAR FONT, STYLE, SIZE, OR COLOR.

CLASS 32—LIGHT BEVERAGES

FOR BEER AND SOFT DRINKS (U.S. CLS. 45, 46 AND 48).
FIRST USE 4-19-2011; IN COMMERCE 4-19-2011.

CLASS 33—WINES AND SPIRITS

FOR ALCOHOLIC BEVERAGES EXCEPT BEERS (U.S. CLS. 47 AND 49).
FIRST USE 4-19-2011; IN COMMERCE 4-19-2011.
KELLY BOULTON, EXAMINING ATTORNEY

SN 85-530,874. THE AMERICAN INDIAN CANCER FOUNDATION, MINNEAPOLIS, MN. FILED 2-1-2012.



THE MARK CONSISTS OF A RIBBON/FEATHER DESIGN.

CLASS 35—ADVERTISING AND BUSINESS

FOR ASSOCIATION SERVICES, NAMELY, PROMOTING THE PUBLIC INTEREST AND AWARENESS IN CANCER RESEARCH AND EDUCATION (U.S. CLS. 100, 101 AND 102).

CLASS 36—INSURANCE AND FINANCIAL

FOR CHARITABLE FOUNDATION SERVICES, NAMELY, PROVIDING FUNDRAISING ACTIVITIES, FUNDING, SCHOLARSHIPS AND/OR FINANCIAL ASSISTANCE FOR CANCER RESEARCH AND EDUCATION (U.S. CLS. 100, 101 AND 102).
RENEE MCCRAY, EXAMINING ATTORNEY

LEGION OF THE DAMNED

THE MARK CONSISTS OF STANDARD CHARACTERS WITHOUT CLAIM TO ANY PARTICULAR FONT, STYLE, SIZE, OR COLOR.

CLASS 9—ELECTRICAL AND SCIENTIFIC APPARATUS

FOR VIDEO GAMES FOR MOBILE DEVICES, PERSONAL COMPUTERS, AND TABLETS (U.S. CLS. 21, 23, 26, 36 AND 38).
FIRST USE 12-15-2011; IN COMMERCE 12-15-2011.

CLASS 16—PAPER GOODS AND PRINTED MATTER

FOR SERIES OF FICTION BOOKS (U.S. CLS. 2, 5, 22, 23, 29, 37, 38 AND 50).
FIRST USE 8-0-1993; IN COMMERCE 8-0-1993.
NATALIE POLZER, EXAMINING ATTORNEY

SN 85-530,883. ZUMIEZ INC., EVERETT, WA. FILED 2-1-2012.

LOCAL LEADERS

THE MARK CONSISTS OF STANDARD CHARACTERS WITHOUT CLAIM TO ANY PARTICULAR FONT, STYLE, SIZE, OR COLOR.

CLASS 9—ELECTRICAL AND SCIENTIFIC APPARATUS

FOR HEADPHONES (U.S. CLS. 21, 23, 26, 36 AND 38).

CLASS 25—CLOTHING

FOR CLOTHING, NAMELY, DRESSES, TANK TOPS, T-SHIRTS, SHIRTS, JACKETS, SHORTS, PANTS, HOODED SWEATSHIRTS, SWEATPANTS, SWEATSHIRTS, SWEATERS, BANDANAS, SOCKS, BELTS, SCARVES; HEADWEAR; FOOTWEAR (U.S. CLS. 22 AND 39).
LOURDES AYALA, EXAMINING ATTORNEY

SN 85-530,904. BARR, KENNETH, FORT LAUDERDALE, FL.
FILED 2-1-2012.

FIFTH POINT

THE MARK CONSISTS OF STANDARD CHARACTERS WITHOUT CLAIM TO ANY PARTICULAR FONT, STYLE, SIZE, OR COLOR.

CLASS 18—LEATHER GOODS

FOR BACKPACKS (U.S. CLS. 1, 2, 3, 22 AND 41).

CLASS 25—CLOTHING

FOR CLOTHING, NAMELY, TOPS, BOTTOMS, SHIRTS, SHORTS, HATS, JACKETS, PANTS, BEANIES, HOODED SWEATSHIRTS, JEANS, SWEATERS, SWEATSHIRTS, BANDANAS, PANTIES, BOXERS, SWIMWEAR, UNDERWEAR (U.S. CLS. 22 AND 39).

JOHN DALIER, EXAMINING ATTORNEY

SN 85-530,910. KARINE SHAVARSHYAN, MIAMI BEACH, FL. FILED 2-1-2012.

BUCK 15

THE MARK CONSISTS OF STANDARD CHARACTERS WITHOUT CLAIM TO ANY PARTICULAR FONT, STYLE, SIZE, OR COLOR.

CLASS 41—EDUCATION AND ENTERTAINMENT

FOR NIGHT CLUBS (U.S. CLS. 100, 101 AND 107).
FIRST USE 5-1-2011; IN COMMERCE 5-1-2011.

CLASS 43—HOTEL AND RESTAURANT SERVICES

FOR (BASED ON USE IN COMMERCE) BAR SERVICES (BASED ON INTENT TO USE) RESTAURANT SERVICES (U.S. CLS. 100 AND 101).

FIRST USE 5-1-2011; IN COMMERCE 5-1-2011.
LINDA LAVACHE, EXAMINING ATTORNEY

SN 85-530,934. CRYSTAL RESEARCH ASSOCIATES, LLC, CRANBURY, NJ. FILED 2-1-2012.

FACTS WITHOUT FICTION

THE MARK CONSISTS OF STANDARD CHARACTERS WITHOUT CLAIM TO ANY PARTICULAR FONT, STYLE, SIZE, OR COLOR.

OWNER OF U.S. REG. NOS. 2,904,801, 2,986,632 AND 3,010,491.

CLASS 35—ADVERTISING AND BUSINESS

FOR PUBLIC RELATIONS SERVICES; BUSINESS RESEARCH AND CONSULTING SERVICES RELATING TO BUSINESS MARKETING (U.S. CLS. 100, 101 AND 102).
FIRST USE 4-2-2003; IN COMMERCE 4-2-2003.

CLASS 36—INSURANCE AND FINANCIAL

FOR INVESTOR SERVICES, NAMELY INDEPENDENT AND ACCURATE CORPORATE VALUATIONS, CAPITAL INVESTMENT CONSULTATION, AND COMMODITY INVESTMENT ADVICE; CONSULTING SERVICES, NAMELY FINANCIAL ANALYSIS AND PRESENTATION AND FINANCIAL INVESTMENT CONSULTATION (U.S. CLS. 100, 101 AND 102).

FIRST USE 4-2-2003; IN COMMERCE 4-2-2003.
FRANK LATTUCA, EXAMINING ATTORNEY

SN 85-530,971. FELLOWSHIP ASSOCIATES, LITTLE ROCK, AR. FILED 2-1-2012.



OWNER OF U.S. REG. NO. 2,838,838.
THE COLOR(S) RED AND BLACK IS/ARE CLAIMED AS A FEATURE OF THE MARK.
THE MARK CONSISTS OF RED RECTANGULAR BOX. INSIDE THE BOX IS A BLACK LINED RECTANGULAR BOX AND INSIDE THAT BOX ARE THE WORDS "AUTHENTIC MANHOOD" IN STYLIZED BLACK FONT.

CLASS 41—EDUCATION AND ENTERTAINMENT

FOR EDUCATIONAL AND ENTERTAINMENT SERVICES, NAMELY, PROVIDING MOTIVATIONAL SPEAKING SERVICES IN THE FIELD OF MINISTRY SERVICES FOR MEN (U.S. CLS. 100, 101 AND 107).

CLASS 45—PERSONAL AND LEGAL SERVICES

FOR CHRISTIAN MINISTRY SERVICES (U.S. CLS. 100 AND 101).
RICHARD WHITE, EXAMINING ATTORNEY

SN 85-530,999. FELLOWSHIP ASSOCIATES, LITTLE ROCK, AR. FILED 2-1-2012.



OWNER OF U.S. REG. NO. 2,838,838.
THE COLOR(S) BLACK AND RED IS/ARE CLAIMED AS A FEATURE OF THE MARK.
THE MARK CONSISTS OF BLACK RECTANGULAR BOX. INSIDE THE BOX IS A RED LINED RECTANGULAR BOX AND INSIDE THAT BOX ARE THE WORDS "AUTHENTIC MANHOOD" IN STYLIZED RED FONT.

CLASS 41—EDUCATION AND ENTERTAINMENT

FOR EDUCATIONAL AND ENTERTAINMENT SERVICES, NAMELY, PROVIDING MOTIVATIONAL SPEAKING SERVICES IN THE FIELD OF MINISTRY SERVICES FOR MEN (U.S. CLS. 100, 101 AND 107).

CLASS 45—PERSONAL AND LEGAL SERVICES

FOR CHRISTIAN MINISTRY SERVICES (U.S. CLS. 100 AND 101).
RICHARD WHITE, EXAMINING ATTORNEY

SN 85-531,025. FELLOWSHIP ASSOCIATES, LITTLE ROCK, AR. FILED 2-1-2012.



OWNER OF U.S. REG. NO. 2,838,838.
THE COLOR(S) RED AND WHITE IS/ARE CLAIMED AS A FEATURE OF THE MARK.

THE MARK CONSISTS OF RED RECTANGULAR BOX. INSIDE THE BOX IS A WHITE LINED RECTANGULAR BOX AND INSIDE THAT BOX ARE THE WORDS "AUTHENTIC MANHOOD" IN STYLIZED WHITE FONT.

CLASS 41—EDUCATION AND ENTERTAINMENT

FOR EDUCATIONAL AND ENTERTAINMENT SERVICES, NAMELY, PROVIDING MOTIVATIONAL SPEAKING SERVICES IN THE FIELD OF MINISTRY SERVICES FOR MEN (U.S. CLS. 100, 101 AND 107).

CLASS 45—PERSONAL AND LEGAL SERVICES

FOR CHRISTIAN MINISTRY SERVICES (U.S. CLS. 100 AND 101).
RICHARD WHITE, EXAMINING ATTORNEY

SN 85-531,128. FAMILIES FIRST, INC., ATLANTA, GA. FILED 2-1-2012.

I AM THE VILLAGE

THE MARK CONSISTS OF STANDARD CHARACTERS WITHOUT CLAIM TO ANY PARTICULAR FONT, STYLE, SIZE, OR COLOR.

CLASS 35—ADVERTISING AND BUSINESS

FOR PROMOTING PUBLIC AWARENESS AND PUBLIC ACTION IN SUPPORT OF ISSUES RELATED TO CHILDREN, FAMILIES, AND COMMUNITIES (U.S. CLS. 100, 101 AND 102).

CLASS 36—INSURANCE AND FINANCIAL

FOR CHARITABLE FUNDRAISING SERVICES (U.S. CLS. 100, 101 AND 102).
JAMES GRIFFIN, EXAMINING ATTORNEY

SN 85-531,158. APPMATRIX, INC., ROSEVILLE, CA. FILED 2-1-2012.

AppMatrix

THE MARK CONSISTS OF STANDARD CHARACTERS WITHOUT CLAIM TO ANY PARTICULAR FONT, STYLE, SIZE, OR COLOR.

CLASS 9—ELECTRICAL AND SCIENTIFIC APPARATUS

FOR COMPUTER APPLICATION SOFTWARE FOR MOBILE PHONES, PORTABLE MEDIA PLAYERS, HANDHELD COMPUTERS, AND TABLET COMPUTERS, NAMELY, SOFTWARE FOR USE IN COMMERCIAL, BUSINESS TO BUSINESS AND MOBILE ADVERTISING (U.S. CLS. 21, 23, 26, 36 AND 38).
FIRST USE 5-24-2011; IN COMMERCE 5-24-2011.

CLASS 42—SCIENTIFIC AND COMPUTER SERVICES

FOR COMPUTER SOFTWARE DEVELOPMENT IN THE FIELD OF MOBILE APPLICATIONS (U.S. CLS. 100 AND 101).
FIRST USE 5-24-2011; IN COMMERCE 5-24-2011.
DAVID MURRAY, EXAMINING ATTORNEY

SN 85-531,318. BLUE BOTTLE COFFEE, LLC, OAKLAND, CA. FILED 2-1-2012.



THE COLOR(S) BLUE IS/ARE CLAIMED AS A FEATURE OF THE MARK.

THE MARK CONSISTS OF A BLUE BOTTLE. THE WHITE IN THE DRAWING REPRESENTS BACKGROUND OR TRANSPARENT AREAS AND IS NOT CLAIMED AS PART OF THE MARK.

CLASS 35—ADVERTISING AND BUSINESS

FOR ONLINE RETAIL STORE SERVICES FEATURING COFFEE AND RELATED GOODS (U.S. CLS. 100, 101 AND 102).

FIRST USE 9-1-2002; IN COMMERCE 9-1-2002.

CLASS 43—HOTEL AND RESTAURANT SERVICES

FOR CAFE SERVICES; COFFEE SHOPS; PROVIDING CAFE SERVICES VIA A MOBILE TRAILER (U.S. CLS. 100 AND 101).

FIRST USE 8-15-2002; IN COMMERCE 8-15-2002.

BRIAN NEVILLE, EXAMINING ATTORNEY

SN 85-531,329. ECA MEDICAL INSTRUMENTS, NEWBURY PARK, CA. FILED 2-1-2012.

SpeedECap

THE MARK CONSISTS OF STANDARD CHARACTERS WITHOUT CLAIM TO ANY PARTICULAR FONT, STYLE, SIZE, OR COLOR.

CLASS 8—HAND TOOLS

FOR HAND TOOLS, NAMELY, TORQUE MULTIPLIERS (U.S. CLS. 23, 28 AND 44).

CLASS 10—MEDICAL APPARATUS

FOR MEDICAL APPARATUS AND INSTRUMENTS FOR USE IN SURGERY (U.S. CLS. 26, 39 AND 44).

ELLEN B. AWRICH, EXAMINING ATTORNEY

SN 85-531,356. PINK CLOUD, INC., DBA PINK CLOUD EVENTS, LOS ANGELES, CA. FILED 2-1-2012.

Pink Cloud

THE MARK CONSISTS OF STANDARD CHARACTERS WITHOUT CLAIM TO ANY PARTICULAR FONT, STYLE, SIZE, OR COLOR.

CLASS 35—ADVERTISING AND BUSINESS

FOR EVENT PLANNING AND MANAGEMENT FOR MARKETING, BRANDING, PROMOTING OR ADVERTISING THE GOODS AND SERVICES OF OTHERS (U.S. CLS. 100, 101 AND 102).

FIRST USE 9-12-2006; IN COMMERCE 10-20-2006.

CLASS 41—EDUCATION AND ENTERTAINMENT

FOR SPECIAL EVENT PLANNING FOR SOCIAL ENTERTAINMENT PURPOSES (U.S. CLS. 100, 101 AND 107).

FIRST USE 9-12-2006; IN COMMERCE 10-20-2006.
TOBY BULLOFF, EXAMINING ATTORNEY

SN 85-531,397. REMS, MARYANN, WINDERMERE, FL. FILED 2-1-2012.

ANGELS ARE WATCHING

THE MARK CONSISTS OF STANDARD CHARACTERS WITHOUT CLAIM TO ANY PARTICULAR FONT, STYLE, SIZE, OR COLOR.

CLASS 9—ELECTRICAL AND SCIENTIFIC APPARATUS

FOR DECORATIVE MAGNETS (U.S. CLS. 21, 23, 26, 36 AND 38).

CLASS 14—JEWELRY

FOR COLLECTIBLE COINS; JEWELRY; ORNAMENTAL LAPEL PINS (U.S. CLS. 2, 27, 28 AND 50).

CLASS 26—FANCY GOODS

FOR EMBROIDERED PATCHES FOR CLOTHING (U.S. CLS. 37, 39, 40, 42 AND 50).

CLASS 28—TOYS AND SPORTING GOODS

FOR STUFFED AND PLUSH TOYS; TOY FIGURES (U.S. CLS. 22, 23, 38 AND 50).

CLASS 41—EDUCATION AND ENTERTAINMENT

FOR PROVIDING A WEBSITE FEATURING INFORMATION IN THE FIELDS OF EDUCATION AND ENTERTAINMENT FOR CHILDREN; PROVIDING ADVICE AND INFORMATION IN THE FIELD OF EDUCATIONAL AND ENTERTAINMENT ACTIVITIES AND EVENTS FOR CHILDREN (U.S. CLS. 100, 101 AND 107).

JOHN GARTNER, EXAMINING ATTORNEY

SN 85-531,428. SO SO HAPPY STUDIO, INC., CALABASAS, CA. FILED 2-1-2012.

SO SO
HAPPY

THE MARK CONSISTS OF THE WORDING SO SO HAPPY WITH A STYLIZED HEART IN BETWEEN THE WORDS SO AND SO.

CLASS 3—COSMETICS AND CLEANING PREPARATIONS

FOR COSMETICS AND MAKE-UP; NAIL POLISH (U.S. CLS. 1, 4, 6, 50, 51 AND 52).

CLASS 9—ELECTRICAL AND SCIENTIFIC APPARATUS

FOR AUDIO SPEAKERS; BLANK USB FLASH DRIVES; DIGITAL AUDIO PLAYERS; DIGITAL CAMERAS; EARPHONES AND HEADPHONES (U.S. CLS. 21, 23, 26, 36 AND 38).

SN 85-531,462. DRF INSTALLATIONS, INC., PLAINFIELD, IL. FILED 2-1-2012.

CLASS 14—JEWELRY

FOR WATCHES AND CLOCKS (U.S. CLS. 2, 27, 28 AND 50).

CLASS 16—PAPER GOODS AND PRINTED MATTER

FOR BLANK JOURNALS; NOTEBOOKS; POSTERS (U.S. CLS. 2, 5, 22, 23, 29, 37, 38 AND 50).

CLASS 25—CLOTHING

FOR BELTS (U.S. CLS. 22 AND 39).
DAVID COLLIER, EXAMINING ATTORNEY



SN 85-531,447. KENNECOTT UTAH COPPER LLC, SOUTH JORDAN, UT. FILED 2-1-2012.



THE MARK CONSISTS OF RECTANGULAR STENCIL WITH THE WORDS KEEP, EACH, OTHER, SAFE STACKED (WITH KEEP ON THE TOP) AND SMALLER STENCIL UNDERNEATH WITH THE WORDS ZERO HARM. THE WORDS APPEAR TO BE FILLED IN WITH SPRAY PAINT, AND PAINT SPLATTER IS VISIBLE AROUND THE EDGE OF THE STENCILS.

CLASS 1—CHEMICALS

FOR SULPHURIC ACID (U.S. CLS. 1, 5, 6, 10, 26 AND 46).

CLASS 14—JEWELRY

FOR PRECIOUS METALS (U.S. CLS. 2, 27, 28 AND 50).
JENNY PARK, EXAMINING ATTORNEY

OWNER OF U.S. REG. NOS. 3,916,399 AND 3,970,558.
THE MARK CONSISTS OF A DRAWING IN CHIAROSCURO OF THE UPPER TORSO AND HEAD OF A MAN, WHO IS WEARING A HARD HAT AND WHOSE FACE IS DIRECTED TO HIS LEFT. THE MAN IS WEARING A CREW NECK SHIRT WITH "DRF" BELOW THE LEFT SHOULDER. THE MAN IS POSED BEFORE A SUNBURST DESIGN WHICH IS ENCLOSED IN A CIRCLE. THE CIRCLE IS BROKEN BY A HORIZONTAL BANNER UNDER THE MAN'S UPPER TORSO. THE BANNER CONTAINS THE LETTERS DRF, IN A LARGE BOLD FONT. THE BANNER IS BORDERED BY TOP AND BOTTOM HORIZONTAL LINES. A THIRD HORIZONTAL LINE RUNS BELOW DRF.

CLASS 37—CONSTRUCTION AND REPAIR

FOR IRRIGATION SERVICES, NAMELY, THE INSTALLATION, MAINTENANCE AND REPAIR OF COMMERCIAL AND RESIDENTIAL IRRIGATION SYSTEMS AND REVERSE PRESSURE ZONE WATER BACKFLOW VALVES; RESIDENTIAL AND COMMERCIAL PLUMBING SERVICES AND WATER HEATER INSTALLATION SERVICES; WATER FILTRATION SERVICES, NAMELY, INSTALLATION AND REPAIR OF WATER FILTRATION SYSTEMS; IRON STAIN REMOVAL SERVICES; HEATING, VENTILATION AND AIR CONDITIONING SERVICES, NAMELY, THE INSTALLATION, MAINTENANCE AND REPAIR OF RESIDENTIAL AND COMMERCIAL HEATING, VENTILATION AND AIR CONDITIONING SYSTEMS, BOILERS, CONTROLS, AIR PURIFIERS AND HUMIDIFIERS; ELECTRICAL CONTRACTING SERVICES (U.S. CLS. 100, 103 AND 106).
FIRST USE 10-7-2009; IN COMMERCE 10-7-2009.

CLASS 42—SCIENTIFIC AND COMPUTER SERVICES

FOR IRRIGATION SERVICES, NAMELY, THE DESIGN OF COMMERCIAL AND RESIDENTIAL IRRIGATION SYSTEMS AND REVERSE PRESSURE ZONE WATER BACKFLOW VALVES; TECHNICAL MONITORING SERVICES FOR CONDITION OF WATER; HEATING, VENTILATION AND AIR CONDITIONING SERVICES, NAMELY, THE DESIGN OF RESIDENTIAL AND COMMERCIAL HEATING, VENTILATION AND AIR CONDITIONING SYSTEMS, BOILERS, CONTROLS, AIR PURIFIERS AND HUMIDIFIERS; ANALYSIS OF THE QUALITY OF HOME AND COMMERCIAL WATER SUPPLY (U.S. CLS. 100 AND 101).
FIRST USE 10-7-2009; IN COMMERCE 10-7-2009.
DAVID COLLIER, EXAMINING ATTORNEY

SN 85-531,481. GEEKLIST, INC., LA JOLLA, CA. FILED 2-1-2012.

GEEKLIST

THE MARK CONSISTS OF STANDARD CHARACTERS WITHOUT CLAIM TO ANY PARTICULAR FONT, STYLE, SIZE, OR COLOR.

CLASS 35—ADVERTISING AND BUSINESS

FOR ONLINE BUSINESS NETWORKING SERVICES (U.S. CLS. 100, 101 AND 102).
FIRST USE 4-8-2011; IN COMMERCE 4-8-2011.

CLASS 42—SCIENTIFIC AND COMPUTER SERVICES

FOR COMPUTER SERVICES, NAMELY, CREATING AN ON-LINE COMMUNITY FOR REGISTERED USERS TO PARTICIPATE IN DISCUSSIONS, GET FEEDBACK FROM THEIR PEERS, FORM VIRTUAL COMMUNITIES, AND ENGAGE IN SOCIAL NETWORKING SERVICES IN THE FIELD OF COMPUTER CODE DEVELOPERS, WEB SITE DEVELOPERS, COMPUTER SOFTWARE DEVELOPERS; COMPUTER SERVICES, NAMELY, PROVIDING A SEARCH ENGINE TO ALLOW USERS TO SEARCH CONTENT OF WEB SITE FOR PEOPLE WITH SPECIFIC EXPERIENCE (U.S. CLS. 100 AND 101).
FIRST USE 4-8-2011; IN COMMERCE 4-8-2011.

CLASS 45—PERSONAL AND LEGAL SERVICES

FOR PROVIDING INFORMATION IN THE FIELD OF PERSONAL DEVELOPMENT AND ACHIEVEMENTS; ON-LINE SOCIAL NETWORKING SERVICES (U.S. CLS. 100 AND 101).

FIRST USE 4-8-2011; IN COMMERCE 4-8-2011.
CHERYL CLAYTON, EXAMINING ATTORNEY

SN 85-531,559. CLEOPATRA RECORDS, INC., LOS ANGELES, CA. FILED 2-1-2012.

Blackburner

THE MARK CONSISTS OF STANDARD CHARACTERS WITHOUT CLAIM TO ANY PARTICULAR FONT, STYLE, SIZE, OR COLOR.

CLASS 9—ELECTRICAL AND SCIENTIFIC APPARATUS

FOR AUDIO AND VIDEO RECORDINGS FEATURING MUSIC AND ARTISTIC PERFORMANCES; AUDIO RECORDINGS FEATURING MUSIC; AUDIO TAPES FEATURING MUSIC; COMPACT DISCS FEATURING MUSIC; DIGITAL MUSIC DOWNLOADABLE FROM THE INTERNET; DOWNLOADABLE MUSIC FILES; DOWNLOADABLE MUSICAL SOUND RECORDINGS; DOWNLOADABLE RING TONES, GRAPHICS AND MUSIC VIA A GLOBAL COMPUTER NETWORK AND WIRELESS DEVICES; DOWNLOADABLE VIDEO RECORDINGS FEATURING MUSIC; DOWNLOADABLE MUSIC VIA THE INTERNET AND WIRELESS DEVICES; MUSICAL RECORDINGS; MUSICAL SOUND RECORDINGS; MUSICAL VIDEO RECORDINGS; PHONOGRAPH RECORDS FEATURING MUSIC; PRERECORDED AUDIO TAPES FEATURING MUSIC; PRERECORDED VIDEO CASSETTES FEATURING MUSIC; PRERECORDED VIDEO TAPES FEATURING MUSIC; SERIES OF MUSICAL SOUND RECORDINGS; SOUND RECORDINGS FEATURING MUSIC; VIDEO RECORDINGS FEATURING MUSIC; VISUAL RECORDINGS AND AUDIOVISUAL RECORDINGS FEATURING MUSIC AND ANIMATION (U.S. CLS. 21, 23, 26, 36 AND 38).

CLASS 25—CLOTHING

FOR WEARABLE GARMENTS AND CLOTHING, NAMELY, SHIRTS (U.S. CLS. 22 AND 39).

CLASS 41—EDUCATION AND ENTERTAINMENT

FOR ENTERTAINMENT SERVICES IN THE NATURE OF LIVE MUSICAL PERFORMANCES (U.S. CLS. 100, 101 AND 107).

HOWARD SMIGA, EXAMINING ATTORNEY

SN 85-531,584. CON CERRO, INC., SAN DIEGO, CA. FILED 2-1-2012.

SHIFTPREDICT

THE MARK CONSISTS OF STANDARD CHARACTERS WITHOUT CLAIM TO ANY PARTICULAR FONT, STYLE, SIZE, OR COLOR.

CLASS 35—ADVERTISING AND BUSINESS

FOR BUSINESS STAFFING CONSULTING SERVICES FOR PROVIDING SCHEDULING DECISIONS FOR EMPLOYEES BASED ON THE USE OF STAFFING EFFECTIVENESS STANDARDS AND HISTORICAL CENSUS AND INTENSITY OF CARE DATA TO MODEL PREDICTIVE STAFFING NEEDS (U.S. CLS. 100, 101 AND 102).

FIRST USE 11-1-2011; IN COMMERCE 11-1-2011.

CLASS 42—SCIENTIFIC AND COMPUTER SERVICES

FOR PROVIDING ONLINE WEB-BASED NON-DOWNLOADABLE COMPUTER SOFTWARE FOR MANAGING THE PRACTICE AND SCHEDULING OF HEALTH CARE PROFESSIONALS, NAMELY, THE USE OF HISTORICAL CENSUS AND INTENSITY OF CARE DATA TO MODEL PREDICTIVE STAFFING NEEDS (U.S. CLS. 100 AND 101).

FIRST USE 11-1-2011; IN COMMERCE 11-1-2011.
ALLISON SCHRODY, EXAMINING ATTORNEY

SN 85-531,593. CLEOPATRA RECORDS, INC., LOS ANGELES, CA. FILED 2-1-2012.

SN 85-531,650. AISHA FRANCIS, NORTH HOLLYWOOD, CA. FILED 2-1-2012.



THE MARK CONSISTS OF THE CAPITAL LETTER "B" AND ITS MIRROR IMAGE.

CLASS 9—ELECTRICAL AND SCIENTIFIC APPARATUS

FOR AUDIO AND VIDEO RECORDINGS FEATURING MUSIC AND ARTISTIC PERFORMANCES; AUDIO RECORDINGS FEATURING MUSIC; AUDIO TAPES FEATURING MUSIC; COMPACT DISCS FEATURING MUSIC; DIGITAL MUSIC DOWNLOADABLE FROM THE INTERNET; DOWNLOADABLE MUSIC FILES; DOWNLOADABLE MUSICAL SOUND RECORDINGS; DOWNLOADABLE RING TONES, GRAPHICS AND MUSIC VIA A GLOBAL COMPUTER NETWORK AND WIRELESS DEVICES; DOWNLOADABLE VIDEO RECORDINGS FEATURING MUSIC; DOWNLOADABLE MUSIC VIA THE INTERNET AND WIRELESS DEVICES; MUSICAL RECORDINGS; MUSICAL SOUND RECORDINGS; MUSICAL VIDEO RECORDINGS; PHONOGRAPH RECORDS FEATURING MUSIC; PRERECORDED AUDIO TAPES FEATURING MUSIC; PRERECORDED VIDEO CASSETTES FEATURING MUSIC; PRERECORDED VIDEO TAPES FEATURING MUSIC; SERIES OF MUSICAL SOUND RECORDINGS; SOUND RECORDINGS FEATURING MUSIC; VIDEO RECORDINGS FEATURING MUSIC; VISUAL RECORDINGS AND AUDIOVISUAL RECORDINGS FEATURING MUSIC AND ANIMATION (U.S. CLS. 21, 23, 26, 36 AND 38).

CLASS 25—CLOTHING

FOR WEARABLE GARMENTS AND CLOTHING, NAMELY, SHIRTS (U.S. CLS. 22 AND 39).

CLASS 41—EDUCATION AND ENTERTAINMENT

FOR ENTERTAINMENT SERVICES IN THE NATURE OF LIVE MUSICAL PERFORMANCES (U.S. CLS. 100, 101 AND 107).
HOWARD SMIGA, EXAMINING ATTORNEY

Pump Camp

THE MARK CONSISTS OF STANDARD CHARACTERS WITHOUT CLAIM TO ANY PARTICULAR FONT, STYLE, SIZE, OR COLOR.

CLASS 9—ELECTRICAL AND SCIENTIFIC APPARATUS

FOR DVDS FEATURING INSTRUCTIONAL, FITNESS WORK-OUT VIDEOS (U.S. CLS. 21, 23, 26, 36 AND 38).

CLASS 25—CLOTHING

FOR BODY SUITS; FOOTWEAR; HEELS; LEGGINGS; PUMPS; SHOES; SHORTS; T-SHIRTS; TANK TOPS (U.S. CLS. 22 AND 39).

CAROLYN CATALDO, EXAMINING ATTORNEY

SN 85-531,674. ZEROTOSIXTY MEDIA PTE LTD., SINGAPORE, SINGAPORE, FILED 2-2-2012.

Racerbook

THE MARK CONSISTS OF STANDARD CHARACTERS WITHOUT CLAIM TO ANY PARTICULAR FONT, STYLE, SIZE, OR COLOR.

CLASS 35—ADVERTISING AND BUSINESS

FOR COOPERATIVE ADVERTISING AND MARKETING SERVICES BY WAY OF SOLICITATION, CUSTOMER SERVICE AND PROVIDING MARKETING INFORMATION VIA WEB SITES ON A GLOBAL COMPUTER NETWORK; DEVELOPMENT, OPERATION AND ADMINISTRATION OF DIGITAL SIGNAGE SYSTEMS AND DIGITAL ADVERTISING SYSTEMS FOR OTHERS, NAMELY, PROVIDING ADVERTISING SPACE BY ELECTRONIC MEANS AND GLOBAL COMPUTER INFORMATION NETWORKS; DISSEMINATION OF ADVERTISING FOR OTHERS VIA PUBLIC AND PRIVATE WIRELESS NETWORKS FOR DISPLAY ON MOBILE DEVICES; DISSEMINATION OF ADVERTISING, SCHEDULING AND MANAGING OF TRAINING COURSES AND PROGRAMS FOR OTHERS VIA A GLOBAL COMPUTER NETWORK; ELECTRONIC COMMERCE SERVICES, NAMELY, PROVIDING INFORMATION ABOUT PRODUCTS VIA TELECOMMUNICATION NETWORKS FOR ADVERTISING AND SALES PURPOSES; GENERAL BUSINESS NETWORKING REFERRAL SERVICES, NAMELY, PROMOTING THE GOODS AND SERVICES OF OTHERS BY PASSING BUSINESS LEADS AND REFERRALS AMONG GROUP MEMBERS; MATCHING CONSUMERS WITH PROFESSIONALS IN THE FIELD OF RESIDENTIAL AND COMMERCIAL SERVICES VIA COMPUTER NETWORK; ON-LINE ADVERTISING ON COMPUTER COMMUNICATION NETWORKS; ON-LINE ADVERTISING ON COMPUTER NETWORKS; ON-LINE SERVICE FOR CONNECTING SOCIAL NETWORK USERS WITH RETAILERS FOR THE PURPOSE OF FACILITATING DISCOUNTED PURCHASES; PROMOTING THE GOODS AND SERVICES OF OTHERS BY PREPARING AND PLACING ADVERTISEMENTS IN AN ELECTRONIC MAGAZINE ACCESSED THROUGH A GLOBAL COMPUTER NETWORK; PROVIDING A WEBSITE FOR USERS WITH SPECIFIC INFORMED RECOMMENDATIONS OF SPECIFIC CONSUMER PRODUCTS AND SERVICES VALIDATED BY THE USERS' INPUTTED PREFERENCES AND SOCIAL NETWORK; PROVIDING INFORMATION ABOUT THE GOODS AND SERVICES OF OTHERS VIA THE GLOBAL COMPUTER NETWORK; PROVIDING INFORMATION PERTAINING TO PROCUREMENT, BUYING, SELLING AND TENDERING INFORMATION AND OPPORTUNITIES RELATING TO GOODS, SERVICES, AND CONSTRUCTION VIA COMPUTER, COMPUTER NETWORKS, TELEPHONE, THE INTERNET OR ELECTRONIC MAIL; PROVISION OF ADVERTISING SPACE BY ELECTRONIC MEANS AND GLOBAL INFORMATION NETWORKS; PROVISION OF BUSINESS INFORMATION VIA GLOBAL COMPUTER NETWORKS; SOCIAL MEDIA STRATEGY AND MARKETING CONSULTANCY FOCUSING ON HELPING CLIENTS CREATE AND EXTEND THEIR PRODUCT AND BRAND STRATEGIES BY BUILDING VIRALLY ENGAGING MARKETING SOLUTIONS (U.S. CLS. 100, 101 AND 102).

CLASS 42—SCIENTIFIC AND COMPUTER SERVICES

FOR PROVIDING ONLINE RESEARCH AND REFERENCE SERVICES VIA AN ON-LINE COMPUTER NETWORK BY LIBRARIANS AND REFERENCE SERVICE SPECIALISTS; SOCIAL BOOKMARKING WEBSITE SERVICES, NAMELY, PROVIDING A WEBSITE FEATURING TECHNOLOGY THAT ENABLES USERS TO ORGANIZE, STORE, MANAGE, SHARE AND SEARCH FOR BOOKMARKS OF RESOURCES ONLINE (U.S. CLS. 100 AND 101).

CLASS 45—PERSONAL AND LEGAL SERVICES

FOR INTERNET-BASED SOCIAL NETWORKING SERVICES; ON-LINE SOCIAL NETWORKING SERVICES; ONLINE SOCIAL NETWORKING SERVICES IN THE FIELD OF AUTOMOBILES, MOTORCYCLES, KARTS, AND AUTO RACING ; ONLINE SOCIAL NETWORKING SERVICES IN THE FIELD OF AUTOMOBILES, MOTORCYCLES, KARTS, AND AUTO RACING PROVIDED VIA A WEBSITE; PROVIDING A SOCIAL NETWORKING WEBSITE FOR ENTERTAINMENT PURPOSES; PROVIDING ON-LINE COMPUTER DATABASES AND ON-LINE SEARCHABLE DATABASES IN THE FIELD OF SOCIAL NETWORKING; SOCIAL NETWORKING SERVICES IN THE FIELD OF AUTOMOBILES, MOTORCYCLES, KARTS, AND AUTO RACING PROVIDED VIA A WEBSITE (U.S. CLS. 100 AND 101).

KATHERINE STOIDES, EXAMINING ATTORNEY

SN 85-531,708. ICE LAND, INC., PITTSBURGH, PA. FILED 2-2-2012.

CATCH-UP LOGISTICS

THE MARK CONSISTS OF STANDARD CHARACTERS WITHOUT CLAIM TO ANY PARTICULAR FONT, STYLE, SIZE, OR COLOR.

NO CLAIM IS MADE TO THE EXCLUSIVE RIGHT TO USE "LOGISTICS", APART FROM THE MARK AS SHOWN.

CLASS 35—ADVERTISING AND BUSINESS

FOR PROCUREMENT, NAMELY, PURCHASING RAW FOOD PRODUCTS AND FOOD INGREDIENTS FOR OTHERS (U.S. CLS. 100, 101 AND 102).

FIRST USE 1-5-1996; IN COMMERCE 1-5-1996.

CLASS 39—TRANSPORTATION AND STORAGE

FOR TRANSPORT OF RAW FOOD PRODUCTS AND FOOD INGREDIENTS FOR OTHERS BY MEANS OF TRUCK, AIR, SHIP AND RAIL; STORAGE OF RAW FOOD PRODUCTS AND FOOD INGREDIENTS FOR OTHERS (U.S. CLS. 100 AND 105).

FIRST USE 1-5-1996; IN COMMERCE 1-5-1996.

KELLY BOULTON, EXAMINING ATTORNEY

SN 85-531,738. GOFF PUBLIC, INC., ST. PAUL, MN. FILED 2-2-2012.

ANN E. ANSWERS

THE MARK CONSISTS OF STANDARD CHARACTERS WITHOUT CLAIM TO ANY PARTICULAR FONT, STYLE, SIZE, OR COLOR.

THE NAME(S), PORTRAIT(S), AND/OR SIGNATURE(S) SHOWN IN THE MARK DOES NOT IDENTIFY A PARTICULAR LIVING INDIVIDUAL.

CLASS 16—PAPER GOODS AND PRINTED MATTER

FOR BOOKS AND WRITTEN ARTICLES IN THE FIELD OF COMMUNICATIONS ETIQUETTE (U.S. CLS. 2, 5, 22, 23, 29, 37, 38 AND 50).

CLASS 41—EDUCATION AND ENTERTAINMENT

FOR BOOK PUBLISHING; AND PROVIDING ON-LINE PUBLICATIONS IN THE NATURE OF E-BOOKS AND ARTICLES IN THE FIELD OF COMMUNICATIONS ETIQUETTE (U.S. CLS. 100, 101 AND 107).

DEZMONA MIZELLE, EXAMINING ATTORNEY

CLASS 14—JEWELRY

FOR COLLECTIBLE COINS; MEDALLIONS (U.S. CLS. 2, 27, 28 AND 50).

CLASS 16—PAPER GOODS AND PRINTED MATTER

FOR CHILDREN'S BOOKS; EDUCATIONAL PUBLICATIONS, NAMELY, HANDBOOKS IN THE FIELDS OF INSPIRING AND MOTIVATING CHILDREN (U.S. CLS. 2, 5, 22, 23, 29, 37, 38 AND 50).

CLASS 26—FANCY GOODS

FOR EMBROIDERED PATCHES FOR CLOTHING (U.S. CLS. 37, 39, 40, 42 AND 50).

CLASS 28—TOYS AND SPORTING GOODS

FOR STUFFED AND PLUSH TOYS; TOY FIGURES (U.S. CLS. 22, 23, 38 AND 50).

CLASS 41—EDUCATION AND ENTERTAINMENT

FOR PROVIDING A WEBSITE FEATURING INFORMATION IN THE FIELDS OF EDUCATION AND ENTERTAINMENT FOR CHILDREN (U.S. CLS. 100, 101 AND 107).

JOHN GARTNER, EXAMINING ATTORNEY

SN 85-531,743. HON HAI PRECISION INDUSTRY CO., LTD., TAIPEI HSIEN, TAIWAN, FILED 2-2-2012.

UNIGATE

THE MARK CONSISTS OF STANDARD CHARACTERS WITHOUT CLAIM TO ANY PARTICULAR FONT, STYLE, SIZE, OR COLOR.

CLASS 9—ELECTRICAL AND SCIENTIFIC APPARATUS

FOR COMPUTER NETWORK SERVER; MOBILE PHONES; NOTEBOOK COMPUTERS; PERSONAL COMPUTERS; SET-TOP BOXES; TABLET COMPUTER; TELEVISIONS (U.S. CLS. 21, 23, 26, 36 AND 38).

CLASS 42—SCIENTIFIC AND COMPUTER SERVICES

FOR COMPUTER PROGRAMMING; COMPUTER SOFTWARE DESIGN; COMPUTER SYSTEM DESIGN SERVICES; COMPUTER SYSTEMS ANALYSIS; INSTALLATION OF COMPUTER SOFTWARE; MAINTENANCE OF COMPUTER SOFTWARE (U.S. CLS. 100 AND 101).

DEZMONA MIZELLE, EXAMINING ATTORNEY

SN 85-531,854. THE ORIGINAL 3 MEN MOVERS, LTD., HOUSTON, TX. FILED 2-2-2012.



THE MARK CONSISTS OF THREE STYLIZED HUMAN FIGURES THAT APPEAR TO BE RUNNING.

CLASS 35—ADVERTISING AND BUSINESS

FOR MOVING AND RELOCATION SERVICES, NAMELY, PLANNING AND IMPLEMENTING MOVES OF HOMES AND OFFICES (U.S. CLS. 100, 101 AND 102). FIRST USE 10-19-1988; IN COMMERCE 10-19-1988.

CLASS 39—TRANSPORTATION AND STORAGE

FOR MOVING COMPANY SERVICES; MOVING VAN SERVICES; MOVING VAN TRANSPORT; PACKING ARTICLES FOR TRANSPORTATION; PROVIDING SELF-STORAGE FACILITIES FOR OTHERS; RENTAL OF STORAGE CONTAINERS; TRANSPORTATION AND STORAGE OF GOODS (U.S. CLS. 100 AND 105).

FIRST USE 10-19-1988; IN COMMERCE 10-19-1988. SANJEEV VOHRA, EXAMINING ATTORNEY

SN 85-531,747. REMS, MARYANN, WINDERMERE, FL. FILED 2-2-2012.



THE MARK CONSISTS OF A DOG IN A SITTING POSITION WITH WINGS ON THE DOG'S BACK.

SN 85-531,953. THE TULSA DERBY LEAGUE, SAND SPRINGS, OK. FILED 2-2-2012.

SN 85-531,969. KOREN PAALMAN, VENICE, CA. FILED 2-2-2012.

Derby Strong

THE MARK CONSISTS OF STANDARD CHARACTERS WITHOUT CLAIM TO ANY PARTICULAR FONT, STYLE, SIZE, OR COLOR.

CLASS 16—PAPER GOODS AND PRINTED MATTER

FOR POSTERS (U.S. CLS. 2, 5, 22, 23, 29, 37, 38 AND 50).
FIRST USE 8-1-2008; IN COMMERCE 9-1-2008.

CLASS 25—CLOTHING

FOR BEANIES; HATS; HOODED SWEAT SHIRTS; SOCKS; T-SHIRTS (U.S. CLS. 22 AND 39).
FIRST USE 8-1-2008; IN COMMERCE 9-1-2008.
JAY FLOWERS, EXAMINING ATTORNEY

SN 85-531,964. THE REGULATORY FUNDAMENTALS GROUP LLC, NEW YORK, NY. FILED 2-2-2012.

RFG Collaborate!

THE MARK CONSISTS OF STANDARD CHARACTERS WITHOUT CLAIM TO ANY PARTICULAR FONT, STYLE, SIZE, OR COLOR.

CLASS 35—ADVERTISING AND BUSINESS

FOR BUSINESS RISK MANAGEMENT CONSULTING (U.S. CLS. 100, 101 AND 102).
FIRST USE 1-10-2012; IN COMMERCE 1-10-2012.

CLASS 45—PERSONAL AND LEGAL SERVICES

FOR REGULATORY COMPLIANCE CONSULTING FOR BUSINESS; TRACKING AND MONITORING REGULATORY REQUIREMENTS FOR BUSINESS FOR REGULATORY COMPLIANCE PURPOSES (U.S. CLS. 100 AND 101).
FIRST USE 1-10-2012; IN COMMERCE 1-10-2012.
JAY FLOWERS, EXAMINING ATTORNEY

Conscious Grieving

THE MARK CONSISTS OF STANDARD CHARACTERS WITHOUT CLAIM TO ANY PARTICULAR FONT, STYLE, SIZE, OR COLOR.

NO CLAIM IS MADE TO THE EXCLUSIVE RIGHT TO USE "GRIEVING", APART FROM THE MARK AS SHOWN.

CLASS 41—EDUCATION AND ENTERTAINMENT

FOR EDUCATIONAL SERVICES, NAMELY, CONDUCTING CLASSES, WORKSHOPS, AND SEMINARS IN THE FIELD OF YOGA AND GRIEVING; YOGA INSTRUCTION (U.S. CLS. 100, 101 AND 107).
FIRST USE 1-1-2010; IN COMMERCE 1-1-2010.

CLASS 45—PERSONAL AND LEGAL SERVICES

FOR GRIEF COUNSELING; PROVIDING SPIRITUAL RETREATS IN THE FIELD OF YOGA AND GRIEVING (U.S. CLS. 100 AND 101).
FIRST USE 1-1-2010; IN COMMERCE 1-1-2010.
JAY FLOWERS, EXAMINING ATTORNEY

SN 85-531,971. IR2DX, INC., MORAGA, CA. FILED 2-2-2012.

IR2DX

THE MARK CONSISTS OF STANDARD CHARACTERS WITHOUT CLAIM TO ANY PARTICULAR FONT, STYLE, SIZE, OR COLOR.

CLASS 5—PHARMACEUTICALS

FOR MEDICAL KITS CONSISTING PRIMARILY OF MEDICAL DIAGNOSTIC REAGENTS, ASSAYS AND CONSUMABLES, NAMELY, ARRAYS AND MEDICAL REACTION TUBES, STRIPS AND CHIPS FOR MEASURING PROTEINS AND MRNA FOR CLINICAL DIAGNOSTIC USE FOR METABOLIC SYNDROME, INSULIN RESISTANCE, CARDIOVASCULAR INFLAMMATORY RESPONSE, AND METABOLIC DISEASES AND DISORDERS (U.S. CLS. 6, 18, 44, 46, 51 AND 52).

CLASS 10—MEDICAL APPARATUS

FOR MEDICAL DEVICES IN THE NATURE OF A COLORIMETER TO MEASURE PROTEINS AND MRNA FOR CLINICAL DIAGNOSTIC USE FOR METABOLIC SYNDROME, INSULIN RESISTANCE, CARDIOVASCULAR INFLAMMATORY RESPONSE, AND METABOLIC DISEASES AND DISORDERS (U.S. CLS. 26, 39 AND 44).
FRANK LATTUCA, EXAMINING ATTORNEY

SN 85-531,977. IR2DX, INC., MORAGA, CA. FILED 2-2-2012.

SN 85-532,044. IR2DX, INC., MORAGA, CA. FILED 2-2-2012.

METABSCREEN

THE MARK CONSISTS OF STANDARD CHARACTERS WITHOUT CLAIM TO ANY PARTICULAR FONT, STYLE, SIZE, OR COLOR.

CLASS 5—PHARMACEUTICALS

FOR MEDICAL KITS CONSISTING PRIMARILY OF MEDICAL DIAGNOSTIC REAGENTS, ASSAYS AND CONSUMABLES, NAMELY, ARRAYS AND MEDICAL REACTION TUBES, STRIPS AND CHIPS FOR MEASURING PROTEINS AND MRNA FOR CLINICAL DIAGNOSTIC USE FOR METABOLIC SYNDROME, INSULIN RESISTANCE, CARDIOVASCULAR INFLAMMATORY RESPONSE, AND METABOLIC DISEASES AND DISORDERS (U.S. CLS. 6, 18, 44, 46, 51 AND 52).

CLASS 10—MEDICAL APPARATUS

FOR MEDICAL DEVICES IN THE NATURE OF A COLORIMETER TO MEASURE PROTEINS AND MRNA FOR CLINICAL DIAGNOSTIC USE FOR METABOLIC SYNDROME, INSULIN RESISTANCE, CARDIOVASCULAR INFLAMMATORY RESPONSE, AND METABOLIC DISEASES AND DISORDERS (U.S. CLS. 26, 39 AND 44).
FRANK LATTUCA, EXAMINING ATTORNEY

SN 85-531,985. HARRELL'S EQUIPMENT & SUPPLY CO., INC., INDIANAPOLIS, IN. FILED 2-2-2012.

HARRELL'S CAR WASH SYSTEMS

THE MARK CONSISTS OF STANDARD CHARACTERS WITHOUT CLAIM TO ANY PARTICULAR FONT, STYLE, SIZE, OR COLOR.

NO CLAIM IS MADE TO THE EXCLUSIVE RIGHT TO USE "CAR WASH SYSTEMS", APART FROM THE MARK AS SHOWN.

THE NAME(S), PORTRAIT(S), AND/OR SIGNATURE(S) SHOWN IN THE MARK DOES NOT IDENTIFY A PARTICULAR LIVING INDIVIDUAL.

SEC. 2(F) AS TO "HARRELL'S".

CLASS 35—ADVERTISING AND BUSINESS

FOR RETAIL DISTRIBUTORSHIP FEATURING COMMERCIAL MACHINES AND RELATED EQUIPMENT USED TO CLEAN AND WASH MOTOR VEHICLES (U.S. CLS. 100, 101 AND 102).

FIRST USE 6-25-1990; IN COMMERCE 6-25-1990.

CLASS 37—CONSTRUCTION AND REPAIR

FOR MAINTENANCE AND REPAIR OF COMMERCIAL MACHINES AND RELATED EQUIPMENT USED TO CLEAN AND WASH MOTOR VEHICLES (U.S. CLS. 100, 103 AND 106).

FIRST USE 6-25-1990; IN COMMERCE 6-25-1990.

GISELLE AGOSTO, EXAMINING ATTORNEY

IR2DIAGNOSTICS

THE MARK CONSISTS OF STANDARD CHARACTERS WITHOUT CLAIM TO ANY PARTICULAR FONT, STYLE, SIZE, OR COLOR.

CLASS 5—PHARMACEUTICALS

FOR MEDICAL KITS CONSISTING PRIMARILY OF MEDICAL DIAGNOSTIC REAGENTS, ASSAYS AND CONSUMABLES, NAMELY, ARRAYS AND MEDICAL REACTION TUBES, STRIPS AND CHIPS FOR MEASURING PROTEINS AND MRNA FOR CLINICAL DIAGNOSTIC USE FOR METABOLIC SYNDROME, INSULIN RESISTANCE, CARDIOVASCULAR INFLAMMATORY RESPONSE, AND METABOLIC DISEASES AND DISORDERS (U.S. CLS. 6, 18, 44, 46, 51 AND 52).

CLASS 10—MEDICAL APPARATUS

FOR MEDICAL DEVICES IN THE NATURE OF A COLORIMETER TO MEASURE PROTEINS AND MRNA FOR CLINICAL DIAGNOSTIC USE FOR METABOLIC SYNDROME, INSULIN RESISTANCE, CARDIOVASCULAR INFLAMMATORY RESPONSE, AND METABOLIC DISEASES AND DISORDERS (U.S. CLS. 26, 39 AND 44).
FRANK LATTUCA, EXAMINING ATTORNEY

SN 85-532,071. UNITE FITNESS LLC, PHILADELPHIA, PA. FILED 2-2-2012.

UNITE FITNESS

THE MARK CONSISTS OF STANDARD CHARACTERS WITHOUT CLAIM TO ANY PARTICULAR FONT, STYLE, SIZE, OR COLOR.

NO CLAIM IS MADE TO THE EXCLUSIVE RIGHT TO USE "FITNESS", APART FROM THE MARK AS SHOWN.

CLASS 41—EDUCATION AND ENTERTAINMENT

FOR CONDUCTING FITNESS CLASSES; CONSULTING SERVICES IN THE FIELDS OF FITNESS AND EXERCISE; PERSONAL FITNESS TRAINING SERVICES AND CONSULTANCY; PERSONAL TRAINER SERVICES; PHYSICAL FITNESS CONSULTATION; PHYSICAL FITNESS STUDIO SERVICES, NAMELY, PROVIDING EXERCISE CLASSES, BODY SCULPTING CLASSES, AND GROUP FITNESS CLASSES; PHYSICAL FITNESS TRAINING OF INDIVIDUALS AND GROUPS; PHYSICAL FITNESS TRAINING SERVICES; PROVIDING A WEBSITE FEATURING INFORMATION ON EXERCISE AND FITNESS; PROVIDING A WEBSITE FEATURING ONLINE SPORTS TRAINING AND TRAINING ADVICE AND THE RECORDING OF TRAINING AND WORKOUTS; PROVIDING ASSISTANCE, PERSONAL TRAINING AND PHYSICAL FITNESS CONSULTATION TO CORPORATE CLIENTS TO HELP THEIR EMPLOYEES MAKE PHYSICAL FITNESS, STRENGTH, CONDITIONING, AND EXERCISE ALTERATIONS IN THEIR DAILY LIVING (U.S. CLS. 100, 101 AND 107).

CLASS 44—MEDICAL, BEAUTY AND AGRICULTURAL SERVICES

FOR CONSULTING SERVICES IN THE FIELDS OF HEALTH AND NUTRITION; NUTRITION COUNSELING; PROVIDING A WEBSITE FEATURING INFORMATION ABOUT HEALTH, WELLNESS AND NUTRITION; PROVIDING A WEBSITE FEATURING INFORMATION AND ADVICE IN THE FIELDS OF DIET, WEIGHT LOSS, DIET PLANNING AND LIFESTYLE WELLNESS; PROVIDING ASSISTANCE, FITNESS EVALUATION AND CONSULTATION TO CORPORATE CLIENTS TO HELP THEIR EMPLOYEES MAKE HEALTH, WELLNESS AND NUTRITIONAL CHANGES IN THEIR DAILY LIVING TO IMPROVE HEALTH; PROVIDING HEALTHY LIFESTYLE AND NUTRITION SERVICES, NAMELY, PERSONAL ASSESSMENTS, PERSONALIZED ROUTINES, MAINTENANCE SCHEDULES, AND COUNSELING (U.S. CLS. 100 AND 101).

TEJBIR SINGH, EXAMINING ATTORNEY

SN 85-532,121. STANISLAUS PARTNERS, MODESTO, CA. FILED 2-2-2012.

CESTERIA

THE MARK CONSISTS OF STANDARD CHARACTERS WITHOUT CLAIM TO ANY PARTICULAR FONT, STYLE, SIZE, OR COLOR.

THE ENGLISH TRANSLATION OF CESTERIA IN THE MARK IS BASKET MAKING.

CLASS 29—MEATS AND PROCESSED FOODS

FOR PROCESSED VEGETABLES; CANNED VEGETABLES; CANNED TOMATOES; VEGETABLE PASTE; VEGETABLE PUREE; TOMATO PASTE; TOMATO PUREE (U.S. CL. 46).

CLASS 30—STAPLE FOODS

FOR SAUCES; TOMATO-BASED SAUCES; READY-MADE SAUCES; TOMATO SAUCE; CANNED TOMATO SAUCE; PIZZA SAUCE; SPAGHETTI AND PASTA SAUCE; MARINARA SAUCE; SALSA (U.S. CL. 46).

TIMOTHY FINNEGAN, EXAMINING ATTORNEY

SN 85-532,146. DISCOVERY HOUSE PUBLISHERS, GRAND RAPIDS, MI. FILED 2-2-2012.

DHP

THE MARK CONSISTS OF STANDARD CHARACTERS WITHOUT CLAIM TO ANY PARTICULAR FONT, STYLE, SIZE, OR COLOR.

CLASS 9—ELECTRICAL AND SCIENTIFIC APPARATUS

FOR PRE-RECORDED AUDIO AND VIDEO CDS AND DVDS FEATURING RELIGIOUS TOPICS (U.S. CLS. 21, 23, 26, 36 AND 38).

FIRST USE 9-1-1988; IN COMMERCE 9-1-1988.

CLASS 16—PAPER GOODS AND PRINTED MATTER

FOR PRINTED BOOKS AND BOOKLETS, CARDS, STATIONERY, DAY PLANNERS, AND CALENDARS FEATURING RELIGIOUS TOPICS (U.S. CLS. 2, 5, 22, 23, 29, 37, 38 AND 50).

FIRST USE 9-1-1988; IN COMMERCE 9-1-1988.

TARAH HARDY, EXAMINING ATTORNEY

SN 85-532,189. MIZUHO FINANCIAL GROUP, INC., TOKYO, JAPAN, FILED 2-2-2012.

MIZUHO EUREKAHEDGE

THE MARK CONSISTS OF STANDARD CHARACTERS WITHOUT CLAIM TO ANY PARTICULAR FONT, STYLE, SIZE, OR COLOR.

OWNER OF U.S. REG. NOS. 2,787,842 AND 3,125,825.

THE ENGLISH TRANSLATION OF "MIZUHO" IN THE MARK IS "A FRESH HARVEST OF RICE".

CLASS 35—ADVERTISING AND BUSINESS

FOR PROVIDING FINANCIAL INDICES BASED ON SELECTED GROUPS OF SECURITIES (U.S. CLS. 100, 101 AND 102).

CLASS 36—INSURANCE AND FINANCIAL

FOR HEDGE FUND INVESTMENT SERVICES (U.S. CLS. 100, 101 AND 102).

FRANK LATTUCA, EXAMINING ATTORNEY

SN 85-532,257. PLASTIC LOGIC LIMITED, CAMBRIDGE, UNITED KINGDOM, FILED 2-2-2012.

SKYPAPER

THE MARK CONSISTS OF STANDARD CHARACTERS WITHOUT CLAIM TO ANY PARTICULAR FONT, STYLE, SIZE, OR COLOR.

CLASS 38—COMMUNICATION

FOR TELECOMMUNICATION SERVICES, NAMELY, TRANSMISSION OF ELECTRONIC AND DIGITAL FILES (U.S. CLS. 100, 101 AND 104).

CLASS 42—SCIENTIFIC AND COMPUTER SERVICES

FOR PROVIDING AN ONLINE SERVICE FOR THE SYNCHRONIZATION OF ELECTRONIC AND DIGITAL FILES BETWEEN HANDHELD COMPUTERS, E-READERS AND TABLET COMPUTERS AND COMPUTER NETWORKS OR OTHER COMPUTERS; PROVIDING ONLINE NON-DOWNLOADABLE SOFTWARE THAT ENABLES SYNCHRONIZATION OF DATA FILES; PROVIDING TEMPORARY USE OF NON-DOWNLOADABLE SOFTWARE FOR RECEIVING, DISPLAYING, STORING, ORGANIZING AND SHARING WITH OTHER USERS DOCUMENTS, SOUNDS, MUSIC, VIDEOS, PHOTOGRAPHS, DRAWINGS, IMAGES AND DATA STORED ELECTRONICALLY (U.S. CLS. 100 AND 101).
 JANICE L. MCMORROW, EXAMINING ATTORNEY

SN 85-532,299. TOWNSEND, MARYANN M., WENTZVILLE, MO. FILED 2-2-2012.



THE MARK CONSISTS OF A FISHERMAN CASTING A LINE WITH A FISHING ROD THAT MAKES UP A FISH ENCOMPASSING HIM.

CLASS 28—TOYS AND SPORTING GOODS

FOR FISHING RODS; FISHING TACKLE (U.S. CLS. 22, 23, 38 AND 50).
 FIRST USE 9-0-2011; IN COMMERCE 9-0-2011.

CLASS 41—EDUCATION AND ENTERTAINMENT

FOR EDUCATIONAL SERVICES, NAMELY, CONDUCTING COURSES, CLASSES, SEMINARS, AND WORKSHOPS IN THE FIELD OF FISHING, FLY TYING, FLY CASTING, FISHING ROD BUILDING, AND FLY ROD BUILDING AND DISTRIBUTION OF COURSE MATERIAL IN CONNECTION THEREWITH (U.S. CLS. 100, 101 AND 107).
 FIRST USE 12-0-2011; IN COMMERCE 12-0-2011.
 KIMBERLY PERRY, EXAMINING ATTORNEY

SN 85-532,316. GLOBAL EXPORT MARKETING CO., LTD., NEW YORK, NY. FILED 2-2-2012.

LISHUS

THE MARK CONSISTS OF STANDARD CHARACTERS WITHOUT CLAIM TO ANY PARTICULAR FONT, STYLE, SIZE, OR COLOR.
 THE WORDING LISHUS HAS NO MEANING IN A FOREIGN LANGUAGE.

CLASS 29—MEATS AND PROCESSED FOODS

FOR BUTTER; CANNED, COOKED OR OTHERWISE PROCESSED TOMATOES; CHEESE; DAIRY PRODUCTS EXCLUDING ICE CREAM, ICE MILK AND FROZEN YOGURT; DICED TOMATOES; FRUIT-BASED FILLING FOR CAKES AND PIES; FRUITS, NAMELY, PROCESSED FRUIT IN SYRUP; JELLIES AND JAMS; MARASCHINO CHERRIES; PEANUT BUTTER; PEANUT BUTTER TOPPINGS; PICKLED JALAPENOS; PICKLED VEGETABLES; PROCESSED CHERRIES; PROCESSED FRUITS; PROCESSED GRAPE LEAVES; PROCESSED MEAT; PROCESSED VEGETABLES; SANDWICH SPREAD, NAMELY, A MAYONNAISE-BASED SANDWICH SPREAD; SAUSAGES; TOMATO PUREE (U.S. CL. 46).

CLASS 30—STAPLE FOODS

FOR BARBEQUE SAUCE; BREAD CRUMB; CHOCOLATE SAUCE; CHOCOLATE SYRUP; EGG- AND DAIRY-FREE MAYONNAISE; HORSERADISH; HOT SAUCE; KETCHUP; MARINADE MIXES; MARINADES; MAYONNAISE; MEAT TENDERIZERS; MICROWAVE POPCORN; MUSTARD; PANCAKE SYRUP; PASTA SAUCE; PICANTE SAUCE; PIZZA SAUCE; POPCORN; PREPARED HORSERADISH; PROCESSED POPCORN; SALAD DRESSINGS; SALT; SAUCES; SOY SAUCE; SPICE BLENDS; SPICES; STEAK SAUCE; TABLE SYRUP; TOMATO SAUCE; VINEGAR; WORCESTERSHIRE SAUCE (U.S. CL. 46).
 SAMUEL E. SHARPER JR., EXAMINING ATTORNEY

SN 85-532,329. BAKER & TAYLOR, INC., CHARLOTTE, NC. FILED 2-2-2012.

CATS

THE MARK CONSISTS OF STANDARD CHARACTERS WITHOUT CLAIM TO ANY PARTICULAR FONT, STYLE, SIZE, OR COLOR.

CLASS 35—ADVERTISING AND BUSINESS

FOR WHOLESALE ORDERING SERVICES IN THE FIELD OF YOUTH AND YOUNG ADULT BOOKS, AUDIOVISUAL, AND DIGITAL MATERIALS FOR LIBRARIES (U.S. CLS. 100, 101 AND 102).
 FIRST USE 1-0-2009; IN COMMERCE 1-0-2009.

CLASS 41—EDUCATION AND ENTERTAINMENT

FOR CONSULTING SERVICES FOR LIBRARIES, NAMELY, SELECTION ASSISTANCE AND COLLECTION DEVELOPMENT OF YOUTH AND YOUNG ADULT BOOK, AUDIOVISUAL, AND DIGITAL TITLES (U.S. CLS. 100, 101 AND 107).
 FIRST USE 1-0-2009; IN COMMERCE 1-0-2009.
 DORITT L. CARROLL, EXAMINING ATTORNEY

SN 85-532,340. DAYCO PRODUCTS, LLC, TULSA, OK.
FILED 2-2-2012.

SN 85-532,405. SIZEMORE, INC., AUGUSTA, GA. FILED 2-2-2012.

DAYCO

THE MARK CONSISTS OF STANDARD CHARACTERS WITHOUT CLAIM TO ANY PARTICULAR FONT, STYLE, SIZE, OR COLOR.

OWNER OF U.S. REG. NOS. 1,391,387, 1,647,865 AND 1,689,837.

CLASS 7—MACHINERY

FOR BELTS, PULLEYS AND BELT TENSIONERS FOR MOTORS AND ENGINES, USED IN INDUSTRIAL MACHINES AND/OR APPLICATIONS (U.S. CLS. 13, 19, 21, 23, 31, 34 AND 35).

FIRST USE 4-1-1960; IN COMMERCE 4-1-1960.

CLASS 12—VEHICLES

FOR BELTS, PULLEYS AND BELT TENSIONERS FOR LAND VEHICLES (U.S. CLS. 19, 21, 23, 31, 35 AND 44).

FIRST USE 4-16-1945; IN COMMERCE 4-16-1945.
MEGHAN REINHART, EXAMINING ATTORNEY

SN 85-532,393. 4EVERGREEN GROUP LLC, SEATTLE, WA.
FILED 2-2-2012.



THE MARK CONSISTS OF THE STYLIZED WORDING OF "4E" THAT SUGGESTS AN EVERGREEN TREE, AND WITH A CROSS SYMBOL DIRECTLY ABOVE THE "E".

CLASS 25—CLOTHING

FOR HATS; T-SHIRTS (U.S. CLS. 22 AND 39).
FIRST USE 8-20-2010; IN COMMERCE 8-20-2010.

CLASS 41—EDUCATION AND ENTERTAINMENT

FOR PROVIDING INFORMATION, NEWS AND COMMENTARY IN THE FIELD OF CURRENT EVENTS RELATING TO MEDICAL CANNABIS (U.S. CLS. 100, 101 AND 107).

FIRST USE 6-19-2010; IN COMMERCE 6-19-2010.
LAURIE KAUFMAN, EXAMINING ATTORNEY

SIZEMORE

THE MARK CONSISTS OF STANDARD CHARACTERS WITHOUT CLAIM TO ANY PARTICULAR FONT, STYLE, SIZE, OR COLOR.

OWNER OF U.S. REG. NO. 3,751,652.
SEC. 2(F).

CLASS 35—ADVERTISING AND BUSINESS

FOR EMPLOYMENT AGENCY SERVICES, NAMELY, FILLING THE TEMPORARY AND PERMANENT STAFFING NEEDS OF BUSINESSES (U.S. CLS. 100, 101 AND 102).

FIRST USE 0-0-1980; IN COMMERCE 0-0-1980.

CLASS 37—CONSTRUCTION AND REPAIR

FOR JANITORIAL SERVICES (U.S. CLS. 100, 103 AND 106).

FIRST USE 0-0-1991; IN COMMERCE 0-0-1991.

CLASS 45—PERSONAL AND LEGAL SERVICES

FOR SECURITY SERVICES, NAMELY, SECURITY GUARD SERVICES, SECURITY INSPECTION SERVICES, SURVEILLANCE AND CONFIDENTIAL INVESTIGATIONS, MOBILE PATROL, FIRE PROTECTION, AND CONSULTING SERVICES THEREFOR (U.S. CLS. 100 AND 101).

FIRST USE 0-0-1968; IN COMMERCE 0-0-1968.
ZACHARY BELLO, EXAMINING ATTORNEY

SN 85-532,420. NATIONAL MARROW DONOR PROGRAM,
MINNEAPOLIS, MN. FILED 2-2-2012.

MY SOCIAL STRAND

THE MARK CONSISTS OF STANDARD CHARACTERS WITHOUT CLAIM TO ANY PARTICULAR FONT, STYLE, SIZE, OR COLOR.

CLASS 25—CLOTHING

FOR CLOTHING, NAMELY, T-SHIRTS, SHIRTS, HATS, CAPS, HOODED JACKETS, HOODED SHIRTS, SWEATSHIRTS, SWEATPANTS (U.S. CLS. 22 AND 39).

CLASS 35—ADVERTISING AND BUSINESS

FOR PROMOTING AWARENESS OF THE NEED FOR BONE MARROW, PERIPHERAL BLOOD STEM CELLS AND CORD BLOOD DONATION (U.S. CLS. 100, 101 AND 102).

CLASS 36—INSURANCE AND FINANCIAL

FOR CHARITABLE FUNDRAISING SERVICES, NAMELY, RAISING FUNDS FOR BONE MARROW, PERIPHERAL BLOOD STEM CELLS AND CORD BLOOD RESEARCH AND TRANSPLANT SERVICES AND TO INCREASE BONE MARROW, PERIPHERAL BLOOD STEM CELLS AND CORD BLOOD DONOR RECRUITMENT (U.S. CLS. 100, 101 AND 102).

CLASS 42—SCIENTIFIC AND COMPUTER SERVICES

FOR PROVIDING A WEBSITE FEATURING EDUCATIONAL INFORMATION AND EDUCATIONAL ONLINE VIDEOS RELATED TO STEM CELL, CORD BLOOD AND BONE MARROW TRANSPLANTATION AND DONOR RECRUITMENT; CREATING AN ON-LINE COMMUNITY RELATED TO BONE MARROW, PERIPHERAL BLOOD STEM CELLS AND CORD BLOOD DONATION FOR THE PURPOSE OF CONNECTING PATIENTS AND DONORS (U.S. CLS. 100 AND 101).

NAPOLEON SHARMA, EXAMINING ATTORNEY

SN 85-532,444. O.C. TANNER COMPANY, SALT LAKE CITY, UT. FILED 2-2-2012.

RECOGNITION@WORK

THE MARK CONSISTS OF STANDARD CHARACTERS WITHOUT CLAIM TO ANY PARTICULAR FONT, STYLE, SIZE, OR COLOR.

OWNER OF U.S. REG. NO. 3,074,918.
SEC. 2(F).

CLASS 35—ADVERTISING AND BUSINESS

FOR CONDUCTING AN EMPLOYEE RECOGNITION AND INCENTIVE AWARD PROGRAM FOR OTHERS ACCESSIBLE VIA AN ON-LINE COMPUTER NETWORK TO PROMOTE EMPLOYEE ACHIEVEMENT, PRODUCTIVITY, PERFORMANCE, SALES, SERVICE, CUSTOMER SATISFACTION, QUALITY, SAFETY, RETIREMENT; CREATION OF RECOGNITION AND INCENTIVE AWARD PROGRAMS FOR OTHERS, NAMELY, EMPLOYEE ACHIEVEMENT, PRODUCTIVITY, PERFORMANCE, SALES, SERVICE, CUSTOMER SATISFACTION, QUALITY, SAFETY, RETIREMENT, EVENT, AND OTHER RECOGNITION AND INCENTIVE AWARD PROGRAMS; ADMINISTRATION OF RECOGNITION AND INCENTIVE AWARD PROGRAMS FOR OTHERS TO PROMOTE JOB SAFETY, QUALITY, PRODUCTIVITY, PERFORMANCE, SALES, SERVICE, AND CUSTOMER SATISFACTION (U.S. CLS. 100, 101 AND 102).

FIRST USE 1-16-2006; IN COMMERCE 1-16-2006.

CLASS 42—SCIENTIFIC AND COMPUTER SERVICES

FOR PROVIDING TEMPORARY USE OF NON-DOWNLOADABLE COMPUTER SOFTWARE THAT FACILITATES EMPLOYEE NOMINATION, AWARD SELECTION AND AWARD FULFILLMENT, AND PROGRAM ADMINISTRATION AND REPORTING (U.S. CLS. 100 AND 101).

FIRST USE 1-16-2006; IN COMMERCE 1-16-2006.
BARBARA A. GOLD, EXAMINING ATTORNEY

SN 85-532,432. PREDPOL, INC., SANTA CRUZ, CA. FILED 2-2-2012.

PREDPOL

THE MARK CONSISTS OF STANDARD CHARACTERS WITHOUT CLAIM TO ANY PARTICULAR FONT, STYLE, SIZE, OR COLOR.

CLASS 9—ELECTRICAL AND SCIENTIFIC APPARATUS

FOR COMPUTER SOFTWARE FOR USE IN LAW ENFORCEMENT AND RELATED BUSINESSES, NAMELY, COMPUTER SOFTWARE USED FOR USE IN THE ANALYSIS AND DETERMINATION OF PROBABLE LOCATIONS WHERE CRIMES WILL BE COMMITTED WITH INFORMATION DELIVERY THROUGH BROWSER AND PORTABLE DEVICE APPLICATIONS AND MAP OVERLAYS (U.S. CLS. 21, 23, 26, 36 AND 38).

CLASS 42—SCIENTIFIC AND COMPUTER SERVICES

FOR DESIGNING AND DEVELOPING COMPUTER SOFTWARE FOR USE IN LAW ENFORCEMENT AND RELATED BUSINESS ENTERPRISES, NAMELY, COMPUTER SOFTWARE USED FOR ANALYSIS OF PROBABLE LOCATIONS WHERE CRIMES WILL BE COMMITTED WITH INFORMATION DELIVERY THROUGH BROWSER, PORTABLE DEVICE APPLICATION AND AS MAP OVERLAY (U.S. CLS. 100 AND 101).

TARAH HARDY, EXAMINING ATTORNEY

SN 85-532,481. PERFORM GROUP, LLC, YORK, PA. FILED 2-2-2012.

COMPETE WITH CONFIDENCE

THE MARK CONSISTS OF STANDARD CHARACTERS WITHOUT CLAIM TO ANY PARTICULAR FONT, STYLE, SIZE, OR COLOR.

CLASS 25—CLOTHING

FOR BODY SUITS; BRIEFS; JACKETS; LEOTARDS; PANTS; PULLOVERS; SHOES; SHORTS; SLEEVELESS JERSEYS; TEE SHIRTS; TIGHTS; TRUNKS; WARM-UP SUITS (U.S. CLS. 22 AND 39).

CLASS 35—ADVERTISING AND BUSINESS

FOR COMPUTERIZED ON-LINE RETAIL STORE SERVICES IN THE FIELD OF APPAREL FOR GYMNASTS; MAIL ORDER CATALOG SERVICES FEATURING APPAREL FOR GYMNASTS (U.S. CLS. 100, 101 AND 102).

EMILY CARLSEN, EXAMINING ATTORNEY

SN 85-532,544. MICRON TECHNOLOGY, INC., BOISE, ID. FILED 2-2-2012.



NO CLAIM IS MADE TO THE EXCLUSIVE RIGHT TO USE "VIDEO", APART FROM THE MARK AS SHOWN.

THE MARK CONSISTS OF THE WORDS "POP VIDEO" WHEREIN THE WORD "POP" IS DEPICTING A FACE WITH TWO CURVED CONES PLACED ABOVE TWO "P"'S DEPICTING EYE BROWS AND THE WORD "VIDEO" IS WRITTEN BELOW THE WORD "POP" AS SHOWN IN THE MARK.

CLASS 9—ELECTRICAL AND SCIENTIFIC APPARATUS

FOR PICO SLIDE PROJECTORS; COMPUTER SOFTWARE APPLICATION FOR USE ON MOBILE PHONES, TABLET PCS, AND HANDHELD COMPUTERS, NAMELY, SOFTWARE FOR PROJECTING ITEMS USING PICO PROJECTOR (U.S. CLS. 21, 23, 26, 36 AND 38).

CLASS 11—ENVIRONMENTAL CONTROL APPARATUS

FOR PROJECTOR LAMPS (U.S. CLS. 13, 21, 23, 31 AND 34).

JULIE GUTTADAURO, EXAMINING ATTORNEY

SN 85-532,562. IDDICTION, INC., PALO ALTO, CA. FILED 2-2-2012.

APP-O-DAY

THE MARK CONSISTS OF STANDARD CHARACTERS WITHOUT CLAIM TO ANY PARTICULAR FONT, STYLE, SIZE, OR COLOR.

CLASS 9—ELECTRICAL AND SCIENTIFIC APPARATUS

FOR DOWNLOADABLE SOFTWARE IN THE NATURE OF A MOBILE APPLICATION FOR SEARCHING AND DOWNLOADING MOBILE APPLICATIONS AND GAMES (U.S. CLS. 21, 23, 26, 36 AND 38).

CLASS 35—ADVERTISING AND BUSINESS

FOR ON-LINE RETAIL STORE SERVICES FEATURING DOWNLOADABLE MOBILE APPLICATIONS AND GAMES; ADVERTISING SERVICES, NAMELY, PROMOTING THE DOWNLOADABLE MOBILE APPLICATIONS AND GAMES OF OTHERS (U.S. CLS. 100, 101 AND 102).

CLASS 42—SCIENTIFIC AND COMPUTER SERVICES

FOR PROVIDING AN ON-LINE SEARCHABLE DATABASE FEATURING DOWNLOADABLE MOBILE APPLICATIONS AND GAMES OF OTHERS; PROVIDING A WEBSITE FEATURING INFORMATION IN THE FIELD OF SOFTWARE FOR USE WITH MOBILE DEVICES, SOFTWARE APPLICATIONS FOR USE WITH MOBILE DEVICES AND INFORMATIONAL TECHNOLOGY; COMPUTER SERVICES, NAMELY, PROVIDING SEARCH ENGINES FOR OBTAINING DATA VIA ELECTRONIC COMMUNICATIONS NETWORKS; INTERNET SERVICES, NAMELY, CREATING INDEXES OF INFORMATION, SITES, AND OTHER RESOURCES AVAILABLE ON GLOBAL COMPUTER NETWORKS FOR OTHERS; SEARCHING AND RETRIEVING INFORMATION, SITES, AND OTHER RESOURCES AVAILABLE ON GLOBAL COMPUTER NETWORKS AND OTHER ELECTRONIC COMMUNICATION NETWORKS FOR OTHERS (U.S. CLS. 100 AND 101).

SUNG IN, EXAMINING ATTORNEY

SN 85-532,570. DAIKEN CORPORATION, NANTO CITY, TOYAMA, JAPAN, FILED 2-2-2012.

EXCELSTONE

THE MARK CONSISTS OF STANDARD CHARACTERS WITHOUT CLAIM TO ANY PARTICULAR FONT, STYLE, SIZE, OR COLOR.

CLASS 17—RUBBER GOODS

FOR INSULATING MATERIALS FOR CEILINGS; INSULATING MATERIALS COMPOSED PRIMARILY OF ROCK WOOL; INSULATING MATERIALS, NAMELY, CEILING BOARDS AND PANELS, COMPOSED PRIMARILY OF ROCK WOOL (U.S. CLS. 1, 5, 12, 13, 35 AND 50).

CLASS 19—NON-METALLIC BUILDING MATERIALS

FOR BUILDING MATERIALS COMPOSED PRIMARILY OF ROCK WOOL; CEILING BOARDS AND PANELS, NOT OF METAL; CEILING BOARDS AND PANELS, COMPOSED PRIMARILY OF ROCK WOOL (U.S. CLS. 1, 12, 33 AND 50).

JULIE GUTTADAURO, EXAMINING ATTORNEY

SN 85-532,573. JAMES W. POTTS LLC, ALTADENA, CA. FILED 2-2-2012.

SN 85-532,808. CRAWFORD, JANET, DBA CASCADANCE, MILL VALLEY, CA. FILED 2-2-2012.

"Walking On Eggshells"

CASCADANCE

THE MARK CONSISTS OF STANDARD CHARACTERS WITHOUT CLAIM TO ANY PARTICULAR FONT, STYLE, SIZE, OR COLOR.

THE MARK CONSISTS OF STANDARD CHARACTERS WITHOUT CLAIM TO ANY PARTICULAR FONT, STYLE, SIZE, OR COLOR.

CLASS 16—PAPER GOODS AND PRINTED MATTER

CLASS 35—ADVERTISING AND BUSINESS

FOR PRINTED MATTER, NAMELY, PAPER SIGNS, BOOKS, MANUALS, CURRICULUM, NEWSLETTERS, INFORMATIONAL CARDS AND BROCHURES IN THE FIELD OF MANAGEMENT IN THE WORKPLACE (U.S. CLS. 2, 5, 22, 23, 29, 37, 38 AND 50).

FOR PROVIDING BUSINESS INFORMATION IN THE FIELD OF ORGANIZATIONAL EFFECTIVENESS AND CULTURE BASED ON HUMAN BIOLOGY AND NEUROSCIENCE PRINCIPLES TO THE CORPORATE AND NON-PROFIT SECTORS (U.S. CLS. 100, 101 AND 102). FIRST USE 10-12-2003; IN COMMERCE 10-12-2003.

CLASS 41—EDUCATION AND ENTERTAINMENT

CLASS 41—EDUCATION AND ENTERTAINMENT

FOR EDUCATIONAL SERVICES, NAMELY, CONDUCTING SEMINARS AND WORKSHOPS IN THE FIELD OF MANAGEMENT IN THE WORKPLACE AND DISTRIBUTION OF EDUCATIONAL MATERIALS IN CONNECTION THEREWITH (U.S. CLS. 100, 101 AND 107).

FOR EDUCATIONAL AND ENTERTAINMENT SERVICES, NAMELY, PROVIDING MOTIVATIONAL SPEAKING SERVICES IN THE FIELD OF ORGANIZATIONAL EFFECTIVENESS AND CULTURE BASED ON HUMAN BIOLOGY AND NEUROSCIENCE PRINCIPLES (U.S. CLS. 100, 101 AND 107).

TINA MAI, EXAMINING ATTORNEY

FIRST USE 10-12-2003; IN COMMERCE 10-12-2003. LYNDSEY KUYKENDALL, EXAMINING ATTORNEY

SN 85-532,660. STEVEN AND WILLIAM LADD INCORPORATED, DBA STEVEN AND WILLIAM, BROOKLYN, NY. FILED 2-2-2012.

SN 85-532,835. XIANGTAN ELECTRIC MANUFACTURING GROUP CO., LTD., XIANGTAN CITY, HUNAN, CHINA. FILED 2-3-2012.

STEVEN AND WILLIAM



THE MARK CONSISTS OF STANDARD CHARACTERS WITHOUT CLAIM TO ANY PARTICULAR FONT, STYLE, SIZE, OR COLOR.

CLASS 20—FURNITURE AND ARTICLES NOT OTHERWISE CLASSIFIED

THE MARK CONSISTS OF STYLIZED LETTERS "XEMC".

FOR BED PILLOWS, PILLOWS (U.S. CLS. 2, 13, 22, 25, 32 AND 50).

CLASS 24—FABRICS

CLASS 7—MACHINERY

FOR BED SHEETS, PILLOW CASES, PILLOW SHAMS, COMFORTERS, QUILTS, BED SPREADS, BED SKIRTS, DUVETS, COMFORTER COVERS, BED BLANKETS, TOWELS, CURTAINS, DRAPERIES (U.S. CLS. 42 AND 50).

FOR ELECTRICITY GENERATORS; ELEVATORS; ENGINES, OTHER THAN FOR LAND VEHICLES; HYDRAULIC TURBINES; MINE BORERS; MOTORS OTHER THAN FOR LAND VEHICLES; PUMPS FOR MACHINES; WIND-POWERED ELECTRICITY GENERATORS (U.S. CLS. 13, 19, 21, 23, 31, 34 AND 35). FIRST USE 3-18-2009; IN COMMERCE 3-18-2009.

KATHLEEN KOLACZ, EXAMINING ATTORNEY

CLASS 9—ELECTRICAL AND SCIENTIFIC APPARATUS

FOR ELECTRIC CONVERTERS; ELECTRIC INSTALLATIONS FOR THE REMOTE CONTROL OF INDUSTRIAL OPERATIONS; ELECTRIC WIRE AND CABLE; ELECTRONIC CONTROLLER TO MANAGE THE POWER, MOVEMENT AND FUNCTIONS OF AN ELEVATOR; INDUCTION VOLTAGE REGULATORS; PLATES FOR BATTERIES; RECTIFIERS; SILICON CHIPS; SOLAR BATTERIES (U.S. CLS. 21, 23, 26, 36 AND 38).

FIRST USE 3-18-2009; IN COMMERCE 3-18-2009.

CLASS 12—VEHICLES

FOR AERIAL CONVEYORS; AIR-CUSHION VEHICLES; AUTOMOBILE ENGINES; AUTOMOBILES; BUSES; ELECTRIC VEHICLES, NAMELY, ELECTRIC BUSES; LOCOMOTIVES; MOTOR CARS FOR TRANSPORT ON LAND; TROLLEYS; VEHICLE BODIES (U.S. CLS. 19, 21, 23, 31, 35 AND 44).

FIRST USE 3-18-2009; IN COMMERCE 3-18-2009.
SUE LAWRENCE, EXAMINING ATTORNEY

SN 85-532,841. XIANGTAN ELECTRIC MANUFACTURING GROUP CO., LTD., XIANGTAN CITY, HUNAN, CHINA, FILED 2-3-2012.



THE MARK CONSISTS OF A CIRCLE DESIGN AND THERE IS RIVER IN IT.

CLASS 7—MACHINERY

FOR ELECTRICITY GENERATORS; ELEVATORS; ENGINES, OTHER THAN FOR LAND VEHICLES; HYDRAULIC TURBINES; MINE BORERS; MOTORS OTHER THAN FOR LAND VEHICLES; PUMPS FOR MACHINES; WIND-POWERED ELECTRICITY GENERATORS (U.S. CLS. 13, 19, 21, 23, 31, 34 AND 35).

FIRST USE 3-18-2009; IN COMMERCE 3-18-2009.

CLASS 9—ELECTRICAL AND SCIENTIFIC APPARATUS

FOR ELECTRIC CONVERTERS; ELECTRIC INSTALLATIONS FOR THE REMOTE CONTROL OF INDUSTRIAL OPERATIONS; ELECTRIC WIRE AND CABLE; ELECTRONIC CONTROLLER TO MANAGE THE POWER, MOVEMENT AND FUNCTIONS OF AN ELEVATOR; INDUCTION VOLTAGE REGULATORS; PLATES FOR BATTERIES; RECTIFIERS; SILICON CHIPS; SOLAR BATTERIES (U.S. CLS. 21, 23, 26, 36 AND 38).

FIRST USE 3-18-2009; IN COMMERCE 3-18-2009.

CLASS 12—VEHICLES

FOR AERIAL CONVEYORS; AIR-CUSHION VEHICLES; AUTOMOBILE ENGINES; AUTOMOBILES; BUSES; ELECTRIC VEHICLES, NAMELY, ELECTRIC BUSES; LOCOMOTIVES; MOTOR CARS FOR TRANSPORT ON LAND; TROLLEYS; VEHICLE BODIES (U.S. CLS. 19, 21, 23, 31, 35 AND 44).

FIRST USE 3-18-2009; IN COMMERCE 3-18-2009.
SUE LAWRENCE, EXAMINING ATTORNEY

SN 85-532,865. DELO INDUSTRIAL ADHESIVES LLC, SUDBURY, MA. FILED 2-3-2012.

AIRDOT

THE MARK CONSISTS OF STANDARD CHARACTERS WITHOUT CLAIM TO ANY PARTICULAR FONT, STYLE, SIZE, OR COLOR.

CLASS 7—MACHINERY

FOR COMPRESSED AIR MACHINES (U.S. CLS. 13, 19, 21, 23, 31, 34 AND 35).

CLASS 9—ELECTRICAL AND SCIENTIFIC APPARATUS

FOR AUTOMATED VALVES FOR DOSING AND DISPENSING LOW TO HIGH VISCOSITY LIQUIDS TO SURFACES IN INDUSTRIAL APPLICATIONS. MECHANICAL DEVICES, NAMELY, DISPENSERS OF LOW TO HIGH VISCOSITY FLUIDS FOR DOSING PURPOSES IN INDUSTRIAL APPLICATIONS (U.S. CLS. 21, 23, 26, 36 AND 38).

ANDREA BUTLER, EXAMINING ATTORNEY

SN 85-532,876. NPC, INC., CLAYSBURG, PA. FILED 2-3-2012.

ENIVATION

THE MARK CONSISTS OF STANDARD CHARACTERS WITHOUT CLAIM TO ANY PARTICULAR FONT, STYLE, SIZE, OR COLOR.

CLASS 39—TRANSPORTATION AND STORAGE

FOR STORAGE SERVICES FOR ARCHIVING ELECTRONIC DATA (U.S. CLS. 100 AND 105).

FIRST USE 11-3-2011; IN COMMERCE 11-3-2011.

CLASS 42—SCIENTIFIC AND COMPUTER SERVICES

FOR CONVERSION OF DATA OR DOCUMENTS FROM PHYSICAL TO ELECTRONIC MEDIA (U.S. CLS. 100 AND 101).

FIRST USE 11-3-2011; IN COMMERCE 11-3-2011.
SHAVELL MCPHERSON, EXAMINING ATTORNEY

SN 85-532,986. THREE POINT VENTURES, LLC, ROCHESTER, NY. FILED 2-3-2012.

SN 85-533,016. TARPON TAVERN LLC, DBA TARPON TAVERN, TARPON SPRINGS, FL. FILED 2-3-2012.



THE MARK CONSISTS OF THE TERM HOTDOG UNDER A STYLIZED DESIGN OF A DOG STRETCHING ITS FRONT LEGS ON THE GROUND.

CLASS 18—LEATHER GOODS

FOR GENERAL PURPOSE BAGS FOR CARRYING YOGA EQUIPMENT (U.S. CLS. 1, 2, 3, 22 AND 41).

CLASS 28—TOYS AND SPORTING GOODS

FOR STRETCH BANDS USED FOR YOGA AND PHYSICAL FITNESS PURPOSES; YOGA BLANKETS; YOGA BLOCKS; YOGA BOARDS; YOGA BOLSTERS; YOGA CUSHIONS; YOGA MATS; YOGA STRAPS (U.S. CLS. 22, 23, 38 AND 50).

ANTHONY RINKER, EXAMINING ATTORNEY

SN 85-533,012. AUSTIN JR., STANLEY R, TAMPA, FL. FILED 2-3-2012.

SCHIZOCRATEZ

THE MARK CONSISTS OF STANDARD CHARACTERS WITHOUT CLAIM TO ANY PARTICULAR FONT, STYLE, SIZE, OR COLOR.

CLASS 9—ELECTRICAL AND SCIENTIFIC APPARATUS

FOR AUDIO BOOKS IN THE FIELD OF POETRY/PUZZLES; AUDIO BOOKS IN THE NATURE OF NOVELS; DIGITAL BOOK READERS (U.S. CLS. 21, 23, 26, 36 AND 38).

CLASS 16—PAPER GOODS AND PRINTED MATTER

FOR A SERIES OF BOOKS AND WRITTEN ARTICLES IN THE FIELD OF POETRY/PUZZLES; A SERIES OF BOOKS, WRITTEN ARTICLES, HANDOUTS AND WORKSHEETS IN THE FIELD OF POETRY/PUZZLES (U.S. CLS. 2, 5, 22, 23, 29, 37, 38 AND 50).

GENE MACIOL, EXAMINING ATTORNEY

Get Tapped At The Tavern

THE MARK CONSISTS OF STANDARD CHARACTERS WITHOUT CLAIM TO ANY PARTICULAR FONT, STYLE, SIZE, OR COLOR.

CLASS 16—PAPER GOODS AND PRINTED MATTER

FOR COASTERS MADE OF CARDBOARD; COASTERS MADE OF PAPER; COASTERS OF PAPER; FOOD WRAPPERS (U.S. CLS. 2, 5, 22, 23, 29, 37, 38 AND 50).

CLASS 21—HOUSEWARES AND GLASS

FOR COFFEE CUPS, TEA CUPS AND MUGS; SHOT GLASSES; WINE GLASSES (U.S. CLS. 2, 13, 23, 29, 30, 33, 40 AND 50).

CLASS 24—FABRICS

FOR COASTERS OF TEXTILE (U.S. CLS. 42 AND 50).

CLASS 25—CLOTHING

FOR COLLARED SHIRTS; DRESS SHIRTS; GOLF SHIRTS; HATS; KNIT SHIRTS; SWEATSHIRTS; T-SHIRTS (U.S. CLS. 22 AND 39).

CLASS 29—MEATS AND PROCESSED FOODS

FOR DIP MIXES; NUT-BASED SNACK FOODS; SNACK DIPS (U.S. CL. 46).

CLASS 30—STAPLE FOODS

FOR BARBECUE DRY RUB; DRY SPICE RUB FOR MEATS AND FISH; SALSA; SPICE RUBS (U.S. CL. 46).

CLASS 32—LIGHT BEVERAGES

FOR BEER (U.S. CLS. 45, 46 AND 48).

CLASS 39—TRANSPORTATION AND STORAGE

FOR DELIVERY OF FOOD BY RESTAURANTS; FOOD DELIVERY (U.S. CLS. 100 AND 105).

CLASS 43—HOTEL AND RESTAURANT SERVICES

FOR FAST-FOOD RESTAURANT SERVICES; FOOD PREPARATION SERVICES; PROVIDING OF FOOD AND DRINK; PROVIDING OF FOOD AND DRINK VIA A MOBILE TRUCK; SERVING FOOD AND DRINKS; SNACK BAR SERVICES (U.S. CLS. 100 AND 101).

GENE MACIOL, EXAMINING ATTORNEY

SN 85-533,031. KENNEY, YURI L, VALENCIA, CA. FILED 2-3-2012.

Unpaper

THE MARK CONSISTS OF STANDARD CHARACTERS WITHOUT CLAIM TO ANY PARTICULAR FONT, STYLE, SIZE, OR COLOR.

CLASS 21—HOUSEWARES AND GLASS

FOR CLOTH FOR WIPING OR DUSTING; MULTI-PURPOSE WIPING CLOTH FOR USE WITH INFANTS AND TODDLERS; NAPKIN DISPENSERS FOR HOUSEHOLD USE (U.S. CLS. 2, 13, 23, 29, 30, 33, 40 AND 50).

CLASS 24—FABRICS

FOR HAND-TOWELS MADE OF TEXTILE FABRICS; KITCHEN TOWELS (U.S. CLS. 42 AND 50).
LOURDES AYALA, EXAMINING ATTORNEY

SN 85-533,119. EIC EQUIPMENT, INC., PORTLAND, OR. FILED 2-3-2012.



THE MARK CONSISTS OF THE STYLIZED LETTERS "EIC".

CLASS 7—MACHINERY

FOR BEAM TROLLEY FOR ATTACHING HOISTS; ELECTRIC AND PNEUMATIC HOISTS; ELEVATING OR LIFTING WORK PLATFORMS; ELEVATING WORK PLATFORMS; HOISTS; HOISTS THAT ARE MOUNTED ON MILITARY AND LAW ENFORCEMENT VEHICLES FOR RAISING AND LOWERING EQUIPMENT THEREON; LIFTING INSTALLATIONS FOR THE TRANSPORT OF PERSONS AND GOODS; MECHANICAL AND PNEUMATIC HOISTING APPARATUS; MECHANICAL RAILED LIFTING CONVEYORS; METAL PARTS AND FITTINGS FOR POWER-OPERATED LIFTING EQUIPMENT; POWER-OPERATED LIFTING AND MOVING EQUIPMENT, NAMELY, PIPE LAYERS, FORK LIFTS, TELEHANDLERS, AND LIFTS; REPLACEMENT PARTS FOR MACHINES, NAMELY, REPLACEMENT PARTS FOR TRENCH EXCAVATORS, DRAG-LINE EXCAVATORS, HOISTING MACHINES, LOCOMOTIVE CRANES, SHOVELING MACHINES, POWER SHOVELS AND LOG HANDLING MACHINES, NAMELY, CHASSIS PARTS, HYDRAULIC AND PNEUMATIC PARTS; SELF-LUBRICATING MECHANICAL FRICTION PARTS, ESPECIALLY OF COMPOSITE MATERIALS, NAMELY, WEAR RINGS, WASHERS, BUSHINGS, SPHERICAL BEARINGS, BEARING PADS, SLIDING BLOCKS AND MACHINE TRANSMISSION GEARS ALL FOR LOAD BEARING MACHINES, CONVEYORS, HANDLING TRUCKS AND MACHINES, LIFTING MACHINES, AGRICULTURAL MACHINERY, CONSTRUCTION EQUIPMENT MACHINES AND HYDRAULIC TURBINES; STORAGE MACHINERY, NAMELY, A VERTICAL HOIST FOR RAISING AND STORING RECREATIONAL EQUIPMENT, SPORTING GOODS AND HOUSEHOLD ITEMS ELEVATED FROM GROUND LEVEL; TRUCK BED-MOUNTED MATERIAL HANDLING MACHINERY PRIMARILY FOR USE IN THE CONSTRUCTION MATERIALS DELIVERY INDUSTRY, NAMELY, HYDRAULIC EXTENDABLE MATERIAL CONVEYORS, MECHANICAL EXTENDABLE MATERIAL CONVEYORS, AND TRUCK BED MATERIAL LIFTING PLATFORMS (U.S. CLS. 13, 19, 21, 23, 31, 34 AND 35).

CLASS 9—ELECTRICAL AND SCIENTIFIC APPARATUS

FOR LABORATORY ROBOTS; TACTICAL ROBOTS (U.S. CLS. 21, 23, 26, 36 AND 38).
RENEE MCCRAY, EXAMINING ATTORNEY

SN 85-533,224. GOOD MEASURES, LLC, BOSTON, MA. FILED 2-3-2012.

GOOD MEASURES

THE MARK CONSISTS OF STANDARD CHARACTERS WITHOUT CLAIM TO ANY PARTICULAR FONT, STYLE, SIZE, OR COLOR.

CLASS 5—PHARMACEUTICALS

FOR LIQUID VITAMIN SUPPLEMENTS; VITAMIN AND MINERAL SUPPLEMENTS; VITAMIN AND MINERAL PREPARATIONS FOR USE AS INGREDIENTS IN THE FOOD AND PHARMACEUTICAL INDUSTRY; DIETARY AND NUTRITIONAL SUPPLEMENTS; FOOD AND DIETARY BEVERAGE SUPPLEMENTS; NUTRACEUTICALS FOR USE AS A DIETARY SUPPLEMENT; POWDERED NUTRITIONAL SUPPLEMENT DRINK MIX AND CONCENTRATE (U.S. CLS. 6, 18, 44, 46, 51 AND 52).

CLASS 9—ELECTRICAL AND SCIENTIFIC APPARATUS

FOR COMPUTER APPLICATION SOFTWARE FOR MOBILE PLATFORMS, NAMELY, SOFTWARE FOR COLLECTING AND ANALYZING INFORMATION RELATING TO HEALTH, HEALTHY LIVING, WELLNESS, NUTRITION, DIET, AND WEIGHT LOSS (U.S. CLS. 21, 23, 26, 36 AND 38).

CLASS 21—HOUSEWARES AND GLASS

FOR CROCKERY, NAMELY, POTS, DISHES, DRINKING CUPS AND SAUCERS, BOWLS, SERVING BOWLS AND TRAYS; BEVERAGE GLASSWARE; FOOD AND BEVERAGE CONTAINERS, NAMELY, HOUSEHOLD CONTAINERS FOR FOODS (U.S. CLS. 2, 13, 23, 29, 30, 33, 40 AND 50).

CLASS 43—HOTEL AND RESTAURANT SERVICES

FOR PROVIDING A DATABASE IN THE FIELD OF RECIPES AND COOKING INFORMATION (U.S. CLS. 100 AND 101).

CLASS 44—MEDICAL, BEAUTY AND AGRICULTURAL SERVICES

FOR HEALTH CARE SERVICES, NAMELY, WELLNESS AND DISEASE MANAGEMENT PROGRAMS; INTERNET-BASED HEALTH CARE INFORMATION SERVICES; WEB-BASED HEALTH ASSESSMENT SERVICES, NAMELY, A SERIES OF HEALTH-RELATED QUESTIONS FOR RESPONSE FROM THE USER THAT RESULT IN A REPORT THAT PROVIDES HEALTH-RELATED INFORMATION IN THE FORM OF RECOMMENDED EDUCATIONAL RESOURCES AND TREATMENT INFORMATION; PROVIDING INFORMATION ABOUT DIETARY SUPPLEMENTS (U.S. CLS. 100 AND 101).

TEJBIR SINGH, EXAMINING ATTORNEY

CLASS 5—PHARMACEUTICALS

FOR LIQUID VITAMIN SUPPLEMENTS; VITAMIN AND MINERAL SUPPLEMENTS; VITAMIN AND MINERAL PREPARATIONS FOR USE AS INGREDIENTS IN THE FOOD AND PHARMACEUTICAL INDUSTRY; DIETARY AND NUTRITIONAL SUPPLEMENTS; FOOD AND DIETARY BEVERAGE SUPPLEMENTS; NUTRACEUTICALS FOR USE AS A DIETARY SUPPLEMENT; POWDERED NUTRITIONAL SUPPLEMENT DRINK MIX AND CONCENTRATE (U.S. CLS. 6, 18, 44, 46, 51 AND 52).

CLASS 9—ELECTRICAL AND SCIENTIFIC APPARATUS

FOR COMPUTER APPLICATION SOFTWARE FOR MOBILE PLATFORMS, NAMELY, SOFTWARE FOR COLLECTING AND ANALYZING INFORMATION RELATING TO HEALTH, HEALTHY LIVING, WELLNESS, NUTRITION, DIET, AND WEIGHT LOSS (U.S. CLS. 21, 23, 26, 36 AND 38).

CLASS 21—HOUSEWARES AND GLASS

FOR CROCKERY, NAMELY, POTS, DISHES, DRINKING CUPS AND SAUCERS, BOWLS, SERVING BOWLS AND TRAYS; BEVERAGE GLASSWARE; FOOD AND BEVERAGE CONTAINERS, NAMELY, HOUSEHOLD CONTAINERS FOR FOODS (U.S. CLS. 2, 13, 23, 29, 30, 33, 40 AND 50).

CLASS 43—HOTEL AND RESTAURANT SERVICES

FOR PROVIDING A DATABASE IN THE FIELD OF RECIPES AND COOKING INFORMATION (U.S. CLS. 100 AND 101).

CLASS 44—MEDICAL, BEAUTY AND AGRICULTURAL SERVICES

FOR HEALTH CARE SERVICES, NAMELY, WELLNESS AND DISEASE MANAGEMENT PROGRAMS; INTERNET-BASED HEALTH CARE INFORMATION SERVICES; WEB-BASED HEALTH ASSESSMENT SERVICES, NAMELY, A SERIES OF HEALTH-RELATED QUESTIONS FOR RESPONSE FROM THE USER THAT RESULT IN A REPORT THAT PROVIDES HEALTH-RELATED INFORMATION IN THE FORM OF RECOMMENDED EDUCATIONAL RESOURCES AND TREATMENT INFORMATION; PROVIDING INFORMATION ABOUT DIETARY SUPPLEMENTS (U.S. CLS. 100 AND 101).

TEJBIR SINGH, EXAMINING ATTORNEY

SN 85-533,232. GOOD MEASURES, LLC, BOSTON, MA. FILED 2-3-2012.



THE MARK CONSISTS OF TWO STACKED BOWLS DESIGN.

SN 85-533,266. NOVARTIS AG, BASEL, SWITZERLAND, FILED 2-3-2012.

FOR US - IT'S PERSONAL

THE MARK CONSISTS OF STANDARD CHARACTERS WITHOUT CLAIM TO ANY PARTICULAR FONT, STYLE, SIZE, OR COLOR.

CLASS 5—PHARMACEUTICALS

FOR ANTI-INFLAMMATORIES; ANTIBACTERIAL PHARMACEUTICALS; ANTIBIOTICS; ANTIFUNGAL PREPARATIONS; ANTIVIRALS; CARDIOVASCULAR PHARMACEUTICALS; PHARMACEUTICAL PREPARATIONS ACTING ON THE CENTRAL NERVOUS SYSTEM; PHARMACEUTICAL PREPARATIONS AND SUBSTANCES FOR THE TREATMENT OF GASTRO-INTESTINAL DISEASES; PHARMACEUTICAL PREPARATIONS FOR THE TREATMENT AND PREVENTION OF DISEASES AND DISORDERS OF THE AUTOIMMUNE SYSTEM, THE METABOLIC SYSTEM, THE MUSCULOSKELETAL SYSTEM AND THE GENITOURINARY SYSTEM; PHARMACEUTICAL PREPARATIONS FOR USE IN HEMATOLOGY AND IN TISSUE AND ORGAN TRANSPLANTATION; PHARMACEUTICAL PREPARATIONS FOR THE TREATMENT OF EYE DISEASES AND CONDITIONS; PHARMACEUTICAL PREPARATIONS FOR THE TREATMENT OF HEART RHYTHM DISORDERS; PHARMACEUTICAL PREPARATIONS FOR THE TREATMENT OF IMMUNE SYSTEM RELATED DISEASES AND DISORDERS; PHARMACEUTICAL PREPARATIONS FOR THE TREATMENT OF KIDNEY DISEASES; PHARMACEUTICAL PREPARATIONS FOR TREATING DIABETES; PHARMACEUTICAL PREPARATIONS FOR USE IN DERMATOLOGY; PHARMACEUTICAL PRODUCTS FOR OPHTHALMOLOGICAL USE; PHARMACEUTICAL PRODUCTS FOR THE PREVENTION AND TREATMENT OF CANCER; PHARMACEUTICAL PRODUCTS FOR THE TREATMENT OF BONE DISEASES; PHARMACEUTICAL PRODUCTS FOR TREATING RESPIRATORY DISEASES; PHARMACEUTICAL PRODUCTS FOR TREATING RESPIRATORY DISEASES AND ASTHMA; PHARMACEUTICALS, NAMELY, ANTI-INFECTIVES (U.S. CLS. 6, 18, 44, 46, 51 AND 52).

CLASS 35—ADVERTISING AND BUSINESS

FOR ADVERTISING, MARKETING AND PROMOTION SERVICES IN THE FIELD OF HEALTHCARE; BUSINESS MANAGEMENT CONSULTING AND ADVISORY SERVICES FOR THE HEALTHCARE INDUSTRY; BUSINESS MANAGEMENT SERVICES, NAMELY, ADMINISTRATION OF BUSINESS ENGAGED IN THE HEALTHCARE SECTOR; CONSUMER MARKETING RESEARCH AND CONSULTING RELATED THERETO (U.S. CLS. 100, 101 AND 102).

CLASS 41—EDUCATION AND ENTERTAINMENT

FOR EDUCATIONAL SERVICES, NAMELY, CONDUCTING PROGRAMS IN THE FIELD OF HEALTHCARE; EDUCATIONAL SERVICES, NAMELY, CONDUCTING CLASSES, SEMINARS AND WORKSHOPS IN THE FIELD OF HEALTHCARE (U.S. CLS. 100, 101 AND 107).

CLASS 42—SCIENTIFIC AND COMPUTER SERVICES

FOR PROVIDING MEDICAL AND SCIENTIFIC RESEARCH INFORMATION IN THE FIELD OF PHARMACEUTICALS AND CLINICAL TRIALS; RESEARCH AND DEVELOPMENT IN THE FIELD OF MEDICINE AND PHARMACEUTICALS (U.S. CLS. 100 AND 101).

CLASS 44—MEDICAL, BEAUTY AND AGRICULTURAL SERVICES

FOR MEDICAL SERVICES; PROVIDING HEALTHCARE INFORMATION; PROVIDING MEDICAL INFORMATION (U.S. CLS. 100 AND 101).
GEORGE LORENZO, EXAMINING ATTORNEY

SN 85-533,308. TURTLE MOUNTAIN, LLC, EUGENE, OR.
FILED 2-3-2012.

ALMOND+PLUS

THE MARK CONSISTS OF STANDARD CHARACTERS WITHOUT CLAIM TO ANY PARTICULAR FONT, STYLE, SIZE, OR COLOR.

CLASS 29—MEATS AND PROCESSED FOODS

FOR NUT-BASED MILK; PROCESSED ALMONDS; PROCESSED NUTS (U.S. CL. 46).
FIRST USE 1-2-2012; IN COMMERCE 1-2-2012.

CLASS 32—LIGHT BEVERAGES

FOR MILK OF ALMONDS FOR BEVERAGE (U.S. CLS. 45, 46 AND 48).
FIRST USE 1-2-2012; IN COMMERCE 1-2-2012.
GIANCARLO CASTRO, EXAMINING ATTORNEY

SN 85-533,336. TURTLE MOUNTAIN, LLC, EUGENE, OR.
FILED 2-3-2012.

SO DELICIOUS ALMOND+PLUS

THE MARK CONSISTS OF STANDARD CHARACTERS WITHOUT CLAIM TO ANY PARTICULAR FONT, STYLE, SIZE, OR COLOR.

OWNER OF U.S. REG. NOS. 3,197,705, 3,867,331 AND OTHERS.

CLASS 29—MEATS AND PROCESSED FOODS

FOR NUT-BASED MILK; PROCESSED ALMONDS; PROCESSED NUTS (U.S. CL. 46).
FIRST USE 1-2-2012; IN COMMERCE 1-2-2012.

CLASS 32—LIGHT BEVERAGES

FOR MILK OF ALMONDS FOR BEVERAGE (U.S. CLS. 45, 46 AND 48).
FIRST USE 1-2-2012; IN COMMERCE 1-2-2012.
GIANCARLO CASTRO, EXAMINING ATTORNEY

SN 85-533,340. NOVARTIS AG, BASEL, SWITZERLAND,
FILED 2-3-2012.

ACCURACE

THE MARK CONSISTS OF STANDARD CHARACTERS WITHOUT CLAIM TO ANY PARTICULAR FONT, STYLE, SIZE, OR COLOR.

CLASS 9—ELECTRICAL AND SCIENTIFIC APPARATUS

FOR COMPUTER SOFTWARE FOR CONTROLLING AND MANAGING PATIENT MEDICAL INFORMATION (U.S. CLS. 21, 23, 26, 36 AND 38).

CLASS 44—MEDICAL, BEAUTY AND AGRICULTURAL SERVICES

FOR INTERNET-BASED HEALTH CARE INFORMATION SERVICES; PROVIDING HEALTH INFORMATION (U.S. CLS. 100 AND 101).

RONALD MCMORROW, EXAMINING ATTORNEY

SN 85-533,416. LIOZU, STEPHAN M., MOON TOWNSHIP, PA. FILED 2-3-2012.

**PRICING CONFIDENCE
REVOLUTION**

THE MARK CONSISTS OF STANDARD CHARACTERS WITHOUT CLAIM TO ANY PARTICULAR FONT, STYLE, SIZE, OR COLOR.

NO CLAIM IS MADE TO THE EXCLUSIVE RIGHT TO USE "PRICING", APART FROM THE MARK AS SHOWN.

CLASS 35—ADVERTISING AND BUSINESS

FOR BUSINESS STRATEGY DEVELOPMENT SERVICES; CONSULTANCY AND ADVISORY SERVICES IN THE FIELD OF BUSINESS STRATEGY; MARKETING CONSULTING (U.S. CLS. 100, 101 AND 102).

CLASS 41—EDUCATION AND ENTERTAINMENT

FOR EDUCATIONAL SERVICES, NAMELY, CONDUCTING SEMINARS, WORKSHOPS AND CONFERENCES IN THE FIELD OF BUSINESS MANAGEMENT (U.S. CLS. 100, 101 AND 107).

ANTHONY RINKER, EXAMINING ATTORNEY

SN 85-533,426. MADEWELL INC., NEW YORK, NY. FILED 2-3-2012.

MADEWELL

THE MARK CONSISTS OF STANDARD CHARACTERS WITHOUT CLAIM TO ANY PARTICULAR FONT, STYLE, SIZE, OR COLOR.

OWNER OF U.S. REG. NOS. 968,685, 3,957,991 AND OTHERS.

CLASS 9—ELECTRICAL AND SCIENTIFIC APPARATUS

FOR MAGNETIC CODED GIFT CARDS (U.S. CLS. 21, 23, 26, 36 AND 38).

FIRST USE 8-0-2006; IN COMMERCE 8-0-2006.

CLASS 35—ADVERTISING AND BUSINESS

FOR ISSUING GIFT CERTIFICATES WHICH MAY THEN BE REDEEMED FOR GOODS OR SERVICES (U.S. CLS. 100, 101 AND 102).

FIRST USE 8-0-2006; IN COMMERCE 8-0-2006.

JENNIFER VASQUEZ, EXAMINING ATTORNEY

SN 85-533,427. DUTCH VALLEY FOOD DISTRIBUTORS INC., MYERSTOWN, PA. FILED 2-3-2012.

Dutch Value

THE MARK CONSISTS OF STANDARD CHARACTERS WITHOUT CLAIM TO ANY PARTICULAR FONT, STYLE, SIZE, OR COLOR.

OWNER OF U.S. REG. NOS. 2,993,861 AND 3,844,549.

CLASS 29—MEATS AND PROCESSED FOODS

FOR PROCESSED COCONUT (U.S. CL. 46).

FIRST USE 1-3-2011; IN COMMERCE 1-3-2011.

CLASS 30—STAPLE FOODS

FOR CAPPUCCINO; CHAI TEA; HOT CHOCOLATE (U.S. CL. 46).

FIRST USE 1-3-2011; IN COMMERCE 1-3-2011.

ELLEN PERKINS, EXAMINING ATTORNEY

SN 85-533,439. HULU, LLC, LOS ANGELES, CA. FILED 2-3-2012.

**AN EVIL(ER) PLOT TO
DESTROY THE WORLD. ENJOY.**

THE MARK CONSISTS OF STANDARD CHARACTERS WITHOUT CLAIM TO ANY PARTICULAR FONT, STYLE, SIZE, OR COLOR.

CLASS 38—COMMUNICATION

FOR BROADCASTING AND STREAMING OF AUDIO-VISUAL MEDIA CONTENT IN THE FIELDS OF NEWS, ENTERTAINMENT, SPORTS, COMEDY, DRAMA, MUSIC, AND MUSIC VIDEOS VIA A GLOBAL COMPUTER NETWORK; VIDEO-ON-DEMAND TRANSMISSION SERVICES (U.S. CLS. 100, 101 AND 104).

CLASS 41—EDUCATION AND ENTERTAINMENT

FOR EDUCATION AND ENTERTAINMENT SERVICES, NAMELY, ONLINE SERVICES PROVIDING AUDIO-VISUAL CONTENT IN THE FIELDS OF CURRENT EVENT REPORTING, ENTERTAINMENT, SPORTS, COMEDY, DRAMA, MUSIC, AND MUSIC VIDEOS; PROVIDING ONLINE INFORMATION VIA A GLOBAL COMPUTER NETWORK ON THE SUBJECTS OF MOTION PICTURES, TELEVISION PROGRAMMING, VIDEOS, MUSIC VIDEOS, AND MUSIC; PROVIDING A WEBSITE FEATURING AUDIO-VISUAL CONTENT, SPECIFICALLY, MOTION PICTURES, TELEVISION PROGRAMMING, VIDEOS, MUSIC VIDEOS, AND MUSIC, AND VIDEO CLIPS, AUDIO CLIPS, MUSIC CLIPS, FILM CLIPS, AND PHOTOGRAPHS, IN THE FIELDS OF CURRENT EVENT REPORTING, ENTERTAINMENT, SPORTS, COMEDY, DRAMA, MUSIC, AND MUSIC VIDEOS (U.S. CLS. 100, 101 AND 107).

JILL C. ALT, EXAMINING ATTORNEY

SN 85-533,441. C&C CREATIVE, LLC, UPPER MARLSBORO, MD. FILED 2-3-2012.

TRUE FORM

THE MARK CONSISTS OF STANDARD CHARACTERS WITHOUT CLAIM TO ANY PARTICULAR FONT, STYLE, SIZE, OR COLOR.

CLASS 25—CLOTHING

FOR HOODED SWEAT SHIRTS; JEANS; JERSEYS; SHIRTS; SHOES; SHORTS; SWEAT PANTS; SWEATSHIRTS; T-SHIRTS (U.S. CLS. 22 AND 39).

CLASS 28—TOYS AND SPORTING GOODS

FOR EXERCISE EQUIPMENT, NAMELY, RESISTANCE BANDS (U.S. CLS. 22, 23, 38 AND 50).

CURTIS FRENCH, EXAMINING ATTORNEY

SN 85-533,457. C&C CREATIVE, LLC, UPPER MARLSBORO, MD. FILED 2-3-2012.



THE MARK CONSISTS OF THE STYLIZED IMAGE OF A CROWN.

CLASS 25—CLOTHING

FOR HOODED SWEATSHIRTS; JEANS; JERSEYS; SHIRTS; SHOES; SHORTS; SWEAT PANTS; SWEATSHIRTS; T-SHIRTS (U.S. CLS. 22 AND 39).

CLASS 28—TOYS AND SPORTING GOODS

FOR EXERCISE EQUIPMENT, NAMELY, RESISTANCE BANDS (U.S. CLS. 22, 23, 38 AND 50).

CURTIS FRENCH, EXAMINING ATTORNEY

SN 85-533,562. SPHERE MARKETING, LLC, WATERFORD, MI. FILED 2-3-2012.

IDEA NOMAD

THE MARK CONSISTS OF STANDARD CHARACTERS WITHOUT CLAIM TO ANY PARTICULAR FONT, STYLE, SIZE, OR COLOR.

CLASS 9—ELECTRICAL AND SCIENTIFIC APPARATUS

FOR DOWNLOADABLE ELECTRONIC NEWSLETTERS IN THE FIELD OF TRENDS IN ARCHITECTURE, INTERIOR DESIGN AND BUILDING CONSTRUCTION (U.S. CLS. 21, 23, 26, 36 AND 38).

CLASS 16—PAPER GOODS AND PRINTED MATTER

FOR NEWSLETTERS IN THE FIELD OF TRENDS IN ARCHITECTURE, INTERIOR DESIGN AND BUILDING CONSTRUCTION (U.S. CLS. 2, 5, 22, 23, 29, 37, 38 AND 50).

CLASS 35—ADVERTISING AND BUSINESS

FOR BUSINESS CONSULTING AND RESEARCH SERVICES IN THE FIELD OF TRENDS IN ARCHITECTURE, INTERIOR DESIGN AND BUILDING CONSTRUCTION; MARKETING AND ADVERTISING CONSULTING SERVICES IN THE FIELD OF TRENDS IN ARCHITECTURE, INTERIOR DESIGN AND BUILDING CONSTRUCTION (U.S. CLS. 100, 101 AND 102).

NAKWAMA ANKRAH, EXAMINING ATTORNEY

SN 85-533,586. REGENEDYNE, LLC, SIERRA VISTA, AZ. FILED 2-3-2012.

REGENEDYNE

THE MARK CONSISTS OF STANDARD CHARACTERS WITHOUT CLAIM TO ANY PARTICULAR FONT, STYLE, SIZE, OR COLOR.

CLASS 7—MACHINERY

FOR POWER GENERATORS, NAMELY, WIND ENERGY TURBINES (U.S. CLS. 13, 19, 21, 23, 31, 34 AND 35).

CLASS 40—MATERIAL TREATMENT

FOR TECHNICAL CONSULTATION FOR OTHERS WITH REGARD TO POWER GENERATION, NAMELY, PRODUCING WIND ENERGY (U.S. CLS. 100, 103 AND 106).

SN 85-533,661. WIDEPop, LLC, BIRMINGHAM, AL. FILED 2-3-2012.

CLASS 42—SCIENTIFIC AND COMPUTER SERVICES

FOR RESEARCH, DEVELOPMENT, AND ENGINEERING SERVICES FOR OTHERS WITH REGARD TO POWER GENERATION, NAMELY, PRODUCING WIND ENERGY (U.S. CLS. 100 AND 101).

EUGENIA MARTIN, EXAMINING ATTORNEY

WIDEPop

THE MARK CONSISTS OF STANDARD CHARACTERS WITHOUT CLAIM TO ANY PARTICULAR FONT, STYLE, SIZE, OR COLOR.

CLASS 35—ADVERTISING AND BUSINESS

FOR ADVERTISING AND MARKETING; PROMOTING THE GOODS OF OTHERS, NAMELY, PROVIDING INFORMATION REGARDING DISCOUNTS, COUPONS, REBATES, VOUCHERS AND SPECIAL OFFERS FOR THE GOODS OF OTHERS (U.S. CLS. 100, 101 AND 102).

SN 85-533,599. NFL PROPERTIES LLC, NEW YORK, NY. FILED 2-3-2012.

CLASS 41—EDUCATION AND ENTERTAINMENT

FOR ENTERTAINMENT SERVICES, NAMELY, PROVIDING GAMES OF CHANCE VIA THE INTERNET (U.S. CLS. 100, 101 AND 107).

LESLIE RICHARDS, EXAMINING ATTORNEY

FOREVER FORWARD FOREVER
FOOTBALL

SN 85-533,757. AMBERTECH TECHNOLOGIES, LLC, PARIS, TX. FILED 2-3-2012.

THE MARK CONSISTS OF STANDARD CHARACTERS WITHOUT CLAIM TO ANY PARTICULAR FONT, STYLE, SIZE, OR COLOR.

AMBERTECH

CLASS 25—CLOTHING

FOR TOPS, BOTTOMS, JACKETS, SHIRTS, HEADWEAR, FOOTWEAR (U.S. CLS. 22 AND 39).

THE MARK CONSISTS OF STANDARD CHARACTERS WITHOUT CLAIM TO ANY PARTICULAR FONT, STYLE, SIZE, OR COLOR.

CLASS 41—EDUCATION AND ENTERTAINMENT

FOR EDUCATION AND ENTERTAINMENT SERVICES IN THE NATURE OF PROFESSIONAL FOOTBALL GAMES AND EXHIBITIONS; PROVIDING SPORTS AND ENTERTAINMENT INFORMATION VIA A GLOBAL COMPUTER NETWORK OR A COMMERCIAL ON-LINE COMPUTER SERVICE OR BY CABLE, SATELLITE, TELEVISION AND RADIO; ARRANGING AND CONDUCTING ATHLETIC COMPETITIONS, NAMELY, PROFESSIONAL FOOTBALL GAMES AND EXHIBITIONS; FOOTBALL FAN CLUB SERVICES; ENTERTAINMENT SERVICES, NAMELY, MUSICAL AND DANCE PERFORMANCES PROVIDED DURING INTERVALS AT SPORTS EVENTS; EDUCATIONAL SERVICES, NAMELY, PHYSICAL EDUCATION PROGRAMS; PRODUCTION OF RADIO AND TELEVISION PROGRAMS; LIVE SHOWS FEATURING FOOTBALL GAMES, EXHIBITIONS, COMPETITIONS, MUSIC AND DANCE PERFORMANCES, FESTIVALS, SPORTING AND CULTURAL ACTIVITIES AND EVENTS FOR FANS OF A PROFESSIONAL FOOTBALL TEAM (U.S. CLS. 100, 101 AND 107).

HOWARD SMIGA, EXAMINING ATTORNEY

CLASS 1—CHEMICALS

FOR CHEMICAL ADDITIVES FOR ENHANCING THE PERFORMANCE OF LUBRICATING OILS, GREASES AND INTERNAL COMBUSTION ENGINE FUELS; CHEMICAL ADDITIVES FOR OIL WELL DRILLING FLUID; CHEMICAL ADDITIVES FOR OILS (U.S. CLS. 1, 5, 6, 10, 26 AND 46).

CLASS 4—LUBRICANTS AND FUELS

FOR AUTOMOTIVE LUBRICANTS; DRILLING LUBRICANTS; GEAR OILS; GUN BARREL OIL; INDUSTRIAL LUBRICANTS; LUBRICANTS FOR USE ON HOUSEHOLD ITEMS; LUBRICATING OILS AND GREASES; NON-CHEMICAL ADDITIVES FOR FUELS, LUBRICANTS AND GREASES; NON-MINERAL OILS AND GREASES FOR INDUSTRIAL PURPOSES; PENETRATING OIL (U.S. CLS. 1, 6 AND 15).

JENNIFER WILLISTON, EXAMINING ATTORNEY

SN 85-533,781. RANIA INVESTMENTS AND HOLDINGS LTD, TORONTO, ONTARIO, CANADA, FILED 2-3-2012.

CHERISTÉ

THE MARK CONSISTS OF STANDARD CHARACTERS WITHOUT CLAIM TO ANY PARTICULAR FONT, STYLE, SIZE, OR COLOR.

THE WORDING CHERISTÉ HAS NO MEANING IN A FOREIGN LANGUAGE.

CLASS 14—JEWELRY

FOR JEWELRY; WATCHES (U.S. CLS. 2, 27, 28 AND 50).

CLASS 35—ADVERTISING AND BUSINESS

FOR ON-LINE RETAIL STORE SERVICES FEATURING JEWELRY AND WATCHES (U.S. CLS. 100, 101 AND 102).

LUCY ARANT, EXAMINING ATTORNEY

SN 85-533,782. ADVANCED PAYMENT PRODUCTS, LYNCHBURG, VA. FILED 2-3-2012.

Just Push Pay

THE MARK CONSISTS OF STANDARD CHARACTERS WITHOUT CLAIM TO ANY PARTICULAR FONT, STYLE, SIZE, OR COLOR.

CLASS 9—ELECTRICAL AND SCIENTIFIC APPARATUS

FOR COMPUTER APPLICATION SOFTWARE FOR MOBILE PHONES, NAMELY, SOFTWARE FOR USE IN PAYMENT TRANSACTION PROCESSING (U.S. CLS. 21, 23, 26, 36 AND 38).

CLASS 36—INSURANCE AND FINANCIAL

FOR MERCHANT SERVICES, NAMELY, PAYMENT TRANSACTION PROCESSING SERVICES (U.S. CLS. 100, 101 AND 102).

PATRICIA EVANKO, EXAMINING ATTORNEY

SN 85-533,803. RANIA INVESTMENTS AND HOLDINGS LTD, TORONTO, ONTARIO, CANADA, FILED 2-3-2012.

TRESARA

THE MARK CONSISTS OF STANDARD CHARACTERS WITHOUT CLAIM TO ANY PARTICULAR FONT, STYLE, SIZE, OR COLOR.

THE WORDING TRESARA HAS NO MEANING IN A FOREIGN LANGUAGE.

CLASS 14—JEWELRY

FOR WATCHES AND JEWELRY (U.S. CLS. 2, 27, 28 AND 50).

CLASS 35—ADVERTISING AND BUSINESS

FOR ON-LINE RETAIL STORE SERVICES FEATURING WATCHES AND JEWELRY (U.S. CLS. 100, 101 AND 102).

LUCY ARANT, EXAMINING ATTORNEY

SN 85-533,808. SIMPLY HAIRFREE IP, LLC, MINNEAPOLIS, MN. FILED 2-3-2012.

SIMPLY HAIRFREE

THE MARK CONSISTS OF STANDARD CHARACTERS WITHOUT CLAIM TO ANY PARTICULAR FONT, STYLE, SIZE, OR COLOR.

CLASS 35—ADVERTISING AND BUSINESS

FOR ADVICE IN THE RUNNING OF ESTABLISHMENTS AS FRANCHISES; ASSISTANCE IN BUSINESS MANAGEMENT AND PRODUCT COMMERCIALIZATION, WITHIN THE FRAMEWORK OF A FRANCHISE CONTRACT; ASSISTANCE IN FRANCHISED COMMERCIAL BUSINESS MANAGEMENT; BUSINESS MANAGEMENT ADVISORY SERVICES RELATING TO FRANCHISING; FRANCHISE SERVICES, NAMELY, OFFERING BUSINESS MANAGEMENT ASSISTANCE IN THE ESTABLISHMENT AND OPERATION OF BEAUTY SALONS AND HEALTH SPAS; FRANCHISING, NAMELY, CONSULTATION AND ASSISTANCE IN BUSINESS MANAGEMENT, ORGANIZATION AND PROMOTION (U.S. CLS. 100, 101 AND 102).

CLASS 44—MEDICAL, BEAUTY AND AGRICULTURAL SERVICES

FOR DEPILATORY HAIR REMOVAL SERVICES; HEALTH SPA SERVICES FOR HEALTH AND WELLNESS OF THE BODY AND SPIRIT, NAMELY, PROVIDING MASSAGE, FACIAL AND BODY TREATMENT SERVICES, COSMETIC BODY CARE SERVICES; MASSAGE THERAPY SERVICES (U.S. CLS. 100 AND 101).

JESSICA FATHY, EXAMINING ATTORNEY

SN 85-533,884. AMERICAN FUSION INC., DBA CA OFF-PRICE INC, MONTEBELLO, CA 90640, CA. FILED 2-3-2012.

DUTCH & HARLEY

THE MARK CONSISTS OF STANDARD CHARACTERS WITHOUT CLAIM TO ANY PARTICULAR FONT, STYLE, SIZE, OR COLOR.

CLASS 25—CLOTHING

FOR APPAREL FOR DANCERS, NAMELY, TEE SHIRTS, SWEATSHIRTS, PANTS, LEGGINGS, SHORTS AND JACKETS (U.S. CLS. 22 AND 39).

CLASS 42—SCIENTIFIC AND COMPUTER SERVICES

FOR CUSTOM DESIGN OF T' SHIRTS BASED ON PERSONAL SELECTIONS MADE BY THE CUSTOMER (U.S. CLS. 100 AND 101).

PATRICIA EVANKO, EXAMINING ATTORNEY

SN 85-533,900. JASON SOBEL, CALABASAS, CA. FILED 2-3-2012.



THE MARK CONSISTS OF ARTISTIC DESIGN OF A LIGHTED MATCH ABOVE THE WORD FUSION.

CLASS 41—EDUCATION AND ENTERTAINMENT

FOR PROVIDING ON-LINE RELIGIOUS INSTRUCTION PROMOTING CHRISTIAN AND FAMILY VALUES (U.S. CLS. 100, 101 AND 107).

FIRST USE 10-0-2011; IN COMMERCE 10-0-2011.

CLASS 45—PERSONAL AND LEGAL SERVICES

FOR CONDUCTING RELIGIOUS PRAYER SERVICES; RELIGIOUS AND SPIRITUAL SERVICES, NAMELY, CONDUCTING RELIGIOUS WORSHIP, MARRIAGE CEREMONIES, BAPTISMAL CEREMONIES, BABY DEDICATIONS, BEREAVEMENT CEREMONIES, AND RELIGIOUS COUNSELING (U.S. CLS. 100 AND 101).

FIRST USE 10-0-2011; IN COMMERCE 10-0-2011.

THEODORE MCBRIDE, EXAMINING ATTORNEY

SN 85-533,937. KOOL BRANDS, LLC., RENO, NV. FILED 2-3-2012.

GO RETRO!

THE MARK CONSISTS OF STANDARD CHARACTERS WITHOUT CLAIM TO ANY PARTICULAR FONT, STYLE, SIZE, OR COLOR.

CLASS 9—ELECTRICAL AND SCIENTIFIC APPARATUS

FOR BATTERY CHARGERS; CARRYING CASES FOR CELL PHONES; CARRYING CASES FOR MOBILE COMPUTERS; CARRYING CASES, HOLDERS, PROTECTIVE CASES AND STANDS FEATURING POWER SUPPLY CONNECTORS, ADAPTORS, SPEAKERS AND BATTERY CHARGING DEVICES, SPECIALLY ADAPTED FOR USE WITH HANDHELD DIGITAL ELECTRONIC DEVICES; CELL PHONE BATTERY CHARGERS; CELL PHONE BATTERY CHARGERS FOR USE IN VEHICLES; CHARGERS FOR BATTERIES; COMPUTER CARRYING CASES; CONNECTION CABLES; EARPHONE ACCESSORIES, NAMELY, EARPHONE CUSHIONS, EARPHONE PADS, CORD MANAGEMENT SYSTEMS, EARPHONE CASES, AND EARPHONE EXTENSION CORDS; NOTEBOOK COMPUTER CARRYING CASES; PROTECTIVE CARRYING CASES FOR PORTABLE MUSIC PLAYERS, NAMELY, MP3 PLAYERS; PROTECTIVE CARRYING CASES SPECIALLY ADAPTED FOR PERSONAL DIGITAL ASSISTANTS (PDA); PROTECTIVE COVERS AND CASES FOR CELL PHONES, LAPTOPS AND PORTABLE MEDIA PLAYERS (U.S. CLS. 21, 23, 26, 36 AND 38).

CLASS 28—TOYS AND SPORTING GOODS

FOR AMUSEMENT APPARATUS ADAPTED FOR USE WITH AN EXTERNAL DISPLAY SCREEN OR MONITOR; AMUSEMENT APPARATUS INCORPORATING A TELEVISION MONITOR; AMUSEMENT APPARATUS INCORPORATING A TELEVISION SCREEN; AMUSEMENT APPARATUS INCORPORATING A VIDEO MONITOR; AMUSEMENT GAME MACHINES; AMUSEMENT MACHINES, NAMELY, HAND-HELD ELECTRONIC GAME UNITS ADAPTED FOR USE WITH AN EXTERNAL DISPLAY SCREEN OR MONITOR; APPARATUS FOR ELECTRONIC GAMES OTHER THAN THOSE ADAPTED FOR USE WITH AN EXTERNAL DISPLAY SCREEN OR MONITOR; AUDIO AND VISUAL HEADSETS FOR USE IN PLAYING VIDEO GAMES; COMPUTER GAME CONSOLES FOR USE WITH AN EXTERNAL DISPLAY SCREEN OR MONITOR; COMPUTER GAME JOYSTICKS; FACE PLATES FOR VIDEO GAME CONSOLES FOR USE WITH EXTERNAL MONITORS; FITTED COVERS SPECIALLY ADAPTED TO PROTECT VIDEO GAME CONSOLES FOR USE WITH AN EXTERNAL DISPLAY SCREEN OR MONITOR; GAME CONTROLLERS FOR COMPUTER GAMES; GAMING HEADSETS ADAPTED FOR USE IN PLAYING VIDEO GAMES; HAND HELD JOY STICK UNITS FOR PLAYING VIDEO GAMES; HAND HELD UNITS FOR PLAYING ELECTRONIC GAMES OTHER THAN THOSE ADAPTED FOR USE WITH AN EXTERNAL DISPLAY SCREEN OR MONITOR; HAND HELD UNITS FOR PLAYING VIDEO GAMES OTHER THAN THOSE ADAPTED FOR USE WITH AN EXTERNAL DISPLAY SCREEN OR MONITOR; HAND-HELD ELECTRONIC GAMES ADAPTED FOR USE WITH TELEVISION RECEIVERS ONLY; HAND-HELD GAMES WITH LIQUID CRYSTAL DISPLAYS; HAND-HELD UNITS FOR PLAYING ELECTRONIC GAMES FOR USE WITH EXTERNAL DISPLAY SCREEN OR MONITOR; PLAYER-OPERATED ELECTRONIC CONTROLLERS FOR ELECTRONIC VIDEO GAME MACHINES; PROTECTIVE CARRYING CASES SPECIALLY ADAPTED FOR HANDHELD VIDEO GAMES; PROTECTIVE CARRYING CASES SPECIALLY ADAPTED FOR VIDEO GAME CONSOLES FOR USE WITH AN EXTERNAL DISPLAY SCREEN OR MONITOR; VIDEO GAME CONSOLES FOR USE WITH AN EXTERNAL DISPLAY SCREEN OR MONITOR; VIDEO GAME INTERACTIVE CONTROL FLOOR PADS OR MATS; VIDEO GAME INTERACTIVE HAND HELD REMOTE CONTROLS FOR PLAYING ELECTRONIC GAMES; VIDEO GAME INTERACTIVE REMOTE CONTROL UNITS; VIDEO GAME JOYSTICKS; VIDEO GAME MACHINES FOR USE WITH EXTERNAL DISPLAY SCREEN OR MONITOR; VIDEO GAME MACHINES FOR USE WITH TELEVISIONS; VIDEO OUTPUT GAME MACHINES FOR USE WITH EXTERNAL DISPLAY SCREEN OR MONITOR; VIDEO OUTPUT GAME MACHINES FOR USE WITH TELEVISIONS; VIRTUAL REALITY HEADSETS AND HELMETS ADAPTED FOR USE IN PLAYING VIDEO GAMES (U.S. CLS. 22, 23, 38 AND 50).

Laurie Mayes, Examining Attorney

SN 85-533,994. AZULAY, NAOMI, DBA NAOMI AZULAY PT, NEW YORK, NY. FILED 2-4-2012.

SN 85-534,341. IN VIN VERITAS PRODUCTIONS, LLC, ARROYO GRANDE, CA. FILED 2-6-2012.

BEFORE THE FALL

THE MARK CONSISTS OF STANDARD CHARACTERS WITHOUT CLAIM TO ANY PARTICULAR FONT, STYLE, SIZE, OR COLOR.

CLASS 41—EDUCATION AND ENTERTAINMENT

FOR PHYSICAL FITNESS TRAINING OF INDIVIDUALS AND GROUPS (U.S. CLS. 100, 101 AND 107).
FIRST USE 1-2-2011; IN COMMERCE 1-2-2011.

CLASS 44—MEDICAL, BEAUTY AND AGRICULTURAL SERVICES

FOR PHYSICAL THERAPY EVALUATION AND TREATMENT OF PROBLEMS WITH BALANCE (U.S. CLS. 100 AND 101).
FIRST USE 10-20-2010; IN COMMERCE 10-20-2010.
KATINA MISTER, EXAMINING ATTORNEY

SN 85-534,084. BRIAN WELCH, BRENTWOOD, TN. FILED 2-4-2012.

Love and Death

THE MARK CONSISTS OF STANDARD CHARACTERS WITHOUT CLAIM TO ANY PARTICULAR FONT, STYLE, SIZE, OR COLOR.

CLASS 9—ELECTRICAL AND SCIENTIFIC APPARATUS

FOR PRE-RECORDED COMPACT DISCS FEATURING MUSICAL ENTERTAINMENT; DIGITAL MEDIA, NAMELY DOWNLOADABLE AUDIO FILES FEATURING MUSICAL ENTERTAINMENT; VIDEO RECORDINGS FEATURING MUSICAL ENTERTAINMENT (U.S. CLS. 21, 23, 26, 36 AND 38).

CLASS 41—EDUCATION AND ENTERTAINMENT

FOR ENTERTAINMENT SERVICES, NAMELY, LIVE MUSICAL PERFORMANCES (U.S. CLS. 100, 101 AND 107).
ADA HAN, EXAMINING ATTORNEY

In Vina Veritas

THE MARK CONSISTS OF STANDARD CHARACTERS WITHOUT CLAIM TO ANY PARTICULAR FONT, STYLE, SIZE, OR COLOR.

CLASS 35—ADVERTISING AND BUSINESS

FOR PRODUCTION OF FILM AND TELEVISION ADVERTISING (U.S. CLS. 100, 101 AND 102).

CLASS 41—EDUCATION AND ENTERTAINMENT

FOR ENTERTAINMENT MEDIA PRODUCTION SERVICES FOR MOTION PICTURES, TELEVISION AND INTERNET; FILM AND VIDEO FILM PRODUCTION; FILM AND VIDEO PRODUCTION; MOTION PICTURE FILM PRODUCTION; PRODUCTION AND DISTRIBUTION OF INDEPENDENT MOTION PICTURES (U.S. CLS. 100, 101 AND 107).
ANDREW LEASER, EXAMINING ATTORNEY

SN 85-534,365. BRISTOL-MYERS SQUIBB COMPANY, NEW YORK, NY. FILED 2-6-2012.



NO CLAIM IS MADE TO THE EXCLUSIVE RIGHT TO USE "NETWORK" AND "BELATACEPT", APART FROM THE MARK AS SHOWN.

THE MARK CONSISTS OF CIRCLES AND THE WORDS "MY NULOJIX NETWORK" WITH THE WORDING BELATACEPT IN PARENTHESES NEXT TO "NULOJIX".

THE WORDING "NULOJIX" HAS NO MEANING IN A FOREIGN LANGUAGE.

CLASS 35—ADVERTISING AND BUSINESS

FOR ADMINISTRATION OF PATIENT REIMBURSEMENT PROGRAM (U.S. CLS. 100, 101 AND 102).

CLASS 44—MEDICAL, BEAUTY AND AGRICULTURAL SERVICES

FOR PHARMACEUTICAL ADVICE; CHARITABLE SERVICES, NAMELY, PATIENT ASSISTANCE PROGRAM TO PROVIDE DRUGS AT A REDUCED COST TO LOW-INCOME PATIENTS WITHOUT PRESCRIPTION DRUG COVERAGE OR HEALTH INSURANCE COVERAGE (U.S. CLS. 100 AND 101).

CLASS 45—PERSONAL AND LEGAL SERVICES

FOR PROVIDING PERSONAL SUPPORT SERVICES FOR PATIENTS AND FAMILIES OF KIDNEY TRANSPLANTS (U.S. CLS. 100 AND 101).
ZACHARY BELLO, EXAMINING ATTORNEY

SN 85-534,436. SKINNY NUTRITIONAL CORPORATION, BALA CYNWYD, PA. FILED 2-6-2012.

SKINNY

THE MARK CONSISTS OF STANDARD CHARACTERS WITHOUT CLAIM TO ANY PARTICULAR FONT, STYLE, SIZE, OR COLOR.

CLASS 32—LIGHT BEVERAGES

FOR FLAVORED ENHANCED WATER (U.S. CLS. 45, 46 AND 48).

CLASS 33—WINES AND SPIRITS

FOR ALCOHOLIC MIXED BEVERAGES EXCEPT BEERS (U.S. CLS. 47 AND 49).
KIMBERLY PERRY, EXAMINING ATTORNEY

INSANE BODY

THE MARK CONSISTS OF STANDARD CHARACTERS WITHOUT CLAIM TO ANY PARTICULAR FONT, STYLE, SIZE, OR COLOR.

CLASS 25—CLOTHING

FOR HATS; PANTS; SHIRTS; SHORTS; TANK TOPS (U.S. CLS. 22 AND 39).

CLASS 28—TOYS AND SPORTING GOODS

FOR EXERCISE EQUIPMENT, NAMELY, RUBBER GRIPS (U.S. CLS. 22, 23, 38 AND 50).
JOHN WILKE, EXAMINING ATTORNEY

SN 85-534,495. K. PAGE LLC, MOUNT KISCO, NY. FILED 2-6-2012.

Katharine Page

THE MARK CONSISTS OF STANDARD CHARACTERS WITHOUT CLAIM TO ANY PARTICULAR FONT, STYLE, SIZE, OR COLOR.

THE NAME "KATHARINE PAGE" IDENTIFIES A LIVING INDIVIDUAL WHOSE CONSENT IS OF RECORD.

SN 85-534,413. BUFFALO STUDIOS, LLC, SANTA MONICA, CA. FILED 2-6-2012.

BLITZWORLD

THE MARK CONSISTS OF STANDARD CHARACTERS WITHOUT CLAIM TO ANY PARTICULAR FONT, STYLE, SIZE, OR COLOR.

CLASS 9—ELECTRICAL AND SCIENTIFIC APPARATUS

FOR DOWNLOADABLE COMPUTER GAME SOFTWARE FOR USE ON WIRELESS DEVICES AND COMPUTERS (U.S. CLS. 21, 23, 26, 36 AND 38).

CLASS 41—EDUCATION AND ENTERTAINMENT

FOR ENTERTAINMENT SERVICES, NAMELY, PROVIDING ONLINE ELECTRONIC GAMES (U.S. CLS. 100, 101 AND 107).
BILL DAWE, EXAMINING ATTORNEY

CLASS 14—JEWELRY

FOR JEWELRY (U.S. CLS. 2, 27, 28 AND 50).

CLASS 18—LEATHER GOODS

FOR BACKPACKS; BRIEFCASE-TYPE PORTFOLIOS; CARRY-ALL BAGS; HANDBAGS; LUGGAGE; WALLETS (U.S. CLS. 1, 2, 3, 22 AND 41).

CLASS 25—CLOTHING

FOR BELTS; SHOES (U.S. CLS. 22 AND 39).
SUNG IN, EXAMINING ATTORNEY

SN 85-534,500. GREAT LAKES SERVICES, LLC, MADISON, WI. FILED 2-6-2012.

SPIRIT ISLAND

THE MARK CONSISTS OF STANDARD CHARACTERS WITHOUT CLAIM TO ANY PARTICULAR FONT, STYLE, SIZE, OR COLOR.

CLASS 41—EDUCATION AND ENTERTAINMENT

FOR ENTERTAINMENT SERVICES IN THE NATURE OF A WATER PARK (U.S. CLS. 100, 101 AND 107).
FIRST USE 5-0-1997; IN COMMERCE 5-0-1997.

CLASS 43—HOTEL AND RESTAURANT SERVICES

FOR RESORT HOTEL SERVICES; RESTAURANT SERVICES (U.S. CLS. 100 AND 101).
FIRST USE 3-0-2003; IN COMMERCE 3-0-2003.
KAREN K. BUSH, EXAMINING ATTORNEY

SN 85-534,510. VERACITY PAYMENT SOLUTIONS, INC.,
ATLANTA, GA. FILED 2-6-2012.

Ring-it-Up

THE MARK CONSISTS OF STANDARD CHARACTERS WITHOUT CLAIM TO ANY PARTICULAR FONT, STYLE, SIZE, OR COLOR.

CLASS 36—INSURANCE AND FINANCIAL

FOR MERCHANT SERVICES, NAMELY, PAYMENT TRANSACTION PROCESSING SERVICES; PAYMENT PROCESSING SERVICES, NAMELY, CREDIT CARD AND DEBIT CARD TRANSACTION PROCESSING SERVICES; PROVIDING ELECTRONIC PROCESSING OF ELECTRONIC FUNDS TRANSFER, ACH, CREDIT CARD, DEBIT CARD, ELECTRONIC CHECK AND ELECTRONIC PAYMENTS (U.S. CLS. 100, 101 AND 102).

CLASS 38—COMMUNICATION

FOR COMMUNICATION SERVICES, NAMELY, PROVIDING ELECTRONIC TRANSMISSION OF INFORMATION STORED IN A DATABASE VIA INTERACTIVELY COMMUNICATING COMPUTER SYSTEMS; ELECTRONIC DATA TRANSMISSION; ELECTRONIC EXCHANGE OF DATA STORED IN DATABASES ACCESSIBLE VIA TELECOMMUNICATION NETWORKS; PROVIDING ELECTRONIC TELECOMMUNICATION CONNECTIONS; TRANSMISSION OF DATABASE INFORMATION VIA TELECOMMUNICATIONS NETWORKS (U.S. CLS. 100, 101 AND 104).

COLLEEN MULCRONE, EXAMINING ATTORNEY

SN 85-534,642. SWOOP.COM, INC., CAMBRIDGE, MA.
FILED 2-6-2012.



THE COLOR(S) GRAY AND ORANGE IS/ARE CLAIMED AS A FEATURE OF THE MARK.

THE MARK CONSISTS OF THE STYLIZED WORDS "SWOOP THERE IT IS.", WITH THE LETTERS S, W, AND P IN "SWOOP" IN GRAY, THE TWO LETTERS O IN "SWOOP" IN ORANGE, AND THE WORDS AND PUNCTUATION "THERE IT IS." IN GRAY.

CLASS 35—ADVERTISING AND BUSINESS

FOR ADVERTISING SERVICES; ADVERTISING, MARKETING AND PROMOTION SERVICES; INTERNET ADVERTISING SERVICES; ADVERTISING ON THE INTERNET FOR OTHERS; DESIGN OF INTERNET ADVERTISING; DISSEMINATION OF ADVERTISING FOR OTHERS VIA THE INTERNET; PROMOTING THE GOODS AND SERVICES OF OTHER BY PROVIDING AN INTERACTIVE MEANS FOR CONSUMERS TO ACCESS INFORMATION, PROMOTIONS, DISCOUNTS, REBATES, SPECIAL OFFERS, AND COUPONS, ON AND FOR THE GOODS AND SERVICES OF OTHERS (U.S. CLS. 100, 101 AND 102).

CLASS 42—SCIENTIFIC AND COMPUTER SERVICES

FOR DEVELOPMENT, MANAGEMENT, AND MAINTENANCE OF NON-DOWNLOADABLE SOFTWARE FOR ON-LINE ADVERTISING, MARKETING AND PROMOTION SERVICES (U.S. CLS. 100 AND 101).
JESSICA FATHY, EXAMINING ATTORNEY

SN 85-534,648. SEASONED DEVELOPMENT, LLC, DENVER,
CO. FILED 2-6-2012.

PUNCH BOWL SOCIAL

THE MARK CONSISTS OF STANDARD CHARACTERS WITHOUT CLAIM TO ANY PARTICULAR FONT, STYLE, SIZE, OR COLOR.

CLASS 41—EDUCATION AND ENTERTAINMENT

FOR BOWLING ALLEYS (U.S. CLS. 100, 101 AND 107).

CLASS 43—HOTEL AND RESTAURANT SERVICES

FOR BAR SERVICES; CATERING SERVICES; RESTAURANT SERVICES (U.S. CLS. 100 AND 101).
JOHN WILKE, EXAMINING ATTORNEY

SN 85-534,664. FILM ROW, L.L.C., KANSAS CITY, MO.
FILED 2-6-2012.

SCREENLAND

THE MARK CONSISTS OF STANDARD CHARACTERS WITHOUT CLAIM TO ANY PARTICULAR FONT, STYLE, SIZE, OR COLOR.

OWNER OF U.S. REG. NO. 3,013,134.

CLASS 25—CLOTHING

FOR CAPS; HATS; SWEAT PANTS; SWEAT SHIRTS; T-SHIRTS (U.S. CLS. 22 AND 39).
FIRST USE 4-16-2010; IN COMMERCE 4-16-2010.

CLASS 30—STAPLE FOODS

FOR CANDY; COOKIES; NACHOS; POPCORN (U.S. CL. 46).
FIRST USE 4-10-2010; IN COMMERCE 4-10-2010.
TAMARA FRAZIER, EXAMINING ATTORNEY

SN 85-534,681. ONCUE MARKETING, LLC, STILLWATER, OK. FILED 2-6-2012.

ONCUE

THE MARK CONSISTS OF STANDARD CHARACTERS WITHOUT CLAIM TO ANY PARTICULAR FONT, STYLE, SIZE, OR COLOR.

OWNER OF U.S. REG. NOS. 3,303,698, 3,341,500 AND 3,482,313.

CLASS 4—LUBRICANTS AND FUELS

FOR COMPRESSED NATURAL GAS (U.S. CLS. 1, 6 AND 15).

CLASS 35—ADVERTISING AND BUSINESS

FOR RETAIL STORE SERVICES FEATURING CONVENIENCE STORE ITEMS AND GASOLINE (U.S. CLS. 100, 101 AND 102).

CLASS 36—INSURANCE AND FINANCIAL

FOR WHOLESALE DISTRIBUTORSHIPS FEATURING GASOLINE (U.S. CLS. 100, 101 AND 102).

CLASS 39—TRANSPORTATION AND STORAGE

FOR TRANSPORTATION OF FUELS (U.S. CLS. 100 AND 105).
HOWARD B. LEVINE, EXAMINING ATTORNEY

SN 85-534,714. MARTINES, SUUZ T, CHARLOTTE, NC. FILED 2-6-2012.

CoCo Cheznaynay

THE MARK CONSISTS OF STANDARD CHARACTERS WITHOUT CLAIM TO ANY PARTICULAR FONT, STYLE, SIZE, OR COLOR.

THE NAME "COCO CHEZNAYNAY" DOES NOT IDENTIFY A LIVING INDIVIDUAL.

THE WORDING "COCO CHEZNAYNAY" HAS NO MEANING IN A FOREIGN LANGUAGE.

CLASS 16—PAPER GOODS AND PRINTED MATTER

FOR NOTEPADS, GREETING CARDS, FICTIONAL INSPIRATIONAL BOOKS (U.S. CLS. 2, 5, 22, 23, 29, 37, 38 AND 50).

FIRST USE 7-31-1999; IN COMMERCE 7-31-1999.

CLASS 25—CLOTHING

FOR SHIRTS, HATS, SKIRTS, PANTS (U.S. CLS. 22 AND 39).
FIRST USE 7-31-1999; IN COMMERCE 7-31-1999.
JEFFREY LOOK, EXAMINING ATTORNEY

SN 85-534,749. JOIE DE VIVRE HOSPITALITY, INC., SAN FRANCISCO, CA. FILED 2-6-2012.

JDV

THE MARK CONSISTS OF STANDARD CHARACTERS WITHOUT CLAIM TO ANY PARTICULAR FONT, STYLE, SIZE, OR COLOR.

CLASS 35—ADVERTISING AND BUSINESS

FOR MANAGEMENT OF HOTELS, RESORTS, RESTAURANTS, AND SPAS FOR OTHERS; ARRANGING AND COORDINATING BUSINESS MEETINGS FOR OTHERS IN BANQUET ROOMS; AND CUSTOMER LOYALTY SERVICES, NAMELY, A REWARDS PROGRAM FEATURING GIFT INCENTIVES FOR COMMERCIAL, PROMOTIONAL, AND ADVERTISING PURPOSES FOR HOTEL, RESTAURANT AND SPA SERVICES (U.S. CLS. 100, 101 AND 102).

CLASS 39—TRANSPORTATION AND STORAGE

FOR COORDINATING TRAVEL ARRANGEMENTS FOR INDIVIDUALS AND GROUPS, NAMELY, DESTINATIONS STAYS, HONEYMOONS, FAMILY VACATIONS, AND DESTINATION WEDDINGS; ARRANGING TRAVEL TOURS; COORDINATING TRAVEL ARRANGEMENTS FOR INDIVIDUALS AND FOR GROUPS; MAKING TRAVEL AND EXCURSION ARRANGEMENTS FOR BANDS AND ORCHESTRAS; ORGANIZATION OF TRAVEL; ORGANIZATION OF EXCURSIONS, SIGHTSEEING TOURS, HOLIDAYS, TOURS AND TRAVEL; ORGANIZATION OF TRAVEL AND BOAT TRIPS; PROVIDING A WEB SITE FEATURING TRAVEL INFORMATION AND COMMENTARY; PROVIDING A WEBSITE FEATURING INFORMATION ON TRAVEL; PROVIDING LINKS TO WEB SITES OF OTHERS FEATURING TRAVEL; TRAVEL AND TOUR INFORMATION SERVICE; TRAVEL PLANNING FOR INDIVIDUALS, FAMILIES, AND GROUPS FOR SPECIAL OCCASIONS SUCH AS DESTINATION WEDDINGS AND HONEYMOONS; TRAVEL, EXCURSION AND CRUISE ARRANGEMENT (U.S. CLS. 100 AND 105).

CLASS 43—HOTEL AND RESTAURANT SERVICES

FOR RESERVATIONS OF HOTEL ROOMS FOR TRAVELERS; ARRANGING TRAVEL PACKAGES IN THE NATURE OF HOTEL ACCOMMODATIONS, SPA RESERVATIONS, RESTAURANT VOUCHERS, AND SIGHTSEEING TOURS SOLD TOGETHER AS A PACKAGE (U.S. CLS. 100 AND 101).

HEATHER THOMPSON, EXAMINING ATTORNEY

SN 85-534,756. CYBERWAYS AND WATERWAYS, AUSTIN, TX. FILED 2-6-2012.

HEALTHIVORES

THE MARK CONSISTS OF STANDARD CHARACTERS WITHOUT CLAIM TO ANY PARTICULAR FONT, STYLE, SIZE, OR COLOR.

CLASS 36—INSURANCE AND FINANCIAL

FOR CHARITABLE FUND RAISING SERVICES INVOLVING THE SALE OF NUTRITIOUS SNACKS AND OTHER FOOD PRODUCTS (U.S. CLS. 100, 101 AND 102).

CLASS 41—EDUCATION AND ENTERTAINMENT

FOR EDUCATION AND ENTERTAINMENT SERVICES, NAMELY, PROVIDING ON-LINE COMPUTER EDUCATIONAL GAMES BY MEANS OF THE INTERNET; TEACHING IN THE FIELD OF LIFESTYLE CHOICE AND WELLNESS THROUGH SEMINARS AND WORKSHOPS; DEVELOPING CURRICULUM AND LESSON PLANS FOR OTHERS IN THE FIELD OF LIFESTYLE CHOICE AND WELLNESS (U.S. CLS. 100, 101 AND 107).

TINA MAI, EXAMINING ATTORNEY

SN 85-534,811. KOOL BRANDS, LLC., RENO, NV. FILED 2-6-2012.

PROTECTO SHIELD

THE MARK CONSISTS OF STANDARD CHARACTERS WITHOUT CLAIM TO ANY PARTICULAR FONT, STYLE, SIZE, OR COLOR.

CLASS 9—ELECTRICAL AND SCIENTIFIC APPARATUS

FOR CARRYING CASES FOR CELL PHONES; CARRYING CASES FOR ELECTRONIC EQUIPMENT, NAMELY, PORTABLE MUSIC PLAYERS, MOBILE PHONES, GLOBAL POSITIONING SYSTEMS, PERSONAL DIGITAL ASSISTANTS, COMPUTERS, TABLET COMPUTERS, ELECTRONIC BOOK READERS AND CAMERAS; CARRYING CASES FOR MOBILE COMPUTERS; CARRYING CASES SPECIALLY ADAPTED FOR POCKET CALCULATORS AND CELLPHONES; CARRYING CASES, HOLDERS, PROTECTIVE CASES AND STANDS FEATURING POWER SUPPLY CONNECTORS, ADAPTORS, SPEAKERS AND BATTERY CHARGING DEVICES, SPECIALLY ADAPTED FOR USE WITH HANDHELD DIGITAL ELECTRONIC DEVICES; CASES FOR MOBILE PHONES; CELL PHONE CASES; CELL PHONE COVERS; CLEAR PROTECTIVE COVERS SPECIALLY ADAPTED FOR PERSONAL ELECTRONIC DEVICES; COMPUTER CARRYING CASES; EARPHONE ACCESSORIES, NAMELY, EARPHONE CUSHIONS, EARPHONE PADS, CORD MANAGEMENT SYSTEMS, EARPHONE CASES, AND EARPHONE EXTENSION CORDS; ELECTRONIC BOOK READER COVERS; FITTED PLASTIC FILMS KNOWN AS SKINS FOR COVERING AND PROTECTING ELECTRONIC APPARATUS, NAMELY, PORTABLE MUSIC PLAYERS, MOBILE PHONES, GLOBAL POSITIONING SYSTEMS, PERSONAL DIGITAL ASSISTANTS, COMPUTERS, TABLET COMPUTERS, ELECTRONIC BOOK READERS AND CAMERAS; FITTED PLASTIC FILMS KNOWN AS SKINS FOR COVERING AND PROVIDING A SCRATCH PROOF BARRIER OR PROTECTION FOR ELECTRONIC DEVICES, NAMELY, MP3 PLAYERS, MOBILE TELEPHONES, SMART TELEPHONES, DIGITAL CAMERAS, GLOBAL POSITIONING SYSTEMS AND PERSONAL DIGITAL ASSISTANTS; LAPTOP CARRYING CASES; NOTEBOOK COMPUTER CARRYING CASES; PROTECTIVE CARRYING CASES FOR PORTABLE MUSIC PLAYERS, NAMELY, MP3 PLAYERS; PROTECTIVE CARRYING CASES SPECIALLY ADAPTED FOR GLOBAL POSITIONING SYSTEM (GPS) APPARATUS; PROTECTIVE CARRYING CASES SPECIALLY ADAPTED FOR PERSONAL DIGITAL ASSISTANTS (PDA); PROTECTIVE COVERS AND CASES FOR CELL PHONES, LAPTOPS AND PORTABLE MEDIA PLAYERS; PROTECTIVE COVERS FOR ELECTRONIC READING DEVICES; VIDEO GRAPHICS CONTROLLER (U.S. CLS. 21, 23, 26, 36 AND 38).

CLASS 28—TOYS AND SPORTING GOODS

FOR AMUSEMENT APPARATUS INCORPORATING A VIDEO MONITOR; AMUSEMENT GAME MACHINES; AMUSEMENT MACHINES, NAMELY, HAND-HELD ELECTRONIC GAME UNITS ADAPTED FOR USE WITH AN EXTERNAL DISPLAY SCREEN OR MONITOR; APPARATUS FOR ELECTRONIC GAMES OTHER THAN THOSE ADAPTED FOR USE WITH AN EXTERNAL DISPLAY SCREEN OR MONITOR; AUDIO AND VISUAL HEADSETS FOR USE IN PLAYING VIDEO GAMES; COMPUTER GAME CONSOLES FOR USE WITH AN EXTERNAL DISPLAY SCREEN OR MONITOR; COMPUTER GAME JOYSTICKS; ELECTRONIC GAMES OTHER THAN THOSE ADAPTED FOR USE WITH TELEVISION RECEIVERS ONLY; ELECTRONIC INTERACTIVE BOARD GAMES FOR USE WITH EXTERNAL MONITOR; EXERCISE MACHINES INCORPORATING ELECTRONIC AND VIDEO GAME CONTROLLERS; FACE PLATES FOR VIDEO GAME CONSOLES FOR USE WITH EXTERNAL MONITORS; FITTED COVERS SPECIALLY ADAPTED TO PROTECT VIDEO GAME CONSOLES FOR USE WITH AN EXTERNAL DISPLAY SCREEN OR MONITOR; GAME CONTROLLERS FOR COMPUTER GAMES; GAMING HEADSETS ADAPTED FOR USE IN PLAYING VIDEO GAMES; GUITAR SKINS FOR ELECTRONIC GUITAR GAME CONTROLLERS; HAND HELD JOY STICK UNITS FOR PLAYING VIDEO GAMES; HAND HELD UNITS FOR PLAYING ELECTRONIC GAMES OTHER THAN THOSE ADAPTED FOR USE WITH AN EXTERNAL DISPLAY SCREEN OR MONITOR; HAND HELD UNITS FOR PLAYING VIDEO GAMES OTHER THAN THOSE ADAPTED FOR USE WITH AN EXTERNAL DISPLAY SCREEN OR MONITOR; HAND-HELD ELECTRONIC GAMES ADAPTED FOR USE WITH TELEVISION RECEIVERS ONLY; HAND-HELD GAMES WITH LIQUID CRYSTAL DIS-

PLAYS; HAND-HELD UNITS FOR PLAYING ELECTRONIC GAMES FOR USE WITH EXTERNAL DISPLAY SCREEN OR MONITOR; JOYSTICKS FOR VIDEO GAMES; LCD GAME MACHINES; PLAYER-OPERATED ELECTRONIC CONTROLLERS FOR ELECTRONIC VIDEO GAME MACHINES; PROTECTIVE CARRYING CASES SPECIALLY ADAPTED FOR HANDHELD VIDEO GAMES; PROTECTIVE CARRYING CASES SPECIALLY ADAPTED FOR VIDEO GAME CONSOLES FOR USE WITH AN EXTERNAL DISPLAY SCREEN OR MONITOR; STAND ALONE VIDEO GAME MACHINES; STAND ALONE VIDEO OUTPUT GAME MACHINES; VIDEO GAME CONSOLES FOR USE WITH AN EXTERNAL DISPLAY SCREEN OR MONITOR; VIDEO GAME INTERACTIVE CONTROL FLOOR PADS OR MATS; VIDEO GAME INTERACTIVE HAND HELD REMOTE CONTROLS FOR PLAYING ELECTRONIC GAMES; VIDEO GAME INTERACTIVE REMOTE CONTROL UNITS; VIDEO GAME JOYSTICKS; VIDEO GAME MACHINES FOR USE WITH EXTERNAL DISPLAY SCREEN OR MONITOR; VIDEO GAME MACHINES FOR USE WITH TELEVISIONS; VIDEO OUTPUT GAME MACHINES FOR USE WITH EXTERNAL DISPLAY SCREEN OR MONITOR; VIDEO OUTPUT GAME MACHINES FOR USE WITH TELEVISIONS; VIRTUAL REALITY HEADSETS AND HELMETS ADAPTED FOR USE IN PLAYING VIDEO GAMES (U.S. CLS. 22, 23, 38 AND 50).
 LAURIE MAYES, EXAMINING ATTORNEY

CLASS 9—ELECTRICAL AND SCIENTIFIC APPARATUS

FOR CARRYING CASES FOR ELECTRONIC EQUIPMENT, NAMELY, PORTABLE MUSIC PLAYERS, MOBILE PHONES, GLOBAL POSITIONING SYSTEMS, PERSONAL DIGITAL ASSISTANTS, COMPUTERS, PORTABLE COMPUTERS, TABLET COMPUTERS, ELECTRONIC BOOK READERS AND CAMERAS; CARRYING CASES FOR MOBILE COMPUTERS; CARRYING CASES SPECIALLY ADAPTED FOR POCKET CALCULATORS AND CELLPHONES; CARRYING CASES, HOLDERS, PROTECTIVE CASES AND STANDS FEATURING POWER SUPPLY CONNECTORS, ADAPTORS, SPEAKERS AND BATTERY CHARGING DEVICES, SPECIALLY ADAPTED FOR USE WITH HANDHELD DIGITAL ELECTRONIC DEVICES; CASES FOR MOBILE PHONES; CELL PHONE COVERS; CLEAR PROTECTIVE COVERS SPECIALLY ADAPTED FOR PERSONAL ELECTRONIC DEVICES; COMPUTER CARRYING CASES; EARPHONE ACCESSORIES, NAMELY, EARPHONE CUSHIONS, EARPHONE PADS, CORD MANAGEMENT SYSTEMS, EARPHONE CASES, AND EARPHONE EXTENSION CORDS; ELECTRONIC BOOK READER COVERS; FITTED PLASTIC FILMS KNOWN AS SKINS FOR COVERING AND PROTECTING ELECTRONIC APPARATUS, NAMELY, PORTABLE MUSIC PLAYERS, MOBILE PHONES, GLOBAL POSITIONING SYSTEMS, PERSONAL DIGITAL ASSISTANTS, COMPUTERS, PORTABLE COMPUTERS, TABLET COMPUTERS, ELECTRONIC BOOK READERS AND CAMERAS; FITTED PLASTIC FILMS KNOWN AS SKINS FOR COVERING AND PROVIDING A SCRATCH PROOF BARRIER OR PROTECTION FOR ELECTRONIC DEVICES, NAMELY, MP3 PLAYERS, MOBILE TELEPHONES, SMART TELEPHONES, DIGITAL CAMERAS, GLOBAL POSITIONING SYSTEMS AND PERSONAL DIGITAL ASSISTANTS; LAPTOP CARRYING CASES; NOTEBOOK COMPUTER CARRYING CASES; PROTECTIVE CARRYING CASES FOR PORTABLE MUSIC PLAYERS, NAMELY, MP3 PLAYERS; PROTECTIVE CARRYING CASES SPECIALLY ADAPTED FOR GLOBAL POSITIONING SYSTEM (GPS) APPARATUS; PROTECTIVE CARRYING CASES SPECIALLY ADAPTED FOR PERSONAL DIGITAL ASSISTANTS (PDA); PROTECTIVE COVERS AND CASES FOR CELL PHONES, LAPTOPS AND PORTABLE MEDIA PLAYERS; PROTECTIVE COVERS FOR ELECTRONIC READING DEVICES (U.S. CLS. 21, 23, 26, 36 AND 38).

SN 85-534,910. KOOL BRANDS, LLC., RENO, NV. FILED 2-6-2012.

CLASS 28—TOYS AND SPORTING GOODS

FOR AMUSEMENT APPARATUS INCORPORATING A VIDEO MONITOR; AMUSEMENT GAME MACHINES; AMUSEMENT MACHINES, NAMELY, HAND-HELD ELECTRONIC GAME UNITS ADAPTED FOR USE WITH AN EXTERNAL DISPLAY SCREEN OR MONITOR; APPARATUS FOR ELECTRONIC GAMES OTHER THAN THOSE ADAPTED FOR USE WITH AN EXTERNAL DISPLAY SCREEN OR MONITOR; AUDIO AND VISUAL HEADSETS FOR USE IN PLAYING VIDEO GAMES; COMPUTER GAME CONSOLES FOR USE WITH AN EXTERNAL DISPLAY SCREEN OR MONITOR; COMPUTER GAME JOYSTICKS; ELECTRONIC GAMING MACHINES, NAMELY, DEVICES WHICH ACCEPT A WAGER; ELECTRONIC INTERACTIVE BOARD GAMES FOR USE WITH EXTERNAL MONITOR; FACE PLATES FOR VIDEO GAME CONSOLES FOR USE WITH EXTERNAL MONITORS; FITTED COVERS SPECIALLY ADAPTED TO PROTECT VIDEO GAME CONSOLES FOR USE WITH AN EXTERNAL DISPLAY SCREEN OR MONITOR; GAME CONTROLLERS FOR COMPUTER GAMES; GAMING HEADSETS ADAPTED FOR USE IN PLAYING VIDEO GAMES; GUITAR SKINS FOR ELECTRONIC GUITAR GAME CONTROLLERS; HAND HELD JOY STICK UNITS FOR PLAYING VIDEO GAMES; HAND HELD UNITS FOR PLAYING ELECTRONIC GAMES OTHER THAN THOSE ADAPTED FOR USE WITH AN EXTERNAL DISPLAY SCREEN OR MONITOR; HAND HELD UNITS FOR PLAYING VIDEO GAMES OTHER THAN THOSE ADAPTED FOR USE WITH AN EXTERNAL DISPLAY SCREEN OR MONITOR; HAND-HELD ELECTRONIC GAMES ADAPTED FOR USE WITH TELEVISION RECEIVERS ONLY; HAND-HELD GAMES WITH LIQUID CRYSTAL DISPLAYS; HAND-HELD UNITS FOR PLAYING ELECTRONIC GAMES FOR USE WITH EXTERNAL DISPLAY SCREEN OR MONITOR; JOYSTICKS FOR VIDEO

LITE ARMOR

THE MARK CONSISTS OF STANDARD CHARACTERS WITHOUT CLAIM TO ANY PARTICULAR FONT, STYLE, SIZE, OR COLOR.

GAMES; LCD GAME MACHINES; PLAYER-OPERATED ELECTRONIC CONTROLLERS FOR ELECTRONIC VIDEO GAME MACHINES; PROTECTIVE CARRYING CASES SPECIALLY ADAPTED FOR HANDHELD VIDEO GAMES; PROTECTIVE CARRYING CASES SPECIALLY ADAPTED FOR VIDEO GAME CONSOLES FOR USE WITH AN EXTERNAL DISPLAY SCREEN OR MONITOR; STAND ALONE VIDEO GAME MACHINES; STAND ALONE VIDEO OUTPUT GAME MACHINES; VIDEO GAME CONSOLES FOR USE WITH AN EXTERNAL DISPLAY SCREEN OR MONITOR; VIDEO GAME INTERACTIVE CONTROL FLOOR PADS OR MATS; VIDEO GAME INTERACTIVE HAND HELD REMOTE CONTROLS FOR PLAYING ELECTRONIC GAMES; VIDEO GAME INTERACTIVE REMOTE CONTROL UNITS; VIDEO GAME JOYSTICKS; VIDEO GAME MACHINES FOR USE WITH EXTERNAL DISPLAY SCREEN OR MONITOR; VIDEO GAME MACHINES FOR USE WITH TELEVISIONS; VIDEO OUTPUT GAME MACHINES FOR USE WITH EXTERNAL DISPLAY SCREEN OR MONITOR; VIDEO OUTPUT GAME MACHINES FOR USE WITH TELEVISIONS; VIRTUAL REALITY HEADSETS AND HELMETS ADAPTED FOR USE IN PLAYING VIDEO GAMES (U.S. CLS. 22, 23, 38 AND 50).
LAURIE MAYES, EXAMINING ATTORNEY

SN 85-534,947. CSTOWN USA, HENDERSON, NV. FILED 2-6-2012.

CSTOWN

THE MARK CONSISTS OF STANDARD CHARACTERS WITHOUT CLAIM TO ANY PARTICULAR FONT, STYLE, SIZE, OR COLOR.

CLASS 16—PAPER GOODS AND PRINTED MATTER

FOR DECALS; STICKERS AND TRANSFERS; IRON-ON TRANSFERS (U.S. CLS. 2, 5, 22, 23, 29, 37, 38 AND 50).

FIRST USE 3-0-2011; IN COMMERCE 3-0-2011.

CLASS 25—CLOTHING

FOR DRESSES (U.S. CLS. 22 AND 39).
FIRST USE 3-0-2011; IN COMMERCE 3-0-2011.
KAREN K. BUSH, EXAMINING ATTORNEY

SN 85-534,959. KANER, JERRY, CHATSWORTH, CA. FILED 2-6-2012.

CIPHERTEX

THE MARK CONSISTS OF STANDARD CHARACTERS WITHOUT CLAIM TO ANY PARTICULAR FONT, STYLE, SIZE, OR COLOR.

OWNER OF U.S. REG. NO. 3,973,322.

CLASS 9—ELECTRICAL AND SCIENTIFIC APPARATUS

FOR COMPUTER DISC DRIVES; COMPUTER HARDWARE; COMPUTER SOFTWARE AND HARDWARE FOR CAPTURING, STORING, DISTRIBUTING, PROTECTING, TRANSFERRING, AND ACCESSING DATA; ELECTRONIC COMPONENTS FOR COMPUTERS; SOLID STATE DRIVES (U.S. CLS. 21, 23, 26, 36 AND 38).
FIRST USE 3-1-2010; IN COMMERCE 3-1-2010.

CLASS 42—SCIENTIFIC AND COMPUTER SERVICES

FOR COMPUTER CONSULTATION IN THE FIELD OF COMPUTER SECURITY; COMPUTER FORENSIC SERVICES; COMPUTER SECURITY CONSULTANCY; COMPUTER SECURITY SERVICE, NAMELY, RESTRICTING ACCESS TO AND BY COMPUTER NETWORKS TO AND OF UNDESIRE WEB SITES, MEDIA AND INDIVIDUALS AND FACILITIES (U.S. CLS. 100 AND 101).
FIRST USE 3-1-2010; IN COMMERCE 3-1-2010.
JENNIFER WILLISTON, EXAMINING ATTORNEY

SN 85-534,970. HELEN'S HEART LLC, DALLAS, TX. FILED 2-6-2012.

VIENNA PROM

THE MARK CONSISTS OF STANDARD CHARACTERS WITHOUT CLAIM TO ANY PARTICULAR FONT, STYLE, SIZE, OR COLOR.

NO CLAIM IS MADE TO THE EXCLUSIVE RIGHT TO USE "PROM", APART FROM THE MARK AS SHOWN.

CLASS 14—JEWELRY

FOR COSTUME JEWELRY; JEWELRY (U.S. CLS. 2, 27, 28 AND 50).

CLASS 18—LEATHER GOODS

FOR HANDBAGS; PURSES (U.S. CLS. 1, 2, 3, 22 AND 41).

CLASS 25—CLOTHING

FOR DRESSES; EVENING DRESSES; EVENING GOWNS; HEADBANDS; SHOES (U.S. CLS. 22 AND 39).
FIRST USE 8-1-2011; IN COMMERCE 8-1-2011.
KATHERINE M. DUBRAY, EXAMINING ATTORNEY

SN 85-534,979. CSTOWN USA, HENDERSON, NV. FILED 2-6-2012.

CSTOWN

THE COLOR(S) RED AND BLACK IS/ARE CLAIMED AS A FEATURE OF THE MARK.

THE MARK CONSISTS OF THE STYLIZED WORD CSTOWN, CS AND OWN IN BLACK AND T IN RED.

CLASS 16—PAPER GOODS AND PRINTED MATTER

FOR DECALS; STICKERS AND TRANSFERS; IRON-ON TRANSFERS (U.S. CLS. 2, 5, 22, 23, 29, 37, 38 AND 50).

FIRST USE 3-0-2011; IN COMMERCE 3-0-2011.

CLASS 25—CLOTHING

FOR DRESSES (U.S. CLS. 22 AND 39).

FIRST USE 3-0-2011; IN COMMERCE 3-0-2011.

KAREN K. BUSH, EXAMINING ATTORNEY

SN 85-535,007. A GROUP DISCOUNT.COM, LLC, DBA WWW.GOODGET.COM, WASHINGTON, DC. FILED 2-6-2012.

GOODGET

THE MARK CONSISTS OF STANDARD CHARACTERS WITHOUT CLAIM TO ANY PARTICULAR FONT, STYLE, SIZE, OR COLOR.

CLASS 35—ADVERTISING AND BUSINESS

FOR PROMOTING THE GOODS AND SERVICES OF OTHERS BY PROVIDING A WEB SITE FEATURING COUPONS, REBATES, PRICE COMPARISON INFORMATION, PRODUCT REVIEWS, AND THE LIKE; PROVIDING INFORMATION ABOUT AND MAKING REFERRALS IN THE FIELD OF CONSUMER PRODUCTS AND SERVICES FOR RETAIL SERVICES CONCERNING PRODUCTS, SERVICES, EVENTS, ACTIVITIES, ATTRACTIONS AND FACILITIES, IN PARTICULAR GEOGRAPHIC LOCATIONS; PROVIDING MARKETING AND PROMOTION OF SPECIAL EVENTS; ADVERTISING AND PROMOTIONAL SERVICES; PROMOTING THE GOODS AND SERVICES OF OTHERS VIA A GLOBAL COMPUTER NETWORK; PROVIDING INFORMATION REGARDING DISCOUNTS, COUPONS, REBATES, VOUCHERS, AND SPECIAL OFFERS FOR THE GOODS AND SERVICES OF OTHERS (U.S. CLS. 100, 101 AND 102).

CLASS 36—INSURANCE AND FINANCIAL

FOR CHARITABLE FUNDRAISING SERVICES (U.S. CLS. 100, 101 AND 102).

AMY HELLA, EXAMINING ATTORNEY

SN 85-535,102. KOOL BRANDS, LLC., RENO, NV. FILED 2-6-2012.

TRANSLU

THE MARK CONSISTS OF STANDARD CHARACTERS WITHOUT CLAIM TO ANY PARTICULAR FONT, STYLE, SIZE, OR COLOR.

CLASS 9—ELECTRICAL AND SCIENTIFIC APPARATUS

FOR BAGS AND CASES SPECIALLY ADAPTED FOR HOLDING OR CARRYING PORTABLE TELEPHONES AND TELEPHONE EQUIPMENT AND ACCESSORIES; BATTERY CASES; CAMERA CASES; CARRYING CASES FOR CELL PHONES; CARRYING CASES FOR ELECTRONIC EQUIPMENT, NAMELY, PORTABLE MUSIC PLAYERS, MOBILE PHONES, GLOBAL POSITIONING SYSTEMS, PERSONAL DIGITAL ASSISTANTS, COMPUTERS, PORTABLE COMPUTERS, TABLET COMPUTERS, ELECTRONIC BOOK READERS AND CAMERAS; CARRYING CASES FOR MOBILE COMPUTERS; CARRYING CASES SPECIALLY ADAPTED FOR POCKET CALCULATORS AND CELLPHONES; CARRYING CASES, HOLDERS, PROTECTIVE CASES AND STANDS FEATURING POWER SUPPLY CONNECTORS, ADAPTORS, SPEAKERS AND BATTERY CHARGING DEVICES, SPECIALLY ADAPTED FOR USE WITH HANDHELD DIGITAL ELECTRONIC DEVICES; CASES FOR MUSIC, AUDIO AND RELATED ELECTRONIC EQUIPMENT, NAMELY, CASES FOR AUDIO TUNERS, AUDIO RECEIVERS, AMPLIFIERS, TAPE PLAYERS, COMPACT DISC PLAYERS, MP3 CONTROLLERS/PLAYERS, AUDIO MIXERS, AUDIO SPEAKERS IN THE NATURE OF MUSIC STUDIO MONITORS, MICROPHONES, AUDIO SPEAKERS, COMPACT DISCS, AUDIO TAPES, PORTABLE COMPUTERS, ANTENNAS, PHONOGRAPHIC RECORD PLAYERS, AUDIO RECORDING EQUIPMENT, AND THE CABLES ASSOCIATED WITH ALL OF THE FOREGOING EQUIPMENT; CASES FOR PHOTOGRAPHIC APPARATUS; CASES FOR POCKET CALCULATORS; CASES FOR TELEPHONES; CD CASES; CELL PHONE CASES; CELL PHONE COVERS; CLEAR PROTECTIVE COVERS SPECIALLY ADAPTED FOR PERSONAL ELECTRONIC DEVICES; COMPACT DISC CASES; COMPUTER CARRYING CASES; CONSUMER ELECTRONIC PRODUCTS, NAMELY, AUDIO AMPLIFIERS, AUDIO SPEAKERS, AUDIO RECEIVERS, ELECTRICAL AUDIO AND SPEAKER CABLES AND CONNECTORS, AUDIO DECODERS, VIDEO DECODERS, SPEAKERS, POWER CONVERSION DEVICES, POWER CONVERTERS, AND POWER INVERTERS; DVD CASES; EARPHONE ACCESSORIES, NAMELY, EARPHONE CUSHIONS, EARPHONE PADS, CORD MANAGEMENT SYSTEMS, EARPHONE CASES, AND EARPHONE EXTENSION CORDS; FITTED PLASTIC FILMS KNOWN AS SKINS FOR COVERING AND PROTECTING ELECTRONIC APPARATUS, NAMELY, PORTABLE MUSIC PLAYERS, MOBILE PHONES, GLOBAL POSITIONING SYSTEMS, PERSONAL DIGITAL ASSISTANTS, COMPUTERS, PORTABLE COMPUTERS, TABLET COMPUTERS, ELECTRONIC BOOK READERS AND CAMERAS; FITTED PLASTIC FILMS KNOWN AS SKINS FOR COVERING AND PROVIDING A SCRATCH PROOF BARRIER OR PROTECTION FOR ELECTRONIC DEVICES, NAMELY, MP3 PLAYERS, MOBILE TELEPHONES, SMART TELEPHONES, DIGITAL CAMERAS, GLOBAL POSITIONING SYSTEMS AND PERSONAL DIGITAL ASSISTANTS; LAPTOP CARRYING CASES; NOTEBOOK COMPUTER CARRYING CASES; PLASTIC CASES SPECIALLY ADAPTED HOLDING COMPACT DISCS, DVDS AND OTHER ELECTRONIC MEDIA; PROTECTIVE CARRYING CASES FOR PORTABLE MUSIC PLAYERS, NAMELY, MP3 PLAYERS; PROTECTIVE CARRYING CASES SPECIALLY ADAPTED FOR GLOBAL POSITIONING SYSTEM (GPS) APPARATUS; PROTECTIVE CARRYING CASES SPECIALLY ADAPTED FOR PERSONAL DIGITAL ASSISTANTS (PDA); PROTECTIVE COVERS AND CASES FOR CELL PHONES, LAPTOPS AND PORTABLE MEDIA PLAYERS; PROTECTIVE COVERS FOR ELECTRONIC READING DEVICES; VIDEO GRAPHICS CONTROLLER (U.S. CLS. 21, 23, 26, 36 AND 38).

CLASS 28—TOYS AND SPORTING GOODS

FOR AMUSEMENT APPARATUS INCORPORATING A VIDEO MONITOR; AMUSEMENT GAME MACHINES; AMUSEMENT MACHINES, NAMELY, HAND-HELD ELECTRONIC GAME UNITS ADAPTED FOR USE WITH AN EXTERNAL DISPLAY SCREEN OR MONITOR; APPARATUS FOR ELECTRONIC GAMES OTHER THAN THOSE ADAPTED FOR USE WITH AN EXTERNAL DISPLAY SCREEN OR MONITOR; AUDIO AND VISUAL HEADSETS FOR USE IN PLAYING VIDEO GAMES; BATTERY-POWERED COMPUTER GAME WITH LCD SCREEN; CARRYING BAGS SPECIALLY ADAPTED FOR TOY VEHICLES; CASES FOR PLAY ACCESSORIES; CASES FOR TOY STRUCTURES; CASES FOR TOY VEHICLES; CASES SPECIALLY ADAPTED FOR SPORTS EQUIPMENT; COMPUTER GAME CONSOLES FOR USE WITH AN EXTERNAL DISPLAY SCREEN OR MONITOR; COMPUTER GAME JOYSTICKS; ELECTRONIC GAMES OTHER THAN THOSE ADAPTED FOR USE WITH TELEVISION RECEIVERS ONLY; ELECTRONIC GAMING MACHINES, NAMELY, DEVICES WHICH ACCEPT A WAGER; ELECTRONIC INTERACTIVE BOARD GAMES FOR USE WITH EXTERNAL MONITOR; EXERCISE MACHINES INCORPORATING ELECTRONIC AND VIDEO GAME CONTROLLERS; FACE PLATES FOR VIDEO GAME CONSOLES FOR USE WITH EXTERNAL MONITORS; FITTED COVERS SPECIALLY ADAPTED TO PROTECT VIDEO GAME CONSOLES FOR USE WITH AN EXTERNAL DISPLAY SCREEN OR MONITOR; GAME CONTROLLERS FOR COMPUTER GAMES; GAMING HEADSETS ADAPTED FOR USE IN PLAYING VIDEO GAMES; GUITAR SKINS FOR ELECTRONIC GUITAR GAME CONTROLLERS; HAND HELD JOY STICK UNITS FOR PLAYING VIDEO GAMES; HAND HELD UNITS FOR PLAYING ELECTRONIC GAMES OTHER THAN THOSE ADAPTED FOR USE WITH AN EXTERNAL DISPLAY SCREEN OR MONITOR; HAND HELD UNITS FOR PLAYING VIDEO GAMES OTHER THAN THOSE ADAPTED FOR USE WITH AN EXTERNAL DISPLAY SCREEN OR MONITOR; HAND-HELD ELECTRONIC GAMES ADAPTED FOR USE WITH TELEVISION RECEIVERS ONLY; HAND-HELD GAMES WITH LIQUID CRYSTAL DISPLAYS; HAND-HELD UNITS FOR PLAYING ELECTRONIC GAMES FOR USE WITH EXTERNAL DISPLAY SCREEN OR MONITOR; JOYSTICKS FOR VIDEO GAMES; LCD GAME MACHINES; PROTECTIVE CARRYING CASES SPECIALLY ADAPTED FOR HAND-HELD VIDEO GAMES; PROTECTIVE CARRYING CASES SPECIALLY ADAPTED FOR VIDEO GAME CONSOLES FOR USE WITH AN EXTERNAL DISPLAY SCREEN OR MONITOR; STAND ALONE VIDEO GAME MACHINES; STAND ALONE VIDEO OUTPUT GAME MACHINES; VIDEO GAME CONSOLES FOR USE WITH AN EXTERNAL DISPLAY SCREEN OR MONITOR; VIDEO GAME INTERACTIVE CONTROL FLOOR PADS OR MATS; VIDEO GAME INTERACTIVE HAND HELD REMOTE CONTROLS FOR PLAYING ELECTRONIC GAMES; VIDEO GAME INTERACTIVE REMOTE CONTROL UNITS; VIDEO GAME JOYSTICKS; VIDEO GAME MACHINES FOR USE WITH EXTERNAL DISPLAY SCREEN OR MONITOR; VIDEO GAME MACHINES FOR USE WITH TELEVISIONS; VIDEO OUTPUT GAME MACHINES FOR USE WITH EXTERNAL DISPLAY SCREEN OR MONITOR; VIDEO OUTPUT GAME MACHINES FOR USE WITH TELEVISIONS; VIRTUAL REALITY HEADSETS AND HELMETS ADAPTED FOR USE IN PLAYING VIDEO GAMES (U.S. CLS. 22, 23, 38 AND 50).

Laurie Mayes, Examining Attorney

SN 85-535,137. CHEATERVILLE, INC., LAS VEGAS, NV.
FILED 2-6-2012.

JUDGEVILLE.COM

THE MARK CONSISTS OF STANDARD CHARACTERS WITHOUT CLAIM TO ANY PARTICULAR FONT, STYLE, SIZE, OR COLOR.

CLASS 41—EDUCATION AND ENTERTAINMENT

FOR ENTERTAINMENT SERVICES IN THE NATURE OF AN ON-GOING REALITY BASED TELEVISION PROGRAM; ENTERTAINMENT SERVICES IN THE NATURE OF ON-GOING TELEVISION SHOWS, MOTION PICTURE FILMS, RADIO SHOWS AND LIVE PERFORMANCES FEATURING LIVE ACTION AND DRAMA, COURTROOM-STYLE TRIALS, COMMENTARIES, AND INTERVIEWS (U.S. CLS. 100, 101 AND 107).

CLASS 42—SCIENTIFIC AND COMPUTER SERVICES

FOR COMPUTER SERVICES, NAMELY, CREATING AN ON-LINE COMMUNITY FOR REGISTERED USERS TO PARTICIPATE IN DISCUSSIONS, GET FEEDBACK FROM THEIR PEERS, FORM VIRTUAL COMMUNITIES, AND ENGAGE IN SOCIAL NETWORKING (U.S. CLS. 100 AND 101).

Christine Martin, Examining Attorney

SN 85-535,191. IRTS SOLUTIONS, INC., COLUMBUS, OH.
FILED 2-6-2012.

UTILISPHERE

THE MARK CONSISTS OF STANDARD CHARACTERS WITHOUT CLAIM TO ANY PARTICULAR FONT, STYLE, SIZE, OR COLOR.

CLASS 9—ELECTRICAL AND SCIENTIFIC APPARATUS

FOR COMPUTER SOFTWARE FOR USE IN COLLECTING, CORRELATING, ANALYZING, AND REPORTING ON UTILITY DELIVERY SYSTEM DATA AND ACTIVITIES OF OTHERS; AND FOR USE IN COLLECTING, CORRELATING, ANALYZING, AND REPORTING ON PETROLEUM DELIVERY SYSTEM DATA AND ACTIVITIES OF OTHERS (U.S. CLS. 21, 23, 26, 36 AND 38).

CLASS 42—SCIENTIFIC AND COMPUTER SERVICES

FOR SOFTWARE AS A SERVICE (SAAS) SERVICES FEATURING SOFTWARE FOR USE IN COLLECTING, CORRELATING, ANALYZING, AND REPORTING ON UTILITY DELIVERY SYSTEM DATA AND ACTIVITIES OF OTHERS; AND FOR USE IN COLLECTING, CORRELATING, ANALYZING, AND REPORTING ON PETROLEUM DELIVERY SYSTEM DATA AND ACTIVITIES OF OTHERS (U.S. CLS. 100 AND 101).

Paul Moreno, Examining Attorney

SN 85-535,208. IRTH SOLUTIONS, INC., COLUMBUS, OH. FILED 2-6-2012.



THE MARK CONSISTS OF THE WORD UTILISPHERE ACCOMPANYING A FIBROUS SPHERE OR SWIRL.

CLASS 9—ELECTRICAL AND SCIENTIFIC APPARATUS

FOR COMPUTER SOFTWARE FOR USE IN COLLECTING, CORRELATING, ANALYZING, AND REPORTING ON UTILITY DELIVERY SYSTEM DATA AND ACTIVITIES OF OTHERS; AND FOR USE IN COLLECTING, CORRELATING, ANALYZING, AND REPORTING ON PETROLEUM DELIVERY SYSTEM DATA AND ACTIVITIES OF OTHERS (U.S. CLS. 21, 23, 26, 36 AND 38).

CLASS 42—SCIENTIFIC AND COMPUTER SERVICES

FOR SOFTWARE AS A SERVICE (SAAS) SERVICES FEATURING SOFTWARE FOR USE IN COLLECTING, CORRELATING, ANALYZING, AND REPORTING ON UTILITY DELIVERY SYSTEM DATA AND ACTIVITIES OF OTHERS; AND FOR USE IN COLLECTING, CORRELATING, ANALYZING, AND REPORTING ON PETROLEUM DELIVERY SYSTEM DATA AND ACTIVITIES OF OTHERS (U.S. CLS. 100 AND 101).
PAUL MORENO, EXAMINING ATTORNEY

SN 85-535,221. KOOL BRANDS, LLC., RENO, NV. FILED 2-6-2012.

INDESTRUCTO

THE MARK CONSISTS OF STANDARD CHARACTERS WITHOUT CLAIM TO ANY PARTICULAR FONT, STYLE, SIZE, OR COLOR.

CLASS 9—ELECTRICAL AND SCIENTIFIC APPARATUS

FOR BATTERY CASES; CAMERA CASES; CARRYING CASES FOR CELL PHONES; CARRYING CASES FOR ELECTRONIC EQUIPMENT, NAMELY, PORTABLE MUSIC PLAYERS, MOBILE PHONES, GLOBAL POSITIONING SYSTEMS, PERSONAL DIGITAL ASSISTANTS, COMPUTERS, PORTABLE COMPUTERS, TABLE COMPUTERS, ELECTRONIC BOOK READERS AND CAMERAS; CARRYING CASES FOR MOBILE COMPUTERS; CARRYING CASES SPECIALLY ADAPTED FOR POCKET CALCULATORS AND CELLPHONES; CARRYING CASES, HOLDERS, PROTECTIVE CASES AND STANDS FEATURING POWER SUPPLY CONNECTORS, ADAPTORS, SPEAKERS AND BATTERY CHARGING DEVICES, SPECIALLY ADAPTED FOR USE WITH HANDHELD DIGITAL ELECTRONIC DEVICES; CASES FOR ELECTRONIC DIARIES; CASES FOR MOBILE PHONES; CASES FOR MUSIC, AUDIO AND RELATED ELECTRONIC EQUIPMENT, NAMELY, CASES FOR AUDIO TUNERS, AUDIO RECEIVERS, AMPLIFIERS, TAPE PLAYERS, COMPACT DISC PLAYERS, MP3 CONTROLLERS/PLAYERS, AUDIO MIXERS, AUDIO SPEAKERS IN THE NATURE OF MUSIC STUDIO MONITORS, MICROPHONES, AUDIO SPEAKERS, COMPACT DISCS, AUDIO TAPES, PORTABLE COMPUTERS, ANTENNAS, PHONOGRAPHIC RECORD PLAYERS, AUDIO RECORDING EQUIPMENT, AND THE CABLES ASSOCIATED WITH ALL OF THE FOREGOING EQUIPMENT; CASES FOR PHOTOGRAPHIC APPARATUS; CASES FOR POCKET CALCULATORS; CASES FOR TELEPHONES; CD CASES; CELL PHONE CASES; CELL PHONE COVERS; CLEAR PROTECTIVE COVERS SPECIALLY ADAPTED FOR PERSONAL ELECTRONIC DEVICES; COMPACT DISC CASES; COMPUTER CARRYING CASES; EARPHONE ACCESSORIES, NAMELY, EARPHONE CUSHIONS, EARPHONE PADS, CORD MANAGEMENT SYSTEMS, EARPHONE CASES, AND EARPHONE EXTENSION CORDS; FITTED PLASTIC FILMS KNOWN AS SKINS FOR COVERING AND PROTECTING ELECTRONIC APPARATUS, NAMELY, PORTABLE MUSIC PLAYERS, MOBILE PHONES, GLOBAL POSITIONING SYSTEMS, PERSONAL DIGITAL ASSISTANTS, COMPUTERS, PORTABLE COMPUTERS, TABLE COMPUTERS, ELECTRONIC BOOK READERS AND CAMERAS; FITTED PLASTIC FILMS KNOWN AS SKINS FOR COVERING AND PROVIDING A SCRATCH PROOF BARRIER OR PROTECTION FOR ELECTRONIC DEVICES, NAMELY, MP3 PLAYERS, MOBILE TELEPHONES, SMART TELEPHONES, DIGITAL CAMERAS, GLOBAL POSITIONING SYSTEMS AND PERSONAL DIGITAL ASSISTANTS; LAPTOP CARRYING CASES; NOTEBOOK COMPUTER CARRYING CASES; PROTECTIVE CARRYING CASES FOR PORTABLE MUSIC PLAYERS, NAMELY, MP3 PLAYERS; PROTECTIVE CARRYING CASES SPECIALLY ADAPTED FOR GLOBAL POSITIONING SYSTEM (GPS) APPARATUS; PROTECTIVE CARRYING CASES SPECIALLY ADAPTED FOR PERSONAL DIGITAL ASSISTANTS (PDA); PROTECTIVE COVERS AND CASES FOR CELL PHONES, LAPTOPS AND PORTABLE MEDIA PLAYERS; PROTECTIVE COVERS FOR ELECTRONIC READING DEVICES (U.S. CLS. 21, 23, 26, 36 AND 38).

CLASS 28—TOYS AND SPORTING GOODS

FOR AMUSEMENT APPARATUS INCORPORATING A VIDEO MONITOR; AMUSEMENT GAME MACHINES; AMUSEMENT MACHINES, NAMELY, HAND-HELD ELECTRONIC GAME UNITS ADAPTED FOR USE WITH AN EXTERNAL DISPLAY SCREEN OR MONITOR; APPARATUS FOR ELECTRONIC GAMES OTHER THAN THOSE ADAPTED FOR USE WITH AN EXTERNAL DISPLAY SCREEN OR MONITOR; AUDIO AND VISUAL HEADSETS FOR USE IN PLAYING VIDEO GAMES; BATTERY-POWERED COMPUTER GAME WITH LCD SCREEN; CASES FOR PLAY ACCESSORIES; COMPUTER GAME CONSOLES FOR USE WITH AN EXTERNAL DISPLAY SCREEN OR MONITOR; COMPUTER GAME JOYSTICKS; ELECTRONIC EDUCATIONAL GAME MACHINES FOR CHILDREN; EXERCISE MACHINES INCORPORATING ELECTRONIC AND VIDEO GAME CONTROLLERS; FACE PLATES FOR VIDEO GAME CONSOLES FOR USE WITH EXTERNAL MONITORS; FITTED COVERS SPECIALLY ADAPTED TO PROTECT VIDEO GAME CONSOLES FOR USE WITH AN EXTERNAL DISPLAY SCREEN OR MONITOR; GAMING

HEADSETS ADAPTED FOR USE IN PLAYING VIDEO GAMES; GUITAR SKINS FOR ELECTRONIC GUITAR GAME CONTROLLERS; HAND HELD JOY STICK UNITS FOR PLAYING VIDEO GAMES; HAND HELD UNITS FOR PLAYING ELECTRONIC GAMES OTHER THAN THOSE ADAPTED FOR USE WITH AN EXTERNAL DISPLAY SCREEN OR MONITOR; HAND HELD UNITS FOR PLAYING VIDEO GAMES OTHER THAN THOSE ADAPTED FOR USE WITH AN EXTERNAL DISPLAY SCREEN OR MONITOR; HAND-HELD ELECTRONIC GAMES ADAPTED FOR USE WITH TELEVISION RECEIVERS ONLY; HAND-HELD GAMES WITH LIQUID CRYSTAL DISPLAYS; HAND-HELD UNITS FOR PLAYING ELECTRONIC GAMES FOR USE WITH EXTERNAL DISPLAY SCREEN OR MONITOR; JOY-STICKS FOR VIDEO GAMES; LCD GAME MACHINES; PROTECTIVE CARRYING CASES SPECIALLY ADAPTED FOR HANDHELD VIDEO GAMES; PROTECTIVE CARRYING CASES SPECIALLY ADAPTED FOR VIDEO GAME CONSOLES FOR USE WITH AN EXTERNAL DISPLAY SCREEN OR MONITOR; STAND ALONE VIDEO OUTPUT GAME MACHINES; VIDEO GAME CONSOLES FOR USE WITH AN EXTERNAL DISPLAY SCREEN OR MONITOR; VIDEO GAME INTERACTIVE CONTROL FLOOR PADS OR MATS; VIDEO GAME INTERACTIVE HAND HELD REMOTE CONTROLS FOR PLAYING ELECTRONIC GAMES; VIDEO GAME INTERACTIVE REMOTE CONTROL UNITS; VIDEO GAME JOYSTICKS; VIDEO GAME MACHINES FOR USE WITH EXTERNAL DISPLAY SCREEN OR MONITOR; VIDEO GAME MACHINES FOR USE WITH TELEVISIONS; VIDEO OUTPUT GAME MACHINES FOR USE WITH EXTERNAL DISPLAY SCREEN OR MONITOR; VIDEO OUTPUT GAME MACHINES FOR USE WITH TELEVISIONS; VIRTUAL REALITY HEADSETS AND HELMETS ADAPTED FOR USE IN PLAYING VIDEO GAMES (U.S. CLS. 22, 23, 38 AND 50).

Laurie Mayes, Examining Attorney

SN 85-535,243. NEURELIS, INC., SAN DIEGO, CA. FILED 2-6-2012.

NEURELIS

THE MARK CONSISTS OF STANDARD CHARACTERS WITHOUT CLAIM TO ANY PARTICULAR FONT, STYLE, SIZE, OR COLOR.

CLASS 5—PHARMACEUTICALS

FOR PHARMACEUTICAL PREPARATIONS FOR THE TREATMENT OF NERVOUS SYSTEM DISORDERS; PHARMACEUTICAL PREPARATIONS, NAMELY, PAIN MEDICATION; PHARMACEUTICAL PREPARATIONS FOR THE TREATMENT OF PAIN AND CONDITIONS ASSOCIATED WITH PAIN (U.S. CLS. 6, 18, 44, 46, 51 AND 52).

CLASS 10—MEDICAL APPARATUS

FOR PHARMACEUTICAL DEVICES, NAMELY, MEDICAL APPARATUS AND DRUG DELIVERY DEVICES FOR INTRODUCING PHARMACEUTICAL PREPARATIONS INTO THE HUMAN BODY (U.S. CLS. 26, 39 AND 44).

CLASS 42—SCIENTIFIC AND COMPUTER SERVICES

FOR PHARMACEUTICAL RESEARCH (U.S. CLS. 100 AND 101).

Bridgett Smith, Examining Attorney

SN 85-535,261. LIONS GATE ENTERTAINMENT, INC., SANTA MONICA, CA. FILED 2-6-2012.

MAY THE ODDS BE EVER IN YOUR FAVOR

THE MARK CONSISTS OF STANDARD CHARACTERS WITHOUT CLAIM TO ANY PARTICULAR FONT, STYLE, SIZE, OR COLOR.

CLASS 9—ELECTRICAL AND SCIENTIFIC APPARATUS

FOR COMPUTER GAME PROGRAMS, CARTRIDGES, AND CASSETTES; DVDS FEATURING FICTIONAL DRAMA; MOTION PICTURE FILMS ABOUT FICTIONAL DRAMA; PRE-RECORDED ELECTRONIC MEDIA FEATURING FICTIONAL DRAMA; DOWNLOADABLE FILES IN THE FIELD OF ENTERTAINMENT, NAMELY, RINGTONES, GRAPHICS, IMAGES, ELECTRONIC GAMES, AND MUSIC, VIA A GLOBAL COMPUTER NETWORK AND WIRELESS DEVICES; DOWNLOADABLE ELECTRONIC PUBLICATIONS IN THE NATURE OF SONG BOOKS, TABLATURE, AND SHEET MUSIC; MAGNETS; MAGNET SHEETS; MAGNETICALLY ENCODED DEBIT CARDS; MUSICAL SOUND RECORDINGS; COMPUTER STORAGE DEVICES, NAMELY, BLANK FLASH DRIVES; DIGITAL MEDIA, NAMELY, DOWNLOADABLE AUDIO AND VIDEO RECORDINGS, AND CDS FEATURING AND PROMOTING MOTION PICTURES AND DOCUMENTARIES; COVERS FOR MOBILE PHONES; AND FITTED PLASTIC FILMS KNOWN AS SKINS FOR COVERING AND PROTECTING ELECTRONIC APPARATUS, NAMELY, MOBILE PHONES, PORTABLE MUSIC PLAYERS, COMPUTERS, COMPUTER ACCESSORIES AND PERIPHERALS, PDAS, GAMING DEVICES, CAMERAS, CAMCORDERS, AND E-BOOK READERS; BACKPACKS ADAPTED FOR HOLDING COMPUTERS; CAMERA CASES; CASES FOR MOBILE PHONES; CASES FOR PDAS; CELL PHONES; COMPUTER GAMES, NAMELY, COMPUTER GAME CARTRIDGES, DISCS, AND SOFTWARE; DECORATIVE CHARMS FOR CELL PHONES; DISPOSABLE CAMERAS; ELECTRONIC DIARIES; LAPTOP CARRYING CASES; MOUSEPADS; NEON SIGNS; AND VIDEO GAMES, NAMELY, VIDEO GAME CARTRIDGES, DISCS AND SOFTWARE (U.S. CLS. 21, 23, 26, 36 AND 38).

CLASS 14—JEWELRY

FOR JEWELRY (U.S. CLS. 2, 27, 28 AND 50).

CLASS 35—ADVERTISING AND BUSINESS

FOR ORGANIZATION OF TRADE CONVENTIONS IN THE FIELDS OF MOTION PICTURES AND ENTERTAINMENT FOR BUSINESS PURPOSES (U.S. CLS. 100, 101 AND 102).

CLASS 41—EDUCATION AND ENTERTAINMENT

FOR PRODUCTION AND DISTRIBUTION OF MOTION PICTURES; PROVIDING INFORMATION RELATING TO MOTION PICTURES; PROVIDING A WEBSITE FEATURING NON-DOWNLOADABLE FILM CLIPS AND MUSIC VIDEOS, AND INFORMATION ON MOTION PICTURES, LITERARY WORKS, AND MUSIC; ORGANIZATION OF CONVENTIONS IN THE FIELDS OF MOTION PICTURES AND ENTERTAINMENT FOR ENTERTAINMENT PURPOSES; FAN CLUB SERVICES; PROVIDING PODCASTS RELATING TO MUSIC AND MOTION PICTURES; PROVIDING ONLINE COMPUTER GAMES (U.S. CLS. 100, 101 AND 107).

CLASS 42—SCIENTIFIC AND COMPUTER SERVICES

FOR COMPUTER SERVICES, NAMELY, CREATING AN ONLINE COMMUNITY FOR REGISTERED USERS TO PARTICIPATE IN COMPETITIONS, SHOWCASE THEIR SKILLS, GET FEEDBACK FROM THEIR PEERS, FORM VIRTUAL COMMUNITIES, AND ENGAGE IN SOCIAL NETWORKING (U.S. CLS. 100 AND 101).

CLASS 45—PERSONAL AND LEGAL SERVICES

FOR LICENSING OF MERCHANDISE AND INTELLECTUAL PROPERTY ASSOCIATED WITH MOTION PICTURES; PROVIDING ONLINE INFORMATION ON THE LICENSING OF MERCHANDISE ASSOCIATED WITH MOTION PICTURES (U.S. CLS. 100 AND 101).
JENNIFER RICHARDSON, EXAMINING ATTORNEY

SN 85-535,286. IVANKA TRUMP MARKS LLC, NEW YORK, NY. FILED 2-6-2012.

IVANKA

THE MARK CONSISTS OF STANDARD CHARACTERS WITHOUT CLAIM TO ANY PARTICULAR FONT, STYLE, SIZE, OR COLOR.

OWNER OF U.S. REG. NOS. 3,589,236, 3,945,446 AND OTHERS.

THE NAME "IVANKA" IDENTIFIES IVANKA TRUMP A LIVING INDIVIDUAL WHOSE CONSENT IS OF RECORD.

CLASS 3—COSMETICS AND CLEANING PREPARATIONS

FOR PERFUME, LOTIONS FOR COSMETIC PURPOSES, FACE CREAMS, SOAPS FOR PERSONAL USE, BATH AND BODY WASH, SCENTED OILS AND FRAGRANCES (U.S. CLS. 1, 4, 6, 50, 51 AND 52).

CLASS 9—ELECTRICAL AND SCIENTIFIC APPARATUS

FOR EYEWEAR (U.S. CLS. 21, 23, 26, 36 AND 38).
JUSTINE D. PARKER, EXAMINING ATTORNEY

SN 85-535,379. TESTIVE, INC, SOMERVILLE, MA. FILED 2-6-2012.

TurboTest

THE MARK CONSISTS OF STANDARD CHARACTERS WITHOUT CLAIM TO ANY PARTICULAR FONT, STYLE, SIZE, OR COLOR.

CLASS 41—EDUCATION AND ENTERTAINMENT

FOR EDUCATION SERVICES, NAMELY, PROVIDING ONLINE COGNITIVE ASSESSMENTS AND TRAINING PROGRAMS THAT HELP IDENTIFY COGNITIVE STRENGTHS AND WEAKNESSES OF AN INDIVIDUAL (U.S. CLS. 100, 101 AND 107).

CLASS 42—SCIENTIFIC AND COMPUTER SERVICES

FOR PROVIDING A WEB SITE FEATURING TEMPORARY USE OF NON-DOWNLOADABLE SOFTWARE FOR PROVIDING AN INDIVIDUAL A SCORE ON AN EDUCATIONAL TEST (U.S. CLS. 100 AND 101).

MATTHEW KLINE, EXAMINING ATTORNEY

SN 85-535,393. COMMUNIKATE MUSIC, INC., NEW YORK, NY. FILED 2-6-2012.

SIX STRING RELIGION

THE MARK CONSISTS OF STANDARD CHARACTERS WITHOUT CLAIM TO ANY PARTICULAR FONT, STYLE, SIZE, OR COLOR.

CLASS 14—JEWELRY

FOR JEWELRY (U.S. CLS. 2, 27, 28 AND 50).

CLASS 25—CLOTHING

FOR ARTIFICIAL FLOWER HEADDRESSES; BIKINIS; BLOUSES; BRALETTES; BRAS; BUSTIERS; CAMISOLES; CARDIGANS; CHEMISETTES; COATS MADE OF COTTON; COLLARED SHIRTS; CREW NECKS; DENIMS; DRESS SHIRTS; DRESSES; DRESSING GOWNS; FOOTWEAR FOR WOMEN; GARTER BELTS; GARTERS; HEAD SCARVES; HEADBANDS; HOODED PULLOVERS; JACKETS; KNEE-HIGH STOCKINGS; KNICKERS; KNIT DRESSES; KNIT JACKETS; KNIT SHIRTS; KNIT TOPS; LADIES' UNDERWEAR; LEATHER JACKETS; LEGGINGS; LINGERIE; NIGHTGOWNS; NIGHTIES; PANTIES; PANTIES, SHORTS AND BRIEFS; SCARVES; SHIRTS AND SHORT-SLEEVED SHIRTS; SHORT-SLEEVED OR LONG-SLEEVED T-SHIRTS; SHORT-SLEEVED SHIRTS; SHORTS; SKIRTS AND DRESSES; SOCKS AND STOCKINGS; STRAPLESS BRAS; TANK-TOPS; THONGS; TOPS; UNDER GARMENTS; WOMEN'S CLOTHING, NAMELY, SHIRTS, DRESSES, SKIRTS, BLOUSES; WOMEN'S UNDERWEAR (U.S. CLS. 22 AND 39).

EDWARD FENNESSY, EXAMINING ATTORNEY

SN 85-535,400. COMMUNIKATE MUSIC, INC., NEW YORK, NY. FILED 2-6-2012.

WE THE DREAMERS

THE MARK CONSISTS OF STANDARD CHARACTERS WITHOUT CLAIM TO ANY PARTICULAR FONT, STYLE, SIZE, OR COLOR.

CLASS 14—JEWELRY

FOR JEWELRY (U.S. CLS. 2, 27, 28 AND 50).

SN 85-535,506. BE A JOKE! INDUSTRIES, INC., GRAND LEDGE, MI. FILED 2-7-2012.

CLASS 16—PAPER GOODS AND PRINTED MATTER

FOR ART PICTURES; ART PRINTS; ART PRINTS ON CANVAS; FRAMED ART ETCHINGS; FRAMED ART PICTURES; FRAMED ART PRINTS (U.S. CLS. 2, 5, 22, 23, 29, 37, 38 AND 50).

BE A JOKE!

CLASS 25—CLOTHING

FOR ARTIFICIAL FLOWER HEADDRESSES; BIKINIS; BLOUSES; BRALETTES; BRAS; BUSTIERS; CAMISOLES; CARDIGANS; CHEMISETTES; COATS MADE OF COTTON; COLLARED SHIRTS; CREW NECKS; DENIMS; DRESS SHIRTS; DRESSES; DRESSING GOWNS; FOOTWEAR FOR WOMEN; GARTER BELTS; GARTERS; HEAD SCARVES; HEADBANDS; HOODED PULLOVERS; JACKETS; KNEE-HIGH STOCKINGS; KNICKERS; KNIT DRESSES; KNIT JACKETS; KNIT SHIRTS; KNIT TOPS; LADIES' UNDERWEAR; LEATHER JACKETS; LEGGINGS; LINGERIE; NIGHT GOWNS; NIGHTIES; PANTIES; PANTIES, SHORTS AND BRIEFS; SCARVES; SHIRTS AND SHORT-SLEEVED SHIRTS; SHORT-SLEEVED OR LONG-SLEEVED T-SHIRTS; SHORT-SLEEVED SHIRTS; SHORTS; SKIRTS AND DRESSES; SOCKS AND STOCKINGS; STRAPLESS BRAS; TANK-TOPS; THONGS; TOPS; UNDERGARMENTS; WOMEN'S CLOTHING, NAMELY, SHIRTS, DRESSES, SKIRTS, BLOUSES; WOMEN'S UNDERWEAR (U.S. CLS. 22 AND 39).

THE MARK CONSISTS OF STANDARD CHARACTERS WITHOUT CLAIM TO ANY PARTICULAR FONT, STYLE, SIZE, OR COLOR.

CLASS 35—ADVERTISING AND BUSINESS

FOR ADVERTISING AND DIRECTORY SERVICES, NAMELY, PROMOTING THE SERVICES OF OTHERS BY PROVIDING A WEB PAGE FEATURING LINKS TO THE WEBSITES OF OTHERS (U.S. CLS. 100, 101 AND 102).

CLASS 35—ADVERTISING AND BUSINESS

FOR ART GALLERIES; ART GALLERY SERVICES; ON-LINE ART GALLERIES (U.S. CLS. 100, 101 AND 102).

CLASS 45—PERSONAL AND LEGAL SERVICES

FOR INTERNET-BASED SOCIAL NETWORKING SERVICES (U.S. CLS. 100 AND 101).
TASHIA BUNCH, EXAMINING ATTORNEY

CLASS 41—EDUCATION AND ENTERTAINMENT

FOR ENTERTAINMENT SERVICES IN THE NATURE OF PRESENTING LIVE MUSICAL PERFORMANCES (U.S. CLS. 100, 101 AND 107).

EDWARD FENNESSY, EXAMINING ATTORNEY

SN 85-535,513. AMES TRUE TEMPER, INC., CAMP HILL, PA. FILED 2-7-2012.

HDR

SN 85-535,448. DR. RAYMOND HALL, DC, DBA HALL INNOVATIONS, LLC, MALIBU, CA. FILED 2-7-2012.

Unlock the Mystery of Sleep

THE MARK CONSISTS OF STANDARD CHARACTERS WITHOUT CLAIM TO ANY PARTICULAR FONT, STYLE, SIZE, OR COLOR.

THE MARK CONSISTS OF STANDARD CHARACTERS WITHOUT CLAIM TO ANY PARTICULAR FONT, STYLE, SIZE, OR COLOR.

CLASS 10—MEDICAL APPARATUS

FOR CERVICAL PILLOWS FOR MEDICAL USE (U.S. CLS. 26, 39 AND 44).

CLASS 8—HAND TOOLS

FOR RAKES, SNOW SHOVELS, SNOW PUSHERS (U.S. CLS. 23, 28 AND 44).

CLASS 12—VEHICLES

FOR WHEELBARROWS AND CARTS (U.S. CLS. 19, 21, 23, 31, 35 AND 44).

CLASS 20—FURNITURE AND ARTICLES NOT OTHERWISE CLASSIFIED

FOR BEDS, MATTRESSES, PILLOWS AND BOLSTERS (U.S. CLS. 2, 13, 22, 25, 32 AND 50).
CHARISMA HAMPTON, EXAMINING ATTORNEY

CLASS 20—FURNITURE AND ARTICLES NOT OTHERWISE CLASSIFIED

FOR HAND-OPERATED NON-METAL GARDEN HOSE REELS (U.S. CLS. 2, 13, 22, 25, 32 AND 50).

CLASS 21—HOUSEWARES AND GLASS

FOR WATERING CANS (U.S. CLS. 2, 13, 23, 29, 30, 33, 40 AND 50).
CHRIS WELLS, EXAMINING ATTORNEY

SN 85-535,519. LAKE NONA PROPERTY HOLDINGS, LLC, ORLANDO, FL. FILED 2-7-2012.

SN 85-535,674. INVESTMENTS LIMITED.BEST INTENTIONS, TORTOLA, BR.VIRGIN ISLANDS, FILED 2-7-2012.

DAIS

THE MARK CONSISTS OF STANDARD CHARACTERS WITHOUT CLAIM TO ANY PARTICULAR FONT, STYLE, SIZE, OR COLOR.

CLASS 37—CONSTRUCTION AND REPAIR

FOR TELECOMMUNICATION WIRING (U.S. CLS. 100, 103 AND 106).

CLASS 38—COMMUNICATION

FOR DIGITAL NETWORK TELECOMMUNICATIONS SERVICES; PROVIDING ELECTRONIC TELECOMMUNICATION CONNECTIONS; TELECOMMUNICATION ACCESS SERVICES; TELECOMMUNICATION SERVICES, NAMELY, TRANSMISSION OF VOICE, DATA, GRAPHICS, IMAGES, AUDIO AND VIDEO BY MEANS OF TELECOMMUNICATIONS NETWORKS, WIRELESS COMMUNICATION NETWORKS, AND THE INTERNET; WIRELESS BROADBAND COMMUNICATION SERVICES (U.S. CLS. 100, 101 AND 104).

CLASS 45—PERSONAL AND LEGAL SERVICES

FOR MONITORING OF SECURITY SYSTEMS (U.S. CLS. 100 AND 101).
GRETTA YAO, EXAMINING ATTORNEY

SN 85-535,648. XYLA ENTERTAINMENT, LLC, FORMERLY XYLA ENTERTAINMENTS, LLC, TRENTON, NJ. FILED 2-7-2012.

Xyla

THE MARK CONSISTS OF STANDARD CHARACTERS WITHOUT CLAIM TO ANY PARTICULAR FONT, STYLE, SIZE, OR COLOR.

CLASS 9—ELECTRICAL AND SCIENTIFIC APPARATUS

FOR COMPUTER GAME SOFTWARE FOR PERSONAL COMPUTERS AND HOME VIDEO GAME CONSOLES; COMPUTER GAME SOFTWARE FOR USE ON MOBILE AND CELLULAR PHONES; INTERACTIVE GAME SOFTWARE (U.S. CLS. 21, 23, 26, 36 AND 38).
FIRST USE 9-25-2011; IN COMMERCE 11-23-2011.

CLASS 42—SCIENTIFIC AND COMPUTER SERVICES

FOR COMPUTER WEBSITE DESIGN; DATABASE DESIGN AND DEVELOPMENT; VIDEO GAME DEVELOPMENT SERVICES; VIDEO GAME PROGRAMMING DEVELOPMENT SERVICES (U.S. CLS. 100 AND 101).
FIRST USE 9-25-2011; IN COMMERCE 9-25-2011.
MICHAEL ENGEL, EXAMINING ATTORNEY

FREESURF

THE MARK CONSISTS OF STANDARD CHARACTERS WITHOUT CLAIM TO ANY PARTICULAR FONT, STYLE, SIZE, OR COLOR.

CLASS 18—LEATHER GOODS

FOR ANIMAL HARNESES; ANIMAL SKINS AND HIDES; LEATHER AND IMITATION LEATHER SPORT BAGS AND GENERAL PURPOSE TROLLEY BAGS; LEATHER BAGS AND WALLETS; LEATHER BAGS, SUITCASES AND WALLETS; RIDING SADDLES; UMBRELLAS; WHIPS (U.S. CLS. 1, 2, 3, 22 AND 41).

CLASS 25—CLOTHING

FOR FOOTWEAR FOR MEN AND WOMEN; GYMNAS TIC SHOES; HEADGEAR, NAMELY, HATS AND CAPS (U.S. CLS. 22 AND 39).

CLASS 28—TOYS AND SPORTING GOODS

FOR ARTIFICIAL CHRISTMAS TREES (U.S. CLS. 22, 23, 38 AND 50).
MORGAN WYNNE, EXAMINING ATTORNEY

SN 85-535,732. BIZNIK, INC., DBA BIZNIK, SEATTLE, WA. FILED 2-7-2012.

MYFIVE

THE MARK CONSISTS OF STANDARD CHARACTERS WITHOUT CLAIM TO ANY PARTICULAR FONT, STYLE, SIZE, OR COLOR.

CLASS 9—ELECTRICAL AND SCIENTIFIC APPARATUS

FOR DOWNLOADABLE SOFTWARE IN THE NATURE OF A MOBILE APPLICATION FOR USE IN RELATIONSHIP MANAGEMENT (U.S. CLS. 21, 23, 26, 36 AND 38).

CLASS 42—SCIENTIFIC AND COMPUTER SERVICES

FOR PROVIDING A WEB SITE FEATURING TEMPORARY USE OF NON-DOWNLOADABLE SOFTWARE FOR USE IN RELATIONSHIP MANAGEMENT; PROVIDING TEMPORARY USE OF ON-LINE NON-DOWNLOADABLE SOFTWARE DEVELOPMENT TOOLS FOR USE IN RELATIONSHIP MANAGEMENT (U.S. CLS. 100 AND 101).
CHRISTINA SOBRAL, EXAMINING ATTORNEY

SN 85-535,872. EDUCATIONDYNAMICS, LLC, HOBOKEN, NJ. FILED 2-7-2012.



NO CLAIM IS MADE TO THE EXCLUSIVE RIGHT TO USE "CHRISTIANEUCATION.COM", APART FROM THE MARK AS SHOWN.

THE MARK CONSISTS OF A DESIGN OF A BIRD OVER AND TO THE RIGHT OF THE TERM "CHRISTIANEUCATION.COM".

CLASS 35—ADVERTISING AND BUSINESS

FOR PROVIDING AN ON-LINE DIRECTORY INFORMATION SERVICE FEATURING INFORMATION AND LINKS TO THE WEB SITES OF OTHERS PERTAINING TO EDUCATION, EDUCATIONAL OPPORTUNITIES, EDUCATIONAL RESOURCES AND FAITH BASED PROGRAMS; ADVERTISING, MARKETING AND PROMOTION SERVICES (U.S. CLS. 100, 101 AND 102).

FIRST USE 11-16-2011; IN COMMERCE 11-16-2011.

CLASS 41—EDUCATION AND ENTERTAINMENT

FOR PROVISION OF INFORMATION RELATING TO EDUCATION, EDUCATIONAL OPPORTUNITIES, EDUCATIONAL RESOURCES AND FAITH BASED EDUCATIONAL PROGRAMS (U.S. CLS. 100, 101 AND 107).

FIRST USE 11-16-2011; IN COMMERCE 11-16-2011.

KEVON CHISOLM, EXAMINING ATTORNEY

SN 85-535,899. CAMERON P LOVETT-WOODSUM, BOSTON, MA. FILED 2-7-2012.

Moufy

THE MARK CONSISTS OF STANDARD CHARACTERS WITHOUT CLAIM TO ANY PARTICULAR FONT, STYLE, SIZE, OR COLOR.

CLASS 9—ELECTRICAL AND SCIENTIFIC APPARATUS

FOR AUDIO AND VIDEO RECORDINGS FEATURING MUSIC AND ARTISTIC PERFORMANCES; DIGITAL MUSIC DOWNLOADABLE FROM THE INTERNET; DOWNLOADABLE MUSICAL SOUND RECORDINGS; DOWNLOADABLE RING TONES, GRAPHICS AND MUSIC VIA A GLOBAL COMPUTER NETWORK AND WIRELESS DEVICES (U.S. CLS. 21, 23, 26, 36 AND 38).

FIRST USE 3-27-2011; IN COMMERCE 3-27-2011.

CLASS 41—EDUCATION AND ENTERTAINMENT

FOR ENTERTAINMENT SERVICES IN THE NATURE OF LIVE MUSICAL PERFORMANCES; ENTERTAINMENT SERVICES, NAMELY, PROVIDING NON-DOWNLOADABLE PLAYBACK OF MUSIC VIA GLOBAL COMMUNICATIONS NETWORKS; PRESENTATION OF LIVE SHOW PERFORMANCES; PRODUCTION OF MUSICAL VIDEOS (U.S. CLS. 100, 101 AND 107).

FIRST USE 12-11-2010; IN COMMERCE 12-11-2010.

JOHN WILKE, EXAMINING ATTORNEY

SN 85-536,061. SUNTON ENTERPRISES INC., MEBANE, NC. FILED 2-7-2012.

AYL

THE MARK CONSISTS OF THE LETTERS AYL, THE Y BEING JOINED TO THE LETTER A.

CLASS 18—LEATHER GOODS

FOR HANDBAGS (U.S. CLS. 1, 2, 3, 22 AND 41).

CLASS 20—FURNITURE AND ARTICLES NOT OTHERWISE CLASSIFIED

FOR SOFAS (U.S. CLS. 2, 13, 22, 25, 32 AND 50).

KAREN K. BUSH, EXAMINING ATTORNEY

SN 85-536,114. VELLOCET GROUP, LLC, SAN DIEGO, CA. FILED 2-7-2012.

VELLOCET

THE MARK CONSISTS OF STANDARD CHARACTERS WITHOUT CLAIM TO ANY PARTICULAR FONT, STYLE, SIZE, OR COLOR.

CLASS 25—CLOTHING

FOR MEN'S AND WOMEN'S JACKETS, COATS, TROUSERS, VESTS; MEN'S SUITS, WOMEN'S SUITS; WEARABLE GARMENTS AND CLOTHING, NAMELY, SHIRTS; WOMEN'S CLOTHING, NAMELY, SHIRTS, DRESSES, SKIRTS, BLOUSES (U.S. CLS. 22 AND 39).

CLASS 35—ADVERTISING AND BUSINESS

FOR ADVERTISING AND MARKETING; ADVERTISING AND MARKETING SERVICES PROVIDED BY MEANS OF INDIRECT METHODS OF MARKETING COMMUNICATIONS, NAMELY, SOCIAL MEDIA, SEARCH ENGINE MARKETING, INQUIRY MARKETING, INTERNET MARKETING, MOBILE MARKETING, BLOGGING AND OTHER FORMS OF PASSIVE, SHARABLE OR VIRAL COMMUNICATIONS CHANNELS (U.S. CLS. 100, 101 AND 102).

WILLIAM BRECKENFELD, EXAMINING ATTORNEY

SN 85-536,125. LITTLE SWITZERLAND, INC., TROY, MI.
FILED 2-7-2012.

SN 85-536,254. 28 IN 28 LLC, CLEARWATER, FL. FILED 2-7-2012.

BLINGOLOGIE

THE MARK CONSISTS OF STANDARD CHARACTERS WITHOUT CLAIM TO ANY PARTICULAR FONT, STYLE, SIZE, OR COLOR.

CLASS 14—JEWELRY

FOR JEWELRY (U.S. CLS. 2, 27, 28 AND 50).

CLASS 35—ADVERTISING AND BUSINESS

FOR ON-LINE RETAIL STORE SERVICES FEATURING JEWELRY; RETAIL STORE SERVICES FEATURING JEWELRY (U.S. CLS. 100, 101 AND 102).

JENNIFER VASQUEZ, EXAMINING ATTORNEY

SN 85-536,180. FLAGEOLI CLASSIC LIMITED, LLC, LAS VEGAS, NV. FILED 2-7-2012.



THE MARK CONSISTS OF AN ABSTRACT IMAGE OF A FLOWER BLOSSOM IN A FOUR POINT CONFIGURATION.

CLASS 3—COSMETICS AND CLEANING PREPARATIONS

FOR NON-MEDICATED PREPARATIONS ALL FOR THE CARE OF SKIN, HAIR AND SCALP (U.S. CLS. 1, 4, 6, 50, 51 AND 52).

FIRST USE 9-14-2011; IN COMMERCE 9-14-2011.

CLASS 5—PHARMACEUTICALS

FOR MEDICATED SKIN CARE PREPARATIONS, NAMELY, CREAMS, LOTIONS, GELS, TONERS, CLEANSERS AND PEELS (U.S. CLS. 6, 18, 44, 46, 51 AND 52).

FIRST USE 9-14-2011; IN COMMERCE 9-14-2011.
SUE LAWRENCE, EXAMINING ATTORNEY

THE COLOR(S) BLUE, GREEN, AND GREY IS/ARE CLAIMED AS A FEATURE OF THE MARK.

THE MARK CONSISTS OF THE NUMBER "28" IN TWO SHADES OF BLUE, THEN WORD "IN" IN GREY, AND THE NUMBER "28" AGAIN IN TWO SHADES OF GREEN.

CLASS 5—PHARMACEUTICALS

FOR DIETARY AND NUTRITIONAL SUPPLEMENTS USED FOR WEIGHT LOSS; WEIGHT MANAGEMENT SUPPLEMENTS (U.S. CLS. 6, 18, 44, 46, 51 AND 52).

FIRST USE 5-11-2011; IN COMMERCE 11-1-2011.

CLASS 41—EDUCATION AND ENTERTAINMENT

FOR CONSULTING SERVICES IN THE FIELDS OF FITNESS AND EXERCISE; PROVIDING A WEBSITE FEATURING INFORMATION ON EXERCISE AND FITNESS; PROVIDING INFORMATION IN THE FIELD OF EXERCISE TRAINING; PROVIDING INFORMATION ON PHYSICAL EXERCISE (U.S. CLS. 100, 101 AND 107).

FIRST USE 5-11-2011; IN COMMERCE 11-1-2011.

CLASS 44—MEDICAL, BEAUTY AND AGRICULTURAL SERVICES

FOR PROVIDING A WEBSITE FEATURING INFORMATION AND ADVICE IN THE FIELDS OF DIET, WEIGHT LOSS, DIET PLANNING AND LIFESTYLE WELLNESS; PROVIDING AN INTERACTIVE WEBSITE FEATURING INFORMATION AND LINKS RELATING TO HEALTHY LIVING AND WEIGHT LOSS; PROVIDING INFORMATION ON MAINTAINING A HEALTHY LIFESTYLE AND LOSING WEIGHT; PROVIDING WEIGHT LOSS PROGRAM SERVICES; WEIGHT MANAGEMENT SERVICES, NAMELY, PROVIDING WEIGHT LOSS AND/OR WEIGHT MAINTENANCE PROGRAMS; WEIGHT REDUCTION DIET PLANNING AND SUPERVISION (U.S. CLS. 100 AND 101).

FIRST USE 5-11-2011; IN COMMERCE 11-1-2011.

GINA FINK, EXAMINING ATTORNEY

SN 85-536,340. TAILORED LIVING, LLC, ORANGE, CA.
FILED 2-7-2012.

PREMIERSPACES

THE MARK CONSISTS OF STANDARD CHARACTERS WITHOUT CLAIM TO ANY PARTICULAR FONT, STYLE, SIZE, OR COLOR.

CLASS 35—ADVERTISING AND BUSINESS

FOR FRANCHISE SERVICES, NAMELY, OFFERING BUSINESS MANAGEMENT ASSISTANCE IN THE ESTABLISHMENT AND OPERATION OF BUSINESSES THAT DESIGN, SELL AND INSTALL ORGANIZING UNITS AND STORAGE AND ORGANIZING ACCESSORIES FOR CLOSETS, PANTRIES, HOME OFFICES, STOREROOMS, UTILITY ROOMS, BASEMENTS, LAUNDRY ROOMS, ATTICS AND GARAGES (U.S. CLS. 100, 101 AND 102).

CLASS 37—CONSTRUCTION AND REPAIR

FOR CUSTOM INSTALLATION OF ORGANIZING UNITS AND STORAGE AND ORGANIZING ACCESSORIES FOR CLOSETS, PANTRIES, HOME OFFICES, STOREROOMS, UTILITY ROOMS, BASEMENTS, LAUNDRY ROOMS, ATTICS AND GARAGES (U.S. CLS. 100, 103 AND 106).

CLASS 40—MATERIAL TREATMENT

FOR CUSTOM ASSEMBLY FOR OTHERS OF ORGANIZING UNITS AND STORAGE AND ORGANIZING ACCESSORIES FOR CLOSETS, PANTRIES, HOME OFFICES, STOREROOMS, UTILITY ROOMS, BASEMENTS, LAUNDRY ROOMS, ATTICS AND GARAGES (U.S. CLS. 100, 103 AND 106).

CLASS 42—SCIENTIFIC AND COMPUTER SERVICES

FOR DESIGN SERVICES IN THE FIELD OF CUSTOMIZED ORGANIZING UNITS AND STORAGE AND ORGANIZING ACCESSORIES FOR CLOSETS, PANTRIES, HOME OFFICES, STOREROOMS, UTILITY ROOMS, BASEMENTS, LAUNDRY ROOMS, ATTICS AND GARAGES (U.S. CLS. 100 AND 101).

LESLIE RICHARDS, EXAMINING ATTORNEY

SN 85-536,460. AMCOR LIMITED, BUENA PARK, CA. FILED 2-7-2012.

TEMPSAFE

THE MARK CONSISTS OF STANDARD CHARACTERS WITHOUT CLAIM TO ANY PARTICULAR FONT, STYLE, SIZE, OR COLOR.

CLASS 11—ENVIRONMENTAL CONTROL APPARATUS

FOR TEMPERATURE-CONTROLLED PORTABLE INSULATED SHIPPING CONTAINERS (U.S. CLS. 13, 21, 23, 31 AND 34).

CLASS 16—PAPER GOODS AND PRINTED MATTER

FOR INSULATED SHIPPING CONTAINERS FOR TRANSPORTING FROZEN MATERIALS MADE OF PAPER OR CARDBOARD (U.S. CLS. 2, 5, 22, 23, 29, 37, 38 AND 50).

CLASS 17—RUBBER GOODS

FOR MOLDED FOAM INSULATED CONTAINER PACKING FOR COMMERCIAL TRANSPORTATION (U.S. CLS. 1, 5, 12, 13, 35 AND 50).

CLASS 20—FURNITURE AND ARTICLES NOT OTHERWISE CLASSIFIED

FOR NON-PAPER AND PRIMARILY NON-METAL PORTABLE INSULATED SHIPPING CONTAINERS (U.S. CLS. 2, 13, 22, 25, 32 AND 50).

CLASS 42—SCIENTIFIC AND COMPUTER SERVICES

FOR DESIGN AND DEVELOPMENT OF INSULATED AND TEMPERATURE CONTROLLED INSULATED CONTAINERS AND PANELS; DESIGN AND TESTING FOR NEW PRODUCT DEVELOPMENT; DESIGN AND TESTING OF NEW PRODUCTS, NAMELY, INSULATED AND TEMPERATURE CONTROLLED CONTAINERS AND PANELS, FOR OTHERS; DESIGN FOR OTHERS IN THE FIELD OF INSULATED AND TEMPERATURE CONTROLLED CONTAINERS; DESIGN SERVICES FOR PACKAGING (U.S. CLS. 100 AND 101).

THEODORE MCBRIDE, EXAMINING ATTORNEY

SN 85-536,465. E! ENTERTAINMENT TELEVISION, LLC, LOS ANGELES, CA. FILED 2-7-2012.

**WORK IT. LIVE IT.
CELEBRATE IT.**

THE MARK CONSISTS OF STANDARD CHARACTERS WITHOUT CLAIM TO ANY PARTICULAR FONT, STYLE, SIZE, OR COLOR.

CLASS 38—COMMUNICATION

FOR TELEVISION, CABLE TELEVISION, SATELLITE TELEVISION, INTERNET AND RADIO BROADCASTING SERVICES; MOBILE MEDIA SERVICES IN THE NATURE OF ELECTRONIC TRANSMISSION OF ENTERTAINMENT MEDIA CONTENT; BROADCASTING, TRANSMISSION, AND PROVISION OF AUDIO AND VIDEO PROGRAMMING, AUDIO AND VISUAL CONTENT, AND ENTERTAINMENT MEDIA CONTENT VIA TELEVISION, CABLE TELEVISION, SATELLITE TELEVISION, VIDEO-ON-DEMAND, DIGITAL MEDIA, THE INTERNET, AND WIRELESS AND MOBILE NETWORKS (U.S. CLS. 100, 101 AND 104).

CLASS 41—EDUCATION AND ENTERTAINMENT

FOR EDUCATIONAL AND ENTERTAINMENT SERVICES, NAMELY, PROVIDING CONTENT IN THE FIELDS OF BUYER AND CONSUMER BEHAVIOR VIA THE INTERNET, MOBILE AND WIRELESS NETWORKS, AND BROADCAST, CABLE AND SATELLITE TELEVISION; PROVIDING INFORMATION IN THE FIELD OF ENTERTAINMENT FOR OTHERS VIA THE INTERNET AND PRINTED, AUDIO, AND VISUAL MATERIALS (U.S. CLS. 100, 101 AND 107).

MORGAN WYNNE, EXAMINING ATTORNEY

SN 85-536,485. E! ENTERTAINMENT TELEVISION, LLC, LOS ANGELES, CA. FILED 2-7-2012.

WORK IT. LIVE IT. LOVE IT.

THE MARK CONSISTS OF STANDARD CHARACTERS WITHOUT CLAIM TO ANY PARTICULAR FONT, STYLE, SIZE, OR COLOR.

CLASS 38—COMMUNICATION

FOR TELEVISION, CABLE TELEVISION, SATELLITE TELEVISION, INTERNET AND RADIO BROADCASTING SERVICES; MOBILE MEDIA SERVICES IN THE NATURE OF ELECTRONIC TRANSMISSION OF ENTERTAINMENT MEDIA CONTENT; BROADCASTING, TRANSMISSION, AND PROVISION OF AUDIO AND VIDEO PROGRAMMING, AUDIO AND VISUAL CONTENT, AND ENTERTAINMENT MEDIA CONTENT VIA TELEVISION, CABLE TELEVISION, SATELLITE TELEVISION, VIDEO-ON-DEMAND, DIGITAL MEDIA, THE INTERNET, AND WIRELESS AND MOBILE NETWORKS (U.S. CLS. 100, 101 AND 104).

SN 85-536,533. THE GAMBLE GROUP, LLC, DBA PER DOZEN, SAN FRANCISCO, CA. FILED 2-7-2012.

Per Dozen

THE MARK CONSISTS OF STANDARD CHARACTERS WITHOUT CLAIM TO ANY PARTICULAR FONT, STYLE, SIZE, OR COLOR.

CLASS 41—EDUCATION AND ENTERTAINMENT

FOR EDUCATIONAL AND ENTERTAINMENT SERVICES, NAMELY, PROVIDING CONTENT IN THE FIELDS OF BUYER AND CONSUMER BEHAVIOR VIA THE INTERNET, MOBILE AND WIRELESS NETWORKS, AND BROADCAST, CABLE AND SATELLITE TELEVISION; PROVIDING INFORMATION IN THE FIELD OF ENTERTAINMENT FOR OTHERS VIA THE INTERNET AND PRINTED, AUDIO, AND VISUAL MATERIALS (U.S. CLS. 100, 101 AND 107).

CLASS 14—JEWELRY

FOR BRACELETS; BROOCHES; CUFFLINKS; LAPEL PINS; NECKLACES; POCKET WATCHES; RINGS; TIE BARS; TIE CLIPS; TIE PINS; TIE TACKS; WATCHES (U.S. CLS. 2, 27, 28 AND 50).

MORGAN WYNNE, EXAMINING ATTORNEY

CLASS 25—CLOTHING

FOR BELTS; BOW TIES; DENIM JACKETS; DENIMS; HATS; JACKETS; NECKTIES; PANTS; POCKET KERICHEFS; POCKET SQUARES; SCARVES; SHIRTS; SHOES; SUITS; SWEATERS (U.S. CLS. 22 AND 39).
NAKIA HENRY, EXAMINING ATTORNEY

SN 85-536,494. THE EPITEC GROUP, INC., SOUTHFIELD, MI. FILED 2-7-2012.

SN 85-536,541. AMERICAN BLUE RIBBON HOLDINGS, LLC, DENVER, CO. FILED 2-7-2012.

PLACING PEOPLE FIRST

**EAT...TO GO....FEEL
GOOD.....**

THE MARK CONSISTS OF STANDARD CHARACTERS WITHOUT CLAIM TO ANY PARTICULAR FONT, STYLE, SIZE, OR COLOR.

THE MARK CONSISTS OF STANDARD CHARACTERS WITHOUT CLAIM TO ANY PARTICULAR FONT, STYLE, SIZE, OR COLOR.

CLASS 30—STAPLE FOODS

FOR BAKERY PRODUCTS (U.S. CL. 46).

CLASS 35—ADVERTISING AND BUSINESS

FOR EMPLOYMENT AGENCY SERVICES, NAMELY, FILLING THE TEMPORARY AND PERMANENT STAFFING NEEDS OF BUSINESSES; EMPLOYMENT HIRING, RECRUITING, PLACEMENT, STAFFING AND CAREER NETWORKING SERVICES; EMPLOYMENT STAFFING CONSULTATION SERVICES; EMPLOYMENT STAFFING IN THE FIELD OF INFORMATION TECHNOLOGY; PROFESSIONAL STAFFING AND RECRUITING SERVICES (U.S. CLS. 100, 101 AND 102).

CLASS 43—HOTEL AND RESTAURANT SERVICES

FOR CATERING SERVICES; RESTAURANT SERVICES; TAKE-OUT RESTAURANT SERVICES (U.S. CLS. 100 AND 101).
BRIDGETT SMITH, EXAMINING ATTORNEY

CLASS 42—SCIENTIFIC AND COMPUTER SERVICES

FOR BUSINESS TECHNOLOGY SOFTWARE CONSULTATION SERVICES; COMPUTER CONSULTATION; COMPUTER DIAGNOSTIC SERVICES; COMPUTER DISASTER RECOVERY PLANNING; COMPUTER PROGRAMMING AND SOFTWARE DESIGN; COMPUTER PROJECT MANAGEMENT SERVICES; COMPUTER SOFTWARE CONSULTING; CONSULTING IN THE FIELD OF INFORMATION TECHNOLOGY; CONSULTING IN THE FIELD OF IT PROJECT MANAGEMENT (U.S. CLS. 100 AND 101).

SN 85-536,644. NUCOR CORPORATION, CHARLOTTE, NC. FILED 2-8-2012.

NUBIM

THE MARK CONSISTS OF STANDARD CHARACTERS WITHOUT CLAIM TO ANY PARTICULAR FONT, STYLE, SIZE, OR COLOR.

DEZMONA MIZELLE, EXAMINING ATTORNEY

CLASS 9—ELECTRICAL AND SCIENTIFIC APPARATUS

FOR COMPUTER SOFTWARE FOR ENABLING THE COMPUTER AIDED DESIGN OF OBJECTS; COMPUTER SOFTWARE AND COMPUTER SOFTWARE PLATFORMS FOR GENERATING, MANAGING AND EXCHANGING DATA FOR USE IN THE DESIGN, CONSTRUCTION, AND MANAGEMENT OF BUILDINGS; COMPUTER SOFTWARE AND DOWNLOADABLE COMPUTER SOFTWARE FOR DESIGN, SIMULATION AND ENGINEERING OF BUILDINGS AND BUILDING COMPONENTS, RENDERING AND DISPLAYING DIGITAL OBJECTS REPRESENTING BUILDING COMPONENTS, PROVIDING A DATABASE OF DIGITAL REPRESENTATIONS OF BUILDING COMPONENTS, AND ELECTRONIC FULFILLMENT OF BUILDING COMPONENTS, ALL IN THE FIELD OF BUILDING DESIGN AND CONSTRUCTION (U.S. CLS. 21, 23, 26, 36 AND 38).

SN 85-536,688. C G PUBLISHING LLC, PATASKALA, OH. FILED 2-8-2012.

Forgot Your Password?
↑

CLASS 42—SCIENTIFIC AND COMPUTER SERVICES

FOR CONSULTING IN THE FIELDS OF ENGINEERING AND ARCHITECTURE; COMPUTER AIDED DESIGN FOR OTHERS; COMPUTER AIDED ENGINEERING SERVICES FOR OTHERS; STRUCTURAL ENGINEERING DESIGN SERVICES; CONSULTING IN THE FIELD OF STRUCTURAL ENGINEERING (U.S. CLS. 100 AND 101).
JOSETTE BEVERLY, EXAMINING ATTORNEY

THE MARK CONSISTS OF THE STYLIZED WORDS "FORGOT YOUR PASSWORD?". THE WORDS ARE UNDERLINED. AN IMAGE OF AN ARROW POINTING UPWARDS TOWARDS THE LETTER "SS" IN THE WORD "PASSWORD".

CLASS 16—PAPER GOODS AND PRINTED MATTER

FOR PENS; PERSONALIZED WRITING JOURNALS (U.S. CLS. 2, 5, 22, 23, 29, 37, 38 AND 50).
FIRST USE 11-11-2011; IN COMMERCE 11-11-2011.

CLASS 25—CLOTHING

FOR T-SHIRTS (U.S. CLS. 22 AND 39).
FIRST USE 11-11-2011; IN COMMERCE 11-11-2011.
ASMAT KHAN, EXAMINING ATTORNEY

SN 85-536,683. NAGLE, KIERA, BAYSIDE, NY. FILED 2-8-2012.

SN 85-536,732. CHARLES A. PADUANO, COOPER CITY, FL. FILED 2-8-2012.

MeridianMassage

THE MARK CONSISTS OF STANDARD CHARACTERS WITHOUT CLAIM TO ANY PARTICULAR FONT, STYLE, SIZE, OR COLOR.

CLASS 41—EDUCATION AND ENTERTAINMENT

FOR EDUCATION SERVICES, NAMELY, PROVIDING SEMINARS AND WORKSHOPS IN THE FIELD OF MASSAGE THERAPY (U.S. CLS. 100, 101 AND 107).
FIRST USE 1-1-2012; IN COMMERCE 2-1-2012.

CLASS 44—MEDICAL, BEAUTY AND AGRICULTURAL SERVICES

FOR MASSAGE THERAPY SERVICES (U.S. CLS. 100 AND 101).
FIRST USE 1-1-2012; IN COMMERCE 2-1-2012.
ZACHARY BELLO, EXAMINING ATTORNEY

THE MARK CONSISTS OF STANDARD CHARACTERS WITHOUT CLAIM TO ANY PARTICULAR FONT, STYLE, SIZE, OR COLOR.

CLASS 37—CONSTRUCTION AND REPAIR

FOR DRAIN AND SEWER CLEANING AND ROOTERING SERVICES; REPAIR OF SEWERS AND DRAINS; RESTORATION IN THE FIELD OF FLOOD DAMAGE; WASTE DISPOSAL FOR OTHERS (U.S. CLS. 100, 103 AND 106).

CLASS 40—MATERIAL TREATMENT

FOR RECYCLING OF WASTE AND TRASH (U.S. CLS. 100, 103 AND 106).
ALICIA COLLINS, EXAMINING ATTORNEY

1 888 MR ENVIRO

SN 85-536,752. CHARLES A. PADUANO, COOPER CITY, FL.
FILED 2-8-2012.

MR. ENVIRONMENTAL

THE MARK CONSISTS OF STANDARD CHARACTERS WITHOUT CLAIM TO ANY PARTICULAR FONT, STYLE, SIZE, OR COLOR.

CLASS 37—CONSTRUCTION AND REPAIR

FOR DRAIN AND SEWER CLEANING AND ROOTER-ING SERVICES; REPAIR OF SEWERS AND DRAINS; RESTORATION IN THE FIELD OF FLOOD DAMAGE; WASTE DISPOSAL FOR OTHERS (U.S. CLS. 100, 103 AND 106).

CLASS 40—MATERIAL TREATMENT

FOR RECYCLING OF WASTE AND TRASH (U.S. CLS. 100, 103 AND 106).
ALICIA COLLINS, EXAMINING ATTORNEY

SN 85-536,784. MULTI MEDIA EXPOSURE, INC., AKA MME,
BERNARDSVILLE, NJ. FILED 2-8-2012.

CLARKG & ME

THE MARK CONSISTS OF STANDARD CHARACTERS WITHOUT CLAIM TO ANY PARTICULAR FONT, STYLE, SIZE, OR COLOR.

CLASS 3—COSMETICS AND CLEANING PREPARATIONS

FOR DEODORIZERS FOR PETS; PET SHAMPOO AND CONDITIONER (U.S. CLS. 1, 4, 6, 50, 51 AND 52).

CLASS 5—PHARMACEUTICALS

FOR DIETARY PET SUPPLEMENTS IN THE FORM OF PET TREATS; DIETARY SUPPLEMENTS FOR PETS; VITAMINS FOR PETS (U.S. CLS. 6, 18, 44, 46, 51 AND 52).
MAUREEN DALL, EXAMINING ATTORNEY

SN 85-536,865. CAPFUZION, LLC, CHARLOTTE, NC. FILED
2-8-2012.

CAPFUZION

THE MARK CONSISTS OF STANDARD CHARACTERS WITHOUT CLAIM TO ANY PARTICULAR FONT, STYLE, SIZE, OR COLOR.

CLASS 14—JEWELRY

FOR BRACELETS; BROACHES; CHARMS; CHARMS FOR COLLAR JEWELRY AND BRACELET; JEWEL PENDANTS; JEWELRY; JEWELRY FOR ATTACHMENT TO CLOTHING; KEY CHAINS AS JEWELLERY; NECKLACES; PENDANTS; PINS BEING JEWELRY; RINGS; RINGS BEING JEWELRY (U.S. CLS. 2, 27, 28 AND 50).
FIRST USE 8-1-2010; IN COMMERCE 10-1-2010.

CLASS 26—FANCY GOODS

FOR CLOTHING ACCESSORIES, NAMELY, CHARMS FOR ATTACHMENT TO ZIPPER PULLS AND BUTTONS; ZIPPER PULLS (U.S. CLS. 37, 39, 40, 42 AND 50).
FIRST USE 8-1-2010; IN COMMERCE 10-1-2010.
ODESSA BIBBINS, EXAMINING ATTORNEY

SN 85-536,881. THE AL J SCHNEIDER COMPANY, LOUISVILLE, KY. FILED 2-8-2012.

NIGHT OF DERBY

THE MARK CONSISTS OF STANDARD CHARACTERS WITHOUT CLAIM TO ANY PARTICULAR FONT, STYLE, SIZE, OR COLOR.

CLASS 36—INSURANCE AND FINANCIAL

FOR CHARITABLE FUNDRAISING SERVICES BY MEANS OF AN ENTERTAINMENT EVENT (U.S. CLS. 100, 101 AND 102).

CLASS 41—EDUCATION AND ENTERTAINMENT

FOR ARRANGING AND CONDUCTING SPECIAL EVENTS FOR SOCIAL ENTERTAINMENT PURPOSES; ARRANGING, ORGANIZING, CONDUCTING, AND HOSTING SOCIAL ENTERTAINMENT EVENTS (U.S. CLS. 100, 101 AND 107).
LINDA POWELL, EXAMINING ATTORNEY

SN 85-536,900. YOLICKITY, LLC, ROCHESTER, NY. FILED
2-8-2012.

YOLICKITY

THE MARK CONSISTS OF STANDARD CHARACTERS WITHOUT CLAIM TO ANY PARTICULAR FONT, STYLE, SIZE, OR COLOR.

CLASS 30—STAPLE FOODS

FOR FROZEN YOGURT, FROZEN YOGURT CAKES, FROZEN YOGURT PIES, AND FROZEN YOGURT COOKIE SANDWICHES (U.S. CL. 46).

CLASS 35—ADVERTISING AND BUSINESS

FOR RETAIL STORE SERVICES FEATURING FROZEN YOGURT, FROZEN YOGURT CAKES, FROZEN YOGURT PIES, FROZEN YOGURT COOKIE SANDWICHES, BOTTLED WATER AND SOFT DRINKS (U.S. CLS. 100, 101 AND 102).

ANDREW LEASER, EXAMINING ATTORNEY

SN 85-536,938. SARA'S CITY WORKOUT, INC., NORTH-BROOK, IL. FILED 2-8-2012.

MANIA

THE MARK CONSISTS OF STANDARD CHARACTERS WITHOUT CLAIM TO ANY PARTICULAR FONT, STYLE, SIZE, OR COLOR.

CLASS 21—HOUSEWARES AND GLASS

FOR REUSABLE PLASTIC WATER BOTTLES SOLD EMPTY (U.S. CLS. 2, 13, 23, 29, 30, 33, 40 AND 50).
FIRST USE 0-0-2008; IN COMMERCE 0-0-2008.

CLASS 35—ADVERTISING AND BUSINESS

FOR ARRANGING AND CONDUCTING TRADE SHOW EXHIBITIONS IN THE FIELD OF PHYSICAL FITNESS; ARRANGING AND CONDUCTING TRADE SHOWS IN THE FIELD OF PHYSICAL FITNESS EDUCATION; ORGANIZING BUSINESS EXPOSITIONS FOR PHYSICAL FITNESS PROFESSIONALS (U.S. CLS. 100, 101 AND 102).

FIRST USE 10-0-1988; IN COMMERCE 10-0-1988.

CLASS 41—EDUCATION AND ENTERTAINMENT

FOR EDUCATIONAL SERVICES, NAMELY, CONDUCTING CLASSES, SEMINARS, CONFERENCES, WORKSHOPS AND CONVENTIONS IN THE FIELD OF PHYSICAL FITNESS; EDUCATIONAL SERVICES, NAMELY, PROVIDING TRAINING OF FITNESS PROFESSIONALS FOR CERTIFICATION IN THE FIELD OF PHYSICAL FITNESS INSTRUCTION; PHYSICAL FITNESS INSTRUCTION; PHYSICAL FITNESS TRAINING OF INDIVIDUALS AND GROUPS; PHYSICAL FITNESS TRAINING SERVICES; PROVIDING A WEBSITE FEATURING INFORMATION ON EXERCISE AND FITNESS (U.S. CLS. 100, 101 AND 107).

FIRST USE 10-0-1988; IN COMMERCE 10-0-1988.
DOMINICK J. SALEMI, EXAMINING ATTORNEY

SN 85-536,961. MARTIN W. FOURKILLER, FARMERS BRANCH, TX. FILED 2-8-2012.

4KILLER

THE MARK CONSISTS OF STANDARD CHARACTERS WITHOUT CLAIM TO ANY PARTICULAR FONT, STYLE, SIZE, OR COLOR.

CLASS 25—CLOTHING

FOR CLOTHING, NAMELY, SHIRTS, HATS, SHORTS AND JACKETS (U.S. CLS. 22 AND 39).

CLASS 28—TOYS AND SPORTING GOODS

FOR FISHING TACKLE AND LURES (U.S. CLS. 22, 23, 38 AND 50).

MICHAEL WEBSTER, EXAMINING ATTORNEY

SN 85-537,098. HANK SHALOM, NEW YORK, NY. FILED 2-8-2012.

WILIM

THE MARK CONSISTS OF STANDARD CHARACTERS WITHOUT CLAIM TO ANY PARTICULAR FONT, STYLE, SIZE, OR COLOR.

CLASS 25—CLOTHING

FOR ATHLETIC CLOTHING, NAMELY, SHIRTS, PANTS, JACKETS, SHORTS, TOPS, HEADWEAR (U.S. CLS. 22 AND 39).

CLASS 28—TOYS AND SPORTING GOODS

FOR PERSONAL EXERCISE MATS (U.S. CLS. 22, 23, 38 AND 50).

DOMINIC FATHY, EXAMINING ATTORNEY

SN 85-537,187. COOPERSURGICAL, INC., TRUMBULL, CT. FILED 2-8-2012.

GYNEFIX

THE MARK CONSISTS OF STANDARD CHARACTERS WITHOUT CLAIM TO ANY PARTICULAR FONT, STYLE, SIZE, OR COLOR.

CLASS 5—PHARMACEUTICALS

FOR PHARMACEUTICAL PREPARATIONS, NAMELY, A DRUG DELIVERY SYSTEM COMPRISING COPPER AGENTS THAT FACILITATE THE DELIVERY OF PHARMACEUTICALS FOR USE IN CONTRACEPTION (U.S. CLS. 6, 18, 44, 46, 51 AND 52).

CLASS 10—MEDICAL APPARATUS

FOR MEDICAL DEVICES, NAMELY, INTRAUTERINE DEVICE CONSISTING OF COPPER SLEEVES THREADED ON A LENGTH OF SUTURE MATERIAL USED FOR CONTRACEPTION AND REPLACEMENT PARTS THEREFOR (U.S. CLS. 26, 39 AND 44).

JENNY PARK, EXAMINING ATTORNEY

SN 85-537,312. BONAGRA CO., HIALEAH, FL. FILED 2-8-2012.

BONAGRA

THE MARK CONSISTS OF STANDARD CHARACTERS WITHOUT CLAIM TO ANY PARTICULAR FONT, STYLE, SIZE, OR COLOR.

CLASS 29—MEATS AND PROCESSED FOODS

FOR FRUIT AND SOY BASED SNACK FOOD; FRUIT-BASED FOOD BEVERAGE; MILK BEVERAGES CONTAINING FRUITS; POWDERED MILK FOR FOOD PURPOSES; PRESERVED SOYA BEANS FOR FOOD; SOY-BASED FOOD BEVERAGE USED AS A MILK SUBSTITUTE (U.S. CL. 46).

CLASS 32—LIGHT BEVERAGES

FOR SOY-BASED BEVERAGES NOT BEING MILK SUBSTITUTES; SYRUP SUBSTITUTES FOR MAKING BEVERAGES; SYRUPS FOR BEVERAGES; SYRUPS FOR MAKING BEVERAGES (U.S. CLS. 45, 46 AND 48).
TOBY BULLOFF, EXAMINING ATTORNEY

SN 85-537,374. LANIADO, MOSHE, OAKHURST, NJ. FILED 2-8-2012.

S4A

THE MARK CONSISTS OF STANDARD CHARACTERS WITHOUT CLAIM TO ANY PARTICULAR FONT, STYLE, SIZE, OR COLOR.

CLASS 25—CLOTHING

FOR SWIMSUITS (U.S. CLS. 22 AND 39).

CLASS 35—ADVERTISING AND BUSINESS

FOR ON-LINE RETAIL STORE SERVICES FEATURING SWIMWEAR (U.S. CLS. 100, 101 AND 102).
JOHN KELLY, EXAMINING ATTORNEY

SN 85-537,403. ERIK HARRINGTON, DALLAS, TX. FILED 2-8-2012.

Window to the Body

THE MARK CONSISTS OF STANDARD CHARACTERS WITHOUT CLAIM TO ANY PARTICULAR FONT, STYLE, SIZE, OR COLOR.

CLASS 3—COSMETICS AND CLEANING PREPARATIONS

FOR TOOTH PASTE (U.S. CLS. 1, 4, 6, 50, 51 AND 52).

CLASS 21—HOUSEWARES AND GLASS

FOR TOOTH BRUSHES (U.S. CLS. 2, 13, 23, 29, 30, 33, 40 AND 50).

CLASS 44—MEDICAL, BEAUTY AND AGRICULTURAL SERVICES

FOR DENTIST SERVICES (U.S. CLS. 100 AND 101).
DEIRDRE ROBERTSON, EXAMINING ATTORNEY

SN 85-537,546. EBNER PUBLISHING INTERNATIONAL, INC., NEW YORK, NY. FILED 2-8-2012.

WATCHTIME

THE MARK CONSISTS OF STANDARD CHARACTERS WITHOUT CLAIM TO ANY PARTICULAR FONT, STYLE, SIZE, OR COLOR.

CLASS 9—ELECTRICAL AND SCIENTIFIC APPARATUS

FOR DOWNLOADABLE ELECTRONIC PUBLICATION IN THE NATURE OF A MAGAZINE FEATURING WRISTWATCHES (U.S. CLS. 21, 23, 26, 36 AND 38).
FIRST USE 12-31-2010; IN COMMERCE 12-31-2010.

CLASS 16—PAPER GOODS AND PRINTED MATTER

FOR MAGAZINE FEATURING WRISTWATCHES (U.S. CLS. 2, 5, 22, 23, 29, 37, 38 AND 50).
FIRST USE 12-31-1999; IN COMMERCE 12-31-1999.
MARTHA FROMM, EXAMINING ATTORNEY

SN 85-537,734. LDH HAWAII INC., HONOLULU, HI. FILED 2-8-2012.



THE MARK CONSISTS OF PARTIALLY OVERLAPPING NUMBERS 2 AND 4 IN THE CENTER OF A CIRCLE.

CLASS 9—ELECTRICAL AND SCIENTIFIC APPARATUS

FOR CELLULAR PHONE ACCESSORY CHARMS (U.S. CLS. 21, 23, 26, 36 AND 38).
FIRST USE 4-1-2011; IN COMMERCE 4-1-2011.

CLASS 18—LEATHER GOODS

FOR TOTE BAGS (U.S. CLS. 1, 2, 3, 22 AND 41).
FIRST USE 4-1-2011; IN COMMERCE 4-1-2011.

CLASS 24—FABRICS

FOR BEACH TOWELS (U.S. CLS. 42 AND 50).
FIRST USE 4-1-2011; IN COMMERCE 4-1-2011.

CLASS 25—CLOTHING

FOR FLIP FLOPS; HATS; SHORTS; SWEATSHIRTS; T-SHIRTS (U.S. CLS. 22 AND 39).
FIRST USE 4-1-2011; IN COMMERCE 4-1-2011.
PAM WILLIS, EXAMINING ATTORNEY

SN 85-537,868. WANKOWSKI, NORMAN, BERLIN, FED REP GERMANY, FILED 2-9-2012.

THE MARK CONSISTS OF THE STYLIZED LETTERS RSB.

CLASS 18—LEATHER GOODS

FOR BACKPACKS, BOOK BAGS, SPORTS BAGS, BUM BAGS, WALLETS AND HANDBAGS; LEATHER BAGS AND WALLETS (U.S. CLS. 1, 2, 3, 22 AND 41).

CLASS 25—CLOTHING

FOR CAPS; DRESSES; HATS; JACKETS; PANTS; SHIRTS (U.S. CLS. 22 AND 39).
JEFF DEFORD, EXAMINING ATTORNEY

SN 85-537,898. BALL STATE UNIVERSITY, MUNCIE, IN. FILED 2-9-2012.

THE MARK CONSISTS OF STANDARD CHARACTERS WITHOUT CLAIM TO ANY PARTICULAR FONT, STYLE, SIZE, OR COLOR.

CLASS 21—HOUSEWARES AND GLASS

FOR BEVERAGE GLASSWARE (U.S. CLS. 2, 13, 23, 29, 30, 33, 40 AND 50).
FIRST USE 1-1-2010; IN COMMERCE 1-1-2010.

CLASS 25—CLOTHING

FOR ATHLETIC APPAREL, NAMELY, SHIRTS, PANTS, JACKETS, FOOTWEAR, HATS AND CAPS, ATHLETIC UNIFORMS (U.S. CLS. 22 AND 39).
FIRST USE 1-1-2010; IN COMMERCE 1-1-2010.
REBECCA SMITH, EXAMINING ATTORNEY

SN 85-537,909. ACCUBUILT, INC., LIMA, OH. FILED 2-9-2012.



THE MARK CONSISTS OF A STYLIZED CHEVRON.

CLASS 12—VEHICLES

FOR FUNERAL VEHICLES, NAMELY, FUNERAL CARS, FUNERAL COACHES, FUNERAL TRUCKS, HEARSEs AND FLOWER CARS (U.S. CLS. 19, 21, 23, 31, 35 AND 44).
FIRST USE 9-0-2008; IN COMMERCE 9-0-2008.

CLASS 35—ADVERTISING AND BUSINESS

FOR AUTOMOBILE DEALERSHIP SERVICES OF SPECIALTY VEHICLES, NAMELY, LIMOUSINES AND FUNERAL COACHES (U.S. CLS. 100, 101 AND 102).
FIRST USE 9-0-2008; IN COMMERCE 9-0-2008.

CLASS 40—MATERIAL TREATMENT

FOR CUSTOM MANUFACTURE OF SPECIALTY VEHICLES (U.S. CLS. 100, 103 AND 106).
FIRST USE 9-0-2008; IN COMMERCE 9-0-2008.

CLASS 42—SCIENTIFIC AND COMPUTER SERVICES

FOR DESIGN FOR OTHERS OF SPECIALTY VEHICLES (U.S. CLS. 100 AND 101).
FIRST USE 9-0-2008; IN COMMERCE 9-0-2008.
ADA HAN, EXAMINING ATTORNEY

SN 85-538,059. DEATH ADDERS INC., BROOKLYN, NY. FILED 2-9-2012.

SN 85-538,353. CRI 2000, L.P., SAN DIEGO, CA. FILED 2-9-2012.



THE MARK CONSISTS OF AN IMAGE OF A STYLIZED EYEBALL LOOKING TOWARDS THE TOP RIGHT.

CLASS 18—LEATHER GOODS

FOR BACKPACKS; DUFFEL BAGS; MESSENGER BAGS (U.S. CLS. 1, 2, 3, 22 AND 41). FIRST USE 2-1-2007; IN COMMERCE 2-1-2007.

CLASS 25—CLOTHING

FOR HATS; JACKETS; POLO SHIRTS; SHIRTS (U.S. CLS. 22 AND 39). FIRST USE 2-1-2007; IN COMMERCE 2-1-2007. JILL PRATER, EXAMINING ATTORNEY

SN 85-538,185. MEDICALL, A CALIFORNIA CORPORATION, PLEASANTON, CA. FILED 2-9-2012.

UM Continuum

THE MARK CONSISTS OF STANDARD CHARACTERS WITHOUT CLAIM TO ANY PARTICULAR FONT, STYLE, SIZE, OR COLOR.

CLASS 35—ADVERTISING AND BUSINESS

FOR MANAGED CARE SERVICES, NAMELY, UTILIZATION REVIEW AND PRE-CERTIFICATION SERVICES (U.S. CLS. 100, 101 AND 102). FIRST USE 1-5-2011; IN COMMERCE 1-5-2011.

CLASS 36—INSURANCE AND FINANCIAL

FOR MEDICAL INSURANCE CASE AND UTILIZATION REVIEW AND INSURANCE CLAIMS ADJUSTMENT SERVICES FOR HEALTHCARE PURCHASERS AND PAYORS AND PROVIDERS AND MEDICARE BENEFICIARIES (U.S. CLS. 100, 101 AND 102). FIRST USE 9-5-2010; IN COMMERCE 1-5-2011. NAAKWAMA ANKRAH, EXAMINING ATTORNEY

LIGHTSPEED

THE MARK CONSISTS OF STANDARD CHARACTERS WITHOUT CLAIM TO ANY PARTICULAR FONT, STYLE, SIZE, OR COLOR.

OWNER OF U.S. REG. NO. 3,703,318.

CLASS 20—FURNITURE AND ARTICLES NOT OTHERWISE CLASSIFIED

FOR SLEEPING MATS (U.S. CLS. 2, 13, 22, 25, 32 AND 50).

CLASS 24—FABRICS

FOR BLANKETS FOR OUTDOOR USE (U.S. CLS. 42 AND 50). JEFFREY LOOK, EXAMINING ATTORNEY

SN 85-538,455. ROBINETT, RONALD, PHOENIX, AZ. FILED 2-9-2012.

KINDNESS GATEWAY

THE MARK CONSISTS OF STANDARD CHARACTERS WITHOUT CLAIM TO ANY PARTICULAR FONT, STYLE, SIZE, OR COLOR.

CLASS 25—CLOTHING

FOR T-SHIRTS (U.S. CLS. 22 AND 39).

CLASS 35—ADVERTISING AND BUSINESS

FOR ON-LINE RETAIL STORE SERVICES FEATURING T-SHIRTS (U.S. CLS. 100, 101 AND 102). SOPHIA S. KIM, EXAMINING ATTORNEY

SN 85-538,466. CHEATERTVILLE, INC, LAS VEGAS, NV. FILED 2-9-2012.

FROM RAGS TO DITCHES

THE MARK CONSISTS OF STANDARD CHARACTERS WITHOUT CLAIM TO ANY PARTICULAR FONT, STYLE, SIZE, OR COLOR.

CLASS 41—EDUCATION AND ENTERTAINMENT

FOR EDUCATIONAL AND ENTERTAINMENT SERVICES, NAMELY, PROVIDING MOTIVATIONAL AND EDUCATIONAL SPEAKERS IN THE FIELD OF SELF-AND PERSONAL IMPROVEMENT (U.S. CLS. 100, 101 AND 107).

CLASS 45—PERSONAL AND LEGAL SERVICES

FOR PERSONAL GROWTH AND MOTIVATION CONSULTING SERVICES (U.S. CLS. 100 AND 101).
CHRISTINE MARTIN, EXAMINING ATTORNEY

SN 85-538,494. STEVEN AND WILLIAM LADD INCORPORATED, DBA STEVEN AND WILLIAM, BROOKLYN, NY. FILED 2-9-2012.

STEVEN & WILLIAM

THE MARK CONSISTS OF STANDARD CHARACTERS WITHOUT CLAIM TO ANY PARTICULAR FONT, STYLE, SIZE, OR COLOR.

CLASS 14—JEWELRY

FOR JEWELRY AND FASHION JEWELRY, BRACELETS, NECKLACES, PENDANTS (U.S. CLS. 2, 27, 28 AND 50).

FIRST USE 1-31-2001; IN COMMERCE 1-31-2001.

CLASS 18—LEATHER GOODS

FOR LEATHER AND NON-LEATHER HANDBAGS, TOTE BAGS, WALLETS, CLUTCH PURSES, COIN PURSES, TRAVEL BAGS, LUGGAGE (U.S. CLS. 1, 2, 3, 22 AND 41).

FIRST USE 1-31-2001; IN COMMERCE 1-31-2001.
KATHLEEN KOLACZ, EXAMINING ATTORNEY

SN 85-538,514. SKINAGAIN, LLC, CARLSBAD, CA. FILED 2-9-2012.

VisagePro

THE MARK CONSISTS OF STANDARD CHARACTERS WITHOUT CLAIM TO ANY PARTICULAR FONT, STYLE, SIZE, OR COLOR.

CLASS 3—COSMETICS AND CLEANING PREPARATIONS

FOR NON-MEDICATED PREPARATIONS ALL FOR THE CARE OF SKIN, HAIR AND SCALP (U.S. CLS. 1, 4, 6, 50, 51 AND 52).

CLASS 10—MEDICAL APPARATUS

FOR COSMETIC APPARATUS, NAMELY, LIGHT BASED DEVICES PROVIDING MAINLY PULSED LIGHT FOR PERFORMING NON-ABLATIVE AESTHETIC SKIN TREATMENT PROCEDURES; ELECTROMEDICAL REHABILITATIVE AND PAIN MANAGEMENT PRODUCTS FOR CLINICAL AND HOME USE, NAMELY, ELECTRICAL NERVE AND MUSCLE STIMULATORS, ULTRASONIC STIMULATORS, MAGNET THERAPY STIMULATORS AND LASER THERAPY STIMULATORS; ELECTRONIC AESTHETIC SKIN TREATMENT DEVICES USING LIGHT EMITTING DIODES, NAMELY, INFRARED, RED, ORANGE, YELLOW, GREEN, AND BLUE WAVELENGTHS FOR GENERATING LIGHT RAYS; ELECTRONIC LIGHT THERAPY APPARATUS FOR THE SKIN; ELECTRONIC STIMULATOR FOR THE SKIN; FACIAL TONING MACHINES FOR COSMETIC USE; LASERS FOR THE COSMETIC TREATMENT OF THE FACE AND SKIN; LIGHT EMITTING DEVICES, NAMELY, LAMPS AND LED DEVICES FOR TREATMENT OF A VARIETY OF SKIN CONDITIONS; LIGHT-BASED MEDICAL DEVICES, NAMELY, A LIGHT EMITTING DIODE (LED) DEVICE FOR INCREASING THE HUMAN BODY'S OWN PRODUCTION OF COLLAGEN (U.S. CLS. 26, 39 AND 44).

RENEE MCCRAY, EXAMINING ATTORNEY

SN 85-538,527. KAMLA HOTELS, INC, DOWNEY, CA. FILED 2-9-2012.



THE STIPPLING IS A FEATURE OF THE MARK AND DOES NOT INDICATE COLOR; THE STIPPLING IS FOR SHADING PURPOSES ONLY.

THE MARK CONSISTS OF A STYLIZED LOTUS FLOWER.

CLASS 35—ADVERTISING AND BUSINESS

FOR HOTEL, RESORT, SPA, RESTAURANT AND BAR MANAGEMENT FOR OTHERS; PROJECT MANAGEMENT SERVICES IN THE FIELD OF REAL ESTATE, NAMELY, BUSINESS MANAGEMENT OF HOTEL RENOVATION AND RECONSTRUCTION PROJECTS FOR OTHERS (U.S. CLS. 100, 101 AND 102).

FIRST USE 11-23-2010; IN COMMERCE 11-23-2010.

CLASS 36—INSURANCE AND FINANCIAL

FOR INVESTMENT SERVICES, NAMELY REAL ESTATE INVESTMENT FOR HOTELS, RESORTS, SPAS, RESTAURANTS AND BARS, MARKETED TO INVESTORS IN COMMERCIAL REAL ESTATE (U.S. CLS. 100, 101 AND 102).

FIRST USE 11-23-2010; IN COMMERCE 11-23-2010.

CLASS 37—CONSTRUCTION AND REPAIR

FOR REAL ESTATE DEVELOPMENT AND CONSTRUCTION OF COMMERCIAL, RESIDENTIAL AND HOTEL PROPERTY (U.S. CLS. 100, 103 AND 106).

FIRST USE 11-23-2010; IN COMMERCE 11-23-2010.
REBECCA SMITH, EXAMINING ATTORNEY

SN 85-538,602. RECO PRODUCTIONS INTERNATIONAL BV, WASSENAAR, NETHERLANDS, FILED 2-9-2012.

JOURNEY THROUGH THE HUMAN BODY

THE MARK CONSISTS OF STANDARD CHARACTERS WITHOUT CLAIM TO ANY PARTICULAR FONT, STYLE, SIZE, OR COLOR.

CLASS 16—PAPER GOODS AND PRINTED MATTER

FOR PRINTED MATTER, NAMELY, PRINTED INSTRUCTIONAL, EDUCATIONAL AND TEACHING MATERIALS RELATING TO THE FORM AND FUNCTION OF THE HUMAN BODY (U.S. CLS. 2, 5, 22, 23, 29, 37, 38 AND 50).

CLASS 25—CLOTHING

FOR CLOTHING, NAMELY, TOPS, BOTTOMS, JACKETS, SOCKS, JERSEYS, SHIRTS, SHORTS, STOCKINGS, SWEATSHIRTS, T-SHIRTS, TRACK SUITS, POLO SHIRTS, SHIRTS FOR SPORTS, TROUSERS FOR SPORTS, JACKETS FOR SPORTS, SHORTS FOR SPORTS, FOOTBALL SHIRTS, RUGBY SHIRTS, RAINWEAR, RAIN COATS, SWEATERS, PULLOVERS, CARDIGANS, SKIRTS, DRESSES, TROUSERS, TIGHTS, DRESSING GOWNS, SCARVES, GLOVES, COATS, SWIMWEAR, TENNIS WEAR, UNDERWEAR, VESTS, YOGA PANTS, TIES; HEADGEAR IN THE NATURE OF HATS, CAPS AND SUN VISORS; BELTS; FOOTWEAR (U.S. CLS. 22 AND 39).

CLASS 41—EDUCATION AND ENTERTAINMENT

FOR EDUCATIONAL SERVICES, NAMELY, THEME EXHIBITIONS, ART EXHIBITIONS, SEMINARS AND WORKSHOPS IN THE FIELD OF THE FORM AND FUNCTION OF THE HUMAN BODY; EDUCATIONAL SERVICES, NAMELY, THEME EXHIBITIONS, ART EXHIBITIONS, GUIDED TOURS, SEMINARS AND WORKSHOPS PROVIDED IN MUSEUMS IN THE FIELD OF THE FORM AND FUNCTION OF THE HUMAN BODY (U.S. CLS. 100, 101 AND 107).

MICHAEL GAAFAR, EXAMINING ATTORNEY

SN 85-538,610. LIMES DATENTECHNIK GMBH, BAD HOMBOURG V.D.H., FED REP GERMANY, FILED 2-9-2012.

FLAMFILE

THE MARK CONSISTS OF STANDARD CHARACTERS WITHOUT CLAIM TO ANY PARTICULAR FONT, STYLE, SIZE, OR COLOR.

OWNER OF U.S. REG. NO. 2,270,928.

CLASS 9—ELECTRICAL AND SCIENTIFIC APPARATUS

FOR COMPUTER PROGRAMS FOR THE STORAGE, CONVERSION, ENCODING AND DECODING, ARCHIVING AND TRANSMISSION OF DATA (U.S. CLS. 21, 23, 26, 36 AND 38).

CLASS 42—SCIENTIFIC AND COMPUTER SERVICES

FOR DESIGN AND DEVELOPMENT OF COMPUTER SOFTWARE FOR THE STORAGE, CONVERSION, ENCODING AND DECODING, ARCHIVING AND TRANSMISSION OF DATA; CONSULTANCY FOR THE USERS OF COMPUTER SOFTWARE FOR THE STORAGE, CONVERSION, ENCODING AND DECODING, ARCHIVING AND TRANSMISSION OF DATA; SERVICING AND MAINTENANCE OF COMPUTER SOFTWARE FOR THE STORAGE, CONVERSION, ENCODING AND DECODING, ARCHIVING AND TRANSMISSION OF DATA (U.S. CLS. 100 AND 101).

LINDA MICKLEBURGH, EXAMINING ATTORNEY

SN 85-538,612. RECO PRODUCTIONS INTERNATIONAL BV, WASSENAAR, NETHERLANDS, FILED 2-9-2012.

CORPUS

THE MARK CONSISTS OF STANDARD CHARACTERS WITHOUT CLAIM TO ANY PARTICULAR FONT, STYLE, SIZE, OR COLOR.

OWNER OF U.S. REG. NO. 3,983,056.

CLASS 16—PAPER GOODS AND PRINTED MATTER

FOR PRINTED MATTER, NAMELY, PRINTED INSTRUCTIONAL, EDUCATIONAL AND TEACHING MATERIALS RELATING TO THE FORM AND FUNCTION OF THE HUMAN BODY (U.S. CLS. 2, 5, 22, 23, 29, 37, 38 AND 50).

CLASS 25—CLOTHING

FOR CLOTHING, NAMELY, TOPS, BOTTOMS, JACKETS, SOCKS, JERSEYS, SHIRTS, SHORTS, STOCKINGS, SWEATSHIRTS, T-SHIRTS, TRACK SUITS, POLO SHIRTS, SHIRTS FOR SPORTS, TROUSERS FOR SPORTS, JACKETS FOR SPORTS, SHORTS FOR SPORTS, FOOTBALL SHIRTS, RUGBY SHIRTS, RAINWEAR, RAIN COATS, SWEATERS, PULLOVERS, CARDIGANS, SKIRTS, DRESSES, TROUSERS, TIGHTS, DRESSING GOWNS, SCARVES, GLOVES, COATS, SWIMWEAR, TENNIS WEAR, UNDERWEAR, VESTS, YOGA PANTS, TIES; HEADGEAR IN THE NATURE OF HATS, CAPS AND SUN VISORS; BELTS; FOOTWEAR (U.S. CLS. 22 AND 39).

CLASS 41—EDUCATION AND ENTERTAINMENT

FOR EDUCATIONAL SERVICES, NAMELY, THEME EXHIBITIONS, ART EXHIBITIONS, SEMINARS AND WORKSHOPS IN THE FIELD OF THE FORM AND FUNCTION OF THE HUMAN BODY; EDUCATIONAL SERVICES, NAMELY, THEME EXHIBITIONS, ART EXHIBITIONS, GUIDED TOURS, SEMINARS AND WORKSHOPS PROVIDED IN MUSEUMS IN THE FIELD OF THE FORM AND FUNCTION OF THE HUMAN BODY (U.S. CLS. 100, 101 AND 107).

MICHAEL GAAFAR, EXAMINING ATTORNEY

SN 85-538,658. HOLTZBERRY FARMS, LLC, WINTER HAVEN, FL. FILED 2-9-2012.

SN 85-538,766. ROMANO, CHASE, HOUSTON, TX. FILED 2-9-2012.

YUMMY TEAM

THE MARK CONSISTS OF STANDARD CHARACTERS WITHOUT CLAIM TO ANY PARTICULAR FONT, STYLE, SIZE, OR COLOR.

CLASS 21—HOUSEWARES AND GLASS

FOR COOKIE CUTTERS (U.S. CLS. 2, 13, 23, 29, 30, 33, 40 AND 50).

CLASS 30—STAPLE FOODS

FOR COOKIE DOUGH (U.S. CL. 46).
TIMOTHY FINNEGAN, EXAMINING ATTORNEY

SN 85-538,708. ARY, INC., DBA AFTERMATH ENTERTAINMENT, LOS ANGELES, CA. FILED 2-9-2012.

AFTERMATH

THE MARK CONSISTS OF STANDARD CHARACTERS WITHOUT CLAIM TO ANY PARTICULAR FONT, STYLE, SIZE, OR COLOR.

OWNER OF U.S. REG. NO. 1,692,053.

CLASS 9—ELECTRICAL AND SCIENTIFIC APPARATUS

FOR MUSICAL SOUND RECORDINGS; DOWNLOADABLE MUSICAL SOUND RECORDINGS (U.S. CLS. 21, 23, 26, 36 AND 38).

FIRST USE 0-0-1996; IN COMMERCE 0-0-1996.

CLASS 41—EDUCATION AND ENTERTAINMENT

FOR PROVIDING A WEBSITE FEATURING NON-DOWNLOADABLE AUDIO AND AUDIOVISUAL RECORDINGS FEATURING MUSIC AND MUSICAL-BASED ENTERTAINMENT; PROVIDING PICTURES AND INFORMATION ON A RECORD LABEL, MUSIC, MUSICAL ARTISTS, MUSIC VIDEOS, RECORD PRODUCERS AND NEWS RELATING TO THE MUSIC AND ENTERTAINMENT INDUSTRIES; PROVIDING A WEBSITE WHERE USERS CAN POST COMMENTS ABOUT RECORDINGS, MUSICAL ARTISTS AND COMMENTS ABOUT THE MUSIC INDUSTRY; ONLINE JOURNALS, NAMELY, BLOGS IN THE FIELD OF MUSIC AND THE MUSIC INDUSTRY; PRODUCTION OF AUDIO RECORDINGS (U.S. CLS. 100, 101 AND 107).

FIRST USE 0-0-2001; IN COMMERCE 0-0-2001.
CAROLINE WOOD, EXAMINING ATTORNEY

" Never lose sight, Never
lose faith, Never lose
yourself."

THE MARK CONSISTS OF STANDARD CHARACTERS WITHOUT CLAIM TO ANY PARTICULAR FONT, STYLE, SIZE, OR COLOR.

CLASS 14—JEWELRY

FOR RUBBER OR SILICON WRISTBANDS IN THE NATURE OF A BRACELET (U.S. CLS. 2, 27, 28 AND 50).

CLASS 25—CLOTHING

FOR HOODED SWEATSHIRTS; PANTS; SHIRTS; SHOES; SWEATERS; T-SHIRTS (U.S. CLS. 22 AND 39).
JOHN DWYER, EXAMINING ATTORNEY

SN 85-538,851. MAX PROTECTION LLC, KENT, WA. FILED 2-9-2012.

PERFECT FIT

THE MARK CONSISTS OF STANDARD CHARACTERS WITHOUT CLAIM TO ANY PARTICULAR FONT, STYLE, SIZE, OR COLOR.

CLASS 16—PAPER GOODS AND PRINTED MATTER

FOR TRADING CARDS (U.S. CLS. 2, 5, 22, 23, 29, 37, 38 AND 50).

CLASS 28—TOYS AND SPORTING GOODS

FOR CARD GAMES; GAME CARDS; PLAYING CARD CASES; PLAYING CARDS; TRADING CARD GAMES (U.S. CLS. 22, 23, 38 AND 50).

ZACHARY BELLO, EXAMINING ATTORNEY

SN 85-538,875. DASH FIT, LLC, DBA OX BOX GYM, SEATTLE, WA. FILED 2-9-2012.

OX BOX

THE MARK CONSISTS OF STANDARD CHARACTERS WITHOUT CLAIM TO ANY PARTICULAR FONT, STYLE, SIZE, OR COLOR.

CLASS 41—EDUCATION AND ENTERTAINMENT

FOR PHYSICAL FITNESS TRAINING SERVICES (U.S. CLS. 100, 101 AND 107).
FIRST USE 10-30-2011; IN COMMERCE 10-30-2011.

CLASS 44—MEDICAL, BEAUTY AND AGRICULTURAL SERVICES

FOR MASSAGE THERAPY SERVICES (U.S. CLS. 100 AND 101).
FIRST USE 10-30-2011; IN COMMERCE 10-30-2011.
JOHN DWYER, EXAMINING ATTORNEY

SN 85-538,989. ZHONGSHAN GUIYUAN LIQUOR TRADING CO., LTD., ZHONGSHAN, GUANGDONG, CHINA, FILED 2-10-2012.

Morning Morning Up

THE MARK CONSISTS OF STANDARD CHARACTERS WITHOUT CLAIM TO ANY PARTICULAR FONT, STYLE, SIZE, OR COLOR.

CLASS 5—PHARMACEUTICALS

FOR ADJUVANTS FOR MEDICAL PURPOSES; AIR PURIFYING PREPARATIONS; ANALGESICS; BY-PRODUCTS OF THE PROCESSING OF CEREALS FOR MEDICAL PURPOSES; COD LIVER OIL; DIETARY AND NUTRITIONAL SUPPLEMENTS USED FOR WEIGHT LOSS; DIETARY BEVERAGE SUPPLEMENTS FOR HUMAN CONSUMPTION IN LIQUID AND DRY MIX FORM FOR THERAPEUTIC PURPOSES; FOOD FOR BABIES; GLUCOSE FOR MEDICAL PURPOSES; HEADACHE TREATMENT PREPARATIONS; LIQUID NUTRITIONAL SUPPLEMENT; MEDICAL DRESSINGS; MEDICAL PREPARATIONS FOR SLIMMING PURPOSES; MEDICINAL ALCOHOL; MEDICINAL DRINKS; MEDICINAL OILS; MEDICINAL TEA; MINERAL NUTRITIONAL SUPPLEMENTS; MINERAL, VITAMIN, OR NUTRITIONALLY ENHANCED WATER; NUTRITIONAL SUPPLEMENTS FOR BOOSTING ENERGY; NUTRITIONAL SUPPLEMENTS IN THE FORM OF POWDER; PHARMACEUTICAL PREPARATIONS ACTING ON THE CENTRAL NERVOUS SYSTEM; PROTEIN SUPPLEMENTS; ROYAL JELLY FOR MEDICAL PURPOSES; SANITARY NAPKINS; SEDATIVES (U.S. CLS. 6, 18, 44, 46, 51 AND 52).

CLASS 30—STAPLE FOODS

FOR BISCUITS; BREAD; COFFEE; FLAVOURINGS FOR FOODS; GLUCOSE FOR CULINARY PURPOSES; HERBAL INFUSIONS; HONEY; NOODLES; PROPOLIS FOR HUMAN CONSUMPTION; ROYAL JELLY FOR HUMAN CONSUMPTION NOT FOR MEDICAL PURPOSES; SEASONINGS; SOY SAUCE; STARCH FOR USE IN MANUFACTURING FOOD; SUSHI; SWEETMEATS; TEA; TEA-BASED BEVERAGES; VANILLA; WHEAT FLOUR (U.S. CL. 46).

CLASS 33—WINES AND SPIRITS

FOR ALCOHOLIC BEVERAGES CONTAINING FRUIT; ALCOHOLIC BEVERAGES EXCEPT BEERS; ALCOHOLIC COCKTAIL MIXES; ALCOHOLIC ESSENCES; ALCOHOLIC FRUIT EXTRACTS; APERITIFS; ARRACK; BRANDY; DISTILLED SPIRITS; HARD CIDER; HYDROMEL; KIRSCH; LIQUEURS; PEPPERMINT LIQUEURS; RICE ALCOHOL; SPIRITS; VODKA; WHISKY; WINE (U.S. CLS. 47 AND 49).
ANNE E. GUSTASON, EXAMINING ATTORNEY

SN 85-539,038. FABELLA PARTNERS B.V., CURACAO, CURACAO, FILED 2-10-2012.

BuddyBet

THE MARK CONSISTS OF STANDARD CHARACTERS WITHOUT CLAIM TO ANY PARTICULAR FONT, STYLE, SIZE, OR COLOR.

CLASS 9—ELECTRICAL AND SCIENTIFIC APPARATUS

FOR COMPUTER PROGRAMS FOR ONLINE GAMING (U.S. CLS. 21, 23, 26, 36 AND 38).

CLASS 35—ADVERTISING AND BUSINESS

FOR ADVERTISING SERVICES (U.S. CLS. 100, 101 AND 102).

CLASS 41—EDUCATION AND ENTERTAINMENT

FOR ENTERTAINMENT SERVICES, NAMELY, PROVIDING A WEB SITE FEATURING NON-DOWNLOADABLE MUSICAL PERFORMANCES, MUSICAL VIDEOS, RELATED FILM CLIPS, PHOTOGRAPHS, AND OTHER MULTIMEDIA MATERIALS FEATURING PEER-TO-PEER GAMING; GAMBLING SERVICES (U.S. CLS. 100, 101 AND 107).

CLASS 42—SCIENTIFIC AND COMPUTER SERVICES

FOR APPLICATION SERVICE PROVIDER (ASP) FEATURING SOFTWARE FOR USE TO ENABLE OR FACILITATE UPLOADING, DOWNLOADING, CAPTURING, POSTING, SHOWING, EDITING, PLAYING, STREAMING, VIEWING, PREVIEWING, DISPLAYING, TAGGING, BLOGGING, SHARING, COMMENTING, MANIPULATING, DISTRIBUTING, PUBLISHING, REPRODUCING, OR OTHERWISE PROVIDING ELECTRONIC MEDIA, MULTIMEDIA CONTENT, VIDEOS, PICTURES, IMAGES, TEXT, PHOTOS, GAMES, USER-GENERATED CONTENT, AUDIO CONTENT, AND INFORMATION VIA THE INTERNET AND OTHER COMPUTER AND COMMUNICATIONS NETWORKS; COMPUTER SERVICES, NAMELY, CREATING AN ONLINE VIRTUAL ENVIRONMENT FOR PEER-TO-PEER AND SPORTS GAMES, INCLUDING FANTASY SPORTS LEAGUES (U.S. CLS. 100 AND 101).

ANGELA DUONG, EXAMINING ATTORNEY

SN 85-539,124. GEN9, INC., CAMBRIDGE, MA. FILED 2-10-2012.

CHIP TO GENE

THE MARK CONSISTS OF STANDARD CHARACTERS WITHOUT CLAIM TO ANY PARTICULAR FONT, STYLE, SIZE, OR COLOR.

CLASS 40—MATERIAL TREATMENT

FOR CUSTOM MANUFACTURING SERVICES IN CONNECTION WITH THE SYNTHESIS AND ASSEMBLY OF NUCLEIC ACIDS, PEPTIDES, PROTEINS, CELLS, NUCLEIC ACID ARRAYS, PEPTIDE ARRAYS, AND PROTEIN ARRAYS (U.S. CLS. 100, 103 AND 106).

CLASS 42—SCIENTIFIC AND COMPUTER SERVICES

FOR RESEARCH AND DEVELOPMENT SERVICES IN CONNECTION WITH THE DESIGN, SYNTHESIS AND ASSEMBLY OF NUCLEIC ACIDS, PEPTIDES, PROTEINS, CELLS, NUCLEIC ACID ARRAYS, PEPTIDE ARRAYS, AND PROTEIN ARRAYS (U.S. CLS. 100 AND 101).

MARK SHINER, EXAMINING ATTORNEY

SN 85-539,134. GEN9, INC., CAMBRIDGE, MA. FILED 2-10-2012.

GENEBIT

THE MARK CONSISTS OF STANDARD CHARACTERS WITHOUT CLAIM TO ANY PARTICULAR FONT, STYLE, SIZE, OR COLOR.

CLASS 40—MATERIAL TREATMENT

FOR CUSTOM MANUFACTURING SERVICES IN CONNECTION WITH THE SYNTHESIS AND ASSEMBLY OF NUCLEIC ACIDS, PEPTIDES, PROTEINS, CELLS, NUCLEIC ACID ARRAYS, PEPTIDE ARRAYS, AND PROTEIN ARRAYS (U.S. CLS. 100, 103 AND 106).

CLASS 42—SCIENTIFIC AND COMPUTER SERVICES

FOR RESEARCH AND DEVELOPMENT SERVICES IN CONNECTION WITH THE DESIGN, SYNTHESIS AND ASSEMBLY OF NUCLEIC ACIDS, PEPTIDES, PROTEINS, CELLS, NUCLEIC ACID ARRAYS, PEPTIDE ARRAYS, AND PROTEIN ARRAYS (U.S. CLS. 100 AND 101).

MARK SHINER, EXAMINING ATTORNEY

SN 85-539,144. GEN9, INC., BOSTON, MA. FILED 2-10-2012.

GENEBYTE

THE MARK CONSISTS OF STANDARD CHARACTERS WITHOUT CLAIM TO ANY PARTICULAR FONT, STYLE, SIZE, OR COLOR.

CLASS 40—MATERIAL TREATMENT

FOR CUSTOM MANUFACTURING SERVICES IN CONNECTION WITH THE SYNTHESIS AND ASSEMBLY OF NUCLEIC ACIDS, PEPTIDES, PROTEINS, CELLS, NUCLEIC ACID ARRAYS, PEPTIDE ARRAYS, AND PROTEIN ARRAYS (U.S. CLS. 100, 103 AND 106).

CLASS 42—SCIENTIFIC AND COMPUTER SERVICES

FOR RESEARCH AND DEVELOPMENT SERVICES IN CONNECTION WITH THE DESIGN, SYNTHESIS AND ASSEMBLY OF NUCLEIC ACIDS, PEPTIDES, PROTEINS, CELLS, NUCLEIC ACID ARRAYS, PEPTIDE ARRAYS, AND PROTEIN ARRAYS (U.S. CLS. 100 AND 101).

MARK SHINER, EXAMINING ATTORNEY

SN 85-539,156. FUR INFORMATION COUNCIL OF AMERICA, WEST HOLLYWOOD, CA. FILED 2-10-2012.

FURINSIDER.COM

THE MARK CONSISTS OF STANDARD CHARACTERS WITHOUT CLAIM TO ANY PARTICULAR FONT, STYLE, SIZE, OR COLOR.

CLASS 35—ADVERTISING AND BUSINESS

FOR PROMOTING THE GOODS AND SERVICES OF OTHERS BY PROVIDING HYPERLINKS TO WEB SITES OF OTHERS FEATURING FASHION APPAREL AND ACCESSORIES (U.S. CLS. 100, 101 AND 102).

FIRST USE 12-1-2010; IN COMMERCE 12-1-2010.

CLASS 41—EDUCATION AND ENTERTAINMENT

FOR ONLINE JOURNALS, NAMELY BLOGS FEATURING INFORMATION, NEWS, ARTICLES, AND COMMENTARY IN THE FIELD OF FASHION (U.S. CLS. 100, 101 AND 107).

FIRST USE 12-1-2010; IN COMMERCE 12-1-2010.

KATHERINE E. HALMEN, EXAMINING ATTORNEY

SN 85-539,392. NEW TROPICANA HOLDINGS, INC., LAS VEGAS, NV. FILED 2-10-2012.

LIVE THE ADVANTAGED LIFE

THE MARK CONSISTS OF STANDARD CHARACTERS WITHOUT CLAIM TO ANY PARTICULAR FONT, STYLE, SIZE, OR COLOR.

CLASS 35—ADVERTISING AND BUSINESS

FOR ADMINISTRATION OF A CUSTOMER LOYALTY PROGRAM WHICH PROVIDES REPEAT CUSTOMERS WITH LOYALTY POINTS THAT ARE REDEEMABLE TOWARDS CASINO, HOTEL, BAR, AND RESTAURANT BENEFITS (U.S. CLS. 100, 101 AND 102).

FIRST USE 7-1-2010; IN COMMERCE 7-1-2010.

CLASS 41—EDUCATION AND ENTERTAINMENT

FOR PROVIDING CASINO SERVICES FEATURING A CASINO PLAYERS REWARDS PROGRAM (U.S. CLS. 100, 101 AND 107).

FIRST USE 7-1-2010; IN COMMERCE 7-1-2010.
CORY BOONE, EXAMINING ATTORNEY

CLASS 25—CLOTHING

FOR CLOTHING, NAMELY, DRESSES, PANTS, JUMPSUITS, SHIRTS, BLOUSES, SKIRTS, SHORTS, SCARFS, PONCHOS, SHAWLS, T-SHIRTS, ROBES, PAJAMAS, SWIMWEAR, FABRIC BELTS, HATS, JACKETS, SLEEPWEAR, PULLOVERS, SWEATERS AND LEGGINGS (U.S. CLS. 22 AND 39).

FIRST USE 5-4-2006; IN COMMERCE 4-5-2008.
ANNE E. GUSTASON, EXAMINING ATTORNEY

SN 85-539,449. DEXTRO, LLC, LANSLOWNE, VA. FILED 2-10-2012.

SN 85-539,506. ANDRE BROWN, WEST BABYLON, NY. FILED 2-10-2012.

WILLBELOGIST

THE MARK CONSISTS OF STANDARD CHARACTERS WITHOUT CLAIM TO ANY PARTICULAR FONT, STYLE, SIZE, OR COLOR.

CLASS 35—ADVERTISING AND BUSINESS

FOR BUSINESS CONSULTING AND INFORMATION SERVICES; BUSINESS CONSULTING SERVICES, NAMELY, PROVIDING ASSISTANCE IN DEVELOPMENT OF BUSINESS STRATEGIES AND CREATIVE IDEATION; HUMAN RESOURCES SERVICES IN THE FIELD OF EDUCATION, NAMELY, OFFERING OF ASSESSMENTS AND SURVEYS IN THE FIELD OF EDUCATOR TRAINING AND PERFORMANCE FOR THE PURPOSE OF TEACHER PLACEMENT BASED ON SUCCESS IN AN ACADEMIC PROGRAM (U.S. CLS. 100, 101 AND 102).

CLASS 41—EDUCATION AND ENTERTAINMENT

FOR BUSINESS TRAINING (U.S. CLS. 100, 101 AND 107).
ALEX KEAM, EXAMINING ATTORNEY

SN 85-539,487. HARDY DEBBIE MARTINE, BROOKLYN, NY. FILED 2-10-2012.

Martine's Dream

THE MARK CONSISTS OF MARTINE'S DREAM IN STYLIZED FONTS.

CLASS 24—FABRICS

FOR HOME GOODS, NAMELY, BEDSHEETS, THROWS, PILLOW COVERS, DRAPES, CURTAINS, TABLECLOTHS, MATS, CUSHION COVERS, TEXTILE WALL HANGINGS, FABRIC SHOWER CURTAINS, BLANKETS AND DUVET COVERS (U.S. CLS. 42 AND 50).

FIRST USE 5-4-2006; IN COMMERCE 4-5-2008.

I GOT A RING

THE MARK CONSISTS OF STANDARD CHARACTERS WITHOUT CLAIM TO ANY PARTICULAR FONT, STYLE, SIZE, OR COLOR.

CLASS 14—JEWELRY

FOR RINGS (U.S. CLS. 2, 27, 28 AND 50).

CLASS 25—CLOTHING

FOR ATHLETIC APPAREL, NAMELY, SHIRTS, PANTS, JACKETS, FOOTWEAR, HATS AND CAPS, ATHLETIC UNIFORMS; HOODED SWEATSHIRTS; SWEATSHIRTS; T-SHIRTS; WRIST BANDS (U.S. CLS. 22 AND 39).

BRENDAN MCCAULEY, EXAMINING ATTORNEY

SN 85-539,525. SIMPLEWEALTH INC., CALGARY, ALBERTA, CANADA, FILED 2-10-2012.

TRUSTED AUTHORITY

THE MARK CONSISTS OF STANDARD CHARACTERS WITHOUT CLAIM TO ANY PARTICULAR FONT, STYLE, SIZE, OR COLOR.

CLASS 9—ELECTRICAL AND SCIENTIFIC APPARATUS

FOR DIGITAL MATERIALS, NAMELY, DOWNLOADABLE AUDIO AND TEXT FILES FEATURING INFORMATION AND RESOURCES IN THE FIELD OF MARKETING AND ENTREPRENEURISM; DOWNLOADABLE ELECTRONIC NEWSLETTERS DELIVERED BY E-MAIL IN THE FIELD OF MARKETING AND ENTREPRENEURISM (U.S. CLS. 21, 23, 26, 36 AND 38).

FIRST USE 9-1-2010; IN COMMERCE 9-1-2010.

CLASS 41—EDUCATION AND ENTERTAINMENT

FOR EDUCATION SERVICES, NAMELY, PROVIDING CLASSES, WORKSHOPS, SEMINARS, LECTURES, WEBINARS, TELESEMINARS, TRAINING AND PERSONAL AND PROFESSIONAL COACHING IN THE FIELD OF MARKETING AND ENTREPRENEURISM AND THE DISTRIBUTION OF COURSE AND TRAINING MATERIALS IN CONNECTION THEREWITH; ON-LINE JOURNALS, NAMELY, BLOGS IN THE FIELD OF MARKETING AND ENTREPRENEURISM; ON-LINE ELECTRONIC NEWSLETTERS DELIVERED BY E-MAIL IN THE FIELD OF MARKETING AND ENTREPRENEURISM (U.S. CLS. 100, 101 AND 107).

FIRST USE 9-1-2010; IN COMMERCE 9-1-2010.

JULIE WATSON, EXAMINING ATTORNEY

SN 85-539,695. EUROW & O'REILLY CORPORATION, CAMARILLO, CA. FILED 2-10-2012.



THE MARK CONSISTS OF THE WORD GROOMTEX WITH THE IMAGE OF A FURRY TAIL ON THE RIGHT OF THE IMAGE AND DROPLETS OF WATER SURROUND THE IMAGE AND A STYLIZED SHADOWING OF THE WORDS GROOMTEX APPEAR IN THE BACKGROUND BUT THE APPLICANT DOES NOT CLAIM COLOR AS A FEATURE OF THE MARK.

CLASS 10—MEDICAL APPARATUS

FOR EAR PLUGS FOR PROTECTION WHEN WASHING AND GROOMING ANIMALS AND MADE OF SHEEPSKIN (U.S. CLS. 26, 39 AND 44).

CLASS 24—FABRICS

FOR BATH MITTS; TOWELS; WASHING MITTS (U.S. CLS. 42 AND 50).

JOHN WILKE, EXAMINING ATTORNEY

SN 85-539,710. ZHONGSHAN GUIYUAN LIQUOR TRADING CO., LTD., ZHONGSHAN, GUANGDONG, CHINA, FILED 2-10-2012.

朝朝向上

THE MARK CONSISTS OF CHINESE CHARACTERS THAT TRANSLITERATE TO ZHAO ZHAO XIANG SHANG. THE NON-LATIN CHARACTERS IN THE MARK TRANSLITERATE TO ZHAO ZHAO XIANG SHANG AND THIS MEANS MORNING MORNING TOWARDS UP IN ENGLISH.

CLASS 5—PHARMACEUTICALS

FOR ADJUVANTS FOR MEDICAL PURPOSES; AIR PURIFYING PREPARATIONS; ANALGESICS; BY-PRODUCTS OF THE PROCESSING OF CEREALS FOR MEDICAL PURPOSES; COD LIVER OIL; DIETARY AND NUTRITIONAL SUPPLEMENTS USED FOR WEIGHT LOSS; DIETARY BEVERAGE SUPPLEMENTS FOR HUMAN CONSUMPTION IN LIQUID AND DRY MIX FORM FOR THERAPEUTIC PURPOSES; FOOD FOR BABIES; GLUCOSE FOR MEDICAL PURPOSES; HEADACHE TREATMENT PREPARATIONS; LIQUID NUTRITIONAL SUPPLEMENT; MEDICAL DRESSINGS; MEDICAL PREPARATIONS FOR SLIMMING PURPOSES; MEDICINAL ALCOHOL; MEDICINAL DRINKS; MEDICINAL OILS; MEDICINAL TEA; MINERAL NUTRITIONAL SUPPLEMENTS; MINERAL, VITAMIN, OR NUTRITIONALLY ENHANCED WATER; NUTRITIONAL SUPPLEMENTS FOR BOOSTING ENERGY; NUTRITIONAL SUPPLEMENTS IN THE FORM OF POWDER; PHARMACEUTICAL PREPARATIONS ACTING ON THE CENTRAL NERVOUS SYSTEM; PROTEIN SUPPLEMENTS; ROYAL JELLY FOR MEDICAL PURPOSES; SANITARY NAPKINS; SEDATIVES (U.S. CLS. 6, 18, 44, 46, 51 AND 52).

CLASS 30—STAPLE FOODS

FOR BISCUITS; BREAD; COFFEE; FLAVOURINGS FOR FOODS; GLUCOSE FOR CULINARY PURPOSES; HERBAL INFUSIONS; HONEY; NOODLES; PROPOLIS FOR HUMAN CONSUMPTION; ROYAL JELLY FOR HUMAN CONSUMPTION NOT FOR MEDICAL PURPOSES; SEASONINGS; SOY SAUCE; STARCH FOR USE IN MANUFACTURING FOOD; SUSHI; SWEETMEATS; TEA; TEA-BASED BEVERAGES; VANILLA; WHEAT FLOUR (U.S. CL. 46).

CLASS 33—WINES AND SPIRITS

FOR ALCOHOLIC BEVERAGES CONTAINING FRUIT; ALCOHOLIC BEVERAGES EXCEPT BEERS; ALCOHOLIC COCKTAIL MIXES; ALCOHOLIC ESSENCES; ALCOHOLIC FRUIT EXTRACTS; APERITIFS; ARRACK; BRANDY; DISTILLED SPIRITS; HARD CIDER; HYDROMEL; KIRSCH; LIQUEURS; PEPPERMINT LIQUEURS; RICE ALCOHOL; SPIRITS; VODKA; WHISKY; WINE (U.S. CLS. 47 AND 49).

ANNE E. GUSTASON, EXAMINING ATTORNEY

SN 85-539,714. X PLUS PRODUCTS, INC., GOTHA, FL. FILED 2-10-2012.

PO-RUM-BO

THE MARK CONSISTS OF STANDARD CHARACTERS WITHOUT CLAIM TO ANY PARTICULAR FONT, STYLE, SIZE, OR COLOR.

CLASS 9—ELECTRICAL AND SCIENTIFIC APPARATUS

FOR COMPUTER GAME SOFTWARE FOR PERSONAL COMPUTERS AND HOME VIDEO GAME CONSOLES; COMPUTER GAME SOFTWARE FOR USE ON MOBILE AND CELLULAR PHONES (U.S. CLS. 21, 23, 26, 36 AND 38).

CLASS 28—TOYS AND SPORTING GOODS

FOR BOARD GAMES (U.S. CLS. 22, 23, 38 AND 50).
FIRST USE 2-9-2012; IN COMMERCE 2-9-2012.
ALICE BENMAMAN, EXAMINING ATTORNEY

SN 85-539,793. WILMORITE MANAGEMENT GROUP, LLC, ROCHESTER, NY. FILED 2-10-2012.

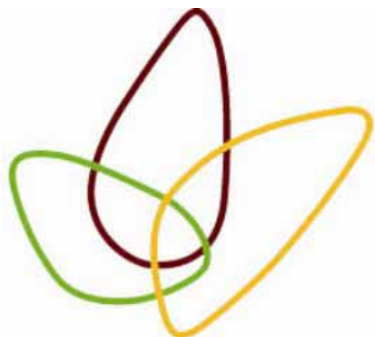

THE COLOR(S) LIME GREEN, BROWN AND YELLOW IS/ ARE CLAIMED AS A FEATURE OF THE MARK. THE MARK CONSISTS OF LIME GREEN, BROWN AND YELLOW OVAL SHAPES OVERLAID IN THE PATTERN OF A LEAF.

CLASS 36—INSURANCE AND FINANCIAL

FOR REAL ESTATE LEASING AND MANAGEMENT (U.S. CLS. 100, 101 AND 102). FIRST USE 4-30-2007; IN COMMERCE 2-5-2008.

CLASS 37—CONSTRUCTION AND REPAIR

FOR REAL ESTATE DEVELOPMENT AND COMMERCIAL REAL ESTATE CONSTRUCTION (U.S. CLS. 100, 103 AND 106). FIRST USE 4-30-2007; IN COMMERCE 2-5-2008. KRISTIN DAHLING, EXAMINING ATTORNEY

SN 85-539,805. GARY AND MARY WEST WIRELESS HEALTH INSTITUTE, LA JOLLA, CA. FILED 2-10-2012.

MED4MATION

THE MARK CONSISTS OF STANDARD CHARACTERS WITHOUT CLAIM TO ANY PARTICULAR FONT, STYLE, SIZE, OR COLOR.

CLASS 9—ELECTRICAL AND SCIENTIFIC APPARATUS

FOR SOFTWARE IN THE FIELD OF MEDICAL INFORMATICS FOR USE IN MEDICAL DEVICES TO FACILITATE CONNECTIVITY AND INTEROPERABILITY BETWEEN AND AMONG MEDICAL DEVICES. TO PROVIDE LOCATION INFORMATION ABOUT THE MEDICAL DEVICES, AND TO FORMAT, ENCODE, TRANSFER, CONVERT AND STORE ELECTRONIC DATA AND IMAGES (U.S. CLS. 21, 23, 26, 36 AND 38).

CLASS 42—SCIENTIFIC AND COMPUTER SERVICES

FOR PROVIDING TEMPORARY USE OF ON-LINE NON DOWNLOADABLE SOFTWARE IN THE FIELD OF MEDICAL INFORMATICS FOR USE IN MEDICAL DEVICES TO FACILITATE CONNECTIVITY AND INTEROPERABILITY BETWEEN AND AMONG MEDICAL DEVICES, TO PROVIDE LOCATION INFORMATION ABOUT THE MEDICAL DEVICES, AND TO FORMAT, ENCODE, TRANSFER, CONVERT AND STORE ELECTRONIC DATA AND IMAGES (U.S. CLS. 100 AND 101). HENRY S. ZAK, EXAMINING ATTORNEY

SN 85-539,822. MATTISON CONSULTING LLC, DBA MAT-TISONNETWORK, PRINCETON, NJ. FILED 2-10-2012.



THE MARK CONSISTS OF THE LETTER B WITH TWO LETTER C'S SUPERIMPOSED ON TOP OF THE LETTER B AND WITH THE TWO LETTER C'S FACING AWAY FROM EACH OTHER AND JUST BARELY TOUCHING GIVING THE CBC COMBINATION A STYLIZED EFFECT.

CLASS 16—PAPER GOODS AND PRINTED MATTER

FOR PRINTED BRIDAL PUBLICATIONS, NAMELY, A MAGAZINE FEATURING WEDDING INFORMATION (U.S. CLS. 2, 5, 22, 23, 29, 37, 38 AND 50).

CLASS 35—ADVERTISING AND BUSINESS

FOR ARRANGING AND CONDUCTING BRIDAL TRADE SHOWS FOR VENDORS AND BRIDES FOR BUSINESS PURPOSES (U.S. CLS. 100, 101 AND 102). LAKEISHA LEWIS, EXAMINING ATTORNEY

SN 85-539,834. EXPONENTIAL INTERACTIVE, INC., EMERYVILLE, CA. FILED 2-10-2012.

AppSnack

THE MARK CONSISTS OF STANDARD CHARACTERS WITHOUT CLAIM TO ANY PARTICULAR FONT, STYLE, SIZE, OR COLOR.

CLASS 9—ELECTRICAL AND SCIENTIFIC APPARATUS

FOR COMPUTER APPLICATION SOFTWARE FOR MOBILE PHONES, MOBILE DEVICES AND COMPUTERS, NAMELY, SOFTWARE FOR DEMONSTRATING MOBILE ADVERTISING APPEARANCE AND CAPABILITIES; SOFTWARE DEVELOPMENT TOOLS FOR THE CREATION OF MOBILE APPLICATIONS CAPABLE OF DISPLAYING ADVERTISEMENTS DELIVERED FROM AD SERVERS (U.S. CLS. 21, 23, 26, 36 AND 38).

CLASS 35—ADVERTISING AND BUSINESS

FOR ADVERTISING AND MARKETING SERVICES FOR OTHERS PROVIDED VIA INTERNET AND MOBILE COMMUNICATION NETWORKS, NAMELY, SERVICES FOR THE PURCHASE, SALE, DISSEMINATION, TARGETING, ANALYSIS, AND MANAGEMENT OF ADVERTISING FOR DISPLAY ON COMPUTERS, MOBILE DEVICES, AND TELEVISIONS; CREATIVE MARKETING DESIGN SERVICES; ONLINE AND MOBILE ADVERTISING EXCHANGE SERVICES (U.S. CLS. 100, 101 AND 102).

CLASS 42—SCIENTIFIC AND COMPUTER SERVICES

FOR TECHNOLOGICAL SERVICES FOR THE CREATION OF COMPUTER AND MOBILE DEVICE SOFTWARE APPLICATIONS, WEB PAGES AND PAGE TAKEOVERS THAT PROVIDE USER EXPERIENCES CONSISTING OF VIEWING AND ENGAGING WITH ADVERTISEMENTS, PLAYING GAMES, VIEWING AND INTERACTING WITH VIDEOS, AND PERFORMING SOCIAL INTERACTIONS (U.S. CLS. 100 AND 101).
CHRISTINE MARTIN, EXAMINING ATTORNEY

SN 85-539,875. SOGNO GROUP LLC, ALAMEDA, CA. FILED 2-10-2012.

Mr. Tooshie

THE MARK CONSISTS OF STANDARD CHARACTERS WITHOUT CLAIM TO ANY PARTICULAR FONT, STYLE, SIZE, OR COLOR.

CLASS 3—COSMETICS AND CLEANING PREPARATIONS

FOR BABY BUBBLE BATH; BABY HAND SOAP; BABY LOTION; BABY OILS; BABY POWDERS; BABY SHAMPOO; BABY WIPES; BODY AND BEAUTY CARE COSMETICS (U.S. CLS. 1, 4, 6, 50, 51 AND 52).

CLASS 11—ENVIRONMENTAL CONTROL APPARATUS

FOR HOT AIR BLOWERS (U.S. CLS. 13, 21, 23, 31 AND 34).
SUE LAWRENCE, EXAMINING ATTORNEY

SN 85-539,914. PARTYPANDAS INC., SAN FRANCISCO, CA. FILED 2-10-2012.

PARTY PANDAS

THE MARK CONSISTS OF STANDARD CHARACTERS WITHOUT CLAIM TO ANY PARTICULAR FONT, STYLE, SIZE, OR COLOR.

CLASS 35—ADVERTISING AND BUSINESS

FOR ADVERTISING AND MARKETING SERVICES FOR NIGHTCLUBS, BARS, RESTAURANTS, AND PERFORMANCE EVENTS, PROVIDED BY MEANS OF INDIRECT METHODS OF MARKETING COMMUNICATIONS, NAMELY, SOCIAL MEDIA, INTERNET MARKETING, MOBILE MARKETING, OR VIRAL COMMUNICATIONS CHANNELS; SOCIAL MEDIA STRATEGY AND MARKETING CONSULTANCY FOCUSING ON HELPING CLIENTS IN THE NIGHTCLUB, BAR, RESTAURANT, AND PERFORMANCE EVENTS INDUSTRIES CREATE AND EXTEND THEIR PRODUCT AND BRAND STRATEGIES BY BUILDING VIRALLY ENGAGING MARKETING SOLUTIONS (U.S. CLS. 100, 101 AND 102).

CLASS 42—SCIENTIFIC AND COMPUTER SERVICES

FOR DESIGNING AND MAINTAINING WEBSITES AND SMART PHONE APPLICATIONS FOR OTHERS IN THE NIGHTCLUB, BAR, RESTAURANT, AND PERFORMANCE EVENTS INDUSTRIES (U.S. CLS. 100 AND 101).
LIEF MARTIN, EXAMINING ATTORNEY

SN 85-539,927. PARTYPANDAS INC., SAN FRANCISCO, CA. FILED 2-10-2012.

PARTY PANDA

THE MARK CONSISTS OF STANDARD CHARACTERS WITHOUT CLAIM TO ANY PARTICULAR FONT, STYLE, SIZE, OR COLOR.

CLASS 35—ADVERTISING AND BUSINESS

FOR ADVERTISING AND MARKETING SERVICES FOR NIGHTCLUBS, BARS, RESTAURANTS, AND PERFORMANCE EVENTS, PROVIDED BY MEANS OF INDIRECT METHODS OF MARKETING COMMUNICATIONS, NAMELY, SOCIAL MEDIA, INTERNET MARKETING, MOBILE MARKETING, OR VIRAL COMMUNICATIONS CHANNELS; SOCIAL MEDIA STRATEGY AND MARKETING CONSULTANCY FOCUSING ON HELPING CLIENTS IN THE NIGHTCLUB, BAR, RESTAURANT, AND PERFORMANCE EVENTS INDUSTRIES CREATE AND EXTEND THEIR PRODUCT AND BRAND STRATEGIES BY BUILDING VIRALLY ENGAGING MARKETING SOLUTIONS (U.S. CLS. 100, 101 AND 102).

CLASS 42—SCIENTIFIC AND COMPUTER SERVICES

FOR DESIGNING AND MAINTAINING WEBSITES AND SMART PHONE APPLICATIONS FOR OTHERS IN THE NIGHTCLUB, BAR, RESTAURANT, AND PERFORMANCE EVENTS INDUSTRIES (U.S. CLS. 100 AND 101).
LIEF MARTIN, EXAMINING ATTORNEY

SN 85-539,943. PARTYPANDAS INC., SAN FRANCISCO, CA. FILED 2-10-2012.



THE MARK CONSISTS OF A FORWARD FACING PANDA BEAR.

CLASS 35—ADVERTISING AND BUSINESS

FOR ADVERTISING AND MARKETING SERVICES FOR NIGHTCLUBS, BARS, RESTAURANTS, AND PERFORMANCE EVENTS, PROVIDED BY MEANS OF INDIRECT METHODS OF MARKETING COMMUNICATIONS, NAMELY, SOCIAL MEDIA, INTERNET MARKETING, MOBILE MARKETING, OR VIRAL COMMUNICATIONS CHANNELS; SOCIAL MEDIA STRATEGY AND MARKETING CONSULTANCY FOCUSING ON HELPING CLIENTS IN THE NIGHTCLUB, BAR, RESTAURANT, AND PERFORMANCE EVENTS INDUSTRIES CREATE AND EXTEND THEIR PRODUCT AND BRAND STRATEGIES BY BUILDING VIRALLY ENGAGING MARKETING SOLUTIONS (U.S. CLS. 100, 101 AND 102).

SN 85-539,938. GEEKLIST, INC., LA JOLLA, CA. FILED 2-10-2012.



THE MARK CONSISTS OF THE WORD GEEKLIST IN LOWER CASE LETTERS WITH A PERIOD BETWEEN THE "I" AND "S".

CLASS 35—ADVERTISING AND BUSINESS

FOR ONLINE BUSINESS NETWORKING SERVICES (U.S. CLS. 100, 101 AND 102).
FIRST USE 4-8-2011; IN COMMERCE 4-8-2011.

CLASS 42—SCIENTIFIC AND COMPUTER SERVICES

FOR DESIGNING AND MAINTAINING WEBSITES AND SMART PHONE APPLICATIONS FOR OTHERS IN THE NIGHTCLUB, BAR, RESTAURANT, AND PERFORMANCE EVENTS INDUSTRIES (U.S. CLS. 100 AND 101).
LIEF MARTIN, EXAMINING ATTORNEY

CLASS 42—SCIENTIFIC AND COMPUTER SERVICES

FOR COMPUTER SERVICES, NAMELY, CREATING AN ON-LINE COMMUNITY FOR REGISTERED USERS TO PARTICIPATE IN DISCUSSIONS, GET FEEDBACK FROM THEIR PEERS, FORM VIRTUAL COMMUNITIES, AND ENGAGE IN SOCIAL NETWORKING SERVICES IN THE FIELD OF COMPUTER CODE DEVELOPERS, WEB SITE DEVELOPERS, COMPUTER SOFTWARE DEVELOPERS; COMPUTER SERVICES, NAMELY, PROVIDING A SEARCH ENGINE TO ALLOW USERS TO SEARCH CONTENT OF WEB SITE FOR PEOPLE WITH SPECIFIC EXPERIENCE (U.S. CLS. 100 AND 101).
FIRST USE 4-8-2011; IN COMMERCE 4-8-2011.

SN 85-539,953. PARTYPANDAS INC., SAN FRANCISCO, CA. FILED 2-10-2012.



THE MARK CONSISTS OF A STYLIZED LETTER "P".

CLASS 45—PERSONAL AND LEGAL SERVICES

FOR PROVIDING INFORMATION IN THE FIELD OF PERSONAL DEVELOPMENT AND ACHIEVEMENTS; ON-LINE SOCIAL NETWORKING SERVICES (U.S. CLS. 100 AND 101).
FIRST USE 4-8-2011; IN COMMERCE 4-8-2011.
CHERYL CLAYTON, EXAMINING ATTORNEY

CLASS 35—ADVERTISING AND BUSINESS

FOR ADVERTISING AND MARKETING SERVICES FOR NIGHTCLUBS, BARS, RESTAURANTS, AND PERFORMANCE EVENTS, PROVIDED BY MEANS OF INDIRECT METHODS OF MARKETING COMMUNICATIONS, NAMELY, SOCIAL MEDIA, INTERNET MARKETING, MOBILE MARKETING, OR VIRAL COMMUNICATIONS CHANNELS; SOCIAL MEDIA STRATEGY AND MARKETING CONSULTANCY FOCUSING ON HELPING CLIENTS IN THE NIGHTCLUB, BAR, RESTAURANT, AND PERFORMANCE EVENTS INDUSTRIES CREATE AND EXTEND THEIR PRODUCT AND BRAND STRATEGIES BY BUILDING VIRALLY ENGAGING MARKETING SOLUTIONS (U.S. CLS. 100, 101 AND 102).

CLASS 42—SCIENTIFIC AND COMPUTER SERVICES

FOR DESIGNING AND MAINTAINING WEBSITES AND SMART PHONE APPLICATIONS FOR OTHERS IN THE NIGHTCLUB, BAR, RESTAURANT, AND PERFORMANCE EVENTS INDUSTRIES (U.S. CLS. 100 AND 101). LIEF MARTIN, EXAMINING ATTORNEY

SN 85-539,963. GEEKLIST, INC., LA JOLLA, CA. FILED 2-10-2012.



THE MARK CONSISTS OF A BLACK FILLED CIRCLE WITH THE LETTERS GG IN LOWER CASE BACK TO BACK IN WHITE.

CLASS 35—ADVERTISING AND BUSINESS

FOR ONLINE BUSINESS NETWORKING SERVICES (U.S. CLS. 100, 101 AND 102). FIRST USE 4-8-2011; IN COMMERCE 4-8-2011.

CLASS 42—SCIENTIFIC AND COMPUTER SERVICES

FOR COMPUTER SERVICES, NAMELY, CREATING AN ON-LINE COMMUNITY FOR REGISTERED USERS TO PARTICIPATE IN DISCUSSIONS, GET FEEDBACK FROM THEIR PEERS, FORM VIRTUAL COMMUNITIES, AND ENGAGE IN SOCIAL NETWORKING SERVICES IN THE FIELD OF COMPUTER CODE DEVELOPERS, WEB SITE DEVELOPERS, COMPUTER SOFTWARE DEVELOPERS; COMPUTER SERVICES, NAMELY, PROVIDING A SEARCH ENGINE TO ALLOW USERS TO SEARCH CONTENT OF WEB SITE FOR PEOPLE WITH SPECIFIC EXPERIENCE (U.S. CLS. 100 AND 101). FIRST USE 4-8-2011; IN COMMERCE 4-8-2011.

CLASS 45—PERSONAL AND LEGAL SERVICES

FOR PROVIDING INFORMATION IN THE FIELD OF PERSONAL DEVELOPMENT AND ACHIEVEMENTS; ON-LINE SOCIAL NETWORKING SERVICES (U.S. CLS. 100 AND 101). FIRST USE 4-8-2011; IN COMMERCE 4-8-2011. CHERYL CLAYTON, EXAMINING ATTORNEY

SN 85-539,966. YOGURT MOUNTAIN, LLC, BIRMINGHAM, AL. FILED 2-10-2012.

YOQUAKE

THE MARK CONSISTS OF STANDARD CHARACTERS WITHOUT CLAIM TO ANY PARTICULAR FONT, STYLE, SIZE, OR COLOR.

CLASS 25—CLOTHING

FOR CLOTHING, NAMELY, SHIRTS, SHORTS, T-SHIRTS, PANTS, JACKETS, HATS, SWEATSHIRTS AND FOOTWEAR (U.S. CLS. 22 AND 39).

CLASS 29—MEATS AND PROCESSED FOODS

FOR DAIRY-BASED BEVERAGES; YOGURT-BASED BEVERAGES (U.S. CL. 46).

CLASS 30—STAPLE FOODS

FOR FROZEN YOGURT; FROZEN YOGURT AS A DESSERT AND CONTAINING FRUIT, NUTS, CANDY, COOKIES AND CEREAL TOPPINGS; FROZEN DESSERTS, NAMELY, FROZEN YOGURT; FROZEN DAIRY DESSERTS; FROZEN CONFECTIONERY; AND FROZEN DAIRY DESSERTS ALSO CONTAINING FRUIT, NUTS, CANDY, COOKIES AND CEREAL TOPPINGS (U.S. CL. 46).

CLASS 32—LIGHT BEVERAGES

FOR FRUIT-BASED BEVERAGES; SMOOTHIES; FROZEN FRUIT BEVERAGES (U.S. CLS. 45, 46 AND 48).

CLASS 35—ADVERTISING AND BUSINESS

FOR RESTAURANT FRANCHISING, NAMELY OFFERING BUSINESS MANAGEMENT ASSISTANCE IN THE ESTABLISHMENT AND/OR OPERATION OF RESTAURANTS (U.S. CLS. 100, 101 AND 102).

CLASS 43—HOTEL AND RESTAURANT SERVICES

FOR RESTAURANT; RESTAURANT SERVICES; TAKE-OUT RESTAURANT SERVICES; CAFÉ-RESTAURANTS; AND FAST-FOOD RESTAURANTS (U.S. CLS. 100 AND 101). WILLIAM JACKSON, EXAMINING ATTORNEY

SN 85-540,073. GLOMINEX ENTERPRISES LLC, FORMERLY AMERICAN GLOW PAINTS LLC, COPPELL, TX. FILED 2-10-2012.

GLOMINEX

THE MARK CONSISTS OF STANDARD CHARACTERS WITHOUT CLAIM TO ANY PARTICULAR FONT, STYLE, SIZE, OR COLOR.

CLASS 2—PAINTS

FOR FLUORESCENT PAINTS; PAINTS (U.S. CLS. 6, 11 AND 16).

CLASS 35—ADVERTISING AND BUSINESS

FOR ON-LINE RETAIL STORE SERVICES FEATURING PAINT; ON-LINE WHOLESALE STORE SERVICES FEATURING PAINT (U.S. CLS. 100, 101 AND 102).
ZACHARY BELLO, EXAMINING ATTORNEY

SN 85-540,087. SAN DIEGO ASSOCIATION OF REALTORS, SAN DIEGO, CA. FILED 2-10-2012.

SDAR

THE MARK CONSISTS OF STANDARD CHARACTERS WITHOUT CLAIM TO ANY PARTICULAR FONT, STYLE, SIZE, OR COLOR.

CLASS 35—ADVERTISING AND BUSINESS

FOR TRADE ASSOCIATION SERVICES, NAMELY, PROMOTING AND SERVING THE INTERESTS OF REAL ESTATE AGENTS AND BROKERS (U.S. CLS. 100, 101 AND 102).
FIRST USE 3-7-1991; IN COMMERCE 3-7-1991.

CLASS 41—EDUCATION AND ENTERTAINMENT

FOR EDUCATION AND TRAINING SERVICES, NAMELY, PROVIDING PROGRAMS IN THE FIELD OF REAL ESTATE (U.S. CLS. 100, 101 AND 107).
FIRST USE 3-7-1991; IN COMMERCE 3-7-1991.
KIM MONINGHOFF, EXAMINING ATTORNEY

SN 85-540,094. GOODMAN, BURT, DBA SEATTLE HI-FI, AUBURN, WA. FILED 2-10-2012.

SEATTLE HI-FI

THE MARK CONSISTS OF STANDARD CHARACTERS WITHOUT CLAIM TO ANY PARTICULAR FONT, STYLE, SIZE, OR COLOR.
SEC. 2(F).

CLASS 35—ADVERTISING AND BUSINESS

FOR ON-LINE RETAIL STORE SERVICES FEATURING AUDIO EQUIPMENT, TELEVISION, DVD AND VIDEO EQUIPMENT, HOME THEATERS, CONSUMER ELECTRONICS, MOBILE ELECTRONICS, COMPUTERS, COMPUTER NETWORKS, COMMUNICATIONS EQUIPMENT, HOME AND MOBILE ENTERTAINMENT EQUIPMENT, CONVERGENCE APPLIANCES, AND SOFTWARE FOR USE IN STORING AND DISPLAYING MULTI-MEDIA PROGRAMS AND SUBSCRIPTIONS TO INFORMATION MEDIA PACKAGES (U.S. CLS. 100, 101 AND 102).
FIRST USE 6-30-2000; IN COMMERCE 12-2-2003.

CLASS 37—CONSTRUCTION AND REPAIR

FOR INSTALLATION, MAINTENANCE AND REPAIR OF AUDIO EQUIPMENT, TELEVISION, DVD AND VIDEO EQUIPMENT, AND HOME THEATERS, CONSUMER ELECTRONICS, MOBILE ELECTRONICS, COMPUTERS, COMPUTER NETWORKS, COMMUNICATIONS EQUIPMENT, HOME ENTERTAINMENT EQUIPMENT, AND CONVERGENCE APPLIANCES (U.S. CLS. 100, 103 AND 106).

FIRST USE 6-30-2000; IN COMMERCE 12-2-2003.
ZACHARY BELLO, EXAMINING ATTORNEY

SN 85-540,123. ASHLEY, DAN, WALNUT CREEK, CA. FILED 2-10-2012.

Rock the Casa

THE MARK CONSISTS OF STANDARD CHARACTERS WITHOUT CLAIM TO ANY PARTICULAR FONT, STYLE, SIZE, OR COLOR.
THE ENGLISH TRANSLATION OF "CASA" IN THE MARK IS HOUSE.

CLASS 25—CLOTHING

FOR T-SHIRTS (U.S. CLS. 22 AND 39).

CLASS 41—EDUCATION AND ENTERTAINMENT

FOR ARRANGING AND CONDUCTING OF CONCERTS (U.S. CLS. 100, 101 AND 107).
WANDA KAY PRICE, EXAMINING ATTORNEY

SN 85-540,205. FAVATA, MARIA L., SAN FRANCISCO, CA. FILED 2-11-2012.

Glamourist

THE MARK CONSISTS OF STANDARD CHARACTERS WITHOUT CLAIM TO ANY PARTICULAR FONT, STYLE, SIZE, OR COLOR.

CLASS 35—ADVERTISING AND BUSINESS

FOR ON-LINE RETAIL STORE SERVICES FEATURING A CLOTHING, LINGERIE, SHOES, JEWELRY, FASHION ACCESSORIES, AND HANDBAGS (U.S. CLS. 100, 101 AND 102).

CLASS 41—EDUCATION AND ENTERTAINMENT

FOR ON-LINE JOURNALS, NAMELY, BLOGS FEATURING DISCUSSIONS AND INFORMATION ON FASHION, STYLE, AND CLOTHING (U.S. CLS. 100, 101 AND 107).
VIVIAN MICZNIK FIRST, EXAMINING ATTORNEY

SN 85-540,208. RONEN, DAHLIA, LONG GROVE, IL. FILED 2-11-2012.

SN 85-540,289. ADATEPE, AHMET G., AKA ADATEPE, ADAM G., WALNUT CREE, CA. FILED 2-11-2012.

HOPE'S CLOSET

THE MARK CONSISTS OF STANDARD CHARACTERS WITHOUT CLAIM TO ANY PARTICULAR FONT, STYLE, SIZE, OR COLOR.

CLASS 25—CLOTHING

FOR CLOTHING, NAMELY, TOPS, BOTTOMS, SHIRTS, PANTS, DRESSES, SKIRTS, SCARVES, BELTS, SOCKS, STOCKINGS, AND HATS; CLOTHING, NAMELY, TOPS, BOTTOMS, SHIRTS, PANTS, DRESSES, SKIRTS, SCARVES, BELTS, SOCKS, STOCKINGS, AND HATS FOR PEOPLE WITH SCOLIOSIS AND FOR YOUTH WHO MUST WEAR A BACK BRACE AS PART OF THEIR TREATMENT (U.S. CLS. 22 AND 39).

CLASS 35—ADVERTISING AND BUSINESS

FOR RETAIL STORE SERVICES AND ON-LINE RETAIL STORE SERVICES FEATURING TOPS, BOTTOMS, SHIRTS, PANTS, DRESSES, SKIRTS, SCARVES, BELTS, SOCKS, STOCKINGS, AND HATS; RETAIL STORE SERVICES AND ON-LINE RETAIL STORE SERVICES FEATURING TOPS, BOTTOMS, SHIRTS, PANTS, DRESSES, SKIRTS, SCARVES, BELTS, SOCKS, STOCKINGS, AND HATS FOR PEOPLE WITH SCOLIOSIS AND FOR YOUTH WHO MUST WEAR A BACK BRACE AS PART OF THEIR TREATMENT (U.S. CLS. 100, 101 AND 102).

WENDY JUN, EXAMINING ATTORNEY

SN 85-540,222. DEMARCO, AUTUMN, DRIFTWOOD, TX. FILED 2-11-2012.

THE F.I.R.S.T. AND THE L.A.S.T.

THE MARK CONSISTS OF STANDARD CHARACTERS WITHOUT CLAIM TO ANY PARTICULAR FONT, STYLE, SIZE, OR COLOR.

CLASS 10—MEDICAL APPARATUS

FOR BODY REHABILITATION APPARATUS FOR MEDICAL PURPOSES; PHYSICAL REHABILITATION, PHYSICAL THERAPY AND SPORTS MEDICINE EQUIPMENT ALL DESIGNED SPECIFICALLY FOR MEDICAL USE; MEDICAL FITNESS APPARATUS; POST OPERATIVE REHABILITATION APPARATUS (U.S. CLS. 26, 39 AND 44).

CLASS 25—CLOTHING

FOR CLOTHING, NAMELY, TOPS, BOTTOMS, SHIRTS, PANTS, SHORTS, HATS, HEADBANDS, WRISTBANDS (U.S. CLS. 22 AND 39).

KARANENDRA S. CHHINA, EXAMINING ATTORNEY

1. Suzy Webmaster and the Pearls of Wisdom 2. Suzy Webmaster

THE MARK CONSISTS OF STANDARD CHARACTERS WITHOUT CLAIM TO ANY PARTICULAR FONT, STYLE, SIZE, OR COLOR.

CLASS 9—ELECTRICAL AND SCIENTIFIC APPARATUS

FOR COMPUTER GAME SOFTWARE (U.S. CLS. 21, 23, 26, 36 AND 38).

CLASS 16—PAPER GOODS AND PRINTED MATTER

FOR CHILDREN'S BOOKS; COMIC BOOKS; SERIES OF FICTION BOOKS (U.S. CLS. 2, 5, 22, 23, 29, 37, 38 AND 50).

CHRISIE B. KING, EXAMINING ATTORNEY

SN 85-540,300. GATTUSO, VICKI L., JOHNS ISLAND, SC. FILED 2-11-2012.

diva Pearl

THE MARK CONSISTS OF STANDARD CHARACTERS WITHOUT CLAIM TO ANY PARTICULAR FONT, STYLE, SIZE, OR COLOR.

CLASS 16—PAPER GOODS AND PRINTED MATTER

FOR PORTRAITS (U.S. CLS. 2, 5, 22, 23, 29, 37, 38 AND 50).

FIRST USE 1-3-2012; IN COMMERCE 1-3-2012.

CLASS 18—LEATHER GOODS

FOR DOG APPAREL (U.S. CLS. 1, 2, 3, 22 AND 41).

FIRST USE 1-3-2012; IN COMMERCE 1-3-2012.

CYNTHIA TRIPI, EXAMINING ATTORNEY

SN 85-540,313. ENICA, LLC, DBA ENICA CONSULTING, NEW YORK, NY. FILED 2-11-2012.

Enica

THE MARK CONSISTS OF STANDARD CHARACTERS WITHOUT CLAIM TO ANY PARTICULAR FONT, STYLE, SIZE, OR COLOR.

CLASS 35—ADVERTISING AND BUSINESS

FOR CONSULTING SERVICES USED IN THE FIELD OF FACILITY MANAGEMENT AND ENERGY EFFICIENCY NAMELY TO IDENTIFY, ANALYZE AND IMPLEMENT STRATEGIES AIMED AT REDUCING THE COST OF OPERATING A COMMERCIAL, INSTITUTIONAL, OR INDUSTRIAL FACILITY (U.S. CLS. 100, 101 AND 102).

FIRST USE 6-23-2010; IN COMMERCE 6-23-2010.

CLASS 42—SCIENTIFIC AND COMPUTER SERVICES

FOR ENGINEERING SERVICES USED IN THE FIELDS OF BUILDING AND PROPERTY CONDITION ASSESSMENT, REPAIRS AND UPGRADES, BUILDING INSTRUMENTATION AND MONITORING, BUILDING SYSTEMS AND EQUIPMENT CONTROLS OPTIMIZATION, FACILITY MANAGEMENT, CONSTRUCTION MANAGEMENT, ALTERNATIVE ENERGY, ENERGY CONSERVATION, AND ENVIRONMENTAL CONSULTING (U.S. CLS. 100 AND 101).

FIRST USE 6-23-2010; IN COMMERCE 6-23-2010.
MICHAEL WIENER, EXAMINING ATTORNEY

SN 85-540,377. CLUBHOUSE INTERNATIONAL LLC, LAS VEGAS, NV. FILED 2-11-2012.

Goretorium

THE MARK CONSISTS OF STANDARD CHARACTERS WITHOUT CLAIM TO ANY PARTICULAR FONT, STYLE, SIZE, OR COLOR.

CLASS 20—FURNITURE AND ARTICLES NOT OTHERWISE CLASSIFIED

FOR FURNITURE FOR USE IN THE HAUNTED ATTRACTION INDUSTRY (U.S. CLS. 2, 13, 22, 25, 32 AND 50).

CLASS 28—TOYS AND SPORTING GOODS

FOR AMUSEMENT PARK RIDES (U.S. CLS. 22, 23, 38 AND 50).

CLASS 41—EDUCATION AND ENTERTAINMENT

FOR AMUSEMENT PARK AND THEME PARK SERVICES (U.S. CLS. 100, 101 AND 107).

CLASS 42—SCIENTIFIC AND COMPUTER SERVICES

FOR HAUNTED ATTRACTION DESIGN SERVICES (U.S. CLS. 100 AND 101).
COLLEEN DOMBROW, EXAMINING ATTORNEY

SN 85-540,380. MEENAXI ENTERPRISE, INC., DBA MEE-NAXI ENTERPRISE, INC., SOUTH PLAINFIELD, NJ. FILED 2-11-2012.

Bournvita

THE MARK CONSISTS OF STANDARD CHARACTERS WITHOUT CLAIM TO ANY PARTICULAR FONT, STYLE, SIZE, OR COLOR.

THE WORDING "BOURNVITA" HAS NO MEANING IN A FOREIGN LANGUAGE.

CLASS 29—MEATS AND PROCESSED FOODS

FOR BASES FOR MAKING MILK SHAKES; BEVERAGES CONSISTING PRINCIPALLY OF MILK; BEVERAGES HAVING A MILK BASE; CHOCOLATE MILK; DRIED MILK POWDER; MILK BEVERAGES CONTAINING FRUITS; MILK DRINKS CONTAINING FRUITS; MILK POWDER; MILK SHAKES; MILK-BASED BEVERAGES WITH CHOCOLATE; MILK-BASED BEVERAGES WITH HIGH MILK CONTENT; MILK-BASED ENERGY DRINKS; NUT-BASED MILK; POWDERED MILK; PROTEIN MILK; STRAWBERRY MILK; VANILLA MILK (U.S. CL. 46).

FIRST USE 1-1-2008; IN COMMERCE 1-1-2008.

CLASS 30—STAPLE FOODS

FOR CHOCOLATE POWDER; CHOCOLATE-BASED BEVERAGES; CHOCOLATE-BASED BEVERAGES WITH MILK; COCOA; COCOA BEVERAGES WITH MILK; COCOA POWDER; COCOA-BASED BEVERAGES; COCOA-BASED CONDIMENTS AND SEASONINGS FOR FOOD AND DRINK; HOT CHOCOLATE (U.S. CL. 46).

FIRST USE 1-1-2008; IN COMMERCE 1-1-2008.
GINA HAYES, EXAMINING ATTORNEY

SN 85-540,529. CARLOS ANTHONY PADILLA, AKA BOOGIE PADILLA, CORONA, CA. FILED 2-12-2012.

Black Finger Tribe

THE MARK CONSISTS OF STANDARD CHARACTERS WITHOUT CLAIM TO ANY PARTICULAR FONT, STYLE, SIZE, OR COLOR.

CLASS 25—CLOTHING

FOR CLOTHING, NAMELY, PANTS, JEANS, JACKETS, SKIRTS, SHORTS, SWEAT PANTS, SWEATSHIRTS, AND VESTS (U.S. CLS. 22 AND 39).

CLASS 35—ADVERTISING AND BUSINESS

FOR ON-LINE RETAIL STORE SERVICES FEATURING CLOTHING; RETAIL STORE SERVICES FEATURING CLOTHING (U.S. CLS. 100, 101 AND 102).
KIMBERLY PERRY, EXAMINING ATTORNEY

SN 85-540,649. DELTA CARD SERVICES, INC., THE WOODLANDS, TX. FILED 2-13-2012.

SN 85-540,965. COMPASS GROUP USA, INC., CHARLOTTE, NC. FILED 2-13-2012.

DeltaPay

THE MARK CONSISTS OF STANDARD CHARACTERS WITHOUT CLAIM TO ANY PARTICULAR FONT, STYLE, SIZE, OR COLOR.

CLASS 9—ELECTRICAL AND SCIENTIFIC APPARATUS

FOR CARD READERS FOR CREDIT CARDS; CARD READERS FOR MAGNETICALLY ENCODED CARDS; COMPUTER SOFTWARE, NAMELY, ELECTRONIC FINANCIAL PLATFORM THAT ACCOMMODATES MULTIPLE TYPES OF PAYMENT AND DEBT TRANSACTIONS IN AN INTEGRATED MOBILE PHONE, PDA, AND WEB BASED ENVIRONMENT; ELECTRONIC CARD READERS (U.S. CLS. 21, 23, 26, 36 AND 38).

CLASS 36—INSURANCE AND FINANCIAL

FOR CREDIT CARD PAYMENT PROCESSING SERVICES (U.S. CLS. 100, 101 AND 102).
SAMUEL E. SHARPER JR., EXAMINING ATTORNEY

SN 85-540,806. DELANY, BRANDT, HOUSTON, TX. FILED 2-13-2012.

YES TO SPIRIT

THE MARK CONSISTS OF STANDARD CHARACTERS WITHOUT CLAIM TO ANY PARTICULAR FONT, STYLE, SIZE, OR COLOR.

CLASS 41—EDUCATION AND ENTERTAINMENT

FOR EDUCATIONAL SERVICES, NAMELY, CONDUCTING CLASSES, SEMINARS, CONFERENCES, AND WORKSHOPS IN THE FIELD OF SPIRITUAL AWARENESS AND SPIRITUAL AWAKENING AND DISTRIBUTION OF COURSE MATERIAL IN CONNECTION THEREWITH (U.S. CLS. 100, 101 AND 107).

CLASS 45—PERSONAL AND LEGAL SERVICES

FOR PSYCHIC READING SERVICES (U.S. CLS. 100 AND 101).
DEZMONA MIZELLE, EXAMINING ATTORNEY

OUTTAHERE!

THE MARK CONSISTS OF STANDARD CHARACTERS WITHOUT CLAIM TO ANY PARTICULAR FONT, STYLE, SIZE, OR COLOR.

CLASS 35—ADVERTISING AND BUSINESS

FOR RETAIL CONVENIENCE STORE SERVICES (U.S. CLS. 100, 101 AND 102).

CLASS 43—HOTEL AND RESTAURANT SERVICES

FOR CONTRACT FOOD SERVICES, PROVIDING OF FOOD AND DRINK (U.S. CLS. 100 AND 101).
MATTHEW KLINE, EXAMINING ATTORNEY

SN 85-544,311. HUMANA INC., LOUISVILLE, KY. FILED 2-16-2012.

NLIVEN SYSTEMS

THE MARK CONSISTS OF STANDARD CHARACTERS WITHOUT CLAIM TO ANY PARTICULAR FONT, STYLE, SIZE, OR COLOR.

NO CLAIM IS MADE TO THE EXCLUSIVE RIGHT TO USE "SYSTEMS", APART FROM THE MARK AS SHOWN.

CLASS 9—ELECTRICAL AND SCIENTIFIC APPARATUS

FOR COMPUTER SOFTWARE FOR THE DESIGN, DEVELOPMENT AND DEPLOYMENT OF MODULAR INTRANET, EXTRANET AND PUBLIC ACCESS INTERNET SITES (U.S. CLS. 21, 23, 26, 36 AND 38).

CLASS 41—EDUCATION AND ENTERTAINMENT

FOR ENTERTAINMENT SERVICES, NAMELY, PROVIDING ON-LINE EDUCATIONAL COMPUTER GAMES (U.S. CLS. 100, 101 AND 107).

CLASS 42—SCIENTIFIC AND COMPUTER SERVICES

FOR CONSULTING SERVICES IN THE FIELD OF COMPUTER HARDWARE DESIGN AND DEVELOPMENT; COMPUTER SOFTWARE CONSULTING; DEVELOPMENT AND IMPLEMENTATION OF SOFTWARE, HARDWARE AND TECHNOLOGY SOLUTIONS FOR THE PURPOSE OF FACILITATING CONTINUOUS HEALTH AND WELLNESS MONITORING, IN-HOME CARE, AND FAMILY REMOTE MONITORING FOR SENIORS AND DISABLED ADULTS (U.S. CLS. 100 AND 101).

CLASS 45—PERSONAL AND LEGAL SERVICES

FOR LICENSING OF COMPUTER SOFTWARE (U.S. CLS. 100 AND 101).
SUE LAWRENCE, EXAMINING ATTORNEY

SN 85-544,744. ALLTECH, INC., NICHOLASVILLE, KY. FILED 2-16-2012.



THE MARK CONSISTS OF A KEY STANDING UPRIGHT NEXT TO THE LETTER "N".

SN 85-544,711. GORADIO, LLC, NEW YORK, NY. FILED 2-16-2012.



CLASS 5—PHARMACEUTICALS

FOR NON-MEDICATED ADDITIVES FOR ANIMAL FEED FOR USE AS NUTRITIONAL SUPPLEMENTS (U.S. CLS. 6, 18, 44, 46, 51 AND 52).

CLASS 31—NATURAL AGRICULTURAL PRODUCTS

FOR ANIMAL FOODSTUFFS (U.S. CLS. 1 AND 46).
KELLEY WELLS, EXAMINING ATTORNEY

NO CLAIM IS MADE TO THE EXCLUSIVE RIGHT TO USE "RADIO", APART FROM THE MARK AS SHOWN.
THE MARK CONSISTS OF THE WORDS "GO RADIO" WITH THE "O" IN THE "GO" IN THE SHAPE OF A RECORD WEARING HEADPHONES.

SN 85-545,999. PERFECT FIT INDUSTRIES, LLC, BLOOMFIELD HILLS, MI. FILED 2-17-2012.

CLASS 38—COMMUNICATION

FOR INTERNET BROADCASTING SERVICES; INTERNET RADIO BROADCASTING SERVICES; RADIO BROADCASTING SERVICES; STREAMING OF AUDIO AND VIDEO MATERIAL ON THE INTERNET, ON MOBILE TELEPHONES OR ON OTHER ELECTRONIC OR DIGITAL COMMUNICATIONS NETWORKS; PROVIDING AN INTERNET WEBSITE PORTAL FOR INTERNET RADIO BROADCASTING SERVICES (U.S. CLS. 100, 101 AND 104).

MemoryAire

THE MARK CONSISTS OF STANDARD CHARACTERS WITHOUT CLAIM TO ANY PARTICULAR FONT, STYLE, SIZE, OR COLOR.

CLASS 41—EDUCATION AND ENTERTAINMENT

FOR ENTERTAINMENT SERVICES, NAMELY, PROVIDING CONTINUING AUDIO PROGRAMS FEATURING MUSIC, SPORTS, TALK, NEWS AND DATA VIA SATELLITE, GLOBAL COMPUTER NETWORK, TELECOMMUNICATION NETWORK, WIRELESS COMMUNICATION NETWORK, OR OTHER ELECTRONIC OR DIGITAL COMMUNICATIONS NETWORK OR DIGITAL COMMUNICATIONS DEVICE; PROVIDING AN INTERNET WEBSITE PORTAL IN THE FIELD OF INTERNET MUSIC AND ENTERTAINMENT; PROVIDING A WEBSITE FEATURING INFORMATION AND CONTENT IN THE FIELD OF MUSIC AND ENTERTAINMENT (U.S. CLS. 100, 101 AND 107).
SANDRA BUJA, EXAMINING ATTORNEY

CLASS 20—FURNITURE AND ARTICLES NOT OTHERWISE CLASSIFIED

FOR MATTRESS TOPPERS; PILLOWS (U.S. CLS. 2, 13, 22, 25, 32 AND 50).

CLASS 24—FABRICS

FOR MATTRESS PADS (U.S. CLS. 42 AND 50).
AMY C. KEAN, EXAMINING ATTORNEY

SN 85-546,260. GENERAL ELECTRIC COMPANY, SCHE-
NECTADY, NY. FILED 2-17-2012.

SN 85-553,521. ISCA TECHNOLOGIES, INC., RIVERSIDE,
CA. FILED 2-27-2012.

POWERTREAT

THE MARK CONSISTS OF STANDARD CHARACTERS
WITHOUT CLAIM TO ANY PARTICULAR FONT, STYLE,
SIZE, OR COLOR.

CLASS 1—CHEMICALS

FOR CHEMICALS FOR USE IN TREATING POWER
GENERATING AND STEAM GENERATING SYSTEMS,
GAS SCRUBBERS, COOLING SYSTEMS, COAL HAND-
LING AND STORAGE SYSTEMS, ASH HANDLING
SYSTEMS, INFLUENT AND EFFLUENT WATER
TREATMENT SYSTEMS (U.S. CLS. 1, 5, 6, 10, 26 AND
46).

CLASS 9—ELECTRICAL AND SCIENTIFIC APPARATUS

FOR PREDICTIVE AND MODELING SOFTWARE
PROGRAMS FOR USE IN THE TREATMENT OF FUEL
AND IN FUEL COMBUSTION SYSTEMS (U.S. CLS. 21,
23, 26, 36 AND 38).

FRANK LATTUCA, EXAMINING ATTORNEY

SN 85-548,898. KUDOS INC., CALGARY, CANADA, FILED 2-
21-2012.

Kudos2U

THE MARK CONSISTS OF STANDARD CHARACTERS
WITHOUT CLAIM TO ANY PARTICULAR FONT, STYLE,
SIZE, OR COLOR.

CLASS 42—SCIENTIFIC AND COMPUTER SERVICES

FOR SOFTWARE AS A SERVICE (SAAS) FEATURING
SOFTWARE FOR PEER-TO-PEER AND GROUP-TO-
GROUP INTERACTION IN THE AREA OF RECOGNITION,
REWARDS, MONETIZATION AND PAYMENT
THAT MAY INCORPORATE THE ALLOCATION, COL-
LECTION, AND DISTRIBUTION OF POINTS, CHARAC-
TERISTICS, MICRO MESSAGES, AND MONEY THAT
CAN BE ASSOCIATED TO RECOGNITION OF INDIV-
DUALS FOR ACHIEVEMENTS, EFFORTS, ATTITUDES,
SKILLS, AND OBJECTIVES (U.S. CLS. 100 AND 101).

CLASS 45—PERSONAL AND LEGAL SER- VICES

FOR INTERNET-BASED SOCIAL NETWORKING SER-
VICES (U.S. CLS. 100 AND 101).

RONALD MCMORROW, EXAMINING ATTORNEY

ECRT

THE MARK CONSISTS OF STANDARD CHARACTERS
WITHOUT CLAIM TO ANY PARTICULAR FONT, STYLE,
SIZE, OR COLOR.

CLASS 5—PHARMACEUTICALS

FOR INSECTICIDES AND INSECT ATTRACTANTS,
NAMELY, CHEMICAL COMPOSITIONS TO ATTRACT
INSECTS FOR PEST CONTROL PURPOSES (U.S. CLS. 6,
18, 44, 46, 51 AND 52).

CLASS 21—HOUSEWARES AND GLASS

FOR INSECT TRAPS; INSECT TRAPS WITH INSECT
LURES FOR PEST CONTROL PURPOSES SOLD AS A
UNIT (U.S. CLS. 2, 13, 23, 29, 30, 33, 40 AND 50).

WILLIAM VERHOSEK, EXAMINING ATTORNEY

SN 85-553,616. CITY OF DUNEDIN, DUNEDIN, FL. FILED 2-
27-2012.



NO CLAIM IS MADE TO THE EXCLUSIVE RIGHT TO
USE "DUNEDIN", APART FROM THE MARK AS SHOWN.
THE COLOR(S) BLACK, GREEN, ORANGE, AND BLUE
IS/ARE CLAIMED AS A FEATURE OF THE MARK.

THE MARK CONSISTS OF THE WORD "DUNEDIN" IN
THE COLOR BLACK WITH THE "E" BEING REPRE-
SENTED BY THREE WAVY LINES, THE TOP WAVE IN
BLUE, THE MIDDLE WAVE IN ORANGE, AND THE
BOTTOM WAVE IN GREEN; THE WORDING "HOME OF
HONEYMOON ISLAND" IN BLUE AND "LIFE FLOWS
YOUR WAY" IN BLACK.

CLASS 16—PAPER GOODS AND PRINTED MATTER

FOR PRINTED PERIODICALS IN THE FIELD OF
TOURISM (U.S. CLS. 2, 5, 22, 23, 29, 37, 38 AND 50).

CLASS 35—ADVERTISING AND BUSINESS

FOR PROMOTING TOURISM IN DUNEDIN, FLOR-
IDA AREA (U.S. CLS. 100, 101 AND 102).

HOWARD B. LEVINE, EXAMINING ATTORNEY

SN 85-554,493. FMR LLC, BOSTON, MA. FILED 2-28-2012.

SN 85-560,597. CARL KARCHER ENTERPRISES, INC., CARPINTERIA, CA. AND HARDEE'S FOOD SYSTEMS, INC., ST. LOUIS, MO. FILED 3-5-2012.

SEA THE DIFFERENCE

THE MARK CONSISTS OF STANDARD CHARACTERS WITHOUT CLAIM TO ANY PARTICULAR FONT, STYLE, SIZE, OR COLOR.

CLASS 39—TRANSPORTATION AND STORAGE

FOR PARKING GARAGE SERVICES (U.S. CLS. 100 AND 105).

CLASS 41—EDUCATION AND ENTERTAINMENT

FOR HEALTH CLUB SERVICES, NAMELY, PROVIDING INSTRUCTION AND EQUIPMENT IN THE FIELD OF PHYSICAL EXERCISE (U.S. CLS. 100, 101 AND 107).

CLASS 43—HOTEL AND RESTAURANT SERVICES

FOR HOTEL SERVICES; RESTAURANT AND CATERING SERVICES; PROVISION OF CONFERENCE, EXHIBITION AND MEETING FACILITIES (U.S. CLS. 100 AND 101).

CLASS 45—PERSONAL AND LEGAL SERVICES

FOR PROVIDING FACILITIES FOR WEDDING CEREMONIES (U.S. CLS. 100 AND 101).
TINA MAI, EXAMINING ATTORNEY

SN 85-554,560. GENERAL ELECTRIC COMPANY, SCHEMECTADY, NY. FILED 2-28-2012.

INTRINSX

THE MARK CONSISTS OF STANDARD CHARACTERS WITHOUT CLAIM TO ANY PARTICULAR FONT, STYLE, SIZE, OR COLOR.

CLASS 9—ELECTRICAL AND SCIENTIFIC APPARATUS

FOR LIGHT EMITTING DIODES (LEDS) (U.S. CLS. 21, 23, 26, 36 AND 38).

CLASS 11—ENVIRONMENTAL CONTROL APPARATUS

FOR LED (LIGHT EMITTING DIODE) LIGHTING FIXTURES; LED LIGHTING SYSTEMS, NAMELY, LED MODULES, POWER SUPPLIES, AND WIRING; LED LUMINAIRES (U.S. CLS. 13, 21, 23, 31 AND 34).
FRANK LATTUCA, EXAMINING ATTORNEY

OUR NEXT SUCCESS STORY: YOU

THE MARK CONSISTS OF STANDARD CHARACTERS WITHOUT CLAIM TO ANY PARTICULAR FONT, STYLE, SIZE, OR COLOR.

CLASS 35—ADVERTISING AND BUSINESS

FOR FRANCHISE AND FRANCHISING SERVICES, NAMELY, OFFERING BUSINESS MANAGEMENT, BUSINESS CONSULTATION, BUSINESS ORGANIZATION, AND PROMOTION ASSISTANCE IN THE ESTABLISHMENT AND OPERATION OF RESTAURANTS; BUSINESS SERVICES, NAMELY, CONSULTING SERVICES IN THE FIELD OF FACILITIES MANAGEMENT OF TECHNICAL OPERATIONS (U.S. CLS. 100, 101 AND 102).

CLASS 43—HOTEL AND RESTAURANT SERVICES

FOR RESTAURANT SERVICES (U.S. CLS. 100 AND 101).
KAREN SEVERSON, EXAMINING ATTORNEY

SN 85-562,480. AMERICAN EXPRESS MARKETING & DEVELOPMENT CORP., NEW YORK, NY. FILED 3-7-2012.

RUN LEAN. THINK BIG.

THE MARK CONSISTS OF STANDARD CHARACTERS WITHOUT CLAIM TO ANY PARTICULAR FONT, STYLE, SIZE, OR COLOR.

CLASS 35—ADVERTISING AND BUSINESS

FOR BUSINESS CONSULTATION IN THE FIELD OF SMALL BUSINESS OPERATION AND SUPPORT (U.S. CLS. 100, 101 AND 102).

CLASS 36—INSURANCE AND FINANCIAL

FOR CHARGE CARD AND CREDIT CARD SERVICES (U.S. CLS. 100, 101 AND 102).
KIMBERLY FRYE, EXAMINING ATTORNEY

SN 85-563,142. GOODWILL COMMUNITY FOUNDATION, INC., DURHAM, NC. FILED 3-7-2012.

GCF GLOBAL

THE MARK CONSISTS OF STANDARD CHARACTERS WITHOUT CLAIM TO ANY PARTICULAR FONT, STYLE, SIZE, OR COLOR.

OWNER OF U.S. REG. NOS. 2,624,347, 2,627,919 AND OTHERS.

NO CLAIM IS MADE TO THE EXCLUSIVE RIGHT TO USE "GLOBAL", APART FROM THE MARK AS SHOWN.

CLASS 35—ADVERTISING AND BUSINESS

FOR CHARITABLE SERVICES, NAMELY, COORDINATION OF NON-MONETARY CONTRIBUTIONS TO CHARITIES AND NON-PROFITS; CHARITABLE SERVICES, NAMELY, PROVIDING OFFICE EQUIPMENT TO THOSE IN NEED; PROVIDING BUSINESS CONSULTING RELATING TO CHARITABLE FUNDRAISING TO NON-PROFIT ORGANIZATIONS (U.S. CLS. 100, 101 AND 102).

FIRST USE 11-14-2011; IN COMMERCE 11-14-2011.

CLASS 36—INSURANCE AND FINANCIAL

FOR CHARITABLE FUNDRAISING; CHARITABLE FUNDRAISING SERVICES BY MEANS OF COLLECTING AND REDEEMING RECYCLABLES FOR DONATION OF REDEMPTION PROCEEDS TO CHARITABLE ORGANIZATIONS; CHARITABLE FUNDRAISING SERVICES BY MEANS OF ORGANIZING AND CONDUCTING SPECIAL EVENTS; CHARITABLE FUNDRAISING SERVICES BY MEANS OF COLLECTING AND REDEEMING RECYCLABLES FOR DONATION OF REDEMPTION PROCEEDS TO NON-PROFIT CHARITABLE ORGANIZATIONS; CHARITABLE FUNDRAISING SERVICES BY MEANS OF PROVIDING GRANTS TO NON-PROFIT CHARITABLE ORGANIZATIONS; PROVIDING PHILANTHROPY AND FINANCIAL CONSULTING RELATING TO CHARITABLE FUNDRAISING TO NON-PROFIT ORGANIZATIONS; CHARITABLE FUNDRAISING TO SUPPORT EDUCATION, EMPLOYMENT AND LIFE ENRICHMENT OPPORTUNITIES FOR PERSONS WITH DISABILITIES OR OTHER DISADVANTAGING CIRCUMSTANCES (U.S. CLS. 100, 101 AND 102).

FIRST USE 11-14-2011; IN COMMERCE 11-14-2011.

LAURIE MAYES, EXAMINING ATTORNEY

SN 85-565,208. ALEXANDRIA REAL ESTATE EQUITIES, INC., PASADENA, CA. FILED 3-9-2012.



ALEXANDRIA

Collaborate to Innovate

OWNER OF U.S. REG. NOS. 2,798,395, 2,887,368 AND OTHERS.

THE MARK CONSISTS OF DESIGN OF LIGHTHOUSE WITH THE WORDS "ALEXANDRIA COLLABORATE TO INNOVATE".

CLASS 36—INSURANCE AND FINANCIAL

FOR REAL ESTATE SERVICES, NAMELY, REAL ESTATE BROKERAGE, FINANCING, RENTAL, LEASING AND CONSULTANCY SERVICES (U.S. CLS. 100, 101 AND 102).

CLASS 37—CONSTRUCTION AND REPAIR

FOR REAL ESTATE DEVELOPMENT SERVICES, NAMELY, DEVELOPMENT, CONSTRUCTION, MAINTENANCE AND REPAIR OF OFFICE, RESEARCH AND LABORATORY PROPERTIES (U.S. CLS. 100, 103 AND 106).

CLASS 42—SCIENTIFIC AND COMPUTER SERVICES

FOR ARCHITECTURAL DESIGN SERVICES; ENGINEERING SERVICES; RENTAL AND LEASING OF COMPUTERS AND LABORATORY EQUIPMENT (U.S. CLS. 100 AND 101).

FRANK LATTUCA, EXAMINING ATTORNEY

SN 85-568,722. ILLUMINA, INC., SAN DIEGO, CA. FILED 3-13-2012.

RAPIDSEQ

THE MARK CONSISTS OF STANDARD CHARACTERS WITHOUT CLAIM TO ANY PARTICULAR FONT, STYLE, SIZE, OR COLOR.

CLASS 1—CHEMICALS

FOR REAGENTS FOR RESEARCH PURPOSES, REAGENT KITS COMPRISING NUCLEIC ACIDS, NUCLEOTIDES, ENZYMES, LABELS, AND BUFFERS, MICROSCOPIC CARRIER BEADS WITH ATTACHED BIOMOLECULES, BUFFERS, AND ENZYMES, FOR THE PURPOSE OF PREPARING, DETECTING, SEQUENCING, AND ANALYZING NUCLEIC ACIDS AND OTHER BIOLOGICAL MOLECULES, GENES, GENOMES, SEQUENCE VARIANTS AND MODIFICATIONS, REGULATION, TRANSCRIPTION, AND EXPRESSION, AND FOR STUDYING RELATED ASSOCIATIONS IN THE FIELDS OF SCIENTIFIC, DIAGNOSTIC AND CLINICAL RESEARCH (U.S. CLS. 1, 5, 6, 10, 26 AND 46).

CLASS 9—ELECTRICAL AND SCIENTIFIC APPARATUS

FOR SCIENTIFIC AND CLINICAL DIAGNOSTIC INSTRUMENTS, NAMELY, NUCLEIC ACID SEQUENCERS, IMAGING DEVICES, NAMELY, ELECTRONIC IMAGING APPARATUS FOR DETECTING IMAGES AND OPTICAL SIGNALS, AND FOR PROCESSING IMAGES AND OPTICAL SIGNALS INTO DATA, FOR USE IN GENOTYPING AND SEQUENCING; EQUIPMENT FOR SAMPLE PREPARATION, AMPLIFICATION, MIXING, HYBRIDIZATION, INCUBATION, AND WASHING, NAMELY, SAMPLE CONTAINERS, REAGENT HOLDERS, AND PIPETTES, CARRYING MULTIPLE REAGENTS, AND SAMPLE CONTAINERS AND HOLLOW CHAMBERS HAVING CHEMICALLY MODIFIED SURFACES; AUTOMATED LABORATORY EQUIPMENT AND SYSTEMS, NAMELY, ROBOTIC EQUIPMENT IN THE NATURE OF A MECHANICAL ARM FOR POSITIONING AND MOVING CONTAINERS FOR SAMPLES OR ADDING REAGENTS THERETO, AND BARCODE READERS; COMPUTER SYSTEMS COMPRISED OF NETWORKED, DESKTOP, MOBILE, AND HAND-HELD COMPUTER HARDWARE, COMPUTER OPERATING SYSTEMS, WIRELESS DATA NETWORKS, COMPUTER SOFTWARE, COMPUTER APPLICATION PROGRAMS FOR USE ON MOBILE AND NETWORKED COMPUTING DEVICES FOR RECEIVING AND DISPLAYING INFORMATION FROM SCIENTIFIC INSTRUMENTS, DATA FILES, MODEMS AND COMPUTER PERIPHERAL DEVICES FOR COLLECTING, STORING, ANALYZING AND REPORTING BIOLOGICAL INFORMATION, AND FOR SAMPLE TRACKING AND MANAGING PROJECTS, LABORATORY WORKFLOW AND DATA, ALL THE FOREGOING FOR USE IN THE FIELDS OF SCIENTIFIC, DIAGNOSTIC, CLINICAL RESEARCH, AND FOR CLINICAL DIAGNOSTIC PURPOSES (U.S. CLS. 21, 23, 26, 36 AND 38).

CURTIS FRENCH, EXAMINING ATTORNEY

SN 85-571,561. GOLDMAN, SACHS & CO., NEW YORK, NY. FILED 3-16-2012.

GSET MAST

THE MARK CONSISTS OF STANDARD CHARACTERS WITHOUT CLAIM TO ANY PARTICULAR FONT, STYLE, SIZE, OR COLOR.

OWNER OF U.S. REG. NOS. 2,875,013, 3,979,600 AND OTHERS.

CLASS 35—ADVERTISING AND BUSINESS

FOR EXECUTION OF SECURITIES AND FUTURES TRADE ORDERS AND ROUTING OF SECURITIES AND FUTURES TRADE ORDERS, NAMELY, DIRECTING ORDERS FOR SECURITIES AND FUTURE TRADE ORDERS BY MEANS OF COMPUTER SOFTWARE WHICH AUTOMATICALLY DIRECTS TRADES TO THE BEST LOCATION FOR EXECUTING SUCH ORDERS AND PROVIDING ON-LINE FACILITIES FEATURING ROUTING OF SECURITIES AND FUTURES TRADER ORDERS, TRANSACTION ORDER ENTRY, ORDER DIRECTING AND ORDER CONFIRMATION SERVICES TO CUSTOMERS IN THE FIELD OF INVESTING (U.S. CLS. 100, 101 AND 102).

CLASS 36—INSURANCE AND FINANCIAL

FOR FINANCIAL SERVICES, NAMELY, ELECTRONIC TRADING OF SECURITIES AND FUTURES; FINANCIAL PORTFOLIO MANAGEMENT SERVICES; INVESTMENT MANAGEMENT AND ADVISORY SERVICES; TRADING OF FINANCIAL SECURITIES AND FUTURES; FINANCIAL PLANNING SERVICES; MANAGEMENT OF FINANCIAL ACCOUNTS; TRADING OF SECURITIES AND FUTURES VIA AN ONLINE PLATFORM; FINANCIAL TRANSACTION AND PORTFOLIO INVESTMENT ADVISORY SERVICES; FINANCIAL RESEARCH SERVICES (U.S. CLS. 100, 101 AND 102).

KEVIN CORWIN, EXAMINING ATTORNEY

SN 85-572,905. GE HEALTHCARE UK LIMITED, BUCKINGHAMSHIRE, UNITED KINGDOM, FILED 3-19-2012.

XURI

THE MARK CONSISTS OF STANDARD CHARACTERS WITHOUT CLAIM TO ANY PARTICULAR FONT, STYLE, SIZE, OR COLOR.

THE WORDING "XURI" HAS NO MEANING IN A FOREIGN LANGUAGE.

CLASS 9—ELECTRICAL AND SCIENTIFIC APPARATUS

FOR LABORATORY INSTRUMENT USED TO HARVEST, PROCESS AND PURIFY CELLS FROM CORD BLOOD; PRE-FILLED PLASTIC CASSETTE FOR THE SEPARATION AND MIXING OF VARIOUS CHEMICAL REAGENTS USED TO HARVEST, PROCESS AND PURIFY CELLS FROM CORD BLOOD ALL FOR SCIENTIFIC OR LABORATORY USE; COMPUTER SOFTWARE USED TO COLLECT AND ANALYZE DATA FROM LABORATORY INSTRUMENTS USED TO HARVEST, PROCESS AND PURIFY CELLS FROM CORD BLOOD (U.S. CLS. 21, 23, 26, 36 AND 38).

CLASS 10—MEDICAL APPARATUS

FOR MEDICAL LABORATORY INSTRUMENT USED TO HARVEST, PROCESS AND PURIFY CELLS FROM CORD BLOOD; PRE-FILLED PLASTIC CASSETTE FOR THE SEPARATION AND MIXING OF VARIOUS CHEMICAL REAGENTS USED TO HARVEST, PROCESS AND PURIFY CELLS FROM CORD BLOOD ALL FOR MEDICAL OR CLINICAL USE (U.S. CLS. 26, 39 AND 44).

AHSEN KHAN, EXAMINING ATTORNEY

SN 85-573,097. FLEXIBLE MEDIA, LLC, VALENCIA, CA. FILED 3-19-2012.

Flexible Media

THE MARK CONSISTS OF STANDARD CHARACTERS WITHOUT CLAIM TO ANY PARTICULAR FONT, STYLE, SIZE, OR COLOR.

NO CLAIM IS MADE TO THE EXCLUSIVE RIGHT TO USE "MEDIA", APART FROM THE MARK AS SHOWN.

CLASS 35—ADVERTISING AND BUSINESS

FOR POST-PRODUCTION EDITING SERVICES FOR VIDEO AND AUDIO COMMERCIALS; PRODUCTION OF ADVERTISING MATTER AND COMMERCIALS (U.S. CLS. 100, 101 AND 102).

CLASS 41—EDUCATION AND ENTERTAINMENT

FOR VIDEO PRODUCTION SERVICES (U.S. CLS. 100, 101 AND 107).

SETH A. RAPPAPORT, EXAMINING ATTORNEY

SN 85-574,580. MOSAIC MEDIA GROUP, INC., LOS ANGELES, CA. FILED 3-20-2012.



SN 85-574,579. MOSAIC MEDIA GROUP, INC., LOS ANGELES, CA. FILED 3-20-2012.



OWNER OF U.S. REG. NOS. 2,605,524 AND 2,793,518.
THE COLOR(S) RED, WHITE, BLACK, DARK BROWN AND LIGHT BROWN IS/ARE CLAIMED AS A FEATURE OF THE MARK.

THE MARK CONSISTS OF THE FOLLOWING: A DEPICTION OF AN ERUPTING VOLCANO IN DARK AND LIGHT BROWN TONES, SUPERIMPOSED ON WHICH IS THE WORD "MOSAIC" IN WHITE LETTERING EXCEPT FOR THE LETTER "O" WHICH IS IN RED WITH A BLACK STAR DESIGN IN ITS CENTER, ALL WITHIN A BLACK RECTANGULAR BACKGROUND CARRIER.

CLASS 35—ADVERTISING AND BUSINESS

FOR TALENT MANAGEMENT AGENCY SERVICES (U.S. CLS. 100, 101 AND 102).

CLASS 41—EDUCATION AND ENTERTAINMENT

FOR ENTERTAINMENT SERVICES, NAMELY, FILM, VIDEO AND TELEVISION SHOW PRODUCTION (U.S. CLS. 100, 101 AND 107).

BARNEY CHARLON, EXAMINING ATTORNEY

SN 85-575,636. SILVER SPRING NETWORKS, INC., REDWOOD CITY, CA. FILED 3-21-2012.

THE EVERYTHING NETWORK

THE MARK CONSISTS OF STANDARD CHARACTERS WITHOUT CLAIM TO ANY PARTICULAR FONT, STYLE, SIZE, OR COLOR.

NO CLAIM IS MADE TO THE EXCLUSIVE RIGHT TO USE "NETWORK", APART FROM THE MARK AS SHOWN.

CLASS 9—ELECTRICAL AND SCIENTIFIC APPARATUS

FOR COMPUTER SOFTWARE FOR ENABLING ENERGY CONSUMERS, INCLUDING PUBLIC UTILITY CUSTOMERS, TO TRACK, VIEW, AND MONITOR ENERGY CONSUMPTION INFORMATION, NAMELY, INFORMATION RELATED TO USAGE ANALYSIS, COST ANALYSIS, BILL ANALYSIS, BILL ESTIMATION, ENERGY BUDGETING, NEIGHBORHOOD COMPARISONS, COMMUNITY ANALYSIS, ENVIRONMENTAL ANALYSIS, RATE COMPARISONS, WEATHER MODELING, AND HVAC MODELING, AS WELL AS TO RECEIVE ENERGY-RELATED REPORTS; COMPUTER HARDWARE; COMPUTER SOFTWARE AND NETWORKING EQUIPMENT, NAMELY, NETWORK HARDWARE AND SOFTWARE FOR DEVELOPING, SECURING, MONI-

OWNER OF U.S. REG. NOS. 2,605,524 AND 2,793,518.
THE COLOR(S) RED, WHITE, BLACK, DARK BROWN, LIGHT BROWN AND GRAY IS/ARE CLAIMED AS A FEATURE OF THE MARK.

THE MARK CONSISTS OF THE FOLLOWING: A MOTION MARK CONSISTING OF FIVE FREEZE FRAMES DEPICTING AN ERUPTING VOLCANO IN DARK AND LIGHT BROWN TONES; IN THE FOURTH IMAGE, SUPERIMPOSED ON THE ERUPTING VOLCANO IS THE WORD "MOSAIC" IN WHITE LETTERING EXCEPT FOR THE LETTER "O" WHICH IS IN RED WITH A CIRCULAR BLACK CENTER; IN THE FIFTH IMAGE, THE LETTER "O" IS IN RED WITH A BLACK STAR DESIGN IN ITS CENTER, AND A GRAY RECTANGLE BORDERS THE MARK'S WORDING AND DESIGN WITHIN A LARGER BLACK RECTANGULAR BACKGROUND CARRIER.

CLASS 35—ADVERTISING AND BUSINESS

FOR TALENT MANAGEMENT AGENCY SERVICES (U.S. CLS. 100, 101 AND 102).

CLASS 41—EDUCATION AND ENTERTAINMENT

FOR ENTERTAINMENT SERVICES, NAMELY, FILM, VIDEO AND TELEVISION SHOW PRODUCTION (U.S. CLS. 100, 101 AND 107).

BARNEY CHARLON, EXAMINING ATTORNEY

TORING AND MANAGING MACHINE TO MACHINE NETWORKS; COMPUTER SOFTWARE AND NETWORKING EQUIPMENT, NAMELY, NETWORK HARDWARE AND SOFTWARE FOR SECURING, MONITORING AND MANAGING ENERGY IN THE PUBLIC UTILITIES, GAS UTILITIES, ELECTRIC UTILITIES AND WATER UTILITIES INDUSTRIES; COMPUTER SOFTWARE AND NETWORKING EQUIPMENT, NAMELY, NETWORK HARDWARE AND SOFTWARE FOR DATA COLLECTION APPLICATIONS, NAMELY, DISTRIBUTION AUTOMATION AND DEMAND SIDE MANAGEMENT APPLICATIONS; COMMUNICATIONS NETWORKING SYSTEMS CONSISTING OF COMPUTER HARDWARE, WAN (WIDE AREA NETWORK) OPERATING SOFTWARE, AND SOFTWARE ENABLING PUBLIC UTILITIES TO COMMUNICATE WITH AND CONTROL IN-HOME APPLIANCES AND ELECTRONIC DEVICES; RADIO FREQUENCY WIRELESS COMMUNICATIONS TECHNOLOGY, NAMELY, NETWORK INTERFACE DEVICES, RELAYS, ACCESS POINTS, AND COMPUTER NETWORK BRIDGES; ONE-WAY AND TWO-WAY AUTOMATED METER READING DEVICES FOR USE IN THE ENERGY AND UTILITY FIELDS; COMPUTER HARDWARE AND SOFTWARE FOR USE IN TRANSMITTING DATA ONE-WAY AND TWO-WAY BETWEEN A DATA COMPUTING NETWORK AND REMOTE COMMUNICATIONS DEVICES, NAMELY, WIRELESS NETWORK REPEATERS, ROUTERS, PERSONAL COMPUTERS, LAPTOP COMPUTERS, CELLULAR PHONES AND HANDHELD COMPUTERS; ELECTRONIC INTERFACE MODULES FOR RECEIVING AND TRANSMITTING ENERGY-RELATED INFORMATION AND REQUESTS BETWEEN AND AMONG COMMODITY METERS, ELECTRONIC VEHICLE CHARGING STATIONS, ELECTRONIC DEVICES AND A HOST COMPUTER OVER A WIDE AREA NETWORK AND A LOCAL AREA NETWORK; COMPUTER DATABASE MANAGEMENT SOFTWARE USED FOR RECEIVING AND MONITORING ENERGY USAGE INFORMATION FROM MULTIPLE REMOTE COMMODITY METERS IN THE PUBLIC UTILITIES, GAS UTILITIES, ELECTRIC UTILITIES AND WATER UTILITIES INDUSTRIES; ELECTRIC UTILITY METERS, NAMELY, GAS METERS, ELECTRIC METERS, AND WATER METERS; NETWORK INTERFACE CARDS; GATEWAY ROUTERS IN THE NATURE OF COMPUTER CONTROL HARDWARE; ELECTRONIC DEVICES, NAMELY, RADIO FREQUENCY REPEATERS USED IN LONG RANGE COMMUNICATION FOR TRACKING AND MONITORING ENERGY USAGE AND ADVANCED METER READING DATA; ADVANCED METER COMMUNICATIONS DEVICES, NAMELY, TRANSMITTERS, RECEIVERS AND ANTENNAS USED TO COLLECT, STORE AND PROCESS CONSUMPTION DATA, DISTRIBUTION AUTOMATION DATA, DEMAND RESPONSE DATA AND OTHER INFORMATION IN THE ENERGY AND UTILITY FIELDS, INCLUDING ELECTRIC, WATER, GAS, SOLAR, COAL, THERMAL AND NUCLEAR ENERGY (U.S. CLS. 21, 23, 26, 36 AND 38).

CLASS 42—SCIENTIFIC AND COMPUTER SERVICES

FOR COMPUTER SERVICES FOR OTHERS, NAMELY, IMPLEMENTING AND OPERATING COMPUTER NETWORKS COMPRISED OF COMPUTER HARDWARE AND SOFTWARE FOR SECURING, MONITORING AND MANAGING MACHINE TO MACHINE NETWORKS; COMPUTER SERVICES FOR OTHERS, NAMELY, IMPLEMENTING AND OPERATING COMPUTER NETWORKS COMPRISED OF COMPUTER HARDWARE AND SOFTWARE FOR RECEIVING AND TRANSMITTING ENERGY-RELATED INFORMATION AND REQUESTS BETWEEN AND AMONG COMMODITY METERS, SECURING, MONITORING AND MANAGING UTILITY DISTRIBUTION EQUIPMENT AND MONITORING CUSTOMER UTILITY USAGE; COMPUTER SOFTWARE DESIGN; TECHNICAL SUPPORT, NAMELY, MONITORING OF NETWORK SYSTEMS AND TROUBLESHOOTING IN THE NATURE OF DIAGNOSING COMPUTER HARDWARE AND SOFTWARE PROBLEMS; DESIGN AND DEVELOPMENT OF COMPUTER SYSTEMS FOR THE COLLECTION, STORAGE AND TRANSMISSION OF DATA; SOFTWARE AS A SERVICE (SAAS) SERVICES, NAMELY, HOSTING SOFTWARE FOR USE BY OTHERS FOR SECURING, MONITORING AND MANAGING MACHINE TO MACHINE NETWORKS; SOFTWARE AS A SERVICE (SAAS) SER-

VICES, NAMELY, HOSTING SOFTWARE FOR USE BY OTHERS FOR RECEIVING AND TRANSMITTING ENERGY-RELATED INFORMATION AND REQUESTS BETWEEN AND AMONG UTILITY METERS, SECURING, MONITORING AND MANAGING UTILITY DISTRIBUTION AUTOMATION AND DEMAND RESPONSE DATA AND MONITORING CUSTOMER UTILITY USAGE; SOFTWARE AS A SERVICE (SAAS) SERVICES, NAMELY, HOSTING SOFTWARE THAT ALLOWS ENERGY CONSUMERS, INCLUDING PUBLIC UTILITY CUSTOMERS, TO VIEW AND MONITOR ENERGY CONSUMPTION (U.S. CLS. 100 AND 101).

LINDA LAVACHE, EXAMINING ATTORNEY

SN 85-575,639. SILVER SPRING NETWORKS, INC., REDWOOD CITY, CA. FILED 3-21-2012.

NETWORKIQ

THE MARK CONSISTS OF STANDARD CHARACTERS WITHOUT CLAIM TO ANY PARTICULAR FONT, STYLE, SIZE, OR COLOR.

CLASS 9—ELECTRICAL AND SCIENTIFIC APPARATUS

FOR COMPUTER HARDWARE; COMPUTER SOFTWARE AND NETWORKING EQUIPMENT FOR USE IN THE UTILITY AND ENERGY FIELDS, NAMELY, NETWORK HARDWARE AND SOFTWARE FOR DEVELOPING, SECURING, MONITORING, CONFIGURING AND MANAGING MACHINE TO MACHINE NETWORKS; COMPUTER SOFTWARE AND NETWORKING EQUIPMENT, NAMELY, NETWORK HARDWARE AND SOFTWARE FOR SECURING, MONITORING, AND MANAGING ENERGY IN THE PUBLIC UTILITIES, GAS UTILITIES, ELECTRIC UTILITIES AND WATER UTILITIES INDUSTRIES; COMPUTER SOFTWARE AND NETWORKING EQUIPMENT, NAMELY, NETWORK HARDWARE AND SOFTWARE FOR DATA COLLECTION APPLICATIONS, NAMELY, DISTRIBUTION AUTOMATION AND DEMAND SIDE MANAGEMENT APPLICATIONS; COMMUNICATIONS NETWORKING SYSTEMS CONSISTING OF COMPUTER HARDWARE, WAN (WIDE AREA NETWORK) OPERATING SOFTWARE, AND SOFTWARE ENABLING PUBLIC UTILITIES TO COMMUNICATE WITH, MANAGE, CONFIGURE, PROVIDE SECURITY FOR AND CONTROL IN-HOME APPLIANCES, ELECTRONIC DEVICES, AND DISTRIBUTION AUTOMATION COMMUNICATIONS DEVICES; RADIO FREQUENCY WIRELESS COMMUNICATIONS TECHNOLOGY, NAMELY, NETWORK INTERFACE DEVICES, RELAYS, ACCESS POINTS, AND COMPUTER NETWORK BRIDGES, ONE-WAY AND TWO-WAY AUTOMATED METER READING DEVICES FOR USE IN THE ENERGY AND UTILITY FIELDS, AND COMPUTER SOFTWARE FOR CONTROLLING, MANAGING AND CONFIGURING RADIO FREQUENCY COMMUNICATIONS DEVICES; COMPUTER HARDWARE AND SOFTWARE FOR USE BY UTILITY AND ENERGY COMPANIES IN TRANSMITTING DATA ONE-WAY AND TWO-WAY BETWEEN A DATA COMPUTING NETWORK AND REMOTE COMMUNICATIONS DEVICES, NAMELY, WIRELESS NETWORK REPEATERS, ROUTERS, PERSONAL COMPUTERS, LAPTOP COMPUTERS, CELLULAR PHONES AND HANDHELD COMPUTERS; ELECTRONIC INTERFACE MODULES FOR RECEIVING AND TRANSMITTING ENERGY-RELATED INFORMATION AND REQUESTS BETWEEN AND AMONG COMMODITY METERS, ELECTRONIC VEHICLE CHARGING STATIONS, ELECTRONIC DEVICES AND A HOST COMPUTER OVER A WIDE AREA NETWORK AND A LOCAL AREA NETWORK; COMPUTER DATABASE MANAGEMENT SOFTWARE USED FOR RECEIVING AND MONITORING ENERGY USAGE INFORMATION FROM MULTIPLE REMOTE COMMODITY METERS IN THE PUBLIC

UTILITIES, GAS UTILITIES, ELECTRIC UTILITIES AND WATER UTILITIES INDUSTRIES; ELECTRIC UTILITY METERS, NAMELY, GAS METERS, ELECTRIC METERS, AND WATER METERS; NETWORK INTERFACE CARDS; GATEWAY ROUTERS IN THE NATURE OF COMPUTER CONTROL HARDWARE; ELECTRONIC DEVICES, NAMELY, RADIO FREQUENCY REPEATERS USED IN LONG RANGE COMMUNICATION FOR TRACKING AND MONITORING ENERGY USAGE AND ADVANCED METER READING DATA; ADVANCED METER COMMUNICATIONS DEVICES, NAMELY, TRANSMITTERS, RECEIVERS AND ANTENNAS USED TO COLLECT, STORE AND PROCESS CONSUMPTION DATA, DISTRIBUTION AUTOMATION DATA, DEMAND RESPONSE DATA AND OTHER INFORMATION IN THE ENERGY AND UTILITY FIELDS, INCLUDING ELECTRIC, WATER, GAS, SOLAR, COAL, THERMAL AND NUCLEAR ENERGY (U.S. CLS. 21, 23, 26, 36 AND 38).

SN 85-578,069. AVATAR PROPERTIES, INC., POINCIANA, FL. FILED 3-23-2012.



THE MARK CONSISTS OF A STYLIZED LETTER "V" IMPOSED ON TOP OF A SECOND "V" GIVING THE TWO LETTERS A SHADOW BOX EFFECT.

CLASS 42—SCIENTIFIC AND COMPUTER SERVICES

FOR COMPUTER SERVICES FOR UTILITY AND ENERGY COMPANIES, NAMELY, IMPLEMENTING AND OPERATING COMPUTER NETWORKS COMPRISED OF COMPUTER HARDWARE AND SOFTWARE FOR SECURING, MONITORING AND MANAGING MACHINE TO MACHINE NETWORKS; COMPUTER SERVICES FOR OTHERS, NAMELY, IMPLEMENTING AND OPERATING COMPUTER NETWORKS COMPRISED OF COMPUTER HARDWARE AND SOFTWARE FOR RECEIVING AND TRANSMITTING ENERGY-RELATED INFORMATION AND REQUESTS BETWEEN AND AMONG COMMODITY METERS, SECURING, MONITORING AND MANAGING UTILITY DISTRIBUTION EQUIPMENT AND MONITORING CUSTOMER UTILITY USAGE; COMPUTER SOFTWARE DESIGN FOR UTILITY AND ENERGY COMPANIES; TECHNICAL SUPPORT, NAMELY, MONITORING OF NETWORK SYSTEMS AND TROUBLESHOOTING IN THE NATURE OF DIAGNOSING COMPUTER HARDWARE AND SOFTWARE PROBLEMS FOR UTILITY AND ENERGY COMPANIES; DESIGN AND DEVELOPMENT OF COMPUTER SYSTEMS FOR UTILITY AND ENERGY COMPANIES FOR THE COLLECTION, STORAGE AND TRANSMISSION OF DATA; SOFTWARE AS A SERVICE (SAAS) SERVICES, NAMELY, HOSTING SOFTWARE FOR USE BY UTILITY AND ENERGY COMPANIES FOR SECURING, MONITORING AND MANAGING MACHINE TO MACHINE NETWORKS; SOFTWARE AS A SERVICE (SAAS) SERVICES, NAMELY, HOSTING SOFTWARE FOR USE BY OTHERS FOR RECEIVING AND TRANSMITTING ENERGY-RELATED INFORMATION AND REQUESTS BETWEEN AND AMONG UTILITY METERS, SECURING, MONITORING AND MANAGING UTILITY DISTRIBUTION AUTOMATION AND DEMAND RESPONSE DATA AND MONITORING CUSTOMER UTILITY USAGE; SOFTWARE AS A SERVICE (SAAS) SERVICES, NAMELY, HOSTING SOFTWARE THAT ALLOWS ENERGY CONSUMERS, INCLUDING PUBLIC UTILITY CUSTOMERS, TO VIEW AND MONITOR ENERGY CONSUMPTION (U.S. CLS. 100 AND 101).

LINDA LAVACHE, EXAMINING ATTORNEY

CLASS 36—INSURANCE AND FINANCIAL

FOR REAL ESTATE AGENCY SERVICES AND REAL ESTATE BROKERAGE SERVICES (U.S. CLS. 100, 101 AND 102).

CLASS 37—CONSTRUCTION AND REPAIR

FOR REAL ESTATE DEVELOPMENT SERVICES; LAND DEVELOPMENT SERVICES, NAMELY, PLANNING AND LAYING OUT OF RESIDENTIAL COMMUNITIES, RECREATIONAL FACILITIES, SOCIAL AND COMMUNITY FACILITIES, OFFICE COMPLEXES, SHOPPING CENTERS AND MEETING AND CONVENTION CENTERS; CONSTRUCTION SERVICES, NAMELY, PLANNING, LAYING OUT, AND CONSTRUCTION OF RESIDENCES, RECREATIONAL FACILITIES, SOCIAL AND COMMUNITY FACILITIES AND COMMERCIAL BUILDINGS (U.S. CLS. 100, 103 AND 106).

CLASS 41—EDUCATION AND ENTERTAINMENT

FOR PROVIDING RECREATIONAL FACILITIES, NAMELY, TENNIS COURTS, SWIMMING FACILITIES AND FITNESS AND EXERCISE FACILITIES (U.S. CLS. 100, 101 AND 107).

SHARON MEIER, EXAMINING ATTORNEY

SN 85-580,297. CLIF BAR & COMPANY, EMERYVILLE, CA. FILED 3-26-2012.

MEET THE MOMENT

THE MARK CONSISTS OF STANDARD CHARACTERS WITHOUT CLAIM TO ANY PARTICULAR FONT, STYLE, SIZE, OR COLOR.

CLASS 29—MEATS AND PROCESSED FOODS

FOR SOY-BASED FOOD BARS; ORGANIC DRIED FRUIT SNACKS; READY-TO-EAT FOOD BARS CONSISTING PRIMARILY OF FRUITS AND NUTS; FRUIT BASED SNACK BARS (U.S. CL. 46).

CLASS 30—STAPLE FOODS

FOR READY-TO-EAT GRAIN-BASED FOOD BARS CONSISTING PRIMARILY OF PRETZELS; GRAIN BASED FOOD BARS; CEREAL-BASED ENERGY BARS COMPRISED PRIMARILY OF BROWN RICE SYRUP; NUTRITIONAL GRANOLA-BASED SNACK BARS; SNACK FOOD CHEWS MADE PRIMARILY FROM BROWN RICE SYRUP FOR CONSUMPTION DURING ATHLETIC ACTIVITIES (U.S. CL. 46).

SN 85-590,578. CARRERA SPORTS INT, LLC, FORT MYERS, FL. FILED 4-5-2012.

**OWNED BY PROS. USED BY
PROS.**

CLASS 32—LIGHT BEVERAGES

FOR NON-ALCOHOLIC BEVERAGES, NAMELY, SPORTS DRINKS; POWDERS USED IN THE PREPARATION OF ISOTONIC SPORTS DRINKS AND SPORTS BEVERAGES; CONCENTRATES, SYRUPS OR POWDERS USED IN THE PREPARATION OF SOFT DRINKS (U.S. CLS. 45, 46 AND 48).

THE MARK CONSISTS OF STANDARD CHARACTERS WITHOUT CLAIM TO ANY PARTICULAR FONT, STYLE, SIZE, OR COLOR.

CLASS 25—CLOTHING

FOR BASEBALL CAPS AND HATS; BASEBALL SHOES; ATHLETIC APPAREL, NAMELY, SHIRTS, PANTS, JACKETS, FOOTWEAR, HATS AND CAPS; ATHLETIC UNIFORMS (U.S. CLS. 22 AND 39).

CLASS 35—ADVERTISING AND BUSINESS

FOR CHARITABLE SERVICES, NAMELY, PROMOTING ENVIRONMENTAL AWARENESS (U.S. CLS. 100, 101 AND 102).

FIRST USE 5-0-2011; IN COMMERCE 5-0-2011.
TEJBIR SINGH, EXAMINING ATTORNEY

CLASS 28—TOYS AND SPORTING GOODS

FOR BASEBALL BATS; BASEBALL BATTING GLOVES; BASEBALL GLOVES; BASEBALL BAT BAGS (U.S. CLS. 22, 23, 38 AND 50).

FIRST USE 6-0-2011; IN COMMERCE 1-0-2012.
DAVID H. STINE, EXAMINING ATTORNEY

SN 85-583,693. DEAN FOODS COMPANY, DALLAS, TX. FILED 3-29-2012.

SN 85-596,654. ASTUTE NETWORKS, INC., SAN DIEGO, CA. FILED 4-12-2012.



NETWORKED PERFORMANCE FLASH

THE MARK CONSISTS OF STANDARD CHARACTERS WITHOUT CLAIM TO ANY PARTICULAR FONT, STYLE, SIZE, OR COLOR.

NO CLAIM IS MADE TO THE EXCLUSIVE RIGHT TO USE "NETWORKED" AND "FLASH", APART FROM THE MARK AS SHOWN.

OWNER OF U.S. REG. NO. 1,199,735.
THE MARK CONSISTS OF A STYLIZED LETTER "R" IN A CIRCLE.

CLASS 9—ELECTRICAL AND SCIENTIFIC APPARATUS

FOR COMPUTER HARDWARE AND SOFTWARE SYSTEMS FOR CLOUD COMPUTING; COMPUTER HARDWARE AND SOFTWARE SYSTEMS FOR DATA STORAGE; SOLID STATE COMPUTER STORAGE DEVICES AND SYSTEMS, NAMELY, SOLID STATE DRIVES; COMPUTER HARDWARE FOR ACCELERATING PROCESSING IN ONLINE AND VIRTUAL DATA STORES; DATA STORES FOR VISUALIZED ENVIRONMENTS; COMPUTER SOFTWARE FOR PROVIDING ONLINE DATA STORAGE AND MANAGEMENT; COMPUTER SOFTWARE FOR PROVIDING AND MANAGING VIRTUAL DATA STORES; COMPUTER SOFTWARE FOR PROVIDING SYSTEM DIAGNOSIS AND MANAGEMENT OF DATA STORAGE SYSTEMS (U.S. CLS. 21, 23, 26, 36 AND 38).

CLASS 29—MEATS AND PROCESSED FOODS

FOR DAIRY PRODUCTS EXCLUDING ICE CREAM, ICE MILK AND FROZEN YOGURT (U.S. CL. 46).
FIRST USE 0-0-2001; IN COMMERCE 0-0-2001.

CLASS 42—SCIENTIFIC AND COMPUTER SERVICES

FOR COMPUTER SERVICES, NAMELY, ACTING AS AN APPLICATION SERVICE PROVIDER IN THE FIELD OF KNOWLEDGE MANAGEMENT TO HOST COMPUTER APPLICATION SOFTWARE FOR THE COLLECTION, EDITING, ORGANIZING, MODIFYING, BOOK MARKING, TRANSMISSION, STORAGE AND SHARING OF DATA AND INFORMATION (U.S. CLS. 100 AND 101).

CLASS 30—STAPLE FOODS

FOR ICE CREAM (U.S. CL. 46).
FIRST USE 0-0-2001; IN COMMERCE 0-0-2001.

CLASS 32—LIGHT BEVERAGES

FOR FRUIT JUICES (U.S. CLS. 45, 46 AND 48).
FIRST USE 0-0-2001; IN COMMERCE 0-0-2001.
MEGHAN REINHART, EXAMINING ATTORNEY

JORDAN BAKER, EXAMINING ATTORNEY

SN 85-976,307. ACOS, WAYNE, PA. FILED 10-19-2011.

SN 85-599,617. INNOVATIVE PRODUCT DEVELOPMENT, LLC, JACKSONVILLE, FL. FILED 4-17-2012.

ACOS

The logo for VITACHEF features the word "VITACHEF" in a bold, sans-serif font. The letter "A" is stylized with a leaf-like shape extending from its top and crossing over the letter "C".

THE MARK CONSISTS OF THE WORD "VITACHEF" IN A STYLIZED FONT WITH THE CROSSING ON THE LETTER "A" FORMED BY A DESIGN OF A STEM AND LEAF.

CLASS 5—PHARMACEUTICALS

FOR DIETARY AND NUTRITIONAL SUPPLEMENTS; DIETARY BEVERAGE SUPPLEMENTS FOR HUMAN CONSUMPTION IN LIQUID AND DRY MIX FORM FOR THERAPEUTIC PURPOSES; DIETARY SUPPLEMENTAL DRINKS (U.S. CLS. 6, 18, 44, 46, 51 AND 52).

CLASS 11—ENVIRONMENTAL CONTROL APPARATUS

FOR ELECTRIC COOKWARE, NAMELY, BROILERS; ELECTRIC COOKWARE, NAMELY, ROASTERS; ELECTRIC FOOD STEAMER; ELECTRIC SKILLETS; HOT PLATES (U.S. CLS. 13, 21, 23, 31 AND 34).

CLASS 21—HOUSEWARES AND GLASS

FOR COOKING UTENSILS, NAMELY, GRILLS; COOKWARE, NAMELY, POTS AND PANS; COOKWARE, NAMELY, STEAMERS; DISHES AND PLATES; HOUSEHOLD UTENSILS, NAMELY, GRATERS; HOUSEHOLD UTENSILS, NAMELY, KITCHEN TONGS; HOUSEHOLD UTENSILS, NAMELY, SIEVES; HOUSEHOLD UTENSILS, NAMELY, SKIMMERS; HOUSEHOLD UTENSILS, NAMELY, SPATULAS; HOUSEHOLD UTENSILS, NAMELY, STRAINERS; HOUSEHOLD UTENSILS, NAMELY, TURNERS; NON-ELECTRIC JUICERS; SKILLETS; UTENSILS FOR BARBECUES, NAMELY, FORKS, TONGS, TURNERS (U.S. CLS. 2, 13, 23, 29, 30, 33, 40 AND 50).

CLASS 25—CLOTHING

FOR APRONS; HATS; JACKETS; PANTS; SHIRTS (U.S. CLS. 22 AND 39).

CLASS 29—MEATS AND PROCESSED FOODS

FOR MEAT, FROZEN; PREPARED FOOD KITS COMPOSED OF MEAT, POULTRY, FISH, SEAFOOD, AND/OR VEGETABLES AND ALSO INCLUDING SAUCES OR SEASONINGS, READY FOR COOKING AND ASSEMBLY AS A MEAL; PRESERVED, FROZEN, DRIED, OR COOKED VEGETABLES; FROZEN, PREPARED, OR PACKAGED MEALS CONSISTING PRIMARILY OF MEAT, FISH, POULTRY, OR VEGETABLES (U.S. CL. 46).

CLASS 30—STAPLE FOODS

FOR COOKING SAUCES; GRILLING SAUCES; HOT SAUCE; PASTA SAUCE; PESTO SAUCE; SAUCE MIXES; SAUCES; SPICES (U.S. CL. 46).
CORY BOONE, EXAMINING ATTORNEY

THE MARK CONSISTS OF STANDARD CHARACTERS WITHOUT CLAIM TO ANY PARTICULAR FONT, STYLE, SIZE, OR COLOR.

CLASS 36—INSURANCE AND FINANCIAL

FOR CHARITABLE FUNDRAISING SERVICES, NAMELY, RAISING FUNDS FOR THE ADVANCEMENT OF OPHTHALMOLOGY AND VISION CARE AND THE IMPROVEMENT OF THE PATIENT'S QUALITY OF LIFE (U.S. CLS. 100, 101 AND 102).

CLASS 42—SCIENTIFIC AND COMPUTER SERVICES

FOR PROVIDING MEDICAL AND SCIENTIFIC RESEARCH, NAMELY, CONDUCTING CLINICAL TRIALS FOR OTHERS IN THE FIELD OF OPHTHALMOLOGY (U.S. CLS. 100 AND 101).

DAVID COLLIER, EXAMINING ATTORNEY

SN 85-976,645. MARK K. INVESTMENTS, INC., PITTSBURGH, PA. FILED 7-25-2011.

BLACK AND GOLD

THE MARK CONSISTS OF STANDARD CHARACTERS WITHOUT CLAIM TO ANY PARTICULAR FONT, STYLE, SIZE, OR COLOR.

OWNER OF U.S. REG. NO. 3,797,697.

CLASS 21—HOUSEWARES AND GLASS

FOR BEVERAGE GLASSWARE; DINNERWARE; EATING PLATES; CUPS; MUGS; SHOT GLASSES; WINEWARE, NAMELY, WINE GLASSES; PORCELAIN AND EARTHENWARE MUGS; UTENSILS FOR HOUSEHOLD AND KITCHEN USE, NAMELY, SERVING SPOONS, GRATERS, SIEVES, AND SPATULAS; CONTAINERS FOR HOUSEHOLD AND KITCHEN USE; PAILS AND PANS OF ALUMINUM, PLASTICS AND OTHER MATERIALS; INSULATING SLEEVE HOLDER FOR BEVERAGE CUPS; DRINK COASTERS NOT OF PAPER AND NOT BEING TABLE LINEN (U.S. CLS. 2, 13, 23, 29, 30, 33, 40 AND 50).

CLASS 25—CLOTHING

FOR PAPER PRODUCTS, NAMELY, PAPER APRONS; TEE-SHIRTS; SWEATSHIRTS; SWEAT PANTS; BLOUSES; JERSEYS; SWEATERS; PULLOVERS; BLAZERS; CARDIGANS; BANDANAS; HEADBANDS; HATS; CAPS; STOCKINGS; SOCKS; TIGHTS; UNDERWEAR; NIGHTGOWNS; PAJAMAS; SHORTS; BATHROBES; JACKETS; SWEATSUITS; TIES; NECKTIES; SCARVES; SHAWLS; FOULARDS; HOSIERY; GLOVES; SASHES; BELTS; FOOTWEAR; BOOTS; SHOES; SLIPPERS; CLOTHING FOR CHILDREN, NAMELY, COATS, MANTLES, RAINCOATS, DRESSES, SUITS, SKIRTS, JACKETS, TROUSERS, JEANS, WAISTCOATS, SHIRTS, AND T-SHIRTS; CLOTHING FOR INFANTS, NAMELY, ONE-PIECE GARMENTS, CLOTH BIBS, BABY BOTTOMS, BABY SLEEPERS, BABY DIAPER COVERS, BABY BODYSUITS, BABY TOPS, BABY TROUSERS, CREEPERS, NIGHTGOWNS, PAJAMAS, AND SWEATSUITS; LEATHER CLOTHING, NAMELY, LEATHER JACKETS, LEATHER PANTS, LEATHER OVERCOATS, LEATHER COATS, LEATHER SUITS, AND LEATHER SKIRTS; WRIST BANDS; TANK TOPS (U.S. CLS. 22 AND 39).

CLASS 32—LIGHT BEVERAGES

FOR BEER; WATER FOR HUMAN CONSUMPTION; FRUIT AND VEGETABLE JUICES; SODA POP; ENERGY AND SPORTS DRINKS (U.S. CLS. 45, 46 AND 48).
KIM MONINGHOFF, EXAMINING ATTORNEY

CLASS 5—PHARMACEUTICALS

FOR DIETETIC BEVERAGES ADAPTED FOR MEDICAL PURPOSES; DIETARY AND NUTRITIONALLY FORTIFIED FOOD PRODUCTS ADAPTED FOR MEDICAL USE; DIETETIC FOODS ADAPTED FOR MEDICAL PURPOSES; MEDICINAL DRINKS; MEDICINAL HERBS; MEDICINES FOR IMPROVING CONSTIPATION SYMPTOMS, HELPING DIGESTION AND LOSING WEIGHT; MENSTRUATION BANDAGES; CANDIES FOR MEDICAL PURPOSES; CHEMICAL REAGENTS FOR MEDICAL OR VETERINARY PURPOSES; AIR FRESHENING PREPARATIONS; DEODORANTS FOR CLOTHING AND TEXTILES; DEPURATIVES FOR THE BODY; CLEANSING SOLUTIONS FOR MEDICAL USE; ENZYMES FOR MEDICAL PURPOSES; DISINFECTANTS FOR HYGIENE PURPOSES; SANITARY STERILIZING PREPARATIONS; FOOD FOR BABIES; LACTOSE TO BE USED IN THE MANUFACTURE OF FOODSTUFFS; WHEY PROTEIN SUPPLEMENTS; MINERAL FOOD SUPPLEMENTS; NUTRITIONAL ADDITIVES FOR MEDICAL PURPOSES USED IN FOODS AND DIETARY SUPPLEMENTS FOR HUMAN CONSUMPTION; DIETARY SUPPLEMENTS CONSISTING OF VITAMINS, MINERALS, HERBS, FIBER, OR PROTEIN IN TABLET, POWDER, CAPSULE OR LIQUID FORM; NUTRITIONAL FORTIFIED PROTEIN DRINK MIXES; VITAMIN SUPPLEMENT IN TABLET FORM FOR USE IN MAKING AN EFFERVESCENT BEVERAGE WHEN ADDED TO WATER; VITAMIN SUPPLEMENT IN POWDER FORM FOR USE IN MAKING AN EFFERVESCENT BEVERAGE WHEN ADDED TO WATER (U.S. CLS. 6, 18, 44, 46, 51 AND 52).

CLASS 30—STAPLE FOODS

FOR BEE GLUE BEING PROPOLIS FOR HUMAN CONSUMPTION; ROYAL JELLY FOR HUMAN CONSUMPTION, NOT FOR MEDICAL PURPOSES; HONEY; MOLASSES; YEAST; YEAST IN PILL FORM, NOT FOR MEDICAL USE; CHOCOLATE-BASED BEVERAGES WITH MILK; COCOA-BASED BEVERAGES; COFFEE-BASED BEVERAGES; TEA-BASED BEVERAGES; TEA SUBSTITUTES; FARINACEOUS FOODS PASTE FOR HUMAN CONSUMPTION; GLUCOSE FOR FOOD; GROATS FOR HUMAN CONSUMPTION (U.S. CL. 46).

CLASS 32—LIGHT BEVERAGES

FOR AERATED WATER; WHEY BEVERAGES; NON-ALCOHOLIC BEVERAGES, NAMELY, ENERGY DRINKS, NONALCOHOLIC BEVERAGES CONTAINING FRUIT JUICES, NON-ALCOHOLIC MALT BEVERAGES, MINERAL WATERS, FRUIT BEVERAGES, FRUIT JUICES, CARBONATED AND NON-CARBONATED DRINKING WATERS, SYRUPS FOR NON-ALCOHOLIC BEVERAGES; NON-ALCOHOLIC FRUIT JUICE BEVERAGES; NON-ALCOHOLIC FRUIT EXTRACTS USED IN THE PREPARATION OF BEVERAGES; ISOTONIC BEVERAGES; VEGETABLE DRINKS; SYRUPS FOR MAKING NON-ALCOHOLIC BEVERAGES; WATER BEVERAGES; LITHIA WATER; MINERAL WATER; SODA WATER (U.S. CLS. 45, 46 AND 48).

CLASS 35—ADVERTISING AND BUSINESS

FOR RETAIL AND ON-LINE RETAIL STORE SERVICES FEATURING COSMETICS, HAIRDRESSING PREPARATIONS, CLEANING PREPARATIONS, NUTRITION REPLACEMENT SUPPLEMENTS, BEVERAGES AND FOODS, HEALTH SUPPLEMENTS, BEVERAGES AND FOODS, AND THERAPEUTIC AND PHYSIOTHERAPY PREPARATIONS, FOODS AND BEVERAGES; DIRECT MAIL ADVERTISING; MARKETING AND PROMOTIONAL SERVICES; BUSINESS MANAGEMENT AND ORGANIZATION CONSULTANCY; DISSEMINATION OF ADVERTISING MATTER VIA MAIL ORDER PUBLICATIONS; COMMERCIAL INFORMATION AGENCIES; BUSINESS ASSISTANCE OUTSOURCING SERVICES; SALES PROMOTION FOR OTHERS; PROVIDING COMMERCIAL INFORMATION AND ADVICE FOR CONSUMERS; IMPORT-EXPORT AGENCIES; AUCTIONEERING; PRESENTATION OF GOODS ON COMMUNICATION MEDIA, FOR RETAIL PURPOSES; SYSTEMIZATION OF INFORMATION INTO COMPUTER DATABASES; ORGANIZATION OF EXHIBITIONS FOR COMMERCIAL OR ADVERTISING PURPOSES (U.S. CLS. 100, 101 AND 102).

SN 85-976,668, SHAAN BIOTECHNOLOGY CO., LTD.,
KAOHSIUNG CITY, TAIWAN, FILED 7-8-2011.



The logo features the word "shaan" in a bold, lowercase, sans-serif font. Above the two 'a's, there is a stylized leaf or branch design consisting of three leaves pointing upwards and outwards.

THE MARK CONSISTS OF THE LITERAL ELEMENT "SHAAN" IN STYLIZED LETTERING, WITH THE TWO ADJACENT LOWER-CASE LETTER "A" APPEARING AS MIRROR IMAGES WITH THEIR VERTICAL PORTIONS TOUCHING, AND THE DESIGN ELEMENT OF A SEVEN-LEAF PLANT OR BRANCH DESIGN APPEARING ABOVE THE LOCATION WHERE THE VERTICAL PORTIONS OF THE TWO LETTER "A" MEET.

THE WORDING "SHAAN" HAS NO MEANING IN ANY FOREIGN LANGUAGE.

JUDITH HELFMAN, EXAMINING ATTORNEY

SN 85-976,703. THIRTY-ONE GIFTS, LLC, COLUMBUS, OH.
FILED 9-26-2011.

THE MARK CONSISTS OF THE STYLIZED WORDING "THIRTY-ONE".

CLASS 8—HAND TOOLS

FOR NAIL FILES; MANICURE SETS (U.S. CLS. 23, 28 AND 44).
FIRST USE 9-1-2007; IN COMMERCE 9-1-2007.

CLASS 9—ELECTRICAL AND SCIENTIFIC APPARATUS

FOR LAPTOP CARRYING CASES; CASES FOR EYEGLASSES AND SUNGLASSES; CASES WITH INTERIOR THERMAL LINING FOR STORING OR CARRYING ELECTRIC FLAT IRONS OR ELECTRIC CURLING IRONS (U.S. CLS. 21, 23, 26, 36 AND 38).
FIRST USE 2-1-2009; IN COMMERCE 2-1-2009.

CLASS 16—PAPER GOODS AND PRINTED MATTER

FOR STATIONERY; ADDRESS LABELS; NOTEPADS; NOTE CARDS; PERSONAL ORGANIZERS; PADFOLIOS; PENCIL POUCHES (U.S. CLS. 2, 5, 22, 23, 29, 37, 38 AND 50).
FIRST USE 4-1-2004; IN COMMERCE 4-1-2004.

CLASS 18—LEATHER GOODS

FOR TOTE BAGS; WALLETS; COIN PURSES; CLUTCHES; COSMETIC BAGS SOLD EMPTY; JEWELRY ROLLS FOR TRAVEL; JEWELRY POUCHES; LUGGAGE TAGS; BACK PACKS; SACK PACKS, NAMELY, DRAWSTRING BAGS USED AS BACKPACKS; UMBRELLAS; PURSES; SHOULDER BAGS; WHEELED TOTE BAGS; WRISTLET BAGS; SHOULDER STRAPS; ALL-PURPOSE CARRYING BAGS; HANDBAGS; INTERCHANGEABLE DECORATIVE COVERS FOR ACCESSORIZATION PURPOSES THAT ARE SPECIALLY ADAPTED TO HANDBAGS; TOILETRY BAGS SOLD EMPTY; MESSENGER BAGS; DECORATIVE ORNAMENTS FOR ATTACHING TO HANDBAGS, PURSES, OR BACKPACKS (U.S. CLS. 1, 2, 3, 22 AND 41).
FIRST USE 4-1-2004; IN COMMERCE 4-1-2004.

CLASS 20—FURNITURE AND ARTICLES NOT OTHERWISE CLASSIFIED

FOR KEY FOBS, NOT OF METAL; PERSONAL COMPACT MIRRORS; NON-METAL FABRIC HANGING ORGANIZER; PLASTIC HANG TAGS (U.S. CLS. 2, 13, 22, 25, 32 AND 50).
FIRST USE 9-1-2007; IN COMMERCE 9-1-2007.

CLASS 21—HOUSEWARES AND GLASS

FOR COASTERS NOT OF PAPER AND NOT BEING TABLE LINEN; COLLAPSIBLE STORAGE CONTAINERS FOR DOMESTIC USE; THERMAL INSULATED BAGS FOR FOOD OR BEVERAGES; THERMAL INSULATED CONTAINERS FOR FOOD OR BEVERAGES; BASKETS FOR DOMESTIC USE, NOT OF METAL; GENERAL PURPOSE STORAGE BINS FOR HOUSEHOLD USE; FITTED FABRIC BASKET LINERS FOR DECORATIVE PURPOSES (U.S. CLS. 2, 13, 23, 29, 30, 33, 40 AND 50).
FIRST USE 4-1-2004; IN COMMERCE 4-1-2004.

CLASS 35—ADVERTISING AND BUSINESS

FOR SHOP-AT-HOME PARTIES FEATURING PURSES, INTERCHANGEABLE DECORATIVE PURSE COVERS, WALLETS, HANDBAGS, TOTES, LAPTOP BAGS, SHOULDER BAGS, BACKPACKS, SACK PACKS, STATIONERY, STORAGE CONTAINERS, THERMAL INSULATED CONTAINERS, ORGANIZERS, BLANKETS, MIRROR COMPACTS, MANICURE SETS, JEWELRY ROLLS, JEWELRY POUCHES, LUGGAGE TAGS, KEY FOBS, COASTERS, APRONS, AND SCARVES (U.S. CLS. 100, 101 AND 102).
FIRST USE 12-31-2002; IN COMMERCE 12-31-2002.
BRIAN PINO, EXAMINING ATTORNEY

SN 85-976,755. HOT CHAAT, LLC, GENEVA, IL. FILED 7-29-2011.

MUMBAI MONKEY

THE MARK CONSISTS OF STANDARD CHARACTERS WITHOUT CLAIM TO ANY PARTICULAR FONT, STYLE, SIZE, OR COLOR.

CLASS 25—CLOTHING

FOR WEARABLE GARMENTS AND CLOTHING, NAMELY, SHIRTS (U.S. CLS. 22 AND 39).
FIRST USE 6-24-2011; IN COMMERCE 6-24-2011.

CLASS 35—ADVERTISING AND BUSINESS

FOR ONLINE RETAIL STORE SERVICES FEATURING CLOTHING, NAMELY SHIRTS, EDUCATIONAL AND ENTERTAINING VIDEOS AND RELATED GOODS (U.S. CLS. 100, 101 AND 102).
FIRST USE 6-24-2011; IN COMMERCE 6-24-2011.

CLASS 41—EDUCATION AND ENTERTAINMENT

FOR EDUCATIONAL AND ENTERTAINMENT SERVICES, NAMELY, PROVIDING ON-LINE, NON-DOWNLOADABLE INTERACTIVE CHILDREN'S VIDEOS IN THE FIELD OF LANGUAGES, HEALTHY LIFESTYLES AND CREATIVITY (U.S. CLS. 100, 101 AND 107).
FIRST USE 6-21-2011; IN COMMERCE 6-21-2011.
JAMES GRIFFIN, EXAMINING ATTORNEY

* * * * *

SECTION 2.— INTERNATIONAL CLASSIFICATION

The short titles associated below with the international class numbers are terms designed merely for quick identification and are not an official part of the international classification. The full names of international classes are given in section 6.1 of the trademark rules of practice.

The designation "U.S. Cl." appearing in this section refers to the U.S. class in effect prior to Sep. 1, 1973 rather than the international class which applies to applications filed on or after that date. For adoption of international classification see notice in the OFFICIAL GAZETTE of Jun. 26, 1973 (911 O.G. TM 210).

Application in one class

CLASS 1—CHEMICALS

SN 77-855,307. CLONTECH LABORATORIES, INC., MOUNTAIN VIEW, CA. FILED 10-22-2009.

SMART

THE MARK CONSISTS OF STANDARD CHARACTERS WITHOUT CLAIM TO ANY PARTICULAR FONT, STYLE, SIZE, OR COLOR.

FOR REAGENTS FOR USE IN SCIENTIFIC OR MEDICAL RESEARCH USE (U.S. CLS. 1, 5, 6, 10, 26 AND 46). FIRST USE 1-12-1996; IN COMMERCE 1-12-1996. REBECCA SMITH, EXAMINING ATTORNEY

SN 79-104,977. OTC GMBH, 46047 OBERHAUSEN, FED REP GERMANY, FILED 9-30-2011.

satinbase

THE MARK CONSISTS OF STANDARD CHARACTERS WITHOUT CLAIM TO ANY PARTICULAR FONT, STYLE, SIZE, OR COLOR.

PRIORITY DATE OF 9-30-2011 IS CLAIMED. OWNER OF INTERNATIONAL REGISTRATION 1096633 DATED 9-30-2011, EXPIRES 9-30-2021.

FOR EMULSIFIERS FOR USE IN THE MANUFACTURE OF BODY AND BEAUTY CARE PRODUCTS; CHEMICAL PREPARATIONS FOR USE AS RAW MATERIALS IN THE COSMETICS INDUSTRY; CHEMICAL PREPARATIONS FOR USE IN THE MANUFACTURE OF MEANS FOR BODY AND BEAUTY CARE (U.S. CLS. 1, 5, 6, 10, 26 AND 46).

KHANH LE, EXAMINING ATTORNEY

CLASS 1—(Continued).

SN 85-216,185. PARK METALLURGICAL CORPORATION, DETROIT, MI. FILED 1-12-2011.

IT'S NOT STICKY!

THE MARK CONSISTS OF STANDARD CHARACTERS WITHOUT CLAIM TO ANY PARTICULAR FONT, STYLE, SIZE, OR COLOR.

SEC. 2(F). FOR WATER-BASED QUENCHANT FOR STEEL AND ALUMINUM (U.S. CLS. 1, 5, 6, 10, 26 AND 46). FIRST USE 0-0-2003; IN COMMERCE 0-0-2003. DAVID TAYLOR, EXAMINING ATTORNEY

SN 85-286,902. AQUASPERSIONS LIMITED, HALIFAX, W. YORKSHIRE, UNITED KINGDOM, FILED 4-5-2011.

AQUAREZ

THE MARK CONSISTS OF STANDARD CHARACTERS WITHOUT CLAIM TO ANY PARTICULAR FONT, STYLE, SIZE, OR COLOR.

PRIORITY CLAIMED UNDER SEC. 44(D) ON ERP CMNTY TM OFC APPLICATION NO. 009422239, FILED 10-5-2010, REG. NO. 009422239, DATED 3-18-2011, EXPIRES 10-5-2020.

FOR CHEMICALS, NAMELY, AQUEOUS DISPERSIONS OF POLYMERS, USED IN THE MANUFACTURE OF ADHESIVES, TACKIFIERS, SEALANTS AND COATINGS, ALL FOR INDUSTRIAL USE IN THE RUBBER, LATEX, PLASTICS, AGRICULTURAL, HORTICULTURAL AND WET POLYMER INDUSTRIES (U.S. CLS. 1, 5, 6, 10, 26 AND 46).

REGINA DRUMMOND, EXAMINING ATTORNEY

CLASS 1—(Continued).

SN 85-287,616. BIOSEARCH TECHNOLOGIES, INC., NOVA-TO, CA. FILED 4-6-2011.

Stellaris

THE MARK CONSISTS OF STANDARD CHARACTERS WITHOUT CLAIM TO ANY PARTICULAR FONT, STYLE, SIZE, OR COLOR.

FOR BIOCHEMICAL REAGENTS, COMMONLY KNOWN AS PROBES, FOR SCIENTIFIC OR RESEARCH USE THAT ENABLE THE DETECTION OF RNA IN CELL AND TISSUE SAMPLES BY FLUORESCENCE IN SITU HYBRIDIZATION (FISH) (U.S. CLS. 1, 5, 6, 10, 26 AND 46).

FIRST USE 10-10-2011; IN COMMERCE 10-10-2011.
ALYSSA STEEL, EXAMINING ATTORNEY

CLASS 1—(Continued).

SN 85-358,755. SILK WATER SOLUTIONS INC., SURREY, BC, CANADA, FILED 6-28-2011.



THE COLOR(S) ORANGE IS/ARE CLAIMED AS A FEATURE OF THE MARK.

THE MARK CONSISTS OF A CONTOURED BULB-SHAPED THREE-DIMENSIONAL BOTTLE TAPERED TOWARDS THE CAP. THE BODY AND CAP OF THE BOTTLE IS ORANGE.

FOR WATER TREATMENT CHEMICALS FOR USE IN SWIMMING POOLS AND SPAS (U.S. CLS. 1, 5, 6, 10, 26 AND 46).

FIRST USE 12-0-2007; IN COMMERCE 12-0-2007.
LINDA E. BLOHM, EXAMINING ATTORNEY

SN 85-360,062. R.Y.L. INC., CITY OF COMMERCE, CA. FILED 6-29-2011.

FRESHPAK

THE MARK CONSISTS OF STANDARD CHARACTERS WITHOUT CLAIM TO ANY PARTICULAR FONT, STYLE, SIZE, OR COLOR.

FOR SILICA-BASED MEDIA AND SUBSTANCES USED FOR ABSORBING WATER (U.S. CLS. 1, 5, 6, 10, 26 AND 46).

EDWARD NELSON, EXAMINING ATTORNEY

SN 85-366,414. SAINT-GOBAIN CERAMICS & PLASTICS, INC., WORCESTER, MA. FILED 7-8-2011.

EOS

THE MARK CONSISTS OF STANDARD CHARACTERS WITHOUT CLAIM TO ANY PARTICULAR FONT, STYLE, SIZE, OR COLOR.

FOR CERAMIC ROOFING GRANULE (U.S. CLS. 1, 5, 6, 10, 26 AND 46).

DAVID C. REIHNER, EXAMINING ATTORNEY

SN 85-353,573. KIK POOL ADDITIVES INC., ONTARIO, CA. FILED 6-22-2011.



NO CLAIM IS MADE TO THE EXCLUSIVE RIGHT TO USE "SHOCK", APART FROM THE MARK AS SHOWN.

THE MARK CONSISTS OF THE OUTLINED WORDING "SHOCK QUICK" SURROUNDED BY AN OVAL DESIGN WITH ZIG-ZAG EDGES.

FOR WATER TREATMENT CHEMICALS FOR USE IN SWIMMING POOLS AND SPAS (U.S. CLS. 1, 5, 6, 10, 26 AND 46).

FIRST USE 6-19-1998; IN COMMERCE 6-19-1998.
MARGARET POWER, EXAMINING ATTORNEY

CLASS 1—(Continued).

SN 85-382,717. ISP INVESTMENTS INC., WILMINGTON, DE.
FILED 7-27-2011.

SURVIXYL RZ

THE MARK CONSISTS OF STANDARD CHARACTERS WITHOUT CLAIM TO ANY PARTICULAR FONT, STYLE, SIZE, OR COLOR.

FOR CHEMICAL PRODUCTS FOR INDUSTRY AND SCIENCES, NAMELY, RAW MATERIALS FOR THE FORMULATION OF COSMETICS AND DERMATOLOGICAL COSMETIC PRODUCTS (U.S. CLS. 1, 5, 6, 10, 26 AND 46).

SUSAN LESLIE DUBOIS, EXAMINING ATTORNEY

SN 85-386,699. AIR PRODUCTS AND CHEMICALS, INC., ALLENTOWN, PA. FILED 8-2-2011.

CARBOWET

THE MARK CONSISTS OF STANDARD CHARACTERS WITHOUT CLAIM TO ANY PARTICULAR FONT, STYLE, SIZE, OR COLOR.

FOR CHEMICAL COMPOSITIONS, NAMELY, SURFACE TENSION AND RHEOLOGY MODIFIERS FOR AQUEOUS INKS AND PAPER COATINGS FOR USE IN THE PRINTING INDUSTRY (U.S. CLS. 1, 5, 6, 10, 26 AND 46).

FIRST USE 11-24-1986; IN COMMERCE 11-24-1986.
JOSETTE BEVERLY, EXAMINING ATTORNEY

SN 85-393,227. DFW CHEMICALS, FORT WORTH, TX.
FILED 8-9-2011.



THE COLOR(S) DARK GREEN AND LIGHT GREEN IS/ ARE CLAIMED AS A FEATURE OF THE MARK.

THE MARK CONSISTS OF THE STYLIZED TERM "SANBIOS" ABOVE THE STYLIZED PHRASE "WITH YOU IN EVERY STEPS" WITH A SPIRAL DESIGN THE UPPER LEFT PORTION OF THE MARK CONSISTING OF FIVE

CLASS 1—(Continued).

STYLIZED CURVED BANDS; THE COLOR DARK GREEN APPEARS IN THE LETTERS "SAN" IN "SANBIOS", IN THE PHRASE "WITH YOU IN EVERY STEPS" AND IN THE OUTERMOST CURVED BANDS IN THE STYLIZED SWIRL DESIGN; THE COLOR LIGHT GREEN APPEARS IN THE LETTERS "BIOS" IN THE TERM "SANBIOS" AND IN THE INNER THREE CURVED BANDS IN THE STYLIZED SWIRL DESIGN; THE COLOR WHITE REPRESENTS BACKGROUND AND IS NOT CLAIMED AS A FEATURE OF THE MARK.

THE WORDING "SANBIOS" HAS NO MEANING IN A FOREIGN LANGUAGE.

FOR CHEMICALS FOR USE IN THE MANUFACTURE OF LEATHER (U.S. CLS. 1, 5, 6, 10, 26 AND 46).

MYRIAH HABEEB, EXAMINING ATTORNEY

SN 85-409,288. MCINERNEY, TERRANCE M., ATLANTA, GA. FILED 8-29-2011.

SOLAR OFF-LOADING TECHNOLOGY

THE MARK CONSISTS OF STANDARD CHARACTERS WITHOUT CLAIM TO ANY PARTICULAR FONT, STYLE, SIZE, OR COLOR.

NO CLAIM IS MADE TO THE EXCLUSIVE RIGHT TO USE "TECHNOLOGY", APART FROM THE MARK AS SHOWN.

FOR CHEMICAL PREPARATIONS FOR USE IN THE MANUFACTURE OF PAINTS (U.S. CLS. 1, 5, 6, 10, 26 AND 46).

FIRST USE 3-17-2010; IN COMMERCE 3-17-2010.
KATHERINE CHANG, EXAMINING ATTORNEY

SN 85-425,046. MERCK KGAA, D-64293 DARMSTADT, FED REP GERMANY, FILED 9-16-2011.

TITRISOL

THE MARK CONSISTS OF STANDARD CHARACTERS WITHOUT CLAIM TO ANY PARTICULAR FONT, STYLE, SIZE, OR COLOR.

OWNER OF FED REP GERMANY REG. NO. 517270, DATED 11-7-1939, EXPIRES 6-30-2018.

OWNER OF U.S. REG. NO. 920,476.

FOR CHEMICALS USED IN INDUSTRY AND SCIENCE, CONCENTRATED LABORATORY REAGENT SOLUTIONS FOR RESEARCH PURPOSES PREPACKED IN SPECIAL PLASTIC OR GLASS AMPOULES (U.S. CLS. 1, 5, 6, 10, 26 AND 46).

ALLISON SCHRODY, EXAMINING ATTORNEY

CLASS 1—(Continued).

SN 85-474,265. BEIJING TIANQING CHEMICALS CO., LTD., BEIJING, CHINA, FILED 11-16-2011.



THE COLOR(S) RED, BLUE, LIGHT BLUE, AND BLACK IS/ARE CLAIMED AS A FEATURE OF THE MARK.

THE MARK CONSISTS OF A STYLIZED RED Y-SHAPED DESIGN, THE Y-SHAPE ALIGNED HORIZONTALLY AND OPENING TO THE RIGHT, PLACED OVER THREE CONCENTRIC CIRCLES IN THE COLOR BLUE WHERE THE OUTERMOST CIRCLE IS LIGHT BLUE, WITH THE WORD "TEKING" WRITTEN IN BLACK LETTERS TO THE RIGHT OF THE DESIGN.

THE WORDING "TEKING" HAS NO MEANING IN A FOREIGN LANGUAGE.

FOR CHEMICAL PRESERVATIVES FOR USE IN THE PRODUCTION OF COATINGS, PAINTS, RESINS, AND EMULSIONS; CHEMICAL PRESERVATIVES, NAMELY, CHLOROMETHYLISOTHIAZOLINONE AND METHYLISOTHIAZOLINONE FOR THE TREATMENT OF OIL-FIELD INJECTION WATER AND INDUSTRIAL WATER; CHEMICAL AGENTS FOR THE IMPREGNATING, BINDING, OR COATING OF TEXTILES, FURS, LEATHER, NON-WOVENS, AND FABRICS; CHEMICALS FOR USE IN THE MANUFACTURE OF LEATHER; CHEMICALS USED IN THE MANUFACTURE OF PAPER; ACTIVE CHEMICAL INGREDIENTS FOR USE IN THE MANUFACTURE OF INSECTICIDES; CHEMICAL PREPARATIONS TO PREVENT MILDEW; CHEMICALS FOR USE IN THE PURIFICATION OF WATER; CHEMICAL ADDITIVES TO FUNGICIDES, NAMELY, CHLOROMETHYLISOTHIAZOLINONE AND METHYLISOTHIAZOLINONE; CHEMICAL PREPARATIONS FOR THE MANUFACTURE OF PAINTS (U.S. CLS. 1, 5, 6, 10, 26 AND 46).

CHARISMA HAMPTON, EXAMINING ATTORNEY

SN 85-494,002. ATOTECH DEUTSCHLAND GMBH, 10553 BERLIN, FED REP GERMANY, FILED 12-13-2011.

NOVABOND

THE MARK CONSISTS OF STANDARD CHARACTERS WITHOUT CLAIM TO ANY PARTICULAR FONT, STYLE, SIZE, OR COLOR.

PRIORITY CLAIMED UNDER SEC. 44(D) ON FED REP GERMANY APPLICATION NO. 302011049969, FILED 9-8-2011, REG. NO. 302011049969, DATED 11-1-2011, EXPIRES 9-30-2021.

FOR (BASED ON INTENT TO USE) CHEMICALS USED IN SURFACE TREATMENT OF PRINTED CIRCUIT BOARDS; (BASED ON SECTION 44E AND BASED ON INTENT TO USE) CHEMICALS USED IN SURFACE TREATMENT OF METALS, AND SYNTHETIC POLYMERS; CHEMICAL PREPARATIONS FOR TREATMENT OF COPPER SURFACES, PARTICULARLY FOR THE PRODUCTION OF ELECTRONIC COMPONENTS (U.S. CLS. 1, 5, 6, 10, 26 AND 46).

DEIRDRE ROBERTSON, EXAMINING ATTORNEY

CLASS 1—(Continued).

SN 85-496,961. VESTA SI LLC, SANTEE, CA. FILED 12-16-2011.

SICOMILL

THE MARK CONSISTS OF STANDARD CHARACTERS WITHOUT CLAIM TO ANY PARTICULAR FONT, STYLE, SIZE, OR COLOR.

FOR SILICON POWDER FOR ENGINEERING CERAMICS USE (U.S. CLS. 1, 5, 6, 10, 26 AND 46).

FIRST USE 4-29-1985; IN COMMERCE 4-29-1985.

SOPHIA S. KIM, EXAMINING ATTORNEY

SN 85-498,203. VESTA SI LLC, SANTEE, CA. FILED 12-17-2011.

SICONIDE

THE MARK CONSISTS OF STANDARD CHARACTERS WITHOUT CLAIM TO ANY PARTICULAR FONT, STYLE, SIZE, OR COLOR.

FOR SILICON NITRIDE POWDER FOR MANUFACTURING OF CONSTRUCTION CERAMICS COMPONENTS, IN PARTICULAR, BALL AND ROLL BEARINGS, ENGINE COMPONENTS, HIGH TEMPERATURE PROCESS COMPONENTS, AND COATINGS FOR HANDLING OF METAL MELTS; AND FOR USE IN SLIP-CASTING, INJECTION MOLDING, AND IN THE CERAMICS INDUSTRY (U.S. CLS. 1, 5, 6, 10, 26 AND 46).

FIRST USE 1-31-1983; IN COMMERCE 8-31-1983.

SOPHIA S. KIM, EXAMINING ATTORNEY

SN 85-498,477. ATOTECH DEUTSCHLAND GMBH, 10553 BERLIN, FED REP GERMANY, FILED 12-19-2011.

NOVALINK

THE MARK CONSISTS OF STANDARD CHARACTERS WITHOUT CLAIM TO ANY PARTICULAR FONT, STYLE, SIZE, OR COLOR.

PRIORITY CLAIMED UNDER SEC. 44(D) ON FED REP GERMANY APPLICATION NO. 302011049968, FILED 9-8-2011, REG. NO. 302011049968, DATED 11-1-2011, EXPIRES 9-30-2021.

FOR (BASED ON INTENT TO USE) CHEMICALS USED IN SURFACE TREATMENT OF PRINTED CIRCUIT BOARDS; (BASED ON SECTION 44E AND BASED ON INTENT TO USE) CHEMICALS USED IN SURFACE TREATMENT OF METALS, AND SYNTHETIC POLYMERS; CHEMICAL PREPARATIONS FOR TREATMENT OF COPPER SURFACES, PARTICULARLY FOR THE PRODUCTION OF ELECTRONIC COMPONENTS (U.S. CLS. 1, 5, 6, 10, 26 AND 46).

DEIRDRE ROBERTSON, EXAMINING ATTORNEY

CLASS 1—(Continued).

SN 85-498,513. ATOTECH DEUTSCHLAND GMBH, 10553 BERLIN, FED REP GERMANY, FILED 12-19-2011.

PALLABOND

THE MARK CONSISTS OF STANDARD CHARACTERS WITHOUT CLAIM TO ANY PARTICULAR FONT, STYLE, SIZE, OR COLOR.

PRIORITY CLAIMED UNDER SEC. 44(D) ON FED REP GERMANY APPLICATION NO. 302011047016, FILED 8-29-2011, REG. NO. 302011047016, DATED 11-4-2011, EXPIRES 8-31-2021.

FOR CHEMICAL COMPOSITIONS FOR THE WET CHEMICAL METALLIZATION OF SURFACES, ESPECIALLY WITH PALLADIUM (U.S. CLS. 1, 5, 6, 10, 26 AND 46).

DEIRDRE ROBERTSON, EXAMINING ATTORNEY

CLASS 1—(Continued).

SN 85-531,838. SPI PHARMA, INC., WILMINGTON, DE. FILED 2-2-2012.

MANNOSPHERE

THE MARK CONSISTS OF STANDARD CHARACTERS WITHOUT CLAIM TO ANY PARTICULAR FONT, STYLE, SIZE, OR COLOR.

FOR CHEMICAL ADDITIVES, NAMELY, MANNITOL FOR USE IN THE MANUFACTURE OF FOOD AND PHARMACEUTICALS (U.S. CLS. 1, 5, 6, 10, 26 AND 46). CHRISTOPHER BUONGIORNO, EXAMINING ATTORNEY

SN 85-522,317. CN CREATIVE LTD, LANCASHIRE, UNITED KINGDOM, FILED 1-23-2012.

ECOPURE

THE MARK CONSISTS OF STANDARD CHARACTERS WITHOUT CLAIM TO ANY PARTICULAR FONT, STYLE, SIZE, OR COLOR.

OWNER OF UNITED KINGDOM REG. NO. 2596770, DATED 1-6-2012, EXPIRES 10-5-2021.

FOR LIQUID NICOTINE FOR USE IN ELECTRONIC CIGARETTES; GLYCERINE FOR USE IN ELECTRONIC CIGARETTES; CARTRIDGES SOLD FILLED WITH LIQUID NICOTINE FOR ELECTRONIC CIGARETTES; CARTRIDGES SOLD FILLED WITH GLYCERINE FOR ELECTRONIC CIGARETTES (U.S. CLS. 1, 5, 6, 10, 26 AND 46).

JAMES LOVELACE, EXAMINING ATTORNEY

SN 85-532,027. AG CONCEPTS CORPORATION, BOISE, ID. FILED 2-2-2012.

AGCOR

THE MARK CONSISTS OF STANDARD CHARACTERS WITHOUT CLAIM TO ANY PARTICULAR FONT, STYLE, SIZE, OR COLOR.

FOR FERTILISERS FOR SOIL AND POTTING SOIL; ORGANIC SOIL ENHANCEMENT POWDERS AND PREPARATIONS; SOIL ADDITIVES (U.S. CLS. 1, 5, 6, 10, 26 AND 46).

ALEX KEAM, EXAMINING ATTORNEY

SN 85-531,611. PHILLIPS, MARK, PHOENIX, AZ. FILED 2-1-2012.

Palcohol

THE MARK CONSISTS OF STANDARD CHARACTERS WITHOUT CLAIM TO ANY PARTICULAR FONT, STYLE, SIZE, OR COLOR.

FOR ETHYL ALCOHOL (U.S. CLS. 1, 5, 6, 10, 26 AND 46).

ANNE MADDEN, EXAMINING ATTORNEY

SN 85-532,873. CARGILL, INCORPORATED, WAYZATA, MN. FILED 2-3-2012.

OCEAN WAVES

THE MARK CONSISTS OF STANDARD CHARACTERS WITHOUT CLAIM TO ANY PARTICULAR FONT, STYLE, SIZE, OR COLOR.

FOR SALT FOR USE IN POOLS AND SPAS (U.S. CLS. 1, 5, 6, 10, 26 AND 46).

MIDGE BUTLER, EXAMINING ATTORNEY

CLASS 1—(Continued).

SN 85-533,438. AIRGAS, INC., RADNOR, PA. FILED 2-3-2012.

ABSOLUTEZERO

THE MARK CONSISTS OF STANDARD CHARACTERS WITHOUT CLAIM TO ANY PARTICULAR FONT, STYLE, SIZE, OR COLOR.

FOR PACKAGED AIR AND NITROGEN FOR USE IN THE ZERO CALIBRATION OF INSTRUMENTS USED FOR THE MEASURING OF POLLUTANTS AND RELATED COMPONENTS (U.S. CLS. 1, 5, 6, 10, 26 AND 46).
JILL C. ALT, EXAMINING ATTORNEY

SN 85-533,541. NPO SCIENTIFIC, INC., HOUSTON, TX. FILED 2-3-2012.

NPO CLEANGEL

THE MARK CONSISTS OF STANDARD CHARACTERS WITHOUT CLAIM TO ANY PARTICULAR FONT, STYLE, SIZE, OR COLOR.

FOR A CHEMICALLY MODIFIED POLYMER WHICH PREVENTS THE LEAKING OF COMPLETION FLUIDS AND BRINE INTO AN OIL OR GAS WELL FORMATION IN ORDER TO PREVENT CONTAMINATION OF THE WELL (U.S. CLS. 1, 5, 6, 10, 26 AND 46).

KEVIN DINALLO, EXAMINING ATTORNEY

SN 85-533,774. IMPACT ABSORBENTS, INC., ATASCADERO, CA. FILED 2-3-2012.

THE MARK CONSISTS OF THE WORDING "BIOFRESH" ANGLED IN AN UPWARD WAVE. THE LETTER "I" IN THE MARK IS DOTTED BY A STARBURST-LIKE DESIGN. A FAINT DROP SHADOW APPEARS AROUND THE LOGO.

FOR GRANULAR ABSORBENT MINERAL-BASED COMPOSITION FOR ABSORBING SPILLS FROM FLOORS (U.S. CLS. 1, 5, 6, 10, 26 AND 46).

FIRST USE 12-1-2011; IN COMMERCE 12-7-2011.
DAVID H. STINE, EXAMINING ATTORNEY

CLASS 1—(Continued).

SN 85-533,887. NPO SCIENTIFIC, INC., HOUSTON, TX. FILED 2-3-2012.

NPO SCIENTIFIC

THE MARK CONSISTS OF STANDARD CHARACTERS WITHOUT CLAIM TO ANY PARTICULAR FONT, STYLE, SIZE, OR COLOR.

NO CLAIM IS MADE TO THE EXCLUSIVE RIGHT TO USE "SCIENTIFIC", APART FROM THE MARK AS SHOWN. FOR A CHEMICALLY MODIFIED POLYMER WHICH PREVENTS THE LEAKING OF COMPLETION FLUIDS AND BRINE INTO AN OIL OR GAS WELL FORMATION IN ORDER TO PREVENT CONTAMINATION OF THE WELL (U.S. CLS. 1, 5, 6, 10, 26 AND 46).
KEVIN DINALLO, EXAMINING ATTORNEY

SN 85-534,369. PALA INVESTMENTS HOLDINGS LIMITED, ST. HELIER, JERSEY, FILED 2-6-2012.

ALDEROX

THE MARK CONSISTS OF STANDARD CHARACTERS WITHOUT CLAIM TO ANY PARTICULAR FONT, STYLE, SIZE, OR COLOR.

OWNER OF U.S. REG. NO. 3,022,028. FOR ASPHALT AND CEMENT RELEASE AGENT THAT PREVENTS ADHESION OF THE ASPHALT OR CEMENT TO THEIR CONTAINMENT SURFACES (U.S. CLS. 1, 5, 6, 10, 26 AND 46).

ANDREW LEASER, EXAMINING ATTORNEY

SN 85-534,531. CARGILL, INCORPORATED, WAYZATA, MN. FILED 2-6-2012.

SPLASH READY

THE MARK CONSISTS OF STANDARD CHARACTERS WITHOUT CLAIM TO ANY PARTICULAR FONT, STYLE, SIZE, OR COLOR.

FOR SALT FOR USE IN POOLS AND SPAS (U.S. CLS. 1, 5, 6, 10, 26 AND 46).

MIDGE BUTLER, EXAMINING ATTORNEY

CLASS 1—(Continued).

SN 85-535,285. INNOVATEK, INC., RICHLAND, WA. FILED 2-6-2012.

iTek

THE MARK CONSISTS OF STANDARD CHARACTERS WITHOUT CLAIM TO ANY PARTICULAR FONT, STYLE, SIZE, OR COLOR.

FOR CATALYSTS FOR CHEMICAL AND BIOCHEMICAL PROCESSES (U.S. CLS. 1, 5, 6, 10, 26 AND 46).

FIRST USE 3-2-2007; IN COMMERCE 11-19-2007.

NAKIA HENRY, EXAMINING ATTORNEY

CLASS 1—(Continued).

SN 85-537,496. GEO SPECIALTY CHEMICALS, INC., LAFAYETTE, IN. FILED 2-8-2012.

TRI-AD DF

THE MARK CONSISTS OF STANDARD CHARACTERS WITHOUT CLAIM TO ANY PARTICULAR FONT, STYLE, SIZE, OR COLOR.

FOR DEFOAMING AGENTS (U.S. CLS. 1, 5, 6, 10, 26 AND 46).

KIM MONINGHOFF, EXAMINING ATTORNEY

SN 85-536,530. DEERLAND ENZYMES, INC, KENNESAW, GA. FILED 2-7-2012.

Solarplast

THE MARK CONSISTS OF STANDARD CHARACTERS WITHOUT CLAIM TO ANY PARTICULAR FONT, STYLE, SIZE, OR COLOR.

FOR ENZYME PREPARATIONS FOR USE IN THE DIETARY SUPPLEMENT INDUSTRY; ENZYMES FOR USE IN PROTEIN HYDROLYSIS; ENZYMES FOR USE IN THE MANUFACTURE OF NUTRACEUTICALS; ENZYMES FOR USE IN THE MANUFACTURE OF PET FOOD; ENZYMES TO ASSIST IN DIGESTION FOR USE IN THE MANUFACTURE OF ANIMAL FEEDS (U.S. CLS. 1, 5, 6, 10, 26 AND 46).

NAKIA HENRY, EXAMINING ATTORNEY

SN 85-539,607. APTAKON, INC., KANSAS CITY, KS. FILED 2-10-2012.

apty

THE MARK CONSISTS OF STANDARD CHARACTERS WITHOUT CLAIM TO ANY PARTICULAR FONT, STYLE, SIZE, OR COLOR.

FOR BIOCHEMICALS, NAMELY, POLYPEPTIDES FOR IN VITRO RESEARCH USE (U.S. CLS. 1, 5, 6, 10, 26 AND 46).

JEANIE LEE, EXAMINING ATTORNEY

SN 85-536,861. SOLV-TEC INC., HAINESPORT, NJ. FILED 2-8-2012.

STOP & SEAL

THE MARK CONSISTS OF STANDARD CHARACTERS WITHOUT CLAIM TO ANY PARTICULAR FONT, STYLE, SIZE, OR COLOR.

FOR LEAK REPAIR COMPOSITION FOR USE IN ENGINES, RADIATORS, AND COOLING SYSTEMS OF AUTOMOBILES AND COMMERCIAL AND AGRICULTURAL VEHICLES (U.S. CLS. 1, 5, 6, 10, 26 AND 46).

ODESSA BIBBINS, EXAMINING ATTORNEY

SN 85-539,908. SOMALOGIC, INC., BOULDER, CO. FILED 2-10-2012.

SOMAMER

THE MARK CONSISTS OF STANDARD CHARACTERS WITHOUT CLAIM TO ANY PARTICULAR FONT, STYLE, SIZE, OR COLOR.

FOR REAGENTS, APTAMERS, AND ASSAYS FOR NON-MEDICAL PURPOSES (U.S. CLS. 1, 5, 6, 10, 26 AND 46).

SHAILA SETTLES, EXAMINING ATTORNEY

CLASS 1—(Continued).

SN 85-540,077. WESTERN HOLDINGS, LLC, CARSON CITY, NV. FILED 2-10-2012.

TRISOLARIL

THE MARK CONSISTS OF STANDARD CHARACTERS WITHOUT CLAIM TO ANY PARTICULAR FONT, STYLE, SIZE, OR COLOR.

FOR FORMULATION COMPRISED PRIMARILY OF BOTANICAL EXTRACTS FOR USE IN THE MANUFACTURE OF SKIN CARE PREPARATIONS (U.S. CLS. 1, 5, 6, 10, 26 AND 46).

JACQUELINE A. LAVINE, EXAMINING ATTORNEY

SN 85-540,677. MICHAEL JULIAN RICE, DBA BLACKLION INTERNATIONAL, HEATH, OH. FILED 2-13-2012.

**Once A Big Red Always A
Big Red**

THE MARK CONSISTS OF STANDARD CHARACTERS WITHOUT CLAIM TO ANY PARTICULAR FONT, STYLE, SIZE, OR COLOR.

FOR CARBON CLOTH TO BE PLACED IN JEWELRY BOXES AND SILVER BOXES TO PREVENT TARNISHING (U.S. CLS. 1, 5, 6, 10, 26 AND 46).

KIM MONINGHOFF, EXAMINING ATTORNEY

SN 85-542,398. 3M COMPANY, ST. PAUL, MN. FILED 2-14-2012.

POWERLUX

THE MARK CONSISTS OF STANDARD CHARACTERS WITHOUT CLAIM TO ANY PARTICULAR FONT, STYLE, SIZE, OR COLOR.

FOR SEMI-PROCESSED SYNTHETIC RESINS FOR USE IN MANUFACTURING (U.S. CLS. 1, 5, 6, 10, 26 AND 46).

DAVID H. STINE, EXAMINING ATTORNEY

CLASS 1—(Continued).

SN 85-551,346. MOMENTUM MANAGEMENT, LLC, DBA BUSHMAN PRODUCTS, TORRANCE, CA. FILED 2-23-2012.

OTRACTION

THE MARK CONSISTS OF STANDARD CHARACTERS WITHOUT CLAIM TO ANY PARTICULAR FONT, STYLE, SIZE, OR COLOR.

FOR PHEROMONE SPRAY NOT FOR MEDICAL USE (U.S. CLS. 1, 5, 6, 10, 26 AND 46).

DAVID MURRAY, EXAMINING ATTORNEY

SN 85-555,347. OMS INVESTMENTS, INC., LOS ANGELES, CA. FILED 2-28-2012.



THE MARK CONSISTS OF A FLOWER DESIGN BETWEEN THE "O" AND "A" IN THE WORD GROABLES.

FOR FERTILIZERS, PLANT FOODS; SOIL CONDITIONERS FOR DOMESTIC USE, SOIL AMENDMENTS, SOIL ADDITIVES, SOIL WETTING AGENTS; GROWING MEDIA FOR PLANTS, GARDEN PLANTING SOIL, GARDEN POTTING SOIL, PLANTING SOILS, POTTING SOIL MIXES AND POTTING SOILS (U.S. CLS. 1, 5, 6, 10, 26 AND 46).

MICHAEL GAAFAR, EXAMINING ATTORNEY

SN 85-559,050. JOHNSON CREEK ENTERPRISES, LLC, HARTLAND, WI. FILED 3-2-2012.

RED OAK

THE MARK CONSISTS OF STANDARD CHARACTERS WITHOUT CLAIM TO ANY PARTICULAR FONT, STYLE, SIZE, OR COLOR.

FOR A GLYCERIN-BASED LIQUID USED IN ELECTRONIC SMOKING DEVICES TO PRODUCE THE VAPOR AND SUPPLY THE FLAVORING (U.S. CLS. 1, 5, 6, 10, 26 AND 46).

FIRST USE 2-1-2010; IN COMMERCE 2-1-2010.

THEODORE MCBRIDE, EXAMINING ATTORNEY

CLASS 1—(Continued).

SN 85-575,329. VALENT BIOSCIENCES CORPORATION, LIBERTYVILLE, IL. FILED 3-21-2012.

CONTEGO

THE MARK CONSISTS OF STANDARD CHARACTERS WITHOUT CLAIM TO ANY PARTICULAR FONT, STYLE, SIZE, OR COLOR.

FOR PLANT GROWTH REGULATING PREPARATIONS (U.S. CLS. 1, 5, 6, 10, 26 AND 46).
GEORGE LORENZO, EXAMINING ATTORNEY



CLASS 2—PAINTS

SN 76-710,279. XSE GROUP, INC., MIDDLETOWN, CT. FILED 1-17-2012.

THE BRIGHT SOURCE

THE MARK CONSISTS OF STANDARD CHARACTERS WITHOUT CLAIM TO ANY PARTICULAR FONT, STYLE, SIZE, OR COLOR.

OWNER OF U.S. REG. NO. 3,713,661.
FOR TONER AND INKJET CARTRIDGES (U.S. CLS. 6, 11 AND 16).
MELISSA VALLILLO, EXAMINING ATTORNEY



SN 79-110,125. NEMOTO & CO., LTD., JAPAN, FILED 2-9-2012.

LUMISTAR

OWNER OF INTERNATIONAL REGISTRATION 1086411 DATED 7-22-2011, EXPIRES 7-22-2021.
FOR PIGMENTS; INORGANIC PIGMENTS (U.S. CLS. 6, 11 AND 16).
ELI HELLMAN, EXAMINING ATTORNEY

CLASS 2—(Continued).

SN 85-222,257. U.S. FLOORING COMPANY, INC., JOPLIN, MO. FILED 1-20-2011.

Cover-Clad

THE MARK CONSISTS OF STANDARD CHARACTERS WITHOUT CLAIM TO ANY PARTICULAR FONT, STYLE, SIZE, OR COLOR.

FOR EPOXY COATING FOR USE ON CONCRETE INDUSTRIAL FLOORS (U.S. CLS. 6, 11 AND 16).
FIRST USE 1-22-2008; IN COMMERCE 1-22-2008.
CHRISTOPHER BUONGIORNO, EXAMINING ATTORNEY



SN 85-368,321. WAZANA BROTHERS INTERNATIONAL, INC., DBA MICRO SOLUTIONS ENTERPRISES, VAN NUYS, CA. FILED 7-11-2011.



NO CLAIM IS MADE TO THE EXCLUSIVE RIGHT TO USE "MPS ENGINEERED", APART FROM THE MARK AS SHOWN.

THE COLOR(S) BLUE, WHITE, GREEN, LIGHT GREEN AND BLACK IS/ARE CLAIMED AS A FEATURE OF THE MARK.

THE MARK CONSISTS OF THE CAPITAL LETTERS "MPS" UNDERLINED AND WITH THREE DOTS CENTERED ABOVE THEM IN WHITE AND CONTAINED WITHIN A SOLID BLUE BOX WITH THE CAPITAL LETTERS "ENGINEERED" IN BLACK TO THE RIGHT OF SUCH LETTERS, AND A DESIGN OF THREE INCREASINGLY LARGER RECTANGULAR WAVE-TYPE ELEMENTS APPEARING ABOVE THE LETTERS "MPS" IN GREEN, LIGHT GREEN, AND OUTLINED IN LIGHT GREEN ON A WHITE BACKGROUND.

FOR FILLED INK CARTRIDGES; PHOTOCOPIER TONER IN CARTRIDGES; PRINTING TONER; TONER; TONER CARTRIDGES; TONER FOR COPIERS; TONERS (U.S. CLS. 6, 11 AND 16).

FIRST USE 7-1-2011; IN COMMERCE 7-1-2011.
STEPHANIE ALI, EXAMINING ATTORNEY



SN 85-370,217. GRAPHIX ESSENTIALS, LLC, ST. LOUIS, MO. FILED 7-13-2011.

**The beauty of color
through the science of ink**

THE MARK CONSISTS OF STANDARD CHARACTERS WITHOUT CLAIM TO ANY PARTICULAR FONT, STYLE, SIZE, OR COLOR.

FOR PRINTING INKS (U.S. CLS. 6, 11 AND 16).
TASNEEM HUSSAIN, EXAMINING ATTORNEY

CLASS 2—(Continued).

SN 85-500,174. BLACKPOWDER PRODUCTS, INC., DULUTH, GA. FILED 12-20-2011.

WEATHERGUARD

THE MARK CONSISTS OF STANDARD CHARACTERS WITHOUT CLAIM TO ANY PARTICULAR FONT, STYLE, SIZE, OR COLOR.

FOR NON-CORROSIVE PROTECTIVE COATINGS FOR FIREARMS TO RESIST RUST (U.S. CLS. 6, 11 AND 16).

ESTHER A. BORSUK, EXAMINING ATTORNEY

SN 85-518,035. WAZANA BROTHERS INTERNATIONAL, INC., DBA MICRO SOLUTIONS ENTERPRISES, VAN NUYS, CA. FILED 1-17-2012.

Intelligent Re-Engineering

THE MARK CONSISTS OF STANDARD CHARACTERS WITHOUT CLAIM TO ANY PARTICULAR FONT, STYLE, SIZE, OR COLOR.

OWNER OF U.S. REG. NO. 4,055,517.

NO CLAIM IS MADE TO THE EXCLUSIVE RIGHT TO USE "RE-ENGINEERING", APART FROM THE MARK AS SHOWN.

FOR INK CARTRIDGES FOR PRINTERS; INK JET CARTRIDGES; PHOTOCOPIER TONER; PHOTOCOPIER TONER IN CARTRIDGES; TONER CARTRIDGES (U.S. CLS. 6, 11 AND 16).

FIRST USE 10-1-2010; IN COMMERCE 10-1-2010.

AMY KELLY, EXAMINING ATTORNEY

SN 85-521,355. FERRO CORPORATION, MAYFIELD HEIGHTS, OH. FILED 1-20-2012.

AQUARELEASE

THE MARK CONSISTS OF STANDARD CHARACTERS WITHOUT CLAIM TO ANY PARTICULAR FONT, STYLE, SIZE, OR COLOR.

OWNER OF U.S. REG. NO. 2,735,600.

FOR GLASS ENAMEL CONTAINING COATING COMPOSITION FOR USE IN PRODUCING PROTECTIVE COATINGS ON METAL SUBSTRATES (U.S. CLS. 6, 11 AND 16).

CHRISIE B. KING, EXAMINING ATTORNEY

CLASS 2—(Continued).

SN 85-522,824. ACE HARDWARE CORPORATION, OAK BROOK, IL. FILED 1-23-2012.

SOUL COLOR

THE MARK CONSISTS OF STANDARD CHARACTERS WITHOUT CLAIM TO ANY PARTICULAR FONT, STYLE, SIZE, OR COLOR.

NO CLAIM IS MADE TO THE EXCLUSIVE RIGHT TO USE "COLOR", APART FROM THE MARK AS SHOWN.

FOR INTERIOR AND EXTERIOR LATEX AND OIL-BASE PAINTS, PRIMERS, STAINS FOR WOOD AND CONCRETE, PAINT THINNERS, VARNISHES AND LACQUERS (U.S. CLS. 6, 11 AND 16).

JORDAN BAKER, EXAMINING ATTORNEY

SN 85-533,688. MOSTOWY, RICHARD, ENCINO, CA. FILED 2-3-2012.

prezerve

THE MARK CONSISTS OF STANDARD CHARACTERS WITHOUT CLAIM TO ANY PARTICULAR FONT, STYLE, SIZE, OR COLOR.

FOR ANTI-TARNISHING PREPARATIONS FOR COATING METALS (U.S. CLS. 6, 11 AND 16).

JILL C. ALT, EXAMINING ATTORNEY

SN 85-533,691. ENKI TECHNOLOGY, INC., SANTA CLARA, CA. FILED 2-3-2012.

CLEANARC

THE MARK CONSISTS OF STANDARD CHARACTERS WITHOUT CLAIM TO ANY PARTICULAR FONT, STYLE, SIZE, OR COLOR.

FOR COATING FOR GLASS (U.S. CLS. 6, 11 AND 16).

TOBY BULLOFF, EXAMINING ATTORNEY

CLASS 2—(Continued).

SN 85-533,797. CHROMATIC TECHNOLOGIES, INC., COLORADO SPRINGS, CO. FILED 2-3-2012.

PHOTOTAG

THE MARK CONSISTS OF STANDARD CHARACTERS WITHOUT CLAIM TO ANY PARTICULAR FONT, STYLE, SIZE, OR COLOR.

FOR CHEMICAL BASED INK OR COATING CONTAINING A PROPRIETARY, MACHINE READABLE TAGGANT, USED TO IDENTIFY THE AUTHENTICITY OF A PRODUCT OR DOCUMENT, AND IS USED PRIMARILY FOR ANTI-COUNTERFEIT MEASURES (U.S. CLS. 6, 11 AND 16).

CAROLYN CATALDO, EXAMINING ATTORNEY

CLASS 2—(Continued).

SN 85-539,500. WAZANA BROTHERS INTERNATIONAL, INC., DBA MICRO SOLUTIONS ENTERPRISES, VAN NUYS, CA. FILED 2-10-2012.



NO CLAIM IS MADE TO THE EXCLUSIVE RIGHT TO USE "ISO 14001", APART FROM THE MARK AS SHOWN.

THE MARK CONSISTS OF THE WORDING "ISO 14001" IN DARK LETTERS ON A LIGHT BACKGROUND, ABOVE THE WORDING "ENVIRONMENTAL COMMITMENT" IN LIGHT LETTERS ON A DARK BACKGROUND, ALL WITHIN A RECTANGULAR BORDER WITH ROUNDED CORNERS.

FOR INK CARTRIDGES FOR PRINTERS; PHOTOCOPIER TONER IN CARTRIDGES; TONER CARTRIDGES; TONER FOR COPIERS; TONERS (U.S. CLS. 6, 11 AND 16).

FIRST USE 12-1-2008; IN COMMERCE 12-1-2008.
AMY KELLY, EXAMINING ATTORNEY

SN 85-535,953. TECHNICAL INTERNATIONAL SUPPLY CORP., DBA TECHNICAL TATTOO SUPPLY, INC., WEST BABYLON, NY. FILED 2-7-2012.

MILLENNIUM COLOR WORKS

THE MARK CONSISTS OF STANDARD CHARACTERS WITHOUT CLAIM TO ANY PARTICULAR FONT, STYLE, SIZE, OR COLOR.

FOR TATTOO INKS (U.S. CLS. 6, 11 AND 16).
FIRST USE 12-0-1999; IN COMMERCE 12-0-1999.
SALLY SHIH, EXAMINING ATTORNEY

SN 85-539,740. WAZANA BROTHERS INTERNATIONAL, INC., DBA MICRO SOLUTIONS ENTERPRISES, VAN NUYS, CA. FILED 2-10-2012.



NO CLAIM IS MADE TO THE EXCLUSIVE RIGHT TO USE "ISO 14001", APART FROM THE MARK AS SHOWN.

THE COLOR(S) GREEN AND WHITE IS/ARE CLAIMED AS A FEATURE OF THE MARK.

THE MARK CONSISTS OF THE WORDING "ISO 14001" IN GREEN LETTERS ON A WHITE BACKGROUND, ABOVE THE WORDING "ENVIRONMENTAL COMMITMENT" IN WHITE LETTERS ON A GREEN BACKGROUND, ALL WITHIN A GREEN RECTANGULAR BORDER WITH ROUNDED CORNERS.

FOR FILLED INK CARTRIDGES; INK CARTRIDGES FOR PRINTERS; PHOTOCOPIER TONER; TONER CARTRIDGES; TONER FOR COPIERS (U.S. CLS. 6, 11 AND 16).

FIRST USE 12-1-2008; IN COMMERCE 12-1-2008.
AMY KELLY, EXAMINING ATTORNEY

SN 85-539,019. SEO, MINJIN, TAIPEI, TAIWAN, FILED 2-10-2012.

MIJELLOMISSION

THE MARK CONSISTS OF STANDARD CHARACTERS WITHOUT CLAIM TO ANY PARTICULAR FONT, STYLE, SIZE, OR COLOR.

FOR COBALT OXIDE AS COLORANT; COLOR PIGMENTS; COLORANTS; COLORANTS, PAINTS AND DYES FOR GENERAL INDUSTRIAL USE; OIL COLORS; WATER-COLORS (U.S. CLS. 6, 11 AND 16).

AMY HELLA, EXAMINING ATTORNEY

CLASS 2—(Continued).

SN 85-558,270. MERCK KGAA, 64293 DARMSTADT, FED REP GERMANY, FILED 3-2-2012.

LIVING SPARKLE

THE MARK CONSISTS OF STANDARD CHARACTERS WITHOUT CLAIM TO ANY PARTICULAR FONT, STYLE, SIZE, OR COLOR.

PRIORITY CLAIMED UNDER SEC. 44(D) ON ERPN CMNTY TM OFC APPLICATION NO. 010293827, FILED 9-27-2011, REG. NO. 010293827, DATED 2-7-2012, EXPIRES 9-27-2021.

NO CLAIM IS MADE TO THE EXCLUSIVE RIGHT TO USE "SPARKLE", APART FROM THE MARK AS SHOWN, FOR PAINTS, VARNISHES, LACQUERS; COLORANTS; PIGMENTS (U.S. CLS. 6, 11 AND 16).
DOUGLAS LEE, EXAMINING ATTORNEY

SN 85-596,628. HNI TECHNOLOGIES INC., MUSCATINE, IA. FILED 4-12-2012.

TECH-AGE E

THE MARK CONSISTS OF STANDARD CHARACTERS WITHOUT CLAIM TO ANY PARTICULAR FONT, STYLE, SIZE, OR COLOR.

FOR COATINGS USED FOR FURNITURE FINISHING (U.S. CLS. 6, 11 AND 16).

MARGERY A. TIERNEY, EXAMINING ATTORNEY

CLASS 3—COSMETICS AND CLEANING PREPARATIONS

SN 77-703,101. WESTERN HOLDINGS, LLC, CHEYENNE, WY. FILED 3-31-2009.

THE GIFT OF YOUTH

THE MARK CONSISTS OF STANDARD CHARACTERS WITHOUT CLAIM TO ANY PARTICULAR FONT, STYLE, SIZE, OR COLOR.

FOR COSMETICS (U.S. CLS. 1, 4, 6, 50, 51 AND 52).

FIRST USE 5-13-2007; IN COMMERCE 5-13-2007.

VIVIAN MICZNIK FIRST, EXAMINING ATTORNEY

CLASS 3—(Continued).

SN 77-892,799. WHITE, EDMOND, FORMERLY SILKEWAY, INC, LITTLE ROCK, AR. AND FELLS, KENNETH, FORMERLY SILKEWAY, INC., LITTLE ROCK, AR. FILED 12-14-2009.

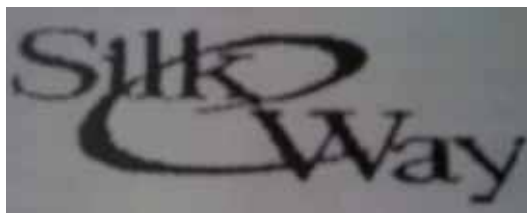

THE MARK CONSISTS OF THE STYLIZED WORD "SILK" WITH THE STYLIZED WORD "WAY" BELOW AND TO THE RIGHT; A STYLIZED SMALL LETTER "E" IS CENTERED OVER THE WORDS "SILK" AND "WAY".

FOR HAIR CARE PRODUCTS, NAMELY, SHAMPOOS, CONDITIONERS, HAIR OIL, HAIR SPRAY, HAIR CURL SPRAY, HAIR SPRITZS, HAIR GELS, HAIR RELAXERS, PRESSING OILS, POMADES, MOUSE, HOT OIL TREATMENTS, SETTING LOTION, HAIR MOISTURIZER, HAIR HOLDING SPRAY, DEEP CONDITIONER (U.S. CLS. 1, 4, 6, 50, 51 AND 52).

FIRST USE 5-5-1996; IN COMMERCE 5-5-1996.

MARY CRAWFORD, EXAMINING ATTORNEY

SN 77-947,868. CHEN, CANDACE, LOS ANGELES, CA. FILED 3-1-2010.

Liquid Armour

THE MARK CONSISTS OF STANDARD CHARACTERS WITHOUT CLAIM TO ANY PARTICULAR FONT, STYLE, SIZE, OR COLOR.

NO CLAIM IS MADE TO THE EXCLUSIVE RIGHT TO USE "LIQUID", APART FROM THE MARK AS SHOWN.

FOR FACIAL MOISTURIZER WITH SPF; SUN SCREEN (U.S. CLS. 1, 4, 6, 50, 51 AND 52).

LINDA M. KING, EXAMINING ATTORNEY

CLASS 3—(Continued).

SN 79-102,173. CASTER, FRANCE, FILED 5-3-2011.



PRIORITY DATE OF 12-3-2010 IS CLAIMED.

OWNER OF INTERNATIONAL REGISTRATION 1089770 DATED 5-3-2011, EXPIRES 5-3-2021.

OWNER OF U.S. REG. NOS. 3,213,624, 3,272,524 AND OTHERS.

NO CLAIM IS MADE TO THE EXCLUSIVE RIGHT TO USE "PARIS", APART FROM THE MARK AS SHOWN.

THE COLOR(S) BLUE AND WHITE IS/ARE CLAIMED AS A FEATURE OF THE MARK.

THE MARK CONSISTS OF A STYLIZED REPRESENTATION OF TWO BLUE LEAVES WITH THE WHITE WORDING "PHYTO PARIS".

FOR PERFUMERY PRODUCTS IN THE NATURE OF PERFUMERY, COLOGNE AND AFTER-SHAVE LOTIONS; COSMETIC PREPARATIONS NOT FOR MEDICAL USE FOR SKIN CARE, MAINTENANCE AND IMPROVEMENT, FOR SHAVING AND AFTER SHAVING; COSMETIC SUN TANNING PREPARATIONS, NAMELY, SUNSCREEN PREPARATIONS FOR USE ON HAIR; NON-MEDICAL PREPARATIONS FOR THE CARE OF SKIN AND HAIR, MAINTENANCE AND BEAUTIFICATION OF THE HAIR, NAMELY, HAIR CARE PREPARATIONS, HAIR LOTIONS, SHAMPOOS, HAIR CREAMS, HAIR GELS, HAIR MASKS, HAIR MOUSSES, NON-MEDICATED BALMS FOR HAIR CARE AND STYLING, HAIR SPRAYS, HAIR DYES AND BLEACHING PREPARATIONS FOR THE HAIR, HAIR WAVING AND STYLING PREPARATIONS (U.S. CLS. 1, 4, 6, 50, 51 AND 52).

JULIE VEPPUMTHARA, EXAMINING ATTORNEY

SN 79-102,176. BIORGANIC PHARMA, S.L., SPAIN, FILED 7-1-2011.



OWNER OF INTERNATIONAL REGISTRATION 1089774 DATED 7-1-2011, EXPIRES 7-1-2021.

THE COLOR(S) RED, GREEN IS/ARE CLAIMED AS A FEATURE OF THE MARK.

THE MARK CONSISTS OF THE WORDING "OMELINE" IN GREEN AND A RED STYLIZED FLOWER.

THE WORDING "OMELINE" HAS NO MEANING IN A FOREIGN LANGUAGE.

FOR SOAPS, PERFUMERY, ESSENTIAL OILS, COSMETICS, HAIR LOTIONS; PERFUMERY, SHAMPOOS, EAUX DE COLOGNE, DEODORANTS FOR PERSONAL USE; DENTIFRICES (U.S. CLS. 1, 4, 6, 50, 51 AND 52).

REBECCA POVARCHUK, EXAMINING ATTORNEY

CLASS 3—(Continued).

SN 79-103,030. JM WORLD CO., LTD., REPUBLIC OF KOREA, FILED 5-27-2011.

OWNER OF INTERNATIONAL REGISTRATION 1091995 DATED 5-27-2011, EXPIRES 5-27-2021.

THE WORDING "CHAMENNE" HAS NO MEANING IN A FOREIGN LANGUAGE.

FOR NAIL ENAMEL REMOVERS; EYEBROW PENCILS; EYEBROW COSMETICS; LAVENDER WATER; LOOSE FACE POWDER; ROUGE; LIQUID ROUGE; SACHETS FOR PERFUMING LINEN; LIP LINER; LIPSTICKS; MASSAGE GELS OTHER THAN FOR MEDICAL PURPOSES; MASSAGE OILS; MASCARA; NAIL VARNISH; NAIL ENAMEL; VARNISH-REMOVING PREPARATIONS; HAIR OILS; MAKE-UP FOUNDATIONS; MAKE-UP PREPARATIONS; GELS FOR SHAVING; SHAVING PREPARATIONS; HAIR DRYING PREPARATIONS; HAIR PRESERVATION TREATMENTS IN THE NATURE OF HAIR SPRAY; HAIR COLORANTS; HAIR MASCARA; WAVING PREPARATIONS FOR THE HAIR; HAIR-WASHING POWDERS; HAIR POMADES; HAIR BLEACHING PREPARATIONS; HAIR CREAMS; COLOR-REMOVING PREPARATIONS FOR HAIR; BATH SALTS; COSMETIC PREPARATIONS FOR BATHS; ADDITIVES FOR COSMETIC BATHS, NAMELY, BATH FOAM AND BATH BEADS; BEAUTY CREAMS; BODY LOTIONS; BODY MILKS; BADIEN ESSENCE; BODY OILS; BODY CREAMS; SACHETS FOR PERFUMING; VANISHING CREAMS FOR COSMETIC PURPOSES; BATH LOTIONS; BATH BEADS; BATH OILS; BATH FOAMS; WHITE MAKE-UP POWDER; BAY RUMS FOR COSMETIC PURPOSES; BABY OILS; BABY POWDERS; BLUSHERS; BLUSH PENCILS; PERFUMED POWDER FOR COSMETIC USE; BATH SALTS NOT FOR MEDICAL PURPOSES; DANDRUFF LOTIONS NOT FOR MEDICAL PURPOSES; DANDRUFF CREAMS NOT FOR MEDICAL PURPOSES; SUN-TANNING PREPARATIONS NOT FOR MEDICAL PURPOSES; SKIN CREAMS NOT FOR MEDICAL PURPOSES; COSMETIC OILS, NAMELY, SAFROL; ANTISEPTIC ALUM STONES; SHOWER AND BATH GELS; SHOWER CREAMS; SHOWER FOAMS AND BATH FOAMS; COSMETIC PREPARATIONS AGAINST SUNBURN; SUN-BLOCK LOTIONS; SUNSCREEN LOTIONS FOR COSMETIC USE; SUNSCREEN CREAMS FOR COSMETIC USE; SUNTAN LOTIONS FOR COSMETIC USE; COSMETIC SUN-TANNING PREPARATIONS; SUN-TANNING CREAMS; SHAVING LOTIONS; SHAVING CREAMS; SHAVING FOAMS; COSMETIC PREPARATIONS FOR EYELASHES; LOTIONS FOR STRENGTHENING THE NAILS; NAIL POLISHING POWDER; NAIL CARE PREPARATIONS; SKIN LOTIONS; COSMETIC CREAMS FOR SKIN CARE; COSMETIC PREPARATIONS FOR SKIN CARE; SKIN CREAMS; SKIN CLEANSERS; EYELINERS; EYELINER PENCILS; EYE LOTIONS; EYE MAKE-UP REMOVERS; EYE SHADOWS; EYE CREAMS; EYE PENCILS; COSMETICS FOR ANIMALS; AFTER SUN CREAMS FOR COSMETIC USE; AFTER-SHAVE LOTIONS; AFTER-SHAVE EMULSIONS; AFTER-SHAVE CREAMS; LIQUID PERFUMES; ETHEREAL ESSENCES; EAU DE COLOGNE; EAU DE PARFUM; EAU DE TOILETTE; COSMETIC OILS FOR THE EPIDERMIS; HAIR CONDITIONER FOR BABY; ANTIPERSPIRANTS FOR PERSONAL USE; DEODORANTS FOR PERSONAL USE; FRAGRANCES FOR PERSONAL USE BEING PERFUME; ESSENTIAL OILS FOR PERSONAL USE; TOILET WATERS; COSMETIC PREPARATIONS FOR DRY SKIN DURING PREGNANCY; LIP GLOSS; NON-MEDICATED LIP CONDITIONERS; NON-MEDICATED PROTECTIVE PREPARATIONS FOR LIPS; COSMETIC SUN-PROTECTING PREPARATIONS; COSMETIC PREPARATIONS FOR SLIMMING PURPOSES; COLD CREAMS FOR COSMETIC USE; COLD WAVING SOLUTIONS; SOLID POWDER FOR COMPACTS BEING COSMETICS; MUSTACHE WAX; CLEANSING MILK; DEPILATORY WAX; DEPILATORY PREPARATIONS; TALCUM POWDER; LOTIONS FOR BEARDS; BEARD DYES; PERMANENT WAVE PREPARATIONS; NEUTRALIZERS FOR PERMANENT WAVING; FOUNDATIONS;

CLASS 3—(Continued).

CREAMY FOUNDATION; PERMANENT WAVING LOTIONS; PERFUMED TALCUM POWDER; PERFUMED PASTE; PERFUMED CREAMS; FACIAL LOTION; FACIAL CLEANSING MILKS; FACIAL CREAMS; FACE MILK AND LOTIONS; FACE AND BODY LOTIONS; FACE AND BODY MILKS FOR COSMETIC USE; COSMETICS FOR FACE AND BODY; COSMETIC LOTIONS FOR FACE AND BODY CARE; FACE AND BODY CREAMS; MAKE-UP BASES IN THE FORM OF PASTES; POMADES FOR COSMETIC USE; PRESSED FACE POWDER; PRE-SHAVE CREAMS; SKIN WHITENING CREAMS; HAND LOTIONS; PERFUMED POWDERS; PERFUMES; HAIR GELS; HAIR GLAZE; HAIR NOURISHERS; COSMETIC HAIR DRESSING PREPARATIONS; HAIR LACQUERS; HAIR LOTIONS; HAIR MOISTURIZERS; HAIR MOUSSE; HAIR BALSAM; HAIR STYLING GELS; HAIR STYLING SPRAY; HAIR SPRAY; HAIR CONDITIONER; HAIR CONDITIONING OILS; HAIR CARE LOTIONS; BATH OILS FOR HAIR CARE; HAIR CARE CREAMS; HAIR TONIC; HELIOTROPIN FOR PERFUMERY; GELS FOR COSMETIC PURPOSES, NAMELY, EYE GELS; HYDROGEN PEROXIDE FOR COSMETIC PURPOSES; GREASES FOR COSMETIC PURPOSES; NOURISHING CREAMS FOR COSMETIC PURPOSES; LOTIONS FOR COSMETIC PURPOSES; COSMETIC ROUGES; FACE MASK PACK FOR COSMETIC PURPOSES; NAIL ENAMELS FOR COSMETIC PURPOSES; BATH POWDERS FOR COSMETIC PURPOSES; PETROLEUM JELLY FOR COSMETIC PURPOSES; ANTIPERSPIRANTS FOR COSMETIC PURPOSES; BATH OILS FOR COSMETIC PURPOSES; SUN MILK LOTIONS FOR COSMETIC PURPOSES; SUNTAN OILS FOR COSMETIC PURPOSES; SUN-TANNING PREPARATIONS FOR COSMETIC PURPOSES; ASTRINGENTS FOR COSMETIC PURPOSES; SKIN LOTIONS FOR COSMETIC PURPOSES; COSMETIC SKIN FRESHENER; ALMOND MILK FOR COSMETIC PURPOSES; LIQUID FOUNDATION FOR COSMETIC PURPOSES; FACE POWDER FOR COSMETIC PURPOSES; PENCILS FOR COSMETIC PURPOSES; DYES FOR COSMETIC PURPOSES, NAMELY, HAIR DYES; OILS FOR COSMETIC PURPOSES; BATH SALTS FOR COSMETIC PURPOSES; COLORANTS FOR COSMETIC PURPOSES, NAMELY, HAIR COLORANTS; CLEANSING CREAMS FOR COSMETIC PURPOSES; CLEANSING MILK FOR COSMETIC PURPOSES; CREAMS FOR COSMETIC PURPOSES; TALCUM POWDER FOR COSMETIC PURPOSES; MAKE-UP POWDER FOR COSMETIC PURPOSES; FACE CREAMS FOR COSMETIC PURPOSES; POMADES FOR COSMETIC PURPOSES; BLEACHING PREPARATIONS FOR COSMETIC PURPOSES; HAND CREAMS FOR COSMETIC PURPOSES; PERFUMED OILS FOR COSMETIC PURPOSES; MAKE-UP REMOVING LOTIONS; MAKE-UP REMOVING MILKS; MAKE-UP REMOVING PREPARATIONS; COSMETICS; COSMETIC KITS COMPRISED OF LIPSTICK, MASCARA AND LIP GLOSS; SOAP FOR PERSONAL USE IN THE FORM OF CAKE; SHAVING MOUSSE; SHAVING SOAP; BATH SOAPS; LIQUID SOAPS; BEAUTY SOAPS; BODY CREAM SOAPS; SOAPS FOR BODY CARE; SOAP FOR FOOT PERSPIRATION; ANTIPERSPIRANT SOAP; DEODORANT SOAP; SHAMPOOS; HAND CLEANING PREPARATIONS; ALMOND SOAP; SHAMPOOS FOR PETS; LIQUID BATH SOAPS; SHAMPOOS FOR BABIES; SOAPS FOR PERSONAL USE; LIQUID SOAPS USED IN FOOT BATH; SOAPS IN THE FORM OF PAPER; CREAM SOAPS; FACIAL WASHES; HAND CLEANERS BEING HAND CLEANING PREPARATIONS; PERFUMED SOAP; COSMETIC HAIR RINSES; COSMETIC SOAPS; ESSENTIAL OILS IN THE NATURE OF GAULTHERIA OIL; AROMATICS BEING ESSENTIAL OILS FOR HOUSEHOLD PURPOSES; FRAGRANCE FOR HOUSEHOLD PURPOSES; EXTRACTS OF FLOWERS BEING PERFUMES; BASES FOR FLOWER PERFUMES; LAVENDER OIL; ESSENTIAL OILS OF LEMON; ELECAMPANE BEING PERFUMERY; MINT ESSENCE BEING ESSENTIAL OIL; VANILLA PERFUMERY; PEPPERMINT OIL PERFUMERY; SCENTED WOOD; BERGAMOT OIL; COMPLEX PERFUMERY; ESSENTIAL OILS OF CEDARWOOD; JOSS STICKS; ESSENTIAL OILS OF CITRON; ALMOND OIL FOR COSMETIC PURPOSES; AMBER PERFUME; ETHEREAL OILS; AMBERGRIS; IONONE PERFUMERY; AROMATICS FOR AUTOMOBILES; JASMINE OIL FOR COSMETIC PURPOSES; ROSE OIL FOR COSMETIC

CLASS 3—(Continued).

PURPOSES; GERANIOL FOR PERFUMERY; COMPOUND PERFUMERY; NATURAL PERFUMERY; CLOVE OIL FOR COSMETIC PURPOSES; TERPENES BEING ESSENTIAL OILS; POTPOURRIS BEING FRAGRANCES; SYNTHETIC MUSK; SYNTHETIC PERFUMERY; INCENSE; PERFUMERY; OILS FOR PERFUMES AND SCENTS; PERFUMERY BEING ESSENTIAL OIL; MINT FOR PERFUMERY; MUSK FOR PERFUMERY; NATURAL MUSK FOR PERFUMERY; PERFUMED OILS FOR THE MANUFACTURE OF COSMETIC PREPARATIONS; FUMIGATION PREPARATIONS BEING PERFUMES (U.S. CLS. 1, 4, 6, 50, 51 AND 52).
KRISTINA MORRIS, EXAMINING ATTORNEY

SN 79-103,721. EXAMONE ENTERPRISES LTD, CYPRUS, FILED 6-23-2011.



PRIORITY DATE OF 12-29-2010 IS CLAIMED.
OWNER OF INTERNATIONAL REGISTRATION 1093720
DATED 6-23-2011, EXPIRES 6-23-2021.
OWNER OF U.S. REG. NO. 3,359,965.

NO CLAIM IS MADE TO THE EXCLUSIVE RIGHT TO USE "ECO-FRIENDLY" AND THE UNIVERSAL RECYCLING SYMBOL, APART FROM THE MARK AS SHOWN.

THE MARK CONSISTS OF THE FIGURE OF A STICK FIGURE GIRL WITH HEAD AS A SMILEY FACE, AND TORSO COMPRISING THE UNIVERSAL RECYCLING SYMBOL. THE WORDING "DIZAO-ECO-FRIENDLY" ENCIRCLES THE TOP HALF OF THE SMILEY-FACE'S HEAD.

THE WORDING "DIZAO" HAS NO MEANING IN A FOREIGN LANGUAGE.

FOR PERFUMERY; COSMETIC CREAMS; SKIN WHITENING CREAMS; HAIR LOTIONS; LOTIONS FOR COSMETIC PURPOSES; BEAUTY MASKS; OILS FOR COSMETIC PURPOSES; ESSENTIAL OILS; CLEANSING MILK FOR TOILET PURPOSES; SOAP; COSMETIC KITS; LIPSTICKS; POMADES FOR COSMETIC PURPOSES; COSMETIC PREPARATIONS FOR BATHS; COSMETIC PREPARATIONS FOR SLIMMING PURPOSES; MAKE-UP REMOVING PREPARATIONS; TISSUES IMPREGNATED WITH COSMETIC LOTIONS; COSMETIC PREPARATIONS FOR SKIN CARE; COSMETICS; SHAMPOOS (U.S. CLS. 1, 4, 6, 50, 51 AND 52).
RON FAIRBANKS, EXAMINING ATTORNEY

CLASS 3—(Continued).

SN 79-103,862. EROL SARL, LUXEMBOURG, FILED 9-15-2011.



OWNER OF INTERNATIONAL REGISTRATION 1094050 DATED 9-15-2011, EXPIRES 9-15-2021.

NO CLAIM IS MADE TO THE EXCLUSIVE RIGHT TO USE "DEPUIS 1760" AND "38, AV. PIERRE 1ER DE SERBIE PARIS", APART FROM THE MARK AS SHOWN.

THE COLOR(S) BLACK, GOLD IS/ARE CLAIMED AS A FEATURE OF THE MARK.

THE MARK CONSISTS OF A GOLD CROWN ABOVE THE WORDING "ROYAL-LOUD", WHICH IS ABOVE THE WORD "MILLESIME". BELOW THIS WORDING IS THE WORDING "DE PÈRE EN FILS DEPUIS 1760 38, AV. PIERRE 1ER DE SERBIE PARIS" PRESENTED ON TWO LINES. ALL OF THE WORDING IS IN GOLD. THE CROWN AND THE WORDING APPEAR ON A BLACK BACKGROUND WITH A GOLD OUTLINE.

THE ENGLISH TRANSLATION OF "MILLESIME; DE PÈRE EN FILS; DEPUIS"; AND "AV. PIERRE 1ER DE SERBIE PARIS" IS AVENUE PETER I OF SERBIA IN THE MARK IS "VINTAGE" OR "DATE"; "OF THE FATHER AND SONS"; "SINCE"; AND "AVENUE PETER I OF SERBIA."

FOR SOAP, PERFUMES, ESSENTIAL OILS, COSMETICS, HAIR LOTIONS (U.S. CLS. 1, 4, 6, 50, 51 AND 52).

SHANNON TWOHIG, EXAMINING ATTORNEY

SN 79-103,874. KOSSWELL COSMETIC, S.L., SPAIN, FILED 6-10-2011.

"KOSSWELL PROFESSIONAL"

THE MARK CONSISTS OF STANDARD CHARACTERS WITHOUT CLAIM TO ANY PARTICULAR FONT, STYLE, SIZE, OR COLOR.

OWNER OF INTERNATIONAL REGISTRATION 1094107 DATED 6-10-2011, EXPIRES 6-10-2021.

NO CLAIM IS MADE TO THE EXCLUSIVE RIGHT TO USE "PROFESSIONAL", APART FROM THE MARK AS SHOWN.

FOR SOAP, NAMELY, BATH SOAP, BEAUTY SOAP, COSMETIC SOAP, DEODORANT SOAP, SOAPS FOR PERSONAL USE AND COSMETIC SOAP; PERFUMERY, ESSENTIAL OILS, COSMETICS, HAIR LOTIONS; DENTIFRICES (U.S. CLS. 1, 4, 6, 50, 51 AND 52).

PRISCILLA MILTON, EXAMINING ATTORNEY

CLASS 3—(Continued).

SN 79-104,150. R & G PARKER GROUP PTY LTD, AUSTRALIA, FILED 8-17-2011.

luccien

OWNER OF INTERNATIONAL REGISTRATION 1094764 DATED 8-17-2011, EXPIRES 8-17-2021.

THE MARK CONSISTS OF THE WORD "LUCCIEN" IN STYLIZED TEXT.

FOR COSMETICS; COSMETICS FOR PERSONAL USE; COSMETICS FOR PROTECTING THE SKIN FROM SUNBURN; COSMETICS IN THE FORM OF CREAMS, LOTIONS AND OILS; COSMETIC PREPARATIONS; ESSENTIAL OILS FOR USE IN COSMETICS; PREPARATIONS FOR REMOVING COSMETICS; DECOLORANTS IN THE NATURE OF BLEACHING PREPARATIONS FOR COSMETIC PURPOSES, NAMELY, HAIR COLOR REMOVERS; ASTRINGENTS FOR COSMETIC PURPOSES; COSMETICS TO REMOVE PIGMENTATION MARKS, NAMELY, NON-MEDICATED PIGMENT LIGHTENING GELS (U.S. CLS. 1, 4, 6, 50, 51 AND 52).

SHANNON TWOHIG, EXAMINING ATTORNEY

SN 79-105,821. LACOTE S.R.L., ITALY, FILED 6-7-2011.

GUAM

THE MARK CONSISTS OF STANDARD CHARACTERS WITHOUT CLAIM TO ANY PARTICULAR FONT, STYLE, SIZE, OR COLOR.

OWNER OF INTERNATIONAL REGISTRATION 0713557 DATED 5-3-1999, EXPIRES 5-3-2019.

FOR BODY AND BEAUTY CARE CREAMS AND COSMETICS (U.S. CLS. 1, 4, 6, 50, 51 AND 52).

SUE LAWRENCE, EXAMINING ATTORNEY

CLASS 3—(Continued).

SN 79-106,280. AGNÈS ANDRÉE MARGUERITE MARIE TROUBLÉ, FRANCE, FILED 11-7-2011.

PRIORITY DATE OF 10-17-2011 IS CLAIMED.
OWNER OF INTERNATIONAL REGISTRATION 1099632 DATED 11-7-2011, EXPIRES 11-7-2021.

FOR FOOT SMOOTHING STONES; COSMETIC SUNSCREEN PREPARATIONS; COSMETIC PREPARATIONS FOR BATHS; JOSS STICKS; HAIR LOTIONS; FALSE EYELASHES; COSMETICS; MAKE-UP REMOVING PRODUCTS; DEODORANTS FOR PERSONAL USE; SOAP; SHOWER GELS; ESSENTIAL OILS; HAIR SPRAYS; DENTIFRICES; HAIR LOTIONS; MAKE-UP PRODUCTS; COSMETIC SETS; NAIL POLISH; NAIL CARE PRODUCTS; SACHETS FOR PERFUMING LINEN; PERFUMERY; EAU DE PARFUM; TOILET WATER; EAU DE COLOGNE; SHAVING PRODUCTS; SHAMPOOS; PRODUCTS FOR REMOVING VARNISH; SHAVING BRUSHES; PERFUMED TOWELETTES; FACE CLEANSER; DEODORANT FOR BODY CARE; COSMETIC PREPARATIONS FOR SLIMMING PURPOSES; LIP BALM; HAIR STYLING PRODUCT (U.S. CLS. 1, 4, 6, 50, 51 AND 52).

KELLY TRUSILO, EXAMINING ATTORNEY

SN 79-107,881. GUANGZHOU FRANDY DAILY; CHEMICAL CO., LTD., CHINA, FILED 12-6-2011.

PRIORITY DATE OF 6-21-2011 IS CLAIMED.
OWNER OF INTERNATIONAL REGISTRATION 1103535 DATED 12-6-2011, EXPIRES 12-6-2021.

THE WORDING "KARTUN" HAS NO MEANING IN A FOREIGN LANGUAGE.

FOR PERFUMES; SHAMPOOS; FACIAL WASHING MILK; BATH LOTION; DENTIFRICES; COSMETICS; HAIR SPRAY; CAKES OF SOAP; HAIR CONDITIONER; ANTIMICROBIAL HAND LOTIONS (U.S. CLS. 1, 4, 6, 50, 51 AND 52).

DAVID ELTON, EXAMINING ATTORNEY

CLASS 3—(Continued).

SN 79-108,747. DADO-COSMED; HERSTELLUNG UND VERTRIEB KOSMETISCHER; ERZEUGNISSE ALLER ART GMBH, CALW, FED REP GERMANY, FILED 11-21-2011.

NATURE'S PHARMACY

THE MARK CONSISTS OF STANDARD CHARACTERS WITHOUT CLAIM TO ANY PARTICULAR FONT, STYLE, SIZE, OR COLOR.

PRIORITY DATE OF 5-25-2011 IS CLAIMED.

OWNER OF INTERNATIONAL REGISTRATION 1105669 DATED 11-21-2011, EXPIRES 11-21-2021.

NO CLAIM IS MADE TO THE EXCLUSIVE RIGHT TO USE "PHARMACY", APART FROM THE MARK AS SHOWN.

FOR COSMETICS AND PERSONAL CARE PREPARATIONS, NAMELY, SHOWER GEL, NON-MEDICATED LIP CARE PREPARATIONS AND SUN SCREEN PREPARATIONS; NON-MEDICATED SKIN CARE PREPARATIONS; SOAPS FOR PERSONAL USE; HAIR CARE PREPARATIONS, NAMELY, HAIR SHAMPOO (U.S. CLS. 1, 4, 6, 50, 51 AND 52).

TINA L. SNAPP, EXAMINING ATTORNEY

SN 85-068,365. THE PREMIERE POLISH COMPANY LIMITED, CHELTENHAM, UNITED KINGDOM, FILED 6-22-2010.

ECOFORCE

THE MARK CONSISTS OF STANDARD CHARACTERS WITHOUT CLAIM TO ANY PARTICULAR FONT, STYLE, SIZE, OR COLOR.

PRIORITY CLAIMED UNDER SEC. 44(D) ON ERPNCMNTY TM OFC APPLICATION NO. 008777005, FILED 12-22-2009.

FOR PREPARATIONS AND SUBSTANCES ALL FOR LAUNDRY USE, NAMELY, LAUNDRY STARCH, LAUNDRY DETERGENT, LAUNDRY BLEACH; CLEANING, POLISHING, SCOURING, DESCALING PREPARATIONS; ABRASIVE PREPARATIONS, NAMELY, SCOURING POWDER; LAUNDRY SOAP, BODY SOAP, SKIN SOAP; TURPENTINE SUBSTITUTE; PAINT OR POLISH STRIPPING PREPARATIONS AND SUBSTANCES; WATER CLOSET COLORING MATERIALS, NAMELY, TOILET BOWL DETERGENTS; ANTISTATIC PREPARATIONS AND SUBSTANCES, NAMELY, ANTI-STATIC SPRAY FOR CLOTHING, FABRICS AND CARPETS; ANTI-STATIC DRY SHEETS, ANTI-STATIC PREPARATIONS FOR HOUSEHOLD PURPOSES; RINSE ADDITIVES, NAMELY, FABRIC SOFTENERS FOR LAUNDRY USE; GLASS CLEANER, DISINFECTANT TOILET BOWL CLEANERS, ALL OF WHICH CONTAIN OR WILL CONTAIN ECOLOGICALLY POSITIVE CHARACTERISTICS, INGREDIENTS OR QUALITIES (U.S. CLS. 1, 4, 6, 50, 51 AND 52).

DAWN FELDMAN, EXAMINING ATTORNEY

CLASS 3—(Continued).

SN 85-071,176. MICHAEL F. BALL, INGLEWOOD, CA.
FILED 6-24-2010.

CLASS 3—(Continued).

SN 85-071,195. R&R APPAREL COMPANY, LLC, WILMING-
TON, DE. FILED 6-24-2010.

Republic by Rock & Republic

Republic by R&R

THE MARK CONSISTS OF STANDARD CHARACTERS WITHOUT CLAIM TO ANY PARTICULAR FONT, STYLE, SIZE, OR COLOR.

OWNER OF U.S. REG. NO. 3,730,120.

FOR COSMETICS, NAMELY, COMPACTS, CONCEALERS, BLUSHES, MASCARAS, MAKE-UP FOUNDATIONS, EYE PENCILS, EYEBROW PENCILS, LIPSTICKS, LIP FOUNDATION, LIP GLOSS, LIP PENCILS, NON-MEDICATED LIP BALM, EYE SHADOW, EYE-LINERS, ARTIFICIAL EYELASHES, EYEBROW GLOSS, NAIL POLISH, NAIL POLISH TOP COAT, NAIL POLISH BASE COAT, ARTIFICIAL FINGERNAILS, AND ROUGES; BATH ITEMS, NAMELY, CRYSTALS, FOAM, GELS, OIL, PEARLS, AND POWDER; HAIR PRODUCTS, NAMELY, SHAMPOOS, CONDITIONERS, GEL, LIGHTENERS, HAIR MOUSSE, LOTIONS, MASCARA, AND POMADES; SKIN CARE PRODUCTS, NAMELY, ASTRINGENT FOR COSMETIC PURPOSES, BATH GEL, BATH OIL, BEAUTY MASKS, BUBBLE BATH, EYE MAKE-UP REMOVER, FACIAL SCRUBS, MAKE-UP REMOVER, SHOWER GEL, SKIN MOUSSE, MASSAGE OIL, SHAVING CREAM, SKIN CLARIFIERS, SKIN SOAP, SKIN EMOLLIENTS AND ANTI-WRINKLE CREAM; SKIN CARE PREPARATIONS, NAMELY, MOISTURIZERS, BODY LOTIONS AND CREAMS; OILS, NAMELY, PERFUME OIL AND SUNTAN OIL; FRAGRANCES, NAMELY, PERFUME, AND COLOGNE; LOTIONS, NAMELY, SUNTAN, SKIN, HAIR, AND FACIAL LOTIONS; AND INCENSE (U.S. CLS. 1, 4, 6, 50, 51 AND 52).

SUSAN RICHARDS, EXAMINING ATTORNEY

THE MARK CONSISTS OF STANDARD CHARACTERS WITHOUT CLAIM TO ANY PARTICULAR FONT, STYLE, SIZE, OR COLOR.

FOR COSMETICS, NAMELY, COMPACTS, CONCEALERS, BLUSHES, MASCARAS, MAKE-UP FOUNDATIONS, EYE PENCILS, EYEBROW PENCILS, LIPSTICKS, LIP FOUNDATION, LIP GLOSS, LIP PENCILS, NON-MEDICATED LIP BALM, EYE SHADOW, EYE-LINERS, ARTIFICIAL EYELASHES, EYEBROW GLOSS, NAIL POLISH, NAIL POLISH TOP COAT, NAIL POLISH BASE COAT, ARTIFICIAL FINGERNAILS, AND ROUGES; BATH ITEMS, NAMELY, CRYSTALS, FOAM, GELS, OIL, PEARLS, AND POWDER; HAIR PRODUCTS, NAMELY, SHAMPOOS, CONDITIONERS, GEL, LIGHTENERS, LOTIONS, MASCARA, MOUSSE, AND POMADES; SKIN CARE PRODUCTS, NAMELY, ASTRINGENT FOR COSMETIC PURPOSES, BATH GEL, BATH OIL, BEAUTY MASKS, BUBBLE BATH, EYE MAKE-UP REMOVER, FACIAL SCRUBS, MAKE-UP REMOVER, SHOWER GEL, MASSAGE OIL, SHAVING CREAM, SKIN CLARIFIERS, SKIN SOAP, SKIN EMOLLIENTS AND ANTI-WRINKLE CREAM; SKIN CARE PREPARATIONS, NAMELY, MOISTURIZERS, BODY LOTIONS AND CREAMS; OILS, NAMELY, PERFUME OIL AND SUNTAN OIL; FRAGRANCES, NAMELY, PERFUME, AND COLOGNE; LOTIONS, NAMELY, SUNTAN, SKIN, HAIR, AND FACIAL LOTIONS; AND INCENSE (U.S. CLS. 1, 4, 6, 50, 51 AND 52).

SUSAN RICHARDS, EXAMINING ATTORNEY

SN 85-074,416. RAMANI, KUMAR, PRINCETON JUNCTION,
NJ. FILED 6-29-2010.

HARVEY PRINCE EAU FLIRT

THE MARK CONSISTS OF STANDARD CHARACTERS WITHOUT CLAIM TO ANY PARTICULAR FONT, STYLE, SIZE, OR COLOR.

NO CLAIM IS MADE TO THE EXCLUSIVE RIGHT TO USE "EAU", APART FROM THE MARK AS SHOWN.

THE NAME(S), PORTRAIT(S), AND/OR SIGNATURE(S) SHOWN IN THE MARK DOES NOT IDENTIFY A PARTICULAR LIVING INDIVIDUAL.

THE ENGLISH TRANSLATION OF "EAU" IN THE MARK IS WATER.

FOR EAU DE TOILETTE (U.S. CLS. 1, 4, 6, 50, 51 AND 52).

SUNG IN, EXAMINING ATTORNEY

CLASS 3—(Continued).

SN 85-089,021. KUMAR RAMANI, PRINCETON JUNCTION, NJ. FILED 7-20-2010.

Harvey Prince EAU TEASE

THE MARK CONSISTS OF STANDARD CHARACTERS WITHOUT CLAIM TO ANY PARTICULAR FONT, STYLE, SIZE, OR COLOR.

NO CLAIM IS MADE TO THE EXCLUSIVE RIGHT TO USE "EAU", APART FROM THE MARK AS SHOWN.

THE NAME(S), PORTRAIT(S), AND/OR SIGNATURE(S) SHOWN IN THE MARK DOES NOT IDENTIFY A PARTICULAR LIVING INDIVIDUAL.

THE ENGLISH TRANSLATION OF "EAU" IN THE MARK IS WATER.

FOR EAU DE TOILETTE (U.S. CLS. 1, 4, 6, 50, 51 AND 52).

FIRST USE 7-20-2010; IN COMMERCE 7-20-2010.
SUNG IN, EXAMINING ATTORNEY

SN 85-125,486. JOHNSON & JOHNSON, NEW BRUNSWICK, NJ. FILED 9-8-2010.



THE MARK CONSISTS OF A THREE-DIMENSIONAL CONFIGURATION OF THE PACKAGING FOR THE GOODS. THE CONFIGURATION IS COMPRISED OF THE DESIGN OF A BOTTLE HAVING A BODY THAT IS ROUNDED ON ONE SIDE AND FLAT WITH CURVED EDGES ON THE OTHER SIDE. THE MATTER SHOWN IN BROKEN LINES IS NOT A PART OF THE MARK AND IS MERELY INCLUDED TO SHOW THE POSITION OF THE MARK.

SEC. 2(F).

FOR BODY WASH (U.S. CLS. 1, 4, 6, 50, 51 AND 52).
FIRST USE 12-15-2010; IN COMMERCE 12-15-2010.
ELLEN BURNS, EXAMINING ATTORNEY

CLASS 3—(Continued).

SN 85-138,373. KELLY VAN GOGH HAIR COLOR COSMETICS, LLC, NEW YORK, NY. FILED 9-26-2010.

BEAUTIFUL HAIR COLOUR GETS
YOU NOTICED. KELLY VAN
GOGH MAKES YOU
UNFORGETTABLE.

THE MARK CONSISTS OF STANDARD CHARACTERS WITHOUT CLAIM TO ANY PARTICULAR FONT, STYLE, SIZE, OR COLOR.

THE NAME(S), PORTRAIT(S), AND/OR SIGNATURE(S) SHOWN IN THE MARK IDENTIFIES "KELLY VAN GOGH", WHOSE CONSENT(S) TO REGISTER IS MADE OF RECORD.

FOR NON-MEDICATED HAIR CARE PREPARATIONS, NAMELY, SHAMPOOS, CONDITIONERS, GELS, COLORANTS, AND TONICS; HAIR CARE KITS COMPRISING NON-MEDICATED HAIR CARE PREPARATIONS, NAMELY, SHAMPOOS, CONDITIONERS, GELS, COLORANTS, AND TONICS, AND HAIR CARE PREPARATION APPLICATION TOOLS, NAMELY, APPLICATORS AND MIXING RECEPTACLES ALL OF WHICH ARE SOLD TOGETHER AS A UNIT (U.S. CLS. 1, 4, 6, 50, 51 AND 52).

APRIL ROACH, EXAMINING ATTORNEY

SN 85-187,186. WEST, ELLERY, CRESCENT CITY, CA. FILED 11-30-2010.

Organic Essence

THE MARK CONSISTS OF STANDARD CHARACTERS WITHOUT CLAIM TO ANY PARTICULAR FONT, STYLE, SIZE, OR COLOR.

OWNER OF U.S. REG. NO. 3,042,992.

NO CLAIM IS MADE TO THE EXCLUSIVE RIGHT TO USE "ORGANIC", APART FROM THE MARK AS SHOWN.
SEC. 2(F).

FOR ORGANIC BODY CARE PRODUCTS, NAMELY, ORGANIC NON-MEDICATED LIP BALM, ORGANIC NON-MEDICATED SKIN CARE CREAM (U.S. CLS. 1, 4, 6, 50, 51 AND 52).

FIRST USE 9-10-2004; IN COMMERCE 9-10-2004.
JENNIFER MARTIN, EXAMINING ATTORNEY

CLASS 3—(Continued).

SN 85-254,715. UNITED DEVELOPMENT SYSTEMS, INC., CLEARWATER, FL. FILED 3-1-2011.

DIAMOND FINISH



NO CLAIM IS MADE TO THE EXCLUSIVE RIGHT TO USE "FINISH", APART FROM THE MARK AS SHOWN.

THE MARK CONSISTS OF THE WORDING "DIAMOND FINISH", TO THE LEFT OF A STYLIZED DIAMOND WITH A SPARKLE ON THE LOWER RIGHT PORTION OF THE DIAMOND.

FOR AUTOMOBILE AND CAR WAX PREPARATIONS, AUTOMOBILE CARPET AND UPHOLSTERY CLEANING, AUTOMOBILE TIRE AND WHEEL CLEANING PREPARATIONS; POLYMER SEALANT FOR CLEANING, SHINING AND PROTECTING AUTOMOBILE EXTERIOR SURFACES (U.S. CLS. 1, 4, 6, 50, 51 AND 52).

FIRST USE 1-5-2011; IN COMMERCE 1-5-2011.
SCOTT BIBB, EXAMINING ATTORNEY

CLASS 3—(Continued).

JUICE ASTRINGENT; BODY AND FACIAL SCRUBS AND EXFOLIATORS, NAMELY, ALOE VERA MICRODERMABRASION CREAM, PAPAYA PEELING EXFOLIATING CREAM, APRICOT KERNEL SCRUB, PINEAPPLE AND PAPAYA SCRUB; DAY AND NIGHT HAND AND BODY CREAMS FOR COSMETIC USE, NAMELY, MOISTURIZING CREAMS, HYDRATING CREAM, CITRUS REVITALIZING CREAM, EUCALYPTUS BOTANICAL CREAM, TAMARIND DAY CREAM, MARINE EXTRACTS DAY CREAM, COCOA BUTTER FACIAL MOISTURIZER WITH SPF15, GREEN TEA SUN PROTECTIVE FACIAL AND BODY MOISTURIZERS WITH SPF 30, CARROT NOURISH CREAM MARINE COLLAGEN CREAM, PEACH ANTI-AGING CREAM, SWEET ALMOND OIL HYDRATING CREAM; BEAUTY SERUMS, NAMELY, 24K GOLD SERUM, GLYCOPROTEIN PREVENTING SERUM, NON-MEDICATED SKIN SERUM CONTAINING MULTIVITAMINS, ALOE VERA GEL FOR COSMETIC PURPOSES; BEAUTY MASKS, NAMELY, MANGO LUXURY NOURISH MASK, PINEAPPLE CLEANSING MASK, DEAD SEA MUD MASK, CUCUMBER REGENERATING MASK, GINSENG REVITALIZING MASK, SAFFLOWER MASK, EYE CREAM, NAMELY, ALMOND OIL EYE CREAM, AND AVOCADO OIL CREAM (U.S. CLS. 1, 4, 6, 50, 51 AND 52).

MARC LEIPZIG, EXAMINING ATTORNEY

SN 85-319,254. SIMI ESSENTIALS CORP., MIAMI, FL. FILED 5-12-2011.

SIMI



ESSENTIALS

OWNER OF U.S. REG. NO. 4,126,323.
NO CLAIM IS MADE TO THE EXCLUSIVE RIGHT TO USE "ESSENTIALS", APART FROM THE MARK AS SHOWN.

THE MARK CONSISTS OF THE WORD "SIMI" WRITTEN IN A UNIQUE FONT IN WHICH THE LETTER "M" IS PREDOMINANT. UNDERNEATH THERE IS A DESIGN OF A FLYING WOMAN CARRYING IN HER BACK A HUGE DROP; AND UNDERNEATH THE WORD "ESSENTIALS" IS WRITTEN IN SMALL PRINT LETTERS.

FOR BODY LINE PRODUCTS NAMELY, ALMOND BODY MILK, JOJOBA BODY SCRUB, SEAWEED SHOWER GEL, MANGO BODY NOURISH CREAM, SESAME BODY CREAM, CUCUMBER BODY CREAM, CALENDULA SOOTHING GEL, SWEET HAZELNUT NOURISH OIL, SEAWEED MASK, LAVENDER BODY SOAK, AVOCADO BODY BUTTER, NON-MEDICATED SKIN CARE PREPARATION IN THE NATURE OF TEA TREE GEL FOR COSMETIC USE IN REDUCING AND IMPROVING THE APPEARANCE OF UNSIGHTLY RAZOR BUMPS, FOR PROTECTING THE SKIN AGAINST GENERAL IRRITATION, AND FOR PREVENTING RAZOR BURN AND INGROWN HAIRS DURING SHAVING, ELECTROLYSIS AND WAXING, FRENCH SALT BATH CRYSTALS, DEAD SEA SALT FOR COSMETIC USE, SWEET ALMOND HAND AND BODY OIL, PINEAPPLE HAND AND BODY LOTION; HAND AND BODY CLEANSING GELS AND LOTIONS, NAMELY, ROSEMARY CLEANSING, LAVENDER CLEANSING, LINE TREE SOUFFLE, CALENDULA CLEANSING, AND ORANGE PEEL CLEANSING MILK, CAMELLIA MILK, CHAMOMILE EYE MAKEUP REMOVER, PROPOLIS DRYING LOTION FOR COSMETIC PURPOSES; SKIN TONERS AND ASTRINGENTS FOR COSMETIC USE, NAMELY, HAZEL ASTRINGENT TONER, HERBAL ASTRINGENT, ALOE VERA ASTRINGENT, LEMON

SN 85-347,295. LAURENCE C RAINES, BERKELEY, CA. FILED 6-15-2011.

Querida

THE MARK CONSISTS OF STANDARD CHARACTERS WITHOUT CLAIM TO ANY PARTICULAR FONT, STYLE, SIZE, OR COLOR.

OWNER OF U.S. REG. NO. 3,887,785.

THE ENGLISH TRANSLATION OF "QUERIDA" IN THE MARK IS BELOVED, DEAR, AND SWEETHEART.

FOR COLOGNES, PERFUMES AND COSMETICS; COSMETICS IN GENERAL, INCLUDING PERFUMES; DISINFECTING PERFUMED SOAPS; EAU DE PERFUME; ESSENTIAL OILS AS PERFUME FOR LAUNDRY PURPOSES; LIQUID PERFUMES; OILS FOR PERFUMES AND SCENTS; PERFUME; PERFUME OILS; PERFUME OILS FOR THE MANUFACTURE OF COSMETIC PREPARATIONS; PERFUMED CREAMS; PERFUMED EXTRACTS FOR TISSUES AND PERFUMES; PERFUMED PASTE; PERFUMED POWDER; PERFUMED POWDERS; PERFUMED SOAP; PERFUMED SOAPS; PERFUMED TALCUM POWDER; PERFUMES; PERFUMES AND COLOGNES; PERFUMES AND TOILET WATERS; PERFUMES IN SOLID FORM; PERFUMES, AFTERSHAVES AND COLOGNES; PERFUMES, EAU DE COLOGNES AND AFTERSHAVES; PERFUMES, EAUX DE COLOGNE AND AFTERSHAVES; PERFUMING SACHETS; SACHETS FOR PERFUMING LINEN (U.S. CLS. 1, 4, 6, 50, 51 AND 52).

FIRST USE 12-7-2010; IN COMMERCE 6-1-2011.
DARRYL SPRUILL, EXAMINING ATTORNEY

CLASS 3—(Continued).

SN 85-350,490. PWA GLOBAL INC., MANHASSET, NY. FILED 6-20-2011.

BRAZILIAN INSTANT BEAUTY

THE MARK CONSISTS OF STANDARD CHARACTERS WITHOUT CLAIM TO ANY PARTICULAR FONT, STYLE, SIZE, OR COLOR.

NO CLAIM IS MADE TO THE EXCLUSIVE RIGHT TO USE "BRAZILIAN" AND "BEAUTY", APART FROM THE MARK AS SHOWN.

FOR BEAUTY CREAMS FOR BODY CARE; BODY AND BEAUTY CARE COSMETICS; FACE AND BODY BEAUTY CREAMS (U.S. CLS. 1, 4, 6, 50, 51 AND 52).

CIMMERIAN COLEMAN, EXAMINING ATTORNEY

CLASS 3—(Continued).

SN 85-358,376. FINANZ ST. HONORE, B.V., 1097 JB AMSTERDAM, NETHERLANDS, FILED 6-28-2011.



OWNER OF U.S. REG. NO. 1,582,172.

THE MARK CONSISTS OF A THREE-DIMENSIONAL CONFIGURATION OF FRAGRANCE BOTTLE WITH ONE CURVED SIDE AND ONE POINTED SIDE WITH A GEOMETRICALLY SHAPED CAP. THE BROKEN LINES DEPICTING THE SPRAY NOZZLE, PUMP AND PIPE INDICATE PLACEMENT OF THE MARK ON THE GOODS AND ARE NOT PART OF THE MARK.

FOR AFTER-SHAVE; AFTER-SHAVE LIQUID; AFTER-SHAVE COLOGNE; COLOGNE; EAU DE COLOGNES; FRAGRANCES; FRAGRANCES AND PERFUMERY; FRAGRANCES FOR PERSONAL USE (U.S. CLS. 1, 4, 6, 50, 51 AND 52).

FIRST USE 11-18-1988; IN COMMERCE 11-18-1988.

JANET LEE, EXAMINING ATTORNEY

SN 85-355,438. BURT'S BEES, INC, DURHAM, NC. FILED 6-24-2011.



THE COLOR(S) PINK AND WHITE IS/ARE CLAIMED AS A FEATURE OF THE MARK.

THE MARK CONSISTS OF THE PHRASE "SOFT, PRETTY, FLIRTY, FLOWERY, YOU KNOW, YOU-EY," APPEARING ON A FLOWER WITH NOTCHED PETALS AND A DARK ROUND CENTER. BOTH THE PETALS AND THE CENTER HAVE A VARIEGATED PATTERN. ALL OF THE WORDING AND PUNCTUATION IS IN THE COLOR WHITE. THE FLOWER IS IN THE COLOR PINK.

FOR BODY LOTION; BODY WASH; HAIR SHAMPOOS AND CONDITIONERS; HAND CREAMS; HAND SOAPS; NON-MEDICATED SKIN CARE PREPARATION, NAMELY, BODY MIST; PERFUME; SHOWER GELS (U.S. CLS. 1, 4, 6, 50, 51 AND 52).

MICHAEL WIENER, EXAMINING ATTORNEY

SN 85-361,239. XLEAR, INC., OREM, UT. FILED 6-30-2011.

Spry White

THE MARK CONSISTS OF STANDARD CHARACTERS WITHOUT CLAIM TO ANY PARTICULAR FONT, STYLE, SIZE, OR COLOR.

OWNER OF U.S. REG. NO. 2,886,319.

NO CLAIM IS MADE TO THE EXCLUSIVE RIGHT TO USE "WHITE", APART FROM THE MARK AS SHOWN.

FOR NON-MEDICATED MOUTH RINSE; TOOTH GELS; INFANT TOOTH GELS; TOOTHPASTE AND MOUTH WASHES; TOOTH WHITENERS FOR COSMETIC PURPOSES; ORAL SPRAYS, NAMELY, BREATH FRESHENING SPRAYS (U.S. CLS. 1, 4, 6, 50, 51 AND 52).

ANDREA K. NADELMAN, EXAMINING ATTORNEY

CLASS 3—(Continued).

SN 85-363,887. AEKYUNG INDUSTRIAL CO., LTD., SEOUL, REPUBLIC OF KOREA, FILED 7-6-2011.

AEKYUNG LUNA

THE MARK CONSISTS OF STANDARD CHARACTERS WITHOUT CLAIM TO ANY PARTICULAR FONT, STYLE, SIZE, OR COLOR.

THE ENGLISH TRANSLATION OF "AE" IS "LOVE" AND THE ENGLISH TRANSLATION OF "KYUNG" IS "RESPECT".

FOR COSMETICS AND COSMETIC PREPARATIONS; SOLID POWDER FOR COMPACTS; LOOSE FACE POWDER; MAKEUP FOUNDATIONS; MAKEUP PRIMERS; EYE CONCEALER; FACE CONCEALER; EYESHADOW; TINTED LIP BALM; LIPSTICKS; LIP GLOSS; LIP LINER; MASCARA; EYEBROW COSMETICS; SUN-BLOCK LOTIONS; FACIAL CREAMS; FACE HIGHLIGHTER; BLUSH; FACIAL MAKEUP; LIP AND EYE MAKEUP, LIP AND EYE COSMETICS AND LIP AND EYE COSMETIC PREPARATIONS (U.S. CLS. 1, 4, 6, 50, 51 AND 52).

JULIE WATSON, EXAMINING ATTORNEY

CLASS 3—(Continued).

SN 85-368,841. DONNATELLA HANDBAGS & PERFUMES INC., MIAMI, FL. FILED 7-12-2011.



THE COLOR(S) ORANGE, BLUE AND WHITE IS/ARE CLAIMED AS A FEATURE OF THE MARK.

THE MARK CONSISTS OF THE WORD "DONNATELLA" IN BLUE SCRIPT SUPERIMPOSED OVER A RECTANGLE BORDERED IN AN ORANGE AND BLUE LINE, WITH LARGE WHITE LETTER "D" OVER A BLUE, ORANGE AND WHITE BACKGROUND.

FOR COLOGNES, PERFUMES AND COSMETICS (U.S. CLS. 1, 4, 6, 50, 51 AND 52).

FIRST USE 1-1-2000; IN COMMERCE 1-1-2000.

SUSAN LESLIE DUBOIS, EXAMINING ATTORNEY

SN 85-402,106. ORGANIC SALES & MARKETING, INC., RAYNHAM, MA. FILED 8-19-2011.



THE COLOR(S) LIGHT GREEN, DARK GREEN, AND WHITE IS/ARE CLAIMED AS A FEATURE OF THE MARK.

THE MARK CONSISTS OF THE WORDS "HEALTHIER HOMESTEAD" AND "URBAN TO SUBURBAN SUSTAINABILITY". THE WORD "HEALTHIER" APPEARS ABOVE THE WORD "HOMESTEAD", WHICH APPEARS ABOVE THE PHRASE "URBAN TO SUBURBAN SUSTAINABILITY". THE FIRST LETTER "H" IN THE WORD "HEALTHIER" IS CAPPED BY THE ROOFLINE OF A HOUSE AND THE FIRST LETTER "H" IN THE WORD "HOMESTEAD" IS CAPPED BY THE ROOFLINE OF A BARN. THE DOT OF THE "I" IN "HEALTHIER" HAS BEEN REPLACED BY A GREEN LEAF. THE WORDS "URBAN TO SUBURBAN SUSTAINABILITY" ARE FRAMED IN A RECTANGLE. THE WORD "HEALTHIER" APPEARS IN A LIGHT GREEN COLOR, WHILE THE WORD "HOMESTEAD" APPEARS IN A DARK GREEN COLOR. THE WORDS "URBAN TO SUBURBAN SUSTAINABILITY" APPEAR IN WHITE AND ARE CONTAINED IN A DARK GREEN RECTANGLE WITH A LIGHT GREEN BORDER.

FOR ALL-PURPOSE CLEANING PREPARATIONS (U.S. CLS. 1, 4, 6, 50, 51 AND 52).

FIRST USE 12-7-2010; IN COMMERCE 12-7-2010.

NAKIA HENRY, EXAMINING ATTORNEY

SN 85-364,561. ALMAR SALES CO., INC., NEW YORK, NY. FILED 7-6-2011.

EYE PAD

THE MARK CONSISTS OF STANDARD CHARACTERS WITHOUT CLAIM TO ANY PARTICULAR FONT, STYLE, SIZE, OR COLOR.

NO CLAIM IS MADE TO THE EXCLUSIVE RIGHT TO USE "EYE", APART FROM THE MARK AS SHOWN.

FOR EYE SHADOW THAT IS APPLIED USING AN APPLICATOR BRUSH, AND NOT A PAD (U.S. CLS. 1, 4, 6, 50, 51 AND 52).

STEVEN R. FINE, EXAMINING ATTORNEY

CLASS 3—(Continued).

SN 85-413,796. TUPPERWARE PRODUCTS S.A., FRIBOURG, SWITZERLAND, FILED 9-2-2011.

ACCELERIN III

THE MARK CONSISTS OF STANDARD CHARACTERS WITHOUT CLAIM TO ANY PARTICULAR FONT, STYLE, SIZE, OR COLOR.

THE WORD(S) "ACCELERIN" HAS NO MEANING IN A FOREIGN LANGUAGE.

FOR NON-MEDICATED SKIN CARE PREPARATIONS (U.S. CLS. 1, 4, 6, 50, 51 AND 52).

ANDREW RHIM, EXAMINING ATTORNEY

SN 85-425,718. AMAZING BOTANICALS, BROOKLYN, NY, FILED 9-19-2011.

Amazing Botanicals

THE MARK CONSISTS OF STANDARD CHARACTERS WITHOUT CLAIM TO ANY PARTICULAR FONT, STYLE, SIZE, OR COLOR.

NO CLAIM IS MADE TO THE EXCLUSIVE RIGHT TO USE "BOTANICALS", APART FROM THE MARK AS SHOWN.

FOR SHAMPOOS; HAIR CONDITIONER; BODY BUTTER; POMADES; NON-MEDICATED HERBAL BODY CARE PRODUCTS, NAMELY, SALVES; HAIR OILS; BODY OILS; BATH SALTS; FOOT SCRUBS; NON-MEDICATED FOAMING BATH BUTTER (U.S. CLS. 1, 4, 6, 50, 51 AND 52).

FIRST USE 6-12-2010; IN COMMERCE 8-5-2010.

ELI HELLMAN, EXAMINING ATTORNEY

CLASS 3—(Continued).

SN 85-428,482. DOS SYSTEMS LLC., WILMINGTON, DE, FILED 9-21-2011.

MAGIC GLAZE

THE MARK CONSISTS OF STANDARD CHARACTERS WITHOUT CLAIM TO ANY PARTICULAR FONT, STYLE, SIZE, OR COLOR.

NO CLAIM IS MADE TO THE EXCLUSIVE RIGHT TO USE "GLAZE", APART FROM THE MARK AS SHOWN.

FOR PREPARATIONS IN THE FORM OF LIQUIDS, POWDERS, AND CREAMS FOR CLEANING AND PROTECTING HARD NATURAL OR MAN-MADE SURFACES, SUCH AS GLASS, GRANITE, STONE, PORCELAIN, WOOD, FIBERGLASS, STAINLESS STEEL, ALUMINUM, CHROME, PAINTED METAL AND PLASTIC; PREPARATIONS IN THE FORM OF LIQUIDS, POWDERS, AND CREAMS FOR CLEANING, PROTECTING, AND PRESERVING SOFT SURFACES SUCH AS RUBBER, LEATHER, VINYL AND FABRIC, FOR USE IN HOMES, HOSPITALS, HOTELS, INDUSTRIAL AND COMMERCIAL BUILDINGS, AND FOR USE ON VEHICLES IN AVIATION INDUSTRY, MARINE INDUSTRY AND GROUND TRANSPORTATION (U.S. CLS. 1, 4, 6, 50, 51 AND 52).

FIRST USE 8-1-2011; IN COMMERCE 9-1-2011.

AMY ALFIERI, EXAMINING ATTORNEY

SN 85-443,911. CHEMCORP PTY LTD, TAREN POINT, AUSTRALIA, FILED 10-11-2011.

Effortless
Beauty brings you
SilkyFoot 

NO CLAIM IS MADE TO THE EXCLUSIVE RIGHT TO USE "BEAUTY" AND "SILKY FOOT", APART FROM THE MARK AS SHOWN.

THE MARK CONSISTS OF "EFFORTLESS BEAUTY" WRITTEN AT THE TOP, FOLLOWED BY "BRINGS YOU" WRITTEN IN A SMALLER FONT. FEATURES "SILKY FOOT" WRITTEN IN LARGE FREE-HAND FONT FOLLOWED BY PICTURE OF FOOTPRINT.

FOR EXFOLIANTS FOR FEET (U.S. CLS. 1, 4, 6, 50, 51 AND 52).

FIRST USE 3-26-2007; IN COMMERCE 3-26-2007.

MEGHAN REINHART, EXAMINING ATTORNEY

CLASS 3—(Continued).

SN 85-448,393. LAURICE EL BADRY RAHME LTD., DBA LAURICE & CO., NEW YORK, NY. FILED 10-16-2011.

NEW YORK WATER

THE MARK CONSISTS OF STANDARD CHARACTERS WITHOUT CLAIM TO ANY PARTICULAR FONT, STYLE, SIZE, OR COLOR.

OWNER OF U.S. REG. NO. 3,025,035.

NO CLAIM IS MADE TO THE EXCLUSIVE RIGHT TO USE "NEW YORK", APART FROM THE MARK AS SHOWN.

FOR FRAGRANCES FOR PERSONAL USE, NAMELY, PERFUMES AND COLOGNES; AFTER BATH BODY SPLASHES, BODY SPRAYS, SHOWER GELS, SOAPS, BODY LOTIONS, MASSAGE OILS; COSMETICS, NAMELY, NON-MEDICATED SKIN CARE PREPARATIONS, MAKEUP, LIPSTICK, FOUNDATION FACE POWDER, EYESHADOW, NAIL POLISH, MASCARA AND EYE PENCILS (U.S. CLS. 1, 4, 6, 50, 51 AND 52).
MICHAEL ENGEL, EXAMINING ATTORNEY

SN 85-454,500. AVEDON B.V., AMSTERDAM, NETHERLANDS, FILED 10-24-2011.

OPSYONS

THE MARK CONSISTS OF STANDARD CHARACTERS WITHOUT CLAIM TO ANY PARTICULAR FONT, STYLE, SIZE, OR COLOR.

OWNER OF BENELUX REG. NO. 901891, DATED 9-12-2011, EXPIRES 5-18-2021.

FOR COSMETICS AND SKIN CARE PRODUCTS, NAMELY, BASIC CREAMS, LIPSTICKS, LIP LINER, LIP BALM, MOISTURIZERS; SOAPS FOR THE SKIN; BATH GEL, BATH OILS, BATH SALTS, FIZZING BATH BALLS AND EFFERVESCENT BATH TABLETS; NON-MEDICINAL SKIN CARE PRODUCTS, NAMELY, LOTIONS, CREAMS, CLEANSERS, SCRUBS, MASKS AND VITALIZING BODY LOTION AND BODY OIL; HAIR CARE PRODUCTS AND HAIR SHAPING PRODUCTS, NAMELY, SHAMPOOS, HAIR CONDITIONERS; PERFUMES, EAU DE TOILETTE, ESSENTIAL OILS FOR PERSONAL USE, SCENTED OILS; PERFUMED SCENTED OILS FOR ROOMS, INCENSE STICKS, SCENTED OIL MIXTURES AND SACHETS; WIPES IMPREGNATED WITH LOTIONS; GIFT SETS AND SETS COMPRISING SKIN CARE PRODUCTS, NAMELY, BODY LOTIONS AND SKIN CREAMS; GIFT SETS AND SETS COMPRISING HAIR CARE PRODUCTS, NAMELY, SHAMPOOS AND CONDITIONERS (U.S. CLS. 1, 4, 6, 50, 51 AND 52).
DANIEL BRODY, EXAMINING ATTORNEY

CLASS 3—(Continued).

SN 85-459,710. JUVENTAS SKIN CARE, GILBERT, AZ. FILED 10-29-2011.

**SKIN TIGHT
GENES**

NO CLAIM IS MADE TO THE EXCLUSIVE RIGHT TO USE "SKIN", APART FROM THE MARK AS SHOWN.

THE MARK CONSISTS OF THE WORDS "SKIN TIGHT GENES" IN A UNIQUE FONT, WITH "SKIN TIGHT" CENTERED ABOVE, AND "GENES" CENTERED BELOW.

FOR NON-MEDICATED ANTI-AGING CREAMS, LOTIONS, AND SERUMS FOR USE ON SKIN (U.S. CLS. 1, 4, 6, 50, 51 AND 52).

ERIN FALK, EXAMINING ATTORNEY

SN 85-460,249. BY KILIAN, PARIS, FRANCE, FILED 10-31-2011.

**IN THE CITY OF SIN BY
KILIAN**

THE MARK CONSISTS OF STANDARD CHARACTERS WITHOUT CLAIM TO ANY PARTICULAR FONT, STYLE, SIZE, OR COLOR.

PRIORITY CLAIMED UNDER SEC. 44(D) ON FRANCE APPLICATION NO. 11/3829856, FILED 5-10-2011, REG. NO. 113829856, DATED 5-10-2011, EXPIRES 5-10-2021.

OWNER OF U.S. REG. NOS. 3,436,358 AND 4,088,282.

FOR PERFUMES, EAU DE PARFUM, TOILET WATER, EAU-DE-COLOGNE, ESSENTIAL OILS, COSMETIC CREAMS, NON-MEDICATED COSMETIC PREPARATIONS FOR USE IN THE BATH OR SHOWER, NAMELY, BATH AND SHOWER MILK, BATH AND SHOWER GEL, BATH OIL, BATH SALTS, SKIN MOISTURIZING CREAMS, ANTI-WRINKLE CREAMS, SKIN CLEANSING GELS, NON-MEDICATED EXFOLIATING CREAMS AND GELS FOR THE SKIN, BEAUTY MASKS, COSMETIC PREPARATIONS FOR SKIN RENEWAL, COSMETIC SUN TANNING PREPARATIONS, NAMELY, MILKS, GELS, LOTIONS AND OILS, HAIR LOTIONS, HAIR SPRAYS, COSMETIC PREPARATIONS, NAMELY, MASCARA, LIPSTICK, MAKE-UP, FACIAL FOUNDATION, EYE-LINER, MAKE-UP POWDER, NAIL VARNISH FOR COSMETIC PURPOSES, COSMETIC PREPARATIONS FOR SLIMMING PURPOSES, NAMELY, SCULPTING GELS, CREAMS AND LOTIONS FOR CELLULITE REDUCTION, MAKE-UP REMOVING PREPARATIONS, NAMELY, MILKS, GELS, LOTIONS AND CREAMS, DEODORANTS FOR PERSONAL USE, ANTI-PERSPIRANTS, SOAPS, OILS FOR COSMETIC PURPOSES, COSMETIC MILK, BODY CREAM, MOISTURIZING LOTION FOR THE BODY, TALCUM POWDER FOR TOILETRY USE, AFTER-SHAVE LOTION, AFTER-SHAVE BALM, ALUM STONE FOR PERSONAL USE, SHAVING FOAM, SHAVING PREPARATIONS, POT-POURRIS, TISSUES IMPREGNATED WITH COSMETIC LOTIONS, COSMETIC PREPARATIONS FOR MOUTH CARE, DENTIFRICES (U.S. CLS. 1, 4, 6, 50, 51 AND 52).
GEOFFREY FOSDICK, EXAMINING ATTORNEY

CLASS 3—(Continued).

SN 85-460,298. BY KILIAN, PARIS, FRANCE, FILED 10-31-2011.

FORBIDDEN GAMES BY KILIAN

THE MARK CONSISTS OF STANDARD CHARACTERS WITHOUT CLAIM TO ANY PARTICULAR FONT, STYLE, SIZE, OR COLOR.

PRIORITY CLAIMED UNDER SEC. 44(D) ON FRANCE APPLICATION NO. 11/3829850, FILED 5-10-2011, REG. NO. 113829850, DATED 5-10-2011, EXPIRES 5-10-2021.

OWNER OF U.S. REG. NOS. 3,436,358 AND 4,088,282.

FOR PERFUMES, EAU DE PARFUM, TOILET WATER, EAU-DE-COLOGNE, ESSENTIAL OILS, COSMETIC CREAMS, NON MEDICATED COSMETIC PREPARATIONS FOR USE IN THE BATH OR SHOWER, NAMELY, BATH AND SHOWER MILK, BATH AND SHOWER GEL, BATH OIL, BATH SALTS, SKIN MOISTURIZING CREAMS, ANTI-WRINKLE CREAMS, SKIN CLEANSING GELS, NON MEDICATED EXFOLIATING CREAMS AND GELS FOR THE SKIN, BEAUTY MASKS, COSMETIC PREPARATIONS FOR SKIN RENEWAL, COSMETIC SUN TANNING PREPARATIONS, NAMELY, MILKS, GELS, LOTIONS AND OILS, HAIR LOTIONS, HAIR SPRAYS, COSMETIC PREPARATIONS, NAMELY, MASCARA, LIPSTICK, MAKE-UP, FACIAL FOUNDATION, EYE-LINER, MAKE-UP POWDER, NAIL VARNISH FOR COSMETIC PURPOSES, COSMETIC PREPARATIONS FOR SLIMMING PURPOSES, NAMELY, SCULPTING GELS, CREAMS AND LOTIONS FOR CELLULITE REDUCTION, MAKE-UP REMOVING PREPARATIONS, NAMELY, MILKS, GELS, LOTIONS AND CREAMS, DEODORANTS FOR PERSONAL USE, ANTI-PERSPIRANTS, SOAPS, OILS FOR COSMETIC PURPOSES, COSMETIC MILK, BODY CREAM, MOISTURIZING LOTION FOR THE BODY, TALCUM POWDER FOR TOILETRY USE, AFTER-SHAVE LOTION, AFTER-SHAVE BALM, ALUM STONE FOR PERSONAL USE, SHAVING FOAM, SHAVING PREPARATIONS, POT-POURRIS, TISSUES IMPREGNATED WITH COSMETIC LOTIONS, COSMETIC PREPARATIONS FOR MOUTH CARE, DENTIFRICES (U.S. CLS. 1, 4, 6, 50, 51 AND 52).
GEOFFREY FOSDICK, EXAMINING ATTORNEY

CLASS 3—(Continued).

SN 85-460,325. BY KILIAN, PARIS, FRANCE, FILED 10-31-2011.

GOOD GIRL GONE BAD BY
KILIAN

THE MARK CONSISTS OF STANDARD CHARACTERS WITHOUT CLAIM TO ANY PARTICULAR FONT, STYLE, SIZE, OR COLOR.

PRIORITY CLAIMED UNDER SEC. 44(D) ON FRANCE APPLICATION NO. 11/3829806, FILED 5-9-2011, REG. NO. 113829806, DATED 5-9-2011, EXPIRES 5-9-2021.

OWNER OF U.S. REG. NOS. 3,436,358 AND 4,088,282.

FOR PERFUMES, EAU DE PARFUM, TOILET WATER, EAU-DE-COLOGNE, ESSENTIAL OILS, COSMETIC CREAMS, NON MEDICATED COSMETIC PREPARATIONS FOR USE IN THE BATH OR SHOWER, NAMELY, BATH AND SHOWER MILK, BATH AND SHOWER GEL, BATH OIL, BATH SALTS, SKIN MOISTURIZING CREAMS, ANTI-WRINKLE CREAMS, SKIN CLEANSING GELS, NON MEDICATED EXFOLIATING CREAMS AND GELS FOR THE SKIN, BEAUTY MASKS, COSMETIC PREPARATIONS FOR SKIN RENEWAL, COSMETIC SUN TANNING PREPARATIONS, NAMELY, MILKS, GELS, LOTIONS AND OILS, HAIR LOTIONS, HAIR SPRAYS, COSMETIC PREPARATIONS, NAMELY, MASCARA, LIPSTICK, MAKE-UP, FACIAL FOUNDATION, EYE-LINER, MAKE-UP POWDER, NAIL VARNISH FOR COSMETIC PURPOSES, COSMETIC PREPARATIONS FOR SLIMMING PURPOSES, NAMELY, SCULPTING GELS, CREAMS AND LOTIONS FOR CELLULITE REDUCTION, MAKE-UP REMOVING PREPARATIONS, NAMELY, MILKS, GELS, LOTIONS AND CREAMS, DEODORANTS FOR PERSONAL USE, ANTI-PERSPIRANTS, SOAPS, OILS FOR COSMETIC PURPOSES, COSMETIC MILK, BODY CREAM, MOISTURIZING LOTION FOR THE BODY, TALCUM POWDER FOR TOILETRY USE, AFTER-SHAVE LOTION, AFTER-SHAVE BALM, ALUM STONE FOR PERSONAL USE, SHAVING FOAM, SHAVING PREPARATIONS, POT-POURRIS, TISSUES IMPREGNATED WITH COSMETIC LOTIONS, COSMETIC PREPARATIONS FOR MOUTH CARE, DENTIFRICES (U.S. CLS. 1, 4, 6, 50, 51 AND 52).
GEOFFREY FOSDICK, EXAMINING ATTORNEY

CLASS 3—(Continued).

SN 85-460,342. BY KILIAN, PARIS, FRANCE, FILED 10-31-2011.

CLASS 3—(Continued).

SN 85-460,360. BY KILIAN, PARIS, FRANCE, FILED 10-31-2011.

LIGHT MY FIRE BY KILIAN

KISSES DON'T LIE BY KILIAN

THE MARK CONSISTS OF STANDARD CHARACTERS WITHOUT CLAIM TO ANY PARTICULAR FONT, STYLE, SIZE, OR COLOR.

PRIORITY CLAIMED UNDER SEC. 44(D) ON FRANCE APPLICATION NO. 11/3829802, FILED 5-9-2011, REG. NO. 11/3829802, DATED 5-9-2011, EXPIRES 5-9-2021.

OWNER OF U.S. REG. NOS. 3,436,358 AND 4,088,282.

FOR PERFUMES, EAU DE PARFUM, TOILET WATER, EAU-DE-COLOGNE, ESSENTIAL OILS, COSMETIC CREAMS, NON MEDICATED COSMETIC PREPARATIONS FOR USE IN THE BATH OR SHOWER, NAMELY, BATH AND SHOWER MILK, BATH AND SHOWER GEL, BATH OIL, BATH SALTS, SKIN MOISTURIZING CREAMS, ANTI-WRINKLE CREAMS, SKIN CLEANSING GELS, NON MEDICATED EXFOLIATING CREAMS AND GELS FOR THE SKIN, BEAUTY MASKS, COSMETIC PREPARATIONS FOR SKIN RENEWAL, COSMETIC SUN TANNING PREPARATIONS, NAMELY, MILKS, GELS, LOTIONS AND OILS, HAIR LOTIONS, HAIR SPRAYS, COSMETIC PREPARATIONS, NAMELY, MASCARA, LIPSTICK, MAKE-UP, FACIAL FOUNDATION, EYE-LINER, MAKE-UP POWDER, NAIL VARNISH FOR COSMETIC PURPOSES, COSMETIC PREPARATIONS FOR SLIMMING PURPOSES, NAMELY, SCULPTING GELS, CREAMS AND LOTIONS FOR CELLULITE REDUCTION, MAKE-UP REMOVING PREPARATIONS, NAMELY, MILKS, GELS, LOTIONS AND CREAMS, DEODORANTS FOR PERSONAL USE, ANTI-PERSPIRANTS, SOAPS, OILS FOR COSMETIC PURPOSES, COSMETIC MILK, BODY CREAM, MOISTURIZING LOTION FOR THE BODY, TALCUM POWDER FOR TOILETRY USE, AFTER-SHAVE LOTION, AFTER-SHAVE BALM, ALUM STONE FOR PERSONAL USE, SHAVING FOAM, SHAVING PREPARATIONS, POT-POURRIS, TISSUES IMPREGNATED WITH COSMETIC LOTIONS, COSMETIC PREPARATIONS FOR MOUTH CARE, DENTIFRICES (U.S. CLS. 1, 4, 6, 50, 51 AND 52).
GEOFFREY FOSDICK, EXAMINING ATTORNEY

THE MARK CONSISTS OF STANDARD CHARACTERS WITHOUT CLAIM TO ANY PARTICULAR FONT, STYLE, SIZE, OR COLOR.

PRIORITY CLAIMED UNDER SEC. 44(D) ON FRANCE APPLICATION NO. 11/3829798, FILED 5-9-2011, REG. NO. 113829798, DATED 5-9-2011, EXPIRES 5-9-2021.

OWNER OF U.S. REG. NOS. 3,436,358 AND 4,088,282.

FOR PERFUMES, EAU DE PARFUM, TOILET WATER, EAU-DE-COLOGNE, ESSENTIAL OILS, COSMETIC CREAMS, NON MEDICATED COSMETIC PREPARATIONS FOR USE IN THE BATH OR SHOWER, NAMELY, BATH AND SHOWER MILK, BATH AND SHOWER GEL, BATH OIL, BATH SALTS, SKIN MOISTURIZING CREAMS, ANTI-WRINKLE CREAMS, SKIN CLEANSING GELS, NON MEDICATED EXFOLIATING CREAMS AND GELS FOR THE SKIN, BEAUTY MASKS, COSMETIC PREPARATIONS FOR SKIN RENEWAL, COSMETIC SUN TANNING PREPARATIONS, NAMELY, MILKS, GELS, LOTIONS AND OILS, HAIR LOTIONS, HAIR SPRAYS, COSMETIC PREPARATIONS, NAMELY, MASCARA, LIPSTICK, MAKE-UP, FACIAL FOUNDATION, EYE-LINER, MAKE-UP POWDER, NAIL VARNISH FOR COSMETIC PURPOSES, COSMETIC PREPARATIONS FOR SLIMMING PURPOSES, NAMELY, SCULPTING GELS, CREAMS AND LOTIONS FOR CELLULITE REDUCTION, MAKE-UP REMOVING PREPARATIONS, NAMELY, MILKS, GELS, LOTIONS AND CREAMS, DEODORANTS FOR PERSONAL USE, ANTI-PERSPIRANTS, SOAPS, OILS FOR COSMETIC PURPOSES, COSMETIC MILK, BODY CREAM, MOISTURIZING LOTION FOR THE BODY, TALCUM POWDER FOR TOILETRY USE, AFTER-SHAVE LOTION, AFTER-SHAVE BALM, ALUM STONE FOR PERSONAL USE, SHAVING FOAM, SHAVING PREPARATIONS, POT-POURRIS, TISSUES IMPREGNATED WITH COSMETIC LOTIONS, COSMETIC PREPARATIONS FOR MOUTH CARE, DENTIFRICES (U.S. CLS. 1, 4, 6, 50, 51 AND 52).
GEOFFREY FOSDICK, EXAMINING ATTORNEY

CLASS 3—(Continued).

SN 85-460,371. BY KILIAN, PARIS, FRANCE, FILED 10-31-2011.

DANGEROUSLY IN LOVE BY
KILIAN

THE MARK CONSISTS OF STANDARD CHARACTERS WITHOUT CLAIM TO ANY PARTICULAR FONT, STYLE, SIZE, OR COLOR.

PRIORITY CLAIMED UNDER SEC. 44(D) ON FRANCE APPLICATION NO. 11/3829799, FILED 5-9-2011, REG. NO. 113829799, DATED 5-9-2011, EXPIRES 5-9-2021.

OWNER OF U.S. REG. NOS. 3,436,358 AND 4,088,282.

FOR PERFUMES, EAU DE PARFUM, TOILET WATER, EAU-DE-COLOGNE, ESSENTIAL OILS, COSMETIC CREAMS, NON MEDICATED COSMETIC PREPARATIONS FOR USE IN THE BATH OR SHOWER, NAMELY, BATH AND SHOWER MILK, BATH AND SHOWER GEL, BATH OIL, BATH SALTS, SKIN MOISTURIZING CREAMS, ANTI-WRINKLE CREAMS, SKIN CLEANSING GELS, NON MEDICATED EXFOLIATING CREAMS AND GELS FOR THE SKIN, BEAUTY MASKS, COSMETIC PREPARATIONS FOR SKIN RENEWAL, COSMETIC SUN TANNING PREPARATIONS, NAMELY, MILKS, GELS, LOTIONS AND OILS, HAIR LOTIONS, HAIR SPRAYS, COSMETIC PREPARATIONS, NAMELY, MASCARA, LIPSTICK, MAKE-UP, FACIAL FOUNDATION, EYE-LINER, MAKE-UP POWDER, NAIL VARNISH FOR COSMETIC PURPOSES, COSMETIC PREPARATIONS FOR SLIMMING PURPOSES, NAMELY, SCULPTING GELS, CREAMS AND LOTIONS FOR CELLULITE REDUCTION, MAKE-UP REMOVING PREPARATIONS, NAMELY, MILKS, GELS, LOTIONS AND CREAMS, DEODORANTS FOR PERSONAL USE, ANTI-PERSPIRANTS, SOAPS, OILS FOR COSMETIC PURPOSES, COSMETIC MILK, BODY CREAM, MOISTURIZING LOTION FOR THE BODY, TALCUM POWDER FOR TOILETRY USE, AFTER-SHAVE LOTION, AFTER-SHAVE BALM, ALUM STONE FOR PERSONAL USE, SHAVING FOAM, SHAVING PREPARATIONS, POT-POURRI, TISSUES IMPREGNATED WITH COSMETIC LOTIONS, COSMETIC PREPARATIONS FOR MOUTH CARE, DENTIFRICES (U.S. CLS. 1, 4, 6, 50, 51 AND 52).

GEOFFREY FOSDICK, EXAMINING ATTORNEY

CLASS 3—(Continued).

SN 85-482,021. BURT'S BEES, INC, DURHAM, NC. FILED 11-28-2011.



OWNER OF U.S. REG. NOS. 2,171,302, 3,855,940 AND OTHERS.

NO CLAIM IS MADE TO THE EXCLUSIVE RIGHT TO USE "EARTH FRIENDLY NATURAL PERSONAL CARE PRODUCTS", APART FROM THE MARK AS SHOWN.

THE NAME(S), PORTRAIT(S), AND/OR SIGNATURE(S) SHOWN IN THE MARK IDENTIFIES INGRAM BURT SHAVITZ, WHOSE CONSENT(S) TO REGISTER IS MADE OF RECORD.

THE COLOR(S) RED, BLACK, GOLD AND WHITE IS/ARE CLAIMED AS A FEATURE OF THE MARK.

THE MARK CONSISTS OF THE STYLIZED WORDS "BURT'S BEES" IN RED WITH A BLACK SHADOW ABOVE THE WORDS "EARTH FRIENDLY NATURAL PERSONAL CARE PRODUCTS" IN BLACK ITALIC LETTERING. THE STACKED WORDS ARE SET IN A WAVY PATTERN ON TOP OF AN IMAGE OF A BEEHIVE ON GRASS. THE IMAGE IS GOLD ON A WHITE BACKGROUND.

FOR COSMETICS AND SKIN CARE PRODUCTS, NAMELY, CREAMS, OILS, SOAPS, MOISTURIZERS, LOTIONS, LIP BALMS, AND GLOSSES, SHAVING LOTIONS, SHAVING BALMS, AND COLOGNES (U.S. CLS. 1, 4, 6, 50, 51 AND 52).

CHERYL CLAYTON, EXAMINING ATTORNEY

SN 85-482,901. VO, THANH THUY DAO, LAS VEGAS, NV. FILED 11-29-2011.



NO CLAIM IS MADE TO THE EXCLUSIVE RIGHT TO USE "RX" AND "LIP PLUMPER", APART FROM THE MARK AS SHOWN.

THE MARK CONSISTS OF STYLIZED CURLING GRAPHICS ABOUT AND BELOW THE WORD: "SMILE SECRET RX" IN STYLIZED CURSIVE FONT WITH "SEXY LIP PLUMPER" BELOW IN STYLIZED STANDARD FONT.

FOR LIP CREAM; LIP GLOSS; LIP POLISHER; NON-MEDICATED BALMS FOR USE ON LIPS AS A LIP VOLUME MAXIMIZER (U.S. CLS. 1, 4, 6, 50, 51 AND 52). FIRST USE 11-1-2011; IN COMMERCE 11-1-2011.

KELLY TRUSILO, EXAMINING ATTORNEY

CLASS 3—(Continued).

SN 85-484,276. N.C. HELMS INC., HOUSTON, TX. FILED 11-30-2011.



NO CLAIM IS MADE TO THE EXCLUSIVE RIGHT TO USE "SEXUAL HEALTH" AND "AFTER CARE", APART FROM THE MARK AS SHOWN.

THE MARK CONSISTS OF THE WORDS "SEXUAL HEALTH ENTHUSIASTS", WITH A GREEK CROSS APPEARING OVER AND INTERSECTING A SECOND GREEK CROSS AND THE WORDS "AFTER CARE" APPEARING BELOW.

FOR BODY LOTIONS; BODY WASH; PRE-MOISTENED COSMETIC WIPES; SKIN MOISTURIZER (U.S. CLS. 1, 4, 6, 50, 51 AND 52).

FIRST USE 11-1-2010; IN COMMERCE 11-1-2010.
EDWARD NELSON, EXAMINING ATTORNEY

CLASS 3—(Continued).

SN 85-487,091. HAYADI, INC., SPRINGFIELD, VA. FILED 12-5-2011.



THE MARK CONSISTS OF AN OUTLINE OF A FACE WITH HAIR IN THE FORM OF TREE LEAVES.

FOR HAIR CARE PRODUCTS, NAMELY, SHAMPOO, CONDITIONER, RELAXER, FIXATIVE, MOISTURIZER, LOTION AND HAIR DRESSING (U.S. CLS. 1, 4, 6, 50, 51 AND 52).

FIRST USE 1-11-2011; IN COMMERCE 1-11-2011.
MELISSA VALLILLO, EXAMINING ATTORNEY

SN 85-485,029. WANG, DEYOU, MARKHAM, ONTARIO, CANADA, FILED 12-1-2011.

Haiology

THE MARK CONSISTS OF STANDARD CHARACTERS WITHOUT CLAIM TO ANY PARTICULAR FONT, STYLE, SIZE, OR COLOR.

FOR HAIR CARE PRODUCTS, NAMELY, SHAMPOO, CONDITIONER, HAIRSPRAY, HAIR STYLING GEL, HAIR MOUSSE; NON-MEDICATED SKIN PRODUCTS, NAMELY, FACIAL CREAMS, BODY LOTIONS, SKIN MOISTURIZERS, SKIN TONERS, SKIN ASTRINGENTS, SKIN CLEANSERS, FOUNDATIONS, PRESSED FACE POWERS, BLUSHES, EYE LINERS, EYEBROW PENCILS, EYE SHADOWS, MASCARAS, LIPSTICKS, LIP LINERS, FACIAL MASKS, PERFUME, LIQUID SOAPS, SHOWER AND BATH GELS (U.S. CLS. 1, 4, 6, 50, 51 AND 52).

ERIN FALK, EXAMINING ATTORNEY

SN 85-489,114. WANG, DEYOU, MARKHAM, ONTARIO, CANADA, FILED 12-7-2011.

Sifado

THE MARK CONSISTS OF STANDARD CHARACTERS WITHOUT CLAIM TO ANY PARTICULAR FONT, STYLE, SIZE, OR COLOR.

THE ENGLISH TRANSLATION OF THE WORD "SIFADO" IN THE MARK IS THE CITY OF HAIR.

FOR HAIR CARE PRODUCTS, NAMELY, SHAMPOO, CONDITIONER, HAIRSPRAY, HAIR STYLING GEL, HAIR MOUSSE; NON-MEDICATED SKIN PRODUCTS, NAMELY, FACIAL CREAMS, BODY LOTIONS, SKIN MOISTURIZERS, SKIN TONERS, SKIN ASTRINGENTS, SKIN CLEANSERS, FOUNDATIONS, PRESSED FACE POWERS, BLUSHES, EYE LINERS, EYEBROW PENCILS, EYE SHADOWS, MASCARAS, LIPSTICKS, LIP LINERS, FACIAL MASKS, PERFUME, LIQUID SOAPS, SHOWER AND BATH GELS (U.S. CLS. 1, 4, 6, 50, 51 AND 52).

ERIN FALK, EXAMINING ATTORNEY

CLASS 3—(Continued).

SN 85-493,752. MARLY PRODUCTS, ISMANING, FED REP GERMANY, FILED 12-13-2011.

MARLY SKIN GUARD

THE MARK CONSISTS OF STANDARD CHARACTERS WITHOUT CLAIM TO ANY PARTICULAR FONT, STYLE, SIZE, OR COLOR.

OWNER OF U.S. REG. NO. 2,982,616.

NO CLAIM IS MADE TO THE EXCLUSIVE RIGHT TO USE "SKIN", APART FROM THE MARK AS SHOWN.

FOR COSMETIC PREPARATIONS FOR SKIN CARE, NAMELY, COSMETIC PREPARATIONS FOR THE PROTECTION OF SKIN FROM HARMFUL OR DAMAGING SUBSTANCES (U.S. CLS. 1, 4, 6, 50, 51 AND 52).

FIRST USE 6-1-1992; IN COMMERCE 6-1-1992.

KELLY TRUSILO, EXAMINING ATTORNEY

SN 85-496,567. HAGER & WERKEN GMBH & CO. KG, DUISBURG, FED REP GERMANY, FILED 12-15-2011.

MIRA WHITE

THE MARK CONSISTS OF STANDARD CHARACTERS WITHOUT CLAIM TO ANY PARTICULAR FONT, STYLE, SIZE, OR COLOR.

FOR DENTAL WHITENING PEN CONTAINING TOOTH WHITENING LIQUID; DENTAL BLEACHING GEL IN A BRUSH-PEN APPLICATOR (U.S. CLS. 1, 4, 6, 50, 51 AND 52).

FIRST USE 12-2-2009; IN COMMERCE 12-2-2009.

JOHN DWYER, EXAMINING ATTORNEY

SN 85-511,029. ALLEN COX, MCMINNVILLE, OR. FILED S.R. 1-6-2012; AM. P.R. 5-1-2012.

Pure Life Tropics

THE MARK CONSISTS OF STANDARD CHARACTERS WITHOUT CLAIM TO ANY PARTICULAR FONT, STYLE, SIZE, OR COLOR.

FOR ESSENTIAL OILS FOR PERSONAL USE; NON-MEDICATED COSMETIC SKIN CARE PREPARATIONS CONSISTING OF ORGANIC COCONUT VIRGIN OIL AND COCONUT VIRGIN OIL (U.S. CLS. 1, 4, 6, 50, 51 AND 52).

JAY FLOWERS, EXAMINING ATTORNEY

CLASS 3—(Continued).

SN 85-511,210. IT'S NOT THAT BAD, INC, MORROW, GA. FILED 1-7-2012.

CHOICES

THE MARK CONSISTS OF STANDARD CHARACTERS WITHOUT CLAIM TO ANY PARTICULAR FONT, STYLE, SIZE, OR COLOR.

FOR SKIN CARE, BODY CARE PRODUCTS, NAMELY, SKIN MOISTURIZERS, HAND AND BODY LOTIONS, SKIN CREAMS, SKIN CLEANSERS, SKIN TONERS, EXFOLIANTS FOR SKIN, BODY SCRUBS, FACIAL SCRUBS, SKIN MASKS, NON-MEDICATED SKIN CARE PREPARATIONS, BATH OILS, BATH SALTS, SOAPS, MASSAGE LOTIONS, MASSAGE OILS (U.S. CLS. 1, 4, 6, 50, 51 AND 52).

DAWN HAN, EXAMINING ATTORNEY

SN 85-516,088. SPORTSMAN SCENT SOLUTIONS, INC., BRIDGEPORT, NY. FILED 1-13-2012.



THE COLOR(S) GREEN AND SILVER IS/ARE CLAIMED AS A FEATURE OF THE MARK.

THE MARK CONSISTS OF THE STYLIZED WORDING "SLAY" WITH THE LETTERS "SL" AND "Y" IN GREEN WITH SILVER OUTLINING AND THE LETTER "A" IN SILVER.

FOR BODY WASH; BREATH FRESHENING SPRAYS; CONDITIONERS; DETERGENTS FOR HOUSEHOLD USE; DISPOSABLE WIPES IMPREGNATED WITH CLEANSING CHEMICALS OR COMPOUNDS FOR PERSONAL USE; LAUNDRY DETERGENT; LAUNDRY SOAP; SHAMPOOS; SOAPS AND DETERGENTS (U.S. CLS. 1, 4, 6, 50, 51 AND 52).

AMY C. KEAN, EXAMINING ATTORNEY

CLASS 3—(Continued).

SN 85-521,635. THE PROCTER & GAMBLE COMPANY, CINCINNATI, OH. FILED 1-20-2012.



OWNER OF U.S. REG. NOS. 2,153,065, 2,724,753 AND 2,821,456.

NO CLAIM IS MADE TO THE EXCLUSIVE RIGHT TO USE "SENSITIVE", APART FROM THE MARK AS SHOWN.

THE MARK CONSISTS OF A STYLIZED HEART WITH 3 ACCENT MARKS APPEARING ABOVE THE HEART AND TWO CURVED SLASHES APPEARING BELOW THE HEART AND ABOVE THE WORDING "PAMPERS". THE WORDING "SENSITIVE" APPEARS IN A CLOUD BELOW THE REST OF THE DESIGN.

FOR DISPOSABLE BABY WIPES IMPREGNATED WITH CHEMICALS OR COMPOUNDS FOR PERSONAL CLEANSING (U.S. CLS. 1, 4, 6, 50, 51 AND 52). ELI HELLMAN, EXAMINING ATTORNEY

SN 85-521,988. MOUNTAIN VIEW PACKAGING, LLC, OREM, UT. FILED 1-21-2012.

E.O. 2 Go

THE MARK CONSISTS OF STANDARD CHARACTERS WITHOUT CLAIM TO ANY PARTICULAR FONT, STYLE, SIZE, OR COLOR.

NO CLAIM IS MADE TO THE EXCLUSIVE RIGHT TO USE "E.O.", APART FROM THE MARK AS SHOWN.

FOR AROMATIC ESSENTIAL OILS; AROMATIC PREPARATIONS, NAMELY, BODY SPRAY; ESSENTIAL OILS (U.S. CLS. 1, 4, 6, 50, 51 AND 52).

FIRST USE 1-20-2012; IN COMMERCE 1-20-2012. JOHN WILKE, EXAMINING ATTORNEY

SN 85-524,443. DEBORAH LIPPMANN, LLC, NEW YORK, NY. FILED 1-24-2012.

The Stripper

THE MARK CONSISTS OF STANDARD CHARACTERS WITHOUT CLAIM TO ANY PARTICULAR FONT, STYLE, SIZE, OR COLOR.

SEC. 2(F). FOR NAIL POLISH REMOVER (U.S. CLS. 1, 4, 6, 50, 51 AND 52).

FIRST USE 10-1-1999; IN COMMERCE 10-1-1999. ANDREA HACK, EXAMINING ATTORNEY

CLASS 3—(Continued).

SN 85-525,216. EY & L INC., BEVERLY HILLS, CA. FILED 1-25-2012.

STEM CELL MIRACLE

THE MARK CONSISTS OF STANDARD CHARACTERS WITHOUT CLAIM TO ANY PARTICULAR FONT, STYLE, SIZE, OR COLOR.

NO CLAIM IS MADE TO THE EXCLUSIVE RIGHT TO USE "STEM CELL", APART FROM THE MARK AS SHOWN. FOR FACE CREAMS (U.S. CLS. 1, 4, 6, 50, 51 AND 52). DAVID MURRAY, EXAMINING ATTORNEY

SN 85-528,197. ABIO CORPORATION, ORLANDO, FL. FILED 1-30-2012.

Bode Nue'

THE MARK CONSISTS OF STANDARD CHARACTERS WITHOUT CLAIM TO ANY PARTICULAR FONT, STYLE, SIZE, OR COLOR.

FOR BODY SPRAY WITH NUTRIENTS (U.S. CLS. 1, 4, 6, 50, 51 AND 52).

DAVID C. REIHNER, EXAMINING ATTORNEY

SN 85-529,437. PROCTER & GAMBLE COMPANY, THE, CINCINNATI, OH. FILED 1-31-2012.

ALWAYS RADIANT WIPES TO GO

THE MARK CONSISTS OF STANDARD CHARACTERS WITHOUT CLAIM TO ANY PARTICULAR FONT, STYLE, SIZE, OR COLOR.

OWNER OF U.S. REG. NO. 2,369,464.

NO CLAIM IS MADE TO THE EXCLUSIVE RIGHT TO USE "WIPES", APART FROM THE MARK AS SHOWN.

FOR DISPOSABLE WIPES IMPREGNATED WITH CHEMICALS OR COMPOUNDS FOR EXTERNAL VAGINAL AND PERINEAL CLEANSING (U.S. CLS. 1, 4, 6, 50, 51 AND 52).

ELI HELLMAN, EXAMINING ATTORNEY

CLASS 3—(Continued).

SN 85-530,648. SOAP & GLORY LIMITED, LONDON, UNITED KINGDOM, FILED 2-1-2012.

superblur

THE MARK CONSISTS OF STANDARD CHARACTERS WITHOUT CLAIM TO ANY PARTICULAR FONT, STYLE, SIZE, OR COLOR.

FOR COSMETICS NAMELY; FACIAL MOISTURISERS, FACE POWDER, TINTED FACIAL MOISTURISERS, FACE FOUNDATION, FACIAL BEAUTY BALM CREAMS, FACIAL BLEMISH CONCEALERS (U.S. CLS. 1, 4, 6, 50, 51 AND 52).

CHRIS WELLS, EXAMINING ATTORNEY

SN 85-530,693. HENKEL AG & CO. KGAA, DUESSELDORF, FED REP GERMANY, FILED 2-1-2012.

DIAMOND DAZZLE

THE MARK CONSISTS OF STANDARD CHARACTERS WITHOUT CLAIM TO ANY PARTICULAR FONT, STYLE, SIZE, OR COLOR.

FOR HAIR CARE PREPARATIONS; HAIR STYLING PREPARATIONS (U.S. CLS. 1, 4, 6, 50, 51 AND 52).

ELISSA GARBER KON, EXAMINING ATTORNEY

SN 85-530,825. JULY MOON PRODUCTIONS, INC., LOS ANGELES, CA. FILED 2-1-2012.

SELENA GOMEZ

THE MARK CONSISTS OF STANDARD CHARACTERS WITHOUT CLAIM TO ANY PARTICULAR FONT, STYLE, SIZE, OR COLOR.

OWNER OF U.S. REG. NOS. 4,071,132 AND 4,071,139.

THE NAME(S), PORTRAIT(S), AND/OR SIGNATURE(S) SHOWN IN THE MARK IDENTIFIES "SELENA GOMEZ", WHOSE CONSENT(S) TO REGISTER IS MADE OF RECORD.

FOR COLOGNES, PERFUMES AND COSMETICS; EAU DE PERFUME; FRAGRANCES; FRAGRANCES AND PERFUMERY; FRAGRANCES FOR PERSONAL USE; LIQUID PERFUMES; PERFUME; PERFUMES; PERFUMES AND COLOGNES; PERFUMES AND TOILET WATERS; PERFUMES IN SOLID FORM; PERFUMES, AFTERSHAVES AND COLOGNES; PERFUMES, EAU DE COLOGNE AND AFTERSHAVES; PERFUMES, EAU DE COLOGNE AND AFTERSHAVES; PRE-SCENTED STRIPS AND CARDS FOR SAMPLING FRAGRANCES (U.S. CLS. 1, 4, 6, 50, 51 AND 52).

TOBY BULLOFF, EXAMINING ATTORNEY

CLASS 3—(Continued).

SN 85-531,072. FAROUK SYSTEMS, INC., HOUSTON, TX. FILED 2-1-2012.

CHI LUXE

THE MARK CONSISTS OF STANDARD CHARACTERS WITHOUT CLAIM TO ANY PARTICULAR FONT, STYLE, SIZE, OR COLOR.

OWNER OF U.S. REG. NOS. 3,426,769, 3,829,683 AND OTHERS.

FOR HAIR SHAMPOOS AND CONDITIONERS; HAIR STYLING GEL; HAIR STYLING PREPARATIONS; HAIR STYLING SPRAY; HAIR-WASHING POWDER (U.S. CLS. 1, 4, 6, 50, 51 AND 52).

ANDREW RHIM, EXAMINING ATTORNEY

SN 85-531,339. BEE BALD LLC, BEACHWOOD, OH. FILED 2-1-2012.

BEE BALD

THE MARK CONSISTS OF STANDARD CHARACTERS WITHOUT CLAIM TO ANY PARTICULAR FONT, STYLE, SIZE, OR COLOR.

FOR BEAUTY SERUMS; COSMETIC CREAMS FOR SKIN CARE; COSMETIC PREPARATIONS FOR THE HAIR AND SCALP; COSMETICS; LOTIONS FOR COSMETIC PURPOSES; NON-MEDICATED PREPARATIONS ALL FOR THE CARE OF SKIN, HAIR AND SCALP; NON-MEDICATED SCALP TREATMENT CREAM; PRE-MOISTENED COSMETIC TOWELETTES; PRE-MOISTENED COSMETIC WIPES; SHAMPOO-CONDITIONERS; SHAVING PREPARATIONS; SKIN CONDITIONING CREAMS FOR COSMETIC PURPOSES (U.S. CLS. 1, 4, 6, 50, 51 AND 52).

KIM MONINGHOFF, EXAMINING ATTORNEY

CLASS 3—(Continued).

SN 85-531,501. JESSICA LIEBESKIND MAKE-UP ARTISTRY, LLC, NEW YORK, NY. FILED 2-1-2012.

VINTAGE BY JESSICA LIEBESKIND

THE MARK CONSISTS OF STANDARD CHARACTERS WITHOUT CLAIM TO ANY PARTICULAR FONT, STYLE, SIZE, OR COLOR.

THE NAME(S), PORTRAIT(S), AND/OR SIGNATURE(S) SHOWN IN THE MARK IDENTIFIES "JESSICA LIEBESKIND", WHOSE CONSENT(S) TO REGISTER IS MADE OF RECORD.

FOR BODY LOTION; BODY WASH; EYE CREAM; FACE POWDER; FACIAL CONCEALER; FACIAL SCRUBS; HAND CREAM; LIP BALM; LIPSTICKS; MAKE-UP FOUNDATIONS; MAKE-UP KITS COMPRISED OF EYE SHADOW, EYE LINER, BLUSH, SKIN BRONZER, LIPSTICK, AND/OR LIPGLOSS; MASCARA; NAIL POLISH; NON-MEDICATED CLEANSERS, NAMELY, SKIN CLEANSERS; NON-MEDICATED SKIN TONERS; PENCILS FOR COSMETIC PURPOSES; PERFUMES; SKIN BRONZER; SKIN MASKS; SKIN MOISTURIZER; MAKE-UP BAGS SOLD CONTAINING COSMETICS (U.S. CLS. 1, 4, 6, 50, 51 AND 52).

ANNE FARRELL, EXAMINING ATTORNEY

SN 85-531,541. WELDERMA, LLC, SALT LAKE CITY, UT. FILED 2-1-2012.

Bumpkin & Bellee

THE MARK CONSISTS OF STANDARD CHARACTERS WITHOUT CLAIM TO ANY PARTICULAR FONT, STYLE, SIZE, OR COLOR.

FOR NON-MEDICATED SKIN CARE PREPARATIONS, NAMELY, CREAMS, LOTIONS, GELS, TONERS, CLEANSERS, PEELS, EXFOLIATES, BATH AND SHOWER GELS, BATH SALTS AND BATH CREAMS NOT FOR MEDICAL PURPOSES, SUN CARE LOTIONS, AFTER-SUN GELS, AFTER-SUN MILKS, AFTER SUN OILS AND ALOE VERA GEL FOR COSMETIC PURPOSES, HAIR CARE PRODUCTS, NAMELY, SHAMPOOS, CONDITIONERS, HAIR GEL, HAIR MOUSSE, HAIR SPRAY, HAIR COLOURING AND DYES, HAIR STRAIGHTENING PREPARATIONS, HAIR COLORING PREPARATIONS, HAIR RELAXERS, PERMANENT WAVING AND CURLING PREPARATIONS; FALSE NAILS, ADHESIVES FOR ARTIFICIAL NAILS, LOTIONS FOR STRENGTHENING THE NAILS, NAIL POLISH, NAIL POLISH REMOVER, NAIL STRENGTHENERS; BABY BUBBLE BATH, BATH OIL, BABY LOTIONS, BABY OILS, BABY CREAMS, BABY POWDERS, BABY HAIR CONDITIONER AND SHAMPOOS, COSMETICS IN GENERAL, INCLUDING PERFUMES (U.S. CLS. 1, 4, 6, 50, 51 AND 52).

ELISSA GARBER KON, EXAMINING ATTORNEY

CLASS 3—(Continued).

SN 85-531,560. EAU 2, LOS ANGELES, CA. FILED 2-1-2012.

chemical attraction

THE MARK CONSISTS OF STANDARD CHARACTERS WITHOUT CLAIM TO ANY PARTICULAR FONT, STYLE, SIZE, OR COLOR.

FOR COLOGNE; COSMETICS; FRAGRANCES; PERFUMES (U.S. CLS. 1, 4, 6, 50, 51 AND 52).

WILLIAM P. SHANAHAN, EXAMINING ATTORNEY

SN 85-531,637. URPIN TRADING CO., LTD., NEW TAIPEI CITY, TAIWAN, FILED 2-1-2012.



THE COLOR(S) BEIGE, LIGHT BROWN, AND WHITE IS/ARE CLAIMED AS A FEATURE OF THE MARK.

THE MARK CONSISTS OF A LIGHT BROWN RECTANGLE BORDERED WITH A BEIGE FRAME, A BEIGE FLOWER DESIGN WITHIN THE RECTANGLE, AND THE WORD "FASUN" IN WHITE IN THE CENTER OF THE RECTANGLE.

FOR FACIAL CLEANSERS; NATURAL SOAP BARS; SHOWER GELS; HAIR CARE PREPARATIONS; CONDITIONERS IN THE FORM OF SPRAYS FOR THE SCALP; HAIR SHAMPOO; HAIR CONDITIONERS (U.S. CLS. 1, 4, 6, 50, 51 AND 52).

FIRST USE 4-7-2010; IN COMMERCE 2-1-2012.
LOURDES AYALA, EXAMINING ATTORNEY

SN 85-531,679. SU, YU HONG, KOWLOON BAY, HONG KONG, FILED 2-2-2012.



THE MARK CONSISTS OF THE WORDS SWISSNATÜRLICH AND A FLOWER.

THE WORDING "SWISSNATÜRLICH" HAS NO MEANING IN A FOREIGN LANGUAGE.

FOR BABY POWDER; BATH OILS; CLEANING PREPARATIONS; COSMETIC PREPARATIONS FOR SKIN CARE; DENTIFRICE; ESSENTIAL OILS; HAIR LOTIONS; NON-MEDICATED PREPARATIONS ALL FOR THE CARE OF SKIN, HAIR AND SCALP; PERFUMERY; SUNSCREEN CREAMS (U.S. CLS. 1, 4, 6, 50, 51 AND 52).

EDWARD FENNESSY, EXAMINING ATTORNEY

CLASS 3—(Continued).

SN 85-531,759. NOBUKAZU F. SHIOYA, MAMARONECK, NY. FILED 2-2-2012.

A LAB ON FIRE

THE MARK CONSISTS OF STANDARD CHARACTERS WITHOUT CLAIM TO ANY PARTICULAR FONT, STYLE, SIZE, OR COLOR.

FOR FRAGRANCES, NAMELY, PERFUMES, COLOGNES AND TOILET WATER (U.S. CLS. 1, 4, 6, 50, 51 AND 52).

FIRST USE 10-29-2010; IN COMMERCE 10-29-2010.
JOHN WILKE, EXAMINING ATTORNEY

SN 85-531,830. TUPPERWARE PRODUCTS S.A., FRIBOURG, SWITZERLAND, FILED 2-2-2012.

BE FUNNY

THE MARK CONSISTS OF STANDARD CHARACTERS WITHOUT CLAIM TO ANY PARTICULAR FONT, STYLE, SIZE, OR COLOR.

FOR DEODORANTS AND ANTIPERSPIRANTS FOR PERSONAL USE; NON-MEDICATED SKIN CARE PREPARATIONS; PERFUMERY; TALCUM POWDER (U.S. CLS. 1, 4, 6, 50, 51 AND 52).

GEOFFREY FOSDICK, EXAMINING ATTORNEY

SN 85-531,836. TUPPERWARE PRODUCTS S.A., FRIBOURG, SWITZERLAND, FILED 2-2-2012.

HYDRA-SUPREME

THE MARK CONSISTS OF STANDARD CHARACTERS WITHOUT CLAIM TO ANY PARTICULAR FONT, STYLE, SIZE, OR COLOR.

FOR NON-MEDICATED SKIN CARE PREPARATIONS (U.S. CLS. 1, 4, 6, 50, 51 AND 52).

GEOFFREY FOSDICK, EXAMINING ATTORNEY

CLASS 3—(Continued).

SN 85-531,839. TUPPERWARE PRODUCTS S.A., FRIBOURG, SWITZERLAND, FILED 2-2-2012.

INSESANTE

THE MARK CONSISTS OF STANDARD CHARACTERS WITHOUT CLAIM TO ANY PARTICULAR FONT, STYLE, SIZE, OR COLOR.

FOR DEODORANTS AND ANTIPERSPIRANTS FOR PERSONAL USE; NON-MEDICATED SKIN CARE PREPARATIONS; PERFUMERY; TALCUM POWDER (U.S. CLS. 1, 4, 6, 50, 51 AND 52).

GEOFFREY FOSDICK, EXAMINING ATTORNEY

SN 85-531,843. TUPPERWARE PRODUCTS S.A., FRIBOURG, SWITZERLAND, FILED 2-2-2012.

OCASSION

THE MARK CONSISTS OF STANDARD CHARACTERS WITHOUT CLAIM TO ANY PARTICULAR FONT, STYLE, SIZE, OR COLOR.

THE ENGLISH TRANSLATION OF "OCASSION" IN THE MARK IS "OCCASION".

FOR DEODORANTS AND ANTIPERSPIRANTS FOR PERSONAL USE; NON-MEDICATED SKIN CARE PREPARATIONS; PERFUMERY; TALCUM POWDER (U.S. CLS. 1, 4, 6, 50, 51 AND 52).

GEOFFREY FOSDICK, EXAMINING ATTORNEY

SN 85-531,848. TUPPERWARE PRODUCTS S.A., FRIBOURG, SWITZERLAND, FILED 2-2-2012.

SCAPPARE FLY

THE MARK CONSISTS OF STANDARD CHARACTERS WITHOUT CLAIM TO ANY PARTICULAR FONT, STYLE, SIZE, OR COLOR.

THE ENGLISH TRANSLATION OF "SCAPPARE" IN THE MARK IS "RUN AWAY", "TO ESCAPE", "RUSH OFF", "SLIP BY" OR "TO SCARPER".

FOR DEODORANTS AND ANTIPERSPIRANTS FOR PERSONAL USE; NON-MEDICATED SKIN CARE PREPARATIONS; PERFUMERY; TALCUM POWDER (U.S. CLS. 1, 4, 6, 50, 51 AND 52).

GEOFFREY FOSDICK, EXAMINING ATTORNEY

CLASS 3—(Continued).

SN 85-531,853. TUPPERWARE PRODUCTS S.A., FRIBOURG, SWITZERLAND, FILED 2-2-2012.

WILD OCEAN

THE MARK CONSISTS OF STANDARD CHARACTERS WITHOUT CLAIM TO ANY PARTICULAR FONT, STYLE, SIZE, OR COLOR.

FOR DEODORANTS AND ANTIPERSPIRANTS FOR PERSONAL USE; NON-MEDICATED SKIN CARE PREPARATIONS; PERFUMERY; TALCUM POWDER (U.S. CLS. 1, 4, 6, 50, 51 AND 52).

GEOFFREY FOSDICK, EXAMINING ATTORNEY

CLASS 3—(Continued).

SN 85-532,270. SILLAGE, LLC, CORONA DEL MAR, CA. FILED 2-2-2012.

ANGELS OF EDEN

THE MARK CONSISTS OF STANDARD CHARACTERS WITHOUT CLAIM TO ANY PARTICULAR FONT, STYLE, SIZE, OR COLOR.

FOR PERFUMES AND COLOGNES (U.S. CLS. 1, 4, 6, 50, 51 AND 52).

WILLIAM VERHOSEK, EXAMINING ATTORNEY

SN 85-532,607. GINIGER, MARTIN, POMPANO BEACH, FL. FILED 2-2-2012.

SN 85-531,998. SOAP & GLORY LIMITED, LONDON, UNITED KINGDOM, FILED 2-2-2012.

SOAP & GLORY ARCH ANGEL

THE MARK CONSISTS OF STANDARD CHARACTERS WITHOUT CLAIM TO ANY PARTICULAR FONT, STYLE, SIZE, OR COLOR.

FOR COSMETICS, NAMELY; EYEBROW PENCILS, EYEBROW STENCILS, BROW HIGHLIGHTERS, EYEBROW PEN (U.S. CLS. 1, 4, 6, 50, 51 AND 52).

CHRIS WELLS, EXAMINING ATTORNEY

WhiteActiv

THE MARK CONSISTS OF STANDARD CHARACTERS WITHOUT CLAIM TO ANY PARTICULAR FONT, STYLE, SIZE, OR COLOR.

FOR TOOTH WHITENING PREPARATIONS (U.S. CLS. 1, 4, 6, 50, 51 AND 52).

FLORENTINA BLANDU, EXAMINING ATTORNEY

SN 85-532,619. SORHAINDO, GAVIN, NEW YORK, NY. AND UZZARDI, JOSEPH, NEW YORK, NY. FILED 2-2-2012.



THE MARK CONSISTS OF THE NUMBER SIX AND THE AMPERSAND SIGN.

FOR COSMETIC CREAMS; COSMETIC CREAMS FOR SKIN CARE; COSMETIC HAND CREAMS; COSMETIC MASKS; COSMETIC MASSAGE CREAMS; COSMETIC OILS; COSMETICS; COSMETICS IN GENERAL, INCLUDING PERFUMES; EAU DE PERFUME; LIQUID PERFUMES; PERFUME; PERFUME OILS; PERFUMED CREAMS; PERFUMES; PERFUMES AND COLOGNES; PERFUMES AND TOILET WATERS; PERFUMES, AFTERSHAVES AND COLOGNES; PERFUMES, EAU DE COLOGNES AND AFTERSHAVES (U.S. CLS. 1, 4, 6, 50, 51 AND 52).

FIRST USE 8-1-2007; IN COMMERCE 8-1-2007.

FLORENTINA BLANDU, EXAMINING ATTORNEY

SN 85-532,058. COMBE INCORPORATED, WHITE PLAINS, NY. FILED 2-2-2012.

VAGISIL

THE MARK CONSISTS OF STANDARD CHARACTERS WITHOUT CLAIM TO ANY PARTICULAR FONT, STYLE, SIZE, OR COLOR.

OWNER OF U.S. REG. NOS. 1,104,172, 2,971,826 AND OTHERS.

FOR MOISTURIZERS FOR THE SKIN AT THE EXTERNAL VAGINAL AREA (U.S. CLS. 1, 4, 6, 50, 51 AND 52).

FIRST USE 7-24-1995; IN COMMERCE 7-24-1995.

KIMBERLY PERRY, EXAMINING ATTORNEY

CLASS 3—(Continued).

SN 85-532,959. THE KIND GROUP, LLC, NEW YORK, NY.
FILED 2-3-2012.

EVOLUTION OF SMOOTH

THE MARK CONSISTS OF STANDARD CHARACTERS WITHOUT CLAIM TO ANY PARTICULAR FONT, STYLE, SIZE, OR COLOR.

FOR LIP BALMS, PREPARATIONS AND TREATMENTS; SHAVING PRODUCTS, NAMELY, SHAVING AND PRESHAVING CREAMS; BODY CARE PRODUCTS, NAMELY, HAND AND BODY LOTION (U.S. CLS. 1, 4, 6, 50, 51 AND 52).

FIRST USE 3-2-2008; IN COMMERCE 3-2-2008.
HENRY S. ZAK, EXAMINING ATTORNEY

SN 85-533,006. HU, CHI-YUN, TAIPEI 432, TAIWAN, FILED
2-3-2012.

SISIGA

THE MARK CONSISTS OF STANDARD CHARACTERS WITHOUT CLAIM TO ANY PARTICULAR FONT, STYLE, SIZE, OR COLOR.

FOR CLEANING PREPARATIONS; COSMETICS; HAIR CARE PREPARATIONS; HAIR COLOURING AND DYES; HAIR CURLING PREPARATIONS; HAIR STYLING GEL; HAIR STYLING PREPARATIONS; HAIR WAVING LOTION; LOTIONS FOR COSMETIC PURPOSES; MAKE-UP REMOVER; MEDICATED SOAPS; PERFUME; PERFUME OILS FOR THE MANUFACTURE OF COSMETIC PREPARATIONS; PERFUMERY; SHAVING PREPARATIONS; SKIN CREAMS; SKIN MASKS (U.S. CLS. 1, 4, 6, 50, 51 AND 52).

JEFFREY LOOK, EXAMINING ATTORNEY

SN 85-533,111. KINGDOM ANIMALIA, LLC, VENICE, CA.
FILED 2-3-2012.

ILLUSION

THE MARK CONSISTS OF STANDARD CHARACTERS WITHOUT CLAIM TO ANY PARTICULAR FONT, STYLE, SIZE, OR COLOR.

FOR COSMETICS, NAMELY, A TINTED MOISTURIZER FOR FACIAL USE (U.S. CLS. 1, 4, 6, 50, 51 AND 52).

FIRST USE 1-0-2009; IN COMMERCE 1-0-2009.
ROBERT C. CLARK JR., EXAMINING ATTORNEY

CLASS 3—(Continued).

SN 85-533,145. AUSTRALIAN GOLD, LLC, INDIANAPOLIS, IN. FILED 2-3-2012.

LITTLE BLACK DRESS

THE MARK CONSISTS OF STANDARD CHARACTERS WITHOUT CLAIM TO ANY PARTICULAR FONT, STYLE, SIZE, OR COLOR.

FOR INDOOR AND OUTDOOR NON-MEDICATED SKIN TANNING PREPARATIONS (U.S. CLS. 1, 4, 6, 50, 51 AND 52).

FIRST USE 11-1-2011; IN COMMERCE 11-1-2011.
LINDA ORNDORFF, EXAMINING ATTORNEY

SN 85-533,157. AMINOGENESIS SKIN CARE, NEWPORT BEACH, CA. FILED 2-3-2012.

Paranormal-EFX

THE MARK CONSISTS OF STANDARD CHARACTERS WITHOUT CLAIM TO ANY PARTICULAR FONT, STYLE, SIZE, OR COLOR.

FOR ANTI-AGING CREAM; ANTI-WRINKLE CREAMS; BEAUTY CREAMS; FACE CREAMS (U.S. CLS. 1, 4, 6, 50, 51 AND 52).

FIRST USE 10-21-2011; IN COMMERCE 10-21-2011.
NICHOLAS COLEMAN, EXAMINING ATTORNEY

SN 85-533,206. AMINOGENESIS SKIN CARE, NEWPORT BEACH, CA. FILED 2-3-2012.

Simply One

THE MARK CONSISTS OF STANDARD CHARACTERS WITHOUT CLAIM TO ANY PARTICULAR FONT, STYLE, SIZE, OR COLOR.

FOR ANTI-AGING CREAMS; ANTI-WRINKLE CREAM; BEAUTY CREAMS; FACE CREAMS; FACE CREAMS FOR COSMETIC USE (U.S. CLS. 1, 4, 6, 50, 51 AND 52).

NICHOLAS COLEMAN, EXAMINING ATTORNEY

CLASS 3—(Continued).

SN 85-533,255. JOHNSON & JOHNSON, NEW BRUNSWICK, NJ. FILED 2-3-2012.

NOURISH +

THE MARK CONSISTS OF STANDARD CHARACTERS WITHOUT CLAIM TO ANY PARTICULAR FONT, STYLE, SIZE, OR COLOR.

FOR HAIR CARE PRODUCTS, NAMELY, SHAMPOO, CONDITIONER, LEAVE-IN TREATMENT, HAIR SPRAY AND GEL CREAM (U.S. CLS. 1, 4, 6, 50, 51 AND 52).

FIRST USE 3-30-2009; IN COMMERCE 3-30-2009.
ALICE BENMAMAN, EXAMINING ATTORNEY

CLASS 3—(Continued).

SN 85-533,375. THE GILLETTE COMPANY, BOSTON, MA. FILED 2-3-2012.

THE BEST A MAN CAN GET

THE MARK CONSISTS OF STANDARD CHARACTERS WITHOUT CLAIM TO ANY PARTICULAR FONT, STYLE, SIZE, OR COLOR.

FOR SHAVING PREPARATIONS, NAMELY, SHAVING CREAMS, SHAVING GELS, SHAVING LOTIONS, AND SHAVING FOAMS; AFTER SHAVE LOTIONS AND BALMS; ANTI-PERSPIRANTS AND DEODORANTS FOR PERSONAL USE; BODY WASH; HAIR CARE PREPARATIONS (U.S. CLS. 1, 4, 6, 50, 51 AND 52).
C. DIONNE CLYBURN, EXAMINING ATTORNEY

SN 85-533,322. SECRET OF THE ISLANDS, LLC, COLUMBIA, SC. FILED 2-3-2012.

Secret of the Islands

THE MARK CONSISTS OF STANDARD CHARACTERS WITHOUT CLAIM TO ANY PARTICULAR FONT, STYLE, SIZE, OR COLOR.

FOR AFTER SUN CREAMS; ANTI-WRINKLE CREAMS; AROMATIC BODY CARE PRODUCTS, NAMELY, BODY LOTION, SHOWER GEL, CUTICLE CREAM, SHAMPOO, CONDITIONER, NON-MEDICATED LIP BALM, SOAP, BODY POLISH, BODY AND FOOT SCRUB AND NON-MEDICATED FOOT CREAM; AROMATIC PREPARATIONS, NAMELY, LOTION; BABY HAND SOAP; BATH AND SHOWER GELS AND SALTS NOT FOR MEDICAL PURPOSES; BATH OILS AND BATH SALTS; BATH SALTS; BATH SALTS; BEAUTY CREAMS; BEAUTY CREAMS FOR BODY CARE; BODY CREAM; BODY CREAMS; BODY MASK CREAM; BODY SCRUB; CLEANING PREPARATIONS FOR HAND; COSMETIC BATH SALTS; COSMETIC CREAMS; COSMETIC CREAMS FOR SKIN CARE; COSMETIC HAND CREAMS; COSMETIC MASSAGE CREAMS; COSMETIC NOURISHING CREAMS; EXFOLIANT CREAMS; EXFOLIANTS FOR SKIN; FACE AND BODY BEAUTY CREAMS; FACE AND BODY CREAMS; FACE AND BODY LOTIONS; FACE CREAMS; FACIAL SCRUBS; FOOT SCRUBS; FRAGRANCED BODY CARE PREPARATIONS, NAMELY, HAND, FOOT AND BODY CREAM; FRAGRANCED FACE CARE PREPARATIONS, NAMELY, HAND, FOOT AND BODY CREAM; HAND CLEANERS; HAND CLEANING GELS; HAND CLEANING PREPARATIONS; HAND CREAM; HAND CREAMS; HAND LOTIONS; HAND SCRUBS; HAND SOAPS; LIQUID SOAPS FOR HANDS AND FACE; LIQUID SOAPS FOR HANDS, FACE AND BODY; LOTIONS FOR FACE AND BODY CARE; MINERAL SALT IN THE NATURE OF BATH SALTS NOT FOR MEDICAL PURPOSES; NON-MEDICATED BATH SALTS; SCENTED BATHING SALTS (U.S. CLS. 1, 4, 6, 50, 51 AND 52).

FIRST USE 4-1-2009; IN COMMERCE 4-1-2009.
TASNEEM HUSSAIN, EXAMINING ATTORNEY

SN 85-533,424. THE AVENTO CORPORATION, VIRGINIA BEACH, VA. FILED 2-3-2012.

Restor8

THE MARK CONSISTS OF STANDARD CHARACTERS WITHOUT CLAIM TO ANY PARTICULAR FONT, STYLE, SIZE, OR COLOR.

FOR POLYMER SEALANT FOR CLEANING, SHINING AND PROTECTING AUTOMOBILE EXTERIOR SURFACES (U.S. CLS. 1, 4, 6, 50, 51 AND 52).

DAVID MURRAY, EXAMINING ATTORNEY

SN 85-533,593. WEST MARINE PRODUCTS, INC., WATSONVILLE, CA. FILED 2-3-2012.



THE MARK CONSISTS OF A SHARK.
FOR SUNSCREEN CREAMS, SUNSCREEN LOTIONS, SUNSCREEN SPRAYS, LIP BALM (U.S. CLS. 1, 4, 6, 50, 51 AND 52).

WILLIAM VERHOSEK, EXAMINING ATTORNEY

CLASS 3—(Continued).

SN 85-533,664. L'OREAL USA CREATIVE, INC., NEW YORK, NY. FILED 2-3-2012.

SHEER FEATHERIZER

THE MARK CONSISTS OF STANDARD CHARACTERS WITHOUT CLAIM TO ANY PARTICULAR FONT, STYLE, SIZE, OR COLOR.
FOR HAIR STYLING PREPARATION (U.S. CLS. 1, 4, 6, 50, 51 AND 52).
DORITT L. CARROLL, EXAMINING ATTORNEY

SN 85-534,062. MASTOLONI, ANDREA P., MADISON, CT. AND STRANO, ANGELINA M., GUILFORD, CT. FILED 2-4-2012.

MOUTHSTIX

THE MARK CONSISTS OF STANDARD CHARACTERS WITHOUT CLAIM TO ANY PARTICULAR FONT, STYLE, SIZE, OR COLOR.
FOR COSMETICS, INCLUDING LIP GLOSS, LIP STICK, AND LIP BALM (U.S. CLS. 1, 4, 6, 50, 51 AND 52).
STEVEN PEREZ, EXAMINING ATTORNEY

SN 85-534,467. THE PAPER MAGIC GROUP, INC., WILMINGTON, DE. FILED 2-6-2012.

HALLOW'S EVE

THE MARK CONSISTS OF STANDARD CHARACTERS WITHOUT CLAIM TO ANY PARTICULAR FONT, STYLE, SIZE, OR COLOR.
FOR MASCARA, EYE SHADOW, LIPSTICK, LIP GLOSS, NAIL POLISH, EYELINER, FALSE EYELASHES, FINGERNAIL DECALS, FACE POWDER, AND BODY POWDER (U.S. CLS. 1, 4, 6, 50, 51 AND 52).
JASON BLAIR, EXAMINING ATTORNEY

CLASS 3—(Continued).

SN 85-534,637. JACOBS, MARSHALL L, OMAHA, NE. FILED 2-6-2012.

Cleanze-a-Guard

THE MARK CONSISTS OF STANDARD CHARACTERS WITHOUT CLAIM TO ANY PARTICULAR FONT, STYLE, SIZE, OR COLOR.
FOR SPRAY CLEANERS FOR FRESHENING ATHLETIC MOUTH GUARDS (U.S. CLS. 1, 4, 6, 50, 51 AND 52).
DAVID C. REIHNER, EXAMINING ATTORNEY

SN 85-534,879. LADIBUGS, INCORPORATED, SAVAGE, MN. FILED 2-6-2012.



THE MARK CONSISTS OF A DESIGN OF A LADYBUG INCORPORATING THREE HEARTS.
FOR HAIR CARE KITS COMPRISING NON-MEDICATED HAIR CARE PREPARATIONS, NAMELY, SHAMPOO, CONDITIONER, AND NON-MEDICATED HAIR CARE PREPARATIONS; HAIR CARE LOTIONS; HAIR CARE PREPARATIONS; HAIR SHAMPOOS AND CONDITIONERS (U.S. CLS. 1, 4, 6, 50, 51 AND 52).
FIRST USE 5-3-2010; IN COMMERCE 5-3-2010.
THOMAS MANOR, EXAMINING ATTORNEY

SN 85-535,074. WESTERN HOLDINGS, LLC, CARSON CITY, NV. FILED 2-6-2012.

GIFT OF YOUTH

THE MARK CONSISTS OF STANDARD CHARACTERS WITHOUT CLAIM TO ANY PARTICULAR FONT, STYLE, SIZE, OR COLOR.
FOR COSMETICS (U.S. CLS. 1, 4, 6, 50, 51 AND 52).
JACQUELINE A. LAVINE, EXAMINING ATTORNEY

CLASS 3—(Continued).

SN 85-535,115. GUO, YULI, WOODRIDGE, NJ. FILED 2-6-2012.

YULIMADE

THE MARK CONSISTS OF STANDARD CHARACTERS WITHOUT CLAIM TO ANY PARTICULAR FONT, STYLE, SIZE, OR COLOR.

FOR BAR SOAP; BATH SOAPS; BODY WASH; LIP BALM; SHAMPOOS; SOAPS (U.S. CLS. 1, 4, 6, 50, 51 AND 52).

FIRST USE 12-0-2011; IN COMMERCE 12-0-2011.

WILLIAM BRECKENFELD, EXAMINING ATTORNEY

CLASS 3—(Continued).

SN 85-535,597. MILLENIA PRODUCTIONS, LLC, WICHITA, KS. FILED 2-7-2012.

The logo features the word "gel" in a cursive script font, followed by the Roman numeral "II" in a smaller, simpler font.

NO CLAIM IS MADE TO THE EXCLUSIVE RIGHT TO USE "GEL", APART FROM THE MARK AS SHOWN.

THE MARK CONSISTS OF STYLIZED SCRIPT LETTERS FOR THE WORD "GEL" AND ROMAN NUMERAL "II" FOR NAIL GEL (U.S. CLS. 1, 4, 6, 50, 51 AND 52).

ALICE BENMAMAN, EXAMINING ATTORNEY

SN 85-535,251. ADVANCED MEDICAL AND SURGICAL DERMATOLOGY CORPORATION, SAN RAFAEL, CA. FILED 2-6-2012.

Anya

THE MARK CONSISTS OF STANDARD CHARACTERS WITHOUT CLAIM TO ANY PARTICULAR FONT, STYLE, SIZE, OR COLOR.

FOR SKIN SOAPS; BATHS GELS, BATH OILS, BATH SALTS; NON-MEDICATED SKIN CARE PREPARATIONS, NAMELY LOTIONS, SPRAYS, SERUMS, CREAMS, CLEANSERS, SCRUBS, MASKS, EXFOLIATORS, AND TONERS; PEELS; HAIR CARE AND STYLING PREPARATIONS, NAMELY, SHAMPOOS, CONDITIONERS, FINISHING SPRAYS, AND GELS; COSMETICS, NAMELY, FOUNDATIONS, CONCEALERS, MASCARAS, EYE SHADOWS, EYE LINERS, BROW LINERS, LIPSTICKS, LIP LINERS, LIP BALMS, FACE POWDERS, BRONZERS, BLUSHERS, MOISTURIZERS, MAKE-UP REMOVERS; NON-MEDICATED BODY POWERS; EYE BALM; SUN-TANNING PREPARATIONS; SUNSCREEN OILS AND LOTIONS; SHAVING PREPARATIONS; PERFUMES, EAU DE TOILETTE, ESSENTIAL OILS FOR PERSONAL USE, PERFUME OILS; NAIL CARE PREPARATIONS, NAIL ENAMELS, NAIL POLISHES; NON-MEDICATED ACNE TREATMENT PREPARATIONS (U.S. CLS. 1, 4, 6, 50, 51 AND 52).

BRIDGETT SMITH, EXAMINING ATTORNEY

SN 85-535,954. VICTORIA'S SECRET STORES BRAND MANAGEMENT, INC., REYNOLDSBURG, OH. FILED 2-7-2012.

SEXY LITTLE SWEETHEART

THE MARK CONSISTS OF STANDARD CHARACTERS WITHOUT CLAIM TO ANY PARTICULAR FONT, STYLE, SIZE, OR COLOR.

OWNER OF U.S. REG. NOS. 3,357,655 AND 3,974,219. FOR BODY CREAMS; BODY LOTIONS; BODY WASH; EAU DE PARFUM; NON-MEDICATED SKIN CARE PREPARATION, NAMELY, BODY MIST (U.S. CLS. 1, 4, 6, 50, 51 AND 52).

DAVID C. REIHNER, EXAMINING ATTORNEY

SN 85-535,965. VICTORIA'S SECRET STORES BRAND MANAGEMENT, INC., REYNOLDSBURG, OH. FILED 2-7-2012.

SEXY LITTLE DREAMER

THE MARK CONSISTS OF STANDARD CHARACTERS WITHOUT CLAIM TO ANY PARTICULAR FONT, STYLE, SIZE, OR COLOR.

OWNER OF U.S. REG. NOS. 3,357,655 AND 3,974,219. FOR BODY CREAMS; BODY LOTIONS; BODY WASH; EAU DE PARFUM; NON-MEDICATED SKIN CARE PREPARATION, NAMELY, BODY MIST (U.S. CLS. 1, 4, 6, 50, 51 AND 52).

DAVID C. REIHNER, EXAMINING ATTORNEY

CLASS 3—(Continued).

SN 85-535,978. VICTORIA'S SECRET STORES BRAND MANAGEMENT, INC., REYNOLDSBURG, OH. FILED 2-7-2012.

SEXY LITTLE STAR

THE MARK CONSISTS OF STANDARD CHARACTERS WITHOUT CLAIM TO ANY PARTICULAR FONT, STYLE, SIZE, OR COLOR.

OWNER OF U.S. REG. NOS. 3,357,655 AND 3,974,219.
FOR BODY CREAMS; BODY LOTIONS; BODY WASH; EAU DE PARFUM; NON-MEDICATED SKIN CARE PREPARATION, NAMELY, BODY MIST (U.S. CLS. 1, 4, 6, 50, 51 AND 52).

DAVID C. REIHNER, EXAMINING ATTORNEY

SN 85-536,019. VICTORIA'S SECRET STORES BRAND MANAGEMENT, INC., REYNOLDSBURG, OH. FILED 2-7-2012.

BEACH BOMBSHELL

THE MARK CONSISTS OF STANDARD CHARACTERS WITHOUT CLAIM TO ANY PARTICULAR FONT, STYLE, SIZE, OR COLOR.

FOR AFTER SUN CREAMS; AFTER-SUN LOTIONS; SELF-TANNING PREPARATIONS; SKIN BRONZER; SKIN BRONZING CREAMS; SUN BLOCK PREPARATIONS; SUN SCREEN PREPARATIONS; SUN TAN LOTION; SUN-BLOCK LOTIONS; SUN-TANNING OILS; SUN-TANNING PREPARATIONS; SUNSCREEN CREAMS; TANNING CREAMS (U.S. CLS. 1, 4, 6, 50, 51 AND 52).

DAVID C. REIHNER, EXAMINING ATTORNEY

SN 85-536,251. NATURAL REMEDIES, LLC, HESPERIA, CA. FILED 2-7-2012.

Total Perfection

THE MARK CONSISTS OF STANDARD CHARACTERS WITHOUT CLAIM TO ANY PARTICULAR FONT, STYLE, SIZE, OR COLOR.

FOR ANTI-WRINKLE CREAM; ANTI-WRINKLE CREAMS (U.S. CLS. 1, 4, 6, 50, 51 AND 52).

EDWARD FENNESSY, EXAMINING ATTORNEY

CLASS 3—(Continued).

SN 85-536,728. GILCHRIST & SOAMES, INC., INDIANAPOLIS, IN. FILED 2-8-2012.

GILCHRIST & SOAMES BATHE

THE MARK CONSISTS OF STANDARD CHARACTERS WITHOUT CLAIM TO ANY PARTICULAR FONT, STYLE, SIZE, OR COLOR.

OWNER OF U.S. REG. NOS. 1,162,380 AND 2,017,167.
FOR BATH LOTION; BATH SALTS; BATH SOAPS; HAIR SHAMPOOS AND CONDITIONERS; SHOWER AND BATH GEL; SKIN LOTIONS (U.S. CLS. 1, 4, 6, 50, 51 AND 52).

NAPOLÉON SHARMA, EXAMINING ATTORNEY

SN 85-537,033. THE GILLETTE COMPANY, BOSTON, MA. FILED 2-8-2012.



THE MARK CONSISTS OF A STYLIZED LETTER "V" ENCLOSED IN A CIRCLE DESIGN.

FOR SKIN GEL FOR USE WITH A LASER HAIR REMOVAL DEVICE (U.S. CLS. 1, 4, 6, 50, 51 AND 52).

C. DIONNE CLYBURN, EXAMINING ATTORNEY

SN 85-537,139. NIOXIN RESEARCH LABORATORIES, INC., LITHIA SPRINGS, GA. FILED 2-8-2012.

HTX

THE MARK CONSISTS OF STANDARD CHARACTERS WITHOUT CLAIM TO ANY PARTICULAR FONT, STYLE, SIZE, OR COLOR.

FOR HAIR CARE PREPARATIONS (U.S. CLS. 1, 4, 6, 50, 51 AND 52).

FIRST USE 1-31-2012; IN COMMERCE 1-31-2012.

JIM RINGLE, EXAMINING ATTORNEY

CLASS 3—(Continued).

SN 85-537,145. NIOXIN RESEARCH LABORATORIES, INC., LITHIA SPRINGS, GA. FILED 2-8-2012.

DIAMAX

THE MARK CONSISTS OF STANDARD CHARACTERS WITHOUT CLAIM TO ANY PARTICULAR FONT, STYLE, SIZE, OR COLOR.

FOR HAIR CARE PREPARATIONS (U.S. CLS. 1, 4, 6, 50, 51 AND 52).

FIRST USE 1-31-2012; IN COMMERCE 1-31-2012.
JIM RINGLE, EXAMINING ATTORNEY

CLASS 3—(Continued).

SN 85-537,426. L'OREAL USA CREATIVE, INC., NEW YORK, NY. FILED 2-8-2012.

SHEAR TOUCH

THE MARK CONSISTS OF STANDARD CHARACTERS WITHOUT CLAIM TO ANY PARTICULAR FONT, STYLE, SIZE, OR COLOR.

FOR HAIR STYLING PREPARATION (U.S. CLS. 1, 4, 6, 50, 51 AND 52).

DORITT L. CARROLL, EXAMINING ATTORNEY

SN 85-537,288. L'OREAL USA CREATIVE, INC., NEW YORK, NY. FILED 2-8-2012.

RUFFLE UP

THE MARK CONSISTS OF STANDARD CHARACTERS WITHOUT CLAIM TO ANY PARTICULAR FONT, STYLE, SIZE, OR COLOR.

FOR HAIR STYLING PREPARATION (U.S. CLS. 1, 4, 6, 50, 51 AND 52).

DORITT L. CARROLL, EXAMINING ATTORNEY

SN 85-537,370. SCALISI COSMETICS LLC, NEW YORK, NY. FILED 2-8-2012.



THE COLOR(S) DEEP PERIWINKLE, WHITE AND LIGHT PERIWINKLE IS/ARE CLAIMED AS A FEATURE OF THE MARK.

THE MARK CONSISTS OF A SQUARE THAT IS BISECTED VERTICALLY BY A WHITE CURVED LINE WITH THE LEFT SIDE OF THE SQUARE BEING DEEP PERIWINKLE AND THE RIGHT SIDE OF THE SQUARE BEING LIGHT PERIWINKLE.

FOR SKIN CARE PRODUCTS, NAMELY, CREAMS, LOTIONS, MOISTURIZERS FOR BODY, FACE AND EYES; ANTI-AGING CREAMS AND LOTIONS (U.S. CLS. 1, 4, 6, 50, 51 AND 52).

FIRST USE 11-25-2011; IN COMMERCE 11-25-2011.
JAMES STEIN, EXAMINING ATTORNEY

SN 85-537,635. HATCH BEAUTY AGENCY, LLC, SANTA MONICA, CA. FILED 2-8-2012.

BETTER YOU

THE MARK CONSISTS OF STANDARD CHARACTERS WITHOUT CLAIM TO ANY PARTICULAR FONT, STYLE, SIZE, OR COLOR.

FOR BAR SOAP; BEAUTY SERUMS; BODY AND BEAUTY CARE COSMETICS; BODY WASH; COLORING PREPARATIONS FOR COSMETIC PURPOSES; COSMETIC PREPARATIONS; COSMETIC PREPARATIONS FOR BATH AND SHOWER; COSMETIC PREPARATIONS FOR BODY CARE; COSMETIC PREPARATIONS FOR SKIN CARE; COSMETICS AND MAKE-UP; EYE CREAM; EYE GELS; FACE AND BODY CREAMS; HAIR CARE PREPARATIONS; HAIR CONDITIONER; HAIR SHAMPOO; HAIR STYLING PREPARATIONS; NAIL CARE PREPARATIONS; NON-MEDICATED FACIAL AND EYE SERUM CONTAINING ANTIOXIDANTS; NON-MEDICATED SKIN CARE PREPARATIONS, NAMELY, CREAMS, LOTIONS, GELS, TONERS, CLEANERS AND PEELS; PRE-MOISTENED COSMETIC TOWELETTES (U.S. CLS. 1, 4, 6, 50, 51 AND 52).

CHRISIE B. KING, EXAMINING ATTORNEY

SN 85-538,007. DEEP COVER SYSTEMS, LLC, FORT MEYERS, FL. FILED 2-9-2012.

WHERE FASHION MEETS FUNCTION

THE MARK CONSISTS OF STANDARD CHARACTERS WITHOUT CLAIM TO ANY PARTICULAR FONT, STYLE, SIZE, OR COLOR.

FOR NAIL POLISH (U.S. CLS. 1, 4, 6, 50, 51 AND 52).
JUDITH HELFMAN, EXAMINING ATTORNEY

CLASS 3—(Continued).

SN 85-538,009. MANA PRODUCTS, INC., LONG ISLAND CITY, NY. FILED 2-9-2012.

INVENTOR

THE MARK CONSISTS OF STANDARD CHARACTERS WITHOUT CLAIM TO ANY PARTICULAR FONT, STYLE, SIZE, OR COLOR.

FOR COSMETICS, NON-MEDICATED SKIN CARE PREPARATIONS, HAIR CARE PREPARATIONS (U.S. CLS. 1, 4, 6, 50, 51 AND 52).

HELENE LIWINSKI, EXAMINING ATTORNEY

SN 85-538,079. BEAUTYBANK INC., NEW YORK, NY. FILED 2-9-2012.

BB10

THE MARK CONSISTS OF STANDARD CHARACTERS WITHOUT CLAIM TO ANY PARTICULAR FONT, STYLE, SIZE, OR COLOR.

FOR NON-MEDICATED SKIN CARE PREPARATIONS (U.S. CLS. 1, 4, 6, 50, 51 AND 52).

TIMOTHY FINNEGAN, EXAMINING ATTORNEY

SN 85-538,095. PEART, DIANN, DBA TRUCE, TEMPE, AZ. FILED 2-9-2012.

TRUCE

THE MARK CONSISTS OF STANDARD CHARACTERS WITHOUT CLAIM TO ANY PARTICULAR FONT, STYLE, SIZE, OR COLOR.

FOR PET CARE KITS COMPRISING SHAMPOO, CONDITIONER, BODY SPRAY; PET SHAMPOO AND CONDITIONER; PET STAIN REMOVERS; SCENTED ROOM SPRAYS; SHAVING CREAM; SOAPS AND DETERGENTS; SPOT REMOVER; STAIN REMOVERS (U.S. CLS. 1, 4, 6, 50, 51 AND 52).

JESSICA A. POWERS, EXAMINING ATTORNEY

CLASS 3—(Continued).

SN 85-538,142. LITTLE ANGELS, LLC, NEW YORK, NY. FILED 2-9-2012.



THE MARK CONSISTS OF DEPICTIONS OF EIGHT ANGELS WITH HALOS AND WINGS AND TWO CHILDREN ALL WITHIN A CLOUD.

FOR TOILETRIES, NAMELY, TOOTHPASTE, SHAMPOO, CONDITIONER, SOAP, BODY WASH, LOTIONS, SKIN CLEANSERS AND WASHES AND HAIR DETANGLERS (U.S. CLS. 1, 4, 6, 50, 51 AND 52).

LUCY ARANT, EXAMINING ATTORNEY

SN 85-538,221. PEART, DIANN, DBA TRUCE, TEMPE, AZ. FILED 2-9-2012.

WE MAKE GOOD

THE MARK CONSISTS OF STANDARD CHARACTERS WITHOUT CLAIM TO ANY PARTICULAR FONT, STYLE, SIZE, OR COLOR.

FOR PET CARE KITS COMPRISING SHAMPOO, CONDITIONER, BODY SPRAY; PET SHAMPOO AND CONDITIONER; PET STAIN REMOVERS; SCENTED ROOM SPRAYS; SHAVING CREAM; SOAPS AND DETERGENTS; SPOT REMOVER; STAIN REMOVERS (U.S. CLS. 1, 4, 6, 50, 51 AND 52).

JESSICA A. POWERS, EXAMINING ATTORNEY

SN 85-538,319. PURE & NATURAL COMPANY, SCOTTSDALE, AZ. FILED 2-9-2012.

TEMPTING INDULGENCES

THE MARK CONSISTS OF STANDARD CHARACTERS WITHOUT CLAIM TO ANY PARTICULAR FONT, STYLE, SIZE, OR COLOR.

FOR AIR FRAGRANCING PREPARATIONS (U.S. CLS. 1, 4, 6, 50, 51 AND 52).

JUHI KAVEESHVAR, EXAMINING ATTORNEY

CLASS 3—(Continued).

SN 85-538,387. G.I. SKINCARE, LLC, NEW YORK, NY. FILED 2-9-2012.

BOOST

THE MARK CONSISTS OF STANDARD CHARACTERS WITHOUT CLAIM TO ANY PARTICULAR FONT, STYLE, SIZE, OR COLOR.
 OWNER OF U.S. REG. NO. 3,779,441.
 FOR NON-MEDICATED SKIN CARE PREPARATIONS (U.S. CLS. 1, 4, 6, 50, 51 AND 52).
 FIRST USE 9-18-2009; IN COMMERCE 9-28-2009.
 DEIRDRE ROBERTSON, EXAMINING ATTORNEY

CLASS 3—(Continued).

SN 85-538,860. SOMME INC., NEW YORK, NY. FILED 2-9-2012.

MDT5

THE MARK CONSISTS OF STANDARD CHARACTERS WITHOUT CLAIM TO ANY PARTICULAR FONT, STYLE, SIZE, OR COLOR.
 FOR SKIN CARE PRODUCTS, NAMELY, CLEANSERS, EXFOLIANTS, NON-MEDICATED SERUMS, AND MOISTURIZERS (U.S. CLS. 1, 4, 6, 50, 51 AND 52).
 FIRST USE 0-0-1999; IN COMMERCE 0-0-2000.
 ZACHARY BELLO, EXAMINING ATTORNEY

SN 85-538,572. BRAZZ, LLC, ATLANTA, GA. FILED 2-9-2012.

BRAZZ

THE MARK CONSISTS OF STANDARD CHARACTERS WITHOUT CLAIM TO ANY PARTICULAR FONT, STYLE, SIZE, OR COLOR.
 FOR HAIR REMOVING CREAM (U.S. CLS. 1, 4, 6, 50, 51 AND 52).
 MARIA-VICTORIA SUAREZ, EXAMINING ATTORNEY

SN 85-539,046. PRECISION DERMATOLOGY, INC., CUMBERLAND, RI. FILED 2-10-2012.

METASEB

THE MARK CONSISTS OF STANDARD CHARACTERS WITHOUT CLAIM TO ANY PARTICULAR FONT, STYLE, SIZE, OR COLOR.
 FOR NON-MEDICATED SKIN CARE PREPARATIONS (U.S. CLS. 1, 4, 6, 50, 51 AND 52).
 WILLIAM BRECKENFELD, EXAMINING ATTORNEY

SN 85-538,619. ANNETTE GREEN, NEW YORK, NY. FILED 2-9-2012.

MakingOut

THE MARK CONSISTS OF STANDARD CHARACTERS WITHOUT CLAIM TO ANY PARTICULAR FONT, STYLE, SIZE, OR COLOR.
 FOR COLOGNES, PERFUMES AND COSMETICS (U.S. CLS. 1, 4, 6, 50, 51 AND 52).
 CHRISTINE MARTIN, EXAMINING ATTORNEY

SN 85-539,130. DOGGONIT PRODUCTS, LLC, WESTMONT, IL. FILED 2-10-2012.

**OGGO MAKES DIRT AND GERMS
 SIMPLY GO GO**

THE MARK CONSISTS OF STANDARD CHARACTERS WITHOUT CLAIM TO ANY PARTICULAR FONT, STYLE, SIZE, OR COLOR.
 FOR CLEANING PREPARATIONS FOR HOUSEHOLD PURPOSES (U.S. CLS. 1, 4, 6, 50, 51 AND 52).
 FIRST USE 2-9-2012; IN COMMERCE 2-9-2012.
 DAVID H. STINE, EXAMINING ATTORNEY

CLASS 3—(Continued).

SN 85-540,006. DERMAMED SOLUTIONS, LLC, LENNI, PA.
FILED 2-10-2012.

DAILY ECLIPSE

THE MARK CONSISTS OF STANDARD CHARACTERS WITHOUT CLAIM TO ANY PARTICULAR FONT, STYLE, SIZE, OR COLOR.

FOR SUN BLOCK; SUN-BLOCK LOTIONS (U.S. CLS. 1, 4, 6, 50, 51 AND 52).

FIRST USE 10-14-2002; IN COMMERCE 10-14-2002.

YAT SYE, LEE, EXAMINING ATTORNEY

CLASS 3—(Continued).

SN 85-540,554. CHEN, YU-HUA, CHANGHUA COUNTY, TAIWAN, FILED 2-12-2012.



THE COLOR(S) BLUE AND GREEN IS/ARE CLAIMED AS A FEATURE OF THE MARK.

THE MARK CONSISTS OF THE LETTERS "YCM" WITH THE LETTER "C" WRITTEN AS A GEOMETRIC SYMBOL (A FIGURE THAT IS KNOWN AS A GLOBE). ON THE ABOVE OF THE LETTER "C" SETTING A SAPLING. THE LETTER "Y" IS IN BLUE; THE LETTERS "CM" ARE IN GREEN.

FOR AROMATIC ESSENTIAL OILS; CLEANSING MILK FOR TOILET PURPOSES; COSMETICS; ESSENTIAL OILS; PLANT AND HERB EXTRACTS SOLD AS COMPONENTS OF COSMETICS; POTPOURRI; RUST REMOVING PREPARATIONS; SKIN WHITENING CREAMS (U.S. CLS. 1, 4, 6, 50, 51 AND 52).

FIRST USE 12-20-2010; IN COMMERCE 11-1-2011.

NAKWAMA ANKRAH, EXAMINING ATTORNEY

SN 85-540,432. ELIN BIANCO, INC., TORONTO, ONTARIO, CANADA, FILED 2-12-2012.

**LIGHTMASTER**

THE MARK CONSISTS OF STANDARD CHARACTERS WITHOUT CLAIM TO ANY PARTICULAR FONT, STYLE, SIZE, OR COLOR.

FOR HAIR COLOR AND HAIR BLEACH (U.S. CLS. 1, 4, 6, 50, 51 AND 52).

DORITT L. CARROLL, EXAMINING ATTORNEY

SN 85-545,943. SEVENTH GENERATION, INC., BURLINGTON, VT. FILED 2-17-2012.

HERBAVERA

THE MARK CONSISTS OF A HORSE WITH WINGS (A PEGASUS).

FOR HAIR CARE LOTIONS; HAIR CREAMS; HAIR GEL AND HAIR MOUSSE; HAIR OILS; HAIR SHAMPOOS AND CONDITIONERS; HAIR TONICS (U.S. CLS. 1, 4, 6, 50, 51 AND 52).

SHAILA SETTLES, EXAMINING ATTORNEY

THE MARK CONSISTS OF STANDARD CHARACTERS WITHOUT CLAIM TO ANY PARTICULAR FONT, STYLE, SIZE, OR COLOR.

FOR DISHWASHING DETERGENTS; DISHWASHING PREPARATIONS (U.S. CLS. 1, 4, 6, 50, 51 AND 52).

TEJBIR SINGH, EXAMINING ATTORNEY

CLASS 3—(Continued).

SN 85-546,089. JESSICA COSMETICS INTERNATIONAL, INC., NORTH HOLLYWOOD, CA. FILED 2-17-2012.

COLOURGROW

THE MARK CONSISTS OF STANDARD CHARACTERS WITHOUT CLAIM TO ANY PARTICULAR FONT, STYLE, SIZE, OR COLOR.

FOR COSMETIC PREPARATIONS FOR NAIL DRYING; CUTICLE CONDITIONERS; CUTICLE CREAM; HAND CREAMS; NAIL CARE KITS COMPRISING NAIL POLISH; NAIL CARE PREPARATIONS; NAIL CARE PREPARATIONS, NAMELY, NAIL SOFTENERS; NAIL ENAMEL REMOVERS; NAIL ENAMELS; NAIL HARDENERS; NAIL POLISH BASE COAT; NAIL POLISH REMOVER; NAIL POLISH TOP COAT; NAIL STRENGTHENERS (U.S. CLS. 1, 4, 6, 50, 51 AND 52).

LINDA LAVACHE, EXAMINING ATTORNEY

SN 85-552,843. JOHN PAUL PRODUCTS, LLC, VENTURA, CA. FILED 2-25-2012.

JOHN PAUL PET

THE MARK CONSISTS OF STANDARD CHARACTERS WITHOUT CLAIM TO ANY PARTICULAR FONT, STYLE, SIZE, OR COLOR.

NO CLAIM IS MADE TO THE EXCLUSIVE RIGHT TO USE "PET", APART FROM THE MARK AS SHOWN.

THE NAME(S), PORTRAIT(S), AND/OR SIGNATURE(S) SHOWN IN THE MARK IDENTIFIES "JOHN PAUL" DEJORIA, WHOSE CONSENT(S) TO REGISTER IS MADE OF RECORD.

FOR PET CARE KITS COMPRISING SHAMPOO, CONDITIONER, BODY SPRAY; PET SHAMPOO AND CONDITIONER (U.S. CLS. 1, 4, 6, 50, 51 AND 52).

FIRST USE 5-1-2003; IN COMMERCE 5-1-2003.

JENNIFER VASQUEZ, EXAMINING ATTORNEY

SN 85-556,187. VICTORIA'S SECRET STORES BRAND MANAGEMENT, INC., REYNOLDSBURG, OH. FILED 2-29-2012.

SHINE ENVY

THE MARK CONSISTS OF STANDARD CHARACTERS WITHOUT CLAIM TO ANY PARTICULAR FONT, STYLE, SIZE, OR COLOR.

NO CLAIM IS MADE TO THE EXCLUSIVE RIGHT TO USE "SHINE", APART FROM THE MARK AS SHOWN.

FOR LIP BALM; LIP GLOSS; LIPSTICK; NON-MEDICATED LIP CARE PREPARATIONS (U.S. CLS. 1, 4, 6, 50, 51 AND 52).

DAVID C. REIHNER, EXAMINING ATTORNEY

CLASS 3—(Continued).

SN 85-556,194. VICTORIA'S SECRET STORES BRAND MANAGEMENT, INC., REYNOLDSBURG, OH. FILED 2-29-2012.

MOISTURE ENVY

THE MARK CONSISTS OF STANDARD CHARACTERS WITHOUT CLAIM TO ANY PARTICULAR FONT, STYLE, SIZE, OR COLOR.

NO CLAIM IS MADE TO THE EXCLUSIVE RIGHT TO USE "MOISTURE", APART FROM THE MARK AS SHOWN.

FOR LIP BALM; LIP GLOSS; LIPSTICK; NON-MEDICATED LIP CARE PREPARATIONS (U.S. CLS. 1, 4, 6, 50, 51 AND 52).

DAVID C. REIHNER, EXAMINING ATTORNEY

SN 85-556,216. VICTORIA'S SECRET STORES BRAND MANAGEMENT, INC., REYNOLDSBURG, OH. FILED 2-29-2012.

SHINE DRAMA

THE MARK CONSISTS OF STANDARD CHARACTERS WITHOUT CLAIM TO ANY PARTICULAR FONT, STYLE, SIZE, OR COLOR.

NO CLAIM IS MADE TO THE EXCLUSIVE RIGHT TO USE "SHINE", APART FROM THE MARK AS SHOWN.

FOR LIP BALM; LIP GLOSS; LIPSTICK; NON-MEDICATED LIP CARE PREPARATIONS (U.S. CLS. 1, 4, 6, 50, 51 AND 52).

DAVID C. REIHNER, EXAMINING ATTORNEY

SN 85-566,873. GENUINE 7, LLC, CHARLOTTE, NC. FILED 3-12-2012.

GENUINE 7

THE MARK CONSISTS OF STANDARD CHARACTERS WITHOUT CLAIM TO ANY PARTICULAR FONT, STYLE, SIZE, OR COLOR.

FOR DISPOSABLE WASH MITTS PRE-IMPREGNATED WITH SKIN CLEANSERS AND FRAGRANCE (U.S. CLS. 1, 4, 6, 50, 51 AND 52).

DAVID C. REIHNER, EXAMINING ATTORNEY

CLASS 3—(Continued).

SN 85-574,178. BLISS WORLD LLC, NEW YORK, NY. FILED 3-20-2012.

that's incredi-'peel'!

THE MARK CONSISTS OF STANDARD CHARACTERS WITHOUT CLAIM TO ANY PARTICULAR FONT, STYLE, SIZE, OR COLOR.

FOR SKIN CARE PREPARATIONS, NAMELY, SKIN PEELS (U.S. CLS. 1, 4, 6, 50, 51 AND 52).
KEVON CHISOLM, EXAMINING ATTORNEY

SN 85-575,907. BEFIT ENTERPRISES, MORRO BAY, CA. FILED 3-21-2012.

lalanne

THE MARK CONSISTS OF STANDARD CHARACTERS WITHOUT CLAIM TO ANY PARTICULAR FONT, STYLE, SIZE, OR COLOR.

OWNER OF U.S. REG. NOS. 1,351,946, 3,034,163 AND 3,161,990.
SEC. 2(F).
FOR COSMETIC CREAMS FOR SKIN CARE (U.S. CLS. 1, 4, 6, 50, 51 AND 52).
FIRST USE 0-0-1955; IN COMMERCE 0-0-1955.
NICHOLAS COLEMAN, EXAMINING ATTORNEY

CLASS 3—(Continued).

SN 85-577,475. IES ENTERPRISES, INC., NEW YORK, NY. FILED 3-22-2012.



OWNER OF U.S. REG. NOS. 1,457,886, 2,711,651 AND OTHERS.

NO CLAIM IS MADE TO THE EXCLUSIVE RIGHT TO USE "CLEAN", APART FROM THE MARK AS SHOWN.

THE MARK CONSISTS OF THE MARK "SOFTSOAP" IN STYLIZED LETTERS CONTAINED IN A STYLIZED BANNER SHAPE WITH A BAR RUNNING ALONG THE BOTTOM EDGE AND CURVING UPWARD IN THE LOWER RIGHT HAND CORNER OF THE BANNER SHAPE. IMMEDIATELY BENEATH THAT IS THE TRADEMARK "CLEAN PROTECTION" IN STYLIZED LETTERING. BENEATH THAT IS A SOLID RECTANGLE WITH ROUNDED EDGES. DIRECTLY UNDER THAT IS AN IMAGE OF A SHIELD AND CROSS DESIGN.

SEC. 2(F) AS TO "SOFTSOAP".
FOR PERSONAL CARE PRODUCTS, NAMELY, NON-MEDICATED SKIN CLEANSING PREPARATIONS (U.S. CLS. 1, 4, 6, 50, 51 AND 52).
KEVON CHISOLM, EXAMINING ATTORNEY

SN 85-580,399. LARRY WILLIAMS & ASSOCIATES, INC., CARLSBAD, CA. FILED 3-26-2012.

ENGOT

THE MARK CONSISTS OF STANDARD CHARACTERS WITHOUT CLAIM TO ANY PARTICULAR FONT, STYLE, SIZE, OR COLOR.

FOR HAIR STYLING PREPARATIONS; HAIR STYLING GEL; HAIR STYLING SPRAY (U.S. CLS. 1, 4, 6, 50, 51 AND 52).
JORDAN BAKER, EXAMINING ATTORNEY

CLASS 3—(Continued).

SN 85-580,527. LARRY WILLIAMS & ASSOCIATES, INC., CARLSBAD, CA. FILED 3-27-2012.

SHEER CONCEPTS

THE MARK CONSISTS OF STANDARD CHARACTERS WITHOUT CLAIM TO ANY PARTICULAR FONT, STYLE, SIZE, OR COLOR.

FOR HAIR STYLING PREPARATIONS; HAIR STYLING GEL; HAIR STYLING SPRAY (U.S. CLS. 1, 4, 6, 50, 51 AND 52).

JORDAN BAKER, EXAMINING ATTORNEY

CLASS 3—(Continued).

SN 85-595,764. NAIL ALLIANCE, LLC, GLADSTONE, MO. FILED 4-12-2012.

MAGNETO

THE MARK CONSISTS OF STANDARD CHARACTERS WITHOUT CLAIM TO ANY PARTICULAR FONT, STYLE, SIZE, OR COLOR.

FOR NAIL CARE PREPARATIONS (U.S. CLS. 1, 4, 6, 50, 51 AND 52).

FIRST USE 1-31-2012; IN COMMERCE 1-31-2012.
JAMES GRIFFIN, EXAMINING ATTORNEY

SN 85-585,398. JENUWINE ARTICLES, INC., TROY, MI. FILED 3-30-2012.

SURFACE STRIKE

THE MARK CONSISTS OF STANDARD CHARACTERS WITHOUT CLAIM TO ANY PARTICULAR FONT, STYLE, SIZE, OR COLOR.

FOR NON-TOXIC BOAT HULL CLEANER (U.S. CLS. 1, 4, 6, 50, 51 AND 52).

FIRST USE 1-1-2012; IN COMMERCE 1-1-2012.
LINDA E. BLOHM, EXAMINING ATTORNEY

SN 85-976,711. THEOCORP HOLDING COMPANY, LLC, METAIRIE, LA. FILED 9-14-2011.

OUT WITH THE OLD...IN WITH RENNOU

THE MARK CONSISTS OF STANDARD CHARACTERS WITHOUT CLAIM TO ANY PARTICULAR FONT, STYLE, SIZE, OR COLOR.

FOR DENTAL CARE PRODUCTS, NAMELY, TOOTH-PASTE HAVING COMPOUNDS CONTAINING NATURAL OR SYNTHESIZED THEOBROMINE (U.S. CLS. 1, 4, 6, 50, 51 AND 52).

FIRST USE 1-2-2012; IN COMMERCE 1-2-2012.
MAYUR VAGHANI, EXAMINING ATTORNEY

SN 85-589,692. JESSICA COSMETICS INTERNATIONAL, INC., NORTH HOLLYWOOD, CA. FILED 4-5-2012.

PEDICURE IN A FLASH

THE MARK CONSISTS OF STANDARD CHARACTERS WITHOUT CLAIM TO ANY PARTICULAR FONT, STYLE, SIZE, OR COLOR.

NO CLAIM IS MADE TO THE EXCLUSIVE RIGHT TO USE "PEDICURE", APART FROM THE MARK AS SHOWN.

FOR CUTICLE CONDITIONERS; CUTICLE CREAM; NAIL CARE PREPARATIONS; NAIL CARE PREPARATIONS, NAMELY, NAIL SOFTENERS; NAIL ENAMEL; NAIL ENAMEL REMOVERS; NAIL HARDENERS; NAIL POLISH; NAIL POLISH BASE COAT; NAIL POLISH REMOVERS; NAIL STRENGTHENERS; NON-MEDICATED SKIN CARE PREPARATIONS; NON-MEDICATED NAIL CARE PREPARATIONS (U.S. CLS. 1, 4, 6, 50, 51 AND 52).

LINDA LAVACHE, EXAMINING ATTORNEY

CLASS 4—LUBRICANTS AND FUELS

SN 76-710,307. SANTINA, VERGINIA DELLA, DBA ANTONINO AJELLO & BROS. HOUSE OF CANDLES, CULVER CITY, CA. FILED 1-19-2012.

ANTONINO AJELLO & BROS. HOUSE OF CANDLES

THE MARK CONSISTS OF STANDARD CHARACTERS WITHOUT CLAIM TO ANY PARTICULAR FONT, STYLE, SIZE, OR COLOR.

THE NAME "ANTONINO AJELLO" DOES NOT IDENTIFY A LIVING INDIVIDUAL.

FOR CANDLES (U.S. CLS. 1, 6 AND 15).
FIRST USE 11-0-1940; IN COMMERCE 11-0-1940.
AMEEN IMAM, EXAMINING ATTORNEY

CLASS 4—(Continued).

SN 77-915,532. GENERAL MOTORS LLC, DETROIT, MI.
FILED 1-20-2010.

TOP TIER

THE MARK CONSISTS OF STANDARD CHARACTERS
WITHOUT CLAIM TO ANY PARTICULAR FONT, STYLE,
SIZE, OR COLOR.
SEC. 2(F).
FOR GASOLINE (U.S. CLS. 1, 6 AND 15).
FIRST USE 9-1-2004; IN COMMERCE 9-1-2004.
HANNO RITTFNER, EXAMINING ATTORNEY

SN 79-107,356. HROVAL ROBERT, SLOVENIA, FILED 11-11-
2011.



PRIORITY DATE OF 5-12-2011 IS CLAIMED.
OWNER OF INTERNATIONAL REGISTRATION 1102148
DATED 11-11-2011, EXPIRES 11-11-2021.
THE MARK CONSISTS OF THE WORDING "EASYCAN-
DLE" IN STYLIZED TEXT TO THE RIGHT OF A FANCIFUL
FLAME DESIGN.
FOR CANDLES AND WICKS FOR CANDLES FOR
LIGHTING; CANDLES; GRAVEYARD CANDLES; TA-
PERS; PERFUMED CANDLES; CHRISTMAS TREE CAN-
DLES; WICKS FOR CANDLES; WAX (U.S. CLS. 1, 6 AND
15).
SHANNON TWOHIG, EXAMINING ATTORNEY

SN 85-186,432. COSMETIC WARRIORS LTD., POOLE, DOR-
SET BH15 1AB, UNITED KINGDOM, FILED 11-29-2010.

LUSH

THE MARK CONSISTS OF STANDARD CHARACTERS
WITHOUT CLAIM TO ANY PARTICULAR FONT, STYLE,
SIZE, OR COLOR.
OWNER OF U.S. REG. NOS. 2,282,428, 3,001,303 AND
OTHERS.
FOR CANDLES (U.S. CLS. 1, 6 AND 15).
JOHN GARTNER, EXAMINING ATTORNEY

CLASS 4—(Continued).

SN 85-452,675. SOUTH BEACH CANDLE COMPANY, INC.,
HIALEAH, FL. FILED 10-20-2011.

A Blend For You To Be

THE MARK CONSISTS OF STANDARD CHARACTERS
WITHOUT CLAIM TO ANY PARTICULAR FONT, STYLE,
SIZE, OR COLOR.
FOR CANDLES; PERFUMED CANDLES; SCENTED
CANDLES; SCENTED WAX FOR USE IN CANDLE
WARMERS (U.S. CLS. 1, 6 AND 15).
FIRST USE 9-1-2011; IN COMMERCE 9-1-2011.
HEATHER BIDDULPH, EXAMINING ATTORNEY

SN 85-455,028. SOUTH BEACH CANDLE COMPANY, INC.,
HIALEAH, FL. FILED 10-24-2011.

Best Friends

THE MARK CONSISTS OF STANDARD CHARACTERS
WITHOUT CLAIM TO ANY PARTICULAR FONT, STYLE,
SIZE, OR COLOR.
FOR CANDLES; PERFUMED CANDLES; SCENTED
CANDLES; SCENTED WAX FOR USE IN CANDLE
WARMERS (U.S. CLS. 1, 6 AND 15).
FIRST USE 9-1-2011; IN COMMERCE 9-1-2011.
HEATHER BIDDULPH, EXAMINING ATTORNEY

SN 85-456,262. SOUTH BEACH CANDLE COMPANY, INC.,
HIALEAH, FL. FILED 10-26-2011.

Clean Sensations

THE MARK CONSISTS OF STANDARD CHARACTERS
WITHOUT CLAIM TO ANY PARTICULAR FONT, STYLE,
SIZE, OR COLOR.
FOR CANDLES; PERFUMED CANDLES; SCENTED
CANDLES; SCENTED WAX FOR USE IN CANDLE
WARMERS (U.S. CLS. 1, 6 AND 15).
FIRST USE 8-1-2011; IN COMMERCE 8-1-2011.
HEATHER BIDDULPH, EXAMINING ATTORNEY

CLASS 4—(Continued).

SN 85-504,437. SOUTH BEACH CANDLE COMPANY, INC.,
HIALEAH, FL. FILED 12-27-2011.

Delicate Beauty

THE MARK CONSISTS OF STANDARD CHARACTERS
WITHOUT CLAIM TO ANY PARTICULAR FONT, STYLE,
SIZE, OR COLOR.

FOR AROMATHERAPY FRAGRANCE CANDLES;
CANDLES; PERFUMED CANDLES; SCENTED CAN-
DLES; SCENTED WAX FOR USE IN CANDLE WAR-
MERS (U.S. CLS. 1, 6 AND 15).

FIRST USE 9-1-2011; IN COMMERCE 10-1-2011.
HEATHER BIDDULPH, EXAMINING ATTORNEY

CLASS 4—(Continued).

SN 85-531,701. AUNT SADIE'S, INC., LUNENBURG, VT.
FILED 2-2-2012.

AUNT SADIE'S

THE MARK CONSISTS OF STANDARD CHARACTERS
WITHOUT CLAIM TO ANY PARTICULAR FONT, STYLE,
SIZE, OR COLOR.

FOR CANDLES (U.S. CLS. 1, 6 AND 15).
FIRST USE 11-1-1997; IN COMMERCE 11-1-1997.
HOWARD SMIGA, EXAMINING ATTORNEY

SN 85-535,690. M & J SUNSHINE, CORP., MEDLEY, FL.
FILED 2-7-2012.

valgab

THE MARK CONSISTS OF STANDARD CHARACTERS
WITHOUT CLAIM TO ANY PARTICULAR FONT, STYLE,
SIZE, OR COLOR.

FOR MOTOR OIL (U.S. CLS. 1, 6 AND 15).
FIRST USE 10-1-2011; IN COMMERCE 10-1-2011.
MIDGE BUTLER, EXAMINING ATTORNEY

SN 85-536,417. AMYRIS, INC., EMERYVILLE, CA. FILED 2-
7-2012.

EVOSHIELD

THE MARK CONSISTS OF STANDARD CHARACTERS
WITHOUT CLAIM TO ANY PARTICULAR FONT, STYLE,
SIZE, OR COLOR.

FOR BASE OILS AND INDUSTRIAL LUBRICANTS
(U.S. CLS. 1, 6 AND 15).
GEOFFREY FOSDICK, EXAMINING ATTORNEY

SN 85-519,381. MAURER, IRVING K., AKA I.K. MAURER
SALES, INC., EL CAJON, CA. FILED 1-18-2012.

Test
1
Chain Lubricant

NO CLAIM IS MADE TO THE EXCLUSIVE RIGHT TO
USE "CHAIN LUBRICANT", APART FROM THE MARK AS
SHOWN.

THE COLOR(S) BLUE AND BLACK IS/ARE CLAIMED AS
A FEATURE OF THE MARK.

THE MARK CONSISTS OF THE WORD "TEST" WITH A
BLUE "T" AND BLACK "EST", WITH A NUMERIC "1"
CENTERED UNDERNEATH ALSO IN BLACK. THE LET-
TERS IN THE WORD "TEST" IS WRITTEN IN TWO
ASCENDING FROM THE "T" AND THEN ONE DESCEND-
ING IN HEIGHT. THE TOP OF THE NUMERIC "1" IS
NESTLED UNDER THE "E" AND THE "S" OF THE WORD
"TEST". THE WORDS "CHAIN LUBRICANT" ARE WRIT-
TEN IN BLACK BELOW IN SKEWED LETTERING SLANT-
ING DESCENDING UNDERNEATH THE "TEST 1"
LETTERING.

FOR CHAIN LUBRICANT (U.S. CLS. 1, 6 AND 15).
FIRST USE 12-1-2010; IN COMMERCE 12-1-2010.
BRIDGETT SMITH, EXAMINING ATTORNEY

CLASS 4—(Continued).

SN 85-539,415. ABERCROMBIE & FITCH TRADING CO.,
NEW ALBANY, OH. FILED 2-10-2012.

SOCAL

THE MARK CONSISTS OF STANDARD CHARACTERS
WITHOUT CLAIM TO ANY PARTICULAR FONT, STYLE,
SIZE, OR COLOR.

OWNER OF U.S. REG. NO. 3,450,430.
FOR CANDLES (U.S. CLS. 1, 6 AND 15).
KATHERINE CHANG, EXAMINING ATTORNEY

CLASS 5—(Continued).

SN 76-709,784. HERAEUS KULZER GMBH, D-63450 HANAU,
FED REP GERMANY, FILED 11-18-2011.

XANTASIL

THE MARK CONSISTS OF STANDARD CHARACTERS
WITHOUT CLAIM TO ANY PARTICULAR FONT, STYLE,
SIZE, OR COLOR.

PRIORITY CLAIMED UNDER SEC. 44(D) ON FED REP
GERMANY APPLICATION NO. 302011056688, FILED 10-17-
2011, REG. NO. 302011056688, DATED 12-7-2011, EXPIRES 10-
31-2021.

FOR CHEMICAL PRODUCTS FOR DENTAL AND
DENTAL TECHNOLOGY PURPOSES, NAMELY, DEN-
TAL IMPRESSION MATERIAL (U.S. CLS. 6, 18, 44, 46, 51
AND 52).

ANTHONY RINKER, EXAMINING ATTORNEY

SN 77-236,192. KOWA PHARMACEUTICALS AMERICA,
INC., MONTGOMERY, AL. FILED 7-23-2007.

CLASS 5—PHARMACEUTICALS

SN 76-472,341. KERTELS, PETER, FOEHREN, FED REP
GERMANY, FILED 12-4-2002.



OWNER OF U.S. REG. NOS. 3,697,337 AND 4,010,690.
COLOR IS NOT CLAIMED AS A FEATURE OF THE
MARK.

THE MARK CONSISTS OF THE DESIGN OF A HUMAN
BACK AND BUTTOCKS. THE BROKEN LINES IN THE
DRAWING ARE NOT PART OF THE MARK, BUT SERVE
TO SHOW THE POSITION OF THE MARK.

FOR GELS FOR USE AS PERSONAL LUBRICANTS;
PERSONAL LUBRICANT GELS CONTAINING SKIN
CONDITIONERS AND SKIN MOISTURIZERS (U.S.
CLS. 6, 18, 44, 46, 51 AND 52).

FIRST USE 11-0-1995; IN COMMERCE 11-0-1995.
LESLIE RICHARDS, EXAMINING ATTORNEY

QCERA

THE MARK CONSISTS OF STANDARD CHARACTERS
WITHOUT CLAIM TO ANY PARTICULAR FONT, STYLE,
SIZE, OR COLOR.

FOR HEADACHE TREATMENT PREPARATIONS; MI-
GRAINE TREATMENT PREPARATIONS; PAIN RELIEF
MEDICATION (U.S. CLS. 6, 18, 44, 46, 51 AND 52).

WENDY JUN, EXAMINING ATTORNEY

SN 77-792,744. NATURAL FACTORS NUTRITIONAL PRO-
DUCTS LTD., COQUITLAM, BC, CANADA, FILED 7-29-
2009.

GLUCOMODERX

THE MARK CONSISTS OF STANDARD CHARACTERS
WITHOUT CLAIM TO ANY PARTICULAR FONT, STYLE,
SIZE, OR COLOR.

PRIORITY CLAIMED UNDER SEC. 44(D) ON CANADA
APPLICATION NO. 1446555, FILED 7-29-2009, REG. NO.
TMA823,217, DATED 5-2-2012, EXPIRES 5-2-2027.

FOR DIETARY AND NUTRITIONAL SUPPLEMENTS
(U.S. CLS. 6, 18, 44, 46, 51 AND 52).

SEAN CROWLEY, EXAMINING ATTORNEY

CLASS 5—(Continued).

SN 77-792,760. NATURAL FACTORS NUTRITIONAL PRODUCTS LTD., COQUITLAM, BC, CANADA, FILED 7-29-2009.

DETOXICLEANSE

THE MARK CONSISTS OF STANDARD CHARACTERS WITHOUT CLAIM TO ANY PARTICULAR FONT, STYLE, SIZE, OR COLOR.

PRIORITY CLAIMED UNDER SEC. 44(D) ON CANADA APPLICATION NO. 1446560, FILED 7-29-2009, REG. NO. TMA821,138, DATED 3-30-2012, EXPIRES 3-30-2027.

FOR DIETARY AND NUTRITIONAL SUPPLEMENTS (U.S. CLS. 6, 18, 44, 46, 51 AND 52).
SEAN CROWLEY, EXAMINING ATTORNEY

SN 77-797,008. NATURAL FACTORS NUTRITIONAL PRODUCTS LTD., COQUITLAM, BC, CANADA, FILED 8-4-2009.

BIOLIVX

THE MARK CONSISTS OF STANDARD CHARACTERS WITHOUT CLAIM TO ANY PARTICULAR FONT, STYLE, SIZE, OR COLOR.

PRIORITY CLAIMED UNDER SEC. 44(D) ON CANADA APPLICATION NO. 1447089, FILED 8-4-2009, REG. NO. TMA794,764, DATED 4-6-2011, EXPIRES 4-6-2026.

FOR DIETARY AND NUTRITIONAL SUPPLEMENTS (U.S. CLS. 6, 18, 44, 46, 51 AND 52).
SEAN CROWLEY, EXAMINING ATTORNEY

SN 79-101,152. BUILDING APS, DK-2930 KLAMPENBORG, DENMARK, FILED 7-7-2011.

QUA

THE MARK CONSISTS OF STANDARD CHARACTERS WITHOUT CLAIM TO ANY PARTICULAR FONT, STYLE, SIZE, OR COLOR.

OWNER OF INTERNATIONAL REGISTRATION 1087056 DATED 7-7-2011, EXPIRES 7-7-2021.

FOR SANITARY PREPARATIONS FOR MEDICAL USE; DIETETIC SUBSTANCES, NAMELY, FOODS AND BEVERAGES ADAPTED FOR MEDICAL USE, FOOD FOR BABIES; PLASTERS FOR MEDICAL PURPOSES, MATERIALS FOR DRESSINGS, NAMELY, BANDAGES AND GAUZES FOR DRESSINGS; MATERIAL FOR STOPPING TEETH, DENTAL WAX; ALL-PURPOSE DISINFECTANTS (U.S. CLS. 6, 18, 44, 46, 51 AND 52).
CARYN GLASSER, EXAMINING ATTORNEY

CLASS 5—(Continued).

SN 79-102,223. BIORGANIC PHARMA, S.L., SPAIN, FILED 7-1-2011.



OWNER OF INTERNATIONAL REGISTRATION 1089824 DATED 7-1-2011, EXPIRES 7-1-2021.

THE COLOR(S) BROWN, BLUE, GREEN AND WHITE IS/ARE CLAIMED AS A FEATURE OF THE MARK.

THE MARK CONSISTS OF THE FOLLOWING: THE WORDING "EOPHY" WHERE ALL OF THE LETTERS EXCEPT FOR "O" ARE BROWN AND "O" IS BLUE ON THE TOP, WHITE IN THE CENTER AND FILLED WITH GREEN AT THE BOTTOM.

FOR PHARMACEUTICAL PREPARATIONS FOR USE IN DERMATOLOGY; MEDICINAL TEAS; MEDICINAL HERBS; MEDICINAL HERBAL TEAS; LAXATIVES; MINERAL FOOD SUPPLEMENTS; DIETETIC FOOD AND SUGAR ADAPTED FOR MEDICAL USE; DIETETIC FOODS ADAPTED FOR MEDICAL PURPOSES; DIETETIC BEVERAGES ADAPTED FOR MEDICAL PURPOSES (U.S. CLS. 6, 18, 44, 46, 51 AND 52).

REBECCA POVARCHUK, EXAMINING ATTORNEY

SN 79-102,459. MICRO MEGA INTERNATIONAL MANUFACTURES, F-25000 BESANCON, FRANCE, FILED 7-19-2011.

MM-MTA

PRIORITY DATE OF 5-26-2011 IS CLAIMED.
OWNER OF INTERNATIONAL REGISTRATION 1090512 DATED 7-19-2011, EXPIRES 7-19-2021.

NO CLAIM IS MADE TO THE EXCLUSIVE RIGHT TO USE "MTA", APART FROM THE MARK AS SHOWN.

FOR ROOT CANAL FILLING PRODUCTS FOR DENTAL PURPOSES, PARTICULARLY ROOT CANAL FILLING CEMENT (U.S. CLS. 6, 18, 44, 46, 51 AND 52).
DAVID HOFFMAN, EXAMINING ATTORNEY

CLASS 5—(Continued).

SN 79-103,145. LOHMANN ANIMAL HEALTH GMBH, FED REP GERMANY, FILED 7-5-2011.

Siderozyme

THE MARK CONSISTS OF STANDARD CHARACTERS WITHOUT CLAIM TO ANY PARTICULAR FONT, STYLE, SIZE, OR COLOR.

PRIORITY DATE OF 6-29-2011 IS CLAIMED.

OWNER OF INTERNATIONAL REGISTRATION 1092331 DATED 7-5-2011, EXPIRES 7-5-2021.

FOR PHARMACEUTICAL AND VETERINARY PREPARATIONS, NAMELY, FOR ANTI-BACTERIAL MEDICATION; PREPARATIONS FOR DESTROYING VERMIN; FUNGICIDES; HERBICIDES; ALGICIDES; AMINO ACIDS FOR VETERINARY PURPOSES; ANTI-BIOTICS; MEDICINES FOR VETERINARY PURPOSES, NAMELY, MEDICINES FOR TREATMENT OF INFECTIONS; BACTERIAL PREPARATIONS FOR VETERINARY PURPOSES; CHEMICAL PREPARATIONS FOR VETERINARY PURPOSES; ENZYMES FOR VETERINARY PURPOSES; ENZYME PREPARATIONS FOR VETERINARY PURPOSES; GREASES FOR VETERINARY PURPOSES; ANTIPARASITIC COLLARS FOR ANIMALS; ANTIPARASITIC PREPARATIONS; VITAMIN PREPARATIONS; VACCINES; FOODSTUFF ADDITIVES FOR MEDICAL AND VETERINARY PURPOSES; ADDITIVES TO FODDER FOR MEDICAL AND VETERINARY PURPOSES; AIR PURIFYING PREPARATIONS; SOIL-STERILIZING PREPARATIONS (U.S. CLS. 6, 18, 44, 46, 51 AND 52).

KIMBERLY FRYE, EXAMINING ATTORNEY

SN 79-104,375. IL YANG PHARMACEUTICAL CO., LTD, REPUBLIC OF KOREA, FILED 7-29-2011.

SUPECT

OWNER OF INTERNATIONAL REGISTRATION 1095326 DATED 7-29-2011, EXPIRES 7-29-2021.

THE WORD(S) "SUPECT" HAS NO MEANING IN A FOREIGN LANGUAGE.

FOR ANTI-VIRUS PHARMACEUTICAL PREPARATIONS, NAMELY, ANTIVIRALS; DIAGNOSTIC PREPARATIONS FOR MEDICAL PURPOSES; ANTI-INFLAMMATORY PREPARATIONS; FEBRIFUGES; ALLERGY MEDICATIONS; PHARMACEUTICAL PRODUCTS FOR TREATING RESPIRATORY DISEASES; PHARMACEUTICAL PREPARATIONS FOR TREATING DIGESTIVE DISEASES; HORMONES FOR MEDICAL PURPOSES; MEDICINES FOR NUTRIENTS; INSECTICIDES; DIARRHEA MEDICINES; PHARMACEUTICAL PREPARATIONS FOR EPIDERMIS; MEDICINES FOR ATOPIC DERMATITIS; PHARMACEUTICAL PREPARATIONS FOR SKIN CARE; PHARMACEUTICAL PREPARATIONS FOR SKIN REGENERATION; ANTI-AGING PREPARATIONS FOR SKIN FOR MEDICAL PURPOSES; AMINO ACIDS FOR MEDICAL PURPOSES; VITAMIN PREPARATIONS; CARDIOVASCULAR PHARMACEUTICALS; MEDICINES FOR CEREBROVASCULAR DISEASES; MEDICINES FOR MENOPAUSAL DISORDERS; MEDICINES FOR LEUKEMIA; ANTI-CANCER PREPARATIONS; PHARMACEUTICAL PREPARATIONS ACTING ON THE CENTRAL NERVOUS SYSTEM (U.S. CLS. 6, 18, 44, 46, 51 AND 52).

JAMES STEIN, EXAMINING ATTORNEY

CLASS 5—(Continued).

SN 79-108,495. PROBIONOV, FRANCE, FILED 9-15-2011.

IMMUNIO

THE MARK CONSISTS OF STANDARD CHARACTERS WITHOUT CLAIM TO ANY PARTICULAR FONT, STYLE, SIZE, OR COLOR.

PRIORITY DATE OF 5-5-2011 IS CLAIMED.

OWNER OF INTERNATIONAL REGISTRATION 1105096 DATED 9-15-2011, EXPIRES 9-15-2021.

THE WORDING "IMMUNIO" HAS NO MEANING IN A FOREIGN LANGUAGE.

FOR DIETARY SUPPLEMENTS IN THE NATURE OF NUTRITIONAL ADDITIVES FOR MEDICAL USE; MEDICAL NUTRITIONAL SUPPLEMENTS TAKEN BY MOUTH; FOODSTUFFS, DIETETIC SUGAR FOR MEDICAL USE; NUTRITIONALLY FORTIFIED BEVERAGES; FOODSTUFFS FOR MEDICAL USE, NAMELY, DIETETIC SUGAR; VITAMIN PREPARATIONS; MINERAL FOOD-SUPPLEMENTS; PHARMACEUTICAL AND SANITARY PREPARATIONS FOR MEDICAL USE FOR FIGHTING AGAINST VIRAL AND BACTERIAL INFECTIONS AND/OR IMPROVING THE EFFECTS OF VACCINATIONS; PHARMACEUTICAL AND SANITARY PREPARATIONS FOR MEDICAL USE FOR FIGHTING AGAINST RESPIRATORY AND GASTRO-INTESTINAL INFECTIONS; PHARMACEUTICAL AND SANITARY PREPARATIONS FOR MEDICAL USE FOR STIMULATING THE IMMUNE DEFENSE; MEDICINES AND MEDICAL PREPARATIONS, NAMELY, FREEZE-DRIED BACTERIA USED FOR PRODUCING BIOLOGICAL PREPARATIONS FOR USE IN TREATMENTS IN HUMANS FOR VIRAL, GASTRO-INTESTINAL AND BACTERIAL INFECTIONS AND/OR FOR IMPROVING THE EFFECTS OF VACCINATION; ANTI-FUNGAL AND/OR ANTI-BIOTIC PREPARATIONS; DISINFECTANTS FOR USE IN THE SANITARY FOLLOW-UP OF PATIENTS SUFFERING FROM INFECTIONS; APPETITE SUPPRESSANTS; MINERAL ENHANCED WATERS FOR MEDICAL PURPOSES; MEDICAL PREPARATIONS FOR SLIMMING PURPOSES; REDUCING TEA FOR MEDICAL PURPOSES; MILK FERMENTS FOR PHARMACEUTICAL PURPOSES; DIETARY SUPPLEMENTS IN THE NATURE OF NON-NUTRITIVE EDIBLE PLANT FIBERS; DIETARY SUPPLEMENTS IN THE FORM OF GELATIN FOR MEDICAL PURPOSES; ROYAL JELLY FOR MEDICAL PURPOSES; HOMEOPATHIC SUPPLEMENTS; MEDICATED MOUTHWASHES; MEDICINAL INFUSIONS FOR TREATING INTESTINAL DISORDERS, VAGINAL DISORDERS; MEDICINAL PLANT EXTRACTS; VACCINES; LACTOSE FOR MEDICAL PURPOSES; EXTRACTS OF HOPS FOR PHARMACEUTICAL USE; ALBUMEN FOR MEDICAL USE; STARCH FOR DIETETIC OR PHARMACEUTICAL USE; DIETETIC SUGAR, MALT, LECITHIN, YEAST FOR MEDICAL USE PURPOSES; BABY FOOD; PHARMACEUTICAL PREPARATIONS FOR THE TREATMENT OF INTESTINAL DISORDERS, VAGINAL DISORDERS, THE AFOREMENTIONED IN THE FORM OF WAFERS, PASTILS, SACHETS, HARD GELATIN CAPSULES, AND SYRUPS; MEDICINES FOR THE TREATMENT OF INTESTINAL DISORDERS, VAGINAL DISORDERS, THE AFOREMENTIONED NOT WATER SOLUBLE AND ADMINISTERED IN SUSPENSION FORM TO BE SHAKEN FOR BLENDING BEFORE ABSORPTION (U.S. CLS. 6, 18, 44, 46, 51 AND 52).

ELI HELLMAN, EXAMINING ATTORNEY

CLASS 5—(Continued).

SN 85-011,113. VLADIMIR BADMAEV, STATEN ISLAND, NY. FILED 4-10-2010.

TISANAX

THE MARK CONSISTS OF STANDARD CHARACTERS WITHOUT CLAIM TO ANY PARTICULAR FONT, STYLE, SIZE, OR COLOR.

FOR DIETARY AND NUTRITIONAL SUPPLEMENTS (U.S. CLS. 6, 18, 44, 46, 51 AND 52).

FIRST USE 6-15-1986; IN COMMERCE 6-15-1986.
RAMONA ORTIGA, EXAMINING ATTORNEY

SN 85-151,498. ECO ANIMAL HEALTH LIMITED, LONDON, UNITED KINGDOM, FILED 10-13-2010.

ECO ANIMAL HEALTH

THE MARK CONSISTS OF STANDARD CHARACTERS WITHOUT CLAIM TO ANY PARTICULAR FONT, STYLE, SIZE, OR COLOR.

OWNER OF ERPN CMNTY TM OFC REG. NO. 009803511, DATED 2-6-2012, EXPIRES 3-11-2021.

NO CLAIM IS MADE TO THE EXCLUSIVE RIGHT TO USE "ANIMAL HEALTH", APART FROM THE MARK AS SHOWN.

FOR VETERINARY PREPARATIONS, NAMELY, POWDERS, SOLUTIONS, PASTES AND PRE-MIXES FOR THE TREATMENT OF PNEUMONIA IN LIVESTOCK AND COMPANION ANIMALS; VETERINARY PREPARATIONS, NAMELY, POWDERS, SOLUTIONS, PASTES AND PRE-MIXES FOR THE TREATMENT OF ENTERIC DISEASES IN LIVESTOCK AND COMPANION ANIMALS; ANTIBIOTICS FOR THE TREATMENT OF LIVESTOCK AND COMPANION ANIMALS; VETERINARY PREPARATIONS, NAMELY, POWDERS, SOLUTIONS, PASTES AND PRE-MIXES FOR THE CONTROL OF PARASITES IN LIVESTOCK AND COMPANION ANIMALS; VETERINARY PREPARATIONS, NAMELY, POWDERS, SOLUTIONS, PASTES AND PRE-MIXES FOR THE TREATMENT OF E-COLI IN LIVESTOCK AND COMPANION ANIMALS; VETERINARY PREPARATIONS, NAMELY, POWDERS, SOLUTIONS, PASTES AND PRE-MIXES FOR THE TREATMENT OF RESPIRATORY INFECTIONS IN LIVESTOCK AND COMPANION ANIMALS; VETERINARY PREPARATIONS, NAMELY, POWDERS, SOLUTIONS, PASTES AND PRE-MIXES FOR THE TREATMENT OF GALL SICKNESS, HEART WATER, FOOT ROT IN LIVESTOCK AND COMPANION ANIMALS; FUNGICIDES, GERMICIDES, BACTERICIDES, VIRUCIDES, INSECTICIDES; FOOD SUPPLEMENTS FOR ANIMALS, NAMELY, SUPPLEMENTS FOR THE TREATMENT OF RESPIRATORY AND ENTERIC DISEASE IN LIVESTOCK AND COMPANION ANIMALS; FOOD SUPPLEMENTS FOR ANIMALS, NAMELY, SUPPLEMENTS FOR THE TREATMENT OF PARASITES IN LIVESTOCK AND COMPANION ANIMALS; FOOD SUPPLEMENTS FOR ANIMALS, NAMELY, SUPPLEMENTS TO ENHANCE THE GROWTH OF LIVESTOCK AND COMPANION ANIMALS (U.S. CLS. 6, 18, 44, 46, 51 AND 52).

ANDREA HACK, EXAMINING ATTORNEY

CLASS 5—(Continued).

SN 85-178,718. TGR BIOSCIENCES PTY LTD, THEBARTON, AUSTRALIA, FILED 11-17-2010.

SUREFIRE ULTRA

THE MARK CONSISTS OF STANDARD CHARACTERS WITHOUT CLAIM TO ANY PARTICULAR FONT, STYLE, SIZE, OR COLOR.

OWNER OF AUSTRALIA REG. NO. 1367588, DATED 1-31-2011, EXPIRES 6-17-2020.

OWNER OF U.S. REG. NO. 3,228,037.

FOR DIAGNOSTIC PREPARATIONS AND REAGENTS FOR MEDICAL USE; DIAGNOSTIC TESTING KITS CONSISTING OF DIAGNOSTIC PREPARATIONS AND REAGENTS FOR USE IN MEASURING PROTEINS IN PATIENT SAMPLES AND FOR MEASURING PROTEIN LEVELS IN HUMAN BODY FLUIDS (U.S. CLS. 6, 18, 44, 46, 51 AND 52).

JEFFREY LOOK, EXAMINING ATTORNEY

SN 85-184,813. TEST LABORATORIES, INC., RESEDA, CA. FILED 11-24-2010.

INGREDIENTS BY NATURE

THE MARK CONSISTS OF STANDARD CHARACTERS WITHOUT CLAIM TO ANY PARTICULAR FONT, STYLE, SIZE, OR COLOR.

NO CLAIM IS MADE TO THE EXCLUSIVE RIGHT TO USE "INGREDIENTS", APART FROM THE MARK AS SHOWN.

FOR BIOFLAVONOIDS, CITRUS DERIVATIVES, CITRUS CONCENTRATES, FOOD HERBS AND POWDERS FOR USE AS NUTRITIONAL SUPPLEMENTS (U.S. CLS. 6, 18, 44, 46, 51 AND 52).

TARA PATE, EXAMINING ATTORNEY

SN 85-199,743. COPPER BRITE, INC., SANTA BARBARA, CA. FILED 12-16-2010.

Termite Prufe

THE MARK CONSISTS OF STANDARD CHARACTERS WITHOUT CLAIM TO ANY PARTICULAR FONT, STYLE, SIZE, OR COLOR.

OWNER OF U.S. REG. NO. 2,349,893.

NO CLAIM IS MADE TO THE EXCLUSIVE RIGHT TO USE "TERMITE", APART FROM THE MARK AS SHOWN. SEC. 2(F).

FOR INSECTICIDAL AND FUNGICIDAL PREPARATION FOR DESTROYING TERMITES FOR DOMESTIC USE (U.S. CLS. 6, 18, 44, 46, 51 AND 52).

FIRST USE 5-12-1998; IN COMMERCE 5-12-1998.

CHARLES L. JENKINS, EXAMINING ATTORNEY

CLASS 5—(Continued).

SN 85-225,275. L. PERRIGO COMPANY, ALLEGAN, MI.
FILED 1-25-2011.



THE MARK CONSISTS OF THE WORD "PRO-TECT" WITH CONCENTRIC CIRCLES IN A SHIELD IN PLACE OF THE "O".
FOR OVER-THE-COUNTER MEDICATIONS, NAMELY, ORAL ANALGESICS FOR INFANTS (U.S. CLS. 6, 18, 44, 46, 51 AND 52).
BILL DAWE, EXAMINING ATTORNEY

SN 85-269,865. PAUL CONYETTE, WINNIPEG, MANITOBA,
CANADA, FILED 3-17-2011.

SMACK

THE MARK CONSISTS OF STANDARD CHARACTERS WITHOUT CLAIM TO ANY PARTICULAR FONT, STYLE, SIZE, OR COLOR.
PRIORITY CLAIMED UNDER SEC. 44(D) ON CANADA APPLICATION NO. 1519588, FILED 3-17-2011, REG. NO. TMA822,612, DATED 4-20-2012, EXPIRES 4-20-2027.
FOR MOSQUITO REPELLANT (U.S. CLS. 6, 18, 44, 46, 51 AND 52).
NELSON SNYDER, EXAMINING ATTORNEY

SN 85-321,420. CALDWELL CONSUMER PRODUCTS, LLC,
DBA REVIVE PERSONAL PRODUCTS COMPANY, MADISON, NJ. FILED 5-16-2011.

HEALTHY BALANCE

THE MARK CONSISTS OF STANDARD CHARACTERS WITHOUT CLAIM TO ANY PARTICULAR FONT, STYLE, SIZE, OR COLOR.
NO CLAIM IS MADE TO THE EXCLUSIVE RIGHT TO USE "HEALTHY", APART FROM THE MARK AS SHOWN.
FOR MEDICATED MOUTH WASH (U.S. CLS. 6, 18, 44, 46, 51 AND 52).
PATRICIA EVANKO, EXAMINING ATTORNEY

CLASS 5—(Continued).

SN 85-324,198. VITONOMY, LLC, PHOENIX, AZ. FILED 5-18-2011.

BRAIN BUILDER

THE MARK CONSISTS OF STANDARD CHARACTERS WITHOUT CLAIM TO ANY PARTICULAR FONT, STYLE, SIZE, OR COLOR.
NO CLAIM IS MADE TO THE EXCLUSIVE RIGHT TO USE "BRAIN", APART FROM THE MARK AS SHOWN.
FOR DIETARY AND NUTRITIONAL SUPPLEMENTS (U.S. CLS. 6, 18, 44, 46, 51 AND 52).
FIRST USE 8-13-2011; IN COMMERCE 8-13-2011.
TRACY CROSS, EXAMINING ATTORNEY

SN 85-330,272. KEDRION S.P.A., BARGA, LUCCA, ITALY,
FILED 5-25-2011.

KEDBUMIN

THE MARK CONSISTS OF STANDARD CHARACTERS WITHOUT CLAIM TO ANY PARTICULAR FONT, STYLE, SIZE, OR COLOR.
FOR PHARMACEUTICAL PREPARATIONS, NAMELY, ALBUMIN FOR HUMANS FOR THE TREATMENT OF HYPOVOLEMIA AND HYPOALBUMINEMIA, PREVENTION OF CENTRAL VOLUME DEPLETION AFTER PARACENTESIS DUE TO CIRRHOTIC ASCITES, OVARIAN HYPERSTIMULATION SYNDROME (OHSS), ADULT RESPIRATORY DISTRESS SYNDROME (ARDS), BURNS, HEMODIALYSIS PATIENTS UNDERGOING LONG TERM DIALYSIS, PATIENTS WHO CANNOT TOLERATE SUBSTANTIAL VOLUMES OF SALT SOLUTION AND PRIMING AS PART OF A CARDIOPULMONARY BYPASS FLUIDS (U.S. CLS. 6, 18, 44, 46, 51 AND 52).
CAROLINE WOOD, EXAMINING ATTORNEY

SN 85-362,457. BARLEAN'S ORGANIC OILS, LLC, FERDALE, WA. FILED 7-2-2011.

Omega Smooth

THE MARK CONSISTS OF STANDARD CHARACTERS WITHOUT CLAIM TO ANY PARTICULAR FONT, STYLE, SIZE, OR COLOR.
OWNER OF U.S. REG. NO. 2,929,665.
NO CLAIM IS MADE TO THE EXCLUSIVE RIGHT TO USE "OMEGA", APART FROM THE MARK AS SHOWN.
FOR DIETARY AND NUTRITIONAL SUPPLEMENTS CONTAINING OMEGA FATTY ACIDS (U.S. CLS. 6, 18, 44, 46, 51 AND 52).
BRIAN CALLAGHAN, EXAMINING ATTORNEY

CLASS 5—(Continued).

SN 85-378,232. NUTRITION & FITNESS, INC., FAYETTEVILLE, NC. FILED 7-22-2011.

MANGOTRIM

THE MARK CONSISTS OF STANDARD CHARACTERS WITHOUT CLAIM TO ANY PARTICULAR FONT, STYLE, SIZE, OR COLOR.
FOR DIETARY SUPPLEMENTS CONTAINING MANGO (U.S. CLS. 6, 18, 44, 46, 51 AND 52).
DARRYL SPRUILL, EXAMINING ATTORNEY

SN 85-379,555. NUTRITION & FITNESS, INC., FAYETTEVILLE, NC. FILED 7-25-2011.

AFRICAN MANGOTRIM

THE MARK CONSISTS OF STANDARD CHARACTERS WITHOUT CLAIM TO ANY PARTICULAR FONT, STYLE, SIZE, OR COLOR.
FOR DIETARY SUPPLEMENTS CONTAINING AFRICAN MANGO (U.S. CLS. 6, 18, 44, 46, 51 AND 52).
DARRYL SPRUILL, EXAMINING ATTORNEY

SN 85-380,098. 1 2 8 WORLDWIDE, INC., NORTH VENICE, FL. FILED 7-25-2011.

NAKED CALORIES

THE MARK CONSISTS OF STANDARD CHARACTERS WITHOUT CLAIM TO ANY PARTICULAR FONT, STYLE, SIZE, OR COLOR.
FOR VITAMIN AND MINERAL SUPPLEMENTS (U.S. CLS. 6, 18, 44, 46, 51 AND 52).
JAMES LOVELACE, EXAMINING ATTORNEY

CLASS 5—(Continued).

SN 85-381,620. CLINICAL INNOVATIONS, LLC, MURRAY, UT. FILED 7-26-2011.

ROM +

THE MARK CONSISTS OF STANDARD CHARACTERS WITHOUT CLAIM TO ANY PARTICULAR FONT, STYLE, SIZE, OR COLOR.
NO CLAIM IS MADE TO THE EXCLUSIVE RIGHT TO USE "ROM", APART FROM THE MARK AS SHOWN.
FOR MEDICAL DIAGNOSTIC REAGENTS AND ASSAYS FOR TESTING OF BODY FLUIDS; MEDICAL DIAGNOSTIC TEST STRIPS FOR USE IN THE FIELD OF OBSTETRICS AND GYNECOLOGY FOR RUPTURE OF MEMBRANES (U.S. CLS. 6, 18, 44, 46, 51 AND 52).
FIRST USE 1-19-2012; IN COMMERCE 1-19-2012.
KATHLEEN M. VANSTON, EXAMINING ATTORNEY

SN 85-392,298. CYTOCHROMA INC., MARKHAM, ONTARIO, CANADA, FILED 8-8-2011.

REPLIDEA

THE MARK CONSISTS OF STANDARD CHARACTERS WITHOUT CLAIM TO ANY PARTICULAR FONT, STYLE, SIZE, OR COLOR.
FOR NUTRITIONAL SUPPLEMENTS, VITAMIN SUPPLEMENTS; PHARMACEUTICAL PREPARATIONS FOR THE TREATMENT OF DISEASES AND DISORDERS OF THE PARATHYROID, SECONDARY HYPER-PARATHYROIDISM, AND RENAL DISEASE; PREPARATIONS FOR THE TREATMENT OF VITAMIN D DEFICIENCY (U.S. CLS. 6, 18, 44, 46, 51 AND 52).
REBECCA POVARCHUK, EXAMINING ATTORNEY

SN 85-392,751. CYTOCHROMA INC., MARKHAM, ONTARIO, CANADA, FILED 8-8-2011.

D-REPLA

THE MARK CONSISTS OF STANDARD CHARACTERS WITHOUT CLAIM TO ANY PARTICULAR FONT, STYLE, SIZE, OR COLOR.
FOR NUTRITIONAL SUPPLEMENTS, VITAMIN SUPPLEMENTS; PHARMACEUTICAL PREPARATIONS FOR THE TREATMENT OF DISEASES AND DISORDERS OF THE PARATHYROID, SECONDARY HYPER-PARATHYROIDISM, AND RENAL DISEASE; PREPARATIONS FOR THE TREATMENT OF VITAMIN D DEFICIENCY; ALL OF THE FOREGOING CONTAINING VITAMIN D OR VITAMIN D METABOLIC DERIVATIVE (U.S. CLS. 6, 18, 44, 46, 51 AND 52).
REBECCA POVARCHUK, EXAMINING ATTORNEY

CLASS 5—(Continued).

SN 85-395,873. HIKARI HOLDINGS, L.C., VALLEY CENTER, CA. FILED 8-11-2011.

DOC BROC ROCKS

THE MARK CONSISTS OF STANDARD CHARACTERS WITHOUT CLAIM TO ANY PARTICULAR FONT, STYLE, SIZE, OR COLOR.

OWNER OF U.S. REG. NOS. 2,984,685, 3,138,676 AND 3,243,233.

FOR DIETARY AND NUTRITIONAL SUPPLEMENTS; VITAMIN AND MINERAL SUPPLEMENTS (U.S. CLS. 6, 18, 44, 46, 51 AND 52).

FIRST USE 5-1-2006; IN COMMERCE 5-1-2006.

FLORENTINA BLANDU, EXAMINING ATTORNEY

SN 85-396,522. NUTRITION & FITNESS, INC., FAYETTEVILLE, NC. FILED 8-12-2011.

MULBERRY TRIM

THE MARK CONSISTS OF STANDARD CHARACTERS WITHOUT CLAIM TO ANY PARTICULAR FONT, STYLE, SIZE, OR COLOR.

NO CLAIM IS MADE TO THE EXCLUSIVE RIGHT TO USE "MULBERRY", APART FROM THE MARK AS SHOWN.

FOR DIETARY SUPPLEMENTS CONTAINING MULBERRY (U.S. CLS. 6, 18, 44, 46, 51 AND 52).

DARRYL SPRUILL, EXAMINING ATTORNEY

SN 85-398,958. VITA ZAHNFABRIK H. RAUTER GMBH & CO. KG. BAD SACKINGEN, FED REP GERMANY, FILED 8-16-2011.

VITA ENAMIC

THE MARK CONSISTS OF STANDARD CHARACTERS WITHOUT CLAIM TO ANY PARTICULAR FONT, STYLE, SIZE, OR COLOR.

OWNER OF FED REP GERMANY REG. NO. 302010005552, DATED 4-1-2010, EXPIRES 1-30-2020.

OWNER OF U.S. REG. NOS. 873,134, 2,909,972 AND OTHERS.

FOR DENTAL CERAMICS WITH PLASTIC FRACTIONS FOR PREPARING DENTAL PROSTHESES (U.S. CLS. 6, 18, 44, 46, 51 AND 52).

CHRISTOPHER SIDOTI, EXAMINING ATTORNEY

CLASS 5—(Continued).

SN 85-411,813. GRIFOLS THERAPEUTICS, INC., RESEARCH TRIANGLE PARK, NC. FILED 8-31-2011.

PROLASTIN C

THE MARK CONSISTS OF STANDARD CHARACTERS WITHOUT CLAIM TO ANY PARTICULAR FONT, STYLE, SIZE, OR COLOR.

OWNER OF U.S. REG. NOS. 1,473,862 AND 3,536,975. FOR PHARMACEUTICAL PREPARATION, NAMELY, AN ENZYME INHIBITOR FOR PULMONARY FUNCTION (U.S. CLS. 6, 18, 44, 46, 51 AND 52).

FIRST USE 1-13-2010; IN COMMERCE 1-13-2010.

ALICE BENMAMAN, EXAMINING ATTORNEY

SN 85-428,060. SHIN, JUN SIK, SEOUL, REPUBLIC OF KOREA, FILED 9-21-2011.

YOOKGONGDAN

THE MARK CONSISTS OF STANDARD CHARACTERS WITHOUT CLAIM TO ANY PARTICULAR FONT, STYLE, SIZE, OR COLOR.

OWNER OF U.S. REG. NOS. 2,976,974, 3,151,213 AND 3,151,214.

THE WORDING "YOOKGONGDAN" HAS NO MEANING IN A FOREIGN LANGUAGE.

FOR HERBAL SUPPLEMENTS FOR INCREASING ENERGY, VIGOR AND STAMINA, AND FOR ALLEVIATING STRESS, FADING MEMORY, INSOMNIA AND OVER SENSITIVENESS (U.S. CLS. 6, 18, 44, 46, 51 AND 52).

TARAH HARDY, EXAMINING ATTORNEY

SN 85-429,454. VIRBAC, 06516 CARROS, FRANCE, FILED 9-22-2011.

ZERAMEC

THE MARK CONSISTS OF STANDARD CHARACTERS WITHOUT CLAIM TO ANY PARTICULAR FONT, STYLE, SIZE, OR COLOR.

OWNER OF FRANCE REG. NO. 033241314, DATED 8-12-2003, EXPIRES 8-13-2013.

FOR PARASITICIDES FOR VETERINARY USE (U.S. CLS. 6, 18, 44, 46, 51 AND 52).

HANNO RITTNER, EXAMINING ATTORNEY

CLASS 5—(Continued).

SN 85-429,984. HUBEI KONSON KONJAC GUM, WUHAN, HUBEI, CHINA, CHINA, FILED 9-22-2011.



THE MARK CONSISTS OF STYLIZED LETTERS "F I B E R H I".

FOR NUTRITIONAL MEAL REPLACEMENT BARS CONTAINING FIBER ADAPTED FOR MEDICAL USE FOR INDIVIDUALS UNDERGOING MEDICAL TREATMENTS; DIETARY SUPPLEMENTAL DRINKS CONTAINING FIBER; DIETARY SUPPLEMENTS IN THE NATURE OF WEIGHT LOSS POWDERS CONTAINING FIBER; HERBAL DRINKS CONTAINING FIBER USED TO AID IN SLEEP AND RELAXATION; NUTRITIONAL DRINKS FOR ANIMALS CONTAINING FIBER; NUTRITIONAL SUPPLEMENTS, NAMELY, CARBOHYDRATES IN POWDERED FORM CONTAINING FIBER; POWDERED FRUIT-FLAVORED DIETARY SUPPLEMENT DRINK MIX CONTAINING FIBER; POWDERED NUTRITIONAL SUPPLEMENT CONCENTRATE CONTAINING FIBER; POWDERED NUTRITIONAL SUPPLEMENT DRINK MIX CONTAINING FIBER; POWDERED NUTRITIONAL SUPPLEMENT DRINK MIX AND CONCENTRATE CONTAINING FIBER (U.S. CLS. 6, 18, 44, 46, 51 AND 52).

KIMBERLY PERRY, EXAMINING ATTORNEY

SN 85-444,252. WASIELEWSKI, RAY, COLUMBUS, OH. FILED 10-11-2011.



THE MARK CONSISTS OF STANDARD CHARACTERS WITHOUT CLAIM TO ANY PARTICULAR FONT, STYLE, SIZE, OR COLOR.

FOR BIOLOGICAL PREPARATIONS DERIVED FROM MAMMALIAN MOLARS FOR USE IN TRANSPLANTATION SURGERY AND THERAPY FOR TISSUE INJURY OR DEGENERATION (U.S. CLS. 6, 18, 44, 46, 51 AND 52).

SANDRA BUJA, EXAMINING ATTORNEY

CLASS 5—(Continued).

SN 85-462,092. GLYCOMYR, INC., AMES, IA. FILED 11-2-2011.



THE MARK CONSISTS OF THE PHRASE "WEAN-D", WITH THE IMAGE OF A PIGLET PROTRUDING FROM THE CENTER OF THE "D".

FOR PHARMACEUTICAL PREPARATIONS, NAMELY, VITAMIN, MINERAL, ANTI-OXIDANT, AND DIETARY SUPPLEMENT PREPARATIONS FOR USE IN VETERINARY MEDICINE, ALL CONTAINING VITAMIN D (U.S. CLS. 6, 18, 44, 46, 51 AND 52).

FIRST USE 6-22-2011; IN COMMERCE 6-22-2011.
JAMES STEIN, EXAMINING ATTORNEY

SN 85-470,168. ARCH CHEMICALS, INC., NORWALK, CT. FILED 11-11-2011.



THE MARK CONSISTS OF STANDARD CHARACTERS WITHOUT CLAIM TO ANY PARTICULAR FONT, STYLE, SIZE, OR COLOR.

OWNER OF U.S. REG. NO. 4,032,683.
FOR AQUATIC HERBICIDES (U.S. CLS. 6, 18, 44, 46, 51 AND 52).

FIRST USE 7-25-2011; IN COMMERCE 7-25-2011.
SARA BENJAMIN, EXAMINING ATTORNEY

SN 85-475,430. HEARTLAND PRODUCTS, INC., VALLEY CITY, ND. FILED 11-17-2011.

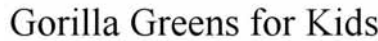

THE MARK CONSISTS OF STANDARD CHARACTERS WITHOUT CLAIM TO ANY PARTICULAR FONT, STYLE, SIZE, OR COLOR.

NO CLAIM IS MADE TO THE EXCLUSIVE RIGHT TO USE "GREENS FOR KIDS", APART FROM THE MARK AS SHOWN.

FOR DIETARY AND NUTRITIONAL SUPPLEMENTS CONTAINING GREENS (U.S. CLS. 6, 18, 44, 46, 51 AND 52).

KEVON CHISOLM, EXAMINING ATTORNEY

CLASS 5—(Continued).

SN 85-475,860. MTHFR SOLUTIONS LLC, SEATTLE, WA. FILED 11-17-2011.



NO CLAIM IS MADE TO THE EXCLUSIVE RIGHT TO USE "METHYL", APART FROM THE MARK AS SHOWN. THE COLOR(S) BLUE AND GREEN IS/ARE CLAIMED AS A FEATURE OF THE MARK.

THE MARK CONSISTS OF THE TERMS "METHYL", IN BLUE, AND "LIFE", IN GREEN, SEPARATED BY A CLUSTER OF GREEN HEXAGONS, ALL POSITIONED ABOVE THE WORDING "RESTORING CELLULAR VITALITY", IN BLUE, AND A GENETIC HELIX DESIGN, IN BLUE AND GREEN, AND POSITIONED TO THE LEFT OF A HUMAN FIGURE WITH A GREEN HEAD AND BLUE BODY.

FOR DIETARY SUPPLEMENTS FOR PROMOTING AND OPTIMIZING THE BODY'S METHYLATION PROCESSES (U.S. CLS. 6, 18, 44, 46, 51 AND 52).

FIRST USE 3-17-2012; IN COMMERCE 3-17-2012.
NAPOLEON SHARMA, EXAMINING ATTORNEY

SN 85-481,094. BRIGGS, CHERYL JEAN, SPRINGFIELD, MO. FILED 11-27-2011.



NO CLAIM IS MADE TO THE EXCLUSIVE RIGHT TO USE "HEALTH", APART FROM THE MARK AS SHOWN.

THE COLOR(S) PURPLE AND GREEN IS/ARE CLAIMED AS A FEATURE OF THE MARK.

THE MARK CONSISTS OF THE WORD "DERMA" IN PURPLE FOLLOWED BY A FEMALE FACIAL SILHOUETTE IN PURPLE FOLLOWED BY A MALE FACIAL SILHOUETTE IN GREEN AND THE WORD "HEALTH" IN PURPLE ABOVE THE WORD "CONFIDENCE" APPEARING IN GREEN.

FOR VITAMIN AND MINERAL SUPPLEMENTS (U.S. CLS. 6, 18, 44, 46, 51 AND 52).

NORA BUCHANAN WILL, EXAMINING ATTORNEY

CLASS 5—(Continued).

SN 85-485,943. AKERS BIOSCIENCES, INC., THOROFARE, NJ. FILED 12-2-2011.

PIFA PLUSS

THE MARK CONSISTS OF STANDARD CHARACTERS WITHOUT CLAIM TO ANY PARTICULAR FONT, STYLE, SIZE, OR COLOR.

OWNER OF U.S. REG. NO. 2,713,959.
SEC. 2(F) AS TO "PIFA".

FOR MEDICAL DIAGNOSTIC REAGENTS AND ASSAYS FOR TESTING OF BODY FLUIDS (U.S. CLS. 6, 18, 44, 46, 51 AND 52).

LINDA ORNDORFF, EXAMINING ATTORNEY

SN 85-495,234. CELGENE CORPORATION, SUMMIT, NJ. FILED 12-14-2011.

IMNOLVID

THE MARK CONSISTS OF STANDARD CHARACTERS WITHOUT CLAIM TO ANY PARTICULAR FONT, STYLE, SIZE, OR COLOR.

PRIORITY CLAIMED UNDER SEC. 44(D) ON SWITZERLAND APPLICATION NO. 63910/2011, FILED 12-12-2011, REG. NO. 628507, DATED 12-12-2011, EXPIRES 12-12-2021.

OWNER OF U.S. REG. NOS. 3,988,920 AND 4,045,529.

FOR PHARMACEUTICAL PREPARATIONS, NAMELY, CYTOKINE INHIBITORY DRUGS; PHARMACEUTICAL PREPARATIONS THAT MODULATE THE IMMUNE SYSTEM; PHARMACEUTICAL PREPARATIONS FOR THE TREATMENT OF CERTAIN CANCER AND BLOOD DISEASES (U.S. CLS. 6, 18, 44, 46, 51 AND 52).

BARBARA GAYNOR, EXAMINING ATTORNEY

SN 85-495,253. HCG HOT BODY LLC, SEDONA, AZ. FILED 12-14-2011.

HCG Hot Body

THE MARK CONSISTS OF STANDARD CHARACTERS WITHOUT CLAIM TO ANY PARTICULAR FONT, STYLE, SIZE, OR COLOR.

NO CLAIM IS MADE TO THE EXCLUSIVE RIGHT TO USE "HCG", APART FROM THE MARK AS SHOWN.

FOR DIETARY SUPPLEMENTS, FOR WEIGHT LOSS, CONTAINING HUMAN CHORIONIC GONADOTROPIN (HCG) (U.S. CLS. 6, 18, 44, 46, 51 AND 52).

FIRST USE 6-28-2011; IN COMMERCE 7-1-2011.

RUDY R. SINGLETON, EXAMINING ATTORNEY

CLASS 5—(Continued).

SN 85-495,285. CELGENE CORPORATION, SUMMIT, NJ.
FILED 12-14-2011.

IMNOLVYD

THE MARK CONSISTS OF STANDARD CHARACTERS WITHOUT CLAIM TO ANY PARTICULAR FONT, STYLE, SIZE, OR COLOR.

PRIORITY CLAIMED UNDER SEC. 44(D) ON SWITZERLAND APPLICATION NO. 63909/2011, FILED 12-12-2011, REG. NO. 628506, DATED 12-12-2011, EXPIRES 12-12-2021.

OWNER OF U.S. REG. NOS. 3,988,920 AND 4,045,529.
FOR PHARMACEUTICAL PREPARATIONS, NAMELY, CYTOKINE INHIBITORY DRUGS; PHARMACEUTICAL PREPARATIONS THAT MODULATE THE IMMUNE SYSTEM; PHARMACEUTICAL PREPARATIONS FOR THE TREATMENT OF CERTAIN CANCER AND BLOOD DISEASES (U.S. CLS. 6, 18, 44, 46, 51 AND 52).

BARBARA GAYNOR, EXAMINING ATTORNEY

SN 85-497,014. HAGER WORLDWIDE, INC., HICKORY, NY.
FILED 12-16-2011.

ONE TOUCH

THE MARK CONSISTS OF STANDARD CHARACTERS WITHOUT CLAIM TO ANY PARTICULAR FONT, STYLE, SIZE, OR COLOR.

FOR ORAL TOPICAL ANESTHETIC GEL SOLD EXCLUSIVELY TO DENTISTS FOR USE IN NUMBING PATIENTS' GUMS BEFORE PERFORMING ORAL PROCEDURES (U.S. CLS. 6, 18, 44, 46, 51 AND 52).

FIRST USE 12-16-1996; IN COMMERCE 12-16-1996.
DAVID ELTON, EXAMINING ATTORNEY

SN 85-497,690. ALEX JUN YANG, DBA SOLAR MINERALS,
LOS ANGELES, CA. FILED 12-16-2011.

VC 2000

THE MARK CONSISTS OF STANDARD CHARACTERS WITHOUT CLAIM TO ANY PARTICULAR FONT, STYLE, SIZE, OR COLOR.

NO CLAIM IS MADE TO THE EXCLUSIVE RIGHT TO USE "2000", APART FROM THE MARK AS SHOWN.

FOR VITAMIN AND MINERAL SUPPLEMENTS (U.S. CLS. 6, 18, 44, 46, 51 AND 52).

FIRST USE 8-1-2006; IN COMMERCE 8-1-2006.
LESLIE RICHARDS, EXAMINING ATTORNEY

CLASS 5—(Continued).

SN 85-497,741. YANG, ALEX JUN, DBA SOLAR MINERALS,
LOS ANGELES, CA. FILED 12-16-2011.

SELLA CARE

THE MARK CONSISTS OF STANDARD CHARACTERS WITHOUT CLAIM TO ANY PARTICULAR FONT, STYLE, SIZE, OR COLOR.

FOR VITAMIN AND MINERAL SUPPLEMENTS (U.S. CLS. 6, 18, 44, 46, 51 AND 52).

FIRST USE 8-1-2006; IN COMMERCE 8-1-2006.
LESLIE RICHARDS, EXAMINING ATTORNEY

SN 85-499,895. NOVARTIS AG, BASEL, SWITZERLAND,
FILED 12-20-2011.

DON'T LET HEADACHES STEAL YOUR DREAMS

THE MARK CONSISTS OF STANDARD CHARACTERS WITHOUT CLAIM TO ANY PARTICULAR FONT, STYLE, SIZE, OR COLOR.

FOR PHARMACEUTICAL PREPARATIONS FOR THE TREATMENT OF HEADACHES AND INSOMNIA (U.S. CLS. 6, 18, 44, 46, 51 AND 52).

NAKWAMA ANKRAH, EXAMINING ATTORNEY

SN 85-503,426. MINERAL RESOURCES INTERNATIONAL,
INC., DBA IONIQUE, OGDEN, UT. FILED 12-23-2011.

Sea M.D.

THE MARK CONSISTS OF STANDARD CHARACTERS WITHOUT CLAIM TO ANY PARTICULAR FONT, STYLE, SIZE, OR COLOR.

NO CLAIM IS MADE TO THE EXCLUSIVE RIGHT TO USE "M.D.", APART FROM THE MARK AS SHOWN.

FOR DIETARY AND NUTRITIONAL SUPPLEMENTS (U.S. CLS. 6, 18, 44, 46, 51 AND 52).

FIRST USE 12-23-2011, THE MARK WAS FIRST USED ANYWHERE IN A DIFFERENT FORM OTHER THAN THAT SOUGHT TO BE REGISTERED AT LEAST AS EARLY AS 07/01/2008.; IN COMMERCE 12-23-2011, THE MARK WAS FIRST USED IN COMMERCE IN A DIFFERENT FORM OTHER THAN THAT SOUGHT TO BE REGISTERED AT LEAST AS EARLY AS 07/01/2008..

MARY ROSSMAN, EXAMINING ATTORNEY

CLASS 5—(Continued).

SN 85-507,143. CRUSADOR ENTERPRISES, INC., AKA 7 LIGHTS, BLACK MOUNTAIN, NC. FILED 1-2-2012.

KING OF GREENS

THE MARK CONSISTS OF STANDARD CHARACTERS WITHOUT CLAIM TO ANY PARTICULAR FONT, STYLE, SIZE, OR COLOR.

NO CLAIM IS MADE TO THE EXCLUSIVE RIGHT TO USE "GREENS", APART FROM THE MARK AS SHOWN.

FOR DIETARY AND NUTRITIONAL SUPPLEMENTS CONTAINING GREEN FOODS AND SEA VEGETABLES (U.S. CLS. 6, 18, 44, 46, 51 AND 52).

FIRST USE 8-2-2010; IN COMMERCE 8-2-2010.
CHRIS WELLS, EXAMINING ATTORNEY

SN 85-508,541. APR APPLIED PHARMA RESEARCH, S.A., BALERNA, SWITZERLAND, FILED 1-4-2012.

SETOFILM

THE MARK CONSISTS OF STANDARD CHARACTERS WITHOUT CLAIM TO ANY PARTICULAR FONT, STYLE, SIZE, OR COLOR.

FOR PHARMACEUTICAL FILM CONTAINING DO-SAGE OF ANTIEMETIC PREPARATIONS (U.S. CLS. 6, 18, 44, 46, 51 AND 52).

SANDRA BUJA, EXAMINING ATTORNEY

SN 85-509,939. DC COMICS, NEW YORK, NY. FILED 1-5-2012.



**DC
ENTERTAINMENT**

OWNER OF U.S. REG. NOS. 736,443, 3,291,067 AND OTHERS.

THE MARK CONSISTS OF THE LETTER "D" FLIPPING BACK TO REVEAL THE LETTER "C" AND "DC ENTERTAINMENT".

FOR PHARMACEUTICALS, NAMELY, VITAMINS AND MINERAL SUPPLEMENTS; ADHESIVE BANDAGES (U.S. CLS. 6, 18, 44, 46, 51 AND 52).

WON TEAK OH, EXAMINING ATTORNEY

CLASS 5—(Continued).

SN 85-510,328. VITAL SOLUTIONS, LLC, WEST PALM BEACH, FL. FILED 1-6-2012.

VITAL SOLUTIONS

THE MARK CONSISTS OF STANDARD CHARACTERS WITHOUT CLAIM TO ANY PARTICULAR FONT, STYLE, SIZE, OR COLOR.

NO CLAIM IS MADE TO THE EXCLUSIVE RIGHT TO USE "SOLUTIONS", APART FROM THE MARK AS SHOWN.

FOR ALL PURPOSE DISINFECTANTS (U.S. CLS. 6, 18, 44, 46, 51 AND 52).
STEVEN JACKSON, EXAMINING ATTORNEY

SN 85-510,362. VITAL SOLUTIONS, LLC, WEST PALM BEACH, FL. FILED 1-6-2012.



NO CLAIM IS MADE TO THE EXCLUSIVE RIGHT TO USE "SOLUTIONS", APART FROM THE MARK AS SHOWN.

THE COLOR(S) BLUE AND GREEN IS/ARE CLAIMED AS A FEATURE OF THE MARK.

THE MARK CONSISTS OF THE WORD "VITAL" IN BLUE, THE WORD "SOLUTIONS" IN GREEN AND A GREEN LEAF ABOVE THE LETTER "I" IN THE WORD "VITAL".

FOR ALL PURPOSE DISINFECTANTS (U.S. CLS. 6, 18, 44, 46, 51 AND 52).
STEVEN JACKSON, EXAMINING ATTORNEY

SN 85-510,863. SKINCALM, LLC, BEAVERTON, OR. FILED 1-6-2012.

SKINCALM

THE MARK CONSISTS OF STANDARD CHARACTERS WITHOUT CLAIM TO ANY PARTICULAR FONT, STYLE, SIZE, OR COLOR.

FOR NON-MEDICATED SKIN CARE PRODUCTS, NAMELY, SKIN CREAM, SKIN SALVE, HAND AND BODY SOAP, AND SCALP OIL (U.S. CLS. 6, 18, 44, 46, 51 AND 52).

FIRST USE 8-7-2010; IN COMMERCE 8-7-2010.
DAWN HAN, EXAMINING ATTORNEY

CLASS 5—(Continued).

SN 85-512,166. CLINIAL THERAPEUTIC SOLUTIONS, WALL, NJ. FILED 1-9-2012.

KERA-42 CREAM

THE MARK CONSISTS OF STANDARD CHARACTERS WITHOUT CLAIM TO ANY PARTICULAR FONT, STYLE, SIZE, OR COLOR.

NO CLAIM IS MADE TO THE EXCLUSIVE RIGHT TO USE "CREAM", APART FROM THE MARK AS SHOWN.

FOR MEDICAL CREAM CONTAINING UREA FOR TOPICAL USE, DESIGNED TO SOFTEN AND HYDRATE SKIN (U.S. CLS. 6, 18, 44, 46, 51 AND 52).

RUSS HERMAN, EXAMINING ATTORNEY

SN 85-515,619. SHER, EDUARD, STATEN ISLAND, NY. FILED 1-13-2012.

FIGURIN DIETARY SUPPLEMENT

THE MARK CONSISTS OF STANDARD CHARACTERS WITHOUT CLAIM TO ANY PARTICULAR FONT, STYLE, SIZE, OR COLOR.

NO CLAIM IS MADE TO THE EXCLUSIVE RIGHT TO USE "DIETARY SUPPLEMENT", APART FROM THE MARK AS SHOWN.

FOR DIETARY AND NUTRITIONAL SUPPLEMENTS (U.S. CLS. 6, 18, 44, 46, 51 AND 52).

GISELLE AGOSTO, EXAMINING ATTORNEY

SN 85-518,322. SAFE-T PRODUCTS, LLC, AKA SAFE-T-PRODUCTS, LLC, MONROE, LA. FILED 1-17-2012.

SAFE-T-PRODUCTS, LLC

THE MARK CONSISTS OF STANDARD CHARACTERS WITHOUT CLAIM TO ANY PARTICULAR FONT, STYLE, SIZE, OR COLOR.

OWNER OF U.S. REG. NOS. 3,817,073 AND 3,817,074.

NO CLAIM IS MADE TO THE EXCLUSIVE RIGHT TO USE "LLC", APART FROM THE MARK AS SHOWN.

FOR ANTIMICROBIALS FOR DERMATOLOGIC USE; HAND-SANITIZING PREPARATIONS; SANITIZING PREPARATIONS FOR HOSPITAL USE; SANITIZING PREPARATIONS FOR HOUSEHOLD USE; SANITIZING PREPARATIONS FOR USE IN INSTITUTIONAL AND INDUSTRIAL AREAS; SANITIZING WIPES (U.S. CLS. 6, 18, 44, 46, 51 AND 52).

TEJBIR SINGH, EXAMINING ATTORNEY

CLASS 5—(Continued).

SN 85-519,272. BEFIT ENTERPRISES, MORRO BAY, CA. FILED 1-18-2012.

Jack LaLanne

THE MARK CONSISTS OF STANDARD CHARACTERS WITHOUT CLAIM TO ANY PARTICULAR FONT, STYLE, SIZE, OR COLOR.

OWNER OF U.S. REG. NOS. 1,351,946, 3,034,163 AND 3,161,990.

THE NAME "JACK LALANNE" DOES NOT IDENTIFY A LIVING INDIVIDUAL.

FOR VITAMINS (U.S. CLS. 6, 18, 44, 46, 51 AND 52).

FIRST USE 4-8-2011; IN COMMERCE 4-8-2011.

NICHOLAS COLEMAN, EXAMINING ATTORNEY

SN 85-521,090. WISCONSIN CHEESE GROUP, MONROE, WI. FILED 1-20-2012.

YA SALUD

THE MARK CONSISTS OF STANDARD CHARACTERS WITHOUT CLAIM TO ANY PARTICULAR FONT, STYLE, SIZE, OR COLOR.

OWNER OF U.S. REG. NOS. 3,355,299 AND 3,355,301.

NO CLAIM IS MADE TO THE EXCLUSIVE RIGHT TO USE "SALUD", APART FROM THE MARK AS SHOWN.

THE ENGLISH TRANSLATION OF "YA SALUD" IS "GET HEALTH".

FOR NUTRITIONAL SUPPLEMENTS, NAMELY, PROBIOTIC DRINKS (U.S. CLS. 6, 18, 44, 46, 51 AND 52).

DAVID ELTON, EXAMINING ATTORNEY

SN 85-521,119. WISCONSIN CHEESE GROUP, MONROE, WI. FILED 1-20-2012.

JELLY JOY

THE MARK CONSISTS OF STANDARD CHARACTERS WITHOUT CLAIM TO ANY PARTICULAR FONT, STYLE, SIZE, OR COLOR.

NO CLAIM IS MADE TO THE EXCLUSIVE RIGHT TO USE "JELLY", APART FROM THE MARK AS SHOWN.

FOR NUTRITIONAL SUPPLEMENTS, NAMELY, PROBIOTIC DRINKS (U.S. CLS. 6, 18, 44, 46, 51 AND 52).

DAVID ELTON, EXAMINING ATTORNEY

CLASS 5—(Continued).

SN 85-523,118. BISCO, INC., SCHAUMBURG, IL. FILED 1-23-2012.

ALL-BOND UNIVERSAL

THE MARK CONSISTS OF STANDARD CHARACTERS WITHOUT CLAIM TO ANY PARTICULAR FONT, STYLE, SIZE, OR COLOR.

OWNER OF U.S. REG. NOS. 1,651,166, 3,370,793 AND OTHERS.

NO CLAIM IS MADE TO THE EXCLUSIVE RIGHT TO USE "UNIVERSAL", APART FROM THE MARK AS SHOWN.

FOR FLOWABLE DENTAL MATERIAL FOR DENTAL RESTORATIONS, NAMELY, DENTAL ADHESIVES (U.S. CLS. 6, 18, 44, 46, 51 AND 52).

KRISTIN DAHLING, EXAMINING ATTORNEY

SN 85-523,893. GREAT SOLUTIONS, LLC, WOODHAVEN, MI. FILED 1-24-2012.

AMAZING MIRACLE SPRAY

THE MARK CONSISTS OF STANDARD CHARACTERS WITHOUT CLAIM TO ANY PARTICULAR FONT, STYLE, SIZE, OR COLOR.

NO CLAIM IS MADE TO THE EXCLUSIVE RIGHT TO USE "SPRAY", APART FROM THE MARK AS SHOWN.

FOR HERBAL SPRAYS FOR THE RELIEF OF PAIN AND DISCOMFORT (U.S. CLS. 6, 18, 44, 46, 51 AND 52).

FIRST USE 1-20-2012; IN COMMERCE 1-20-2012.

KIMBERLY PERRY, EXAMINING ATTORNEY

SN 85-525,988. NOVARTIS AG, BASEL, SWITZERLAND, FILED 1-26-2012.

SOFTWAREAR

THE MARK CONSISTS OF STANDARD CHARACTERS WITHOUT CLAIM TO ANY PARTICULAR FONT, STYLE, SIZE, OR COLOR.

OWNER OF U.S. REG. NO. 2,536,866.

FOR CONTACT LENS SOLUTIONS (U.S. CLS. 6, 18, 44, 46, 51 AND 52).

CHRISTINE MARTIN, EXAMINING ATTORNEY

CLASS 5—(Continued).

SN 85-529,505. VITAMIN SHOPPE INDUSTRIES INC., NORTH BERGEN, NJ. FILED 1-31-2012.

PROSTAX100

THE MARK CONSISTS OF STANDARD CHARACTERS WITHOUT CLAIM TO ANY PARTICULAR FONT, STYLE, SIZE, OR COLOR.

FOR VITAMINS; VITAMIN, MINERAL, DIETARY AND NUTRITIONAL SUPPLEMENTS; DIETARY AND NUTRITIONAL SUPPLEMENT FOR SPORTS NUTRITION, BODY BUILDING, MUSCLE GAIN AND TRAINING; NUTRITIONAL SUPPLEMENT BODYBUILDING AND SPORTS NUTRITION DRINKS (U.S. CLS. 6, 18, 44, 46, 51 AND 52).

KATHLEEN KOLACZ, EXAMINING ATTORNEY

SN 85-531,160. AMNIOX MEDICAL, INC., MARIETTA, GA. FILED 2-1-2012.

NEOX

THE MARK CONSISTS OF STANDARD CHARACTERS WITHOUT CLAIM TO ANY PARTICULAR FONT, STYLE, SIZE, OR COLOR.

FOR BIOLOGICAL TISSUE GRAFTS; BIOLOGICAL HUMAN AMNIOTIC MEMBRANE TISSUE PREPARATIONS INTENDED FOR SUBSEQUENT IMPLANTATION FOR SURGERY, WOUND CARE, TISSUE REPAIR AND FOR THE TREATMENT OF INFLAMMATORY DISEASES; SPINAL AND ORTHOPEDIC IMPLANTS MADE OF HUMAN AMNIOTIC MEMBRANE TISSUE; WOUND COVERINGS MADE OF HUMAN AMNIOTIC MEMBRANE TISSUE, NAMELY, TENDON, LIGAMENT AND NERVE WRAPS (U.S. CLS. 6, 18, 44, 46, 51 AND 52).

FIRST USE 7-31-2011; IN COMMERCE 7-31-2011.

MICHAEL WEBSTER, EXAMINING ATTORNEY

CLASS 5—(Continued).

SN 85-531,192. AMNIOX MEDICAL, INC., MARIETTA, GA. FILED 2-1-2012.



THE MARK CONSISTS OF "NEOX" IN LOWER CASE LETTERS, WHERE THE "X" IS FORMED USING TWO CONCAVE LINES.

FOR BIOLOGICAL TISSUE GRAFTS; BIOLOGICAL HUMAN AMNIOTIC MEMBRANE TISSUE PREPARATIONS INTENDED FOR SUBSEQUENT IMPLANTATION FOR SURGERY, WOUND CARE, TISSUE REPAIR AND FOR THE TREATMENT OF INFLAMMATORY DISEASES; SPINAL AND ORTHOPEDIC IMPLANTS MADE OF HUMAN AMNIOTIC MEMBRANE TISSUE; WOUND COVERINGS MADE OF HUMAN AMNIOTIC MEMBRANE TISSUE, NAMELY, TENDON, LIGAMENT AND NERVE WRAPS (U.S. CLS. 6, 18, 44, 51 AND 52).

FIRST USE 7-31-2011; IN COMMERCE 7-31-2011. MICHAEL WEBSTER, EXAMINING ATTORNEY

CLASS 5—(Continued).

SN 85-531,255. METAGENICS, INC., SAN CLEMENTE, CA. FILED 2-1-2012.



THE MARK CONSISTS OF STANDARD CHARACTERS WITHOUT CLAIM TO ANY PARTICULAR FONT, STYLE, SIZE, OR COLOR.

FOR DIETARY SUPPLEMENTS (U.S. CLS. 6, 18, 44, 46, 51 AND 52).

CHRISTOPHER LAW, EXAMINING ATTORNEY

SN 85-531,223. METAGENICS, INC., SAN CLEMENTE, CA. FILED 2-1-2012.



THE MARK CONSISTS OF STANDARD CHARACTERS WITHOUT CLAIM TO ANY PARTICULAR FONT, STYLE, SIZE, OR COLOR.

FOR DIETARY SUPPLEMENTS (U.S. CLS. 6, 18, 44, 46, 51 AND 52).

CHRISTOPHER LAW, EXAMINING ATTORNEY



THE MARK CONSISTS OF STANDARD CHARACTERS WITHOUT CLAIM TO ANY PARTICULAR FONT, STYLE, SIZE, OR COLOR.

FOR ODOR ELIMINATOR NOT FOR PERSONAL USE AND ALL PURPOSE DEODORIZER FOR HOUSEHOLD, COMMERCIAL AND INDUSTRIAL USE IN GEL AND LIQUID FORM (U.S. CLS. 6, 18, 44, 46, 51 AND 52).

Laurie Mayes, Examining Attorney

SN 85-531,245. PATRIN PHARMA, INC., SKOKIE, IL. FILED 2-1-2012.



THE MARK CONSISTS OF STANDARD CHARACTERS WITHOUT CLAIM TO ANY PARTICULAR FONT, STYLE, SIZE, OR COLOR.

FOR MEDICAL CLEANSERS FOR SKIN AND WOUNDS; PHARMACEUTICAL PREPARATIONS FOR WOUNDS (U.S. CLS. 6, 18, 44, 46, 51 AND 52).

NAKIA HENRY, EXAMINING ATTORNEY

SN 85-531,280. ECP INCORPORATED, WOODRIDGE, IL. FILED 2-1-2012.



THE MARK CONSISTS OF THE WORDS "WICKED GOOD" IN STYLIZED LETTERS WITH AN OVAL SHAPE TOUCHING THE TOP OF THE LETTER "D" IN THE WORD "WICKED".

FOR ODOR ELIMINATOR NOT FOR PERSONAL USE AND ALL PURPOSE DEODORIZER FOR HOUSEHOLD, COMMERCIAL AND INDUSTRIAL USE IN GEL AND LIQUID FORM (U.S. CLS. 6, 18, 44, 46, 51 AND 52).

Laurie Mayes, Examining Attorney

CLASS 5—(Continued).

SN 85-531,283. CELLOXESS, PENNINGTON, NJ. FILED 2-1-2012.

CellOxess

THE MARK CONSISTS OF STANDARD CHARACTERS WITHOUT CLAIM TO ANY PARTICULAR FONT, STYLE, SIZE, OR COLOR.

FOR DIETARY AND NUTRITIONAL SUPPLEMENTS; NUTRACEUTICALS FOR THE TREATMENT OF CONDITIONS ASSOCIATED WITH OXIDATIVE STRESS AND DNA DAMAGE; NUTRACEUTICALS FOR USE AS A DIETARY SUPPLEMENT; NUTRACEUTICALS FOR USE AS A DIETARY SUPPLEMENT FOR ENHANCING FERTILITY; PHARMACEUTICAL PREPARATIONS FOR THE TREATMENT AND PREVENTION OF CONDITIONS ASSOCIATED WITH OXIDATIVE STRESS AND DNA DAMAGE (U.S. CLS. 6, 18, 44, 46, 51 AND 52).
KEVIN CORWIN, EXAMINING ATTORNEY

SN 85-531,341. SURVIVOR SOLUTIONS, LLC, ST. IGNATIUS, MT. FILED 2-1-2012.

SYSTEMIC MAKEOVER FOR LIFE

THE MARK CONSISTS OF STANDARD CHARACTERS WITHOUT CLAIM TO ANY PARTICULAR FONT, STYLE, SIZE, OR COLOR.

FOR DIETARY AND NUTRITIONAL SUPPLEMENTS (U.S. CLS. 6, 18, 44, 46, 51 AND 52).
CHARLES L. JENKINS, EXAMINING ATTORNEY

SN 85-531,372. SURVIVOR SOLUTIONS, LLC, ST. IGNATIUS, MT. FILED 2-1-2012.

WAVY BLUE

THE MARK CONSISTS OF STANDARD CHARACTERS WITHOUT CLAIM TO ANY PARTICULAR FONT, STYLE, SIZE, OR COLOR.

FOR DIETARY AND NUTRITIONAL SUPPLEMENTS (U.S. CLS. 6, 18, 44, 46, 51 AND 52).
CHARLES L. JENKINS, EXAMINING ATTORNEY

CLASS 5—(Continued).

SN 85-531,440. PATRICK SCALLAN, BATON ROUGE, LA. FILED 2-1-2012.

DRINK NOW, THINK BETTER

THE MARK CONSISTS OF STANDARD CHARACTERS WITHOUT CLAIM TO ANY PARTICULAR FONT, STYLE, SIZE, OR COLOR.

FOR DIETARY AND NUTRITIONAL SUPPLEMENTS (U.S. CLS. 6, 18, 44, 46, 51 AND 52).
DAVID COLLIER, EXAMINING ATTORNEY

SN 85-531,445. SMART & FINAL STORES LLC, COMMERCE, CA. FILED 2-1-2012.

FIRST STREET

THE MARK CONSISTS OF STANDARD CHARACTERS WITHOUT CLAIM TO ANY PARTICULAR FONT, STYLE, SIZE, OR COLOR.

OWNER OF U.S. REG. NOS. 3,776,718, 3,776,726 AND OTHERS.

FOR ANALGESICS; ANTISEPTICS; COTTON SWABS FOR MEDICAL PURPOSES; COTTON WOOL FOR MEDICAL PURPOSES; RUBBING ALCOHOL; VITAMINS (U.S. CLS. 6, 18, 44, 46, 51 AND 52).

CHERYL CLAYTON, EXAMINING ATTORNEY

SN 85-531,655. ROTH, JOHN H., TUSTIN, CA. FILED 2-2-2012.

Next Nutrition

THE MARK CONSISTS OF STANDARD CHARACTERS WITHOUT CLAIM TO ANY PARTICULAR FONT, STYLE, SIZE, OR COLOR.

NO CLAIM IS MADE TO THE EXCLUSIVE RIGHT TO USE "NUTRITION", APART FROM THE MARK AS SHOWN.

FOR VITAMIN AND MINERAL SUPPLEMENTS (U.S. CLS. 6, 18, 44, 46, 51 AND 52).

FIRST USE 1-5-2012; IN COMMERCE 1-10-2012.

CHARLOTTE CORWIN, EXAMINING ATTORNEY

CLASS 5—(Continued).

SN 85-531,656. ROTH, JOHN H., TUSTIN, CA. FILED 2-2-2012.

Xynergy Science

THE MARK CONSISTS OF STANDARD CHARACTERS WITHOUT CLAIM TO ANY PARTICULAR FONT, STYLE, SIZE, OR COLOR.

NO CLAIM IS MADE TO THE EXCLUSIVE RIGHT TO USE "SCIENCE", APART FROM THE MARK AS SHOWN. FOR VITAMIN AND MINERAL SUPPLEMENTS (U.S. CLS. 6, 18, 44, 46, 51 AND 52).

FIRST USE 1-5-2012; IN COMMERCE 1-10-2012.

CHARLOTTE CORWIN, EXAMINING ATTORNEY

CLASS 5—(Continued).

SN 85-531,852. NANOTHERAPEUTICS, INC., ALACHUA, FL. FILED 2-2-2012.



OWNER OF U.S. REG. NOS. 3,926,171, 3,959,227 AND 4,038,864.

THE MARK CONSISTS OF THREE CRESCENT DESIGNS NEXT TO THE STYLIZED TERM "NANODOX".

FOR PHARMACEUTICAL DELIVERY SYSTEMS, NAMELY, TOPICAL GEL FOR LOCAL DELIVERY OF DOXYCYCLINE FOR USE IN THE TREATMENT OF LOCAL WOUND HEALING (U.S. CLS. 6, 18, 44, 46, 51 AND 52).

FIRST USE 1-4-2012; IN COMMERCE 1-4-2012.

JOHN E. MICHOS, EXAMINING ATTORNEY

SN 85-531,682. 8 IP LLC, ALPHARETTA, GA. FILED 2-2-2012.

KROTON

THE MARK CONSISTS OF STANDARD CHARACTERS WITHOUT CLAIM TO ANY PARTICULAR FONT, STYLE, SIZE, OR COLOR.

FOR PHARMACEUTICAL PREPARATIONS, NAMELY, FOR MUSCLE BUILDING APPLICATIONS TO BE SOLD IN JARS, BOTTLES, TABLETS, CAPSULES, LIQUID, TO RETAILS STORES, GYMS, WEBSITES, CATALOGS (U.S. CLS. 6, 18, 44, 46, 51 AND 52).

LAURIE MAYES, EXAMINING ATTORNEY

SN 85-531,775. HARTINGTON PHARMA LTD, LONDON, UNITED KINGDOM, FILED 2-2-2012.

Nasodren

THE MARK CONSISTS OF STANDARD CHARACTERS WITHOUT CLAIM TO ANY PARTICULAR FONT, STYLE, SIZE, OR COLOR.

FOR PHARMACEUTICAL PREPARATIONS FOR TREATMENT OF DISEASES AND DISORDERS IN THE EARS, NOSE, NASAL SINUSES AND THROAT (U.S. CLS. 6, 18, 44, 46, 51 AND 52).

SANJEEV VOHRA, EXAMINING ATTORNEY

SN 85-532,084. NOVARTIS AG, BASEL, SWITZERLAND, FILED 2-2-2012.

EOTRIZ

THE MARK CONSISTS OF STANDARD CHARACTERS WITHOUT CLAIM TO ANY PARTICULAR FONT, STYLE, SIZE, OR COLOR.

FOR ANTI-INFLAMMATORIES; ANTIBACTERIAL PHARMACEUTICALS; ANTIBIOTICS; ANTIFUNGAL PREPARATIONS; ANTIVIRALS; CARDIOVASCULAR PHARMACEUTICALS; PHARMACEUTICAL PREPARATIONS ACTING ON THE CENTRAL NERVOUS SYSTEM; PHARMACEUTICAL PREPARATIONS AND SUBSTANCES FOR THE TREATMENT OF GASTRO-INTESTINAL DISEASES; PHARMACEUTICAL PREPARATIONS FOR THE TREATMENT AND PREVENTION OF DISEASES AND DISORDERS OF THE AUTOIMMUNE SYSTEM, THE METABOLIC SYSTEM, THE MUSCULOSKELETAL SYSTEM AND THE GENITOURINARY SYSTEM; PHARMACEUTICAL PREPARATIONS FOR USE IN HEMATOLOGY AND IN TISSUE AND ORGAN TRANSPLANTATION; PHARMACEUTICAL PREPARATIONS FOR THE TREATMENT OF EYE DISEASES AND CONDITIONS; PHARMACEUTICAL PREPARATIONS FOR THE TREATMENT OF HEART RHYTHM DISORDERS; PHARMACEUTICAL PREPARATIONS FOR THE TREATMENT OF IMMUNE SYSTEM RELATED DISEASES AND DISORDERS; PHARMACEUTICAL PREPARATIONS FOR THE TREATMENT OF KIDNEY DISEASES; PHARMACEUTICAL PREPARATIONS FOR TREATING DIABETES; PHARMACEUTICAL PREPARATIONS FOR USE IN DERMATOLOGY; PHARMACEUTICAL PRODUCTS FOR OPHTHALMOLOGICAL USE; PHARMACEUTICAL PRODUCTS FOR THE PREVENTION AND TREATMENT OF CANCER; PHARMACEUTICAL PRODUCTS FOR THE TREATMENT OF BONE DISEASES; PHARMACEUTICAL PRODUCTS FOR TREATING RESPIRATORY DISEASES; PHARMACEUTICAL PRODUCTS FOR TREATING RESPIRATORY DISEASES AND ASTHMA; PHARMACEUTICALS, NAMELY, ANTI-INFECTIVES (U.S. CLS. 6, 18, 44, 46, 51 AND 52).

GEORGE LORENZO, EXAMINING ATTORNEY

CLASS 5—(Continued).

SN 85-532,087. NOVARTIS AG, BASEL, SWITZERLAND,
FILED 2-2-2012.

CLASS 5—(Continued).

SN 85-532,094. NOVARTIS AG, BASEL, SWITZERLAND,
FILED 2-2-2012.

RAXCEEVA

REASANZ

THE MARK CONSISTS OF STANDARD CHARACTERS WITHOUT CLAIM TO ANY PARTICULAR FONT, STYLE, SIZE, OR COLOR.

FOR ANTI-INFLAMMATORIES; ANTIBACTERIAL PHARMACEUTICALS; ANTIBIOTICS; ANTIFUNGAL PREPARATIONS; ANTIVIRALS; CARDIOVASCULAR PHARMACEUTICALS; PHARMACEUTICAL PREPARATIONS ACTING ON THE CENTRAL NERVOUS SYSTEM; PHARMACEUTICAL PREPARATIONS AND SUBSTANCES FOR THE TREATMENT OF GASTRO-INTESTINAL DISEASES; PHARMACEUTICAL PREPARATIONS FOR THE TREATMENT AND PREVENTION OF DISEASES AND DISORDERS OF THE AUTOIMMUNE SYSTEM, THE METABOLIC SYSTEM, THE MUSCULO-SKELETAL SYSTEM AND THE GENITOURINARY SYSTEM; PHARMACEUTICAL PREPARATIONS FOR USE IN HEMATOLOGY AND IN TISSUE AND ORGAN TRANSPLANTATION; PHARMACEUTICAL PREPARATIONS FOR THE TREATMENT OF EYE DISEASES AND CONDITIONS; PHARMACEUTICAL PREPARATIONS FOR THE TREATMENT OF HEART RHYTHM DISORDERS; PHARMACEUTICAL PREPARATIONS FOR THE TREATMENT OF IMMUNE SYSTEM RELATED DISEASES AND DISORDERS; PHARMACEUTICAL PREPARATIONS FOR THE TREATMENT OF KIDNEY DISEASES; PHARMACEUTICAL PREPARATIONS FOR TREATING DIABETES; PHARMACEUTICAL PREPARATIONS FOR USE IN DERMATOLOGY; PHARMACEUTICAL PRODUCTS FOR OPHTHALMOLOGICAL USE; PHARMACEUTICAL PRODUCTS FOR THE PREVENTION AND TREATMENT OF CANCER; PHARMACEUTICAL PRODUCTS FOR THE TREATMENT OF BONE DISEASES; PHARMACEUTICAL PRODUCTS FOR TREATING RESPIRATORY DISEASES; PHARMACEUTICAL PRODUCTS FOR TREATING RESPIRATORY DISEASES AND ASTHMA; PHARMACEUTICALS, NAMELY, ANTI-INFECTIVES (U.S. CLS. 6, 18, 44, 46, 51 AND 52).

GEORGE LORENZO, EXAMINING ATTORNEY

THE MARK CONSISTS OF STANDARD CHARACTERS WITHOUT CLAIM TO ANY PARTICULAR FONT, STYLE, SIZE, OR COLOR.

FOR ANTI-INFLAMMATORIES; ANTIBACTERIAL PHARMACEUTICALS; ANTIBIOTICS; ANTIFUNGAL PREPARATIONS; ANTIVIRALS; CARDIOVASCULAR PHARMACEUTICALS; PHARMACEUTICAL PREPARATIONS ACTING ON THE CENTRAL NERVOUS SYSTEM; PHARMACEUTICAL PREPARATIONS AND SUBSTANCES FOR THE TREATMENT OF GASTRO-INTESTINAL DISEASES; PHARMACEUTICAL PREPARATIONS FOR THE TREATMENT AND PREVENTION OF DISEASES AND DISORDERS OF THE AUTOIMMUNE SYSTEM, THE METABOLIC SYSTEM, THE MUSCULO-SKELETAL SYSTEM AND THE GENITOURINARY SYSTEM; PHARMACEUTICAL PREPARATIONS FOR USE IN HEMATOLOGY AND IN TISSUE AND ORGAN TRANSPLANTATION; PHARMACEUTICAL PREPARATIONS FOR THE TREATMENT OF EYE DISEASES AND CONDITIONS; PHARMACEUTICAL PREPARATIONS FOR THE TREATMENT OF HEART RHYTHM DISORDERS; PHARMACEUTICAL PREPARATIONS FOR THE TREATMENT OF IMMUNE SYSTEM RELATED DISEASES AND DISORDERS; PHARMACEUTICAL PREPARATIONS FOR THE TREATMENT OF KIDNEY DISEASES; PHARMACEUTICAL PREPARATIONS FOR TREATING DIABETES; PHARMACEUTICAL PREPARATIONS FOR USE IN DERMATOLOGY; PHARMACEUTICAL PRODUCTS FOR OPHTHALMOLOGICAL USE; PHARMACEUTICAL PRODUCTS FOR THE PREVENTION AND TREATMENT OF CANCER; PHARMACEUTICAL PRODUCTS FOR THE TREATMENT OF BONE DISEASES; PHARMACEUTICAL PRODUCTS FOR TREATING RESPIRATORY DISEASES; PHARMACEUTICAL PRODUCTS FOR TREATING RESPIRATORY DISEASES AND ASTHMA; PHARMACEUTICALS, NAMELY, ANTI-INFECTIVES (U.S. CLS. 6, 18, 44, 46, 51 AND 52).

GEORGE LORENZO, EXAMINING ATTORNEY

CLASS 5—(Continued).

SN 85-532,097. NOVARTIS AG, BASEL, SWITZERLAND, FILED 2-2-2012.

REQAVEL

THE MARK CONSISTS OF STANDARD CHARACTERS WITHOUT CLAIM TO ANY PARTICULAR FONT, STYLE, SIZE, OR COLOR.

FOR ANTI-INFLAMMATORIES; ANTIBACTERIAL PHARMACEUTICALS; ANTIBIOTICS; ANTIFUNGAL PREPARATIONS; ANTIVIRALS; CARDIOVASCULAR PHARMACEUTICALS; PHARMACEUTICAL PREPARATIONS ACTING ON THE CENTRAL NERVOUS SYSTEM; PHARMACEUTICAL PREPARATIONS AND SUBSTANCES FOR THE TREATMENT OF GASTRO-INTESTINAL DISEASES; PHARMACEUTICAL PREPARATIONS FOR THE TREATMENT AND PREVENTION OF DISEASES AND DISORDERS OF THE AUTOIMMUNE SYSTEM, THE METABOLIC SYSTEM, THE MUSCULOSKELETAL SYSTEM AND THE GENITOURINARY SYSTEM; PHARMACEUTICAL PREPARATIONS FOR USE IN HEMATOLOGY AND IN TISSUE AND ORGAN TRANSPLANTATION; PHARMACEUTICAL PREPARATIONS FOR THE TREATMENT OF EYE DISEASES AND CONDITIONS; PHARMACEUTICAL PREPARATIONS FOR THE TREATMENT OF HEART RHYTHM DISORDERS; PHARMACEUTICAL PREPARATIONS FOR THE TREATMENT OF IMMUNE SYSTEM RELATED DISEASES AND DISORDERS; PHARMACEUTICAL PREPARATIONS FOR THE TREATMENT OF KIDNEY DISEASES; PHARMACEUTICAL PREPARATIONS FOR TREATING DIABETES; PHARMACEUTICAL PREPARATIONS FOR USE IN DERMATOLOGY; PHARMACEUTICAL PRODUCTS FOR OPHTHALMOLOGICAL USE; PHARMACEUTICAL PRODUCTS FOR THE PREVENTION AND TREATMENT OF CANCER; PHARMACEUTICAL PRODUCTS FOR THE TREATMENT OF BONE DISEASES; PHARMACEUTICAL PRODUCTS FOR TREATING RESPIRATORY DISEASES; PHARMACEUTICAL PRODUCTS FOR TREATING RESPIRATORY DISEASES AND ASTHMA; PHARMACEUTICALS, NAMELY, ANTI-INFECTIVES (U.S. CLS. 6, 18, 44, 46, 51 AND 52).

GEORGE LORENZO, EXAMINING ATTORNEY

CLASS 5—(Continued).

SN 85-532,241. ACCURA-FX LIMITED, VICTORIA, MAHE, SEYCHELLES, FILED 2-2-2012.

SLIMNOGYM

THE MARK CONSISTS OF STANDARD CHARACTERS WITHOUT CLAIM TO ANY PARTICULAR FONT, STYLE, SIZE, OR COLOR.

FOR HERBAL SUPPLEMENTS FOR WEIGHT LOSS (U.S. CLS. 6, 18, 44, 46, 51 AND 52).

JANICE L. MCMORROW, EXAMINING ATTORNEY

SN 85-532,250. ACCURA-FX LIMITED, VICTORIA, MAHE, SEYCHELLES, FILED 2-2-2012.

GETNOGRAY

THE MARK CONSISTS OF STANDARD CHARACTERS WITHOUT CLAIM TO ANY PARTICULAR FONT, STYLE, SIZE, OR COLOR.

FOR HERBAL SUPPLEMENTS; HERBAL SUPPLEMENTS FOR HAIR COLOR RESTORATION IN THE FORM OF A PILL (U.S. CLS. 6, 18, 44, 46, 51 AND 52).

JANICE L. MCMORROW, EXAMINING ATTORNEY

SN 85-532,198. ACCURA-FX LIMITED, VICTORIA, MAHE, SEYCHELLES, FILED 2-2-2012.

NOFATPATCH

THE MARK CONSISTS OF STANDARD CHARACTERS WITHOUT CLAIM TO ANY PARTICULAR FONT, STYLE, SIZE, OR COLOR.

FOR HERBAL SUPPLEMENTS FOR WEIGHT LOSS (U.S. CLS. 6, 18, 44, 46, 51 AND 52).

JANICE L. MCMORROW, EXAMINING ATTORNEY

SN 85-532,272. VORLO INC., BURLINGTON, NC. FILED 2-2-2012.

CLASH

THE MARK CONSISTS OF STANDARD CHARACTERS WITHOUT CLAIM TO ANY PARTICULAR FONT, STYLE, SIZE, OR COLOR.

FOR DIETARY AND NUTRITIONAL SUPPLEMENTS (U.S. CLS. 6, 18, 44, 46, 51 AND 52).

WILLIAM VERHOSEK, EXAMINING ATTORNEY

CLASS 5—(Continued).

SN 85-532,307. MILES, DR. TOM DBA REAL ENERGY, MALVERN, PA. FILED 2-2-2012.

FOR THE HEALTH OF IT

THE MARK CONSISTS OF STANDARD CHARACTERS WITHOUT CLAIM TO ANY PARTICULAR FONT, STYLE, SIZE, OR COLOR.

FOR NUTRITIONAL SUPPLEMENTS (U.S. CLS. 6, 18, 44, 46, 51 AND 52).

ANDREW RHIM, EXAMINING ATTORNEY

CLASS 5—(Continued).

SN 85-532,802. APHROTEASIAC HERBAL BLENDS LLC, PHOENIX, AZ. FILED 2-2-2012.

APHROTEASIAC

THE MARK CONSISTS OF STANDARD CHARACTERS WITHOUT CLAIM TO ANY PARTICULAR FONT, STYLE, SIZE, OR COLOR.

FOR DIETARY HERBAL SUPPLEMENTS IN THE FORM OF INSTANT TEA GRANULES TO FACILITATE BLOOD FLOW TO THE GENITALS AND INCREASE PLEASURE (U.S. CLS. 6, 18, 44, 46, 51 AND 52).

HENRY S. ZAK, EXAMINING ATTORNEY

SN 85-532,317. MILES, DR. TOM DBA REAL ENERGY, MALVERN, PA. FILED 2-2-2012.

FOR REALLY BUSY PEOPLE

THE MARK CONSISTS OF STANDARD CHARACTERS WITHOUT CLAIM TO ANY PARTICULAR FONT, STYLE, SIZE, OR COLOR.

FOR NUTRITIONAL SUPPLEMENTS (U.S. CLS. 6, 18, 44, 46, 51 AND 52).

ANDREW RHIM, EXAMINING ATTORNEY

SN 85-532,909. SKINNY MISS, INC., LOS ANGELES, CA. FILED 2-3-2012.

LET'S GET SKINNY

THE MARK CONSISTS OF STANDARD CHARACTERS WITHOUT CLAIM TO ANY PARTICULAR FONT, STYLE, SIZE, OR COLOR.

FOR APPETITE SUPPRESSANTS; DIETARY AND NUTRITIONAL SUPPLEMENTS; HOMEOPATHIC-STYLE HCG (HUMAN CHORIONIC GONADOTROPIN) ORAL SPRAYS FOR WEIGHT LOSS PURPOSES (U.S. CLS. 6, 18, 44, 46, 51 AND 52).

ANNE E. GUSTASON, EXAMINING ATTORNEY

SN 85-532,328. MILES, DR. TOM DBA REAL ENERGY, MALVERN, PA. FILED 2-2-2012.

WHEN YOU WANT TO PLAY ALL DAY

THE MARK CONSISTS OF STANDARD CHARACTERS WITHOUT CLAIM TO ANY PARTICULAR FONT, STYLE, SIZE, OR COLOR.

FOR NUTRITIONAL SUPPLEMENTS (U.S. CLS. 6, 18, 44, 46, 51 AND 52).

ANDREW RHIM, EXAMINING ATTORNEY

SN 85-532,967. THE KIND GROUP, LLC, NEW YORK, NY. FILED 2-3-2012.

EVOLUTION OF SMOOTH

THE MARK CONSISTS OF STANDARD CHARACTERS WITHOUT CLAIM TO ANY PARTICULAR FONT, STYLE, SIZE, OR COLOR.

FOR MEDICATED LIP BALMS, PREPARATIONS AND TREATMENTS (U.S. CLS. 6, 18, 44, 46, 51 AND 52).

FIRST USE 10-1-2010; IN COMMERCE 10-1-2010.
HENRY S. ZAK, EXAMINING ATTORNEY

CLASS 5—(Continued).

SN 85-533,081. BIOTEST PHARMACEUTICALS CORPORATION, BOCA RATON, FL. FILED 2-3-2012.

BIVIGAM

THE MARK CONSISTS OF STANDARD CHARACTERS WITHOUT CLAIM TO ANY PARTICULAR FONT, STYLE, SIZE, OR COLOR.

FOR IMMUNE GLOBULIN FOR TREATMENT OF PRIMARY IMMUNODEFICIENCY DISEASE (U.S. CLS. 6, 18, 44, 46, 51 AND 52).

AMY C. KEAN, EXAMINING ATTORNEY

CLASS 5—(Continued).

SN 85-533,213. NOVARTIS AG, BASEL, SWITZERLAND, FILED 2-3-2012.

YISEVA

SN 85-533,212. NOVARTIS AG, BASEL, SWITZERLAND, FILED 2-3-2012.

ELERAXI

THE MARK CONSISTS OF STANDARD CHARACTERS WITHOUT CLAIM TO ANY PARTICULAR FONT, STYLE, SIZE, OR COLOR.

FOR ANTI-INFLAMMATORIES; ANTIBACTERIAL PHARMACEUTICALS; ANTIBIOTICS; ANTIFUNGAL PREPARATIONS; ANTIVIRALS; CARDIOVASCULAR PHARMACEUTICALS; PHARMACEUTICAL PREPARATIONS ACTING ON THE CENTRAL NERVOUS SYSTEM; PHARMACEUTICAL PREPARATIONS AND SUBSTANCES FOR THE TREATMENT OF GASTRO-INTESTINAL DISEASES; PHARMACEUTICAL PREPARATIONS FOR THE TREATMENT AND PREVENTION OF DISEASES AND DISORDERS OF THE AUTOIMMUNE SYSTEM, THE METABOLIC SYSTEM, THE MUSCULO-SKELETAL SYSTEM AND THE GENITOURINARY SYSTEM; PHARMACEUTICAL PREPARATIONS FOR USE IN HEMATOLOGY AND IN TISSUE AND ORGAN TRANSPLANTATION; PHARMACEUTICAL PREPARATIONS FOR THE TREATMENT OF EYE DISEASES AND CONDITIONS; PHARMACEUTICAL PREPARATIONS FOR THE TREATMENT OF HEART RHYTHM DISORDERS; PHARMACEUTICAL PREPARATIONS FOR THE TREATMENT OF IMMUNE SYSTEM RELATED DISEASES AND DISORDERS; PHARMACEUTICAL PREPARATIONS FOR THE TREATMENT OF KIDNEY DISEASES; PHARMACEUTICAL PREPARATIONS FOR TREATING DIABETES; PHARMACEUTICAL PREPARATIONS FOR USE IN DERMATOLOGY; PHARMACEUTICAL PRODUCTS FOR OPHTHALMOLOGICAL USE; PHARMACEUTICAL PRODUCTS FOR THE PREVENTION AND TREATMENT OF CANCER; PHARMACEUTICAL PRODUCTS FOR THE TREATMENT OF BONE DISEASES; PHARMACEUTICAL PRODUCTS FOR TREATING RESPIRATORY DISEASES; PHARMACEUTICAL PRODUCTS FOR TREATING RESPIRATORY DISEASES AND ASTHMA; PHARMACEUTICALS, NAMELY, ANTI-INFECTIVES (U.S. CLS. 6, 18, 44, 46, 51 AND 52).

GEORGE LORENZO, EXAMINING ATTORNEY

THE MARK CONSISTS OF STANDARD CHARACTERS WITHOUT CLAIM TO ANY PARTICULAR FONT, STYLE, SIZE, OR COLOR.

FOR ANTI-INFLAMMATORIES; ANTIBACTERIAL PHARMACEUTICALS; ANTIBIOTICS; ANTIFUNGAL PREPARATIONS; ANTIVIRALS; CARDIOVASCULAR PHARMACEUTICALS; PHARMACEUTICAL PREPARATIONS ACTING ON THE CENTRAL NERVOUS SYSTEM; PHARMACEUTICAL PREPARATIONS AND SUBSTANCES FOR THE TREATMENT OF GASTRO-INTESTINAL DISEASES; PHARMACEUTICAL PREPARATIONS FOR THE TREATMENT AND PREVENTION OF DISEASES AND DISORDERS OF THE AUTOIMMUNE SYSTEM, THE METABOLIC SYSTEM, THE MUSCULO-SKELETAL SYSTEM AND THE GENITOURINARY SYSTEM; PHARMACEUTICAL PREPARATIONS FOR USE IN HEMATOLOGY AND IN TISSUE AND ORGAN TRANSPLANTATION; PHARMACEUTICAL PREPARATIONS FOR THE TREATMENT OF EYE DISEASES AND CONDITIONS; PHARMACEUTICAL PREPARATIONS FOR THE TREATMENT OF HEART RHYTHM DISORDERS; PHARMACEUTICAL PREPARATIONS FOR THE TREATMENT OF IMMUNE SYSTEM RELATED DISEASES AND DISORDERS; PHARMACEUTICAL PREPARATIONS FOR THE TREATMENT OF KIDNEY DISEASES; PHARMACEUTICAL PREPARATIONS FOR TREATING DIABETES; PHARMACEUTICAL PREPARATIONS FOR USE IN DERMATOLOGY; PHARMACEUTICAL PRODUCTS FOR OPHTHALMOLOGICAL USE; PHARMACEUTICAL PRODUCTS FOR THE PREVENTION AND TREATMENT OF CANCER; PHARMACEUTICAL PRODUCTS FOR THE TREATMENT OF BONE DISEASES; PHARMACEUTICAL PRODUCTS FOR TREATING RESPIRATORY DISEASES; PHARMACEUTICAL PRODUCTS FOR TREATING RESPIRATORY DISEASES AND ASTHMA; PHARMACEUTICALS, NAMELY, ANTI-INFECTIVES (U.S. CLS. 6, 18, 44, 46, 51 AND 52).

GEORGE LORENZO, EXAMINING ATTORNEY

CLASS 5—(Continued).

SN 85-533,214. NOVARTIS AG, BASEL, SWITZERLAND,
FILED 2-3-2012.

RHAPSIDO

THE MARK CONSISTS OF STANDARD CHARACTERS WITHOUT CLAIM TO ANY PARTICULAR FONT, STYLE, SIZE, OR COLOR.

FOR ANTI-INFLAMMATORIES; ANTIBACTERIAL PHARMACEUTICALS; ANTIBIOTICS; ANTIFUNGAL PREPARATIONS; ANTIVIRALS; CARDIOVASCULAR PHARMACEUTICALS; PHARMACEUTICAL PREPARATIONS ACTING ON THE CENTRAL NERVOUS SYSTEM; PHARMACEUTICAL PREPARATIONS AND SUBSTANCES FOR THE TREATMENT OF GASTRO-INTESTINAL DISEASES; PHARMACEUTICAL PREPARATIONS FOR THE TREATMENT AND PREVENTION OF DISEASES AND DISORDERS OF THE AUTOIMMUNE SYSTEM, THE METABOLIC SYSTEM, THE MUSCULOSKELETAL SYSTEM AND THE GENITOURINARY SYSTEM; PHARMACEUTICAL PREPARATIONS FOR USE IN HEMATOLOGY AND IN TISSUE AND ORGAN TRANSPLANTATION; PHARMACEUTICAL PREPARATIONS FOR THE TREATMENT OF EYE DISEASES AND CONDITIONS; PHARMACEUTICAL PREPARATIONS FOR THE TREATMENT OF HEART RHYTHM DISORDERS; PHARMACEUTICAL PREPARATIONS FOR THE TREATMENT OF IMMUNE SYSTEM RELATED DISEASES AND DISORDERS; PHARMACEUTICAL PREPARATIONS FOR THE TREATMENT OF KIDNEY DISEASES; PHARMACEUTICAL PREPARATIONS FOR TREATING DIABETES; PHARMACEUTICAL PREPARATIONS FOR USE IN DERMATOLOGY; PHARMACEUTICAL PRODUCTS FOR OPHTHALMOLOGICAL USE; PHARMACEUTICAL PRODUCTS FOR THE PREVENTION AND TREATMENT OF CANCER; PHARMACEUTICAL PRODUCTS FOR THE TREATMENT OF BONE DISEASES; PHARMACEUTICAL PRODUCTS FOR TREATING RESPIRATORY DISEASES; PHARMACEUTICAL PRODUCTS FOR TREATING RESPIRATORY DISEASES AND ASTHMA; PHARMACEUTICALS, NAMELY, ANTI-INFECTIVES (U.S. CLS. 6, 18, 44, 46, 51 AND 52).

GEORGE LORENZO, EXAMINING ATTORNEY

CLASS 5—(Continued).

SN 85-533,218. NOVARTIS AG, BASEL, SWITZERLAND,
FILED 2-3-2012.

REVYANZ

THE MARK CONSISTS OF STANDARD CHARACTERS WITHOUT CLAIM TO ANY PARTICULAR FONT, STYLE, SIZE, OR COLOR.

FOR ANTI-INFLAMMATORIES; ANTIBACTERIAL PHARMACEUTICALS; ANTIBIOTICS; ANTIFUNGAL PREPARATIONS; ANTIVIRALS; CARDIOVASCULAR PHARMACEUTICALS; PHARMACEUTICAL PREPARATIONS ACTING ON THE CENTRAL NERVOUS SYSTEM; PHARMACEUTICAL PREPARATIONS AND SUBSTANCES FOR THE TREATMENT OF GASTRO-INTESTINAL DISEASES; PHARMACEUTICAL PREPARATIONS FOR THE TREATMENT AND PREVENTION OF DISEASES AND DISORDERS OF THE AUTOIMMUNE SYSTEM, THE METABOLIC SYSTEM, THE MUSCULOSKELETAL SYSTEM AND THE GENITOURINARY SYSTEM; PHARMACEUTICAL PREPARATIONS FOR USE IN HEMATOLOGY AND IN TISSUE AND ORGAN TRANSPLANTATION; PHARMACEUTICAL PREPARATIONS FOR THE TREATMENT OF EYE DISEASES AND CONDITIONS; PHARMACEUTICAL PREPARATIONS FOR THE TREATMENT OF HEART RHYTHM DISORDERS; PHARMACEUTICAL PREPARATIONS FOR THE TREATMENT OF IMMUNE SYSTEM RELATED DISEASES AND DISORDERS; PHARMACEUTICAL PREPARATIONS FOR THE TREATMENT OF KIDNEY DISEASES; PHARMACEUTICAL PREPARATIONS FOR TREATING DIABETES; PHARMACEUTICAL PREPARATIONS FOR USE IN DERMATOLOGY; PHARMACEUTICAL PRODUCTS FOR OPHTHALMOLOGICAL USE; PHARMACEUTICAL PRODUCTS FOR THE PREVENTION AND TREATMENT OF CANCER; PHARMACEUTICAL PRODUCTS FOR THE TREATMENT OF BONE DISEASES; PHARMACEUTICAL PRODUCTS FOR TREATING RESPIRATORY DISEASES; PHARMACEUTICAL PRODUCTS FOR TREATING RESPIRATORY DISEASES AND ASTHMA; PHARMACEUTICALS, NAMELY, ANTI-INFECTIVES (U.S. CLS. 6, 18, 44, 46, 51 AND 52).

GEORGE LORENZO, EXAMINING ATTORNEY

SN 85-533,498. MACUCLEAR, INC., PLANO, TX. FILED 2-3-2012.

A Simple. Solution for millions to see!

THE MARK CONSISTS OF STANDARD CHARACTERS WITHOUT CLAIM TO ANY PARTICULAR FONT, STYLE, SIZE, OR COLOR.

FOR PHARMACEUTICAL PREPARATIONS FOR THE TREATMENT OF EYE DISEASES AND CONDITIONS (U.S. CLS. 6, 18, 44, 46, 51 AND 52).

ODESSA BIBBINS, EXAMINING ATTORNEY

CLASS 5—(Continued).

SN 85-533,704. MERCK SHARP & DOHME CORP., WHITEHOUSE STATION, NJ. FILED 2-3-2012.

PARTROM

THE MARK CONSISTS OF STANDARD CHARACTERS WITHOUT CLAIM TO ANY PARTICULAR FONT, STYLE, SIZE, OR COLOR.

FOR PHARMACEUTICAL PREPARATIONS FOR THE TREATMENT OF CARDIOVASCULAR DISORDERS (U.S. CLS. 6, 18, 44, 46, 51 AND 52).

SANJEEV VOHRA, EXAMINING ATTORNEY

CLASS 5—(Continued).

SN 85-534,077. THORNE RESEARCH, INC., SANDPOINT, ID. FILED 2-4-2012.

MucosaQOL

THE MARK CONSISTS OF STANDARD CHARACTERS WITHOUT CLAIM TO ANY PARTICULAR FONT, STYLE, SIZE, OR COLOR.

FOR DIETARY SUPPLEMENTS FOR THE NUTRITIONAL SUPPORT OF ONCOLOGY PATIENTS (U.S. CLS. 6, 18, 44, 46, 51 AND 52).

SARA BENJAMIN, EXAMINING ATTORNEY

SN 85-533,899. OLLIE'S HEALTH, LLC, PASCO, WA. FILED 2-3-2012.

VitaPastor

THE MARK CONSISTS OF STANDARD CHARACTERS WITHOUT CLAIM TO ANY PARTICULAR FONT, STYLE, SIZE, OR COLOR.

FOR MIXED VITAMIN PREPARATIONS; MULTI-VITAMIN PREPARATIONS; VITAMIN AND MINERAL SUPPLEMENTS; VITAMIN B PREPARATIONS; VITAMIN C PREPARATIONS; VITAMIN D PREPARATIONS; VITAMIN SUPPLEMENTS (U.S. CLS. 6, 18, 44, 46, 51 AND 52).

FIRST USE 9-0-2011; IN COMMERCE 1-10-2012.
ANGELA DUONG, EXAMINING ATTORNEY

SN 85-534,099. THORNE RESEARCH, INC., SANDPOINT, ID. FILED 2-4-2012.

MyoQOL

THE MARK CONSISTS OF STANDARD CHARACTERS WITHOUT CLAIM TO ANY PARTICULAR FONT, STYLE, SIZE, OR COLOR.

FOR DIETARY SUPPLEMENTS FOR THE NUTRITIONAL SUPPORT OF ONCOLOGY PATIENTS (U.S. CLS. 6, 18, 44, 46, 51 AND 52).

SARA BENJAMIN, EXAMINING ATTORNEY

SN 85-534,074. THORNE RESEARCH, INC., SANDPOINT, ID. FILED 2-4-2012.

DermaQOL

THE MARK CONSISTS OF STANDARD CHARACTERS WITHOUT CLAIM TO ANY PARTICULAR FONT, STYLE, SIZE, OR COLOR.

FOR DIETARY SUPPLEMENTS FOR THE NUTRITIONAL SUPPORT OF ONCOLOGY PATIENTS (U.S. CLS. 6, 18, 44, 46, 51 AND 52).

SARA BENJAMIN, EXAMINING ATTORNEY

SN 85-534,151. MULLINIX, ANGELINE LOUISE, LOVE-TTSVILLE, VA. FILED 2-4-2012.

CoverBum

THE MARK CONSISTS OF STANDARD CHARACTERS WITHOUT CLAIM TO ANY PARTICULAR FONT, STYLE, SIZE, OR COLOR.

FOR INFANT CLOTH DIAPERS (U.S. CLS. 6, 18, 44, 46, 51 AND 52).

JACQUELINE A. LAVINE, EXAMINING ATTORNEY

CLASS 5—(Continued).

SN 85-534,552. REDTREE NEUTRACEUTICALS INC., FORMERLY B GONE ENTERPRISES INC., POUGHKEEPSIE, NY. FILED 2-6-2012.

ROOTOLOGY

THE MARK CONSISTS OF STANDARD CHARACTERS WITHOUT CLAIM TO ANY PARTICULAR FONT, STYLE, SIZE, OR COLOR.

FOR NATURAL HERBAL SUPPLEMENTS (U.S. CLS. 6, 18, 44, 46, 51 AND 52).

BRIAN NEVILLE, EXAMINING ATTORNEY

CLASS 5—(Continued).

SN 85-535,250. STACKIT, INC., SPOKANE, WA. FILED 2-6-2012.

STACKIT HEALTH

THE MARK CONSISTS OF STANDARD CHARACTERS WITHOUT CLAIM TO ANY PARTICULAR FONT, STYLE, SIZE, OR COLOR.

NO CLAIM IS MADE TO THE EXCLUSIVE RIGHT TO USE "HEALTH", APART FROM THE MARK AS SHOWN.

FOR HEALTH FOOD SUPPLEMENTS AND DIETARY SUPPLEMENTAL DRINKS (U.S. CLS. 6, 18, 44, 46, 51 AND 52).

BRIDGETT SMITH, EXAMINING ATTORNEY

SN 85-534,774. NOVAST LABORATORIES, INC., STERLING, VA. FILED 2-6-2012.

MONO-LINYAH

THE MARK CONSISTS OF STANDARD CHARACTERS WITHOUT CLAIM TO ANY PARTICULAR FONT, STYLE, SIZE, OR COLOR.

FOR PHARMACEUTICAL PREPARATIONS FOR OVULATION CONTROL AND GYNECOLOGICAL CONDITIONS; ORAL CONTRACEPTIVES; HORMONE PREPARATIONS (U.S. CLS. 6, 18, 44, 46, 51 AND 52).

DAVID C. REIHNER, EXAMINING ATTORNEY

SN 85-535,310. THORNE RESEARCH, INC., SANDPOINT, ID. FILED 2-6-2012.

NeuroQOL

THE MARK CONSISTS OF STANDARD CHARACTERS WITHOUT CLAIM TO ANY PARTICULAR FONT, STYLE, SIZE, OR COLOR.

FOR DIETARY SUPPLEMENTS FOR THE NUTRITIONAL SUPPORT OF ONCOLOGY PATIENTS (U.S. CLS. 6, 18, 44, 46, 51 AND 52).

SARA BENJAMIN, EXAMINING ATTORNEY

SN 85-535,213. ACCELERATED NUTRACEUTICAL RESEARCH, INC., HIALEAH, FL. FILED 2-6-2012.

speedpump

THE MARK CONSISTS OF STANDARD CHARACTERS WITHOUT CLAIM TO ANY PARTICULAR FONT, STYLE, SIZE, OR COLOR.

FOR DIETARY FOOD SUPPLEMENTS (U.S. CLS. 6, 18, 44, 46, 51 AND 52).

LINDA POWELL, EXAMINING ATTORNEY

SN 85-535,318. THORNE RESEARCH, INC., SANDPOINT, ID. FILED 2-6-2012.

ProbioQOL

THE MARK CONSISTS OF STANDARD CHARACTERS WITHOUT CLAIM TO ANY PARTICULAR FONT, STYLE, SIZE, OR COLOR.

FOR DIETARY SUPPLEMENTS FOR THE NUTRITIONAL SUPPORT OF ONCOLOGY PATIENTS (U.S. CLS. 6, 18, 44, 46, 51 AND 52).

SARA BENJAMIN, EXAMINING ATTORNEY

CLASS 5—(Continued).

SN 85-535,459. IMEX MARKETING CO., INC., FULLERTON, CA. FILED 2-7-2012.



THE MARK CONSISTS OF A STYLIZED ARROW HEADED POINTED DOWN WITH THE RIGHT SIDE SHADED DARKER THAN THE LEFT AND THE ARROW OUTLINE DOES NOT COME TO A COMPLETE CLOSE.

FOR DEODORIZING PRODUCTS, NAMELY, ALL PURPOSE DEODORIZER PREPARATIONS FOR HOUSEHOLD, COMMERCIAL, AIR DEODORANT, AIR DEODORIZER AND INDUSTRIAL USE (U.S. CLS. 6, 18, 44, 46, 51 AND 52).

GRETTA YAO, EXAMINING ATTORNEY

CLASS 5—(Continued).

SN 85-535,764. CAI LIMITED, WANCHAI, HONG KONG, FILED 2-7-2012.

AgriColle

THE MARK CONSISTS OF STANDARD CHARACTERS WITHOUT CLAIM TO ANY PARTICULAR FONT, STYLE, SIZE, OR COLOR.

FOR PESTICIDES; INSECTICIDES; FUNGICIDES; PESTICIDES, NAMELY INSECTICIDES AND FUNGICIDES, FOR AGRICULTURAL, COMMERCIAL, INDUSTRIAL AND DOMESTIC USE; PESTICIDES, NAMELY INSECTICIDES AND FUNGICIDES, FOR VETERINARY USE; TOPICAL ANTI-FLEA PREPARATIONS FOR VETERINARY USE; TOPICAL ANTI-TICK PREPARATIONS FOR VETERINARY USE (U.S. CLS. 6, 18, 44, 46, 51 AND 52).

MIAH ROSENBERG, EXAMINING ATTORNEY

SN 85-535,518. SWEET CORN PRODUCTS, L.L.C., BLOOMFIELD, NE. FILED 2-7-2012.

TRAP-N-A-SAK

THE MARK CONSISTS OF STANDARD CHARACTERS WITHOUT CLAIM TO ANY PARTICULAR FONT, STYLE, SIZE, OR COLOR.

FOR RODENTICIDES (U.S. CLS. 6, 18, 44, 46, 51 AND 52).

GRETTA YAO, EXAMINING ATTORNEY

SN 85-535,789. CAI LIMITED, WANCHAI, HONG KONG, FILED 2-7-2012.

AgriTrap

SN 85-535,716. U.S. HISPANIC VENTURES, INC., DBA MILAGROS DE MEXICO, SAN FRANCISCO, CA. FILED 2-7-2012.

ReumoMax

THE MARK CONSISTS OF STANDARD CHARACTERS WITHOUT CLAIM TO ANY PARTICULAR FONT, STYLE, SIZE, OR COLOR.

FOR DIETARY AND NUTRITIONAL SUPPLEMENTS (U.S. CLS. 6, 18, 44, 46, 51 AND 52).

BRIDGETT SMITH, EXAMINING ATTORNEY

THE MARK CONSISTS OF STANDARD CHARACTERS WITHOUT CLAIM TO ANY PARTICULAR FONT, STYLE, SIZE, OR COLOR.

FOR PESTICIDES; INSECTICIDES; FUNGICIDES; PESTICIDES, NAMELY INSECTICIDES AND FUNGICIDES, FOR AGRICULTURAL, COMMERCIAL, INDUSTRIAL AND DOMESTIC USE; PESTICIDES, NAMELY INSECTICIDES AND FUNGICIDES, FOR VETERINARY USE; TOPICAL ANTI-FLEA PREPARATIONS FOR VETERINARY USE; TOPICAL ANTI-TICK PREPARATIONS FOR VETERINARY USE (U.S. CLS. 6, 18, 44, 46, 51 AND 52).

MIAH ROSENBERG, EXAMINING ATTORNEY

CLASS 5—(Continued).

SN 85-535,917. PFIZER INC., NEW YORK, NY. FILED 2-7-2012.

STATHERZ

THE MARK CONSISTS OF STANDARD CHARACTERS WITHOUT CLAIM TO ANY PARTICULAR FONT, STYLE, SIZE, OR COLOR.

FOR PHARMACEUTICAL PREPARATIONS FOR THE TREATMENT OF CARDIOVASCULAR, CENTRAL NERVOUS SYSTEM, ENDOCRINE, GASTROINTESTINAL, GENETIC IMMUNOLOGICAL, INFECTIOUS, INFLAMMATORY, MENOPAUSAL, METABOLIC, AUTOIMMUNE, MUSCULOSKELETAL, NEUROLOGICAL, OPHTHALMOLOGICAL, PSYCHIATRIC, RESPIRATORY, UROGENITAL, UROLOGICAL AND VIRAL DISEASES AND DISORDERS; PHARMACEUTICAL PREPARATIONS FOR THE TREATMENT OF ERECTILE DYSFUNCTION, SEXUAL DYSFUNCTION, CANCER, PAIN AND DIABETES; PHARMACEUTICAL PREPARATIONS FOR USE IN HEMATOLOGY; PHARMACEUTICAL PREPARATIONS, NAMELY, ANTIFUNGAL PREPARATIONS, DERMATOLOGICAL PREPARATIONS, SMOKING CESSATION PREPARATIONS, AND TISSUE REPAIR PREPARATIONS; VACCINES FOR HUMAN USE (U.S. CLS. 6, 18, 44, 46, 51 AND 52).

EDWARD FENNESSY, EXAMINING ATTORNEY

SN 85-536,062. EMERGENT HEALTH CORP, KING OF PRUSSIA, PA. FILED 2-7-2012.

Nutracide

THE MARK CONSISTS OF STANDARD CHARACTERS WITHOUT CLAIM TO ANY PARTICULAR FONT, STYLE, SIZE, OR COLOR.

FOR DIETARY SUPPLEMENTS (U.S. CLS. 6, 18, 44, 46, 51 AND 52).

KAREN K. BUSH, EXAMINING ATTORNEY

SN 85-536,115. BIOD, LLC, CORDOVA, TN. FILED 2-7-2012.

**ENHANCING LIFE THROUGH
BIRTH**

THE MARK CONSISTS OF STANDARD CHARACTERS WITHOUT CLAIM TO ANY PARTICULAR FONT, STYLE, SIZE, OR COLOR.

FOR HUMAN ALLOGRAFT TISSUE (U.S. CLS. 6, 18, 44, 46, 51 AND 52).

FIRST USE 4-0-2011; IN COMMERCE 4-0-2011.

WILLIAM BRECKENFELD, EXAMINING ATTORNEY

CLASS 5—(Continued).

SN 85-536,163. EMERGENT HEALTH CORP., KING OF PRUSSIA, PA. FILED 2-7-2012.

Cancide

THE MARK CONSISTS OF STANDARD CHARACTERS WITHOUT CLAIM TO ANY PARTICULAR FONT, STYLE, SIZE, OR COLOR.

FOR DIETARY SUPPLEMENTS (U.S. CLS. 6, 18, 44, 46, 51 AND 52).

BARNEY CHARLON, EXAMINING ATTORNEY

SN 85-536,249. PFIZER INC., NEW YORK, NY. FILED 2-7-2012.

AQUESSA

THE MARK CONSISTS OF STANDARD CHARACTERS WITHOUT CLAIM TO ANY PARTICULAR FONT, STYLE, SIZE, OR COLOR.

OWNER OF U.S. REG. NO. 3,785,144.

FOR PHARMACEUTICAL PREPARATIONS FOR THE TREATMENT OF CARDIOVASCULAR, CENTRAL NERVOUS SYSTEM, ENDOCRINE, GASTROINTESTINAL, GENETIC IMMUNOLOGICAL, INFECTIOUS, INFLAMMATORY, MENOPAUSAL, METABOLIC, AUTOIMMUNE, MUSCULOSKELETAL, NEUROLOGICAL, OPHTHALMOLOGICAL, PSYCHIATRIC, RESPIRATORY, UROGENITAL, UROLOGICAL AND VIRAL DISEASES AND DISORDERS; PHARMACEUTICAL PREPARATIONS FOR THE TREATMENT OF ERECTILE DYSFUNCTION, SEXUAL DYSFUNCTION, CANCER, PAIN AND DIABETES; PHARMACEUTICAL PREPARATIONS FOR USE IN HEMATOLOGY; PHARMACEUTICAL PREPARATIONS, NAMELY, ANTIFUNGAL PREPARATIONS, DERMATOLOGICAL PREPARATIONS, SMOKING CESSATION PREPARATIONS, AND TISSUE REPAIR PREPARATIONS; VACCINES FOR HUMAN USE, ALL IN INTERNATIONAL CLASS 5 (U.S. CLS. 6, 18, 44, 46, 51 AND 52).

EDWARD FENNESSY, EXAMINING ATTORNEY

SN 85-536,468. MARINE INGREDIENTS, LLC, MT. BETHEL, PA. FILED 2-7-2012.

LIPOMAR

THE MARK CONSISTS OF STANDARD CHARACTERS WITHOUT CLAIM TO ANY PARTICULAR FONT, STYLE, SIZE, OR COLOR.

FOR DIETARY AND NUTRITIONAL SUPPLEMENTS (U.S. CLS. 6, 18, 44, 46, 51 AND 52).

DAVID COLLIER, EXAMINING ATTORNEY

CLASS 5—(Continued).

SN 85-536,538. BIOLIFE CORPORATION, TEMPLE CITY, CA. FILED 2-7-2012.

Nature Label

THE MARK CONSISTS OF STANDARD CHARACTERS WITHOUT CLAIM TO ANY PARTICULAR FONT, STYLE, SIZE, OR COLOR.

FOR DIETARY AND NUTRITIONAL SUPPLEMENTS (U.S. CLS. 6, 18, 44, 46, 51 AND 52).

KATHERINE CONNOLLY, EXAMINING ATTORNEY

SN 85-536,851. NOVARTIS AG, BASEL, SWITZERLAND, FILED 2-8-2012.



THE COLOR(S) WHITE AND ORANGE IS/ARE CLAIMED AS A FEATURE OF THE MARK.

THE MARK CONSISTS OF A PARTIAL WHITE SPHERE SUPERIMPOSED OVER AN ORANGE RECTANGLE.

FOR ANTI-INFLAMMATORIES; ANTIBACTERIAL PHARMACEUTICALS; ANTIBIOTICS; ANTIFUNGAL PREPARATIONS; ANTIVIRALS; CARDIOVASCULAR PHARMACEUTICALS; PHARMACEUTICAL PREPARATIONS ACTING ON THE CENTRAL NERVOUS SYSTEM; PHARMACEUTICAL PREPARATIONS AND SUBSTANCES FOR THE TREATMENT OF GASTRO-INTESTINAL DISEASES; PHARMACEUTICAL PREPARATIONS FOR THE TREATMENT AND PREVENTION OF DISEASES AND DISORDERS OF THE AUTOIMMUNE SYSTEM, THE METABOLIC SYSTEM, THE MUSCULOSKELETAL SYSTEM AND THE GENITOURINARY SYSTEM; PHARMACEUTICAL PREPARATIONS FOR USE IN HEMATOLOGY AND IN TISSUE AND ORGAN TRANSPLANTATION; PHARMACEUTICAL PREPARATIONS FOR THE TREATMENT OF EYE DISEASES AND CONDITIONS; PHARMACEUTICAL PREPARATIONS FOR THE TREATMENT OF HEART RHYTHM DISORDERS; PHARMACEUTICAL PREPARATIONS FOR THE TREATMENT OF IMMUNE SYSTEM RELATED DISEASES AND DISORDERS; PHARMACEUTICAL PREPARATIONS FOR THE TREATMENT OF KIDNEY DISEASES; PHARMACEUTICAL PREPARATIONS FOR TREATING DIABETES; PHARMACEUTICAL PREPARATIONS FOR USE IN DERMATOLOGY; PHARMACEUTICAL PRODUCTS FOR OPHTHALMOLOGICAL USE; PHARMACEUTICAL PRODUCTS FOR THE PREVENTION AND TREATMENT OF CANCER; PHARMACEUTICAL PRODUCTS FOR THE TREATMENT OF BONE DISEASES; PHARMACEUTICAL PRODUCTS FOR TREATING RESPIRATORY DISEASES; PHARMACEUTICAL PRODUCTS FOR TREATING RESPIRATORY DISEASES AND ASTHMA; PHARMACEUTICALS, NAMELY, ANTI-INFECTIVES (U.S. CLS. 6, 18, 44, 46, 51 AND 52).

RONALD MCMORROW, EXAMINING ATTORNEY

CLASS 5—(Continued).

SN 85-536,858. TIFU LLC, NEW YORK, NY. FILED 2-8-2012.

VROU

THE MARK CONSISTS OF STANDARD CHARACTERS WITHOUT CLAIM TO ANY PARTICULAR FONT, STYLE, SIZE, OR COLOR.

FOR DIETARY AND NUTRITIONAL SUPPLEMENTS; DIETARY AND NUTRITIONAL SUPPLEMENTS FOR ENDURANCE SPORTS; DIETARY AND NUTRITIONAL SUPPLEMENTS USED FOR WEIGHT LOSS; DIETARY BEVERAGE SUPPLEMENTS FOR HUMAN CONSUMPTION IN LIQUID AND DRY MIX FORM FOR THERAPEUTIC PURPOSES; DIETARY SUPPLEMENTAL DRINKS IN THE NATURE OF VITAMIN AND MINERAL BEVERAGES; LIQUID NUTRITIONAL SUPPLEMENT; MINERAL NUTRITIONAL SUPPLEMENTS; NUTRITIONAL AND DIETARY SUPPLEMENTS FORMED AND PACKAGED AS BARS; NUTRITIONAL SUPPLEMENT ENERGY BARS; NUTRITIONAL SUPPLEMENT IN THE NATURE OF A NUTRIENT-DENSE, PROTEIN-BASED DRINK MIX; NUTRITIONAL SUPPLEMENT SHAKES; NUTRITIONAL SUPPLEMENTS; NUTRITIONAL SUPPLEMENTS IN THE NATURE OF NUTRITIONALLY FORTIFIED SOFT CHEWS; NUTRITIONAL SUPPLEMENTS, NAMELY, CARBOHYDRATES IN POWDERED FORM; NUTRITIONAL SUPPLEMENTS, NAMELY, PROBIOTIC COMPOSITIONS; NUTRITIONALLY FORTIFIED BEVERAGES; POWDERED NUTRITIONAL SUPPLEMENT CONCENTRATE; POWDERED NUTRITIONAL SUPPLEMENT DRINK MIX; POWDERED NUTRITIONAL SUPPLEMENT DRINK MIX AND CONCENTRATE; SOY PROTEIN FOR USE AS A NUTRITIONAL SUPPLEMENT IN VARIOUS POWDERED AND READY-TO-DRINK BEVERAGES; VEGAN PROTEIN FOR USE AS A NUTRITIONAL SUPPLEMENT IN READY-TO-DRINK BEVERAGES; VITAMIN FORTIFIED BEVERAGES (U.S. CLS. 6, 18, 44, 46, 51 AND 52).

CARYN GLASSER, EXAMINING ATTORNEY

SN 85-536,928. VISIONSTAR, INC., LOS ANGELES, CA. FILED 2-8-2012.

TestoBoost

THE MARK CONSISTS OF STANDARD CHARACTERS WITHOUT CLAIM TO ANY PARTICULAR FONT, STYLE, SIZE, OR COLOR.

FOR DIETARY FOOD SUPPLEMENTS (U.S. CLS. 6, 18, 44, 46, 51 AND 52).

FIRST USE 12-1-2010; IN COMMERCE 12-1-2010. COLLEEN DOMBROW, EXAMINING ATTORNEY

CLASS 5—(Continued).

SN 85-536,999. NORBROOK LABORATORIES LIMITED, NEWRY, COUNTY DOWN, NORTHERN IRELAND, FILED 2-8-2012.

TANDEM PEN-BEN-PRO

THE MARK CONSISTS OF STANDARD CHARACTERS WITHOUT CLAIM TO ANY PARTICULAR FONT, STYLE, SIZE, OR COLOR.

FOR PHARMACEUTICAL AND VETERINARY PREPARATIONS AND SUBSTANCES, NAMELY, ANTIBIOTICS (U.S. CLS. 6, 18, 44, 46, 51 AND 52).

BRIAN CALLAGHAN, EXAMINING ATTORNEY

SN 85-537,062. SANOFI PASTEUR LIMITED / SANOFI PASTEUR LIMITEE, TORONTO, ONTARIO, CANADA, FILED 2-8-2012.

FLUZONE QUADRA

THE MARK CONSISTS OF STANDARD CHARACTERS WITHOUT CLAIM TO ANY PARTICULAR FONT, STYLE, SIZE, OR COLOR.

FOR HUMAN VACCINES (U.S. CLS. 6, 18, 44, 46, 51 AND 52).

ZHALEH DELANEY, EXAMINING ATTORNEY

SN 85-537,086. STADA ARZNEIMITTEL AG, BAD VILBEL, FED REP GERMANY, FILED 2-8-2012.

GRIPPOSTAD

THE MARK CONSISTS OF STANDARD CHARACTERS WITHOUT CLAIM TO ANY PARTICULAR FONT, STYLE, SIZE, OR COLOR.

OWNER OF FED REP GERMANY REG. NO. 740021, DATED 9-8-1960, EXPIRES 10-31-2019.

OWNER OF U.S. REG. NO. 3,034,865.

FOR PHARMACEUTICAL PREPARATIONS FOR THE TREATMENT OF COUGH AND COLDS (U.S. CLS. 6, 18, 44, 46, 51 AND 52).

TOBY BULLOFF, EXAMINING ATTORNEY

CLASS 5—(Continued).

SN 85-537,088. STADA ARZNEIMITTEL AG, BAD VILBEL, FED REP GERMANY, FILED 2-8-2012.

KAMISTAD

THE MARK CONSISTS OF STANDARD CHARACTERS WITHOUT CLAIM TO ANY PARTICULAR FONT, STYLE, SIZE, OR COLOR.

OWNER OF FED REP GERMANY REG. NO. 30330181, DATED 11-26-2003, EXPIRES 6-30-2013.

OWNER OF U.S. REG. NO. 3,034,866.

FOR PHARMACEUTICAL PREPARATIONS, NAMELY, AN ORAL THERAPEUTIC GEL FOR THE TREATMENT OF PAINFUL AND INFLAMMATORY GUMS, THE ORAL MUCOUS MEMBRANE, AND THE LIPS (U.S. CLS. 6, 18, 44, 46, 51 AND 52).

TOBY BULLOFF, EXAMINING ATTORNEY

SN 85-537,115. SANOFI PASTEUR LIMITED / SANOFI PASTEUR LIMITEE, TORONTO, ONTARIO, CANADA, FILED 2-8-2012.

FLUZONE FOURCE

THE MARK CONSISTS OF STANDARD CHARACTERS WITHOUT CLAIM TO ANY PARTICULAR FONT, STYLE, SIZE, OR COLOR.

FOR HUMAN VACCINES (U.S. CLS. 6, 18, 44, 46, 51 AND 52).

ZHALEH DELANEY, EXAMINING ATTORNEY

SN 85-537,154. SANOFI PASTEUR LIMITED / SANOFI PASTEUR LIMITEE, TORONTO, ONTARIO, CANADA, FILED 2-8-2012.

FLUFORCE

THE MARK CONSISTS OF STANDARD CHARACTERS WITHOUT CLAIM TO ANY PARTICULAR FONT, STYLE, SIZE, OR COLOR.

FOR HUMAN VACCINES (U.S. CLS. 6, 18, 44, 46, 51 AND 52).

ZHALEH DELANEY, EXAMINING ATTORNEY

CLASS 5—(Continued).

SN 85-537,178. 4 DIMENSION NUTRITION, LLC, HARTFORD, CT. FILED 2-8-2012.

MultiPax

THE MARK CONSISTS OF STANDARD CHARACTERS WITHOUT CLAIM TO ANY PARTICULAR FONT, STYLE, SIZE, OR COLOR.
FOR DIETARY AND NUTRITIONAL SUPPLEMENTS (U.S. CLS. 6, 18, 44, 46, 51 AND 52).
ASMAT KHAN, EXAMINING ATTORNEY

CLASS 5—(Continued).

SN 85-538,253. NOVARTIS AG, BASEL, SWITZERLAND, FILED 2-9-2012.

VANCUITY

THE MARK CONSISTS OF STANDARD CHARACTERS WITHOUT CLAIM TO ANY PARTICULAR FONT, STYLE, SIZE, OR COLOR.
FOR OPHTHALMIC PREPARATIONS (U.S. CLS. 6, 18, 44, 46, 51 AND 52).
RONALD MCMORROW, EXAMINING ATTORNEY

SN 85-537,640. ENDURANCE EVOLUTION, INC., DBA ENDUROFUELS, COLORADO SPRINGS, CO. FILED 2-8-2012.

ENDUROFUELS

THE MARK CONSISTS OF STANDARD CHARACTERS WITHOUT CLAIM TO ANY PARTICULAR FONT, STYLE, SIZE, OR COLOR.
FOR NUTRITIONAL SUPPLEMENTS FOR SUPPORTING ATHLETIC PERFORMANCE (U.S. CLS. 6, 18, 44, 46, 51 AND 52).
CHRISIE B. KING, EXAMINING ATTORNEY

SN 85-538,264. NOVARTIS AG, BASEL, SWITZERLAND, FILED 2-9-2012.

FOCUITY

THE MARK CONSISTS OF STANDARD CHARACTERS WITHOUT CLAIM TO ANY PARTICULAR FONT, STYLE, SIZE, OR COLOR.
FOR OPHTHALMIC PREPARATIONS (U.S. CLS. 6, 18, 44, 46, 51 AND 52).
RONALD MCMORROW, EXAMINING ATTORNEY

SN 85-538,048. PHILIP GEORGE, SCARSDALE, NY. FILED 2-9-2012.

RENERVEE

THE MARK CONSISTS OF STANDARD CHARACTERS WITHOUT CLAIM TO ANY PARTICULAR FONT, STYLE, SIZE, OR COLOR.
FOR NUTRITIONAL SUPPLEMENTS (U.S. CLS. 6, 18, 44, 46, 51 AND 52).
JOHN HWANG, EXAMINING ATTORNEY

SN 85-538,270. NOVARTIS AG, BASEL, SWITZERLAND, FILED 2-9-2012.

VIZALAY

THE MARK CONSISTS OF STANDARD CHARACTERS WITHOUT CLAIM TO ANY PARTICULAR FONT, STYLE, SIZE, OR COLOR.
FOR OPHTHALMIC PREPARATIONS (U.S. CLS. 6, 18, 44, 46, 51 AND 52).
RONALD MCMORROW, EXAMINING ATTORNEY

CLASS 5—(Continued).

SN 85-538,421. THE PROCTER & GAMBLE COMPANY, CINCINNATI, OH. FILED 2-9-2012.



OWNER OF U.S. REG. NOS. 386,984, 3,461,443 AND OTHERS.

THE MARK CONSISTS OF A TRIANGLE WITH THE WORD "VICKS" ACROSS THE CENTER.

FOR SLEEP AID PREPARATIONS (U.S. CLS. 6, 18, 44, 46, 51 AND 52).

AMY ALFIERI, EXAMINING ATTORNEY

CLASS 5—(Continued).

SN 85-538,569. EAST SIDE PHARMACY, INC., NEW YORK, NY. FILED 2-9-2012.

NANO-MELTS

THE MARK CONSISTS OF STANDARD CHARACTERS WITHOUT CLAIM TO ANY PARTICULAR FONT, STYLE, SIZE, OR COLOR.

FOR VETERINARY PHARMACEUTICAL PREPARATIONS IN THE FORM OF ORALLY DISINTEGRATING TABLETS FOR DOGS, CATS, AND OTHER DOMESTIC ANIMALS, NAMELY, PAIN RELIEF MEDICATION, PREPARATIONS FOR TREATMENT OF INTESTINAL BACTERIA, INCONTINENCE, HEART CONDITIONS, KIDNEY CONDITIONS, LIVER CONDITIONS, PREPARATIONS FOR THE TREATMENT OF CANCER AND DISEASES OF THE HEART, PREPARATIONS FOR TREATMENT OF DISORDERS OF THE GASTRO-INTESTINAL TRACT; ANTIBIOTIC PREPARATIONS; ANTI-INFECTIVES; ANTI-FUNGAL PREPARATIONS; ANTIPARASITIC PREPARATIONS; ANTI-ARTHRITIC COMPOSITIONS AND PREPARATIONS; ANTI-INFLAMMATORY AND ANTIPYRETIC PREPARATIONS; GASTRO-INTESTINAL TREATMENT PREPARATIONS; PHARMACEUTICAL PREPARATIONS FOR THE TREATMENT OF INFECTIOUS DISEASES; PHARMACEUTICAL PREPARATIONS FOR WOUNDS (U.S. CLS. 6, 18, 44, 46, 51 AND 52).

MARIA-VICTORIA SUAREZ, EXAMINING ATTORNEY

SN 85-538,694. PVP PERFORMANCE INC., NEW YORK, NY. FILED 2-9-2012.

POWER OFF

THE MARK CONSISTS OF STANDARD CHARACTERS WITHOUT CLAIM TO ANY PARTICULAR FONT, STYLE, SIZE, OR COLOR.

FOR SLEEP AID PREPARATIONS (U.S. CLS. 6, 18, 44, 46, 51 AND 52).

CAROLINE WOOD, EXAMINING ATTORNEY

SN 85-538,706. PVP PERFORMANCE INC., NEW YORK, NY. FILED 2-9-2012.

POWER ON

THE MARK CONSISTS OF STANDARD CHARACTERS WITHOUT CLAIM TO ANY PARTICULAR FONT, STYLE, SIZE, OR COLOR.

FOR DIETARY SUPPLEMENTS TO HELP INCREASE FEELINGS OF ALERTNESS AND FOR THE RELIEF AND PREVENTION OF FATIGUE (U.S. CLS. 6, 18, 44, 46, 51 AND 52).

CAROLINE WOOD, EXAMINING ATTORNEY

SAVESTA

THE MARK CONSISTS OF STANDARD CHARACTERS WITHOUT CLAIM TO ANY PARTICULAR FONT, STYLE, SIZE, OR COLOR.

FOR DIETARY SUPPLEMENTS (U.S. CLS. 6, 18, 44, 46, 51 AND 52).

FIRST USE 1-31-2012; IN COMMERCE 1-31-2012.
SUE LAWRENCE, EXAMINING ATTORNEY

CLASS 5—(Continued).

SN 85-538,733. WESTERN HOLDINGS, LLC, CARSON CITY, NV. FILED 2-9-2012.

AIR SHOT

THE MARK CONSISTS OF STANDARD CHARACTERS WITHOUT CLAIM TO ANY PARTICULAR FONT, STYLE, SIZE, OR COLOR.
FOR DIETARY SUPPLEMENTS (U.S. CLS. 6, 18, 44, 46, 51 AND 52).
JACQUELINE A. LAVINE, EXAMINING ATTORNEY

CLASS 5—(Continued).

SN 85-538,909. PARADISE HERBS & ESSENTIALS, INC., HUNTINGTON BEACH, CA. FILED 2-9-2012.

WHOLE-CHILD

THE MARK CONSISTS OF STANDARD CHARACTERS WITHOUT CLAIM TO ANY PARTICULAR FONT, STYLE, SIZE, OR COLOR.
FOR NUTRITIONAL SUPPLEMENTS (U.S. CLS. 6, 18, 44, 46, 51 AND 52).
ANDREA HACK, EXAMINING ATTORNEY

SN 85-538,802. STRUM, GAIL H., NEW YORK, NY. FILED 2-9-2012.

LUBE FOR LOVE

THE MARK CONSISTS OF STANDARD CHARACTERS WITHOUT CLAIM TO ANY PARTICULAR FONT, STYLE, SIZE, OR COLOR.
FOR PERSONAL LUBRICANTS (U.S. CLS. 6, 18, 44, 46, 51 AND 52).
AISHA SALEM, EXAMINING ATTORNEY

SN 85-539,485. WYETH LLC, MADISON, NJ. FILED 2-10-2012.

SLEPT

SN 85-538,845. BONK BREAKER, LLC, CHATSWORTH, CA. FILED 2-9-2012.

BONK BREAKER

THE MARK CONSISTS OF STANDARD CHARACTERS WITHOUT CLAIM TO ANY PARTICULAR FONT, STYLE, SIZE, OR COLOR.
FOR NUTRITIONAL SUPPLEMENT ENERGY BARS (U.S. CLS. 6, 18, 44, 46, 51 AND 52).
FIRST USE 0-0-2006; IN COMMERCE 0-0-2006.
ZACHARY BELLO, EXAMINING ATTORNEY

THE MARK CONSISTS OF STANDARD CHARACTERS WITHOUT CLAIM TO ANY PARTICULAR FONT, STYLE, SIZE, OR COLOR.
FOR PHARMACEUTICAL PREPARATIONS FOR THE TREATMENT OF CARDIOVASCULAR, CENTRAL NERVOUS SYSTEM, ENDOCRINE, GASTROINTESTINAL, HEMATOLOGIC, IMMUNOLOGICAL, INFECTIOUS, INFLAMMATORY, MENOPAUSAL, METABOLIC, MUSCULOSKELETAL, NEUROLOGICAL, ONCOLOGICAL, OPHTHALMOLOGICAL, PSYCHIATRIC, RESPIRATORY, UROGENITAL, UROLOGICAL AND VIRAL DISEASES AND DISORDERS; PHARMACEUTICAL PREPARATIONS FOR THE TREATMENT OF ERECTILE DYSFUNCTION, SEXUAL DYSFUNCTION AND PAIN; PHARMACEUTICAL PREPARATIONS, NAMELY, ANTI-FUNGAL PREPARATIONS, DERMATOLOGICAL PREPARATIONS, SMOKING CESSATION PREPARATIONS; VACCINES FOR HUMAN USE; PHARMACEUTICAL SLEEP AID PREPARATIONS (U.S. CLS. 6, 18, 44, 46, 51 AND 52).
KATHLEEN LORENZO, EXAMINING ATTORNEY

CLASS 5—(Continued).

SN 85-539,491. WYETH LLC, MADISON, NJ. FILED 2-10-2012.

ZARIAZ

THE MARK CONSISTS OF STANDARD CHARACTERS WITHOUT CLAIM TO ANY PARTICULAR FONT, STYLE, SIZE, OR COLOR.

FOR PHARMACEUTICAL PREPARATIONS FOR THE TREATMENT OF CARDIOVASCULAR, CENTRAL NERVOUS SYSTEM, ENDOCRINE, GASTROINTESTINAL, HEMATOLOGIC, IMMUNOLOGICAL, INFECTIOUS, INFLAMMATORY, MENOPAUSAL, METABOLIC, MUSCULOSKELETAL, NEUROLOGICAL, ONCOLOGICAL, OPHTHALMOLOGICAL, PSYCHIATRIC, RESPIRATORY, UROGENITAL, UROLOGICAL AND VIRAL DISEASES AND DISORDERS; PHARMACEUTICAL PREPARATIONS FOR THE TREATMENT OF ERECTILE DYSFUNCTION, SEXUAL DYSFUNCTION AND PAIN; PHARMACEUTICAL PREPARATIONS, NAMELY, ANTI-FUNGAL PREPARATIONS, DERMATOLOGICAL PREPARATIONS, SMOKING CESSATION PREPARATIONS; VACCINES FOR HUMAN USE; PHARMACEUTICAL SLEEP AID PREPARATIONS (U.S. CLS. 6, 18, 44, 46, 51 AND 52).

KATHLEEN LORENZO, EXAMINING ATTORNEY

SN 85-539,541. AVEO PHARMACEUTICALS, INC., CAMBRIDGE, MA. FILED 2-10-2012.

TIVZ

THE MARK CONSISTS OF STANDARD CHARACTERS WITHOUT CLAIM TO ANY PARTICULAR FONT, STYLE, SIZE, OR COLOR.

FOR MEDICINAL PREPARATIONS FOR USE IN ONCOLOGY; PHARMACEUTICAL PREPARATIONS FOR THE TREATMENT OF CANCER (U.S. CLS. 6, 18, 44, 46, 51 AND 52).

WON TEAK OH, EXAMINING ATTORNEY

CLASS 5—(Continued).

SN 85-539,913. SOMALOGIC, INC., BOULDER, CO. FILED 2-10-2012.

SOMAMER

THE MARK CONSISTS OF STANDARD CHARACTERS WITHOUT CLAIM TO ANY PARTICULAR FONT, STYLE, SIZE, OR COLOR.

FOR REAGENTS, APTAMERS, AND ASSAYS FOR MEDICAL AND VETERINARY PURPOSES; PHARMACEUTICAL PREPARATIONS AND SUBSTANCES FOR THE TREATMENT OF INFECTIOUS DISEASES, BLOOD DISORDERS, PAIN, INFLAMMATION, SEPSIS, ALOPECIA, OBESITY AND COGNITIVE DISORDERS; PHARMACEUTICAL PREPARATIONS AND SUBSTANCES FOR THE TREATMENT OF VIRAL, METABOLIC, ENDOCRINE, MUSCULOSKELETAL, CARDIOVASCULAR, CARDIOPULMONARY, GENITOURINARY, SEXUAL DYSFUNCTION, ONCOLOGICAL, HEPATOLOGICAL, OPHTHALMIC, RESPIRATORY, NEUROLOGICAL, GASTROINTESTINAL, HORMONAL, DERMATOLOGICAL, PSYCHIATRIC AND IMMUNE SYSTEM RELATED DISEASES AND DISORDERS; PHARMACEUTICAL PREPARATIONS AND SUBSTANCES FOR THE TREATMENT OF DAMAGED SKIN AND TISSUE; AND FOR VACCINES (U.S. CLS. 6, 18, 44, 46, 51 AND 52).

SHAILA SETTLES, EXAMINING ATTORNEY

SN 85-539,921. SENSOTHERAPY PRODUCTS, LLC, FORT WORTH, TX. FILED 2-10-2012.

SENSOTHERAPY

THE MARK CONSISTS OF STANDARD CHARACTERS WITHOUT CLAIM TO ANY PARTICULAR FONT, STYLE, SIZE, OR COLOR.

FOR THERAPEUTIC AGENTS FOR WEIGHT CONTROL AND APPETITE SUPPRESSION; WEIGHT MANAGEMENT SUPPLEMENTS (U.S. CLS. 6, 18, 44, 46, 51 AND 52).

FIRST USE 1-1-2007; IN COMMERCE 1-1-2007.

SHAILA SETTLES, EXAMINING ATTORNEY

SN 85-545,354. EDISON NATION, LLC, CHARLOTTE, NC. FILED 2-16-2012.

CRAVE BEHAVE

THE MARK CONSISTS OF STANDARD CHARACTERS WITHOUT CLAIM TO ANY PARTICULAR FONT, STYLE, SIZE, OR COLOR.

FOR MEDICATED DISSOLVABLE ORAL STRIPS FOR APPETITE SUPPRESSANT USE (U.S. CLS. 6, 18, 44, 46, 51 AND 52).

FONG HSU, EXAMINING ATTORNEY

CLASS 5—(Continued).

SN 85-549,658. BIO LOGIC AQUA RESEARCH TECHNOLOGIES INTERNATIONAL, INC., GRANTS PASS, OR. FILED 2-22-2012.

DRY EYE SOLUTION

THE MARK CONSISTS OF STANDARD CHARACTERS WITHOUT CLAIM TO ANY PARTICULAR FONT, STYLE, SIZE, OR COLOR.

NO CLAIM IS MADE TO THE EXCLUSIVE RIGHT TO USE "DRY EYE", APART FROM THE MARK AS SHOWN.

FOR LIQUID FOR REFRESHING EYES, NAMELY, PURIFIED WATER EYE DROPS; LIQUID FOR REFRESHING TEAR FILM, NAMELY, ARTIFICIAL TEARS COMPRISED OF PURIFIED WATER APPLIED VIA A MISTING SPRAY BOTTLE OR AN EYE DROPPER (U.S. CLS. 6, 18, 44, 46, 51 AND 52).

AMY C. KEAN, EXAMINING ATTORNEY

CLASS 5—(Continued).

SN 85-555,721. SPORTSMAN SCENT SOLUTIONS, INC., BRIDGEPORT, NY. FILED 2-29-2012.



THE COLOR(S) GREEN AND SILVER IS/ARE CLAIMED AS A FEATURE OF THE MARK.

THE MARK CONSISTS OF THE STYLIZED WORDING "SLAY" WITH THE LETTERS "SL" AND "Y" IN GREEN WITH SILVER OUTLINING AND THE LETTER "A" IN SILVER.

FOR CAFFEINE PREPARATIONS FOR STIMULATIVE USE (U.S. CLS. 6, 18, 44, 46, 51 AND 52).

AMY C. KEAN, EXAMINING ATTORNEY

SN 85-574,089. ALLTECH, INC., LEXINGTON, KY. FILED 3-20-2012.

ACTIGEN

THE MARK CONSISTS OF STANDARD CHARACTERS WITHOUT CLAIM TO ANY PARTICULAR FONT, STYLE, SIZE, OR COLOR.

FOR ANIMAL FEED SUPPLEMENTS (U.S. CLS. 6, 18, 44, 46, 51 AND 52).

FIRST USE 4-8-2009; IN COMMERCE 4-8-2009.

KELLEY WELLS, EXAMINING ATTORNEY

SN 85-555,156. TOKUYAMA CORPORATION, YAMAGUCHI, JAPAN, FILED 2-28-2012.

PEARLESTE

THE MARK CONSISTS OF STANDARD CHARACTERS WITHOUT CLAIM TO ANY PARTICULAR FONT, STYLE, SIZE, OR COLOR.

OWNER OF JAPAN REG. NO. 4746518, DATED 2-6-2004, EXPIRES 2-6-2014.

FOR HARD RESINS FOR USE IN THE MANUFACTURE OF DENTAL CROWN AND BRIDGE; COMPOSITE RESINS FOR DENTAL USE; PROSTHETIC AND FILLING MATERIALS FOR DENTAL USE; DENTAL CEMENTS; ARTIFICIAL TOOTH MATERIALS; WAXES FOR DENTAL USE; LINING MATERIALS FOR DENTAL USE IN THE FORM OF LIQUID OR PASTE; ADHESIVES FOR DENTAL USE (U.S. CLS. 6, 18, 44, 46, 51 AND 52).

ALLISON HOLTZ, EXAMINING ATTORNEY

SN 85-574,120. ALLTECH, INC., LEXINGTON, KY. FILED 3-20-2012.



THE COLOR(S) GREY AND BLUE IS/ARE CLAIMED AS A FEATURE OF THE MARK.

THE MARK CONSISTS OF THE WORD "ACTIGEN" IN STYLIZED FORM WITH THE LETTERS "A", "C", "T", "I" IN GREY AND THE DOT OF THE "I", "G", "E", AND "N" IN BLUE.

FOR ANIMAL FEED SUPPLEMENTS (U.S. CLS. 6, 18, 44, 46, 51 AND 52).

KELLEY WELLS, EXAMINING ATTORNEY

CLASS 5—(Continued).

SN 85-579,431. FUSE SCIENCE, INC., MIAMI, FL. FILED 3-26-2012.

ELECTROFUSE

THE MARK CONSISTS OF STANDARD CHARACTERS WITHOUT CLAIM TO ANY PARTICULAR FONT, STYLE, SIZE, OR COLOR.

FOR ANALGESICS; DIETARY SUPPLEMENTAL DRINKS IN THE NATURE OF VITAMIN AND MINERAL BEVERAGES; LIQUID VITAMIN SUPPLEMENTS; MEDICINAL PREPARATIONS FOR THE MOUTH TO BE APPLIED IN THE FORM OF DROPS, CAPSULES, TABLETS AND COMPRESSED TABLETS; NUTRITIONAL SUPPLEMENTS FOR BOOSTING ENERGY; VITAMIN AND MINERAL SUPPLEMENTS; VITAMIN DROPS (U.S. CLS. 6, 18, 44, 46, 51 AND 52).

LINDSEY RUBIN, EXAMINING ATTORNEY

SN 85-583,607. DARK ANGEL MEDICAL, LLC, LAFAYETTE, CO. FILED 3-29-2012.

Simplicity Under Stress

THE MARK CONSISTS OF STANDARD CHARACTERS WITHOUT CLAIM TO ANY PARTICULAR FONT, STYLE, SIZE, OR COLOR.

FOR FIRST AID KITS (U.S. CLS. 6, 18, 44, 46, 51 AND 52).

FIRST USE 8-16-2011; IN COMMERCE 1-10-2012.
ESTHER BELENKER, EXAMINING ATTORNEY

SN 85-588,121. RIO RANCH SUPPLY INC., VESTA, MN. FILED 4-3-2012.

RIOMUNE

THE MARK CONSISTS OF STANDARD CHARACTERS WITHOUT CLAIM TO ANY PARTICULAR FONT, STYLE, SIZE, OR COLOR.

FOR ANIMAL FEED SUPPLEMENTS; DIETARY SUPPLEMENTS FOR ANIMALS (U.S. CLS. 6, 18, 44, 46, 51 AND 52).

FIRST USE 1-1-2008; IN COMMERCE 1-1-2008.
KEVIN DINALLO, EXAMINING ATTORNEY

CLASS 5—(Continued).

SN 85-588,126. RIO RANCH SUPPLY INC., VESTA, MN. FILED 4-3-2012.

RUMENGUARD

THE MARK CONSISTS OF STANDARD CHARACTERS WITHOUT CLAIM TO ANY PARTICULAR FONT, STYLE, SIZE, OR COLOR.

FOR ANIMAL FEED SUPPLEMENTS; DIETARY SUPPLEMENTS FOR ANIMALS (U.S. CLS. 6, 18, 44, 46, 51 AND 52).

FIRST USE 1-1-2008; IN COMMERCE 1-1-2008.
KEVIN DINALLO, EXAMINING ATTORNEY

SN 85-608,201. GENENTECH, INC., SOUTH SAN FRANCISCO, CA. FILED 4-25-2012.

RETRAQ

THE MARK CONSISTS OF STANDARD CHARACTERS WITHOUT CLAIM TO ANY PARTICULAR FONT, STYLE, SIZE, OR COLOR.

FOR PHARMACEUTICAL PREPARATIONS FOR THE TREATMENT OF CARDIOVASCULAR DISEASES, ATHEROSCLEROSIS AND DYSLIPIDEMIA (U.S. CLS. 6, 18, 44, 46, 51 AND 52).

SAMUEL E. SHARPER JR., EXAMINING ATTORNEY

SN 85-608,219. GENENTECH, INC., SOUTH SAN FRANCISCO, CA. FILED 4-25-2012.

RETERIQA

THE MARK CONSISTS OF STANDARD CHARACTERS WITHOUT CLAIM TO ANY PARTICULAR FONT, STYLE, SIZE, OR COLOR.

FOR PHARMACEUTICAL PREPARATIONS FOR THE TREATMENT OF CARDIOVASCULAR DISEASES, ATHEROSCLEROSIS AND DYSLIPIDEMIA (U.S. CLS. 6, 18, 44, 46, 51 AND 52).

SAMUEL E. SHARPER JR., EXAMINING ATTORNEY

CLASS 6—METAL GOODS

SN 77-899,056. KABUSHIKI KAISHA KOBE SEIKO SHO, TA KOBE STEEL, LTD., KOBE-SHI, HYOGO, JAPAN, FILED 12-22-2009.

KOBE GREEN MACHINABLE STEEL

THE MARK CONSISTS OF STANDARD CHARACTERS WITHOUT CLAIM TO ANY PARTICULAR FONT, STYLE, SIZE, OR COLOR.

OWNER OF U.S. REG. NO. 2,038,390. NO CLAIM IS MADE TO THE EXCLUSIVE RIGHT TO USE "GREEN MACHINABLE STEEL", APART FROM THE MARK AS SHOWN.

SEC. 2(F) AS TO "KOBE". FOR STEEL PLATE, STEEL BAR, STEEL WIRE, STEEL TUBE, METAL SHEET (U.S. CLS. 2, 12, 13, 14, 23, 25 AND 50).

ANGELA DUONG, EXAMINING ATTORNEY

CLASS 6—(Continued).

SN 79-103,223. SHIN NIPPON SEITETSU KABUSHIKI KAISHA, DBA NIPPON STEEL CORPORATION, CHIYODA-KU; TOKYO, JAPAN, FILED 8-29-2011.

LATIS

PRIORITY DATE OF 8-18-2011 IS CLAIMED. OWNER OF INTERNATIONAL REGISTRATION 1092468 DATED 8-29-2011, EXPIRES 8-29-2021.

THE WORDING "LATIS" HAS NO MEANING IN A FOREIGN LANGUAGE.

FOR EMBOSSED STEEL SHEETS; GALVANIZED STEEL SHEETS; COLORED STEEL SHEETS; STEEL SHEETS WITH DESIGN; STEEL SHEETS; STEEL STRIPS; METAL BOARDS FOR BUILDING; LININGS OF METAL FOR BUILDING PURPOSES; METAL MATERIALS USED FOR BUILDING, NAMELY, SHEETS AND PLATES OF METAL FOR USE IN BUILDING CONSTRUCTION (U.S. CLS. 2, 12, 13, 14, 23, 25 AND 50).

SUZANNE BLANE, EXAMINING ATTORNEY

SN 79-103,509. SHIN NIPPON SEITETSU KABUSHIKI KAISHA, DBA NIPPON STEEL CORPORATION, JAPAN, FILED 8-29-2011.

SN 79-103,082. SFS INTEC HOLDING AG, CH-9435 HEERBRUGG, SWITZERLAND, FILED 9-6-2011.

SolarGrip

THE MARK CONSISTS OF STANDARD CHARACTERS WITHOUT CLAIM TO ANY PARTICULAR FONT, STYLE, SIZE, OR COLOR.

PRIORITY DATE OF 4-27-2011 IS CLAIMED. OWNER OF INTERNATIONAL REGISTRATION 1092150 DATED 9-6-2011, EXPIRES 9-6-2021.

FOR FASTENERS OF METAL, NAMELY, BOLTS, NAILS, RIVETS, SCREWS; ASSEMBLY ELEMENTS, NAMELY, METAL RIVETS, METAL BOLTS AND METAL SCREWS AND STRUCTURAL COMPONENTS THEREOF; BLIND METAL RIVETS; THREADED BLIND METAL RIVETS; BLIND METAL RIVETS WITH FLANGED SECTIONS; PROGRESSIVE BLIND METAL RIVETS AND BLIND METAL NUTS (U.S. CLS. 2, 12, 13, 14, 23, 25 AND 50).

KATHERINE E. HALMEN, EXAMINING ATTORNEY



PRIORITY DATE OF 8-18-2011 IS CLAIMED. OWNER OF INTERNATIONAL REGISTRATION 1093170 DATED 8-29-2011, EXPIRES 8-29-2021.

THE COLOR(S) BLUE, PURPLE, GREEN, WHITE, BLACK AND GREY IS/ARE CLAIMED AS A FEATURE OF THE MARK.

THE MARK CONSISTS OF THE FOLLOWING: A LARGE WHITE SQUARE BORDERED BY A THIN GREY LINE WITHIN WHICH IS THE WORDING "LATIS" IN THE COLOR BLACK APPEARING IN THE UPPER LEFT SECTION OF THE LARGE WHITE SQUARE; IN THE BOTTOM RIGHT CORNER OF THE SQUARE APPEARS A SMALLER GREEN SQUARE; TO THE LEFT OF THE GREEN SQUARE ARE TWO PURPLE SQUARES OF THE SAME SIZE AS THE GREEN AND APPEARING IN A DIAGONAL LINE; TO THE LEFT OF THE TWO PURPLE SQUARES ARE THREE BLUE SQUARES FORMING A DIAGONAL LINE.

FOR EMBOSSED STEEL SHEETS; GALVANIZED STEEL SHEETS; COLORED STEEL SHEETS; STEEL SHEETS WITH DESIGN; STEEL SHEETS; STEEL STRIPS; METAL BOARDS FOR BUILDING; LININGS OF METAL FOR BUILDING PURPOSES; METAL MATERIALS USED FOR BUILDING, NAMELY, SHEETS AND PLATES OF METAL FOR USE IN BUILDING CONSTRUCTION (U.S. CLS. 2, 12, 13, 14, 23, 25 AND 50).

SUZANNE BLANE, EXAMINING ATTORNEY

CLASS 6—(Continued).

SN 85-248,626. BOSTON TEA PARTY SHIP, INC., KEY WEST, FL. FILED 2-22-2011.

**BOSTON TEA PARTY SHIPS &
MUSEUM**

THE MARK CONSISTS OF STANDARD CHARACTERS WITHOUT CLAIM TO ANY PARTICULAR FONT, STYLE, SIZE, OR COLOR.

NO CLAIM IS MADE TO THE EXCLUSIVE RIGHT TO USE "SHIPS & MUSEUM", APART FROM THE MARK AS SHOWN.

FOR METAL RINGS AND CHAINS FOR KEYS; HOLIDAY ORNAMENTS OF COMMON METAL (U.S. CLS. 2, 12, 13, 14, 23, 25 AND 50).

LESLIE RICHARDS, EXAMINING ATTORNEY

SN 85-271,567. SANYO SPECIAL STEEL CO., LTD., HYOGO, JAPAN, FILED 3-19-2011.

Sanyo Special Steel

THE MARK CONSISTS OF STANDARD CHARACTERS WITHOUT CLAIM TO ANY PARTICULAR FONT, STYLE, SIZE, OR COLOR.

NO CLAIM IS MADE TO THE EXCLUSIVE RIGHT TO USE "SPECIAL STEEL", APART FROM THE MARK AS SHOWN.

THE ENGLISH TRANSLATION OF "SANYO" IN THE MARK IS "MOUNTAIN SUN" OR "SOUTH SIDE OF MOUNTAIN".

FOR ALLOYS OF COMMON METAL, NAMELY, STEEL ALLOYS; ANTI-FRICTION METAL, NAMELY, STEEL; BALLS OF STEEL; BOLTS OF METAL, NAMELY, STEEL BOLTS; BINDING SCREW OF METAL FOR CABLES, NAMELY, STEEL BINDING SCREWS FOR CABLES; BINDINGS OF METAL, NAMELY, STEEL BINDING STRIPS FOR USE ON PACKAGING; BINS OF METAL, NAMELY, STEEL BINS; STEEL METALLURGY BLOOMS; STEEL LOCK BOLTS; BOLTS OF METAL, NAMELY, STEEL BOLTS; CAST STEEL; CERMETS MADE OF STEEL; STEEL FOUNDRY CHILL-MOLDS; COMMON METALS, NAMELY, STEEL IN SHEET, ROD, BAR AND/OR BILLET FORM; COMMON METALS, NAMELY, STEEL IN POWDER, TUBES AND/OR PIPE FORM; RODS OF METAL, NAMELY, STEEL RODS; UNWROUGHT STEEL; SEMI-WROUGHT STEEL; IRON WIRE, NAMELY, STEEL CABLE WIRE; IRONMONGERY, NAMELY, STEEL SCREWS, STEEL NAILS, STEEL NUTS, STEEL BOLTS, STEEL PINS, STEEL RIVETS, AND STEEL HOOKS; MANIFOLDS OF METAL FOR PIPELINES, NAMELY, BRANCHING TUBES OF STEEL FOR PIPELINES; STEEL ALLOYS FOR FURTHER MANUFACTURING; METAL HARDWARE, NAMELY, STEEL SPRINGS, STEEL PULLEYS, STEEL NUTS, AND STEEL WASHERS; METAL SPUTTERING TARGETS MADE OF STEEL; NICKEL, NAMELY, CASTINGS, FOILS, POWDER, AND ROLLED, DRAWN OR EXTRUDED SEMI-FINISHED ARTICLES OF NICKEL FOR USE IN THE MANUFACTURE OF STEEL; PEN-STOCK PIPES OF METAL, NAMELY, STEEL PENSTOCK PIPES; STEEL COTTER PINS; STEEL PINS FOR WHEELS; METAL HARDWARE, NAMELY, STEEL PINS; PIPES OF METAL, NAMELY, STEEL PIPES; PIPES OF METAL, NAMELY, STEEL PIPES FOR CENTRAL HEAT-

CLASS 6—(Continued).

ING INSTALLATIONS; POLES OF METAL, NAMELY, STEEL POLES; RING-SHAPED FITTINGS OF METAL MADE OF STEEL; RODS OF METAL FOR BRAZING AND WELDING, NAMELY, STEEL RODS FOR BRAZING AND WELDING; SCREWS OF METAL, NAMELY, STEEL SCREWS; SHEETS AND PLATES OF METAL, NAMELY, STEEL PLATES AND SHEETS; SILVER SOLDER CONTAINING STEEL; METAL HARDWARE, NAMELY, STEEL SLEEVES; SOLDERING WIRE OF METAL, NAMELY, STEEL SOLDER WIRE; STEEL ALLOYS; STEEL IN SHEET, ROD, POWDER, BAR AND/OR BILLET FORM; STEEL PIPES; STEEL TUBES; STEEL WIRE; TUBES OF METAL, NAMELY, STEEL TUBES; METAL HARDWARE, NAMELY, STEEL WASHERS; WATER-PIPES OF METAL, NAMELY, STEEL WATER PIPES; WIRE OF COMMON METAL, NAMELY, NON-ELECTRICAL WIRES OF STEEL; NON-ELECTRICAL WIRES OF STEEL ALLOYS, EXCLUDING FUSE WIRE; WORKS OF ART OF COMMON METAL, NAMELY, WORKS OF ART OF STEEL (U.S. CLS. 2, 12, 13, 14, 23, 25 AND 50).

JOHN KELLY, EXAMINING ATTORNEY

SN 85-335,215. DELTA SCREEN & FILTRATION, LLC, HOUSTON, TX. FILED 6-1-2011.

DELTA DIRECT

THE MARK CONSISTS OF STANDARD CHARACTERS WITHOUT CLAIM TO ANY PARTICULAR FONT, STYLE, SIZE, OR COLOR.

FOR METAL WELL SCREENS FOR SAND CONTROL IN OIL AND GAS WELLS (U.S. CLS. 2, 12, 13, 14, 23, 25 AND 50).

FIRST USE 10-28-2010; IN COMMERCE 10-28-2010.

SUZANNE BLANE, EXAMINING ATTORNEY

SN 85-347,773. HART & COOLEY, INC., GRAND RAPIDS, MI. FILED 6-16-2011.

Z CLEAR

THE MARK CONSISTS OF STANDARD CHARACTERS WITHOUT CLAIM TO ANY PARTICULAR FONT, STYLE, SIZE, OR COLOR.

FOR METAL GREASE DUCTS FOR EXHAUST VENTILATING INSTALLATIONS FOR RESTAURANTS AND FOOD COURTS (U.S. CLS. 2, 12, 13, 14, 23, 25 AND 50).

KATHERINE STOIDES, EXAMINING ATTORNEY

CLASS 6—(Continued).

SN 85-354,320. HUNTING ENERGY SERVICES, I. INC., DBA HUNTING ENERGY SERVICES, INC., HOUSTON, TX. FILED 6-23-2011.

CWC

THE MARK CONSISTS OF STANDARD CHARACTERS WITHOUT CLAIM TO ANY PARTICULAR FONT, STYLE, SIZE, OR COLOR.

FOR METALLIC PIPES FOR USE IN TRENCHLESS HORIZONTAL DRILLING; METALLIC CONNECTIONS FOR THE AFORESAID PIPES (U.S. CLS. 2, 12, 13, 14, 23, 25 AND 50).

JACLYN KIDWELL WALKER, EXAMINING ATTORNEY

SN 85-356,725. DW-NATIONAL STANDARD-NILES, LLC, NILES, MI. FILED 6-27-2011.

SATIN GLIDE

THE MARK CONSISTS OF STANDARD CHARACTERS WITHOUT CLAIM TO ANY PARTICULAR FONT, STYLE, SIZE, OR COLOR.

FOR WELDING WIRE (U.S. CLS. 2, 12, 13, 14, 23, 25 AND 50).

FIRST USE 9-25-1984; IN COMMERCE 9-25-1984.
KEVON CHISOLM, EXAMINING ATTORNEY

SN 85-376,929. GAY, DWIGHT S., DBA VARILOC PRODUCTS, LLC, DAVISON, MI. FILED 7-21-2011.

Variloc

THE MARK CONSISTS OF STANDARD CHARACTERS WITHOUT CLAIM TO ANY PARTICULAR FONT, STYLE, SIZE, OR COLOR.

FOR RELEASABLE METAL LATCH FOR LATCHING ROTATING PARTS IN A SELECTED ONE OF A PLURALITY OF ANGULARY ADJUSTED POSITIONS (U.S. CLS. 2, 12, 13, 14, 23, 25 AND 50).

FIRST USE 7-15-1995; IN COMMERCE 7-15-1995.
KIMBERLY FRYE, EXAMINING ATTORNEY

CLASS 6—(Continued).

SN 85-383,863. STEELSMITH, INC., PITTSBURGH, PA. FILED 7-28-2011.

Steelsmith

THE MARK CONSISTS OF STANDARD CHARACTERS WITHOUT CLAIM TO ANY PARTICULAR FONT, STYLE, SIZE, OR COLOR.

FOR PRE-FABRICATED AND PRE-ENGINEERED STEEL BUILDINGS (U.S. CLS. 2, 12, 13, 14, 23, 25 AND 50).

FIRST USE 1-1-2007; IN COMMERCE 1-1-2007.
DANIEL CAPSHAW, EXAMINING ATTORNEY

SN 85-384,486. NINGGUO OPEN SOURCE POWER WEAR-RESISTANT MATERIALS CO., LTD., NINGGUO CITY, CHINA, FILED 7-29-2011.

THE MARK CONSISTS OF CHINESE CHARACTERS THE NON-LATIN CHARACTERS IN THE MARK TRANSLITERATE TO GUO YANG AND THIS HAS NO MEANING IN A FOREIGN LANGUAGE.

FOR UNWROUGHT STEEL; STEEL ALLOYS; STEEL; COMMON METALS, UNWROUGHT AND SEMI-WORKED, FOR FURTHER MANUFACTURE; PIG IRON; CAST IRON (U.S. CLS. 2, 12, 13, 14, 23, 25 AND 50).

ERNEST SHOSHO, EXAMINING ATTORNEY

CLASS 6—(Continued).

SN 85-407,343. IRON MAN CLIP, LLC, HILLSBOROUGH, CA. FILED 8-25-2011.

FAST CONNECT

THE MARK CONSISTS OF STANDARD CHARACTERS WITHOUT CLAIM TO ANY PARTICULAR FONT, STYLE, SIZE, OR COLOR.

FOR METAL WIRE BUILDING MATERIALS, NAMELY, REBAR TIES MADE OF WIRE AND REINFORCING METAL WIRE FOR BUILDING PURPOSES; METAL BUILDING MATERIALS, NAMELY, REBAR TIES; REBAR PRODUCTS, NAMELY, REINFORCING MATERIALS OF METAL FOR BUILDING PURPOSES (U.S. CLS. 2, 12, 13, 14, 23, 25 AND 50).

DAVID C. REIHNER, EXAMINING ATTORNEY

CLASS 6—(Continued).

SN 85-520,578. PETERSON AMERICAN CORPORATION, SOUTHFIELD, MI. FILED 1-19-2012.

TOMAHAWK

THE MARK CONSISTS OF STANDARD CHARACTERS WITHOUT CLAIM TO ANY PARTICULAR FONT, STYLE, SIZE, OR COLOR.

FOR METAL HARDWARE, NAMELY, SPRINGS (U.S. CLS. 2, 12, 13, 14, 23, 25 AND 50).

ESTHER A. BORSUK, EXAMINING ATTORNEY

SN 85-422,750. KIMSAPRINCESS INC., WOODLAND HILLS, CA. AND 2DIE4KOURT, WOODLAND HILLS, CA. AND KHLOMONEY INC., WOODLAND HILLS, CA. AND JENNER COMMUNICATIONS INC., WOODLAND HILLS, CA. FILED 9-14-2011.

KARDASHIAN KHAOS

THE MARK CONSISTS OF STANDARD CHARACTERS WITHOUT CLAIM TO ANY PARTICULAR FONT, STYLE, SIZE, OR COLOR.

THE NAME(S), PORTRAIT(S), AND/OR SIGNATURE(S) SHOWN IN THE MARK IDENTIFIES KIMBERLY KARDASHIAN, KOURTNEY KARDASHIAN, KHLOE KARDASHIAN ODOM, WHOSE CONSENT(S) TO REGISTER IS MADE OF RECORD.

FOR DECORATIVE METAL CUBES; NON-LUMINOUS AND NON-MECHANICAL METAL SIGNS; METAL KEY CHAINS (U.S. CLS. 2, 12, 13, 14, 23, 25 AND 50).

REBECCA EISINGER, EXAMINING ATTORNEY

SN 85-522,535. TARGET BRANDS, INC., MINNEAPOLIS, MN. FILED 1-23-2012.

BE MERRY

THE MARK CONSISTS OF STANDARD CHARACTERS WITHOUT CLAIM TO ANY PARTICULAR FONT, STYLE, SIZE, OR COLOR.

OWNER OF U.S. REG. NOS. 3,990,165, 3,990,167 AND OTHERS.

FOR METAL STORAGE CONTAINERS FOR HOUSEHOLD USE (U.S. CLS. 2, 12, 13, 14, 23, 25 AND 50).

NICHOLAS ALTREE, EXAMINING ATTORNEY

SN 85-482,726. ACTRON MANUFACTURING, INC., CORONA, CA. FILED 11-29-2011.

OMEGA SERIES

THE MARK CONSISTS OF STANDARD CHARACTERS WITHOUT CLAIM TO ANY PARTICULAR FONT, STYLE, SIZE, OR COLOR.

NO CLAIM IS MADE TO THE EXCLUSIVE RIGHT TO USE "SERIES", APART FROM THE MARK AS SHOWN.

FOR METAL DRAWER LATCHES (U.S. CLS. 2, 12, 13, 14, 23, 25 AND 50).

INGA ERVIN, EXAMINING ATTORNEY

SN 85-524,985. KEGMAN LLC, ASHLAND, MA. FILED 1-25-2012.

Kegman

THE MARK CONSISTS OF STANDARD CHARACTERS WITHOUT CLAIM TO ANY PARTICULAR FONT, STYLE, SIZE, OR COLOR.

FOR METAL TAPS FOR BEER KEGS (U.S. CLS. 2, 12, 13, 14, 23, 25 AND 50).

FIRST USE 1-15-1990; IN COMMERCE 1-15-1990.

KATHLEEN M. VANSTON, EXAMINING ATTORNEY

CLASS 6—(Continued).

SN 85-528,647. ADVANCE MAGAZINE PUBLISHERS INC., NEW YORK, NY. FILED 1-30-2012.

DOC SAVAGE

THE MARK CONSISTS OF STANDARD CHARACTERS WITHOUT CLAIM TO ANY PARTICULAR FONT, STYLE, SIZE, OR COLOR.

OWNER OF U.S. REG. NOS. 1,033,845, 3,194,745 AND 4,049,309.

THE NAME "DOC SAVAGE" DOES NOT IDENTIFY A LIVING INDIVIDUAL.

FOR METAL RINGS AND CHAINS FOR KEYS (U.S. CLS. 2, 12, 13, 14, 23, 25 AND 50).

FIRST USE 6-15-2011; IN COMMERCE 6-15-2011.
MICHELE SWAIN, EXAMINING ATTORNEY

CLASS 6—(Continued).

SN 85-531,155. FACTORY DIRECT LOGISTICS, LLC, DBA FDL FASTENERS, SCHAUMBURG, IL. FILED 2-1-2012.

FDL

THE MARK CONSISTS OF STANDARD CHARACTERS WITHOUT CLAIM TO ANY PARTICULAR FONT, STYLE, SIZE, OR COLOR.

FOR METAL INTERNALLY AND EXTERNALLY THREADED FASTENERS, NAMELY, NUTS AND BOLTS, AND METAL HARDWARE, NAMELY, WASHERS (U.S. CLS. 2, 12, 13, 14, 23, 25 AND 50).

FIRST USE 11-1-2011; IN COMMERCE 3-1-2012.
KATINA MISTER, EXAMINING ATTORNEY

SN 85-530,720. SANDCAN INC., SAN ANTONIO, TX. FILED 2-1-2012.

SandCan

THE MARK CONSISTS OF THE WORDS "SAND" AND "CAN" RUN TOGETHER, WHERE THE "S" AND "C" ARE CAPITAL LETTERS.

FOR CARGO CONTAINER OF METAL THAT HAS BEEN MODIFIED TO HAUL GRANULAR MATERIAL (U.S. CLS. 2, 12, 13, 14, 23, 25 AND 50).

CAROLINE WOOD, EXAMINING ATTORNEY

SN 85-531,348. GUTTER GUARD SYSTEMS, INC., ST. CLAIR, MO. FILED 2-1-2012.

E-Z-STEP DOWN

THE MARK CONSISTS OF STANDARD CHARACTERS WITHOUT CLAIM TO ANY PARTICULAR FONT, STYLE, SIZE, OR COLOR.

OWNER OF U.S. REG. NO. 1,423,614.

FOR METAL DEBRIS GUARDS FOR GUTTERS (U.S. CLS. 2, 12, 13, 14, 23, 25 AND 50).

FIRST USE 1-19-2005; IN COMMERCE 1-19-2005.
CURTIS FRENCH, EXAMINING ATTORNEY

SN 85-531,041. HUDSON, KATHERINE L., CHANDLER, AZ. FILED 2-1-2012.

OFF THE FLOOR

THE MARK CONSISTS OF STANDARD CHARACTERS WITHOUT CLAIM TO ANY PARTICULAR FONT, STYLE, SIZE, OR COLOR.

FOR HANGERS IN THE NATURE OF METAL HOOKS USED TO HANG A PURSE OR BAG FROM A TABLE (U.S. CLS. 2, 12, 13, 14, 23, 25 AND 50).

FONG HSU, EXAMINING ATTORNEY

SN 85-531,382. GUTTER GUARD SYSTEMS, INC., ST. CLAIR, MO. FILED 2-1-2012.

E-Z-SLIDE

THE MARK CONSISTS OF STANDARD CHARACTERS WITHOUT CLAIM TO ANY PARTICULAR FONT, STYLE, SIZE, OR COLOR.

OWNER OF U.S. REG. NO. 1,423,614.

FOR METAL DEBRIS GUARDS FOR GUTTERS (U.S. CLS. 2, 12, 13, 14, 23, 25 AND 50).

FIRST USE 11-0-1998; IN COMMERCE 11-0-1998.
CURTIS FRENCH, EXAMINING ATTORNEY

CLASS 6—(Continued).

SN 85-531,391. GUTTER GUARD SYSTEMS, INC., ST. CLAIR, MO. FILED 2-1-2012.

E-Z-LEAF SWEEP

THE MARK CONSISTS OF STANDARD CHARACTERS WITHOUT CLAIM TO ANY PARTICULAR FONT, STYLE, SIZE, OR COLOR.

OWNER OF U.S. REG. NO. 1,423,614.
FOR METAL DEBRIS GUARDS FOR GUTTERS (U.S. CLS. 2, 12, 13, 14, 23, 25 AND 50).
FIRST USE 2-7-2007; IN COMMERCE 2-7-2007.
CURTIS FRENCH, EXAMINING ATTORNEY

SN 85-531,403. GUTTER GUARD SYSTEMS, INC., ST. CLAIR, MO. FILED 2-1-2012.

E-Z-UNDER

THE MARK CONSISTS OF STANDARD CHARACTERS WITHOUT CLAIM TO ANY PARTICULAR FONT, STYLE, SIZE, OR COLOR.

OWNER OF U.S. REG. NO. 1,423,614.
FOR METAL DEBRIS GUARDS FOR GUTTERS (U.S. CLS. 2, 12, 13, 14, 23, 25 AND 50).
FIRST USE 1-19-2005; IN COMMERCE 1-19-2005.
CURTIS FRENCH, EXAMINING ATTORNEY

SN 85-531,478. KIDCO, INC., LIBERTYVILLE, IL. FILED 2-1-2012.

COMMAND

THE MARK CONSISTS OF STANDARD CHARACTERS WITHOUT CLAIM TO ANY PARTICULAR FONT, STYLE, SIZE, OR COLOR.

FOR PET GATES MADE OF METAL (U.S. CLS. 2, 12, 13, 14, 23, 25 AND 50).
DAVID COLLIER, EXAMINING ATTORNEY

CLASS 6—(Continued).

SN 85-531,714. PHIL FELDHAUS, LAKE VILLAGE, IN. FILED 2-2-2012.

ULTRAKLEAN

THE MARK CONSISTS OF STANDARD CHARACTERS WITHOUT CLAIM TO ANY PARTICULAR FONT, STYLE, SIZE, OR COLOR.

FOR METAL DEBRIS GUARDS FOR GUTTERS (U.S. CLS. 2, 12, 13, 14, 23, 25 AND 50).
KELLY BOULTON, EXAMINING ATTORNEY

SN 85-531,740. AMES TRUE TEMPER, INC., CAMP HILL, PA. FILED 2-2-2012.

AUTO-TRACK

THE MARK CONSISTS OF STANDARD CHARACTERS WITHOUT CLAIM TO ANY PARTICULAR FONT, STYLE, SIZE, OR COLOR.

FOR MANUALLY OPERATED METAL HOSE REELS (U.S. CLS. 2, 12, 13, 14, 23, 25 AND 50).
FIRST USE 12-0-2008; IN COMMERCE 12-0-2008.
CHRIS WELLS, EXAMINING ATTORNEY

SN 85-532,696. IRONRIDGE, INC., WILLITS, CA. FILED 2-2-2012.



THE MARK CONSISTS OF A GRAPHIC DEPICTION OF A MOUNTAIN RANGE. TO THE RIGHT SIDE OF THE GRAPHICAL ELEMENT IS THE LITERAL ELEMENT "IRONRIDGE".

FOR METAL STRUCTURES FOR MOUNTING SOLAR PANELS; SOLAR PANEL MOUNTS MADE OF METAL (U.S. CLS. 2, 12, 13, 14, 23, 25 AND 50).
FIRST USE 4-1-2008; IN COMMERCE 4-1-2008.
STEVEN PEREZ, EXAMINING ATTORNEY

CLASS 6—(Continued).

SN 85-533,584. WEST MARINE PRODUCTS, INC., WATSONVILLE, CA. FILED 2-3-2012.



THE MARK CONSISTS OF A SHARK.
FOR METAL KEY CHAINS (U.S. CLS. 2, 12, 13, 14, 23, 25 AND 50).
WILLIAM VERHOSEK, EXAMINING ATTORNEY

SN 85-534,526. HEB GROCERY COMPANY, LP, SAN ANTONIO, TX. FILED 2-6-2012.



OWNER OF U.S. REG. NOS. 1,519,398, 1,867,930 AND OTHERS.
THE COLOR(S) RED AND WHITE IS/ARE CLAIMED AS A FEATURE OF THE MARK.
THE MARK CONSISTS OF THE LETTERS "H-E-B" IN WHITE LETTERS WITHIN A RED OVAL DESIGN.
FOR ALUMINUM FOIL (U.S. CLS. 2, 12, 13, 14, 23, 25 AND 50).
FIRST USE 11-2-2008; IN COMMERCE 11-2-2008.
ANGELA M. MICHELI, EXAMINING ATTORNEY

SN 85-535,474. HI-PERFORMANCE FASTENING SYSTEMS, BENSENVILLE, IL. FILED 2-7-2012.



THE MARK CONSISTS OF AN IMAGE OF A LARGE TRIANGLE WITH A DIAMOND SHAPE IN THE CENTER AND TWO TRIANGLES AT THE BOTTOM CORNERS WITHIN THE LARGE TRIANGLE AND A LINE UNDERNEATH AS SHOWN IN THE MARK.
FOR METAL FASTENERS, NAMELY, SCREWS AND BOLTS (U.S. CLS. 2, 12, 13, 14, 23, 25 AND 50).
TASHIA BUNCH, EXAMINING ATTORNEY

CLASS 6—(Continued).

SN 85-535,936. XWERX, LLC, DBA GR8-WHITE, LLC, NAPLES, FL. FILED 2-7-2012.

Gr8-White

THE MARK CONSISTS OF STANDARD CHARACTERS WITHOUT CLAIM TO ANY PARTICULAR FONT, STYLE, SIZE, OR COLOR.
FOR METAL STEPLADDERS AND LADDERS (U.S. CLS. 2, 12, 13, 14, 23, 25 AND 50).
FIRST USE 7-18-2011; IN COMMERCE 7-18-2011.
GRETCHEN ULRICH, EXAMINING ATTORNEY

SN 85-536,294. IMPACT RECOVERY SYSTEMS, INC., SAN ANTONIO, TX. FILED 2-7-2012.

Slowstop

THE MARK CONSISTS OF STANDARD CHARACTERS WITHOUT CLAIM TO ANY PARTICULAR FONT, STYLE, SIZE, OR COLOR.
FOR METAL BOLLARDS (U.S. CLS. 2, 12, 13, 14, 23, 25 AND 50).
KATINA MISTER, EXAMINING ATTORNEY

SN 85-536,776. NAC INTERNATIONAL, INC., NORCROSS, GA. FILED 2-8-2012.

MAGNATRAN

THE MARK CONSISTS OF STANDARD CHARACTERS WITHOUT CLAIM TO ANY PARTICULAR FONT, STYLE, SIZE, OR COLOR.
FOR METAL CONTAINERS FOR SPENT NUCLEAR FUEL (U.S. CLS. 2, 12, 13, 14, 23, 25 AND 50).
ROSELLE HERRERA, EXAMINING ATTORNEY

CLASS 6—(Continued).

SN 85-537,515. PIPING TECHNOLOGY & PRODUCTS, INC., HOUSTON, TX. FILED 2-8-2012.

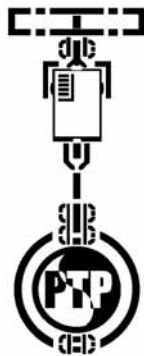

THE MARK CONSISTS OF A STYLIZED/LOGO VERSION OF A PIPE SUPPORT WITH THE TEXT "PTP" IN THE CIRCULAR PART OF THE BOTTOM OF THE DESIGN. FOR METAL EXPANSION JOINTS FOR PIPING AND DUCTING (U.S. CLS. 2, 12, 13, 14, 23, 25 AND 50). FIRST USE 8-30-2004; IN COMMERCE 8-30-2004. TASNEEM HUSSAIN, EXAMINING ATTORNEY

SN 85-537,518. INE S.P.A., CITTADELLA, ITALY, FILED 2-8-2012.



THE MARK CONSISTS OF THE LETTERS "INE" BETWEEN TWO HALF-OVAL SHAPED BARS ALL INSIDE A RECTANGULAR BOX WITH TWO CURVED SIDES. FOR WELDING WIRE (U.S. CLS. 2, 12, 13, 14, 23, 25 AND 50). FIRST USE 0-0-1951; IN COMMERCE 7-24-2003. LINDA ESTRADA, EXAMINING ATTORNEY

SN 85-537,628. INE S.P.A., CITTADELLA, ITALY, FILED 2-8-2012.

INE AK-10

THE MARK CONSISTS OF STANDARD CHARACTERS WITHOUT CLAIM TO ANY PARTICULAR FONT, STYLE, SIZE, OR COLOR. FOR WELDING WIRE (U.S. CLS. 2, 12, 13, 14, 23, 25 AND 50). FIRST USE 7-24-2003; IN COMMERCE 7-24-2003. LINDA ESTRADA, EXAMINING ATTORNEY

CLASS 6—(Continued).

SN 85-537,977. 4FRONT ENGINEERED SOLUTIONS, INC., SUSSEX, WI. FILED 2-9-2012.

LOADHOG

THE MARK CONSISTS OF STANDARD CHARACTERS WITHOUT CLAIM TO ANY PARTICULAR FONT, STYLE, SIZE, OR COLOR.

OWNER OF U.S. REG. NO. 3,091,926. FOR METAL DOCK BRIDGES (U.S. CLS. 2, 12, 13, 14, 23, 25 AND 50). FIRST USE 8-13-2004; IN COMMERCE 8-13-2004. ANDREW RHIM, EXAMINING ATTORNEY

SN 85-538,665. SAN ANTONIO STEEL COMPANY, LTD., SAN ANTONIO, TX. FILED 2-9-2012.

Texas50

THE MARK CONSISTS OF STANDARD CHARACTERS WITHOUT CLAIM TO ANY PARTICULAR FONT, STYLE, SIZE, OR COLOR.

FOR METAL WIRE FENCING (U.S. CLS. 2, 12, 13, 14, 23, 25 AND 50).

STEPHANIE ALI, EXAMINING ATTORNEY

SN 85-539,496. ADVANCE AUTO INNOVATIONS, LLC, ROANOKE, VA. FILED 2-10-2012.

AUTOCRAFT

THE MARK CONSISTS OF STANDARD CHARACTERS WITHOUT CLAIM TO ANY PARTICULAR FONT, STYLE, SIZE, OR COLOR.

OWNER OF U.S. REG. NOS. 1,622,118, 3,144,780 AND OTHERS.

FOR METAL FASTENERS, NAMELY, U-BOLTS (U.S. CLS. 2, 12, 13, 14, 23, 25 AND 50).

VIVIAN MICZNIK FIRST, EXAMINING ATTORNEY

CLASS 6—(Continued).

SN 85-539,863. NEEDCARE, INC., FULLERTON, CA. FILED 2-10-2012.



FOR METAL STAPLES FOR CONSTRUCTION OR INDUSTRIAL USE; NAILS (U.S. CLS. 2, 12, 13, 14, 23, 25 AND 50).
FIRST USE 1-2-2012; IN COMMERCE 1-2-2012.
KRISTINA MORRIS, EXAMINING ATTORNEY

SN 85-557,006. KRASDALE FOODS, INC., WHITE PLAINS, NY. FILED 2-29-2012.

KRASDALE

THE MARK CONSISTS OF STANDARD CHARACTERS WITHOUT CLAIM TO ANY PARTICULAR FONT, STYLE, SIZE, OR COLOR.
OWNER OF U.S. REG. NOS. 1,243,353, 2,694,649 AND OTHERS.
FOR ALUMINUM FOIL; ALUMINUM FOIL PAPER; METAL FOIL (U.S. CLS. 2, 12, 13, 14, 23, 25 AND 50).
FIRST USE 9-0-1924; IN COMMERCE 0-0-1974.
GENE MACIOL, EXAMINING ATTORNEY

CLASS 7—(Continued).

SN 79-102,186. SYMAX LIFT (CHINA) CO., LTD., WUXI CITY, JIANGSU, CHINA, FILED 8-15-2011.

SYMAX

OWNER OF INTERNATIONAL REGISTRATION 1089794 DATED 8-15-2011, EXPIRES 8-15-2021.
THIS MARK IS ORIGINAL BY THE OWNER AND HAS NO MEANING.
FOR LIFTS, OTHER THAN SKI LIFTS, NAMELY, MECHANICAL AND HYDRAULIC LIFTS; ELEVATORS; HOISTS; MOVING STAIRCASES; ESCALATORS; ROLLER BRIDGES; CONVEYOR MACHINES; HOISTING MACHINE; ELEVATOR DESIGNED FOR LIFTING LAND VEHICLES FOR USE IN GARAGES; ELEVATOR BELTS (U.S. CLS. 13, 19, 21, 23, 31, 34 AND 35).
RUSS HERMAN, EXAMINING ATTORNEY

SN 79-103,405. OERLIKON TEXTILE GMBH & CO. KG, FED REP GERMANY, FILED 7-30-2011.

RoTac

CLASS 7—MACHINERY

SN 76-710,535. BAUER, DAVID J., BROTHERTOWN, WI. FILED 2-3-2012.

WINDIDIT

THE MARK CONSISTS OF STANDARD CHARACTERS WITHOUT CLAIM TO ANY PARTICULAR FONT, STYLE, SIZE, OR COLOR.
FOR AUTOMOBILE MOUNTED WIND DRIVEN ELECTRICITY GENERATOR (U.S. CLS. 13, 19, 21, 23, 31, 34 AND 35).
GINA HAYES, EXAMINING ATTORNEY

THE MARK CONSISTS OF STANDARD CHARACTERS WITHOUT CLAIM TO ANY PARTICULAR FONT, STYLE, SIZE, OR COLOR.
PRIORITY DATE OF 4-14-2011 IS CLAIMED.
OWNER OF INTERNATIONAL REGISTRATION 1092980 DATED 7-30-2011, EXPIRES 7-30-2021.
FOR MELT-SPINNING MACHINES FOR THE PRODUCTION OF YARNS, FIBRES OR FILAMENTS MADE OF THERMOPLASTIC AND COMPONENTS FOR THESE MACHINES INCLUDED IN THIS CLASS; SPINNING TEXTURING MACHINES FOR THE PRODUCTION OF CRIMPED YARNS, CRIMPED FIBRES OR CRIMPED FILAMENTS MADE OF THERMOPLASTIC AND COMPONENTS FOR THESE MACHINES INCLUDED IN THIS CLASS; TEXTILE MACHINE COMPONENTS AND APPARATUS FOR TREATMENT OF SYNTHETIC FILAMENTS, FIBRES, YARNS OR THREADS NAMELY TEXTILE MACHINE COMPONENTS AND APPARATUS FOR ENTANGLEMENT OR INTERMINGLING OF SYNTHETIC MULTIFILAMENT YARNS; ALL OF THE FOREGOING EXCLUDING ROTARY ACTUATORS (U.S. CLS. 13, 19, 21, 23, 31, 34 AND 35).
ANN E. SAPPENFIELD, EXAMINING ATTORNEY

CLASS 7—(Continued).

SN 79-104,084. WUXI HAIFENG HAILIN PRECISION BEARING CO., LTD, CHINA, FILED 10-10-2011.

LFK

OWNER OF INTERNATIONAL REGISTRATION 1094644 DATED 10-10-2011, EXPIRES 10-10-2021.

THE MARK CONSISTS OF THE WORDING "LFK". FOR BEARINGS BEING PARTS OF MACHINES; BEARINGS FOR TRANSMISSION SHAFTS BEING PARTS OF MACHINES; BALL-BEARINGS FOR MACHINES, NAMELY, BALL-BEARINGS FOR CUTTING MACHINES, BALL-BEARINGS FOR ROLLING MACHINES, BALL-BEARINGS FOR INDUSTRIAL MACHINES PRESSES, BALL-BEARINGS FOR INJECTION MOLDING MACHINES (U.S. CLS. 13, 19, 21, 23, 31, 34 AND 35).

NICHOLAS COLEMAN, EXAMINING ATTORNEY

SN 79-106,291. BRABENDER GMBH & CO. KG, 47055 DUISBURG, FED REP GERMANY, FILED 10-6-2011.

Quadrumat

OWNER OF INTERNATIONAL REGISTRATION 0247853 DATED 9-27-1961, EXPIRES 9-27-2021.

THE MARK CONSISTS OF THE TERM "QUADRUMAT" IN STYLIZED FONT.

THE WORDING "QUADRUMAT" HAS NO MEANING IN A FOREIGN LANGUAGE.

FOR MILLS, NAMELY, GRINDING MACHINES FOR CRUSHING GRAIN SEEDS, PARTICULARLY WHEAT AND RYE; MILLS, NAMELY, GRINDING MACHINES FOR MILLING PLANT AND GRAIN SEEDS (U.S. CLS. 13, 19, 21, 23, 31, 34 AND 35).

STEVEN PEREZ, EXAMINING ATTORNEY

SN 79-106,566. MIRAIE CORPORATION, MATSUE-CITY, SHIMANE-PREFECTURE 690-0021, JAPAN, FILED 10-31-2011.

Easy Jet Jr.

PRIORITY DATE OF 10-19-2011 IS CLAIMED. OWNER OF INTERNATIONAL REGISTRATION 1100177 DATED 10-31-2011, EXPIRES 10-31-2021.

THE COLOR(S) LIGHT BLUE AND WHITE IS/ARE CLAIMED AS A FEATURE OF THE MARK.

THE COLOR LIGHT BLUE APPEARS IN THE STYLIZED WORDING "EASY JET JR." AND IN THE CIRCLES THAT FORM THE INVERTED TRIANGLE. THE COLOR WHITE APPEARS BETWEEN THE CIRCLES AND IN THE BACKGROUND OF THE MARK.

FOR ORGANIC WASTE PROCESSING EQUIPMENT, NAMELY, COMPOSTING MACHINES IN THE NATURE OF MACHINES THAT AGITATE ORGANIC MATTER TO SUPPLY AIR IN ORDER TO FACILITATE DECOMPOSITION (U.S. CLS. 13, 19, 21, 23, 31, 34 AND 35).

EVELYN BRADLEY, EXAMINING ATTORNEY

CLASS 7—(Continued).

SN 79-106,804. MIRAIE CORPORATION, MATSUE-CITY, SHIMANE-PREFECTURE 690-0021, JAPAN, FILED 10-31-2011.

Easy Jet

PRIORITY DATE OF 10-19-2011 IS CLAIMED. OWNER OF INTERNATIONAL REGISTRATION 1100763 DATED 10-31-2011, EXPIRES 10-31-2021.

THE COLOR(S) LIGHT BLUE AND WHITE IS/ARE CLAIMED AS A FEATURE OF THE MARK.

THE COLOR LIGHT BLUE APPEARS IN THE STYLIZED WORDING "EASY JET" AND IN THE CIRCLES THAT FORM THE INVERTED TRIANGLE. THE COLOR WHITE APPEARS BETWEEN THE CIRCLES AND IN THE BACKGROUND OF THE MARK.

FOR ORGANIC WASTE PROCESSING EQUIPMENT, NAMELY, COMPOSTING MACHINES IN THE NATURE OF MACHINES THAT AGITATE ORGANIC MATTER TO SUPPLY AIR IN ORDER TO FACILITATE DECOMPOSITION (U.S. CLS. 13, 19, 21, 23, 31, 34 AND 35).

EVELYN BRADLEY, EXAMINING ATTORNEY

SN 79-107,252. SUZHOU GLOBAL GROUP CO.,LTD., CHINA, FILED 12-6-2011.

环 球

OWNER OF INTERNATIONAL REGISTRATION 1101869 DATED 12-6-2011, EXPIRES 12-6-2021.

THE MARK CONSISTS OF AN OUTLINE OF A GLOBE WITH AN ORBIT RING. ON EITHER SIDE OF THE GLOBE, ASIAN CHARACTERS APPEAR.

THE NON-LATIN CHARACTERS IN THE MARK TRANSLITERATE TO HUAN QIU AND THIS HAS NO MEANING IN A FOREIGN LANGUAGE.

FOR DRIVE CHAINS AND DRIVING CHAINS OTHER THAN FOR LAND VEHICLES, NAMELY, FOR USE WITH SLEEVE BEARING (U.S. CLS. 13, 19, 21, 23, 31, 34 AND 35).

MARILYN IZZI, EXAMINING ATTORNEY

CLASS 7—(Continued).

SN 79-107,628. POOLRITE RESEARCH PTY LTD, MOUNT GRAVATT, AUSTRALIA, FILED 10-31-2011.

QUATRABOT

THE MARK CONSISTS OF STANDARD CHARACTERS WITHOUT CLAIM TO ANY PARTICULAR FONT, STYLE, SIZE, OR COLOR.

OWNER OF INTERNATIONAL REGISTRATION 1102817 DATED 10-31-2011, EXPIRES 10-31-2021.

THE WORD(S) "QUATRABOT" HAS NO MEANING IN A FOREIGN LANGUAGE.

FOR SWIMMING POOL AND SPA CLEANING AND MAINTENANCE MACHINES AND EQUIPMENT, NAMELY, VACUUM CLEANERS, WATER PURIFYING AND FILTRATION APPARATUS FOR SWIMMING POOLS AND SPAS; SWEEPING MACHINES AND SWEEPERS FOR USE IN SWIMMING POOLS AND SPAS; SKIMMERS FOR CLEANING POOLS AND SPAS; PUMPS, NAMELY, HYDRAULIC PUMPS AND ELECTRIC PUMPS; GENERATORS, NAMELY, ELECTRIC GENERATORS; PARTS FOR THE AFOREMENTIONED GOODS (U.S. CLS. 13, 19, 21, 23, 31, 34 AND 35).

EVELYN BRADLEY, EXAMINING ATTORNEY

CLASS 7—(Continued).

SN 85-001,654. LG ELECTRONICS INC., SEOUL, REPUBLIC OF KOREA, FILED 3-30-2010.



KOMPRESSOR

OWNER OF REPUBLIC OF KOREA REG. NO. 0860228, DATED 4-8-2011, EXPIRES 4-8-2021.

OWNER OF U.S. REG. NO. 3,631,943.

NO CLAIM IS MADE TO THE EXCLUSIVE RIGHT TO USE "KOMPRESSOR", APART FROM THE MARK AS SHOWN.

THE MARK CONSISTS OF THE WORDING "KOMPRESSOR" IN A STYLIZED FONT UNDERNEATH A SQUARE WITH ROUNDED EDGES AND A SPIRAL DESIGN. WITHIN THE SQUARE IS A LETTER "K" IN A STYLIZED FONT, TO THE RIGHT OF WHICH IS A HEXAGON WITH SIX SURROUNDING HEXAGONS.

THE ENGLISH TRANSLATION OF "KOMPRESSOR" IN THE MARK IS "COMPRESSOR".

FOR ELECTRIC VACUUM CLEANERS (U.S. CLS. 13, 19, 21, 23, 31, 34 AND 35).

JAMES MACFARLANE, EXAMINING ATTORNEY

SN 79-109,691. XYLEM WATER SOLUTIONS AB, SWEDEN, FILED 1-19-2012.

EXPERIOR

THE MARK CONSISTS OF STANDARD CHARACTERS WITHOUT CLAIM TO ANY PARTICULAR FONT, STYLE, SIZE, OR COLOR.

PRIORITY DATE OF 9-8-2011 IS CLAIMED.

OWNER OF INTERNATIONAL REGISTRATION 1108151 DATED 1-19-2012, EXPIRES 1-19-2022.

FOR ELECTRONICALLY MONITORED AND CONTROLLED SUBMERSIBLE PUMPING SYSTEMS COMPRISED OF A ELECTRIC MOTOR DRIVEN PUMP, ELECTRIC MOTOR, ELECTRIC MOTOR SPEED CONTROLLER AND ELECTRONIC PUMP CONDITION MONITOR (U.S. CLS. 13, 19, 21, 23, 31, 34 AND 35).

ARETHA SOMERVILLE, EXAMINING ATTORNEY

SN 85-229,021. K-TEC, INC., OREM, UT. FILED 1-28-2011.

MAKE YOUR OWN DANG SMOOTHIE

THE MARK CONSISTS OF STANDARD CHARACTERS WITHOUT CLAIM TO ANY PARTICULAR FONT, STYLE, SIZE, OR COLOR.

FOR SELF-SERVE ELECTRIC FOOD AND DRINK BLENDERS FEATURING A SERVICE PITCHER FOR DISPENSING THE BLENDED FOOD AND DRINK (U.S. CLS. 13, 19, 21, 23, 31, 34 AND 35).

ELI HELLMAN, EXAMINING ATTORNEY

CLASS 7—(Continued).

SN 85-229,025. K-TEC, INC., OREM, UT. FILED 1-28-2011.

SMOOTHIE SHOP IN A BOX

THE MARK CONSISTS OF STANDARD CHARACTERS WITHOUT CLAIM TO ANY PARTICULAR FONT, STYLE, SIZE, OR COLOR.

FOR SELF-SERVE ELECTRIC FOOD AND DRINK BLENDERS FEATURING A SERVICE PITCHER FOR DISPENSING THE BLENDED FOOD AND DRINK (U.S. CLS. 13, 19, 21, 23, 31, 34 AND 35).

ELI HELLMAN, EXAMINING ATTORNEY

SN 85-278,686. CRONE, ADAM, BLOOMSBURG, PA. AND CRONE, MATT, BLOOMSBURG, PA. FILED 3-28-2011.



THE MARK CONSISTS OF "CS" IN CAPITAL LETTERS SURROUNDED BY "SUPER" ALONG THE TOP AND "DUALS" ALONG THE BOTTOM IN CAPITAL LETTERS AS WELL.

FOR AUTOMOTIVE EXHAUST PIPE (U.S. CLS. 13, 19, 21, 23, 31, 34 AND 35).

JULIE VEPPUMTHARA, EXAMINING ATTORNEY

CLASS 7—(Continued).

SN 85-279,547. WIWA, LP, ALGER, OH. FILED 3-29-2011.



OWNER OF U.S. REG. NO. 3,048,518.

NO CLAIM IS MADE TO THE EXCLUSIVE RIGHT TO USE "LP CUSTOM AIRLESS SPRAY SYSTEMS", APART FROM THE MARK AS SHOWN.

THE MARK CONSISTS OF THE NAME OF THE COMPANY "WIWA LP" AND ITS PRIMARY PRODUCT "CUSTOM AIRLESS SPRAY SYSTEMS", THE STRAIGHT LINE SEPARATES THE NAME FROM THE PURPOSE OF THE COMPANY.

FOR PISTON PUMPS FOR THE TRANSPORTATION OF COLORINGS, FLAME RETARDANT AGENTS AND LIQUID COATING AGENTS; HIGH AND LOW PRESSURE SPRAYING APPARATUS AND THEIR PARTS, NAMELY, POWER OPERATED HIGH AND LOW PRESSURE SPRAYERS AND THEIR PARTS; COATING AND SPRAYING APPARATUS FOR INDUSTRIAL AND DO-IT-YOURSELF PURPOSES AND THEIR PARTS, NAMELY, POWDER AND LIQUID COATING SPRAY GUNS AND POWER OPERATED SPRAYERS FOR INDUSTRIAL AND DO-IT-YOURSELF PURPOSES AND THEIR PARTS; SPRAY GUNS FOR PAINT; GREASE EQUIPMENT, NAMELY, PNEUMATIC GREASE GUNS; RAM PRESSES, NAMELY, PNEUMATIC RAM PRESSES FOR EMPTYING CONTAINERS FILLED WITH HIGHLY VISCOUS MATERIALS; MIXERS AND THEIR PARTS (U.S. CLS. 13, 19, 21, 23, 31, 34 AND 35).

BRIAN CALLAGHAN, EXAMINING ATTORNEY

SN 85-365,267. THOROUGHbred INDUSTRIAL CYLINDER EXCHANGE, LLC, LEXINGTON, KY. FILED 7-7-2011.

PLASMAPONY

THE MARK CONSISTS OF STANDARD CHARACTERS WITHOUT CLAIM TO ANY PARTICULAR FONT, STYLE, SIZE, OR COLOR.

FOR WELDING KIT COMPRISED OF ELECTRIC CUTTING MACHINES, WELDING GLOVES, A WELDING HELMET, REPLACEMENT TIPS FOR THE CUTTING MACHINES AND REPLACEMENT NOZZLES FOR THE CUTTING MACHINES (U.S. CLS. 13, 19, 21, 23, 31, 34 AND 35).

LOURDES AYALA, EXAMINING ATTORNEY

CLASS 7—(Continued).

SN 85-372,281. ISTOBAL, S.A., L'ALCUDIA, VALENCIA, SPAIN, FILED 7-15-2011.

The logo for HEAVYWASH ISTOBAL features the word "HEAVYWASH" in a bold, italicized, sans-serif font. Below it, the word "ISTOBAL" is written in a smaller, bold, sans-serif font, centered within a dark, horizontal rectangular bar that has a gradient effect.

OWNER OF U.S. REG. NO. 3,504,506.
NO CLAIM IS MADE TO THE EXCLUSIVE RIGHT TO USE "HEAVY WASH", APART FROM THE MARK AS SHOWN.

THE MARK CONSISTS OF THE STYLIZED WORD "HEAVYWASH" WITH THE STYLIZED WORD "ISTOBAL" APPEARING BELOW WITHIN A RECTANGULAR DESIGN FEATURING GRADUALLY FADING CIRCLES ON ITS LEFT SIDE.

FOR AIR SUCTION MACHINES; AUTOMOTIVE SERVICE EQUIPMENT, NAMELY, BRAKE FLUSHING MACHINES; CAR LIFTS; CONVEYORS; ELECTRIC WASHING MACHINES FOR INDUSTRIAL PURPOSES; ELECTRIC WAX-POLISHING MACHINES FOR INDUSTRIAL PURPOSES; ELEVATING OR LIFTING WORK PLATFORMS; ELEVATING WORK PLATFORMS; ELEVATORS; HIGH-PRESSURE PUMPS FOR WASHING APPLIANCES AND INSTALLATIONS; HYDRAULIC JACKS; HYDRAULIC LIFT TABLES; LUBRICATING PUMPS; LUBRICATION MACHINES; MACHINES FOR BLAST CLEANING A SURFACE; MACHINES FOR CLEANING SURFACES USING HIGH PRESSURE WATER; MECHANICAL AND HYDRAULIC LIFTS; PAINTING MACHINES; PNEUMATICALLY OPERATED TIRE INFLATION MACHINE; POWER JACKS; POWER-OPERATED LIFTS FOR MOVING, PARKING AND STORING LAND VEHICLES; POWER-OPERATED LUBRICANT DISPENSERS FOR MACHINES; POWER-OPERATED TIRE MOUNTING MACHINES; POWERED TIRE CHANGER MACHINES FOR LAND VEHICLES; PRESSURE WASHING MACHINES; SPRAY PAINT SYSTEMS COMPRISED OF PUMPS, PUMP CONTROLLERS, NOZZLES, TUBING AND VALVES; STEAM CLEANING MACHINES; VACUUM CLEANERS; VEHICLE WASHING INSTALLATIONS; VEHICLE WASHING MACHINES (U.S. CLS. 13, 19, 21, 23, 31, 34 AND 35).

DEBORAH LOBO, EXAMINING ATTORNEY

CLASS 7—(Continued).

SN 85-393,856. APPLIED MATERIALS, INC., SANTA CLARA, CA. FILED 8-9-2011.

APPLIED HCT

THE MARK CONSISTS OF STANDARD CHARACTERS WITHOUT CLAIM TO ANY PARTICULAR FONT, STYLE, SIZE, OR COLOR.

OWNER OF U.S. REG. NOS. 2,445,458, 4,002,845 AND 4,044,528.

FOR MACHINES AND PARTS THEREFOR FOR WORKING METALS, METALLOIDS, SEMICONDUCTORS; MACHINES AND PARTS THEREFOR FOR SAWING, CUTTING, POLISHING, AND LAPPING; LOADING BRIDGES, CRANES, AND ELEVATORS; TRANSFER DEVICES IN THE NATURE OF BELT CONVEYORS, ROPE CONVEYORS, CHAIN CONVEYORS, PNEUMATIC CONVEYORS, CONVEYORS TUBES AND SLOPES; TRANSPORTERS IN THE NATURE OF PNEUMATIC, POWER-OPERATED RAIL, AND POWER-OPERATED ROPE TRANSPORTERS; HANDLING APPARATUS IN THE NATURE OF POWER-OPERATED GRIPPING MANIPULATORS; MACHINES FOR WASHING AND CLEANING OF SAWED PRODUCTS; MACHINES FOR SAWING HARD MATERIALS AND MATERIALS FOR THE SEMICONDUCTOR AND SOLAR INDUSTRIES; MACHINES FOR ORIENTING AND TRANSFERRING MONOCRYSTALS AND MONOCRYSTALLINE MATERIALS FOR SAWING MACHINES AND PARTS THEREFOR; AND MECHANICAL CONTROL FOR MACHINES, MACHINE ENGINES AND MACHINE MOTORS (U.S. CLS. 13, 19, 21, 23, 31, 34 AND 35).

FIRST USE 3-31-2011; IN COMMERCE 3-31-2011.

MICHAEL WIENER, EXAMINING ATTORNEY

SN 85-463,231. AIR CONTROL INDUSTRIES, INC., WINDSOR, ME. FILED 11-3-2011.

JETBLACK

THE MARK CONSISTS OF STANDARD CHARACTERS WITHOUT CLAIM TO ANY PARTICULAR FONT, STYLE, SIZE, OR COLOR.

SEC. 2(F).

FOR POWER-OPERATED PERSONAL BLOWERS, NAMELY, FIXED AND PORTABLE BLOWERS AND CLEANING STATIONS COMPOSED OF FAN, CONTROL BOX, HOSE, NOZZLE, AND INLET FILTER, POWER-OPERATED BLOWERS FOR CLEANING PERSONS AND OBJECTS (U.S. CLS. 13, 19, 21, 23, 31, 34 AND 35).

FIRST USE 6-3-2003; IN COMMERCE 6-3-2003.

TIMOTHY FINNEGAN, EXAMINING ATTORNEY

CLASS 7—(Continued).

SN 85-466,172. BF GERMANY GMBH, ASPERG, FED REP GERMANY, FILED 11-7-2011.



OWNER OF ERPN CMNTY TM OFC REG. NO. 2357374, DATED 2-13-2003, EXPIRES 8-30-2021.

OWNER OF U.S. REG. NO. 4,107,286.

NO CLAIM IS MADE TO THE EXCLUSIVE RIGHT TO USE "GERMANY", APART FROM THE MARK AS SHOWN. THE COLOR(S) BLUE, BLACK AND WHITE IS/ARE CLAIMED AS A FEATURE OF THE MARK.

THE MARK CONSISTS OF THE LETTERS "BF" IN BLUE WITH A BLACK BORDER, A BLUE OVAL AND "GERMANY" IN WHITE UPON A BLACK RECTANGLE.

FOR DIESEL ENGINE PARTS, NAMELY, CYLINDER BLOCKS, CYLINDER LINERS, CYLINDER HEADS, GASKETS, SLIDE BEARINGS, CRANK SHAFTS, CRANK SHAFT BEARINGS, CRANKCASES, VIBRATION DAMPERS, PISTONS, PISTON PINS, PISTON RINGS, PISTON RING SEGMENTS, PISTON RING SETS, PISTON PIN CIRCLIPS, CONNECTING RODS, CONNECTING ROD BEARINGS, CAMSHAFTS, CAMSHAFT BEARINGS, ROCKER ARMS, PUSHING RODS, INLET VALVES, OUTLET VALVES, VALVE TAPPETS, VALVE STEM GUIDES, VALVE SEATS, VALVE SEAT RINGS, VALVE SPRINGS, INTAKE MANIFOLDS, EXHAUST MANIFOLDS, CARBURETORS, GEAR CASES, GEAR DRIVES, STARTER RING GEARS, PUMPS, CENTRIFUGAL PUMPS, ROTARY PUMPS, WATER PUMPS, FUEL PUMPS, OIL PUMPS, REPAIR KITS FOR PUMPS, OIL COOLERS, OIL PRESSURE RELIEF VALVES, CHARGE AIR COOLERS, FLYWHEELS, FANS, NUTS, BOLTS; COMPRESSORS AS PART OF DIESEL ENGINES AND THEIR PARTS, NAMELY, CYLINDER BLOCKS, CYLINDER HEADS, PISTONS, CRANK SHAFTS, DRIVE GEARS, CONNECTING RODS (U.S. CLS. 13, 19, 21, 23, 31, 34 AND 35).

APRIL HESIK, EXAMINING ATTORNEY

SN 85-487,263. MCLAREN STAINLESS LIMITED, HASTINGS 4120, NEW ZEALAND, FILED 12-5-2011.

iSHRINK

THE MARK CONSISTS OF STANDARD CHARACTERS WITHOUT CLAIM TO ANY PARTICULAR FONT, STYLE, SIZE, OR COLOR.

OWNER OF NEW ZEALAND REG. NO. 832875, DATED 5-9-2011, EXPIRES 11-5-2020.

FOR MACHINES AND MACHINE TOOLS, NAMELY, SHRINK WRAPPING MACHINES AND SHRINK WRAPPING MACHINE TOOLS, MACHINES AND MACHINE TOOLS FOR PACKAGING, WRAPPING AND SHRINK WRAPPING FOOD AND BEVERAGES; MACHINES AND MACHINE TOOLS FOR THE PROCESSING AND PREPARATION OF FOOD AND BEVERAGES (U.S. CLS. 13, 19, 21, 23, 31, 34 AND 35).

ANDREA K. NADELMAN, EXAMINING ATTORNEY

CLASS 7—(Continued).

SN 85-487,305. MCLAREN STAINLESS LIMITED, HASTINGS 4120, NEW ZEALAND, FILED 12-5-2011.

iDRY

THE MARK CONSISTS OF STANDARD CHARACTERS WITHOUT CLAIM TO ANY PARTICULAR FONT, STYLE, SIZE, OR COLOR.

OWNER OF NEW ZEALAND REG. NO. 832874, DATED 5-9-2011, EXPIRES 11-5-2020.

FOR MACHINES AND MACHINE TOOLS FOR DRYING, PRESERVING, PACKAGING AND STORING OF FOOD AND BEVERAGES; MACHINES AND MACHINE TOOLS FOR THE PROCESSING AND PREPARATION OF FOODS AND BEVERAGES (U.S. CLS. 13, 19, 21, 23, 31, 34 AND 35).

ANDREA K. NADELMAN, EXAMINING ATTORNEY

SN 85-487,970. DIAMOND INNOVATIONS, INC., WORTHINGTON, OH. FILED 12-6-2011.

VERSIMAX

THE MARK CONSISTS OF STANDARD CHARACTERS WITHOUT CLAIM TO ANY PARTICULAR FONT, STYLE, SIZE, OR COLOR.

FOR WEAR PLATES FOR MACHINES; MACHINE PARTS, NAMELY, WEAR SEGMENTS, NAMELY, WEAR PLATES FOR CRUSHERS; PUMP WEAR COMPONENTS, NAMELY, BUSHINGS AND PUMP WEAR RINGS, BEARINGS, IMPELLERS, ROTORS, STATORS, ROTARY SEALS, SLIDING SEALS; DIAMOND CUTTING TOOLS FOR MACHINES; DIAMOND DRILL BITS FOR ELECTRICALLY POWERED MACHINES AND HYDRAULICALLY POWERED MACHINES; DIAMOND TIPPED MACHINE PARTS, NAMELY, WORK REST PLATES, GRINDING AND TURNING CENTERS, SLIDING BEARING SURFACES, ANVILS, NOZZLES, AND DIAMOND TIPS FOR MEASURING MACHINES; DIAMOND TIPPED MACHINE TOOLS FOR METALWORKING AND CUTTING METAL, WOOD, PLASTICS, CERAMICS, STRUCTURAL MATERIALS, NATURAL ROCK AND MINERALS, AND REINFORCED COMPOSITES; DIAMOND TIPS FOR TOOL BITS FOR MACHINES; DIAMOND TIPPED TOOLS FOR CUTTING, NAMELY, DIAMOND COMPOSITE METAL-CUTTING TOOLS FOR MACHINES; DIAMOND TOOLS FOR DRILLING, NAMELY, ANCHOR BITS, CORE FINGER BITS, CROWN CORE BITS, TURBO CORE BITS, SPADE BITS, ROTARY DRILLS, CUTTING INSERTS AND ADAPTERS FOR MACHINES; DIAMOND TIPPED TOOLS FOR MILLING, NAMELY, MILLING CUTTERS AND MILLING WHEELS FOR MACHINES; DIAMOND-POINTED METAL-CUTTING TOOLS; POLYCRYSTALLINE DIAMOND COMPOSITE MACHINE TOOLS, NAMELY, TOOLS FOR THE CUTTING AND MACHINING OF WORKPIECES; POLYCRYSTALLINE DIAMOND CUTTERS FOR READY CUTTING OF WORKPIECES; DIAMOND-EDGED CUTTING TOOLS FOR USE WITH POWER OPERATED MACHINE TOOLS; TOOLS INCORPORATING DIAMOND CUTTING EDGES FOR USE WITH POWER OPERATED MACHINE TOOLS (U.S. CLS. 13, 19, 21, 23, 31, 34 AND 35).

NANCY CLARKE, EXAMINING ATTORNEY

CLASS 7—(Continued).

SN 85-520,082. SHEER WIND, INC., CHASKA, MN. FILED 1-19-2012.

INVELOX

THE MARK CONSISTS OF STANDARD CHARACTERS WITHOUT CLAIM TO ANY PARTICULAR FONT, STYLE, SIZE, OR COLOR.

THE WORDING "INVELOX" HAS NO MEANING IN A FOREIGN LANGUAGE.

FOR WIND TURBINE, NAMELY, A GROUND-BASED TURBINE TO CAPTURE WIND AND INCREASE VELOCITY (U.S. CLS. 13, 19, 21, 23, 31, 34 AND 35).

BILL DAWE, EXAMINING ATTORNEY

SN 85-520,516. HOLLEY PERFORMANCE PRODUCTS, INC., BOWLING GREEN, KY. FILED 1-19-2012.

Fuel Your Passion

THE MARK CONSISTS OF STANDARD CHARACTERS WITHOUT CLAIM TO ANY PARTICULAR FONT, STYLE, SIZE, OR COLOR.

FOR FUEL PUMPS FOR LAND VEHICLES, FUEL PRESSURE REGULATORS BEING PARTS OF MACHINES AND FUEL FILTERS FOR INTERNAL COMBUSTION ENGINES AND INSTRUCTIONAL MANUALS SOLD THEREWITH AS A UNIT (U.S. CLS. 13, 19, 21, 23, 31, 34 AND 35).

LOURDES AYALA, EXAMINING ATTORNEY

SN 85-525,101. NATIVE SEEDSTERS, INC., BILLINGS, MT. FILED 1-25-2012.



OWNER OF U.S. REG. NOS. 3,437,166 AND 3,441,692. NO CLAIM IS MADE TO THE EXCLUSIVE RIGHT TO USE "INC", APART FROM THE MARK AS SHOWN.

THE MARK CONSISTS OF THE STYLIZED WORDING "NATIVE SEEDSTERS INC" FEATURED ON A SHADED OVAL WITH A DESIGN RESEMBLING ONE SEED APPEARING ON EACH SIDE OF THE ABBREVIATION "INC" AND WITH AN INCOMPLETE OVAL FORMED BY A SEED STALK ENCOMPASSING THE SHADED OVAL.

FOR AGRICULTURAL MACHINERY, NAMELY, HARVESTERS (U.S. CLS. 13, 19, 21, 23, 31, 34 AND 35).
CYNTHIA TRIPI, EXAMINING ATTORNEY

CLASS 7—(Continued).

SN 85-525,616. THOGUS PRODUCTS COMPANY, AVON LAKE, OH. FILED 1-26-2012.

TIME MACHINE

THE MARK CONSISTS OF STANDARD CHARACTERS WITHOUT CLAIM TO ANY PARTICULAR FONT, STYLE, SIZE, OR COLOR.

NO CLAIM IS MADE TO THE EXCLUSIVE RIGHT TO USE "MACHINE", APART FROM THE MARK AS SHOWN.

FOR INJECTION MOLDING INSTALLATIONS AND INJECTION MOLDING MACHINES FOR PLASTIC MATERIALS COMPOSED OF MACHINES AND MECHANICAL EQUIPMENT, AND ASSOCIATED PARTS AND COMPONENTS, NAMELY, HOT-CHANNEL DISTRIBUTORS AND HOT-CHANNEL DISTRIBUTOR SYSTEMS COMPOSED THEREOF, INJECTION MOLDING NOZZLES, NOZZLE GATES, MECHANICAL INJECTION MOLDING TOOLS, NEEDLE VALVES FOR INJECTION MOLDING NOZZLES, MECHANICALLY, ELECTRICALLY OR PNEUMATICALLY ACTUATED MACHINE PARTS OF PLASTIC MATERIAL INJECTION MOLDING MACHINES FOR ACTUATING NEEDLE VALVES; MECHANICAL AND PNEUMATIC CONTROLLERS FOR INJECTION MOLDING INSTALLATIONS AND INJECTION MOLDING MACHINES; MACHINES AND MACHINE TOOLS FOR PLASTIC PROCESSING, NAMELY, INDUSTRIAL HOT RUNNER SYSTEMS COMPRISED OF TUBES, MACHINE NOZZLES, GATES, HOT RUNNERS, MANIFOLDS, MANIFOLD PLATES, NOZZLE TIPS, MANIFOLD BARS, THERMIC SENSORS AND THERMIC CONDUCTORS; INJECTION MOLDING TOOLS AND ACCESSORIES, NAMELY, HOT RUNNER SYSTEM NOZZLES, CONNECTION NOZZLES, MANIFOLDS, MANIFOLD PLATES, MANIFOLD BARS, THERMIC SENSORS AND THERMIC CONDUCTORS (U.S. CLS. 13, 19, 21, 23, 31, 34 AND 35).

TASNEEM HUSSAIN, EXAMINING ATTORNEY

SN 85-526,182. SAVICORP, SANTA ANA, CA. FILED 1-26-2012.

DYNOVALVE

THE MARK CONSISTS OF STANDARD CHARACTERS WITHOUT CLAIM TO ANY PARTICULAR FONT, STYLE, SIZE, OR COLOR.

OWNER OF U.S. REG. NOS. 3,173,466, 3,204,740 AND 3,303,777.

SEC. 2(F).

FOR EMISSION REDUCTION UNITS FOR MOTORS AND ENGINES, NAMELY, PCV VALVES (U.S. CLS. 13, 19, 21, 23, 31, 34 AND 35).

FIRST USE 10-1-2006; IN COMMERCE 10-1-2006.
VERNA BETH RIRIE, EXAMINING ATTORNEY

CLASS 7—(Continued).

SN 85-526,898. DELAWARE CAPITAL FORMATION, INC., WILMINGTON, DE. FILED 1-27-2012.

ECYLINDER

THE MARK CONSISTS OF STANDARD CHARACTERS WITHOUT CLAIM TO ANY PARTICULAR FONT, STYLE, SIZE, OR COLOR.

OWNER OF U.S. REG. NO. 3,056,363.
FOR MACHINERY FOR USE IN THE AUTOMATION INDUSTRY, NAMELY, MOTOR DRIVEN SLIDES (U.S. CLS. 13, 19, 21, 23, 31, 34 AND 35).
FONG HSU, EXAMINING ATTORNEY

SN 85-530,434. FLUID LINE PRODUCTS, INC., WILLOUGHBY, OH. FILED 1-31-2012.

SLOWEASE

THE MARK CONSISTS OF STANDARD CHARACTERS WITHOUT CLAIM TO ANY PARTICULAR FONT, STYLE, SIZE, OR COLOR.

FOR PURGE VALVES (U.S. CLS. 13, 19, 21, 23, 31, 34 AND 35).
COLLEEN MULCRONE, EXAMINING ATTORNEY

SN 85-531,225. ZOSANY INTERNATIONAL CORPORATION, DORAL, FL. FILED 2-1-2012.

ZANO

THE MARK CONSISTS OF STANDARD CHARACTERS WITHOUT CLAIM TO ANY PARTICULAR FONT, STYLE, SIZE, OR COLOR.

FOR ELECTRIC FOOD BLENDERS; ELECTRIC FOOD BLENDERS; ELECTRIC FOOD CHOPPERS; ELECTRIC FOOD PROCESSORS; ELECTRIC FOOD SLICERS; ELECTRIC MIXERS FOR HOUSEHOLD PURPOSES (U.S. CLS. 13, 19, 21, 23, 31, 34 AND 35).
TIMOTHY FINNEGAN, EXAMINING ATTORNEY

CLASS 7—(Continued).

SN 85-533,604. WEST MARINE PRODUCTS, INC., WATSONVILLE, CA. FILED 2-3-2012.



THE MARK CONSISTS OF A SHARK.
FOR WATER AERATION SYSTEMS COMPRISING WATER PUMPS, AIR COMPRESSORS AND AIR BLOWERS; BILGE PUMPS, TROLLING MOTOR FOR BOATS (U.S. CLS. 13, 19, 21, 23, 31, 34 AND 35).

WILLIAM VERHOSEK, EXAMINING ATTORNEY

SN 85-534,030. STASIS, INC., SUMMIT POINT, WV. FILED 2-4-2012.

EUROJET

THE MARK CONSISTS OF STANDARD CHARACTERS WITHOUT CLAIM TO ANY PARTICULAR FONT, STYLE, SIZE, OR COLOR.

FOR AUTOMOTIVE EXHAUST PIPE; ENGINE EXHAUST SYSTEMS COMPRISING PIPES AND MUFFLERS; ENGINE EXHAUST TIPS; CATALYTIC CONVERTER UNITS FOR VEHICLE EXHAUSTS; ACCESSORIES FOR AUTOMOTIVE POSITIVE CRANKCASE VENTILATION (PCV) SYSTEMS, NAMELY, LINK PLATES, CATCH CANS, AND HOSE KITS; AUTOMOBILE ENGINE VALVE COVERS; INTERCOOLERS FOR AUTOMOBILE ENGINES; ENGINE AIR INTAKE SYSTEMS COMPRISING TUBES AND AIR FILTERS; AIR FILTERS FOR AUTOMOBILE ENGINES; THROTTLE BODY HOSES FOR AUTOMOBILE ENGINES; TURBOCHARGERS FOR AUTOMOBILE ENGINES; AND TURBO DISCHARGE PIPES FOR AUTOMOBILE ENGINES (U.S. CLS. 13, 19, 21, 23, 31, 34 AND 35).

FIRST USE 2-5-2011; IN COMMERCE 2-5-2011.
PATRICIA EVANKO, EXAMINING ATTORNEY

CLASS 7—(Continued).

SN 85-534,032. STASIS, INC., SUMMIT POINT, WV. FILED 2-4-2012.



THE MARK CONSISTS OF A SHIELD WITH A FIVE-POINTED STAR INSIDE, THE POINTS OF THE STAR TRUNCATED BY THE EDGES OF THE SHIELD.
FOR AUTOMOTIVE EXHAUST PIPE; ENGINE EXHAUST SYSTEMS COMPRISING PIPES AND MUFFLERS; ENGINE EXHAUST TIPS; CATALYTIC CONVERTER UNITS FOR VEHICLE EXHAUSTS; ACCESSORIES FOR AUTOMOTIVE POSITIVE CRANKCASE VENTILATION (PCV) SYSTEMS, NAMELY, LINK PLATES, CATCH CANS, AND HOSE KITS; AUTOMOBILE ENGINE VALVE COVERS; INTERCOOLERS FOR AUTOMOBILE ENGINES; ENGINE AIR INTAKE SYSTEMS COMPRISING TUBES AND AIR FILTERS; AIR FILTERS FOR AUTOMOBILE ENGINES; THROTTLE BODY HOSES FOR AUTOMOBILE ENGINES; TURBOCHARGERS FOR AUTOMOBILE ENGINES; AND TURBO DISCHARGE PIPES FOR AUTOMOBILE ENGINES (U.S. CLS. 13, 19, 21, 23, 31, 34 AND 35).
FIRST USE 2-5-2011; IN COMMERCE 2-5-2011.
PATRICIA EVANKO, EXAMINING ATTORNEY

SN 85-534,840. ASTARAS, INC., LARGO, FL. FILED 2-6-2012.

E3

THE MARK CONSISTS OF STANDARD CHARACTERS WITHOUT CLAIM TO ANY PARTICULAR FONT, STYLE, SIZE, OR COLOR.
FOR TUNGSTEN ELECTRODES FOR WELDING AND CUTTING (U.S. CLS. 13, 19, 21, 23, 31, 34 AND 35).
ELIZABETH KAJUBI, EXAMINING ATTORNEY

CLASS 7—(Continued).

SN 85-535,432. ZOJE AMERICA, INC., MIAMI, FL. FILED 2-6-2012.



THE MARK CONSISTS OF THE WORD "SISTER" IN ITALIC MONOTYPE CORSIVA FONT, SURROUNDED BY AN OVAL.
FOR SEWING MACHINES (U.S. CLS. 13, 19, 21, 23, 31, 34 AND 35).
JORDAN BAKER, EXAMINING ATTORNEY

SN 85-536,266. FULL SPECTRUM SOLUTIONS, INC, JACKSON, MI. FILED 2-7-2012.



THE MARK CONSISTS OF THE WORD "DELTEON" WITH THE IMAGE OF THE SUN REPLACING THE VOWEL "O".
FOR DC GENERATOR; ELECTRIC GENERATORS; GENERATORS FOR WIND TURBINES; SOLAR-POWERED ELECTRICITY GENERATORS; WIND-POWERED ELECTRICITY GENERATORS (U.S. CLS. 13, 19, 21, 23, 31, 34 AND 35).
SALLY SHIH, EXAMINING ATTORNEY

SN 85-536,929. MANUS ABRASIVE SYSTEMS INC., EDMONTON, ALBERTA, CANADA, FILED 2-8-2012.

MEGA-BLAST

THE MARK CONSISTS OF STANDARD CHARACTERS WITHOUT CLAIM TO ANY PARTICULAR FONT, STYLE, SIZE, OR COLOR.
FOR PARTICLE BLAST CLEANING MACHINES AND STRUCTURAL PARTS THEREOF (U.S. CLS. 13, 19, 21, 23, 31, 34 AND 35).
COLLEEN DOMBROW, EXAMINING ATTORNEY

CLASS 7—(Continued).

SN 85-537,091. FRADAN MANUFACTURING CORP., NEW ROCHELLE, NY. FILED 2-8-2012.

FRADAN

THE MARK CONSISTS OF STANDARD CHARACTERS WITHOUT CLAIM TO ANY PARTICULAR FONT, STYLE, SIZE, OR COLOR.

FOR POWER BLOWERS FOR LAWN DEBRIS; VACUUM SHREDDERS FOR CLEARING DEBRIS (U.S. CLS. 13, 19, 21, 23, 31, 34 AND 35).

FIRST USE 11-30-1991; IN COMMERCE 11-30-1991.
TOBY BULLOFF, EXAMINING ATTORNEY

SN 85-537,122. KSIN LUXEMBOURG II, S.A.R.L., LUXEMBOURG, LUXEMBOURG, FILED 2-8-2012.

POWERQUILTER

THE MARK CONSISTS OF STANDARD CHARACTERS WITHOUT CLAIM TO ANY PARTICULAR FONT, STYLE, SIZE, OR COLOR.

FOR SEWING MACHINES (U.S. CLS. 13, 19, 21, 23, 31, 34 AND 35).

ALYSSA STEEL, EXAMINING ATTORNEY

SN 85-537,339. RICHARD C. RACZUK, LAKE HAVASU CITY, AZ. FILED 2-8-2012.

SURSEAT

THE MARK CONSISTS OF STANDARD CHARACTERS WITHOUT CLAIM TO ANY PARTICULAR FONT, STYLE, SIZE, OR COLOR.

FOR BITS FOR POWER TOOLS THAT REPAIR FLARED TUBING CONNECTIONS (U.S. CLS. 13, 19, 21, 23, 31, 34 AND 35).

JENNIFER RICHARDSON, EXAMINING ATTORNEY

CLASS 7—(Continued).

SN 85-539,595. REMY TECHNOLOGIES L.L.C., PENDLETON, IN. FILED 2-10-2012.

DR29S

THE MARK CONSISTS OF STANDARD CHARACTERS WITHOUT CLAIM TO ANY PARTICULAR FONT, STYLE, SIZE, OR COLOR.

FOR ALTERNATORS; ALTERNATORS FOR LAND VEHICLES (U.S. CLS. 13, 19, 21, 23, 31, 34 AND 35).

TASHIA BUNCH, EXAMINING ATTORNEY

SN 85-557,207. TECHNOLOGY LICENSING CORP., CINCINNATI, OH. FILED 3-1-2012.

RATTLESNAKE

THE MARK CONSISTS OF STANDARD CHARACTERS WITHOUT CLAIM TO ANY PARTICULAR FONT, STYLE, SIZE, OR COLOR.

FOR ARTIFICIAL TURF REMOVAL DEVICE, NAMELY, A MECHANISM FOR REMOVING AND COLLECTING PARTICULATE INFILL FROM ARTIFICIAL TURF (U.S. CLS. 13, 19, 21, 23, 31, 34 AND 35).

FIRST USE 2-24-2012; IN COMMERCE 2-24-2012.
KIM SAITO, EXAMINING ATTORNEY

SN 85-564,971. THE BLACK & DECKER CORPORATION, TOWSON, MD. FILED 3-9-2012.

CONSTRUCT YOUR SYSTEM

THE MARK CONSISTS OF STANDARD CHARACTERS WITHOUT CLAIM TO ANY PARTICULAR FONT, STYLE, SIZE, OR COLOR.

FOR POWER TOOLS, NAMELY, DRILLS, DRILL/DRIVERS, SAWS, SANDERS, ROUTERS, SCREWDRIVERS, AIR COMPRESSORS, GRINDERS, NAILERS, PLANERS AND OSCILLATING TOOLS, AND POWER TOOLS BEING DRILLS, DRILL/DRIVERS, SAWS, SANDERS, ROUTERS, SCREWDRIVERS, AIR COMPRESSORS, GRINDERS, NAILERS, PLANERS AND OSCILLATING TOOLS INCLUDING A MOTOR AND INTERCHANGEABLE TOOLS HEADS, AND ACCESSORIES THEREFORE, NAMELY, POWER DRILL AND SCREWDRIVER BITS, POWER SAW BLADES, OSCILLATING TOOL BLADES, AND GRINDING WHEELS (U.S. CLS. 13, 19, 21, 23, 31, 34 AND 35).

MARC LEIPZIG, EXAMINING ATTORNEY

CLASS 8—HAND TOOLS

SN 76-710,365. ASSENMACHER SPECIALTY TOOLS, INC., BOULDER, CO. FILED 1-25-2012.

ASSENMACHER SPECIALTY TOOLS

THE MARK CONSISTS OF STANDARD CHARACTERS WITHOUT CLAIM TO ANY PARTICULAR FONT, STYLE, SIZE, OR COLOR.

NO CLAIM IS MADE TO THE EXCLUSIVE RIGHT TO USE "SPECIALTY TOOLS", APART FROM THE MARK AS SHOWN.

SEC. 2(F).

FOR AUTOMOTIVE HAND TOOLS, NAMELY, WRENCHES AND WRENCH SETS, DRIVERS AND DRIVER SETS, SOCKETS AND SOCKET SETS, STUD REMOVERS AND INSERTION EXTRACTION TOOLS, FILES AND FILE SETS, FILLER ADAPTERS, TIMING TOOLS, CLUTCH CENTERING TOOLS, TIE ROD AND BALL JOINT PULLERS, RADIO REMOVAL TOOLS, ADJUSTMENT GAUGES, HINGE/HANDLE TOOLS, BITS, CAMSHAFT RULERS, CAMSHAFT ALIGNMENT TOOLS, KEYS, BELT INSTALL TOOLS, CHAIN ADJUSTERS, SUPPORT GUIDES, SPREADERS, LOCKING FIXTURES, LOCKING PINS, COIL PACK PULLERS, TENSIONER HOLDERS, SPROCKET HOLDERS, PULLY HOLDERS, FILLERS AND FUNNELS, FLUID FILL CONTAINERS, SPROCKET TURNERS, LINE DISCONNECTORS, TANK ADAPTERS, WEDGE SETS, PLIERS, IGNITION LOCK REMOVAL TOOLS, CYLINDER HEAD SOCKETS, REAMERS, WIRE TERMINAL EXTRACTORS, CRANKSHAFT STOPS, CAM LOCK CLAMPS, AND VALVE SPRING DEPRESSORS (U.S. CLS. 23, 28 AND 44).

FIRST USE 7-0-1979; IN COMMERCE 7-0-1979.

MICHAEL KEATING, EXAMINING ATTORNEY

SN 77-289,115. BDA INDUSTRIES LLC, PALM BEACH GARDENS, FL. FILED 9-26-2007.

LADY INFINITY

THE MARK CONSISTS OF STANDARD CHARACTERS WITHOUT CLAIM TO ANY PARTICULAR FONT, STYLE, SIZE, OR COLOR.

OWNER OF U.S. REG. NO. 3,109,635.

NO CLAIM IS MADE TO THE EXCLUSIVE RIGHT TO USE "LADY", APART FROM THE MARK AS SHOWN.

FOR ELECTRIC RAZORS, NON-ELECTRIC RAZORS, RAZOR BLADES, AND RAZOR CASES (U.S. CLS. 23, 28 AND 44).

SUNG IN, EXAMINING ATTORNEY

CLASS 8—(Continued).

SN 79-101,772. AB GENSE, SE-631 80 ESKILSTUNA, SWEDEN, FILED 8-16-2011.

DOROTEA

THE MARK CONSISTS OF STANDARD CHARACTERS WITHOUT CLAIM TO ANY PARTICULAR FONT, STYLE, SIZE, OR COLOR.

PRIORITY DATE OF 2-16-2011 IS CLAIMED.

OWNER OF INTERNATIONAL REGISTRATION 1088613 DATED 8-16-2011, EXPIRES 8-16-2021.

FOR CUTLERY (U.S. CLS. 23, 28 AND 44).

ANNE FARRELL, EXAMINING ATTORNEY

SN 79-106,336. LIGHT MY FIRE SWEDEN AB, SWEDEN, FILED 5-17-2011.

LIGHT MY FIRE

THE MARK CONSISTS OF STANDARD CHARACTERS WITHOUT CLAIM TO ANY PARTICULAR FONT, STYLE, SIZE, OR COLOR.

OWNER OF INTERNATIONAL REGISTRATION 0929928 DATED 1-15-2007, EXPIRES 1-15-2017.

OWNER OF U.S. REG. NO. 2,876,989.

FOR HAND TOOLS FOR CUTTING AND FOR STARTING FIRES, NAMELY, UTILITY KNIVES, KNIFE SHEATHS, AND FIRE IGNITERS ALL SOLD TOGETHER AS A UNIT (U.S. CLS. 23, 28 AND 44).

WILLIAM ROSSMAN, EXAMINING ATTORNEY

SN 79-106,737. ZHEJIANG VOLCANO MACHINERY CO., LTD., CHINA, FILED 11-24-2011.



OWNER OF INTERNATIONAL REGISTRATION 1100604 DATED 11-24-2011, EXPIRES 11-24-2021.

THE MARK CONSISTS OF THE WORDING "FOAMMATE" WITH THE LETTER "F" IN THE SHAPE OF A GUN WITH BUBBLES EXTENDING FROM THE END OF THE GUN.

FOR GUNS, NAMELY, CAULKING GUNS, MANUALLY-OPERATED GREASE GUNS; GUNS, HAND-OPERATED, FOR THE EXTRUSION OF MASTICS; HAND TOOLS, NAMELY, RIVETERS; HAND TOOLS FOR DECANTING LIQUIDS, NOT FOR HOUSEHOLD USE; HAND-OPERATED CUTTING TOOLS; TOOL BELTS; HAND TOOLS, NAMELY, SPATULAS; SCREWDRIVERS; HAND-OPERATED SCRAPING TOOLS (U.S. CLS. 23, 28 AND 44).

DAVID HOFFMAN, EXAMINING ATTORNEY

CLASS 8—(Continued).

SN 85-186,745. MODERNICA, INC., LOS ANGELES, CA.
FILED 11-29-2010.

GEORGE NELSON

THE MARK CONSISTS OF STANDARD CHARACTERS WITHOUT CLAIM TO ANY PARTICULAR FONT, STYLE, SIZE, OR COLOR.

OWNER OF U.S. REG. NO. 3,733,895.

THE NAME(S), PORTRAIT(S), AND/OR SIGNATURE(S) SHOWN IN THE MARK DOES NOT IDENTIFY A PARTICULAR LIVING INDIVIDUAL.

FOR FIREPLACE TONGS; FIRE IRONS; FIREPLACE POKERS; FIREPLACE SHOVELS; FIREPLACE TOOL SETS CONSISTING OF A SHOVEL, GRATE, POKER, FIRE SCREEN AND FIRE LIGHTER, ALL SOLD TOGETHER AS A UNIT (U.S. CLS. 23, 28 AND 44).
BARBARA A. GOLD, EXAMINING ATTORNEY

SN 85-305,385. AT BOX TECHNOLOGY INC., IRVINE, CA.
FILED 4-26-2011.

SmartPliers

THE MARK CONSISTS OF STANDARD CHARACTERS WITHOUT CLAIM TO ANY PARTICULAR FONT, STYLE, SIZE, OR COLOR.

FOR MULTI-PURPOSE PLIERS FOR REMOVING STUCK SCREWS, CUTTING WIRES AND TWISTING (U.S. CLS. 23, 28 AND 44).

TOBY BULLOFF, EXAMINING ATTORNEY

SN 85-324,317. EA VENTURE GROUP, LLC, WESTPORT, CT.
FILED 5-18-2011.

ELEPHANT SPROUTS

THE MARK CONSISTS OF STANDARD CHARACTERS WITHOUT CLAIM TO ANY PARTICULAR FONT, STYLE, SIZE, OR COLOR.

FOR GARDENING SHEARS AND SCISSORS; GARDENING TOOLS, NAMELY, A MANUALLY OPERATED TOOL FOR INJECTING SOLID FERTILIZER SPIKES INTO THE SOIL; GARDENING TOOLS, NAMELY, HAND-OPERATED HANDHELD SHOVELS, TROWELS, FORKS, SPADES, AND HOES; GARDENING TROWELS (U.S. CLS. 23, 28 AND 44).

TRACY CROSS, EXAMINING ATTORNEY

CLASS 8—(Continued).

SN 85-365,587. NORTHWEST PLASTICS, INC., REDDING, CA. FILED 7-7-2011.

BOLT-RITE

THE MARK CONSISTS OF STANDARD CHARACTERS WITHOUT CLAIM TO ANY PARTICULAR FONT, STYLE, SIZE, OR COLOR.

FOR HAND OPERATED FOUNDATION BOLT PLACEMENT TOOLS (U.S. CLS. 23, 28 AND 44).

FIRST USE 1-1-2004; IN COMMERCE 1-1-2004.

STEVEN JACKSON, EXAMINING ATTORNEY

SN 85-400,265. FROST CUTLERY COMPANY LLC, OOLTEWAH, TN. FILED 8-17-2011.

BAREFOOT CUTLERY

THE MARK CONSISTS OF STANDARD CHARACTERS WITHOUT CLAIM TO ANY PARTICULAR FONT, STYLE, SIZE, OR COLOR.

NO CLAIM IS MADE TO THE EXCLUSIVE RIGHT TO USE "CUTLERY", APART FROM THE MARK AS SHOWN.

FOR CUTLERY, NAMELY, POCKET KNIVES, BOOT KNIVES, HUNTING KNIVES AND COLLECTOR'S KNIVES (U.S. CLS. 23, 28 AND 44).

MATTHEW KLINE, EXAMINING ATTORNEY

SN 85-520,884. NEPTUNE TRADING INC., ONTARIO, CA.
FILED 1-20-2012.

Neptune Trading

THE MARK CONSISTS OF STANDARD CHARACTERS WITHOUT CLAIM TO ANY PARTICULAR FONT, STYLE, SIZE, OR COLOR.

NO CLAIM IS MADE TO THE EXCLUSIVE RIGHT TO USE "TRADING", APART FROM THE MARK AS SHOWN.

FOR DAGGERS; DIVING KNIVES; FISHING KNIVES; FIXED BLADE KNIVES; FOLDING KNIVES; HOUSEHOLD KNIVES; HUNTING KNIVES; JACK KNIVES; JAPANESE CHOPPING KITCHEN KNIVES; JAPANESE SWORDS; KNIVES; KNIVES FOR HOBBY USE; LEATHER SHEATHS FOR KNIVES; PARING KNIVES; PEN KNIVES; POCKET KNIVES; POLICE BATONS; SABRES; SCALING KNIVES; SIDE ARMS, NOT INCLUDING FIREARMS, NAMELY, HUNTING KNIVES; SIDE ARMS, NOT INCLUDING FIREARMS, NAMELY, SWORDS; SPORT KNIVES; SWORD CANES; SWORDS; THROWING KNIVES; UTILITY KNIVES (U.S. CLS. 23, 28 AND 44).

FIRST USE 1-9-2002; IN COMMERCE 1-9-2002.

ADA HAN, EXAMINING ATTORNEY

CLASS 8—(Continued).

SN 85-533,807. ZERMENO KNIVES LLC, HOUSTON, TX. FILED 2-3-2012.

Seraph

THE MARK CONSISTS OF STANDARD CHARACTERS WITHOUT CLAIM TO ANY PARTICULAR FONT, STYLE, SIZE, OR COLOR.
FOR FIXED BLADE KNIVES; FOLDING KNIVES (U.S. CLS. 23, 28 AND 44).
FIRST USE 11-17-2011; IN COMMERCE 1-20-2012.
KATHY DE JONGE, EXAMINING ATTORNEY

SN 85-535,460. EASY STRIKE CO., LTD., LONG-CHING, TAICHUNG, TAIWAN, FILED 2-7-2012.

CrossStrike

THE MARK CONSISTS OF STANDARD CHARACTERS WITHOUT CLAIM TO ANY PARTICULAR FONT, STYLE, SIZE, OR COLOR.
FOR HAMMERS; SLEDGEHAMMERS; NAIL PULLER BARS; AXES; MATTOCKS; MAULS; NAIL PULLERS (U.S. CLS. 23, 28 AND 44).
FIRST USE 12-5-2011; IN COMMERCE 1-30-2012.
GRETTA YAO, EXAMINING ATTORNEY

SN 85-535,983. OMEGA TECHNOLOGIES, INC., WESTLAKE VILLAGE, CA. FILED 2-7-2012.

SAVI

THE MARK CONSISTS OF STANDARD CHARACTERS WITHOUT CLAIM TO ANY PARTICULAR FONT, STYLE, SIZE, OR COLOR.
FOR HAND TOOLS, NAMELY, SOCKET SETS (U.S. CLS. 23, 28 AND 44).
FIRST USE 5-1-2010; IN COMMERCE 5-1-2010.
JORDAN BAKER, EXAMINING ATTORNEY

CLASS 8—(Continued).

SN 85-536,766. SOUTH STREET, INC., DBA SNOW & NEALLEY COMPANY, UNIVERSITY PARK, FL. FILED 2-8-2012.

SNOW & NEALLEY

THE MARK CONSISTS OF STANDARD CHARACTERS WITHOUT CLAIM TO ANY PARTICULAR FONT, STYLE, SIZE, OR COLOR.
FOR AXES; HAND TOOLS, NAMELY, MAULS (U.S. CLS. 23, 28 AND 44).
FIRST USE 1-1-1864; IN COMMERCE 1-1-1864.
ALICIA COLLINS, EXAMINING ATTORNEY

SN 85-536,771. SOUTH STREET, INC., DBA SNOW & NEALLEY COMPANY, UNIVERSITY PARK, FL. FILED 2-8-2012.

OURBEST

THE MARK CONSISTS OF STANDARD CHARACTERS WITHOUT CLAIM TO ANY PARTICULAR FONT, STYLE, SIZE, OR COLOR.
FOR AXES; HAND TOOLS, NAMELY, MAULS (U.S. CLS. 23, 28 AND 44).
FIRST USE 1-1-1952; IN COMMERCE 1-1-1952.
ALICIA COLLINS, EXAMINING ATTORNEY

SN 85-537,029. THE GILLETTE COMPANY, BOSTON, MA. FILED 2-8-2012.



THE MARK CONSISTS OF A STYLIZED LETTER "V" ENCLOSED IN A CIRCLE DESIGN.
FOR RAZORS AND RAZOR BLADES; DISPENSERS, CASSETTES, HOLDERS, AND CARTRIDGES ALL SPECIFICALLY DESIGNED FOR AND CONTAINING RAZOR BLADES, AND STRUCTURAL PARTS THEREFOR (U.S. CLS. 23, 28 AND 44).
C. DIONNE CLYBURN, EXAMINING ATTORNEY

CLASS 8—(Continued).

SN 85-537,684. THE HANGER'S EDGE LLC, LIBERTY, MO.
FILED 2-8-2012.

Hanger's Edge

THE MARK CONSISTS OF STANDARD CHARACTERS WITHOUT CLAIM TO ANY PARTICULAR FONT, STYLE, SIZE, OR COLOR.

FOR HAND TOOLS, NAMELY, CLAMPS (U.S. CLS. 23, 28 AND 44).

LESLIE RICHARDS, EXAMINING ATTORNEY

SN 85-538,394. SUKOTTO PRODUCTS, INC., HALLANDALE, FL. FILED 2-9-2012.

SUKOTTO

THE MARK CONSISTS OF STANDARD CHARACTERS WITHOUT CLAIM TO ANY PARTICULAR FONT, STYLE, SIZE, OR COLOR.

FOR BAGS AND CASES SPECIALLY ADAPTED FOR HOLDING OR CARRYING HAIR CUTTING SCISSORS AND SHEARS; ELECTRIC HAIR CURLING IRONS; ELECTRIC HAIR STRAIGHTENING IRONS; ELECTRIC IRONS FOR STYLING HAIR; HAIR CUTTING SCISSORS; RAZOR CASES; RAZORS; SCISSORS (U.S. CLS. 23, 28 AND 44).

FIRST USE 3-1-2007; IN COMMERCE 4-1-2007.
ANDREA HACK, EXAMINING ATTORNEY

SN 85-538,662. UNIVERSAL RAZOR INDUSTRIES, LLC, LOS ANGELES, CA. FILED 2-9-2012.

SONAR III

THE MARK CONSISTS OF STANDARD CHARACTERS WITHOUT CLAIM TO ANY PARTICULAR FONT, STYLE, SIZE, OR COLOR.

FOR RAZORS (U.S. CLS. 23, 28 AND 44).
STEPHANIE ALI, EXAMINING ATTORNEY

CLASS 9—ELECTRICAL AND SCIENTIFIC APPARATUS

SN 76-707,818. SMARTDOOR HOLDINGS, INC., FALLS CHURCH, VA. FILED 6-1-2011.

SDS-0400IP

THE MARK CONSISTS OF STANDARD CHARACTERS WITHOUT CLAIM TO ANY PARTICULAR FONT, STYLE, SIZE, OR COLOR.

FOR CONTROLLERS FOR PORTALS, NAMELY, ELECTRONIC CONTROLLERS FOR CONTROLLING INGRESS AND EGRESS TO AN ACCESS CONTROLLER AREA SUCH AS A PARKING GARAGE FACILITY BY OPERATING DOOR BARRIERS AND PARKING BARRIERS IN RESPONSE TO INPUT FROM ACCESS IDENTIFICATION EQUIPMENT; DOOR CONTROLLERS, NAMELY, DOOR CONTROLLERS FOR CONTROLLING INGRESS AND EGRESS TO AN ACCESS CONTROLLER AREA SUCH AS A PARKING GARAGE FACILITY BY OPERATING DOOR BARRIERS AND PARKING BARRIERS IN RESPONSE TO INPUT FROM ACCESS IDENTIFICATION EQUIPMENT (U.S. CLS. 21, 23, 26, 36 AND 38).

EUGENIA MARTIN, EXAMINING ATTORNEY

SN 76-709,624. KLH INTERNATIONAL, L.L.C., BROOKLYN, NY. FILED 11-2-2011.

SOUNDBITES

THE MARK CONSISTS OF STANDARD CHARACTERS WITHOUT CLAIM TO ANY PARTICULAR FONT, STYLE, SIZE, OR COLOR.

FOR AUDIO SPEAKERS, AUDIO HEADPHONES, AUDIO-VIDEO CABLES (U.S. CLS. 21, 23, 26, 36 AND 38).
DAVID C. REIHNER, EXAMINING ATTORNEY

SN 76-710,254. SPORTSATIONALS, LLC, CHADDS FORD, PA. FILED 1-12-2012.

Sportsationals

THE MARK CONSISTS OF STANDARD CHARACTERS WITHOUT CLAIM TO ANY PARTICULAR FONT, STYLE, SIZE, OR COLOR.

FOR AUDIO AND VIDEO RECORDINGS IN COMPACT DISC (CD) AND DIGITAL VERSATILE DISC (DVD) FORMATS FEATURING ENTERTAINMENT AND EDUCATIONAL INFORMATION DIRECTED AT CHILDREN AND THEIR FAMILIES ABOUT LEARNING SKILLS, HEALTHFUL LIVING AND STAYING ACTIVE THROUGH INVOLVEMENT IN SPORTS (U.S. CLS. 21, 23, 26, 36 AND 38).

KATINA MISTER, EXAMINING ATTORNEY

CLASS 9—(Continued).

SN 77-705,548. LG ELECTRONICS INC., SEOUL, REPUBLIC OF KOREA, FILED 4-2-2009.



PRIORITY CLAIMED UNDER SEC. 44(D) ON REPUBLIC OF KOREA APPLICATION NO. 40-2009-0011, FILED 3-11-2009.

OWNER OF ERPN CMNTY TM OFC REG. NO. 008539868, DATED 3-8-2010, EXPIRES 9-10-2019.

NO CLAIM IS MADE TO THE EXCLUSIVE RIGHT TO USE "FULL HD 1080P", APART FROM THE MARK AS SHOWN.

FOR TELEVISION RECEIVERS (U.S. CLS. 21, 23, 26, 36 AND 38).

JANICE L. MCMORROW, EXAMINING ATTORNEY

CLASS 9—(Continued).

SN 77-909,032. BRIGHT IDEAS, INC, AGOURA HILLS, CA. FILED 1-11-2010.

Accessory Power Powerup

THE MARK CONSISTS OF STANDARD CHARACTERS WITHOUT CLAIM TO ANY PARTICULAR FONT, STYLE, SIZE, OR COLOR.

OWNER OF U.S. REG. NOS. 3,594,464 AND 3,678,698.

NO CLAIM IS MADE TO THE EXCLUSIVE RIGHT TO USE "ACCESSORY POWER", APART FROM THE MARK AS SHOWN.

FOR BATTERY CHARGER (U.S. CLS. 21, 23, 26, 36 AND 38).

FIRST USE 1-1-2005; IN COMMERCE 1-1-2005.

MARIA-VICTORIA SUAREZ, EXAMINING ATTORNEY

SN 77-839,106. LG ELECTRONICS INC., SEOUL, REPUBLIC OF KOREA, FILED 10-1-2009.

Image booster

THE MARK CONSISTS OF STANDARD CHARACTERS WITHOUT CLAIM TO ANY PARTICULAR FONT, STYLE, SIZE, OR COLOR.

OWNER OF ERPN CMNTY TM OFC REG. NO. 008595647, DATED 3-29-2010, EXPIRES 10-6-2019.

NO CLAIM IS MADE TO THE EXCLUSIVE RIGHT TO USE "IMAGE", APART FROM THE MARK AS SHOWN.

FOR COMPUTER MONITORS (U.S. CLS. 21, 23, 26, 36 AND 38).

TAMARA FRAZIER, EXAMINING ATTORNEY

SN 78-524,787. KINETEKS CORPORATION, VANCOUVER, BRITISH COLUMBIA, CANADA, FILED 11-30-2004.

KINETEKS

THE MARK CONSISTS OF STANDARD CHARACTERS WITHOUT CLAIM TO ANY PARTICULAR FONT, STYLE, SIZE, OR COLOR.

PRIORITY CLAIMED UNDER SEC. 44(D) ON CANADA APPLICATION NO. 1230523, FILED 9-16-2004, REG. NO. 820875, DATED 3-28-2012, EXPIRES 3-28-2027.

FOR ELECTRONIC MEASURING APPARATUSES AND INSTRUMENTS, NAMELY, MULTIFUNCTIONAL SENSORS, WIRELESS COMMUNICATION SYSTEMS COMPRISING WIRELESS TRANSMITTERS, WIRELESS RECEIVERS AND COMPUTER SOFTWARE FOR USE THEREWITH AND COMPUTERS FOR IN SITU USE TO MEASURE PRESSURE, TORQUE, POSITION AND TIME AND ANALYZE SUCH DATA; ELECTRONIC NAVIGATION SYSTEM AND APPARATUS, NAMELY, SATELLITE NAVIGATIONAL SYSTEM, NAMELY, A GLOBAL POSITIONING SYSTEM FOR PERSONAL POSITION MEASUREMENT AND LOGGING; COMPUTER SOFTWARE FOR REAL TIME ANALYSIS OF SENSORY DATA TO PROVIDE WEIGHT TRANSFER ANALYSIS, SPEED AND ACCELERATION CALCULATIONS, CALORIC BURN CALCULATIONS, WORKOUT PROFILING, TRAJECTORY CALCULATIONS, RECOMMENDATIONS

SN 77-907,860. LG ELECTRONICS INC., SEOUL, REPUBLIC OF KOREA, FILED 1-8-2010.

PWiz

THE MARK CONSISTS OF STANDARD CHARACTERS WITHOUT CLAIM TO ANY PARTICULAR FONT, STYLE, SIZE, OR COLOR.

PRIORITY CLAIMED UNDER SEC. 44(D) ON REPUBLIC OF KOREA APPLICATION NO. 40-2009-0060, FILED 12-8-2009, REG. NO. 0872168, DATED 7-11-2011, EXPIRES 7-11-2021.

FOR TELEVISION RECEIVERS; ENCODED ELECTRONIC CHIP CARDS FOR TV IMAGE IMPROVEMENT (U.S. CLS. 21, 23, 26, 36 AND 38).

JESSICA FATHY, EXAMINING ATTORNEY

CLASS 9—(Continued).

FOR MOVEMENT AND GAIT ALTERATIONS FOR OPTIMAL PERFORMANCE INJURY AND/OR RISK ASSESSMENTS, ORTHOTICS ASSESSMENT AND 3-D MODELING; IN SITU SENSORS TO PROVIDE MOVEMENT AND GAIT ANALYSIS COMPRISING FORCE PRESSURE SHOE INLAY SENSORS, VIDEO CAMERAS, SATELLITE NAVIGATIONAL SYSTEM, NAMELY, A GLOBAL POSITIONING SYSTEM, WIRELESS COMMUNICATION SYSTEMS COMPRISING WIRELESS TRANSMITTERS, WIRELESS RECEIVERS AND COMPUTER SOFTWARE FOR USE THEREWITH AND ACCELEROMETERS; ELECTRONIC MOVEMENT AND GAIT PERFORMANCE TESTING MACHINES IN THE NATURE OF FORCE AND/OR PRESSURE INLAY MONITORS, VIDEO CAMERAS, WIRELESS COMMUNICATION SYSTEMS COMPRISING WIRELESS TRANSMITTERS, WIRELESS RECEIVERS AND COMPUTER SOFTWARE FOR USE THEREWITH, SATELLITE NAVIGATIONAL SYSTEM, NAMELY, A GLOBAL POSITIONING SYSTEM, ACCELEROMETERS AND OPERATIONAL SOFTWARE SOLD AS A UNIT THEREOF (U.S. CLS. 21, 23, 26, 36 AND 38).
KAREN SEVERSON, EXAMINING ATTORNEY

SN 78-762,050. ABLE PLANET, INC., WHEAT RIDGE, CO.
FILED 11-28-2005.

CLEAR HARMONY

THE MARK CONSISTS OF STANDARD CHARACTERS WITHOUT CLAIM TO ANY PARTICULAR FONT, STYLE, SIZE, OR COLOR.

FOR TECHNOLOGICAL DEVICES FOR IMPROVING ACOUSTIC CLARITY AND AUDIO TRANSMISSION AND RECEPTION FOR ASSISTING PERSONS WITH SENSORY OR COGNITIVE IMPAIRMENTS AND TO PRESERVE HEARING LEVELS, NAMELY, ADAPTED STEREO HEADPHONES, ADAPTED TELEPHONES, ADAPTED HANDS-FREE CORDLESS TELEPHONE UNITS, AND ADAPTED COMPUTER-TELEPHONE, CELLULAR TELEPHONE AND VOICE OVER INTERNET PROTOCOL TELEPHONE HEADSET UNITS; ELECTRONIC DEVICES FOR ASSISTING PERSONS WITH SENSORY OR COGNITIVE IMPAIRMENTS, NAMELY, STEREO AUDIO AMPLIFICATION UNITS, AND RADIO AUDIO AMPLIFICATION UNITS; ELECTRONIC UNITS FOR MINIMIZING OR ELIMINATING ELECTROMAGNETIC AUDIO INTERFERENCES; VOICE OVER INTERNET PROTOCOL TELEPHONES, AND EMERGENCY TELEPHONES, ALL ADAPTED FOR ASSISTING PERSONS WITH SENSORY OR COGNITIVE IMPAIRMENTS, AND TO PRESERVE HEARING LEVELS (U.S. CLS. 21, 23, 26, 36 AND 38).
MYRIAH HABEIB, EXAMINING ATTORNEY

CLASS 9—(Continued).

SN 79-093,158. GUANGZHOU SHANGKE INFORMATION TECHNOLOGY CO., LTD, TIANHE DISTRICT, GUANGZHOU, CHINA, FILED 8-13-2010.

TECLAST

THE MARK CONSISTS OF STANDARD CHARACTERS WITHOUT CLAIM TO ANY PARTICULAR FONT, STYLE, SIZE, OR COLOR.

PRIORITY DATE OF 5-31-2010 IS CLAIMED.

OWNER OF INTERNATIONAL REGISTRATION 1066696 DATED 8-13-2010, EXPIRES 8-13-2020.

FOR DATA PROCESSING APPARATUS; COMPUTER MEMORIES; COMPUTERS; COMPUTER KEYBOARDS; COMPUTER PERIPHERAL DEVICES; COMPUTER SOFTWARE RECORDED ON DATA MEDIA, NAMELY, WORD PROCESSING PROGRAM, THE EMBEDDED SOFTWARE FOR CONSUMER ELECTRONICS AND OTHER PROGRAMS USED IN CARTOON INDUSTRY; ELECTRIC AND FIBER OPTIC COUPLINGS FOR DATA PROCESSING EQUIPMENT; ELECTRONIC PENS FOR VISUAL DISPLAY UNITS USE; COMPUTER MICE; BLANK OPTICAL DISCS; DISK DRIVES FOR COMPUTERS; ELECTRONIC POCKET TRANSLATORS; BLANK SMART CARDS; NOTEBOOK COMPUTERS; COMPUTER GAME PROGRAMS; ELECTRONIC BOOK READERS; MULTILINGUAL ELECTRONIC HAND-HELD TRANSLATORS; REMOVABLE MEMORY DISKS; DIGITAL PHOTO FRAMES FOR DISPLAYING DIGITAL PICTURES, VIDEO CLIPS AND MUSIC; DICTATING MACHINES; VIDEO TELEPHONES; PORTABLE TELEPHONES; ELECTRIC NAVIGATIONAL INSTRUMENTS; WALKIE-TALKIES; TAPE RECORDERS; CABINETS FOR LOUDSPEAKERS; SOUND RECORDING APPARATUS; RECORD PLAYERS; RADIOS; MICROPHONES; TELEVISIONS; AMUSEMENT MACHINES, NAMELY, HAND-HELD ELECTRONIC GAMES UNITS ADAPTED FOR USE WITH AN EXTERNAL DISPLAY SCREEN OR MONITOR; HORNS FOR LOUDSPEAKERS; AMUSEMENT APPARATUS ADAPTED FOR USE WITH AN EXTERNAL DISPLAY SCREEN OR MONITOR; CAMERAS; HEADPHONES; DVD PLAYERS; EARPHONES; ELECTRONIC SOUNDING BOOKS; DIGITAL AUDIO AND VIDEO PLAYER; PHOTOGRAPHIC CAMERAS; SLIDE PROJECTORS; PROJECTION SCREENS; SLIDE OR PHOTOGRAPH PROJECTION APPARATUS; CAMERAS FOR COMPUTER USE; CHARGERS FOR ELECTRIC BATTERIES; BATTERIES; PHOTOGRAPHIC PHOTOCOPIERS, ELECTROSTATIC PHOTOCOPIERS, THERMIC PHOTOCOPIERS; INTEGRATED CIRCUITS, INTEGRATED CIRCUIT CHIPS AND INTEGRATED CIRCUIT MODULES FOR ENCODING AND DECODING DIGITAL VIDEO; FLUORESCENT SCREENS; REMOTE CONTROLS FOR CONSUMER ELECTRONIC PRODUCTS, NAMELY, FOR AUDIO AMPLIFIERS, AUDIO SPEAKERS, AUDIO RECEIVERS, ELECTRICAL AUDIO AND SPEAKER CABLES AND CONNECTORS, AUDIO DECODERS, VIDEO DECODERS, SPEAKERS, POWER CONVERSION DEVICES, POWER CONVERTERS, AND POWER INVERTERS; VEHICLE TRACKING DEVICES COMPRISED OF CELLULAR RADIO MODULES, COMPUTER SOFTWARE AND COMPUTER HARDWARE, SENSORS, TRANSMITTERS, RECEIVERS AND GLOBAL POSITIONING SATELLITE RECEIVERS, ALL FOR USE IN CONNECTION WITH VEHICLE TRACKING, VEHICLE MONITORING AND ANTI-THEFT VEHICLE ALARMS; ELECTRONIC AGENDAS; ELECTRONIC NOTICE BOARDS; ELECTRICITY INDUCTORS (U.S. CLS. 21, 23, 26, 36 AND 38).
KELLEY WELLS, EXAMINING ATTORNEY

CLASS 9—(Continued).

SN 79-101,386. SHIN, HYUNG KYUN, REPUBLIC OF KOREA, FILED 7-1-2011.



PRIORITY DATE OF 6-20-2011 IS CLAIMED.
OWNER OF INTERNATIONAL REGISTRATION 1087600 DATED 7-1-2011, EXPIRES 7-1-2021.

THE COLOR(S) RED, BLUE, WHITE AND GREY IS/ARE CLAIMED AS A FEATURE OF THE MARK.

THE MARK CONSISTS OF A SMALL RED SQUARE IS ON THE OUTER LEFT TOPSIDE OF A BLUE OVAL INCLINED TO THE RIGHT, LETTERS OF "DA" SLIGHTLY INCLINED TOWARD THE RIGHT INSIDE THE OVAL ARE IN WHITE, AND RIGHT BEHIND THE OVAL, LETTERS OF "CELL" IN THE SAME FONT AS "DA" ARE IN GREY.

FOR LOAD CELLS, NAMELY, TRANSDUCERS FOR CONVERTING FORCE OR WEIGHT INTO ELECTRICAL SIGNALS; MATERIAL TESTING INSTRUMENTS AND MACHINES, NAMELY, APPARATUSES TO TEST THE STRENGTH OF MATERIALS SUCH AS CEMENT, GLASS, PLASTIC, AND METAL; COMPRESSION TESTING APPARATUS; SCALES; REVOLUTION SPEED INDICATORS; ACCELEROMETERS; STRAIN GAUGES; POWER TRANSFORMERS FOR AMPLIFICATION; POWER AMPLIFIERS; AMPLIFIERS; AMPLIFYING TUBES; INDICATORS, NAMELY, APPARATUSES FOR DIGITALLY INDICATING OUTPUT VALUES OR ELECTRICAL SIGNALS RECEIVED FROM LOAD CELLS OR OTHER EQUIPMENT THAT MEASURES FORCE OR WEIGHT; RECORDED COMPUTER PROGRAMS, NAMELY, SOFTWARE FOR OPERATING MEASUREMENT MACHINES SUCH AS LOAD CELLS OR MATERIALS TESTING INSTRUMENTS THAT TEST THE STRENGTH OF MATERIALS; TORQUE METER (U.S. CLS. 21, 23, 26, 36 AND 38).

REBECCA POVARCHUK, EXAMINING ATTORNEY

CLASS 9—(Continued).

SN 79-101,869. C.E.I.A. - COSTRUZIONI ELETTRONICHE INDUSTRIALI AUTOMATISMI S.P.A., ITALY, FILED 7-5-2011.

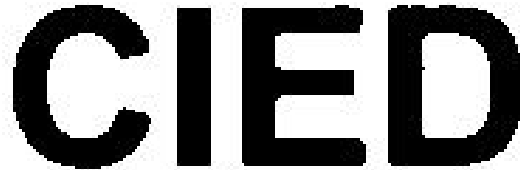

THE MARK CONSISTS OF STANDARD CHARACTERS WITHOUT CLAIM TO ANY PARTICULAR FONT, STYLE, SIZE, OR COLOR.

PRIORITY DATE OF 1-28-2011 IS CLAIMED.
OWNER OF INTERNATIONAL REGISTRATION 1088865 DATED 7-5-2011, EXPIRES 7-5-2021.

FOR ELECTROMAGNETIC DETECTORS FOR INDUSTRIAL AND SECURITY INSPECTION (U.S. CLS. 21, 23, 26, 36 AND 38).

NATALIE POLZER, EXAMINING ATTORNEY

SN 79-102,033. BARCO N.V., B-8500 KORTRIJK, BELGIUM, FILED 7-15-2011.



THE MARK CONSISTS OF STANDARD CHARACTERS WITHOUT CLAIM TO ANY PARTICULAR FONT, STYLE, SIZE, OR COLOR.

PRIORITY DATE OF 4-6-2011 IS CLAIMED.
OWNER OF INTERNATIONAL REGISTRATION 1089294 DATED 7-15-2011, EXPIRES 7-15-2021.

FOR MEDICAL WORKSTATION COMPRISED OF COMPUTER HARDWARE AND SOFTWARE FOR GATHERING AND TRANSMITTING PATIENT IMAGE DATA FOR USE DURING SURGICAL PROCEDURES, MORE SPECIFICALLY, COMPUTER HARDWARE COMPONENTS, NAMELY, ENCODERS, DECODERS, AND DISPLAYS, AND SOFTWARE, ALL FOR VISUALIZATION OF MEDICAL VIDEO AND DATA IN A NETWORKED SURGICAL OPERATING ROOM ENVIRONMENT, WITH SIGNALS THAT ENCODE FOR DISTRIBUTION VIA EXISTING NETWORKS AND DECODE ON THE LOCATION AND/OR DISPLAYS WHERE THEY SHOULD BE SHOWN, MORE SPECIFICALLY FOR THE TRANSMISSION OF MEDICAL VIDEO AND DATA BETWEEN TWO POINTS (U.S. CLS. 21, 23, 26, 36 AND 38).

MARLENE BELL, EXAMINING ATTORNEY

SN 79-101,728. COLLECTE LOCALISATION SATELLITES, F-31520 RAMONVILLE SAINT AGNE, FRANCE, FILED 7-8-2011.



THE MARK CONSISTS OF STANDARD CHARACTERS WITHOUT CLAIM TO ANY PARTICULAR FONT, STYLE, SIZE, OR COLOR.

PRIORITY DATE OF 1-10-2011 IS CLAIMED.
OWNER OF INTERNATIONAL REGISTRATION 1088479 DATED 7-8-2011, EXPIRES 7-8-2021.

FOR COMPUTER SOFTWARE FOR RECEIVING AND PROCESSING DATA IN CONNECTION WITH OBSERVING LAND, SEAS AND OCEANS; COMPUTER SOFTWARE FOR RECEIVING AND PROCESSING DATA IN CONNECTION WITH FISHING, OCEANOGRAPHY, MONITORING SEAS AND OCEANS, MARITIME SAFETY, MARITIME SEARCH AND RESCUE (U.S. CLS. 21, 23, 26, 36 AND 38).

JACLYN KIDWELL WALKER, EXAMINING ATTORNEY

CLASS 9—(Continued).

SN 79-102,357. FISCHER CONNECTORS HOLDING S.A., SWITZERLAND, FILED 8-3-2011.

Fischer MiniMax

THE MARK CONSISTS OF STANDARD CHARACTERS WITHOUT CLAIM TO ANY PARTICULAR FONT, STYLE, SIZE, OR COLOR.

PRIORITY DATE OF 7-21-2011 IS CLAIMED.

OWNER OF INTERNATIONAL REGISTRATION 1090183 DATED 8-3-2011, EXPIRES 8-3-2021.

OWNER OF U.S. REG. NOS. 1,732,667, 2,749,222 AND OTHERS.

FOR CONNECTORS AND COMPONENT PARTS, PARTICULARLY CONNECTORS FOR ELECTRIC AND ELECTRONIC INSTRUMENTS AND APPARATUS, NAMELY, ELECTRICAL CONNECTORS, ELECTRIC CABLES, ELECTRIC CONTACTS, PROTECTORS FOR ELECTRIC CONTACTS, NAMELY, COVERS FOR ELECTRIC CONTACTS, OPTICAL FIBERS, SHEATHS FOR ELECTRIC CABLES; ELECTRIC FLUIDIC CONNECTORS (U.S. CLS. 21, 23, 26, 36 AND 38).

MARY CRAWFORD, EXAMINING ATTORNEY

SN 79-104,745. ANSALDO SISTEMI INDUSTRIALI S.P.A., ITALY, FILED 11-22-2010.

GT 3000

OWNER OF INTERNATIONAL REGISTRATION 0860791 DATED 7-18-2005, EXPIRES 7-18-2015.

THE TRADEMARK CONSISTS IN THE WORD "GT 3000".

FOR ELECTRIC AND ELECTRONIC CHECKING APPARATUS FOR PUMPING SYSTEMS, VENTILATION SYSTEMS, LIFTING APPARATUS, PAPER AND STEEL PRODUCTIONS LINES AND SHIPYARDS; ELECTRIC AND ELECTRONIC APPARATUS FOR SWITCHING, TRANSFORMING, REGULATING ELECTRICITY; ELECTRIC AND ELECTRONIC CONVERTERS; TRANSFORMERS (U.S. CLS. 21, 23, 26, 36 AND 38).

LAURA KOVALSKY, EXAMINING ATTORNEY

SN 79-106,564. NINGBO ULICA; SOLAR SCIENCE & TECHNOLOGY CO., LTD., CHINA, FILED 11-2-2011.



PRIORITY DATE OF 6-16-2011 IS CLAIMED.

OWNER OF INTERNATIONAL REGISTRATION 1100175 DATED 11-2-2011, EXPIRES 11-2-2021.

OWNER OF U.S. REG. NO. 4,097,706.

NO CLAIM IS MADE TO THE EXCLUSIVE RIGHT TO USE "SOLAR", APART FROM THE MARK AS SHOWN.

THE MARK CONSISTS OF THE WORDING "ULICA SOLAR" AND A SUN DESIGN ABOVE THE WORDING "LEADING IN TECHNOLOGY" ON A BROKEN HORIZONTAL LINE.

FOR MONOCRYSTALLINE SILICON WAFERS; POLY-CRYSTALLINE SILICON SOLAR CELLS; BATTERIES FOR LIGHTING; BATTERY CHARGERS; EPITAXIAL WAFERS OF SILICON; CURRENT RECTIFIERS; ELECTRICITY INVERTERS (U.S. CLS. 21, 23, 26, 36 AND 38).

LEIGH LOWRY, EXAMINING ATTORNEY

CLASS 9—(Continued).

SN 79-107,278. HAWO GERÄTEBAU GMBH & CO MASCHINENBAU K.G, 74847 OBRIGHEIM, FED REP GERMANY, FILED 5-30-2011.

SelfSealMatic

THE MARK CONSISTS OF STANDARD CHARACTERS WITHOUT CLAIM TO ANY PARTICULAR FONT, STYLE, SIZE, OR COLOR.

OWNER OF INTERNATIONAL REGISTRATION 1101933 DATED 5-30-2011, EXPIRES 5-30-2021.

FOR SENSORS FOR THE CONTROL OF CONTACT PRESSURE AND PASSING SPEED OF ADHESIVE BONDS AND CONTROL SOFTWARE INTEGRATED IN ELECTRIC SEALING MACHINES FOR SEALING STERILE GOODS PACKAGING (U.S. CLS. 21, 23, 26, 36 AND 38).

ERNEST SHOSHO, EXAMINING ATTORNEY

SN 79-107,578. CHANGZHOU WUJIN HONGGUANG; RADIO CO., LTD, CHINA, FILED 12-9-2011.

HGPOWER

OWNER OF INTERNATIONAL REGISTRATION 1102668 DATED 12-9-2011, EXPIRES 12-9-2021.

THE MARK CONSISTS OF THE TERM "HGPOWER" APPEARING IN A STYLIZED FONT.

THE WORDING "HGPOWER" HAS NO MEANING IN A FOREIGN LANGUAGE.

FOR COMPUTER PERIPHERAL DEVICES; ELECTRIC CONVERTERS; ELECTRONIC CONTROLLERS USED TO REDUCE POWER CONSUMPTION; COMMUTATORS; VOLTAGE STABILIZING POWER SUPPLY; DISTRIBUTION BOXES FOR ELECTRICITY; MATERIALS FOR ELECTRICITY MAINS, NAMELY, WIRES AND CABLES; LOW VOLTAGE DC POWER SUPPLIES (U.S. CLS. 21, 23, 26, 36 AND 38).

SAIMA MAKHDOOM, EXAMINING ATTORNEY

SN 79-107,590. GUANGZHOU TIMETOP; ELECTRONICS TECHNOLOGY CO.,LTD, CHINA, FILED 12-13-2011.



OWNER OF INTERNATIONAL REGISTRATION 1102697 DATED 12-13-2011, EXPIRES 12-13-2021.

THE MARK CONSISTS OF THE TERM "TIMETOP" WITH A CONTRASTING CURVED-EDGE SQUARE BEHIND THE FIRST "T", AN OVAL-SHAPED DOT OVER THE "I" AND A SHADED CENTER IN THE LETTER "O".

FOR CAMERAS; CINEMATOGRAPHIC CAMERAS; AUDIOVISUAL TEACHING APPARATUS, NAMELY, AUDIO-VISUAL RECEIVERS, MULTIMEDIA PROJECTORS, FLAT PANEL DISPLAY SCREENS; EYEGASSES; GALVANIC BATTERIES; VIDEO DISKS AND VIDEO TAPES WITH RECORDED ANIMATED CARTOONS; COMPUTER MEMORIES; TELECONTROLLER FOR HOUSE-USE ONLY, NAMELY, REMOTE CONTROLS FOR RADIOS, TELEVISIONS, STEREOS (U.S. CLS. 21, 23, 26, 36 AND 38).

HEATHER THOMPSON, EXAMINING ATTORNEY

CLASS 9—(Continued).

SN 79-108,260. VIMAR S.P.A., ITALY, FILED 10-26-2011.

PLANA

THE MARK CONSISTS OF STANDARD CHARACTERS WITHOUT CLAIM TO ANY PARTICULAR FONT, STYLE, SIZE, OR COLOR.

OWNER OF INTERNATIONAL REGISTRATION 0725163 DATED 8-23-1999, EXPIRES 8-23-2019.

THE ENGLISH TRANSLATION OF "PLANA" IN THE MARK IS "PLANE" OR "FLAT SURFACE".

FOR ELECTRICAL COVER OUTLET PLATES; CONTROL DEVICES TO BE USED IN THE ELECTRIC FIELD, NAMELY, SWITCHES, REVERSING SWITCHES, PUSH BUTTONS AND REMOTE CONTROL SWITCHES; ELECTRIC SWITCH PLATES AND OUTLETS, NAMELY, BLANK COVERS AND CORD OUTLETS; ELECTRIC SOCKET-OUTLETS AND TELEPHONE SOCKET CONNECTORS; SIGNAL ELECTRICAL SOCKET-OUTLETS; TV-ELECTRICAL SOCKET OUTLETS; COAXIAL ELECTRICAL CONNECTORS; ELECTRICAL OPTICAL AND ACOUSTIC SIGNALING EQUIPMENT, NAMELY, EMERGENCY WARNING LIGHTS, ELECTROMECHANICAL, ELECTRONIC AND ELECTRIC CALL, DOOR, WARNING, AND SIGNAL, BELLS, BUZZERS AND CHIMES; ELECTRONIC PROTECTION AND DETECTION EQUIPMENT, NAMELY, CIRCUIT BREAKERS, GAS AND CARBON MONOXIDE DETECTORS, SMOKE DETECTORS, PRESENCE DETECTORS FOR BURGLAR AND ALARM SYSTEMS; ELECTRONIC DIMMERS FOR RESISTIVE AND INDUCTIVE LOADS; ELECTRONIC TIME-DELAY SWITCHES; ELECTRONIC PROGRAMMABLE SWITCHES; ELECTRIC RESISTORS; ELECTRONIC THERMOSTATS; REGULATION ELECTRIC SWITCHES; STEREOPHONIC SOUND SYSTEM EQUIPMENT, NAMELY, SOUND AMPLIFIERS AND SOUND TRANSMITTING APPARATUS; INFRARED CONTROL EQUIPMENT, NAMELY, REMOTE CONTROLS FOR CONTROLLING ENTRY; INFRARED RECEIVERS AND REGULATORS FOR LIGHTS, CURRENT, VOLTAGE, TEMPERATURE; PROGRAMMABLE MAGNETIC CHIP-CARDS; ANTI-BURGLAR EQUIPMENT, NAMELY, ALARMS, CENTRAL CONTROL UNITS, SIRENS, POWER SUPPLIES, DETECTORS, TRANSFORMERS, RECEIVERS, TRANSMITTERS OF ELECTRICAL SIGNALS AND PARTS THEREOF (U.S. CLS. 21, 23, 26, 36 AND 38).

LOURDES AYALA, EXAMINING ATTORNEY

CLASS 9—(Continued).

SN 79-108,501. MULTI-HOLDING AG, SWITZERLAND, FILED 11-21-2011.

MultLink
by Multi-Contact & Shoals

PRIORITY DATE OF 5-27-2011 IS CLAIMED.
OWNER OF INTERNATIONAL REGISTRATION 1105107 DATED 11-21-2011, EXPIRES 11-21-2021.

THE MARK CONSISTS OF THE WORDING "MULTILINK BY MULTI-CONTACT & SHOALS" WITH A STYLIZED SUN DESIGN ABOVE THE SECOND "L" IN "MULTILINK" AND THE WORD "SUN" DEPICTED VERTICALLY WITHIN THE UPPER STEM OF THE SECOND "L" IN "MULTILINK".

FOR ELECTRICAL CONNECTORS; ELECTRIC CONTACTS; ELECTROMECHANICAL AND ELECTRONIC COMPONENTS, NAMELY, SOCKETS FOR ELECTRICAL CONNECTORS; LABORATORY LEADS TO BE USED FOR MAKING ELECTRICAL CONNECTIONS, CONNECTING CABLES, DISCONNECTORS AND DISTRIBUTORS, CROSS-BAR CONNECTORS, CONNECTION WASHERS, SLIDE ISOLATORS, SHORT CIRCUIT BRIDGES, AND MULTICOMPONENT ELECTRICAL PLUG AND SOCKET UNITS, ELECTRICAL CONNECTION BOXES; CABLE CONNECTORS AND ELECTRICAL JUNCTION BOXES FOR PHOTOVOLTAIC SOLAR PANELS (U.S. CLS. 21, 23, 26, 36 AND 38).

TINA L. SNAPP, EXAMINING ATTORNEY

SN 79-108,560. SHENZHEN AONI; ELECTRONIC INDUSTRY CO., CHINA, FILED 11-7-2011.



PRIORITY DATE OF 8-8-2011 IS CLAIMED.
OWNER OF INTERNATIONAL REGISTRATION 1105206 DATED 11-7-2011, EXPIRES 11-7-2021.

THE MARK CONSISTS OF A STYLIZED DESIGN OF THE TOP OF A FROG HEAD WITH TWO-EYES CAST UPWARDS.

FOR COMPUTER PERIPHERAL DEVICES; QUANTITY INDICATORS, NAMELY, AIR QUALITY MEASUREMENT APPARATUS IN THE NATURE OF PARTICLE COUNTERS, INSTRUMENTS FOR MEASURING MILK QUALITY PARAMETERS, ELECTROOPTICAL INSTRUMENTS FOR USE IN INSPECTION AND MEASUREMENT OF INDUSTRIAL COMPONENTS; PHOTOTELEGRAPHY APPARATUS; AUTOMATIC GAUGE, NAMELY, FUEL GAUGES, TIRE PRESSURE GAUGES; MEASURES, NAMELY, TAPE MEASURES, INSTRUMENTS FOR MEASURING LENGTH, LASER MEASURING SYSTEMS, MEASURING GLASSWARE; ELECTRONIC NOTICE BOARDS; TRANSMITTERS OF ELECTRONIC SIGNALS; CABINETS FOR LOUDSPEAKERS; RADIOS; MICROPHONES; VIDEO RECORDERS; HORNS FOR LOUDSPEAKERS; AMUSEMENT APPARATUS ADAPTED FOR USE WITH TELEVISION RECEIVERS ONLY; PERSONAL STEREOs; HEADPHONES; CAMCORDERS; CAMERAS FOR PHOTOGRAPHY; SOUND RECORDING CARRIERS, NAMELY, BLACK MAGNETIC DATA CARRIERS FOR SOUND RECORDINGS, BLANK AUDIO TAPES, BLANK CD-ROMS FOR SOUND OR VIDEO RECORDING; AUDIOVISUAL TEACHING APPARATUS, NAMELY, AUDIOVISUAL RECEIVERS, VISUAL RECORDINGS AND AUDIOVISUAL RECORDINGS FEATURING MUSIC AND ANI-

CLASS 9—(Continued).

MATION, VIDEO AND SOUND PROJECTORS; STEREO-SCOPES; STEREOSCOPIC APPARATUS, NAMELY, 3D DIGITAL PHOTOGRAPH VIEWERS, LIQUID CRYSTAL SHUTTER GLASSES, POLARIZED GLASSES, AUTO-STEREOSCOPIC VIDEO MONITORS; MATERIAL FOR ELECTRICITY MAINS, NAMELY, ELECTRIC WIRES, POWER WIRES, ELECTRIC CABLES, BATTERY CABLES, ELECTRICAL CABLES; SOCKETS, PLUGS AND OTHER CONTACTS, NAMELY, ELECTRICAL SOCKETS, ELECTRICAL PLUGS, ELECTRIC CONNECTIONS AND CONNECTORS; TURNSTILES, AUTOMATIC; ELECTROPLATING APPARATUS, NAMELY, ELECTROLYSIS APPARATUS FOR ELECTROPLATING; SPRINKLER SYSTEMS FOR FIRE PROTECTION; SOLDERING IRONS, ELECTRIC; X-RAYS PRODUCING APPARATUS AND INSTALLATIONS, NOT FOR MEDICAL PURPOSES; PROTECTION DEVICES FOR PERSONAL USE AGAINST ACCIDENTS, NAMELY, FACE-PROTECTION SHIELDS, NETS FOR PROTECTION AGAINST ACCIDENTS, HEARING PROTECTION HEADSETS NOT FOR MEDICAL USE; THEFT PREVENTION INSTALLATIONS, ELECTRIC, NAMELY, BURGLAR ALARMS, THEFT ALARMS; PINCE-NEZ CORDS; CHARGERS FOR ELECTRIC BATTERIES; GALVANIC CELLS, NAMELY, GALVANIC BATTERIES; ANIMATED CARTOONS, NAMELY, VIDEOTAPES AND VIDEO DISKS RECORDED WITH ANIMATION, VISUAL RECORDINGS AND AUDIOVISUAL RECORDING FEATURING MUSIC AND ANIMATION; DECORATIVE MAGNETS; PORTABLE TELEPHONES; WALKIE-TALKIES; ANTENNAS; ANTI-INTERFERENCE DEVICES, NAMELY, CONDUCTIVE SILICONE PACKING FOR ELECTRO-MAGNETIC INTERFERENCE, ELECTRICAL SHIELDING SPACERS FOR CABLES AND CABLE ASSEMBLIES; INTERCOMMUNICATION APPARATUS, NAMELY, APPARATUS FOR TRANSMISSION OF COMMUNICATION, COMMUNICATION HUBS, COMMUNICATIONS COMPUTERS (U.S. CLS. 21, 23, 26, 36 AND 38).

MARK SHINER, EXAMINING ATTORNEY

SN 79-109,052. EBEL WATCHES SA, SWITZERLAND, FILED 11-15-2011.

⌘
EBEL

OWNER OF INTERNATIONAL REGISTRATION 0517146 DATED 10-7-1987, EXPIRES 10-7-2017.

OWNER OF U.S. REG. NO. 1,655,257, FOR SPECTACLES AND SUNGLASSES (U.S. CLS. 21, 23, 26, 36 AND 38).

ZACHARY BELLO, EXAMINING ATTORNEY

CLASS 9—(Continued).

SN 79-109,348. ETORO GROUP LTD., BR.VIRGIN ISLANDS, FILED 9-15-2011.

Copy.Me

THE MARK CONSISTS OF STANDARD CHARACTERS WITHOUT CLAIM TO ANY PARTICULAR FONT, STYLE, SIZE, OR COLOR.

PRIORITY DATE OF 9-15-2011 IS CLAIMED.

OWNER OF INTERNATIONAL REGISTRATION 1107362 DATED 9-15-2011, EXPIRES 9-15-2021.

FOR COMPUTER SOFTWARE COMPONENT FOR ACCESSING ONLINE INTERACTIVE FINANCIAL SERVICES AND OTHER RELATED ONLINE SERVICES, DOWNLOADABLE AS AN INTEGRAL COMPONENT OF COMPUTER SOFTWARE (U.S. CLS. 21, 23, 26, 36 AND 38).

CHARLOTTE CORWIN, EXAMINING ATTORNEY

SN 79-109,483. HENGDIAN GROUP DMEGC CO., LTD., CHINA, FILED 7-18-2011.



PRIORITY DATE OF 5-20-2011 IS CLAIMED. OWNER OF INTERNATIONAL REGISTRATION 1107659 DATED 7-18-2011, EXPIRES 7-18-2021.

OWNER OF U.S. REG. NO. 2,824,385.

THE MARK CONSISTS OF THE LETTERING "DMEGC" BELOW A ROUNDED TRIANGLE PENETRATED BY A ROUND-NOSED FORM FROM WHICH LINES EXTEND REPRESENTING SPEED.

FOR POLYSILICON WAFER; MONOSILICON WAFER; SILICON EPITAXIAL WAFER; SOLAR CELLS; SOLAR PANELS FOR PRODUCTION OF ELECTRICITY; BATTERIES; WALKIE-TALKIES; INTEGRATED CIRCUITS; MEDIUM-HIGH VOLTAGE ETCHED FOIL AND FORMED FOIL FOR ALUMINUM ELECTROLYTIC CAPACITOR; MAGNETIC MATERIALS AND DEVICES, NAMELY, MAGNETIC COILS, MAGNETIC HEADS, MAGNETIC CORES (U.S. CLS. 21, 23, 26, 36 AND 38).

HANNO RITTNER, EXAMINING ATTORNEY

CLASS 9—(Continued).

SN 79-109,583. DPA MICROPHONES A/S, DENMARK, FILED 12-14-2011.

d:facto

PRIORITY DATE OF 9-28-2011 IS CLAIMED.
OWNER OF INTERNATIONAL REGISTRATION 1107902 DATED 12-14-2011, EXPIRES 12-14-2021.
THE MARK CONSISTS OF THE WORDING "D FACTO" WITH A COLON BETWEEN "D" AND "FACTO".
FOR MICROPHONES, MICROPHONE GRIDS AND NOSE CONES, MICROPHONE WIND SCREENS, MICROPHONE HOLDERS, MICROPHONE STANDS, MICROPHONE CABLES, MICROPHONE CONNECTORS AND ADAPTERS, MICROPHONE BOOMS, MICROPHONE AMPLIFIERS, MICROPHONE POWER SUPPLIES AND MICROPHONE CALIBRATORS (U.S. CLS. 21, 23, 26, 36 AND 38).
EUGENIA MARTIN, EXAMINING ATTORNEY

SN 79-109,584. DPA MICROPHONES A/S, DENMARK, FILED 12-14-2011.

d:mension

PRIORITY DATE OF 9-28-2011 IS CLAIMED.
OWNER OF INTERNATIONAL REGISTRATION 1107903 DATED 12-14-2011, EXPIRES 12-14-2021.
THE MARK CONSISTS OF THE WORDING "D MENSION" WITH A COLON BETWEEN "D" AND "MENSION".
FOR MICROPHONES, MICROPHONE GRIDS AND NOSE CONES, MICROPHONE WIND SCREENS, MICROPHONE HOLDERS, MICROPHONE STANDS, MICROPHONE CABLES, MICROPHONE CONNECTORS AND ADAPTERS, MICROPHONE BOOMS, MICROPHONE AMPLIFIERS, MICROPHONE POWER SUPPLIES AND MICROPHONE CALIBRATORS (U.S. CLS. 21, 23, 26, 36 AND 38).
EUGENIA MARTIN, EXAMINING ATTORNEY

SN 79-109,585. DPA MICROPHONES A/S, DENMARK, FILED 12-14-2011.

d:vote

PRIORITY DATE OF 9-28-2011 IS CLAIMED.
OWNER OF INTERNATIONAL REGISTRATION 1107904 DATED 12-14-2011, EXPIRES 12-14-2021.
THE MARK CONSISTS OF THE WORDING "D VOTE" WITH A COLON BETWEEN "D" AND "VOTE".
FOR MICROPHONES, MICROPHONE GRIDS AND NOSE CONES, MICROPHONE WIND-SCREENS, MICROPHONE HOLDERS, MICROPHONE STANDS, MICROPHONE CABLES, MICROPHONE CONNECTORS AND ADAPTERS, MICROPHONE BOOMS, MICROPHONE AMPLIFIERS, MICROPHONE POWER SUPPLIES AND MICROPHONE CALIBRATORS (U.S. CLS. 21, 23, 26, 36 AND 38).
EUGENIA MARTIN, EXAMINING ATTORNEY

CLASS 9—(Continued).

SN 79-109,586. DPA MICROPHONES A/S, DENMARK, FILED 12-14-2011.

d:screet

PRIORITY DATE OF 9-28-2011 IS CLAIMED.
OWNER OF INTERNATIONAL REGISTRATION 1107905 DATED 12-14-2011, EXPIRES 12-14-2021.
THE MARK CONSISTS OF THE WORDING "D SCREET" WITH A COLON BETWEEN "D" AND "SCREET".
FOR MICROPHONES, MICROPHONE GRIDS AND NOSE CONES, MICROPHONE WIND-SCREENS, MICROPHONE HOLDERS, MICROPHONE STANDS, MICROPHONE CABLES, MICROPHONE CONNECTORS AND ADAPTERS, MICROPHONE BOOMS, MICROPHONE AMPLIFIERS, MICROPHONE POWER SUPPLIES AND MICROPHONE CALIBRATORS (U.S. CLS. 21, 23, 26, 36 AND 38).
EUGENIA MARTIN, EXAMINING ATTORNEY

SN 79-109,587. DPA MICROPHONES A/S, DENMARK, FILED 12-14-2011.

d:fine

PRIORITY DATE OF 9-28-2011 IS CLAIMED.
OWNER OF INTERNATIONAL REGISTRATION 1107906 DATED 12-14-2011, EXPIRES 12-14-2021.
THE MARK CONSISTS OF THE WORDING "D FINE" WITH A COLON BETWEEN "D" AND "FINE".
FOR MICROPHONES, MICROPHONE GRIDS AND NOSE CONES, MICROPHONE WIND-SCREENS, MICROPHONE HOLDERS, MICROPHONE STANDS, MICROPHONE CABLES, MICROPHONE CONNECTORS AND ADAPTERS, MICROPHONE BOOMS, MICROPHONE AMPLIFIERS, MICROPHONE POWER SUPPLIES AND MICROPHONE CALIBRATORS (U.S. CLS. 21, 23, 26, 36 AND 38).
EUGENIA MARTIN, EXAMINING ATTORNEY

SN 79-110,500. STMICROELECTRONICS NV, NETHERLANDS, FILED 12-30-2011.

gapDRIVE

THE MARK CONSISTS OF STANDARD CHARACTERS WITHOUT CLAIM TO ANY PARTICULAR FONT, STYLE, SIZE, OR COLOR.
PRIORITY DATE OF 7-7-2011 IS CLAIMED.
OWNER OF INTERNATIONAL REGISTRATION 1110303 DATED 12-30-2011, EXPIRES 12-30-2021.
FOR SEMI-CONDUCTORS; INTEGRATED CIRCUITS; MICROPROCESSORS; MICRO CONTROLLERS; EMBEDDED MICROPROCESSORS; INTEGRATED CIRCUIT CARDS; INTEGRATED CIRCUIT CHIPS; PRINTED ELECTRONIC CIRCUITS FOR INTEGRATED CIRCUIT APPARATUS AND CARDS (U.S. CLS. 21, 23, 26, 36 AND 38).
KATHERINE E. HALMEN, EXAMINING ATTORNEY

CLASS 9—(Continued).

SN 85-000,031. 247 SF CERTIFIED CORP, ALHAMBRA, CA.
FILED 3-27-2010.

SKYION7

THE MARK CONSISTS OF STANDARD CHARACTERS WITHOUT CLAIM TO ANY PARTICULAR FONT, STYLE, SIZE, OR COLOR.

FOR COMPUTER AND SOFTWARE PRODUCTS AND ELECTRICAL AND SCIENTIFIC PRODUCTS, NAMELY, SCIENTIFIC, NAUTICAL, SURVEYING, PHOTOGRAPHIC, CINEMATOGRAPHIC, OPTICAL, WEIGHING, MEASURING, SIGNALLING, CHECKING (SUPERVISION), LIFE-SAVING AND TEACHING APPARATUS AND INSTRUMENTS IN THE NATURE OF SIGNALLING BUOYS AND COMPUTER DATABASE MANAGEMENT SOFTWARE FOR USE IN PERSONALIZING THE CONTENT OF E-MAIL COMMUNICATIONS; APPARATUS FOR RECORDING, TRANSMISSION OR REPRODUCTION OF SOUND AND IMAGES; BLANK MAGNETIC DATA CARRIERS AND PRERECORDED MAGNETIC DATA CARRIERS FEATURING MUSIC, RECORDING DISCS, NAMELY, DVDS FEATURING MUSIC; AUTOMATIC VENDING MACHINES AND MECHANISMS FOR COIN OPERATED APPARATUS; CASH REGISTERS, CALCULATING MACHINES, DATA PROCESSING EQUIPMENT AND COMPUTERS; FIRE EXTINGUISHING APPARATUS FOR CONSUMERS (U.S. CLS. 21, 23, 26, 36 AND 38).
RAMONA ORTIGA, EXAMINING ATTORNEY

SN 85-057,216. CADMAN POWER EQUIPMENT LTD.,
COURTLAND, ONTARIO, CANADA, FILED 6-8-2010.

IWATER

THE MARK CONSISTS OF STANDARD CHARACTERS WITHOUT CLAIM TO ANY PARTICULAR FONT, STYLE, SIZE, OR COLOR.

PRIORITY CLAIMED UNDER SEC. 44(D) ON CANADA APPLICATION NO. 1,483,912, FILED 5-27-2010.
FOR ELECTRONIC IRRIGATION RATE CONTROLLERS FOR USE WITH IRRIGATION DEVICES (U.S. CLS. 21, 23, 26, 36 AND 38).
FIRST USE 5-0-2010; IN COMMERCE 5-0-2010.
MARCIE MILONE, EXAMINING ATTORNEY

CLASS 9—(Continued).

SN 85-065,213. SCHOLASTIC INC., NEW YORK, NY. FILED
6-17-2010.



THE MARK CONSISTS OF THE WORDS "FLY GUY" IN STYLIZED LETTERING.

FOR PRE-RECORDED VIDEO DISCS AND VIDEO GAME DISCS BASED ON A SERIES OF BOOKS FOR CHILDREN (U.S. CLS. 21, 23, 26, 36 AND 38).
MARY ROSSMAN, EXAMINING ATTORNEY

SN 85-071,287. R&R APPAREL COMPANY, LLC, WILMINGTON, DE. FILED 6-24-2010.

Republic by Rock & Republic

THE MARK CONSISTS OF STANDARD CHARACTERS WITHOUT CLAIM TO ANY PARTICULAR FONT, STYLE, SIZE, OR COLOR.

OWNER OF U.S. REG. NO. 3,868,778.
FOR EYEWEAR, NAMELY, READING GLASSES AND SUNGLASSES (U.S. CLS. 21, 23, 26, 36 AND 38).
SUSAN RICHARDS, EXAMINING ATTORNEY

CLASS 9—(Continued).

SN 85-085,844. PULSUS TECHNOLOGIES, INC., POHANG, GYUNGBUK, REPUBLIC OF KOREA, FILED 7-15-2010.

TUUBILIZER

THE MARK CONSISTS OF STANDARD CHARACTERS WITHOUT CLAIM TO ANY PARTICULAR FONT, STYLE, SIZE, OR COLOR.

PRIORITY CLAIMED UNDER SEC. 44(D) ON REPUBLIC OF KOREA APPLICATION NO. 402010036770, FILED 7-14-2010, REG. NO. 40-0905978, DATED 2-21-2012, EXPIRES 2-21-2022.

FOR ELECTRONIC SOFTWARE ALGORITHM FOR DIGITAL AUDIO SIGNAL PROCESSING, PORTED IN AUDIO SEMICONDUCTOR FOR THE PURPOSE OF MAKING DIGITAL AUDIO SYSTEM TO CONTROL AND IMPROVE SOUND QUALITY; SOUND PROCESSING SEMICONDUCTOR CHIPS; SOUND PROCESSING SOFTWARE; SOUND REPRODUCTION APPARATUS; AMPLIFIERS; PORTABLE APPARATUS FOR TRANSMISSION OF COMMUNICATION; SEMICONDUCTORS; INTEGRATED CIRCUITS (U.S. CLS. 21, 23, 26, 36 AND 38).

PAM WILLIS, EXAMINING ATTORNEY

CLASS 9—(Continued).

SN 85-128,123. CJ 4DPLEX CO., LTD., SEOUL, REPUBLIC OF KOREA, FILED 9-13-2010.

4DPLEX

THE MARK CONSISTS OF STANDARD CHARACTERS WITHOUT CLAIM TO ANY PARTICULAR FONT, STYLE, SIZE, OR COLOR.

PRIORITY CLAIMED UNDER SEC. 44(D) ON REPUBLIC OF KOREA APPLICATION NO. 40-2010-4770, FILED 9-10-2010, REG. NO. 0914934, DATED 4-10-2012, EXPIRES 4-10-2022.

FOR DVDS FEATURING PRERECORDED ENTERTAINMENT IN THE NATURE OF MOTION PICTURES, TELEVISION SERIES EPISODES AND MADE FOR TELEVISION MOTION PICTURES; BLANK RECORDABLE DVDS; AMUSEMENT APPARATUS ADAPTED FOR USE WITH COMPUTER MONITORS; COMPUTER SOFTWARE FOR USE IN PRODUCING SPECIAL CINEMATIC EFFECTS; COMPUTER GRAPHICS SOFTWARE; EYEGLASSES; AMUSEMENT APPARATUS ADAPTED FOR USE WITH TELEVISION RECEIVERS ONLY; COMPUTER GRAPHICS SOFTWARE, EYEGLASSES AND AMUSEMENT APPARATUS ADAPTED FOR USE WITH TELEVISION RECEIVERS ONLY FEATURING MOVIES AUDIENCE EFFECTS IN CINEMAS WITH SPECIAL EFFECTS SUCH AS WIND, SCENT, WATER SPRAY, MOTION, VIBRATION, SMOKE, BUBBLE, LASER OR FLASH; OPTICAL GLASSES; PICTURE PROJECTORS; EDITING APPLIANCES FOR CINEMATOGRAPHIC FILMS; PROJECTION SCREENS FOR MOVIE FILMS; MOVIE EDITING PROJECTORS; CINEMATOGRAPHIC CAMERAS; CINEMATOGRAPHIC PROJECTORS; SOUND RECORDING APPARATUS AND INSTRUMENTS BEING CINEMATOGRAPHIC APPARATUS; CINEMATOGRAPHIC MACHINES AND APPARATUS; PHOTOGRAPHY EQUIPMENT, NAMELY, REFLECTORS; PROJECTION SCREENS; DIGITAL CAMERAS; THEATRE GLASSES; GLASSES FOR VIEWING 3D DIGITAL PHOTOGRAPHS; BLINKERS BEING SIGNALING LIGHTS; VOLTAGE STABILIZING POWER SUPPLY; MP3 PLAYERS; DVD PLAYERS; CD PLAYERS; SOUND REPRODUCTION APPARATUS; SOUND RECORDING APPARATUS; CD-ROMS FEATURING PRERECORDED ENTERTAINMENT IN THE NATURE OF MOTION PICTURES, TELEVISION SERIES EPISODES AND MADE FOR TELEVISION MOTION PICTURES; BLANK RECORDABLE CD-ROMS; SOFTWARE TO CONTROL AND IMPROVE AUDIO EQUIPMENT SOUND QUALITY; COMPUTER PROGRAMS FOR EDITING IMAGES, SOUND AND VIDEO; SOFTWARE FOR PROCESSING IMAGES, GRAPHICS AND TEXT; DATA PROCESSING APPARATUS; DOWNLOADABLE COMPUTER PROGRAMS FOR USE IN PRODUCING SPECIAL CINEMATIC EFFECTS; PRE-RECORDED ELECTRONIC MEDIA FEATURING MUSIC; DOWNLOADABLE ELECTRONIC MUSIC; DOWNLOADABLE ELECTRONIC PUBLICATIONS IN THE NATURE OF ELECTRONIC JOURNALS, MAGAZINES, AND NEWSPAPERS, ALL IN THE FIELD OF CINEMATIC SPECIAL EFFECTS (U.S. CLS. 21, 23, 26, 36 AND 38).

RON FAIRBANKS, EXAMINING ATTORNEY

SN 85-115,824. STOPLIFT, INC., DBA STOPLIFT CHECKOUT VISION SYSTEMS, CAMBRIDGE, MA. FILED 8-25-2010.

ScanItAll

THE MARK CONSISTS OF STANDARD CHARACTERS WITHOUT CLAIM TO ANY PARTICULAR FONT, STYLE, SIZE, OR COLOR.

FOR SOFTWARE TO DETECT RETAIL FRAUD; SYSTEMS COMPRISING COMPUTERS, CAMERAS AND SOFTWARE TO DETECT RETAIL FRAUD (U.S. CLS. 21, 23, 26, 36 AND 38).

FIRST USE 7-29-2009; IN COMMERCE 7-29-2009.
LIEF MARTIN, EXAMINING ATTORNEY

CLASS 9—(Continued).

SN 85-177,195. DELTEK, INC., HERNDON, VA. FILED 11-15-2010.

DELTEK PM COMPASS

THE MARK CONSISTS OF STANDARD CHARACTERS WITHOUT CLAIM TO ANY PARTICULAR FONT, STYLE, SIZE, OR COLOR.

OWNER OF U.S. REG. NOS. 1,674,008, 2,835,962 AND 3,782,842.

NO CLAIM IS MADE TO THE EXCLUSIVE RIGHT TO USE "PM", APART FROM THE MARK AS SHOWN.

FOR COMPUTER SOFTWARE FOR PROJECT MANAGEMENT IN THE FIELDS OF GOVERNMENT CONTRACTING, ENERGY, OIL AND GAS, UTILITIES, AEROSPACE AND DEFENSE, ARCHITECTURE, ENGINEERING, CONSTRUCTION, INFORMATION TECHNOLOGY, PROJECT PERFORMANCE ANALYTICS, PROJECT COST MANAGEMENT, PROJECT SCHEDULE MANAGEMENT, RISK IDENTIFICATION AND ASSESSMENT TO FEDERAL, STATE AND LOCAL GOVERNMENTS, AND USER MANUALS SOLD THEREWITH (U.S. CLS. 21, 23, 26, 36 AND 38).

EDWARD NELSON, EXAMINING ATTORNEY

CLASS 9—(Continued).

SN 85-188,563. TRI FASTER, LLC, MUSKEGO, WI. FILED 12-1-2010.



OWNER OF U.S. REG. NO. 3,917,073.

NO CLAIM IS MADE TO THE EXCLUSIVE RIGHT TO USE "SWIM", APART FROM THE MARK AS SHOWN.

THE COLOR(S) YELLOW AND BLUE IS/ARE CLAIMED AS A FEATURE OF THE MARK.

THE MARK CONSISTS OF THE WORDS "SWIM FASTER" IN YELLOW LETTERING THAT FADES TO LIGHTER YELLOW OVER A BLUE POOL BACKGROUND.

FOR DVDS FEATURING ENDURANCE SPORT ANALYSIS, DRILLS AND COACHING (U.S. CLS. 21, 23, 26, 36 AND 38).

BERYL GARDNER, EXAMINING ATTORNEY

SN 85-191,381. PROFESSIONAL MEDICAL SURGICAL SUPPLY, INC., NEW LENOX, IL. FILED 12-6-2010.

**FOR THE PERFECT SURVEY
EVERY DAY**

SN 85-177,657. DEEPINVENT SOFTWARE GMBH, VIERSEN, FED REP GERMANY, FILED 11-16-2010.



OWNER OF U.S. REG. NOS. 3,443,247 AND 3,443,248.
NO CLAIM IS MADE TO THE EXCLUSIVE RIGHT TO USE "MAIL STORE", APART FROM THE MARK AS SHOWN.

THE MARK CONSISTS OF A SQUARE HAVING ROUNDED CORNERS AND A REPRESENTATION OF AN ORANGE IN THE LOWER RIGHT CORNER TOGETHER WITH THE MARK "MAILSTORE".

FOR SOFTWARE FOR EMAIL ARCHIVING (U.S. CLS. 21, 23, 26, 36 AND 38).

FIRST USE 5-23-2008; IN COMMERCE 5-23-2008.
AMY ALFIERI, EXAMINING ATTORNEY

THE MARK CONSISTS OF STANDARD CHARACTERS WITHOUT CLAIM TO ANY PARTICULAR FONT, STYLE, SIZE, OR COLOR.

FOR PROVIDING NECESSARY TOOLS, TRAINING AND TRACKING RESOURCES ONLINE IN THE FIELD OF LONG TERM CARE FACILITY MANAGEMENT TO ASSIST IN PREPARATION FOR THE QUALITY INDICATOR SURVEY, NAMELY, DOWNLOADABLE ONLINE SURVEY FORMS CATEGORIZED BY F-TAG, TASK AND CATEGORY, EDUCATIONAL MATERIALS, NAMELY, DOWNLOADABLE ONLINE IN-SERVICE GUIDE, ONLINE COURSES AND DOWNLOADABLE ONLINE MANUALS TO ASSIST IN THE TRAINING OF STAFF, AND DOWNLOADABLE ONLINE FORMS TO TRACK THE PROCESS OF STAFF MEMBERS (U.S. CLS. 21, 23, 26, 36 AND 38).

FIRST USE 6-11-2010; IN COMMERCE 6-11-2010.
EUGENIA MARTIN, EXAMINING ATTORNEY

CLASS 9—(Continued).

SN 85-198,450. MICROLAN INTEGRATION, INC., DBA KTI PROMOTION, HOUSTON, TX. FILED 12-15-2010.

Brochure Key

THE MARK CONSISTS OF STANDARD CHARACTERS WITHOUT CLAIM TO ANY PARTICULAR FONT, STYLE, SIZE, OR COLOR.

NO CLAIM IS MADE TO THE EXCLUSIVE RIGHT TO USE "KEY", APART FROM THE MARK AS SHOWN.

FOR COMBINATION OF A USB (UNIVERSAL SERIAL BUS) HARDWARE ENCASED IN A HARDCOVER PAPER PAMPHLET, WITH THE HARDWARE USED TO LAUNCH PRE-PROGRAMMED WEB ADDRESS WHEN CONNECTED TO A COMPUTER AND THE PAPER PAMPHLET CONTAINING ADVERTISEMENTS AND INSTRUCTIONS ASSOCIATED USING THE HARDWARE (U.S. CLS. 21, 23, 26, 36 AND 38).

FIRST USE 11-1-2010; IN COMMERCE 12-1-2010.
RAMONA ORTIGA, EXAMINING ATTORNEY

SN 85-207,392. PANASONIC CORPORATION, OSAKA, JAPAN, FILED 12-29-2010.



NO CLAIM IS MADE TO THE EXCLUSIVE RIGHT TO USE "3D LINK", APART FROM THE MARK AS SHOWN. THE COLOR(S) BLUE AND WHITE IS/ARE CLAIMED AS A FEATURE OF THE MARK.

THE MARK CONSISTS OF BLUE CIRCULAR DESIGN CONTAINING A WHITE AREA AT THE TOP OF THE DESIGN. WITHIN THE CIRCULAR DESIGN ARE THE BLUE WORDING "3D", OUTLINED IN WHITE, AND THE WHITE TERM "LINK".

FOR PLASMA TELEVISIONS; LCD TELEVISIONS; VIDEO APPARATUS, NAMELY, SLIM TELEVISION SETS, DIGITAL VIDEO DISC PLAYERS AND DIGITAL VIDEO DISC RECORDERS, ALL EQUIPPED WITH A FLAT DISPLAY; HOME THEATER SYSTEMS COMPRISING TELEVISIONS, DVD PLAYERS, AUDIO AMPLIFIERS, AND AUDIO SPEAKERS; DIGITAL CAMERA; DIGITAL STILL CAMERA (U.S. CLS. 21, 23, 26, 36 AND 38).

BRENDAN MCCAULEY, EXAMINING ATTORNEY

CLASS 9—(Continued).

SN 85-211,000. GEORGE W. MCKEE III, DBA PROFITUITY, PITTSBURGH, PA. FILED 1-5-2011.

PROFITUITY

THE MARK CONSISTS OF STANDARD CHARACTERS WITHOUT CLAIM TO ANY PARTICULAR FONT, STYLE, SIZE, OR COLOR.

FOR COMPUTER PROGRAMS FOR BUSINESS APPLICATIONS, NAMELY, SOFTWARE AND ASSOCIATED SYSTEM OPERATING PLATFORMS FOR COLLECTING, ORGANIZING, AND MANIPULATING DATA FOR PREDICTIVE MODELING, FOR ANALYZING DATA FOR REAL TIME DECISION MAKING, FOR UTILIZING INPUTS FOR DATA, DOCUMENT, KNOWLEDGE AND MODEL DRIVEN DECISION SUPPORT SYSTEMS, AND FOR STORING BUSINESS, FINANCIAL, AND MARKETING INFORMATION (U.S. CLS. 21, 23, 26, 36 AND 38).

JOHN KELLY, EXAMINING ATTORNEY

SN 85-214,471. HUTTON COMMUNICATIONS, INC., CARROLLTON, TX. FILED 1-10-2011.



NO CLAIM IS MADE TO THE EXCLUSIVE RIGHT TO USE "SIGNAL", APART FROM THE MARK AS SHOWN.

THE MARK CONSISTS OF CURVED BANDS AND A CURVY LINE REPRESENTING SOUND WAVES BEHIND THE STYLIZED WORDING "SIGNAL INSIDE".

FOR WIRELESS COMMUNICATIONS AND POWER SYSTEMS EQUIPMENT, NAMELY, ANTENNAS; BATTERIES; BATTERY ELIMINATORS, NAMELY, ELECTRIC CONNECTORS FOR CAMCORDERS, PORTABLE RADIOS, PAGERS, CELLULAR TELEPHONES AND SOLAR POWER APPLICATIONS; BATTERY CHARGERS; ELECTRICAL CABLES; CABLE INSTALLATION ACCESSORIES, NAMELY, CABLE BOOTS IN THE NATURE OF ETHERNET CABLE PROTECTORS, GROUNDING UNITS IN THE NATURE OF METAL GROUNDING BUSHINGS AND METAL GROUNDING CLAMPS, BOTH FOR USE ONLY AS PARTS AND FITTINGS FOR COAXIAL CABLE, AND NOT FOR NON-ELECTRIC CABLE OR MACHINERY OR MACHINE PARTS, LIGHTNING ARRESTORS, AND FEED-THROUGHS IN THE NATURE OF SURGE PROTECTORS; CELLULAR COMMUNICATION PRODUCTS, NAMELY, ANTENNAS, BATTERIES, ELIMINATORS IN THE NATURE OF BATTERY ELIMINATORS, CHARGERS, MOUNTS, AND CABLES; CONNECTORS IN THE NATURE OF CABLE CONNECTORS; ADAPTERS; AUDIO AND TRANSMISSION FILTERS, NAMELY, FILTERS FOR RADIO INTERFERENCE SUPPRESSION; MICROPHONES; LOUDSPEAKERS; PUBLIC ADDRESS HORNS; PUBLIC ADDRESS AMPLIFIERS; BASE STATION AMPLIFIERS; MOBILE AMPLIFIERS; REPEATER AMPLIFIERS; POWER SUPPLIES, NAMELY, CONVERTERS; INVERTERS; RADIOS; REPEATERS, NAMELY, WIRELESS NETWORK AND ETHERNET REPEATERS; SIGNALING DEVICES, NAMELY, SIGNALING ENCODERS AND DECODERS; REMOTE DEVICES, NAMELY, TONE AND DC REMOTES IN THE NATURE OF REMOTES FOR TWO-WAY RADIO COMMUNICATION, RADIO REMOTE INTERFACES IN THE NATURE OF INTERFACE CABLES; SOLAR ELECTRIC POWER DEVICES, NAMELY, POWER DISTRIBUTION UNITS FOR HOME

CLASS 9—(Continued).

POWER, SOLAR-POWERED CELLULAR EQUIPMENT, SOLAR LIGHTING UNITS, SOLAR UNITS, MOUNTING STRUCTURES, BATTERIES, CHARGE CONTROLS AND CHARGERS, BATTERY CHARGERS AND INVERTERS, AND UTILITY PUMPS; SOLAR-POWERED CELLULAR EQUIPMENT IN THE NATURE OF CABLES, BATTERIES AND CHARGERS FOR SOLAR PANEL UNITS; SOLAR UNITS, NAMELY, SOLAR CELLS; CHARGE CONTROLS IN THE NATURE OF BATTERY CHARGE DEVICES AND CHARGERS FOR BATTERIES; BATTERY CHARGERS AND INVERTERS; TESTING EQUIPMENT FOR ELECTRICAL COMMUNICATION DEVICES, NAMELY, SPECTRUM ANALYZERS, NETWORK ANALYZERS, VECTOR NETWORK ANALYZERS, SIGNAL GENERATORS IN THE NATURE OF GENERATORS FOR TESTING CELLULAR COMMUNICATION COMPONENTS, RADAR TEST SYSTEMS COMPRISING SIGNAL MEASUREMENT INSTRUMENTS; FIELD STRENGTH ANALYZERS FOR MEASURING THE STRENGTH OF SIGNALS, RF POWER METERS AND OSCILLOSCOPES; AND TELECOMMUNICATION TOWERS (U.S. CLS. 21, 23, 26, 36 AND 38).

KRISTINA MORRIS, EXAMINING ATTORNEY

SN 85-215,600. UNION LEAGUE CIVIC & ARTS FOUNDATION, CHICAGO, IL. FILED 1-12-2011.

CHICAGO PALETTE

THE MARK CONSISTS OF STANDARD CHARACTERS WITHOUT CLAIM TO ANY PARTICULAR FONT, STYLE, SIZE, OR COLOR.

NO CLAIM IS MADE TO THE EXCLUSIVE RIGHT TO USE "CHICAGO", APART FROM THE MARK AS SHOWN.

FOR PRERECORDED CDS FEATURING MUSIC FROM ANNUAL JAZZ COMPETITION WINNERS (U.S. CLS. 21, 23, 26, 36 AND 38).

STEVEN JACKSON, EXAMINING ATTORNEY

SN 85-220,025. SEKAI ELECTRONICS, INC., LA MIRADA, CA. FILED 1-18-2011.

SYNC ROLL

THE MARK CONSISTS OF STANDARD CHARACTERS WITHOUT CLAIM TO ANY PARTICULAR FONT, STYLE, SIZE, OR COLOR.

NO CLAIM IS MADE TO THE EXCLUSIVE RIGHT TO USE "SYNC", APART FROM THE MARK AS SHOWN.

FOR VIDEO RECORDER PLAYBACK COMPUTER SOFTWARE (U.S. CLS. 21, 23, 26, 36 AND 38).

FIRST USE 10-25-2010; IN COMMERCE 10-25-2010.

RONALD AIKENS, EXAMINING ATTORNEY

CLASS 9—(Continued).

SN 85-227,827. TLS CORP., CLEVELAND, OH. FILED 1-27-2011.

THE TELOS ALLIANCE

THE MARK CONSISTS OF STANDARD CHARACTERS WITHOUT CLAIM TO ANY PARTICULAR FONT, STYLE, SIZE, OR COLOR.

OWNER OF U.S. REG. NOS. 3,115,975 AND 3,115,976.

NO CLAIM IS MADE TO THE EXCLUSIVE RIGHT TO USE "ALLIANCE", APART FROM THE MARK AS SHOWN.

FOR DIGITAL TELEPHONE INTERFACE CIRCUITS; TELECOMMUNICATION SWITCHES; ELECTRIC CONTROL PANELS; TRANSCEIVERS; COMMUNICATIONS SERVERS; AUDIO SIGNAL PROCESSORS; EQUIPMENT FOR BROADCASTING STATIONS, NAMELY, CODECS, AUDIO MIXING CONSOLES, TELEPHONE INTERFACE MODULES, AUDIO/VIDEO EQUIPMENT, NAMELY, ROUTING SWITCHERS, ELECTRONIC CIRCUITS, NAMELY, AUDIO CIRCUITS AND VIDEO CIRCUITS, TELEPHONE HYBRIDS, NAMELY, 2-WIRE TO 4-WIRE CONVERTERS AND 4-WIRE TO 2-WIRE CONVERTERS, COMPUTER-BASED AUDIO RECORDING, PROCESSING, EDITING, AND/OR PLAYBACK UNITS, AND COMPUTER SOFTWARE FOR CONTROLLING AND MANAGING SERVER APPLICATIONS FOR USE IN CONNECTION WITH THE FOREGOING; COMPUTER HARDWARE AND SOFTWARE USED TO DISTRIBUTE MULTIPLE CHANNELS OF MULTI-MEDIA DATA OVER A COMPUTER NETWORK TO OTHER DEVICES; ELECTRONIC PRODUCTS FOR THE MANIPULATION OF THE FREQUENCY, TIME, AND AMPLITUDE CHARACTERISTICS OF AUDIO SIGNALS, NAMELY, AUDIO PROCESSORS; ELECTRONIC HARDWARE AND SOFTWARE FOR AUDIO PROCESSING, NAMELY, FOR UPMIXING AUDIO, DOWNMIXING AUDIO, ENCODING AUDIO, DECODING AUDIO, AND MANAGING AUDIO METADATA; ELECTRONIC HARDWARE AND SOFTWARE FOR AUDIO PROCESSING, NAMELY, FOR MANAGING AUDIO AND LOUDNESS ISSUES (U.S. CLS. 21, 23, 26, 36 AND 38).

ROBERT C. CLARK JR., EXAMINING ATTORNEY

SN 85-229,095. LG ELECTRONICS INC., SEOUL 150-721, REPUBLIC OF KOREA, FILED 1-28-2011.



PRIORITY CLAIMED UNDER SEC. 44(D) ON REPUBLIC OF KOREA APPLICATION NO. 402011000257, FILED 1-17-2011, REG. NO. 0913153, DATED 3-30-2012, EXPIRES 3-30-2022.

NO CLAIM IS MADE TO THE EXCLUSIVE RIGHT TO USE "3D MULTI INPUT", APART FROM THE MARK AS SHOWN.

THE MARK CONSISTS OF THE DESIGNATION "3D" THAT HAS THE APPEARANCE OF COMING OUT OF A FLAT SCREEN TELEVISION. TO THE RIGHT OF THE "3D" LOGO AND DESIGN ARE WRITTEN THE WORDS "MULTI INPUT". THE TERM "MULTI" IS POSITIONED ABOVE THE WORD "INPUT". BOTH WORDS ARE SHOWN IN STYLIZED FONT.

FOR TELEVISION RECEIVERS (U.S. CLS. 21, 23, 26, 36 AND 38).

RUSS HERMAN, EXAMINING ATTORNEY

CLASS 9—(Continued).

SN 85-241,032. HOLLYWOOD CHAMBER OF COMMERCE, HOLLYWOOD, CA. FILED 2-13-2011.



OWNER OF U.S. REG. NOS. 3,031,701 AND 3,040,573.
 THE MARK CONSISTS OF A FIVE POINT OPEN STAR WITH AN IMAGE OF A MOVIE CAMERA IN A CIRCLE LOCATED IN THE CENTER OF THE FIVE POINT OPEN STAR.

FOR COMPUTER SOFTWARE FOR THE DATABASING, VISUALIZATION, MANIPULATION, VIRTUAL REALITY IMMERSION AND INTEGRATION OF GEOGRAPHIC INFORMATION WITH ON-LINE MEMBER COMMUNITIES; DOWNLOADABLE VIRTUAL GOODS, NAMELY, COMPUTER PROGRAMS FEATURING IMAGES OF THE HOLLYWOOD WALK OF FAME SIDEWALK MONUMENT FOR USE BY OTHERS IN ONLINE VIRTUAL WORLDS; INTERACTIVE VIDEO GAMES OF VIRTUAL REALITY COMPRISED OF COMPUTER HARDWARE FOR USE WITH AN EXTERNAL MONITOR AND SOFTWARE; VIRTUAL REALITY GAME SOFTWARE; VIRTUAL REALITY SOFTWARE THAT ENABLES OTHERS TO SUPERIMPOSE AND PRINT PHOTOGRAPHS OF THEMSELVES NEAR THE HOLLYWOOD WALK OF FAME SIDEWALK MONUMENT; VPN VIRTUAL PRIVATE NETWORK HARDWARE; VPN VIRTUAL PRIVATE NETWORK OPERATING SOFTWARE (U.S. CLS. 21, 23, 26, 36 AND 38).

ELISSA GARBER KON, EXAMINING ATTORNEY

SN 85-275,094. QUOMATION INSURANCE SERVICES, INC., MIDVALE, UT. FILED 3-23-2011.



THE COLOR(S) GREEN, BLACK IS/ARE CLAIMED AS A FEATURE OF THE MARK.

THE MARK CONSISTS OF A GREEN GEOMETRIC DESIGN ELEMENT DIRECTLY LEFT OF THE WORD "QUOLYTICS" IN BLACK.

FOR COMPUTER SOFTWARE FOR COMPARATIVE RATING OF AUTOMOBILES, HOMES AND COMMERCIAL INSURANCE QUOTES THAT MAY BE DOWNLOADED FROM A GLOBAL COMPUTER NETWORK (U.S. CLS. 21, 23, 26, 36 AND 38).

FIRST USE 11-10-2010; IN COMMERCE 11-10-2010.
 MARK SPARACINO, EXAMINING ATTORNEY

CLASS 9—(Continued).

SN 85-293,324. ALEXIS POWER SYSTEMS, INC., RENO, NV. FILED 4-12-2011.



NO CLAIM IS MADE TO THE EXCLUSIVE RIGHT TO USE "POWER SYSTEMS", APART FROM THE MARK AS SHOWN.

THE MARK CONSISTS OF THE STYLIZED TEXT "ALEXIS" IN A BOX WITH A LIGHTING BOLT COMING OUT OF THE BOTTOM OF THE "X" AND THE STYLIZED TEXT "POWER SYSTEMS" IN THE LOWER BOARDER OF THE BOX.

FOR LITHIUM ION BATTERIES; NICKEL METAL HYDRIDE BATTERIES; BATTERY MONITORING SYSTEMS COMPRISED OF ELECTRIC CIRCUITRY AND COMPUTING HARDWARE THAT MONITORS THE CONDITION OF BATTERIES, CALCULATES THE BATTERY LIFE-CYCLE AND REPORTS BATTERY HEALTH (U.S. CLS. 21, 23, 26, 36 AND 38).

FIRST USE 2-7-2011; IN COMMERCE 2-7-2011.
 NAAKWAMA ANKRAH, EXAMINING ATTORNEY

SN 85-313,518. TESPRO ELECTRONICS CO., LTD., GUANDONG PROVINCE, CHINA, FILED 5-5-2011.



OWNER OF CHINA REG. NO. 6098549, DATED 2-14-2010, EXPIRES 2-13-2020.

THE MARK CONSISTS OF THE WORD "TESPRO" IN STYLIZED FORM.

FOR OPTICAL COMMUNICATION DEVICES, NAMELY, OPTICAL PROBES IN THE NATURE OF OPTICAL SENSORS FOR DATA EXCHANGE BETWEEN ELECTRIC ENERGY METERS OR GAS METERS, AND OTHER METERING EQUIPMENT, OPTICAL TRANSMITTERS AND OPTICAL RECEIVERS; INTERCOMMUNICATION APPARATUS, NAMELY, MODEM, SOUND AMPLIFIERS, AND ELECTRICAL OUTLET SOCKETS; ELECTRIC CONNECTORS AND COUPLERS; INSTRUMENT TRANSFORMERS; ELECTRIC SIGNS (U.S. CLS. 21, 23, 26, 36 AND 38).

BRENDAN MCCAULEY, EXAMINING ATTORNEY

CLASS 9—(Continued).

SN 85-320,596. ASSOCIATION OF AMERICAN MEDICAL COLLEGES, WASHINGTON, DC. FILED 5-13-2011.



OWNER OF U.S. REG. NOS. 1,946,740, 3,249,566 AND OTHERS.

NO CLAIM IS MADE TO THE EXCLUSIVE RIGHT TO USE "TEST", APART FROM THE MARK AS SHOWN.

THE MARK CONSISTS OF THE TERM "MEDICAL COLLEGE ADMISSION TEST" ABOVE THE LETTERS "MCAT" TO THE RIGHT OF WHICH IS A VERTICAL LINE, A STYLIZED STAFF INTERTWINED BY A SNAKE, AND THE LETTERS "AAMC".

SEC. 2(F) AS TO "MEDICAL COLLEGE ADMISSION TEST".

FOR DOWNLOADABLE ELECTRONIC PUBLICATIONS, NAMELY, PRACTICE STANDARDIZED TESTS AND GUIDEBOOKS FOR TAKING AND PREPARING FOR STANDARDIZED TESTS (U.S. CLS. 21, 23, 26, 36 AND 38).

FIRST USE 3-0-2011; IN COMMERCE 3-0-2011.
ROBIN MITTLER, EXAMINING ATTORNEY

SN 85-321,069. MA YAOGUANG, AKA VINCENT MA, CHICAGO, IL. FILED 5-14-2011.



THE COLOR(S) BLUE AND BLACK IS/ARE CLAIMED AS A FEATURE OF THE MARK.

THE MARK CONSISTS OF FOUR RECTANGLES OUTLINED IN BLUE IN A STYLIZED DIAMOND DESIGN. THE WORD, "PINGTEC" IS ENTIRELY IN BLACK.

FOR ALL-IN-ONE PCS; BACKUP DRIVES FOR COMPUTERS; BATTERIES; BATTERIES AND BATTERY CHARGERS; BATTERIES AND BATTERY CHARGERS FOR INTRAVENOUS FLUID DELIVERY APPARATUS; BATTERY CHARGERS; BLANK HARD COMPUTER DISCS; BLANK HARD DRIVES FOR COMPUTERS; BLANK MAGNETIC COMPUTER TAPES; BLANK TAPES FOR STORAGE OF COMPUTER DATA; BLANK USB FLASH DRIVES; BRIEFCASES SPECIALLY ADAPTED FOR HOLDING LAPTOP COMPUTERS; BROADBAND POWER LINE COMMUNICATION SYSTEMS FOR TRANSFERRING BROADBAND DATA OVER ELECTRICAL POWER LINES, COMPRISED OF COMPUTER HARDWARE, SOFTWARE AND MODEMS; CALCULATING MACHINES, DATA PROCESSING EQUIPMENT AND COMPUTERS; CALCULATING MACHINES, DATA-PROCESSING EQUIPMENT AND COMPUTERS; CAR NAVIGATION COMPUTERS; CARDS AND MICROPROCESSORS FOR COMPUTERS; CARRYING CASES FOR CELL PHONES; CARRYING CASES FOR ELECTRONIC EQUIPMENT, NAMELY, COMPUTERS, TABLET PERSONAL COMPUTERS AND CELL PHONES; CARRYING CASES FOR MOBILE COMPUTERS; CASES FOR MUSIC, AUDIO AND RELATED ELECTRONIC EQUIPMENT, NAMELY, CASES FOR AUDIO TUNERS, AUDIO RECEIVERS, AMPLIFIERS, TAPE PLAYERS, COMPACT DISC PLAYERS, MP3 CONTROLLERS/PLAYERS, AUDIO MIXERS, AUDIO SPEAKERS IN THE NATURE OF MUSIC STUDIO MONITORS, MICROPHONES, AUDIO SPEAKERS, COMPACT DISCS, AUDIO TAPES, PORTABLE COMPUTERS, ANTENNAS, PHONOGRAPHIC RECORD PLAYERS, AUDIO RECORDING EQUIPMENT, AND THE CABLES ASSO-

CLASS 9—(Continued).

CIATED WITH ALL OF THE FOREGOING EQUIPMENT; CASH REGISTERS, CALCULATING MACHINES AND DATA PROCESSING EQUIPMENT AND COMPUTERS; CD DRIVES FOR COMPUTERS; CD-ROM DRIVES; CELL PHONE BACKPLATES; CELL PHONE BATTERY CHARGERS; CELL PHONE BATTERY CHARGERS FOR USE IN VEHICLES; CELL PHONE COVERS; CELL PHONE FACEPLATES; CELL PHONE HAVING LARGE KEYS AND NUMBERS THAT ASSIST USERS HAVING IMPAIRED VISION OR DEXTERITY; CELL PHONE STRAPS; CELL PHONES; CHARGERS FOR BATTERIES; CHARGERS FOR ELECTRIC BATTERIES; COMPUTER CURSOR CONTROL DEVICES, NAMELY, DIGITIZER TABLETS, COMPUTER HARDWARE AND SOFTWARE SYSTEM FOR TRACKING PEOPLE, OBJECTS AND PETS USING GPS DATA ON A DEVICE ON THE TRACKED PEOPLE, OBJECTS AND PETS; COMPUTER MOUSE; DIGITAL PHOTO FRAMES FOR DISPLAYING DIGITAL PICTURES, VIDEO CLIPS AND MUSIC; ELECTRIC SHAVER CHARGERS; ELECTRONIC DEVICES FOR ANIMAL LOCATING AND TRACKING PROGRAMMED TO USE GLOBAL POSITIONING SYSTEMS (GPS) AND CELLULAR COMMUNICATIONS; GLOBAL POSITIONING SYSTEM (GPS); GPS DATA LOGGER FOR RECORDING TRIPS AND CLASSIFYING THEM INTO DIFFERENT ACCOUNTS; GPS NAVIGATION DEVICE; GPS TRACKING DEVICE TO BE WORN ON THE WRIST OF AN ATHLETE DURING ENDURANCE EVENTS; HEAD-CLIP CELL PHONE HOLDERS; PC TABLET; PROTECTIVE COVERS AND CASES FOR CELL PHONES, LAPTOPS AND PORTABLE MEDIA PLAYERS; TABLET COMPUTER; USB HUBS; VINYL COVERS SPECIALLY ADAPTED FOR CELL PHONES, MP3 PLAYERS, LAPTOPS, COMPUTERS, PORTABLE SATELLITE RADIOS, PERSONAL DIGITAL ASSISTANTS, REMOTE CONTROLS, AND TELEVISION SATELLITE RECORDERS (U.S. CLS. 21, 23, 26, 36 AND 38).
HOWARD SMIGA, EXAMINING ATTORNEY

SN 85-325,094. POWERTECH ELECTRONICS INC., TAIPEI CITY 116, TAIWAN, FILED 5-19-2011.



THE MARK CONSISTS OF "POWERTECH" IN STYLIZED UPPER CASE LETTERS FOLLOWING A STYLIZED LETTER "P".

FOR AUTOMATED GATE OPERATORS (U.S. CLS. 21, 23, 26, 36 AND 38).

FIRST USE 9-20-2006; IN COMMERCE 5-15-2007.
DAVID TAYLOR, EXAMINING ATTORNEY

SN 85-344,277. ADI SOFTWARE, LLC, MINNEAPOLIS, MN. FILED 6-13-2011.

ADIPAD

THE MARK CONSISTS OF STANDARD CHARACTERS WITHOUT CLAIM TO ANY PARTICULAR FONT, STYLE, SIZE, OR COLOR.

OWNER OF U.S. REG. NOS. 2,663,934 AND 3,959,761.
FOR TIME CLOCKS; TIME RECORDING APPARATUS (U.S. CLS. 21, 23, 26, 36 AND 38).

FIRST USE 6-1-2011; IN COMMERCE 6-1-2011.

MARTHA SANTOMARTINO, EXAMINING ATTORNEY

CLASS 9—(Continued).

SN 85-344,325. ADI SOFTWARE, LLC, MINNEAPOLIS, MN. FILED 6-13-2011.

ADITOUCH

THE MARK CONSISTS OF STANDARD CHARACTERS WITHOUT CLAIM TO ANY PARTICULAR FONT, STYLE, SIZE, OR COLOR.

OWNER OF U.S. REG. NOS. 2,663,934 AND 3,959,761. FOR TIME CLOCKS; TIME RECORDING APPARATUS (U.S. CLS. 21, 23, 26, 36 AND 38). FIRST USE 6-1-2011; IN COMMERCE 6-1-2011. MARTHA SANTOMARTINO, EXAMINING ATTORNEY

SN 85-345,535. ALLSOFT TECHNOLOGIES, INC., TAMPA, FL. FILED 6-14-2011.

TOOL MANAGER

THE MARK CONSISTS OF STANDARD CHARACTERS WITHOUT CLAIM TO ANY PARTICULAR FONT, STYLE, SIZE, OR COLOR.

NO CLAIM IS MADE TO THE EXCLUSIVE RIGHT TO USE "MANAGER", APART FROM THE MARK AS SHOWN. SEC. 2(F).

FOR COMPUTER DATABASE MANAGEMENT SOFTWARE FOR USE IN DATABASE MANAGEMENT OF INVENTORY CONTROL AND CUSTOMER ACCOUNT INFORMATION (U.S. CLS. 21, 23, 26, 36 AND 38).

FIRST USE 4-1-1992; IN COMMERCE 4-1-1992. AMY KERTGATE, EXAMINING ATTORNEY

SN 85-345,760. FREMANTLEMEDIA NORTH AMERICA, INC., BURBANK, CA. FILED 6-14-2011.

DANGER MOUSE

THE MARK CONSISTS OF STANDARD CHARACTERS WITHOUT CLAIM TO ANY PARTICULAR FONT, STYLE, SIZE, OR COLOR.

FOR CAMERA CASES; CAMERAS; CASES FOR ELECTRONIC DIARIES; CASES FOR MOBILE PHONES; CASES FOR POCKET CALCULATORS; CD CASES; CD PLAYERS; CELLULAR PHONE ACCESSORY CHARMS; DECORATIVE MAGNETS; MOUSE PADS; ELECTRONIC DIARIES; ELECTRONIC DAY PLANNERS; EYEGLASSES; FITTED PLASTIC FILMS KNOWN AS SKINS FOR COVERING AND PROVIDING A SCRATCH PROOF BARRIER OR PROTECTION FOR ELECTRONIC DEVICES, NAMELY, MP3 PLAYERS, MOBILE TELEPHONES, SMART TELEPHONES, DIGITAL CAMERAS, GLOBAL POSITIONING SYSTEMS AND PERSONAL DIGITAL ASSISTANTS; GAMING MACHINES, NAMELY, SLOT MACHINES AND VIDEO LOTTERY TERMINALS; GAMING MACHINES, NAMELY, DEVICES WHICH ACCEPT A WAGER; HEADSETS FOR

CLASS 9—(Continued).

MOBILE TELEPHONES; HOLDERS FOR MAGNETICALLY ENCODED GIFT CARDS; MAGNETICALLY ENCODED DEBIT CARDS; MAGNETIC CODED GIFT CARDS; MOBILE TELEPHONES; MP3 PLAYERS; PERSONAL DIGITAL ASSISTANTS (PDA); POCKET CALCULATORS; PRE-PAID TELEPHONE CALLING CARDS, MAGNETICALLY ENCODED; RADIOS; SUNGLASSES; VIDEO GAME INTERACTIVE CONTROL FLOOR PADS OR MATS; VIDEO GAME INTERACTIVE HAND HELD REMOTE CONTROLS FOR PLAYING ELECTRONIC GAMES; VIDEO GAME MACHINES FOR USE WITH EXTERNAL DISPLAY SCREEN OR MONITOR; ELECTRIC HAIR APPLIANCES, NAMELY, BRAIDERS, WRAPPERS, IRONS, CRIMPERS, CURLERS, CURLING IRONS, ROLLERS, STRAIGHTENERS; BATTERY-OPERATED HAIR APPLIANCES, NAMELY, BRAIDERS, WRAPPERS, IRONS, CRIMPERS, CURLERS, CURLING IRONS, ROLLERS, STRAIGHTENERS; PRINTERS; PICTURE PROJECTORS; DIGITAL PHOTO FRAMES FOR DISPLAYING DIGITAL PHOTOS; ELECTRONIC AUDIO TAPE RECORDER; DIGITAL AUDIO TAPE PLAYER AND RECORDER; INTERACTIVE EDUCATIONAL SOFTWARE FEATURING SINGING INSTRUCTIONS AND KARAOKE MUSIC; KARAOKE PLAYER AND RECORDER; DOWNLOADABLE ELECTRONIC NEWSLETTERS IN THE FIELD OF ENTERTAINMENT; DOWNLOADABLE ELECTRONIC PUBLICATIONS IN THE NATURE OF MAGAZINES OR BOOKS IN THE FIELD OF ENTERTAINMENT; ALL OF THE FOREGOING RELATING TO AN ANIMATED SERIES FEATURING THE ADVENTURES OF A MOUSE WHO WORKS AS A SECRET AGENT (U.S. CLS. 21, 23, 26, 36 AND 38).

KATHLEEN LORENZO, EXAMINING ATTORNEY

SN 85-346,339. DIVAKARAN, HARISH, SAN DIEGO, CA. FILED 6-14-2011.

Peoplegraph

THE MARK CONSISTS OF STANDARD CHARACTERS WITHOUT CLAIM TO ANY PARTICULAR FONT, STYLE, SIZE, OR COLOR.

FOR CHILDREN'S EDUCATIONAL SOFTWARE (U.S. CLS. 21, 23, 26, 36 AND 38).

TAMARA FRAZIER, EXAMINING ATTORNEY

CLASS 9—(Continued).

SN 85-346,404. GXL TECHNOLOGIES LIMITED, LONDON, ENGLAND, UNITED KINGDOM, FILED 6-15-2011.



NO CLAIM IS MADE TO THE EXCLUSIVE RIGHT TO USE "TECHNOLOGIES", APART FROM THE MARK AS SHOWN.

THE MARK CONSISTS OF THE LETTERS "GXL" WITH A STAR IN THE "G" AND "TECHNOLOGIES".

FOR COMPUTERS; ELECTRICAL TRANSDUCER; ELECTRONIC CHIPS FOR THE MANUFACTURER OF INTEGRATED CIRCUITS; INTEGRATED CIRCUIT CARDS AND COMPONENTS; INTEGRATED CIRCUIT MODULE; INTEGRATED CIRCUIT MODULES; MICROWAVE ANTENNAE; MICROWAVE TRANSMISSION APPARATUS FOR DELIVERING RADIO PROGRAMS AND MESSAGES; OSCILLATORS; PORTABLE TELEPHONES; SEMICONDUCTOR DEVICES; TRANSMITTERS OF ELECTRONIC SIGNALS (U.S. CLS. 21, 23, 26, 36 AND 38).

FIRST USE 12-5-2006; IN COMMERCE 8-9-2010.
 JULIE VEPPUMTHARA, EXAMINING ATTORNEY

CLASS 9—(Continued).

SN 85-350,894. DIGITAL WELL FILE, KATY, TX. FILED 6-20-2011.



NO CLAIM IS MADE TO THE EXCLUSIVE RIGHT TO USE "RIG" AND "COMPANY" AND "PARTNER", APART FROM THE MARK AS SHOWN.

THE MARK CONSISTS OF THE STYLIZED WORDS "WELLDIGITS RIG COMPANY PARTNER" ALL WITHIN AN HEXAGON. THE WORDS "RIG", "COMPANY" AND "PARTNER" ARE SEPARATED BY ARROWS. AN IMAGE OF A WELL RIG IS IN THE CENTER OF THE HEXAGON.

FOR DATABASE MANAGEMENT SOFTWARE FOR THE OIL INDUSTRY USING SECURE WEB BASED TECHNOLOGY TO UPLOAD DATA FILES FROM CONTRACTORS DURING THE DRILLING PROCESS INTO A DATABASE, WHERE THE OIL COMPANY CAN VIEW, EDIT, DOWNLOAD AND SHARE SELECTED FILES WITH PARTNER COMPANIES (U.S. CLS. 21, 23, 26, 36 AND 38).

FIRST USE 6-1-2011; IN COMMERCE 6-1-2011.
 LAKEISHA LEWIS, EXAMINING ATTORNEY

SN 85-349,926. MR JASON K VEARING, TA RIFF AXELERATOR, GOLD COAST, AUSTRALIA, FILED 6-19-2011.



NO CLAIM IS MADE TO THE EXCLUSIVE RIGHT TO USE "RIFF", APART FROM THE MARK AS SHOWN.

THE COLOR(S) BLACK, WHITE AND GOLD IS/ARE CLAIMED AS A FEATURE OF THE MARK.

THE MARK CONSISTS OF THE STYLIZED WORDING "RIFF AXELERATOR"; "RIFF" IS IN GOLD, BLACK AND WHITE WITH THE "R" IN THE SHAPE OF A GUITAR HEADSTOCK WITH TUNING KNOBS IN BLACK; "AXELERATOR" IS IN BLACK.

FOR COMPUTER HARDWARE AND COMPUTER SOFTWARE PROGRAMS FOR THE INTEGRATION OF TEXT, AUDIO, GRAPHICS, STILL IMAGES AND MOVING PICTURES INTO AN INTERACTIVE DELIVERY INTENDED TO ENHANCE GUITAR PLAYERS' SKILLS (U.S. CLS. 21, 23, 26, 36 AND 38).

HOWARD B. LEVINE, EXAMINING ATTORNEY

SN 85-354,374. LODE DATA SYSTEMS, INC., ORLAND PARK, IL. FILED 6-23-2011.



NO CLAIM IS MADE TO THE EXCLUSIVE RIGHT TO USE "RETAIL", APART FROM THE MARK AS SHOWN.

THE MARK CONSISTS OF THE WORD "TAM" IN CAPITAL LETTERS IN FRONT OF SYMBOL CONSISTING OF EIGHT LINES FORMING A CIRCLE WITH A SOLID HALF CIRCLE ON RIGHT SIDE FOLLOWED BY THE WORD "RETAIL" WITH INITIAL "R".

FOR SOFTWARE SUITE FOR USE BY RETAILERS, NAMELY, COMPUTER PROGRAMS IN THE FIELD OF POINT OF SALE MANAGEMENT, INVENTORY MANAGEMENT, CUSTOMER MANAGEMENT, REWARD MANAGEMENT, TIME AND ATTENDANCE MANAGEMENT, ORDER MANAGEMENT, ECOMMERCE MANAGEMENT, AND ACCOUNTING MANAGEMENT (U.S. CLS. 21, 23, 26, 36 AND 38).

C. DIONNE CLYBURN, EXAMINING ATTORNEY

CLASS 9—(Continued).

SN 85-355,544. COREL CORPORATION, OTTAWA, ONTARIO K1Z8R7, CANADA, FILED 6-24-2011.

PAINTER

THE MARK CONSISTS OF STANDARD CHARACTERS WITHOUT CLAIM TO ANY PARTICULAR FONT, STYLE, SIZE, OR COLOR.

SEC. 2(F).

FOR COMPUTER GRAPHICS SOFTWARE, COMPUTER SOFTWARE FOR DIGITAL IMAGE PROCESSING AND DIGITAL ART; COMPUTER SOFTWARE FOR DIGITAL IMAGE PROCESSING THAT MAY BE DOWNLOADED; SOFTWARE FOR DISSEMINATING, RECEIVING, CREATING, PUBLISHING AND EDITING DIGITAL IMAGES AND MULTIMEDIA CONTENTS, USER MANUALS IN ELECTRONIC AND/OR PHYSICAL FORM SOLD AS A UNIT THEREWITH (U.S. CLS. 21, 23, 26, 36 AND 38).

FIRST USE 0-0-1991; IN COMMERCE 0-0-1991.
JOHN E. MICHOS, EXAMINING ATTORNEY

SN 85-357,359. SONY CORPORATION, TOKYO, JAPAN, FILED 6-27-2011.

WhiteMagic

THE MARK CONSISTS OF STANDARD CHARACTERS WITHOUT CLAIM TO ANY PARTICULAR FONT, STYLE, SIZE, OR COLOR.

OWNER OF U.S. REG. NO. 2,942,283.

FOR LIQUID CRYSTAL DISPLAYS WITH LOW POWER CONSUMPTION TECHNOLOGY; LIQUID CRYSTAL DISPLAYS; MOBILE PHONES; SMARTPHONES; COMPUTERS; HANDHELD COMPUTERS; TABLET COMPUTERS; PERSONAL DIGITAL ASSISTANTS; PORTABLE AND HANDHELD DIGITAL ELECTRONIC DEVICES; PORTABLE AUDIO PLAYERS; CAMERAS; VIDEO CAMERAS; TELEVISIONS; PORTABLE TELEVISIONS; CAR AUDIO PLAYERS AND SPEAKERS; CAR NAVIGATION SYSTEMS COMPRISED OF RECEIVERS, TRANSMITTERS, DECODERS, DISC PLAYERS AND MONITORS FOR SIGNALS FROM GLOBAL POSITIONING SYSTEM (GPS) SATELLITES; ALL OF THE ABOVE WITH LIQUID CRYSTAL DISPLAY PANELS AND NONE OF THE ABOVE GOODS FOR USE IN OR IN CONNECTION WITH GAMING OR GAMBLING MACHINES (U.S. CLS. 21, 23, 26, 36 AND 38).

BRIAN PINO, EXAMINING ATTORNEY

CLASS 9—(Continued).

SN 85-357,453. DREAMGEAR, LLC, TORRANCE, CA. FILED 6-27-2011.

I.SOUND

THE MARK CONSISTS OF STANDARD CHARACTERS WITHOUT CLAIM TO ANY PARTICULAR FONT, STYLE, SIZE, OR COLOR.

OWNER OF U.S. REG. NOS. 3,105,624, 3,185,384 AND 3,423,348.

FOR ELECTRONICS EQUIPMENT, NAMELY, RADIOS INCORPORATING CLOCKS CONTAINING A COMPUTER DOCKING STATION FOR USE WITH MP3 AND MP4 DIGITAL PLAYERS, MOBILE TELEPHONES, AND TABLET COMPUTERS; ELECTRONICS ACCESSORIES FOR USE WITH PORTABLE OR HANDHELD DIGITAL ELECTRONIC DEVICES FOR ORGANIZING, TRANSMITTING, MANIPULATING, AND REVIEWING TEXT, DATA, AUDIO, IMAGE, AND VIDEO FILES, NAMELY, DOCKING STATIONS, STANDS SPECIALLY DESIGNED FOR HOLDING A DIGITAL ELECTRONIC DEVICE, MOBILE TELEPHONES AND ACCESSORIES IN THE NATURE OF HEADSETS, BATTERIES, BATTERY CHARGERS, BATTERY PACKS, ELECTRICAL WIRES, ELECTRICAL CABLES AND ELECTRICAL ADAPTORS; COMPUTER, VIDEO GAME AND ELECTRONICS EQUIPMENT, NAMELY, KEYBOARDS; COMPUTER AND VIDEO GAME CONTROLLERS, NAMELY, STEERING WHEEL UNITS FOR PLAYING COMPUTER AND VIDEO GAMES; ELECTRICAL CABLES TO CONNECT VIDEO GAME SYSTEMS, MOBILE TELEPHONES AND OTHER HANDHELD DIGITAL DEVICES TO TELEVISIONS, DVD PLAYERS, VCR PLAYERS, COMPUTERS AND MULTIPLE VIDEO GAME SYSTEMS; AUTOMOBILE AND AC ELECTRICAL POWER ADAPTORS FOR HANDHELD DIGITAL ELECTRONIC DEVICES; COMPUTER MICE; COMPUTER MOUSE PADS AND WRIST PADS IN THE NATURE OF WRIST RESTS AND SUPPORTS FOR USE WITH COMPUTERS; HEADPHONES; EAR PHONES FOR VIDEO GAME SYSTEMS, TELEVISIONS, VCRS, DVD PLAYERS, MOBILE TELEPHONES, HANDHELD DIGITAL ELECTRONIC DEVICES, MP3 PLAYERS AND RADIOS; MICROPHONES; WIRELESS MICROPHONES; MICROPHONE RECEIVERS; ELECTRICAL CONNECTION BOXES FOR CONNECTING MULTIPLE MICROPHONES; SHIELDED COMPUTER AND MOBILE TELEPHONE SPEAKERS; HEADSETS FOR COMPUTERS, TELEVISIONS, DVD PLAYERS, CD PLAYERS, MP3 PLAYERS, MOBILE TELEPHONES, HANDHELD DIGITAL ELECTRONIC DEVICES AND RADIOS, MP4 DIGITAL PLAYERS, COMBINATION STEREO AUDIO RECEIVER AND TAPE RECORDER, RECORD PLAYERS, TAPE RECORDERS, CD PLAYERS, DVD PLAYERS, MINI DISC RECORDERS, AND MINI DISC; AUDIO SPEAKERS; WIRELESS SPEAKERS; PORTABLE AUDIO SPEAKERS; SPEAKER BASE STATIONS, NAMELY, A MP3 PLAYER DOCKING STATION CONTAINING AUDIO SPEAKERS; LOUDSPEAKERS; LOUDSPEAKER SYSTEMS, NAMELY, WOOFER, TWEETER, OR MID-RANGE SPEAKER CONES CONTAINED IN A CABINET; REMOTE CONTROL UNITS FOR CONTROLLING STEREOS, TELEVISIONS, VIDEO CASSETTE PLAYERS, DVD PLAYERS, AND MP3 PLAYERS; WOOFERS; KEYBOARDS NOT SOLD AS AN INTEGRATED PART OF PERSONAL COMPUTERS; ADAPTORS TO CONNECT KEYBOARDS TO COMPUTER SYSTEMS; ELECTRIC WIRE, NAMELY, SPEAKER WIRE; ELECTRICAL SWITCHES USED TO CONTROL THE AUDIO SOUND LEVEL; COMPUTER CABLES, COMPUTER MONITOR CABLES, MODEM CABLES, AND VIDEO GAME SYSTEM ELECTRICAL CABLES; AUDIO CABLES, AND OPTICAL CABLES FOR VIDEO CAMERAS AND STEREO SYSTEMS; TELEPHONES, TELEPHONE ACCESSORIES AND EQUIPMENT, NAMELY, WIRELESS TELEPHONES; BATTERIES; BATTERY CHARGERS; TELEPHONE CARRYING CASES; HANDS-FREE DEVICES, NAMELY, EARPHONES FOR ALLOWING HANDS FREE OPERATION OF CELLULAR TELEPHONES; CARRYING CLIPS FOR WIRELESS TEL-

CLASS 9—(Continued).

EPHONES SOLD AS A UNIT IN COMBINATION WITH WIRELESS TELEPHONES; COMMUNICATIONS DEVICES IN THE NATURE OF WIRELESS APPLICATION PROTOCOL (WAP) RECEIVERS AND TRANSMITTERS; TELECOMMUNICATIONS TRANSMISSION EQUIPMENT, COMPONENTS, SWITCHING, AND NETWORK SYSTEMS COMPRISED OF RADIO TRANSMITTERS AND RECEIVERS; ANTENNAS; TELECOMMUNICATIONS SWITCHES; SIGNAL TRANSFER POINT DIGITAL MEDIA AND COMPUTER SERVERS; SIGNAL CONTROL POINT DIGITAL MEDIA AND COMPUTER SERVERS; SERVICE RESOURCE PLATFORM DIGITAL MEDIA AND COMPUTER SERVERS; CALL ROUTING DIGITAL MEDIA AND COMPUTER SERVERS AND OPERATING SOFTWARE FOR THE FOREGOING; COMPUTERS AND COMPUTER SOFTWARE FOR THE ACTIVATION AND OPERATION OF WIRELESS TELECOMMUNICATIONS SERVICES; MACHINE READABLE MAGNETICALLY ENCODED CALLING CARDS, CALLER IDENTIFICATION CARDS, DEBIT AND CREDIT CARDS; PAGERS; CALLER IDENTIFICATION BOXES; PROTECTIVE CASES FOR PORTABLE ELECTRONIC DEVICES, NAMELY, PERSONAL DIGITAL ASSISTANTS AND MOBILE TELEPHONES (U.S. CLS. 21, 23, 26, 36 AND 38).

FIRST USE 8-2-2004; IN COMMERCE 10-7-2004.
ANDREA HACK, EXAMINING ATTORNEY

SN 85-359,302. BAEZ, MARK ANTHONY, SANTA MONICA, CA. FILED 6-29-2011.

cloud

THE MARK CONSISTS OF STANDARD CHARACTERS WITHOUT CLAIM TO ANY PARTICULAR FONT, STYLE, SIZE, OR COLOR.

FOR COMPACT DISCS FEATURING MUSIC; DIGITAL MUSIC DOWNLOADABLE FROM THE INTERNET (U.S. CLS. 21, 23, 26, 36 AND 38).

AHSEN KHAN, EXAMINING ATTORNEY

SN 85-361,090. THE CIVIL WARS, LLC, DBA THE CIVIL WARS, NASHVILLE, TX. FILED 6-30-2011.

The Civil Wars

THE MARK CONSISTS OF STANDARD CHARACTERS WITHOUT CLAIM TO ANY PARTICULAR FONT, STYLE, SIZE, OR COLOR.

FOR DIGITAL MEDIA, NAMELY, PRE-RECORDED VIDEO CASSETTES, DIGITAL VIDEO DISCS, DIGITAL VIDEO DISCS, DIGITAL VERSATILE DISCS, DOWNLOADABLE AUDIO AND VIDEO RECORDINGS, DVDS, AND HIGH-DEFINITION DISCS FEATURING MUSICAL PERFORMANCES; PRE-RECORDED CDS FEATURING MUSICAL PERFORMANCES; PRE-RECORDED CDS, VIDEO TAPES, LASER DISCS AND DVDS FEATURING MUSICAL PERFORMANCES; SOUND RECORDINGS FEATURING MUSICAL PERFORMANCES (U.S. CLS. 21, 23, 26, 36 AND 38).

FIRST USE 11-15-2009; IN COMMERCE 11-15-2009.
DOMINIC J. FERRAIUOLO, EXAMINING ATTORNEY

CLASS 9—(Continued).

SN 85-364,042. COPPERGATE COMMUNICATIONS LTD., TEL AVIV, ISRAEL, FILED 7-6-2011.

Clear Path

THE MARK CONSISTS OF STANDARD CHARACTERS WITHOUT CLAIM TO ANY PARTICULAR FONT, STYLE, SIZE, OR COLOR.

FOR COMPUTER CHIPSET FOR NETWORKING HOME COMPUTER AND ELECTRONIC DEVICES, FOR THE TRANSMISSION OF ENTERTAINMENT, VIDEO, AUDIO AND DATA THROUGHOUT THE HOME OVER EXISTING ELECTRICAL WIRING, UTILIZING ALL THREE WIRES IN A POWER OUTLET (U.S. CLS. 21, 23, 26, 36 AND 38).

KIMBERLY FRYE, EXAMINING ATTORNEY

SN 85-364,299. GLEASON, JASON, VERONA, NJ. FILED 7-6-2011.

Old Wives

THE MARK CONSISTS OF STANDARD CHARACTERS WITHOUT CLAIM TO ANY PARTICULAR FONT, STYLE, SIZE, OR COLOR.

FOR AUDIO AND VIDEO RECORDINGS FEATURING MUSIC AND ARTISTIC PERFORMANCES (U.S. CLS. 21, 23, 26, 36 AND 38).

FIRST USE 8-9-2007; IN COMMERCE 1-1-2008.
FONG HSU, EXAMINING ATTORNEY

SN 85-365,398. ZHEJIANG YUHUI SOLAR ENERGY SOURCE CO., LTD., JIAXING CITY, CHINA, FILED 7-7-2011.

Virtus Module

THE MARK CONSISTS OF STANDARD CHARACTERS WITHOUT CLAIM TO ANY PARTICULAR FONT, STYLE, SIZE, OR COLOR.

NO CLAIM IS MADE TO THE EXCLUSIVE RIGHT TO USE "MODULE", APART FROM THE MARK AS SHOWN.

FOR MONOCRYSTALLINE SILICON WAFERS; POLY-CRYSTALLINE SILICON WAFERS; PHOTOVOLTAIC CELLS; ELECTRIC CONTROL PANELS; ELECTRIC ACCUMULATORS FOR VEHICLES; ACCUMULATOR BOXES; SOLAR BATTERIES; GALVANIC BATTERIES; PLATES FOR BATTERIES; ACCUMULATOR JARS; PHOTOVOLTAIC SOLAR MODULES FOR PRODUCTION OF ELECTRICITY (U.S. CLS. 21, 23, 26, 36 AND 38).

FIRST USE 4-29-2011; IN COMMERCE 4-29-2011.
EMILY CHUO, EXAMINING ATTORNEY

CLASS 9—(Continued).

SN 85-365,884. RITA ORA, NEW YORK, NY. FILED 7-7-2011.

CLASS 9—(Continued).

SN 85-367,081. ORACLE INTERNATIONAL CORPORATION, REDWOOD SHORES, CA. FILED 7-8-2011.

RITA ORA

SUPERCLUSTER

THE MARK CONSISTS OF STANDARD CHARACTERS WITHOUT CLAIM TO ANY PARTICULAR FONT, STYLE, SIZE, OR COLOR.

THE NAME(S), PORTRAIT(S), AND/OR SIGNATURE(S) SHOWN IN THE MARK IDENTIFIES "RITA ORA", WHOSE CONSENT(S) TO REGISTER IS MADE OF RECORD.

FOR AUDIO AND VIDEO RECORDINGS FEATURING MUSIC; DOWNLOADABLE RINGTONES (U.S. CLS. 21, 23, 26, 36 AND 38).

FIRST USE 4-12-2010; IN COMMERCE 4-12-2010.
KAREN K. BUSH, EXAMINING ATTORNEY

THE MARK CONSISTS OF STANDARD CHARACTERS WITHOUT CLAIM TO ANY PARTICULAR FONT, STYLE, SIZE, OR COLOR.

PRIORITY CLAIMED UNDER SEC. 44(D) ON FED REP GERMANY APPLICATION NO. 302011000703, FILED 1-25-2011.

FOR COMPUTER HARDWARE; COMPUTER OPERATING SYSTEM AND UTILITY SOFTWARE; COMPUTER OPERATING SOFTWARE; COMPUTER PROGRAMS FOR USE IN COMPUTER NETWORKING; COMPUTER PROGRAMS FOR USE IN COMPUTER SECURITY; SOFTWARE FOR USE IN STORAGE, MANAGEMENT, ANALYSIS AND OPTIMIZATION OF DATA WAREHOUSES AND VERY LARGE DATABASES; COMPUTER SOFTWARE FOR DATABASE MANAGEMENT; COMPUTER PROGRAMS USED IN ACCESSING DATABASES (U.S. CLS. 21, 23, 26, 36 AND 38).

JOHN HWANG, EXAMINING ATTORNEY

SN 85-366,528. PRABAL GURUNG, LLC, NEW YORK, NY. FILED 7-8-2011.

SN 85-368,604. MINDKONTROL INDUSTRIES LLC, SAN JOSE, CA. FILED 7-12-2011.

PRABAL GURUNG

MINDKONTROL

THE MARK CONSISTS OF STANDARD CHARACTERS WITHOUT CLAIM TO ANY PARTICULAR FONT, STYLE, SIZE, OR COLOR.

OWNER OF U.S. REG. NO. 4,009,030.
THE NAME(S), PORTRAIT(S), AND/OR SIGNATURE(S) SHOWN IN THE MARK IDENTIFIES "PRABAL GURUNG", WHOSE CONSENT(S) TO REGISTER IS MADE OF RECORD.

THE WORDING "PRABAL GURUNG" HAS NO MEANING IN A FOREIGN LANGUAGE.

FOR EYEWEAR, NAMELY, SUNGLASSES AND FRAMES FOR EYEGLASSES; EYEWEAR CASES (U.S. CLS. 21, 23, 26, 36 AND 38).

COLLEEN KEARNEY, EXAMINING ATTORNEY

THE MARK CONSISTS OF STANDARD CHARACTERS WITHOUT CLAIM TO ANY PARTICULAR FONT, STYLE, SIZE, OR COLOR.

FOR COMPUTER HARDWARE AND SOFTWARE THAT ENABLES USERS TO PARTICIPATE IN TELEPRESENCE CONFERENCING, VIDEO CONFERENCING, TELECOMMUNICATIONS, NAMELY, TELECONFERENCES, TELEPHONE COMMUNICATION AND WEB CONFERENCING AND INTERACTIVE VIRTUAL REALITIES (U.S. CLS. 21, 23, 26, 36 AND 38).

KAREN BRACEY, EXAMINING ATTORNEY

CLASS 9—(Continued).

SN 85-368,608. MINDKONTROL INDUSTRIES LLC, SAN JOSE, CA. FILED 7-12-2011.

TELEMERSION

THE MARK CONSISTS OF STANDARD CHARACTERS WITHOUT CLAIM TO ANY PARTICULAR FONT, STYLE, SIZE, OR COLOR.

FOR COMPUTER HARDWARE AND SOFTWARE THAT ENABLES USERS TO PARTICIPATE IN TELEPRESENCE CONFERENCING, VIDEO CONFERENCING, TELECOMMUNICATIONS, NAMELY, TELECONFERENCES, TELEPHONE COMMUNICATION, WEB CONFERENCING AND INTERACTIVE VIRTUAL REALITIES (U.S. CLS. 21, 23, 26, 36 AND 38).

KAREN BRACEY, EXAMINING ATTORNEY

SN 85-368,948. CLUB SPEED, INC., IRVINE, CA. FILED 7-12-2011.

Speedticket

THE MARK CONSISTS OF STANDARD CHARACTERS WITHOUT CLAIM TO ANY PARTICULAR FONT, STYLE, SIZE, OR COLOR.

FOR COMPUTER SOFTWARE FOR TICKET VALIDATION, PATRON ACCESS CONTROL, EVENT BOOKING, AND RACING TIMING FOR USE IN MOTORSPORTS AND SPORTING VENUE MANAGEMENT (U.S. CLS. 21, 23, 26, 36 AND 38).

FIRST USE 1-1-2011; IN COMMERCE 6-1-2011.
REBECCA SMITH, EXAMINING ATTORNEY

SN 85-370,070. BABOO, INC., TORRANCE, CA. FILED 7-13-2011.

BABOOSHKA

THE MARK CONSISTS OF STANDARD CHARACTERS WITHOUT CLAIM TO ANY PARTICULAR FONT, STYLE, SIZE, OR COLOR.

THE ENGLISH TRANSLATION OF "BABOOSHKA" IN THE MARK IS "GRANDMOTHER".

FOR DOWNLOADABLE VIRTUAL GOODS, NAMELY, COMPUTER PROGRAMS FEATURING ARTICLES OF CLOTHING, FURNITURE, DECORATIONS, FURNITURE, FURNISHINGS, GAMES, AVATARS, ART, TOYS, MASKS, VEHICLES, FANTASY ANIMALS, TOOLS, TREES AND SHRUBS, PLANTS, FISH SUPPLIES AND EQUIPMENT, BATHROOM FIXTURES, KITCHEN FIXTURES, VIRTUAL CURRENCY, COUPONS, TICKETS, AND OTHER CONSUMER GOODS FOR USE IN ONLINE VIRTUAL WORLDS (U.S. CLS. 21, 23, 26, 36 AND 38).

GISELLE AGOSTO, EXAMINING ATTORNEY

CLASS 9—(Continued).

SN 85-371,216. BEARY, WESLEY RAPHAEL, IOWA CITY, IA. FILED 7-14-2011.

fog

THE MARK CONSISTS OF STANDARD CHARACTERS WITHOUT CLAIM TO ANY PARTICULAR FONT, STYLE, SIZE, OR COLOR.

FOR COMPUTER SOFTWARE FOR INTERACTING WITH CLOUD SERVICES, NAMELY, PROVIDING DATA ACCESS AND PORTABILITY FOR DEPLOYING, MANAGING AND DEVELOPING APPLICATIONS ON AND ACROSS MULTIPLE CLOUD COMPUTING INFRASTRUCTURE SERVICES (U.S. CLS. 21, 23, 26, 36 AND 38).

FIRST USE 5-18-2009; IN COMMERCE 5-18-2009.
THOMAS MANOR, EXAMINING ATTORNEY

SN 85-372,068. SHENZHEN YONGNUO PHOTOGRAPHIC EQUIPMENT CO., LTD., SHENZHEN, CHINA, FILED 7-15-2011.

YONGNUO

OWNER OF U.S. REG. NO. 3,882,063.

THE MARK CONSISTS OF STYLIZED WORD "YONGNUO".

THE ENGLISH TRANSLATION OF "YONGNUO" IN THE MARK IS ETERNAL PROMISE.

FOR BAGS FOR CAMERAS AND PHOTOGRAPHIC EQUIPMENT; CAMERAS; CASES FOR PHOTOGRAPHIC APPARATUS; DRYING RACKS FOR PHOTOGRAPHY; FLASHLIGHTS FOR USE IN PHOTOGRAPHY; PHOTOGRAPHIC FILTERS; SHUTTER RELEASES; SHUTTERS; SPEED INDICATORS; STANDS FOR PHOTOGRAPHIC APPARATUS (U.S. CLS. 21, 23, 26, 36 AND 38).

FIRST USE 3-19-2009; IN COMMERCE 3-19-2009.
HOWARD SMIGA, EXAMINING ATTORNEY

CLASS 9—(Continued).

SN 85-372,208. FOOTWEAR INDUSTRIES PTY LTD, MALAGA, WA, AUSTRALIA, FILED 7-15-2011.



OWNER OF U.S. REG. NOS. 3,017,700 AND 3,369,565.
NO CLAIM IS MADE TO THE EXCLUSIVE RIGHT TO USE "STEEL" AND "100% COMFORT", APART FROM THE MARK AS SHOWN.

THE MARK CONSISTS OF A STYLIZED DOG HEAD ABOVE THE WORD "STEEL" WITHIN A RECTANGLE ABOVE THE WORD "BLUE" ABOVE "100% COMFORT".

FOR PROTECTIVE INDUSTRIAL FOOTWEAR; SAFETY FOOTWEAR, SAFETY BOOTS AND SAFETY SHOES, ALL FOR PROTECTION AGAINST ACCIDENTS; FOOTWEAR FOR PROTECTION AGAINST ACCIDENTS, IRRADIATION AND FIRE, NAMELY, BOOTS AND SHOES FOR PROTECTION AGAINST ACCIDENTS FOR USE IN INDUSTRY; BOOTS AND SHOES FOR PROTECTION AGAINST ACCIDENTS FOR USE AT WORK; ALL OF THE FOREGOING IN WHOLE OR SIGNIFICANT PART OF STEEL (U.S. CLS. 21, 23, 26, 36 AND 38).
MYRIAH HABEEB, EXAMINING ATTORNEY

SN 85-373,013. SANDISK CORPORATION, MILPITAS, CA. FILED 7-15-2011.

SANDISK MOBILE EXTREME PRO

THE MARK CONSISTS OF STANDARD CHARACTERS WITHOUT CLAIM TO ANY PARTICULAR FONT, STYLE, SIZE, OR COLOR.

OWNER OF U.S. REG. NOS. 2,036,202, 2,964,378 AND OTHERS.

NO CLAIM IS MADE TO THE EXCLUSIVE RIGHT TO USE "MOBILE" AND "PRO", APART FROM THE MARK AS SHOWN.

FOR FLASH MEMORY CARDS FOR USE WITH WIRELESS MOBILE TELEPHONES AND OTHER PORTABLE TELECOMMUNICATION DEVICES (U.S. CLS. 21, 23, 26, 36 AND 38).

CHRIS WELLS, EXAMINING ATTORNEY

CLASS 9—(Continued).

SN 85-373,015. SANDISK CORPORATION, MILPITAS, CA. FILED 7-15-2011.

SANDISK MOBILE EXTREME

THE MARK CONSISTS OF STANDARD CHARACTERS WITHOUT CLAIM TO ANY PARTICULAR FONT, STYLE, SIZE, OR COLOR.

OWNER OF U.S. REG. NOS. 2,036,202, 2,964,378 AND OTHERS.

NO CLAIM IS MADE TO THE EXCLUSIVE RIGHT TO USE "MOBILE", APART FROM THE MARK AS SHOWN.

FOR FLASH MEMORY CARDS FOR USE WITH WIRELESS MOBILE TELEPHONES AND OTHER PORTABLE TELECOMMUNICATION DEVICES (U.S. CLS. 21, 23, 26, 36 AND 38).

CHRIS WELLS, EXAMINING ATTORNEY

SN 85-373,489. VERTIFI SOFTWARE, LLC, BURLINGTON, MA. FILED 7-18-2011.

VERTIFI SOFTWARE

THE MARK CONSISTS OF STANDARD CHARACTERS WITHOUT CLAIM TO ANY PARTICULAR FONT, STYLE, SIZE, OR COLOR.

NO CLAIM IS MADE TO THE EXCLUSIVE RIGHT TO USE "SOFTWARE", APART FROM THE MARK AS SHOWN.

FOR DOWNLOADABLE COMPUTER SOFTWARE IN THE NATURE OF A MOBILE APPLICATION TO ENABLE CUSTOMERS OF FINANCIAL INSTITUTIONS TO ACCESS BANK ACCOUNT INFORMATION, CONDUCT BANKING TRANSACTIONS AND MAKE DEPOSITS REMOTELY; COMPUTER SOFTWARE FOR FINANCIAL INSTITUTIONS TO PROCESS CHECKS AND OTHER FINANCIAL INSTRUMENTS; COMPUTER SOFTWARE FOR FINANCIAL INSTITUTIONS TO PROCESS CHECKS AND LOANS; COMPUTER SOFTWARE FOR FINANCIAL INSTITUTIONS TO DOWNLOAD IMAGES OF CHECKS AND BANK STATEMENTS (U.S. CLS. 21, 23, 26, 36 AND 38).

FIRST USE 12-1-2009; IN COMMERCE 12-1-2009.

DEIRDRE ROBERTSON, EXAMINING ATTORNEY

CLASS 9—(Continued).

SN 85-373,742. PROTEINSIMPLE, SANTA CLARA, CA. FILED 7-18-2011.

PROTEINSIMPLE

THE MARK CONSISTS OF STANDARD CHARACTERS WITHOUT CLAIM TO ANY PARTICULAR FONT, STYLE, SIZE, OR COLOR.

FOR PROTEIN ANALYSIS EQUIPMENT COMPRISED OF COMPUTER HARDWARE, SOFTWARE, AND DISPLAY SCREENS FOR PROTEIN DETECTION, IMAGING, AND QUANTITATIVE ANALYSIS FOR USE IN GENETIC RESEARCH, ANTIBODY RESEARCH, BIOMARKER DISCOVERY, AND BIOTHERAPEUTICS PRODUCTION; LABORATORY APPARATUS, NAMELY, PROTEIN SAMPLE FRACTIONATORS (U.S. CLS. 21, 23, 26, 36 AND 38).

RICHARD WHITE, EXAMINING ATTORNEY

SN 85-373,969. ASUSTEK COMPUTER INCORPORATION, PEI TOU, TAIPEI, TAIWAN, FILED 7-18-2011.

Dark Knight

PRIORITY CLAIMED UNDER SEC. 44(D) ON TAIWAN APPLICATION NO. 100035004, FILED 7-12-2011, REG. NO. 01509074, DATED 3-16-2012, EXPIRES 3-15-2022.

THE MARK CONSISTS OF THE WORD "DARK" AND THE WORD "KNIGHT", BOTH IN STYLIZED LETTERING, THE TWO WORDS SEPARATED BY AN EMPTY SPACE. IN THE FIRST WORD, THE LETTER "D" IS IN UPPER CASE, FOLLOWED BY THE LETTERS "A", "R", AND "K", ALL IN LOWER CASE WITHOUT SPACING BETWEEN THESE LETTERS. AFTER AN EMPTY SPACE, THE SECOND WORD BEGINS WITH THE LETTER "K" IN UPPER CASE, FOLLOWED BY THE LETTERS "N", "I", "G", "H", AND "T", ALL IN LOWER CASE WITHOUT SPACING BETWEEN THESE LETTERS.

FOR COMPUTER NETWORK SERVER; COMPUTER EQUIPMENT, NAMELY, WIRELESS CARDS; ETHERNET TRANSCIEVERS; COMPUTER HARDWARE, NAMELY, WIRELESS NETWORK REPEATERS; NETWORK ROUTERS; COMPUTER NETWORK SWITCHES; COMPUTER NETWORK BRIDGES; COMPUTER NETWORK HUBS (U.S. CLS. 21, 23, 26, 36 AND 38).

ELIZABETH KAJUBI, EXAMINING ATTORNEY

CLASS 9—(Continued).

SN 85-377,941. SADDLEBACK EDUCATIONAL, INC., COSTA MESA, CA. FILED 7-21-2011.

21ST CENTURY LIFESKILLS

THE MARK CONSISTS OF STANDARD CHARACTERS WITHOUT CLAIM TO ANY PARTICULAR FONT, STYLE, SIZE, OR COLOR.

NO CLAIM IS MADE TO THE EXCLUSIVE RIGHT TO USE "LIFE SKILLS", APART FROM THE MARK AS SHOWN.

FOR DOWNLOADABLE ELECTRONIC PUBLICATIONS, IN THE NATURE OF ELECTRONIC BOOKS, WORKBOOKS, HANDBOOKS, AND TEACHER'S GUIDES IN THE FIELD OF REMEDIAL EDUCATION FOR SECONDARY AND ADULT EDUCATION (U.S. CLS. 21, 23, 26, 36 AND 38).

JULIE GUTTADAURO, EXAMINING ATTORNEY

SN 85-378,880. VITA PLUS CORPORATION, MADISON, WI. FILED 7-22-2011.

DAIRY PULSE

THE MARK CONSISTS OF STANDARD CHARACTERS WITHOUT CLAIM TO ANY PARTICULAR FONT, STYLE, SIZE, OR COLOR.

NO CLAIM IS MADE TO THE EXCLUSIVE RIGHT TO USE "DAIRY", APART FROM THE MARK AS SHOWN.

FOR COMPUTER SOFTWARE THAT PROVIDES WEB-BASED ACCESS TO APPLICATIONS AND SERVICES THROUGH A WEB OPERATING SYSTEM OR PORTAL INTERFACE, NAMELY, A COMPUTER PROGRAM FOR THE ELECTRONIC STORAGE AND DISPLAY OF DATA THAT PROVIDES DAIRY OWNERS, MANAGEMENT TEAMS AND KEY PERSONNEL WITH WEB-BASED, REAL-TIME MANAGEMENT IN AN INTEGRATED ENVIRONMENT BY MULTIPLE FRAGMENTED OPERATIONAL DATA SOURCES AND INTEGRATING THEM FOR RESPONSIBLE MONITORING, DECISION MAKING AND BUSINESS PROJECTIONS (U.S. CLS. 21, 23, 26, 36 AND 38).

AMY C. KEAN, EXAMINING ATTORNEY

CLASS 9—(Continued).

SN 85-380,440. IGNER, JONATHAN M., DBA FREEV, CALABASAS, CA. FILED 7-25-2011.

freEV

THE MARK CONSISTS OF STANDARD CHARACTERS WITHOUT CLAIM TO ANY PARTICULAR FONT, STYLE, SIZE, OR COLOR.

FOR COMPUTER APPLICATION SOFTWARE FOR MOBILE DIGITAL DEVICES, NAMELY, SOFTWARE THAT ALLOWS USERS OF ELECTRIC VEHICLES TO ACCESS COUPONS, REBATES, DISCOUNT INFORMATION, PRICE-COMPARISON INFORMATION, AND RETAIL LOCATIONS OF OTHERS OFFERING COMMERCIAL CHARGING AT THEIR PLACES OF BUSINESS (U.S. CLS. 21, 23, 26, 36 AND 38).

ALICE BENMAMAN, EXAMINING ATTORNEY

SN 85-381,317. SEMTECH CORPORATION, CAMARILLO, CA. FILED 7-26-2011.



NO CLAIM IS MADE TO THE EXCLUSIVE RIGHT TO USE "TOUCH", APART FROM THE MARK AS SHOWN.

THE MARK CONSISTS OF THE NUMERAL "4" WITH ARROWS ON THE END OF EACH LINE COMPRISING THE NUMBER, DIRECTLY TO THE LEFT OF THE LETTER "D" WITH THE WORD "TOUCH" IN STYLIZED FORM IN THE CENTER OF THE LETTER "D" AND EXTENDING OUT TO THE RIGHT THEREOF.

FOR SEMICONDUCTORS FOR USE AS COMPONENTS IN CONSUMER ELECTRONIC PRODUCTS (U.S. CLS. 21, 23, 26, 36 AND 38).

LAURA KOVALSKY, EXAMINING ATTORNEY

CLASS 9—(Continued).

SN 85-382,351. SMA SOLAR TECHNOLOGY AG, NIESTETAL, FED REP GERMANY, FILED 7-27-2011.



THE COLOR(S) LIGHT BLUE, BLUE, GRAY, WHITE, AND RED IS/ARE CLAIMED AS A FEATURE OF THE MARK.

THE MARK CONSISTS OF A LIGHT BLUE MAGNIFYING GLASS WITH GRAY SHADING WITH A WHITE AND GRAY SHADED BORDER AND HANDLE SHOWN IN FRONT OF A CURVED RECTANGLE DIVIDED INTO THREE SECTIONS. THE TOP SECTION IS BLUE AND THE BOTTOM SECTION IS RED, AND THERE IS A THICK, CURVED WHITE LINE BETWEEN EACH SECTION.

FOR DOWNLOADABLE COMPUTER SOFTWARE IN THE NATURE OF A DESKTOP, LAPTOP, OR NET BOOK APPLICATION FOR COMMUNICATING WITH INVERTERS; OPTICAL DISPLAYS, NAMELY, DISPLAYS FOR INVERTERS IN PHOTOVOLTAIC UNITS (U.S. CLS. 21, 23, 26, 36 AND 38).

DARRYL SPRUILL, EXAMINING ATTORNEY

SN 85-384,160. MAPTEK PTY LTD, GLENSIDE SA, AUSTRALIA, FILED 7-29-2011.

BlastLogic

THE MARK CONSISTS OF STANDARD CHARACTERS WITHOUT CLAIM TO ANY PARTICULAR FONT, STYLE, SIZE, OR COLOR.

PRIORITY CLAIMED UNDER SEC. 44(D) ON AUSTRALIA APPLICATION NO. 1408851, FILED 2-24-2011.

FOR COMPUTER SOFTWARE, NAMELY, DRILLING AND BLAST ACCURACY MANAGEMENT SOFTWARE FOR USE IN THE MINING INDUSTRY; MINE MODELING SOFTWARE; DRILLING AND BLAST OPERATIONS PLANNING AND EVALUATION SOFTWARE FOR THE MINING INDUSTRY (U.S. CLS. 21, 23, 26, 36 AND 38).

BARBARA GAYNOR, EXAMINING ATTORNEY

CLASS 9—(Continued).

SN 85-385,295. ITTAVI, INC, DBA ITTAVI, SANTA CLARA, CA. FILED 7-30-2011.

Ittavi

THE MARK CONSISTS OF STANDARD CHARACTERS WITHOUT CLAIM TO ANY PARTICULAR FONT, STYLE, SIZE, OR COLOR.

FOR COMPUTER SOFTWARE FOR SINGLE PARENTS USED TO MANAGE CHILD SUPPORT AND SPOUSAL SUPPORT PAYMENTS AND FOR TRACKING CHILD VISITATION SCHEDULES (U.S. CLS. 21, 23, 26, 36 AND 38).

BRENDAN MCCAULEY, EXAMINING ATTORNEY

SN 85-395,305. AMERICAN MICROWAVE CORPORATION, FREDERICK, MD. FILED 8-11-2011.

American Microwave Corporation

THE MARK CONSISTS OF STANDARD CHARACTERS WITHOUT CLAIM TO ANY PARTICULAR FONT, STYLE, SIZE, OR COLOR.

NO CLAIM IS MADE TO THE EXCLUSIVE RIGHT TO USE "MICROWAVE CORPORATION", APART FROM THE MARK AS SHOWN.

SEC. 2(F).

FOR ELECTRONIC SWITCHES; ATTENUATORS (U.S. CLS. 21, 23, 26, 36 AND 38).

FIRST USE 9-1-1978; IN COMMERCE 9-1-1978.

APRIL ROACH, EXAMINING ATTORNEY

SN 85-397,194. VITA ZAHNFABRIK H. RAUTER GMBH & CO. KG, BAD SACKINGEN, FED REP GERMANY, FILED 8-12-2011.

VITA ShadeAssist

THE MARK CONSISTS OF STANDARD CHARACTERS WITHOUT CLAIM TO ANY PARTICULAR FONT, STYLE, SIZE, OR COLOR.

OWNER OF FED REP GERMANY REG. NO. 302009034801, DATED 10-22-2009, EXPIRES 6-30-2019.

OWNER OF U.S. REG. NOS. 873,134, 2,909,972 AND OTHERS.

FOR COMMUNICATION SOFTWARE FOR DENTAL PURPOSES, NAMELY, FOR DETAILED TOOTH COLOR PRESCRIPTION, CASE PLANNING AND PATIENT DATA STORAGE (U.S. CLS. 21, 23, 26, 36 AND 38).

CHRISTOPHER SIDOTI, EXAMINING ATTORNEY

CLASS 9—(Continued).

SN 85-397,633. ENTHENERGY, LLC, INDIANAPOLIS, IN. FILED 8-15-2011.

SUBMITS

THE MARK CONSISTS OF STANDARD CHARACTERS WITHOUT CLAIM TO ANY PARTICULAR FONT, STYLE, SIZE, OR COLOR.

FOR LIQUID CRYSTAL DISPLAY MONITORS FOR ENERGY MANAGEMENT (U.S. CLS. 21, 23, 26, 36 AND 38).

NICHOLAS COLEMAN, EXAMINING ATTORNEY

SN 85-399,212. WAL-MART STORES, INC., BENTONVILLE, AR. FILED 8-16-2011.

WALMART FAMILY MOBILE

THE MARK CONSISTS OF STANDARD CHARACTERS WITHOUT CLAIM TO ANY PARTICULAR FONT, STYLE, SIZE, OR COLOR.

OWNER OF U.S. REG. NOS. 1,783,039, 3,612,345 AND OTHERS.

NO CLAIM IS MADE TO THE EXCLUSIVE RIGHT TO USE "MOBILE", APART FROM THE MARK AS SHOWN.

FOR AUDIO HEADPHONES; BATTERIES AND BATTERY CHARGERS (U.S. CLS. 21, 23, 26, 36 AND 38).

SUSAN RICHARDS, EXAMINING ATTORNEY

SN 85-399,251. WAL-MART STORES, INC., BENTONVILLE, AR. FILED 8-16-2011.

WALMART FAMILY MOBILE

THE MARK CONSISTS OF STANDARD CHARACTERS WITHOUT CLAIM TO ANY PARTICULAR FONT, STYLE, SIZE, OR COLOR.

OWNER OF U.S. REG. NOS. 1,783,039, 3,162,345 AND OTHERS.

NO CLAIM IS MADE TO THE EXCLUSIVE RIGHT TO USE "MOBILE", APART FROM THE MARK AS SHOWN.

FOR CLEAR PROTECTIVE COVERS SPECIALLY ADAPTED FOR PERSONAL ELECTRONIC DEVICES; WIRELESS CELLULAR PHONE HEADSETS; WIRELESS TELEPHONES; WIRELESS TELEPHONY APPARATUS (U.S. CLS. 21, 23, 26, 36 AND 38).

SUSAN RICHARDS, EXAMINING ATTORNEY

CLASS 9—(Continued).

SN 85-399,679. SANDISK CORPORATION, MILPITAS, CA. FILED 8-16-2011.

CONNECTING YOUR MEMORIES

THE MARK CONSISTS OF STANDARD CHARACTERS WITHOUT CLAIM TO ANY PARTICULAR FONT, STYLE, SIZE, OR COLOR.

FOR SEMICONDUCTOR MEMORY DEVICES, NAMELY, INTEGRATED CIRCUITS, ELECTRONIC CIRCUIT CARDS AND CARTRIDGES, AND OTHER SEMICONDUCTOR DEVICES, NAMELY, FLASH AND NON-FLASH MEMORY CARDS, CARTRIDGES, MEMORY CARD ADAPTERS, CONVERTERS, MEMORY CARD CONTROLLERS, MEMORY CARD PLAYERS, MEMORY CARD READERS, STORAGE MODULES IN THE NATURE OF BLANK FLASH MEMORY CARDS, AND COMPUTER PERIPHERALS; PRELOADED MEMORY CARDS FEATURING AUDIO AND VIDEO CONTENT; PORTABLE AUDIO AND VIDEO PLAYERS/RECORDERS WHICH USE SEMICONDUCTOR DEVICES AS RECORDING MEDIA; AND COMPUTER OPERATING PROGRAMS FOR SEMICONDUCTOR MEMORY DEVICES; DOWNLOADABLE SOFTWARE AND SOFTWARE RECORDED ON DATA MEDIA, NAMELY, COMPUTER OPERATING SOFTWARE; SOFTWARE FOR THE INTEGRATION OF DIGITAL FILES INTO AN INTERACTIVE DELIVERY PLATFORM FOR MULTIMEDIA APPLICATIONS; SOFTWARE FOR DOWNLOADING, VIEWING, LISTENING TO, AND RETRANSMITTING DIGITAL FILES FROM THE INTERNET; SOFTWARE FOR TRANSMISSION OF DIGITAL FILES AND DOWNLOADED CONTENT FROM ANY STORAGE DEVICE TO ANY ELECTRONIC COMMUNICATIONS INSTRUMENT AND BETWEEN SUCH INSTRUMENTS; MOBILE APPLICATION SOFTWARE THAT ALLOWS USERS TO MANAGE AND TRANSFER DIGITAL DATA (U.S. CLS. 21, 23, 26, 36 AND 38).

CHRIS WELLS, EXAMINING ATTORNEY

SN 85-401,780. SANDISK CORPORATION, MILPITAS, CA. FILED 8-18-2011.

CHRONOLOCK

THE MARK CONSISTS OF STANDARD CHARACTERS WITHOUT CLAIM TO ANY PARTICULAR FONT, STYLE, SIZE, OR COLOR.

FOR BLANK USB FLASH DRIVES; PRE-RECORDED USB FLASH DRIVES FEATURING SOFTWARE FOR SECURITY AND ENCRYPTION OF DATA; EXTERNAL COMPUTER HARD DRIVE WITH A USB CONNECTION; AND RELATED HARDWARE AND FIRMWARE FOR LONG TERM PRESERVATION OF DIGITAL FILES (U.S. CLS. 21, 23, 26, 36 AND 38).

CHRIS WELLS, EXAMINING ATTORNEY

CLASS 9—(Continued).

SN 85-408,304. ALOAUDIO LLC, PORTLAND, OR. FILED 8-26-2011.



OWNER OF U.S. REG. NOS. 3,780,834, 3,919,637 AND 3,919,902.

NO CLAIM IS MADE TO THE EXCLUSIVE RIGHT TO USE "CRYO TREATMENT", APART FROM THE MARK AS SHOWN.

THE COLOR(S) GREEN IS/ARE CLAIMED AS A FEATURE OF THE MARK.

THE MARK CONSISTS OF A 2PT LINE MAKES A CIRCLE ENCOMPASSING A HORIZONTAL RIGHT ORIENTED ARROW BISECTING THE CIRCLE AT THE MIDPOINT WITH THE ARROW HEAD PROTRUDING JUST PAST THE CIRCLE. A WAVE FORM LINE CROSSES THE ARROW LINE HORIZONTALLY. "ALO" IS WRITTEN ABOVE THE WAVE FORM LINE INSIDE THE CIRCLE. "CRYO-FI" IS WRITTEN BELOW THE WAVE FORM LINE INSIDE THE CIRCLE. "DEEP CRYO TREATMENT" IS WRITTEN OUTSIDE OF AND BELOW THE CIRCLE. ALL LINES AND LETTERING ARE GREEN COLOR. THE FONT IS SF THERAMIN GOTHIC.

FOR HOME THEATER SYSTEMS COMPRISING CRYOGENICALLY TREATED CABLES, INTERCONNECTS AND WIRE (U.S. CLS. 21, 23, 26, 36 AND 38).

FIRST USE 8-1-2011; IN COMMERCE 8-1-2011.

BRIAN NEVILLE, EXAMINING ATTORNEY

SN 85-412,677. CATALYST INC., NEW YORK, NY. FILED 9-1-2011.

CATALYST

THE MARK CONSISTS OF STANDARD CHARACTERS WITHOUT CLAIM TO ANY PARTICULAR FONT, STYLE, SIZE, OR COLOR.

OWNER OF U.S. REG. NO. 1,265,713.

FOR DOWNLOADABLE AUDIO FILES, VIDEO FILES, DATA FILES, AND ELECTRONIC PUBLICATIONS IN THE NATURE OF BOOKS, NEWSLETTERS, ARTICLES, AND REPORTS, AND DVDS AND CDS ALL FEATURING EDUCATIONAL AND TRAINING INFORMATION DEVOTED TO PROMOTING THE INTERESTS OF WOMEN, NAMELY, ISSUES OF GENDER DIVERSITY AND DIVERSITY AND INCLUSION IN THE WORKPLACE (U.S. CLS. 21, 23, 26, 36 AND 38).

FIRST USE 9-30-1980; IN COMMERCE 9-30-1980.

ROBERT STRUCK, EXAMINING ATTORNEY

CLASS 9—(Continued).

SN 85-417,784. WORDEN ENTERPRISES, INC., MIAMI, FL. FILED 9-8-2011.

POPCLIK

THE MARK CONSISTS OF STANDARD CHARACTERS WITHOUT CLAIM TO ANY PARTICULAR FONT, STYLE, SIZE, OR COLOR.

FOR CELLULAR TELEPHONES; CELLULAR TELEPHONE ACCESSORIES, NAMELY, BAGS, CASES, HEADSETS, EAR BUDS, BATTERIES, BATTERY CHARGERS, POWER ADAPTERS, AUTOMOBILE CHARGERS, FACE PLATES, BACK PLATES, CELLULAR TELEPHONE COVERS AND DEVICES FOR HANDS FREE USE OF CELLULAR TELEPHONES; CAMERAS; VIDEO CAMERAS; HAND HELD COMPUTERS; AND KEYPADS FOR HAND HELD COMPUTERS (U.S. CLS. 21, 23, 26, 36 AND 38).

ASMAT KHAN, EXAMINING ATTORNEY

SN 85-419,953. NEURONETICS, INC., MALVERN, PA. FILED 9-12-2011.

Neuro Guidance Positioning System

THE MARK CONSISTS OF STANDARD CHARACTERS WITHOUT CLAIM TO ANY PARTICULAR FONT, STYLE, SIZE, OR COLOR.

NO CLAIM IS MADE TO THE EXCLUSIVE RIGHT TO USE "NEURO" AND "POSITIONING SYSTEM", APART FROM THE MARK AS SHOWN.

FOR COMPUTER SOFTWARE FOR USE WITH TRANSCRANIAL MAGNETIC STIMULATION DEVICES; CAMERAS; COMPUTER HARDWARE (U.S. CLS. 21, 23, 26, 36 AND 38).

SKYE YOUNG, EXAMINING ATTORNEY

SN 85-420,592. RAININ INSTRUMENT, LLC, OAKLAND, CA. FILED 9-12-2011.

PureSpeed

THE MARK CONSISTS OF STANDARD CHARACTERS WITHOUT CLAIM TO ANY PARTICULAR FONT, STYLE, SIZE, OR COLOR.

FOR LABORATORY APPARATUS AND INSTRUMENTS, NAMELY, PIPETTES AND PIPETTE TIPS; LABWARE, SUPPLIES, AND ACCESSORIES FOR USE IN BIOMOLECULE SEPARATION, ISOLATION, AND PURIFICATION, NAMELY, MULTI-Well PLATES, PLATE BASES AND SUPPORTS, PIPETTE ADAPTERS, PIPETTING GUIDES, PIPETTING SOFTWARE AND FIRMWARE, AND COMPUTER STORAGE MEDIA CONTAINING PIPETTING SOFTWARE AND FIRMWARE (U.S. CLS. 21, 23, 26, 36 AND 38).

TARAH HARDY, EXAMINING ATTORNEY

CLASS 9—(Continued).

SN 85-421,964. JAVIER MILIAN, MIAMI LAKES, FL. FILED 9-13-2011.

Akros Labs

THE MARK CONSISTS OF STANDARD CHARACTERS WITHOUT CLAIM TO ANY PARTICULAR FONT, STYLE, SIZE, OR COLOR.

NO CLAIM IS MADE TO THE EXCLUSIVE RIGHT TO USE "LABS", APART FROM THE MARK AS SHOWN.

FOR KITS COMPRISING MICROCHIPS, MICRO-PROCESSORS, VOLTAGE REGULATORS, ELECTRIC RESISTORS, ELECTRIC WIRES, CAPACITATORS, AND CIRCUIT BOARDS FOR THE ASSEMBLY OF WIRED AND WIRELESS CONTROLLERS TO MONITOR AND CONTROL THE FUNCTIONING OF OTHER ELECTRONIC DEVICES, AND STRUCTURAL AND REPLACEMENT PARTS THEREOF (U.S. CLS. 21, 23, 26, 36 AND 38).

FIRST USE 6-15-2011; IN COMMERCE 6-15-2011.
JANET LEE, EXAMINING ATTORNEY

SN 85-422,596. MODELSHEET SOFTWARE, LLC, ARLINGTON, MA. FILED 9-14-2011.

ModelSheet

OWNER OF U.S. REG. NO. 3,541,620.

THE COLOR(S) DARK BLUE, LIGHT BLUE, GREEN, GRAY IS/ARE CLAIMED AS A FEATURE OF THE MARK.

THE MARK CONSISTS OF THE TERM "MODEL" IN DARK BLUE SAN SERIF FONT FOLLOWED WITHOUT A SPACE BY THE TERM "SHEET" IN GRAY IN THE SAME FONT. TO THE RIGHT OF THIS WORD IS A GRAPHICAL ELEMENT CONSISTING OF THREE ROWS OF COLORED RECTANGLES, WITH THREE DARK BLUE RECTANGLES ON TOP ROW, THREE LIGHT BLUE RECTANGLES IN THE MIDDLE ROW, AND THREE GREEN RECTANGLES IN THE BOTTOM ROW.

FOR COMPUTER SOFTWARE FOR AUTHORIZING AND CUSTOMIZING SPREADSHEETS AND TABLE AND GRAPHICAL REPORTS FOR QUANTITATIVE ANALYSIS IN BUSINESS, ENGINEERING AND OTHER FIELDS WITH A GRAPHICAL USER INTERFACE (U.S. CLS. 21, 23, 26, 36 AND 38).

FIRST USE 8-31-2011; IN COMMERCE 8-31-2011.
LESLEY LAMOTHE, EXAMINING ATTORNEY

CLASS 9—(Continued).

SN 85-423,151. ICON ENERGY SYSTEM CO., LTD, SHENZHEN, CHINA, FILED 9-15-2011.



THE COLOR(S) RED AND BLUE IS/ARE CLAIMED AS A FEATURE OF THE MARK.

THE MARK CONSISTS OF THE WORD "ECUBE" IN BLUE WITH THE LETTER "E" IN RED POSITIONED ATOP AND WITHIN THE LETTER "C".

FOR ACCUMULATOR JARS; BATTERIES, ELECTRIC, FOR VEHICLES; BATTERY BOXES; CHARGERS FOR ELECTRIC BATTERIES; DRY CELLS; DRY CELLS AND BATTERIES; ELECTRIC ACCUMULATORS; ELECTRIC ACCUMULATORS FOR VEHICLES; GRIDS FOR BATTERIES; HIGH TENSION BATTERIES; SOLAR BATTERIES (U.S. CLS. 21, 23, 26, 36 AND 38).

FIRST USE 12-18-2009; IN COMMERCE 11-18-2010.
JOHN WILKE, EXAMINING ATTORNEY

CLASS 9—(Continued).

SN 85-423,154. ICON ENERGY SYSTEM CO.,LTD, SHENZHEN, CHINA, FILED 9-15-2011.



THE COLOR(S) PURPLE AND RED IS/ARE CLAIMED AS A FEATURE OF THE MARK.

THE MARK CONSISTS OF THE LETTERS "IES" IN PURPLE WITH THE DOT ON THE "I" BEING RED, RINGED BY A PURPLE OVAL PASSING BETWEEN THE "I" AND "E" AND BEHIND THE "S".

FOR ACCUMULATOR JARS; BATTERIES, ELECTRIC, FOR VEHICLES; BATTERY BOXES; CHARGERS FOR ELECTRIC BATTERIES; DRY CELLS; DRY CELLS AND BATTERIES; ELECTRIC ACCUMULATORS; ELECTRIC ACCUMULATORS FOR VEHICLES; GRIDS FOR BATTERIES; HIGH TENSION BATTERIES; SOLAR BATTERIES (U.S. CLS. 21, 23, 26, 36 AND 38).

FIRST USE 12-18-2009; IN COMMERCE 11-18-2010.
JOHN WILKE, EXAMINING ATTORNEY

SN 85-423,904. SPERASOFT, INC., SANTA CLARA, CA. FILED 9-15-2011.

**WHEELS OF DESTRUCTION:
WORLD TOUR**

SN 85-423,152. ICON ENERGY SYSTEM CO., LTD, SHENZHEN, CHINA, FILED 9-15-2011.



THE MARK CONSISTS OF STANDARD CHARACTERS WITHOUT CLAIM TO ANY PARTICULAR FONT, STYLE, SIZE, OR COLOR.

FOR DOWNLOADABLE COMPUTER AND VIDEO GAME PROGRAMS; VIDEO AND COMPUTER GAME PROGRAMS (U.S. CLS. 21, 23, 26, 36 AND 38).

FIRST USE 5-15-2010; IN COMMERCE 5-15-2010.
DARRYL SPRUILL, EXAMINING ATTORNEY

SN 85-424,472. GATEWAY SAFETY, INC., CLEVELAND, OH. FILED 9-16-2011.

VARSIITY

THE COLOR(S) RED AND BLACK IS/ARE CLAIMED AS A FEATURE OF THE MARK.

THE MARK CONSISTS OF THE WORD "ICONERGY" IN BLACK OTHER THAN THE LETTER "E" BEING IN RED AND HAVING A CURVED TAIL EXTENDING UNDER THE LETTERS "ON".

FOR ACCUMULATOR JARS; BATTERIES, ELECTRIC, FOR VEHICLES; BATTERY BOXES; CHARGERS FOR ELECTRIC BATTERIES; DRY CELLS; DRY CELLS AND BATTERIES; ELECTRIC ACCUMULATORS; ELECTRIC ACCUMULATORS FOR VEHICLES; GRIDS FOR BATTERIES; HIGH TENSION BATTERIES; SOLAR BATTERIES (U.S. CLS. 21, 23, 26, 36 AND 38).

FIRST USE 12-18-2009; IN COMMERCE 11-18-2010.
JOHN WILKE, EXAMINING ATTORNEY

THE MARK CONSISTS OF STANDARD CHARACTERS WITHOUT CLAIM TO ANY PARTICULAR FONT, STYLE, SIZE, OR COLOR.

FOR PROTECTIVE EYEWEAR NOT FOR ATHLETIC PURPOSES (U.S. CLS. 21, 23, 26, 36 AND 38).

NELSON SNYDER, EXAMINING ATTORNEY

CLASS 9—(Continued).

SN 85-428,295. ITRACS CORPORATION, OAK BROOK, IL. FILED 9-21-2011.

PowerEye

THE MARK CONSISTS OF STANDARD CHARACTERS WITHOUT CLAIM TO ANY PARTICULAR FONT, STYLE, SIZE, OR COLOR.

FOR COMPUTER SOFTWARE FOR MANAGING, MONITORING, VISUALIZING AND OPTIMIZING DATA CENTER INFRASTRUCTURE AND ITS PERFORMANCE AND FOR CENTRALIZED CONTROL AND MANAGEMENT OF COMPUTING AND NETWORK DEVICES DISTRIBUTED THROUGHOUT AN ORGANIZATION PROVIDING NETWORKING AND STORAGE (U.S. CLS. 21, 23, 26, 36 AND 38).

LESLEY LAMOTHE, EXAMINING ATTORNEY

CLASS 9—(Continued).

SN 85-433,733. SICK AG, WALDKIRCH, FED REP GERMANY, FILED 9-28-2011.

DELTA-S-TECHNOLOGY

THE MARK CONSISTS OF STANDARD CHARACTERS WITHOUT CLAIM TO ANY PARTICULAR FONT, STYLE, SIZE, OR COLOR.

PRIORITY CLAIMED UNDER SEC. 44(D) ON ERPNCMNTY TM OFC APPLICATION NO. 009950205, FILED 5-9-2011, REG. NO. 009950205, DATED 10-13-2011, EXPIRES 10-13-2021.

FOR OPTICAL, OPTO-ELECTRONIC AND PHOTO-ELECTRIC SENSORS FOR SENSING LIGHT AND LIGHT REFLECTED BY OBJECTS; LIGHT BARRIERS, LIGHT SCANNERS, SAFETY LIGHT GRIDS AND LIGHT GRIDS FOR MEASURING OBJECT DIMENSIONS; OPTICAL, OPTO-ELECTRONIC, AND PHOTO-ELECTRIC SENSORS FOR USE IN RECOGNIZING THE SHAPE, POSITION, CONTOUR, VOLUME, DISTANCE, TEXTURE OR SURFACE CHARACTERISTICS OF ARTICLES FOR THE PURPOSE OF AUTOMATIC INSPECTION, FOR INSPECTION OF PLAIN OR WEB-LIKE MATERIALS AND CHECKING THE CHARACTERISTICS OF SUCH MATERIALS, FOR FAULT RECOGNITION, FOR AUTOMATIC IDENTIFICATION, QUALITY CONTROL, POSITIONING, HANDLING AND CONTROL OF ARTICLES, AND FOR THE PURPOSE OF AUTOMATION IN THE FIELDS OF MANUFACTURE, QUALITY CONTROL, STORAGE, FLOW OF GOODS, SALES, TRANSPORT, LABORATORY, PLANTS, TRAFFIC, INSTALLATIONS AND PUBLIC BUILDINGS; ELECTRONIC AND OPTICAL SENSORS FOR THE PURPOSE OF MEASURING A POSITION OR LENGTH OR DISTANCE; ELECTRONIC POSITION ENCODERS; OPTICAL SENSORS FOR DISTANCE MEASUREMENTS; OPTICAL, OPTO-ELECTRONIC AND PHOTOELECTRIC SENSORS FOR SENSING LIGHT AND LIGHT REFLECTED BY OBJECTS FOR THE PURPOSE OF SAFETY GUARDING AND MONITORING OF ROOMS, SPACES, POINTS OF DANGER OR DANGER ZONES; SAFETY LIGHT CURTAINS; SCANNERS WORKING ON AN ELECTRONIC BASIS AND IN THE FIELD OF INFRARED, VISIBLE OR ULTRAVIOLET RADIATION; SCANNERS WHICH OPERATE WITH A SCANNING BEAM FOR THE SCANNING OF SPECIFIC SURFACES AND SPATIAL REGIONS (U.S. CLS. 21, 23, 26, 36 AND 38).

JENNIFER WILLISTON, EXAMINING ATTORNEY

SN 85-428,742. APP47, INC., RESTON, VA. FILED 9-21-2011.

App47

THE MARK CONSISTS OF STANDARD CHARACTERS WITHOUT CLAIM TO ANY PARTICULAR FONT, STYLE, SIZE, OR COLOR.

FOR COMPUTER APPLICATION SOFTWARE FOR INTERNET-ENABLED DEVICES, MOBILE PHONES, PORTABLE MEDIA PLAYERS, COMPUTERS AND TELEVISIONS, NAMELY, SOFTWARE FOR USE IN MANAGEMENT OF APPLICATIONS OPERATING ON INTERNET-ENABLED, MOBILE DEVICES PORTABLE MEDIA PLAYERS, COMPUTERS AND TELEVISIONS IN THE FIELDS OF ANALYTICS, PERFORMANCE MANAGEMENT, REPORTING, CONFIGURATION MANAGEMENT, ASSET MANAGEMENT, DEPLOYMENT, PROVISIONING, COMPLIANCE, SECURITY MANAGEMENT AND APPLICATION STOREFRONTS (U.S. CLS. 21, 23, 26, 36 AND 38).

FIRST USE 6-29-2011; IN COMMERCE 2-15-2012.

PAUL MORENO, EXAMINING ATTORNEY

CLASS 9—(Continued).

SN 85-433,817. HOME BOX OFFICE, INC., NEW YORK, NY.
FILED 9-28-2011.

THE SOPRANOS

THE MARK CONSISTS OF STANDARD CHARACTERS WITHOUT CLAIM TO ANY PARTICULAR FONT, STYLE, SIZE, OR COLOR.
OWNER OF U.S. REG. NOS. 3,317,641, 3,537,044 AND OTHERS.

FOR PROTECTIVE CASES FOR LAPTOP COMPUTERS, TABLET COMPUTERS, SMART PHONES AND OTHER PORTABLE ELECTRONIC DEVICES, NAMELY, MEDIA PLAYERS, MOBILE PHONES, GLOBAL POSITIONING SYSTEMS AND PERSONAL DIGITAL ASSISTANTS; PROTECTIVE COVERINGS FOR LAPTOP COMPUTERS, TABLET COMPUTERS, SMART PHONES AND OTHER PORTABLE ELECTRONIC DEVICES, NAMELY, MEDIA PLAYERS, MOBILE PHONES, GLOBAL POSITIONING SYSTEMS AND PERSONAL DIGITAL ASSISTANTS (U.S. CLS. 21, 23, 26, 36 AND 38).

FIRST USE 3-24-2011; IN COMMERCE 3-24-2011.
KEVIN DINALLO, EXAMINING ATTORNEY

SN 85-435,898. SCG POWER RANGERS LLC, LOS ANGELES, CA. FILED 9-29-2011.

POWER RANGERS MEGAFORCE

THE MARK CONSISTS OF STANDARD CHARACTERS WITHOUT CLAIM TO ANY PARTICULAR FONT, STYLE, SIZE, OR COLOR.

OWNER OF U.S. REG. NOS. 1,893,768, 2,506,454 AND OTHERS.

FOR VIDEO GAME CARTRIDGES, CASSETTES, DISCS AND TAPES; COMPUTER GAME PROGRAMS, CARTRIDGES AND DISCS; DOWNLOADABLE COMPUTER GAME PROGRAMS; INTERACTIVE GAME PROGRAMS; INTERACTIVE GAME SOFTWARE; VIDEO GAMES FOR MOBILE DEVICES, PERSONAL COMPUTERS, CONSOLES, AND TABLETS; DOWNLOADABLE ELECTRONIC GAME PROGRAMS; ELECTRONIC GAME SOFTWARE; APPARATUS FOR GAMES ADAPTED FOR USE WITH TELEVISION RECEIVERS; CINEMATOGRAPHIC APPARATUS; PROTECTIVE CARRYING CASES SPECIFICALLY ADAPTED FOR WIRELESS TELEPHONES, MP3 PLAYERS, DIGITAL CAMERAS, PERSONAL DIGITAL ASSISTANTS AND HANDHELD COMPUTERS; CAMERAS; DIGITAL CAMERAS; PRERECORDED DVDS FEATURING LIVE ACTION ENTERTAINMENT FOR CHILDREN AND MUSIC; EYEWEAR, NAMELY, SUNGLASSES, EYEGASSES AND OPHTHALMIC FRAMES AND CASES THEREFOR; AND EYEWEAR ACCESSORIES, NAMELY, STRAPS, NECK CORDS AND HEAD STRAPS WHICH RESTRAIN EYEWEAR FROM MOVEMENT ON A WEARER (U.S. CLS. 21, 23, 26, 36 AND 38).

MARIA-VICTORIA SUAREZ, EXAMINING ATTORNEY

CLASS 9—(Continued).

SN 85-436,457. INMOTION CCTV, INC., SAN GABRIEL, CA.
FILED 9-30-2011.



NO CLAIM IS MADE TO THE EXCLUSIVE RIGHT TO USE "SICHER", APART FROM THE MARK AS SHOWN.

THE MARK CONSISTS OF THE TERM "SICHER" WHERE THE LETTER "S" IS CONTAINED IN AN OVAL. OVAL HAS CONTRASTED SHADING IN THE UPPER LEFT CORNER THAT ILLUMINATES AND GIVES IT DIMENSION.

THE ENGLISH TRANSLATION OF "SICHER" IN THE MARK IS "CERTAIN", "SECURE", "SAFE".

FOR BUILDING SECURITY SYSTEMS COMPRISING SOFTWARE AND HARDWARE FOR PROVIDING PICTURE, VIDEO, ALARM STATUS, BUILDING PLANS, AND OTHER INFORMATION TO A REMOTE STATION (U.S. CLS. 21, 23, 26, 36 AND 38).

FIRST USE 6-1-2011; IN COMMERCE 6-1-2011.
BILL DAWE, EXAMINING ATTORNEY

SN 85-438,022. SAFETY GLASSES USA, INC., THREE RIVERS, MI. FILED 10-3-2011.



NO CLAIM IS MADE TO THE EXCLUSIVE RIGHT TO USE "SAFETY GLASSES USA.COM", APART FROM THE MARK AS SHOWN.

THE COLOR(S) RED, WHITE, BLUE AND BLACK IS/ARE CLAIMED AS A FEATURE OF THE MARK.

THE MARK CONSISTS OF A BLUE STAR WITH THE UPPER HALF OF THE STAR IN A LIGHTER BLUE THAN THE BOTTOM HALF AND PARTIAL BLACK AND WHITE OUTLINING ON THE STAR, FIVE RED STRIPES WHICH GRADUALLY FADE FROM RED ON THE LEFT TO WHITE ON THE RIGHT, THERE IS BLACK UNDERLINING ON EACH STRIPE, AND THE LETTERS ON THE WORDS "SAFETY GLASSES USA.COM" ARE BLUE, EXCEPT THE LETTERS "USA" WHICH ARE RED.

FOR EYE COVERS FOR PROTECTIVE PURPOSES (U.S. CLS. 21, 23, 26, 36 AND 38).

FIRST USE 10-10-2000; IN COMMERCE 10-10-2000.
BARBARA RUTLAND, EXAMINING ATTORNEY

CLASS 9—(Continued).

SN 85-438,180. NAGI K CORPORATION, LOS ANGELES, CA.
FILED 10-3-2011.

GXG Eyewear

THE MARK CONSISTS OF STANDARD CHARACTERS WITHOUT CLAIM TO ANY PARTICULAR FONT, STYLE, SIZE, OR COLOR.

OWNER OF U.S. REG. NO. 3,897,968.

NO CLAIM IS MADE TO THE EXCLUSIVE RIGHT TO USE "EYEWEAR", APART FROM THE MARK AS SHOWN.

THE WORDING "GXG" HAS NO MEANING IN A FOREIGN LANGUAGE.

FOR CASES FOR EYEGLASSES AND SUNGLASSES; SUNGLASSES (U.S. CLS. 21, 23, 26, 36 AND 38).

FIRST USE 9-0-2009; IN COMMERCE 7-19-2011.

MYRIAH HABEEB, EXAMINING ATTORNEY

CLASS 9—(Continued).

SN 85-442,162. PROGRESS SOFTWARE CORPORATION,
BEDFORD, MA. FILED 10-7-2011.

PROGRESS RESPONSIVE CLOUD

THE MARK CONSISTS OF STANDARD CHARACTERS WITHOUT CLAIM TO ANY PARTICULAR FONT, STYLE, SIZE, OR COLOR.

OWNER OF U.S. REG. NOS. 1,382,068, 3,812,875 AND OTHERS.

NO CLAIM IS MADE TO THE EXCLUSIVE RIGHT TO USE "RESPONSIVE CLOUD", APART FROM THE MARK AS SHOWN.

FOR COMPUTER SOFTWARE IN THE FIELD OF INFORMATION TECHNOLOGY FOR USE IN THE DEVELOPMENT, DEPLOYMENT, INTEGRATION, AND MANAGEMENT OF BUSINESS APPLICATIONS AND FOR CONFIGURING LOCAL AND WIDE AREA COMPUTER NETWORKS AND MANUALS SOLD TOGETHER THEREWITH (U.S. CLS. 21, 23, 26, 36 AND 38).

HENRY S. ZAK, EXAMINING ATTORNEY

SN 85-442,154. PROGRESS SOFTWARE CORPORATION,
BEDFORD, MA. FILED 10-7-2011.

PROGRESS CLOUDWARE

THE MARK CONSISTS OF STANDARD CHARACTERS WITHOUT CLAIM TO ANY PARTICULAR FONT, STYLE, SIZE, OR COLOR.

OWNER OF U.S. REG. NOS. 1,382,068, 3,812,875 AND OTHERS.

NO CLAIM IS MADE TO THE EXCLUSIVE RIGHT TO USE "CLOUDWARE", APART FROM THE MARK AS SHOWN.

FOR COMPUTER SOFTWARE IN THE FIELD OF INFORMATION TECHNOLOGY FOR USE IN THE DEVELOPMENT, DEPLOYMENT, INTEGRATION, AND MANAGEMENT OF BUSINESS APPLICATIONS AND FOR CONFIGURING LOCAL AND WIDE AREA COMPUTER NETWORKS AND MANUALS SOLD TOGETHER THEREWITH (U.S. CLS. 21, 23, 26, 36 AND 38).

HENRY S. ZAK, EXAMINING ATTORNEY

SN 85-445,942. SITECORE CORPORATION DENMARK,
COPENHAGEN, DENMARK, FILED 10-12-2011.

AIDA

THE MARK CONSISTS OF STANDARD CHARACTERS WITHOUT CLAIM TO ANY PARTICULAR FONT, STYLE, SIZE, OR COLOR.

FOR COMPUTER SOFTWARE FOR THE COLLECTION, EVALUATION, MANAGEMENT AND ANALYSIS OF CUSTOMER PATTERNS, BEHAVIORS, AND DECISIONS AS GATHERED FROM VARIOUS DIGITAL CHANNELS, NAMELY, WEB, EMAIL, MOBILE, AND SOCIAL NETWORKING MEDIUMS; BUSINESS ANALYTICS SOFTWARE IN THE FIELD OF SALES AND MARKETING WHICH USES ARTIFICIAL INTELLIGENCE TO SUGGEST AND IMPLEMENT RECOMMENDATIONS FOR OPERATIONAL IMPROVEMENT; BUSINESS MANAGEMENT SOFTWARE TO EVALUATE CUSTOMER CONVERSION RATES, SUGGEST MEANS OF IMPROVEMENT, AND IMPLEMENT SOLUTIONS TO IMPROVE CUSTOMER CONVERSION (U.S. CLS. 21, 23, 26, 36 AND 38).

DAWN FELDMAN, EXAMINING ATTORNEY

CLASS 9—(Continued).

SN 85-446,082. POPULATION REFERENCE BUREAU, WASHINGTON, DC. FILED 10-12-2011.

AN **ENGAGE**
PRESENTATION

NO CLAIM IS MADE TO THE EXCLUSIVE RIGHT TO USE "PRESENTATION", APART FROM THE MARK AS SHOWN.

THE COLOR(S) BLACK AND BLUE IS/ARE CLAIMED AS A FEATURE OF THE MARK.

THE MARK CONSISTS OF THREE WORDS, "AN ENGAGE PRESENTATION", IN WHICH THE WORD "ENGAGE" IS IN BLUE AND THE WORDS "AN" AND "PRESENTATION" ARE IN BLACK.

FOR PRE-RECORDED VIDEO RECORDINGS FEATURING PRESENTATIONS IN THE FIELD OF HEALTH, FAMILY PLANNING, AND REPRODUCTIVE HEALTH FOR USE IN CLASSROOMS, MEETINGS, AND ON THE WEBSITE (U.S. CLS. 21, 23, 26, 36 AND 38).

FIRST USE 6-1-2011; IN COMMERCE 6-1-2011.
WILLIAM VERHOSEK, EXAMINING ATTORNEY

CLASS 9—(Continued).

SN 85-453,622. INCREMENTAL SYSTEMS CORPORATION, DBA INCSYS, BELLEVUE, WA. FILED 10-21-2011.



THE COLOR(S) CYAN AND WHITE IS/ARE CLAIMED AS A FEATURE OF THE MARK.

THE MARK CONSISTS OF A MISCELLANEOUS DESIGN, NAMELY, A FANCIFUL CIRCULAR RING IN THE COLOR CYAN AND BOLDED; THREE WAVE-LIKE DESIGNS EXTENDING THROUGH AND BEYOND THE CIRCULAR RING IN THE COLOR CYAN ON TOP OF A WHITE SQUARE.

FOR ELECTRIC UTILITY GRID OPERATIONS AND MODELING SOFTWARE FOR TRAINING ELECTRIC SYSTEM OPERATORS (U.S. CLS. 21, 23, 26, 36 AND 38).

FIRST USE 8-1-2010; IN COMMERCE 9-1-2010.
TASHIA BUNCH, EXAMINING ATTORNEY

SN 85-450,320. Z-SOFTNET, PORTLAND, OR. FILED 10-18-2011.

PACHANGACMS

THE MARK CONSISTS OF STANDARD CHARACTERS WITHOUT CLAIM TO ANY PARTICULAR FONT, STYLE, SIZE, OR COLOR.

THE ENGLISH TRANSLATION OF "PACHANGA" IN THE MARK IS "LIVELY PARTY".

FOR COMPUTER SOFTWARE DEVELOPMENT TOOLS; COMPUTER SOFTWARE FOR APPLICATION AND DATABASE INTEGRATION; COMPUTER SOFTWARE FOR COMPUTER SYSTEM AND APPLICATION DEVELOPMENT, DEPLOYMENT AND MANAGEMENT; COMPUTER SOFTWARE FOR PROVIDING AN ONLINE DATABASE IN THE FIELD OF TRANSACTION PROCESSING TO UPLOAD TRANSACTIONAL DATA, PROVIDE STATISTICAL ANALYSIS, AND PRODUCE NOTIFICATIONS AND REPORTS; COMPUTER SOFTWARE THAT PROVIDES WEB-BASED ACCESS TO APPLICATIONS AND SERVICES THROUGH A WEB OPERATING SYSTEM OR PORTAL INTERFACE; WEB SITE DEVELOPMENT SOFTWARE (U.S. CLS. 21, 23, 26, 36 AND 38).

FIRST USE 10-18-2011; IN COMMERCE 10-18-2011.
SANJEEV VOHRA, EXAMINING ATTORNEY

SN 85-454,082. PURGRO ELECTRONICS, LLC, ELLIJAY, GA. FILED 10-24-2011.

PURGRO

THE MARK CONSISTS OF STANDARD CHARACTERS WITHOUT CLAIM TO ANY PARTICULAR FONT, STYLE, SIZE, OR COLOR.

FOR HYDROPONIC GARDENING ELECTRONIC CONTROL SYSTEM COMPRISED OF SENSORS, INJECTION PUMPS, AND RELAYS USED FOR REGULATING AND MONITORING LIGHTING, WATER LEVEL, ADDITIVE DOSING, AND OTHER ENVIRONMENTAL FACTORS FOR HYDROPONICALLY-GROWN PLANTS (U.S. CLS. 21, 23, 26, 36 AND 38).

FIRST USE 2-28-2010; IN COMMERCE 3-31-2010.
ANDREA K. NADELMAN, EXAMINING ATTORNEY

CLASS 9—(Continued).

SN 85-455,381. DST SYSTEMS, INC., KANSAS CITY, MO. FILED 10-25-2011.

DST INPAYCE

THE MARK CONSISTS OF STANDARD CHARACTERS WITHOUT CLAIM TO ANY PARTICULAR FONT, STYLE, SIZE, OR COLOR.

OWNER OF U.S. REG. NOS. 2,836,985 AND 3,523,213.

FOR COMPUTER SOFTWARE FOR USE IN PERFORMING THE FOLLOWING FUNCTIONS: POLICYHOLDER RECORDKEEPING AND ADMINISTRATION; NEW BUSINESS SET-UP; CALCULATING, BASED ON THE FACTORS SPECIFIC TO THE POLICYHOLDER, THE POLICYHOLDER'S INITIAL AND ONGOING CONTRIBUTIONS, TAKING INTO ACCOUNT THE POLICYHOLDER'S LONG-TERM FINANCIAL GOALS; SUPPORTING THE PAYMENT OF RETIREMENT BENEFITS TO POLICYHOLDERS NECESSARY FOR DETERMINING AMOUNTS, FREQUENCY AND TIMING OF BENEFITS TO POLICYHOLDERS; SUPPORTING BUSINESS PROCESS OUTSOURCING SERVICES AS IT RELATES TO THE SERVICING OF POLICYHOLDERS AND AGENTS THROUGH MAILROOM PROCESSING, TRANSACTION PROCESSING, CLIENT SERVICE, AGENT SERVICE, AND CALL-CENTER OPERATIONS; ENABLING AUTOMATED, CONSISTENT COMMUNICATION OF STANDARD PROCESSES ASSOCIATED WITH THE ESTABLISHMENT OF NEW POLICIES, AS WELL AS COMPLIANCE WITH RULES, STANDARDS AND REGULATIONS AS THEY RELATE TO THE PROCESSING OF WORK; SUPPORTS INSURANCE PRODUCT MANAGEMENT AND POLICYHOLDER MANAGEMENT EFFORTS TO DEVELOP NEW PRODUCTS, IMPROVE EXISTING PRODUCTS AND MANAGE THE RELATIONSHIP WITH THE POLICYHOLDERS AND INSURANCE AGENTS; PROVIDES WORKFLOW AUTOMATION IN SUPPORT OF CARRIER-SPECIFIC AND PRODUCT-SPECIFIC BUSINESS RULES; AND MANAGING THE INFORMATION ASSOCIATED WITH THE CONTRACT BETWEEN AN INSURANCE COMPANY AND POLICYHOLDER (U.S. CLS. 21, 23, 26, 36 AND 38).
NORA BUCHANAN WILL, EXAMINING ATTORNEY

SN 85-457,425. LSI CORPORATION, MILPITAS, CA. FILED 10-27-2011.

SoftDFE

THE MARK CONSISTS OF STANDARD CHARACTERS WITHOUT CLAIM TO ANY PARTICULAR FONT, STYLE, SIZE, OR COLOR.

FOR INTEGRATED CIRCUITS; COMPUTER HARDWARE, NAMELY, A PROGRAMMABLE PROCESSOR FOR NETWORK AND WIRELESS COMMUNICATIONS (U.S. CLS. 21, 23, 26, 36 AND 38).

AMY ALFIERI, EXAMINING ATTORNEY

CLASS 9—(Continued).

SN 85-460,468. TRANSPORT WIRELESS TECHNOLOGIES, INC., DE PERE, WI. FILED 10-31-2011.

SENSORLINK

THE MARK CONSISTS OF STANDARD CHARACTERS WITHOUT CLAIM TO ANY PARTICULAR FONT, STYLE, SIZE, OR COLOR.

FOR WIRELESS SENSOR SYSTEM CONSISTING OF ELECTRONIC SENSORS, WIRELESS TRANSMITTERS, WIRELESS RECEIVERS, AND HANDHELD MONITORING DEVICES FOR MONITORING DOORS, FUEL TANKS, TIRES, AND CARGO SPACES OF VEHICLES, VEHICLE TRAILERS, VEHICLE ACCESSORIES, AND TRANSPORTATION CONTAINERS; WIRELESS DOOR SENSORS; WIRELESS FUEL SENSORS; WIRELESS TIRE SENSORS; WIRELESS CARGO SENSORS; WIRELESS TEMPERATURE SENSORS; HANDHELD DEVICES FOR MONITORING AND CONTROLLING THE FOREGOING; WIRELESS RECEIVERS (U.S. CLS. 21, 23, 26, 36 AND 38).

JACLYN KIDWELL WALKER, EXAMINING ATTORNEY

SN 85-460,491. TRANSPORT WIRELESS TECHNOLOGIES, INC., DE PERE, WI. FILED 10-31-2011.

YARDLINK

THE MARK CONSISTS OF STANDARD CHARACTERS WITHOUT CLAIM TO ANY PARTICULAR FONT, STYLE, SIZE, OR COLOR.

FOR VEHICLE MANAGEMENT SYSTEM CONSISTING OF COMPUTER HARDWARE, COMPUTER SOFTWARE, ELECTRONIC SENSORS, WIRELESS TRANSMITTERS, WIRELESS RECEIVERS, AND HANDHELD MONITORING DEVICES FOR MONITORING AND CONTROLLING TRANSPORT REFRIGERATION SYSTEMS AND VEHICLE, VEHICLE TRAILER, VEHICLE ACCESSORY, AND TRANSPORTATION CONTAINER STATUS AND OPERATIONS (U.S. CLS. 21, 23, 26, 36 AND 38).

JACLYN KIDWELL WALKER, EXAMINING ATTORNEY

CLASS 9—(Continued).

SN 85-460,495. TRANSPORT WIRELESS TECHNOLOGIES, INC., DE PERE, WI. FILED 10-31-2011.

FLEETLINK

THE MARK CONSISTS OF STANDARD CHARACTERS WITHOUT CLAIM TO ANY PARTICULAR FONT, STYLE, SIZE, OR COLOR.

FOR VEHICLE MANAGEMENT SYSTEM CONSISTING OF COMPUTER HARDWARE, COMPUTER SOFTWARE, ELECTRONIC SENSORS, WIRELESS TRANSMITTERS, WIRELESS RECEIVERS, AND HANDHELD MONITORING DEVICES FOR MONITORING AND CONTROLLING TRANSPORT REFRIGERATION SYSTEMS AND VEHICLE, VEHICLE TRAILER, VEHICLE ACCESSORY, AND TRANSPORTATION CONTAINER STATUS AND OPERATIONS (U.S. CLS. 21, 23, 26, 36 AND 38).

JACLYN KIDWELL WALKER, EXAMINING ATTORNEY

SN 85-461,463. LUNDY, RODNEY, TOBYHANNA, PA. AND LUNDY, STEVEN, TOBYHANNA, PA. FILED 11-1-2011.

Force M.D.'s

THE MARK CONSISTS OF STANDARD CHARACTERS WITHOUT CLAIM TO ANY PARTICULAR FONT, STYLE, SIZE, OR COLOR.

FOR AUDIO AND VIDEO RECORDINGS FEATURING MUSIC AND ARTISTIC PERFORMANCES; COMPACT DISCS FEATURING MUSIC; MUSICAL SOUND RECORDINGS (U.S. CLS. 21, 23, 26, 36 AND 38).

FIRST USE 1-1-1984; IN COMMERCE 1-1-1984.
TRACY CROSS, EXAMINING ATTORNEY

SN 85-461,990. TELIRIS, INC., NEW YORK, NY. FILED 11-1-2011.

STARTPOINT

THE MARK CONSISTS OF STANDARD CHARACTERS WITHOUT CLAIM TO ANY PARTICULAR FONT, STYLE, SIZE, OR COLOR.

FOR TELEPRESENCE AND VIDEO CONFERENCING SYSTEM PRIMARILY COMPRISED OF A CENTRAL VIDEO PROCESSING UNIT, MICROPHONE AND WIRELESS COMPUTER MOUSE AND ALSO CONTAINING VIDEO AND AUDIO COMPONENT CABLING FOR ENABLING VIDEO DISPLAYS TO COMMUNICATE THROUGHOUT AN ENTERPRISE (U.S. CLS. 21, 23, 26, 36 AND 38).

SETH A. RAPPAPORT, EXAMINING ATTORNEY

CLASS 9—(Continued).

SN 85-462,214. 2135624 ONTARIO INC., OAKVILLE, ONTARIO, CANADA, FILED 11-2-2011.

BIOGENIK

THE MARK CONSISTS OF STANDARD CHARACTERS WITHOUT CLAIM TO ANY PARTICULAR FONT, STYLE, SIZE, OR COLOR.

PRIORITY CLAIMED UNDER SEC. 44(D) ON CANADA APPLICATION NO. 1,539,220, FILED 8-10-2011.

FOR COMPUTER PRODUCTS, NAMELY, COMPUTER PERIPHERALS AND VIDEO GAME ACCESSORIES, NAMELY, GAME CONTROLLERS FOR COMPUTER GAMES; AUDIO HEADPHONES; BATTERY CHARGERS; RECHARGEABLE BATTERIES; REMOTE CONTROLS FOR RADIOS, TELEVISIONS AND STEREOS; AUDIO CABLES, ELECTRIC CABLES; COMPUTER NETWORK ADAPTERS; CONSOLE COOLING DEVICES IN THE NATURE OF INTERNAL COOLING FANS FOR COMPUTER GAME CONSOLES; USB HUBS; ELECTRONIC MEMORY CARD READERS; GAME CONTROLLER ACCESSORIES AND ATTACHMENTS, NAMELY, CONTROLLER GRIPS, GUN-SHAPED CONTROLLER ENCASEMENTS, CARRYING CASES AND CARRYING BAGS SPECIALLY ADAPTED FOR STORING GAME CONTROLLERS, EXTERNAL COMPUTER HARD DRIVES, AUDIO HEADSETS FOR GAMING, DECORATIVE CONTROLLER FACEPLATES, PROTECTIVE CASES AND COVERS SPECIALLY ADAPTED FOR GAME CONSOLES, SCREEN MAGNIFIERS, EXTERNAL SCREEN ILLUMINATING LIGHTS, STORAGE CASES SPECIALLY ADAPTED FOR STORING GAME CONTROLLERS; CARRYING CASES SPECIALLY ADAPTED FOR USE WITH HANDHELD MOBILE DIGITAL MEDIA ELECTRONIC DEVICES; CASES SPECIALLY ADAPTED FOR USE WITH WIRELESS DEVICES IN THE NATURE OF MOBILE PHONES; MP3 PLAYER CASES; CASES SPECIALLY ADAPTED FOR USE WITH TABLET COMPUTERS; SCREEN PROTECTORS IN THE NATURE OF ACRYLIC SHIELDS TO BE MOUNTED OVER TELEVISION SCREENS AND SCREENS OF HANDHELD MOBILE DEVICES (U.S. CLS. 21, 23, 26, 36 AND 38).

ADA HAN, EXAMINING ATTORNEY

SN 85-463,629. THE HERALD PUBLISHING COMPANY, LLC, SYRACUSE, NY. FILED 11-3-2011.

MLIVE.COM

THE MARK CONSISTS OF STANDARD CHARACTERS WITHOUT CLAIM TO ANY PARTICULAR FONT, STYLE, SIZE, OR COLOR.

FOR DOWNLOADABLE SOFTWARE APPLICATIONS FOR USE IN CONNECTION WITH SMARTPHONES, PDA DEVICES, TABLET COMPUTERS AND OTHER PORTABLE AND HANDHELD DIGITAL ELECTRONIC DEVICES, NAMELY, SOFTWARE FOR ACCESSING, VIEWING, INTERACTING WITH AND DOWNLOADING CONTENT FROM NEWSPAPERS AND NEWS SERVICES (U.S. CLS. 21, 23, 26, 36 AND 38).

FIRST USE 9-20-2011; IN COMMERCE 9-20-2011.
SANDRA BUJA, EXAMINING ATTORNEY

CLASS 9—(Continued).

SN 85-463,648. INTERNATIONAL FELLOWSHIP OF CHRISTIANS & JEWS, INC., CHICAGO, IL. FILED 11-3-2011.



*Guardians
of Israel*

NO CLAIM IS MADE TO THE EXCLUSIVE RIGHT TO USE "ISRAEL", APART FROM THE MARK AS SHOWN.

THE MARK CONSISTS OF A SILHOUETTE OF AN UPRIGHT LION AND THE WORDS "SHOMRAY YISRAEL" INSIDE OF A CREST OR SHIELD, NEXT TO THE WORDS "GUARDIANS OF ISRAEL".

THE ENGLISH TRANSLATION OF "SHOMRAY YISRAEL" IN THE MARK IS "GUARDIANS OF ISRAEL".

FOR PRE-RECORDED DVDS ABOUT ISSUES RELATED TO JEWISH FAITH AND TRADITIONS, JEWISH-CHRISTIAN RELATIONS, AND THE POLITICAL, ECONOMIC, SOCIAL, AND SPIRITUAL NEEDS OF ISRAEL, THE PEOPLE OF ISRAEL, AND JEWISH PEOPLE AROUND THE WORLD (U.S. CLS. 21, 23, 26, 36 AND 38).

FIRST USE 3-1-2008; IN COMMERCE 3-1-2008.

DEZMONA MIZELLE, EXAMINING ATTORNEY

CLASS 9—(Continued).

SN 85-467,955. NEC BIGLOBE, LTD., TOKYO, JAPAN, FILED 11-9-2011.

HYAKUZAN

THE MARK CONSISTS OF STANDARD CHARACTERS WITHOUT CLAIM TO ANY PARTICULAR FONT, STYLE, SIZE, OR COLOR.

THE WORD(S) "HYAKUZAN" HAS NO MEANING IN A FOREIGN LANGUAGE.

FOR COMPUTER SOFTWARE FOR GAMES; DOWNLOADABLE COMPUTER SOFTWARE FOR GAMES; DOWNLOADABLE COMPUTER GAME PROGRAMS; COMPUTER APPLICATION SOFTWARE FOR COMPUTERS, PORTABLE COMPUTERS, MOBILE PHONES, CELLULAR PHONES, SMARTPHONES AND MOBILE HANDHELD DEVICES FOR GAME PROGRAMS IN THE FIELD OF ENTERTAINMENT (U.S. CLS. 21, 23, 26, 36 AND 38).

KYLE PEETE, EXAMINING ATTORNEY

SN 85-465,809. PASSING SCORE LLC, SAN FRANCISCO, CA. FILED 11-7-2011.

**Passing
SCORE**

THE MARK CONSISTS OF THE STYLIZED TEXT "PASSING SCORE" WITH A CHECK MARK OVER THE LOWER CASE LETTER "I" AND A RECTANGULAR BAR UNDER THE LETTERS "PA" AND PART OF THE FIRST LETTER "S" IN "PASSING".

FOR INTERACTIVE EDUCATIONAL SOFTWARE FEATURING INSTRUCTION IN MATH, FINANCE AND ENGLISH FOR USE ON TABLETS AND MOBILE PHONES (U.S. CLS. 21, 23, 26, 36 AND 38).

FIRST USE 8-1-2009; IN COMMERCE 10-13-2009.

TRICIA SONNEBORN, EXAMINING ATTORNEY

SN 85-469,693. ROBOTZONE, LLC, WINFIELD, KS. FILED 11-10-2011.

ACTOBOTICS

THE MARK CONSISTS OF STANDARD CHARACTERS WITHOUT CLAIM TO ANY PARTICULAR FONT, STYLE, SIZE, OR COLOR.

FOR ROBOTS FOR PERSONAL, EDUCATIONAL AND HOBBY USE AND STRUCTURAL PARTS THEREFOR; ROBOTS FOR EDUCATIONAL USE IN SCHOOLS AND COMPONENTS AND SUB-ASSEMBLIES FOR USE WITH THE ROBOTS; ROBOT KITS COMPRISED OF SERVOS, WHEELS, THREADED NUTS, SCREWS, AND STRUCTURAL PARTS; AND SOFTWARE FOR CONTROLLING ROBOTS (U.S. CLS. 21, 23, 26, 36 AND 38).

KELLY TRUSILO, EXAMINING ATTORNEY

CLASS 9—(Continued).

SN 85-470,397. GLOBE TECHNOLOGIES CORPORATION, STANDISH, MI. FILED 11-11-2011.



CLASS 9—(Continued).

SN 85-473,463. BITTORRENT, INC., SAN FRANCISCO, CA. FILED 11-15-2011.

GYRE

THE COLOR(S) SILVER IS/ARE CLAIMED AS A FEATURE OF THE MARK.

THE MARK CONSISTS OF THE CONFIGURATION OF A HEAT FUSIBLE LINK. THE COLOR SILVER APPEARS AS TO THE ENTIRE LINK.

SEC. 2(F).

FOR A HEAT FUSIBLE LINK FOR USE IN FIRE PROTECTION EQUIPMENT (U.S. CLS. 21, 23, 26, 36 AND 38).

FIRST USE 4-30-1977; IN COMMERCE 4-30-1977.
DAWN HAN, EXAMINING ATTORNEY

THE MARK CONSISTS OF STANDARD CHARACTERS WITHOUT CLAIM TO ANY PARTICULAR FONT, STYLE, SIZE, OR COLOR.

FOR CONSUMER ELECTRONIC DEVICES, NAMELY, APPARATUS FOR RECORDING, TRANSMISSION, PROCESSING OR REPRODUCTION OF AUDIO, VIDEO, OR OTHER MULTIMEDIA FILES, OR SOFTWARE OR DIGITAL FILES OR ELECTRONIC BROADCASTS OR DATA; CONSUMER ELECTRONIC DEVICES, NAMELY, TELEVISIONS, DIGITAL IMAGE PROJECTORS, DIGITAL VIDEO PROJECTORS, SET-TOP BOXES, VIDEO GAME CONSOLES; OPTICAL DRIVE WRITERS; OPTICAL DRIVE READERS; DVD PLAYERS; DVD RECORDERS; REWRITEABLE IMAGE, AUDIO AND VIDEO STORAGE DEVICES, NAMELY, HARD DISK DRIVES; DIGITAL STORAGE DEVICES, NAMELY, BLANK DIGITAL STORAGE MEDIA; COMPUTER STORAGE DEVICES, NAMELY, BLANK FLASH DRIVES OR BLANK EXTERNAL HARD DRIVES; TABLET COMPUTERS; PERSONAL COMPUTERS; NOTEBOOK COMPUTERS; IN-CAR MEDIA PLAYERS; VIDEO, IMAGE, TV OR AUDIO CAPTURE CARDS; DIGITAL VIDEO RECORDERS; IMAGE OR SOUND FAX MACHINES; DIGITAL PHOTO FRAMES; COMPUTER PRINTERS; DIGITAL MEDIA RECEIVERS; COMPUTER HARDWARE FOR ENCODING, DECODING, CAPTURING, PLAYING, VIEWING, DOWNLOADING, UPLOADING, RETRIEVAL, TRANSFERRING OR SHARING AUDIO, VIDEO OR OTHER MULTIMEDIA FILES, OR SOFTWARE OR DIGITAL FILES OR ELECTRONIC BROADCASTS OR DATA; SOFTWARE FOR ENCODING, DECODING, CAPTURING, PLAYING, VIEWING, DOWNLOADING, UPLOADING, RETRIEVAL, TRANSFERRING OR SHARING AUDIO, VIDEO OR OTHER MULTIMEDIA FILES, OR SOFTWARE OR DIGITAL FILES OR ELECTRONIC BROADCASTS OR DATA; COMPUTER HARDWARE FOR THE COLLECTION, EDITING, ORGANIZING, MODIFYING, BOOKMARKING, TRANSMISSION, STORAGE, OR SHARING OF AUDIO, VIDEO OR OTHER MULTIMEDIA FILES, OR SOFTWARE OR DIGITAL FILES OR ELECTRONIC BROADCASTS OR DATA; NETWORK ROUTERS; GATEWAY ROUTERS; COMPUTER PERIPHERAL DEVICES; DIGITAL MEDIA RECEIVERS; INTEGRATED CIRCUITS (U.S. CLS. 21, 23, 26, 36 AND 38).

JOHN HWANG, EXAMINING ATTORNEY

SN 85-472,914. MOBILE ELECTRONICS DISPLAY AND ACCESSORIES CO INC., GLENDALE, CA. FILED 11-15-2011.

Safesight

THE MARK CONSISTS OF STANDARD CHARACTERS WITHOUT CLAIM TO ANY PARTICULAR FONT, STYLE, SIZE, OR COLOR.

FOR VEHICLE BACK-UP CAMERA SYSTEM COMPRISED OF BACK-UP SENSORS, CAMERAS, VIDEO MONITORS AND VIDEO RECORDERS FOR ALLOWING DRIVERS TO SEE WHEN DRIVING IN REVERSE (U.S. CLS. 21, 23, 26, 36 AND 38).

WENDY GOODMAN, EXAMINING ATTORNEY

CLASS 9—(Continued).

SN 85-474,171. COOPER TECHNOLOGIES COMPANY, HOUSTON, TX. FILED 11-16-2011.

POWERMATE

THE MARK CONSISTS OF STANDARD CHARACTERS WITHOUT CLAIM TO ANY PARTICULAR FONT, STYLE, SIZE, OR COLOR.

FOR ELECTRICAL PLUGS AND SOCKETS; ELECTRICAL RECEPTACLES; ELECTRICAL CONNECTORS; ELECTRICAL BACK BOXES, EXCLUDING RELOCATABLE POWER TAPS FOR USE IN CLINICAL SETTINGS WITH PATIENT CARE EQUIPMENT (U.S. CLS. 21, 23, 26, 36 AND 38).

LUCY ARANT, EXAMINING ATTORNEY

SN 85-475,813. CULINATE, INC., PORTLAND, OR. FILED 11-17-2011.

CULINATE

THE MARK CONSISTS OF STANDARD CHARACTERS WITHOUT CLAIM TO ANY PARTICULAR FONT, STYLE, SIZE, OR COLOR.

OWNER OF U.S. REG. NOS. 3,393,046 AND 3,393,047.

FOR DOWNLOADABLE COMPUTER SOFTWARE PROVIDING DATABASES OF INFORMATION RELATED TO FOOD, DINING, COOKING, MENUS, RECIPES, GROCERIES, GROCERY SHOPPING INFORMATION AND OTHER AREAS OF CULINARY PURSUIT, NAMELY, ENTERTAINING, WINE AND BEVERAGES, AND THE CULINARY ARTS; AND FEATURING, TOOLS IN THE NATURE OF COMPUTER SOFTWARE DEVELOPMENT TOOLS FOR THE CREATION OF MOBILE INTERNET APPLICATIONS AND CLIENT INTERFACES AND OTHER RESOURCES IN THE NATURE OF COMPUTER SOFTWARE FOR CREATING SEARCHABLE DATABASE OF INFORMATION AND DATA ALL RELATED TO FOOD, DINING, COOKING, MENUS, RECIPES, GROCERIES, GROCERY SHOPPING INFORMATION AND OTHER AREAS OF CULINARY PURSUIT, NAMELY, ENTERTAINING, WINE AND BEVERAGES, AND THE CULINARY ARTS (U.S. CLS. 21, 23, 26, 36 AND 38).

FIRST USE 7-10-2009; IN COMMERCE 4-17-2010.

ANDREA K. NADELMAN, EXAMINING ATTORNEY

CLASS 9—(Continued).

SN 85-478,894. JET SOFTWARE GROUP INC., BAY SHORE, NY. FILED 11-22-2011.



NO CLAIM IS MADE TO THE EXCLUSIVE RIGHT TO USE "POS", APART FROM THE MARK AS SHOWN.

THE COLOR(S) YELLOW, BLUE AND WHITE IS/ARE CLAIMED AS A FEATURE OF THE MARK.

THE MARK CONSISTS OF A SQUARE DIVIDED BY A WHITE DIAGONAL LINE INTO A FIRST TRIANGULAR PORTION AND A SECOND TRIANGULAR PORTION. THE FIRST TRIANGULAR PORTION OF THE SQUARE INCLUDES A PLURALITY OF GEOMETRIC SHAPES SEPARATED BY WHITE VERTICAL AND HORIZONTAL LINES. THE RIGHT ANGLE CORNER OF THE FIRST TRIANGULAR PORTION IS A YELLOW SQUARE AND THE REMAINING GEOMETRIC SHAPES ARE BLUE SQUARES OR TRIANGLES. THE SECOND TRIANGULAR PORTION OF THE SQUARE IS A SOLID YELLOW TRIANGLE. THE TOP EDGE OF THE "UPDATA" PORTION OF THE TERM IS ALIGNED WITH THE TOP EDGE OF THE SQUARE. THE LETTERS OF "UPDATA" ARE IN YELLOW WITH WHITE HORIZONTAL LINES DIVIDING EACH LETTER INTO SEGMENTS. THE "POS" PORTION OF THE TERM IS POSITIONED BELOW THE "UPDATA" TERM WITH THE BOTTOM EDGE OF THE "POS" PORTION IS ALIGNED WITH THE BOTTOM EDGE OF THE SQUARE. THE "POS" PORTION OF THE TERM IS IN SOLID BLUE LETTERS.

FOR COMPUTER SOFTWARE FOR ACCESSING, ORGANIZING AND REPORTING POINT OF SALE DATA (U.S. CLS. 21, 23, 26, 36 AND 38).

LAURIE KAUFMAN, EXAMINING ATTORNEY

SN 85-482,110. THE OWL 360, LLC, GLASTONBURY, CT. FILED 11-28-2011.



NO CLAIM IS MADE TO THE EXCLUSIVE RIGHT TO USE "360", APART FROM THE MARK AS SHOWN.

THE MARK CONSISTS OF THE WORD "THE" WHICH IS SMALLER AND SUPERSCRIBED ABOVE THE SECOND WORD "OWL" WHICH IS FOLLOWED BY AN OUTLINE IMAGE OF AN OWL'S FACE AND UPPER BODY WHICH IS FOLLOWED BY THE NUMBER "360".

FOR SAFETY DEVICES FOR USE WITH BICYCLES IN THE NATURE OF AN ELECTRONIC CAMERA FEATURING A REAR VIEWING SCREEN (U.S. CLS. 21, 23, 26, 36 AND 38).

FIRST USE 9-1-2011; IN COMMERCE 9-14-2011.

NORA BUCHANAN WILL, EXAMINING ATTORNEY

CLASS 9—(Continued).

SN 85-482,555. C3E PRESS, LLC, COLORADO CITY, CO. FILED 11-29-2011.



Comprehensive Child Custody Evaluation

NO CLAIM IS MADE TO THE EXCLUSIVE RIGHT TO USE "COMPREHENSIVE CHILD CUSTODY EVALUATION", APART FROM THE MARK AS SHOWN.

THE MARK CONSISTS OF THE STYLIZED TEXT "C3E" ON THE TOP. BELOW THERE IS THE STYLIZED TEXT "COMPREHENSIVE CHILD CUSTODY EVALUATION".

FOR DIGITAL MATERIALS, NAMELY, DOWNLOADABLE EVALUATION FORMS AND USER HANDBOOKS FEATURING INFORMATION ON CONDUCTING CHILD CUSTODY EVALUATIONS (U.S. CLS. 21, 23, 26, 36 AND 38).

KAPIL BHANOT, EXAMINING ATTORNEY

SN 85-483,473. CARECYCLE SOLUTIONS, DALLAS, TX. FILED 11-30-2011.



THE MARK CONSISTS OF STANDARD CHARACTERS WITHOUT CLAIM TO ANY PARTICULAR FONT, STYLE, SIZE, OR COLOR.

OWNER OF U.S. REG. NO. 4,032,770.

FOR COMPUTER SOFTWARE FEATURING AN INTELLIGENT CLINICAL DECISION ENGINE THAT INTEGRATES PATIENT DATA AND GENERATES A RISK-STRATIFIED PLAN OF CARE (U.S. CLS. 21, 23, 26, 36 AND 38).

LINDA POWELL, EXAMINING ATTORNEY

SN 85-483,715. LIBERTY MUTUAL INSURANCE COMPANY, BOSTON, MA. FILED 11-30-2011.



THE MARK CONSISTS OF STANDARD CHARACTERS WITHOUT CLAIM TO ANY PARTICULAR FONT, STYLE, SIZE, OR COLOR.

NO CLAIM IS MADE TO THE EXCLUSIVE RIGHT TO USE "HOME", APART FROM THE MARK AS SHOWN.

FOR DOWNLOADABLE SOFTWARE IN THE NATURE OF A MOBILE APPLICATION FOR COLLECTING AND SAVING DATA FOR PURPOSES OF CREATING AN INVENTORY OF BELONGINGS (U.S. CLS. 21, 23, 26, 36 AND 38).

FIRST USE 12-23-2011; IN COMMERCE 12-23-2011.

JORDAN BAKER, EXAMINING ATTORNEY

CLASS 9—(Continued).

SN 85-483,899. BADGER VMS, LLC, ATLANTA, GA. FILED 11-30-2011.



NO CLAIM IS MADE TO THE EXCLUSIVE RIGHT TO USE "VMS", APART FROM THE MARK AS SHOWN.

THE MARK CONSISTS OF A PROFILE OF A STYLIZED BADGER, WITHIN AN OVAL, WITH THE ANIMAL WEARING A HAT, AND WITH THE RIGHT AND LEFT PAWS OF THE ANIMAL VISIBLE, WITH THE WORD "BADGER" TO THE LEFT OF THE OVAL, AND THE TERM "VMS" TO THE RIGHT OF THE OVAL.

FOR ELECTRONIC INGRESS/EGRESS MANAGEMENT SYSTEM COMPRISED PRIMARILY OF A THIN CLIENT COMPUTER/MONITOR COMBINATION, PROPRIETARY SOFTWARE, AN ID SCANNER, A HANDHELD DEVICE, A SIGNATURE PAD, A BADGE PRINTER, A KEYBOARD, A DATA STORAGE MEDIUM, A CAMERA, AND OTHER HARDWARE, SOLD AS A UNIT, USED TO IDENTIFY INGRESS/EGRESS INFORMATION UPON ARRIVAL/DEPARTURE AT A BUILDING, CAMPUS, GATED COMMUNITY, OR OTHER CONTAINED LOCATION, RECORD ENTRY AND EXIT INFORMATION, AND CREATE BADGES AND/OR LABELS HAVING BARCODES FOR TRACKING THE ENTERED INFORMATION; COMPUTER SOFTWARE, NAMELY, SOFTWARE FOR MANAGING AND STORING THE INGRESS/EGRESS INFORMATION OF A BUILDING, CAMPUS, GATED COMMUNITY, OR OTHER CONTAINED LOCATION (U.S. CLS. 21, 23, 26, 36 AND 38).

ELISSA GARBER KON, EXAMINING ATTORNEY

SN 85-484,485. CIRCLE CARDIOVASCULAR IMAGING INC., CALGARY, ALBERTA, CANADA, FILED 12-1-2011.



PRIORITY CLAIMED UNDER SEC. 44(D) ON CANADA APPLICATION NO. 1552044, FILED 11-15-2011.

NO CLAIM IS MADE TO THE EXCLUSIVE RIGHT TO USE "CVI", APART FROM THE MARK AS SHOWN.

THE MARK CONSISTS OF THE LETTERS "CVI" FOLLOWED BY THE NUMBER "42" IN SUPERSCRIPIT.

FOR SOFTWARE PLATFORM FOR CARDIAC MRI AND CARDIAC CT (U.S. CLS. 21, 23, 26, 36 AND 38).

JEFF DEFORD, EXAMINING ATTORNEY

CLASS 9—(Continued).

SN 85-484,636. IQUEST ANALYTICS, INC., BARRINGTON, RI. FILED 12-1-2011.



OWNER OF U.S. REG. NOS. 3,051,677, 3,101,665 AND 3,210,228.

THE COLOR(S) LIGHT BLUE AND BLACK IS/ARE CLAIMED AS A FEATURE OF THE MARK.

THE MARK CONSISTS OF A STYLIZED LOWERCASE LETTER "I" INSIDE A CAPITAL LETTER "Q"; BELOW THIS IS THE STYLIZED WORDING "IQUEST". ALL THESE APPEAR IN BLACK COLOR EXCEPT THE TITLE OF THE LOWERCASE LETTER "I", WHICH APPEARS IN LIGHT BLUE COLOR.

FOR COMPUTER SOFTWARE FOR CREATING SEARCHABLE DATABASES OF INFORMATION AND DATA; COMPUTER SOFTWARE AND HARDWARE FOR SEMANTIC SEARCHING, RESEARCHING AND ANALYSIS OF DOCUMENTS (U.S. CLS. 21, 23, 26, 36 AND 38).

FIRST USE 1-1-2011; IN COMMERCE 1-1-2011.
DAWN HAN, EXAMINING ATTORNEY

SN 85-486,274. DVO ENTERPRISES, ALPINE, UT. FILED 12-2-2011.

Cook'n

THE MARK CONSISTS OF STANDARD CHARACTERS WITHOUT CLAIM TO ANY PARTICULAR FONT, STYLE, SIZE, OR COLOR.

SEC. 2(F).

FOR COMPUTER APPLICATION SOFTWARE FOR MOBILE PHONES, NAMELY, SOFTWARE FOR FINDING AND MANAGING RECIPES; COMPUTER APPLICATION SOFTWARE FOR COMPUTERS, NAMELY, SOFTWARE FOR FINDING AND MANAGING RECIPES (U.S. CLS. 21, 23, 26, 36 AND 38).

FIRST USE 5-1-1995; IN COMMERCE 5-1-1995.
CURTIS FRENCH, EXAMINING ATTORNEY

CLASS 9—(Continued).

SN 85-486,688. NET-FIT TECNOLOGIA DA INFORMACAO LTDA., SAO JOSE DORIOPRETO/SP, BRAZIL, FILED 12-4-2011.



NO CLAIM IS MADE TO THE EXCLUSIVE RIGHT TO USE "NET", APART FROM THE MARK AS SHOWN.

THE MARK CONSISTS OF THE WORDS "NET FIT" WITH THE PORTION "FIT" BELOW A SQUARE WITH AN OVAL SHAPE INSIDE THE SQUARE.

FOR COMPUTER SOFTWARE FOR USE IN FARM MANAGEMENT IN THE FIELDS OF AGRICULTURE AND AGRICULTURAL CONSULTANCY (U.S. CLS. 21, 23, 26, 36 AND 38).

ZACHARY BELLO, EXAMINING ATTORNEY

SN 85-487,140. VIEW LINK TECHNOLOGY PTE. LTD., SINGAPORE, SINGAPORE, FILED 12-5-2011.

VIZCOM

THE MARK CONSISTS OF STANDARD CHARACTERS WITHOUT CLAIM TO ANY PARTICULAR FONT, STYLE, SIZE, OR COLOR.

FOR ELECTRICAL APPARATUS, NAMELY, A VISUAL COMMUNICATIONS SYSTEM CONSISTING OF A WEARABLE AUDIO AND VIDEO CAPABLE HEADSET WITH HEADS-UP DISPLAY AND INTEGRATED DIGITAL CAMERA AND MICROPHONE THAT IS ELECTRONICALLY TETHERED, WIRELESSLY AND WIRED, TO AN ELECTRONIC CONTROL DEVICE WHICH IS A FULLY OPERATIONAL COMPUTING DEVICE THAT IS CAPABLE OF WIRELESS TRANSMITTING DATA TO AND FROM THE HEADSET FROM OTHER DEVICES, SUCH AS WIRELESS AND CELLULAR, OR NETWORKS, AND IS ALSO CAPABLE OF OPERATION AS A STAND ALONE COMPUTING, GAMING, AND COMMUNICATIONS DEVICE WHEN CONNECTED, WIRED OR WIRELESSLY, TO OTHER DISPLAY TECHNOLOGIES SUCH AS TVS AND PROJECTORS (U.S. CLS. 21, 23, 26, 36 AND 38).

FIRST USE 11-25-2011; IN COMMERCE 11-28-2011.
RENEE MCCRAY, EXAMINING ATTORNEY

CLASS 9—(Continued).

SN 85-487,801. SCHOLASTIC INC., NEW YORK, NY. FILED 12-6-2011.

SCHOLASTIC EXPLORA TU MUNDO

THE MARK CONSISTS OF STANDARD CHARACTERS WITHOUT CLAIM TO ANY PARTICULAR FONT, STYLE, SIZE, OR COLOR.

OWNER OF U.S. REG. NOS. 1,344,129, 2,586,322 AND OTHERS.

THE ENGLISH TRANSLATION OF "EXPLORA TU MUNDO" IN THE MARK IS "EXPLORE YOUR WORLD".

FOR DOWNLOADABLE ELECTRONIC PUBLICATIONS, NAMELY, NON-FICTION AND REFERENCE BOOKS FOR CHILDREN ON A VARIETY OF TOPICS (U.S. CLS. 21, 23, 26, 36 AND 38).

NICHOLAS ALTREE, EXAMINING ATTORNEY

SN 85-489,505. ADVANCED MULTIMEDIA DEVICES INC., FARMINGDALE, NY. FILED 12-7-2011.

iCommunicater

THE MARK CONSISTS OF STANDARD CHARACTERS WITHOUT CLAIM TO ANY PARTICULAR FONT, STYLE, SIZE, OR COLOR.

FOR TABLET COMPUTER FEATURING COMMUNICATION SOFTWARE AND APPLICATIONS FOR USE IN THE ASSISTIVE TECHNOLOGY INDUSTRY FOR PEOPLE WITH SPECIAL NEEDS AND DISABILITIES (U.S. CLS. 21, 23, 26, 36 AND 38).

ALYSSA STEEL, EXAMINING ATTORNEY

SN 85-490,852. SCHLUMBERGER TECHNOLOGY CORPORATION, HOUSTON, TX. FILED 12-8-2011.

VMOD FLEX

THE MARK CONSISTS OF STANDARD CHARACTERS WITHOUT CLAIM TO ANY PARTICULAR FONT, STYLE, SIZE, OR COLOR.

FOR COMPUTER SOFTWARE FOR GENERATING DATA TO SIMULATE GROUNDWATER FLOW IN THE FIELD OF WATER AND CONTAMINATION MODELING (U.S. CLS. 21, 23, 26, 36 AND 38).

PAUL MORENO, EXAMINING ATTORNEY

CLASS 9—(Continued).

SN 85-492,769. VETORA LLC, LEHI, UT. FILED 12-12-2011.

FENZER

THE MARK CONSISTS OF STANDARD CHARACTERS WITHOUT CLAIM TO ANY PARTICULAR FONT, STYLE, SIZE, OR COLOR.

FOR PORTABLE ELECTRONICS ACCESSORIES, NAMELY, BATTERIES, BATTERY CHARGERS, AND POWER CABLES; PORTABLE ELECTRONICS ACCESSORIES, NAMELY, SCREEN PROTECTORS FOR CELL PHONES, COMPUTERS, LAPTOP COMPUTERS, NOTEBOOK COMPUTERS, TABLET COMPUTERS AND HANDHELD COMPUTERS IN THE NATURE OF ACRYLIC SHIELDS TO MOUNTED OVER THE DISPLAY SCREEN; PORTABLE ELECTRONICS ACCESSORIES, NAMELY, CASES FOR ELECTRONIC EQUIPMENT, NAMELY, CELL PHONES, COMPUTERS, LAPTOP COMPUTERS, NOTEBOOK COMPUTERS, TABLET COMPUTERS AND HANDHELD COMPUTERS (U.S. CLS. 21, 23, 26, 36 AND 38).

FIRST USE 6-8-2011; IN COMMERCE 8-12-2011.

TRACY WHITTAKER-BROWN, EXAMINING ATTORNEY

SN 85-492,842. SHOCKSTRIP INC., CANFIELD, OH. FILED 12-12-2011.

Shockstrip

THE MARK CONSISTS OF STANDARD CHARACTERS WITHOUT CLAIM TO ANY PARTICULAR FONT, STYLE, SIZE, OR COLOR.

FOR EXTERNAL PROTECTIVE HELMET PADDING STRIPS THAT ARE ATTACHED TO THE OUTSIDE OF HELMETS FOR IMPACT ABSORPTION, DEFLECTION AND TO ENHANCE THE PROTECTION LEVEL OF VIRTUALLY ALL HELMETS (U.S. CLS. 21, 23, 26, 36 AND 38).

FIRST USE 2-25-2010; IN COMMERCE 7-1-2011.

MICHAEL TANNER, EXAMINING ATTORNEY

CLASS 9—(Continued).

SN 85-492,911. SHOCKSTRIP INC., CANFIELD, OH. FILED 12-12-2011.



THE MARK CONSISTS OF THE STYLIZED WORDING "SHOCKSTRIP" ABOVE WHICH APPEARS THE DEPICTION OF A LIGHTING BOLT SURROUNDED BY AN EXPLOSION.

FOR EXTERNAL PROTECTIVE HELMET PADDING STRIPS THAT ARE ATTACHED TO THE OUTSIDE OF HELMETS FOR IMPACT ABSORPTION, DEFLECTION AND TO ENHANCE THE PROTECTION LEVEL OF VIRTUALLY ALL HELMETS (U.S. CLS. 21, 23, 26, 36 AND 38).

FIRST USE 2-25-2010; IN COMMERCE 7-1-2011.
MICHAEL TANNER, EXAMINING ATTORNEY

SN 85-492,936. SHOCKSTRIP INC., CANFIELD, OH. FILED 12-12-2011.

SAVE YOUR BRAIN. STAY IN
THE GAME.

THE MARK CONSISTS OF STANDARD CHARACTERS WITHOUT CLAIM TO ANY PARTICULAR FONT, STYLE, SIZE, OR COLOR.

FOR EXTERNAL PROTECTIVE HELMET PADDING STRIPS THAT ARE ATTACHED TO THE OUTSIDE OF HELMETS FOR IMPACT ABSORPTION, DEFLECTION AND TO ENHANCE THE PROTECTION LEVEL OF VIRTUALLY ALL HELMETS (U.S. CLS. 21, 23, 26, 36 AND 38).

FIRST USE 2-25-2010; IN COMMERCE 7-1-2011.
MICHAEL TANNER, EXAMINING ATTORNEY

SN 85-494,208. WHITE, JEFFREY, SAINT LOUIS, MO. FILED 12-13-2011.

101SNORKEL

THE MARK CONSISTS OF STANDARD CHARACTERS WITHOUT CLAIM TO ANY PARTICULAR FONT, STYLE, SIZE, OR COLOR.

FOR SCUBA SNORKELS; SNORKELS; FLOTATION VESTS (U.S. CLS. 21, 23, 26, 36 AND 38).

FIRST USE 8-9-2006; IN COMMERCE 8-9-2006.
MICHELE SWAIN, EXAMINING ATTORNEY

CLASS 9—(Continued).

SN 85-494,446. CARL ZEISS AG, OBERKOCHEN, FED REP GERMANY, FILED 12-13-2011.

AURA

THE MARK CONSISTS OF STANDARD CHARACTERS WITHOUT CLAIM TO ANY PARTICULAR FONT, STYLE, SIZE, OR COLOR.

PRIORITY CLAIMED UNDER SEC. 44(D) ON FED REP GERMANY APPLICATION NO. 302011050175, FILED 9-10-2011, REG. NO. 302011050175, DATED 2-27-2012, EXPIRES 9-30-2021.

FOR SPECTROMETERS AND PARTS THEREOF (U.S. CLS. 21, 23, 26, 36 AND 38).

JORDAN BAKER, EXAMINING ATTORNEY

SN 85-497,407. LIGHTIRON DIGITAL, LLC, DBA LIGHT IRON, HOLLYWOOD, CA. FILED 12-16-2011.

LILY PAD

THE MARK CONSISTS OF STANDARD CHARACTERS WITHOUT CLAIM TO ANY PARTICULAR FONT, STYLE, SIZE, OR COLOR.

FOR MOBILE AND MODULAR TOWER CART WITH WHEELS OR TREADS SPECIALLY ADAPTED FOR COMPUTERS; COMPUTER DATA PROCESSORS; DATA PROCESSORS FOR DATA COMPRESSION, DATA TRANSFER, DATA DEBAYERING, DATA TRANSCODING, AND ACCELERATION; INTERNAL AND EXTERNAL COMPUTER STORAGE DEVICES, NAMELY, HIGH-SPEED STORAGE SUBSYSTEMS FOR STORAGE AND BACKUP OF ELECTRONIC DATA EITHER LOCALLY OR VIA A TELECOMMUNICATIONS NETWORK; VIDEO MONITORS OF MULTIPLE RESOLUTIONS FOR GRAPHICAL USER INTERFACE; COMPUTER PERIPHERAL DEVICES FOR MONITORING VIDEO AND COLOR LEVELS; BATTERY BACKUPS, NAMELY, UNINTERRUPTED POWER SUPPLIES; DATA COMPRESSION HARDWARE AND SOFTWARE; COLOR CORRECTION SOFTWARE AND COLOR CONTROL SURFACE FOR USE WITH CAMERAS AND COMPUTERS IN THE FIELDS OF MOTION PICTURE FILMING AND EDITING; COMPUTER SOFTWARE FOR USE IN EDITING, SYNCHING, AND VERIFYING THE EXISTENCE AND QUALITY OF DIGITAL IMAGE AND AUDIO CONTENT VIA COMPUTERS, STORAGE DEVICES, AND MOBILE DEVICES; GPS NAVIGATION DEVICE; COMPUTER SECURITY SOFTWARE, NAMELY, DATA AND IDENTIFY VERIFICATION SOFTWARE; VIDEO AND AUDIO CABLES; ELECTRIC DATA CABLES; AND ALL OF THE ABOVE EQUIPMENT USED FOR PRODUCING, EDITING, AND PERFORMING POST-PRODUCTION ACTIVITIES ON ANALOG CONTENT AND DIGITAL CONTENT INCLUDING STATIC AND MOVING PICTURES, SOUND, DATA, AND OTHER INFORMATION (U.S. CLS. 21, 23, 26, 36 AND 38).

CHARLOTTE CORWIN, EXAMINING ATTORNEY

CLASS 9—(Continued).

SN 85-497,683. 3 STAR GAMES, INC., NASSAU, BAHAMAS, FILED 12-16-2011.

GOSUM

THE MARK CONSISTS OF STANDARD CHARACTERS WITHOUT CLAIM TO ANY PARTICULAR FONT, STYLE, SIZE, OR COLOR.

OWNER OF UNITED KINGDOM REG. NO. 2587469, DATED 10-14-2011, EXPIRES 7-12-2021.

OWNER OF U.S. REG. NO. 3,855,422.

FOR COMPUTER GAME SOFTWARE; DOWNLOADABLE COMPUTER GAME SOFTWARE; COMPUTER GAME AND SOCIAL NETWORKING SOFTWARE APPLICATIONS DOWNLOADABLE VIA THE INTERNET AND OTHER COMMUNICATION NETWORKS FOR USE WITH MOBILE TELEPHONES, SMART PHONES, COMPUTERS AND TABLET COMPUTERS, FOR THE PURPOSE OF UPLOADING, POSTING, SHOWING, DISPLAYING, TAGGING, BLOGGING, SHARING AND PROVIDING ELECTRONIC MEDIA AND INFORMATION IN THE FIELDS OF ELECTRONIC GAMING, ENTERTAINMENT AND GENERAL INTEREST (U.S. CLS. 21, 23, 26, 36 AND 38).

JULIE GUTTADAURO, EXAMINING ATTORNEY

CLASS 9—(Continued).

SN 85-501,757. METTLER-TOLEDO AG, GREIFENSEE, SWITZERLAND, FILED 12-22-2011.

SPECTRAID

THE MARK CONSISTS OF STANDARD CHARACTERS WITHOUT CLAIM TO ANY PARTICULAR FONT, STYLE, SIZE, OR COLOR.

FOR PRINTED CIRCUIT BOARDS; RADIO TRANSMITTERS; ELECTRODES; DIODES; LASER DIODES; LASER SPECTROMETERS; ELECTRONIC MEASURING SYSTEMS COMPRISING DATA PROCESSORS, ELECTRONIC CONTROLS, ELECTRONIC DISPLAY INTERFACES, SENSORS, HOLDERS SPECIFICALLY ADAPTED FOR MEASURING DEVICES, HOUSINGS AND ARMATURES AND OPERATING SOFTWARE THEREFOR FOR MEASURING, TESTING, AND CONTROL OF PHYSICAL, CHEMICAL AND ANALYTICAL PROPERTIES, NAMELY, POTENTIOMETRIC MEASUREMENT, CONDUCTOMETRIC MEASUREMENT, AMPEROMETRIC MEASUREMENT, PH MEASUREMENT, REDOX MEASUREMENT, MEASUREMENT OF IONS, ION SELECTIVE MEASUREMENT, TURBIDITY MEASUREMENT, OXYGEN MEASUREMENT, OZONE MEASUREMENT, CARBON DIOXIDE MEASUREMENT, MEASUREMENT OF GASES, MEASUREMENT OF GASES IN GAS MIXTURES, CONDUCTIVITY MEASUREMENT, TOTAL-ORGANIC-CONTENT MEASUREMENT, TENSIDE MEASUREMENT, TEMPERATURE MEASUREMENT, PRESSURE MEASUREMENT, AND SPECTROSCOPIC MEASUREMENT (U.S. CLS. 21, 23, 26, 36 AND 38).

DAVID ELTON, EXAMINING ATTORNEY

SN 85-501,469. ASA AUTOMOTIVE SYSTEMS, LLC, MERRIMACK, NH. FILED 12-21-2011.

AUTOREPAIRMASTER

THE MARK CONSISTS OF STANDARD CHARACTERS WITHOUT CLAIM TO ANY PARTICULAR FONT, STYLE, SIZE, OR COLOR.

FOR COMPUTER SOFTWARE FOR USE IN BUSINESS OPERATIONS AND MANAGEMENT FUNCTIONS, NAMELY, ACCOUNTING, POINT-OF-SALE TRACKING AND INVENTORY CONTROL FOR USE IN THE FIELD OF AUTO REPAIR AND AUTO SERVICE (U.S. CLS. 21, 23, 26, 36 AND 38).

FIRST USE 11-0-1998; IN COMMERCE 11-0-1998.

ROBERT C. CLARK JR., EXAMINING ATTORNEY

SN 85-502,002. LIFELINE SYSTEMS, INC., WAUTOMA, WI. FILED 12-22-2011.



THE COLOR(S) GRAY AND BLUE IS/ARE CLAIMED AS A FEATURE OF THE MARK.

THE MARK CONSISTS OF "LIFETRAX" WRITTEN IN ONE WORD IN A STYLIZED FONT. "LIFE" IS WRITTEN IN GRAY AND "TRAX" IS WRITTEN IN BLUE. ICON IS A STAR OF LIFE BROKEN BY CIRCULAR RINGS AND A HEARTBEAT. THE ICON IS HALF BLUE AND HALF GRAY. THE UPPER THREE ARMS ARE BLUE AND THE LOWER THREE ARE GRAY.

FOR GPS DATA LOGGER FOR RECORDING TRIPS AND CLASSIFYING THEM INTO DIFFERENT ACCOUNTS (U.S. CLS. 21, 23, 26, 36 AND 38).

FIRST USE 10-7-2011; IN COMMERCE 10-7-2011.

CHARLOTTE CORWIN, EXAMINING ATTORNEY

CLASS 9—(Continued).

SN 85-503,914. LARGAN MEDICAL CO., LTD., TAICHUNG CITY, 40850, TAIWAN, FILED 12-27-2011.



The logo for Largan Medical features the word "Largan" in a large, bold, italicized sans-serif font, followed by the word "Medical" in a smaller, regular, italicized sans-serif font.

NO CLAIM IS MADE TO THE EXCLUSIVE RIGHT TO USE "MEDICAL", APART FROM THE MARK AS SHOWN.

THE MARK CONSISTS OF THE WORDS "LARGANMEDICAL" DEPICTED IN ITALIC FONT WITH NO SPACING BETWEEN THE WORDS, BUT WITH THE WORD "LARGAN" IN A LARGER SIZE FONT THAN THE WORD "MEDICAL".

FOR CONTACT LENSES (U.S. CLS. 21, 23, 26, 36 AND 38).

RONALD DELGIZZI, EXAMINING ATTORNEY

SN 85-505,678. DECAGON DEVICES, INC., PULLMAN, WA, FILED 12-29-2011.

DATASPRING

THE MARK CONSISTS OF STANDARD CHARACTERS WITHOUT CLAIM TO ANY PARTICULAR FONT, STYLE, SIZE, OR COLOR.

FOR SOIL MOISTURE AND ENVIRONMENTAL ELECTRIC SENSORS, ELECTRONIC DATA LOGGERS, AND OPERATING SOFTWARE THEREFOR (U.S. CLS. 21, 23, 26, 36 AND 38).

JENNIFER VASQUEZ, EXAMINING ATTORNEY

SN 85-506,121. NINGBO YINZHOU SELF PHOTOELECTRON TECHNOLOGY CO., LTD, ZHEJIANG PROVINCE, CHINA, FILED 12-30-2011.



The logo for 911 features the number "911" in a bold, sans-serif font. The "9" is stylized with a thick, curved line that overlaps the top of the "1"s, creating a circular shape around the top of the "9".

OWNER OF U.S. REG. NO. 3,832,670.

NO CLAIM IS MADE TO THE EXCLUSIVE RIGHT TO USE "911", APART FROM THE MARK AS SHOWN.

THE MARK CONSISTS OF THE STYLIZED NUMBERS "911" WITH THE NUMBER "9" OVERLAPPING A CIRCLE DESIGN ELEMENT.

FOR SAFETY EQUIPMENT, NAMELY, BEACON LIGHTS; EMERGENCY WARNING LIGHTS; ROTATING LIGHTS, NAMELY, FOR SIGNALING; FLASHING SAFETY LIGHTS; ELECTRIC SWITCHES; TRAFFIC LIGHT APPARATUS, NAMELY, SIGNALING DEVICES; LOUDSPEAKERS; ALARM INSTALLATIONS AND ALARMS; SIRENS; ELECTRONIC LED SIGNS (U.S. CLS. 21, 23, 26, 36 AND 38).

KAELIE KUNG, EXAMINING ATTORNEY

CLASS 9—(Continued).

SN 85-506,298. ADLOPTICA OPTICAL SYSTEMS GMBH, 12489 BERLIN, FED REP GERMANY, FILED 12-30-2011.



The logo for pi Shaper features the Greek letter pi (π) in a large, bold, sans-serif font, followed by the word "Shaper" in a smaller, bold, sans-serif font.

THE MARK CONSISTS OF PI SYMBOL NEXT TO THE WORD "SHAPER".

FOR LASER BEAM DELIVERY SYSTEMS AND COMPONENTS, NAMELY, BEAM SHAPERS AND BEAM ATTENUATORS; OPTICAL APPARATUS AND INSTRUMENTS, NAMELY, SHAPERS AND ATTENUATORS FOR LASER BEAMS (U.S. CLS. 21, 23, 26, 36 AND 38).

FIRST USE 7-31-2006; IN COMMERCE 7-31-2006.

PAUL E. FAHRENKOPF, EXAMINING ATTORNEY

SN 85-506,607. FREDERICK T. ELDER & ASSOCIATES, MADISON, WI, FILED 12-30-2011.

SRVCalc

THE MARK CONSISTS OF STANDARD CHARACTERS WITHOUT CLAIM TO ANY PARTICULAR FONT, STYLE, SIZE, OR COLOR.

FOR COMPUTER SOFTWARE FOR SOLVING SAFETY RELIEF VALVE RELIABILITY PROBLEMS USING STATISTICAL METHODS; OPERATING AND USER INSTRUCTIONS STORED IN DIGITAL FORM FOR COMPUTERS AND COMPUTER SOFTWARE, IN PARTICULAR ON FLOPPY DISKS OR CD-ROM (U.S. CLS. 21, 23, 26, 36 AND 38).

FIRST USE 12-20-2011; IN COMMERCE 12-20-2011.

SHANNON TWOHIG, EXAMINING ATTORNEY

SN 85-508,071. CLEAR LAW INSTITUTE LLC, ARLINGTON, VA, FILED 1-3-2012.

CLEAR LAW INSTITUTE

THE MARK CONSISTS OF STANDARD CHARACTERS WITHOUT CLAIM TO ANY PARTICULAR FONT, STYLE, SIZE, OR COLOR.

NO CLAIM IS MADE TO THE EXCLUSIVE RIGHT TO USE "LAW INSTITUTE", APART FROM THE MARK AS SHOWN.

FOR DOWNLOADABLE ELECTRONIC PUBLICATIONS IN THE NATURE OF MANUALS, BOOKS, HANDOUTS, AND PAMPHLETS IN THE FIELD OF CONDUCTING INVESTIGATIONS, DETECTING DECEPTION, LAW, COMPLIANCE WITH LAWS AND REGULATIONS, HUMAN RESOURCES, AND BUSINESS ETHICS (U.S. CLS. 21, 23, 26, 36 AND 38).

FIRST USE 10-4-2011; IN COMMERCE 10-4-2011.

JENNIFER RICHARDSON, EXAMINING ATTORNEY

CLASS 9—(Continued).

SN 85-510,736. LIFEGUARD HEALTH NETWORKS, INC., DBA LIFEGUARD HEALTH NETWORKS, INC., BERYN, PA. FILED 1-6-2012.

Lifeguard Health Networks, Inc.

THE MARK CONSISTS OF STANDARD CHARACTERS WITHOUT CLAIM TO ANY PARTICULAR FONT, STYLE, SIZE, OR COLOR.

NO CLAIM IS MADE TO THE EXCLUSIVE RIGHT TO USE "HEALTH NETWORKS, INC.", APART FROM THE MARK AS SHOWN.

FOR COMPUTER SOFTWARE FOR CONTROLLING AND MANAGING PATIENT MEDICAL INFORMATION (U.S. CLS. 21, 23, 26, 36 AND 38).

EVELYN BRADLEY, EXAMINING ATTORNEY

SN 85-511,378. WUXI JIEFU ELECTROACOUSTIC CO. LTD, JIANGSU PROVINCE, CHINA, FILED 1-9-2012.

OFFICINE MOTOJOY

THE MARK CONSISTS OF STYLIZED CAPITAL WORDING "OFFICINE MOTOJOY".

THE ENGLISH TRANSLATION OF "OFFICINE" IN THE MARK IS WORKSHOP.

FOR AUDIO-RECEIVERS AND VIDEO-RECEIVERS; CABINETS FOR LOUDSPEAKERS; EAR PLUGS FOR DIVERS; HORNS FOR LOUDSPEAKERS; JUKE BOXES; JUKE BOXES; PERSONAL STEREOs; RADIOS FOR VEHICLES; RECORD PLAYERS (U.S. CLS. 21, 23, 26, 36 AND 38).

FIRST USE 12-7-2010; IN COMMERCE 12-7-2010.
LOURDES AYALA, EXAMINING ATTORNEY

SN 85-511,486. HACSKAYLO, JACKSON, ASHEBORO, NC. FILED 1-9-2012.

Jaxon Haze

THE MARK CONSISTS OF STANDARD CHARACTERS WITHOUT CLAIM TO ANY PARTICULAR FONT, STYLE, SIZE, OR COLOR.

THE NAME(S), PORTRAIT(S), AND/OR SIGNATURE(S) SHOWN IN THE MARK IDENTIFIES JACKSON HACSKAYLO, WHOSE CONSENT(S) TO REGISTER IS MADE OF RECORD.

FOR AUDIO AND VIDEO RECORDINGS FEATURING MUSIC AND ARTISTIC PERFORMANCES; DOWNLOADABLE MUSICAL SOUND RECORDINGS; DVDS FEATURING MUSIC; MUSICAL SOUND RECORDINGS (U.S. CLS. 21, 23, 26, 36 AND 38).

PATRICIA EVANKO, EXAMINING ATTORNEY

CLASS 9—(Continued).

SN 85-512,270. VALIANT RECORDS, PORTLAND, OR. FILED 1-9-2012.

VALIANT RECORDS

THE MARK CONSISTS OF STANDARD CHARACTERS WITHOUT CLAIM TO ANY PARTICULAR FONT, STYLE, SIZE, OR COLOR.

NO CLAIM IS MADE TO THE EXCLUSIVE RIGHT TO USE "RECORDS", APART FROM THE MARK AS SHOWN. FOR MUSICAL SOUND RECORDINGS; MUSICAL VIDEO RECORDINGS; PHONOGRAPH RECORDS FEATURING MUSIC; PRE-RECORDED CDS FEATURING MUSIC; PRE-RECORDED ELECTRONIC AND DIGITAL MEDIA FEATURING MUSIC (U.S. CLS. 21, 23, 26, 36 AND 38).

RONALD MCMORROW, EXAMINING ATTORNEY

SN 85-515,939. TRIAL ADVANTAGE LLC, MURRIETA, CA. FILED 1-13-2012.

NeuralNet Case Development

THE MARK CONSISTS OF STANDARD CHARACTERS WITHOUT CLAIM TO ANY PARTICULAR FONT, STYLE, SIZE, OR COLOR.

NO CLAIM IS MADE TO THE EXCLUSIVE RIGHT TO USE "CASE DEVELOPMENT", APART FROM THE MARK AS SHOWN.

FOR COMPUTER SOFTWARE FOR USE BY THE LEGAL INDUSTRY IN DEVELOPING A LAWSUIT AND ITS CONTENTS FOR NEGOTIATIONS, SETTLEMENTS, ARBITRATION AND JURY TRIAL (U.S. CLS. 21, 23, 26, 36 AND 38).

FIRST USE 8-1-2011; IN COMMERCE 8-1-2011.
JOHN DALIER, EXAMINING ATTORNEY

SN 85-517,042. CERTIFIED PAYMENT PROCESSING, L.P., FORT WORTH, TX. FILED 1-16-2012.

PROXIMA

THE MARK CONSISTS OF STANDARD CHARACTERS WITHOUT CLAIM TO ANY PARTICULAR FONT, STYLE, SIZE, OR COLOR.

THE ENGLISH TRANSLATION OF "PROXIMA" IS "NEXT".

FOR ELECTRONIC PAYMENT TERMINAL (U.S. CLS. 21, 23, 26, 36 AND 38).

JEFF DEFORD, EXAMINING ATTORNEY

CLASS 9—(Continued).

SN 85-517,606. PARACE, LLC, YORKTOWN HEIGHTS, NY.
FILED 1-16-2012.

WORDBANKER

THE MARK CONSISTS OF STANDARD CHARACTERS WITHOUT CLAIM TO ANY PARTICULAR FONT, STYLE, SIZE, OR COLOR.

FOR ELECTRONIC GAMING SOFTWARE FOR STRUCTURED INTERACTIVE LEARNING OF VOCABULARY WORDS USING A UNIQUE LEARNING PROCESS, FOR USE ON MOBILE DEVICES (U.S. CLS. 21, 23, 26, 36 AND 38).

KRISTINA MORRIS, EXAMINING ATTORNEY

SN 85-518,180. AURUM ENTERPRISES, BOCA RATON, FL.
FILED 1-17-2012.

SecondShells

THE MARK CONSISTS OF STANDARD CHARACTERS WITHOUT CLAIM TO ANY PARTICULAR FONT, STYLE, SIZE, OR COLOR.

FOR CARRYING CASES FOR MOBILE COMPUTERS (U.S. CLS. 21, 23, 26, 36 AND 38).

FIRST USE 4-15-2011; IN COMMERCE 9-15-2011.
SANDRA BUJA, EXAMINING ATTORNEY

SN 85-518,747. SUZANNE EVANOFF, PINE BUSH, NY.
FILED 1-18-2012.

MotherStone Records

THE MARK CONSISTS OF STANDARD CHARACTERS WITHOUT CLAIM TO ANY PARTICULAR FONT, STYLE, SIZE, OR COLOR.

NO CLAIM IS MADE TO THE EXCLUSIVE RIGHT TO USE "RECORDS", APART FROM THE MARK AS SHOWN.

FOR MUSICAL RECORDINGS (U.S. CLS. 21, 23, 26, 36 AND 38).

JOHN DALIER, EXAMINING ATTORNEY

CLASS 9—(Continued).

SN 85-519,358. GUY PISTONE, SHREWSBURY, MA. FILED 1-18-2012.

FITIVITY

THE MARK CONSISTS OF STANDARD CHARACTERS WITHOUT CLAIM TO ANY PARTICULAR FONT, STYLE, SIZE, OR COLOR.

FOR COMPUTER APPLICATION SOFTWARE FOR MOBILE PHONES, NAMELY, SOFTWARE FOR USE IN LOCATING AND LEARNING ABOUT THE AVAILABILITY OF PHYSICAL ACTIVITY OPTIONS IN A SPECIFIC GEOGRAPHIC AREA (U.S. CLS. 21, 23, 26, 36 AND 38).

JAMES GRIFFIN, EXAMINING ATTORNEY

SN 85-519,405. UV CONCEPTS LLC, SAUK RAPIDS, MN.
FILED 1-18-2012.

Nova Flex

THE MARK CONSISTS OF STANDARD CHARACTERS WITHOUT CLAIM TO ANY PARTICULAR FONT, STYLE, SIZE, OR COLOR.

NO CLAIM IS MADE TO THE EXCLUSIVE RIGHT TO USE "FLEX", APART FROM THE MARK AS SHOWN.

FOR FLEXIBLE LED (LIGHT EMITTING DIODES) RIBBON LIGHTING FIXTURES FOR USE IN DISPLAY, COMMERCIAL, INDUSTRIAL, RESIDENTIAL AND ARCHITECTURAL ACCENT LIGHTING APPLICATIONS (U.S. CLS. 21, 23, 26, 36 AND 38).

ALICE BENMAMAN, EXAMINING ATTORNEY

SN 85-519,820. HV DIAGNOSTICS, INC., WOODSTOCK, GA.
FILED 1-19-2012.

EZ-CABLE ID

THE MARK CONSISTS OF STANDARD CHARACTERS WITHOUT CLAIM TO ANY PARTICULAR FONT, STYLE, SIZE, OR COLOR.

NO CLAIM IS MADE TO THE EXCLUSIVE RIGHT TO USE "ID", APART FROM THE MARK AS SHOWN.

FOR ELECTRICAL TEST AND MEASUREMENT DEVICE FOR USE IN IDENTIFYING CABLES (U.S. CLS. 21, 23, 26, 36 AND 38).

FIRST USE 0-0-2011; IN COMMERCE 0-0-2011.

CARYN GLASSER, EXAMINING ATTORNEY

CLASS 9—(Continued).

SN 85-521,149. AYOPA GAMES, ALBANY, CA. FILED 1-20-2012.

Ayopa

THE MARK CONSISTS OF STANDARD CHARACTERS WITHOUT CLAIM TO ANY PARTICULAR FONT, STYLE, SIZE, OR COLOR.
FOR VIDEO GAME SOFTWARE (U.S. CLS. 21, 23, 26, 36 AND 38).
TRACY WHITTAKER-BROWN, EXAMINING ATTORNEY

CLASS 9—(Continued).

SN 85-521,891. NORGART, MITCHELL L., NAPLES, FL. FILED 1-20-2012.

HOLD THAT THOUGHT

THE MARK CONSISTS OF STANDARD CHARACTERS WITHOUT CLAIM TO ANY PARTICULAR FONT, STYLE, SIZE, OR COLOR.
FOR PORTABLE, HAND-HELD, CLIP-ON AND BUTTON-ON DIGITAL ELECTRONIC DEVICES FOR AUDIO RECORDING AND PLAYBACK (U.S. CLS. 21, 23, 26, 36 AND 38).
MATTHEW MCDOWELL, EXAMINING ATTORNEY

SN 85-521,707. CLOCKWORK IP, LLC, SARASOTA, FL. FILED 1-20-2012.

**PHONE
FACTS**

NO CLAIM IS MADE TO THE EXCLUSIVE RIGHT TO USE "PHONE", APART FROM THE MARK AS SHOWN.
THE MARK CONSISTS OF "PHONE FACTS" WITH "O" IN PHONE CONSISTING OF A PHONE RECEIVER IN A BALL.
FOR COMPUTER SOFTWARE FOR USE IN RECORDING, MONITORING, AND TRACKING TELEPHONE CALLS AND CREATING CUSTOMIZED REPORTS CONTAINING INFORMATION PERTAINING TO SUCH TELEPHONE CALLS (U.S. CLS. 21, 23, 26, 36 AND 38).
REBECCA SMITH, EXAMINING ATTORNEY

SN 85-522,017. PERFORMANCE ELECTRONICS, LTD., WEST CHESTER, OH. FILED 1-21-2012.

PERFORMANCE ELECTRONICS

SN 85-521,777. CLOCKWORK IP, LLC, SARASOTA, FL. FILED 1-20-2012.

CALL TAKING'S CRYSTAL BALL

THE MARK CONSISTS OF STANDARD CHARACTERS WITHOUT CLAIM TO ANY PARTICULAR FONT, STYLE, SIZE, OR COLOR.
NO CLAIM IS MADE TO THE EXCLUSIVE RIGHT TO USE "CALL TAKING'S", APART FROM THE MARK AS SHOWN.
FOR COMPUTER SOFTWARE FOR USE IN RECORDING, MONITORING, AND TRACKING TELEPHONE CALLS AND CREATING CUSTOMIZED REPORTS CONTAINING INFORMATION PERTAINING TO SUCH TELEPHONE CALLS (U.S. CLS. 21, 23, 26, 36 AND 38).
REBECCA SMITH, EXAMINING ATTORNEY

THE MARK CONSISTS OF STANDARD CHARACTERS WITHOUT CLAIM TO ANY PARTICULAR FONT, STYLE, SIZE, OR COLOR.
NO CLAIM IS MADE TO THE EXCLUSIVE RIGHT TO USE "ELECTRONICS", APART FROM THE MARK AS SHOWN.
FOR ELECTRONIC CONTROL SYSTEMS FOR MACHINES (U.S. CLS. 21, 23, 26, 36 AND 38).
FIRST USE 6-23-1999; IN COMMERCE 6-23-1999.
AISHA SALEM, EXAMINING ATTORNEY

CLASS 9—(Continued).

SN 85-522,492. COPSYNC, INC., NEW BRAUNFELS, TX. FILED 1-23-2012.

VidTac

THE MARK CONSISTS OF STANDARD CHARACTERS WITHOUT CLAIM TO ANY PARTICULAR FONT, STYLE, SIZE, OR COLOR.

FOR AUDIO AND VIDEO RECORDING SYSTEMS, NAMELY, CAMERAS, VIDEO CAMERAS, INFRARED CAMERAS, THERMOGRAPHIC CAMERAS, OPTICAL AND ELECTRONIC APPARATUS AND INSTRUMENTS, VIDEO RECORDERS, THERMAL IMAGERS, MICROPHONES, COMPUTER HARDWARE AND COMPUTER SOFTWARE, ALL FOR USE IN LAW ENFORCEMENT, POLICE PATROL, VEHICLE TRAFFIC MANAGEMENT, SECURITY MONITORING, SURVEILLANCE, TRACKING, INFRARED SIGNATURE, NIGHT OBSERVATION, AND SEARCH AND RESCUE APPLICATIONS; AUDIO AND VIDEO EQUIPMENT AND COMPONENTS, NAMELY, AUDIO AND VIDEO TRANSMITTERS, RECEIVERS AND TRANSCEIVERS AND RELATED COMPONENTS AND ACCESSORIES, ALL FOR TRANSMISSION AND RECEPTION OF AUDIO, VIDEO AND DATA, FOR USE IN LAW ENFORCEMENT, POLICE PATROL, VEHICLE TRAFFIC MANAGEMENT, SECURITY MONITORING, SURVEILLANCE, TRACKING, INFRARED SIGNATURE, NIGHT OBSERVATION, SEARCH AND RESCUE APPLICATIONS, AND FOR COMMUNICATION, EXCHANGES AND COORDINATION WITH AND SUPPORT OF FIRE, LAW ENFORCEMENT, POLICE, AMBULANCE, HOSPITAL, PRIVATE SECURITY MONITORING, AND OTHER PUBLIC AND PRIVATE SAFETY PERSONNEL (U.S. CLS. 21, 23, 26, 36 AND 38).

JOHN E. MICHOS, EXAMINING ATTORNEY

SN 85-522,719. TRIMBLE NAVIGATION LIMITED, SUNNYVALE, CA. FILED 1-23-2012.

TRACTOR BEAM

THE MARK CONSISTS OF STANDARD CHARACTERS WITHOUT CLAIM TO ANY PARTICULAR FONT, STYLE, SIZE, OR COLOR.

FOR DEVICES FOR WIRELESS RADIO TRANSMISSION, FOR USE IN COORDINATING THE MOVEMENTS OF AGRICULTURAL MACHINERY; DEVICES FOR WIRELESS RADIO TRANSMISSION, SOLD AS AN INTEGRAL COMPONENT OF AGRICULTURAL MACHINERY, FOR USE IN COORDINATING THE MOVEMENTS OF AGRICULTURAL MACHINERY; A FEATURE OF DEVICES FOR WIRELESS RADIO TRANSMISSION, FOR USE IN COORDINATING THE MOVEMENTS OF AGRICULTURAL MACHINERY (U.S. CLS. 21, 23, 26, 36 AND 38).

ANNE MADDEN, EXAMINING ATTORNEY

CLASS 9—(Continued).

SN 85-522,843. BEYER, ROBERT W., LONG BEACH, CA. AND ROSS, BRUCE E., SAN CLEMENTE, CA. AND INDORF, KENNETH G., MISSION VIEJO, CA. AND BEYER, ROBERT WAYNE, LONG BEACH, CA. FILED 1-23-2012.

Wine Winners

THE MARK CONSISTS OF STANDARD CHARACTERS WITHOUT CLAIM TO ANY PARTICULAR FONT, STYLE, SIZE, OR COLOR.

NO CLAIM IS MADE TO THE EXCLUSIVE RIGHT TO USE "WINE", APART FROM THE MARK AS SHOWN.

FOR APPLICATION SOFTWARE FOR PERSONAL COMPUTING DEVICES, FEATURING A WORLDWIDE LISTING SERVICE OF TOP PLACING WINES, WINNERS OF WINE TASTING EVENTS, LOCAL RESTAURANTS SERVING TOP RATED WINES, DIRECTORY OF WINE-RY'S WITH MAPS, LOCATIONS TO PURCHASE TOP PLACING WINES, DESCRIPTION OF TASTE, FOODS AND RECIPES THAT COMPLIMENT A PARTICULAR WINE, DUI CALCULATOR, VIA PERSONAL COMPUTING DEVICES, NAMELY, MOBILE DEVICES, SMART PHONES, TABLETS, AND PERSONAL COMPUTING DEVICES (U.S. CLS. 21, 23, 26, 36 AND 38).

WILLIAM ROSSMAN, EXAMINING ATTORNEY

SN 85-523,287. SATMETRIX SYSTEMS, INC., SAN MATEO, CA. FILED 1-23-2012.

SATMETRIX SPARKSCORE

THE MARK CONSISTS OF STANDARD CHARACTERS WITHOUT CLAIM TO ANY PARTICULAR FONT, STYLE, SIZE, OR COLOR.

OWNER OF U.S. REG. NOS. 2,692,050, 2,812,058 AND OTHERS.

FOR COMPUTER SOFTWARE, NAMELY, COMPUTER SOFTWARE FOR CONDUCTING MARKET RESEARCH IN THE FIELD OF ECOMMERCE SALES AND SERVICES; COMPUTER SOFTWARE FOR EVALUATING EFFECTIVENESS OF INTERNET SITES; COMPUTER SOFTWARE FOR BUSINESS CONSULTING, NAMELY, FOR ANALYZING CUSTOMER RECOMMENDATIONS AND CUSTOMER LOYALTY; COMPUTER SOFTWARE FOR ANALYZING THE EFFECTIVENESS OF ECOMMERCE SITES; COMPUTER SOFTWARE FOR CREATING GRAPHICS; COMPUTER SOFTWARE FOR ANALYZING STATISTICS; COMPUTER SOFTWARE FOR PROVIDING ACCESS TO GLOBAL COMPUTER NETWORKS; COMPUTER SOFTWARE FOR FINANCIAL ANALYSIS (U.S. CLS. 21, 23, 26, 36 AND 38).

HANNO RITTNER, EXAMINING ATTORNEY

CLASS 9—(Continued).

SN 85-523,326. BOENN TECHNOLOGIES INC, HILLSBOROUGH, NJ. FILED 1-23-2012.

KAPAXEN

THE MARK CONSISTS OF STANDARD CHARACTERS WITHOUT CLAIM TO ANY PARTICULAR FONT, STYLE, SIZE, OR COLOR.

FOR ACCESSORIES AND PARTS FOR CONSUMER ELECTRONICS, NAMELY, BATTERIES, BATTERY CHARGERS, POWER ADAPTERS, BATTERY CABLES, AND BATTERY CASES (U.S. CLS. 21, 23, 26, 36 AND 38).
FIRST USE 12-1-2011; IN COMMERCE 1-1-2012.
SHARON MEIER, EXAMINING ATTORNEY

CLASS 9—(Continued).

SN 85-524,148. MINDREFLECTOR TECHNOLOGIES, LLC, HARRISBURG, PA. FILED 1-24-2012.

MindReflector

THE MARK CONSISTS OF STANDARD CHARACTERS WITHOUT CLAIM TO ANY PARTICULAR FONT, STYLE, SIZE, OR COLOR.

FOR COMPUTER APPLICATION SOFTWARE FOR BIOFEEDBACK, NAMELY, SOFTWARE FOR NEUROFEEDBACK APPLICATIONS (U.S. CLS. 21, 23, 26, 36 AND 38).
FIRST USE 6-1-2011; IN COMMERCE 1-1-2012.
DOUGLAS LEE, EXAMINING ATTORNEY

SN 85-523,425. GARESSIO S.R.L., CLUJ-NAPOCA, ROMANIA, FILED 1-24-2012.

ModenaCam

THE MARK CONSISTS OF STANDARD CHARACTERS WITHOUT CLAIM TO ANY PARTICULAR FONT, STYLE, SIZE, OR COLOR.

FOR WEB SITE DEVELOPMENT SOFTWARE; COMPUTER SOFTWARE FOR INSTALLATION INTO A WEB SITE TO PROVIDE VIDEO CHAT CAPABILITIES FOR THAT WEB SITE (U.S. CLS. 21, 23, 26, 36 AND 38).
FIRST USE 1-19-2012; IN COMMERCE 1-19-2012.
HANNO RITTNER, EXAMINING ATTORNEY

SN 85-524,601. STRONG GEAR, LLC, COLUMBUS, OH. FILED 1-25-2012.

HEADBANGER

THE MARK CONSISTS OF STANDARD CHARACTERS WITHOUT CLAIM TO ANY PARTICULAR FONT, STYLE, SIZE, OR COLOR.

FOR PROTECTIVE SPORTS HELMET ACCESSORIES THAT ATTACH TO THE HELMETS, NAMELY, PADDED CHIN STRAPS (U.S. CLS. 21, 23, 26, 36 AND 38).
ALEX KEAM, EXAMINING ATTORNEY

SN 85-523,427. KOBEISSI, NADIM, MONTRÉAL, CANADA, FILED S.R. 1-24-2012; AM. P.R. 5-3-2012.

Cryptocat

THE MARK CONSISTS OF STANDARD CHARACTERS WITHOUT CLAIM TO ANY PARTICULAR FONT, STYLE, SIZE, OR COLOR.

FOR COMMUNICATION SOFTWARE FOR PROVIDING ACCESS TO THE INTERNET; COMMUNICATIONS SOFTWARE FOR CONNECTING COMPUTER NETWORK USERS; COMPUTER APPLICATION SOFTWARE FOR MOBILE PHONES, NAMELY, SOFTWARE FOR ENCRYPTING COMMUNICATION OF SMART PHONE DEVICES; COMPUTER SOFTWARE FOR COMMUNICATING WITH USERS OF HAND-HELD COMPUTERS; COMPUTER SOFTWARE FOR ENCRYPTION (U.S. CLS. 21, 23, 26, 36 AND 38).
FIRST USE 5-19-2011; IN COMMERCE 5-19-2011.
HANNO RITTNER, EXAMINING ATTORNEY

SN 85-524,730. URBAN CODE, INCORPORATED, FORMERLY STARBELLY PRODUCTIONS, INCORPORATED, CLEVELAND, OH. FILED 1-25-2012.

UDEPLOY

THE MARK CONSISTS OF STANDARD CHARACTERS WITHOUT CLAIM TO ANY PARTICULAR FONT, STYLE, SIZE, OR COLOR.

FOR COMPUTER SOFTWARE DEVELOPMENT TOOLS (U.S. CLS. 21, 23, 26, 36 AND 38).
FIRST USE 1-23-2012; IN COMMERCE 1-23-2012.
MEGHAN REINHART, EXAMINING ATTORNEY

CLASS 9—(Continued).

SN 85-525,509. THE MELODY BOOK, LLC, NEW YORK, NY.
FILED 1-25-2012.

A Jazzy Day

THE MARK CONSISTS OF STANDARD CHARACTERS WITHOUT CLAIM TO ANY PARTICULAR FONT, STYLE, SIZE, OR COLOR.

FOR COMPUTER APPLICATION SOFTWARE FOR MOBILE PHONES, NAMELY, SOFTWARE FOR CHILDREN'S MUSIC EDUCATION (U.S. CLS. 21, 23, 26, 36 AND 38).

FIRST USE 11-1-2011; IN COMMERCE 1-12-2012.
JUDITH HELFMAN, EXAMINING ATTORNEY

CLASS 9—(Continued).

SN 85-526,644. 8G ELECTRONICS LLC, NEWBURGH, IN.
FILED 1-26-2012.



SN 85-526,211. UNIVERSAL MEDIA SYNDICATE, INC., DBA
BRILLIANT BUILT TECHNOLOGIES, NORTH CANTON,
OH. FILED 1-26-2012.



THE COLOR(S) BLUE, ORANGE, AND WHITE IS/ARE CLAIMED AS A FEATURE OF THE MARK.

THE MARK CONSISTS OF A STYLIZED REPRESENTATION OF A "USB" CONNECTION IN BLUE WITH AN ORANGE AND WHITE SOCKET REPRESENTATION AND THE WORDS "USB" APPEARING IN THE "USB" WHEREIN "US" IS IN WHITE AND "B" IS IN BLUE. THE CORD OF THE "USB" APPEARS IN BLUE AND BELOW THE "USB" APPEARS THE WORDING "SOCK-IT" STYLIZED IN BLUE. THE BACKGROUND OF THE MARK IS TRANSPARENT.

FOR CHARGERS FOR ELECTRIC BATTERIES; ELECTRICAL OUTLETS (U.S. CLS. 21, 23, 26, 36 AND 38).
ANDREA HACK, EXAMINING ATTORNEY

NO CLAIM IS MADE TO THE EXCLUSIVE RIGHT TO USE "CLEAR SIGNAL", APART FROM THE MARK AS SHOWN.

THE MARK CONSISTS OF THE WORD "CLEAR SIGNAL" WITH A CIRCLE BETWEEN THE "R" AND "S" WITH THREE CURVED LINES ABOVE THE CIRCLE BETWEEN THE "R" AND "S".

FOR TELEVISION CONVERTER BOX FOR CONVERTING DIGITAL SIGNALS TO ANALOG (U.S. CLS. 21, 23, 26, 36 AND 38).

ELLEN B. AWRICH, EXAMINING ATTORNEY

SN 85-526,871. INFOALCHEMY LLC, NORTH BETHESDA,
MD. FILED 1-27-2012.

MEDVANA

SN 85-526,293. MEDISERVE INFORMATION SYSTEMS,
INC., CHANDLER, AZ. FILED 1-26-2012.

ATTIGO

THE MARK CONSISTS OF STANDARD CHARACTERS WITHOUT CLAIM TO ANY PARTICULAR FONT, STYLE, SIZE, OR COLOR.

FOR SOFTWARE FOR MANAGEMENT, MAINTENANCE, RECORDING, EXCHANGE, AND RETRIEVAL OF INFORMATION FOR PHYSICAL MEDICINE AND REHABILITATION SERVICE PROVIDERS (U.S. CLS. 21, 23, 26, 36 AND 38).

GEOFFREY FOSDICK, EXAMINING ATTORNEY

THE MARK CONSISTS OF STANDARD CHARACTERS WITHOUT CLAIM TO ANY PARTICULAR FONT, STYLE, SIZE, OR COLOR.

FOR COMPUTER SOFTWARE FOR COMMUNICATING WITH USERS OF DESK-TOP COMPUTERS, HANDHELD COMPUTERS, SMART PHONES, AND REGULAR PHONES FOR DIRECTING USERS TO SPECIFIC MEDICAL RESOURCES, NAMELY, PRESCRIPTION DRUGS, PHARMACY SERVICES, HEALTHCARE PROVIDERS AND MEDICAL FACILITIES, CARE MANAGEMENT RESOURCES, DIFFERENTIAL DIAGNOSIS LISTS, DISEASE SPECIFIC INFORMATION, HEALTHCARE SOCIAL NETWORKS, INSURANCE INFORMATION, COST AND QUALITY INFORMATION AND WEB SEARCHES (U.S. CLS. 21, 23, 26, 36 AND 38).

FIRST USE 2-1-2012; IN COMMERCE 2-28-2012.
MATTHEW PAPPAS, EXAMINING ATTORNEY

CLASS 9—(Continued).

SN 85-527,466. AGILENT TECHNOLOGIES, INC., SANTA CLARA, CA. FILED 1-27-2012.

INFINIIVIEW

THE MARK CONSISTS OF STANDARD CHARACTERS WITHOUT CLAIM TO ANY PARTICULAR FONT, STYLE, SIZE, OR COLOR.

OWNER OF U.S. REG. NOS. 2,476,188, 3,726,065 AND OTHERS.

FOR COMPUTER APPLICATION SOFTWARE FOR COMPUTERS, MOBILE COMPUTERS AND TABLET COMPUTERS, NAMELY, SOFTWARE FOR ANALYZING ELECTRONIC MEASUREMENT DATA CAPTURED ON AN OSCILLOSCOPE (U.S. CLS. 21, 23, 26, 36 AND 38).
RENEE MCCRAY, EXAMINING ATTORNEY

CLASS 9—(Continued).

SN 85-528,818. ZY HOLDINGS LLC, NEW YORK, NY. FILED 1-30-2012.

ZOO YORK

THE MARK CONSISTS OF STANDARD CHARACTERS WITHOUT CLAIM TO ANY PARTICULAR FONT, STYLE, SIZE, OR COLOR.

OWNER OF U.S. REG. NOS. 1,927,011, 3,060,810 AND OTHERS.

FOR EYEWEAR, NAMELY, SUNGLASSES AND CASES THEREFOR (U.S. CLS. 21, 23, 26, 36 AND 38).

FIRST USE 12-31-2011; IN COMMERCE 12-31-2011.

TARAH HARDY, EXAMINING ATTORNEY

SN 85-530,444. KONAMI GAMING, INC., LAS VEGAS, NV. FILED 1-31-2012.

HAWAIIAN HEAT

THE MARK CONSISTS OF STANDARD CHARACTERS WITHOUT CLAIM TO ANY PARTICULAR FONT, STYLE, SIZE, OR COLOR.

OWNER OF U.S. REG. NOS. 3,098,847, 3,938,315 AND OTHERS.

FOR ELECTRONIC GAME PROGRAMS; GAMING EQUIPMENT, NAMELY, SLOT MACHINES WITH OR WITHOUT VIDEO OUTPUT; GAMING MACHINES; MACHINES FOR PLAYING GAMES OF CHANCE; SLOT MACHINES (U.S. CLS. 21, 23, 26, 36 AND 38).

TINA MAI, EXAMINING ATTORNEY

SN 85-528,702. ZY HOLDINGS LLC, NEW YORK, NY. FILED 1-30-2012.



OWNER OF U.S. REG. NOS. 2,951,831, 2,976,072 AND OTHERS.

THE MARK CONSISTS OF A FANCIFUL INTERLOCKING "ZY" DESIGN.

FOR EYEWEAR, NAMELY, SUNGLASSES AND CASES THEREFOR (U.S. CLS. 21, 23, 26, 36 AND 38).

FIRST USE 12-31-2011; IN COMMERCE 12-31-2011.

TARAH HARDY, EXAMINING ATTORNEY

SN 85-530,448. KONAMI GAMING, INC., LAS VEGAS, NV. FILED 1-31-2012.

LADY BUTTERFLY

THE MARK CONSISTS OF STANDARD CHARACTERS WITHOUT CLAIM TO ANY PARTICULAR FONT, STYLE, SIZE, OR COLOR.

OWNER OF U.S. REG. NOS. 3,396,514, 3,908,846 AND OTHERS.

FOR ELECTRONIC GAME PROGRAMS; GAMING EQUIPMENT, NAMELY, SLOT MACHINES WITH OR WITHOUT VIDEO OUTPUT; GAMING MACHINES; MACHINES FOR PLAYING GAMES OF CHANCE; SLOT MACHINES (U.S. CLS. 21, 23, 26, 36 AND 38).

TINA MAI, EXAMINING ATTORNEY

CLASS 9—(Continued).

SN 85-530,452. KONAMI GAMING, INC., LAS VEGAS, NV.
FILED 1-31-2012.

LAVISH FORTUNES

THE MARK CONSISTS OF STANDARD CHARACTERS WITHOUT CLAIM TO ANY PARTICULAR FONT, STYLE, SIZE, OR COLOR.

OWNER OF U.S. REG. NOS. 3,184,826, 4,071,439 AND OTHERS.

FOR ELECTRONIC GAME PROGRAMS; GAMING EQUIPMENT, NAMELY, SLOT MACHINES WITH OR WITHOUT VIDEO OUTPUT; GAMING MACHINES; MACHINES FOR PLAYING GAMES OF CHANCE; SLOT MACHINES (U.S. CLS. 21, 23, 26, 36 AND 38).

TINA MAI, EXAMINING ATTORNEY

SN 85-530,456. KONAMI GAMING, INC., LAS VEGAS, NV.
FILED 1-31-2012.

BONFIRE BEACH JACKPOT

THE MARK CONSISTS OF STANDARD CHARACTERS WITHOUT CLAIM TO ANY PARTICULAR FONT, STYLE, SIZE, OR COLOR.

OWNER OF U.S. REG. NOS. 3,056,323, 4,074,328 AND OTHERS.

FOR ELECTRONIC GAME PROGRAMS; GAMING EQUIPMENT, NAMELY, SLOT MACHINES WITH OR WITHOUT VIDEO OUTPUT; GAMING MACHINES; MACHINES FOR PLAYING GAMES OF CHANCE; SLOT MACHINES (U.S. CLS. 21, 23, 26, 36 AND 38).

TINA MAI, EXAMINING ATTORNEY

CLASS 9—(Continued).

SN 85-530,471. PISMO LABS TECHNOLOGY LTD, HONG KONG, HONG KONG, FILED 1-31-2012.

SPEEDFUSION

THE MARK CONSISTS OF STANDARD CHARACTERS WITHOUT CLAIM TO ANY PARTICULAR FONT, STYLE, SIZE, OR COLOR.

FOR APPARATUS FOR RECORDING, TRANSMISSION, PROCESSING AND REPRODUCTION OF SOUND, IMAGES OR DATA; APPARATUS FOR TRANSMISSION OF COMMUNICATION; COMMUNICATION SOFTWARE FOR PROVIDING ACCESS TO THE INTERNET; COMMUNICATIONS SOFTWARE FOR CONNECTING COMPUTING DEVICES; COMPUTER APPLICATION SOFTWARE FOR MOBILE PHONES, NAMELY, SOFTWARE FOR BONDED NETWORK COMMUNICATIONS; COMPUTER APPLICATION SOFTWARE FOR BONDED NETWORK COMMUNICATIONS, NAMELY, SOFTWARE FOR BONDED NETWORK COMMUNICATIONS; COMPUTER HARDWARE AND PERIPHERAL DEVICES AND COMPUTER SOFTWARE FOR DATA COMMUNICATION AND TRANSLATING AND TRANSMITTING DATA SOLD THEREWITH; COMPUTER HARDWARE FOR COMMUNICATING AUDIO, VIDEO AND DATA BETWEEN COMPUTERS VIA A GLOBAL COMPUTER NETWORK, WIDE-AREA COMPUTER NETWORKS, AND PEER-TO-PEER COMPUTER NETWORKS; COMPUTER HARDWARE FOR HIGH-SPEED PROCESSING AND STORAGE OF DATA USING MULTIPLE CPU'S; COMPUTER HARDWARE FOR UPLOAD, STORAGE, RETRIEVAL, DOWNLOAD, TRANSMISSION AND DELIVERY OF DIGITAL CONTENT; COMPUTER SOFTWARE FOR COMMUNICATING WITH USERS OF HAND-HELD COMPUTERS; DEVICES FOR WIRELESS RADIO TRANSMISSION; GATEWAY ROUTERS IN THE NATURE OF COMPUTER CONTROL HARDWARE; MOBILE COMPUTING AND OPERATING PLATFORMS CONSISTING OF DATA TRANSCEIVERS, WIRELESS NETWORKS AND GATEWAYS FOR COLLECTION AND MANAGEMENT OF DATA; VPN (VIRTUAL PRIVATE NETWORK) HARDWARE; VPN (VIRTUAL PRIVATE NETWORK) OPERATING SOFTWARE (U.S. CLS. 21, 23, 26, 36 AND 38).

KATHERINE CONNOLLY, EXAMINING ATTORNEY

SN 85-530,511. TAKE FANS TECHNOLOGY (US) CO., LTD., EL MONTE, CA. FILED 2-1-2012.

THE MARK CONSISTS OF THE WORDING "TAKE FANS", WITH A HAT IN THE UPPER LEFT CORNER OF THE LETTER "A".

FOR ACOUSTIC COUPLERS; AMPLIFIERS; BATTERIES AND BATTERY CHARGERS; CELL PHONES; CONNECTORS FOR ELECTRONIC CIRCUITS; DATA PROCESSORS; EAR BUDS; EAR PHONES; HANDS FREE KITS FOR PHONES; MICROCHIP CARDS (U.S. CLS. 21, 23, 26, 36 AND 38).

FIRST USE 9-1-2010; IN COMMERCE 9-1-2010.

LINDA M. KING, EXAMINING ATTORNEY

CLASS 9—(Continued).

SN 85-530,513. KONAMI GAMING, INC., LAS VEGAS, NV. FILED 2-1-2012.

VOLCANIC FORTUNE

THE MARK CONSISTS OF STANDARD CHARACTERS WITHOUT CLAIM TO ANY PARTICULAR FONT, STYLE, SIZE, OR COLOR.

OWNER OF U.S. REG. NOS. 3,366,368, 4,071,439 AND OTHERS.

FOR ELECTRONIC GAME PROGRAMS; GAMING EQUIPMENT, NAMELY, SLOT MACHINES WITH OR WITHOUT VIDEO OUTPUT; GAMING MACHINES; MACHINES FOR PLAYING GAMES OF CHANCE; SLOT MACHINES (U.S. CLS. 21, 23, 26, 36 AND 38).

TINA MAI, EXAMINING ATTORNEY

CLASS 9—(Continued).

SN 85-530,632. SWEITZER, MARTIN, CARY, NC. FILED 2-1-2012.

BITMONSTER

THE MARK CONSISTS OF STANDARD CHARACTERS WITHOUT CLAIM TO ANY PARTICULAR FONT, STYLE, SIZE, OR COLOR.

FOR COMPUTER GAME SOFTWARE FOR PERSONAL COMPUTERS AND HOME VIDEO GAME CONSOLES; DOWNLOADABLE IMAGE FILE CONTAINING ARTWORK, TEXT, AUDIO, VIDEO, GAMES AND INTERNET WEB LINKS RELATING TO SPORTING AND CULTURAL ACTIVITIES; VIDEO GAME SOFTWARE (U.S. CLS. 21, 23, 26, 36 AND 38).

LINDA MICKLEBURGH, EXAMINING ATTORNEY

SN 85-530,603. AGILEX TECHNOLOGIES, INC., DBA AGILEX, CHANTILLY, VA. FILED 2-1-2012.



THE COLOR(S) DARK TEAL AND LIGHT TEAL IS/ARE CLAIMED AS A FEATURE OF THE MARK.

THE MARK CONSISTS OF THE WORDING "PHANERO" SPELLED OUT IN DARK TEAL PRECEDED BY A DOUBLE HELIX WITH NINETY DEGREE ANGLES AND ROUNDED ENDS WITH ONE HELIX IN DARK TEAL, THE OTHER HELIX IN LIGHT TEAL.

FOR COMPUTER SOFTWARE FOR ANALYZING STRUCTURED AND UNSTRUCTURED DATA (U.S. CLS. 21, 23, 26, 36 AND 38).

FIRST USE 12-5-2011; IN COMMERCE 12-5-2011.
MICHAEL WIENER, EXAMINING ATTORNEY

SN 85-530,676. NAMCO BANDAI GAMES INC., SHINAGAWA-KU TOKYO, JAPAN, FILED 2-1-2012.

PIRATE WARRIORS

THE MARK CONSISTS OF STANDARD CHARACTERS WITHOUT CLAIM TO ANY PARTICULAR FONT, STYLE, SIZE, OR COLOR.

FOR COMPUTER GAME PROGRAMS; COMPUTER GAME PROGRAMS, CARTRIDGES, AND CASSETTES; COMPUTER GAME SOFTWARE; DOWNLOADABLE COMPUTER GAME PROGRAMS; DOWNLOADABLE COMPUTER GAME SOFTWARE VIA A GLOBAL COMPUTER NETWORK AND WIRELESS DEVICES; VIDEO GAME CARTRIDGES; VIDEO GAME DISCS; VIDEO GAME SOFTWARE (U.S. CLS. 21, 23, 26, 36 AND 38).

CHRISTOPHER SIDOTI, EXAMINING ATTORNEY

SN 85-530,627. JOHNSON, AUGUST, BOISE, ID. FILED 2-1-2012.

Cellfy

THE MARK CONSISTS OF STANDARD CHARACTERS WITHOUT CLAIM TO ANY PARTICULAR FONT, STYLE, SIZE, OR COLOR.

FOR CASES FOR MOBILE PHONES; CELL PHONE CASES; CELL PHONE STRAPS; HANDS FREE DEVICES FOR MOBILE-PHONES; HARNESSES FOR HOLDING ELECTRONIC DEVICES, NAMELY, CELLULAR PHONES; MOBILE PHONE STRAPS; SPECIALTY HOLSTER FOR CARRYING CELLULAR PHONES; STRAPS FOR MOBILE PHONES (U.S. CLS. 21, 23, 26, 36 AND 38).

JOHN DALIER, EXAMINING ATTORNEY

SN 85-530,749. CURIO, LTD., FORT WORTH, TX. FILED 2-1-2012.

HATCHLATCH

THE MARK CONSISTS OF STANDARD CHARACTERS WITHOUT CLAIM TO ANY PARTICULAR FONT, STYLE, SIZE, OR COLOR.

FOR ELECTRO-MECHANICAL LOCK TO RESTRICT AND LOCK DOOR ON ELEVATOR CAB OPENINGS (U.S. CLS. 21, 23, 26, 36 AND 38).

FIRST USE 1-0-1997; IN COMMERCE 1-0-1997.
CHRISTOPHER BUONGIORNO, EXAMINING ATTORNEY

CLASS 9—(Continued).

SN 85-530,764. KWABENA, BOATENG A, AKA G-BOX DA SMOKE, LITHIA SPRINGS, GA. FILED 2-1-2012.

TAKE MONEY GANG

THE MARK CONSISTS OF STANDARD CHARACTERS WITHOUT CLAIM TO ANY PARTICULAR FONT, STYLE, SIZE, OR COLOR.

FOR AUDIO AND VIDEO RECORDINGS FEATURING MUSIC AND ARTISTIC PERFORMANCES; MUSICAL VIDEO RECORDINGS; SERIES OF MUSICAL SOUND RECORDINGS (U.S. CLS. 21, 23, 26, 36 AND 38).

NICHOLAS ALTREE, EXAMINING ATTORNEY

SN 85-530,773. WEST BRANCH TECHNOLOGY, INC., CARMEL, NY. FILED 2-1-2012.

BLACK LAB

THE MARK CONSISTS OF STANDARD CHARACTERS WITHOUT CLAIM TO ANY PARTICULAR FONT, STYLE, SIZE, OR COLOR.

FOR COMPUTER SOFTWARE FOR PROVIDING ACCESS TO EXECUTE AND VIEW RESULTS OF A CATALOGED LIST OF SQL COMMANDS (U.S. CLS. 21, 23, 26, 36 AND 38).

JOSEPH PAPPAFOTIS, EXAMINING ATTORNEY

SN 85-530,776. CARSON OPTICAL, HAUPPAUGE, NY. FILED 2-1-2012.

TOOBZ

THE MARK CONSISTS OF THE STYLIZED WORDING "TOOBZ".

FOR EYEGLASS RETAINERS (U.S. CLS. 21, 23, 26, 36 AND 38).

FIRST USE 1-10-2012; IN COMMERCE 1-10-2012.
EVELYN BRADLEY, EXAMINING ATTORNEY

CLASS 9—(Continued).

SN 85-530,798. RIVER LIGHT V, L.P., NEW YORK, NY. FILED 2-1-2012.

TORY BURCH

THE MARK CONSISTS OF STANDARD CHARACTERS WITHOUT CLAIM TO ANY PARTICULAR FONT, STYLE, SIZE, OR COLOR.

OWNER OF U.S. REG. NOS. 3,428,373, 3,428,816 AND OTHERS.

THE NAME(S), PORTRAIT(S), AND/OR SIGNATURE(S) SHOWN IN THE MARK IDENTIFIES "TORY BURCH", WHOSE CONSENT(S) TO REGISTER IS MADE OF RECORD.

FOR CELL PHONE CASES; LEATHER PROTECTIVE COVERS SPECIALLY ADAPTED FOR PERSONAL ELECTRONIC DEVICES; PROTECTIVE COVERS AND CASES FOR CELL PHONES, LAPTOPS AND PORTABLE MEDIA PLAYERS (U.S. CLS. 21, 23, 26, 36 AND 38).

FIRST USE 10-31-2009; IN COMMERCE 10-31-2009.

MICHAEL GAAFAR, EXAMINING ATTORNEY

SN 85-530,855. STRETCH THE FISH, CHEYENNE, WY. FILED 2-1-2012.

Stretch the Fish

THE MARK CONSISTS OF STANDARD CHARACTERS WITHOUT CLAIM TO ANY PARTICULAR FONT, STYLE, SIZE, OR COLOR.

FOR TAPE MEASURES (U.S. CLS. 21, 23, 26, 36 AND 38).

FIRST USE 12-30-2011; IN COMMERCE 12-30-2011.

ELLEN PERKINS, EXAMINING ATTORNEY

SN 85-530,955. BOSCOV'S INVESTMENT COMPANY, INC., WILMINGTON, DE. FILED 2-1-2012.

PRESWICK & MOORE

THE MARK CONSISTS OF STANDARD CHARACTERS WITHOUT CLAIM TO ANY PARTICULAR FONT, STYLE, SIZE, OR COLOR.

OWNER OF U.S. REG. NOS. 1,221,841 AND 1,290,249.

FOR EYEWEAR (U.S. CLS. 21, 23, 26, 36 AND 38).

FIRST USE 6-23-2011; IN COMMERCE 11-11-2011.

MICHAEL WIENER, EXAMINING ATTORNEY

CLASS 9—(Continued).

SN 85-531,074. JACOBS, MARSHALL, OMAHA, NE. FILED 2-1-2012.

Size-a-Guard

THE MARK CONSISTS OF STANDARD CHARACTERS WITHOUT CLAIM TO ANY PARTICULAR FONT, STYLE, SIZE, OR COLOR.

FOR MEASURING APPARATUS, NAMELY, SIZERS FOR MOUTH GUARDS (U.S. CLS. 21, 23, 26, 36 AND 38).
MAYUR VAGHANI, EXAMINING ATTORNEY

SN 85-531,119. JEFFERSON AUDIO VIDEO SYSTEMS, INC., LOUISVILLE, KY. FILED 2-1-2012.

JAVS

THE MARK CONSISTS OF STANDARD CHARACTERS WITHOUT CLAIM TO ANY PARTICULAR FONT, STYLE, SIZE, OR COLOR.

OWNER OF U.S. REG. NO. 1,624,518.
FOR VIDEO WRIST MONITOR CONNECTED TO A VIDEO CAMERA; ASSISTIVE LISTENING DEVICES NOT FOR MEDICAL PURPOSES, NAMELY, HEADPHONES, MICROPHONES, TRANSMITTERS AND RECEIVERS; COMPUTER SERVERS; INTERNET PROTOCOL VIDEO ENCODERS; ELECTRICAL CABLES; SPEAKER DISTRIBUTION BOXES TO DISTRIBUTE AUDIO INPUT TO MULTIPLE SPEAKERS (U.S. CLS. 21, 23, 26, 36 AND 38).
AISHA SALEM, EXAMINING ATTORNEY

SN 85-531,316. CANADIAN AUTOMOTIVE INSTRUMENTS LTD., STONY PLAIN, AB, CANADA, FILED 2-1-2012.

SKY FENCE

THE MARK CONSISTS OF STANDARD CHARACTERS WITHOUT CLAIM TO ANY PARTICULAR FONT, STYLE, SIZE, OR COLOR.

FOR THEFT DETERRENT SOFTWARE SOLD AS A COMPONENT OF GLOBAL POSITIONING SYSTEMS (GPS) UNITS (U.S. CLS. 21, 23, 26, 36 AND 38).
B. PARADEWELAI, EXAMINING ATTORNEY

CLASS 9—(Continued).

SN 85-531,399. HAMID, HANI, GLEN CARBON, IL. FILED 2-1-2012.

YOUNG RICH

THE MARK CONSISTS OF STANDARD CHARACTERS WITHOUT CLAIM TO ANY PARTICULAR FONT, STYLE, SIZE, OR COLOR.

FOR PRERECORDED DIGITAL AND ELECTRONIC MEDIA FEATURING MUSIC AND MUSICAL PERFORMANCES; ENTERTAINMENT SERVICES, NAMELY, LIVE MUSICAL PERFORMANCES (U.S. CLS. 21, 23, 26, 36 AND 38).
BRIAN NEVILLE, EXAMINING ATTORNEY

SN 85-531,436. FUNMOBILITY, INC., PLEASANTON, CA. FILED 2-1-2012.

APPWIDGETS

THE MARK CONSISTS OF STANDARD CHARACTERS WITHOUT CLAIM TO ANY PARTICULAR FONT, STYLE, SIZE, OR COLOR.

FOR COMPUTER APPLICATION SOFTWARE FOR MOBILE PHONES, PORTABLE MEDIA PLAYERS, AND PORTABLE COMPUTERS, NAMELY, SOFTWARE FOR DYNAMICALLY ADDING FEATURES OR FUNCTIONS TO OTHER MOBILE SOFTWARE APPLICATIONS (U.S. CLS. 21, 23, 26, 36 AND 38).
LAURIE KAUFMAN, EXAMINING ATTORNEY

SN 85-531,620. TECHBIRD, LLC, SAINT MARY'S, GA. FILED 2-1-2012.

TECHBIRD

THE MARK CONSISTS OF STANDARD CHARACTERS WITHOUT CLAIM TO ANY PARTICULAR FONT, STYLE, SIZE, OR COLOR.

FOR COMPUTER APPLICATION SOFTWARE FOR MOBILE PHONES, COMPUTERS, AND TABLET COMPUTERS, NAMELY, SOFTWARE FOR USE IN MONITORING OF COMPUTING DEVICE USER ACTIVITY (U.S. CLS. 21, 23, 26, 36 AND 38).
FIRST USE 1-1-2012; IN COMMERCE 1-1-2012.
LOURDES AYALA, EXAMINING ATTORNEY

CLASS 9—(Continued).

SN 85-531,659. AINSWORTH GAME TECHNOLOGY LIMITED, NEWINGTON, AUSTRALIA, FILED 2-2-2012.

DESPERADO DOLLARS

THE MARK CONSISTS OF STANDARD CHARACTERS WITHOUT CLAIM TO ANY PARTICULAR FONT, STYLE, SIZE, OR COLOR.

FOR COMPUTER SOFTWARE AND FIRMWARE FOR GAMES OF CHANCE ON ANY COMPUTERIZED PLATFORM, INCLUDING DEDICATED GAMING CONSOLES, VIDEO BASED SLOT MACHINES, REEL BASED SLOT MACHINES, AND VIDEO LOTTERY TERMINALS (U.S. CLS. 21, 23, 26, 36 AND 38).
JESSICA A. POWERS, EXAMINING ATTORNEY

SN 85-531,660. AINSWORTH GAME TECHNOLOGY LIMITED, NEWINGTON, AUSTRALIA, FILED 2-2-2012.

BUFFALO RUMBLE

THE MARK CONSISTS OF STANDARD CHARACTERS WITHOUT CLAIM TO ANY PARTICULAR FONT, STYLE, SIZE, OR COLOR.

FOR COMPUTER SOFTWARE AND FIRMWARE FOR GAMES OF CHANCE ON ANY COMPUTERIZED PLATFORM, INCLUDING DEDICATED GAMING CONSOLES, VIDEO BASED SLOT MACHINES, REEL BASED SLOT MACHINES, AND VIDEO LOTTERY TERMINALS (U.S. CLS. 21, 23, 26, 36 AND 38).
JESSICA A. POWERS, EXAMINING ATTORNEY

SN 85-531,751. CSXT INTELLECTUAL PROPERTIES CORPORATION, JACKSONVILLE, FL. FILED 2-2-2012.

CSX MOVES

THE MARK CONSISTS OF STANDARD CHARACTERS WITHOUT CLAIM TO ANY PARTICULAR FONT, STYLE, SIZE, OR COLOR.

OWNER OF U.S. REG. NOS. 3,668,780, 4,088,030 AND 4,088,063.

FOR DOWNLOADABLE SOFTWARE FOR SIMULATION OF CERTAIN RAILROAD OPERATIONS FOR EDUCATIONAL AND ENTERTAINMENT PURPOSES (U.S. CLS. 21, 23, 26, 36 AND 38).
DEZMONA MIZELLE, EXAMINING ATTORNEY

CLASS 9—(Continued).

SN 85-531,889. TABS GROUP, INC., SHELTON, CT. FILED 2-2-2012.

QUICKTABS

THE MARK CONSISTS OF STANDARD CHARACTERS WITHOUT CLAIM TO ANY PARTICULAR FONT, STYLE, SIZE, OR COLOR.

FOR SOFTWARE FOR ANALYSIS OF MARKET SHARE, PRODUCT SALES AND PRODUCT DISTRIBUTION (U.S. CLS. 21, 23, 26, 36 AND 38).

FIRST USE 10-0-1998; IN COMMERCE 10-0-1998.

WILLIAM BRECKENFELD, EXAMINING ATTORNEY

SN 85-532,127. OFS FITEL, LLC, NORCROSS, GA. FILED 2-2-2012.

HCXTREME

THE MARK CONSISTS OF STANDARD CHARACTERS WITHOUT CLAIM TO ANY PARTICULAR FONT, STYLE, SIZE, OR COLOR.

FOR OPTICAL FIBER CABLES; OPTICAL FIBERS; OPTICAL FIBERS SOLD AS A COMPONENT OF FIBER OPTICAL CABLES (U.S. CLS. 21, 23, 26, 36 AND 38).

FIRST USE 5-8-2007; IN COMMERCE 9-5-2008.

CHARLES L. JENKINS, EXAMINING ATTORNEY

SN 85-532,142. MYGUIDES, LLC, MIAMI, FL. FILED 2-2-2012.



THE COLOR(S) GREEN AND BLACK IS/ARE CLAIMED AS A FEATURE OF THE MARK.

THE MARK CONSISTS OF A HALF BLACK, HALF GREEN STYLIZED ARROW POINTING RIGHT.

FOR DOWNLOADABLE SOFTWARE IN THE NATURE OF A MOBILE APPLICATION FOR PROVIDING SELF GUIDED TOURS (U.S. CLS. 21, 23, 26, 36 AND 38).

FIRST USE 9-0-2011; IN COMMERCE 9-0-2011.

SETH A. RAPPAPORT, EXAMINING ATTORNEY

CLASS 9—(Continued).

SN 85-532,164. JAMES K. CHUN, FREMONT, CA. FILED 2-2-2012.

SQUARE JELLYFISH

THE MARK CONSISTS OF STANDARD CHARACTERS WITHOUT CLAIM TO ANY PARTICULAR FONT, STYLE, SIZE, OR COLOR.
FOR PORTABLE VIDEO DEVICE STAND AND EAR-PHONE CASE (U.S. CLS. 21, 23, 26, 36 AND 38).
YAT SYE, LEE, EXAMINING ATTORNEY

SN 85-532,273. INTEGRATED COLOR CORPORATION, NORTH BILLERICA, MA. FILED 2-2-2012.

ColorEyes

THE MARK CONSISTS OF STANDARD CHARACTERS WITHOUT CLAIM TO ANY PARTICULAR FONT, STYLE, SIZE, OR COLOR.
FOR COMPUTER SOFTWARE FOR CALIBRATING COMPUTER MONITORS FOR COLOR ACCURACY; COMPUTER APPLICATION SOFTWARE FOR MOBILE PHONES, PORTABLE MEDIA PLAYERS, HANDHELD COMPUTERS, TABLETS, NAMELY, SOFTWARE FOR CALIBRATING MOBILE DEVICE SCREENS FOR COLOR ACCURACY (U.S. CLS. 21, 23, 26, 36 AND 38).
FIRST USE 5-1-2000; IN COMMERCE 5-1-2000.
WILLIAM VERHOSEK, EXAMINING ATTORNEY

SN 85-532,290. AKTANA, INC., SAN FRANCISCO, CA. FILED 2-2-2012.

AKTANA

THE MARK CONSISTS OF STANDARD CHARACTERS WITHOUT CLAIM TO ANY PARTICULAR FONT, STYLE, SIZE, OR COLOR.
FOR ENTERPRISE COMPUTER SOFTWARE FOR MONITORING, MEASURING, ANALYZING, AND HELPING TO IMPROVE SALES EFFECTIVENESS (U.S. CLS. 21, 23, 26, 36 AND 38).
NAAKWAMA ANKRAH, EXAMINING ATTORNEY

CLASS 9—(Continued).

SN 85-532,306. CARBON AUDIO, LLC, PORTLAND, OR. FILED 2-2-2012.

ZOOKA

THE MARK CONSISTS OF STANDARD CHARACTERS WITHOUT CLAIM TO ANY PARTICULAR FONT, STYLE, SIZE, OR COLOR.
FOR AUDIO SPEAKERS FOR USE WITH TABLETS, PHONES, COMPUTERS, RADIOS, MP3 PLAYERS, AMONG OTHER TYPES OF MUSIC PLAYING DEVICES (U.S. CLS. 21, 23, 26, 36 AND 38).
SAMUEL E. SHARPER JR., EXAMINING ATTORNEY

SN 85-532,321. SHAGHAL, LTD., LOS ANGELES, CA. FILED 2-2-2012.

THE SMOKE

THE MARK CONSISTS OF STANDARD CHARACTERS WITHOUT CLAIM TO ANY PARTICULAR FONT, STYLE, SIZE, OR COLOR.
FOR TABLET COMPUTERS (U.S. CLS. 21, 23, 26, 36 AND 38).
DORITT L. CARROLL, EXAMINING ATTORNEY

SN 85-532,401. JULIO DANIN LOBO NETO, FALLS CHURCH, VA. FILED 2-2-2012.

HutFlow

THE MARK CONSISTS OF STANDARD CHARACTERS WITHOUT CLAIM TO ANY PARTICULAR FONT, STYLE, SIZE, OR COLOR.
FOR COMPUTER SOFTWARE THAT PROVIDES WEB-BASED ACCESS TO APPLICATIONS AND SERVICES THROUGH A WEB OPERATING SYSTEM OR PORTAL INTERFACE (U.S. CLS. 21, 23, 26, 36 AND 38).
RUSS HERMAN, EXAMINING ATTORNEY

CLASS 9—(Continued).

SN 85-532,418. SKY SIGHT TECHNOLOGIES, LLC, FORT WAYNE, IN. FILED 2-2-2012.

SAFESENSOR

THE MARK CONSISTS OF STANDARD CHARACTERS WITHOUT CLAIM TO ANY PARTICULAR FONT, STYLE, SIZE, OR COLOR.

FOR MARKING AND SIGNALING BUOYS (U.S. CLS. 21, 23, 26, 36 AND 38).

GIANCARLO CASTRO, EXAMINING ATTORNEY

CLASS 9—(Continued).

SN 85-532,581. DESERET BOOK COMPANY, SALT LAKE CITY, UT. FILED 2-2-2012.

PRETTY DARN FUNNY

THE MARK CONSISTS OF STANDARD CHARACTERS WITHOUT CLAIM TO ANY PARTICULAR FONT, STYLE, SIZE, OR COLOR.

FOR DIGITAL MATERIALS, NAMELY, CDS, DVDS, VIDEOS, DOWNLOADABLE AUDIO AND VIDEO RECORDINGS FEATURING COMEDY ENTERTAINMENT SEGMENTS (U.S. CLS. 21, 23, 26, 36 AND 38).

MARK T. MULLEN, EXAMINING ATTORNEY

SN 85-532,487. SCHNELLI ENTERPRISES, INC., SPRINGFIELD, OR. FILED 2-2-2012.

PartScouter

THE MARK CONSISTS OF STANDARD CHARACTERS WITHOUT CLAIM TO ANY PARTICULAR FONT, STYLE, SIZE, OR COLOR.

FOR COMPUTER SOFTWARE FOR USE IN DATABASE MANAGEMENT, NAMELY IDENTIFYING, LOCATING AND SELLING PARTS FOR EQUIPMENT REPAIR (U.S. CLS. 21, 23, 26, 36 AND 38).

EMILY CARLSEN, EXAMINING ATTORNEY

SN 85-532,638. DESERET BOOK COMPANY, SALT LAKE CITY, UT. FILED 2-2-2012.



THE MARK CONSISTS OF AN OVAL WITH STYLIZED WORDS "PRETTY DARN FUNNY!" INSIDE THE OVAL. IN THE WORD "PRETTY", A BOBBYPIN IS USED TO CROSS THE TWO LETTER "T"'S.

FOR DIGITAL MATERIALS, NAMELY, CDS, DVDS, VIDEOS, DOWNLOADABLE AUDIO AND VIDEO RECORDINGS FEATURING COMEDY ENTERTAINMENT SEGMENTS (U.S. CLS. 21, 23, 26, 36 AND 38).

MARK T. MULLEN, EXAMINING ATTORNEY

SN 85-532,551. APPERIES LLC, SEATTLE, WA. FILED 2-2-2012.

quadstreaker

THE MARK CONSISTS OF STANDARD CHARACTERS WITHOUT CLAIM TO ANY PARTICULAR FONT, STYLE, SIZE, OR COLOR.

FOR DOWNLOADABLE SOFTWARE IN THE NATURE OF A MOBILE APPLICATION FOR USE IN A GAME DISPLAYING A USER'S LOCATION AND COLLECTING, FINDING, LOCATING, AND INTERACTING WITH PLACES AND OTHER USERS; DOWNLOADABLE MOBILE APPLICATION SOFTWARE FOR DISPLAYING STYLIZED ICONS; COMPUTER APPLICATION SOFTWARE FOR MOBILE PHONES, NAMELY, SOFTWARE FOR COLLECTING PLACES AND SHARING LOCATION INFORMATION WITH USERS (U.S. CLS. 21, 23, 26, 36 AND 38).

MARC LEIPZIG, EXAMINING ATTORNEY

SN 85-532,651. SAFE-D-RIDE RODEO SYSTEMS INC., ALDERGROVE, CANADA, FILED 2-2-2012.

SAFE-D-RIDE

THE MARK CONSISTS OF STANDARD CHARACTERS WITHOUT CLAIM TO ANY PARTICULAR FONT, STYLE, SIZE, OR COLOR.

FOR ELECTRO-MECHANICAL LOCKS, NAMELY, REMOTELY CONTROLLED TENSION RELEASE BELT LOCK FOR RELEASING FLANK STRAPS FROM RODEO ANIMALS (U.S. CLS. 21, 23, 26, 36 AND 38).

ANTHONY RINKER, EXAMINING ATTORNEY

CLASS 9—(Continued).

SN 85-532,768. UNITEDHEALTH GROUP INCORPORATED, MINNETONKA, MN. FILED 2-2-2012.

MYX

THE MARK CONSISTS OF STANDARD CHARACTERS WITHOUT CLAIM TO ANY PARTICULAR FONT, STYLE, SIZE, OR COLOR.

FOR COMPUTER SOFTWARE TO ENABLE UPLOADING, POSTING, TAGGING, BLOGGING, SHARING OR OTHERWISE PROVIDING ELECTRONIC MEDIA OR INFORMATION OVER THE INTERNET OR OTHER COMMUNICATIONS NETWORK; COMPUTER SOFTWARE DEVELOPMENT TOOLS FOR SOCIAL NETWORKING, BUILDING SOCIAL NETWORKING APPLICATIONS AND FOR ALLOWING DATA RETRIEVAL, UPLOAD, ACCESS AND MANAGEMENT; COMPUTER OPERATING SYSTEM SOFTWARE FOR ACCESSING AND USING CLOUD COMPUTING NETWORKS; COMPUTER SOFTWARE FOR USE IN HEALTH CARE DATABASE MANAGEMENT; COMPUTER SOFTWARE USED FOR THE SECURED TRANSMISSION OF HEALTH CARE DATA AND HEALTH CARE INSURANCE DATA VIA A GLOBAL COMPUTER NETWORK (U.S. CLS. 21, 23, 26, 36 AND 38).

MATTHEW EINSTEIN, EXAMINING ATTORNEY

CLASS 9—(Continued).

SN 85-532,922. GE HEALTHCARE LIMITED, BUCKINGHAMSHIRE, UNITED KINGDOM, FILED 2-3-2012.

VIZUMARQ

THE MARK CONSISTS OF STANDARD CHARACTERS WITHOUT CLAIM TO ANY PARTICULAR FONT, STYLE, SIZE, OR COLOR.

FOR COMPUTER SOFTWARE FOR USE WITH MEDICAL DIAGNOSTIC IMAGING (U.S. CLS. 21, 23, 26, 36 AND 38).

HOWARD B. LEVINE, EXAMINING ATTORNEY

SN 85-532,943. EMC CORPORATION, HOPKINTON, MA. FILED 2-3-2012.

RAPIDPATH

SN 85-532,916. ALTOVA GMBH, WIEN (VIENNA), AUSTRIA, FILED 2-3-2012.



THE MARK CONSISTS OF STANDARD CHARACTERS WITHOUT CLAIM TO ANY PARTICULAR FONT, STYLE, SIZE, OR COLOR.

FOR COMPUTER HARDWARE; COMPUTER SOFTWARE FOR DATA STORAGE AND DATA MANAGEMENT; COMPUTER SOFTWARE FOR CONTROLLING AND MANAGING THE TRANSFER AND ROUTING OF DATA OVER PUBLIC AND PRIVATE NETWORKS (U.S. CLS. 21, 23, 26, 36 AND 38).

ELIZABETH HUGHITT, EXAMINING ATTORNEY

SN 85-532,958. IOXUS, INC., ONEONTA, NY. FILED 2-3-2012.

THE MARK CONSISTS OF THE LETTER "F" WITH FIVE (5) ARROWS FORMING A CIRCLE AROUND THE LETTER ALL POINTING IN A CLOCKWISE ORIENTATION.

FOR COMPUTER SOFTWARE FOR AUTOMATING INFORMATION, DATA, AND DOCUMENT WORKFLOW; COMPUTER SOFTWARE FOR USE AS A DATA INTEGRATION SERVER TO TRANSFORM, ACCESS, AND MANIPULATE DATA EXPRESSED IN A PARTICULAR DATA STORAGE FORMAT INTO THAT OF ANOTHER DATA STORAGE FORMAT; COMPUTER SOFTWARE FOR FACILITATING AUTO-GENERATED SOFTWARE CODE REQUIRED TO IMPLEMENT SUCH DATA TRANSFERS FROM ONE ELECTRONIC FORMAT IN A RUN-TIME ENVIRONMENT, THROUGH THE GENERATION OF CUSTOMIZED OUTPUT CODE IN A VARIETY OF DIFFERENT OUTPUT LANGUAGES (U.S. CLS. 21, 23, 26, 36 AND 38).

FIRST USE 10-19-2011; IN COMMERCE 10-19-2011.

JORDAN BAKER, EXAMINING ATTORNEY

IMOD

THE MARK CONSISTS OF STANDARD CHARACTERS WITHOUT CLAIM TO ANY PARTICULAR FONT, STYLE, SIZE, OR COLOR.

FOR ENERGY STORAGE DEVICES, NAMELY, CAPACITORS; RECHARGEABLE ELECTRIC STORAGE BATTERIES (U.S. CLS. 21, 23, 26, 36 AND 38).

FIRST USE 10-0-2011; IN COMMERCE 10-0-2011.

BARBARA BROWN, EXAMINING ATTORNEY

CLASS 9—(Continued).

SN 85-532,966. AMERISTEP, INC., CLIO, MI. FILED 2-3-2012.

BLIND EYE

THE MARK CONSISTS OF STANDARD CHARACTERS WITHOUT CLAIM TO ANY PARTICULAR FONT, STYLE, SIZE, OR COLOR.

FOR DIGITAL CAMERAS (U.S. CLS. 21, 23, 26, 36 AND 38).

TASNEEM HUSSAIN, EXAMINING ATTORNEY

SN 85-532,979. AMERISTEP, INC., CLIO, MI. FILED 2-3-2012.

BLIND SIDE

THE MARK CONSISTS OF STANDARD CHARACTERS WITHOUT CLAIM TO ANY PARTICULAR FONT, STYLE, SIZE, OR COLOR.

FOR DIGITAL CAMERAS (U.S. CLS. 21, 23, 26, 36 AND 38).

TASNEEM HUSSAIN, EXAMINING ATTORNEY

SN 85-532,992. WORLD WIDE LICENSES LTD, CENTRAL, HONG KONG, FILED 2-3-2012.

PODZ

THE MARK CONSISTS OF STANDARD CHARACTERS WITHOUT CLAIM TO ANY PARTICULAR FONT, STYLE, SIZE, OR COLOR.

FOR INTERFACE CIRCUITS FOR VIDEO CAMERAS (U.S. CLS. 21, 23, 26, 36 AND 38).

JEFFREY LOOK, EXAMINING ATTORNEY

SN 85-533,008. WORLD WIDE LICENSES LTD, CENTRAL, HONG KONG, FILED 2-3-2012.

CAMLOCK

THE MARK CONSISTS OF STANDARD CHARACTERS WITHOUT CLAIM TO ANY PARTICULAR FONT, STYLE, SIZE, OR COLOR.

FOR CAMERA MOUNTS AND SUPPORTS (U.S. CLS. 21, 23, 26, 36 AND 38).

JEFFREY LOOK, EXAMINING ATTORNEY

CLASS 9—(Continued).

SN 85-533,015. LATMAN, RICHARD K, HUNT VALLEY, MD. FILED 2-3-2012.

TableText

THE MARK CONSISTS OF STANDARD CHARACTERS WITHOUT CLAIM TO ANY PARTICULAR FONT, STYLE, SIZE, OR COLOR.

FOR COMPUTER HARDWARE AND COMPUTER SOFTWARE PROGRAMS FOR THE INTEGRATION OF TEXT, AUDIO, GRAPHICS, STILL IMAGES AND MOVING PICTURES INTO AN INTERACTIVE DELIVERY FOR MULTIMEDIA APPLICATIONS; COMPUTER SOFTWARE FOR USE IN CUSTOMER RELATIONSHIP MANAGEMENT (CRM); ELECTRONIC TEXT-MESSAGING DEVICE FOR USE IN CONJUNCTION WITH PERSONAL DIGITAL ASSISTANTS (U.S. CLS. 21, 23, 26, 36 AND 38).

REBECCA GILBERT, EXAMINING ATTORNEY

SN 85-533,033. INTERSCAPE TECHNOLOGIES INC., MARTINSVILLE, NJ. FILED 2-3-2012.

PERFORMANCE AS A SERVICE

THE MARK CONSISTS OF STANDARD CHARACTERS WITHOUT CLAIM TO ANY PARTICULAR FONT, STYLE, SIZE, OR COLOR.

FOR COMPUTER SOFTWARE TECHNOLOGY CONSULTING (U.S. CLS. 21, 23, 26, 36 AND 38).

FIRST USE 8-1-2010; IN COMMERCE 8-1-2010.

SALLY SHIH, EXAMINING ATTORNEY

SN 85-533,041. WILLIAMS-PYRO, INC., FORT WORTH, TX. FILED 2-3-2012.

ELECTROLINX

THE MARK CONSISTS OF STANDARD CHARACTERS WITHOUT CLAIM TO ANY PARTICULAR FONT, STYLE, SIZE, OR COLOR.

FOR CONNECTIVITY AND AUTOMATED TEST SYSTEMS, COMPRISED OF CABLE ASSEMBLIES, CONNECTORS, ADAPTERS, ELECTRONIC VOLTAGE, CURRENT AND SIGNAL TESTERS, AND AUTOMATED TEST EQUIPMENT, USED TO TEST PRINTED CIRCUIT BOARDS, INTEGRATED CIRCUITS OR ANY OTHER RELATED ELECTRONIC COMPONENTS OR MODULES FOR USE IN THE AEROSPACE, DEFENSE AND ENERGY INDUSTRIES (U.S. CLS. 21, 23, 26, 36 AND 38).

FIRST USE 6-2-2011; IN COMMERCE 6-2-2011.

B. PARADEWELAI, EXAMINING ATTORNEY

CLASS 9—(Continued).

SN 85-533,140. SYNAPTICS INCORPORATED, SANTA CLARA, CA. FILED 2-3-2012.

FORCEPAD

THE MARK CONSISTS OF STANDARD CHARACTERS WITHOUT CLAIM TO ANY PARTICULAR FONT, STYLE, SIZE, OR COLOR.

FOR INPUT DEVICES FOR COMPUTER HARDWARE AND ELECTRONIC INSTRUMENTS (U.S. CLS. 21, 23, 26, 36 AND 38).

DANIEL CAPSHAW, EXAMINING ATTORNEY

CLASS 9—(Continued).

SN 85-533,221. CASE-MATE, INC., TUCKER, GA. FILED 2-3-2012.

BOING

THE MARK CONSISTS OF STANDARD CHARACTERS WITHOUT CLAIM TO ANY PARTICULAR FONT, STYLE, SIZE, OR COLOR.

FOR CASES FOR ELECTRONIC DEVICES, NAMELY SMART PHONES, PORTABLE MEDIA PLAYERS AND HANDHELD COMPUTERS (U.S. CLS. 21, 23, 26, 36 AND 38).

YAT SYE, LEE, EXAMINING ATTORNEY

SN 85-533,187. KYONG MI CHOI, VANCOUVER, WA. FILED 2-3-2012.

Turbinator

THE MARK CONSISTS OF STANDARD CHARACTERS WITHOUT CLAIM TO ANY PARTICULAR FONT, STYLE, SIZE, OR COLOR.

FOR GLOVES FOR PROTECTION AGAINST ACCIDENTS; PROTECTIVE GLOVES FOR INDUSTRIAL USE; PROTECTIVE WORK GLOVES (U.S. CLS. 21, 23, 26, 36 AND 38).

FIRST USE 10-1-2011; IN COMMERCE 10-1-2011.
KATHERINE CHANG, EXAMINING ATTORNEY

SN 85-533,244. CASE-MATE, INC., TUCKER, GA. FILED 2-3-2012.

LUMEN

THE MARK CONSISTS OF STANDARD CHARACTERS WITHOUT CLAIM TO ANY PARTICULAR FONT, STYLE, SIZE, OR COLOR.

FOR CASES FOR ELECTRONIC DEVICES, NAMELY SMART PHONES, PORTABLE MEDIA PLAYERS AND HANDHELD COMPUTERS (U.S. CLS. 21, 23, 26, 36 AND 38).

YAT SYE, LEE, EXAMINING ATTORNEY

SN 85-533,189. BLACKGLASS, LLC, BOULDER, CO. FILED 2-3-2012.

STEELIE

THE MARK CONSISTS OF STANDARD CHARACTERS WITHOUT CLAIM TO ANY PARTICULAR FONT, STYLE, SIZE, OR COLOR.

FOR HOLDERS AND STANDS SPECIALLY ADAPTED FOR USE WITH MOBILE COMMUNICATION DEVICES AND DEVICES FOR CAPTURING DIGITAL IMAGES (U.S. CLS. 21, 23, 26, 36 AND 38).

FIRST USE 1-11-2011; IN COMMERCE 1-11-2011.
MARC LEIPZIG, EXAMINING ATTORNEY

SN 85-533,251. CASE-MATE, INC., TUCKER, GA. FILED 2-3-2012.

HAZE

THE MARK CONSISTS OF STANDARD CHARACTERS WITHOUT CLAIM TO ANY PARTICULAR FONT, STYLE, SIZE, OR COLOR.

FOR CASES FOR ELECTRONIC DEVICES, NAMELY SMART PHONES, PORTABLE MEDIA PLAYERS AND HANDHELD COMPUTERS (U.S. CLS. 21, 23, 26, 36 AND 38).

YAT SYE, LEE, EXAMINING ATTORNEY

CLASS 9—(Continued).

SN 85-533,277. CAREBINDERS LLC, RIDGEWOOD, NJ.
FILED 2-3-2012.

CBDATA

THE MARK CONSISTS OF STANDARD CHARACTERS WITHOUT CLAIM TO ANY PARTICULAR FONT, STYLE, SIZE, OR COLOR.

OWNER OF U.S. REG. NOS. 3,788,049 AND 3,834,712.
FOR PERSONAL AND SMALL BUSINESS SOFTWARE FOR KEEPING TRACK OF PERSONAL, MEDICAL AND FINANCIAL DATA (U.S. CLS. 21, 23, 26, 36 AND 38).
YAT SYE, LEE, EXAMINING ATTORNEY

SN 85-533,379. HY-VEE, INC., WEST DES MOINES, IA.
FILED 2-3-2012.

HyVee
FUEL
SAVER

NO CLAIM IS MADE TO THE EXCLUSIVE RIGHT TO USE "FUEL SAVER", APART FROM THE MARK AS SHOWN.

THE MARK CONSISTS OF THE WORDS "HY-VEE FUEL SAVER" IN A FANCIFUL FONT. THE WORD "HY-VEE" APPEARS ON THE FIRST LINE, "FUEL" APPEARS ON THE NEXT LINE BENEATH HY-VEE, AND "SAVER" APPEARS ON THE NEXT LINE BENEATH FUEL.

FOR MAGNETICALLY ENCODED CUSTOMER LOYALTY CARDS USED TO PROMOTE AND REWARD CUSTOMERS FOR MAKING STORE PURCHASES BY OFFERING DISCOUNTS ON GASOLINE (U.S. CLS. 21, 23, 26, 36 AND 38).

C. DIONNE CLYBURN, EXAMINING ATTORNEY

SN 85-533,390. SAPPHIRE TECHNOLOGY LTD., SHANTIN, NT, HONG KONG, FILED 2-3-2012.

DUAL-X

THE MARK CONSISTS OF TERM "DUAL-X".
FOR GRAPHICS CARD COOLER FOR USE IN PERSONAL COMPUTERS (U.S. CLS. 21, 23, 26, 36 AND 38).
RAUL CORDOVA, EXAMINING ATTORNEY

CLASS 9—(Continued).

SN 85-533,484. LUTZ, CORY, STUDIO CITY, CA. FILED 2-3-2012.

CINEAPP

THE MARK CONSISTS OF STANDARD CHARACTERS WITHOUT CLAIM TO ANY PARTICULAR FONT, STYLE, SIZE, OR COLOR.

FOR COMPUTER APPLICATION SOFTWARE FOR MOBILE PHONES, NAMELY, SOFTWARE FOR FILM INDUSTRY PRODUCTION; COMPUTER SOFTWARE FOR FILM INDUSTRY PRODUCTION (U.S. CLS. 21, 23, 26, 36 AND 38).

JOSETTE BEVERLY, EXAMINING ATTORNEY

SN 85-533,540. BRUHA ROBOTICS, INC., FOOTHILL RANCH, CA. FILED 2-3-2012.

BuildBot

THE MARK CONSISTS OF STANDARD CHARACTERS WITHOUT CLAIM TO ANY PARTICULAR FONT, STYLE, SIZE, OR COLOR.

FOR COMPUTER PRINTERS; DIGITAL INPUT AND OUTPUT SCANNERS; PRINTERS FOR USE WITH COMPUTERS; SCANNERS (U.S. CLS. 21, 23, 26, 36 AND 38).

FIRST USE 1-23-2012; IN COMMERCE 2-3-2012.

DAVID I, EXAMINING ATTORNEY

SN 85-533,613. WEST MARINE PRODUCTS, INC., WATSONVILLE, CA. FILED 2-3-2012.



THE MARK CONSISTS OF A SHARK.
FOR PROTECTION AND SAFETY APPARATUS, NAMELY, INFLATABLE FLOTATION DEVICES, FLOTATION VESTS, SUNGLASSES (U.S. CLS. 21, 23, 26, 36 AND 38).

WILLIAM VERHOSEK, EXAMINING ATTORNEY

CLASS 9—(Continued).

SN 85-533,670. CAROTRON INC, HEATH SPRINGS, FL.
FILED 2-3-2012.

CHOICE

THE MARK CONSISTS OF STANDARD CHARACTERS
WITHOUT CLAIM TO ANY PARTICULAR FONT, STYLE,
SIZE, OR COLOR.

FOR THREE-PHASE INPUT CONTROLS FOR D.C.
MOTORS (U.S. CLS. 21, 23, 26, 36 AND 38).
FIRST USE 5-2-1990; IN COMMERCE 5-2-1990.
KATHERINE CONNOLLY, EXAMINING ATTORNEY

CLASS 9—(Continued).

SN 85-533,833. MCCOLLOUGH, LANCE, TEMECULA, CA.
FILED 2-3-2012.

GET THINGS FILED

THE MARK CONSISTS OF STANDARD CHARACTERS
WITHOUT CLAIM TO ANY PARTICULAR FONT, STYLE,
SIZE, OR COLOR.

FOR DOWNLOADABLE SOFTWARE FOR ORGANIZ-
ING, LISTING AND LOCATING DOCUMENTS AND
THINGS STORED IN A MECHANICAL FILE STORAGE
SYSTEM (U.S. CLS. 21, 23, 26, 36 AND 38).

FIRST USE 1-24-2012; IN COMMERCE 1-24-2012.
APRIL ROACH, EXAMINING ATTORNEY

SN 85-533,759. REYNALD BENOIT, JERSEY CITY, NJ.
FILED 2-3-2012.

Reyshizz

THE MARK CONSISTS OF STANDARD CHARACTERS
WITHOUT CLAIM TO ANY PARTICULAR FONT, STYLE,
SIZE, OR COLOR.

FOR AUDIO AND VIDEO RECORDINGS FEATURING
MUSIC AND ARTISTIC PERFORMANCES; COMPACT
DISCS FEATURING MUSIC; COMPACT DISCS FEAT-
URING MUSIC AND SPOKEN WORD IN THE FORM
OF POETRY; DIGITAL MUSIC DOWNLOADABLE
FROM THE INTERNET; DOWNLOADABLE MUSIC
FILES; DOWNLOADABLE MUSICAL SOUND RECORD-
INGS; DOWNLOADABLE RING TONES, GRAPHICS
AND MUSIC VIA A GLOBAL COMPUTER NETWORK
AND WIRELESS DEVICES; MUSICAL RECORDINGS
(U.S. CLS. 21, 23, 26, 36 AND 38).

MICHAEL WIENER, EXAMINING ATTORNEY

SN 85-533,838. ENEVATE CORPORATION, IRVINE, CA.
FILED 2-3-2012.

HD-ENERGY

THE MARK CONSISTS OF STANDARD CHARACTERS
WITHOUT CLAIM TO ANY PARTICULAR FONT, STYLE,
SIZE, OR COLOR.

FOR ELECTRICAL CELLS AND BATTERIES, ELEC-
TRICAL STORAGE BATTERIES, LITHIUM ION BAT-
TERIES, COMPONENT PARTS OF BATTERIES,
NAMELY, ELECTRODES, ANODES, CATHODES, AND
BATTERY SEPARATOR MEMBRANES, PRODUCTS FOR
USE IN ELECTRICAL CELLS AND BATTERIES,
NAMELY, ELECTRODES, ANODES, CATHODES, AND
BATTERY SEPARATOR MEMBRANES, BATTERIES,
BATTERY PACKS, BATTERY PACKAGING, BATTERY
MONITORING DEVICES THAT MAY BE ATTACHED
TO A BATTERY TO MONITOR AND MANAGE THE
BATTERY AND OPERATING SOFTWARE FOR USE
THERewith, ANODES, CATHODES, BATTERY SE-
PARATOR MEMBRANES, ELECTRODES (U.S. CLS. 21,
23, 26, 36 AND 38).

JORDAN BAKER, EXAMINING ATTORNEY

SN 85-533,817. SAPPHIRE TECHNOLOGY LTD., SHANTIN,
NT, HONG KONG, FILED 2-3-2012.

DUAL-X

THE MARK CONSISTS OF STANDARD CHARACTERS
WITHOUT CLAIM TO ANY PARTICULAR FONT, STYLE,
SIZE, OR COLOR.

FOR GRAPHICS CARD COOLER FOR USE IN PER-
SONAL COMPUTERS (U.S. CLS. 21, 23, 26, 36 AND 38).
RAUL CORDOVA, EXAMINING ATTORNEY

SN 85-533,894. CLINTON "BUD" WILCOX, GRASS VALLEY,
CA. FILED 2-3-2012.

Freewheelin

THE MARK CONSISTS OF STANDARD CHARACTERS
WITHOUT CLAIM TO ANY PARTICULAR FONT, STYLE,
SIZE, OR COLOR.

FOR HEADSETS FOR WIRELESS CELLULAR
PHONES AND PORTABLE MUSIC PLAYERS (U.S. CLS.
21, 23, 26, 36 AND 38).

FIRST USE 1-31-2012; IN COMMERCE 1-31-2012.
APRIL ROACH, EXAMINING ATTORNEY

CLASS 9—(Continued).

SN 85-533,996. MLETT, INC., CHICAGO, IL. FILED 2-4-2012.

CLASS 9—(Continued).

SN 85-533,998. MLETT, INC., CHICAGO, IL. FILED 2-4-2012.

TRAVEL WITH TRIP

THE MARK CONSISTS OF STANDARD CHARACTERS WITHOUT CLAIM TO ANY PARTICULAR FONT, STYLE, SIZE, OR COLOR.

FOR COMPUTER SOFTWARE, NAMELY, DOWNLOADABLE SOFTWARE IN THE NATURE OF A MOBILE APPLICATION FOR HAND-HELD COMPUTERS AND CELLULAR PHONES FOR PROVIDING TRAVEL INFORMATION AND CONTENT, NAMELY, CURRENCY AND MEASUREMENTS CONVERSION, WEATHER FORECASTS AND UPDATES, WORLD MAPS, TRAVEL PACKING LIST AND AIRLINE STATUS UPDATES; COMPUTER SOFTWARE, NAMELY, DOWNLOADABLE SOFTWARE IN THE NATURE OF A MOBILE APPLICATION FOR HAND-HELD COMPUTERS AND CELLULAR PHONES FOR ORGANIZING AND MANAGING TRAVEL ITINERARIES, NAMELY, TRANSPORTATION AND TEMPORARY HOTEL AND LODGING ACCOMMODATIONS; COMPUTER SOFTWARE, NAMELY, DOWNLOADABLE SOFTWARE IN THE NATURE OF A MOBILE APPLICATION FOR HAND-HELD COMPUTERS AND CELLULAR PHONES FOR MAKING RESERVATIONS AND BOOKINGS FOR TRANSPORTATION AND TEMPORARY HOTEL AND LODGING ACCOMMODATIONS; COMPUTER SOFTWARE, NAMELY, DOWNLOADABLE SOFTWARE IN THE NATURE OF A MOBILE APPLICATION FOR DISPLAYING AND SHARING A USER'S LOCATION FOR FINDING, LOCATING, CHECKING IN TO LOCATIONS AND EVENTS AND INTERACTING WITH OTHER USERS AND PLACES; COMPUTER SOFTWARE, NAMELY, DOWNLOADABLE SOFTWARE IN THE NATURE OF A MOBILE APPLICATION FOR HAND-HELD COMPUTERS AND CELLULAR PHONES FOR POSTING REVIEWS AND RECOMMENDATIONS ON PRODUCTS AND SERVICES OF OTHERS (U.S. CLS. 21, 23, 26, 36 AND 38).

KATINA MISTER, EXAMINING ATTORNEY

THE MARK CONSISTS OF THE STYLIZED DRAWING OF A MAN DRESSED AS A SUPERHERO WITH A FLOWING CAPE, MASK, AND BOOTS AND A STYLIZED LETTER "T" ON HIS CHEST IN THE SHAPE OF A LIGHTNING BOLT.

FOR COMPUTER SOFTWARE, NAMELY, DOWNLOADABLE SOFTWARE IN THE NATURE OF A MOBILE APPLICATION FOR HAND-HELD COMPUTERS AND CELLULAR PHONES FOR PROVIDING TRAVEL INFORMATION AND CONTENT, NAMELY, CURRENCY AND MEASUREMENTS CONVERSION, WEATHER FORECASTS AND UPDATES, WORLD MAPS, TRAVEL PACKING LIST AND AIRLINE STATUS UPDATES; COMPUTER SOFTWARE, NAMELY, DOWNLOADABLE SOFTWARE IN THE NATURE OF A MOBILE APPLICATION FOR HAND-HELD COMPUTERS AND CELLULAR PHONES FOR ORGANIZING AND MANAGING TRAVEL ITINERARIES, NAMELY, TRANSPORTATION AND TEMPORARY HOTEL AND LODGING ACCOMMODATIONS; COMPUTER SOFTWARE, NAMELY, DOWNLOADABLE SOFTWARE IN THE NATURE OF A MOBILE APPLICATION FOR HAND-HELD COMPUTERS AND CELLULAR PHONES FOR MAKING RESERVATIONS AND BOOKINGS FOR TRANSPORTATION AND TEMPORARY HOTEL AND LODGING ACCOMMODATIONS; COMPUTER SOFTWARE, NAMELY, DOWNLOADABLE SOFTWARE IN THE NATURE OF A MOBILE APPLICATION FOR DISPLAYING AND SHARING A USER'S LOCATION FOR FINDING, LOCATING, CHECKING IN TO LOCATIONS AND EVENTS AND INTERACTING WITH OTHER USERS AND PLACES; COMPUTER SOFTWARE, NAMELY, DOWNLOADABLE SOFTWARE IN THE NATURE OF A MOBILE APPLICATION FOR HAND-HELD COMPUTERS AND CELLULAR PHONES FOR POSTING REVIEWS AND RECOMMENDATIONS ON PRODUCTS AND SERVICES OF OTHERS (U.S. CLS. 21, 23, 26, 36 AND 38).

KATINA MISTER, EXAMINING ATTORNEY

CLASS 9—(Continued).

SN 85-534,150. AUDIOVOX ELECTRONICS CORPORATION, HAUPPAUGE, NY. FILED 2-4-2012.

**IF IT'S TOO LOUD YOU'RE
TOO OLD**

THE MARK CONSISTS OF STANDARD CHARACTERS WITHOUT CLAIM TO ANY PARTICULAR FONT, STYLE, SIZE, OR COLOR.

FOR AMPLIFIERS; LOUDSPEAKERS; RECEIVERS FOR AUDIO; VIDEO MONITORS (U.S. CLS. 21, 23, 26, 36 AND 38).

FIRST USE 1-1-1996; IN COMMERCE 1-1-1996.
JACQUELINE A. LAVINE, EXAMINING ATTORNEY

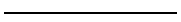

SN 85-534,234. NEVADA RESTAURANT SERVICES, INC., LAS VEGAS, NV. FILED 2-5-2012.

NORTHERN LIGHTS

THE MARK CONSISTS OF STANDARD CHARACTERS WITHOUT CLAIM TO ANY PARTICULAR FONT, STYLE, SIZE, OR COLOR.

FOR INTERACTIVE VIDEO GAME PROGRAMS FOR USE WITH GAMING MACHINES (U.S. CLS. 21, 23, 26, 36 AND 38).

JULIE WATSON, EXAMINING ATTORNEY

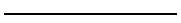

SN 85-534,236. NEVADA RESTAURANT SERVICES, INC., LAS VEGAS, NV. FILED 2-5-2012.

REEL ADVANTAGE

THE MARK CONSISTS OF STANDARD CHARACTERS WITHOUT CLAIM TO ANY PARTICULAR FONT, STYLE, SIZE, OR COLOR.

FOR INTERACTIVE VIDEO GAME PROGRAMS FOR USE WITH GAMING MACHINES (U.S. CLS. 21, 23, 26, 36 AND 38).

JULIE WATSON, EXAMINING ATTORNEY

CLASS 9—(Continued).

SN 85-534,251. SOLVUSOFT CORPORATION, LAS VEGAS, NV. FILED 2-5-2012.

SUPERSONICPC

THE MARK CONSISTS OF STANDARD CHARACTERS WITHOUT CLAIM TO ANY PARTICULAR FONT, STYLE, SIZE, OR COLOR.

FOR COMPUTER UTILITY PROGRAMS TO IMPROVE THE PERFORMANCE OF A PC; DOWNLOADABLE SOFTWARE FOR RECOVERING DATA ON COMPUTER DATA STORAGE DEVICES; COMPUTER UTILITY PROGRAMS FOR INSTALLING, FORMATTING, AND PARTITIONING HARD DISK DRIVES; COMPUTER UTILITY PROGRAMS FOR ANALYZING DATA TO DETECT, ERADICATE AND PREVENT THE OCCURRENCE OF COMPUTER VIRUSES (U.S. CLS. 21, 23, 26, 36 AND 38).

BARBARA BROWN, EXAMINING ATTORNEY

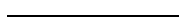

SN 85-534,257. SOLVUSOFT CORPORATION, LAS VEGAS, NV. FILED 2-5-2012.

SOLVUSOFT

THE MARK CONSISTS OF STANDARD CHARACTERS WITHOUT CLAIM TO ANY PARTICULAR FONT, STYLE, SIZE, OR COLOR.

FOR COMPUTER UTILITY PROGRAMS TO IMPROVE THE PERFORMANCE OF A PC; DOWNLOADABLE SOFTWARE FOR RECOVERING DATA ON COMPUTER DATA STORAGE DEVICES; COMPUTER UTILITY PROGRAMS FOR INSTALLING, FORMATTING, AND PARTITIONING HARD DISK DRIVES; COMPUTER UTILITY PROGRAMS FOR ANALYZING DATA TO DETECT, ERADICATE AND PREVENT THE OCCURRENCE OF COMPUTER VIRUSES; INTERNET VIDEO SOFTWARE TO ALLOW A USER TO WATCH LOCAL, NATIONAL OR INTERNATIONAL TELEVISION CHANNELS ON A COMPUTER; COMPUTER PASSWORD MANAGEMENT SOFTWARE TO SECURE PASSWORDS AND ALLOW ONLINE FORM FILLING, INCLUDING AUTOMATIC LOGIN TO WEBSITES, GENERATING, ENCRYPTING, AND STORING STRONG PASSWORDS, PROTECTION AGAINST IDENTITY THEFT, PHISHING AND KEY LOGGERS, AND MANAGING APPLICATION AND WEBSITE PASSWORDS; DOWNLOADABLE COMPUTER SOFTWARE FOR STORING ELECTRONIC DATA, INCLUDING BACKING UP AND ARCHIVING ELECTRONIC DATA (U.S. CLS. 21, 23, 26, 36 AND 38).

BARBARA BROWN, EXAMINING ATTORNEY

CLASS 9—(Continued).

SN 85-534,299. HOUSE COMMUNICATIONS LLC, WAYNE, NJ. FILED 2-5-2012.

SPYPAD

THE MARK CONSISTS OF STANDARD CHARACTERS WITHOUT CLAIM TO ANY PARTICULAR FONT, STYLE, SIZE, OR COLOR.

FOR COMPUTER HARDWARE AND SOFTWARE SYSTEM FOR TRACKING PEOPLE, OBJECTS AND PETS USING GPS DATA ON A DEVICE ON THE TRACKED PEOPLE, OBJECTS AND PETS (U.S. CLS. 21, 23, 26, 36 AND 38).

CHRISTOPHER BUONGIORNO, EXAMINING ATTORNEY

SN 85-534,376. SWEITZER, MARTIN, CARY, NC. FILED 2-6-2012.

BITMONSTER

THE MARK CONSISTS OF "BITMONSTER" IN STYLIZED FONT WITH THE "O" IN "MONSTER" ALSO THE FACE OF A MONSTER.

FOR COMPUTER GAME SOFTWARE FOR PERSONAL COMPUTERS AND HOME VIDEO GAME CONSOLES; COMPUTER GAME SOFTWARE FOR USE WITH PERSONAL COMPUTERS, HOME VIDEO GAME CONSOLES USED WITH TELEVISIONS AND ARCADE-BASED VIDEO GAME CONSOLES; DOWNLOADABLE IMAGE FILE CONTAINING ARTWORK, TEXT, AUDIO, VIDEO, GAMES AND INTERNET WEB LINKS RELATING TO SPORTING AND CULTURAL ACTIVITIES; VIDEO GAME SOFTWARE (U.S. CLS. 21, 23, 26, 36 AND 38).

LINDA MICKLEBURGH, EXAMINING ATTORNEY

SN 85-534,445. NYSE TECHNOLOGIES, INC., NEW YORK, NY. FILED 2-6-2012.

MAMA

THE MARK CONSISTS OF STANDARD CHARACTERS WITHOUT CLAIM TO ANY PARTICULAR FONT, STYLE, SIZE, OR COLOR.

FOR COMPUTER SOFTWARE, NAMELY, APPLICATION PROGRAMMING INTERFACE (API) AND ABSTRACTION LAYER THAT PROVIDES A SINGLE INTERFACE TO MULTIPLE MESSAGE ORIENTED MIDDLEWARES AND ALLOWS MULTIPLE MIDDLEWARES TO COEXIST IN A SINGLE APPLICATION (U.S. CLS. 21, 23, 26, 36 AND 38).

FIRST USE 3-28-2007; IN COMMERCE 3-28-2007.
ANNE E. GUSTASON, EXAMINING ATTORNEY

CLASS 9—(Continued).

SN 85-534,451. ROLAND CORPORATION, HAMAMATSU, SHIZUOKA, JAPAN, FILED 2-6-2012.

AIR RECORDER

THE MARK CONSISTS OF STANDARD CHARACTERS WITHOUT CLAIM TO ANY PARTICULAR FONT, STYLE, SIZE, OR COLOR.

NO CLAIM IS MADE TO THE EXCLUSIVE RIGHT TO USE "RECORDER", APART FROM THE MARK AS SHOWN.

FOR COMPUTER SOFTWARE FOR USE WITH HANDHELD COMPUTERS USED IN CONNECTION WITH ELECTRONIC MUSICAL INSTRUMENTS WHICH ENABLES THE HANDHELD COMPUTER TO RECORD, PLAY AND EDIT WHAT IS PLAYED ON THE ELECTRONIC MUSICAL INSTRUMENT, OPERATES AND ENABLES THE CONNECTIVITY BETWEEN THE HANDHELD COMPUTER AND THE ELECTRONIC MUSICAL INSTRUMENT, ENABLES THE PROGRAMMING OF ELECTRONIC MUSICAL INSTRUMENTS VIA THE HANDHELD COMPUTER, AND ENABLES THE WIRELESS TRANSMISSION OF DIGITAL FILES INCLUDING MUSIC, AUDIO, MESSAGES, TEXT, AND IMAGES BETWEEN THE HANDHELD COMPUTER AND THE MUSICAL INSTRUMENT (U.S. CLS. 21, 23, 26, 36 AND 38).

JEFFREY LOOK, EXAMINING ATTORNEY

SN 85-534,506. FIFTY-SIX HOPE ROAD MUSIC, LIMITED, CABLE BEACH, NASSAU, BAHAMAS, FILED 2-6-2012.

TUFF GONG WORLDWIDE

THE MARK CONSISTS OF STANDARD CHARACTERS WITHOUT CLAIM TO ANY PARTICULAR FONT, STYLE, SIZE, OR COLOR.

NO CLAIM IS MADE TO THE EXCLUSIVE RIGHT TO USE "WORLDWIDE", APART FROM THE MARK AS SHOWN.

FOR (BASED ON USE IN COMMERCE) DVDS FEATURING MUSIC AND MUSICAL PERFORMANCES; MUSICAL SOUND RECORDINGS (BASED ON INTENT TO USE) COMPUTER GAME DISCS; COMPUTER GAME PROGRAMS; COMPUTER GAME SOFTWARE; DOWNLOADABLE ELECTRONIC PUBLICATIONS IN THE NATURE OF E-BOOKS AND ARTICLES IN THE FIELD OF CHILDREN'S STORIES, FICTIONAL STORIES, MUSIC, AND MUSICAL PERFORMANCES (U.S. CLS. 21, 23, 26, 36 AND 38).

FIRST USE 1-1-2006; IN COMMERCE 1-1-2006.
SUNG IN, EXAMINING ATTORNEY

CLASS 9—(Continued).

SN 85-534,680. GID DEVELOPMENT CORP., DBA BODY-DOCK.COM, YORBA LINDA, CA. FILED 2-6-2012.

FIND YOUR SWEET SPOT

THE MARK CONSISTS OF STANDARD CHARACTERS WITHOUT CLAIM TO ANY PARTICULAR FONT, STYLE, SIZE, OR COLOR.

FOR DOCKING MECHANISMS FOR MOBILE DEVICES, NAMELY MAGNETIC DOCKING MECHANISM FOR MOBILE PHONES, PORTABLE MUSIC PLAYERS, AND PORTABLE TABLETS (U.S. CLS. 21, 23, 26, 36 AND 38).

FIRST USE 12-14-2011; IN COMMERCE 12-14-2011.
JOHN WILKE, EXAMINING ATTORNEY



SN 85-534,694. OPNET TECHNOLOGIES, INC., BETHESDA, MD. FILED 2-6-2012.

CX-TRACER

THE MARK CONSISTS OF STANDARD CHARACTERS WITHOUT CLAIM TO ANY PARTICULAR FONT, STYLE, SIZE, OR COLOR.

FOR COMPUTER SOFTWARE FOR MONITORING AND TROUBLESHOOTING PERFORMANCE OF COMPUTER NETWORKS AND OF APPLICATIONS RUNNING ON COMPUTER NETWORKS AND SERVERS (U.S. CLS. 21, 23, 26, 36 AND 38).

CHRISTINA SOBRAL, EXAMINING ATTORNEY



SN 85-534,709. IT'S NEVER 2 LATE, LLC, CENTENNIAL, CO. FILED 2-6-2012.

iN2L

THE MARK CONSISTS OF STANDARD CHARACTERS WITHOUT CLAIM TO ANY PARTICULAR FONT, STYLE, SIZE, OR COLOR.

FOR COMPUTER SOFTWARE AND HARDWARE SYSTEMS, NAMELY SYSTEMS FOR NURSING HOMES, ASSISTED AND INDEPENDENT SENIOR LIVING COMMUNITIES, MEMORY CARE SETTINGS, AND ADULT DAY PROGRAMS, WHICH SYSTEMS ARE STRATEGICALLY DESIGNED AND DEVELOPED TO PROMOTE WELLNESS AND ENGAGE ELDERS (U.S. CLS. 21, 23, 26, 36 AND 38).

FIRST USE 6-1-2002; IN COMMERCE 6-1-2002.
NATALIE POLZER, EXAMINING ATTORNEY

CLASS 9—(Continued).

SN 85-534,752. HEWLETT-PACKARD DEVELOPMENT COMPANY, L.P., HOUSTON, TX. FILED 2-6-2012.

ACCUPAGE

THE MARK CONSISTS OF STANDARD CHARACTERS WITHOUT CLAIM TO ANY PARTICULAR FONT, STYLE, SIZE, OR COLOR.

FOR SOFTWARE FOR OPTICAL CHARACTER RECOGNITION (OCR); SOFTWARE FOR USE IN SCANNING DOCUMENTS AND IMAGES; SCANNERS, PRINTERS, FACSIMILE MACHINES, COPYING MACHINES AND MULTIFUNCTION ELECTRONIC DEVICES FOR USE IN COPYING, PRINTING, SCANNING, VIDEO CAPTURE AND/OR TRANSMITTING DOCUMENTS AND IMAGES (U.S. CLS. 21, 23, 26, 36 AND 38).

BRENDAN REGAN, EXAMINING ATTORNEY



SN 85-534,757. ORIENGE, LLC, SARATOGA SPRINGS, NY. FILED 2-6-2012.

Conterra

THE MARK CONSISTS OF STANDARD CHARACTERS WITHOUT CLAIM TO ANY PARTICULAR FONT, STYLE, SIZE, OR COLOR.

THE ENGLISH TRANSLATION OF "CONTERRA" IN THE MARK IS "WILL CONTAIN".

FOR COMPUTER APPLICATION SOFTWARE FOR MOBILE PHONES, HANDHELD COMPUTERS, NAMELY, SOFTWARE FOR ENTERPRISE CONTENT MANAGEMENT, DOCUMENT MANAGEMENT, BUSINESS PROCESS MANAGEMENT, RECORD MANAGEMENT, HUMAN RESOURCES MANAGEMENT, CONTRACT MANAGEMENT; COMPUTER HARDWARE AND SOFTWARE SYSTEMS FOR ENTERPRISE CONTENT MANAGEMENT, DOCUMENT MANAGEMENT, BUSINESS PROCESS MANAGEMENT, RECORD MANAGEMENT, HUMAN RESOURCES MANAGEMENT, CONTRACT MANAGEMENT; COMPUTER SOFTWARE FOR ACCESSING INFORMATION DIRECTORIES THAT MAY BE DOWNLOADED FROM THE GLOBAL COMPUTER NETWORK; COMPUTER SOFTWARE FOR APPLICATION AND DATABASE INTEGRATION; COMPUTER SOFTWARE FOR CREATING SEARCHABLE DATABASES OF INFORMATION AND DATA; COMPUTER SOFTWARE FOR MANIPULATING DIGITAL AUDIO INFORMATION FOR USE IN AUDIO MEDIA APPLICATIONS; COMPUTER SOFTWARE FOR PROVIDING AN ON-LINE DATABASE IN THE FIELD OF TRANSACTION PROCESSING TO UPLOAD TRANSACTIONAL DATA, PROVIDE STATISTICAL ANALYSIS, AND PRODUCE NOTIFICATIONS AND REPORTS; COMPUTER SOFTWARE FOR THE COLLECTION, EDITING, ORGANIZING, MODIFYING, BOOK MARKING, TRANSMISSION, STORAGE AND SHARING OF DATA AND INFORMATION; COMPUTER SOFTWARE FOR USE IN CUSTOMER RELATIONSHIP MANAGEMENT (CRM); COMPUTER SOFTWARE FOR USE IN THE ENCRYPTION AND DECRYPTION OF DIGITAL FILES, INCLUDING AUDIO, VIDEO, TEXT, BINARY,

CLASS 9—(Continued).

STILL IMAGES, GRAPHICS AND MULTIMEDIA FILES; COMPUTER SOFTWARE FOR USE IN THE SAFEGUARDING OF DIGITAL FILES, INCLUDING AUDIO, VIDEO, TEXT, BINARY, STILL IMAGES, GRAPHICS AND MULTIMEDIA FILES; COMPUTER SOFTWARE FOR ENTERPRISE CONTENT MANAGEMENT, DOCUMENT MANAGEMENT, BUSINESS PROCESS MANAGEMENT, RECORD MANAGEMENT, HUMAN RESOURCES MANAGEMENT, CONTRACT MANAGEMENT; COMPUTER SOFTWARE FOR ENTERPRISE CONTENT MANAGEMENT, DOCUMENT MANAGEMENT, BUSINESS PROCESS MANAGEMENT, RECORD MANAGEMENT, HUMAN RESOURCES MANAGEMENT, CONTRACT MANAGEMENT THAT MAY BE DOWNLOADED FROM A GLOBAL COMPUTER NETWORK; COMPUTER SOFTWARE THAT PROVIDES REAL-TIME, INTEGRATED BUSINESS MANAGEMENT INTELLIGENCE BY COMBINING INFORMATION FROM VARIOUS DATABASES AND PRESENTING IT IN AN EASY-TO-UNDERSTAND USER INTERFACE (U.S. CLS. 21, 23, 26, 36 AND 38).

FIRST USE 9-12-2011; IN COMMERCE 9-12-2011.
TINA MAI, EXAMINING ATTORNEY

SN 85-534,767. BLACK CHAIR GROUP, LLC, CHARLOTTE, NC. FILED 2-6-2012.



THE MARK CONSISTS OF THE LITERAL ELEMENT "STATUS" IN STYLIZED FONT OVER THE LITERAL ELEMENTS "KNOW NOW." NEXT TO THE DESIGN OF A HAND WITHIN A CIRCLE HOLDING UP FOUR FINGERS. FOR DOWNLOADABLE SOFTWARE IN THE NATURE OF A MOBILE APPLICATION FOR REAL-TIME EVENT MANAGEMENT AND FOR PROVIDING REAL-TIME INFORMATION (U.S. CLS. 21, 23, 26, 36 AND 38).

INGA ERVIN, EXAMINING ATTORNEY

SN 85-534,780. IOREVOLUTION INC., WINTER GARDEN, FL. FILED 2-6-2012.

POWERAPP

THE MARK CONSISTS OF STANDARD CHARACTERS WITHOUT CLAIM TO ANY PARTICULAR FONT, STYLE, SIZE, OR COLOR.

FOR COMPUTER SOFTWARE PLATFORMS FOR ENABLING INTERACTIVE CONTENT TO RUN INSIDE EMAILS (U.S. CLS. 21, 23, 26, 36 AND 38).

FIRST USE 1-17-2011; IN COMMERCE 2-26-2011.
JACQUELINE A. LAVINE, EXAMINING ATTORNEY

CLASS 9—(Continued).

SN 85-534,793. SYSTEMONE, LLC, STUART, FL. FILED 2-6-2012.

SYSTEMSONE

THE MARK CONSISTS OF STANDARD CHARACTERS WITHOUT CLAIM TO ANY PARTICULAR FONT, STYLE, SIZE, OR COLOR.

FOR COMPUTER SOFTWARE AND HARDWARE, FOR USE WITH MEDICAL PATIENT MONITORING EQUIPMENT, FOR RECEIVING, PROCESSING, TRANSMITTING AND DISPLAYING DATA (U.S. CLS. 21, 23, 26, 36 AND 38).

FIRST USE 5-31-2005; IN COMMERCE 5-31-2005.
KATHLEEN M. VANSTON, EXAMINING ATTORNEY

SN 85-534,845. !!!MANIC SALAMANDER, INC., DBA !!!MANIC SALAMANDER, MINNEAPOLIS, MN. FILED 2-6-2012.

!!!MANIC SALAMANDER

THE MARK CONSISTS OF STANDARD CHARACTERS WITHOUT CLAIM TO ANY PARTICULAR FONT, STYLE, SIZE, OR COLOR.

FOR ELECTRICAL POWER MANAGEMENT DEVICES; ELECTRIC CHARGING CABLES; ELECTRIC CONNECTIONS AND CONNECTORS; ELECTRIC OUTLETS FOR VEHICLES; ELECTRICAL ACCESSORIES FOR VEHICLES (U.S. CLS. 21, 23, 26, 36 AND 38).

FIRST USE 5-31-2003; IN COMMERCE 9-7-2003.
THOMAS MANOR, EXAMINING ATTORNEY

SN 85-534,928. IOREVOLUTION INC., WINTER GARDEN, FL. FILED 2-6-2012.

POWEREMAIL

THE MARK CONSISTS OF STANDARD CHARACTERS WITHOUT CLAIM TO ANY PARTICULAR FONT, STYLE, SIZE, OR COLOR.

FOR COMPUTER SOFTWARE PLATFORMS FOR ENABLING INTERACTIVE EMAILS (U.S. CLS. 21, 23, 26, 36 AND 38).

JACQUELINE A. LAVINE, EXAMINING ATTORNEY

CLASS 9—(Continued).

SN 85-534,933. CRUMPLEPOP, MINNEAPOLIS, MN. FILED 2-6-2012.

CrumplePop

THE MARK CONSISTS OF STANDARD CHARACTERS WITHOUT CLAIM TO ANY PARTICULAR FONT, STYLE, SIZE, OR COLOR.

FOR COMPUTER SOFTWARE FOR USE IN DIGITAL VIDEO EDITING THAT MAY BE DOWNLOADED FROM A GLOBAL COMPUTER NETWORK (U.S. CLS. 21, 23, 26, 36 AND 38).

FIRST USE 10-1-2011; IN COMMERCE 10-1-2011.
MARC LEIPZIG, EXAMINING ATTORNEY

CLASS 9—(Continued).

SN 85-534,975. GENESIS IP LTD., CENTRAL, HONG KONG, FILED 2-6-2012.

Reel Optimizer

SN 85-534,941. JOHNSON & JOHNSON, NEW BRUNSWICK, NJ. FILED 2-6-2012.

ACUVUE DEFINE

THE MARK CONSISTS OF STANDARD CHARACTERS WITHOUT CLAIM TO ANY PARTICULAR FONT, STYLE, SIZE, OR COLOR.

OWNER OF U.S. REG. NOS. 1,458,177 AND 2,547,208. FOR CONTACT LENSES (U.S. CLS. 21, 23, 26, 36 AND 38).

ALICE BENMAMAN, EXAMINING ATTORNEY

SN 85-534,955. CRUMPLEPOP, MINNEAPOLIS, MN. FILED 2-6-2012.



THE MARK CONSISTS OF A GEOMETRICAL SHAPE RESEMBLING A CRUMPLED PIECE OF PAPER.

FOR COMPUTER SOFTWARE FOR USE IN DIGITAL VIDEO EDITING THAT MAY BE DOWNLOADED FROM A GLOBAL COMPUTER NETWORK (U.S. CLS. 21, 23, 26, 36 AND 38).

FIRST USE 10-1-2011; IN COMMERCE 10-1-2011.
MARC LEIPZIG, EXAMINING ATTORNEY

THE MARK CONSISTS OF STANDARD CHARACTERS WITHOUT CLAIM TO ANY PARTICULAR FONT, STYLE, SIZE, OR COLOR.

FOR COMPUTER GAME PROGRAMMES DOWNLOADABLE VIA THE INTERNET; COMPUTER GAME PROGRAMS; COMPUTER GAME SOFTWARE DOWNLOADABLE FROM A GLOBAL COMPUTER NETWORK; COMPUTER GAME SOFTWARE FOR GAMING MACHINES INCLUDING SLOT MACHINES OR VIDEO LOTTERY TERMINALS; COMPUTER GAME SOFTWARE FOR GAMING MACHINES, NAMELY, SLOT MACHINES AND VIDEO LOTTERY TERMINALS; COMPUTER GAME SOFTWARE FOR USE ON MOBILE AND CELLULAR PHONES; COMPUTER GAME SOFTWARE FOR USE WITH PERSONAL COMPUTERS, HOME VIDEO GAME CONSOLES USED WITH TELEVISIONS AND ARCADE-BASED VIDEO GAME CONSOLES; COMPUTER PROGRAMS FOR VIDEO AND COMPUTER GAMES; COMPUTER SOFTWARE AND FIRMWARE FOR GAMES OF CHANCE ON ANY COMPUTERIZED PLATFORM, INCLUDING DEDICATED GAMING CONSOLES, VIDEO BASED SLOT MACHINES, REEL BASED SLOT MACHINES, AND VIDEO LOTTERY TERMINALS; DOWNLOADABLE COMPUTER GAME PROGRAMS; DOWNLOADABLE COMPUTER GAME SOFTWARE VIA A GLOBAL COMPUTER NETWORK AND WIRELESS DEVICES; ELECTRONIC GAME SOFTWARE FOR CELLULAR TELEPHONES; ELECTRONIC GAME SOFTWARE FOR WIRELESS DEVICES; GAME SOFTWARE; GAMING SOFTWARE THAT GENERATES OR DISPLAYS WAGER OUTCOMES OF GAMING MACHINES; INTERACTIVE GAME PROGRAMS; INTERACTIVE VIDEO GAME PROGRAMS; VIDEO AND COMPUTER GAME PROGRAMS; VIDEO GAME SOFTWARE (U.S. CLS. 21, 23, 26, 36 AND 38).

SAMUEL E. SHARPER JR., EXAMINING ATTORNEY

CLASS 9—(Continued).

SN 85-535,003. GENESIS IP LTD., CENTRAL, HONG KONG, FILED 2-6-2012.

Spin Builder

THE MARK CONSISTS OF STANDARD CHARACTERS WITHOUT CLAIM TO ANY PARTICULAR FONT, STYLE, SIZE, OR COLOR.

FOR COMPUTER GAME PROGRAMMES DOWNLOADABLE VIA THE INTERNET; COMPUTER GAME PROGRAMS; COMPUTER GAME SOFTWARE DOWNLOADABLE FROM A GLOBAL COMPUTER NETWORK; COMPUTER GAME SOFTWARE FOR GAMING MACHINES INCLUDING SLOT MACHINES OR VIDEO LOTTERY TERMINALS; COMPUTER GAME SOFTWARE FOR GAMING MACHINES, NAMELY, SLOT MACHINES AND VIDEO LOTTERY TERMINALS; COMPUTER GAME SOFTWARE FOR USE ON MOBILE AND CELLULAR PHONES; COMPUTER GAME SOFTWARE FOR USE WITH PERSONAL COMPUTERS, HOME VIDEO GAME CONSOLES USED WITH TELEVISIONS AND ARCADE-BASED VIDEO GAME CONSOLES; COMPUTER PROGRAMS FOR VIDEO AND COMPUTER GAMES; COMPUTER SOFTWARE AND FIRMWARE FOR GAMES OF CHANCE ON ANY COMPUTERIZED PLATFORM, INCLUDING DEDICATED GAMING CONSOLES, VIDEO BASED SLOT MACHINES, REEL BASED SLOT MACHINES, AND VIDEO LOTTERY TERMINALS; DOWNLOADABLE COMPUTER GAME PROGRAMS; DOWNLOADABLE COMPUTER GAME SOFTWARE VIA A GLOBAL COMPUTER NETWORK AND WIRELESS DEVICES; ELECTRONIC GAME SOFTWARE FOR CELLULAR TELEPHONES; ELECTRONIC GAME SOFTWARE FOR WIRELESS DEVICES; GAME SOFTWARE; GAMING SOFTWARE THAT GENERATES OR DISPLAYS WAGER OUTCOMES OF GAMING MACHINES; INTERACTIVE GAME PROGRAMS; INTERACTIVE VIDEO GAME PROGRAMS; VIDEO AND COMPUTER GAME PROGRAMS; VIDEO GAME SOFTWARE (U.S. CLS. 21, 23, 26, 36 AND 38).

SAMUEL E. SHARPER JR., EXAMINING ATTORNEY

SN 85-535,020. MICROBRIGHTFIELD, INC., WILLISTON, VT. FILED 2-6-2012.

AUTOSYNAPSE

THE MARK CONSISTS OF STANDARD CHARACTERS WITHOUT CLAIM TO ANY PARTICULAR FONT, STYLE, SIZE, OR COLOR.

FOR COMPUTER SOFTWARE TO ANALYZE BIOLOGICAL TISSUE SAMPLES FOR RESEARCH PURPOSES NAMELY, ANALYSIS OF PRE-SYNAPTIC AND POST-SYNAPTIC STRUCTURES IN IMAGES OBTAINED FROM A MICROSCOPE (U.S. CLS. 21, 23, 26, 36 AND 38).

FIRST USE 2-3-2012; IN COMMERCE 2-3-2012.
CHERYL CLAYTON, EXAMINING ATTORNEY

CLASS 9—(Continued).

SN 85-535,026. VERISONIX CORPORATION, NEW TAIPEI CITY, TAIWAN, FILED 2-6-2012.



THE MARK CONSISTS OF THE STYLIZED WORDING "VERI SONIX" WITH AN INCOMPLETE RECTANGLE AROUND LETTERS "RI".

FOR AUDIO SPEAKERS; LOUD SPEAKERS; SPEAKERS; SPEAKERS FOR COMPUTER; AMPLIFIERS; STEREOS, MEDIA PLAYER; AUDIO EQUIPMENT FOR VEHICLES, NAMELY, LOUD SPEAKERS FOR AUTOMOTIVE AUDIO SYSTEMS; PORTABLE LISTENING DEVICES, NAMELY, MP3 PLAYERS (U.S. CLS. 21, 23, 26, 36 AND 38).

KARANENDRA S. CHHINA, EXAMINING ATTORNEY

SN 85-535,054. MAHONEY, SEAN, MANTECA, CA. FILED 2-6-2012.

THE HOOK

THE MARK CONSISTS OF STANDARD CHARACTERS WITHOUT CLAIM TO ANY PARTICULAR FONT, STYLE, SIZE, OR COLOR.

FOR MICROPHONE BOOM POLES; MICROPHONE STANDS; MICROPHONE CLAMPS (U.S. CLS. 21, 23, 26, 36 AND 38).

FIRST USE 3-1-2011; IN COMMERCE 3-1-2011.
JACQUELINE A. LAVINE, EXAMINING ATTORNEY

SN 85-535,077. MAHONEY, SEAN, MANTECA, CA. FILED 2-6-2012.

WISHBONE

THE MARK CONSISTS OF STANDARD CHARACTERS WITHOUT CLAIM TO ANY PARTICULAR FONT, STYLE, SIZE, OR COLOR.

FOR MICROPHONE STANDS; MICROPHONE BOOMS; MICROPHONE CLAMPS (U.S. CLS. 21, 23, 26, 36 AND 38).

FIRST USE 3-0-2009; IN COMMERCE 3-0-2009.
JACQUELINE A. LAVINE, EXAMINING ATTORNEY

CLASS 9—(Continued).

SN 85-535,134. SIMON & SCHUSTER, INC., NEW YORK, NY. FILED 2-6-2012.



OWNER OF U.S. REG. NOS. 1,455,239 AND 3,097,965.
 THE MARK CONSISTS OF THE UPPER BODY PORTION OF A KANGAROO HOLDING AN ELECTRONIC READER WITH A PARTIAL STAR IN THE BACKGROUND, ALL WITHIN A CIRCLE OUTLINED BY ANOTHER CIRCLE.
 FOR COMPUTER SOFTWARE FOR USE IN DOWNLOADING DIGITAL CONTENT, NAMELY, ELECTRONIC BOOKS, ELECTRONIC PUBLICATIONS, AUDIO BOOKS, DOWNLOADABLE ELECTRONIC PUBLICATIONS IN THE NATURE OF BOOKS ON A VARIETY OF TOPICS (U.S. CLS. 21, 23, 26, 36 AND 38).
 JESSICA A. POWERS, EXAMINING ATTORNEY

SN 85-535,273. CENTRIPETAL NETWORKS, RESTON, VA. FILED 2-6-2012.

RuleGate

THE MARK CONSISTS OF STANDARD CHARACTERS WITHOUT CLAIM TO ANY PARTICULAR FONT, STYLE, SIZE, OR COLOR.
 FOR COMPUTER HARDWARE FOR COMPUTER NETWORKING, IP NETWORK FILTERING, COMPUTER NETWORK SECURITY; COMPUTER NETWORKING HARDWARE (U.S. CLS. 21, 23, 26, 36 AND 38).
 FIRST USE 7-0-2011; IN COMMERCE 8-0-2011.
 DOUGLAS LEE, EXAMINING ATTORNEY

SN 85-535,284. LIMITLESS CREATIONS LLC, VALENCIA, CA. FILED 2-6-2012.

Q Logic

THE MARK CONSISTS OF STANDARD CHARACTERS WITHOUT CLAIM TO ANY PARTICULAR FONT, STYLE, SIZE, OR COLOR.
 FOR SPEAKER ENCLOSURES (U.S. CLS. 21, 23, 26, 36 AND 38).
 NAKIA HENRY, EXAMINING ATTORNEY

CLASS 9—(Continued).

SN 85-535,303. IVANKA TRUMP MARKS LLC, NEW YORK, NY. FILED 2-6-2012.



OWNER OF U.S. REG. NOS. 3,620,026 AND 4,010,394.
 THE MARK CONSISTS OF THE STYLIZED LETTERS "IT".
 FOR EYEWEAR (U.S. CLS. 21, 23, 26, 36 AND 38).
 JUSTINE D. PARKER, EXAMINING ATTORNEY

SN 85-535,466. URBAN PIXELS, LLC, NEW YORK, NY. FILED 2-7-2012.

CAN I STREAM.IT?

THE MARK CONSISTS OF STANDARD CHARACTERS WITHOUT CLAIM TO ANY PARTICULAR FONT, STYLE, SIZE, OR COLOR.
 FOR DOWNLOADABLE SOFTWARE IN THE NATURE OF A MOBILE APPLICATION FOR SEARCHING FOR MEDIA CONTENT; DOWNLOADABLE SOFTWARE IN THE NATURE OF A MOBILE APPLICATION FOR REQUESTING NOTIFICATIONS REGARDING THE AVAILABILITY OF MEDIA CONTENT FOR PURCHASE, RENT, OR INSTANT VIEWING ONLINE (U.S. CLS. 21, 23, 26, 36 AND 38).
 FIRST USE 11-29-2011; IN COMMERCE 11-29-2011.
 TASHIA BUNCH, EXAMINING ATTORNEY

CLASS 9—(Continued).

SN 85-535,558. QUAD/GRAPHICS, INC., SUSSEX, WI. FILED 2-7-2012.

ACTABLE

THE MARK CONSISTS OF STANDARD CHARACTERS WITHOUT CLAIM TO ANY PARTICULAR FONT, STYLE, SIZE, OR COLOR.

FOR DOWNLOADABLE SOFTWARE IN THE NATURE OF A MOBILE APPLICATION FOR INTERACTIVE PRINT SOLUTIONS, NAMELY, NEAR FIELD COMMUNICATION TECHNOLOGY, SCANNING OF QUICK RESPONSE CODES, IMAGE RECOGNITION, AND DISPLAYING AUGMENTED REALITY (U.S. CLS. 21, 23, 26, 36 AND 38).

FIRST USE 1-9-2012; IN COMMERCE 1-9-2012.
TARAH HARDY, EXAMINING ATTORNEY

SN 85-535,567. QUAD/GRAPHICS, INC., SUSSEX, WI. FILED 2-7-2012.



THE MARK CONSISTS OF A DESIGN CONSISTING OF A PLUS SYMBOL SURROUNDED BY FOUR DROPLETS.

FOR DOWNLOADABLE SOFTWARE IN THE NATURE OF A MOBILE APPLICATION FOR INTERACTIVE PRINT SOLUTIONS, NAMELY, NEAR FIELD COMMUNICATION TECHNOLOGY, SCANNING OF QUICK RESPONSE CODES, IMAGE RECOGNITION, AND DISPLAYING AUGMENTED REALITY (U.S. CLS. 21, 23, 26, 36 AND 38).

FIRST USE 1-9-2012; IN COMMERCE 1-9-2012.
TARAH HARDY, EXAMINING ATTORNEY

CLASS 9—(Continued).

SN 85-535,660. IMMERSION PROJECT, FORT MYERS, FL. FILED 2-7-2012.

LOCALS KNOW

THE MARK CONSISTS OF STANDARD CHARACTERS WITHOUT CLAIM TO ANY PARTICULAR FONT, STYLE, SIZE, OR COLOR.

FOR DOWNLOADABLE SOFTWARE IN THE NATURE OF A MOBILE APPLICATION FOR STREAMING AND DOWNLOADING AUDIO, VIDEO, PICTURES, MAPS, AND TEXT THAT TELL A STORY ABOUT A PERSON, PLACE OR THING THAT CAN BE PINPOINTED TO A PARTICULAR GLOBAL POSITION; DOWNLOADABLE SOFTWARE IN THE NATURE OF A MOBILE APPLICATION FOR USERS TO CREATE AND SHARE CONTENT WITH AN ONLINE COMMUNITY (U.S. CLS. 21, 23, 26, 36 AND 38).

FIRST USE 8-1-2011; IN COMMERCE 8-1-2011.
GRETTA YAO, EXAMINING ATTORNEY

SN 85-535,784. SCTI HOLDINGS, INC., SILVER SPRING, MD. FILED 2-7-2012.

AUTOVOICE

THE MARK CONSISTS OF STANDARD CHARACTERS WITHOUT CLAIM TO ANY PARTICULAR FONT, STYLE, SIZE, OR COLOR.

FOR COMPUTER HARDWARE, SOFTWARE AND PROGRAMS THAT CONVERT AUDIO TO TEXT, CONVERT TEXT TO AUDIO AND PROVIDE LANGUAGE TRANSLATION (U.S. CLS. 21, 23, 26, 36 AND 38).

JIM RINGLE, EXAMINING ATTORNEY

CLASS 9—(Continued).

SN 85-535,871. JAMES CHARNE, SANTA MONICA, CA. FILED 2-7-2012.

Final Galaxy

THE MARK CONSISTS OF STANDARD CHARACTERS WITHOUT CLAIM TO ANY PARTICULAR FONT, STYLE, SIZE, OR COLOR.

FOR COMPUTER GAME PROGRAMS; COMPUTER GAME SOFTWARE; COMPUTER GAME SOFTWARE DOWNLOADABLE FROM A GLOBAL COMPUTER NETWORK; COMPUTER GAME SOFTWARE FOR USE ON MOBILE AND CELLULAR PHONES; COMPUTER PROGRAMS FOR VIDEO AND COMPUTER GAMES; DOWNLOADABLE COMPUTER GAME PROGRAMS; DOWNLOADABLE COMPUTER GAME SOFTWARE VIA A GLOBAL COMPUTER NETWORK AND WIRELESS DEVICES; DOWNLOADABLE ELECTRONIC GAME PROGRAMS; ELECTRONIC GAME SOFTWARE FOR CELLULAR TELEPHONES; ELECTRONIC GAME SOFTWARE FOR HANDHELD ELECTRONIC DEVICES; ELECTRONIC GAME SOFTWARE FOR WIRELESS DEVICES; INTERACTIVE GAME PROGRAMS; INTERACTIVE GAME SOFTWARE; VIDEO AND COMPUTER GAME PROGRAMS (U.S. CLS. 21, 23, 26, 36 AND 38).
KEVON CHISOLM, EXAMINING ATTORNEY



SN 85-535,888. LG ELECTRONICS INC., SEOUL 150-721, REPUBLIC OF KOREA, FILED 2-7-2012.

LUCID

THE MARK CONSISTS OF STANDARD CHARACTERS WITHOUT CLAIM TO ANY PARTICULAR FONT, STYLE, SIZE, OR COLOR.

FOR SMART PHONES; MOBILE PHONES (U.S. CLS. 21, 23, 26, 36 AND 38).
FIRST USE 3-29-2012; IN COMMERCE 3-29-2012.
MORGAN WYNNE, EXAMINING ATTORNEY



SN 85-535,941. ATG CEYLON (PVT) LIMITED, IPZ, KATA-NAYAKE, SRI LANKA, FILED 2-7-2012.

MAXIFLEX

THE MARK CONSISTS OF STANDARD CHARACTERS WITHOUT CLAIM TO ANY PARTICULAR FONT, STYLE, SIZE, OR COLOR.

FOR SAFETY GLOVES; INDUSTRIAL SAFETY GLOVES (U.S. CLS. 21, 23, 26, 36 AND 38).
FIRST USE 5-31-2004; IN COMMERCE 5-31-2004.
VERNA BETH RIRIE, EXAMINING ATTORNEY

CLASS 9—(Continued).

SN 85-535,944. CWILL CORP., WHITE MARSH, MD. FILED 2-7-2012.



THE MARK CONSISTS OF SIX CURVED BANDS, WHERE THREE CURVED BANDS WITH A COMMON CENTER CURVE TO THE RIGHT AND UP ABOVE THREE BANDS WITH A COMMON CENTER THAT CURVE TO THE LEFT AND DOWN FROM THE TOP THREE BANDS.

FOR COMPUTER APPLICATION SOFTWARE FOR MOBILE PHONES, PORTABLE MEDIA, PLAYERS, DESKTOP COMPUTERS, AND HANDHELD COMPUTERS, NAMELY, SOFTWARE FOR MANAGING BUSINESS, CUSTOMER, AND PERSONAL RELATIONSHIPS (U.S. CLS. 21, 23, 26, 36 AND 38).
ANDREW LEASER, EXAMINING ATTORNEY



SN 85-536,069. REAL SOURCING NETWORK LLC, NEW YORK, NY. FILED 2-7-2012.

DataLink360

THE MARK CONSISTS OF STANDARD CHARACTERS WITHOUT CLAIM TO ANY PARTICULAR FONT, STYLE, SIZE, OR COLOR.

FOR COMPUTER SOFTWARE THAT PROVIDES WEB-BASED ACCESS TO APPLICATIONS AND SERVICES THROUGH A WEB OPERATING SYSTEM OR PORTAL INTERFACE (U.S. CLS. 21, 23, 26, 36 AND 38).
FIRST USE 12-0-2011; IN COMMERCE 12-0-2011.
SHAILA SETTLES, EXAMINING ATTORNEY

CLASS 9—(Continued).

SN 85-536,155. UMOJA, INC., JACKSON, MS. FILED 2-7-2012.



THE MARK CONSISTS OF THE WORD "UMOJA" ABOVE AN ABSTRACT SHAPE THAT CONSISTS OF A ROUNDED BOTTOM AND TWO POINTS AT THE TOP. INSIDE OF THE ABSTRACT SHAPE IS A WHIRLPOOL.

THE ENGLISH TRANSLATION OF "UMOJA" IN THE MARK IS "UNITED".

FOR EARPHONES AND HEADPHONES (U.S. CLS. 21, 23, 26, 36 AND 38).

FIRST USE 12-0-2010; IN COMMERCE 12-0-2010.
CURTIS FRENCH, EXAMINING ATTORNEY

SN 85-536,333. SOCIAL TITANS, BROOKLYN, NY. FILED 2-7-2012.

Terra Monsters

THE MARK CONSISTS OF STANDARD CHARACTERS WITHOUT CLAIM TO ANY PARTICULAR FONT, STYLE, SIZE, OR COLOR.

FOR COMPUTER GAME SOFTWARE (U.S. CLS. 21, 23, 26, 36 AND 38).

DOUGLAS LEE, EXAMINING ATTORNEY

SN 85-536,403. QUICKBIZ HOLDINGS LIMITED, APIA, SAMOA, FILED 2-7-2012.

ScreenShare

THE MARK CONSISTS OF STANDARD CHARACTERS WITHOUT CLAIM TO ANY PARTICULAR FONT, STYLE, SIZE, OR COLOR.

FOR SOFTWARE FOR SHARING APPLICATIONS ON AND BETWEEN DISPLAY SCREENS OF MULTIPLY CONNECTED PORTABLE ELECTRONIC DEVICES (U.S. CLS. 21, 23, 26, 36 AND 38).

KATHY DE JONGE, EXAMINING ATTORNEY

CLASS 9—(Continued).

SN 85-536,419. PROLIFIC TECHNOLOGY INC., NAN KANG DIST., TAIPEI, TAIWAN, FILED 2-7-2012.

Prolific

THE MARK CONSISTS OF THE WORD "PROLIFIC" FOR SEMICONDUCTOR CHIPS; SEMICONDUCTORS; INTEGRATED CIRCUITS (U.S. CLS. 21, 23, 26, 36 AND 38).

LESLEY LAMOTHE, EXAMINING ATTORNEY

SN 85-536,463. FARINA, CHRISTINE, GALLOWAY, NJ. FILED 2-7-2012.

u game?

THE MARK CONSISTS OF STANDARD CHARACTERS WITHOUT CLAIM TO ANY PARTICULAR FONT, STYLE, SIZE, OR COLOR.

FOR MOTION PICTURE FILMS ABOUT PEOPLE WHO PLAY GAMES, KNOWN AS GAMERS (U.S. CLS. 21, 23, 26, 36 AND 38).

APRIL ROACH, EXAMINING ATTORNEY

SN 85-536,489. SARA BROIHIER & ASSOCIATES LLC, SANTA MONICA, CA. FILED 2-7-2012.

Daily Sweat

THE MARK CONSISTS OF STANDARD CHARACTERS WITHOUT CLAIM TO ANY PARTICULAR FONT, STYLE, SIZE, OR COLOR.

FOR DIGITAL MEDIA, NAMELY, DVDS FEATURING FITNESS TRAINING (U.S. CLS. 21, 23, 26, 36 AND 38).

FIRST USE 11-1-2011; IN COMMERCE 2-1-2012.

BERYL GARDNER, EXAMINING ATTORNEY

CLASS 9—(Continued).

SN 85-536,499. SARA BROIHIER & ASSOCIATES LLC, SANTA MONICA, CA. FILED 2-7-2012.

Expecting More

THE MARK CONSISTS OF STANDARD CHARACTERS WITHOUT CLAIM TO ANY PARTICULAR FONT, STYLE, SIZE, OR COLOR.
FOR DIGITAL MEDIA, NAMELY, DVDS FEATURING FITNESS TRAINING (U.S. CLS. 21, 23, 26, 36 AND 38).
FIRST USE 11-1-2011; IN COMMERCE 2-1-2012.
BERYL GARDNER, EXAMINING ATTORNEY

SN 85-536,564. AINSWORTH GAME TECHNOLOGY LIMITED, NEWINGTON, AUSTRALIA, FILED 2-8-2012.

AROUND THE BOARD

THE MARK CONSISTS OF STANDARD CHARACTERS WITHOUT CLAIM TO ANY PARTICULAR FONT, STYLE, SIZE, OR COLOR.
FOR COMPUTER SOFTWARE AND FIRMWARE FOR GAMES OF CHANCE ON ANY COMPUTERIZED PLATFORM, INCLUDING DEDICATED GAMING CONSOLES, VIDEO BASED SLOT MACHINES, REEL BASED SLOT MACHINES, AND VIDEO LOTTERY TERMINALS (U.S. CLS. 21, 23, 26, 36 AND 38).
JESSICA A. POWERS, EXAMINING ATTORNEY

SN 85-536,566. AINSWORTH GAME TECHNOLOGY LIMITED, NEWINGTON, AUSTRALIA, FILED 2-8-2012.

LIGHT 'EM UP

THE MARK CONSISTS OF STANDARD CHARACTERS WITHOUT CLAIM TO ANY PARTICULAR FONT, STYLE, SIZE, OR COLOR.
FOR COMPUTER SOFTWARE AND FIRMWARE FOR GAMES OF CHANCE ON ANY COMPUTERIZED PLATFORM, INCLUDING DEDICATED GAMING CONSOLES, VIDEO BASED SLOT MACHINES, REEL BASED SLOT MACHINES, AND VIDEO LOTTERY TERMINALS (U.S. CLS. 21, 23, 26, 36 AND 38).
JESSICA A. POWERS, EXAMINING ATTORNEY

CLASS 9—(Continued).

SN 85-536,569. AINSWORTH GAME TECHNOLOGY LIMITED, NEWINGTON, AUSTRALIA, FILED 2-8-2012.

HIT OR MISS

THE MARK CONSISTS OF STANDARD CHARACTERS WITHOUT CLAIM TO ANY PARTICULAR FONT, STYLE, SIZE, OR COLOR.
FOR COMPUTER SOFTWARE AND FIRMWARE FOR GAMES OF CHANCE ON ANY COMPUTERIZED PLATFORM, INCLUDING DEDICATED GAMING CONSOLES, VIDEO BASED SLOT MACHINES, REEL BASED SLOT MACHINES, AND VIDEO LOTTERY TERMINALS (U.S. CLS. 21, 23, 26, 36 AND 38).
JESSICA A. POWERS, EXAMINING ATTORNEY

SN 85-536,627. GOEMERCHANT, LLC, FORT WORTH, TX. FILED 2-8-2012.

M+TERMINAL

THE MARK CONSISTS OF STANDARD CHARACTERS WITHOUT CLAIM TO ANY PARTICULAR FONT, STYLE, SIZE, OR COLOR.
FOR COMPUTER APPLICATION SOFTWARE FOR MOBILE PHONES, PORTABLE ELECTRONIC DEVICES, AND WIRELESS DEVICES, NAMELY, SOFTWARE INCORPORATING AN ELECTRONIC FINANCIAL PLATFORM THAT ACCOMMODATES MULTIPLE TYPES OF PAYMENT AND DEBT TRANSACTIONS, INCLUDING USE OF VISUALIZED PAYMENT CODES AT THE POINT OF SALE (U.S. CLS. 21, 23, 26, 36 AND 38).
CHRISTINE MARTIN, EXAMINING ATTORNEY

SN 85-536,700. FULL SPECTRUM SOLUTIONS, INC, JACKSON, MI. FILED 2-8-2012.



THE MARK CONSISTS OF THE WORD "TESLEON" WITH THE IMAGE OF A STATIC DISCHARGE ON THE TOP OF THE LETTER "T".
FOR LIGHTING BALLASTS (U.S. CLS. 21, 23, 26, 36 AND 38).
SALLY SHIH, EXAMINING ATTORNEY

CLASS 9—(Continued).

SN 85-536,713. EPMOD CONSULTANTS, INC., PITTSBURGH, PA. FILED 2-8-2012.

SYNAPP

THE MARK CONSISTS OF STANDARD CHARACTERS WITHOUT CLAIM TO ANY PARTICULAR FONT, STYLE, SIZE, OR COLOR.

OWNER OF U.S. REG. NO. 3,758,295.

FOR DOWNLOADABLE COMPUTER APPLICATION SOFTWARE IN THE FIELD OF BUSINESS PROCESS MANAGEMENT, BUSINESS PROJECT MANAGEMENT AND TASK MANAGEMENT VIA THE INTERNET AND WIRELESS DEVICES (U.S. CLS. 21, 23, 26, 36 AND 38).

JACQUELINE A. LAVINE, EXAMINING ATTORNEY

SN 85-536,806. POORE, JEFFERY B, WINDSOR, CO. FILED 2-8-2012.

Coconut

THE MARK CONSISTS OF STANDARD CHARACTERS WITHOUT CLAIM TO ANY PARTICULAR FONT, STYLE, SIZE, OR COLOR.

FOR CARRYING CASES FOR CELL PHONES; CARRYING CASES FOR ELECTRONIC EQUIPMENT, NAMELY, TABLET COMPUTERS; CASES FOR MOBILE PHONES (U.S. CLS. 21, 23, 26, 36 AND 38).

LINDSEY RUBIN, EXAMINING ATTORNEY

SN 85-536,918. MOTION SYSTEMS, LLC, NEWARK, NJ. FILED 2-8-2012.

OUTRAGE

THE MARK CONSISTS OF STANDARD CHARACTERS WITHOUT CLAIM TO ANY PARTICULAR FONT, STYLE, SIZE, OR COLOR.

FOR COMPUTER CARRYING CASES, CD AND CD-ROM WALLETS AND PC CARRYING CASES; NOTEBOOK COMPUTER CARRYING CASES; NETBOOK COMPUTER CARRYING CASES; CAMERA CASES; PORTABLE DVD PLAYER CASES; AUDIO CD STORAGE WALLETS; DVD STORAGE WALLETS; GPS NAVIGATION DEVICE CASES; CASES FOR HANDHELD MOBILE DEVICES, NAMELY, CASES FOR CELL PHONES, SMART PHONES, COMPUTERS, TABLETS; CASES FOR WIRELESS DEVICES, NAMELY, CASES FOR CELL PHONES, SMART PHONES, COMPUTERS, TABLETS; CELL PHONE CASES; MP3 PLAYER CASES; TABLET COMPUTER CARRYING CASES; MEMORY CARD STORAGE WALLETS; WEBCAMS; USB, PRINTER, DIGITAL MEDIA AND SPEAKER HUBS; AUDIO HEADPHONES FOR COMPUTERS; CAMERA LENSES; LENS FILTERS; CHIP, ELECTRONIC, SD AND FLASH

CLASS 9—(Continued).

CARD READERS; CAMERA TRIPODS; DISPLAY PROTECTOR TO PROVIDE SHADE AND PRIVACY FOR ELECTRONIC DEVICES HAVING SCREENS; AUDIO HEADPHONES; EAR BUDS; TABLET COMPUTER CARRYING CASES; ELECTRONIC BOOK READER CARRYING CASES; PORTABLE MEDIA STORAGE CASES, NAMELY, USB FLASH DRIVE STORAGE CASES; COMPUTER KEYBOARDS; MICROPHONES FOR COMPUTERS; COMPUTER MICE; POWER INVERTERS; AUDIO SPEAKERS FOR COMPUTERS; STANDS FOR HANDHELD ELECTRICAL DEVICES, NAMELY, CELL PHONES, SMART PHONES AND TABLETS; WIRELESS CHARGING APPLIANCE FOR RECHARGEABLE EQUIPMENT; BLANK MEDIA, NAMELY, BLANK RECORDABLE CDS, CD-RS, DVDS AND DVD-RS; CASES FOR BLANK DIGITAL STORAGE MEDIA; SLEEVES FOR BLANK DIGITAL STORAGE MEDIA; BAGS FOR PHOTOGRAPHIC EQUIPMENT, SPECIALTY HOLSTERS FOR CARRYING CELLULAR TELEPHONE CASES, SPECIALTY HOLSTERS FOR CARRYING PDAS (U.S. CLS. 21, 23, 26, 36 AND 38).

GINA FINK, EXAMINING ATTORNEY

SN 85-537,052. NELSON IRRIGATION CORPORATION, WALLA WALLA, WA. FILED 2-8-2012.

TWIG

THE MARK CONSISTS OF STANDARD CHARACTERS WITHOUT CLAIM TO ANY PARTICULAR FONT, STYLE, SIZE, OR COLOR.

FOR WIRELESS MODULE FOR USE WITH AUTOMATED CONTROLS FOR IRRIGATION SYSTEMS (U.S. CLS. 21, 23, 26, 36 AND 38).

KEVIN DINALLO, EXAMINING ATTORNEY

SN 85-537,105. JERRY LEIGH OF CALIFORNIA, INC., VAN NUYS, CA. FILED 2-8-2012.

INSOUND

THE MARK CONSISTS OF STANDARD CHARACTERS WITHOUT CLAIM TO ANY PARTICULAR FONT, STYLE, SIZE, OR COLOR.

OWNER OF U.S. REG. NO. 3,905,575.

FOR AUDIO HEADPHONES, AUDIO SPEAKERS, EAR BUDS, EARPHONES AND HEADPHONES, HEADPHONES INCLUDING ATTACHED LANYARD, ELECTRONIC AUDIO CIRCUITS (U.S. CLS. 21, 23, 26, 36 AND 38).

FIRST USE 9-30-2010; IN COMMERCE 9-30-2010.

KATHRYN COWARD, EXAMINING ATTORNEY

CLASS 9—(Continued).

SN 85-537,130. GID DEVELOPMENT CORP., DBA BODY-DOCK.COM, YORBA LINDA, CA. FILED 2-8-2012.

Find your sweet spot!

THE MARK CONSISTS OF THE WORDS "FIND YOUR SWEET SPOT" WITH AN EXCLAMATION POINT AT THE END. THE O IN "SPOT" IS A TARGET.

FOR DOCKING MECHANISMS FOR MOBILE DEVICES, NAMELY MAGNETIC DOCKING MECHANISM FOR MOBILE PHONES, PORTABLE MUSIC PLAYERS, AND PORTABLE TABLETS (U.S. CLS. 21, 23, 26, 36 AND 38).

FIRST USE 12-14-2011; IN COMMERCE 12-14-2011.
JOHN WILKE, EXAMINING ATTORNEY

CLASS 9—(Continued).

SN 85-537,299. DREW TECHNOLOGIES, INC., ANN ARBOR, MI. FILED 2-8-2012.

Flasher-PRO

THE MARK CONSISTS OF STANDARD CHARACTERS WITHOUT CLAIM TO ANY PARTICULAR FONT, STYLE, SIZE, OR COLOR.

FOR VEHICLE DIAGNOSTIC APPARATUS, NAMELY COMPUTERS FOR USE IN DIAGNOSING VEHICLE MECHANICAL AND ELECTRICAL PROBLEMS (U.S. CLS. 21, 23, 26, 36 AND 38).

FIRST USE 3-26-2008; IN COMMERCE 3-26-2008.
MATTHEW KLINE, EXAMINING ATTORNEY

SN 85-537,222. IBUTTONLINK, LLC., EAST TROY, WI. FILED 2-8-2012.

T-Sense

THE MARK CONSISTS OF STANDARD CHARACTERS WITHOUT CLAIM TO ANY PARTICULAR FONT, STYLE, SIZE, OR COLOR.

FOR TEMPERATURE SENSORS (U.S. CLS. 21, 23, 26, 36 AND 38).

FIRST USE 11-19-2007; IN COMMERCE 11-19-2007.
EMILY CARLSEN, EXAMINING ATTORNEY

SN 85-537,224. WANCA, FRANK M, KIHEI, HI. FILED 2-8-2012.

NeuroMix

THE MARK CONSISTS OF STANDARD CHARACTERS WITHOUT CLAIM TO ANY PARTICULAR FONT, STYLE, SIZE, OR COLOR.

FOR COMPUTER APPLICATION SOFTWARE FOR MOBILE PHONES, NAMELY, SOFTWARE FOR NEURAL STIMULATION INTEGRATION; COMPUTER APPLICATION SOFTWARE FOR NEURAL STIMULATION, NAMELY, SOFTWARE FOR NEURAL STIMULATION INTEGRATION (U.S. CLS. 21, 23, 26, 36 AND 38).

FIRST USE 12-1-2011; IN COMMERCE 1-15-2012.
HANNO RITTNER, EXAMINING ATTORNEY

SN 85-537,344. KNIGHT-WILLIAMS, NATASHA P., CAMBRIA HEIGHTS, NY. FILED 2-8-2012.

Frequency Fusion

THE MARK CONSISTS OF STANDARD CHARACTERS WITHOUT CLAIM TO ANY PARTICULAR FONT, STYLE, SIZE, OR COLOR.

FOR AUDIO AND VIDEO RECORDINGS FEATURING MUSIC AND ARTISTIC PERFORMANCES (U.S. CLS. 21, 23, 26, 36 AND 38).

JULIE GUTTADAURO, EXAMINING ATTORNEY

SN 85-537,446. CRAY INC., SEATTLE, MN. FILED 2-8-2012.

YARCDATA

THE MARK CONSISTS OF STANDARD CHARACTERS WITHOUT CLAIM TO ANY PARTICULAR FONT, STYLE, SIZE, OR COLOR.

FOR COMPUTER HARDWARE (U.S. CLS. 21, 23, 26, 36 AND 38).

JENNIFER MARTIN, EXAMINING ATTORNEY

CLASS 9—(Continued).

SN 85-537,551. INFOGLIDE SOFTWARE CORPORATION, AUSTIN, TX. FILED 2-8-2012.

I-BIRDS

THE MARK CONSISTS OF STANDARD CHARACTERS WITHOUT CLAIM TO ANY PARTICULAR FONT, STYLE, SIZE, OR COLOR.

FOR COMPUTER SOFTWARE, NAMELY SECURE, DATA-PRIVACY COMPLIANT, COLLABORATIVE, AND AUTOMATED SOFTWARE TO SEARCH FOR AND VERIFY PERSONS OF INTEREST (U.S. CLS. 21, 23, 26, 36 AND 38).

WILLIAM BRECKENFELD, EXAMINING ATTORNEY

SN 85-537,832. PEACH COBBLER SYSTEM DESIGNS LLC, DBA PEACH COBBLER SYSTEMS, SURFSIDE BEACH, SC. FILED 2-9-2012.

WeGottaGo

THE MARK CONSISTS OF STANDARD CHARACTERS WITHOUT CLAIM TO ANY PARTICULAR FONT, STYLE, SIZE, OR COLOR.

FOR DATA PROCESSORS (U.S. CLS. 21, 23, 26, 36 AND 38).

VIVIAN MICZNIK FIRST, EXAMINING ATTORNEY

SN 85-537,905. TEAMOF2, INC., SAN JOSE, CA. FILED 2-9-2012.

LivingOrganized

THE MARK CONSISTS OF STANDARD CHARACTERS WITHOUT CLAIM TO ANY PARTICULAR FONT, STYLE, SIZE, OR COLOR.

FOR COMPUTER APPLICATION SOFTWARE FOR MOBILE PHONES, NAMELY, A SOFTWARE-BASED POWERFUL PERSONAL ORGANIZER THAT SECURELY MANAGES DAY-TO-DAY INFORMATION, CREATES PARTNERSHIPS, AND ENABLES SELECTIVE SHARING OF THE INFORMATION ACROSS THOSE PARTNERSHIPS (U.S. CLS. 21, 23, 26, 36 AND 38).

WILLIAM VERHOSEK, EXAMINING ATTORNEY

CLASS 9—(Continued).

SN 85-537,997. BRITE CASE LLC, TEMPE, AZ. FILED 2-9-2012.

Clip-Its

THE MARK CONSISTS OF STANDARD CHARACTERS WITHOUT CLAIM TO ANY PARTICULAR FONT, STYLE, SIZE, OR COLOR.

FOR PROTECTIVE COVERS AND CASES FOR CELL PHONES, LAPTOPS AND PORTABLE MEDIA PLAYERS (U.S. CLS. 21, 23, 26, 36 AND 38).

KEVEN MITTLER, EXAMINING ATTORNEY

SN 85-538,082. WOWWEE GROUP LIMITED, KOWLOON, HONG KONG, FILED 2-9-2012.

AKODOMON

THE MARK CONSISTS OF STANDARD CHARACTERS WITHOUT CLAIM TO ANY PARTICULAR FONT, STYLE, SIZE, OR COLOR.

FOR COMPUTER APPLICATION SOFTWARE FOR MOBILE PHONES, PORTABLE MEDIA PLAYERS, AND TABLET COMPUTERS, NAMELY, SOFTWARE FOR PLAYING AUGMENTED REALITY GAMES, AND SOFTWARE FOR PLAYING AUGMENTED REALITY GAMES IN CONJUNCTION WITH TOY FIGURES AND ACCESSORIES THEREFORE (U.S. CLS. 21, 23, 26, 36 AND 38).

SUNG IN, EXAMINING ATTORNEY

SN 85-538,084. WOWWEE GROUP LIMITED, KOWLOON, HONG KONG, FILED 2-9-2012.

ELITE COMMANDAR

THE MARK CONSISTS OF STANDARD CHARACTERS WITHOUT CLAIM TO ANY PARTICULAR FONT, STYLE, SIZE, OR COLOR.

FOR COMPUTER APPLICATION SOFTWARE FOR MOBILE PHONES AND PORTABLE MEDIA PLAYERS, NAMELY, SOFTWARE FOR PLAYING AUGMENTED REALITY GAMES, AND SOFTWARE FOR PLAYING AUGMENTED REALITY GAMES IN CONJUNCTION WITH TOY WEAPONS AND CONTROLLERS (U.S. CLS. 21, 23, 26, 36 AND 38).

SUNG IN, EXAMINING ATTORNEY

CLASS 9—(Continued).

SN 85-538,112. 1337 GAME DESIGN AB, GOTHENBURG, SWEDEN, FILED 2-9-2012.

Devil's attorney

THE MARK CONSISTS OF STANDARD CHARACTERS WITHOUT CLAIM TO ANY PARTICULAR FONT, STYLE, SIZE, OR COLOR.

FOR COMPUTER GAME SOFTWARE (U.S. CLS. 21, 23, 26, 36 AND 38).

FIRST USE 5-30-2011; IN COMMERCE 5-30-2011.

ANGELA DUONG, EXAMINING ATTORNEY

SN 85-538,128. WOWWEE GROUP LIMITED, KOWLOON, HONG KONG, FILED 2-9-2012.

ZOMBIE BURBZ

THE MARK CONSISTS OF STANDARD CHARACTERS WITHOUT CLAIM TO ANY PARTICULAR FONT, STYLE, SIZE, OR COLOR.

FOR COMPUTER APPLICATION SOFTWARE FOR MOBILE PHONES, PORTABLE MEDIA PLAYERS, AND TABLET COMPUTERS, NAMELY, SOFTWARE FOR PLAYING AUGMENTED REALITY GAMES, AND SOFTWARE FOR PLAYING AUGMENTED REALITY GAMES IN CONJUNCTION WITH TOY FIGURES AND CONTROLLERS (U.S. CLS. 21, 23, 26, 36 AND 38).

SUNG IN, EXAMINING ATTORNEY

SN 85-538,155. WOWWEE GROUP LIMITED, KOWLOON, HONG KONG, FILED 2-9-2012.

MYSTERIOUS RAYGUN

THE MARK CONSISTS OF STANDARD CHARACTERS WITHOUT CLAIM TO ANY PARTICULAR FONT, STYLE, SIZE, OR COLOR.

FOR COMPUTER APPLICATION SOFTWARE FOR MOBILE PHONES, PORTABLE MEDIA PLAYERS, AND TABLET COMPUTERS, NAMELY, SOFTWARE FOR PLAYING AUGMENTED REALITY GAMES, AND SOFTWARE FOR PLAYING AUGMENTED REALITY GAMES IN CONJUNCTION WITH A GAME CONTROLLER CONTAINING INTERCHANGEABLE PARTS (U.S. CLS. 21, 23, 26, 36 AND 38).

SUNG IN, EXAMINING ATTORNEY

CLASS 9—(Continued).

SN 85-538,170. WOWWEE GROUP LIMITED, KOWLOON, HONG KONG, FILED 2-9-2012.

FOAM FIGHTERS

THE MARK CONSISTS OF STANDARD CHARACTERS WITHOUT CLAIM TO ANY PARTICULAR FONT, STYLE, SIZE, OR COLOR.

FOR COMPUTER APPLICATION SOFTWARE FOR MOBILE PHONES, PORTABLE MEDIA PLAYERS, AND TABLET COMPUTERS, NAMELY, SOFTWARE FOR PLAYING AUGMENTED REALITY GAMES, AND SOFTWARE FOR PLAYING AUGMENTED REALITY GAMES IN CONJUNCTION WITH TOY AIRPLANES AND MOUNTING HARDWARE (U.S. CLS. 21, 23, 26, 36 AND 38).

SUNG IN, EXAMINING ATTORNEY

SN 85-538,187. WOWWEE GROUP LIMITED, KOWLOON, HONG KONG, FILED 2-9-2012.

ALIEN JAILBREAK

THE MARK CONSISTS OF STANDARD CHARACTERS WITHOUT CLAIM TO ANY PARTICULAR FONT, STYLE, SIZE, OR COLOR.

FOR COMPUTER APPLICATION SOFTWARE FOR MOBILE PHONES, PORTABLE MEDIA PLAYERS, AND TABLET COMPUTERS, NAMELY, SOFTWARE FOR PLAYING AUGMENTED REALITY GAMES, AND SOFTWARE FOR PLAYING AUGMENTED REALITY GAMES IN CONJUNCTION WITH FIGURES AND PLAY ACCESSORIES (U.S. CLS. 21, 23, 26, 36 AND 38).

SUNG IN, EXAMINING ATTORNEY

SN 85-538,299. SHELFX, INC., BOULDER, CO. FILED 2-9-2012.

THE COLOR(S) BLACK AND BLUE IS/ARE CLAIMED AS A FEATURE OF THE MARK.

THE MARK CONSISTS OF THE WORD "SHELF" WRITTEN IN BLACK LOWER CASE LETTERS AND THE LETTER "X" IS WRITTEN IN BLUE. BELOW THE MARK IS THE FADING MIRROR IMAGE OF THE WORD "SHELFX" WRITTEN IN BLACK.

FOR ELECTRONIC SCALES (U.S. CLS. 21, 23, 26, 36 AND 38).

LINDA MICKLEBURGH, EXAMINING ATTORNEY

CLASS 9—(Continued).

SN 85-538,311. VIRTUAL HOLD TECHNOLOGY, LLC, AKRON, OH. FILED 2-9-2012.

CONVERSATION BRIDGE

THE MARK CONSISTS OF STANDARD CHARACTERS WITHOUT CLAIM TO ANY PARTICULAR FONT, STYLE, SIZE, OR COLOR.

FOR SOFTWARE FOR USE IN MANAGING AND CONNECTING CUSTOMERS USING SELF-SERVICE ON THE INTERNET, MOBILE COMMUNICATIONS, AND SOCIAL OR VOICE CHANNELS, TO THE APPROPRIATE INTERNAL RESOURCE IN A COMPANY WHO CAN MOST IMMEDIATELY HELP THAT CUSTOMER BY IDENTIFYING AND COORDINATING QUEUE POSITION AND COMMUNICATION ROUTING (U.S. CLS. 21, 23, 26, 36 AND 38).

FIRST USE 5-1-2012; IN COMMERCE 5-1-2012.
FRANK LATTUCA, EXAMINING ATTORNEY

SN 85-538,359. TREESTAR INC., ASHLAND, OR. FILED 2-9-2012.

FlowJo

THE MARK CONSISTS OF STANDARD CHARACTERS WITHOUT CLAIM TO ANY PARTICULAR FONT, STYLE, SIZE, OR COLOR.

FOR COMPUTER SOFTWARE PLATFORMS FOR THE ANALYSIS OF FLOW CYTOMETRY DATA (U.S. CLS. 21, 23, 26, 36 AND 38).

FIRST USE 7-1-1994; IN COMMERCE 6-1-1995.
KAREN SEVERSON, EXAMINING ATTORNEY

SN 85-538,379. PATH MEDIA HOLDINGS, LLC, CHARLESTOWN, ST. KITTS-NEVIS, FILED 2-9-2012.

GGW

THE MARK CONSISTS OF STANDARD CHARACTERS WITHOUT CLAIM TO ANY PARTICULAR FONT, STYLE, SIZE, OR COLOR.

FOR PRERECORDED VIDEOTAPES FEATURING ADULT ENTERTAINMENT (U.S. CLS. 21, 23, 26, 36 AND 38).

SUSAN LESLIE DUBOIS, EXAMINING ATTORNEY

CLASS 9—(Continued).

SN 85-538,558. ACME ENGINEERING & MANUFACTURING CORPORATION, MUSKOGEE, OK. FILED 2-9-2012.

KOOLMASTER

THE MARK CONSISTS OF STANDARD CHARACTERS WITHOUT CLAIM TO ANY PARTICULAR FONT, STYLE, SIZE, OR COLOR.

FOR CONTROL UNITS FOR REGULATING ENVIRONMENTAL CONDITIONS WITHIN HORTICULTURAL/AGRICULTURAL INSTALLATIONS (U.S. CLS. 21, 23, 26, 36 AND 38).

FIRST USE 12-11-2002; IN COMMERCE 12-11-2002.
YAT SYE, LEE, EXAMINING ATTORNEY

SN 85-538,600. INDUSTRIAL TOYBOX LLC, CHICAGO, IL. FILED 2-9-2012.

Industrial Toybox

THE MARK CONSISTS OF STANDARD CHARACTERS WITHOUT CLAIM TO ANY PARTICULAR FONT, STYLE, SIZE, OR COLOR.

FOR COMPUTER APPLICATION SOFTWARE FOR MOBILE PHONES, TABLETS, AND OTHER PORTABLE ELECTRONIC DEVICES, NAMELY, SOFTWARE FOR EDUCATION, ENTERTAINMENT, GAMES, ORGANIZATION, AND BUSINESS FUNCTIONS (U.S. CLS. 21, 23, 26, 36 AND 38).

LINDA MICKLEBURGH, EXAMINING ATTORNEY

SN 85-538,608. INDUSTRIAL TOYBOX LLC, CHICAGO, IL. FILED 2-9-2012.

Industrial Toys

THE MARK CONSISTS OF STANDARD CHARACTERS WITHOUT CLAIM TO ANY PARTICULAR FONT, STYLE, SIZE, OR COLOR.

FOR COMPUTER APPLICATION SOFTWARE FOR MOBILE PHONES, TABLETS, AND OTHER PORTABLE ELECTRONIC DEVICES, NAMELY, SOFTWARE FOR EDUCATION, ENTERTAINMENT, GAMES, ORGANIZATION, AND BUSINESS FUNCTIONS (U.S. CLS. 21, 23, 26, 36 AND 38).

LINDA MICKLEBURGH, EXAMINING ATTORNEY

CLASS 9—(Continued).

SN 85-538,847. ARSENALE SYSTEMS INC., CORTE MADERA, CA. FILED 2-9-2012.

ARSENALE

THE MARK CONSISTS OF STANDARD CHARACTERS WITHOUT CLAIM TO ANY PARTICULAR FONT, STYLE, SIZE, OR COLOR.

THE ENGLISH TRANSLATION OF "ARSENALE" IN THE MARK IS "DOCKYARD", "ARESNAL", "ARMORY".

FOR COMPUTER APPLICATION SOFTWARE FOR MOBILE PHONES, NAMELY, SOFTWARE FOR USE IN EDITING OF DATA AND FILES; COMPUTER APPLICATION SOFTWARE FOR COMPUTERS AND HANDHELD COMPUTERS, NAMELY, SOFTWARE FOR USE IN EDITING OF DATA AND FILES; COMPUTER PROGRAMS FOR PRIORITIZING, ASSIGNING, TRACKING, REPORTING AND AUDITING ISSUES RELATING TO BUSINESS INFORMATION TECHNOLOGY; COMPUTER SOFTWARE DEVELOPMENT TOOLS; COMPUTER SOFTWARE FOR CONTROLLING AND MANAGING ACCESS SERVER APPLICATIONS; COMPUTER SOFTWARE FOR MANIPULATION OF ELECTRONIC DATA; COMPUTER SOFTWARE FOR THE COLLECTION, EDITING, ORGANIZING, MODIFYING, BOOK MARKING, TRANSMISSION, STORAGE, AND SHARING OF DATA AND INFORMATION; COMPUTER SOFTWARE FOR THE COLLECTION, EDITING, ORGANIZING, MODIFYING, BOOK MARKING, TRANSMISSION, STORAGE, AND SHARING OF DATA AND INFORMATION THAT MAY BE DOWNLOADED FROM A GLOBAL COMPUTER NETWORK; DOWNLOADABLE COMPUTER SOFTWARE FOR EDITING DATA AND FILES; DOWNLOADABLE COMPUTER SOFTWARE FOR PRIORITIZING, ASSIGNING, TRACKING, REPORTING AND AUDITING ISSUES RELATING TO BUSINESS INFORMATION TECHNOLOGY; CREATING AND SHARING ELECTRONIC PAGES, DOCUMENTS AND RICH CONTENT WITH OTHER USERS; DOWNLOADABLE COMPUTER SOFTWARE FOR MANIPULATION OF ELECTRONIC DATA; DOWNLOADABLE ELECTRONIC PUBLICATIONS IN THE NATURE OF MANUALS, BROCHURES, NEWSLETTERS, TECHNICAL DATA SHEETS AND PRODUCT SPECIFICATIONS SHEETS IN THE FIELD OF COMPUTER SOFTWARE PROGRAMS AND APPLICATIONS, SUPPLIED ONLINE; DOWNLOADABLE SOFTWARE IN THE NATURE OF A MOBILE APPLICATION FOR MANIPULATION OF ELECTRONIC DATA; ELECTRONIC SOFTWARE UPDATES, NAMELY, DOWNLOADABLE COMPUTER SOFTWARE AND ASSOCIATED DATA FILES FOR UPDATING COMPUTER SOFTWARE IN THE FIELDS OF EDITING OF DATA, MANIPULATION OF DATA, PROVIDED VIA COMPUTER AND COMMUNICATION NETWORKS; ELECTRONIC PUBLICATIONS, NAMELY, NEWSLETTERS FEATURING INFORMATION IN THE FIELD OF COMPUTER SOFTWARE PROGRAMS AND APPLICATIONS RECORDED ON COMPUTER MEDIA; PRE-RECORDED ELECTRONIC MEDIA FEATURING MANUALS, BROCHURES, NEWSLETTERS, TECHNICAL DATA SHEETS AND PRODUCT SPECIFICATIONS, IN THE FIELD OF BUSINESS INFORMATION TECHNOLOGY (U.S. CLS. 21, 23, 26, 36 AND 38).

FIRST USE 2-1-2011; IN COMMERCE 2-15-2011.
ZACHARY BELLO, EXAMINING ATTORNEY

CLASS 9—(Continued).

SN 85-538,863. JEFFREY C TAYLOR, NEWPORT BEACH, CA. FILED 2-9-2012.

MORBID

THE MARK CONSISTS OF STANDARD CHARACTERS WITHOUT CLAIM TO ANY PARTICULAR FONT, STYLE, SIZE, OR COLOR.

FOR CASES FOR SPECTACLES AND SUNGLASSES; FRAMES FOR SPECTACLES AND SUNGLASSES; SUNGLASSES AND SPECTACLES (U.S. CLS. 21, 23, 26, 36 AND 38).

MICHAEL WIENER, EXAMINING ATTORNEY

SN 85-538,931. R. A. PHILLIPS INDUSTRIES, INC., SANTA FE SPRINGS, CA. FILED 2-9-2012.

STA-DRY TRACKER

THE MARK CONSISTS OF STANDARD CHARACTERS WITHOUT CLAIM TO ANY PARTICULAR FONT, STYLE, SIZE, OR COLOR.

OWNER OF U.S. REG. NO. 1,889,719.

FOR ELECTRICAL CONNECTORS FOR TRUCK TRACTORS AND TRAILERS; ELECTRICAL SOCKETS FOR TRUCK TRACTORS AND TRAILERS (U.S. CLS. 21, 23, 26, 36 AND 38).

BARBARA A. GOLD, EXAMINING ATTORNEY

CLASS 9—(Continued).

SN 85-539,023. WANG, HEQIU, CUPERTINO, CA. FILED 2-10-2012.



THE MARK CONSISTS OF THE WORD "ASPOWER" AND A TRAPEZIUM ATOP WHEREAS THE TRAPEZIUM IS SEPARATED BY A LIGHTNING SYMBOL.

THE WORDING "ASPOWER" HAS NO MEANING IN A FOREIGN LANGUAGE.

FOR ADAPTERS; APPARATUS AND INSTRUMENTS FOR CONVEYING, DISTRIBUTING, TRANSFORMING, STORING, REGULATING OR CONTROLLING ELECTRIC CURRENT; BATTERY CHARGERS; COMPUTER PERIPHERAL DEVICES; ELECTRONIC APPARATUS FOR THE REMOTE CONTROL OF INDUSTRIAL OPERATIONS; ELECTRONIC MONITORS AND MONITOR MODULES FOR MONITORING ELECTRIC CURRENT AND ELECTRICAL SIGNALS; ELECTRONIC TEST AND MEASUREMENT DEVICES FOR USE IN THE FIELDS OF NETWORKS AND TELECOMMUNICATIONS, NAMELY, INSTRUMENTATION USED TO TEST AND CERTIFY NEW AND EXISTING DATA AND VOICE COMMUNICATION CABLE AND COAXIAL CABLE; OPTICAL COMMUNICATIONS SYSTEMS COMPRISED OF OPTICAL AND ELECTRONIC HARDWARE AND COMPUTER SOFTWARE FOR THE TRANSMISSION OF DATA BETWEEN TWO POINTS; POWER INVERTERS; POWER SUPPLIES (U.S. CLS. 21, 23, 26, 36 AND 38).

FIRST USE 4-17-2011; IN COMMERCE 12-23-2011.
INGA ERVIN, EXAMINING ATTORNEY

CLASS 9—(Continued).

SN 85-539,028. FLIPMODE GAMES LTD, SWANSEA, UNITED KINGDOM, FILED 2-10-2012.

FINGA NINJA

THE MARK CONSISTS OF STANDARD CHARACTERS WITHOUT CLAIM TO ANY PARTICULAR FONT, STYLE, SIZE, OR COLOR.

FOR COMPUTER GAME PROGRAMMES; COMPUTER GAME PROGRAMMES DOWNLOADABLE VIA THE INTERNET; COMPUTER GAME PROGRAMS; COMPUTER GAME SOFTWARE; COMPUTER GAME SOFTWARE DOWNLOADABLE FROM A GLOBAL COMPUTER NETWORK; COMPUTER GAME SOFTWARE FOR PERSONAL COMPUTERS AND HOME VIDEO GAME CONSOLES; COMPUTER GAME SOFTWARE FOR USE ON MOBILE AND CELLULAR PHONES; COMPUTER GAME SOFTWARE FOR USE WITH PERSONAL COMPUTERS, HOME VIDEO GAME CONSOLES USED WITH TELEVISIONS AND ARCADE-BASED VIDEO GAME CONSOLES; COMPUTER PROGRAMS FOR VIDEO AND COMPUTER GAMES; COMPUTER SOFTWARE AND FIRMWARE FOR GAMES OF CHANCE ON ANY COMPUTERIZED PLATFORM, INCLUDING DEDICATED GAMING CONSOLES, VIDEO BASED SLOT MACHINES, REEL BASED SLOT MACHINES, AND VIDEO LOTTERY TERMINALS; DOWNLOADABLE COMPUTER GAME PROGRAMS; DOWNLOADABLE COMPUTER GAME SOFTWARE VIA A GLOBAL COMPUTER NETWORK AND WIRELESS DEVICES; DOWNLOADABLE ELECTRONIC GAME PROGRAMS; ELECTRONIC GAME PROGRAMS; ELECTRONIC GAME SOFTWARE; ELECTRONIC GAME SOFTWARE FOR CELLULAR TELEPHONES; ELECTRONIC GAME SOFTWARE FOR HANDHELD ELECTRONIC DEVICES; ELECTRONIC GAME SOFTWARE FOR WIRELESS DEVICES; GAME SOFTWARE; INTERACTIVE GAME PROGRAMS; INTERACTIVE GAME SOFTWARE; INTERACTIVE MULTIMEDIA COMPUTER GAME PROGRAM; VIDEO AND COMPUTER GAME PROGRAMS (U.S. CLS. 21, 23, 26, 36 AND 38).

CHARLES L. JENKINS, EXAMINING ATTORNEY

SN 85-539,142. DAVIDS, PAUL JEFFREY, LOS ANGELES, CA. FILED 2-10-2012.

PROFESSOR HACK HARDDRIVES

THE MARK CONSISTS OF STANDARD CHARACTERS WITHOUT CLAIM TO ANY PARTICULAR FONT, STYLE, SIZE, OR COLOR.

FOR DIGITAL MEDIA, NAMELY, CDS, DVDS, AND DOWNLOADABLE AUDIO FILES FEATURING MUSIC, DOWNLOADABLE BOOKS FEATURING FICTIONAL STORIES, POETRY, HUMOR, AND DRAWINGS (U.S. CLS. 21, 23, 26, 36 AND 38).

FIRST USE 9-16-2011; IN COMMERCE 9-22-2011.
JULIE WATSON, EXAMINING ATTORNEY

CLASS 9—(Continued).

SN 85-539,199. SPOC AUTOMATION, INC., TRUSSVILLE, AL. FILED 2-10-2012.

Well-Insight

THE MARK CONSISTS OF STANDARD CHARACTERS WITHOUT CLAIM TO ANY PARTICULAR FONT, STYLE, SIZE, OR COLOR.

FOR SOFTWARE FOR REMOTE MONITORING AND CONTROL OF ARTIFICIAL LIFT CONTROLS AND PUMPING EQUIPMENT USED IN THE OIL AND GAS INDUSTRY (U.S. CLS. 21, 23, 26, 36 AND 38).
SUSAN STIGLITZ, EXAMINING ATTORNEY

CLASS 9—(Continued).

SN 85-539,566. DOCTOR'S ASSOCIATES INC., MILFORD, CT. FILED 2-10-2012.

SUBWAY POS

THE MARK CONSISTS OF STANDARD CHARACTERS WITHOUT CLAIM TO ANY PARTICULAR FONT, STYLE, SIZE, OR COLOR.

NO CLAIM IS MADE TO THE EXCLUSIVE RIGHT TO USE "POS", APART FROM THE MARK AS SHOWN.
FOR COMPUTER SOFTWARE FOR BUSINESS MANAGEMENT AND OFFICE AUTOMATION (U.S. CLS. 21, 23, 26, 36 AND 38).
FIRST USE 9-14-2011; IN COMMERCE 9-14-2011.
TARAH HARDY, EXAMINING ATTORNEY

SN 85-539,471. ROSS, CLIFFORD, NEW YORK, NY. FILED 2-10-2012.

i3

THE MARK CONSISTS OF STANDARD CHARACTERS WITHOUT CLAIM TO ANY PARTICULAR FONT, STYLE, SIZE, OR COLOR.

FOR CYCLORAMA, NAMELY, A CYLINDRICAL PANORAMIC VIDEO SCREEN USED TO PROVIDE THE VIEWER A 360° VIEW OF IMAGERY AND SOUND (U.S. CLS. 21, 23, 26, 36 AND 38).
ALEX KEAM, EXAMINING ATTORNEY

SN 85-539,602. SAYRES TECHNOLOGY LLC, SEATTLE, WA. FILED 2-10-2012.

CloudGiraffe

THE MARK CONSISTS OF STANDARD CHARACTERS WITHOUT CLAIM TO ANY PARTICULAR FONT, STYLE, SIZE, OR COLOR.

FOR COMPUTER SOFTWARE FOR MANAGING AND MONITORING CLOUD COMPUTING RESOURCES (U.S. CLS. 21, 23, 26, 36 AND 38).
LAKEISHA LEWIS, EXAMINING ATTORNEY

SN 85-539,519. CONTINENTAL DISC CORPORATION, LIBERTY, MO. FILED 2-10-2012.

BDI-FLX

THE MARK CONSISTS OF STANDARD CHARACTERS WITHOUT CLAIM TO ANY PARTICULAR FONT, STYLE, SIZE, OR COLOR.

OWNER OF U.S. REG. NO. 1,220,670.
FOR ELECTRONIC MONITORING DEVICES FOR MONITORING THE PHYSICAL CONDITION OF PRESSURE RELIEF RUPTURE DISCS IN GAS AND LIQUID PIPES (U.S. CLS. 21, 23, 26, 36 AND 38).
CHRISTINA SOBRAL, EXAMINING ATTORNEY

SN 85-539,712. BRUHA ROBOTICS, INC., TRABUCO CANYON, CA. FILED 2-10-2012.

ScanBot

THE MARK CONSISTS OF STANDARD CHARACTERS WITHOUT CLAIM TO ANY PARTICULAR FONT, STYLE, SIZE, OR COLOR.

FOR LASER SCANNERS FOR INDUSTRIAL INSPECTION; SCANNERS (U.S. CLS. 21, 23, 26, 36 AND 38).
FIRST USE 2-10-2012; IN COMMERCE 2-10-2012.
DAVID I, EXAMINING ATTORNEY

CLASS 9—(Continued).

SN 85-539,778. GENERAL ELECTRIC COMPANY, SCHE-
NECTADY, NY. FILED 2-10-2012.

AWARE

THE MARK CONSISTS OF STANDARD CHARACTERS
WITHOUT CLAIM TO ANY PARTICULAR FONT, STYLE,
SIZE, OR COLOR.

FOR INDOOR AND OUTDOOR PHOTOCCELL SEN-
SORS; INDOOR OCCUPANCY SENSORS; OUTDOOR
MOTION SENSORS (U.S. CLS. 21, 23, 26, 36 AND 38).
FRANK LATTUCA, EXAMINING ATTORNEY

SN 85-539,847. QUADRIVIO CORPORATION, BERKELEY,
CA. FILED 2-10-2012.

NOTA PLEX

THE MARK CONSISTS OF STANDARD CHARACTERS
WITHOUT CLAIM TO ANY PARTICULAR FONT, STYLE,
SIZE, OR COLOR.

FOR COMPUTER SOFTWARE FOR THE COLLEC-
TION, EDITING, ORGANIZING, MODIFYING, BOOK
MARKING, TRANSMISSION, STORAGE AND SHARING
OF DATA AND INFORMATION (U.S. CLS. 21, 23, 26, 36
AND 38).

CATHERINE ROEHL, EXAMINING ATTORNEY

SN 85-539,872. SYSTRONIX, INC., SALT LAKE CITY, UT.
FILED 2-10-2012.

SYSTRONIX

THE MARK CONSISTS OF STANDARD CHARACTERS
WITHOUT CLAIM TO ANY PARTICULAR FONT, STYLE,
SIZE, OR COLOR.

OWNER OF U.S. REG. NO. 1,739,552.
FOR COMPUTER HARDWARE AND INDUSTRIAL
CONTROL SYSTEMS, NAMELY, EMBEDDED CON-
TROL SYSTEMS, RAPID DEVELOPMENT HARDWARE
FOR EMBEDDED CONTROL SYSTEMS AND CUS-
TOMIZED OEM CONTROL SYSTEMS, EMBEDDED CON-
TROL OEM SYSTEMS, EXPANSION BOARDS
INCLUDING MEZZANINE BOARDS, READY-TO-USE
ENCLOSURES, KEYPADS, LCDS, CABLES, SOCKET
ADAPTERS TO ALLOW USE OF A CONTROLLER WITH
A DIFFERING SOCKET, AND PROGRAMMERS FOR
MICROPROCESSORS, ALL SOLD PRIMARILY VIA DI-
RECT SALES TO USERS (U.S. CLS. 21, 23, 26, 36 AND 38).
FIRST USE 0-0-1990; IN COMMERCE 0-0-1990.

CHRIS WELLS, EXAMINING ATTORNEY

CLASS 9—(Continued).

SN 85-539,959. MONSTER, INC., BRISBANE, CA. FILED 2-11-
2012.

UNLEASH THE POWER WITHIN...

THE MARK CONSISTS OF STANDARD CHARACTERS
WITHOUT CLAIM TO ANY PARTICULAR FONT, STYLE,
SIZE, OR COLOR.

FOR AUDIO SPEAKERS; ELECTRONIC DOCKING
STATIONS; HEADPHONES (U.S. CLS. 21, 23, 26, 36
AND 38).

CHRISTOPHER SIDOTI, EXAMINING ATTORNEY

SN 85-540,057. JACOBSPARTS INCORPORATED, INDIANA-
POLIS, IN. FILED 2-10-2012.

Protronix

THE MARK CONSISTS OF STANDARD CHARACTERS
WITHOUT CLAIM TO ANY PARTICULAR FONT, STYLE,
SIZE, OR COLOR.

FOR CABLE CONNECTORS; CABLES FOR OPTICAL
SIGNAL TRANSMISSION; COMPONENT VIDEO
CABLES; COMPUTER CABLES; CONNECTION CABLES;
CONSUMER ELECTRONIC PRODUCTS, NAMELY,
AUDIO AMPLIFIERS, AUDIO SPEAKERS, AUDIO RE-
CEIVERS, ELECTRICAL AUDIO AND SPEAKER
CABLES AND CONNECTORS, AUDIO DECODERS, VI-
DEO DECODERS, SPEAKERS, POWER CONVERSION
DEVICES, POWER CONVERTERS, AND POWER INVER-
TERS; ELECTRIC CHARGING CABLES; ELECTRICAL
CABLES; ELECTRICAL CABLES AND CORDSETS;
ELECTRICAL CABLES WITH INTEGRATED FITTINGS,
NAMELY, CORDSETS; ELECTRICAL INTERCONNECT
CABLES; ELECTRONIC SWITCHERS FOR AUDIO AND
VIDEO SIGNALS; EXTENSION CABLES; FIBER OPTIC
CABLES; HIGH DEFINITION MULTIMEDIA INTER-
FACE CABLES; OPTICAL CABLES; POWER CABLES;
PRINTER CABLES; STEREO CABLES; USB CABLES;
VIDEO CABLES (U.S. CLS. 21, 23, 26, 36 AND 38).

FIRST USE 12-16-2011; IN COMMERCE 12-16-2011.
FONG HSU, EXAMINING ATTORNEY

SN 85-540,082. JON ROBERT KURTZ, LOUDON, TN. FILED
2-10-2012.

EARSKINZ

THE MARK CONSISTS OF STANDARD CHARACTERS
WITHOUT CLAIM TO ANY PARTICULAR FONT, STYLE,
SIZE, OR COLOR.

FOR EARBUD COVERS FOR USE WITH AUDIO AND
AUDIO/VIDEO DEVICES; CELL PHONE COVERS; CELL
PHONE CASES (U.S. CLS. 21, 23, 26, 36 AND 38).

KIMBERLY PERRY, EXAMINING ATTORNEY

CLASS 9—(Continued).

SN 85-540,091. JON ROBERT KURTZ, LOUDON, TN. FILED 2-10-2012.



THE MARK CONSISTS OF THE WORD "EARSKINZ" IN STYLIZED WRITING. TO THE RIGHT OF THE WORD APPEARS A PICTURE OF THE BACK OF AN EARBUD TURNED UPSIDE DOWN WITH THE CORD OF THE EARBUD WRAPPING AROUND THE LEFT SIDE OF THE EARBUD AND UNDERNEATH THE EARBUD.

FOR EARBUD COVERS FOR USE WITH AUDIO AND AUDIO/VIDEO DEVICES; CELL PHONE COVERS; CELL PHONE CASES (U.S. CLS. 21, 23, 26, 36 AND 38).
KIMBERLY PERRY, EXAMINING ATTORNEY

SN 85-540,246. MONSTER, INC., BRISBANE, CA. FILED 2-11-2012.

SOUND IS LIFE

THE MARK CONSISTS OF STANDARD CHARACTERS WITHOUT CLAIM TO ANY PARTICULAR FONT, STYLE, SIZE, OR COLOR.

FOR AUDIO SPEAKERS; ELECTRONIC DOCKING STATIONS; HEADPHONES (U.S. CLS. 21, 23, 26, 36 AND 38).
CHRISTOPHER SIDOTI, EXAMINING ATTORNEY

SN 85-540,270. NEXSAN TECHNOLOGIES, INC., THOUSAND OAKS, CA. FILED 2-11-2012.

NST

THE MARK CONSISTS OF STANDARD CHARACTERS WITHOUT CLAIM TO ANY PARTICULAR FONT, STYLE, SIZE, OR COLOR.

FOR COMPUTER HARDWARE AND SOFTWARE USED FOR DATA STORAGE (U.S. CLS. 21, 23, 26, 36 AND 38).

JENNIFER MARTIN, EXAMINING ATTORNEY

CLASS 9—(Continued).

SN 85-540,302. DIZTRONIC LLC, MADISON, WI. FILED 2-11-2012.

Diztronic

THE MARK CONSISTS OF STANDARD CHARACTERS WITHOUT CLAIM TO ANY PARTICULAR FONT, STYLE, SIZE, OR COLOR.

FOR CELL PHONE CASES (U.S. CLS. 21, 23, 26, 36 AND 38).

FIRST USE 1-2-2011; IN COMMERCE 1-2-2011.

ODESSA BIBBINS, EXAMINING ATTORNEY

SN 85-540,324. CONCHI KOBE PRODUCTIONS, INC., MARIETTA, GA. FILED 2-11-2012.

DOODOO DODGER

THE MARK CONSISTS OF STANDARD CHARACTERS WITHOUT CLAIM TO ANY PARTICULAR FONT, STYLE, SIZE, OR COLOR.

FOR COMPUTER GAME SOFTWARE FOR USE ON MOBILE AND CELLULAR PHONES (U.S. CLS. 21, 23, 26, 36 AND 38).

MATTHEW PAPPAS, EXAMINING ATTORNEY

SN 85-540,334. MAY, WILLIAM THOMAS, LOCUST VALLEY, NY. FILED 2-11-2012.

limb.al

THE MARK CONSISTS OF STANDARD CHARACTERS WITHOUT CLAIM TO ANY PARTICULAR FONT, STYLE, SIZE, OR COLOR.

FOR ARMATURES FOR USE IN ELECTRICAL APPARATUS; CABLE CONNECTORS; COMPUTER CABLES; CONNECTION CABLES; ELECTRIC CHARGING CABLES; POWER CABLES; STANDS FOR PERSONAL DIGITAL ELECTRONIC DEVICES; USB CABLES (U.S. CLS. 21, 23, 26, 36 AND 38).

KIM SAITO, EXAMINING ATTORNEY

CLASS 9—(Continued).

SN 85-540,355. MENARD, DAVID SAMUEL, DBA SHAMELESS, MILLBREA, CA. FILED 2-11-2012.

ElectroShades

THE MARK CONSISTS OF STANDARD CHARACTERS WITHOUT CLAIM TO ANY PARTICULAR FONT, STYLE, SIZE, OR COLOR.

FOR EYEWEAR; EYEWEAR, NAMELY, SUNGLASSES, EYEGLASSES AND OPHTHALMIC FRAMES AND CASES THEREFOR; EYEWEAR, NAMELY, NOVELTY PARTY EYEWEAR (U.S. CLS. 21, 23, 26, 36 AND 38).

NAKIA HENRY, EXAMINING ATTORNEY

SN 85-540,412. REID, LOYLIN R. AKA L-TEE, BRAMPTON, ONTARIO, CANADA, FILED 2-12-2012.

SWAG-A-LIFE

THE MARK CONSISTS OF STANDARD CHARACTERS WITHOUT CLAIM TO ANY PARTICULAR FONT, STYLE, SIZE, OR COLOR.

FOR AUDIO AND VIDEO RECORDINGS FEATURING MUSIC AND ARTISTIC PERFORMANCES; AUDIO TAPES FEATURING MUSIC; COMPACT DISCS FEATURING MUSIC; DIGITAL MUSIC DOWNLOADABLE FROM THE INTERNET; DOWNLOADABLE MUSIC FILES; DOWNLOADABLE MUSICAL SOUND RECORDINGS; DOWNLOADABLE RING TONES, GRAPHICS AND MUSIC VIA A GLOBAL COMPUTER NETWORK AND WIRELESS DEVICES; MUSICAL RECORDINGS; MUSICAL SOUND RECORDINGS; PRERECORDED AUDIO TAPES FEATURING MUSIC (U.S. CLS. 21, 23, 26, 36 AND 38).

FIRST USE 11-6-2009; IN COMMERCE 2-25-2011.
SETH A. RAPPAPORT, EXAMINING ATTORNEY

SN 85-540,564. CROWHURST, GORDON, OSHAWA, ONTARIO, CANADA, FILED 2-12-2012.

Pic! Six!!

THE MARK CONSISTS OF STANDARD CHARACTERS WITHOUT CLAIM TO ANY PARTICULAR FONT, STYLE, SIZE, OR COLOR.

FOR DOWNLOADABLE COMPUTER GAME SOFTWARE VIA A GLOBAL COMPUTER NETWORK AND WIRELESS DEVICES (U.S. CLS. 21, 23, 26, 36 AND 38).

LINDA LAVACHE, EXAMINING ATTORNEY

CLASS 9—(Continued).

SN 85-540,676. GOEMERCHANT, LLC, FORT WORTH, TX. FILED 2-13-2012.



THE MARK CONSISTS OF A STYLIZED IMAGE OF A HUMAN HAND HOLDING A CREDIT CARD.

FOR COMPUTER APPLICATION SOFTWARE FOR MOBILE PHONES, PORTABLE ELECTRONIC DEVICES, AND WIRELESS DEVICES, NAMELY, SOFTWARE INCORPORATING AN ELECTRONIC FINANCIAL PLATFORM THAT ACCOMMODATES MULTIPLE TYPES OF PAYMENT AND DEBT TRANSACTIONS, INCLUDING USE OF VISUALIZED PAYMENT CODES AT THE POINT OF SALE (U.S. CLS. 21, 23, 26, 36 AND 38).

CHRISTINE MARTIN, EXAMINING ATTORNEY

SN 85-540,826. CYBER360, INC., OVERLAND PARK, KS. FILED 2-13-2012.



THE COLOR(S) ORANGE, LIGHT BLUE, AND DARK BLUE IS/ARE CLAIMED AS A FEATURE OF THE MARK.

THE MARK CONSISTS OF THE WORDING "SHAREAWARE", WITH "SHARE" IN ORANGE AND "AWARE" IN BLUE; TO THE LEFT OF THE WORDING IS A DESIGN COMPRISED OF AN ORANGE SQUARE WITH A DARK BLUE COMMA ATTACHED TO THE LOWER RIGHT CORNER AND A LIGHT BLUE SQUARE UNDERNEATH.

FOR COMPUTER SOFTWARE FOR OPERATING AND MONITORING A DASHBOARD FOR PARENTS TO MANAGE THEIR CHILD'S SOCIAL NETWORKING AND MOBILE PHONE USAGE (U.S. CLS. 21, 23, 26, 36 AND 38).

SHAILA SETTLES, EXAMINING ATTORNEY

CLASS 9—(Continued).

SN 85-540,841. BLUE CROSS AND BLUE SHIELD OF SOUTH CAROLINA, COLUMBIA, SC. FILED 2-13-2012.

HEALTHCORE

THE MARK CONSISTS OF STANDARD CHARACTERS WITHOUT CLAIM TO ANY PARTICULAR FONT, STYLE, SIZE, OR COLOR.

FOR COMPUTER SOFTWARE FOR HEALTH CARE BENEFITS CLAIMS PROCESSING (U.S. CLS. 21, 23, 26, 36 AND 38).

JANICE KIM, EXAMINING ATTORNEY

SN 85-540,844. BLUE CROSS AND BLUE SHIELD OF SOUTH CAROLINA, COLUMBIA, SC. FILED 2-13-2012.

HEALTHSTACK

THE MARK CONSISTS OF STANDARD CHARACTERS WITHOUT CLAIM TO ANY PARTICULAR FONT, STYLE, SIZE, OR COLOR.

FOR COMPUTER SOFTWARE FOR HEALTH CARE BENEFITS CLAIMS PROCESSING (U.S. CLS. 21, 23, 26, 36 AND 38).

JANICE KIM, EXAMINING ATTORNEY

SN 85-540,867. GRADUS GROUP LLC, NEW YORK, NY. FILED 2-13-2012.

MAKE A BETTER PICTURE

THE MARK CONSISTS OF STANDARD CHARACTERS WITHOUT CLAIM TO ANY PARTICULAR FONT, STYLE, SIZE, OR COLOR.

FOR TRIPODS, MONOPODS, STANDS, SUPPORTS AND MOUNTS FOR PHOTOGRAPHIC AND VIDEO CAMERAS; PARTS AND ACCESSORIES FOR PHOTOGRAPHIC AND DIGITAL CAMERA TRIPODS, MONOPODS, SUPPORTS, STANDS, AND MOUNTS, NAMELY, STABILIZERS AND STRAPS, HANDLES, AND CARRYING BAGS AND CASES, ALL SPECIALLY ADAPTED FOR HOLDING TRIPODS, MONOPODS, STANDS, SUPPORTS AND MOUNTS FOR PHOTOGRAPHIC AND VIDEO CAMERAS, AND PARTS AND ACCESSORIES THEREFOR; HEADS, LEGS, ATTACHMENT BRACKETS AND PLATES, SPREADERS, WHEELS, AND DOLLIES, ALL FOR TRIPODS, MONOPODS, STANDS, SUPPORTS AND MOUNTS FOR PHOTOGRAPHIC AND VIDEO CAMERAS (U.S. CLS. 21, 23, 26, 36 AND 38).

JORDAN BAKER, EXAMINING ATTORNEY

CLASS 9—(Continued).

SN 85-540,875. GRADUS GROUP LLC, NEW YORK, NY. FILED 2-13-2012.

GEAR UP AND GO

THE MARK CONSISTS OF STANDARD CHARACTERS WITHOUT CLAIM TO ANY PARTICULAR FONT, STYLE, SIZE, OR COLOR.

FOR REMOTE CONTROLS FOR CAMERAS; REMOTE CONTROLS FOR PHOTOGRAPHY EQUIPMENT; REMOTE CONTROLS FOR CAMERA VIEW MONITORS, VIEWFINDERS, VIEWFINDER SCREENS, AND SCREEN PROTECTORS; CAMERA BATTERY GRIPS; CAMERA EQUIPMENT MOUNTING BRACKETS; HOODS AND SHADES FOR DIGITAL CAMERA VIEW MONITORS, VIEWFINDERS, VIEWFINDER SCREENS; CAMERA BATTERY CHAMBER COVERS; CAMERA RELEASE CABLES; SHUTTER RELEASE CABLES; REMOTE CAMERA FLASH CABLES; LCD CAMERA SCREEN PROTECTORS; HOT SHOE ADAPTERS FOR CAMERAS; ON-CAMERA FLASH DIFFUSERS (U.S. CLS. 21, 23, 26, 36 AND 38).

JORDAN BAKER, EXAMINING ATTORNEY

SN 85-540,878. JEFFREY C. GOLDEN, ESCONDIDO, CA. FILED 2-13-2012.

DYNAGRAPHIC

THE MARK CONSISTS OF STANDARD CHARACTERS WITHOUT CLAIM TO ANY PARTICULAR FONT, STYLE, SIZE, OR COLOR.

FOR ELECTRONIC APPARATUS, NAMELY, ELECTRONIC DISPLAY BOARDS, PLASMA DISPLAY BOARDS, ELECTRONIC DISPLAY SCREENS (U.S. CLS. 21, 23, 26, 36 AND 38).

SUE LAWRENCE, EXAMINING ATTORNEY

CLASS 9—(Continued).

SN 85-541,061. PANASONIC CORPORATION, OSAKA, JAPAN, FILED 2-13-2012.



NO CLAIM IS MADE TO THE EXCLUSIVE RIGHT TO USE "1920" AND "BACK LIGHT SCANNING", APART FROM THE MARK AS SHOWN.

THE MARK CONSISTS OF THE WORDING "1920 BLS BACK LIGHT SCANNING" ALL WITHIN A RECTANGLE. FOR PLASMA TELEVISION SETS; LCD TELEVISION SETS; TELEVISION SETS; OPTICAL DISC PLAYERS; OPTICAL DISC RECORDERS (U.S. CLS. 21, 23, 26, 36 AND 38).

AMY ALFIERI, EXAMINING ATTORNEY

CLASS 9—(Continued).

SN 85-544,714. DENTON VACUUM, L.L.C., MOORESTOWN, NJ. FILED 2-16-2012.

DENTON VACUUM

THE MARK CONSISTS OF STANDARD CHARACTERS WITHOUT CLAIM TO ANY PARTICULAR FONT, STYLE, SIZE, OR COLOR.

OWNER OF U.S. REG. NO. 3,697,990.

NO CLAIM IS MADE TO THE EXCLUSIVE RIGHT TO USE "VACUUM", APART FROM THE MARK AS SHOWN.

FOR AUTOMATED APPARATUS AND INSTRUMENT FOR THIN FILM DEPOSITION, NAMELY, DEPOSIT OF METAL AND DIELECTRIC COATINGS BY MEANS OF PLASMA ENHANCED CHEMICAL VAPOR DEPOSITION OR SPUTTERING FROM METAL AND METAL ALLOYS (U.S. CLS. 21, 23, 26, 36 AND 38).

FIRST USE 3-0-1964; IN COMMERCE 3-0-1964.

SIMON TENG, EXAMINING ATTORNEY

SN 85-550,549. RUCKUS MEDIA GROUP, INC., WILTON, CT. FILED 2-23-2012.

VIDREADER

SN 85-542,296. SPEEDWAY LLC, ENON, OH. FILED 2-14-2012.

SPEEDY SELECT

THE MARK CONSISTS OF STANDARD CHARACTERS WITHOUT CLAIM TO ANY PARTICULAR FONT, STYLE, SIZE, OR COLOR.

OWNER OF U.S. REG. NO. 2,667,115.

FOR MAGNETICALLY OR OPTICALLY ENCODED DEBIT CARDS (U.S. CLS. 21, 23, 26, 36 AND 38).

KAELIE KUNG, EXAMINING ATTORNEY

THE MARK CONSISTS OF STANDARD CHARACTERS WITHOUT CLAIM TO ANY PARTICULAR FONT, STYLE, SIZE, OR COLOR.

FOR COMPUTER SOFTWARE FOR USE IN DISPLAYING AND MANIPULATING AUDIO, TEXT, IMAGE AND VIDEO DATA INTO THE FORM OF ELECTRONIC BOOKS, VIDEOS, GAMES, TEXT, PHOTOS AND ILLUSTRATIONS AND FOR USE IN RECEIVING THE AUDIO, TEXT, IMAGE AND VIDEO DATA THAT COMPRISES ELECTRONIC BOOKS, VIDEOS, GAMES, TEXT, PHOTOS AND ILLUSTRATIONS (U.S. CLS. 21, 23, 26, 36 AND 38).

SOPHIA S. KIM, EXAMINING ATTORNEY

CLASS 9—(Continued).

SN 85-555,393. OMS INVESTMENTS, INC., LOS ANGELES, CA. FILED 2-28-2012.

groables

THE MARK CONSISTS OF A FLOWER DESIGN BETWEEN THE "O" AND "A" IN THE WORD "GROABLES".
 FOR DOWNLOADABLE SOFTWARE FOR MOBILE PHONE APPLICATIONS IN THE FIELD OF ADVICE AND INFORMATION ON THE SUBJECTS OF GARDENING AND LAWN CARE AND THE USE OF PRODUCTS RELATING TO GARDENING AND LAWN CARE; COMPUTER APPLICATION SOFTWARE FOR MOBILE PHONES, NAMELY, MOBILE PHONE APPLICATIONS IN THE FIELD OF ADVICE AND INFORMATION ON THE SUBJECTS OF GARDENING AND LAWN CARE AND THE USE OF PRODUCTS RELATING TO GARDENING AND LAWN CARE (U.S. CLS. 21, 23, 26, 36 AND 38).

MICHAEL GAAFAR, EXAMINING ATTORNEY

SN 85-558,089. HANNA-BARBERA PRODUCTIONS, INC., BURBANK, CA. FILED 3-1-2012.

PENELOPE PITSTOP

THE MARK CONSISTS OF STANDARD CHARACTERS WITHOUT CLAIM TO ANY PARTICULAR FONT, STYLE, SIZE, OR COLOR.

FOR MOTION PICTURE FILMS FEATURING COMEDY, DRAMA, ACTION, ADVENTURE AND/OR ANIMATION, AND MOTION PICTURE FILMS FOR BROADCAST ON TELEVISION FEATURING COMEDY, DRAMA, ACTION, ADVENTURE AND/OR ANIMATION; AUDIO TAPES, AUDIO-VIDEO TAPES, AUDIO VIDEO CASSETTES, AUDIO VIDEO DISCS, AND DIGITAL VERSATILE DISCS FEATURING MUSIC, COMEDY, DRAMA, ACTION, ADVENTURE, AND/OR ANIMATION; STEREO HEADPHONES; BATTERIES; CORDLESS TELEPHONES; AUDIO CASSETTE AND CD PLAYERS; CD ROM COMPUTER GAME DISCS; COMPACT DISC PLAYERS, DIGITAL AUDIO TAPE RECORDERS AND PLAYERS; RADIOS; MOUSE PADS; EYEGLASSES, SUNGLASSES AND CASES THEREFOR; GAME EQUIPMENT SOLD AS A UNIT FOR PLAYING A PARLOR-TYPE COMPUTER GAME; DOWNLOADABLE SOFTWARE FOR USE IN PLAYING ONLINE COMPUTER GAMES, DOWNLOADABLE COMPUTER GAME SOFTWARE; COMPUTER GAME SOFTWARE FOR USE ON MOBILE AND CELLULAR PHONES; VIDEO AND COMPUTER GAME PROGRAMS; VIDEO GAME CARTRIDGES AND CASSETTES; CELLULAR TELEPHONE ACCESSORIES, NAMELY, HANDS-FREE ACCESSORIES, CELLULAR TELEPHONE COVERS AND CELLULAR TELEPHONE FACE COVERS; ENCODED MAGNETIC CARDS, NAMELY, PHONE CARDS, CREDIT CARDS, CASH CARDS, DEBIT CARDS AND MAGNETIC KEY CARDS; AND DECORATIVE MAGNETS (U.S. CLS. 21, 23, 26, 36 AND 38).

PAM WILLIS, EXAMINING ATTORNEY

CLASS 9—(Continued).

SN 85-560,494. UNIVERSAL AVIONICS SYSTEMS CORPORATION, TUCSON, AZ. FILED 3-5-2012.

INTOUCH

THE MARK CONSISTS OF STANDARD CHARACTERS WITHOUT CLAIM TO ANY PARTICULAR FONT, STYLE, SIZE, OR COLOR.

FOR WIRELESS TOUCH-SCREENS FOR CONTROLLING AND DISPLAYING AVIONICS SYSTEMS AND FUNCTIONS IN AN AIRCRAFT (U.S. CLS. 21, 23, 26, 36 AND 38).

ANDREA HACK, EXAMINING ATTORNEY

SN 85-565,257. GENERAL ELECTRIC COMPANY, SCHECTADY, NY. FILED 3-9-2012.

ECHOPILOT

THE MARK CONSISTS OF STANDARD CHARACTERS WITHOUT CLAIM TO ANY PARTICULAR FONT, STYLE, SIZE, OR COLOR.

FOR MEDICAL SOFTWARE FOR PROVIDING CLINICAL INFORMATION FOR REFERENCE BY MEDICAL PROFESSIONALS (U.S. CLS. 21, 23, 26, 36 AND 38).

FRANK LATTUCA, EXAMINING ATTORNEY

SN 85-572,344. SCRAM TECHNOLOGIES, INC., ANNAPOLIS, MD. FILED 3-16-2012.

JOULE

THE MARK CONSISTS OF STANDARD CHARACTERS WITHOUT CLAIM TO ANY PARTICULAR FONT, STYLE, SIZE, OR COLOR.

FOR CINEMATOGRAPHIC PROJECTORS; LCD PROJECTORS USED TO DISPLAY ADVERTISEMENTS; LIQUID CRYSTAL DISPLAY (LCD) PROJECTORS; MOVIE PROJECTORS; MULTIMEDIA PROJECTORS; PHOTOGRAPHIC PROJECTORS; PICTURE PROJECTORS; PROJECTORS PARTICULARLY PROJECTORS FOR THE ENTERTAINMENT INDUSTRY; SELF-ACTING FOCUSING PROJECTORS; SLIDE PROJECTORS; VIDEO PROJECTORS (U.S. CLS. 21, 23, 26, 36 AND 38).

GILBERT SWIFT, EXAMINING ATTORNEY

CLASS 9—(Continued).

SN 85-573,680. FLIR SYSTEMS, INC., WILSONVILLE, OR.
FILED 3-19-2012.

MSX

THE MARK CONSISTS OF STANDARD CHARACTERS WITHOUT CLAIM TO ANY PARTICULAR FONT, STYLE, SIZE, OR COLOR.
FOR VISIBLE LIGHT AND INFRARED RADIATION IMAGERS (U.S. CLS. 21, 23, 26, 36 AND 38).
ODESSA BIBBINS, EXAMINING ATTORNEY

SN 85-573,770. F5 NETWORKS, INC., SEATTLE, WA. FILED
3-19-2012.

DSC

THE MARK CONSISTS OF STANDARD CHARACTERS WITHOUT CLAIM TO ANY PARTICULAR FONT, STYLE, SIZE, OR COLOR.
FOR COMPUTER SOFTWARE AND COMPUTER HARDWARE FOR USE IN MANAGING NETWORK COMMUNICATIONS TRAFFIC OVER THE INTERNET, NETWORKS, CLOUD SERVERS, AND APPLICATIONS; COMPUTER SOFTWARE AND COMPUTER HARDWARE FOR USE IN IMPROVING THE AVAILABILITY, SECURITY, AND PERFORMANCE OF INTERNET, NETWORKS, CLOUD SERVERS, AND APPLICATIONS; AND COMPUTER SOFTWARE AND COMPUTER HARDWARE FOR USE IN MANAGING STORAGE VIRTUALIZATION DEVICES AND APPLICATIONS (U.S. CLS. 21, 23, 26, 36 AND 38).
FIRST USE 11-15-2011; IN COMMERCE 11-15-2011.
ELIZABETH KAJUBI, EXAMINING ATTORNEY

SN 85-577,449. MEISSNER FILTRATION PRODUCTS, INC.,
CAMARILLO, CA. FILED 3-22-2012.

FLEXGRO

THE MARK CONSISTS OF STANDARD CHARACTERS WITHOUT CLAIM TO ANY PARTICULAR FONT, STYLE, SIZE, OR COLOR.
FOR PLASTIC BIOREACTORS FOR CELL CULTURING FOR USE IN LABORATORIES, PHARMACEUTICAL INDUSTRIES AND/OR BIOTECHNOLOGY INDUSTRIES (U.S. CLS. 21, 23, 26, 36 AND 38).
ANGELA DUONG, EXAMINING ATTORNEY

CLASS 9—(Continued).

SN 85-581,645. GAMEFACE APPAREL, LLC, ROSWELL, GA.
FILED 3-27-2012.



THE MARK CONSISTS OF A STYLIZED LETTER "G", WHEREUPON THE TOP OF THE "G" EXTENDS OUTWARD LATERALLY APPROXIMATELY EQUAL TO THE WIDTH OF THE "G" AND THE CURLING SERIPH OF THE "G" EXTENDS OUTWARD LATERALLY APPROXIMATELY EQUAL TO THE WIDTH OF THE "G", BUT SLIGHTLY LESS THAN THAT OF THE TOP EXTENSION. THE END OF EACH EXTENSION IS CUT AT A MATCHING FORTY-FIVE DEGREE ANGLE. THE WORD "GAMEFACE" APPEARS DIRECTLY BELOW AND CENTERED TO THE STYLIZED "G".

FOR EYEWEAR, NAMELY, SUNGLASSES, EYEGLASSES AND OPHTHALMIC FRAMES AND CASES THEREFOR; EYEWEAR, NAMELY, SUNGLASSES, POLYCARBONATE SUNGLASSES, POLARIZED LENS SUNGLASSES, AND MAGNIFICATION LENS SUNGLASSES; SUNGLASS LENSES; SUNGLASSES; SUNGLASSES AND SPECTACLES (U.S. CLS. 21, 23, 26, 36 AND 38).
KAREN BRACEY, EXAMINING ATTORNEY

SN 85-582,823. AGILENT TECHNOLOGIES, INC., SANTA
CLARA, CA. FILED 3-28-2012.

NSCOPE

THE MARK CONSISTS OF STANDARD CHARACTERS WITHOUT CLAIM TO ANY PARTICULAR FONT, STYLE, SIZE, OR COLOR.
FOR RADIOLOGICAL APPARATUS FOR RESEARCH PURPOSES, NAMELY, MAGNETIC RESONANCE SCANNERS FOR USE IN NON-MEDICAL AND LIFE SCIENCES RESEARCH APPLICATIONS; MAGNETIC RESONANCE SCANNERS FOR USE IN PRE-CLINICAL MAGNETIC RESONANCE IMAGING (U.S. CLS. 21, 23, 26, 36 AND 38).
RENEE MCCRAY, EXAMINING ATTORNEY

CLASS 9—(Continued).

SN 85-583,154. PUNCH MEDIA, INC., NEW YORK, NY. FILED 3-29-2012.

PUNCH!

THE MARK CONSISTS OF STANDARD CHARACTERS WITHOUT CLAIM TO ANY PARTICULAR FONT, STYLE, SIZE, OR COLOR.

FOR DOWNLOADABLE ELECTRONIC PUBLICATIONS IN THE NATURE OF PERIODICALS FEATURING NEWS AND TOPICS OF GENERAL INTEREST; COMPUTER APPLICATION SOFTWARE FOR MOBILE PHONES, PORTABLE MEDIA PLAYERS AND HANDHELD COMPUTERS, NAMELY, SOFTWARE FOR DOWNLOADING, RECEIVING, READING AND STORING ELECTRONIC PUBLICATIONS (U.S. CLS. 21, 23, 26, 36 AND 38).

TASHIA BUNCH, EXAMINING ATTORNEY

CLASS 9—(Continued).

SN 85-589,604. PERICOM SEMICONDUCTOR CORPORATION, SAN JOSE, CA. FILED 4-4-2012.



THE MARK CONSISTS OF THE STYLIZED LETTER "P" WITH A SPARK DESIGN.

FOR COMPUTER HARDWARE; INTEGRATED CIRCUITS; SEMICONDUCTOR CHIPS; SEMICONDUCTORS (U.S. CLS. 21, 23, 26, 36 AND 38).

FIRST USE 0-0-1993; IN COMMERCE 0-0-1993.

REBECCA GILBERT, EXAMINING ATTORNEY

SN 85-585,211. FRESH, LLC, LITTLE FALLS, NY. FILED 3-30-2012.

Fresh To Death

THE MARK CONSISTS OF STANDARD CHARACTERS WITHOUT CLAIM TO ANY PARTICULAR FONT, STYLE, SIZE, OR COLOR.

FOR DOWNLOADABLE MUSICAL SOUND RECORDINGS; MUSICAL RECORDINGS; MUSICAL SOUND RECORDINGS; MUSICAL VIDEO RECORDINGS (U.S. CLS. 21, 23, 26, 36 AND 38).

MARK SHINER, EXAMINING ATTORNEY

SN 85-592,134. PEARSON EDUCATION, INC., UPPER SADDLE RIVER, NJ. FILED 4-9-2012.

COURSECONNECT FLASH

SN 85-586,702. SENCHA, INC., REDWOOD CITY, CA. FILED 4-2-2012.

GXT

THE MARK CONSISTS OF STANDARD CHARACTERS WITHOUT CLAIM TO ANY PARTICULAR FONT, STYLE, SIZE, OR COLOR.

FOR COMPUTER SOFTWARE FOR USE IN DEVELOPING WEB APPLICATIONS; COMPUTER SOFTWARE THAT PROVIDES WEB-BASED ACCESS TO APPLICATIONS AND SERVICES THROUGH A WEB OPERATING SYSTEM OR PORTAL INTERFACE (U.S. CLS. 21, 23, 26, 36 AND 38).

ELLEN PERKINS, EXAMINING ATTORNEY

THE MARK CONSISTS OF STANDARD CHARACTERS WITHOUT CLAIM TO ANY PARTICULAR FONT, STYLE, SIZE, OR COLOR.

FOR DOWNLOADABLE EDUCATIONAL SOFTWARE FOR MOBILE DEVICES FEATURING STUDY GUIDES IN THE FIELDS OF SOCIAL SCIENCES AND HUMANITIES (U.S. CLS. 21, 23, 26, 36 AND 38).

FIRST USE 2-1-2012; IN COMMERCE 2-1-2012.

JORDAN BAKER, EXAMINING ATTORNEY

CLASS 9—(Continued).

SN 85-596,564. GRUMBUL, LLC, NEW YORK, NY. FILED 4-12-2012.

IMPROVE YOUR WORLD

THE MARK CONSISTS OF STANDARD CHARACTERS WITHOUT CLAIM TO ANY PARTICULAR FONT, STYLE, SIZE, OR COLOR.

FOR COMPUTER APPLICATION SOFTWARE FOR MOBILE PHONES, SMART PHONES, PORTABLE MEDIA PLAYERS, AND HANDHELD COMPUTERS, NAMELY, SOFTWARE FOR ENABLING USERS, SOURCES AND SUPPLIERS OF PRODUCTS AND SERVICES TO COMMUNICATE WITH EACH OTHER REGARDING COMPLAINTS, COMMENTS, COMPILATIONS, RANKINGS, RATINGS, REVIEWS, REFERRALS, RECOMMENDATIONS, RESPONSES, AND OTHER INFORMATION AND CONTENT ABOUT THE PRODUCTS AND SERVICES (U.S. CLS. 21, 23, 26, 36 AND 38).

FRANK LATTUCA, EXAMINING ATTORNEY

SN 85-602,512. STIENSTRA, DOUGLAS CHARLES, AUSTIN, TX. FILED 4-19-2012.

FlashPals

THE MARK CONSISTS OF STANDARD CHARACTERS WITHOUT CLAIM TO ANY PARTICULAR FONT, STYLE, SIZE, OR COLOR.

FOR COMPUTER ACCESSORIES, NAMELY, BLANK USB FLASH DRIVES; USB FLASH DRIVES PRELOADED WITH MULTIMEDIA CONTENT, NAMELY, TEXT AND PDF FILES, VIDEOS, SONGS, AND HYPERLINKS (U.S. CLS. 21, 23, 26, 36 AND 38).

JORDAN BAKER, EXAMINING ATTORNEY

SN 85-603,398. EDWIN ROSENBERGER, WHITE PLAINS, NY. FILED 4-20-2012.

FLASHTAG

THE MARK CONSISTS OF STANDARD CHARACTERS WITHOUT CLAIM TO ANY PARTICULAR FONT, STYLE, SIZE, OR COLOR.

FOR COMPUTER APPLICATION SOFTWARE FOR MOBILE PHONES, NAMELY, SOFTWARE FOR NETWORKING AND COMMUNICATING WITH OTHERS BASED ON SHARED INTERESTS AND DESIRED COMMUNICATION TOPICS (U.S. CLS. 21, 23, 26, 36 AND 38).

JORDAN BAKER, EXAMINING ATTORNEY

CLASS 9—(Continued).

SN 85-608,581. CEPH STORAGE, INC., LOS ANGELES, CA. FILED 4-25-2012.



THE MARK CONSISTS OF GENERALLY CONCENTRIC CURVED LINES, THE LINES BEING OPEN AT THEIR BOTTOM ENDS, WITH A SOLID CIRCLE IN THE CENTER.

FOR COMPUTER SOFTWARE AND HARDWARE FOR DATA MANAGEMENT, DATA STORAGE, AND DATA ARCHIVING (U.S. CLS. 21, 23, 26, 36 AND 38).

BRIAN PINO, EXAMINING ATTORNEY

SN 85-608,593. CEPH STORAGE, INC., LOS ANGELES, CA. FILED 4-25-2012.

CEPH THE FUTURE OF STORAGE

THE MARK CONSISTS OF STANDARD CHARACTERS WITHOUT CLAIM TO ANY PARTICULAR FONT, STYLE, SIZE, OR COLOR.

OWNER OF U.S. REG. NO. 3,581,493.

FOR COMPUTER SOFTWARE AND HARDWARE FOR DATA MANAGEMENT, DATA STORAGE, AND DATA ARCHIVING (U.S. CLS. 21, 23, 26, 36 AND 38).

BRIAN PINO, EXAMINING ATTORNEY

SN 85-608,601. CEPH STORAGE, INC., LOS ANGELES, CA. FILED 4-25-2012.

CEPH CERTIFIED

THE MARK CONSISTS OF STANDARD CHARACTERS WITHOUT CLAIM TO ANY PARTICULAR FONT, STYLE, SIZE, OR COLOR.

OWNER OF U.S. REG. NO. 3,581,493.

NO CLAIM IS MADE TO THE EXCLUSIVE RIGHT TO USE "CERTIFIED", APART FROM THE MARK AS SHOWN. FOR COMPUTER SOFTWARE AND HARDWARE FOR DATA MANAGEMENT, DATA STORAGE, AND DATA ARCHIVING (U.S. CLS. 21, 23, 26, 36 AND 38).

BRIAN PINO, EXAMINING ATTORNEY

CLASS 10—MEDICAL APPARATUS

SN 76-707,895. HERSCHAP, MELISSA, ROSANKY, TX. FILED 6-8-2011.

BOSOM BUDDY

THE MARK CONSISTS OF STANDARD CHARACTERS WITHOUT CLAIM TO ANY PARTICULAR FONT, STYLE, SIZE, OR COLOR.

NO CLAIM IS MADE TO THE EXCLUSIVE RIGHT TO USE "BOSOM", APART FROM THE MARK AS SHOWN.

FOR MEDICAL DEVICE FOR NONSURGICAL COSMETIC TREATMENT, NAMELY, A PLASTIC SUPPORT DEVICE FOR THERAPEUTIC USE THAT IS WORN AT NIGHT TO SUPPORT A WOMAN'S BREASTS AND PREVENT WRINKLING COMPRISING A T-SHAPED SUPPORT WHICH HAS THE LENGTHWISE PORTION THEREOF EXTENDING BENEATH THE BREASTS ALONG THE LONGITUDINAL AXIS OF THE WEARER'S BODY AND THE TOP OF THE T-SHAPED SUPPORT EXTENDING PERPENDICULAR TO THE LENGTHWISE PORTION AND SUPPORTING THE BREASTS (U.S. CLS. 26, 39 AND 44).

BILL DAWE, EXAMINING ATTORNEY

CLASS 10—(Continued).

SN 79-094,290. CUBE S.R.L., MASSA (MASSA CARRARA), ITALY, FILED 12-29-2010.



PRIORITY DATE OF 11-29-2010 IS CLAIMED. OWNER OF INTERNATIONAL REGISTRATION 1068945 DATED 12-29-2010, EXPIRES 12-29-2020.

THE MARK CONSISTS OF A STYLIZED REPRESENTATION OF A HEART, WITH TOUCHING ADJACENT SQUARES CONNECTING THE HEART TO THE WORDING "CUBE", WRITTEN IN PARTICULAR LOWER-CASE LETTERS, WHICH IS BIGGER THAN THE WORDING "A NEW SPRING IN YOUR LIFE", WRITTEN IN LOWER-CASE LETTERS BELOW THE WORDING "CUBE".

FOR SURGICAL AND MEDICAL APPARATUS AND INSTRUMENTS, NAMELY, SURGICAL AND INTERVENTIONAL MEDICAL ELASTIC DEVICES, BEING ELASTIC RINGS FOR MITRAL ANNULOPLASTY AND ELASTIC BANDS FOR THE TREATMENT OF VENTRICULAR DYSFUNCTION; SURGICAL IMPLANTS COMPRISING ARTIFICIAL MATERIAL AND ASSOCIATED SURGICAL INSTRUMENTS SETS; HEART VALVES, NAMELY, CARDIAC VALVES FOR SURGICAL PROSTHESES; PROSTHESES FOR TREATMENT, REPLACEMENT AND REPAIR OF CARDIAC DISEASES; CARDIAC SURGERY DEVICES, NAMELY, AN ANNULOPLASTY SYSTEM COMPRISED OF A BAND FOR MEDICAL PURPOSES, RING, SIZER SET, AND ANNULOPLASTY HANDLE (U.S. CLS. 26, 39 AND 44).

RUDY R. SINGLETON, EXAMINING ATTORNEY

SN 77-746,572. GYRUS ACMI, INC., SOUTHBOROUGH, MA. FILED 5-28-2009.

HALO

THE MARK CONSISTS OF STANDARD CHARACTERS WITHOUT CLAIM TO ANY PARTICULAR FONT, STYLE, SIZE, OR COLOR.

FOR ELECTROSURGICAL INSTRUMENTS, NAMELY, CUTTING FORCEPS FOR USE IN LAPAROSCOPIC SURGERY IN THE FIELDS OF GYNECOLOGY AND UROLOGY (U.S. CLS. 26, 39 AND 44).

SUNG IN, EXAMINING ATTORNEY

SN 79-098,003. MEDI GMBH & CO. KG, 95448 BAYREUTH, FED REP GERMANY, FILED 3-24-2011.

medi panthera CF I

THE MARK CONSISTS OF STANDARD CHARACTERS WITHOUT CLAIM TO ANY PARTICULAR FONT, STYLE, SIZE, OR COLOR.

PRIORITY DATE OF 12-30-2010 IS CLAIMED. OWNER OF INTERNATIONAL REGISTRATION 1079044 DATED 3-24-2011, EXPIRES 3-24-2021.

FOR CUSHIONED ARTIFICIAL FEET FOR PROSTHESES MADE OF CARBON; CERVICAL, TRUNK, SHOULDER, ARM, HAND, LEG, KNEE, FOOT AND ANKLE JOINT ORTHESES; ARTIFICIAL LEG, KNEE AND FOOT PROSTHESES; PARTS OF PROSTHESES, NAMELY, ARTIFICIAL KNEE CAPS, LINERS FOR PROSTHESES, COVERS FOR PROSTHESES, ADAPTERS FOR PROSTHESES AND ARTIFICIAL LIMBS; PROSTHESES ACCESSORIES OF SILICON, NAMELY, ARTIFICIAL KNEE CAPS, LINERS FOR PROSTHESES, COVERS FOR PROSTHESES, AND ADAPTERS FOR PROSTHESES; ARTIFICIAL JOINTS; ARTIFICIAL KNEE CAPS, LINERS FOR PROSTHESES, ARTIFICIAL FEET FOR PROSTHESES, COVERS FOR PROSTHESES, AND ADAPTERS FOR PROSTHESES, IMPLANTS CONSISTING OF ARTIFICIAL MATERIAL (U.S. CLS. 26, 39 AND 44).

ANNE FARRELL, EXAMINING ATTORNEY

CLASS 10—(Continued).

SN 79-101,273. ALLIED HEALTH MEDICAL SUPPLIES PTY LTD, AUSTRALIA, FILED 7-4-2011.

PHYSIPOD

THE MARK CONSISTS OF STANDARD CHARACTERS WITHOUT CLAIM TO ANY PARTICULAR FONT, STYLE, SIZE, OR COLOR.

OWNER OF INTERNATIONAL REGISTRATION 1087311 DATED 7-4-2011, EXPIRES 7-4-2021.

FOR ORTHOTIC APPARATUS AND DEVICES, NAMELY, ORTHOTICS FOR FEET; ORTHOTIC INSOLES; ELECTROTHERAPY DEVICES FOR PROVIDING TRANSCUTANEOUS ELECTRICAL NERVE STIMULATION AND ELECTRICAL MUSCLE STIMULATION; APPARATUS AND DEVICES FOR THE TREATMENT AND CARE OF FEET, TOES AND SKIN, NAMELY, ORTHOPEDIC INSOLES, ORTHOPEDIC FOOT CUSHIONS, ORTHOPEDIC HEEL CUPS, ORTHOPEDIC HEEL GUARDS, ORTHOPEDIC HEEL WEDGES, ORTHOPEDIC HEEL CUSHIONS, ORTHOPEDIC FORE-FOOT CUSHIONS, ORTHOPEDIC TOE SEPARATORS, ORTHOPEDIC FOOT SUPPORTS, ORTHOPEDIC TOE REGULATORS, ORTHOPEDIC TOE PROPS, ORTHOPEDIC TOE RELIEF PADS, ORTHOPEDIC THONG PROTECTORS; COMPRESSION HOSIERY, GRADUATED COMPRESSION HOSIERY, THERAPEUTIC HOSIERY, MEDICAL SUPPORT HOSIERY, AND HOSIERY TO ENHANCE BLOOD CIRCULATION, NAMELY, MEDICAL COMPRESSION STOCKINGS AND TIGHTS AND CALF HIGH HOSE; ORTHOPEDIC SUPPORT BANDAGES; ELASTIC BANDAGES FOR MEDICAL, THERAPEUTIC AND REHABILITATIVE PURPOSES; EXERCISE EQUIPMENT, DEVICES AND APPARATUS FOR MEDICAL, THERAPEUTIC AND REHABILITATIVE PURPOSES; EXERCISE EQUIPMENT, DEVICES AND APPARATUS FOR PHYSIOTHERAPY PURPOSES (U.S. CLS. 26, 39 AND 44).

HAI-LY LAM, EXAMINING ATTORNEY

CLASS 10—(Continued).

SN 85-308,927. INTEGRATED DIAGNOSTICS, INC., SEATTLE, WA. FILED 4-29-2011.

INDI

THE MARK CONSISTS OF STANDARD CHARACTERS WITHOUT CLAIM TO ANY PARTICULAR FONT, STYLE, SIZE, OR COLOR.

FOR MEDICAL DEVICES AND INSTRUMENTS, NAMELY, MASS SPECTROMETER FOR MEASURING PROTEINS IN BLOOD AND BLOOD DERIVATIVES, HUMAN FLUIDS, MAMMALIAN TISSUE SAMPLES, CSF AND OTHER MAMMALIAN BODY FLUIDS IN THE NATURE OF PROTEIN CAPTURE AGENTS, ANTIBODIES, BUFFERS, REAGENTS, DNA, RNA TRANSCRIPTION AND MICRORNA EXPRESSION, SINGLE NUCLEOTIDE POLYMORPHISMS ANALYSIS; MEDICAL DEVICES AND INSTRUMENTS, NAMELY, MASS SPECTROMETER FOR SMALL MOLECULE ANALYSIS, INCLUDING DETECTION OF PROTEIN LEVELS IN BLOOD AND HUMAN FLUIDS (U.S. CLS. 26, 39 AND 44).

LEIGH LOWRY, EXAMINING ATTORNEY

SN 85-308,931. INTEGRATED DIAGNOSTICS, INC., SEATTLE, WA. FILED 4-29-2011.

SN 85-010,169. SYNOVIS LIFE TECHNOLOGIES, INC., ST. PAUL, MN. FILED 4-9-2010.

GLOBAL EXCELLENCE IN MICROSURGERY

THE MARK CONSISTS OF STANDARD CHARACTERS WITHOUT CLAIM TO ANY PARTICULAR FONT, STYLE, SIZE, OR COLOR.

NO CLAIM IS MADE TO THE EXCLUSIVE RIGHT TO USE "MICROSURGERY", APART FROM THE MARK AS SHOWN.

FOR MICROVASCULAR ANASTOMOTIC COUPLERS FOR PERFORMING ANASTOMOSIS AND MONITORING PARAMETERS DURING AND AFTER SURGERY; ABSORBABLE WOVEN POLYGLYCOLIC ACID MESH TUBE FOR USE IN JOINING SEVERED NERVES TO ALLOW REGENERATION AND REJOINING OF NERVES; SURGICAL MICROCLIPS; SURGICAL HEADLAMP (U.S. CLS. 26, 39 AND 44).

FIRST USE 3-31-2010; IN COMMERCE 3-31-2010.
ROBERT C. CLARK JR., EXAMINING ATTORNEY

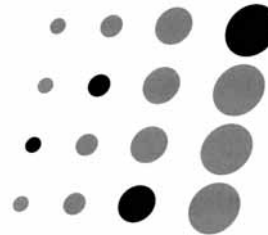

THE MARK CONSISTS OF 4 ROWS OF 4 DOTS.

FOR MEDICAL DEVICES AND INSTRUMENTS, NAMELY, MASS SPECTROMETER FOR MEASURING PROTEINS IN BLOOD AND BLOOD DERIVATIVES, HUMAN FLUIDS, MAMMALIAN TISSUE SAMPLES, CSF AND OTHER MAMMALIAN BODY FLUIDS IN THE NATURE OF PROTEIN CAPTURE AGENTS, ANTIBODIES, BUFFERS, REAGENTS, DNA, RNA TRANSCRIPTION AND MICRORNA EXPRESSION, SINGLE NUCLEOTIDE POLYMORPHISMS ANALYSIS; MEDICAL DEVICES AND INSTRUMENTS, NAMELY, MASS SPECTROMETER FOR SMALL MOLECULE ANALYSIS, INCLUDING DETECTION OF PROTEIN LEVELS IN BLOOD AND HUMAN FLUIDS (U.S. CLS. 26, 39 AND 44).

LEIGH LOWRY, EXAMINING ATTORNEY

CLASS 10—(Continued).

SN 85-316,345. MAST BIOSURGERY AG, ZURICH, SWITZERLAND, FILED 5-9-2011.

Section Sheet

THE MARK CONSISTS OF STANDARD CHARACTERS WITHOUT CLAIM TO ANY PARTICULAR FONT, STYLE, SIZE, OR COLOR.

NO CLAIM IS MADE TO THE EXCLUSIVE RIGHT TO USE "SHEET", APART FROM THE MARK AS SHOWN.

FOR MEDICAL DEVICES, NAMELY, IMPLANTS COMPRISED OF ARTIFICIAL MATERIAL AND PROCESSED NON-LIVING TISSUE FOR USE IN RECONSTRUCTIVE SURGICAL APPLICATIONS AND SURGICAL CESAREAN SECTIONS, AND REPAIR, REINFORCEMENT OR BUTTRESSING OF TISSUE, AND PARTS, FITTINGS AND COMPONENTS THEREFOR; IMPLANTS COMPRISED OF ARTIFICIAL MATERIALS, NAMELY, TISSUE-COMPATIBLE SHEETS, MEMBRANES, AND IMPLANTS COMPOSED OF MATERIALS THAT ARE ARTIFICIAL AND DERIVED FROM NON-LIVING PLANT AND ANIMAL TISSUES, AND PARTS, FITTINGS AND COMPONENTS THEREFORE; MEDICAL DEVICES AND APPARATUS, NAMELY, SURGICAL IMPLANTS COMPRISING ARTIFICIAL MATERIAL FOR USE IN RECONSTRUCTIVE SURGICAL APPLICATIONS, AND REPAIR, REINFORCEMENT OR BUTTRESSING OF SOFT TISSUE; MEDICAL IMPLANTS, NAMELY, POLYMER IMPLANTS FOR USE IN RECONSTRUCTIVE SURGICAL APPLICATIONS, AND REPAIR, REINFORCEMENT OR BUTTRESSING OF SOFT TISSUE; IMPLANTABLE DEVICES MADE OF SYNTHETIC MATERIALS FOR USE IN SOFT TISSUE REPAIR OR THE RECONSTRUCTION OF TISSUE DEFICIENCIES (U.S. CLS. 26, 39 AND 44).

BENJAMIN OKEKE, EXAMINING ATTORNEY

SN 85-331,211. NXTHERA, ST. PAUL, MN. FILED 5-26-2011.

REZŪM

THE MARK CONSISTS OF STANDARD CHARACTERS WITHOUT CLAIM TO ANY PARTICULAR FONT, STYLE, SIZE, OR COLOR.

FOR MEDICAL DEVICES FOR APPLYING ENERGY TO TISSUE IN PROSTATE, BLADDER AND/OR KIDNEY RELATED TREATMENTS, NAMELY, PROBES AND CATHETERS THAT DELIVER THERMAL ENERGY; ENERGY CONTROL SYSTEMS USED FOR APPLYING ENERGY TO TISSUE IN PROSTATE, BLADDER AND/OR KIDNEY RELATED TREATMENTS COMPRISED OF AN ENERGY SUPPLY AND AN ELECTRONIC CONTROL UNIT FOR CONTROLLING THE ENERGY SUPPLY; AND FLUID SUPPLY UNITS FOR USE WITH THE PROBES, CATHETERS AND ENERGY CONTROL SYSTEMS TO GENERATE A THERMAL VAPOR FOR APPLYING ENERGY TO TISSUE IN PROSTATE, BLADDER AND/OR KIDNEY RELATED TREATMENTS (U.S. CLS. 26, 39 AND 44).

WENDY GOODMAN, EXAMINING ATTORNEY

CLASS 10—(Continued).

SN 85-347,607. ZIMMER, INC., WARSAW, IN. FILED 6-16-2011.

NATURAL TIBIA

THE MARK CONSISTS OF STANDARD CHARACTERS WITHOUT CLAIM TO ANY PARTICULAR FONT, STYLE, SIZE, OR COLOR.

OWNER OF U.S. REG. NOS. 1,428,891 AND 3,435,118. NO CLAIM IS MADE TO THE EXCLUSIVE RIGHT TO USE "TIBIA", APART FROM THE MARK AS SHOWN.

FOR ORTHOPAEDIC DEVICES, NAMELY, ORTHOPAEDIC KNEE PROSTHESIS AND SURGICAL INSTRUMENTS USED IN ASSOCIATION THEREWITH (U.S. CLS. 26, 39 AND 44).

WILLIAM VERHOSEK, EXAMINING ATTORNEY

SN 85-366,013. MESYNTHES LIMITED, LOWER HUTT 5010, NEW ZEALAND, FILED 7-7-2011.

ENDOFORM

THE MARK CONSISTS OF STANDARD CHARACTERS WITHOUT CLAIM TO ANY PARTICULAR FONT, STYLE, SIZE, OR COLOR.

PRIORITY CLAIMED UNDER SEC. 44(D) ON NEW ZEALAND APPLICATION NO. 844829, FILED 6-30-2011, REG. NO. 844829, DATED 6-30-2011, EXPIRES 6-30-2021.

FOR SURGICAL APPARATUS AND INSTRUMENTS FOR MEDICAL, DENTAL AND VETERINARY USE; SUTURE MATERIALS; NON-LIVING REGENERATIVE TISSUE SUBSTITUTE FOR USE IN WOUND CARE AND SOFT TISSUE RECONSTRUCTION (U.S. CLS. 26, 39 AND 44).

SUE LAWRENCE, EXAMINING ATTORNEY

SN 85-377,519. DEPUY, INC., WARSAW, IN. FILED 7-21-2011.

TRIPPI-WELLS

THE MARK CONSISTS OF STANDARD CHARACTERS WITHOUT CLAIM TO ANY PARTICULAR FONT, STYLE, SIZE, OR COLOR.

OWNER OF U.S. REG. NO. 2,927,968. FOR SURGICAL INSTRUMENTS FOR ORTHOPAEDIC USE; MEDICAL APPARATUS FOR STABILIZATION OF THE CERVICAL SPINE IN STATIONARY AND/OR MOBILE TRACTION (U.S. CLS. 26, 39 AND 44).

FIRST USE 6-1-2011, THE MARK WAS FIRST USED ANYWHERE IN A DIFFERENT FORM OTHER THAN THAT SOUGHT TO BE REGISTERED AT LEAST AS EARLY AS 10/19/1981; IN COMMERCE 6-1-2011, THE MARK WAS FIRST USED IN COMMERCE IN A DIFFERENT FORM OTHER THAN THAT SOUGHT TO BE REGISTERED AT LEAST AS EARLY AS 10/19/1981.

DAVID TAYLOR, EXAMINING ATTORNEY

CLASS 10—(Continued).

SN 85-384,332. HONEYWELL INTERNATIONAL INC., MORRISTOWN, NJ. FILED 7-29-2011.

GENESIS TOUCH

THE MARK CONSISTS OF STANDARD CHARACTERS WITHOUT CLAIM TO ANY PARTICULAR FONT, STYLE, SIZE, OR COLOR.

NO CLAIM IS MADE TO THE EXCLUSIVE RIGHT TO USE "TOUCH", APART FROM THE MARK AS SHOWN.

FOR IN-HOME PATIENT VITAL SIGN MONITORING SYSTEM SOLD AS A UNIT COMPRISED PRIMARILY OF BLOOD PRESSURE CUFF, GLUCOMETER, SPIROMETER, AND THERMOMETER, PEAK FLOW METER, AND ALSO INCLUDING A SCALE, MAGNETIC CARD READER AND FURTHER INCLUDING A DEVICE FOR TRANSMITTING VITAL SIGN INFORMATION (U.S. CLS. 26, 39 AND 44).

APRIL ROACH, EXAMINING ATTORNEY

CLASS 10—(Continued).

SN 85-416,267. PRIME MEDICAL RESOURCES INC., BURBANK, CA. FILED 9-7-2011.



NO CLAIM IS MADE TO THE EXCLUSIVE RIGHT TO USE "ELECTRO CARE", APART FROM THE MARK AS SHOWN.

THE COLOR(S) RED, WHITE AND GRAY IS/ARE CLAIMED AS A FEATURE OF THE MARK.

THE MARK CONSISTS OF A GRAY HEART BEAT STATUS SYMBOL WITH WORDS "PRIME" AND "ELECTRO" IN RED SEPARATED BY THE HEART BEAT SYMBOL AND BELOW IS THE WORD "CARE" IN WHITE INSIDE A RED RECTANGLE.

FOR ELECTROMEDICAL REHABILITATIVE AND PAIN MANAGEMENT PRODUCTS FOR CLINICAL AND HOME USE, NAMELY, ELECTRICAL NERVE AND MUSCLE STIMULATORS, ULTRASONIC STIMULATORS, MAGNET THERAPY STIMULATORS AND LASER THERAPY STIMULATORS (U.S. CLS. 26, 39 AND 44).

FIRST USE 1-0-2009; IN COMMERCE 1-0-2009.
KELLY TRUSILO, EXAMINING ATTORNEY

SN 85-402,887. ARKAL MEDICAL, INC., FREMONT, CA. FILED 8-19-2011.

GLUCO-POD

THE MARK CONSISTS OF STANDARD CHARACTERS WITHOUT CLAIM TO ANY PARTICULAR FONT, STYLE, SIZE, OR COLOR.

FOR DEVICES FOR MEASURING BLOOD SUGAR; MEDICAL TEST KITS FOR DIABETES MONITORING FOR HOME USE (U.S. CLS. 26, 39 AND 44).

JAY FLOWERS, EXAMINING ATTORNEY

SN 85-417,772. FREEDOM INNOVATIONS, LLC, IRVINE, CA. FILED 9-8-2011.

ENDURACORE

THE MARK CONSISTS OF STANDARD CHARACTERS WITHOUT CLAIM TO ANY PARTICULAR FONT, STYLE, SIZE, OR COLOR.

FOR PROSTHESES FOR FEET COMPRISED OF A LAMINATED COMPOSITE MATERIAL (U.S. CLS. 26, 39 AND 44).

ROBIN CHOSID, EXAMINING ATTORNEY

CLASS 10—(Continued).

SN 85-432,576. FENWAL, INC, LAKE ZURICH, IL. FILED 9-27-2011.

TRANSFER PACK

THE MARK CONSISTS OF STANDARD CHARACTERS WITHOUT CLAIM TO ANY PARTICULAR FONT, STYLE, SIZE, OR COLOR.

NO CLAIM IS MADE TO THE EXCLUSIVE RIGHT TO USE "PACK", APART FROM THE MARK AS SHOWN.

FOR KITS AND PACKAGES OF FLEXIBLE CONTAINERS, FLEXIBLE TUBING AND HYPODERMIC AND COUPLING NEEDLES CONSTITUTING BLOOD OR BLOOD COMPONENT COLLECTING UNITS, BLOOD OR BLOOD COMPONENT STORING UNITS, BLOOD OR BLOOD COMPONENT PROCESSING UNITS, BLOOD OR BLOOD COMPONENT INFUSING UNITS, AND BLOOD OR BLOOD COMPONENT TRANSFER UNITS (U.S. CLS. 26, 39 AND 44).

FIRST USE 0-0-1981; IN COMMERCE 0-0-1981.

JULIE VEPPUMTHARA, EXAMINING ATTORNEY

CLASS 10—(Continued).

SN 85-462,826. EXTREMITY MEDICAL, LLC, PARSIPPANY, NJ. FILED 11-2-2011.

IO Fix Plus
INTRAOSSEOUS FIXATION



OWNER OF U.S. REG. NOS. 3,652,074, 3,756,648 AND OTHERS.

NO CLAIM IS MADE TO THE EXCLUSIVE RIGHT TO USE "INTRAOSSEOUS FIXATION", APART FROM THE MARK AS SHOWN.

THE MARK CONSISTS OF THE TERMS "IO FIX PLUS", WITH THE "X" REPRESENTED BY THE DESIGN OF A PERSON WITH A SOLID CIRCLE FOR A HEAD AND A THIN LINE CURVED DOWNWARD AND RUNNING FROM THE LEFT HAND TO THE RIGHT HAND OF THE PERSON, AND THE TERMS "INTRAOSSEOUS FIXATION", UNDERNEATH.

FOR MEDICAL DEVICES, NAMELY, INTRAMEDULLARY FUSION DEVICES (U.S. CLS. 26, 39 AND 44).

JACQUELINE A. LAVINE, EXAMINING ATTORNEY

SN 85-437,933. MIC CORPORATION, FUNABASHI CITY, CHIBA, JAPAN, FILED 10-3-2011.

MODE-design

THE MARK CONSISTS OF STANDARD CHARACTERS WITHOUT CLAIM TO ANY PARTICULAR FONT, STYLE, SIZE, OR COLOR.

FOR ADULT SEXUAL STIMULATION AIDS, NAMELY, ARTIFICIAL PENISES, PENIS ENLARGERS, VIBRATORS, BENWA BALLS, ARTIFICIAL VAGINAS (U.S. CLS. 26, 39 AND 44).

NAPOLEON SHARMA, EXAMINING ATTORNEY

SN 85-462,998. PRADO, PABLO, SAN DIEGO, CA. FILED 11-2-2011.

ONE RESONANCE

THE MARK CONSISTS OF STANDARD CHARACTERS WITHOUT CLAIM TO ANY PARTICULAR FONT, STYLE, SIZE, OR COLOR.

NO CLAIM IS MADE TO THE EXCLUSIVE RIGHT TO USE "RESONANCE", APART FROM THE MARK AS SHOWN.

FOR RADIOLOGICAL APPARATUS FOR DIAGNOSTIC AND MEDICAL, INDUSTRIAL AND AIRPORT SECURITY PURPOSES, NAMELY, MAGNETIC RESONANCE IMAGER (U.S. CLS. 26, 39 AND 44).

FIRST USE 9-5-2008; IN COMMERCE 9-5-2008.

ERNEST SHOSHO, EXAMINING ATTORNEY

CLASS 10—(Continued).

SN 85-497,020. HAGER WORLDWIDE, INC., HICKORY, NC.
FILED 12-16-2011.

SUPER BIB CLIP

THE MARK CONSISTS OF STANDARD CHARACTERS WITHOUT CLAIM TO ANY PARTICULAR FONT, STYLE, SIZE, OR COLOR.

NO CLAIM IS MADE TO THE EXCLUSIVE RIGHT TO USE "BIB CLIP", APART FROM THE MARK AS SHOWN.
SEC. 2(F).

FOR DENTAL BIB CLIPS FOR SECURING DENTAL BIBS ON PATIENTS DURING DENTAL PROCEDURES (U.S. CLS. 26, 39 AND 44).

FIRST USE 4-7-1994; IN COMMERCE 4-7-1994.
DAVID ELTON, EXAMINING ATTORNEY

CLASS 10—(Continued).

SN 85-516,456. 3GEN, LLC., SAN JUAN CAPISTRANO, CA.
FILED 1-13-2012.

DERMLITE CAM

THE MARK CONSISTS OF STANDARD CHARACTERS WITHOUT CLAIM TO ANY PARTICULAR FONT, STYLE, SIZE, OR COLOR.

OWNER OF U.S. REG. NO. 2,618,309.

NO CLAIM IS MADE TO THE EXCLUSIVE RIGHT TO USE "CAM", APART FROM THE MARK AS SHOWN.

FOR MEDICAL DEVICES, NAMELY, CAMERAS FOR VIEWING AND CAPTURING IMAGES FOR USE IN DERMATOLOGICAL EXAMINATIONS (U.S. CLS. 26, 39 AND 44).

DAVID TAYLOR, EXAMINING ATTORNEY

SN 85-497,033. HAGER WORLDWIDE, INC., HICKORY, NC.
FILED 12-16-2011.

UNI-TIP

THE MARK CONSISTS OF STANDARD CHARACTERS WITHOUT CLAIM TO ANY PARTICULAR FONT, STYLE, SIZE, OR COLOR.

FOR SYRINGE TIPS FOR USE WITH DENTAL AIR AND WATER SYRINGES (U.S. CLS. 26, 39 AND 44).

FIRST USE 12-31-1985; IN COMMERCE 12-31-1985.
DAVID ELTON, EXAMINING ATTORNEY

SN 85-517,736. GUDITH, JEANNIE, THOUSAND OAKS, CA.
FILED 1-17-2012.

OrthoCozy

THE MARK CONSISTS OF STANDARD CHARACTERS WITHOUT CLAIM TO ANY PARTICULAR FONT, STYLE, SIZE, OR COLOR.

FOR FABRIC COVER FOR ORTHODONTIC HEADGEAR (U.S. CLS. 26, 39 AND 44).

ROBERT STRUCK, EXAMINING ATTORNEY

SN 85-509,628. SEVENTH SENSE BIOSYSTEMS, INC., CAMBRIDGE, MA. FILED 1-5-2012.

TAP BLOOD COLLECTION

THE MARK CONSISTS OF STANDARD CHARACTERS WITHOUT CLAIM TO ANY PARTICULAR FONT, STYLE, SIZE, OR COLOR.

NO CLAIM IS MADE TO THE EXCLUSIVE RIGHT TO USE "BLOOD COLLECTION", APART FROM THE MARK AS SHOWN.

FOR A MEDICAL DEVICE APPLIED TO THE SKIN OF A PERSON TO WITHDRAW BLOOD FOR PURPOSES OF MEDICAL ANALYSIS (U.S. CLS. 26, 39 AND 44).

HENRY S. ZAK, EXAMINING ATTORNEY

SN 85-519,145. SOL-MILLENNIUM MEDICAL, INC., LAWRENCEVILLE, GA. FILED 1-18-2012.

SOL-M

THE MARK CONSISTS OF STANDARD CHARACTERS WITHOUT CLAIM TO ANY PARTICULAR FONT, STYLE, SIZE, OR COLOR.

FOR CANNULAE; MEDICAL SYRINGES; NEEDLES FOR MEDICAL USE; LANCETS; BLOOD COLLECTION DEVICES, NAMELY, BLOOD COLLECTION BAGS AND HOLDERS FOR MEDICAL SAMPLE TUBES AND VIALS; MEDICAL APPARATUS, NAMELY, INFUSION DEVICES FOR ADMINISTERING DRUGS (U.S. CLS. 26, 39 AND 44).

CHRISIE B. KING, EXAMINING ATTORNEY

CLASS 10—(Continued).

SN 85-523,783. LOMBARDOZZI RESEARCH & DEVELOPMENT, INC., ERIE, PA. FILED 1-24-2012.



NO CLAIM IS MADE TO THE EXCLUSIVE RIGHT TO USE "CHI ROPE", APART FROM THE MARK AS SHOWN. THE MARK CONSISTS OF GEOMETRIC DESIGN WITH A HEAVY HANDLED ROPE INTERWOVEN THROUGH THE DESIGN AND THE WORD "CHI" ABOVE THE DESIGN AND THE WORD "ROPE" BELOW THE DESIGN.

THE ENGLISH TRANSLATION OF THE WORD "CHI" IN THE MARK IS "ENERGY" OR "LIFE FORCE".

FOR APPARATUS FOR PHYSICAL TRAINING FOR MEDICAL USE; MANUALLY-OPERATED EXERCISE EQUIPMENT FOR PHYSICAL THERAPY PURPOSES (U.S. CLS. 26, 39 AND 44).

FIRST USE 7-15-2008; IN COMMERCE 9-30-2008.
KAPIL BHANOT, EXAMINING ATTORNEY

SN 85-524,552. RODINIA LLC, JUPITER, FL. FILED 1-25-2012.

RODINIA
Revolutionizing Medical Instrumentation

NO CLAIM IS MADE TO THE EXCLUSIVE RIGHT TO USE "MEDICAL INSTRUMENTATION" AND THE REPRESENTATION OF THE CONTINENT OF RODINIA, APART FROM THE MARK AS SHOWN.

THE MARK CONSISTS OF THE WORDS "RODINIA REVOLUTIONIZING MEDICAL INSTRUMENTATION" WITH A HORIZONTAL LINE SEPARATING THE WORD "RODINIA" FROM THE PHRASE "REVOLUTIONIZING MEDICAL INSTRUMENTATION", AND A DEPICTION OF THE CONTINENT OF RODINIA INSIDE THE LETTER "O" IN THE WORD "RODINIA".

FOR FORCEPS FOR MEDICAL USE (U.S. CLS. 26, 39 AND 44).
ERIN FALK, EXAMINING ATTORNEY

CLASS 10—(Continued).

SN 85-530,691. SKYLYNCO LLC, BLANCHARD, OK. FILED 2-1-2012.

TheraBlessing

THE MARK CONSISTS OF STANDARD CHARACTERS WITHOUT CLAIM TO ANY PARTICULAR FONT, STYLE, SIZE, OR COLOR.

FOR THERAPEUTIC HOT AND COLD THERAPY PACKS (U.S. CLS. 26, 39 AND 44).

FIRST USE 1-8-2012; IN COMMERCE 1-8-2012.
MIDGE BUTLER, EXAMINING ATTORNEY

SN 85-530,694. ABLE TREE, INC., LAKE OSWEGO, OR. FILED 2-1-2012.

RE : DESIGN

THE MARK CONSISTS OF STANDARD CHARACTERS WITHOUT CLAIM TO ANY PARTICULAR FONT, STYLE, SIZE, OR COLOR.

FOR DENTAL PROSTHESES (U.S. CLS. 26, 39 AND 44).
FIRST USE 1-31-2012; IN COMMERCE 1-31-2012.
PAM WILLIS, EXAMINING ATTORNEY

SN 85-530,896. CERETEC, INC., LAS VEGAS, NV. FILED 2-1-2012.

Hi-Ox

THE MARK CONSISTS OF STANDARD CHARACTERS WITHOUT CLAIM TO ANY PARTICULAR FONT, STYLE, SIZE, OR COLOR.

FOR MEDICAL OXYGEN FACE MASKS (U.S. CLS. 26, 39 AND 44).
HAI-LY LAM, EXAMINING ATTORNEY

CLASS 10—(Continued).

SN 85-531,184. SKYLYNCO LLC, BLANCHARD, OK. FILED 2-1-2012.

Comforting the World A Wrap at a Time

THE MARK CONSISTS OF STANDARD CHARACTERS WITHOUT CLAIM TO ANY PARTICULAR FONT, STYLE, SIZE, OR COLOR.

FOR THERAPEUTIC HOT AND COLD THERAPY PACKS (U.S. CLS. 26, 39 AND 44).

FIRST USE 1-8-2012; IN COMMERCE 1-8-2012.

MIDGE BUTLER, EXAMINING ATTORNEY

SN 85-532,218. INVATEC S.P.A., RONCADELLE (BRESCIA), ITALY, FILED 2-2-2012.

PACIFIC

THE MARK CONSISTS OF STANDARD CHARACTERS WITHOUT CLAIM TO ANY PARTICULAR FONT, STYLE, SIZE, OR COLOR.

FOR CATHETERS AND PARTS AND FITTINGS THEREFOR (U.S. CLS. 26, 39 AND 44).

JORDAN BAKER, EXAMINING ATTORNEY

SN 85-532,382. BEEKLEY CORPORATION, BRISTOL, CT. FILED 2-2-2012.

TOMOSPOT

THE MARK CONSISTS OF STANDARD CHARACTERS WITHOUT CLAIM TO ANY PARTICULAR FONT, STYLE, SIZE, OR COLOR.

OWNER OF U.S. REG. NOS. 1,352,741, 2,621,382 AND OTHERS.

FOR IDENTIFICATION MARKERS, NAMELY, A SELF-ADHESIVE SUBSTRATE THAT IS ATTACHED TO THE SKIN FOR USE WITH TOMOSYNTHESIS (U.S. CLS. 26, 39 AND 44).

LESLIE RICHARDS, EXAMINING ATTORNEY

CLASS 10—(Continued).

SN 85-532,422. ORTHOVITA, INC., MALVERN, PA. FILED 2-2-2012.



THE MARK CONSISTS OF THE TERM "VITOMATRIX" TO THE RIGHT OF A CIRCLE ENCLOSED EIGHT CIRCLES HORIZONTALLY ALIGNED IN TWO ROWS OF FOUR CIRCLES EACH ALONG THE DIAMETER OF THE OUTER CIRCLE.

FOR BONE IMPLANTS COMPRISED MAINLY OF SYNTHETIC MATERIALS; DENTAL IMPLANTS; SYNTHETIC FILLERS, SUBSTRATES, PLUGS FOR USE IN THE REPLACEMENT AND REPAIR OF TEETH AND BONES (U.S. CLS. 26, 39 AND 44).

SANJEEV VOHRA, EXAMINING ATTORNEY

SN 85-532,429. ORTHOVITA, INC., MALVERN, PA. FILED 2-2-2012.



THE MARK CONSISTS OF A CIRCLE ENCLOSED EIGHT CIRCLES HORIZONTALLY ALIGNED IN TWO ROWS OF FOUR CIRCLES EACH ALONG THE DIAMETER OF THE OUTER CIRCLE.

FOR BONE IMPLANTS COMPRISED MAINLY OF SYNTHETIC MATERIALS; DENTAL IMPLANTS; SYNTHETIC FILLERS, SUBSTRATES, PLUGS FOR USE IN THE REPLACEMENT AND REPAIR OF TEETH AND BONES (U.S. CLS. 26, 39 AND 44).

SANJEEV VOHRA, EXAMINING ATTORNEY

SN 85-532,628. ZYLLION, INC., IRVINE, CA. FILED 2-2-2012.



THE MARK CONSISTS OF ELEVEN IRREGULAR SHAPES THAT FORM A Z SHAPE INSIDE OF A CIRCLE. TO THE RIGHT IS THE STYLIZED TEXT "ZYLLION".

FOR ELECTRIC MASSAGERS (U.S. CLS. 26, 39 AND 44).

FIRST USE 11-22-2011; IN COMMERCE 11-22-2011.

FLORENTINA BLANDU, EXAMINING ATTORNEY

CLASS 10—(Continued).

SN 85-532,631. ELIXIR MEDICAL CORPORATION, SUNNYVALE, CA. FILED 2-2-2012.

COSYNE

THE MARK CONSISTS OF STANDARD CHARACTERS WITHOUT CLAIM TO ANY PARTICULAR FONT, STYLE, SIZE, OR COLOR.

FOR MEDICAL STENTS; STENT DELIVERY SYSTEMS; MEDICAL AND SURGICAL CATHETERS (U.S. CLS. 26, 39 AND 44).

GIANCARLO CASTRO, EXAMINING ATTORNEY

CLASS 10—(Continued).

SN 85-534,193. BONAFIX SURGICAL AND DENTAL IMPLANTS, LLC, DELRAY BEACH, FL. FILED 2-5-2012.

BONAFIX

THE MARK CONSISTS OF STANDARD CHARACTERS WITHOUT CLAIM TO ANY PARTICULAR FONT, STYLE, SIZE, OR COLOR.

FOR DENTAL IMPLANTS; DENTAL INSTRUMENTS FOR USE IN INSTALLING DENTAL IMPLANTS (U.S. CLS. 26, 39 AND 44).

ELIZABETH HUGHITT, EXAMINING ATTORNEY

SN 85-533,381. ZADEH, PARSA T., BEVERLY HILLS, CA. FILED 2-3-2012.

COREFLEX

THE MARK CONSISTS OF STANDARD CHARACTERS WITHOUT CLAIM TO ANY PARTICULAR FONT, STYLE, SIZE, OR COLOR.

FOR DENTAL IMPLANT FIXTURES (U.S. CLS. 26, 39 AND 44).

C. DIONNE CLYBURN, EXAMINING ATTORNEY

SN 85-534,194. BONAFIX SURGICAL AND DENTAL IMPLANTS, LLC, DELRAY BEACH, FL. FILED 2-5-2012.

ORTHOFIX

THE MARK CONSISTS OF STANDARD CHARACTERS WITHOUT CLAIM TO ANY PARTICULAR FONT, STYLE, SIZE, OR COLOR.

FOR DENTAL IMPLANTS; DENTAL INSTRUMENTS FOR USE IN INSERTING DENTAL IMPLANTS (U.S. CLS. 26, 39 AND 44).

ELIZABETH HUGHITT, EXAMINING ATTORNEY

SN 85-533,384. ZADEH, PARSA T., BEVERLY HILLS, CA. FILED 2-3-2012.

SIMPLE LIFT

THE MARK CONSISTS OF STANDARD CHARACTERS WITHOUT CLAIM TO ANY PARTICULAR FONT, STYLE, SIZE, OR COLOR.

FOR DENTAL INSTRUMENTS, NAMELY, SINUS POSITIONING INSTRUMENTS (U.S. CLS. 26, 39 AND 44).

C. DIONNE CLYBURN, EXAMINING ATTORNEY

SN 85-534,195. BONAFIX SURGICAL AND DENTAL IMPLANTS, LLC, DELRAY BEACH, FL. FILED 2-5-2012.

BONAFIX

THE MARK CONSISTS OF STANDARD CHARACTERS WITHOUT CLAIM TO ANY PARTICULAR FONT, STYLE, SIZE, OR COLOR.

FOR DENTAL IMPLANTS; DENTAL INSTRUMENTS FOR USE IN INSERTING DENTAL IMPLANTS (U.S. CLS. 26, 39 AND 44).

ELIZABETH HUGHITT, EXAMINING ATTORNEY

CLASS 10—(Continued).

SN 85-534,196. BONAFIX SURGICAL AND DENTAL IMPLANTS, LLC, DELRAY BEACH, FL. FILED 2-5-2012.

MINIFIX

THE MARK CONSISTS OF STANDARD CHARACTERS WITHOUT CLAIM TO ANY PARTICULAR FONT, STYLE, SIZE, OR COLOR.

FOR DENTAL IMPLANTS; DENTAL INSTRUMENTS FOR USE IN INSTALLING DENTAL IMPLANTS (U.S. CLS. 26, 39 AND 44).

ELIZABETH HUGHITT, EXAMINING ATTORNEY

CLASS 10—(Continued).

SN 85-534,807. BIO CYBERNETICS INTERNATIONAL, INC., LA VERNE, CA. FILED 2-6-2012.

PROTÉGÉ

THE MARK CONSISTS OF STANDARD CHARACTERS WITHOUT CLAIM TO ANY PARTICULAR FONT, STYLE, SIZE, OR COLOR.

FOR ORTHOTIC DEVICES FOR SPINAL SUPPORT (U.S. CLS. 26, 39 AND 44).

JAY FLOWERS, EXAMINING ATTORNEY

SN 85-534,543. MENSSANA RESEARCH, INC., FORT LEE, NJ. FILED 2-6-2012.

BREATHLINK

THE MARK CONSISTS OF STANDARD CHARACTERS WITHOUT CLAIM TO ANY PARTICULAR FONT, STYLE, SIZE, OR COLOR.

FOR MEDICAL DEVICES USED FOR THE COLLECTION, RECORDING, CONCENTRATION AND ANALYSIS OF VOLATILE ORGANIC COMPOUNDS IN HUMAN BREATH; MEDICAL SYSTEMS COMPRISING MEDICAL DEVICES, COMPUTER HARDWARE, COMPUTER SOFTWARE AND PERIPHERALS, FOR USE IN THE COLLECTION, RECORDING, CONCENTRATION AND ANALYSIS OF VOLATILE ORGANIC COMPOUNDS IN HUMAN BREATH (U.S. CLS. 26, 39 AND 44).

BRIAN NEVILLE, EXAMINING ATTORNEY

SN 85-534,903. HEB GROCERY COMPANY, LP, SAN ANTONIO, TX. FILED 2-6-2012.

inControl

THE MARK CONSISTS OF STANDARD CHARACTERS WITHOUT CLAIM TO ANY PARTICULAR FONT, STYLE, SIZE, OR COLOR.

OWNER OF U.S. REG. NOS. 2,875,244 AND 3,105,225. FOR BLOOD PRESSURE MONITORS, INJECTION NEEDLES FOR MEDICAL USE (U.S. CLS. 26, 39 AND 44).

FIRST USE 5-12-2007; IN COMMERCE 5-12-2007. MARK SPARACINO, EXAMINING ATTORNEY

SN 85-534,658. MERIT MEDICAL SYSTEMS, INC., SOUTH JORDAN, UT. FILED 2-6-2012.

Elation

THE MARK CONSISTS OF STANDARD CHARACTERS WITHOUT CLAIM TO ANY PARTICULAR FONT, STYLE, SIZE, OR COLOR.

FOR MEDICAL DEVICES, NAMELY, BALLOON DILATION CATHETERS (U.S. CLS. 26, 39 AND 44).

LESLIE RICHARDS, EXAMINING ATTORNEY

SN 85-534,956. BAUSCH & LOMB INCORPORATED, ROCHESTER, NY. FILED 2-6-2012.

INTELLIGENCE MEETS THE EYE

THE MARK CONSISTS OF STANDARD CHARACTERS WITHOUT CLAIM TO ANY PARTICULAR FONT, STYLE, SIZE, OR COLOR.

FOR LASERS FOR OPHTHALMIC MEDICAL AND SURGICAL PROCEDURES (U.S. CLS. 26, 39 AND 44).

JENNIFER WILLISTON, EXAMINING ATTORNEY

CLASS 10—(Continued).

SN 85-535,153. LOMA VISTA MEDICAL, INC., BURLINGAME, CA. FILED 2-6-2012.

Loma Vista

THE MARK CONSISTS OF STANDARD CHARACTERS WITHOUT CLAIM TO ANY PARTICULAR FONT, STYLE, SIZE, OR COLOR.

FOR CATHETERS; INTRACARDIAC CATHETER; MEDICAL AND SURGICAL CATHETERS; MEDICAL APPARATUS TO IMPROVE CARDIAC PERFORMANCE THROUGH AORTIC FLOW THERAPY; MEDICAL DEVICE, NAMELY, A DEVICE FOR IMPROVING CARDIAC PERFORMANCE THROUGH AORTIC FLOW THERAPY (U.S. CLS. 26, 39 AND 44).

B. PARADEWELAI, EXAMINING ATTORNEY

CLASS 10—(Continued).

SN 85-535,631. INGEN ORTHOPEDICS, L.L.C., CRANBURY, NJ. FILED 2-7-2012.

SEVIIN

THE MARK CONSISTS OF STANDARD CHARACTERS WITHOUT CLAIM TO ANY PARTICULAR FONT, STYLE, SIZE, OR COLOR.

FOR ORTHOPEDIC SHOULDER JOINT IMPLANTS (U.S. CLS. 26, 39 AND 44).

JIM RINGLE, EXAMINING ATTORNEY

SN 85-535,309. MEDICINELODGE, INC., DBA IMDS, LOGAN, UT. FILED 2-6-2012.

ENCAP

THE MARK CONSISTS OF STANDARD CHARACTERS WITHOUT CLAIM TO ANY PARTICULAR FONT, STYLE, SIZE, OR COLOR.

FOR SURGICAL AND MEDICAL APPARATUS AND INSTRUMENTS FOR USE IN ORTHOPEDIC SURGERY (U.S. CLS. 26, 39 AND 44).

DAVID H. STINE, EXAMINING ATTORNEY

SN 85-536,579. LAROSE, ROGER, CHICAGO, IL. FILED 2-8-2012.

HOW OLD ARE YOUR EARS

THE MARK CONSISTS OF STANDARD CHARACTERS WITHOUT CLAIM TO ANY PARTICULAR FONT, STYLE, SIZE, OR COLOR.

FOR HEARING AIDS (U.S. CLS. 26, 39 AND 44).

TRACY CROSS, EXAMINING ATTORNEY

SN 85-535,556. V2R BIOMEDICAL INC., SAINT-JEROME, QUEBEC, CANADA, FILED 2-7-2012.

V2R

THE MARK CONSISTS OF STANDARD CHARACTERS WITHOUT CLAIM TO ANY PARTICULAR FONT, STYLE, SIZE, OR COLOR.

FOR GUIDED SURGERY KIT FOR IMPLANT-BASED DENTAL RESTORATION SURGERY, COMPRISING A PATIENT-CUSTOMIZED SURGICAL TEMPLATE, REMOVABLE DRILL TEMPLATES, AND RETENTIVE PINS; PATIENT-CUSTOMIZED DENTAL PROSTHESIS SUPERSTRUCTURE (U.S. CLS. 26, 39 AND 44).

PAM WILLIS, EXAMINING ATTORNEY

SN 85-536,757. ASTRON DENTAL CORPORATION, LAKE ZURICH, IL. FILED 2-8-2012.

ClearSplint

THE MARK CONSISTS OF STANDARD CHARACTERS WITHOUT CLAIM TO ANY PARTICULAR FONT, STYLE, SIZE, OR COLOR.

FOR SPLINTS (U.S. CLS. 26, 39 AND 44). FIRST USE 5-1-1998; IN COMMERCE 5-1-1998.

NAKIA HENRY, EXAMINING ATTORNEY

CLASS 10—(Continued).

SN 85-537,017. WYETH LLC, MADISON, NJ. FILED 2-8-2012.

THERMAMOVE

THE MARK CONSISTS OF STANDARD CHARACTERS WITHOUT CLAIM TO ANY PARTICULAR FONT, STYLE, SIZE, OR COLOR.

FOR CHEMICALLY-ACTIVATED HEAT-RELEASING WRAPS FOR THERAPEUTIC PURPOSES (U.S. CLS. 26, 39 AND 44).

KATHLEEN LORENZO, EXAMINING ATTORNEY

SN 85-537,147. OPERATING ROOM SAFETY ENTERPRISES, LLC, AKA ORS, BERWYN, PA. FILED 2-8-2012.

ClearAccess

THE MARK CONSISTS OF STANDARD CHARACTERS WITHOUT CLAIM TO ANY PARTICULAR FONT, STYLE, SIZE, OR COLOR.

FOR RADIOLUCENT-SPINAL TABLE; MEDICAL APPARATUS FOR POSITIONING A PATIENT IN A PRONE POSITION FOR SURGERY; MEDICAL APPARATUS FOR LIFTING, SUPPORTING AND TURNING PATIENTS FOR SURGERY; MEDICAL EQUIPMENT, NAMELY, PADS FOR SUPPORTING A PATIENT DURING SPINAL SURGERY; RADIOLUCENT-CHEST SUPPORT FOR SUPPORTING A PATIENT IN A PRONE POSITION; OPERATING TABLES; PATIENT EXAMINATION AND/OR TREATMENT TABLES (U.S. CLS. 26, 39 AND 44).

TAMARA FRAZIER, EXAMINING ATTORNEY

SN 85-537,318. ROCHE DIAGNOSTICS GMBH, 68305 MANNHEIM, FED REP GERMANY, FILED 2-8-2012.

ACCU-CHEK CONNECT

THE MARK CONSISTS OF STANDARD CHARACTERS WITHOUT CLAIM TO ANY PARTICULAR FONT, STYLE, SIZE, OR COLOR.

OWNER OF U.S. REG. NOS. 1,277,867, 3,348,704 AND OTHERS.

FOR BLOOD GLUCOSE MONITORS FOR MEDICAL AND DIAGNOSTIC PURPOSES (U.S. CLS. 26, 39 AND 44).

LUCY ARANT, EXAMINING ATTORNEY

CLASS 10—(Continued).

SN 85-537,382. ISOTIS ORTHOBIOLOGICS, INC., DBA INTEGRAL ORTHOBIOLOGICS, IRVINE, CA. FILED 2-8-2012.

OSTEOADVANCE

THE MARK CONSISTS OF STANDARD CHARACTERS WITHOUT CLAIM TO ANY PARTICULAR FONT, STYLE, SIZE, OR COLOR.

FOR SURGICAL IMPLANTS COMPRISING ARTIFICIAL MATERIAL; BONE SUBSTITUTE FOR SURGICAL USE (U.S. CLS. 26, 39 AND 44).

IRA J. GOODSID, EXAMINING ATTORNEY

SN 85-537,742. POSITRAX, INC, INDIANAPOLIS, IN. FILED 2-8-2012.

ALLIED OSI LABS

THE MARK CONSISTS OF STANDARD CHARACTERS WITHOUT CLAIM TO ANY PARTICULAR FONT, STYLE, SIZE, OR COLOR.

OWNER OF U.S. REG. NO. 1,688,908.

NO CLAIM IS MADE TO THE EXCLUSIVE RIGHT TO USE "LABS", APART FROM THE MARK AS SHOWN.

FOR ORTHOPEDIC BRACES; ORTHOTICS FOR FEET (U.S. CLS. 26, 39 AND 44).

FIRST USE 10-31-1989; IN COMMERCE 10-31-1989.

JENNY PARK, EXAMINING ATTORNEY

SN 85-538,316. COOK MEDICAL TECHNOLOGIES LLC, BLOOMINGTON, IN. FILED 2-9-2012.

VUELITE

THE MARK CONSISTS OF STANDARD CHARACTERS WITHOUT CLAIM TO ANY PARTICULAR FONT, STYLE, SIZE, OR COLOR.

FOR MEDICAL DEVICES, NAMELY, PORTABLE LIGHT SOURCES FOR USE WITH FLEXIBLE AND RIGID ENDOSCOPES (U.S. CLS. 26, 39 AND 44).

ANGELA M. MICHELI, EXAMINING ATTORNEY

CLASS 10—(Continued).

SN 85-538,528. REDYNS MEDICAL LLC, LOS ANGELES, CA. FILED 2-9-2012.

ProStitch

THE MARK CONSISTS OF STANDARD CHARACTERS WITHOUT CLAIM TO ANY PARTICULAR FONT, STYLE, SIZE, OR COLOR.

FOR SURGICAL INSTRUMENTS, IMPLANTS CONSISTING OF ARTIFICIAL MATERIALS, AND SUTURES FOR ATTACHING SOFT TISSUE TO BONE (U.S. CLS. 26, 39 AND 44).

ALYSSA STEEL, EXAMINING ATTORNEY

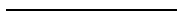

SN 85-539,850. SIEMENS MEDICAL INSTRUMENTS PTE. LTD., SINGAPORE, SINGAPORE, FILED 2-10-2012.

REXTON

THE MARK CONSISTS OF STANDARD CHARACTERS WITHOUT CLAIM TO ANY PARTICULAR FONT, STYLE, SIZE, OR COLOR.

FOR MEDICAL HEARING AIDS AND PARTS THEREOF (U.S. CLS. 26, 39 AND 44).

FIRST USE 3-0-2009; IN COMMERCE 3-0-2009.
MARC LEIPZIG, EXAMINING ATTORNEY



SN 85-540,190. BG MEDICINE, INC., NORTH WALTHAM, MA. FILED 2-10-2012.

CardioSCORE

THE MARK CONSISTS OF STANDARD CHARACTERS WITHOUT CLAIM TO ANY PARTICULAR FONT, STYLE, SIZE, OR COLOR.

FOR IN VITRO DIAGNOSTIC KIT COMPRISED OF ANTIBODY-COATED MICROTITER PLATES, ENZYME-LABELED ANTIBODY CONJUGATE, AQUEOUS BUFFERS, ADHESIVE PLATE SEALERS AND FREEZE-DRIED HUMAN RECOMBINANT GALECTIN-3 COMPRISING THE ASSAY STANDARD CALIBRATOR AND QUALITY CONTROL MATERIALS FOR MEASURING THE GALECTIN-3 PROTEIN CONCENTRATION IN BLOOD FOR USE IN THE CLINICAL EVALUATION OF PATIENTS DIAGNOSED WITH CHRONIC HEART FAILURE (U.S. CLS. 26, 39 AND 44).

ALICIA COLLINS, EXAMINING ATTORNEY

CLASS 10—(Continued).

SN 85-540,327. MELCHER, KYLE R. DBA FREESOM, LAGUNA NIGUEL, CA. FILED 2-11-2012.



THE COLOR(S) GREEN, RED IS/ARE CLAIMED AS A FEATURE OF THE MARK.

THE MARK CONSISTS OF GREEN IN RED FLAME. FOR MEDICAL WEARING APPAREL, NAMELY, SHOES (U.S. CLS. 26, 39 AND 44).

EMILY CARLSEN, EXAMINING ATTORNEY



SN 85-540,577. NONIN MEDICAL, INC., PLYMOUTH, MN. FILED 2-13-2012.

Accuracy You Can Act On

THE MARK CONSISTS OF STANDARD CHARACTERS WITHOUT CLAIM TO ANY PARTICULAR FONT, STYLE, SIZE, OR COLOR.

FOR FINGER TIP PULSE OXIMETER (U.S. CLS. 26, 39 AND 44).

MELISSA VALLILLO, EXAMINING ATTORNEY



SN 85-548,525. TYCO HEALTHCARE GROUP LP, MANSFIELD, MA. FILED 2-21-2012.

SURGISLEEVE

THE MARK CONSISTS OF STANDARD CHARACTERS WITHOUT CLAIM TO ANY PARTICULAR FONT, STYLE, SIZE, OR COLOR.

OWNER OF U.S. REG. NOS. 1,154,781, 1,811,496 AND OTHERS.

FOR WOUND PROTECTOR IN THE NATURE OF CYLINDRICAL DEVICE USED TO KEEP INCISIONS OPEN AND TO PROTECT THE SURROUNDING TISSUE DURING SURGERY; SURGICAL DEVICES AND INSTRUMENTS; AND SURGICAL INSTRUMENTS AND APPARATUS (U.S. CLS. 26, 39 AND 44).

LINDA MICKLEBURGH, EXAMINING ATTORNEY

CLASS 10—(Continued).

SN 85-555,723. REVECOMED INTERNATIONAL INC., FULLERTON, CA. FILED 2-29-2012.

RF MYO

THE MARK CONSISTS OF STANDARD CHARACTERS WITHOUT CLAIM TO ANY PARTICULAR FONT, STYLE, SIZE, OR COLOR.

NO CLAIM IS MADE TO THE EXCLUSIVE RIGHT TO USE "RF", APART FROM THE MARK AS SHOWN.

FOR MEDICAL DEVICES FOR NONSURGICAL COSMETIC TREATMENTS (U.S. CLS. 26, 39 AND 44).

LINDA MICKLEBURGH, EXAMINING ATTORNEY

CLASS 10—(Continued).

SN 85-577,476. MEISSNER FILTRATION PRODUCTS, INC., CAMARILLO, CA. FILED 3-22-2012.

QUADRUM

THE MARK CONSISTS OF STANDARD CHARACTERS WITHOUT CLAIM TO ANY PARTICULAR FONT, STYLE, SIZE, OR COLOR.

FOR PLASTIC CONTAINERS FOR THE STORAGE AND TRANSPORTING OF FLEXIBLE PLASTIC BAGS AND LINERS CONTAINING BIOLOGICAL AND PHARMACEUTICAL LIQUIDS (U.S. CLS. 26, 39 AND 44).

ANGELA DUONG, EXAMINING ATTORNEY

SN 85-555,725. REVECOMED INTERNATIONAL INC., FULLERTON, CA. FILED 2-29-2012.

RF Handpiece

THE MARK CONSISTS OF STANDARD CHARACTERS WITHOUT CLAIM TO ANY PARTICULAR FONT, STYLE, SIZE, OR COLOR.

NO CLAIM IS MADE TO THE EXCLUSIVE RIGHT TO USE "RF", APART FROM THE MARK AS SHOWN.

FOR MEDICAL DEVICES FOR NONSURGICAL COSMETIC TREATMENTS (U.S. CLS. 26, 39 AND 44).

LINDA MICKLEBURGH, EXAMINING ATTORNEY

SN 85-577,908. C. R. BARD, INC., MURRAY HILL, NJ. FILED 3-23-2012.

THRILL

THE MARK CONSISTS OF STANDARD CHARACTERS WITHOUT CLAIM TO ANY PARTICULAR FONT, STYLE, SIZE, OR COLOR.

FOR MEDICAL DEVICES AND APPARATUS, NAMELY, CATHETERS AND PARTS AND FITTINGS THEREFOR (U.S. CLS. 26, 39 AND 44).

MIDGE BUTLER, EXAMINING ATTORNEY

SN 85-572,080. MOMENTUM MANAGEMENT, LLC, DBA BUSHMAN PRODUCTS, TORRANCE, CA. FILED 3-16-2012.

SOULMATE

THE MARK CONSISTS OF STANDARD CHARACTERS WITHOUT CLAIM TO ANY PARTICULAR FONT, STYLE, SIZE, OR COLOR.

FOR ADULT SEXUAL AIDS, NAMELY, VIBRATING RUBBER RINGS FOR THE PENIS, VIBRATORS AND CONDOMS (U.S. CLS. 26, 39 AND 44).

DAVID MURRAY, EXAMINING ATTORNEY

SN 85-581,314. GF HEALTH PRODUCTS, INC., AKA GRAHAM FIELD, ATLANTA, GA. FILED 3-27-2012.

TENDERFLO

THE MARK CONSISTS OF STANDARD CHARACTERS WITHOUT CLAIM TO ANY PARTICULAR FONT, STYLE, SIZE, OR COLOR.

FOR MEDICAL PRODUCTS, NAMELY, THERAPEUTIC MATTRESSES, BEDS, SEATS AND CUSHIONS (U.S. CLS. 26, 39 AND 44).

FIRST USE 4-20-1988; IN COMMERCE 4-20-1988.

DAWN HAN, EXAMINING ATTORNEY

**CLASS 11—ENVIRONMENTAL CONTROL AP-
PARATUS**

SN 77-959,347. THOR TECH, INC., JACKSON CENTER, OH.
FILED 3-15-2010.

COOK-OUT KITCHEN

THE MARK CONSISTS OF STANDARD CHARACTERS
WITHOUT CLAIM TO ANY PARTICULAR FONT, STYLE,
SIZE, OR COLOR.

NO CLAIM IS MADE TO THE EXCLUSIVE RIGHT TO
USE "KITCHEN", APART FROM THE MARK AS SHOWN.

FOR FOOD PREPARATION STATIONS ESPECIALLY
ADAPTED FOR USE IN RECREATIONAL VEHICLES
COMPRISING ELECTRIC AND GAS COOK TOPS,
SINKS, REFRIGERATORS AND REFRIGERATING CAB-
INETS (U.S. CLS. 13, 21, 23, 31 AND 34).

KATHERINE E. HALMEN, EXAMINING ATTORNEY

CLASS 11—(Continued).

SN 79-106,026. CISAPLAST S.P.A., ITALY, FILED 8-2-2011.



OWNER OF INTERNATIONAL REGISTRATION 1098853
DATED 8-2-2011, EXPIRES 8-2-2021.

THE MARK CONSISTS OF THE WORDING "CISA-
PLAST"; ON THE LEFT SIDE OF THE MARK, THERE IS A
SYMBOL COMPOSED BY A LETTER "W" PLACED ABOVE
AND SLIGHTLY SUPERPOSED ON THE LETTER "M"; THE
CHARACTERS OF THE WRITING "CISAPLAST" ARE IN
SQUARED BLOCK ITALICS.

FOR REFRIGERATORS; LIGHTING FIXTURES; COM-
PONENTS FOR INDUSTRIAL REFRIGERATORS MADE
FROM METAL, PLASTIC AND/OR GLASS, NAMELY,
SHELVING, DRAWERS, BINS AND TRAYS; METAL
CONDENSERS FOR INDUSTRIAL REFRIGERATORS;
MODULAR INSULATED PANELS AND DOORS FOR
WALK-IN REFRIGERATED ENCLOSURES, ENVIRON-
MENTAL COOLING ROOMS AND FREEZERS (U.S. CLS.
13, 21, 23, 31 AND 34).

LINDA M. KING, EXAMINING ATTORNEY

SN 85-101,970. LG ELECTRONICS INC., SEOUL, REPUBLIC
OF KOREA, FILED 8-6-2010.

INFRAGRILL

THE MARK CONSISTS OF STANDARD CHARACTERS
WITHOUT CLAIM TO ANY PARTICULAR FONT, STYLE,
SIZE, OR COLOR.

PRIORITY CLAIMED UNDER SEC. 44(D) ON REPUBLIC
OF KOREA APPLICATION NO. 40-2010-0033, FILED 6-28-
2010, REG. NO. 0908716, DATED 3-7-2012, EXPIRES 6-28-2020.

FOR ELECTRIC COOKWARE, NAMELY, INFRARED
BROILERS; GAS COOKTOP; ELECTRIC RANGES FOR
HOUSEHOLD PURPOSES; GAS RANGE; MICROWAVE
OVENS; GAS GRILLS (U.S. CLS. 13, 21, 23, 31 AND 34).

IRA J. GOODSaid, EXAMINING ATTORNEY

SN 79-098,388. FRUMMONDS ARCHITECTURAL AN-
TIQUES LIMITED, NORMANDY, UNITED KINGDOM,
FILED 5-13-2011.



OWNER OF INTERNATIONAL REGISTRATION 1079965
DATED 5-13-2011, EXPIRES 5-13-2021.

THE NAME(S), PORTRAIT(S), AND/OR SIGNATURE(S)
SHOWN IN THE MARK DOES NOT IDENTIFY A PARTI-
CULAR LIVING INDIVIDUAL.

THE MARK CONSISTS OF A CIRCLE WITH THE
LETTER'S "DD" INTERSECTING AND BACKWARDS.
THE WORDING "DRUMMONDS" APPEARS BELOW THE
DESIGN.

FOR BATHS AND BATH TUBS, BASINS BEING PARTS
OF SANITARY INSTALLATIONS AND SINKS, TOILETS
AND WATER CLOSETS, TAPS AND SHOWERS (U.S.
CLS. 13, 21, 23, 31 AND 34).

DAVID HOFFMAN, EXAMINING ATTORNEY

SN 85-195,432. SEARS BRANDS, LLC, HOFFMAN ESTATES,
IL. FILED 12-10-2010.

SMARTFILTER

THE MARK CONSISTS OF STANDARD CHARACTERS
WITHOUT CLAIM TO ANY PARTICULAR FONT, STYLE,
SIZE, OR COLOR.

FOR WATER FILTERS (U.S. CLS. 13, 21, 23, 31 AND
34).

LINDA M. KING, EXAMINING ATTORNEY

CLASS 11—(Continued).

SN 85-222,207. BARED DI BELLUSSI DR. ANTONI PAOLO, CONEGLIANO (TV), ITALY, FILED 1-20-2011.



OWNER OF ITALY REG. NO. 965267, DATED 5-12-2005, RENEWED AS REG. NO. 1474052, DATED 12-7-2011, EXPIRES 12-7-2021.

THE COLOR(S) WHITE, BLACK, BRIGHT RED, DARK RED AND GREY IS/ARE CLAIMED AS A FEATURE OF THE MARK.

THE MARK CONSISTS OF THE WORD "BARED" IN LOWER CASE AND WHITE COLOR WITH A BLACK OUTLINE, BENEATH THE WORD IS A MOTIF CONSISTING OF A THREE DIMENSIONAL ARROW IN BRIGHT AND DARK RED SPLIT IN TWO PARTS, A HORIZONTAL PART DIRECTED FROM LEFT TO RIGHT AND THE OTHER PART DIRECTED DOWNWARDLY, AND A RECTANGULAR BACKGROUND FOR THE WHOLE IN A WHITE AND GREY CHESS BOARD FORMAT.

FOR INDUSTRIAL AND COMMERCIAL FILTERING UNITS FOR FLUIDS, NAMELY, WATER, WINE, JUICE AND MILK (U.S. CLS. 13, 21, 23, 31 AND 34).

JORDAN BAKER, EXAMINING ATTORNEY

SN 85-223,627. STYLE CREST ENTERPRISES, INC., FREMONT, OH. FILED 1-21-2011.

FITRIGHT

THE MARK CONSISTS OF STANDARD CHARACTERS WITHOUT CLAIM TO ANY PARTICULAR FONT, STYLE, SIZE, OR COLOR.

FOR HEATING, VENTING AND AIR CONDITIONER (HVAC) EQUIPMENT AND ACCESSORIES, NAMELY, FITTINGS IN THE NATURE OF BRASS FITTINGS THAT CONNECT THE LINE SET HOSE FROM THE CONDENSER TO THE COILS AND COUPLINGS FOR USE WITH GAS, ELECTRIC AND OIL FURNACES, WITH HEAT PUMPS, WITH CONDENSERS BEING PARTS OF HVAC EQUIPMENT, AND WITH LINE SETS BEING PARTS OF HVAC EQUIPMENT AND COILS BEING PARTS OF HVAC EQUIPMENT (U.S. CLS. 13, 21, 23, 31 AND 34).

FIRST USE 6-0-2010; IN COMMERCE 6-0-2010.

KRISTINA MORRIS, EXAMINING ATTORNEY

SN 85-277,474. KOHLER CO., KOHLER, WI. FILED 3-25-2011.

BELLEGGROVE

THE MARK CONSISTS OF STANDARD CHARACTERS WITHOUT CLAIM TO ANY PARTICULAR FONT, STYLE, SIZE, OR COLOR.

FOR SINKS (U.S. CLS. 13, 21, 23, 31 AND 34).

ZACHARY BELLO, EXAMINING ATTORNEY

CLASS 11—(Continued).

SN 85-310,433. DIRECT GLOBAL SALES, INC., SEATTLE, WA. FILED 5-2-2011.

CHIP STRIP

THE MARK CONSISTS OF STANDARD CHARACTERS WITHOUT CLAIM TO ANY PARTICULAR FONT, STYLE, SIZE, OR COLOR.

NO CLAIM IS MADE TO THE EXCLUSIVE RIGHT TO USE "CHIP", APART FROM THE MARK AS SHOWN.

FOR BARBECUE SMOKER ACCESSORY, NAMELY, CAST IRON CONTAINER FOR SMOKING WOOD CHIPS WHILE USING A BARBECUE SMOKER; GRILLING ACCESSORY, NAMELY, CAST IRON CONTAINER FOR HEATING WOOD CHIPS FOR USE IN SMOKING OR GRILLING (U.S. CLS. 13, 21, 23, 31 AND 34).

BILL DAWE, EXAMINING ATTORNEY

SN 85-327,328. MAGEN ECO-ENERGY (A.C.S.) LTD., KIBBUTZ MAGEN, ISRAEL, FILED 5-23-2011.

ECO SPARK

THE MARK CONSISTS OF STANDARD CHARACTERS WITHOUT CLAIM TO ANY PARTICULAR FONT, STYLE, SIZE, OR COLOR.

OWNER OF ISRAEL REG. NO. 22875, DATED 9-16-2010, EXPIRES 9-16-2020.

FOR HEAT EXCHANGERS AND SOLAR ENERGY HEAT EXCHANGERS NOT BEING PARTS OF MACHINES; SOLAR AND ELECTRIC APPARATUS FOR WATER HEATING, NAMELY, POOL WATER HEATING AND HOT WATER SPACE HEATING APPARATUS; APPARATUS AND INSTRUMENTS FOR WATER SUPPLY, NAMELY, METER VALVES; STRUCTURAL PARTS FOR THE AFOREMENTIONED GOODS (U.S. CLS. 13, 21, 23, 31 AND 34).

HENRY S. ZAK, EXAMINING ATTORNEY

SN 85-336,644. WOLF STEEL LTD., BARRIE, ONTARIO, CANADA, FILED 6-2-2011.

SWISS GRILLS

THE MARK CONSISTS OF STANDARD CHARACTERS WITHOUT CLAIM TO ANY PARTICULAR FONT, STYLE, SIZE, OR COLOR.

NO CLAIM IS MADE TO THE EXCLUSIVE RIGHT TO USE "GRILLS", APART FROM THE MARK AS SHOWN.

FOR BARBEQUES AND OUTDOOR GRILLS (U.S. CLS. 13, 21, 23, 31 AND 34).

WENDY GOODMAN, EXAMINING ATTORNEY

CLASS 11—(Continued).

SN 85-347,056. SUREFIRE, LLC, FOUNTAIN VALLEY, CA. FILED 6-15-2011.

EVO

THE MARK CONSISTS OF STANDARD CHARACTERS WITHOUT CLAIM TO ANY PARTICULAR FONT, STYLE, SIZE, OR COLOR.
FOR FLASHLIGHTS (U.S. CLS. 13, 21, 23, 31 AND 34).
TRACY CROSS, EXAMINING ATTORNEY

CLASS 11—(Continued).

SN 85-355,190. MARANA FORNI DI MARANA FERDINANDO, FRAZIONE CHIEVO, VERONA, ITALY, FILED 6-24-2011.

MARANAFORNI

THE MARK CONSISTS OF STANDARD CHARACTERS WITHOUT CLAIM TO ANY PARTICULAR FONT, STYLE, SIZE, OR COLOR.

OWNER OF ERPN CMNTY TM OFC REG. NO. 008188302, DATED 11-14-2009, EXPIRES 3-30-2019.

THE ENGLISH TRANSLATION OF "FORNI" IN THE MARK IS "OVENS". THE WORDING "MARANA" HAS NO MEANING IN A FOREIGN LANGUAGE.

FOR OVEN FITTINGS MADE OF FIRECLAY, NAMELY, OVEN GAS IGNITERS; COOKING OVENS, NAMELY, PIZZA OVENS AND RUNNING PIZZA OVENS; WOOD BURNING FURNACES; GAS COOKING OVENS; PELLET COOKING OVENS, SHAPED FITTINGS FOR OVENS, NAMELY, OVEN VENTILATOR HOODS; ELECTRIC FIREPLACES; HOT PLATES; AND COOKING APPARATUS AND INSTALLATIONS, NAMELY, GAS GRILLS, ELECTRIC RANGES (U.S. CLS. 13, 21, 23, 31 AND 34).

MELISSA VALLILLO, EXAMINING ATTORNEY

SN 85-350,569. FUSHENG INDUSTRIAL CO., LTD., TAIPEI CITY, TAIWAN, FILED 6-20-2011.

FUSHENG

THE MARK CONSISTS OF A STYLIZED WORD "FUSHENG".

FOR AIR COOLING APPARATUS; AIR-CONDITIONING, AIR COOLING AND VENTILATION APPARATUS AND INSTRUMENTS; AIR FILTERS FOR AIR CONDITIONING UNITS; AIR FILTERS FOR INDUSTRIAL INSTALLATIONS; AIR PURIFYING UNITS FOR COMMERCIAL AND INDUSTRIAL USE; INDUSTRIAL AIR FILTER MACHINES; ELECTRIC SPACE COOLING APPARATUS FOR HOUSEHOLD PURPOSES; DRYERS FOR THE REMOVAL OF WATER VAPOR FROM COMPRESSED AIR AND GASES; DRYERS USED FOR THE REMOVAL OF SOLID, LIQUID AND VAPOR CONTAMINATES FROM COMPRESSED AIR AND GASES; INDUSTRIAL DRYERS FOR HEATING AND DEHUMIDIFYING; HEAT EXCHANGERS NOT BEING PARTS OF MACHINES; DRYING APPARATUS AND INSTALLATIONS, NAMELY, COMPRESSED AIR DRYERS; COMPRESSED AIR DRYERS; AIR-COOLED ROTARY SCREW CHILLER AND AIR-COOLED ROTARY SCROLL CHILLER; WATER-TO-WATER HIGH-TEMPERATURE ENERGY-SAVING MACHINE, NAMELY, HEAT PUMPS; DIRECTLY-HEATED AIR-TO-WATER ENERGY-SAVING MACHINE, NAMELY, HEAT PUMPS; APPARATUS FOR THE EXCHANGE OF SUBSTANCES AND HEAT FOR USE IN THE PRODUCTION OF STEAM, FOR USE IN COOKING AND FOR USE IN REFRIGERATION (U.S. CLS. 13, 21, 23, 31 AND 34).

JANET LEE, EXAMINING ATTORNEY

SN 85-360,128. AQUACULTURE SYSTEMS TECHNOLOGIES, LLC, NEW ORLEANS, LA. FILED 6-30-2011.

BUBBLE BEAD

THE MARK CONSISTS OF STANDARD CHARACTERS WITHOUT CLAIM TO ANY PARTICULAR FONT, STYLE, SIZE, OR COLOR.

NO CLAIM IS MADE TO THE EXCLUSIVE RIGHT TO USE "BEAD", APART FROM THE MARK AS SHOWN.

FOR WATER TREATMENT EQUIPMENT, NAMELY, WATER FILTRATION UNITS AND BUBBLE-WASHED BEAD FILTERS; WATER FILTERS (U.S. CLS. 13, 21, 23, 31 AND 34).

FIRST USE 10-15-1995; IN COMMERCE 10-15-1995.
KIMBERLY PERRY, EXAMINING ATTORNEY

CLASS 11—(Continued).

SN 85-373,936. FSX EQUIPMENT INC., AKA FSX INC., FSX RECONDITIONING INC., GRANITE FALLS, WA. FILED 7-18-2011.

SootSucker

THE MARK CONSISTS OF STANDARD CHARACTERS WITHOUT CLAIM TO ANY PARTICULAR FONT, STYLE, SIZE, OR COLOR.

OWNER OF U.S. REG. NOS. 2,450,125 AND 3,575,627.
FOR AIR PURIFIERS; AIR FILTERS FOR USE IN INDUSTRIAL INSTALLATIONS; AIR CLEANING UNITS, NAMELY, AIR CLEANERS FOR EXTRACTING DIESEL PARTICULATE FROM FILTERS USED ON DIESEL EQUIPMENT (U.S. CLS. 13, 21, 23, 31 AND 34).
FIRST USE 6-5-2008; IN COMMERCE 6-5-2008.
TEJBIR SINGH, EXAMINING ATTORNEY

SN 85-373,950. FSX EQUIPMENT INC., AKA FSX INC., FSX RECONDITIONING INC., GRANITE FALLS, WA. FILED 7-18-2011.

TrapTester

THE MARK CONSISTS OF STANDARD CHARACTERS WITHOUT CLAIM TO ANY PARTICULAR FONT, STYLE, SIZE, OR COLOR.

OWNER OF U.S. REG. NOS. 2,450,125 AND 3,575,627.
FOR AIR CLEANING UNITS, NAMELY, AIR CLEANERS FOR EXTRACTING DIESEL PARTICULATE FROM FILTERS USED ON DIESEL EQUIPMENT (U.S. CLS. 13, 21, 23, 31 AND 34).
FIRST USE 6-5-2008; IN COMMERCE 6-5-2008.
TEJBIR SINGH, EXAMINING ATTORNEY

SN 85-373,972. FSX EQUIPMENT INC., AKA FSX INC., FSX RECONDITIONING INC., GRANITE FALLS, WA. FILED 7-18-2011.

TrapBurner

THE MARK CONSISTS OF STANDARD CHARACTERS WITHOUT CLAIM TO ANY PARTICULAR FONT, STYLE, SIZE, OR COLOR.

OWNER OF U.S. REG. NOS. 2,450,125 AND 3,575,627.
FOR AIR CLEANING UNITS, NAMELY, AIR CLEANERS FOR EXTRACTING DIESEL PARTICULATE FROM FILTERS USED ON DIESEL EQUIPMENT (U.S. CLS. 13, 21, 23, 31 AND 34).
FIRST USE 6-5-2008; IN COMMERCE 6-5-2008.
TEJBIR SINGH, EXAMINING ATTORNEY

CLASS 11—(Continued).

SN 85-383,038. LANDLORD UTILITY MANAGEMENT ASSOCIATION, LLC, RICHARDSON, TX. FILED 7-28-2011.

JEC ENERGY SAVINGS

THE MARK CONSISTS OF STANDARD CHARACTERS WITHOUT CLAIM TO ANY PARTICULAR FONT, STYLE, SIZE, OR COLOR.

NO CLAIM IS MADE TO THE EXCLUSIVE RIGHT TO USE "ENERGY SAVINGS", APART FROM THE MARK AS SHOWN.

FOR LIGHTING FIXTURES; ELECTRIC BULBS; FLUORESCENT ELECTRIC LIGHT BULBS; HALOGEN LIGHT BULBS; LED LIGHT BULBS; INDUCTION FLUORESCENT LIGHT BULBS; HIGH OUTPUT FLUORESCENT LIGHT BULBS (U.S. CLS. 13, 21, 23, 31 AND 34).
LAURIE MAYES, EXAMINING ATTORNEY

SN 85-383,829. RAB LIGHTING INC., NORTHVALE, NJ. FILED 7-28-2011.

LSLED

THE MARK CONSISTS OF STANDARD CHARACTERS WITHOUT CLAIM TO ANY PARTICULAR FONT, STYLE, SIZE, OR COLOR.

OWNER OF U.S. REG. NOS. 3,821,419, 3,843,323 AND 3,920,753.

FOR ELECTRIC LIGHTING FIXTURES; LED (LIGHT EMITTING DIODE) LIGHTING FIXTURES; LIGHTING FIXTURES (U.S. CLS. 13, 21, 23, 31 AND 34).
JAMES GRIFFIN, EXAMINING ATTORNEY

SN 85-385,136. GOLDEN DRAGON ASSOCIATION, INC., TALLAHASSEE, FL. FILED 7-29-2011.

LAUREL DESIGNS

NO CLAIM IS MADE TO THE EXCLUSIVE RIGHT TO USE "DESIGNS", APART FROM THE MARK AS SHOWN.

THE MARK CONSISTS OF THE WORDS "LAUREL DESIGNS" WITH AN IMAGE OF LAUREL IN BETWEEN THE TWO WORDS.

FOR LIGHTING FIXTURES (U.S. CLS. 13, 21, 23, 31 AND 34).
JANICE KIM, EXAMINING ATTORNEY

CLASS 11—(Continued).

SN 85-441,977. NEWTAP SYSTEMS, LLC, BIRMINGHAM, MI. FILED 10-7-2011.

NEW TAP SYSTEMS

THE MARK CONSISTS OF STANDARD CHARACTERS WITHOUT CLAIM TO ANY PARTICULAR FONT, STYLE, SIZE, OR COLOR.

NO CLAIM IS MADE TO THE EXCLUSIVE RIGHT TO USE "SYSTEMS", APART FROM THE MARK AS SHOWN.

FOR MACHINES THAT GENERATE PURIFIED WATER FROM THE ATMOSPHERE (U.S. CLS. 13, 21, 23, 31 AND 34).

NICHOLAS ALTREE, EXAMINING ATTORNEY

SN 85-474,317. MITSUBISHI ELECTRIC CORPORATION, CHIYODA-KU, TOKYO, JAPAN, FILED 11-16-2011.

ECODAN

THE MARK CONSISTS OF STANDARD CHARACTERS WITHOUT CLAIM TO ANY PARTICULAR FONT, STYLE, SIZE, OR COLOR.

FOR APPARATUS FOR HEATING, NAMELY, WATER HEATERS, RADIATORS, ELECTRIC SPACE HEATERS, ELECTRIC HEATERS FOR COMMERCIAL USE, HEATING BOILERS, HEATING INSTALLATIONS, HEATING UNITS FOR INDUSTRIAL PURPOSES, HOT-AIR SPACE HEATING APPARATUS FOR INDUSTRIAL PURPOSES; APPARATUS FOR COOLING, NAMELY, AIR COOLING APPARATUS, BEVERAGES COOLING APPARATUS, INDUSTRIAL COOLING APPARATUS, NAMELY, COMPACT COOLERS, PELTIER COOLING AND HEATING APPARATUS, SOLAR ENERGY BASED COOLING APPARATUS; APPARATUS FOR DRYING, NAMELY, DRYING APPARATUS FOR USE IN HEATING, VENTILATION SYSTEMS, AIR CONDITIONING SYSTEMS AND REFRIGERATION SYSTEMS, ELECTRIC HAND DRYING APPARATUS FOR WASHROOMS, INDUSTRIAL APPARATUS USING AIR FOR DRYING AND CLEANING COMPONENTS IN THE ELECTRONICS, SEMICONDUCTOR, CIRCUIT BOARD, PHARMACEUTICAL, MEDICAL, AND FOOD AND BEVERAGE INDUSTRIES, TOUCHLESS HAND DRYING APPARATUS, CLOTHES DRYING MACHINES; APPARATUS FOR VENTILATION, NAMELY, ELECTRIC FANS, CORDLESS FLOOR DRYING CONE DOLLY, LABORATORY VENTILATION HOODS, VENTILATION UNITS FOR COMMERCIAL FOOD PREPARATION AND FOOD SERVING; APPARATUS FOR AIR CONDITIONING; HEAT PUMP BOILERS; HEAT EXCHANGERS; HEAT PUMPS; WATER-HEATING APPARATUS, NAMELY, WATER HEATERS; SPACE-HEATING APPARATUS, NAMELY, HOT-AIR SPACE HEATING APPARATUS FOR INDUSTRIAL PURPOSES, HOT-WATER SPACE HEATING APPARATUS FOR INDUSTRIAL PURPOSES, ELECTRIC SPACE HEATERS (U.S. CLS. 13, 21, 23, 31 AND 34).

DANIEL BRODY, EXAMINING ATTORNEY

CLASS 11—(Continued).

SN 85-485,533. ROC TON MANAGEMENT GROUP LLC, DALLAS, TX. FILED 12-2-2011.

Conocopia

THE MARK CONSISTS OF STANDARD CHARACTERS WITHOUT CLAIM TO ANY PARTICULAR FONT, STYLE, SIZE, OR COLOR.

FOR RESTAURANT EQUIPMENT, NAMELY, BAKING FORM MACHINES, CONVECTION OVENS, HEATED DISPLAY CASES (U.S. CLS. 13, 21, 23, 31 AND 34).

FIRST USE 10-1-2011; IN COMMERCE 10-1-2011.

TOBY BULLOFF, EXAMINING ATTORNEY

SN 85-502,225. PARK ENVIRONMENTAL EQUIPMENT, LTD., HOUSTON, TX. FILED 12-22-2011.

GREASETROOPER

THE MARK CONSISTS OF STANDARD CHARACTERS WITHOUT CLAIM TO ANY PARTICULAR FONT, STYLE, SIZE, OR COLOR.

OWNER OF U.S. REG. NOS. 2,628,121 AND 3,190,520.
FOR GREASE CONTAINMENT DEVICE COMPRISED OF A CONTAINMENT TANK, INTERNAL BAFFLE, INLET AND OUTLET PIPING, TO INTERCEPT AND REDUCE FATS, OILS AND GREASE IN WASTEWATER TO ACCEPTABLE EFFLUENT LEVELS BEFORE THEY ENTER A MUNICIPAL SANITARY SEWER SYSTEM (U.S. CLS. 13, 21, 23, 31 AND 34).

FIRST USE 10-12-2011; IN COMMERCE 11-9-2011.

HAI-LY LAM, EXAMINING ATTORNEY

CLASS 11—(Continued).

SN 85-522,945. AQUAMOST, INC., MADISON, WI. FILED 1-23-2012.



OWNER OF U.S. REG. NO. 3,620,586.
THE COLOR(S) BLUE, GREEN AND YELLOW IS/ARE CLAIMED AS A FEATURE OF THE MARK.

THE MARK CONSISTS OF A BLUE COLORED WATER DROPLET WITH A FANCIFUL STAR IMAGE CENTERED IN THE WATER DROPLET. THE FANCIFUL STAR IMAGE IS YELLOW. FOLLOWING THE WATER DROPLET IS THE WORDING "AQUAMOST". THE "AQUA" PORTION OF THE WORDING IS IN BLUE AND THE "MOST" PORTION OF THE WORDING IS IN GREEN.

FOR INDUSTRIAL-WATER PURIFYING APPARATUS, UNITS AND INSTALLATIONS; TAP-WATER PURIFYING APPARATUS, UNITS AND INSTALLATIONS; WASTE WATER PURIFICATION APPARATUS, UNITS AND INSTALLATIONS; WATER PURIFICATION APPARATUS, UNITS AND INSTALLATIONS; WATER TREATMENT EQUIPMENT, NAMELY, DEVICES THAT USE ULTRAVIOLET LIGHT OR SUNLIGHT, AN APPLIED VOLTAGE, AND A PHOTOCATALYST TO REDUCE THE LEVEL OF CONTAMINANTS IN WATER AND OTHER SOLUTIONS (U.S. CLS. 13, 21, 23, 31 AND 34).

GEOFFREY FOSDICK, EXAMINING ATTORNEY

SN 85-523,844. SOLAR WHOLESALE, LLC, SADDLE BROOK, NJ. FILED 1-24-2012.



NO CLAIM IS MADE TO THE EXCLUSIVE RIGHT TO USE "HOME", APART FROM THE MARK AS SHOWN.

THE COLOR(S) GREEN, PINK, LIGHT PINK, GRAY, WHITE AND BLUE IS/ARE CLAIMED AS A FEATURE OF THE MARK.

THE MARK CONSISTS OF THE WORDING "LILY'S HOME" IN GREEN AND A GREEN INCOMPLETE CIRCLE WITH A PINK AND LIGHT PINK LILY AT THE BOTTOM OF THAT CIRCLE, AND WITH A GRAY TO LIGHT GRAY HOUSE WITH A WHITE DOOR OUTLINED IN GRAY, AND A GRAY WINDOW FEATURING BLUE AND WHITE ON THE INSIDE AND A GREEN ROOF OUTLINED IN GRAY INSIDE THAT CIRCLE, AND WITH SMOKE IN THE SHAPE OF GREEN LEAVES COMING OUT OF THAT HOUSE'S CHIMNEY.

FOR BATTERY OPERATED ELECTRIC CANDLES; ELECTRIC CANDLES; FLAMELESS CANDLES (U.S. CLS. 13, 21, 23, 31 AND 34).

FIRST USE 4-0-2011; IN COMMERCE 4-0-2011.
LOURDES AYALA, EXAMINING ATTORNEY

CLASS 11—(Continued).

SN 85-525,280. CULLIGAN INTERNATIONAL COMPANY, ROSEMONT, IL. FILED 1-25-2012.

QUADRA-HULL

THE MARK CONSISTS OF STANDARD CHARACTERS WITHOUT CLAIM TO ANY PARTICULAR FONT, STYLE, SIZE, OR COLOR.

FOR WATER SOFTENER RESIN TANKS (U.S. CLS. 13, 21, 23, 31 AND 34).

FIRST USE 1-1-2003; IN COMMERCE 1-1-2003.
KAREN K. BUSH, EXAMINING ATTORNEY

SN 85-526,254. CAPSTONE INDUSTRIES, INC., DEERFIELD BEACH, FL. FILED 1-26-2012.

Capstone Lighting

THE MARK CONSISTS OF STANDARD CHARACTERS WITHOUT CLAIM TO ANY PARTICULAR FONT, STYLE, SIZE, OR COLOR.

NO CLAIM IS MADE TO THE EXCLUSIVE RIGHT TO USE "LIGHTING", APART FROM THE MARK AS SHOWN. FOR ELECTRIC LIGHTING FIXTURES, NAMELY, POWER FAILURE BACKUP SAFETY LIGHTING (U.S. CLS. 13, 21, 23, 31 AND 34).

REBECCA SMITH, EXAMINING ATTORNEY

SN 85-526,981. IDEA FACTORY, INC., MENOMONEE FALLS, WI. FILED 1-27-2012.

FRESH PALS

THE MARK CONSISTS OF STANDARD CHARACTERS WITHOUT CLAIM TO ANY PARTICULAR FONT, STYLE, SIZE, OR COLOR.

FOR RINSING SYSTEMS COMPRISED OF VALVES, HOSES AND SPRAYERS FOR USE IN TUBS AND SHOWER ENCLOSURES; HAIR CATCHERS FOR DRAINS (U.S. CLS. 13, 21, 23, 31 AND 34).

ALICE BENMAMAN, EXAMINING ATTORNEY

CLASS 11—(Continued).

SN 85-531,016. CARGO MANAGEMENT ENTERPRISES, INC., DBA THE SOIREE COMPANY, CLIFTON, NJ. FILED 2-1-2012.

CLASS 11—(Continued).

SN 85-531,741. LAERA, VITO, FORT LAUDERDALE, FL. FILED 2-2-2012.

TILT

THE MARK CONSISTS OF STANDARD CHARACTERS WITHOUT CLAIM TO ANY PARTICULAR FONT, STYLE, SIZE, OR COLOR.

FOR BEVERAGE COOLING APPARATUS, NAMELY, A SOLID COOLABLE INSERT INSERTABLE INTO THE CAVITY OF A BEVERAGE CONTAINER FOR COOLING A BEVERAGE THEREIN (U.S. CLS. 13, 21, 23, 31 AND 34).

WANDA KAY PRICE, EXAMINING ATTORNEY

LINEA LAV BY VLANCO

THE MARK CONSISTS OF STANDARD CHARACTERS WITHOUT CLAIM TO ANY PARTICULAR FONT, STYLE, SIZE, OR COLOR.

OWNER OF U.S. REG. NO. 3,588,180.
NO CLAIM IS MADE TO THE EXCLUSIVE RIGHT TO USE "LINEA LAV", APART FROM THE MARK AS SHOWN.
THE ENGLISH TRANSLATION OF "LINEA" IN THE MARK IS "LINE".

FOR AUTOMATIC FAUCETS; FAUCET AERATORS; FAUCET HANDLES; FAUCET SPRAYERS; FAUCETS; FLEXIBLE PIPES BEING PARTS OF BASIN PLUMBING INSTALLATIONS; FLEXIBLE PIPES BEING PARTS OF BATH PLUMBING INSTALLATIONS; FLEXIBLE PIPES BEING PARTS OF SHOWER PLUMBING INSTALLATIONS; FLEXIBLE PIPES BEING PARTS OF SINK PLUMBING INSTALLATIONS; KITCHEN SINKS; LAVATORIES; LAVATORY BOWLS; LAVATORY SEATS; MANUALLY-OPERATED PLUMBING VALVES; MIXER FAUCETS FOR WATER PIPES; PLUMBING FITTINGS, NAMELY, AERATORS FOR FAUCETS; PLUMBING FITTINGS, NAMELY, DRAINS; PLUMBING FITTINGS, NAMELY, FAUCET FILTERS; PLUMBING FITTINGS, NAMELY, SINK STRAINERS; PLUMBING FIXTURES, NAMELY, SINK SPRAYERS; PLUMBING FIXTURES, NAMELY, SINK TRAPS; PLUMBING SUPPLIES, NAMELY, SINK STRAINERS; SHOWER FAUCET EXTENSIONS; SINGLE LEVER FIXTURES FOR LAVATORIES AND SINKS; SINK DRAINER SYSTEM COMPRISED OF A DRAIN TRAY, SINK MOUNT, KICK STAND AND ROD; SINK PEDESTALS; SINKS; SINKS INTEGRATED INTO COUNTERS OR COUNTERTOPS; STAINLESS STEEL BOTTOM GRIDS SPECIALLY ADAPTED AND SHAPED FOR USE IN SINKS; STRAINERS FOR PLUMBING DRAINS; TAP WATER FAUCETS; TAPS; WATER FAUCET SPOUT (U.S. CLS. 13, 21, 23, 31 AND 34).

FIRST USE 1-1-2007; IN COMMERCE 1-1-2007.
WON TEAK OH, EXAMINING ATTORNEY

SN 85-531,182. FOCAL POINT, L.L.C, CHICAGO, IL. FILED 2-1-2012.

THEORY

THE MARK CONSISTS OF STANDARD CHARACTERS WITHOUT CLAIM TO ANY PARTICULAR FONT, STYLE, SIZE, OR COLOR.

FOR ELECTRIC LIGHTING FIXTURES (U.S. CLS. 13, 21, 23, 31 AND 34).
KATHERINE E. HALMEN, EXAMINING ATTORNEY

CLASS 11—(Continued).

SN 85-531,746. LAERA, VITO, FORT LAUDERDALE, FL. FILED 2-2-2012.

LINEA CUCINA BY VLANCO

THE MARK CONSISTS OF STANDARD CHARACTERS WITHOUT CLAIM TO ANY PARTICULAR FONT, STYLE, SIZE, OR COLOR.

OWNER OF U.S. REG. NO. 3,588,180.

NO CLAIM IS MADE TO THE EXCLUSIVE RIGHT TO USE "LINEA CUCINA", APART FROM THE MARK AS SHOWN.

THE ENGLISH TRANSLATION OF "LINEA CUCINA" IN THE MARK IS "KITCHEN LINE".

FOR FAUCET AERATORS; FAUCET HANDLES; FAUCET SPRAYERS; FAUCETS; FLEXIBLE PIPES BEING PARTS OF BASIN PLUMBING INSTALLATIONS; FLEXIBLE PIPES BEING PARTS OF BATH PLUMBING INSTALLATIONS; FLEXIBLE PIPES BEING PARTS OF SHOWER PLUMBING INSTALLATIONS; FLEXIBLE PIPES BEING PARTS OF SINK PLUMBING INSTALLATIONS; KITCHEN SINK SPRAYERS; KITCHEN SINKS; LAVATORIES; LAVATORY BOWLS; LAVATORY SEATS; MANUALLY-OPERATED PLUMBING VALVES; MIXER FAUCETS FOR WATER PIPES; PLUMBING FITTINGS, NAMELY, AERATORS FOR FAUCETS; PLUMBING FITTINGS, NAMELY, BAFFLES; PLUMBING FITTINGS, NAMELY, BIBBS; PLUMBING FITTINGS, NAMELY, COCKS; PLUMBING FITTINGS, NAMELY, COUPLERS; PLUMBING FITTINGS, NAMELY, DRAINS; PLUMBING FITTINGS, NAMELY, FAUCET FILTERS; PLUMBING FITTINGS, NAMELY, FRESH WATER FILLS FOR RECREATIONAL VEHICLES; PLUMBING FITTINGS, NAMELY, SHOWER CONTROL VALVES; PLUMBING FITTINGS, NAMELY, SINK STRAINERS; PLUMBING FITTINGS, NAMELY, TRAPS; PLUMBING FITTINGS, NAMELY, TUB CONTROL VALVES; PLUMBING FITTINGS, NAMELY, VALVES; PLUMBING FIXTURES, NAMELY, SHOWER MIXERS; PLUMBING FIXTURES, NAMELY, SHOWER SPRAYERS; PLUMBING FIXTURES, NAMELY, SINK SPRAYERS; PLUMBING FIXTURES, NAMELY, SINK TRAPS; PLUMBING SUPPLIES, NAMELY, SINK STRAINERS; SHOWER FAUCET EXTENSIONS; SINGLE LEVER FIXTURES FOR LAVATORIES AND SINKS; SINK PEDESTALS; SINKS; SINKS INTEGRATED INTO COUNTERS OR COUNTERTOPS; STAINLESS STEEL BOTTOM GRIDS SPECIALLY ADAPTED AND SHAPED FOR USE IN SINKS; STRAINERS FOR PLUMBING DRAINS; TAP WATER FAUCETS; TAPS; WATER FAUCET SPOUT (U.S. CLS. 13, 21, 23, 31 AND 34).

FIRST USE 1-1-2007; IN COMMERCE 1-1-2007.

WON TEAK OH, EXAMINING ATTORNEY

SN 85-531,755. ISI TECHNOLOGY, LLC, SULLIVAN'S ISLAND, SC. FILED 2-2-2012.

HEATWORKS

THE MARK CONSISTS OF STANDARD CHARACTERS WITHOUT CLAIM TO ANY PARTICULAR FONT, STYLE, SIZE, OR COLOR.

FOR WATER HEATERS FOR DOMESTIC AND COMMERCIAL USE (U.S. CLS. 13, 21, 23, 31 AND 34).

JORDAN BAKER, EXAMINING ATTORNEY

CLASS 11—(Continued).

SN 85-531,970. NORWALK WASTEWATER EQUIPMENT COMPANY, NORWALK, OH. FILED 2-2-2012.

HYDRO-KINETIC

THE MARK CONSISTS OF STANDARD CHARACTERS WITHOUT CLAIM TO ANY PARTICULAR FONT, STYLE, SIZE, OR COLOR.

FOR WASTE WATER TREATMENT TANKS (U.S. CLS. 13, 21, 23, 31 AND 34).

JAY FLOWERS, EXAMINING ATTORNEY

SN 85-532,136. STORM DRAIN TECHNOLOGIES, L.L.C., OCEAN, NJ. FILED 2-2-2012.

Aqualete

THE MARK CONSISTS OF STANDARD CHARACTERS WITHOUT CLAIM TO ANY PARTICULAR FONT, STYLE, SIZE, OR COLOR.

FOR EXTERNAL FILTERING DEVICE FOR USE IN A LOCAL CONTAINMENT AREA FOR REMOVING OIL AND OTHER CONTAMINANTS FROM STORM DRAIN EFFLUENT AS IT EXITS STORM WATER SYSTEMS; WATER PURIFICATION AND FILTRATION APPARATUS; WATER PURIFICATION, SEDIMENTATION AND FILTRATION APPARATUS FOR CLARIFICATION, THICKENING AND FILTRATION OF WATER, WASTE WATER AND INDUSTRIAL WATER; WATER TREATMENT EQUIPMENT, NAMELY, WATER FILTRATION UNITS (U.S. CLS. 13, 21, 23, 31 AND 34).

FIRST USE 6-1-2011; IN COMMERCE 7-1-2011.

ANNE E. GUSTASON, EXAMINING ATTORNEY

SN 85-533,034. HENSON, MICHAEL, BAKERSFIELD, CA. FILED 2-3-2012.

SWEET PEA

THE MARK CONSISTS OF STANDARD CHARACTERS WITHOUT CLAIM TO ANY PARTICULAR FONT, STYLE, SIZE, OR COLOR.

FOR URINALS FOR OUTDOOR USE (U.S. CLS. 13, 21, 23, 31 AND 34).

SALLY SHIH, EXAMINING ATTORNEY

CLASS 11—(Continued).

SN 85-533,074. YOR EQUIPMENT INC, REDLANDS, CA. FILED 2-3-2012.

Microglaze

THE MARK CONSISTS OF STANDARD CHARACTERS WITHOUT CLAIM TO ANY PARTICULAR FONT, STYLE, SIZE, OR COLOR.
FOR DENTAL OVENS (U.S. CLS. 13, 21, 23, 31 AND 34).
AMY C. KEAN, EXAMINING ATTORNEY

SN 85-533,346. CARGO MANAGEMENT ENTERPRISES, INC., DBA THE SOIREE COMPANY, CLIFTON, NJ. FILED 2-3-2012.

DIMPLE

THE MARK CONSISTS OF STANDARD CHARACTERS WITHOUT CLAIM TO ANY PARTICULAR FONT, STYLE, SIZE, OR COLOR.
FOR BEVERAGE COOLING APPARATUS, NAMELY A SOLID COOLABLE INSERT INSERTABLE INTO THE CAVITY OF A BEVERAGE CONTAINER FOR COOLING A BEVERAGE THEREIN (U.S. CLS. 13, 21, 23, 31 AND 34).
WANDA KAY PRICE, EXAMINING ATTORNEY

SN 85-533,621. WEST MARINE PRODUCTS, INC., WATSONVILLE, CA. FILED 2-3-2012.



THE MARK CONSISTS OF A SHARK.
FOR BARBECUE SMOKERS, ELECTRIC FOOD DEHYDRATORS, DEEP FAT FRYERS, HEADLAMPS FOR BOATS (U.S. CLS. 13, 21, 23, 31 AND 34).
WILLIAM VERHOSEK, EXAMINING ATTORNEY

CLASS 11—(Continued).

SN 85-534,366. ARMSTRONG GLOBAL HOLDINGS, INC., STUART, FL. FILED 2-6-2012.

DIGITAL-FLO

THE MARK CONSISTS OF STANDARD CHARACTERS WITHOUT CLAIM TO ANY PARTICULAR FONT, STYLE, SIZE, OR COLOR.
OWNER OF U.S. REG. NOS. 3,650,343, 4,069,879 AND OTHERS.
FOR WATER HEATERS (U.S. CLS. 13, 21, 23, 31 AND 34).
ANDREW LEASER, EXAMINING ATTORNEY

SN 85-534,396. WILLIAMS, ROGER E., BIRMINGHAM, AL. FILED 2-6-2012.

The Boss

THE MARK CONSISTS OF STANDARD CHARACTERS WITHOUT CLAIM TO ANY PARTICULAR FONT, STYLE, SIZE, OR COLOR.
FOR PORTABLE GAS SPACE HEATER (U.S. CLS. 13, 21, 23, 31 AND 34).
DAVID C. REIHNER, EXAMINING ATTORNEY

SN 85-535,189. SUPERIOR FIBERS, LLC, DBA SUPERIOR FIBERS, BREMEN, OH. FILED 2-6-2012.



THE COLOR(S) BLUE AND GREEN IS/ARE CLAIMED AS A FEATURE OF THE MARK.
THE MARK CONSISTS OF THE WORD "EPURE" WITH THE FIRST LETTER "E" IN BLUE AND THE LETTERS "P", "U", "R" AND "E" IN GREEN.
FOR AIR CLEANING UNITS CONTAINING AN AIR FILTER, ULTRAVIOLET LIGHTS AND A PHOTOCATALYTIC FILTER; AIR FILTERS FOR AIR CONDITIONING UNITS; AIR FILTERS FOR DOMESTIC USE; AIR FILTERS FOR INDUSTRIAL INSTALLATIONS; AIR PURIFYING APPARATUS; FILTERS AND FILTERING DEVICES FOR AIR AND GAS CONDITIONING; FILTERS FOR AIR CONDITIONING; FILTERS FOR AIR EXTRACTOR HOODS; HOUSEHOLD AIR CLEANERS; INDUSTRIAL AIR FILTER MACHINES (U.S. CLS. 13, 21, 23, 31 AND 34).
FIRST USE 1-23-2012; IN COMMERCE 1-23-2012.
ADA HAN, EXAMINING ATTORNEY

CLASS 11—(Continued).

SN 85-535,841. ECOCAMEL LIMITED, LONDON, UNITED KINGDOM, FILED 2-7-2012.

ECOCAMEL

THE MARK CONSISTS OF STANDARD CHARACTERS WITHOUT CLAIM TO ANY PARTICULAR FONT, STYLE, SIZE, OR COLOR.

FOR SHOWERHEADS AND COMPONENTS THEREOF (U.S. CLS. 13, 21, 23, 31 AND 34).

FIRST USE 2-0-2009; IN COMMERCE 2-0-2009.

JANICE L. MCMORROW, EXAMINING ATTORNEY

CLASS 11—(Continued).

SN 85-536,712. SELECTURE, INC., COPPELL, TX. FILED 2-8-2012.

SELECTURE

THE MARK CONSISTS OF STANDARD CHARACTERS WITHOUT CLAIM TO ANY PARTICULAR FONT, STYLE, SIZE, OR COLOR.

FOR ELECTRIC FANS (U.S. CLS. 13, 21, 23, 31 AND 34).

FIRST USE 2-6-2012; IN COMMERCE 2-6-2012.

JACQUELINE A. LAVINE, EXAMINING ATTORNEY

SN 85-535,858. FOXFURY LLC, DBA FOXFURY, VISTA, CA. FILED 2-7-2012.

BREAKTHROUGH

THE MARK CONSISTS OF STANDARD CHARACTERS WITHOUT CLAIM TO ANY PARTICULAR FONT, STYLE, SIZE, OR COLOR.

FOR FLASHLIGHTS (U.S. CLS. 13, 21, 23, 31 AND 34).

KATHY DE JONGE, EXAMINING ATTORNEY

SN 85-536,951. LAMI PRODUCTS INC., HUNTINGDON VALLEY, PA. FILED 2-8-2012.

Fill 'n Brew

THE MARK CONSISTS OF STANDARD CHARACTERS WITHOUT CLAIM TO ANY PARTICULAR FONT, STYLE, SIZE, OR COLOR.

FOR COFFEE FILTERS NOT OF PAPER BEING PART OF ELECTRIC COFFEE MAKERS (U.S. CLS. 13, 21, 23, 31 AND 34).

FIRST USE 5-3-2011; IN COMMERCE 1-8-2012.

DOMINICK J. SALEMI, EXAMINING ATTORNEY

SN 85-536,707. SELECTURE, INC., COPPELL, TX. FILED 2-8-2012.

SELECTURE

THE MARK CONSISTS OF STANDARD CHARACTERS WITHOUT CLAIM TO ANY PARTICULAR FONT, STYLE, SIZE, OR COLOR.

FOR ELECTRIC HEATERS FOR COMMERCIAL USE; ELECTRIC RADIANT HEATERS; ELECTRIC SPACE HEATERS; PORTABLE ELECTRIC HEATERS (U.S. CLS. 13, 21, 23, 31 AND 34).

JACQUELINE A. LAVINE, EXAMINING ATTORNEY

SN 85-537,545. ELECTRONICS TRADEMARK HOLDING COMPANY, LLC, HAUPPAUGE, NY. FILED 2-8-2012.

ADVENT

THE MARK CONSISTS OF STANDARD CHARACTERS WITHOUT CLAIM TO ANY PARTICULAR FONT, STYLE, SIZE, OR COLOR.

FOR MICROWAVE OVENS (U.S. CLS. 13, 21, 23, 31 AND 34).

FIRST USE 6-17-2011; IN COMMERCE 6-17-2011.

ASMAT KHAN, EXAMINING ATTORNEY

CLASS 11—(Continued).

SN 85-537,814. FRANK BLATERI, COPPELL, TX. FILED 2-9-2012.



THE COLOR(S) RED, WHITE, AND BLUE IS/ARE CLAIMED AS A FEATURE OF THE MARK.

THE MARK CONSISTS OF A DARK BLUE SPHERE, DRAPED IN THE CENTER WITH A CURLED RED AND WHITE STRIPED RIBBON.

FOR ELECTRIC FANS; ELECTRIC SPACE HEATERS; PORTABLE ELECTRIC FANS; PORTABLE ELECTRIC HEATERS (U.S. CLS. 13, 21, 23, 31 AND 34).

KEVEN MITTLER, EXAMINING ATTORNEY

CLASS 11—(Continued).

SN 85-538,973. I.D.E. TECHNOLOGIES LTD., KADIMA, ISRAEL, FILED 2-10-2012.

IDE PROGREEN

THE MARK CONSISTS OF STANDARD CHARACTERS WITHOUT CLAIM TO ANY PARTICULAR FONT, STYLE, SIZE, OR COLOR.

OWNER OF ERPN CMNTY TM OFC REG. NO. 010255651, DATED 1-15-2012, EXPIRES 9-11-2021.

FOR DESALINATION UNITS; FAUCETS; FILTERS FOR DRINKING WATER; HOT WATER TANKS; PIPES BEING PARTS OF SANITARY FACILITIES; PLUMBING FITTINGS, NAMELY, VALVES; WATER DESALINATION PLANTS; WATER FILTERING APPARATUS; WATER FILTERING UNITS FOR DOMESTIC AND INDUSTRIAL USE; WATER FILTERS; WATER PURIFICATION INSTALLATIONS (U.S. CLS. 13, 21, 23, 31 AND 34).

CURTIS FRENCH, EXAMINING ATTORNEY

SN 85-538,241. ENERGY INDEPENDENCE PARTNERS, LLC, NY, NY. FILED 2-9-2012.

WETWORKS

THE MARK CONSISTS OF STANDARD CHARACTERS WITHOUT CLAIM TO ANY PARTICULAR FONT, STYLE, SIZE, OR COLOR.

FOR WATER PURIFICATION, SEDIMENTATION AND FILTRATION APPARATUS FOR CLARIFICATION, THICKENING AND FILTRATION OF WATER, WASTE WATER AND INDUSTRIAL WATER (U.S. CLS. 13, 21, 23, 31 AND 34).

KAREN K. BUSH, EXAMINING ATTORNEY

SN 85-539,075. ELECTRONIC CUSTOM DISTRIBUTORS, INC., HOUSTON, TX. FILED 2-10-2012.

LEDBETTER BY DIRECTCONNECT

THE MARK CONSISTS OF STANDARD CHARACTERS WITHOUT CLAIM TO ANY PARTICULAR FONT, STYLE, SIZE, OR COLOR.

FOR LED LIGHTING SYSTEMS, NAMELY, LED MODULES, POWER SUPPLIES, AND WIRING (U.S. CLS. 13, 21, 23, 31 AND 34).

FIRST USE 12-27-2011; IN COMMERCE 12-27-2011.

JAMES GRIFFIN, EXAMINING ATTORNEY

CLASS 11—(Continued).

SN 85-541,326. LAERA, VITO, FORT LAUDERDALE, FL. FILED 2-13-2012.

LOUVRE

THE MARK CONSISTS OF STANDARD CHARACTERS WITHOUT CLAIM TO ANY PARTICULAR FONT, STYLE, SIZE, OR COLOR.

FOR FAUCET AERATORS; FAUCET HANDLES; FAUCET SPRAYERS; FAUCETS; KITCHEN SINK SPRAYERS; KITCHEN SINKS; PLUMBING FITTINGS, NAMELY, AERATORS FOR FAUCETS; PLUMBING FITTINGS, NAMELY, DRAINS; PLUMBING FITTINGS, NAMELY, FAUCET FILTERS; PLUMBING FITTINGS, NAMELY, SINK STRAINERS; PLUMBING FIXTURES, NAMELY, SINK SPRAYERS; PLUMBING FIXTURES, NAMELY, SINK TRAPS; PLUMBING SUPPLIES, NAMELY, SINK STRAINERS; SINGLE LEVER FIXTURES FOR LAVATORIES AND SINKS; SINKS; SINKS INTEGRATED INTO COUNTERS OR COUNTERTOPS; STAINLESS STEEL BOTTOM GRIDS SPECIALLY ADAPTED AND SHAPED FOR USE IN SINKS; TAP WATER FAUCETS; TAPS (U.S. CLS. 13, 21, 23, 31 AND 34).

FIRST USE 1-1-2007; IN COMMERCE 1-1-2007.
WON TEAK OH, EXAMINING ATTORNEY

SN 85-578,071. 3FORM INC., SALT LAKE CITY, UT. FILED 3-23-2012.

3FORM VIVID

THE MARK CONSISTS OF STANDARD CHARACTERS WITHOUT CLAIM TO ANY PARTICULAR FONT, STYLE, SIZE, OR COLOR.

FOR LIGHTING FIXTURES (U.S. CLS. 13, 21, 23, 31 AND 34).

KRISTINA MORRIS, EXAMINING ATTORNEY

CLASS 11—(Continued).

SN 85-581,501. AFKA GROUP INTERNATIONAL, INC., WILDOMAR, CA. FILED 3-27-2012.

ODYNE

THE MARK CONSISTS OF STANDARD CHARACTERS WITHOUT CLAIM TO ANY PARTICULAR FONT, STYLE, SIZE, OR COLOR.

FOR HOME APPLIANCES, NAMELY, REFRIGERATORS, FREEZERS, AIR CONDITIONERS, MICROWAVE OVENS, ELECTRIC TOASTERS, ELECTRIC TOASTER OVENS, COOKING OVENS, WINE COOLERS IN THE NATURE OF REFRIGERATED CABINETS CONTAINING RACKS FOR WINE BOTTLES, ELECTRIC COFFEE MAKERS; LAUNDRY CENTERS, NAMELY, A CLOTHES DRYER COMBINED WITH A CLOTHES WASHER (U.S. CLS. 13, 21, 23, 31 AND 34).

FIRST USE 1-30-2009; IN COMMERCE 1-30-2009.
AHSEN KHAN, EXAMINING ATTORNEY

SN 85-586,147. AS IP HOLDCO, LLC, PISCATAWAY, NJ. FILED 4-2-2012.

ALEJANDRA

THE MARK CONSISTS OF STANDARD CHARACTERS WITHOUT CLAIM TO ANY PARTICULAR FONT, STYLE, SIZE, OR COLOR.

FOR FAUCETS; LAVATORIES; TOILETS (U.S. CLS. 13, 21, 23, 31 AND 34).

TARAH HARDY, EXAMINING ATTORNEY

SN 85-595,822. NAIL ALLIANCE, LLC, GLADSTONE, MO. FILED 4-12-2012.

18G

THE MARK CONSISTS OF STANDARD CHARACTERS WITHOUT CLAIM TO ANY PARTICULAR FONT, STYLE, SIZE, OR COLOR.

FOR APPARATUS FOR DRYING/HARDENING NAIL FINISHES, POLISHES AND VARNISHES, INCLUDING DESICCATE APPARATUS, DRYING APPARATUS, LED TYPE NAIL DRYERS, DRYING APPARATUS AND INSTALLATIONS, AND LAMPS (U.S. CLS. 13, 21, 23, 31 AND 34).

FIRST USE 10-31-2011; IN COMMERCE 10-31-2011.
JAMES GRIFFIN, EXAMINING ATTORNEY

CLASS 12—VEHICLES

SN 76-707,798. ASSEMBLED PRODUCTS CORPORATION, ROGERS, AR. FILED 5-31-2011.



OWNER OF U.S. REG. NO. 1,771,318.
 NO CLAIM IS MADE TO THE EXCLUSIVE RIGHT TO USE "CART", APART FROM THE MARK AS SHOWN.
 THE MARK CONSISTS OF THE IMAGE OF A WHEEL CHAIR WITH A SHOPPING CART ATTACHED TO IT AND THE STYLIZED WORDING "HANDY CART" BELOW WHICH APPEARS THE WORDING "BY MART CART".
 FOR ATTACHABLE SHOPPING CARTS FOR USE WITH WHEEL CHAIRS (U.S. CLS. 19, 21, 23, 31, 35 AND 44).
 DANIEL CAPSHAW, EXAMINING ATTORNEY

SN 77-596,493. ARELLANO REYES, JOSÉ LUIS, ESCOBEDO, NUEVO LEÓN, MEXICO, FILED 10-20-2008.



PRIORITY CLAIMED UNDER SEC. 44(D) ON MEXICO APPLICATION NO. 953591, FILED 8-8-2008, REG. NO. 1060186, DATED 8-9-2008, EXPIRES 8-8-2018.
 THE COLOR(S) LIGHT PURPLE, DARK PURPLE, AND WHITE IS/ARE CLAIMED AS A FEATURE OF THE MARK.
 THE MARK CONSISTS OF THE WORD "LUXOTIK", IN STYLIZED LIGHT PURPLE LETTERS, WITH DARK PURPLE SHADOWING AND WHITE HIGHLIGHTING.
 FOR TIRES; VEHICLE WHEEL RIMS AND STRUCTURAL PARTS THEREFOR (U.S. CLS. 19, 21, 23, 31, 35 AND 44).
 JIM RINGLE, EXAMINING ATTORNEY

CLASS 12—(Continued).

SN 79-090,625. JIAXING XINGTENG CASTER CO.,LTD., CHINA, FILED 11-23-2010.



OWNER OF INTERNATIONAL REGISTRATION 1060152 DATED 11-23-2010, EXPIRES 11-23-2020.
 THE MARK CONSISTS OF THE LETTER "X" INSIDE OF A LUGGAGE OR CART WHEEL DESIGN APPEARING ABOVE THE WORD "TENG".
 FOR MINE CART WHEELS; LUGGAGE HAND TRUCKS; HAND CARTS; WHEELCHAIRS; WHEELBARROWS; CARTS; CASTORS FOR HAND CARTS; SHOPPING CARTS; FOLDING LUGGAGE WHEEL BARROW; GOODS HANDLING CARTS (U.S. CLS. 19, 21, 23, 31, 35 AND 44).
 ALEXANDER L. POWERS, EXAMINING ATTORNEY

SN 79-102,016. SIESTA SYSTEMS, S.A, SPAIN, FILED 7-11-2011.



PRIORITY DATE OF 3-14-2011 IS CLAIMED.
 OWNER OF INTERNATIONAL REGISTRATION 1089229 DATED 7-11-2011, EXPIRES 7-11-2021.
 THE COLOR(S) GRAY AND BLUE IS/ARE CLAIMED AS A FEATURE OF THE MARK.
 THE MARK CONSISTS OF THE FOLLOWING: THE COLOR GRAY IS FOUND IN THE WORDING "SIEST" AND THE COLOR BLUE IS FOUND IN THE WORDING "UP".
 FOR HEAD-RESTS FOR VEHICLE SEATS (U.S. CLS. 19, 21, 23, 31, 35 AND 44).
 ANNE E. GUSTASON, EXAMINING ATTORNEY

CLASS 12—(Continued).

SN 79-104,999. ME-MOVER APS, DK-2610 RØDOVRE, DENMARK, FILED 10-17-2011.

ME-MOVER

THE MARK CONSISTS OF STANDARD CHARACTERS WITHOUT CLAIM TO ANY PARTICULAR FONT, STYLE, SIZE, OR COLOR.

OWNER OF INTERNATIONAL REGISTRATION 1096684 DATED 10-17-2011, EXPIRES 10-17-2021.

FOR LAND VEHICLES, NAMELY, BICYCLES AND BICYCLE TRAILERS; APPARATUS FOR LOCOMOTION BY LAND, AIR OR WATER, NAMELY BICYCLES (U.S. CLS. 19, 21, 23, 31, 35 AND 44).

RAUL CORDOVA, EXAMINING ATTORNEY

CLASS 12—(Continued).

SN 79-109,183. DISC BRAKES AUSTRALIA PTY LIMITED, SILVERWATER NSW 2128, AUSTRALIA, FILED 9-30-2011.



PRIORITY DATE OF 4-1-2011 IS CLAIMED. OWNER OF INTERNATIONAL REGISTRATION 1106884 DATED 9-30-2011, EXPIRES 9-30-2021.

THE COLOR(S) RED, WHITE AND BLACK IS/ARE CLAIMED AS A FEATURE OF THE MARK.

THE MARK CONSISTS OF WORDING "T3" IN STYLIZED FONT, SHOWN IN WHITE, WITH THE "3" OUTLINED IN RED, AND WITH THE RED OUTLINE AROUND THE MIDDLE AND LOWER PARTS OF THE "3" EXTENDING LEFTWARD TOWARD THE "T", WITH THE ENTIRE "T3" SURROUNDED BY A BLACK OUTLINE, AND WITH A CURVED, VERTICAL RED LINE TO THE RIGHT OF THE "T3", BROKEN IN THE MIDDLE, WITH A SMALLER, RED CURVED LINE BISECTING THE VERTICAL RED LINE.

FOR DISC BRAKES FOR LAND VEHICLES; BRAKE PARTS FOR VEHICLES, NAMELY, DISC BRAKE ROTORS AND DISC BRAKES; DISC BRAKE ROTORS FOR VEHICLES; DISC BRAKE PADS FOR VEHICLES (U.S. CLS. 19, 21, 23, 31, 35 AND 44).

ESTHER BELENKER, EXAMINING ATTORNEY

SN 79-107,719. DRETTMANN YACHTS GMBH, FED REP GERMANY, FILED 7-25-2011.



OWNER OF INTERNATIONAL REGISTRATION 1103058 DATED 7-25-2011, EXPIRES 7-25-2021.

THE COLOR(S) BLACK, BEIGE, WHITE, GREY IS/ARE CLAIMED AS A FEATURE OF THE MARK.

THE MARK CONSISTS OF THE STYLIZED LETTERS "DY", THE LEFT PORTION OF THE DESIGN IS IN VARYING SHADES OF THE COLORS BEIGE AND WHITE, AND THE RIGHT SIDE OF THE DESIGN IN THE COLORS BLACK, GREY, AND WHITE.

FOR VEHICLES, NAMELY, BOATS; APPARATUS FOR LOCOMOTION BY WATER, NAMELY, BOATS (U.S. CLS. 19, 21, 23, 31, 35 AND 44).

DAVID HOFFMAN, EXAMINING ATTORNEY

SN 85-256,661. HILMAN, INC., MARLBORO, NJ. FILED 3-3-2011.

SN 79-107,721. DRETTMANN YACHTS GMBH, FED REP GERMANY, FILED 7-25-2011.



OWNER OF INTERNATIONAL REGISTRATION 1103060 DATED 7-25-2011, EXPIRES 7-25-2021.

NO CLAIM IS MADE TO THE EXCLUSIVE RIGHT TO USE "YACHTS", APART FROM THE MARK AS SHOWN.

THE COLOR(S) BLACK, BEIGE, WHITE, GREY IS/ARE CLAIMED AS A FEATURE OF THE MARK.

THE MARK CONSISTS OF THE STYLIZED LETTERS "DY" ABOVE THE WORDING "DRETTMAN YACHTS" IN BLACK. THE LEFT PORTION OF THE DESIGN IS IN VARYING SHADES OF THE COLORS BEIGE AND WHITE, AND THE RIGHT SIDE OF THE DESIGN IN THE COLORS BLACK, GREY, AND WHITE.

FOR VEHICLES, NAMELY, BOATS; APPARATUS FOR LOCOMOTION BY WATER, NAMELY, BOATS (U.S. CLS. 19, 21, 23, 31, 35 AND 44).

DAVID HOFFMAN, EXAMINING ATTORNEY

HILMAN ROLLERS

THE MARK CONSISTS OF STANDARD CHARACTERS WITHOUT CLAIM TO ANY PARTICULAR FONT, STYLE, SIZE, OR COLOR.

NO CLAIM IS MADE TO THE EXCLUSIVE RIGHT TO USE "ROLLERS", APART FROM THE MARK AS SHOWN.

SEC. 2(F).

FOR NON-MOTORIZED LOAD-CARRYING DEVICES, NAMELY, ROLLER MECHANISMS IN THE NATURE OF DOLLIES AND WHEELED PLATFORMS WITH NON-MOTORIZED WHEELS FOR MOVING MACHINERY AND OTHER HEAVY OBJECTS; DOLLIES FOR MOVING LOADS (U.S. CLS. 19, 21, 23, 31, 35 AND 44).

FIRST USE 0-0-1980; IN COMMERCE 0-0-1980.

ROBIN MITTLER, EXAMINING ATTORNEY

CLASS 12—(Continued).

SN 85-305,390. YUKON TRAIL INC., ONTARIO, CA. FILED 4-26-2011.

YUKON TRAIL

THE MARK CONSISTS OF STANDARD CHARACTERS WITHOUT CLAIM TO ANY PARTICULAR FONT, STYLE, SIZE, OR COLOR.

FOR PARTS AND ACCESSORIES FOR CARS AND TRUCKS, NAMELY, TONNEAU COVERS, PICKUP TRUCK CAPS, RACKS, NAMELY, AUTOMOBILE ROOF RACKS, RAILS, NAMELY, GUIDE RAILS FOR TRUCK BEDS, FITTED TRUCK BED LINERS, TRUCK VAULTS, NAMELY, LOCK BOXES SPECIALLY ADAPTED FOR USE IN VEHICLES, TAILGATE ACCESSORIES, NAMELY, RETRACTABLE TAILGATE BENCHES AND CAB AND CARGO ORGANIZERS, NAMELY, TRUCK BED STORAGE ORGANIZERS (U.S. CLS. 19, 21, 23, 31, 35 AND 44).

FIRST USE 3-1-2010; IN COMMERCE 3-1-2010.
WANDA KAY PRICE, EXAMINING ATTORNEY



SN 85-359,907. AVIATION PARTNERS, INC., SEATTLE, WA. FILED 6-29-2011.

SCIMITAR

THE MARK CONSISTS OF STANDARD CHARACTERS WITHOUT CLAIM TO ANY PARTICULAR FONT, STYLE, SIZE, OR COLOR.

FOR STRUCTURAL PARTS OF AIRCRAFT, NAMELY, WINGTIPS AND WINGLETS (U.S. CLS. 19, 21, 23, 31, 35 AND 44).

MARK SPARACINO, EXAMINING ATTORNEY

CLASS 12—(Continued).

SN 85-362,753. YANFENG VISTEON AUTOMOTIVE TRIM SYSTEMS CO., LTD., SHANGHAI, CHINA, FILED 7-5-2011.

YANFENG

THE MARK CONSISTS OF STANDARD CHARACTERS WITHOUT CLAIM TO ANY PARTICULAR FONT, STYLE, SIZE, OR COLOR.

FOR VEHICLE PARTS, COMPONENTS AND ACCESSORIES, NAMELY, STRUCTURAL VEHICLE INTERIOR PARTS FOR LAND VEHICLES, NAMELY, COCKPITS CONSISTING OF INSTRUMENT PANELS, SWITCH MODULES, STEERING COLUMNS, VEHICLE AIRBAGS, SENSORS, HEATING, VENTILATION AND AIR CONDITIONING SYSTEMS, NAVIGATION MODULES, AUDIO SYSTEMS AND WIRE HARNESSSES ASSEMBLED AS A MODULE; INSTRUMENT PANELS, CONSOLES AND PILLARS; DOOR PANELS FOR VEHICLES; VEHICLE SEATS; AUTOMOTIVE VEHICLE PARTS, NAMELY, HEADLINERS AND STEERING WHEELS; VEHICLE SAFETY AIRBAGS, NAMELY, DRIVER AIRBAGS, PASSENGER AIRBAGS, SIDE AIRBAGS AND CURTAIN AIRBAGS; SEAT BELTS, STEPLESS LOAD-LIMITER SEAT BELTS, MULTI-STOP LOAD LIMITER SEAT BELTS AND PRETENSIONER SEAT BELTS ALL FOR USE IN VEHICLES; STRUCTURAL PARTS FOR VEHICLES, NAMELY, BUMPERS, FENDERS, RADIATOR GRILLS; BODY TRIM FOR AUTOMOBILES, NAMELY, ROCK PANELS, ANTI-SCRAPING PANELS, AND WHEEL TRIM; REAR CLOSURES, NAMELY, REAR PARCEL SHELVES; FRONT-END MODULES, NAMELY, ENGINE BRACKETS, COOLING WATER TANKS AND AIR CONDITIONING EVAPORATORS ASSEMBLED AS A MODULE (U.S. CLS. 19, 21, 23, 31, 35 AND 44).

FIRST USE 5-14-2011; IN COMMERCE 5-14-2011.
DAVID MURRAY, EXAMINING ATTORNEY

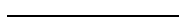

SN 85-369,421. VAUGHN C. JEWELL, CONYERS, GA. FILED 7-12-2011.

TRU-LITE

THE MARK CONSISTS OF STANDARD CHARACTERS WITHOUT CLAIM TO ANY PARTICULAR FONT, STYLE, SIZE, OR COLOR.

FOR AUTOMOTIVE PARTS, NAMELY, FLYWHEELS, LIGHT WEIGHT FLYWHEELS, AND ALUMINUM FLYWHEELS (U.S. CLS. 19, 21, 23, 31, 35 AND 44).

FIRST USE 7-2-2006; IN COMMERCE 7-2-2006.
ALLISON SCHRODY, EXAMINING ATTORNEY

CLASS 12—(Continued).

SN 85-369,682. FOX FACTORY, INC., WATSONVILLE, CA. FILED 7-12-2011.



NO CLAIM IS MADE TO THE EXCLUSIVE RIGHT TO USE "RACING SHOCKS" OR "SERIES", APART FROM THE MARK AS SHOWN.

THE MARK CONSISTS OF A STYLIZED BROKEN CIRCLE WITH THE WORD "FOX" IN THE CENTER AND A WHITE-TIPPED FOX TAIL EXTENDED THROUGH THE CENTER OF THE LETTER "O" IN THE WORD "FOX" AND TO THE RIGHT, "EVOLUTION" (WORD) WITH A PARTIAL STYLIZED UNDERLINE OF ALTERNATING BLACK AND WHITE SQUARES AND "SERIES" (WORD) BELOW, AND TO THE FAR RIGHT, "FOX RACING SHOX" (WORDS) STACKED ON TOP OF EACH OTHER IN STRIPES ORIGINATING FROM THE BROKEN CIRCLE, THE MIDDLE STRIPE BROKEN BY "EVOLUTION", THE UNDERLINING, AND "SERIES".

FOR SUSPENSION SYSTEMS FOR VEHICLES, NAMELY, BICYCLES AND MOTOR VEHICLES; VEHICLE PARTS, NAMELY, SHOCK ABSORBERS (U.S. CLS. 19, 21, 23, 31, 35 AND 44).

FIRST USE 11-15-2010; IN COMMERCE 11-15-2010.

DOMINIC J. FERRAIUOLO, EXAMINING ATTORNEY

CLASS 12—(Continued).

SN 85-392,283. DANA LIMITED, MAUMEE, OH. FILED 8-8-2011.

SPR

THE MARK CONSISTS OF STANDARD CHARACTERS WITHOUT CLAIM TO ANY PARTICULAR FONT, STYLE, SIZE, OR COLOR.

FOR UNIVERSAL JOINTS FOR LAND VEHICLES AND STRUCTURAL PARTS THEREFOR, NAMELY, JOURNAL CROSSES (U.S. CLS. 19, 21, 23, 31, 35 AND 44).

FIRST USE 1-1-1992; IN COMMERCE 1-1-1992.

DAVID YONTEF, EXAMINING ATTORNEY

SN 85-377,648. DIA-COMPE, TAIWAN, CO., LTD., TAI-CHUNG, TAIWAN, FILED 7-21-2011.



NO CLAIM IS MADE TO THE EXCLUSIVE RIGHT TO USE "CICLO", APART FROM THE MARK AS SHOWN.

THE MARK CONSISTS OF THE WORDS "ENE CICLO" IN GENERIC FONT ON THE RIGHT, AND WORD "ENE" IN STYLIZED FORM DEPICTED AS AN OVAL DEVICE ON THE LEFT. IN THE STYLIZED "ENE", THE SECOND STYLIZED LETTER "E" IS SHOWN IN A MIRROR IMAGE OF THE FIRST STYLIZED LETTER "E".

THE ENGLISH TRANSLATION OF "CICLO" IN THE MARK IS "CYCLE".

FOR BICYCLES, BICYCLE FRAMES, BICYCLE HEAD TUBES, BICYCLE FRONT FORKS, BICYCLE PEDALS, BICYCLE WHEELS, QUICK RELEASE DEVICES FOR BICYCLE WHEELS, TIRES FOR BICYCLES, BICYCLE SPOKES, BICYCLE RIMS, BICYCLE BRAKE ASSEMBLIES, BICYCLE CRANKS, BICYCLE CHAINS, CHAINRINGS FOR BICYCLES, WHEEL HUBS FOR BICYCLES, BOTTOM BRACKETS FOR BICYCLES, SEAT POSTS FOR BICYCLES, SEAT TUBES FOR BICYCLES, BICYCLE SADDLES, SADDLE BAGS FOR BICYCLES, WATER BOTTLE CAGES FOR BICYCLES, HANDLEBARS FOR BICYCLES, BICYCLE HANDLEBAR STEM, HEADSET BEARINGS FOR BICYCLES, BEARINGS FOR BICYCLE BOTTOM BRACKETS, WHEEL BEARINGS FOR BICYCLES, BICYCLE GEARS, DERAILLEURS FOR BICYCLES, SPROCKETS FOR BICYCLES, AXLES FOR BICYCLES, FREEWHEELS FOR BICYCLES, BRAKE LEVERS FOR BICYCLES (U.S. CLS. 19, 21, 23, 31, 35 AND 44).

FIRST USE 0-0-2009; IN COMMERCE 4-0-2011.

MICHELE SWAIN, EXAMINING ATTORNEY

SN 85-406,686. TEKTRON TECHNOLOGY CORPORATION, CHANGHUA, TAIWAN, FILED 8-25-2011.



OWNER OF U.S. REG. NOS. 2,739,515, 2,997,590 AND 3,031,686.

THE MARK CONSISTS OF STYLIZED WORDING "TEKTRON" ON AN UPPER PORTION AND STENCILED STYLIZED WORDING "DORADO" CONTAINED WITHIN A DARK BORDER ON A LOWER PORTION AND TO THE LEFT OF THE "TEKTRON".

FOR BICYCLE BRAKES; BICYCLE PARTS, NAMELY, BRAKE LEVERS; HYDRAULIC DISC BRAKES; HYDRAULIC RIM BRAKES (U.S. CLS. 19, 21, 23, 31, 35 AND 44).

FIRST USE 1-1-2011; IN COMMERCE 1-1-2011.

GEORGE LORENZO, EXAMINING ATTORNEY

CLASS 12—(Continued).

SN 85-443,041. YANFENG VISTEON AUTOMOTIVE TRIM SYSTEMS CO., LTD., SHANGHAI, CHINA, FILED 10-10-2011.



THE MARK CONSISTS OF CHINESE CHARACTERS FOR "YANFENG".

THE NON-LATIN CHARACTERS IN THE MARK TRANSLITERATE TO "YANFENG" AND THIS HAS NO MEANING IN A FOREIGN LANGUAGE.

FOR VEHICLE PARTS, COMPONENTS AND ACCESSORIES, NAMELY, STRUCTURAL VEHICLE INTERIOR PARTS FOR LAND VEHICLES, NAMELY, COCKPITS CONSISTING OF INSTRUMENT PANELS, SWITCH MODULES, STEERING COLUMNS, VEHICLE AIRBAGS, SENSORS, HEATING, VENTILATION AND AIR CONDITIONING SYSTEMS, NAVIGATION MODULES, AUDIO SYSTEMS AND WIRE HARNESSSES ASSEMBLED AS A MODULE; INSTRUMENT PANELS, CONSOLES AND PILLARS; DOOR PANELS FOR VEHICLES; VEHICLE SEATS; AUTOMOTIVE VEHICLE PARTS, NAMELY, HEADLINERS AND STEERING WHEELS; VEHICLE SAFETY AIRBAGS, NAMELY, DRIVER AIRBAGS, PASSENGER AIRBAGS, SIDE AIRBAGS AND CURTAIN AIRBAGS; SEAT BELTS, STEPLESS LOAD-LIMITER SEAT BELTS, MULTI-STOP LOAD LIMITER SEAT BELTS AND PRETENSIONER SEAT BELTS ALL FOR USE IN VEHICLES; STRUCTURAL PARTS FOR VEHICLES, NAMELY, BUMPERS, FENDERS, RADIATOR GRILLS; BODY TRIM FOR AUTOMOBILES, NAMELY, ROCK PANELS, ANTI-SCRAPING PANELS, AND WHEEL TRIM; REAR CLOSURES, NAMELY, REAR PARCEL SHELVES; FRONT-END MODULES, NAMELY, ENGINE BRACKETS, COOLING WATER TANKS AND AIR CONDITIONING EVAPORATORS ASSEMBLED AS A MODULE (U.S. CLS. 19, 21, 23, 31, 35 AND 44).

FIRST USE 10-8-2011; IN COMMERCE 10-8-2011.
AMY KELLY, EXAMINING ATTORNEY

CLASS 12—(Continued).

SN 85-443,047. YANFENG VISTEON AUTOMOTIVE TRIM SYSTEMS CO., LTD., SHANGHAI, CHINA, FILED 10-10-2011.



THE MARK CONSISTS OF THE LETTERS "Y" AND "F" IN STYLIZED FONT, WITH THE LETTER "F" CRADLED WITHIN THE TOP OF THE LETTER "Y", ALL OF WHICH IS WITHIN A CIRCULAR BORDER.

FOR VEHICLE PARTS, COMPONENTS AND ACCESSORIES, NAMELY, STRUCTURAL VEHICLE INTERIOR PARTS FOR LAND VEHICLES, NAMELY, COCKPITS CONSISTING OF INSTRUMENT PANELS, SWITCH MODULES, STEERING COLUMNS, VEHICLE AIRBAGS, SENSORS, HEATING, VENTILATION AND AIR CONDITIONING SYSTEMS, NAVIGATION MODULES, AUDIO SYSTEMS AND WIRE HARNESSSES ASSEMBLED AS A MODULE; INSTRUMENT PANELS, CONSOLES AND PILLARS; DOOR PANELS FOR VEHICLES; VEHICLE SEATS; AUTOMOTIVE VEHICLE PARTS, NAMELY, HEADLINERS AND STEERING WHEELS; VEHICLE SAFETY AIRBAGS, NAMELY, DRIVER AIRBAGS, PASSENGER AIRBAGS, SIDE AIRBAGS AND CURTAIN AIRBAGS; SEAT BELTS, STEPLESS LOAD-LIMITER SEAT BELTS, MULTI-STOP LOAD LIMITER SEAT BELTS AND PRETENSIONER SEAT BELTS ALL FOR USE IN VEHICLES; STRUCTURAL PARTS FOR VEHICLES, NAMELY, BUMPERS, FENDERS, RADIATOR GRILLS; BODY TRIM FOR AUTOMOBILES, NAMELY, ROCK PANELS, ANTI-SCRAPING PANELS, AND WHEEL TRIM; REAR CLOSURES, NAMELY, REAR PARCEL SHELVES; FRONT-END MODULES, NAMELY, ENGINE BRACKETS, COOLING WATER TANKS AND AIR CONDITIONING EVAPORATORS ASSEMBLED AS A MODULE (U.S. CLS. 19, 21, 23, 31, 35 AND 44).

FIRST USE 10-8-2011; IN COMMERCE 10-8-2011.
AMY KELLY, EXAMINING ATTORNEY

SN 85-461,443. EATON CORPORATION, CLEVELAND, OH. FILED 11-1-2011.

**POWERED WITH EATON
TECHNOLOGY**

THE MARK CONSISTS OF STANDARD CHARACTERS WITHOUT CLAIM TO ANY PARTICULAR FONT, STYLE, SIZE, OR COLOR.

OWNER OF U.S. REG. NOS. 3,152,397, 3,191,884 AND OTHERS.

NO CLAIM IS MADE TO THE EXCLUSIVE RIGHT TO USE "TECHNOLOGY", APART FROM THE MARK AS SHOWN.

FOR LAND VEHICLE TRANSMISSIONS, LAND VEHICLE CLUTCHES, HYDRAULIC MOTORS FOR LAND VEHICLES, HYDRAULIC PUMPS FOR LAND VEHICLES, HYDRAULIC VALVES FOR STEERING UNITS FOR LAND VEHICLES (U.S. CLS. 19, 21, 23, 31, 35 AND 44).

MARILYN IZZI, EXAMINING ATTORNEY

CLASS 12—(Continued).

SN 85-473,848. FORGE MOTOR SPORT, INC., ORLANDO, FL. FILED 11-16-2011.



NO CLAIM IS MADE TO THE EXCLUSIVE RIGHT TO USE "MOTORSPORT", APART FROM THE MARK AS SHOWN.

THE MARK CONSISTS OF THE WORDS "FORGE MOTORSPORT" IN STYLIZED FONT WITH THE WORD "MOTORSPORT" INSIDE AN ELONGATED OVAL UNDERNEATH THE WORD "FORGE".

FOR VEHICLE AND ENGINE PARTS, NAMELY, CHARGED AIR COMPONENTS, COOLANT SYSTEMS, TURBO CHARGED COMPONENTS, EXHAUSTS, BRAKES, BRAKE HOSES, COOLANT HOSES, RADIATORS, AIR COOLERS, ALLOY TANKS, ACTUATORS, VALVES, AND BOOST CONTROLLERS, ALL FOR USE IN AUTOMOBILES, MOTORCYCLES, WATERCRAFTS AND ALL STATIONARY ENGINES (U.S. CLS. 19, 21, 23, 31, 35 AND 44).

FIRST USE 12-31-1990; IN COMMERCE 12-31-1990.
RAUL CORDOVA, EXAMINING ATTORNEY

CLASS 12—(Continued).

SN 85-508,709. POLYPORTABLES, INC., DBA BASS HUNTER BOATS, DAHLONEGA, GA. FILED 1-4-2012.



NO CLAIM IS MADE TO THE EXCLUSIVE RIGHT TO USE "THE ORIGINAL", APART FROM THE MARK AS SHOWN.

THE MARK CONSISTS OF THE STYLIZED DESIGN OF A FISH IN WITH THE WORDING "BASS HUNTER" IN BOLD LETTERS SUPERIMPOSED ON THE FISH WITH THE WORDING "THE ORIGINAL" IN BOLD LETTERS APPEARING JUST BELOW THE WORDING "BASS HUNTER".

FOR FISHING BOATS (U.S. CLS. 19, 21, 23, 31, 35 AND 44).

FIRST USE 0-0-1977; IN COMMERCE 0-0-1977.
SALLY SHIH, EXAMINING ATTORNEY

SN 85-509,894. DC COMICS, NEW YORK, NY. FILED 1-5-2012.



SN 85-494,654. RAPTOR TRADING LLC, HOUSTON, TX. FILED S.R. 12-14-2011; AM. P.R. 4-1-2012.

RAPTOR

THE MARK CONSISTS OF STANDARD CHARACTERS WITHOUT CLAIM TO ANY PARTICULAR FONT, STYLE, SIZE, OR COLOR.

FOR MOTOR VEHICLE PARTS AND ACCESSORIES, NAMELY, STEERING WHEELS AND STEERING WHEEL INSTALLATION KITS COMPOSED PRIMARILY OF DIE-CAST METAL HUBS AND SCREWS WITH TRIM PIECES, STEERING WHEEL COVERS, STEERING WHEEL STICKERS, STEERING WHEEL HORN BUTTONS AND STEERING WHEEL HORN BUTTON TRIMS PIECES (U.S. CLS. 19, 21, 23, 31, 35 AND 44).

FIRST USE 7-24-2001; IN COMMERCE 11-19-2002.
MARK T. MULLEN, EXAMINING ATTORNEY

OWNER OF U.S. REG. NO. 2,051,606.
NO CLAIM IS MADE TO THE EXCLUSIVE RIGHT TO USE "COMICS", APART FROM THE MARK AS SHOWN.

THE MARK CONSISTS OF THE LETTER "D" FLIPPING BACK TO REVEAL THE LETTER "C" AND "DC COMICS".

FOR BICYCLES; TRICYCLES; SAFETY SEATS FOR CHILDREN FOR MOTOR CARS; CAR STRAPS, NAMELY, STRAPS FOR SECURING SAFETY SEATS FOR CHILDREN FOR MOTOR CARS; SEAT BELTS FOR USE IN VEHICLES; SHOULDER STRAPS, NAMELY, SHOULDER RESTRAINTS FOR SAFETY FOR USE IN MOTOR CARS; AUTOMOBILE SEAT COVERS, WINDSCREENS FOR AUTOMOBILES, SUNBLINDS ADAPTED FOR AUTOMOBILES (U.S. CLS. 19, 21, 23, 31, 35 AND 44).

PAUL MORENO, EXAMINING ATTORNEY

CLASS 12—(Continued).

SN 85-521,141. CLEMENTINE BICYCLE WORKS, LLC, SPARTANBURG, SC. FILED 1-20-2012.

clementine

FOR BICYCLES (U.S. CLS. 19, 21, 23, 31, 35 AND 44).
FIRST USE 11-30-2011; IN COMMERCE 11-30-2011.
CHRISTINE MARTIN, EXAMINING ATTORNEY

SN 85-523,495. ROADSTER WHEELS, LLC, CHATTANOOGA, TN. FILED 1-24-2012.

VINTIQUES

THE MARK CONSISTS OF STANDARD CHARACTERS WITHOUT CLAIM TO ANY PARTICULAR FONT, STYLE, SIZE, OR COLOR.
OWNER OF U.S. REG. NO. 3,625,553.
SEC. 2(F).
FOR TIRES; WHEELS (U.S. CLS. 19, 21, 23, 31, 35 AND 44).
KATHLEEN M. VANSTON, EXAMINING ATTORNEY

SN 85-524,035. ADAM MASTERS, MARSHALL, NC. AND ANNA MASTERS, MARSHALL, NC. FILED 1-24-2012.

BODYBOAT

THE MARK CONSISTS OF STANDARD CHARACTERS WITHOUT CLAIM TO ANY PARTICULAR FONT, STYLE, SIZE, OR COLOR.
FOR KAYAKS (U.S. CLS. 19, 21, 23, 31, 35 AND 44).
MARILYN IZZI, EXAMINING ATTORNEY

CLASS 12—(Continued).

SN 85-526,321. MEDENDORP, PETER A., WILDWOOD, MO. FILED 1-26-2012.



THE MARK CONSISTS OF THE WORDS "MUD" AND "SLINGERS" IN CAPITAL LETTERS SUPERIMPOSED ON A CONTRASTING STYLIZED REPRESENTATION OF MUD SPATTERED ON A CONTRASTING SURFACE BACKGROUND.

FOR TRAILERS AND STRUCTURAL REPAIR PARTS THEREFOR (U.S. CLS. 19, 21, 23, 31, 35 AND 44).
JORDAN BAKER, EXAMINING ATTORNEY

SN 85-530,730. CASTELLO CYCLE COMPANY LTD., TAI-CHUNG CITY 407, TAIWAN, FILED 2-1-2012.

MIGHT²

THE MARK CONSISTS OF THE WORD "MIGHT2" IN STYLIZED FONT WITH THE NUMBER "2" SUPERSCRIPTED AFTER THE LETTER "T".

FOR BICYCLES AND STRUCTURAL PARTS AND ACCESSORIES THEREFOR, NAMELY, BICYCLE BASKETS, BICYCLE BELLS, BICYCLE BRAKE CABLES, BICYCLE BRAKE CASINGS AND BICYCLE BRAKE PADS, BICYCLE BRAKES AND GEAR LEVERS FOR BICYCLE WHEELS, BICYCLE CHAINS, BICYCLE FRAMES, BICYCLE GEARS, BICYCLE GEARS, NAMELY, CRANKS, BICYCLE KICKSTANDS, BICYCLE PEDALS, BICYCLE RIMS, BICYCLE SADDLE COVERS, BICYCLE SADDLES, BICYCLE SEAT POSTS, BICYCLE SEAT TUBES, BICYCLE WHEELS, CHAIN GUARDS FOR BICYCLES, CHANGE-SPEED GEARS FOR BICYCLES, DERAILEURS FOR BICYCLES, DIRECTION SIGNALS FOR BICYCLES, FORKS, FRAMES FOR LUGGAGE CARRIERS FOR BICYCLES, FRONT FORK JOINTS FOR BICYCLES, GEAR WHEELS FOR BICYCLES, HANDLEBAR GRIPS, HANDLEBARS, HANDLEBAR STEMS, HEADSETS WHICH PROVIDE A ROTATABLE INTERFACE BETWEEN THE BICYCLE FORK AND THE BICYCLE FRAME, INNER TUBES FOR BICYCLES, MUDGUARDS, SADDLEBAGS FOR BICYCLES, SPOKES FOR BICYCLE WHEELS, TIRES, TOE STRAPS FOR BICYCLE PEDALS AND CLIPS FOR BICYCLE PEDALS, WATER BOTTLE CAGES FOR BICYCLES, WHEEL HUBS FOR BICYCLES; MOPEDS; MOTORIZED SCOOTERS; MOTORS FOR BICYCLES; PANNIER BAGS FOR BICYCLES; PUMPS FOR BICYCLES AND CYCLES; STANDS FOR BICYCLES AND CYCLES; SUSPENSION SYSTEMS FOR BICYCLES (U.S. CLS. 19, 21, 23, 31, 35 AND 44).
HAI-LY LAM, EXAMINING ATTORNEY

CLASS 12—(Continued).

SN 85-530,832. MARCHFIELD, JOSEPH, CHICAGO, IL.
FILED 2-1-2012.

CYCLEON

THE MARK CONSISTS OF STANDARD CHARACTERS
WITHOUT CLAIM TO ANY PARTICULAR FONT, STYLE,
SIZE, OR COLOR.
FOR BICYCLES (U.S. CLS. 19, 21, 23, 31, 35 AND 44).
KELLY BOULTON, EXAMINING ATTORNEY

SN 85-530,857. JOSEPH MARCHFIELD, CHICAGO, IL.
FILED 2-1-2012.

BATT

THE MARK CONSISTS OF STANDARD CHARACTERS
WITHOUT CLAIM TO ANY PARTICULAR FONT, STYLE,
SIZE, OR COLOR.
FOR BICYCLES (U.S. CLS. 19, 21, 23, 31, 35 AND 44).
DAVID MURRAY, EXAMINING ATTORNEY

SN 85-530,879. WINNEBAGO INDUSTRIES, INC., FOREST
CITY, IA. FILED 2-1-2012.

Winnebago Trend

THE MARK CONSISTS OF STANDARD CHARACTERS
WITHOUT CLAIM TO ANY PARTICULAR FONT, STYLE,
SIZE, OR COLOR.
OWNER OF U.S. REG. NOS. 1,008,781, 1,908,349 AND
OTHERS.
FOR MOTOR HOMES (U.S. CLS. 19, 21, 23, 31, 35 AND
44).
SANDRA BUJA, EXAMINING ATTORNEY

CLASS 12—(Continued).

SN 85-530,892. WINNEBAGO INDUSTRIES, INC., FOREST
CITY, IA. FILED 2-1-2012.

Itasca Viva!

THE MARK CONSISTS OF STANDARD CHARACTERS
WITHOUT CLAIM TO ANY PARTICULAR FONT, STYLE,
SIZE, OR COLOR.
OWNER OF U.S. REG. NOS. 1,025,195 AND 3,172,964.
FOR MOTOR HOMES (U.S. CLS. 19, 21, 23, 31, 35 AND
44).
SANDRA BUJA, EXAMINING ATTORNEY

SN 85-531,181. BRIGGS, YANA, PASADENA, CA. FILED 2-1-
2012.

ERAMOTIVE

THE MARK CONSISTS OF STANDARD CHARACTERS
WITHOUT CLAIM TO ANY PARTICULAR FONT, STYLE,
SIZE, OR COLOR.
FOR AMPHIBIOUS VEHICLES; ELECTRIC VEHICLES,
NAMELY, CARS, BOATS, TRUCKS; MOTOR VEHICLES,
NAMELY, AUTOMOBILES, TRUCKS, VANS, SPORT
UTILITY VEHICLES AND STRUCTURAL PARTS
THEREFOR; MOTOR VEHICLES, NAMELY, CONCEPT
MOTOR VEHICLES; SPACE VEHICLES; WATER VEHI-
CLES, NAMELY, HYDROFOIL BOATS SUPPORTED BY
SINGLE OR MULTI HULLS, AND STRUCTURAL PARTS
THEREFOR (U.S. CLS. 19, 21, 23, 31, 35 AND 44).
SUSAN BILLHEIMER, EXAMINING ATTORNEY

SN 85-531,497. EIBACH SPRINGS, INC., CORONA, CA.
FILED 2-1-2012.

PRO-KIT

THE MARK CONSISTS OF STANDARD CHARACTERS
WITHOUT CLAIM TO ANY PARTICULAR FONT, STYLE,
SIZE, OR COLOR.
FOR AUTOMOTIVE PERFORMANCE SUSPENSION
SPRINGS (U.S. CLS. 19, 21, 23, 31, 35 AND 44).
FIRST USE 8-30-1987; IN COMMERCE 8-30-1987.
KAREN BRACEY, EXAMINING ATTORNEY

CLASS 12—(Continued).

SN 85-532,200. ARCH MOTORCYCLE COMPANY, LLC, GARDENA, CA. FILED 2-2-2012.

ARCH

THE MARK CONSISTS OF STANDARD CHARACTERS WITHOUT CLAIM TO ANY PARTICULAR FONT, STYLE, SIZE, OR COLOR.
FOR MOTORCYCLES (U.S. CLS. 19, 21, 23, 31, 35 AND 44).
GEORGE LORENZO, EXAMINING ATTORNEY

SN 85-532,348. TEXTRON INC., PROVIDENCE, RI. FILED 2-2-2012.

E-Z-GO LX

THE MARK CONSISTS OF STANDARD CHARACTERS WITHOUT CLAIM TO ANY PARTICULAR FONT, STYLE, SIZE, OR COLOR.
OWNER OF U.S. REG. NOS. 1,299,452, 2,706,193 AND 3,605,315.
FOR ELECTRIC AND GASOLINE POWERED VEHICLES USED AS GOLF CARS, PLANT PERSONNEL CARRIERS, BAGGAGE CARRIERS, GENERAL UTILITY AND MAINTENANCE CARS, MOTEL AND RESORT CARS, TURF MAINTENANCE VEHICLES AND STRUCTURAL PARTS THEREFOR; ACCESSORIES FOR ELECTRIC AND GASOLINE POWERED VEHICLES, NAMELY, ALL-WEATHER ENCLOSURES IN THE NATURE OF FITTED COVERS FOR VEHICLES, WINDSHIELDS AND RACKS FOR VEHICLES FOR CARRYING GOLF BAGS (U.S. CLS. 19, 21, 23, 31, 35 AND 44).
WILLIAM JACKSON, EXAMINING ATTORNEY

SN 85-533,209. MAVERICK AMERICAN, LLC, BOULDER, CO. FILED 2-3-2012.

MAVERICK

THE MARK CONSISTS OF STANDARD CHARACTERS WITHOUT CLAIM TO ANY PARTICULAR FONT, STYLE, SIZE, OR COLOR.
FOR BICYCLES; BICYCLE PARTS, NAMELY, FRAMES, FORKS, SEAT POSTS, SEATS AND HANDLE BARS (U.S. CLS. 19, 21, 23, 31, 35 AND 44).
ROBERT C. CLARK JR., EXAMINING ATTORNEY

CLASS 12—(Continued).

SN 85-534,183. REVELATE DESIGNS LLC, ANCHORAGE, AK. FILED 2-5-2012.

Jerrycan

THE MARK CONSISTS OF STANDARD CHARACTERS WITHOUT CLAIM TO ANY PARTICULAR FONT, STYLE, SIZE, OR COLOR.
FOR BAG MOUNTED DIRECTLY TO A BICYCLE (U.S. CLS. 19, 21, 23, 31, 35 AND 44).
FIRST USE 2-4-2012; IN COMMERCE 2-4-2012.
VIVIAN MICZNIK FIRST, EXAMINING ATTORNEY

SN 85-534,249. FOUNDATIONS WORLDWIDE, INC., MEDINA, OH. FILED 2-5-2012.

GAGGLE

THE MARK CONSISTS OF STANDARD CHARACTERS WITHOUT CLAIM TO ANY PARTICULAR FONT, STYLE, SIZE, OR COLOR.
FOR BABY CARRIAGES; BABY STROLLERS; CARTS; CHILD CARRYING TRAILERS FOR USE IN TRANSPORTING CHILDREN WHILE HIKING, JOGGING, WALKING, SKIING, SNOW SHOEING OR SKATING; PRAMS; BABY BUGGIES; STROLLERS; WAGONS (U.S. CLS. 19, 21, 23, 31, 35 AND 44).
KIM MONINGHOFF, EXAMINING ATTORNEY

SN 85-534,267. KRINGSTAD IRONWORKS, INC., PARK RIVER, ND. FILED 2-5-2012.

SAFE-T-PULL

THE MARK CONSISTS OF STANDARD CHARACTERS WITHOUT CLAIM TO ANY PARTICULAR FONT, STYLE, SIZE, OR COLOR.
FOR VEHICLE TOW BARS (U.S. CLS. 19, 21, 23, 31, 35 AND 44).
FIRST USE 1-1-1997; IN COMMERCE 1-1-1997.
ANNE MADDEN, EXAMINING ATTORNEY

CLASS 12—(Continued).

SN 85-534,348. AMERICAN TONGGAI INTERNATIONAL GROUP LIMITED, ROSEMEAD, CA. FILED 2-6-2012.



THE MARK CONSISTS OF THREE LETTERS "LFF" ON A SHADED INCOMPLETE QUADRILATERAL BACKGROUND WITH THE PART ON THE RIGHT OF THE LETTER "F" BEING HORIZONTAL LINES EXTENDING FROM THE LETTER "F".

FOR AIR PUMPS OF AUTOMOBILES; AIR TURBINES FOR LAND VEHICLES; AUTOMOBILE BUMPERS; AUTOMOBILE CHASSIS; BRAKE LININGS FOR LAND VEHICLES; BRAKES FOR LAND VEHICLES; CLUTCHES FOR LAND VEHICLES; DIRECTION SIGNALS FOR VEHICLES; DRIVE SHAFTS FOR LAND VEHICLES; HOOD SHIELDS AS STRUCTURAL PARTS OF VEHICLES; HUBS FOR VEHICLE WHEELS (MOTORCYCLES); HYDRAULIC CIRCUITS FOR VEHICLES; LAND VEHICLE PARTS, NAMELY, AXLES; LAND VEHICLE PARTS, NAMELY, RUNNING BOARDS; LUGGAGE CARRIERS FOR VEHICLES; MOTOR CAR DOORS; REARVIEW MIRRORS; SHOCK ABSORBERS FOR AUTOMOBILES; SHOCK ABSORBING SPRINGS FOR MOTOR CARS; SPOKES FOR BICYCLE WHEELS; STRUCTURAL PARTS FOR AUTOMOBILES; SUN SHIELDS AND VISORS FOR MOTOR CARS; TORSION BARS FOR MOTOR CARS; VEHICLE BODIES; VEHICLE HOODS; VEHICLE PARTS, NAMELY, WINDSHIELD WIPERS; VEHICLE WHEELS; WHEELS (U.S. CLS. 19, 21, 23, 31, 35 AND 44).

ANDREW LEASER, EXAMINING ATTORNEY

CLASS 12—(Continued).

SN 85-534,716. FLOWBELOW, LLC, DBA FLOWBELOW, LLC, AUSTIN, TX. FILED 2-6-2012.

FlowBelow

THE MARK CONSISTS OF STANDARD CHARACTERS WITHOUT CLAIM TO ANY PARTICULAR FONT, STYLE, SIZE, OR COLOR.

FOR AERO-DYNAMIC FAIRINGS FOR VEHICLES; AIR FOILS; AUTOMOBILE WHEEL SHIELDS; AUTOMOTIVE AFTERMARKET PARTS, NAMELY, TRUCK BED EXTENDER AND STORAGE BOX; AUTOMOTIVE BODY KITS COMPRISING EXTERNAL STRUCTURAL PARTS OF AUTOMOBILES; BODY PANELS FOR TRUCKS OR SUVs; FITTED COVERS FOR VEHICLES; GROUND EFFECT VEHICLES; HUB CAP COVERS; LAND VEHICLE PARTS, NAMELY, FENDER FLARES; LAND VEHICLE PARTS, NAMELY, MUD GUARDS; LAND VEHICLE PARTS, NAMELY, RUNNING BOARDS; LAND VEHICLE PARTS, NAMELY, WINDSHIELDS; METAL COVERS USED TO COVER AUTOMOTIVE SHOCK PARTS; METAL PARTS FOR VEHICLES, NAMELY, AUTOMOTIVE EXTERIOR AND INTERIOR METAL DECORATIVE AND PROTECTIVE TRIM; MOTOR VEHICLES, NAMELY, AUTOMOBILES, TRUCKS, VANS, SPORT UTILITY VEHICLES AND STRUCTURAL PARTS THEREFOR; MUD FLAP BRACKETS AS STRUCTURAL PARTS OF VEHICLES; MUD FLAPS FOR VEHICLES; PLASTIC PARTS FOR VEHICLES, NAMELY, AUTOMOTIVE EXTERIOR AND INTERIOR PLASTIC EXTRUDED DECORATIVE AND PROTECTIVE TRIM; SEMI-FITTED COVERS FOR VEHICLES; SIDE SHIELDS AS STRUCTURAL PARTS OF VEHICLES; SPARE TIRE CARRIERS FOR VEHICLES; SPOILERS FOR VEHICLES; VEHICLE HOOD AND FENDER LOUVERS AND VENTS; WHEEL COVERS (U.S. CLS. 19, 21, 23, 31, 35 AND 44).

JEFFREY LOOK, EXAMINING ATTORNEY

SN 85-534,830. NORCO PRODUCTS, LTD., PORT COQUITLAM, BC, CANADA, FILED 2-6-2012.

KILLER B

THE MARK CONSISTS OF STANDARD CHARACTERS WITHOUT CLAIM TO ANY PARTICULAR FONT, STYLE, SIZE, OR COLOR.

FOR BICYCLES (U.S. CLS. 19, 21, 23, 31, 35 AND 44).
JAY BESCH, EXAMINING ATTORNEY

CLASS 12—(Continued).

SN 85-534,861. !!!MANIC SALAMANDER, INC., DBA !!!MANIC SALAMANDER, MINNEAPOLIS, MN. FILED 2-6-2012.

!!!MANIC SALAMANDER

THE MARK CONSISTS OF STANDARD CHARACTERS WITHOUT CLAIM TO ANY PARTICULAR FONT, STYLE, SIZE, OR COLOR.

FOR HANDLEBAR ACCESSORIES FOR MOTORIZED VEHICLES (U.S. CLS. 19, 21, 23, 31, 35 AND 44).
FIRST USE 5-31-2003; IN COMMERCE 9-7-2003.
THOMAS MANOR, EXAMINING ATTORNEY

SN 85-534,868. !!!MANIC SALAMANDER, INC., DBA !!!MANIC SALAMANDER, MINNEAPOLIS, MN. FILED 2-6-2012.

SMOOTH CITY

THE MARK CONSISTS OF STANDARD CHARACTERS WITHOUT CLAIM TO ANY PARTICULAR FONT, STYLE, SIZE, OR COLOR.

FOR HANDLEBAR ACCESSORIES FOR MOTORIZED VEHICLES (U.S. CLS. 19, 21, 23, 31, 35 AND 44).
FIRST USE 4-30-2008; IN COMMERCE 3-7-2010.
THOMAS MANOR, EXAMINING ATTORNEY

SN 85-534,946. SRAM, LLC, CHICAGO, IL. FILED 2-6-2012.

PIKE

THE MARK CONSISTS OF STANDARD CHARACTERS WITHOUT CLAIM TO ANY PARTICULAR FONT, STYLE, SIZE, OR COLOR.

FOR BICYCLE PARTS, NAMELY, BICYCLE SHOCK ABSORBERS, BICYCLE SUSPENSIONS AND BICYCLE FORKS (U.S. CLS. 19, 21, 23, 31, 35 AND 44).
EDWARD NELSON, EXAMINING ATTORNEY

CLASS 12—(Continued).

SN 85-535,090. CHINE DAH INDUSTRY CO., LTD, TAINAN CITY, TAIWAN, FILED 2-6-2012.



THE MARK CONSISTS OF THE WORD "AKINNA" IN STYLIZED PRINT FONT, IN ALL CAPITAL LETTERS, WITH A HIGHLY STYLIZED DESIGN OF A PERSON WITH HALF OF A FACE FORMED BY A HALF CIRCLE WITH PORTIONS FILLED IN AND AN OUTLINE OF ARMS AND LEGS FORMED BY TWO HALF FILLED IN CIRCLES.

FOR BICYCLE PARTS, NAMELY, CHANGE-SPEED GEARS; BICYCLE PARTS, NAMELY, TUBES AND CONNECTORS FOR BICYCLE FRAMES; BICYCLE PARTS, NAMELY, HANDLE BARS; BICYCLE PEDALS; CLUTCHES FOR LAND VEHICLES; ELECTRIC MOTORCYCLES; FITTED MOTORCYCLE COVERS; GEARS FOR VEHICLES; MOTORCYCLE ACCESSORIES, NAMELY, FRONT AND SIDE PLATES; PARTS OF MOTORCYCLES, NAMELY, BRAKE PEDALS; PARTS OF MOTORCYCLES, NAMELY, CLUTCH CABLES; PARTS OF MOTORCYCLES, NAMELY, HANDLE BAR GRIPS; PARTS OF MOTORCYCLES, NAMELY, HANDLE BARS; SHOCK ABSORBERS FOR MOTORCYCLES; VEHICLE PARTS, NAMELY, SHOCK ABSORBERS (U.S. CLS. 19, 21, 23, 31, 35 AND 44).

FIRST USE 5-2-2006; IN COMMERCE 6-22-2007.
DARRYL SPRULL, EXAMINING ATTORNEY

SN 85-535,106. CATALINA YACHTS, INC., SEMINOLE, FL. FILED 2-6-2012.

STRIKEZONE

THE MARK CONSISTS OF STANDARD CHARACTERS WITHOUT CLAIM TO ANY PARTICULAR FONT, STYLE, SIZE, OR COLOR.

FOR SAILBOATS (U.S. CLS. 19, 21, 23, 31, 35 AND 44).
FIRST USE 1-19-2012; IN COMMERCE 1-19-2012.
WILLIAM BRECKENFELD, EXAMINING ATTORNEY

CLASS 12—(Continued).

SN 85-535,333. CHINA MANUFACTURERS ALLIANCE, LLC, MONROVIA, CA. FILED 2-6-2012.

OptiGreen

THE MARK CONSISTS OF THE PHRASE "OPTIGREEN" IN STYLIZED FONT WITH NO CLAIM TO COLOR. FOR TIRES FOR VEHICLES (U.S. CLS. 19, 21, 23, 31, 35 AND 44).

SHAUNIA CARLYLE, EXAMINING ATTORNEY

SN 85-537,526. MAPLE'S SALES, INC., DOWNEY, CA. FILED 2-8-2012.

CITY HOPPER

THE MARK CONSISTS OF STANDARD CHARACTERS WITHOUT CLAIM TO ANY PARTICULAR FONT, STYLE, SIZE, OR COLOR.

FOR BICYCLES (U.S. CLS. 19, 21, 23, 31, 35 AND 44).

FIRST USE 1-1-2012; IN COMMERCE 1-1-2012.

FLORENTINA BLANDU, EXAMINING ATTORNEY

SN 85-537,736. ALLIED WHEEL COMPONENTS, INC., GARDEN GROVE, CA. FILED 2-8-2012.

TREADSTONE

THE MARK CONSISTS OF STANDARD CHARACTERS WITHOUT CLAIM TO ANY PARTICULAR FONT, STYLE, SIZE, OR COLOR.

FOR TIRES (U.S. CLS. 19, 21, 23, 31, 35 AND 44).

PAM WILLIS, EXAMINING ATTORNEY

CLASS 12—(Continued).

SN 85-537,938. DENNY, RUSS, HEMET, CA. FILED 2-9-2012.



THE MARK CONSISTS OF THE WORD "FUSO" AND A DESIGN OF MOLTEN LIQUID POURING FROM A MELTING POT ABOVE A FLAME.

THE ENGLISH TRANSLATION OF "FUSO" IN THE MARK IS "MOUTON".

FOR BICYCLE FRAMES (U.S. CLS. 19, 21, 23, 31, 35 AND 44).

FIRST USE 1-2-1987; IN COMMERCE 1-2-1987.

KEVON CHISOLM, EXAMINING ATTORNEY

SN 85-538,623. MAPLE'S SALES, INC., DOWNEY, CA. FILED 2-9-2012.

RASSINÉ

THE MARK CONSISTS OF STANDARD CHARACTERS WITHOUT CLAIM TO ANY PARTICULAR FONT, STYLE, SIZE, OR COLOR.

FOR BICYCLES (U.S. CLS. 19, 21, 23, 31, 35 AND 44).

FIRST USE 10-10-2011; IN COMMERCE 1-23-2012.

FLORENTINA BLANDU, EXAMINING ATTORNEY

CLASS 12—(Continued).

SN 85-539,785. AUTOTECNICA COLOMBIANA S.A. AUTE-
CO S.A., ITAGUI, COLOMBIA, FILED 2-10-2012.



THE COLOR(S) BLUE, RED AND BLACK IS/ARE CLAIMED AS A FEATURE OF THE MARK.

THE MARK CONSISTS OF THREE GEOMETRIC FIGURES, NAMELY, A BLUE TRAPEZOID, A RED CIRCLE AND A BLUE TRIANGLE, THE THREE FIGURES POSITIONED IN A MANNER SO AS TO CREATE THE SHAPE OF A TRIANGLE, BELOW OF WHICH APPEARS THE WORD AUTEKO IN BLACK STYLIZED LOWER CASE LETTERS.

THE WORDING AUTEKO HAS NO MEANING IN A FOREIGN LANGUAGE.

FOR AIRCRAFT; LAND VEHICLES; MOTOR CARS FOR TRANSPORT ON LAND; MOTORCYCLES; VESSELS (U.S. CLS. 19, 21, 23, 31, 35 AND 44).

JENNIFER WILLISTON, EXAMINING ATTORNEY

SN 85-540,224. MARC REVEL, CEDAR PARK, TX. FILED 2-11-2012.

MULTIMAN

THE MARK CONSISTS OF STANDARD CHARACTERS WITHOUT CLAIM TO ANY PARTICULAR FONT, STYLE, SIZE, OR COLOR.

FOR GOODS HANDLING CARTS; HOSPITAL CARTS; MOBILE STORAGE CART FOR DOMESTIC AND COMMERCIAL USE (U.S. CLS. 19, 21, 23, 31, 35 AND 44).

KARANENDRA S. CHHINA, EXAMINING ATTORNEY

SN 85-543,096. SUNRISE MEDICAL (US) LLC, FRESNO, CA. FILED 2-15-2012.

QM-720

THE MARK CONSISTS OF STANDARD CHARACTERS WITHOUT CLAIM TO ANY PARTICULAR FONT, STYLE, SIZE, OR COLOR.

FOR MOTORIZED WHEELCHAIRS FOR THE DISABLED AND THOSE WITH MOBILITY DIFFICULTIES; WHEELCHAIRS (U.S. CLS. 19, 21, 23, 31, 35 AND 44).

FIRST USE 2-13-2012; IN COMMERCE 2-13-2012.

KIMBERLY PERRY, EXAMINING ATTORNEY

CLASS 12—(Continued).

SN 85-544,234. PARR STUDIOS, INC., NEW YORK, NY. FILED 2-16-2012.

SEA LOUNGE

THE MARK CONSISTS OF STANDARD CHARACTERS WITHOUT CLAIM TO ANY PARTICULAR FONT, STYLE, SIZE, OR COLOR.

NO CLAIM IS MADE TO THE EXCLUSIVE RIGHT TO USE "LOUNGE", APART FROM THE MARK AS SHOWN.

FOR FLOATING RAFTS FOR RECREATIONAL USE (U.S. CLS. 19, 21, 23, 31, 35 AND 44).

JEFFREY LOOK, EXAMINING ATTORNEY

SN 85-545,504. NISSAN JIDOSHA KABUSHIKI KAISHA, TA NISSAN MOTOR CO., LTD., YOKOHAMA-SHI, KANAGAWA, JAPAN, FILED 2-17-2012.

EX37

THE MARK CONSISTS OF STANDARD CHARACTERS WITHOUT CLAIM TO ANY PARTICULAR FONT, STYLE, SIZE, OR COLOR.

OWNER OF U.S. REG. NO. 3,451,404.

FOR MOTOR VEHICLES, NAMELY, AUTOMOBILES, TRUCKS, VANS, SPORT UTILITY VEHICLES AND STRUCTURAL PARTS THEREFOR (U.S. CLS. 19, 21, 23, 31, 35 AND 44).

AMEEN IMAM, EXAMINING ATTORNEY

CLASS 13—FIREARMS

SN 85-333,594. ADVANCED TACTICAL SIGHTING SYSTEMS, SHELTON, WA. FILED 5-31-2011.

ATSS

THE MARK CONSISTS OF STANDARD CHARACTERS WITHOUT CLAIM TO ANY PARTICULAR FONT, STYLE, SIZE, OR COLOR.

FOR FIREARM ATTACHMENTS, NAMELY, MOUNTS FOR ATTACHING LIGHTS AND GUN SIGHTS TO CREW-SERVED FIREARMS (U.S. CLS. 2 AND 9).

FIRST USE 12-1-2008; IN COMMERCE 12-1-2008.

WENDY GOODMAN, EXAMINING ATTORNEY

CLASS 13—(Continued).

SN 85-357,338. SUPERIOR SHOOTING SYSTEM, INC., CANADIAN, TX. FILED 6-27-2011.

TUBB 2000

THE MARK CONSISTS OF STANDARD CHARACTERS WITHOUT CLAIM TO ANY PARTICULAR FONT, STYLE, SIZE, OR COLOR.

NO CLAIM IS MADE TO THE EXCLUSIVE RIGHT TO USE "2000", APART FROM THE MARK AS SHOWN. FOR RIFLES (U.S. CLS. 2 AND 9). FIRST USE 1-1-1999; IN COMMERCE 1-1-1999. SETH A. RAPPAPORT, EXAMINING ATTORNEY

CLASS 13—(Continued).

SN 85-532,185. TAR-HUNT CUSTOM RIFLES, INC., BLOOMSBURG, PA. FILED 2-2-2012.

SCHRIFLE

THE MARK CONSISTS OF STANDARD CHARACTERS WITHOUT CLAIM TO ANY PARTICULAR FONT, STYLE, SIZE, OR COLOR.

FOR FIREARMS (U.S. CLS. 2 AND 9). SUSAN LESLIE DUBOIS, EXAMINING ATTORNEY

SN 85-448,648. GLOCK, INC., SMYRNA, GA. FILED 10-17-2011.

GEN 4

THE MARK CONSISTS OF STANDARD CHARACTERS WITHOUT CLAIM TO ANY PARTICULAR FONT, STYLE, SIZE, OR COLOR.

FOR FIREARMS (U.S. CLS. 2 AND 9). FIRST USE 1-1-2010; IN COMMERCE 1-1-2010. DOMINIC FATHY, EXAMINING ATTORNEY

SN 85-532,975. ALLIANT TECHSYSTEMS INC., MINNEAPOLIS, MN. FILED 2-3-2012.

AXIOM

THE MARK CONSISTS OF STANDARD CHARACTERS WITHOUT CLAIM TO ANY PARTICULAR FONT, STYLE, SIZE, OR COLOR.

FOR GUN STOCKS (U.S. CLS. 2 AND 9). FIRST USE 1-28-2005; IN COMMERCE 1-28-2005. LOURDES AYALA, EXAMINING ATTORNEY

SN 85-517,598. TECHNACLIP, LLC, HIGHLAND, UT. FILED 1-16-2012.



NO CLAIM IS MADE TO THE EXCLUSIVE RIGHT TO USE THE PICTORIAL REPRESENTATION OF THE GUN BELT CLIP AND "CLIP", APART FROM THE MARK AS SHOWN.

THE MARK CONSISTS OF THE WORD "TECHNA" IN CAPITAL LETTERS, WITH THE LETTER "T" BEING THE LARGEST AND THE LETTERS "ECHNA" BEING OF THE SAME HEIGHT. THE WORD "CLIP", WITH ALL LETTERS IN A LOWER CASE CURSIVE FONT, POSITIONED TO THE RIGHT AND BELOW THE WORD "TECHNA" AND SEPARATED THEREFROM BY A HANDGUN BELT CLIP. THE PHRASE "A" COMFORTABLE CONCEALABLE WAY TO CARRY A GUN IS POSITIONED DIRECTLY BELOW THE LETTERS "ECHNA".

FOR HAND GUN ACCESSORIES, NAMELY, BELT CLIPS FOR SECURING A GUN WITHOUT THE USE OF A HOLSTER (U.S. CLS. 2 AND 9).

FIRST USE 2-21-2011; IN COMMERCE 6-15-2011. SUE LAWRENCE, EXAMINING ATTORNEY

SN 85-533,220. ADVANCED INNOVATION AND MANUFACTURING, INC., NORTH ROYALTON, OH. FILED 2-3-2012.

TOUCH IT, YOU'LL LOVE IT!

THE MARK CONSISTS OF STANDARD CHARACTERS WITHOUT CLAIM TO ANY PARTICULAR FONT, STYLE, SIZE, OR COLOR.

FOR FIREARM ATTACHMENTS, NAMELY, MODULAR EXTERNAL RAIL ATTACHMENTS, GRIPS AND MOUNTS FOR SWITCHES, WIRES AND DEVICES FOR FIREARMS (U.S. CLS. 2 AND 9).

FIRST USE 7-1-2010; IN COMMERCE 7-1-2010. MARIA-VICTORIA SUAREZ, EXAMINING ATTORNEY

CLASS 13—(Continued).

SN 85-537,872. HOLMES, GLYNDA L., CARY, NC. FILED 2-9-2012.

SWAGGER

THE MARK CONSISTS OF STANDARD CHARACTERS WITHOUT CLAIM TO ANY PARTICULAR FONT, STYLE, SIZE, OR COLOR.
FOR PISTOL HOLSTERS (U.S. CLS. 2 AND 9).
DEBORAH LOBO, EXAMINING ATTORNEY

SN 85-549,314. HORNADY MANUFACTURING COMPANY, GRAND ISLAND, NE. FILED 2-22-2012.

HMC

THE MARK CONSISTS OF STANDARD CHARACTERS WITHOUT CLAIM TO ANY PARTICULAR FONT, STYLE, SIZE, OR COLOR.
FOR AMMUNITION (U.S. CLS. 2 AND 9).
FIRST USE 5-9-2006; IN COMMERCE 5-9-2006.
JOHN KELLY, EXAMINING ATTORNEY

CLASS 14—JEWELRY

SN 79-105,344. CARTIER INTERNATIONAL AG, SWITZERLAND, FILED 4-29-2011.

COUGAR

THE MARK CONSISTS OF STANDARD CHARACTERS WITHOUT CLAIM TO ANY PARTICULAR FONT, STYLE, SIZE, OR COLOR.
OWNER OF INTERNATIONAL REGISTRATION 0540630 DATED 6-22-1989, EXPIRES 6-22-2019.
OWNER OF U.S. REG. NO. 1,619,761.
FOR PRECIOUS METALS AND THEIR ALLOYS AND GOODS MADE OF OR COATED WITH THESE MATERIALS NOT INCLUDED IN OTHER CLASSES, NAMELY, JEWELRY, KEY RINGS, WATCHES, CHRONOMETERS; BIJOUTERIE, PRECIOUS STONES; TIMEPIECES AND CHRONOMETRIC INSTRUMENTS (U.S. CLS. 2, 27, 28 AND 50).
KAREN SEVERSON, EXAMINING ATTORNEY

CLASS 14—(Continued).

SN 79-105,883. CHRISTIAAN VAN DER KLAUW HORLOGE ATELIER B.V., NETHERLANDS, FILED 5-10-2011.

CHRISTIAAN VAN DER KLAUW

THE MARK CONSISTS OF STANDARD CHARACTERS WITHOUT CLAIM TO ANY PARTICULAR FONT, STYLE, SIZE, OR COLOR.
OWNER OF INTERNATIONAL REGISTRATION 1028824 DATED 1-22-2010, EXPIRES 1-22-2020.
THE NAME(S), PORTRAIT(S), AND/OR SIGNATURE(S) SHOWN IN THE MARK IDENTIFIES "CHRISTIAAN VAN DER KLAUW", WHOSE CONSENT(S) TO REGISTER IS MADE OF RECORD.
FOR PRECIOUS METALS AND THEIR ALLOYS; GOODS IN PRECIOUS METALS OR COATED THEREWITH, NAMELY, WATCHES AND HOROLOGICAL INSTRUMENTS; JEWELRY; TRINKETS, NAMELY, WATCHES AND HOROLOGICAL INSTRUMENTS; PRECIOUS STONES; HOROLOGICAL AND CHRONOMETRIC INSTRUMENTS (U.S. CLS. 2, 27, 28 AND 50).
CAROLINE WOOD, EXAMINING ATTORNEY

SN 79-105,886. CHRISTIAAN VAN DER KLAUW HORLOGE ATELIER B.V., NETHERLANDS, FILED 5-10-2011.



OWNER OF INTERNATIONAL REGISTRATION 1030910 DATED 1-22-2010, EXPIRES 1-22-2020.
FOR PRECIOUS METALS AND THEIR ALLOYS; GOODS IN PRECIOUS METALS OR COATED THEREWITH, NAMELY, WATCHES AND HOROLOGICAL INSTRUMENTS; JEWELRY; TRINKETS, NAMELY, WATCHES AND HOROLOGICAL INSTRUMENTS; PRECIOUS STONES; HOROLOGICAL AND CHRONOMETRIC INSTRUMENTS (U.S. CLS. 2, 27, 28 AND 50).
CAROLINE WOOD, EXAMINING ATTORNEY

CLASS 14—(Continued).

SN 79-107,735. COEUR DE LION SCHMUCKDESIGN GMBH, FED REP GERMANY, FILED 10-28-2011.

COEUR DE LION

OWNER OF INTERNATIONAL REGISTRATION 1103094 DATED 10-28-2011, EXPIRES 10-28-2021.

OWNER OF U.S. REG. NO. 2,282,745.

THE MARK CONSISTS OF THE STYLIZED WORDING "COEUR DE LION" WITH THE "O" AND "E" IN "COEUR" BEING INTERSECTED AND THE TERM "DE" APPEARING IN SMALLER FONT.

THE ENGLISH TRANSLATION OF "COEUR DE LION" IN THE MARK IS "LION HEART".

FOR JEWELLERY, IN PARTICULAR, NECKLACES, EAR JEWELRY, BRACELETS, RINGS, BROOCHES; WATCHES (U.S. CLS. 2, 27, 28 AND 50).

CHRISTINE MARTIN, EXAMINING ATTORNEY

SN 85-175,126. WILKINSON, HUTTON, BEVERLY HILLS, CA. FILED 11-11-2010.

More Is More

THE MARK CONSISTS OF STANDARD CHARACTERS WITHOUT CLAIM TO ANY PARTICULAR FONT, STYLE, SIZE, OR COLOR.

FOR JEWELRY (U.S. CLS. 2, 27, 28 AND 50).

FIRST USE 5-31-1997; IN COMMERCE 5-31-1997.

COLLEEN DOMBROW, EXAMINING ATTORNEY

SN 85-212,991. NILE JEWELERS LLC, DBA NILE JEWELERS, PALM BEACH GARDENS, FL. FILED 1-7-2011.



NO CLAIM IS MADE TO THE EXCLUSIVE RIGHT TO USE "JEWELERS" AND "DIAMONDS", APART FROM THE MARK AS SHOWN.

THE COLOR(S) BLUE, WHITE AND BLACK IS/ARE CLAIMED AS A FEATURE OF THE MARK.

THE MARK CONSISTS OF A BLUE EMERALD CUT DIAMOND WITH A BLUE "N" INSIDE. THE WORDING "NILE JEWELERS DIAMONDS & MORE" APPEARS IN WHITE BELOW THE "N". THE BACKGROUND IS BLACK.

FOR JEWEL CHAINS, JEWEL PENDANTS, JEWELS, PRECIOUS JEWELS, ALL MADE IN WHOLE OR IN SIGNIFICANT PART OF DIAMONDS (U.S. CLS. 2, 27, 28 AND 50).

JUSTINE D. PARKER, EXAMINING ATTORNEY

CLASS 14—(Continued).

SN 85-216,331. KO, ANITA, LOS ANGELES, CA. FILED 1-12-2011.

ANITA KO

THE MARK CONSISTS OF STANDARD CHARACTERS WITHOUT CLAIM TO ANY PARTICULAR FONT, STYLE, SIZE, OR COLOR.

THE NAME(S), PORTRAIT(S), AND/OR SIGNATURE(S) SHOWN IN THE MARK IDENTIFIES "ANITA KO", WHOSE CONSENT(S) TO REGISTER IS MADE OF RECORD.

FOR JEWELLERY AND PRECIOUS STONES; JEWELRY; JEWELRY AND IMITATION JEWELRY; PRECIOUS AND SEMI-PRECIOUS STONES; PRECIOUS METALS AND THEIR ALLOYS; PRECIOUS STONES (U.S. CLS. 2, 27, 28 AND 50).

FIRST USE 1-1-2006; IN COMMERCE 1-1-2006.

ANTHONY RINKER, EXAMINING ATTORNEY

SN 85-237,892. PATTI JO MARTIN, LEWISTOWN, MT. FILED 2-9-2011.

Live Now

THE MARK CONSISTS OF STANDARD CHARACTERS WITHOUT CLAIM TO ANY PARTICULAR FONT, STYLE, SIZE, OR COLOR.

FOR JEWELRY (U.S. CLS. 2, 27, 28 AND 50).

JEFFREY LOOK, EXAMINING ATTORNEY

SN 85-253,633. MOVADO LLC, WILMINGTON, DE. FILED 2-28-2011.

ENVY

THE MARK CONSISTS OF STANDARD CHARACTERS WITHOUT CLAIM TO ANY PARTICULAR FONT, STYLE, SIZE, OR COLOR.

FOR HOROLOGICAL AND CHRONOMETRIC INSTRUMENTS (U.S. CLS. 2, 27, 28 AND 50).

NAKIA HENRY, EXAMINING ATTORNEY

CLASS 14—(Continued).

SN 85-344,491. TEAM FAIRFAX 2013, FAIRFAX, VA. FILED 6-13-2011.



THE MARK CONSISTS OF THE HEAD OF AN EAGLE WHERE THE EYE IS DEPICTED BY A STAR.

FOR CLOCKS AND JEWELRY, COMMEMORATIVE COINS; ORNAMENTAL PINS AND ORNAMENTAL LAPEL PINS OF SOFT ENAMEL, NON-MONETARY COINS OF PRECIOUS METAL, MEDALS USED FOR AWARDS (U.S. CLS. 2, 27, 28 AND 50).

JOSETTE BEVERLY, EXAMINING ATTORNEY

SN 85-349,128. PEACE REHABILITATION CENTER, MINNEAPOLIS, MN. FILED 6-17-2011.

PEACE WARE

THE MARK CONSISTS OF STANDARD CHARACTERS WITHOUT CLAIM TO ANY PARTICULAR FONT, STYLE, SIZE, OR COLOR.

NO CLAIM IS MADE TO THE EXCLUSIVE RIGHT TO USE "WARE", APART FROM THE MARK AS SHOWN.

FOR JEWELRY (U.S. CLS. 2, 27, 28 AND 50).

FIRST USE 12-14-2010; IN COMMERCE 12-14-2010.

NELSON SNYDER, EXAMINING ATTORNEY

SN 85-371,203. SUZANNA DAI, INC, NEW YORK, NY. FILED 7-14-2011.



THE NAME(S), PORTRAIT(S), AND/OR SIGNATURE(S) SHOWN IN THE MARK IDENTIFIES "SUZANNA DAI" GALLEHUGH, WHOSE CONSENT(S) TO REGISTER IS MADE OF RECORD.

THE MARK CONSISTS OF TWO SWIRLED, CURLY-CUED PATTERNS THAT FRAME. IN THE MIDDLE THERE IS THE STYLIZED TEXT "SUZANNA DAI".

FOR JEWELRY (U.S. CLS. 2, 27, 28 AND 50).

FIRST USE 8-0-2008; IN COMMERCE 8-0-2008.

MARK SPARACINO, EXAMINING ATTORNEY

CLASS 14—(Continued).

SN 85-384,086. DISNEY ENTERPRISES, INC., BURBANK, CA. FILED 7-28-2011.

A.N.T. FARM

THE MARK CONSISTS OF STANDARD CHARACTERS WITHOUT CLAIM TO ANY PARTICULAR FONT, STYLE, SIZE, OR COLOR.

FOR CLOCKS; JEWELRY; JEWELRY BOXES; JEWELRY CASES; KEY RINGS OF PRECIOUS METAL; NON-MONETARY COINS; WATCHES; WATCH BANDS (U.S. CLS. 2, 27, 28 AND 50).

STEPHANIE ALI, EXAMINING ATTORNEY

SN 85-390,003. PHILLIPS, ROBIN L., DANA POINT, CA. FILED 8-4-2011.

BOUNCE WEAR

THE MARK CONSISTS OF STANDARD CHARACTERS WITHOUT CLAIM TO ANY PARTICULAR FONT, STYLE, SIZE, OR COLOR.

NO CLAIM IS MADE TO THE EXCLUSIVE RIGHT TO USE "WEAR", APART FROM THE MARK AS SHOWN.

FOR JEWELRY (U.S. CLS. 2, 27, 28 AND 50).

ARETHA SOMERVILLE, EXAMINING ATTORNEY

SN 85-399,717. PEPPY BANDS, JESUP, IA. FILED 8-16-2011.

PEPPY BANDS

THE MARK CONSISTS OF STANDARD CHARACTERS WITHOUT CLAIM TO ANY PARTICULAR FONT, STYLE, SIZE, OR COLOR.

NO CLAIM IS MADE TO THE EXCLUSIVE RIGHT TO USE "BANDS", APART FROM THE MARK AS SHOWN.

FOR HAIR JEWELRY IN THE NATURE OF JEWELRY FOR USE IN THE HAIR (U.S. CLS. 2, 27, 28 AND 50).

FIRST USE 7-1-2011; IN COMMERCE 7-16-2011.

JENNIFER VASQUEZ, EXAMINING ATTORNEY

CLASS 14—(Continued).

SN 85-403,205. IT'S ABOUT TIME, A DIVISION OF CUSTOM QUEST, WEST CHESTER, OH. FILED 8-21-2011.

IT'S ABOUT TIME...

THE MARK CONSISTS OF STANDARD CHARACTERS WITHOUT CLAIM TO ANY PARTICULAR FONT, STYLE, SIZE, OR COLOR.

FOR CHILDREN'S ALARM CLOCKS (U.S. CLS. 2, 27, 28 AND 50).

FIRST USE 0-0-2009; IN COMMERCE 0-0-2009.
JASON TURNER, EXAMINING ATTORNEY

CLASS 14—(Continued).

SN 85-477,934. ROSY BLUE JEWELRY, INC., NEW YORK, NY. FILED 11-21-2011.



THE MARK CONSISTS OF THE WORDS "HUES OF LOVE" AGAINST A BACKGROUND DESIGN CONSISTING OF FOUR INTERLOCKING HEARTS.

FOR DIAMONDS; PRECIOUS AND SEMI-PRECIOUS STONES; JEWELRY (U.S. CLS. 2, 27, 28 AND 50).
SUNG IN, EXAMINING ATTORNEY

SN 85-418,300. PRO-GAIN TRADING LIMITED, HUNG HOM, KOWLOON, HONG KONG, FILED 9-8-2011.

JEANS WARHEAD

NO CLAIM IS MADE TO THE EXCLUSIVE RIGHT TO USE "JEANS", APART FROM THE MARK AS SHOWN.

THE MARK CONSISTS OF THE STYLIZED WORDS "JEANS WARHEAD" WHERE THE WORD "JEANS" IS ABOVE THE LETTERS "ARHEAD" AND THE LETTER "W" IS IN BIGGER SIZE.

FOR BRACELETS; CUFF LINKS; EARRINGS; JEWELLERY; KEY RINGS OF PRECIOUS METALS; NECKLACES; PENDANTS; PRECIOUS STONES; RINGS; WATCHES (U.S. CLS. 2, 27, 28 AND 50).

ARETHA SOMERVILLE, EXAMINING ATTORNEY

SN 85-483,846. RADIUM ENTERPRISE, INC, LOS ANGELES, CA. FILED 11-30-2011.

DIAMOND MAXX

THE MARK CONSISTS OF STANDARD CHARACTERS WITHOUT CLAIM TO ANY PARTICULAR FONT, STYLE, SIZE, OR COLOR.

NO CLAIM IS MADE TO THE EXCLUSIVE RIGHT TO USE "DIAMOND", APART FROM THE MARK AS SHOWN.

FOR DIAMOND BRACELETS; DIAMOND JEWELRY; DIAMOND JEWELLERY AND WATCHES; DIAMOND JEWELRY WATCHES; DIAMOND POCKET WATCHES; DIAMOND STOP WATCHES; DIAMOND WATCHES; DIAMOND WATCHES AND JEWELRY; WOMEN'S DIAMOND JEWELRY; DIAMOND WRIST WATCHES (U.S. CLS. 2, 27, 28 AND 50).

FIRST USE 2-1-2010; IN COMMERCE 2-1-2010.
SHANNON TWOHIG, EXAMINING ATTORNEY

SN 85-447,926. MISSOMA LIMITED, LONDON, UNITED KINGDOM, FILED 10-14-2011.

MISSOMA

THE MARK CONSISTS OF STANDARD CHARACTERS WITHOUT CLAIM TO ANY PARTICULAR FONT, STYLE, SIZE, OR COLOR.

OWNER OF UNITED KINGDOM REG. NO. 2470794, DATED 6-13-2008, EXPIRES 10-29-2017.

FOR JEWELRY (U.S. CLS. 2, 27, 28 AND 50).
RAUL CORDOVA, EXAMINING ATTORNEY

SN 85-505,824. BON MERCATO GMBH, MUENCHEN, FED REP GERMANY, FILED 12-29-2011.

DeLorean

THE MARK CONSISTS OF STANDARD CHARACTERS WITHOUT CLAIM TO ANY PARTICULAR FONT, STYLE, SIZE, OR COLOR.

PRIORITY CLAIMED UNDER SEC. 44(D) ON ERPNTY TM OFC APPLICATION NO. 010374957, FILED 10-27-2011, REG. NO. 010374957, DATED 3-29-2012, EXPIRES 10-27-2021.

FOR HOROLOGICAL AND CHRONOMETRIC INSTRUMENTS; CASES FOR WATCHES (U.S. CLS. 2, 27, 28 AND 50).

TARAH HARDY, EXAMINING ATTORNEY

CLASS 14—(Continued).

SN 85-511,138. WATKINS, CHARLES D., AKA WATCHES USA, SAINT LOUIS, MO. FILED 1-7-2012.



OWNER OF U.S. REG. NO. 2,862,054.
 NO CLAIM IS MADE TO THE EXCLUSIVE RIGHT TO USE "FINE WATCHES", APART FROM THE MARK AS SHOWN.
 THE COLOR(S) RED, GOLD AND BLACK IS/ARE CLAIMED AS A FEATURE OF THE MARK.
 THE MARK CONSISTS OF THE STYLIZED TERM "HAVANA" IN RED AND GOLD, WITH THE "H" IN RED AND "AVANA" IN GOLD, AND WITH GOLD DIAMONDS EXTENDING FROM THE END OF THE "H". BELOW IS THE SLOGAN "FINE WATCHES EXCLUSIVELY FOR YOU" IN BLACK.
 FOR WRISTWATCHES (U.S. CLS. 2, 27, 28 AND 50).
 LINDA M. KING, EXAMINING ATTORNEY

SN 85-515,086. SUBERI BROTHERS LLC, NEW YORK, NY. FILED 1-12-2012.

Suberi Brothers

THE MARK CONSISTS OF STANDARD CHARACTERS WITHOUT CLAIM TO ANY PARTICULAR FONT, STYLE, SIZE, OR COLOR.
 THE WORDING "SUBERI" HAS NO MEANING IN A FOREIGN LANGUAGE.
 FOR DIAMOND JEWELRY; DIAMONDS (U.S. CLS. 2, 27, 28 AND 50).
 FIRST USE 4-1-2004; IN COMMERCE 4-1-2004.
 AMY KERTGATE, EXAMINING ATTORNEY

SN 85-515,560. SHIFMAN, OURI, NEW YORK, NY. FILED 1-12-2012.

BRILLIANT ROCKS OTM

THE MARK CONSISTS OF STANDARD CHARACTERS WITHOUT CLAIM TO ANY PARTICULAR FONT, STYLE, SIZE, OR COLOR.
 NO CLAIM IS MADE TO THE EXCLUSIVE RIGHT TO USE "BRILLIANT ROCKS", APART FROM THE MARK AS SHOWN.
 FOR DIAMONDS (U.S. CLS. 2, 27, 28 AND 50).
 FIRST USE 5-1-2010; IN COMMERCE 5-1-2010.
 MARK SPARACINO, EXAMINING ATTORNEY

CLASS 14—(Continued).

SN 85-517,044. GOLD N DIAMONDS, ATLANTA, GA. FILED 1-16-2012.

SEVILLE DIAMOND COLLECTION

THE MARK CONSISTS OF STANDARD CHARACTERS WITHOUT CLAIM TO ANY PARTICULAR FONT, STYLE, SIZE, OR COLOR.
 NO CLAIM IS MADE TO THE EXCLUSIVE RIGHT TO USE "DIAMOND COLLECTION", APART FROM THE MARK AS SHOWN.
 FOR DIAMOND JEWELRY (U.S. CLS. 2, 27, 28 AND 50).
 FIRST USE 1-7-2012; IN COMMERCE 1-7-2012.
 BRIAN CALLAGHAN, EXAMINING ATTORNEY

SN 85-517,438. CIRCLE-LETS, INC., NASHVILLE, TN. FILED 1-16-2012.

CIRCLE-LETS

THE MARK CONSISTS OF STANDARD CHARACTERS WITHOUT CLAIM TO ANY PARTICULAR FONT, STYLE, SIZE, OR COLOR.
 OWNER OF U.S. REG. NO. 4,087,295.
 FOR COSTUME JEWELRY; JEWELRY (U.S. CLS. 2, 27, 28 AND 50).
 FIRST USE 12-1-1963; IN COMMERCE 12-1-1963.
 PATRICIA EVANKO, EXAMINING ATTORNEY

SN 85-522,618. CHARLES, CHELSEA, NASHVILLE, TN. FILED 1-23-2012.

PULSE NECKLACE

THE MARK CONSISTS OF STANDARD CHARACTERS WITHOUT CLAIM TO ANY PARTICULAR FONT, STYLE, SIZE, OR COLOR.
 NO CLAIM IS MADE TO THE EXCLUSIVE RIGHT TO USE "NECKLACE", APART FROM THE MARK AS SHOWN.
 FOR JEWELRY CHAINS; JEWELRY; NECKLACES (U.S. CLS. 2, 27, 28 AND 50).
 JORDAN BAKER, EXAMINING ATTORNEY

CLASS 14—(Continued).

SN 85-523,996. STANLEY CREATIONS, INC., MELROSE PARK, PA. FILED 1-24-2012.

ILLUMINAIRE

THE MARK CONSISTS OF STANDARD CHARACTERS WITHOUT CLAIM TO ANY PARTICULAR FONT, STYLE, SIZE, OR COLOR.

FOR JEWELRY, NAMELY, STERLING SILVER AND CUBIC ZIRCONIA EARRINGS, RINGS, PENDANTS, BRACELETS AND NECKLACES (U.S. CLS. 2, 27, 28 AND 50).

BRENDAN MCCAULEY, EXAMINING ATTORNEY

CLASS 14—(Continued).

SN 85-530,901. ZOMBIE CHORUS LINE, LLC, SAN MARCOS, TX. FILED 2-1-2012.



THE MARK CONSISTS OF THE WORD "I", FOLLOWED BY A GRAPHIC OF A HEART, FOLLOWED BY "ZOMBIES", FOLLOWED BY A "BIO-HAZARD" SYMBOL, THE TEXT STYLIZED IN A HORROR FONT.

FOR RUBBER OR SILICON WRISTBANDS IN THE NATURE OF A BRACELET (U.S. CLS. 2, 27, 28 AND 50).

JOHN DALIER, EXAMINING ATTORNEY

SN 85-526,995. ROMANCE & CO., INC., NEW YORK, NY. FILED 1-27-2012.



NO CLAIM IS MADE TO THE EXCLUSIVE RIGHT TO USE "CO.", APART FROM THE MARK AS SHOWN.

THE MARK CONSISTS OF THE STYLIZED WORDING "R & CO".

FOR JEWELRY (U.S. CLS. 2, 27, 28 AND 50).

TOBY BULLOFF, EXAMINING ATTORNEY

The Intersecting Hearts

THE MARK CONSISTS OF STANDARD CHARACTERS WITHOUT CLAIM TO ANY PARTICULAR FONT, STYLE, SIZE, OR COLOR.

FOR BEADS FOR USE IN THE MANUFACTURE OF JEWELRY; BODY JEWELRY; BRACELETS; BROACHES; BRONZE JEWELRY; BROOCHES; CHARMS; COSTUME JEWELRY; DIAMOND JEWELRY; GEMSTONE JEWELRY; JEWELRY; JEWELRY AND IMITATION JEWELRY; JEWELRY BOXES; JEWELRY BOXES OF PRECIOUS METAL; JEWELRY BROOCHES; JEWELRY CASES; JEWELRY CHAINS; JEWELRY FINDINGS; JEWELRY WATCHES; LAPEL PINS; PET JEWELRY; RINGS; RINGS BEING JEWELRY; STAINLESS STEEL JEWELRY BRACELETS; WATCHES AND JEWELRY; WATCHES, CLOCKS, JEWELRY AND IMITATION JEWELRY (U.S. CLS. 2, 27, 28 AND 50).

B. PARADEWELAI, EXAMINING ATTORNEY

SN 85-530,888. OKO INTERNATIONAL CO., DEERFIELD BEACH, FL. FILED 2-1-2012.

POWERJET

THE MARK CONSISTS OF STANDARD CHARACTERS WITHOUT CLAIM TO ANY PARTICULAR FONT, STYLE, SIZE, OR COLOR.

FOR TIMEPIECES (U.S. CLS. 2, 27, 28 AND 50).

FIRST USE 9-29-2011; IN COMMERCE 9-29-2011.

JORDAN BAKER, EXAMINING ATTORNEY

SN 85-531,375. SIMON GOLUB & SONS, INC., SEATTLE, WA. FILED 2-1-2012.

CAR074

THE MARK CONSISTS OF STANDARD CHARACTERS WITHOUT CLAIM TO ANY PARTICULAR FONT, STYLE, SIZE, OR COLOR.

OWNER OF U.S. REG. NO. 3,368,612.

THE ENGLISH TRANSLATION OF "CARO" IN THE MARK IS "BELOVED".

FOR CUT DIAMONDS; DIAMONDS; JEWELRY (U.S. CLS. 2, 27, 28 AND 50).

FIRST USE 6-1-2006; IN COMMERCE 5-6-2007.

KATHERINE E. HALMEN, EXAMINING ATTORNEY

CLASS 14—(Continued).

SN 85-531,398. HAWKWILD, LLC, CANOGA PARK, CA. FILED 2-1-2012.

SAVE THE TA-TAS

THE MARK CONSISTS OF STANDARD CHARACTERS WITHOUT CLAIM TO ANY PARTICULAR FONT, STYLE, SIZE, OR COLOR.

FOR JEWELRY; BRACELETS; BRACELETS MADE OF RUBBER; BRACELETS MADE OF SILICON; CHARITY BRACELETS; ORNAMENTAL PINS (U.S. CLS. 2, 27, 28 AND 50).

FIRST USE 12-0-2009; IN COMMERCE 12-0-2009. BRIAN NEVILLE, EXAMINING ATTORNEY

SN 85-531,713. UNIQUE DESIGNS, INC., NEW YORK, NY. FILED 2-2-2012.

SIMPLY STATED

THE MARK CONSISTS OF STANDARD CHARACTERS WITHOUT CLAIM TO ANY PARTICULAR FONT, STYLE, SIZE, OR COLOR.

FOR JEWELRY (U.S. CLS. 2, 27, 28 AND 50). KELLY BOULTON, EXAMINING ATTORNEY

SN 85-531,803. ROCKS AND METALS LLC, FRANKLIN, TN. FILED 2-2-2012.



THE MARK CONSISTS OF THE LETTERS "VP" INSIDE A ROUNDED TRIANGLE, WITH THE WORD "VICSPICKS" UNDERNEATH.

FOR GEMSTONE JEWELRY; JEWELRY; JEWELRY, NAMELY, STONE PENDANTS; NECKLACES MADE OF METALS AND/OR GEMSTONES; ORNAMENTS OF PRECIOUS METAL IN THE NATURE OF JEWELRY (U.S. CLS. 2, 27, 28 AND 50).

TRICIA SONNEBORN, EXAMINING ATTORNEY

CLASS 14—(Continued).

SN 85-531,818. ROCKS AND METALS LLC, FRANKLIN, TN. FILED 2-2-2012.

VICSPICKS

THE MARK CONSISTS OF STANDARD CHARACTERS WITHOUT CLAIM TO ANY PARTICULAR FONT, STYLE, SIZE, OR COLOR.

FOR GEMSTONE JEWELRY; JEWELRY; JEWELRY, NAMELY, STONE PENDANTS; NECKLACES MADE OF METALS AND/OR GEMSTONES; ORNAMENTS OF PRECIOUS METAL IN THE NATURE OF JEWELRY (U.S. CLS. 2, 27, 28 AND 50).

TRICIA SONNEBORN, EXAMINING ATTORNEY

SN 85-532,583. DESERET BOOK COMPANY, SALT LAKE CITY, UT. FILED 2-2-2012.

PRETTY DARN FUNNY

THE MARK CONSISTS OF STANDARD CHARACTERS WITHOUT CLAIM TO ANY PARTICULAR FONT, STYLE, SIZE, OR COLOR.

FOR BRACELETS; CHARMS FOR COLLAR JEWELRY AND BRACELET; JEWELRY; ORNAMENTAL PINS; TIE TACKS (U.S. CLS. 2, 27, 28 AND 50).

MARK T. MULLEN, EXAMINING ATTORNEY

SN 85-532,647. DESERET BOOK COMPANY, SALT LAKE CITY, UT. FILED 2-2-2012.



THE MARK CONSISTS OF AN OVAL WITH STYLIZED WORDS "PRETTY DARN FUNNY!" INSIDE THE OVAL. IN THE WORD "PRETTY", A BOBBYPIN IS USED TO CROSS THE TWO LETTER "T"'S.

FOR BRACELETS; CHARMS FOR COLLAR JEWELRY AND BRACELET; JEWELRY; ORNAMENTAL PINS; TIE TACKS (U.S. CLS. 2, 27, 28 AND 50).

MARK T. MULLEN, EXAMINING ATTORNEY

CLASS 14—(Continued).

SN 85-532,724. DOUSSET HOLDINGS, INC., LOS ANGELES, CA. FILED 2-2-2012.

Beyond the 4 C's

THE MARK CONSISTS OF STANDARD CHARACTERS WITHOUT CLAIM TO ANY PARTICULAR FONT, STYLE, SIZE, OR COLOR.

FOR JEWELRY (U.S. CLS. 2, 27, 28 AND 50).
JUDITH HELFMAN, EXAMINING ATTORNEY

SN 85-532,812. HAWKWILD, LLC, CANOGA PARK, CA. FILED 2-2-2012.

TA-TAS

THE MARK CONSISTS OF STANDARD CHARACTERS WITHOUT CLAIM TO ANY PARTICULAR FONT, STYLE, SIZE, OR COLOR.

OWNER OF U.S. REG. NOS. 3,173,090, 3,471,059 AND 3,904,365.

FOR JEWELRY; BRACELETS; BRACELETS MADE OF RUBBER; BRACELETS MADE OF SILICON; CHARITY BRACELETS; ORNAMENTAL PINS (U.S. CLS. 2, 27, 28 AND 50).

FIRST USE 5-0-2007; IN COMMERCE 5-0-2007.
BRIAN NEVILLE, EXAMINING ATTORNEY

SN 85-533,168. AU-79 LLC, WEST HOLLYWOOD, CA. FILED 2-3-2012.

I LOVE ME

THE MARK CONSISTS OF STANDARD CHARACTERS WITHOUT CLAIM TO ANY PARTICULAR FONT, STYLE, SIZE, OR COLOR.

FOR JEWELRY (U.S. CLS. 2, 27, 28 AND 50).
MICHELE SWAIN, EXAMINING ATTORNEY

CLASS 14—(Continued).

SN 85-533,394. SPIRIT OF SHAMBALLA, INC., WHITE PLAINS, NY. FILED 2-3-2012.



THE COLOR(S) BLACK, ORANGE, AND YELLOW IS/ ARE CLAIMED AS A FEATURE OF THE MARK.

THE MARK CONSISTS OF THE WORDING "SPIRIT OF SHAMBALLA" IN BLACK, ORANGE AND YELLOW ETERNAL SPIRAL CIRCLE.

FOR BEADS FOR MAKING JEWELRY; BRACELETS; BROACHES; BRONZE JEWELRY; BROOCHES; CAMEOS; CHARMS FOR COLLAR JEWELRY AND BRACELET; COSTUME JEWELRY; JEWELRY BROOCHES; JEWELRY, NAMELY, ANKLETS; JEWELRY, NAMELY, ARM CUFFS; JEWELRY, NAMELY, CROSSES; JEWELRY, NAMELY, MAGNETIC NECKLACES; JEWELRY, NAMELY, MAGNETIC PENDANTS; JEWELRY, NAMELY, STONE PENDANTS; PINS BEING JEWELRY; PLASTIC BRACELETS IN THE NATURE OF JEWELRY; PRECIOUS AND SEMI-PRECIOUS CRYSTAL STONES AND BEADS FOR USE IN JEWELRY; RINGS; RINGS BEING JEWELRY; STAINLESS STEEL JEWELRY BRACELETS; WOMEN'S JEWELRY (U.S. CLS. 2, 27, 28 AND 50).

FIRST USE 1-15-2012; IN COMMERCE 2-1-2012.
KEVON CHISOLM, EXAMINING ATTORNEY

SN 85-533,635. WEST MARINE PRODUCTS, INC., WATSONVILLE, CA. FILED 2-3-2012.



THE MARK CONSISTS OF A SHARK.
FOR CLOCKS; WATCHES (U.S. CLS. 2, 27, 28 AND 50).
WILLIAM VERHOSEK, EXAMINING ATTORNEY

CLASS 14—(Continued).

SN 85-533,809. IVANKA TRUMP MARKS LLC, NEW YORK, NY. FILED 2-3-2012.



OWNER OF U.S. REG. NOS. 3,589,236, 3,593,246 AND 3,620,026.

THE NAME "IVANKA TRUMP" IDENTIFIES A LIVING INDIVIDUAL WHOSE CONSENT IS OF RECORD.

THE MARK CONSISTS OF THE WORDS "IVANKA" AND "TRUMP" IN STYLIZED LETTERS SEPARATED BY THE STYLIZED LETTERS "IT".

FOR DIAMONDS; JEWELRY; PEARLS; PRECIOUS METALS, NAMELY, SILVER; PRECIOUS GEMSTONES; SEMI-PRECIOUS GEMSTONES; TIMEPIECES (U.S. CLS. 2, 27, 28 AND 50).

JUSTINE D. PARKER, EXAMINING ATTORNEY

CLASS 14—(Continued).

SN 85-535,154. LINARDI, JUSTIAN, 14440 JAKARTA, INDONESIA, FILED 2-6-2012.

CHRONOFORCE

THE MARK CONSISTS OF STANDARD CHARACTERS WITHOUT CLAIM TO ANY PARTICULAR FONT, STYLE, SIZE, OR COLOR.

FOR JEWELRY; HOROLOGICAL AND CHRONOMETRIC INSTRUMENTS (U.S. CLS. 2, 27, 28 AND 50).

B. PARADEWELAI, EXAMINING ATTORNEY

SN 85-534,328. PINTO, GERARDO A., ANTIOCH, CA. FILED 2-6-2012.

Peace Exists

THE MARK CONSISTS OF STANDARD CHARACTERS WITHOUT CLAIM TO ANY PARTICULAR FONT, STYLE, SIZE, OR COLOR.

FOR AMULETS; BRACELETS; BROACHES; CHARMS; JEWELRY; JEWELRY BOXES; JEWELRY FOR THE HEAD; JEWELRY, NAMELY, CROSSES; LAPEL PINS; LEATHER JEWELRY AND ACCESSORY BOXES; PET JEWELRY; PINS BEING JEWELRY; RINGS ; RUBBER OR SILICON WRISTBANDS IN THE NATURE OF A BRACELET (U.S. CLS. 2, 27, 28 AND 50).

LINDSEY RUBIN, EXAMINING ATTORNEY

SN 85-534,881. WHEATLEY, MICHAEL T, DBA CREATIVE DESIGNS, SAN JOSE, CA. FILED 2-6-2012.

SVCD

THE MARK CONSISTS OF STANDARD CHARACTERS WITHOUT CLAIM TO ANY PARTICULAR FONT, STYLE, SIZE, OR COLOR.

FOR JEWELRY (U.S. CLS. 2, 27, 28 AND 50).

FIRST USE 4-1-2011; IN COMMERCE 4-1-2011.

THOMAS MANOR, EXAMINING ATTORNEY

SN 85-535,194. PACIFIC-CONCEPTS, INC., NEW YORK, NY. FILED 2-6-2012.

INFRARED

THE MARK CONSISTS OF STANDARD CHARACTERS WITHOUT CLAIM TO ANY PARTICULAR FONT, STYLE, SIZE, OR COLOR.

FOR CHRONOGRAPHS AS WATCHES; CHRONOGRAPHS FOR USE AS WATCHES; CHRONOMETRIC INSTRUMENTS AND WATCH MOVEMENTS; CLOCKS AND WATCHES; COMPLICATION WATCHES; DIVING WATCHES; DRESS WATCHES; EQUESTRIAN WATCHES; INEXPENSIVE NON-JEWELRY WATCHES; JEWELLERY AND WATCHES; JEWELLERY, CLOCKS AND WATCHES; JEWELRY WATCHES; MECHANICAL AND AUTOMATIC WATCHES; POCKET WATCHES; PRECIOUS STONES AND WATCHES; SPORTS WATCHES; STOP WATCHES; WATCHES; WATCHES AND CLOCKS; WATCHES AND JEWELLERY; WATCHES AND JEWELRY; WATCHES FOR OUTDOOR USE; WATCHES FOR SPORTING USE; WATCHES MADE OF PRECIOUS METALS OR COATED THEREWITH; WATCHES, CLOCKS; WATCHES, CLOCKS, JEWELLERY AND IMITATION JEWELLERY; WATCHES, CLOCKS, JEWELRY AND IMITATION JEWELRY; WOMEN'S WATCHES; WRIST WATCHES (U.S. CLS. 2, 27, 28 AND 50).

FIRST USE 11-1-2011; IN COMMERCE 11-1-2011.

MICHAEL WIENER, EXAMINING ATTORNEY

CLASS 14—(Continued).

SN 85-535,590. JESUS CHARMS LLC, WOODSTOCK, GA.
FILED 2-7-2012.

Jesus Charms
wear . give . tell

NO CLAIM IS MADE TO THE EXCLUSIVE RIGHT TO USE "CHARMS", APART FROM THE MARK AS SHOWN.

THE MARK CONSISTS OF THE WORDS "JESUS CHARMS" WRITTEN IN A STYLIZED CURSIVE FONT AND UNDERNEATH THE WORDS "JESUS CHARMS" ARE THE WORDS "WEAR", "GIVE" AND "TELL" WITH A PERIOD BETWEEN EACH WORD.

FOR JEWELRY (U.S. CLS. 2, 27, 28 AND 50).
FIRST USE 9-0-2011; IN COMMERCE 9-0-2011.
SUSAN STIGLITZ, EXAMINING ATTORNEY

CLASS 14—(Continued).

SN 85-535,644. MONTRES DEWITT SA, 1217 MEYRIN,
SWITZERLAND, FILED 2-7-2012.

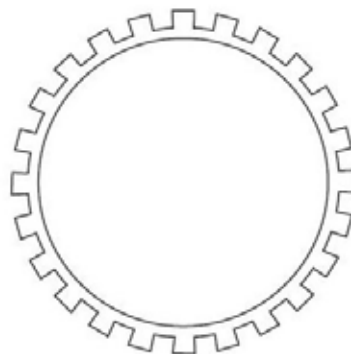

THE MARK CONSISTS OF A CIRCLE WITH DENTIL MOLDING AROUND ITS CIRCUMFERENCE.

FOR WATCHES, WATCH CASES, BUCKLES FOR WATCHSTRAPS, CLASPS FOR WATCH BRACELETS, MOVEMENTS FOR CLOCKS AND WATCHES, BRACELETS AND STRAPS FOR WRISTWATCHES, DIALS FOR WATCHES, WATCH WINDING BUTTONS, CASES FOR WATCHES, POCKET WATCHES, ALARM CLOCKS, CLOCKS, BOXES FOR WATCHES; JEWELLERY ARTICLES NAMELY BRACELETS, RINGS, EARRINGS, PENDANTS, BROOCHES; CUFF-LINKS (U.S. CLS. 2, 27, 28 AND 50).

BARBARA BROWN, EXAMINING ATTORNEY

SN 85-535,626. JEROME GEATHERS, HUNTERSVILLE, NC.
FILED 2-7-2012.

LuckPin

THE MARK CONSISTS OF STANDARD CHARACTERS WITHOUT CLAIM TO ANY PARTICULAR FONT, STYLE, SIZE, OR COLOR.

FOR LAPEL PINS (U.S. CLS. 2, 27, 28 AND 50).
FIRST USE 2-4-2011; IN COMMERCE 1-24-2012.
JIM RINGLE, EXAMINING ATTORNEY

SN 85-535,887. FEARLESS INVENTORY, INC., DBA FEARLESS INVENTORY, INC., NEW YORK, NY. FILED 2-7-2012.



THE MARK CONSISTS OF TWO INTERLOCKING "S"'S, ONE OF WHICH IS REVERSED.

FOR JEWELRY (U.S. CLS. 2, 27, 28 AND 50).
KATINA MISTER, EXAMINING ATTORNEY

CLASS 14—(Continued).

SN 85-536,090. LITTLE ANGELS, LLC, NEW YORK, NY.
FILED 2-7-2012.

LITTLE ANGELS

THE MARK CONSISTS OF STANDARD CHARACTERS WITHOUT CLAIM TO ANY PARTICULAR FONT, STYLE, SIZE, OR COLOR.

FOR JEWELRY, NAMELY, NECKLACES, BRACELETS, EARRINGS, RINGS (U.S. CLS. 2, 27, 28 AND 50).
ELIZABETH KAJUBI, EXAMINING ATTORNEY

CLASS 14—(Continued).

SN 85-536,454. MOISES JACOBO FRANCO, AVENTURA, FL.
FILED 2-7-2012.

SVADHISTHANA

THE MARK CONSISTS OF STANDARD CHARACTERS WITHOUT CLAIM TO ANY PARTICULAR FONT, STYLE, SIZE, OR COLOR.

FOR CASES FOR WATCHES AND CLOCKS; CLOCK AND WATCH HANDS; CLOCKS AND WATCHES; DIALS FOR CLOCK-AND-WATCH-MAKING; JEWELLERY AND WATCHES; JEWELLERY, CLOCKS AND WATCHES (U.S. CLS. 2, 27, 28 AND 50).
THEODORE MCBRIDE, EXAMINING ATTORNEY

SN 85-536,429. MOISES JACOBO FRANCO, AVENTURA, FL.
FILED 2-7-2012.

VISHUDDHA

THE MARK CONSISTS OF STANDARD CHARACTERS WITHOUT CLAIM TO ANY PARTICULAR FONT, STYLE, SIZE, OR COLOR.

FOR CASES FOR WATCHES AND CLOCKS; CLOCK AND WATCH HANDS; DIALS FOR CLOCK-AND-WATCH-MAKING; JEWELLERY, CLOCKS AND WATCHES (U.S. CLS. 2, 27, 28 AND 50).
THEODORE MCBRIDE, EXAMINING ATTORNEY

SN 85-536,459. MOISES JACOBO FRANCO, AVENTURA, FL.
FILED 2-7-2012.

MULADHARA

THE MARK CONSISTS OF STANDARD CHARACTERS WITHOUT CLAIM TO ANY PARTICULAR FONT, STYLE, SIZE, OR COLOR.

FOR CASES FOR WATCHES AND CLOCKS; CLOCK AND WATCH HANDS; DIALS FOR CLOCK-AND-WATCH-MAKING; JEWELLERY AND WATCHES; JEWELLERY, CLOCKS AND WATCHES (U.S. CLS. 2, 27, 28 AND 50).
THEODORE MCBRIDE, EXAMINING ATTORNEY

SN 85-536,442. MOISES JACOBO FRANCO, AVENTURA, FL.
FILED 2-7-2012.

MANIPURA

THE MARK CONSISTS OF STANDARD CHARACTERS WITHOUT CLAIM TO ANY PARTICULAR FONT, STYLE, SIZE, OR COLOR.

FOR CASES FOR WATCHES AND CLOCKS; CLOCK AND WATCH HANDS; CLOCKS AND WATCHES; DIALS FOR CLOCK-AND-WATCH-MAKING; JEWELLERY, CLOCKS AND WATCHES (U.S. CLS. 2, 27, 28 AND 50).
THEODORE MCBRIDE, EXAMINING ATTORNEY

SN 85-536,934. BILL BLASS GROUP, LLC, NEW YORK, NY.
FILED 2-8-2012.

BILL BLASS

THE MARK CONSISTS OF STANDARD CHARACTERS WITHOUT CLAIM TO ANY PARTICULAR FONT, STYLE, SIZE, OR COLOR.

OWNER OF U.S. REG. NOS. 3,884,808, 3,947,493 AND 3,978,854.

THE NAME(S), PORTRAIT(S), AND/OR SIGNATURE(S) SHOWN IN THE MARK DOES NOT IDENTIFY A PARTICULAR LIVING INDIVIDUAL.

FOR CLOCKS AND WATCHES; JEWELRY (U.S. CLS. 2, 27, 28 AND 50).
DOMINICK J. SALEMI, EXAMINING ATTORNEY

CLASS 14—(Continued).

SN 85-537,412. WILLIAMS, BRENT A., TOPSHAM, ME. AND WILLIAMS, JESSICA C., TOPSHAM, ME. FILED 2-8-2012.

b&j

THE MARK CONSISTS OF STANDARD CHARACTERS WITHOUT CLAIM TO ANY PARTICULAR FONT, STYLE, SIZE, OR COLOR.
FOR JEWELRY (U.S. CLS. 2, 27, 28 AND 50).
FIRST USE 8-17-2011; IN COMMERCE 11-9-2011.
LIEF MARTIN, EXAMINING ATTORNEY

SN 85-537,477. SHAREANE BAFF, HOPEWELL JUNCTION, NY. FILED 2-8-2012.

FROM ONE GODDESS TO ANOTHER

THE MARK CONSISTS OF STANDARD CHARACTERS WITHOUT CLAIM TO ANY PARTICULAR FONT, STYLE, SIZE, OR COLOR.
FOR JEWELRY (U.S. CLS. 2, 27, 28 AND 50).
YAT SYE, LEE, EXAMINING ATTORNEY

SN 85-537,597. CHEVAKO, PATRICIA, WHITEFISH BAY, WI. FILED 2-8-2012.

TimeLine

THE MARK CONSISTS OF THE STYLIZED TEXT "TIME-LINE" WITH A LINE FROM THE TOP OF THE "T" CONTINUING ACROSS THE ENTIRE WORD. THERE ARE THREE BOXES FOUND IN THE LINE, TWO ARE ABOVE THE "I"'S AND THE OTHER IS FOUND ABOVE THE "L".
FOR JEWELRY (U.S. CLS. 2, 27, 28 AND 50).
BARBARA BROWN, EXAMINING ATTORNEY

CLASS 14—(Continued).

SN 85-538,094. LITTLE ANGELS, LLC, NEW YORK, NY. FILED 2-9-2012.



THE MARK CONSISTS OF DEPICTIONS OF EIGHT ANGELS WITH HALOS AND WINGS AND TWO CHILDREN ALL WITHIN A CLOUD.
FOR JEWELRY, NAMELY, NECKLACES, BRACELETS, EARRINGS, RINGS (U.S. CLS. 2, 27, 28 AND 50).
ELIZABETH KAJUBI, EXAMINING ATTORNEY

SN 85-538,137. UNCLE LEO LLC., MERRICK, NY. FILED 2-9-2012.

THE STATUS QUO MUST GO

THE MARK CONSISTS OF STANDARD CHARACTERS WITHOUT CLAIM TO ANY PARTICULAR FONT, STYLE, SIZE, OR COLOR.
FOR KEY CHAINS AS JEWELLERY; KEY CHAINS OF PRECIOUS METAL (U.S. CLS. 2, 27, 28 AND 50).
JENNY PARK, EXAMINING ATTORNEY

SN 85-538,158. UNCLE LEO LLC., MERRICK, NY. FILED 2-9-2012.

THE STATUS QUO STINKS

THE MARK CONSISTS OF STANDARD CHARACTERS WITHOUT CLAIM TO ANY PARTICULAR FONT, STYLE, SIZE, OR COLOR.
FOR KEY CHAINS AS JEWELLERY; KEY CHAINS OF PRECIOUS METAL (U.S. CLS. 2, 27, 28 AND 50).
JENNY PARK, EXAMINING ATTORNEY

CLASS 14—(Continued).

SN 85-538,193. RUBBER BRANDS, LLC, SAVANNAH, GA.
FILED 2-9-2012.

Stretcheez

THE MARK CONSISTS OF STANDARD CHARACTERS WITHOUT CLAIM TO ANY PARTICULAR FONT, STYLE, SIZE, OR COLOR.

FOR RUBBER OR SILICON WRISTBANDS IN THE NATURE OF A BRACELET (U.S. CLS. 2, 27, 28 AND 50).
JESSICA FATHY, EXAMINING ATTORNEY

CLASS 14—(Continued).

SN 85-550,920. RIDDEL, HOLLY M., BEVERLY HILLS, CA.
FILED 2-23-2012.

PIECE & LOVE

THE MARK CONSISTS OF STANDARD CHARACTERS WITHOUT CLAIM TO ANY PARTICULAR FONT, STYLE, SIZE, OR COLOR.

FOR JEWELRY (U.S. CLS. 2, 27, 28 AND 50).
FIRST USE 2-7-2012; IN COMMERCE 2-7-2012.
KIM MONINGHOFF, EXAMINING ATTORNEY

SN 85-540,303. SIDNEY-CHARLES CO., INC., VAN NUYS, CA. FILED 2-11-2012.



THE MARK CONSISTS OF STYLIZED LETTER "S" COMBINED WITH STYLIZED LETTER "M".
FOR JEWELRY (U.S. CLS. 2, 27, 28 AND 50).
ODESSA BIBBINS, EXAMINING ATTORNEY

SN 85-554,506. RICHLINE GROUP, INC., NEW YORK, NY.
FILED 2-28-2012.

BRAZILIANCE

THE MARK CONSISTS OF STANDARD CHARACTERS WITHOUT CLAIM TO ANY PARTICULAR FONT, STYLE, SIZE, OR COLOR.

FOR JEWELRY (U.S. CLS. 2, 27, 28 AND 50).
FLORENTINA BLANDU, EXAMINING ATTORNEY

SN 85-540,490. RICHLINE GROUP, INC., NEW YORK, NY.
FILED 2-12-2012.

ENDURING BEAUTY

THE MARK CONSISTS OF STANDARD CHARACTERS WITHOUT CLAIM TO ANY PARTICULAR FONT, STYLE, SIZE, OR COLOR.

FOR JEWELRY (U.S. CLS. 2, 27, 28 AND 50).
FLORENTINA BLANDU, EXAMINING ATTORNEY

SN 85-571,906. SUBERI BROTHERS LLC, NEW YORK, NY.
FILED 3-16-2012.

GABRIELLE

THE MARK CONSISTS OF STANDARD CHARACTERS WITHOUT CLAIM TO ANY PARTICULAR FONT, STYLE, SIZE, OR COLOR.

FOR DIAMOND JEWELRY (U.S. CLS. 2, 27, 28 AND 50).
FIRST USE 1-1-1997; IN COMMERCE 1-1-1997.
AMY KERTGATE, EXAMINING ATTORNEY

CLASS 14—(Continued).

SN 85-595,139. BLUE LEMON LLC, HIGHLAND, UT. FILED 4-11-2012.

BLUE LEMON

THE MARK CONSISTS OF STANDARD CHARACTERS WITHOUT CLAIM TO ANY PARTICULAR FONT, STYLE, SIZE, OR COLOR.
FOR JEWELRY, TIME PIECES (U.S. CLS. 2, 27, 28 AND 50).

KATHERINE M. DUBRAY, EXAMINING ATTORNEY

CLASS 15—MUSICAL INSTRUMENTS

SN 85-372,276. RICHARD NEWMAN, ROCHESTER, NY. FILED 7-15-2011.

HOLOPHONICS

THE MARK CONSISTS OF STANDARD CHARACTERS WITHOUT CLAIM TO ANY PARTICULAR FONT, STYLE, SIZE, OR COLOR.

FOR ACOUSTIC BANJOS (U.S. CLS. 2, 21 AND 36).
TASHIA BUNCH, EXAMINING ATTORNEY

SN 85-518,833. JFM STRINGED INSTRUMENTS, RANCHO CUCAMONGA, CA. FILED 1-18-2012.



THE MARK CONSISTS OF THE STYLIZED LETTERS "JFM".
FOR STRINGED MUSICAL INSTRUMENTS (U.S. CLS. 2, 21 AND 36).
FIRST USE 6-1-2011; IN COMMERCE 6-1-2011.
ROBERT C. CLARK JR., EXAMINING ATTORNEY

CLASS 15—(Continued).

SN 85-525,434. COPPOCK, ALLEN D., GRAFTON, WI. FILED 1-25-2012.



THE MARK CONSISTS OF THE LETTERS, "ARP" , IN ALL CAPITALS, WITH A MUSICAL TREBLE CLEF STAFF ON THE LEFT OF THE THREE CAPITAL LETTERS, AND A POWER CORD EXTENDING FROM THE CLEF SIGN EXTENDING UNDERNEATH THE THREE LETTERS, TO THE RIGHT TO END WITH A POWER PLUG.

FOR SYNTHESIZERS; ELECTRONIC MUSIC SYNTHESIZERS; AND ELECTRONIC MODULES FOR USE WITH MUSIC SYNTHESIZERS; KEYBOARD MUSICAL INSTRUMENTS (U.S. CLS. 2, 21 AND 36).

DAWN FELDMAN, EXAMINING ATTORNEY

SN 85-528,984. PRO MUSIC DEVELOPMENTS LTD., TEL AVIV, ISRAEL, FILED 1-30-2012.

MAXIMUM SHREDABILITY

THE MARK CONSISTS OF STANDARD CHARACTERS WITHOUT CLAIM TO ANY PARTICULAR FONT, STYLE, SIZE, OR COLOR.

NO CLAIM IS MADE TO THE EXCLUSIVE RIGHT TO USE "SHREDABILITY", APART FROM THE MARK AS SHOWN.

FOR GUITAR PICKS (U.S. CLS. 2, 21 AND 36).
LOURDES AYALA, EXAMINING ATTORNEY

SN 85-531,202. CLEAN SLING LLC, ARVADA, CO. FILED 2-1-2012.

Clean Sling

THE MARK CONSISTS OF STANDARD CHARACTERS WITHOUT CLAIM TO ANY PARTICULAR FONT, STYLE, SIZE, OR COLOR.

FOR CASES FOR MUSICAL INSTRUMENTS (U.S. CLS. 2, 21 AND 36).

LYNDSEY KUYKENDALL, EXAMINING ATTORNEY

CLASS 15—(Continued).

SN 85-536,517. ERNIE BALL, INC., COACHELLA, CA. FILED 2-7-2012.

LIII

THE MARK CONSISTS OF STANDARD CHARACTERS WITHOUT CLAIM TO ANY PARTICULAR FONT, STYLE, SIZE, OR COLOR.

FOR ELECTRIC GUITARS; GUITARS (U.S. CLS. 2, 11 AND 36).

DAVID COLLIER, EXAMINING ATTORNEY

CLASS 16—(Continued).

SN 77-710,541. CANADIAN STANDARDS ASSOCIATION, TORONTO, ONTARIO, CANADA, FILED 4-9-2009.

CSA CERTIFIED

THE MARK CONSISTS OF STANDARD CHARACTERS WITHOUT CLAIM TO ANY PARTICULAR FONT, STYLE, SIZE, OR COLOR.

OWNER OF CANADA REG. NO. TMA818944, DATED 3-2-2012, EXPIRES 3-2-2027.

OWNER OF U.S. REG. NOS. 971,065, 2,498,742 AND OTHERS.

NO CLAIM IS MADE TO THE EXCLUSIVE RIGHT TO USE "CERTIFIED", APART FROM THE MARK AS SHOWN.

FOR PUBLICATIONS, NAMELY, NEWSLETTERS, PAMPHLETS, AND BROCHURES TO PROMOTE AND EDUCATE CONSUMERS ON THE HEALTH, SAFETY, PERFORMANCE, AND QUALITY OF GOODS AND SERVICES THAT MEET CERTAIN STANDARDS CONCERNING INDUSTRIAL, COMMERCIAL, AND DOMESTIC TECHNICAL STANDARDS IN A WIDE VARIETY OF FIELDS (U.S. CLS. 2, 5, 22, 23, 29, 37, 38 AND 50).

AMY ALFIERI, EXAMINING ATTORNEY

CLASS 16—PAPER GOODS AND PRINTED MATTER

SN 77-280,745. YAFFA ASSOULINE, PARIS, FRANCE, FILED 9-17-2007.



FOR MAGAZINE CONCERNING LUXURY GOODS AND SERVICES AND LIFESTYLE ISSUES AND DIRECTED TO LUXURY BRAND MANUFACTURERS (U.S. CLS. 2, 5, 22, 23, 29, 37, 38 AND 50).

ASMAT KHAN, EXAMINING ATTORNEY

SN 79-100,244. STORA ENSO OYJ, FINLAND, FILED 7-11-2011.

VIVID

THE MARK CONSISTS OF STANDARD CHARACTERS WITHOUT CLAIM TO ANY PARTICULAR FONT, STYLE, SIZE, OR COLOR.

PRIORITY DATE OF 1-20-2011 IS CLAIMED.

OWNER OF INTERNATIONAL REGISTRATION 1084756 DATED 7-11-2011, EXPIRES 7-11-2021.

FOR PAPER, NAMELY, UNPRINTED BOOK PAPER (U.S. CLS. 2, 5, 22, 23, 29, 37, 38 AND 50).

DAVID HOFFMAN, EXAMINING ATTORNEY

SN 85-095,546. CRAYOLA PROPERTIES, INC., EASTON, PA. FILED 7-29-2010.

PRESTO DOTS

THE MARK CONSISTS OF STANDARD CHARACTERS WITHOUT CLAIM TO ANY PARTICULAR FONT, STYLE, SIZE, OR COLOR.

NO CLAIM IS MADE TO THE EXCLUSIVE RIGHT TO USE "DOTS", APART FROM THE MARK AS SHOWN.

FOR MODELING COMPOUNDS (U.S. CLS. 2, 5, 22, 23, 29, 37, 38 AND 50).

FIRST USE 12-31-2009; IN COMMERCE 12-31-2009.

MARTHA FROMM, EXAMINING ATTORNEY

CLASS 16—(Continued).

SN 85-146,230. KATHLEEN D. COWLEY, DENVER, NC. FILED 10-6-2010.

Alpha-Omega Collection

THE MARK CONSISTS OF STANDARD CHARACTERS WITHOUT CLAIM TO ANY PARTICULAR FONT, STYLE, SIZE, OR COLOR.

NO CLAIM IS MADE TO THE EXCLUSIVE RIGHT TO USE "COLLECTION", APART FROM THE MARK AS SHOWN.

FOR PORTABLE HOME AND OFFICE FILING AND ORGANIZATION SYSTEMS COMPRISED OF A FILE CARRIER IN THE NATURE OF A FILE BOX OR TOTE BAG SPECIALLY ADAPTED FOR USE AS A FILE CARRIER AND ONE OR MORE OF THE FOLLOWING, NAMELY, HANGING FOLDERS, TICKLER FILES, BIENNIAL CALENDARS, MONTHLY CALENDARS, DAILY CALENDARS AND NOTE CARDS SOLD TOGETHER AS A SINGLE UNIT (U.S. CLS. 2, 5, 22, 23, 29, 37, 38 AND 50).

FIRST USE 4-29-2009; IN COMMERCE 10-1-2009.
PRISCILLA MILTON, EXAMINING ATTORNEY

CLASS 16—(Continued).

AND YELLOW STRIPED BALL, WITH ALL OF THE FEATURES OF THE ANT AND BALL OUTLINED IN BLACK. BELOW THESE DESIGN ELEMENTS IS THE WORDING "HATHI CHITI BOOKS FOR KIDS" IN BLUE, EXCEPT FOR THE DOTS OVER EACH LETTER "I" IN "HATHI CHITI", WHICH ARE YELLOW OUTLINED IN BLUE. ALL OF THE WORDING APPEARS INSIDE A WHITE RECTANGLE THAT IS OUTLINED IN THREE CONCENTRIC RECTANGULAR BANDS COMPRISED OF A RED BAND, YELLOW BAND AND ANOTHER RED BAND. THE ENGLISH TRANSLATION OF "HATHI CHITI" IN THE MARK IS "ELEPHANT ANT".

FOR PUBLICATIONS, NAMELY, FICTION CHILDREN'S BOOKS; SERIES OF CHILDREN'S BOOKS; EDUCATIONAL BOOKS IN THE FIELD OF READING; CHILDREN'S ACTIVITY BOOKS (U.S. CLS. 2, 5, 22, 23, 29, 37, 38 AND 50).

FIRST USE 1-1-2005; IN COMMERCE 1-1-2005.

BERNICE MIDDLETON, EXAMINING ATTORNEY

SN 85-208,546. DEETZ, DAYTON J., MENDON, MA. FILED 12-31-2010.

SN 85-174,693. RESHMA SAPRE, NEW YORK, NY. FILED 11-11-2010.



NO CLAIM IS MADE TO THE EXCLUSIVE RIGHT TO USE "BOOKS FOR KIDS", APART FROM THE MARK AS SHOWN.

THE NAME(S), PORTRAIT(S), AND/OR SIGNATURE(S) SHOWN IN THE MARK DOES NOT IDENTIFY A PARTICULAR LIVING INDIVIDUAL.

THE COLOR(S) RED, WHITE, BLUE, YELLOW, DARK BLUE AND BLACK IS/ARE CLAIMED AS A FEATURE OF THE MARK.

THE MARK CONSISTS OF THE DESIGN OF A BLUE ELEPHANT WITH A DARK BLUE HAT, DARK BLUE BOW TIE, DARK BLUE BLANKET, WHITE TUSK, WHITE AND BLACK EYES AND WHITE TOENAILS, WITH ALL OF THE FOREGOING FEATURES OUTLINED IN BLACK. TO THE RIGHT OF THE ELEPHANT IS A RED ANT WITH YELLOW TENNIS SHOES, YELLOW ANTENNAE, BLACK ARMS, AND WHITE AND BLACK EYES, STANDING ON A RED

POLYmatte

THE MARK CONSISTS OF A STYLIZED WORD, "POLY-MATTE".

FOR ART PAPER; ART PRINTS; ART PRINTS ON CANVAS; CHALK BOARDS FOR SCHOOL AND HOME USE; CHILDREN'S WALL STICKERS AND MURALS; DIGITAL PRINTING PAPER; DRAWING BOARDS; DRY ERASE WRITING BOARDS AND WRITING SURFACES; DYE-SUBLIMATION PRINT PAPER; GRAPHIC PRINTS AND REPRESENTATIONS; LASER PRINT PAPER; LASER PRINTING PAPER; MAGNETIC BOARDS; MAGNETIC PAPER; PAPER; PAPER FOR USE IN MAKING SIGNS; PAPER FOR USE IN THE GRAPHIC ARTS INDUSTRY; PAPER FOR USE IN THE MANUFACTURE OF WALLPAPER; PHOTOGRAPHIC PRINTS; PICTORIAL PRINTS; PLASTIC SHEETS FOR WRITING, PRINTING, AND MARKING; POLYESTER FILM FOR USE AS A PAPER SUBSTITUTE FOR DRY TONER XEROGRAPHIC IMAGING, NAMELY, LASER PRINTING, COLOR COPIER PRINTING, DRY TONER PRINTING, SCREEN PRINTING, AND OFFSET PRINTING; PRINT SUBSTRATE, NAMELY, TRANSPARENT, OPAQUE, AND TRANSLUCENT FILMS FOR USE WITH INK JET COPIERS AND LASER PRINTERS; PRINTED EDUCATIONAL MATERIAL, NAMELY, TEACHING TILES; PRINTED GRAPHS; PRINTED PAPER SIGNS; PRINTING PAPER; PRINTING PAPERS (U.S. CLS. 2, 5, 22, 23, 29, 37, 38 AND 50).

FIRST USE 3-1-2007; IN COMMERCE 3-1-2007.

ANTHONY RINKER, EXAMINING ATTORNEY

CLASS 16—(Continued).

SN 85-214,459. GREENSPUN MEDIA GROUP, LLC, HENDERSON, NV. FILED 1-10-2011.

VEGAS INC.

THE MARK CONSISTS OF STANDARD CHARACTERS WITHOUT CLAIM TO ANY PARTICULAR FONT, STYLE, SIZE, OR COLOR.

OWNER OF U.S. REG. NOS. 2,943,458, 3,724,212 AND OTHERS.

NO CLAIM IS MADE TO THE EXCLUSIVE RIGHT TO USE "VEGAS", APART FROM THE MARK AS SHOWN.

FOR PUBLICATIONS, NAMELY, MAGAZINES FOCUSING ON ECONOMICS, NAMELY, GAMING AND NON GAMING RESORTS, SUPPORT ORGANIZATIONS AND COMPANIES (U.S. CLS. 2, 5, 22, 23, 29, 37, 38 AND 50).

DARRYL SPRUILL, EXAMINING ATTORNEY

CLASS 16—(Continued).

SN 85-281,534. FIGHT GAME LLC, LOS ANGELES, CA. FILED 3-30-2011.

FIGHT GAME

NO CLAIM IS MADE TO THE EXCLUSIVE RIGHT TO USE "FIGHT", APART FROM THE MARK AS SHOWN.

THE MARK CONSISTS OF THE STYLIZED WORDS "FIGHT GAME".

FOR MAGAZINES RELATING TO PHYSICAL FITNESS (U.S. CLS. 2, 5, 22, 23, 29, 37, 38 AND 50).

FIRST USE 3-25-2011; IN COMMERCE 3-25-2011.

SKYE YOUNG, EXAMINING ATTORNEY

SN 85-226,956. MICHELLE KILGORE LLC, CHESAPEAKE, VA. FILED 1-26-2011.

i do!

THE MARK CONSISTS OF THE TEXT "I DO!" IN LOW-CASE LETTERS.

FOR MAGAZINES FEATURING WEDDINGS (U.S. CLS. 2, 5, 22, 23, 29, 37, 38 AND 50).

DAWN FELDMAN, EXAMINING ATTORNEY

SN 85-344,495. TEAM FAIRFAX 2013, FAIRFAX, VA. FILED 6-13-2011.



THE MARK CONSISTS OF THE HEAD OF AN EAGLE WHERE THE EYE IS DEPICTED BY A STAR.

FOR MAPS; STATIONERY; STATIONERY SETS COMPRISED PRIMARILY OF STATIONERY, PAPER BAGS, PRINTED PAPER SIGNS, PHOTOGRAPHS, POSTERS; IRON-ON TRANSFERS, PLASTIC TRANSFERS, PENS, PENCILS, GENERAL PURPOSE PLASTIC BAGS, PAPERWEIGHTS, PAPER FLAGS, DECORATIVE PAPER FLAGS (U.S. CLS. 2, 5, 22, 23, 29, 37, 38 AND 50).

JOSETTE BEVERLY, EXAMINING ATTORNEY

SN 85-242,103. GREEN STEPS TO LIFE, DBA BMB CONSTRUCTION PROPERTIES, ALAMEDA, CA. FILED 2-14-2011.

Wait A Green Minute

THE MARK CONSISTS OF STANDARD CHARACTERS WITHOUT CLAIM TO ANY PARTICULAR FONT, STYLE, SIZE, OR COLOR.

FOR EDUCATIONAL PUBLICATIONS, NAMELY, TRAINING MANUALS IN THE FIELD OF SUSTAINABILITY (U.S. CLS. 2, 5, 22, 23, 29, 37, 38 AND 50).

FIRST USE 4-1-2010; IN COMMERCE 2-14-2011.

CORY BOONE, EXAMINING ATTORNEY

SN 85-346,604. BETHARDS, WILLIAM, FREDERICKSBURG, VA. FILED 6-15-2011.

**HEY DIDDLE DIDDLE RIGHT
DOWN THE MIDDLE**

THE MARK CONSISTS OF STANDARD CHARACTERS WITHOUT CLAIM TO ANY PARTICULAR FONT, STYLE, SIZE, OR COLOR.

FOR BOOKS IN THE FIELD OF MARKSMANSHIP (U.S. CLS. 2, 5, 22, 23, 29, 37, 38 AND 50).

ALEX KEAM, EXAMINING ATTORNEY

CLASS 16—(Continued).

SN 85-351,752. DACTEK INTERNATIONAL CORPORATION, FOUNTAIN VALLEY, CA. FILED 6-21-2011.

DACTEK

THE MARK CONSISTS OF STANDARD CHARACTERS WITHOUT CLAIM TO ANY PARTICULAR FONT, STYLE, SIZE, OR COLOR.

OWNER OF U.S. REG. NO. 2,969,310.

FOR INKLESS FINGER PRINTING INK; INKLESS PAD RECHARGING SOLUTION FOR FINGERPRINT PAD; FINGERPRINTING INK; FINGERPRINTING INK PADS; FINGERPRINT CARDS; INKLESS AND INK-BASED FINGER PRINTING KITS FOR OBTAINING FINGERPRINTS, FOOTPRINTS, PALM PRINTS, AND PET PAW PRINTS, COMPRISING OF CARDHOLDER FOR HOLDING FINGERPRINT CARD, FINGERPRINT CARD, FINGERPRINT PAD, PAD SOLUTION FOR FINGERPRINT PAD AND CLEANSING TOWELETTES (U.S. CLS. 2, 5, 22, 23, 29, 37, 38 AND 50).

FIRST USE 3-1-1977; IN COMMERCE 3-1-1977.

BRENDAN MCCAULEY, EXAMINING ATTORNEY

SN 85-365,893. RITA ORA, NEW YORK, NY. FILED 7-7-2011.

RITA ORA

THE MARK CONSISTS OF STANDARD CHARACTERS WITHOUT CLAIM TO ANY PARTICULAR FONT, STYLE, SIZE, OR COLOR.

THE NAME(S), PORTRAIT(S), AND/OR SIGNATURE(S) SHOWN IN THE MARK IDENTIFIES "RITA ORA", WHOSE CONSENT(S) TO REGISTER IS MADE OF RECORD.

FOR PRINTED MATTER, NAMELY, POSTERS, CALENDARS, CONCERT SOUVENIR PROGRAMS, STICKERS, BOOKS AND MAGAZINES IN THE FIELDS OF MUSIC, ENTERTAINMENT, ART AND/OR CULTURE (U.S. CLS. 2, 5, 22, 23, 29, 37, 38 AND 50).

KAREN K. BUSH, EXAMINING ATTORNEY

CLASS 16—(Continued).

SN 85-373,610. KANDRIS, THOMAS P, DBA PACKAGEONE INC, SACRAMENTO, CA. FILED 7-18-2011.

All West Container

THE MARK CONSISTS OF STANDARD CHARACTERS WITHOUT CLAIM TO ANY PARTICULAR FONT, STYLE, SIZE, OR COLOR.

NO CLAIM IS MADE TO THE EXCLUSIVE RIGHT TO USE "CONTAINER", APART FROM THE MARK AS SHOWN.

FOR CARDBOARD; CARDBOARD BOXES; CARDBOARD CARRIERS FOR FOOD AND BEVERAGES; CARDBOARD CARTONS; CARDBOARD CONTAINERS; CARDBOARD PACKAGING; CARDBOARD PACKAGING BOXES IN COLLAPSIBLE FORM; CARDBOARD PACKAGING BOXES IN MADE-UP FORM; CARDBOARD SIGNBOARDS; COLLAPSIBLE CARDBOARD BOXES; CONTAINERS FOR STORAGE OR TRANSPORT MADE OF PAPER OR CARDBOARD; CORRUGATED BOARD; CORRUGATED BOARD AND PAPER CONTAINERS; CORRUGATED BOXES; CORRUGATED CARDBOARD; CORRUGATED CARDBOARD BOXES; CORRUGATED CONTAINERS; CORRUGATED PAPER; CORRUGATED PAPER PANELS LAMINATED WITH BLEACHED WHITE PAPER PRIMARILY FOR APPLICATION OF PRINTED MEDIA FOR FURTHER USE IN SIGNAGE APPLICATIONS; CORRUGATED PAPER PANELS LAMINATED WITH KRAFT LINERBOARD PRIMARILY FOR LAMINATION WITH DECORATIVE OVERLAYS FOR FURTHER USE IN THE CONSTRUCTION OF WALL PARTITIONS, ROOM DIVIDERS, DESKTOPS AND TABLETOPS; CORRUGATED RECORD STORAGE BOXES; FILE BOXES FOR STORAGE OF BUSINESS AND PERSONAL RECORD; FILE BOXES FOR STORAGE OF MAGAZINES; GIFT BOXES MADE OF CARDBOARD; PACKAGING CONTAINERS COMPRISED OF PAPERBOARD FOR FOOD AND BEVERAGES; PACKAGING MATERIALS MADE OF RECYCLED PAPER; PACKING CARDBOARD; PACKING CARDBOARD CONTAINERS; PAPER AND CARDBOARD (U.S. CLS. 2, 5, 22, 23, 29, 37, 38 AND 50).

FIRST USE 6-1-1958; IN COMMERCE 6-1-2011.

STEVEN PEREZ, EXAMINING ATTORNEY

SN 85-375,992. SIMPLY CLING, LLC, LOUISVILLE, KY. FILED 7-20-2011.

SIMPLY CLING

THE MARK CONSISTS OF STANDARD CHARACTERS WITHOUT CLAIM TO ANY PARTICULAR FONT, STYLE, SIZE, OR COLOR.

NO CLAIM IS MADE TO THE EXCLUSIVE RIGHT TO USE "CLING", APART FROM THE MARK AS SHOWN.

FOR DECALS; STICKERS (U.S. CLS. 2, 5, 22, 23, 29, 37 AND 50).

ELLEN B. AWRICH, EXAMINING ATTORNEY

CLASS 16—(Continued).

SN 85-377,944. SADDLEBACK EDUCATIONAL, INC., COSTA MESA, CA. FILED 7-21-2011.

21ST CENTURY LIFESKILLS

THE MARK CONSISTS OF STANDARD CHARACTERS WITHOUT CLAIM TO ANY PARTICULAR FONT, STYLE, SIZE, OR COLOR.

NO CLAIM IS MADE TO THE EXCLUSIVE RIGHT TO USE "LIFE SKILLS", APART FROM THE MARK AS SHOWN.

FOR SERIES OF FICTION BOOKS, WORKBOOKS, HANDBOOKS AND TEACHER'S GUIDES IN THE FIELD OF REMEDIAL EDUCATION FOR SECONDARY AND ADULT EDUCATION; PRINTED MATTER, NAMELY, BOOKS, WORKBOOKS, HANDBOOKS AND TEACHER'S GUIDES IN THE FIELD OF REMEDIAL EDUCATION FOR SECONDARY AND ADULT EDUCATION (U.S. CLS. 2, 5, 22, 23, 29, 37, 38 AND 50).

FIRST USE 0-0-2010; IN COMMERCE 0-0-2010.
JULIE GUTTADAURO, EXAMINING ATTORNEY

CLASS 16—(Continued).

SN 85-383,602. WILLIAMS, CARLA, BUCKLEY, WA. FILED 7-28-2011.

My Very Own Quiet Time

THE MARK CONSISTS OF STANDARD CHARACTERS WITHOUT CLAIM TO ANY PARTICULAR FONT, STYLE, SIZE, OR COLOR.

FOR EDUCATIONAL KITS SOLD AS A UNIT IN THE FIELD OF EARLY CHILDHOOD DEVELOPMENT CONSISTING PRIMARILY OF FLASH CARDS, BOOKS AND PRINTED INSTRUCTIONAL AND TEACHING MATERIALS ALL FEATURING INFORMATION ON, AS WELL AS TIPS AND TECHNIQUES ON HOW TO IMPROVE OR STRENGTHEN, INFANT COGNITIVE DEVELOPMENT, SPEECH DEVELOPMENT, FINE MOTOR SKILL DEVELOPMENT, COUNTING SKILLS, COLOR AND SHAPE RECOGNITION, AND SOCIAL SKILLS AND ALSO INCLUDING DVDS (U.S. CLS. 2, 5, 22, 23, 29, 37, 38 AND 50).

FIRST USE 4-1-2005; IN COMMERCE 4-1-2005.
MICHAEL TANNER, EXAMINING ATTORNEY

SN 85-380,132. SCORES HOLDING COMPANY INC., NEW YORK, NY. FILED 7-25-2011.

SCORES ENTERTAINMENT

THE MARK CONSISTS OF STANDARD CHARACTERS WITHOUT CLAIM TO ANY PARTICULAR FONT, STYLE, SIZE, OR COLOR.

OWNER OF U.S. REG. NOS. 1,830,135, 1,855,829 AND OTHERS.

NO CLAIM IS MADE TO THE EXCLUSIVE RIGHT TO USE "ENTERTAINMENT", APART FROM THE MARK AS SHOWN.

FOR PRINTED MATTER, NAMELY, PHOTOGRAPHS, MAGAZINES, PRINTED PERIODICALS, NEWSLETTERS, AND BROCHURES ALL IN THE FIELD OF ADULT ENTERTAINMENT (U.S. CLS. 2, 5, 22, 23, 29, 37, 38 AND 50).

CHRISTINA SOBRAL, EXAMINING ATTORNEY

SN 85-384,149. VADAKAN-MYUNG, LOS ANGELES, CA. FILED 7-28-2011.

POKETO

THE MARK CONSISTS OF STANDARD CHARACTERS WITHOUT CLAIM TO ANY PARTICULAR FONT, STYLE, SIZE, OR COLOR.

OWNER OF U.S. REG. NO. 3,220,121.

FOR PAPER AND PAPER GOODS, NAMELY, BLOT- TING PAPER, BOND PAPER, CONSTRUCTION PAPER, POST CARDS; STATIONERY; NOTE PADS; NOTE CARDS; NOTEBOOKS; ENVELOPES; DAY PLANNERS; PAPER SHREDDERS; PENS AND PENCILS; BLANK JOURNALS; LETTER SETS IN THE NATURE OF PLAS- TIC AND PAPER LETTERS FOR USE IN MAKING SIGNS AND POSTERS; LETTER SETS IN THE NATURE OF STATIONERY, CARDS AND PAPER ENVELOPES; GREETING CARDS; NOTEBOOK COVERS (U.S. CLS. 2, 5, 22, 23, 29, 37, 38 AND 50).

JENNIFER WILLISTON, EXAMINING ATTORNEY

CLASS 16—(Continued).

SN 85-392,348. THE SAN DIEGO UNION-TRIBUNE, LLC, SAN DIEGO, CA. FILED 8-8-2011.



THE MARK CONSISTS OF A STYLIZED LETTER "U" AND A STYLIZED LETTER "T" SEPARATED BY A STYLIZED HYPHEN.

FOR NEWSPAPERS (U.S. CLS. 2, 5, 22, 23, 29, 37, 38 AND 50).

FIRST USE 1-3-2012; IN COMMERCE 1-3-2012.
JAY BESCH, EXAMINING ATTORNEY

CLASS 16—(Continued).

SN 85-411,215. DOPE MAGAZINE, LLC, SEATTLE, WA. FILED 8-30-2011.

DEFENDING OUR PATIENTS
EVERYWHERE

THE MARK CONSISTS OF STANDARD CHARACTERS WITHOUT CLAIM TO ANY PARTICULAR FONT, STYLE, SIZE, OR COLOR.

FOR MAGAZINES IN THE FIELD OF THE CANNABIS LIFESTYLE (U.S. CLS. 2, 5, 22, 23, 29, 37, 38 AND 50).

FIRST USE 8-19-2011; IN COMMERCE 8-29-2011.
ROBERT STRUCK, EXAMINING ATTORNEY

SN 85-398,193. FROMM WORKS INC., TORONTO, CANADA, FILED 8-15-2011.

MOVE A DOODLE

THE MARK CONSISTS OF STANDARD CHARACTERS WITHOUT CLAIM TO ANY PARTICULAR FONT, STYLE, SIZE, OR COLOR.

FOR CHILDREN'S ARTS AND CRAFTS KITS FOR DRAWING, TRACING, STENCILLING, AND STAMP PAD ACTIVITIES, PAPER STATIONERY (U.S. CLS. 2, 5, 22, 23, 29, 37, 38 AND 50).

ELIZABETH HUGHITT, EXAMINING ATTORNEY

SN 85-412,597. ECO GREEN CRAFTS, INC., FAIRFIELD, NJ. FILED 9-1-2011.

Paris Trunk

FOR STAMP INKS (U.S. CLS. 2, 5, 22, 23, 29, 37, 38 AND 50).

FIRST USE 1-1-2010; IN COMMERCE 1-1-2010.
DEIRDRE ROBERTSON, EXAMINING ATTORNEY

SN 85-408,177. HOOT & OLLIE, LLC, DUNWOODY, GA. FILED 8-26-2011.

OLLIE THE GHOST

THE MARK CONSISTS OF STANDARD CHARACTERS WITHOUT CLAIM TO ANY PARTICULAR FONT, STYLE, SIZE, OR COLOR.

FOR ARTS AND CRAFTS PAINT KITS; PAPER GOODS AND PRINTED MATTER, NAMELY, ADDRESS BOOKS; COMIC BOOKS; NOTEBOOKS; CHILDREN'S BOOKS; PRINTED INVITATIONS; PERSONAL ORGANIZERS; PAPER TABLE CLOTHS; TRADING CARDS; POSTERS; BOOK PLATES; BOOK MARKS; ARTIST'S MATERIALS, NAMELY, PENCILS, PENS; PAPER GIFT WRAP; PAPER GIFT TAGS; PAPER GIFT BAGS; GREETING CARDS, PAPER PARTY DECORATIONS; PAPER NAPKINS; PAPER PARTY BAGS; POSTCARDS; STICKERS; STICKER ALBUMS; CALENDARS; CARDBOARD FIGURES; TEMPORARY TATTOOS; CALENDARS (U.S. CLS. 2, 5, 22, 23, 29, 37, 38 AND 50).

TINA MAI, EXAMINING ATTORNEY

SN 85-413,304. PROMOSD LLC, GREENFIELD, MA. FILED 9-1-2011.

promosd

THE MARK CONSISTS OF STANDARD CHARACTERS WITHOUT CLAIM TO ANY PARTICULAR FONT, STYLE, SIZE, OR COLOR.

FOR PRINTED MATTER, NAMELY, PAMPHLETS, COLORING BOOKS, ADHESIVE BACKED INFORMATIONAL TIP CARDS, FOLDERS AND SLIDE GUIDES FEATURING THE TOPICS OF HEALTH AND WELLNESS, MENTAL AND EMOTIONAL HEALTH, DISEASES, DISEASE MANAGEMENT AND DISEASE PREVENTION, ALCOHOL AND OTHER DRUGS, COGNITIVE AND BEHAVIORAL CHANGE, PARENTING, YOUTH DEVELOPMENT, PERSONAL DEVELOPMENT, INTERPERSONAL SKILLS, FAMILY SERVICES, SOCIAL ISSUES, ELDER ISSUES, FINANCIAL MANAGEMENT, EDUCATION, PATIENT EDUCATION, SAFETY, EMERGENCY PREPAREDNESS, RECREATION AND LEISURE, LAW ENFORCEMENT AND GOVERNMENT (U.S. CLS. 2, 5, 22, 23, 29, 37, 38 AND 50).

ROBERT STRUCK, EXAMINING ATTORNEY

CLASS 16—(Continued).

SN 85-414,686. WOODMAN, CYNTHIA, PASADENA, CA.
FILED 9-2-2011.

WHAT A GIRL EATS

THE MARK CONSISTS OF STANDARD CHARACTERS WITHOUT CLAIM TO ANY PARTICULAR FONT, STYLE, SIZE, OR COLOR.

FOR PRINTED MATTER, NAMELY, BOOKS, COOK-BOOKS, RECIPE CARDS, MAGAZINES AND NEWS-LETTERS, ALL IN THE FIELDS OF FOOD, COOKING, NUTRITION, DIET AND RESTAURANTS (U.S. CLS. 2, 5, 22, 23, 29, 37, 38 AND 50).

SUNG IN, EXAMINING ATTORNEY

SN 85-435,219. NORTHWEST NAPKIN, LLC, VANCOUVER, WA. FILED 9-29-2011.

Ultra-Soft Plus

THE MARK CONSISTS OF STANDARD CHARACTERS WITHOUT CLAIM TO ANY PARTICULAR FONT, STYLE, SIZE, OR COLOR.

FOR DISPOSABLE NAPKINS; FACE TOWELS OF PAPER; HAND TOWELS OF PAPER; NAPKIN PAPER; PAPER HAND-TOWELS; PAPER HANDTOWELS; PAPER NAPKINS; PAPER TISSUES; PAPER TOILET BOWL LINERS; PAPER TOWELS; TOILET PAPER; TOILET SEAT COVER PAPER (U.S. CLS. 2, 5, 22, 23, 29, 37, 38 AND 50).

FIRST USE 5-15-2010; IN COMMERCE 5-15-2010.
JENNIFER VASQUEZ, EXAMINING ATTORNEY

SN 85-444,929. MALIBU MONTHLY, INC., MALIBU, CA.
FILED 10-11-2011.

MALIBU MAGAZINE

THE MARK CONSISTS OF STANDARD CHARACTERS WITHOUT CLAIM TO ANY PARTICULAR FONT, STYLE, SIZE, OR COLOR.

OWNER OF U.S. REG. NO. 3,110,738.

NO CLAIM IS MADE TO THE EXCLUSIVE RIGHT TO USE "MAGAZINE", APART FROM THE MARK AS SHOWN. SEC. 2(F).

FOR PERIODICAL MAGAZINES IN THE FIELD OF LIFESTYLE, BOOKS AND RESTAURANT REVIEWS, FASHION, COMMUNITY EVENTS, CURRENT EVENTS, HOME DECOR, TRAVEL AND ENTERTAINMENT (U.S. CLS. 2, 5, 22, 23, 29, 37, 38 AND 50).

FIRST USE 2-10-2005; IN COMMERCE 3-30-2005.
TINA MAI, EXAMINING ATTORNEY

CLASS 16—(Continued).

SN 85-447,811. JANE BACHRACH, CARBONDALE, CO.
FILED 10-14-2011.

THE WITTY KITTY

THE MARK CONSISTS OF STANDARD CHARACTERS WITHOUT CLAIM TO ANY PARTICULAR FONT, STYLE, SIZE, OR COLOR.

FOR CHILDREN'S BOOKS; BOOKMARKS (U.S. CLS. 2, 5, 22, 23, 29, 37, 38 AND 50).

DAVID I, EXAMINING ATTORNEY

SN 85-447,876. SUSOIX, LLC, NEW YORK, NY. FILED 10-14-2011.

NO CLAIM IS MADE TO THE EXCLUSIVE RIGHT TO USE "MAGAZINE", APART FROM THE MARK AS SHOWN. THE COLOR(S) RED AND BLACK IS/ARE CLAIMED AS A FEATURE OF THE MARK.

THE MARK CONSISTS OF THE LETTERS AND WORDING "SUS MAGAZINE" WHERE THE "SUS" IS IN RED WITH BLACK BORDER, WITH THE TWO "S" LETTERS UPSIDE DOWN, AND THE WORDING "MAGAZINE" IS IN BLACK AND BELOW THE LETTERS "SUS".

THE WORDING "SUS" HAS NO MEANING IN A FOREIGN LANGUAGE.

FOR MAGAZINES FEATURING NEWS AND INFORMATION CONCERNING SPORTS (U.S. CLS. 2, 5, 22, 23, 29, 37, 38 AND 50).

WANDA KAY PRICE, EXAMINING ATTORNEY

CLASS 16—(Continued).

SN 85-453,531. PROMOSSED LLC, GREENFIELD, MA. FILED 10-21-2011.



THE COLOR(S) ORANGE AND GREEN IS/ARE CLAIMED AS A FEATURE OF THE MARK.

THE MARK CONSISTS OF THE WORD "PROMOSSED" WITH THE LETTERING "PROMOS" APPEARING IN ORANGE AND THE LETTERING "ED" APPEARING IN GREEN.

FOR PRINTED MATTER, NAMELY, PAMPHLETS, COLORING BOOKS, ADHESIVE BACKED INFORMATIONAL TIP CARDS, FOLDERS AND SLIDE GUIDES FEATURING THE TOPICS OF HEALTH AND WELLNESS, MENTAL AND EMOTIONAL HEALTH, DISEASES, DISEASE MANAGEMENT AND DISEASE PREVENTION, ALCOHOL AND OTHER DRUGS, COGNITIVE AND BEHAVIORAL CHANGE, PARENTING, YOUTH DEVELOPMENT, PERSONAL DEVELOPMENT, INTERPERSONAL SKILLS, FAMILY SERVICES, SOCIAL ISSUES, ELDER ISSUES, FINANCIAL MANAGEMENT, EDUCATION, PATIENT EDUCATION, SAFETY, EMERGENCY PREPAREDNESS, RECREATION AND LEISURE, LAW ENFORCEMENT AND GOVERNMENT (U.S. CLS. 2, 5, 22, 23, 29, 37, 38 AND 50).

ROBERT STRUCK, EXAMINING ATTORNEY

CLASS 16—(Continued).

SN 85-465,055. PROMOSSED LLC, GREENFIELD, MA. FILED 11-4-2011.



NO CLAIM IS MADE TO THE EXCLUSIVE RIGHT TO USE "PROMOTE", "INFORM" OR "EDUCATE", APART FROM THE MARK AS SHOWN.

THE MARK CONSISTS OF THE STYLIZED LETTER "PROMOSSED" WITH THE WORDS "PROMOTE." "INFORM." "EDUCATE" APPEARING BELOW.

FOR PRINTED MATTER, NAMELY, PAMPHLETS, COLORING BOOKS, ADHESIVE BACKED INFORMATIONAL TIP CARDS, FOLDERS AND SLIDE GUIDES FEATURING THE TOPICS OF HEALTH AND WELLNESS, MENTAL AND EMOTIONAL HEALTH, DISEASES, DISEASE MANAGEMENT AND DISEASE PREVENTION, ALCOHOL AND OTHER DRUGS, COGNITIVE AND BEHAVIORAL CHANGE, PARENTING, YOUTH DEVELOPMENT, PERSONAL DEVELOPMENT, INTERPERSONAL SKILLS, FAMILY SERVICES, SOCIAL ISSUES, ELDER ISSUES, FINANCIAL MANAGEMENT, EDUCATION, PATIENT EDUCATION, SAFETY, EMERGENCY PREPAREDNESS, RECREATION AND LEISURE, LAW ENFORCEMENT AND GOVERNMENT (U.S. CLS. 2, 5, 22, 23, 29, 37, 38 AND 50).

ROBERT STRUCK, EXAMINING ATTORNEY

SN 85-462,202. STUDIO 32, PLLC, DBA LUXE 32, FARMINGTON HILLS, MI. FILED 11-2-2011.

LUXE32

THE MARK CONSISTS OF STANDARD CHARACTERS WITHOUT CLAIM TO ANY PARTICULAR FONT, STYLE, SIZE, OR COLOR.

FOR MAGAZINES IN THE FIELD OF LUXURIOUS AND WEALTHY LIFESTYLE (U.S. CLS. 2, 5, 22, 23, 29, 37, 38 AND 50).

FIRST USE 11-1-2011; IN COMMERCE 11-1-2011.
JOHN DALIER, EXAMINING ATTORNEY

SN 85-468,572. TREASURE LEARNING SYSTEMS, LLC, DBA DISCIPLELAND, FORT COLLINS, CO. FILED 11-9-2011.

Core Bible

THE MARK CONSISTS OF STANDARD CHARACTERS WITHOUT CLAIM TO ANY PARTICULAR FONT, STYLE, SIZE, OR COLOR.

SEC. 2(F).

FOR EDUCATIONAL PUBLICATIONS, NAMELY, EDUCATIONAL LEARNING CARDS, FLASH CARDS, ACTIVITY CARDS, WORKBOOKS, TEXTBOOKS, ACTIVITY BOOKS, STORY BOOKS, PUZZLE BOOKS, PRINTED PUZZLES, TEACHER GUIDES, MANUALS, POSTERS AND EDUCATIONAL BOOKLETS IN THE FIELD OF RELIGION (U.S. CLS. 2, 5, 22, 23, 29, 37, 38 AND 50).

FIRST USE 11-4-2005; IN COMMERCE 11-4-2005.
SUZANNE BLANE, EXAMINING ATTORNEY

CLASS 16—(Continued).

SN 85-468,835. TREASURE LEARNING SYSTEMS, LLC, DBA DISCIPLAND, FORT COLLINS, CO. FILED 11-9-2011.

My Awesome God

THE MARK CONSISTS OF STANDARD CHARACTERS WITHOUT CLAIM TO ANY PARTICULAR FONT, STYLE, SIZE, OR COLOR.

NO CLAIM IS MADE TO THE EXCLUSIVE RIGHT TO USE "GOD", APART FROM THE MARK AS SHOWN.

FOR EDUCATIONAL PUBLICATIONS, NAMELY, EDUCATIONAL LEARNING CARDS, FLASH CARDS, ACTIVITY CARDS, WORKBOOKS, TEXTBOOKS, ACTIVITY BOOKS, STORY BOOKS, PUZZLE BOOKS, PRINTED PUZZLES, TEACHER GUIDES, MANUALS, POSTERS AND EDUCATIONAL BOOKLETS IN THE FIELD OF RELIGION (U.S. CLS. 2, 5, 22, 23, 29, 37, 38 AND 50).

FIRST USE 4-1-2011; IN COMMERCE 4-1-2011.
SUZANNE BLANE, EXAMINING ATTORNEY

SN 85-481,206. PIDGEON AIDEEN BLANAID, DBA DO YOURSELF A FLAVOUR, DUN LAOGAHAIRE DUBLIN, IRELAND, FILED 11-28-2011.

AL DESKO

THE MARK CONSISTS OF STANDARD CHARACTERS WITHOUT CLAIM TO ANY PARTICULAR FONT, STYLE, SIZE, OR COLOR.

OWNER OF AUSTRALIA REG. NO. 1341991, DATED 1-24-2010, EXPIRES 1-23-2020.

FOR COOKBOOKS (U.S. CLS. 2, 5, 22, 23, 29, 37, 38 AND 50).

DAVID MURRAY, EXAMINING ATTORNEY

SN 85-482,841. HOPUNION, L.L.C., YAKIMA, WA. FILED 11-29-2011.

**LIVE TO THE FULLEST BREW
TO THE FULLEST**

THE MARK CONSISTS OF STANDARD CHARACTERS WITHOUT CLAIM TO ANY PARTICULAR FONT, STYLE, SIZE, OR COLOR.

FOR POSTERS; PENS; INFORMATIONAL FLYERS, ADVERTISING PAMPHLETS, BROCHURES AND CATALOGS, ALL IN THE FIELD OF BEER (U.S. CLS. 2, 5, 22, 23, 29, 37, 38 AND 50).

SEAN CROWLEY, EXAMINING ATTORNEY

CLASS 16—(Continued).

SN 85-482,997. SENSACION MARKETING CREATIVES LLC, NEW YORK, NY. FILED 11-29-2011.

FUTBOL MUNDIAL

THE MARK CONSISTS OF STANDARD CHARACTERS WITHOUT CLAIM TO ANY PARTICULAR FONT, STYLE, SIZE, OR COLOR.

NO CLAIM IS MADE TO THE EXCLUSIVE RIGHT TO USE "FUTBOL", APART FROM THE MARK AS SHOWN.

THE ENGLISH TRANSLATION OF "FUTBOL MUNDIAL" IN THE MARK IS "WORLD SOCCER".

SEC. 2(F).

FOR PUBLICATION, NAMELY, PERIODICAL MAGAZINE FEATURING ARTICLES RELATED TO THE SPORT OF SOCCER (U.S. CLS. 2, 5, 22, 23, 29, 37, 38 AND 50).

FIRST USE 1-1-2002; IN COMMERCE 5-1-2002.

JAMES GRIFFIN, EXAMINING ATTORNEY

SN 85-483,758. BPM INC., PESHTIGO, WI. FILED 11-30-2011.

TA-NON-KA

THE MARK CONSISTS OF STANDARD CHARACTERS WITHOUT CLAIM TO ANY PARTICULAR FONT, STYLE, SIZE, OR COLOR.

THE WORDING "TA-NON-KA" HAS NO MEANING IN A FOREIGN LANGUAGE.

FOR BOND PAPER; COPY PAPER (U.S. CLS. 2, 5, 22, 23, 29, 37, 38 AND 50).

FIRST USE 10-1-1931; IN COMMERCE 10-1-1931.

BERYL GARDNER, EXAMINING ATTORNEY

SN 85-487,804. SCHOLASTIC INC., NEW YORK, NY. FILED 12-6-2011.

SCHOLASTIC EXPLORA TU MUNDO

THE MARK CONSISTS OF STANDARD CHARACTERS WITHOUT CLAIM TO ANY PARTICULAR FONT, STYLE, SIZE, OR COLOR.

OWNER OF U.S. REG. NOS. 1,567,119, 2,433,658 AND OTHERS.

THE ENGLISH TRANSLATION OF "EXPLORA TU MUNDO" IN THE MARK IS "EXPLORE YOUR WORLD".

FOR SERIES OF NON-FICTION AND REFERENCE BOOKS FOR CHILDREN ON A VARIETY OF TOPICS (U.S. CLS. 2, 5, 22, 23, 29, 37, 38 AND 50).

NICHOLAS ALTREE, EXAMINING ATTORNEY

CLASS 16—(Continued).

SN 85-489,517. FOREM PACKAGING, INC., NEWARK, NJ. FILED 12-7-2011.



THE MARK CONSISTS OF THE WORD "RITE" IN CURSIVE SCRIPT ABOVE THE WORD "CHOICE" IN BLOCK LETTERS, ON A FIELD CONSISTING OF A RECTANGULAR BAND, ABOVE WHICH SITS A SUN, AND HAVING A CHECK MARK ACROSS THE DESIGN, UNDERNEATH THE WORDING.

FOR PLASTIC BAGS FOR OTHERS TO PACKAGE THEIR PRODUCTS (U.S. CLS. 2, 5, 22, 23, 29, 37, 38 AND 50).

FIRST USE 12-31-2002; IN COMMERCE 12-31-2002. PRISCILLA MILTON, EXAMINING ATTORNEY

CLASS 16—(Continued).

SN 85-502,414. TIN MAN MULTI-MEDIA, LLC, OVERLAND PARK, KS. FILED 12-22-2011.



NO CLAIM IS MADE TO THE EXCLUSIVE RIGHT TO USE "FITNESS", APART FROM THE MARK AS SHOWN.

THE MARK CONSISTS OF A RECTANGLE WITH THE LETTER "F" POSITIONED ABOVE THE WORDS "FITNESS CULTURE", ALL IN UPPERCASE LETTERS.

FOR MAGAZINES FEATURING INFORMATION ABOUT HEALTH, WELLNESS AND FITNESS LIFESTYLES (U.S. CLS. 2, 5, 22, 23, 29, 37, 38 AND 50). MICHELE SWAIN, EXAMINING ATTORNEY

SN 85-492,867. NATIONAL PARKINSON FOUNDATION, INC., MIAMI, FL. FILED 12-12-2011.



NO CLAIM IS MADE TO THE EXCLUSIVE RIGHT TO USE "PARKINSON'S DISEASE" AND "PARKINSON FOUNDATION", APART FROM THE MARK AS SHOWN.

THE COLOR(S) BLUE, WHITE AND BLACK IS/ARE CLAIMED AS A FEATURE OF THE MARK.

THE MARK CONSISTS OF A STYLIZED LETTER "P" WITHIN A CIRCULAR DESIGN, WITH THE WORDING "AWARE IN CARE" AND "PARKINSON'S DISEASE" SET FORTH ABOVE AND BELOW THE "P", RESPECTIVELY. THE WORDING "NATIONAL PARKINSON FOUNDATION" IS TO THE RIGHT OF THE CIRCLE WITHIN STYLIZED LETTERING. THE WORD "NATIONAL" IS PLACED IN A VERTICAL POSITION NEXT TO THE WORDING "PARKINSON FOUNDATION". THE STYLIZED "P" AND THE WORDING "AWARE IN CARE" AND "PARKINSON'S DISEASE" ARE WHITE. THE WORD "PARKINSON" AND THE CIRCLE DESIGN ARE BLUE. THE WORDING "NATIONAL" AND "FOUNDATION" ARE BLACK.

SEC. 2(F) AS TO "NATIONAL PARKINSON FOUNDATION".

FOR PRINTED PAMPHLETS, BOOKLETS, NOTEPADS, NOTECARDS, NEWSLETTERS, BROCHURES AND INFORMATIONAL FLYERS IN THE FIELDS OF MEDICINE AND CAREGIVING, ALL FOR USE IN THE DIAGNOSIS AND TREATMENT OF PARKINSON'S DISEASE (U.S. CLS. 2, 5, 22, 23, 29, 37, 38 AND 50).

FIRST USE 11-0-2011; IN COMMERCE 11-0-2011. ELLEN B. AWRICH, EXAMINING ATTORNEY

SN 85-508,086. NG, TONY K, DBA SATIS PROMO, SAN FRANCISCO, CA. FILED 1-3-2012.



THE MARK CONSISTS OF THE LETTERS "S","A","T","I","S" ABOVE THE EYE BROW. THE RETINA IN THE EYE HAS AN OFF CENTERED STAR WITH A BOLD LINE FROM UNDERNEATH EXTENDING DOWNWARD RIGHT IN A CURVATURE ENDING IN A SPIRAL.

FOR A COMBINATION BOOKMARK AND HIGHLIGHTING MARKER, NAMELY, A BOOKMARK WITH A HIGHLIGHTING MARKER FITTED AT THE TOP THAT MAY BE USED TO BOTH MARK PAGES IN A BOOK AND HIGHLIGHT TEXT (U.S. CLS. 2, 5, 22, 23, 29, 37, 38 AND 50).

KATHERINE M. DUBRAY, EXAMINING ATTORNEY

CLASS 16—(Continued).

SN 85-508,706. REVIEW AND HERALD PUBLISHING ASSOCIATION, HAGERSTOWN, MD. FILED 1-4-2012.

REAL

THE MARK CONSISTS OF STANDARD CHARACTERS WITHOUT CLAIM TO ANY PARTICULAR FONT, STYLE, SIZE, OR COLOR.

FOR CHRISTIAN MAGAZINES FOR YOUTH FEATURING TRUE CHARACTER-BUILDING MISSION STORIES, PUZZLES, BIBLE STUDIES, FUN FACTS, AND CHRISTIAN ADVICE (U.S. CLS. 2, 5, 22, 23, 29, 37, 38 AND 50).

FIRST USE 12-3-2009; IN COMMERCE 12-3-2009.
SALLY SHIH, EXAMINING ATTORNEY

CLASS 16—(Continued).

SN 85-519,767. ASLMATTERS, INC., MCHENRY, IL. FILED 1-19-2012.

ASL360

THE MARK CONSISTS OF STANDARD CHARACTERS WITHOUT CLAIM TO ANY PARTICULAR FONT, STYLE, SIZE, OR COLOR.

FOR PRINTED INSTRUCTIONAL, EDUCATIONAL, AND TEACHING MATERIALS IN THE FIELD OF SIGN LANGUAGE LEARNING FOR HUMAN COMMUNICATION (U.S. CLS. 2, 5, 22, 23, 29, 37, 38 AND 50).

FIRST USE 12-19-2009; IN COMMERCE 1-14-2012.
TASHIA BUNCH, EXAMINING ATTORNEY

SN 85-511,212. MURPHY, HEATHER M, AKA HEATHER CAHOON, MONTGOMERY, NY. FILED 1-7-2012.



THE MARK CONSISTS OF THE STYLIZED WORDING "YOU MAKE DO" INSIDE A ROUND OUTLINE AND THE DESIGN OF A PAIR OF SCISSORS ACROSS THE OUTLINE.

FOR A SERIES OF BOOKS AND WRITTEN ARTICLES IN THE FIELD OF PAPER CRAFTS; BOOKS IN THE FIELD OF PAPER CRAFTS; CHILDREN'S ARTS AND CRAFTS PAPER KITS; PAPER BANNERS; PAPER CAKE DECORATIONS; PAPER DECORATIVE GARLANDS FOR PARTIES; PAPER PARTY DECORATIONS; PAPER PARTY FAVORS; PARTY ORNAMENTS OF PAPER; PUBLICATIONS, NAMELY, BOOKS IN THE FIELDS OF PAPER CRAFTS (U.S. CLS. 2, 5, 22, 23, 29, 37, 38 AND 50).

FIRST USE 5-18-2011; IN COMMERCE 10-5-2011.
DAWN HAN, EXAMINING ATTORNEY

SN 85-521,986. SEAHEAD ENTERPRISES, INC., JACKSONVILLE, FL. FILED 1-21-2012.



THE MARK CONSISTS OF THE INITIALS "L.O.B." THAT STAND FOR LIVE OVER BOARD. IT CONSISTS OF STYLIZED LETTERS "L" AND "B". IN ADDITION, THE MARK INCLUDES ART WORK FEATURING A SILHOUETTE OF A PERSON STANDING UP ON A PADDLE BOARD STYLIZED WITHIN THE LETTER "O".

FOR STICKERS (U.S. CLS. 2, 5, 22, 23, 29, 37, 38 AND 50).
CAROLINE WOOD, EXAMINING ATTORNEY

CLASS 16—(Continued).

SN 85-521,987. SEAHEAD ENTERPRISES, INC., JACKSONVILLE, FL. FILED 1-21-2012.



THE MARK CONSISTS OF THE INITIALS "L.O.B." THAT STAND FOR LIVE OVER BOARD. IT CONSISTS OF STYLIZED LETTERS "L" AND "B". IN ADDITION, THE MARK INCLUDES ART WORK FEATURING A SILHOUETTE OF A PERSON CROUCHING ON A SURF BOARD STYLIZED WITHIN THE LETTER "O".

FOR STICKERS (U.S. CLS. 2, 5, 22, 23, 29, 37, 38 AND 50).

CAROLINE WOOD, EXAMINING ATTORNEY

CLASS 16—(Continued).

SN 85-521,990. SEAHEAD ENTERPRISES, INC., JACKSONVILLE, FL. FILED 1-21-2012.



THE MARK CONSISTS OF THE INITIALS "L.O.B." THAT STAND FOR LIVE OVER BOARD. IT CONSISTS OF STYLIZED LETTERS "L" AND "B". IN ADDITION, THE MARK INCLUDES ART WORK FEATURING A SILHOUETTE OF A PERSON ON A WAKE BOARD STYLIZED WITHIN THE LETTER "O".

FOR STICKERS (U.S. CLS. 2, 5, 22, 23, 29, 37, 38 AND 50).

CAROLINE WOOD, EXAMINING ATTORNEY

SN 85-521,989. SEAHEAD ENTERPRISES, INC., JACKSONVILLE, FL. FILED 1-21-2012.



THE MARK CONSISTS OF THE INITIALS "L.O.B." THAT STAND FOR LIVE OVER BOARD. IT CONSISTS OF STYLIZED LETTERS "L" AND "B". IN ADDITION, THE MARK INCLUDES ART WORK FEATURING A SILHOUETTE OF A PERSON ON A SKATEBOARD STYLIZED WITHIN THE LETTER "O".

FOR STICKERS (U.S. CLS. 2, 5, 22, 23, 29, 37, 38 AND 50).

CAROLINE WOOD, EXAMINING ATTORNEY

SN 85-521,991. SEAHEAD ENTERPRISES, INC., JACKSONVILLE, FL. FILED 1-21-2012.



THE MARK CONSISTS OF THE INITIALS "L.O.B." THAT STAND FOR LIVE OVER BOARD. IT CONSISTS OF STYLIZED LETTERS "L" AND "B". IN ADDITION, THE MARK INCLUDES ART WORK FEATURING A SILHOUETTE OF A PERSON ON A SNOWBOARD STYLIZED WITHIN THE LETTER "O".

FOR STICKERS (U.S. CLS. 2, 5, 22, 23, 29, 37, 38 AND 50).

CAROLINE WOOD, EXAMINING ATTORNEY

CLASS 16—(Continued).

SN 85-522,517. TARGET BRANDS, INC., MINNEAPOLIS, MN. FILED 1-23-2012.

CLASS 16—(Continued).

SN 85-524,838. GOYA FOODS, INC., SECAUCUS, NJ. FILED 1-25-2012.

CLASSIC TIDINGS

THE MARK CONSISTS OF STANDARD CHARACTERS WITHOUT CLAIM TO ANY PARTICULAR FONT, STYLE, SIZE, OR COLOR.

OWNER OF U.S. REG. NOS. 4,009,130, 4,009,131 AND 4,009,132.

NO CLAIM IS MADE TO THE EXCLUSIVE RIGHT TO USE "CLASSIC", APART FROM THE MARK AS SHOWN.

FOR ADVENT CALENDARS; PAPER GIFT BAGS AND GIFT WRAPPING PAPER; PAPER NAPKINS (U.S. CLS. 2, 5, 22, 23, 29, 37, 38 AND 50).

NICHOLAS ALTREE, EXAMINING ATTORNEY

GOYA FOR KIDS

THE MARK CONSISTS OF STANDARD CHARACTERS WITHOUT CLAIM TO ANY PARTICULAR FONT, STYLE, SIZE, OR COLOR.

OWNER OF U.S. REG. NOS. 764,033, 962,193 AND 966,178.

NO CLAIM IS MADE TO THE EXCLUSIVE RIGHT TO USE "FOR KIDS", APART FROM THE MARK AS SHOWN.

FOR BIBS OF PAPER; CALENDARS; COLORING BOOKS; COOK BOOKS; CRAYONS; DECORATIVE PAPER CENTERPIECES; DRAWING PADS; EDUCATIONAL PUBLICATIONS, NAMELY, EDUCATIONAL LEARNING CARDS, FLASH CARDS, ACTIVITY CARDS, WORKBOOKS, TEXTBOOKS, ACTIVITY BOOKS, STORY BOOKS, PUZZLE BOOKS, PRINTED PUZZLES, TEACHER GUIDES, MANUALS, POSTERS AND EDUCATIONAL BOOKLETS IN THE FIELD OF FOOD PREPARATION, HEALTH AND NUTRITION; GIFT BAGS; GIFT BOXES; LUNCH BAGS; LUNCH BAGS MADE OF TEXTILE; NOTE PADS; PACKAGING CONTAINERS OF PAPER; PAPER; PAPER BAGS; PAPER BOARDS; PAPER BOXES; PAPER CAKE DECORATIONS; PAPER FILE JACKETS; PAPER FOLDERS; PAPER HAND-TOWELS; PAPER NAPKINS; PAPER PARTY DECORATIONS; PAPER PARTY FAVORS; PAPER PLACE MATS; PAPER TABLECLOTHS; PARTY GOODIE BAGS OF PAPER OR PLASTIC; PARTY ORNAMENTS OF PAPER; PEN AND PENCIL CASES; PENS; PLACE CARDS; POSTERS; PRINTED MENUS; PRINTED TEACHING ACTIVITY GUIDES IN THE FIELD OF FOOD PREPARATION, HEALTH AND NUTRITION; SCHOOL SUPPLY KITS CONTAINING VARIOUS COMBINATIONS OF SELECTED SCHOOL SUPPLIES, NAMELY, WRITING INSTRUMENTS, PENS, PENCILS, MECHANICAL PENCILS, ERASERS, MARKERS, CRAYONS, HIGHLIGHTER PENS, FOLDERS, NOTEBOOKS, PAPER, PROTRACTORS, PAPER CLIPS, PENCIL SHARPENERS, WRITING GRIPS, GLUE AND BOOK MARKS; WRITING INSTRUMENTS; WRITING PADS; WRITING PAPER (U.S. CLS. 2, 5, 22, 23, 29, 37, 38 AND 50).

KATHLEEN LORENZO, EXAMINING ATTORNEY

SN 85-524,208. CONSOLEA COMPANY, CALGARY, CANADA, FILED 1-24-2012.

Sharper  **CARDS**
Marketing Made Easy.

OWNER OF U.S. REG. NOS. 2,524,948 AND 2,542,840.

NO CLAIM IS MADE TO THE EXCLUSIVE RIGHT TO USE "CARDS", APART FROM THE MARK AS SHOWN.

THE MARK CONSISTS OF THE CAPITALIZED FIRST WORD "SHARPER" IN LARGE FONT, AND THE SECOND WORD "CARDS" APPEARING IN ALL CAPITAL LETTERS, BOTH ON THE FIRST LINE; THE UPPER AND LOWER CASE WORDS "MARKETING MADE EASY." WITH A PERIOD AT THE END OF THE SERIES ON THE SECOND LINE; WITH AN ENVELOPE STYLE DESIGN APPEARING DIRECTLY ABOVE THE WORD "CARDS".

FOR PRINTED MATTER, NAMELY, GREETING CARDS, THANK YOU CARDS, APPOINTMENT REMINDER CARDS, STICKERS AND BOOKMARKS (U.S. CLS. 2, 5, 22, 23, 29, 37, 38 AND 50).

FIRST USE 11-1-2011; IN COMMERCE 11-1-2011.

KRISTIN DAHLING, EXAMINING ATTORNEY

CLASS 16—(Continued).

SN 85-529,099. COLLINS, SUZANNE, SANDY HOOK, CT. FILED 1-30-2012.

PEETA MELLARK

THE MARK CONSISTS OF STANDARD CHARACTERS WITHOUT CLAIM TO ANY PARTICULAR FONT, STYLE, SIZE, OR COLOR.

THE NAME "PEETA MELLARK" DOES NOT IDENTIFY A LIVING INDIVIDUAL.

FOR PAPER AND PAPER ARTICLES, NAMELY, POSTERS, CALENDARS, NOTEBOOKS, BINDERS, DAILY DESKTOP ORGANIZERS, MEMO PADS, STICKERS, COMIC BOOKS, WRITING PAPER, ENVELOPES, GREETING CARDS, PAPER COASTERS, PAPER MATS, NEWSPAPERS FOR SHOWS, PHOTOGRAPHS, POSTCARD, TRADING CARDS, CARDBOARD STAND-UP CUTOUTS FEATURING PHOTOGRAPHS OR ARTWORK, PREPAID PHONE DEBIT CARDS WITHOUT MAGNETIC CODING, PAPER PARTY DECORATIONS, PAPER PARTY BAGS, PAPER PARTY FAVORS, NON-MAGNETIC GIFT CARD HOLDERS; PAPER CAKE DECORATIONS (U.S. CLS. 2, 5, 22, 23, 29, 37, 38 AND 50).
THEODORE MCBRIDE, EXAMINING ATTORNEY

SN 85-529,118. COLLINS, SUZANNE, SANDY HOOK, CT. FILED 1-30-2012.

GALE HAWTHORNE

THE MARK CONSISTS OF STANDARD CHARACTERS WITHOUT CLAIM TO ANY PARTICULAR FONT, STYLE, SIZE, OR COLOR.

THE NAME "GALE HAWTHORNE" DOES NOT IDENTIFY A LIVING INDIVIDUAL.

FOR PAPER AND PAPER ARTICLES, NAMELY, POSTERS, CALENDARS, NOTEBOOKS, BINDERS, DAILY DESKTOP ORGANIZERS, MEMO PADS, STICKERS, COMIC BOOKS, WRITING PAPER, ENVELOPES, GREETING CARDS, PAPER COASTERS, PAPER MATS, NEWSPAPERS FOR SHOWS, PHOTOGRAPHS, POSTCARD, TRADING CARDS, CARDBOARD STAND-UP CUTOUTS FEATURING PHOTOGRAPHS OR ARTWORK, PREPAID PHONE DEBIT CARDS WITHOUT MAGNETIC CODING, PAPER PARTY DECORATIONS, PAPER PARTY BAGS, PAPER PARTY FAVORS, NON-MAGNETIC GIFT CARD HOLDERS; PAPER CAKE DECORATIONS (U.S. CLS. 2, 5, 22, 23, 29, 37, 38 AND 50).
THEODORE MCBRIDE, EXAMINING ATTORNEY

CLASS 16—(Continued).

SN 85-530,352. COMPENDIUM INCORPORATED, SEATTLE, WA. FILED 1-31-2012.

GOOD LAUGH GREETINGS

THE MARK CONSISTS OF STANDARD CHARACTERS WITHOUT CLAIM TO ANY PARTICULAR FONT, STYLE, SIZE, OR COLOR.

NO CLAIM IS MADE TO THE EXCLUSIVE RIGHT TO USE "GREETINGS", APART FROM THE MARK AS SHOWN.

FOR GREETING CARDS (U.S. CLS. 2, 5, 22, 23, 29, 37, 38 AND 50).

VERNA BETH RIRIE, EXAMINING ATTORNEY

SN 85-530,544. SMITH, SHAREKA TAWANDA, PEMBROKE PINES, FL. AND SMITH, JENNIFER MAE, PEMBROKE PINES, FL. FILED 2-1-2012.

**Detour Around the
Wilderness Black Sheep My
Scorned Mother
Buzzin' Around Jennifer's
Thoughts and Feelings**

THE MARK CONSISTS OF STANDARD CHARACTERS WITHOUT CLAIM TO ANY PARTICULAR FONT, STYLE, SIZE, OR COLOR.

FOR A SERIES OF BOOKS, WRITTEN ARTICLES, HANDOUTS AND WORKSHEETS IN THE FIELD OF AUTOBIOGRAPHY MATERIALS (U.S. CLS. 2, 5, 22, 23, 29, 37, 38 AND 50).

HOWARD B. LEVINE, EXAMINING ATTORNEY

SN 85-530,752. FABRICA DE BOLSAS DE PAPEL UNIBOL S.A., SOLEDAD - ATLANTICO, COLOMBIA, FILED 2-1-2012.

NUBE

THE MARK CONSISTS OF STANDARD CHARACTERS WITHOUT CLAIM TO ANY PARTICULAR FONT, STYLE, SIZE, OR COLOR.

THE ENGLISH TRANSLATION OF "NUBE" IS "CLOUD." FOR FACE TOWELS OF PAPER; HYGIENIC PAPER; PAPER HAND-TOWELS; PAPER TOWELS; TISSUE PAPER; TOILET PAPER (U.S. CLS. 2, 5, 22, 23, 29, 37, 38 AND 50).

MAUREEN DALL, EXAMINING ATTORNEY

CLASS 16—(Continued).

SN 85-531,343. FERSTAND, ADAM, MIDDLETOWN, NY. FILED 2-1-2012.

Encapsulator

THE MARK CONSISTS OF STANDARD CHARACTERS WITHOUT CLAIM TO ANY PARTICULAR FONT, STYLE, SIZE, OR COLOR.

FOR GENERAL PURPOSE PLASTIC BAGS (U.S. CLS. 2, 5, 22, 23, 29, 37, 38 AND 50).
JACQUELINE A. LAVINE, EXAMINING ATTORNEY

SN 85-531,919. URCUTE ENTERTAINMENT, LLC, BRIDGEPORT, CT. FILED 2-2-2012.

FACE BUCKS

THE MARK CONSISTS OF STANDARD CHARACTERS WITHOUT CLAIM TO ANY PARTICULAR FONT, STYLE, SIZE, OR COLOR.

FOR STICKERS, NAMELY, STICKER SHEETS CONTAINING STICKERS SHAPED FOR CONTAINING A PORTRAIT AND PLACEMENT ON PAPER CURRENCY (U.S. CLS. 2, 5, 22, 23, 29, 37, 38 AND 50).
FIRST USE 10-25-2011; IN COMMERCE 10-25-2011.
AHSEN KHAN, EXAMINING ATTORNEY

SN 85-531,948. QURAIISHI, GEORGE, BROOKLYN, NY. FILED 2-2-2012.

Howler

THE MARK CONSISTS OF STANDARD CHARACTERS WITHOUT CLAIM TO ANY PARTICULAR FONT, STYLE, SIZE, OR COLOR.

FOR MAGAZINES FEATURING SPORTS (U.S. CLS. 2, 5, 22, 23, 29, 37, 38 AND 50).
JAY FLOWERS, EXAMINING ATTORNEY

CLASS 16—(Continued).

SN 85-532,586. DESERET BOOK COMPANY, SALT LAKE CITY, UT. FILED 2-2-2012.

PRETTY DARN FUNNY

THE MARK CONSISTS OF STANDARD CHARACTERS WITHOUT CLAIM TO ANY PARTICULAR FONT, STYLE, SIZE, OR COLOR.

FOR BLANK JOURNALS; BRAG BOOKS; BUMPER STICKERS; NOTE BOOKS; POSTERS; PRINTED PAMPHLETS, BROCHURES, MANUALS, BOOKS, BOOKLETS, LEAFLETS, FLYERS, INFORMATIONAL SHEETS AND NEWSLETTERS, ADHESIVE BACKED STICKERS, AND KITS COMPRISING ONE OR MORE OF THE FOREGOING MATERIALS IN THE FIELD OF COMEDY; STICKERS; UNMOUNTED POSTERS (U.S. CLS. 2, 5, 22, 23, 29, 37, 38 AND 50).
MARK T. MULLEN, EXAMINING ATTORNEY

SN 85-532,652. DESERET BOOK COMPANY, SALT LAKE CITY, UT. FILED 2-2-2012.



THE MARK CONSISTS OF AN OVAL WITH STYLIZED WORDS PRETTY DARN FUNNY! INSIDE THE OVAL, IN THE WORD "PRETTY," A BOBBYPIN IS USED TO CROSS THE TWO LETTER TS.

FOR BLANK JOURNALS; BRAG BOOKS; BUMPER STICKERS; NOTE BOOKS; POSTERS; PRINTED PAMPHLETS, BROCHURES, MANUALS, BOOKS, BOOKLETS, LEAFLETS, FLYERS, INFORMATIONAL SHEETS AND NEWSLETTERS, ADHESIVE BACKED STICKERS, AND KITS COMPRISING ONE OR MORE OF THE FOREGOING MATERIALS IN THE FIELD OF COMEDY; STICKERS; UNMOUNTED POSTERS (U.S. CLS. 2, 5, 22, 23, 29, 37, 38 AND 50).
MARK T. MULLEN, EXAMINING ATTORNEY

CLASS 16—(Continued).

SN 85-532,767. BIDNIS HOLDINGS, INC., MARINA DEL REY, CA. FILED 2-2-2012.

Rob Thomas

THE MARK CONSISTS OF STANDARD CHARACTERS WITHOUT CLAIM TO ANY PARTICULAR FONT, STYLE, SIZE, OR COLOR.

THE NAME(S), PORTRAIT(S), AND/OR SIGNATURE(S) SHOWN IN THE MARK IDENTIFIES "ROB THOMAS", WHOSE CONSENT(S) TO REGISTER IS MADE OF RECORD.

FOR PAPER GOODS AND PRINTED MATTER, NAMELY SOUVENIR PROGRAMS FOR MUSICAL CONCERTS, SONG BOOKS, POSTCARDS, POSTAGE STAMPS, POSTERS, STICKERS AND DECALS, GREETING CARDS, AND FAN CLUB NEWSLETTERS (U.S. CLS. 2, 5, 22, 23, 29, 37, 38 AND 50).

FIRST USE 2-1-2005; IN COMMERCE 4-1-2005.

HOWARD B. LEVINE, EXAMINING ATTORNEY



SN 85-532,897. SNYDER, EVAN MARCELL, DBA CONSTELLA CONCEPTS, CLEVELAND HEIGHTS, OH. FILED 2-3-2012.

CONSTELLA CONCEPTS

THE MARK CONSISTS OF STANDARD CHARACTERS WITHOUT CLAIM TO ANY PARTICULAR FONT, STYLE, SIZE, OR COLOR.

FOR ART PICTURES; GRAPHIC FINE ART PRINTS (U.S. CLS. 2, 5, 22, 23, 29, 37, 38 AND 50).

KATHERINE CONNOLLY, EXAMINING ATTORNEY



SN 85-532,931. ECOACCENTS, LLC, RALEIGH, NC. FILED 2-3-2012.

ECO-COASTERS

THE MARK CONSISTS OF STANDARD CHARACTERS WITHOUT CLAIM TO ANY PARTICULAR FONT, STYLE, SIZE, OR COLOR.

FOR PAPER COASTERS (U.S. CLS. 2, 5, 22, 23, 29, 37, 38 AND 50).

FIRST USE 6-0-2011; IN COMMERCE 1-6-2012.

MARK SHINER, EXAMINING ATTORNEY

CLASS 16—(Continued).

SN 85-533,042. WARD/KRAFT, INC., FORT SCOTT, KS. FILED 2-3-2012.

REALSEAL

THE MARK CONSISTS OF STANDARD CHARACTERS WITHOUT CLAIM TO ANY PARTICULAR FONT, STYLE, SIZE, OR COLOR.

FOR BUSINESS FORMS (U.S. CLS. 2, 5, 22, 23, 29, 37, 38 AND 50).

B. PARADEWELAI, EXAMINING ATTORNEY



SN 85-533,638. SHERRY BECK, FORT WORTH, TX. FILED 2-3-2012.

zönaa

THE MARK CONSISTS OF STANDARD CHARACTERS WITHOUT CLAIM TO ANY PARTICULAR FONT, STYLE, SIZE, OR COLOR.

FOR CARTOON PRINTS (U.S. CLS. 2, 5, 22, 23, 29, 37, 38 AND 50).

LEIGH CAROLINE CASE, EXAMINING ATTORNEY



SN 85-533,640. WEST MARINE PRODUCTS, INC., WATSONVILLE, CA. FILED 2-3-2012.



THE MARK CONSISTS OF A SHARK. FOR STICKERS, DECALS, BOOKS IN THE FIELD OF FISHING AND BOATING, MAPS, FISHING CHARTS (U.S. CLS. 2, 5, 22, 23, 29, 37, 38 AND 50).

MATTHEW KLINE, EXAMINING ATTORNEY

CLASS 16—(Continued).

SN 85-534,512. FIFTY-SIX HOPE ROAD MUSIC, LIMITED, CABLE BEACH, NASSAU, BAHAMAS, FILED 2-6-2012.

TUFF GONG WORLDWIDE

THE MARK CONSISTS OF STANDARD CHARACTERS WITHOUT CLAIM TO ANY PARTICULAR FONT, STYLE, SIZE, OR COLOR.

NO CLAIM IS MADE TO THE EXCLUSIVE RIGHT TO USE "WORLDWIDE", APART FROM THE MARK AS SHOWN.

FOR BOOKS IN THE FIELD OF FICTIONAL AND CHILDREN'S STORIES; COMIC BOOKS; PHOTOGRAPHIC PRINTS; POSTERS; STICKERS; UNMOUNTED AND MOUNTED PHOTOGRAPHS (U.S. CLS. 2, 5, 22, 23, 29, 37, 38 AND 50).

FIRST USE 1-1-2006; IN COMMERCE 1-1-2006.
SUNG IN, EXAMINING ATTORNEY

SN 85-534,550. THE MEDICI GROUP LLC, NEW YORK, NY. FILED 2-6-2012.

The Smallest Executable Step

THE MARK CONSISTS OF STANDARD CHARACTERS WITHOUT CLAIM TO ANY PARTICULAR FONT, STYLE, SIZE, OR COLOR.

FOR EDUCATIONAL AND LEARNING TOOL, NAMELY QUESTIONNAIRES IN THE FIELD OF BUSINESS EDUCATION, DEVELOPMENT OF BUSINESS STRATEGIES AND CREATIVE IDEATION; PAPER TEACHING MATERIAL IN THE FIELD OF BUSINESS EDUCATION, DEVELOPMENT OF BUSINESS STRATEGIES DEVELOPMENT AND CREATIVE IDEATION (U.S. CLS. 2, 5, 22, 23, 29, 37, 38 AND 50).

FIRST USE 11-18-2011; IN COMMERCE 11-18-2011.
BRIAN NEVILLE, EXAMINING ATTORNEY

CLASS 16—(Continued).

SN 85-534,686. HUTCHINSON, CHERYL J., GALATIN, TN. FILED 2-6-2012.

TOY BOX PRODUCTIONS

THE MARK CONSISTS OF STANDARD CHARACTERS WITHOUT CLAIM TO ANY PARTICULAR FONT, STYLE, SIZE, OR COLOR.

NO CLAIM IS MADE TO THE EXCLUSIVE RIGHT TO USE "PRODUCTIONS", APART FROM THE MARK AS SHOWN.

FOR CHILDREN'S BOOKS; CHILDREN'S INTERACTIVE EDUCATIONAL BOOKS; EDUCATIONAL KITS SOLD AS A UNIT IN THE FIELD OF HISTORY CONSISTING PRIMARILY OF PRINTED INSTRUCTIONAL MATERIALS AND ALSO INCLUDING AUDIO CDS (U.S. CLS. 2, 5, 22, 23, 29, 37, 38 AND 50).

FIRST USE 3-15-1995; IN COMMERCE 3-15-1995.
MATTHEW KLINE, EXAMINING ATTORNEY

SN 85-534,719. MASON, KAREN, CHICAGO, IL. FILED 2-6-2012.

DDW

THE MARK CONSISTS OF STANDARD CHARACTERS WITHOUT CLAIM TO ANY PARTICULAR FONT, STYLE, SIZE, OR COLOR.

FOR PRINTED MATERIALS, NAMELY, NOVELS AND SERIES OF FICTION BOOKS AND SHORT STORIES (U.S. CLS. 2, 5, 22, 23, 29, 37, 38 AND 50).

JEFFREY LOOK, EXAMINING ATTORNEY

SN 85-534,727. HUTCHINSON, CHERYL J., GALATIN, TN. FILED 2-6-2012.



NO CLAIM IS MADE TO THE EXCLUSIVE RIGHT TO USE "PRODUCTIONS", APART FROM THE MARK AS SHOWN.

THE MARK CONSISTS OF A STYLIZED TOY BOX CONTAINING MULTIPLE IMAGES OF TOYS EMERGING FROM THE TOP OF THE BOX, INCLUDING A STRIPED

CLASS 16—(Continued).

BALL, A DRUM, A TOY TRAIN, A TOP, A BOX WITH A TURN HANDLE, A TOY SOLDIER, A BOAT, A BASEBALL BAT AND A TEDDY BEAR HANGING FROM THE RIGHT SIDE OF THE TOY BOX. THE WORD TOY APPEARS STYLIZED NEXT TO THE BEAR ON THE BOX. ON THE GROUND NEXT TO THE BOTTOM LEFT OF THE BOX IS AN UPRIGHT STUFFED DOLL THAT IS SMILING. NEXT TO THE DOLL ARE 3 STYLIZED BLOCKS, EACH CONTAINING A SEPARATE LETTER SPELLING OUT BOX AND EACH CASTING A SHADOW, ABOVE THE STYLIZED WORD PRODUCTIONS.

FOR CHILDREN'S BOOKS; CHILDREN'S INTERACTIVE EDUCATIONAL BOOKS; EDUCATIONAL KITS SOLD AS A UNIT IN THE FIELD OF HISTORY CONSISTING PRIMARILY OF PRINTED INSTRUCTIONAL MATERIALS AND ALSO INCLUDING AUDIO CDS (U.S. CLS. 2, 5, 22, 23, 29, 37, 38 AND 50).

FIRST USE 3-15-1995; IN COMMERCE 3-15-1995.
MATTHEW KLINE, EXAMINING ATTORNEY

SN 85-535,004. BHASKARAN, SUNIL, CAPITOLA, CA. FILED 2-6-2012.

CAHAYA MIND

THE MARK CONSISTS OF STANDARD CHARACTERS WITHOUT CLAIM TO ANY PARTICULAR FONT, STYLE, SIZE, OR COLOR.

THE ENGLISH TRANSLATION OF "CAHAYA" IN THE MARK IS "MALAY FOR LIGHT OR GLOW OR GLEAM".

FOR PRINTED MATERIALS, NAMELY, NEWSLETTERS, PAMPHLETS, BROCHURES, BOOKLETS, AND TEACHING MATERIALS IN THE FIELD OF BUSINESS STRATEGIES AND MARKETING TO ENTREPRENEURS (U.S. CLS. 2, 5, 22, 23, 29, 37, 38 AND 50).

JENNIFER VASQUEZ, EXAMINING ATTORNEY

SN 85-535,259. CRAWLEY, JULIE LINETT, WHITE LAKE, NC. FILED 2-6-2012.

Debutante Hunter

THE MARK CONSISTS OF STANDARD CHARACTERS WITHOUT CLAIM TO ANY PARTICULAR FONT, STYLE, SIZE, OR COLOR.

FOR BUMPER STICKERS; DECALS (U.S. CLS. 2, 5, 22, 23, 29, 37, 38 AND 50).

BRIDGETT SMITH, EXAMINING ATTORNEY

CLASS 16—(Continued).

SN 85-535,383. KORNICK, LACEY C, DBA LACEYCLAIR-EDESIGNS, CLEVELAND HEIGHTS, OH. FILED 2-6-2012.

LaceyClaireDesigns

THE MARK CONSISTS OF STANDARD CHARACTERS WITHOUT CLAIM TO ANY PARTICULAR FONT, STYLE, SIZE, OR COLOR.

FOR BOXES OF CARDBOARD OR PAPER; BOXES OF PAPER OR CARDBOARD; CARDBOARD BOXES; CARDBOARD CAKE BOXES; DESK STANDS AND HOLDERS FOR PENS, PENCILS, AND INK; GIFT BOXES; GIFT BOXES MADE OF CARDBOARD; MEMORY BOXES, NAMELY, CARDBOARD BOXES CONTAINING CARDBOARD CARDS FOR DISPLAYING AND STORING WEDDING, SPECIAL EVENTS, OR PARTY KEEPSAKES AND MEMENTOS; PEN STANDS; PENS; STANDS FOR PENS; WEDDING ALBUMS; WEDDING BOOKS (U.S. CLS. 2, 5, 22, 23, 29, 37, 38 AND 50).

FIRST USE 8-2-2010; IN COMMERCE 8-31-2010.

JACQUELINE A. LAVINE, EXAMINING ATTORNEY

SN 85-535,649. LAFIURA, DEBORAH, BUTLER, NJ. FILED 2-7-2012.

Fun Forward

THE MARK CONSISTS OF STANDARD CHARACTERS WITHOUT CLAIM TO ANY PARTICULAR FONT, STYLE, SIZE, OR COLOR.

FOR BUMPER STICKERS (U.S. CLS. 2, 5, 22, 23, 29, 37, 38 AND 50).

REBECCA SMITH, EXAMINING ATTORNEY

SN 85-535,776. THE ICE BOX COMPANY, INC., SUNSET BEACH, NC. FILED 2-7-2012.

IBC

THE MARK CONSISTS OF STANDARD CHARACTERS WITHOUT CLAIM TO ANY PARTICULAR FONT, STYLE, SIZE, OR COLOR.

FOR PLASTIC BAGS FOR PACKAGING ICE (U.S. CLS. 2, 5, 22, 23, 29, 37, 38 AND 50).

FIRST USE 4-26-1986; IN COMMERCE 4-26-1986.

JULIE VEPPUMTHARA, EXAMINING ATTORNEY

CLASS 16—(Continued).

SN 85-536,418. CARRASCO INTERNATIONAL CORPORATION, DBA KOBAX PAPER, MIAMI, FL. FILED 2-7-2012.

EXELTONE

THE MARK CONSISTS OF STANDARD CHARACTERS WITHOUT CLAIM TO ANY PARTICULAR FONT, STYLE, SIZE, OR COLOR.

FOR PAPER; MULTI-PURPOSE PAPER; COPIER PAPER; COPY PAPER; PRINTING PAPER (U.S. CLS. 2, 5, 22, 23, 29, 37, 38 AND 50).

DAVID COLLIER, EXAMINING ATTORNEY

SN 85-536,887. AMERICAN NUCLEAR SOCIETY INCORPORATED, LA GRANGE PARK, IL. FILED 2-8-2012.

FUSION SCIENCE AND TECHNOLOGY

THE MARK CONSISTS OF STANDARD CHARACTERS WITHOUT CLAIM TO ANY PARTICULAR FONT, STYLE, SIZE, OR COLOR.

OWNER OF U.S. REG. NO. 2,637,671. SEC. 2(F).

FOR JOURNAL CONCERNING SCIENTIFIC AND ENGINEERING SUBJECTS (U.S. CLS. 2, 5, 22, 23, 29, 37, 38 AND 50).

FIRST USE 6-15-2001; IN COMMERCE 6-15-2001. LINDA POWELL, EXAMINING ATTORNEY

SN 85-537,464. THE TOPPS COMPANY, INC., NEW YORK, NY. FILED 2-8-2012.

PRECISION

THE MARK CONSISTS OF STANDARD CHARACTERS WITHOUT CLAIM TO ANY PARTICULAR FONT, STYLE, SIZE, OR COLOR.

FOR TRADING CARDS (U.S. CLS. 2, 5, 22, 23, 29, 37, 38 AND 50).

FIRST USE 2-1-2012; IN COMMERCE 2-1-2012. MARK SPARACINO, EXAMINING ATTORNEY

CLASS 16—(Continued).

SN 85-537,745. CHI HOSSEINION, GLENDALE, CA. FILED 2-8-2012.

U TOUCH I TELL

THE MARK CONSISTS OF STANDARD CHARACTERS WITHOUT CLAIM TO ANY PARTICULAR FONT, STYLE, SIZE, OR COLOR.

FOR SERIES OF BOOKS, WRITTEN ARTICLES, HANDOUTS AND WORKSHEETS IN THE FIELD OF PROTECTING CHILDREN FROM ABUSE AND SEXUAL ABUSE.; BLANK OR PARTIALLY PRINTED PAPER LABELS; BOOKLETS IN THE FIELD OF PROTECTING CHILDREN FROM ABUSE AND SEXUAL ABUSE.; BOOKS IN THE FIELD OF PROTECTING CHILDREN FROM ABUSE AND SEXUAL ABUSE.; BROCHURES ABOUT PROTECTING CHILDREN FROM ABUSE AND SEXUAL ABUSE.; CARTOON PRINTS; COLOR PRINTS; EDUCATIONAL BOOKS FEATURING PROTECTING CHILDREN FROM ABUSE AND SEXUAL ABUSE.; EDUCATIONAL PUBLICATIONS, NAMELY, EDUCATIONAL LEARNING CARDS, FLASH CARDS, ACTIVITY CARDS, WORKBOOKS, TEXTBOOKS, ACTIVITY BOOKS, STORY BOOKS, PUZZLE BOOKS, PRINTED PUZZLES, TEACHER GUIDES, MANUALS, POSTERS AND EDUCATIONAL BOOKLETS IN THE FIELD OF PROTECTING CHILDREN FROM ABUSE AND SEXUAL ABUSE.; EDUCATIONAL PUBLICATIONS, NAMELY, TRAINING MANUALS IN THE FIELD OF PROTECTING CHILDREN FROM ABUSE AND SEXUAL ABUSE.; EDUCATIONAL PUBLICATIONS, NAMELY, SERIES OF BOOKS AND MAGAZINES IN THE FIELDS OF PROTECTING CHILDREN FROM ABUSE AND SEXUAL ABUSE.; JOURNALS CONCERNING PROTECTING CHILDREN FROM ABUSE AND SEXUAL ABUSE; LEAFLETS ABOUT PROTECTING CHILDREN FROM ABUSE AND SEXUAL ABUSE; NEWSLETTERS IN THE FIELD OF PROTECTING CHILDREN FROM ABUSE AND SEXUAL ABUSE; NEWSPAPERS IN THE FIELD OF PROTECTING CHILDREN FROM ABUSE AND SEXUAL ABUSE; ORGANIZATIONAL KITS CONTAINING CALENDARS, STATIONERY, PLANNING FOLDERS, TEMPLATES AND PRINTED GUIDELINES FOR PLANNING SOCIAL EVENTS; PRINTED CHILDREN'S COLORING PAGES; PRINTED CORRESPONDENCE COURSE MATERIALS IN THE FIELD OF PROTECTING CHILDREN FROM ABUSE AND SEXUAL ABUSE; PRINTED EDUCATIONAL MATERIAL, NAMELY, TEACHING TILES; PRINTED EDUCATIONAL MATERIALS IN THE FIELD OF PROTECTING CHILDREN FROM ABUSE AND SEXUAL ABUSE; PRINTED FORMS; PRINTED INFORMATIONAL CARDS IN THE FIELD OF PROTECTING CHILDREN FROM ABUSE AND SEXUAL ABUSE; PRINTED INFORMATIONAL FOLDERS IN THE FIELD OF PROTECTING CHILDREN FROM ABUSE AND SEXUAL ABUSE; PRINTED INSTRUCTIONAL, EDUCATIONAL, AND TEACHING MATERIALS IN THE FIELD OF PROTECTING CHILDREN FROM ABUSE AND SEXUAL ABUSE; PRINTED LECTURES; PRINTED LESSONS ON PROTECTING CHILDREN FROM ABUSE AND SEXUAL ABUSE; PRINTED MATERIALS, NAMELY, CURRICULA IN THE FIELD OF PROTECTING CHILDREN FROM ABUSE AND SEXUAL ABUSE; PRINTED MATERIALS, NAMELY, JOURNALS FEATURING PROTECTING CHILDREN FROM ABUSE AND SEXUAL ABUSE; PRINTED MATERIALS, NAMELY, WRITTEN ARTICLES IN THE FIELD OF PROTECTING CHILDREN FROM ABUSE AND SEXUAL ABUSE; PRINTED MATTER, NAMELY, PAPER SIGNS, BOOKS, MANUALS, CURRICULUM, NEWSLETTERS, INFORMATIONAL CARDS AND BROCHURES IN THE FIELD OF PROTECTING CHILDREN FROM ABUSE AND SEXUAL ABUSE; PRINTED PAMPHLETS, BROCHURES, MANUALS, BOOKS, BOOKLETS, LEAFLETS, FLYERS, INFORMATIONAL SHEETS AND NEWSLETTERS, ADHESIVE BACKED STICKERS, AND KITS COMPRISING ONE OR MORE OF THE FOREGOING MATERIALS IN THE FIELD OF PROTECTING CHILDREN FROM

CLASS 16—(Continued).

ABUSE AND SEXUAL ABUSE; PRINTED PLANS; PRINTED SEMINAR NOTES; PRINTED STORIES IN ILLUSTRATED FORM; PRINTED TEACHING ACTIVITY GUIDES IN THE FIELD OF PROTECTING CHILDREN FROM ABUSE AND SEXUAL ABUSE; PRINTED TEACHING MATERIALS IN THE FIELD OF PROTECTING CHILDREN FROM ABUSE AND SEXUAL ABUSE; PRINTED TEACHING MATERIALS IN THE FIELD OF PROTECTING CHILDREN FROM ABUSE AND SEXUAL ABUSE; PRINTED TRAINING MATERIALS IN THE FIELD OF PROTECTING CHILDREN FROM ABUSE AND SEXUAL ABUSE; PUBLICATIONS, NAMELY, BROCHURES, BOOKLETS, AND TEACHING MATERIALS IN THE FIELD OF PROTECTING CHILDREN FROM ABUSE AND SEXUAL ABUSE; PUBLICATIONS, NAMELY, SERIES OF BOOKS AND MAGAZINES IN THE FIELDS OF PROTECTING CHILDREN FROM ABUSE AND SEXUAL ABUSE; RESOURCE BOOKS IN THE FIELD OF PROTECTING CHILDREN FROM ABUSE AND SEXUAL ABUSE; SCHOLARLY BOOKS ON VARIOUS TOPICS, NAMELY, PROTECTING CHILDREN FROM ABUSE AND SEXUAL ABUSE; TEXTBOOKS IN THE FIELD OF PROTECTING CHILDREN FROM ABUSE AND SEXUAL ABUSE; WORKBOOKS DIRECTED TO PROTECTING CHILDREN FROM ABUSE AND SEXUAL ABUSE (U.S. CLS. 2, 5, 22, 23, 29, 37, 38 AND 50).

KATINA MISTER, EXAMINING ATTORNEY

SN 85-537,778. ORIGINAL COUPON BOOK INC., LAHAINA, HI. FILED 2-9-2012.

Vacations Are Not Cheap

THE MARK CONSISTS OF STANDARD CHARACTERS WITHOUT CLAIM TO ANY PARTICULAR FONT, STYLE, SIZE, OR COLOR.

FOR COUPON BOOKS (U.S. CLS. 2, 5, 22, 23, 29, 37, 38 AND 50).

FIRST USE 2-14-2010; IN COMMERCE 2-14-2010.

JENNIFER VASQUEZ, EXAMINING ATTORNEY

SN 85-537,914. GEORGIA-PACIFIC CONSUMER PRODUCTS LP, ATLANTA, GA. FILED 2-9-2012.

SAFE-T-GARD

THE MARK CONSISTS OF STANDARD CHARACTERS WITHOUT CLAIM TO ANY PARTICULAR FONT, STYLE, SIZE, OR COLOR.

OWNER OF U.S. REG. NO. 3,211,831.

FOR PAPER TISSUES (U.S. CLS. 2, 5, 22, 23, 29, 37, 38 AND 50).

FIRST USE 0-0-2004; IN COMMERCE 0-0-2004.

ANN E. SAPPENFIELD, EXAMINING ATTORNEY

CLASS 16—(Continued).

SN 85-538,070. UNCLE LEO LLC., MERRICK, NY. FILED 2-9-2012.

THE STATUS QUO STINKS

THE MARK CONSISTS OF STANDARD CHARACTERS WITHOUT CLAIM TO ANY PARTICULAR FONT, STYLE, SIZE, OR COLOR.

FOR BUMPER STICKERS; POSTERS; STICKERS (U.S. CLS. 2, 5, 22, 23, 29, 37, 38 AND 50).

JENNY PARK, EXAMINING ATTORNEY

SN 85-538,097. UNCLE LEO LLC., MERRICK, NY. FILED 2-9-2012.

THE STATUS QUO MUST GO

THE MARK CONSISTS OF STANDARD CHARACTERS WITHOUT CLAIM TO ANY PARTICULAR FONT, STYLE, SIZE, OR COLOR.

FOR BUMPER STICKERS; POSTERS; STICKERS (U.S. CLS. 2, 5, 22, 23, 29, 37, 38 AND 50).

JENNY PARK, EXAMINING ATTORNEY

SN 85-538,356. GREEN MEDIA, LLC, FLOWER MOUND, TX. FILED 2-9-2012.

Fort Knox

THE MARK CONSISTS OF STANDARD CHARACTERS WITHOUT CLAIM TO ANY PARTICULAR FONT, STYLE, SIZE, OR COLOR.

FOR TRADING CARDS, NAMELY, TRADING CARDS RELATED TO THE ENTERTAINMENT INDUSTRY SET FORTH ON PLATES MADE OF PRECIOUS METALS (U.S. CLS. 2, 5, 22, 23, 29, 37, 38 AND 50).

JEFFREY LOOK, EXAMINING ATTORNEY

CLASS 16—(Continued).

SN 85-538,477. GISH, STEVE, DBA RECORD FOR THE DATE, PORT ANGELES, WA. AND GISH, JEANETTE, DBA RECORD FOR THE DATE, PORT ANGELES, WA. FILED 2-9-2012.



THE MARK CONSISTS OF THE WORDS "RECORD FOR THE DATE". THE WORDS ARE ENCLOSED IN A CIRCLE. FOR PAPER BANNERS (U.S. CLS. 2, 5, 22, 23, 29, 37, 38 AND 50).
FIRST USE 2-9-2012; IN COMMERCE 2-9-2012.
SALLY SHIH, EXAMINING ATTORNEY

SN 85-538,596. LILLY, RONALD R., PITTSBORO, NC. FILED 2-9-2012.

BORN REDNECK

THE MARK CONSISTS OF STANDARD CHARACTERS WITHOUT CLAIM TO ANY PARTICULAR FONT, STYLE, SIZE, OR COLOR.
FOR STICKERS (U.S. CLS. 2, 5, 22, 23, 29, 37, 38 AND 50).
FIRST USE 11-20-2011; IN COMMERCE 11-20-2011.
TARAH HARDY, EXAMINING ATTORNEY

SN 85-538,822. GEMIGNANI, ROBERT, COLORADO SPRINGS, CO. FILED 2-9-2012.

Not What I Fought For

THE MARK CONSISTS OF STANDARD CHARACTERS WITHOUT CLAIM TO ANY PARTICULAR FONT, STYLE, SIZE, OR COLOR.
FOR ART PICTURES; ART PRINTS; GRAPHIC ART REPRODUCTIONS; PRINTED ART REPRODUCTIONS (U.S. CLS. 2, 5, 22, 23, 29, 37, 38 AND 50).
LUCY ARANT, EXAMINING ATTORNEY

CLASS 16—(Continued).

SN 85-538,866. BLISS SINEMA INC., LOS ANGELES, CA. FILED 2-9-2012.

DECONSTRUCTION RED

THE MARK CONSISTS OF STANDARD CHARACTERS WITHOUT CLAIM TO ANY PARTICULAR FONT, STYLE, SIZE, OR COLOR.
FOR POSTERS (U.S. CLS. 2, 5, 22, 23, 29, 37, 38 AND 50).
ZHALEH DELANEY, EXAMINING ATTORNEY

SN 85-538,883. MCCLURE, GERRY, S., MCLEAN, VA. FILED 2-9-2012.

Walk Tall Mountains

THE MARK CONSISTS OF STANDARD CHARACTERS WITHOUT CLAIM TO ANY PARTICULAR FONT, STYLE, SIZE, OR COLOR.
FOR A SERIES OF BOOKS AND WRITTEN ARTICLES IN THE FIELD OF INSPIRATION; A SERIES OF BOOKS, WRITTEN ARTICLES, HANDOUTS AND WORKSHEETS IN THE FIELD OF INSPIRATION; SERIES OF NON-FICTION BOOKS IN THE FIELD OF INSPIRATION (U.S. CLS. 2, 5, 22, 23, 29, 37, 38 AND 50).
FIRST USE 6-1-2011; IN COMMERCE 6-1-2011.
COLLEEN KEARNEY, EXAMINING ATTORNEY

SN 85-538,961. ORIGINAL COUPON BOOK INC., LAHAINA, HI. FILED 2-9-2012.

The Tourist Best Friend

THE MARK CONSISTS OF STANDARD CHARACTERS WITHOUT CLAIM TO ANY PARTICULAR FONT, STYLE, SIZE, OR COLOR.
FOR COUPON BOOKS (U.S. CLS. 2, 5, 22, 23, 29, 37, 38 AND 50).
FIRST USE 2-14-2010; IN COMMERCE 2-14-2010.
JENNIFER VASQUEZ, EXAMINING ATTORNEY

CLASS 16—(Continued).

SN 85-538,970. ORIGINAL COUPON BOOK INC., LAHAINA, HI. FILED 2-10-2012.



THE MARK CONSISTS OF: TRAVELING KNIGHT IN SUIT OF ARMOR CARRYING SHIELD AND PULLING ROLLING LUGGAGE.

FOR COUPON BOOKS (U.S. CLS. 2, 5, 22, 23, 29, 37, 38 AND 50).

FIRST USE 2-14-2010; IN COMMERCE 2-14-2010.
JENNIFER VASQUEZ, EXAMINING ATTORNEY

SN 85-539,161. UTOPIA DIGITAL TECHNOLOGIES, INC., NEW BERLIN, WI. FILED 2-10-2012.

CRAFT ATTITUDE

THE MARK CONSISTS OF STANDARD CHARACTERS WITHOUT CLAIM TO ANY PARTICULAR FONT, STYLE, SIZE, OR COLOR.

NO CLAIM IS MADE TO THE EXCLUSIVE RIGHT TO USE "CRAFT", APART FROM THE MARK AS SHOWN.

FOR ART PAPER; CONSTRUCTION PAPER; CRAFT PAPER; SCRAPBOOK PAGES (U.S. CLS. 2, 5, 22, 23, 29, 37, 38 AND 50).

LESLEY LAMOTHE, EXAMINING ATTORNEY

SN 85-539,514. MONKEEZ MAKES A DIFFERENCE, LLC, CHARLESTON, SC. FILED 2-10-2012.

DO GOOD

THE MARK CONSISTS OF STANDARD CHARACTERS WITHOUT CLAIM TO ANY PARTICULAR FONT, STYLE, SIZE, OR COLOR.

FOR TRADING CARDS (U.S. CLS. 2, 5, 22, 23, 29, 37, 38 AND 50).

MARGERY A. TIERNEY, EXAMINING ATTORNEY

CLASS 16—(Continued).

SN 85-539,554. DEZARATE, MARCIA GALE, MELBOURNE, FL. FILED 2-10-2012.

"ORGAN"IC GANG

THE MARK CONSISTS OF STANDARD CHARACTERS WITHOUT CLAIM TO ANY PARTICULAR FONT, STYLE, SIZE, OR COLOR.

FOR SERIES OF FICTION BOOKS; SERIES OF FICTION WORKS, NAMELY, NOVELS AND BOOKS (U.S. CLS. 2, 5, 22, 23, 29, 37, 38 AND 50).

JEFFREY LOOK, EXAMINING ATTORNEY

SN 85-539,662. THE JOYCE HAWKINS COMPANY, LLC, ATLANTA, GA. FILED 2-10-2012.

TEAM BREEZY

THE MARK CONSISTS OF STANDARD CHARACTERS WITHOUT CLAIM TO ANY PARTICULAR FONT, STYLE, SIZE, OR COLOR.

FOR POSTERS; CALENDARS; TEMPORARY TATTOOS; STICKERS; DECALS; IRON-ON OR PLASTIC TRANSFERS; BUMPER STICKERS; BLANK CARDS; GIFT AND GREETING CARDS; MOTIVATIONAL CARDS; OCCASION AND NOTE CARDS; PLACE, RECORD, SCORE AND TRADING CARDS; POSTCARDS; SCRAPBOOKS; STATIONERY; NOTE PADS; PAPER NOTE TABLETS; WRITING TABLETS; NOTE BOOKS; FOLDERS; BOOKMARKS; PAPER PENNANTS; BINDERS; WRITING PAPER; ENVELOPES; ADDRESS AND APPOINTMENT BOOKS; DESK PADS; PAPER TAGS; PASSPORT CASES, HOLDERS, AND COVERS; DESK TOP AND PERSONAL ORGANIZERS; ORGANIZERS FOR STATIONERY USE; STATIONERY-TYPE PORTFOLIOS; PAPER FLAGS; MOUNTS FOR STAMPS; RUBBER STAMPS; STAMP ALBUMS; STAMP PAD INKS; STAMP PADS; SLEEVES FOR HOLDING AND PROTECTING STAMPS; PAPER BANNERS; HOLDERS FOR DESK ACCESSORIES; LETTER OPENERS, RACKS AND TRAYS; PEN AND PENCIL CUPS; PENS; PENCILS; MARKERS; PEN AND PENCIL SETS; ERASERS; DRAFTING AND DRAWING RULERS; PENCIL SHARPENERS; BOOKENDS; BOOK COVERS AND HOLDERS; CHECKBOOK COVERS; COIN AND PHOTOGRAPH ALBUMS; PHOTOGRAPHIC OR ART MOUNTS; PAPER OR CARDBOARD PICTURE MOUNTS; PHOTOGRAPHIC PRINTS; PHOTOGRAPHS; LITHOGRAPHS; DECORATIVE PAPER CENTERPIECES AND PENCIL-TOP ORNAMENTS; PICTURE BOOKS; GLOBES; PAPER-WEIGHTS; PAPER CLIP AND SIGN HOLDERS; PRINTED PAPER SIGNS; PAPER PARTY FAVORS; PAPER EMBLEMS; PRINTED EMBLEMS; PAPER IDENTIFICATION TAGS; PAPER NAME BADGES; PAPER ILLUSTRATION BOARDS; PAPER FLOWER POT COVERS; CLIP BOARDS; PAPER HANDKERCHIEFS; TOUR BOOKS; CONCERT PROGRAMS; BOOKS, MAGAZINES, LEAFLETS, FOLIOS, JOURNALS, NEWSLETTERS, BOOKLETS, PAMPHLETS AND BROCHURES FEATURING MUSIC, ENTERTAINMENT, TELEVISION, FILM, THE ARTS, FASHION, LIFESTYLES, CULTURE, TECHNOLOGY, EMERGING BRANDS, SOCIAL ISSUES AND POLITICS (U.S. CLS. 2, 5, 22, 23, 29, 37, 38 AND 50).

JILL PRATER, EXAMINING ATTORNEY

CLASS 16—(Continued).

SN 85-539,711. AMERICAN SOCIETY FOR BONE AND MINERAL RESEARCH, AKA ASBMR, WASHINGTON, DC. FILED 2-10-2012.

JBMR

THE MARK CONSISTS OF STANDARD CHARACTERS WITHOUT CLAIM TO ANY PARTICULAR FONT, STYLE, SIZE, OR COLOR.

FOR PUBLICATIONS, NAMELY, RESEARCH ANALYSES AND JOURNAL ARTICLES IN THE FIELDS OF SCIENCE, AND PARTICULARLY BONE AND MINERAL SCIENCE (U.S. CLS. 2, 5, 22, 23, 29, 37, 38 AND 50).

FIRST USE 1-1-1997; IN COMMERCE 1-1-1997.
ANNE E. GUSTASON, EXAMINING ATTORNEY

CLASS 16—(Continued).

SN 85-540,169. HEALTH ENVIRONMENT ART SERVICES, INC., ARLINGTON HEIGHTS, IL. FILED 2-10-2012.

COMMUNICARE BOARDS

THE MARK CONSISTS OF STANDARD CHARACTERS WITHOUT CLAIM TO ANY PARTICULAR FONT, STYLE, SIZE, OR COLOR.

NO CLAIM IS MADE TO THE EXCLUSIVE RIGHT TO USE "BOARDS", APART FROM THE MARK AS SHOWN.

FOR BLACKBOARD ERASERS; BLACKBOARDS; BLACKBOARDS AND SCRAP BOOKS; BLACKBOARDS, DRAWING BOARDS AND EASELS; BLANK WRITING JOURNALS; CHALK AND BLACKBOARDS; CHALK AND CHALKBOARDS; CHALK BOARDS FOR SCHOOL AND HOME USE; CHALK ERASERS; CHALKS; CLIP BOARDS; DRAWING BOARDS; DRAWING MATERIALS FOR BLACKBOARDS; DRAWING TABLETS; DRAWING TEMPLATES; DRY ERASE WRITING BOARDS AND WRITING SURFACES; ERASERS; FELT TIP MARKERS; HIGHLIGHTING MARKERS; ILLUSTRATION BOARDS; MAGNETIC BOARDS; MAGNETIC BOARDS FOR SCHEDULING ACTIVITIES AND APPOINTMENTS; MARKERS; MAT BOARDS; MOUNTING BOARDS; PAPER BOARD; PAPER BOARDS; PASTE BOARD; POSTER BOARD; PRESENTATION FOLDERS; SLATE BOARDS FOR WRITING; SMALL BLACKBOARDS; STICK-ON WHITEBOARDS AND DRY-ERASE BOARDS; WHITE PAPERBOARD; WHITEBOARD ERASERS; WRITING IMPLEMENTS; WRITING PADS; WRITING TABLETS (U.S. CLS. 2, 5, 22, 23, 29, 37, 38 AND 50).

CARYN GLASSER, EXAMINING ATTORNEY

SN 85-540,034. HODGE, ANDRES DOMINIC JR., DBA HIPS ON DECK, PITTSBURG, CA. FILED 2-10-2012.

Hips On Deck

THE MARK CONSISTS OF STANDARD CHARACTERS WITHOUT CLAIM TO ANY PARTICULAR FONT, STYLE, SIZE, OR COLOR.

FOR GENERAL FEATURE MAGAZINE IN THE FIELD OF MEN'S ENTERTAINMENT (U.S. CLS. 2, 5, 22, 23, 29, 37, 38 AND 50).

FIRST USE 1-1-2008; IN COMMERCE 12-1-2010.
LAURIE KAUFMAN, EXAMINING ATTORNEY

SN 85-540,296. BECHARD, DAVID M, CHARLOTTE, NC. FILED 2-11-2012.

Honk if you see STUPID!

THE MARK CONSISTS OF STANDARD CHARACTERS WITHOUT CLAIM TO ANY PARTICULAR FONT, STYLE, SIZE, OR COLOR.

FOR BUMPER STICKERS (U.S. CLS. 2, 5, 22, 23, 29, 37, 38 AND 50).

ROBIN MITTLER, EXAMINING ATTORNEY

CLASS 16—(Continued).

SN 85-540,306. D-GENERATION, INC., DAYTONA BEACH, FL. FILED 2-11-2012.

LIVE WELL, LAUGH OFTEN,
LOVE MUCH

THE MARK CONSISTS OF STANDARD CHARACTERS WITHOUT CLAIM TO ANY PARTICULAR FONT, STYLE, SIZE, OR COLOR.

OWNER OF U.S. REG. NO. 4,090,303.
FOR ART PRINTS ON CANVAS; DECALS; STICKERS (U.S. CLS. 2, 5, 22, 23, 29, 37, 38 AND 50).
FIRST USE 8-5-1999; IN COMMERCE 8-5-1999.
CYNTHIA TRIPI, EXAMINING ATTORNEY

SN 85-540,817. THE TOPPS COMPANY, INC., NEW YORK, NY. FILED 2-13-2012.

TAG UP

THE MARK CONSISTS OF STANDARD CHARACTERS WITHOUT CLAIM TO ANY PARTICULAR FONT, STYLE, SIZE, OR COLOR.

FOR TRADING CARDS AND STICKERS (U.S. CLS. 2, 5, 22, 23, 29, 37, 38 AND 50).
MARK SPARACINO, EXAMINING ATTORNEY

SN 85-540,855. CLOSE THE LOOP, INC., HEBRON, KY. FILED 2-13-2012.

Enviroliner

THE MARK CONSISTS OF STANDARD CHARACTERS WITHOUT CLAIM TO ANY PARTICULAR FONT, STYLE, SIZE, OR COLOR.

FOR FELT-TIP PENS (U.S. CLS. 2, 5, 22, 23, 29, 37, 38 AND 50).
JANICE KIM, EXAMINING ATTORNEY

CLASS 16—(Continued).

SN 85-540,934. MILLER, LINDSEY, LOUISVILLE, KY. FILED 2-13-2012.

If You Educate . . .

THE MARK CONSISTS OF STANDARD CHARACTERS WITHOUT CLAIM TO ANY PARTICULAR FONT, STYLE, SIZE, OR COLOR.

FOR CHILDREN'S BOOKS (U.S. CLS. 2, 5, 22, 23, 29, 37, 38 AND 50).
SUNG IN, EXAMINING ATTORNEY

SN 85-594,684. ADVISORS EXCEL, LLC, TOPEKA, KS. FILED 4-11-2012.

AE INSIDER

THE MARK CONSISTS OF STANDARD CHARACTERS WITHOUT CLAIM TO ANY PARTICULAR FONT, STYLE, SIZE, OR COLOR.

FOR MAGAZINES IN THE FIELD OF INSURANCE AND FINANCIAL SERVICES (U.S. CLS. 2, 5, 22, 23, 29, 37, 38 AND 50).

FIRST USE 2-22-2011; IN COMMERCE 2-22-2011.
KRISTINA MORRIS, EXAMINING ATTORNEY

CLASS 17—RUBBER GOODS

SN 77-946,219. LAYFIELD POLY FILMS LTD., RICHMOND, BC, CANADA, FILED 2-26-2010.

SEALFLEX

THE MARK CONSISTS OF STANDARD CHARACTERS WITHOUT CLAIM TO ANY PARTICULAR FONT, STYLE, SIZE, OR COLOR.

PRIORITY CLAIMED UNDER SEC. 44(D) ON CANADA APPLICATION NO. 1450249, FILED 9-1-2009, REG. NO. TMA821,031, DATED 3-29-2012, EXPIRES 3-29-2027.

FOR PLASTIC FILM FOR COMMERCIAL, MEDICAL, AND INDUSTRIAL PACKAGING USE, NAMELY, SEALABLE, NON-SHRINK PLASTIC FILM IN THE FORM OF A WEB AND SOLD AS AN INTEGRAL COMPONENT OF MULTI-LAYER PACKAGING TO FORM A LAMINATION SEAL AROUND OTHER NON-FOOD GOODS (U.S. CLS. 1, 5, 12, 13, 35 AND 50).

ALYSSA STEEL, EXAMINING ATTORNEY

CLASS 17—(Continued).

SN 79-102,336. AKSA KARBON ELYAF SANAYI ANONIM SIRKETI, ISTANBUL, TURKEY, FILED 7-22-2011.



OWNER OF INTERNATIONAL REGISTRATION 1090118 DATED 7-22-2011, EXPIRES 7-22-2021.

OWNER OF U.S. REG. NO. 3,692,704.

THE COLOR(S) DARK GREEN, LIGHT GREEN AND BLACK IS/ARE CLAIMED AS A FEATURE OF THE MARK.

THE MARK CONSISTS OF THE DESIGN OF TWO INCOMPLETE CONCENTRIC CIRCLES, WITH THE OUTER LARGER CIRCLE APPEARING IN DARK GREEN AND THE SMALLER INNER CIRCLE APPEARING IN LIGHT GREEN AND THE WORDS "AKSACA" APPEARING IN BLACK AND EMANATING FROM THE BROKEN AREA OF THE CIRCLES.

THE WORDING "AKSACA" HAS NO MEANING IN A FOREIGN LANGUAGE.

FOR CARBON FIBERS, OTHER THAN TEXTILE USE (U.S. CLS. 1, 5, 12, 13, 35 AND 50).

JENNIFER WILLISTON, EXAMINING ATTORNEY

CLASS 17—(Continued).

SN 85-267,064. WESTERN PLASTICS INC., MISSISSAUGA, ONTARIO, CANADA, FILED 3-15-2011.

PANACEA WRAP

THE MARK CONSISTS OF STANDARD CHARACTERS WITHOUT CLAIM TO ANY PARTICULAR FONT, STYLE, SIZE, OR COLOR.

PRIORITY CLAIMED UNDER SEC. 44(D) ON CANADA APPLICATION NO. 1495950, FILED 9-15-2010, REG. NO. TMA823,430, DATED 5-4-2012, EXPIRES 5-4-2027.

NO CLAIM IS MADE TO THE EXCLUSIVE RIGHT TO USE "WRAP", APART FROM THE MARK AS SHOWN.

FOR PLASTIC MULTI-LAYER REINFORCED FLEXIBLE WRAPPING MATERIAL IN THE NATURE OF PACKAGING FILM SOLD IN BULK TO INDUSTRIAL AND COMMERCIAL MANUFACTURERS (U.S. CLS. 1, 5, 12, 13, 35 AND 50).

FIRST USE 7-31-2006; IN COMMERCE 8-31-2006.

ALICIA COLLINS, EXAMINING ATTORNEY

SN 85-344,686. MALLETTE, JOHN W SR, PENSACOLA, FL. FILED S.R. 6-13-2011; AM. P.R. 4-23-2012.



THE MARK CONSISTS OF THE WORDING "SOLAR ARMOR" WITH THREE CURVED LINES ABOVE THE "SOLA" PORTION OF "SOLAR" AND THREE CURVED LINES BELOW THE TERM "ARMOR".

FOR ACOUSTIC AND THERMAL INSULATION FOR USE IN THE AUTOMOTIVE, HVAC, APPLIANCE AND COMMERCIAL INTERIOR INDUSTRIES; ACOUSTICAL INSULATION BARRIER PANELS; HEAT AND ACOUSTICAL COMPOSITE INSULATING SHIELD FOR AUTOMOBILES AND MACHINERY; INSULATING FABRICS; INSULATING MATERIALS; INSULATION FOR AIRCRAFT (U.S. CLS. 1, 5, 12, 13, 35 AND 50).

FIRST USE 6-1-2004; IN COMMERCE 6-1-2004.

PAULA MAHONEY, EXAMINING ATTORNEY

SN 85-226,432. ISOVOLTA AG, WIENER NEUDORF, AUSTRIA, FILED 1-26-2011.

DEGLAS

THE MARK CONSISTS OF STANDARD CHARACTERS WITHOUT CLAIM TO ANY PARTICULAR FONT, STYLE, SIZE, OR COLOR.

THE WORDING "DEGLAS" HAS NO MEANING IN A FOREIGN LANGUAGE.

FOR ELECTRICAL INSULATING GLASS CLOTHS COATED WITH MODIFIED POLYESTER RESINS FOR PHASE INSULATION IN THE PRODUCTION OF LOW AND MEDIUM VOLTAGE MOTORS AND INTERLAYER INSULATION IN TRANSFORMERS AND OTHER ELECTRICAL MACHINES; ELECTRICAL GRADE GLASS CLOTHS IMPREGNATED WITH POLYURETHANE VARNISH FOR INSULATION OF ELECTRICAL MACHINES SUBJECTED TO A HIGH THERMAL STRESS AND CONTINUOUS ALTERNATING DEFORMATIONS CAUSED BY APPLIED FORCES AND PARTICULARLY SUITABLE FOR END-WINDINGS AND OTHER CURVED PARTS IN ELECTRICAL MACHINES (U.S. CLS. 1, 5, 12, 13, 35 AND 50).

FIRST USE 5-6-2003; IN COMMERCE 7-19-2006.

DAVID YONTEF, EXAMINING ATTORNEY

SN 85-386,239. LAMONS GASKET COMPANY, HOUSTON, TX. FILED 8-1-2011.

INHIBITOR

THE MARK CONSISTS OF STANDARD CHARACTERS WITHOUT CLAIM TO ANY PARTICULAR FONT, STYLE, SIZE, OR COLOR.

FOR PIPE GASKETS BEING METAL GASKETS FOR USE BETWEEN PIPE FLANGES (U.S. CLS. 1, 5, 12, 13, 35 AND 50).

BRENDAN MCCAULEY, EXAMINING ATTORNEY

CLASS 17—(Continued).

SN 85-388,281. E. I. DU PONT DE NEMOURS AND COMPANY, WILMINGTON, DE. FILED 8-3-2011.

SPALLSHIELD

THE MARK CONSISTS OF STANDARD CHARACTERS WITHOUT CLAIM TO ANY PARTICULAR FONT, STYLE, SIZE, OR COLOR.

OWNER OF U.S. REG. NO. 1,760,684.
FOR PLASTIC SHEETING FOR USE IN THE MANUFACTURE OF COMMERCIAL AND INDUSTRIAL GOODS (U.S. CLS. 1, 5, 12, 13, 35 AND 50).
EDWARD NELSON, EXAMINING ATTORNEY

SN 85-395,593. OWENS CORNING INTELLECTUAL CAPITAL, TOLEDO, OH. FILED 8-11-2011.

ECOTOUCH

THE MARK CONSISTS OF STANDARD CHARACTERS WITHOUT CLAIM TO ANY PARTICULAR FONT, STYLE, SIZE, OR COLOR.

OWNER OF U.S. REG. NO. 4,049,682.
FOR FIBER GLASS DUCT INSULATION BOARD, DUCT INSULATION LINER, DUCT INSULATION WRAP AND DUCT INSULATION (U.S. CLS. 1, 5, 12, 13, 35 AND 50).
RAUL CORDOVA, EXAMINING ATTORNEY

SN 85-445,548. INTERNATIONAL PAPER COMPANY, MEMPHIS, TN. FILED 10-12-2011.

TAK-PAK

THE MARK CONSISTS OF STANDARD CHARACTERS WITHOUT CLAIM TO ANY PARTICULAR FONT, STYLE, SIZE, OR COLOR.

FOR PLASTIC FILM USED FOR THE PACKAGING AND CONTAINMENT OF RETAIL SHOPPING BAGS (U.S. CLS. 1, 5, 12, 13, 35 AND 50).
DEIRDRE ROBERTSON, EXAMINING ATTORNEY

CLASS 17—(Continued).

SN 85-461,244. M.H. STALLMAN COMPANY, PROVIDENCE, RI. FILED 11-1-2011.

XOLEFIN

THE MARK CONSISTS OF STANDARD CHARACTERS WITHOUT CLAIM TO ANY PARTICULAR FONT, STYLE, SIZE, OR COLOR.

FOR POLYOLEFIN FOAM MATERIALS IN THE FORM OF ROLLS, SLABS, PLANKS AND EXTRUSIONS FOR SALE TO PRODUCT FABRICATORS FOR GENERAL INDUSTRIAL USE (U.S. CLS. 1, 5, 12, 13, 35 AND 50).
FIRST USE 3-24-2011; IN COMMERCE 3-24-2011.
ALICIA COLLINS, EXAMINING ATTORNEY

SN 85-514,329. INHON INTERNATIONAL CO. LTD., TAIPEI CITY, TAIWAN, FILED 1-11-2012.



THE MARK CONSISTS OF THE STYLIZED WORDING "INHON", WHEREBY THE LETTER "I" IS COMPRISED OF A HALF-SHADED VERTICAL HEXAGON.

THE WORD(S) "INHON" HAS NO MEANING IN A FOREIGN LANGUAGE.

FOR SEMI-PROCESSED ARTIFICIAL RESINS; SEMI-PROCESSED SYNTHETIC RESINS; CARBON FIBERS NOT FOR TEXTILE USE; SEMI-PROCESSED PLASTIC SUBSTANCES; PLASTIC FIBERS NOT FOR TEXTILE USE; FIBERGLASS FOR INSULATION (U.S. CLS. 1, 5, 12, 13, 35 AND 50).

TOBY BULLOFF, EXAMINING ATTORNEY

SN 85-531,735. ROBERT BOSCH TOOL CORPORATION, MOUNT PROSPECT, IL. FILED 2-2-2012.

FLEXOGEN

THE MARK CONSISTS OF STANDARD CHARACTERS WITHOUT CLAIM TO ANY PARTICULAR FONT, STYLE, SIZE, OR COLOR.

FOR GARDEN HOSES (U.S. CLS. 1, 5, 12, 13, 35 AND 50).
FIRST USE 5-22-1967; IN COMMERCE 5-22-1967.
ERIN FALK, EXAMINING ATTORNEY

CLASS 17—(Continued).

SN 85-532,433. US GREENFIBER, LLC, CHARLOTTE, NC. FILED 2-2-2012.

Prestige

THE MARK CONSISTS OF STANDARD CHARACTERS WITHOUT CLAIM TO ANY PARTICULAR FONT, STYLE, SIZE, OR COLOR.

FOR BUILDING INSULATION (U.S. CLS. 1, 5, 12, 13, 35 AND 50).

WILLIAM JACKSON, EXAMINING ATTORNEY



SN 85-534,390. FERRO CORPORATION, MAYFIELD HEIGHTS, OH. FILED 2-6-2012.

DURACRYN

THE MARK CONSISTS OF STANDARD CHARACTERS WITHOUT CLAIM TO ANY PARTICULAR FONT, STYLE, SIZE, OR COLOR.

FOR SEMI-FINISHED THERMOPLASTIC ELASTOMERS FOR USE IN FURTHER MANUFACTURE IN A WIDE VARIETY OF INDUSTRIES (U.S. CLS. 1, 5, 12, 13, 35 AND 50).

CHRISIE B. KING, EXAMINING ATTORNEY



SN 85-535,993. ABRO INDUSTRIES, INC., SOUTH BEND, IN. FILED 2-7-2012.

ULTRA PLUS

THE MARK CONSISTS OF STANDARD CHARACTERS WITHOUT CLAIM TO ANY PARTICULAR FONT, STYLE, SIZE, OR COLOR.

FOR LIQUID GASKET MAKING COMPOUNDS IN THE NATURE OF ADHESIVE SEALANTS FOR AUTOMOTIVE ENGINE AND MACHINE USE (U.S. CLS. 1, 5, 12, 13, 35 AND 50).

FIRST USE 7-0-2008; IN COMMERCE 7-0-2008. RUSS HERMAN, EXAMINING ATTORNEY

CLASS 17—(Continued).

SN 85-538,308. INDUMAR SYSTEMS, LP, HOUSTON, TX. FILED 2-9-2012.

SEASEAL

THE MARK CONSISTS OF STANDARD CHARACTERS WITHOUT CLAIM TO ANY PARTICULAR FONT, STYLE, SIZE, OR COLOR.

FOR POLYMER SEALANT FOR USE IN CONNECTION WITH SEAMS, HATCHES, CARGO HOLD OPENINGS, DOORS, WINDOWS, OR OTHER INTERFACE SURFACES; HYDROPHOBIC POLYMER SEALANT EXTRUDED ONTO A PEEL AND STICK FILM FOR APPLICATION TO SEAMS, HATCHES, CARGO HOLD OPENINGS, DOORS, WINDOWS, OR OTHER INTERFACE SURFACES (U.S. CLS. 1, 5, 12, 13, 35 AND 50).

ANGELA M. MICHELI, EXAMINING ATTORNEY



CLASS 18—LEATHER GOODS

SN 79-103,165. ZIPITBAG GMBH & CO.KG, FED REP GERMANY, FILED 7-8-2011.



ZIP&FRIENDS
COMPANY

PRIORITY DATE OF 6-1-2011 IS CLAIMED. OWNER OF INTERNATIONAL REGISTRATION 1092390 DATED 7-8-2011, EXPIRES 7-8-2021.

NO CLAIM IS MADE TO THE EXCLUSIVE RIGHT TO USE "COMPANY", APART FROM THE MARK AS SHOWN.

THE MARK CONSISTS OF THE STYLIZED LETTERS "ZF" ABOVE THE WORDING "ZIP&FRIENDS" WHICH IS ABOVE THE WORD "COMPANY".

FOR CARRY-ALL BAGS, BACKPACKS, PURSES AND WALLETS, LEATHER GOODS, NAMELY, SADDLERY, SUITCASES, TRUNKS AND TRAVELLING BAGS, CARRY-ALL BAGS WITH IMPRINTS (U.S. CLS. 1, 2, 3, 22 AND 41).

JESSICA A. POWERS, EXAMINING ATTORNEY

CLASS 18—(Continued).

SN 85-199,013. VIVINT, INC., PROVO, UT. FILED 12-15-2010.

SIMPLY SMARTER

THE MARK CONSISTS OF STANDARD CHARACTERS WITHOUT CLAIM TO ANY PARTICULAR FONT, STYLE, SIZE, OR COLOR.

FOR LUGGAGE; BACKPACKS; BAGS, NAMELY, HANDBAGS AND ALL-PURPOSE CARRYING BAGS; TOOL BAGS DISTRIBUTED WITHOUT TOOLS; ALL OF THE AFOREMENTIONED DISTRIBUTED IN CONNECTION WITH BUILDING AUTOMATION, UTILITY AND ALARM SYSTEMS (U.S. CLS. 1, 2, 3, 22 AND 41).
KEVIN CORWIN, EXAMINING ATTORNEY

SN 85-224,384. NATIONAL BEEF PACKING COMPANY, LLC, KANSAS CITY, MO. FILED 1-24-2011.

NATIONAL BEEF

THE MARK CONSISTS OF STANDARD CHARACTERS WITHOUT CLAIM TO ANY PARTICULAR FONT, STYLE, SIZE, OR COLOR.

NO CLAIM IS MADE TO THE EXCLUSIVE RIGHT TO USE "BEEF", APART FROM THE MARK AS SHOWN.

FOR CATTLE HIDES SOLD TO OTHERS FOR FURTHER PROCESSING (U.S. CLS. 1, 2, 3, 22 AND 41).
FIRST USE 5-3-2010; IN COMMERCE 5-3-2010.
BRENDAN MCCAULEY, EXAMINING ATTORNEY

SN 85-224,428. TYR TACTICAL, LLC, PEORIA, AZ. FILED 1-24-2011.

PLUMA VIRES

THE MARK CONSISTS OF STANDARD CHARACTERS WITHOUT CLAIM TO ANY PARTICULAR FONT, STYLE, SIZE, OR COLOR.

THE ENGLISH TRANSLATION OF "PLUMA VIRES" IN THE MARK IS "FEATHER FORCE".

FOR BALLISTIC RESISTANT FABRIC SOLD AS AN INTEGRAL COMPONENT OF MILITARY DUFFLE BAGS, TOTE BAGS, SHOULDER BAGS, BACKPACKS AND TEXTILE POUCHES (U.S. CLS. 1, 2, 3, 22 AND 41).
FIRST USE 1-15-2011; IN COMMERCE 1-15-2011.
IRA J. GOODSAD, EXAMINING ATTORNEY

CLASS 18—(Continued).

SN 85-248,650. BOSTON TEA PARTY SHIP, INC., KEY WEST, FL. FILED 2-22-2011.

BOSTON TEA PARTY SHIPS & MUSEUM

THE MARK CONSISTS OF STANDARD CHARACTERS WITHOUT CLAIM TO ANY PARTICULAR FONT, STYLE, SIZE, OR COLOR.

NO CLAIM IS MADE TO THE EXCLUSIVE RIGHT TO USE "SHIPS & MUSEUM", APART FROM THE MARK AS SHOWN.

FOR BAGS, NAMELY, BACKPACKS, DUFFEL BAGS, TOTE BAGS, HAND BAGS, BOOK BAGS, SHOULDER BAGS, ALL PURPOSE ATHLETIC BAGS, MESH SHOPPING BAGS, TEXTILE SHOPPING BAGS, BEACH BAGS, CARRY-ON BAGS, BABY CARRIERS WORN ON THE BODY, WAIST PACKS, FANNY PACKS, AND WALLETS; UMBRELLAS AND BEACH UMBRELLAS; KEY CASES, LEATHER KEY FOBS, COIN PURSES, CHANGE PURSES, SACHELS; LEATHER AND IMITATION LEATHER KEY CHAINS, LEATHER AND IMITATION LEATHER HAND BAGS AND SHOPPING BAGS, LEATHER AND IMITATION LEATHER WALLETS, LEATHER AND IMITATION LEATHER TOILETRY CASES SOLD EMPTY; LEATHER AND IMITATION LEATHER BELT BAGS, LEATHER AND IMITATION LEATHER CHANGE PURSES, LEATHER AND IMITATION LEATHER STRAPS FOR BAGS; TOILETRY CASES SOLD EMPTY (U.S. CLS. 1, 2, 3, 22 AND 41).
LESLIE RICHARDS, EXAMINING ATTORNEY

SN 85-344,525. TEAM FAIRFAX 2013, FAIRFAX, VA. FILED 6-13-2011.



THE MARK CONSISTS OF THE HEAD OF AN EAGLE WHERE THE EYE IS DEPICTED BY A STAR.

FOR TRAVELING BAGS; ATTACHE CASES, BRIEF CASES, TRAVELING CASES, BRIEFCASE-TYPE PORTFOLIOS, TOTE BAGS, DUFFEL BAGS, SPORTS BAGS; GYM BAGS; UMBRELLAS (U.S. CLS. 1, 2, 3, 22 AND 41).
JOSETTE BEVERLY, EXAMINING ATTORNEY

CLASS 18—(Continued).

SN 85-358,541. SASHA HANDBAGS, WALLINGTON, NJ. FILED 6-28-2011.

DIVIAGGIO

THE MARK CONSISTS OF STANDARD CHARACTERS WITHOUT CLAIM TO ANY PARTICULAR FONT, STYLE, SIZE, OR COLOR.

THE ENGLISH TRANSLATION OF "DIVIAGGIO" IN THE MARK IS NOT DIRECTLY TRANSLATABLE, BUT THE ELEMENT "DI" CAN MEAN "BY" IN ITALIAN AND "VIAGGIO" MEANS "JOURNEY" IN ITALIAN.

FOR LUGGAGE, WHEELED LUGGAGE, HAND-CARRIED LUGGAGE, SHOULDER BAGS, WALLETS, HANDBAGS, PURSES, TOTE BAGS, TICKET ORGANIZERS IN THE NATURE OF POUCHES, IDENTIFICATION CARD CASES, COSMETIC CASES SOLD EMPTY, AND TRAVEL CASES (U.S. CLS. 1, 2, 3, 22 AND 41).

TINA L. SNAPP, EXAMINING ATTORNEY

SN 85-363,751. NAIYER, TARIQ, CLARKSBURG, MD. FILED 7-6-2011.

ALL AMERICAN SADDLERY COMPANY

THE MARK CONSISTS OF STANDARD CHARACTERS WITHOUT CLAIM TO ANY PARTICULAR FONT, STYLE, SIZE, OR COLOR.

NO CLAIM IS MADE TO THE EXCLUSIVE RIGHT TO USE "SADDLERY COMPANY", APART FROM THE MARK AS SHOWN.

FOR SADDLES; HORSE TACK, NAMELY, BRIDLES, REINS, LEADS, BITS, STIRRUP LEATHERS, GIRTH STRAPS, LUNGE LINES, HALTERS (U.S. CLS. 1, 2, 3, 22 AND 41).

SIMON TENG, EXAMINING ATTORNEY

SN 85-369,754. JOYNER, BARBRA R., ORLANDO, FL. FILED 7-12-2011.



NO CLAIM IS MADE TO THE EXCLUSIVE RIGHT TO USE "COMPACT", APART FROM THE MARK AS SHOWN.

THE COLOR(S) PURPLE, YELLOW, TAN, WHITE, LIGHT BROWN, DARK BROWN AND BLACK IS/ARE CLAIMED AS A FEATURE OF THE MARK.

THE MARK CONSISTS OF A CAUCASIAN FEMALE'S THUMB SIDE OF HER LEFT HAND IN TAN AND OUT-

CLASS 18—(Continued).

LINED IN DARK BROWN WITH LIGHT BROWN SHADING WITH WHITE FINGERNAIL CUPPED, HOLDING A CIRCLE WHICH CONTAINS A YIN YANG SIGN WITH THE UPPER HALF IN YELLOW AND OUTLINED IN PURPLE AND THE LOWER HALF IN PURPLE; THE WORD "COMPACT" IN BLACK IS ROUNDED AGAINST THE INNER TOPSIDE OF THE CIRCLE AND THE WORD "COZY" IN BLACK IS ROUNDED AGAINST THE INNER BOTTOM OF THE CIRCLE. THE BACKGROUND AREA IS IN WHITE AND IS NOT PART OF THE MARK.

FOR COSMETIC CARRYING CASES SOLD EMPTY; VANITY CASES SOLD EMPTY (U.S. CLS. 1, 2, 3, 22 AND 41).

KATHLEEN M. VANSTON, EXAMINING ATTORNEY

SN 85-399,259. WAL-MART STORES, INC., BENTONVILLE, AR. FILED 8-16-2011.

WALMART FAMILY MOBILE

THE MARK CONSISTS OF STANDARD CHARACTERS WITHOUT CLAIM TO ANY PARTICULAR FONT, STYLE, SIZE, OR COLOR.

OWNER OF U.S. REG. NOS. 1,783,039, 3,612,345 AND OTHERS.

NO CLAIM IS MADE TO THE EXCLUSIVE RIGHT TO USE "MOBILE", APART FROM THE MARK AS SHOWN.

FOR TRAVEL CASES (U.S. CLS. 1, 2, 3, 22 AND 41). SUSAN RICHARDS, EXAMINING ATTORNEY

SN 85-402,012. TWINKLE LEATHERWARE COMPANY LIMITED, KWAICHUN, N. T., HONG KONG, FILED 8-19-2011.

voyLux

OWNER OF TAIWAN REG. NO. 1419242, DATED 7-16-2010, EXPIRES 7-15-2020.

THE COLOR(S) RED AND BLACK IS/ARE CLAIMED AS A FEATURE OF THE MARK.

THE MARK CONSISTS OF THE WORDING "VOYLUX" IN STYLIZED LETTERING; THE LETTER "V" IN COLOR RED AND "OYLUX" IN COLOR BLACK.

FOR HANDBAGS, LEATHER BAGS AND FOLDERS, BRIEFCASES, TRAVELING CASES, UNFITTED VANITY CASES AND VANITY CASES SOLD EMPTY, PURSES, WALLETS, COSMETIC BAGS, NOT FITTED, AND BAGS FOR BEAUTY CASES SOLD EMPTY, LADIES HANDBAGS, BACKPACKS, ALL PURPOSE ATHLETIC BAGS, ALL PURPOSE SPORT BAGS OTHER THAN SHAPED TO CONTAIN SPECIFIC SPORTS APPARATUS, BEACH BAGS, CARRY ON BAGS, CLUTCH BAGS, DUFFEL BAGS, LEATHER SHOPPING BAGS, OVERNIGHT BAGS, SCHOOL BAGS, SHOULDER BAGS, TEXTILE SHOPPING BAGS, TOTE BAGS, TRAVEL BAGS, GARMENT BAGS FOR TRAVEL, SHOE BAGS FOR TRAVEL, ATTACHE CASES, BRIEFCASES, SUITCASES, LUGGAGE TRUNKS, LUGGAGE, KEY CASES, BRIEFCASE-TYPE PORTFOLIOS; ANIMAL SKINS; UMBRELLAS, WALKING STICKS; SADDLERY (U.S. CLS. 1, 2, 3, 22 AND 41).

JOSETTE BEVERLY, EXAMINING ATTORNEY

CLASS 18—(Continued).

SN 85-416,286. PRIME MEDICAL RESOURCES INC., BURBANK, CA. FILED 9-7-2011.



NO CLAIM IS MADE TO THE EXCLUSIVE RIGHT TO USE "POST-OPERATIVE CARE", APART FROM THE MARK AS SHOWN.

THE COLOR(S) RED AND BLACK IS/ARE CLAIMED AS A FEATURE OF THE MARK.

THE MARK CONSISTS OF THE LETTER "PPOC", WITH THE FIRST "P" IN RED AND THE REST OF THE LETTERS IN BLACK, OVERLAPPING EACH OTHER WITH THE WORDS "PRIME POST-OPERATIVE CARE" BELOW SPELLED OUT IN BLACK.

FOR CANES (U.S. CLS. 1, 2, 3, 22 AND 41).
KELLY TRUSILO, EXAMINING ATTORNEY

SN 85-418,305. PRO-GAIN TRADING LIMITED, HUNG HOM, KOWLOON, HONG KONG, FILED 9-8-2011.



NO CLAIM IS MADE TO THE EXCLUSIVE RIGHT TO USE "JEANS", APART FROM THE MARK AS SHOWN.

THE MARK CONSISTS OF THE STYLIZED WORDS "JEANS WARHEAD" WHERE THE WORD "JEANS" IS ABOVE THE LETTERS "ARHEAD" AND THE LETTER "W" IS IN BIGGER SIZE.

FOR BACKPACKS; BRIEFCASES; HANDBAGS; KEY CASES; LEATHER AND IMITATION LEATHER; NAME CARD CASES; PURSES; SHOULDER BAGS; SUITCASES; TRAVELLING BAGS; TRUNKS; UMBRELLAS; WALLETS (U.S. CLS. 1, 2, 3, 22 AND 41).

ARETHA SOMERVILLE, EXAMINING ATTORNEY

CLASS 18—(Continued).

SN 85-470,993. MIAMI MARLINS, L.P., MIAMI, FL. FILED 11-11-2011.



THE COLOR(S) ORANGE, YELLOW, WHITE, BLUE AND SILVER IS/ARE CLAIMED AS A FEATURE OF THE MARK.

THE MARK CONSISTS OF A STYLIZED LETTER "M" ALTERNATELY LINED IN SILVER, ORANGE, YELLOW, WHITE AND BLUE WITH A STYLIZED FISH DESIGN ALTERNATELY LINED IN SILVER, ORANGE, WHITE AND BLUE CURLING AROUND THE UPPER LEFT SIDE OF THE "M".

FOR ALL-PURPOSE SPORT BAGS, ALL-PURPOSE ATHLETIC BAGS, ALL-PURPOSE CARRYING BAGS, ATHLETIC BAGS, BACKPACKS, BRIEFCASES, BUSINESS CARD CASES, CANVAS SHOPPING BAGS, CLUTCHES, COIN PURSES, COLLARS FOR PETS, COSMETIC BAGS SOLD EMPTY, PET CLOTHING, DUFFLE BAGS, UMBRELLAS, HANDBAGS, LEASHES FOR ANIMALS, LEATHER BAGS, SUITCASES AND WALLETS, LEATHER KEY CHAINS, LUGGAGE, LUGGAGE TAGS, PATIO UMBRELLAS, PET TAGS SPECIALLY ADAPTED FOR ATTACHING TO PET LEASHES OR COLLARS, PET COLLAR ACCESSORIES, NAMELY, BOWS AND CHARMS, PURSES, REUSABLE SHOPPING BAGS, TOTE BAGS, TOILETRY BAGS SOLD EMPTY, WALLETS, CREDIT CARD CASES AND HOLDERS, WINE BAGS WITH HANDLES FOR CARRYING OR HOLDING WINE, WRISTLET BAGS (U.S. CLS. 1, 2, 3, 22 AND 41).

KATHY DE JONGE, EXAMINING ATTORNEY

SN 85-475,168. UNITED BAMBOO LLC, NEW YORK, NY. FILED 11-17-2011.

Le Bac

THE MARK CONSISTS OF STANDARD CHARACTERS WITHOUT CLAIM TO ANY PARTICULAR FONT, STYLE, SIZE, OR COLOR.

THE WORDING "BAC" HAS NO MEANING IN A FOREIGN LANGUAGE.

FOR LUGGAGE (U.S. CLS. 1, 2, 3, 22 AND 41).

FIRST USE 1-1-2010; IN COMMERCE 9-1-2010.

JEAN IM, EXAMINING ATTORNEY

CLASS 18—(Continued).

SN 85-477,902. ROGERS BLUE JAYS BASEBALL PARTNER-SHIP, TORONTO, ONTARIO, CANADA, FILED 11-21-2011.



OWNER OF U.S. REG. NOS. 1,258,241, 3,330,437 AND OTHERS.

THE MARK CONSISTS OF THE STYLIZED REPRESENTATION OF THE HEAD OF A BLUE JAY BIRD IN PROFILE SUPERIMPOSED ON A BASEBALL GRAPHIC WITH A STYLIZED REPRESENTATION OF A MAPLE LEAF SUPERIMPOSED ON THE RIGHT SIDE OF THE BIRD GRAPHIC (HEREINAFTER "THE BIRD HEAD DESIGN"); A LIGHT CIRCULAR BORDER SURROUNDS THE BIRD HEAD DESIGN; THE WORD "TORONTO" IN STYLIZED SOLID DARK UPPERCASE LETTERING APPEARS WITHIN THE CIRCULAR BORDER ABOVE THE BIRD HEAD DESIGN; THE WORDS "BLUE JAYS" IN STYLIZED LIGHT AND DARK UPPERCASE LETTERING APPEAR WITHIN THE CIRCULAR BORDER BELOW THE BIRD HEAD DESIGN; THE FOREGOING IS IN TURN SURROUNDED BY AN EXTERIOR CIRCULAR BORDER COMPRISED OF THIN DARK, LIGHT AND DARK STRIPES.

SEC. 2(F) AS TO "TORONTO".

FOR ALL-PURPOSE SPORT BAGS, ALL-PURPOSE ATHLETIC BAGS, ALL-PURPOSE CARRYING BAGS, ATHLETIC BAGS, BACKPACKS, BRIEFCASES, BUSINESS CARD CASES, CANVAS SHOPPING BAGS, CLUTCHES, COIN PURSES, COLLARS FOR PETS, COSMETIC BAGS SOLD EMPTY, PET CLOTHING, DUFFLE BAGS, UMBRELLAS, HANDBAGS, LEASHES FOR ANIMALS, LEATHER BAGS, SUITCASES AND WALLETS, LEATHER KEY CHAINS, LUGGAGE, LUGGAGE TAGS, PATIO UMBRELLAS, PET TAGS SPECIALLY ADAPTED FOR ATTACHING TO PET LEASHES OR COLLARS, PET COLLAR ACCESSORIES, NAMELY BOWS AND CHARMS, PURSES, REUSABLE SHOPPING BAGS, TOTE BAGS, TOILETRY BAGS SOLD EMPTY, WALLETS, CREDIT CARD CASES AND HOLDERS, WINE BAGS WITH HANDLES FOR CARRYING OR HOLDING WINE, WRISTLET BAGS (U.S. CLS. 1, 2, 3, 22 AND 41).

GIANCARLO CASTRO, EXAMINING ATTORNEY

CLASS 18—(Continued).

SN 85-478,397. HOWE, LLC, SEATTLE, WA. FILED 11-21-2011.



OWNER OF U.S. REG. NOS. 2,670,569, 3,061,845 AND 3,487,455.

THE MARK CONSISTS OF A STYLIZED WORD "HOWE". SEC. 2(F).

FOR BACKPACKS, BOOK BAGS, SPORTS BAGS, BUM BAGS, WALLETS AND HANDBAGS; LUGGAGE (U.S. CLS. 1, 2, 3, 22 AND 41).

FIRST USE 11-21-2011; IN COMMERCE 11-21-2011.

JEAN IM, EXAMINING ATTORNEY

SN 85-498,785. TONER MACHINING TECHNOLOGIES, INC., MORGANTON, NC. FILED 12-19-2011.



NO CLAIM IS MADE TO THE EXCLUSIVE RIGHT TO USE "TACTICAL", APART FROM THE MARK AS SHOWN. THE MARK CONSISTS OF THE LETTERS "TMT" INSIDE A DOUBLE BORDERED EIGHT SIDED FIGURE WITH THE WORD "TACTICAL" BENEATH IT.

FOR SURVIVAL, EMERGENCY AND PREPAREDNESS KITS COMPRISED OF WALLET, MONEY CLIP, GLASS BREAKER, PEN, TOOTHPICK, TWEEZERS AND COMPASS (U.S. CLS. 1, 2, 3, 22 AND 41).

EMILY CARLSEN, EXAMINING ATTORNEY

CLASS 18—(Continued).

SN 85-524,863. GOYA FOODS, INC., SECAUCUS, NJ. FILED 1-25-2012.

GOYA FOR KIDS

THE MARK CONSISTS OF STANDARD CHARACTERS WITHOUT CLAIM TO ANY PARTICULAR FONT, STYLE, SIZE, OR COLOR.

OWNER OF U.S. REG. NOS. 764,033, 966,178 AND OTHERS.

NO CLAIM IS MADE TO THE EXCLUSIVE RIGHT TO USE "FOR KIDS", APART FROM THE MARK AS SHOWN.

FOR ALL PURPOSE SPORT BAGS; ALL-PURPOSE CARRYING BAGS; BACKPACKS; DUFFEL BAGS; HANDBAGS; LUGGAGE; PURSES; SACK PACKS; NAMELY, DRAWSTRING BAGS USED AS BACKPACKS; SCHOOL BAGS; TEXTILE SHOPPING BAGS; TOTE BAGS; UMBRELLAS; WALLETS (U.S. CLS. 1, 2, 3, 22 AND 41).

KATHLEEN LORENZO, EXAMINING ATTORNEY

CLASS 18—(Continued).

SN 85-530,777. GOLDWIN INC., TOYAMA-KEN, JAPAN, FILED 2-1-2012.



OWNER OF JAPAN REG. NO. 3062367, DATED 7-31-1995, EXPIRES 7-31-2015.

OWNER OF U.S. REG. NO. 3,045,059.

THE MARK CONSISTS OF A STYLIZED LETTER "G". FOR ALL PURPOSE SPORT BAGS; ATHLETIC BAGS; BOSTON BAGS; SHOULDER BAGS; TRAVELING BAGS; WAIST PACKS; BACKPACKS; WALLETS; DRAWSTRING POUCHES (U.S. CLS. 1, 2, 3, 22 AND 41).

STEVEN PEREZ, EXAMINING ATTORNEY

SN 85-530,541. ARANDEZ, JENNIFER JOYCE TAN, FORMERLY TAN, JENNIFER JOYCE FACTOR, LADERA RANCH, CA. FILED 2-1-2012.

OPHIRAIN

THE MARK CONSISTS OF STANDARD CHARACTERS WITHOUT CLAIM TO ANY PARTICULAR FONT, STYLE, SIZE, OR COLOR.

FOR ATTACHE CASES MADE OF LEATHER; BRIEF-CASES; LEATHER BAGS AND WALLETS; LEATHER BAGS, SUITCASES AND WALLETS; LEATHER BRIEF-CASES; LEATHER CASES FOR KEYS; LEATHER CREDIT CARD CASES; LEATHER CREDIT CARD HOLDER; LEATHER CREDIT CARD WALLETS; LEATHER HANDBAGS; LEATHER KEY CASES; LEATHER KEY CHAINS; LEATHER POUCHES; LEATHER PURSES; LEATHER SHOPPING BAGS; LEATHER SHOULDER BELTS; LEATHER STRAPS; THONGS; WALLETS MADE OF LEATHER OR OTHER MATERIALS (U.S. CLS. 1, 2, 3, 22 AND 41).

FIRST USE 1-15-2012; IN COMMERCE 1-15-2012.

ANDREA K. NADELMAN, EXAMINING ATTORNEY

SN 85-530,794. RIVER LIGHT V, L.P., NEW YORK, NY. FILED 2-1-2012.

TORY BURCH

THE MARK CONSISTS OF STANDARD CHARACTERS WITHOUT CLAIM TO ANY PARTICULAR FONT, STYLE, SIZE, OR COLOR.

OWNER OF U.S. REG. NOS. 3,428,373, 3,428,816 AND OTHERS.

THE NAME(S), PORTRAIT(S), AND/OR SIGNATURE(S) SHOWN IN THE MARK IDENTIFIES "TORY BURCH", WHOSE CONSENT(S) TO REGISTER IS MADE OF RECORD.

FOR BACKPACKS; BEACH BAGS; BUSINESS CARD CASES; COIN PURSES; DOG COLLARS; DOG LEASHES; OVERNIGHT BAGS; PET CLOTHING; WALLETS; WRISTLET BAGS (U.S. CLS. 1, 2, 3, 22 AND 41).

FIRST USE 10-31-2008; IN COMMERCE 10-31-2008.

MICHAEL GAFFAR, EXAMINING ATTORNEY

CLASS 18—(Continued).

SN 85-531,179. LEATHERTEQ LIMITED, TORTOLA, BR. VIRGIN ISLANDS, FILED 2-1-2012.

LITEHIDE

THE MARK CONSISTS OF STANDARD CHARACTERS WITHOUT CLAIM TO ANY PARTICULAR FONT, STYLE, SIZE, OR COLOR.

FOR PRESERVED ANIMAL HIDES, PELTS AND ANIMAL SKINS FOR MANUFACTURING LEATHER (U.S. CLS. 1, 2, 3, 22 AND 41).

RICHARD WHITE, EXAMINING ATTORNEY

CLASS 18—(Continued).

SN 85-532,653. THREE POINT VENTURES, LLC, ROCHESTER, NY. FILED 2-2-2012.

ROLLPACK

THE MARK CONSISTS OF STANDARD CHARACTERS WITHOUT CLAIM TO ANY PARTICULAR FONT, STYLE, SIZE, OR COLOR.

FOR ALL-PURPOSE CARRYING BAGS (U.S. CLS. 1, 2, 3, 22 AND 41).

ANTHONY RINKER, EXAMINING ATTORNEY

SN 85-531,781. LTS PARTNERS, LLC, MINNEAPOLIS, MN. FILED 2-2-2012.



NO CLAIM IS MADE TO THE EXCLUSIVE RIGHT TO USE "LEASH", APART FROM THE MARK AS SHOWN.

THE MARK CONSISTS OF THE WORD "ZEKE LEASH" AND THE LETTER "Z" CONTAINING AN OUTLINE OF DOG.

FOR ANIMAL LEASHES (U.S. CLS. 1, 2, 3, 22 AND 41).
EMILY CARLSEN, EXAMINING ATTORNEY

SN 85-533,979. VITTLING, JOEL, SAN DIEGO, CA. FILED 2-3-2012.

SONS OF BITCHES

THE MARK CONSISTS OF STANDARD CHARACTERS WITHOUT CLAIM TO ANY PARTICULAR FONT, STYLE, SIZE, OR COLOR.

FOR ANIMAL CARRIERS; ANIMAL HARNESSSES; ANIMAL LEASHES; ANIMAL WRAPS AND COVERS; CLOTHING FOR ANIMALS; COLLARS FOR ANIMALS; DOG SHOES; LEASHES FOR ANIMALS; LEGGINGS FOR ANIMALS; PET COLLAR ACCESSORIES, NAMELY, BELLS, SILENCERS, SAFETY LIGHTS AND BLINKERS, PENDANTS AND CHARMS; PET TAGS SPECIALLY ADAPTED FOR ATTACHING TO PET LEASHES OR COLLARS (U.S. CLS. 1, 2, 3, 22 AND 41).

KATHERINE CHANG, EXAMINING ATTORNEY

SN 85-534,050. KIMBERLY A. COMPAGNI, SALT LAKE CITY, UT. FILED 2-4-2012.

DUSHI BAGS

THE MARK CONSISTS OF STANDARD CHARACTERS WITHOUT CLAIM TO ANY PARTICULAR FONT, STYLE, SIZE, OR COLOR.

NO CLAIM IS MADE TO THE EXCLUSIVE RIGHT TO USE "BAGS", APART FROM THE MARK AS SHOWN.

THE ENGLISH TRANSLATION OF "DUSHI" IN THE MARK IS "SWEETHEART".

FOR BACKPACKS, BOOK BAGS, SPORTS BAGS, BUM BAGS, WALLETS AND HANDBAGS; BEACH BAGS; CARRY-ALL BAGS; CLUTCH BAGS; COSMETIC BAGS SOLD EMPTY; DIAPER BAGS; DUFFLE BAGS; HANDBAGS, PURSES AND WALLETS; LEATHER BAGS AND WALLETS; MESSENGER BAGS; SACK PACKS, NAMELY, DRAWSTRING BAGS USED AS BACKPACKS; SHOULDER BAGS (U.S. CLS. 1, 2, 3, 22 AND 41).

LAKEISHA LEWIS, EXAMINING ATTORNEY

SN 85-531,939. DOOLITTLE, KAITY, ALLSTON, MA. FILED 2-2-2012.

kaitydoo

THE MARK CONSISTS OF STANDARD CHARACTERS WITHOUT CLAIM TO ANY PARTICULAR FONT, STYLE, SIZE, OR COLOR.

FOR CLUTCHES; HANDBAGS; PURSES; SPORT BAGS (U.S. CLS. 1, 2, 3, 22 AND 41).

FIRST USE 9-9-2002; IN COMMERCE 8-16-2010.

ALEX KEAM, EXAMINING ATTORNEY

CLASS 18—(Continued).

SN 85-534,174. HATCH, LOREN E., MCLEAN, VA. FILED 2-4-2012.

LH

THE MARK CONSISTS OF STANDARD CHARACTERS WITHOUT CLAIM TO ANY PARTICULAR FONT, STYLE, SIZE, OR COLOR.

FOR BACKPACKS, BOOK BAGS, SPORTS BAGS, BUM BAGS, WALLETS AND HANDBAGS; FITTED PROTECTIVE COVERS FOR HANDBAGS, BRIEFCASES, VALISES, SUITCASES, AND BRIEFCASE-LIKE PORTFOLIOS; HANDBAG FRAMES; HANDBAGS FOR LADIES; HANDBAGS FOR MEN; HANDBAGS, PURSES AND WALLETS; INTERCHANGEABLE DECORATIVE COVERS FOR ACCESSORIZATION PURPOSES THAT ARE SPECIALLY ADAPTED TO HANDBAGS; STRAPS FOR HANDBAGS (U.S. CLS. 1, 2, 3, 22 AND 41).

FIRST USE 12-23-2010; IN COMMERCE 12-23-2010.
ALICE BENMAMAN, EXAMINING ATTORNEY

SN 85-534,216. LUVANIS S.A., LUXEMBOURG, LUXEMBOURG, FILED 2-5-2012.

ISAKOF

THE MARK CONSISTS OF STANDARD CHARACTERS WITHOUT CLAIM TO ANY PARTICULAR FONT, STYLE, SIZE, OR COLOR.

FOR ATTACHE CASES; BACKPACKS; BRIEFCASES; HANDBAGS; HOLDALLS; KEY-CASES; LEATHER SHOPPING BAGS; LUGGAGE; POCKET WALLETS; PURSES; SCHOOLBAGS; SPORT BAGS; SUITCASES; TOTE BAGS; TRAVEL BAGS; TRUNKS; VALISES (U.S. CLS. 1, 2, 3, 22 AND 41).

JENNY PARK, EXAMINING ATTORNEY

SN 85-534,517. FIFTY-SIX HOPE ROAD MUSIC, LIMITED, CABLE BEACH, NASSAU, BAHAMAS, FILED 2-6-2012.

TUFF GONG WORLDWIDE

THE MARK CONSISTS OF STANDARD CHARACTERS WITHOUT CLAIM TO ANY PARTICULAR FONT, STYLE, SIZE, OR COLOR.

NO CLAIM IS MADE TO THE EXCLUSIVE RIGHT TO USE "WORLDWIDE", APART FROM THE MARK AS SHOWN.

FOR ALL-PURPOSE CARRYING BAGS; BACKPACKS; LUGGAGE; WALLETS (U.S. CLS. 1, 2, 3, 22 AND 41).
SUNG IN, EXAMINING ATTORNEY

CLASS 18—(Continued).

SN 85-534,808. JAMES C. ALLEN, JR., SCOTTSDALE, AZ. FILED 2-6-2012.

STAY BOY

THE MARK CONSISTS OF STANDARD CHARACTERS WITHOUT CLAIM TO ANY PARTICULAR FONT, STYLE, SIZE, OR COLOR.

FOR LEASHES FOR ANIMALS (U.S. CLS. 1, 2, 3, 22 AND 41).

MICHAEL LITZAU, EXAMINING ATTORNEY

SN 85-534,851. GYPSY 05, INC., LOS ANGELES, CA. FILED 2-6-2012.

GYPSY 05

THE MARK CONSISTS OF STANDARD CHARACTERS WITHOUT CLAIM TO ANY PARTICULAR FONT, STYLE, SIZE, OR COLOR.

OWNER OF U.S. REG. NOS. 3,106,284, 3,642,608 AND 4,016,896.

FOR BAGS, NAMELY, HANDBAGS, SHOULDER BAGS, PURSES, CLUTCHES, WALLETS AND BACKPACKS (U.S. CLS. 1, 2, 3, 22 AND 41).

FIRST USE 7-29-2011; IN COMMERCE 7-29-2011.
KEVIN DINALLO, EXAMINING ATTORNEY

CLASS 18—(Continued).

SN 85-536,462. RUFF RUFF & MEOW LLC, COSTA MESA, CA. FILED 2-7-2012.



THE MARK CONSISTS OF THE WORD "BITCHES" IN ALL CAPITAL LETTERS WITH A SYMBOL OF A HEART CENTERED DIRECTLY BELOW THE WORD "BITCHES" AND THE WORD "ME" IN ALL CAPITAL LETTERS CENTERED DIRECTLY BELOW THE SYMBOL OF THE HEART.

SEC. 2(F).
 FOR DOG APPAREL; DOG CLOTHING; DOG COLLARS; DOG COLLARS AND LEADS; NECKWEAR FOR DOGS (U.S. CLS. 1, 2, 3, 22 AND 41).
 FIRST USE 8-1-2003; IN COMMERCE 8-1-2003.
 THEODORE MCBRIDE, EXAMINING ATTORNEY

SN 85-539,112. NEXT MILLENNIUM PRODUCTIONS LTD, NEW YORK, NY. FILED 2-10-2012.

DOGGIE MOMS

THE MARK CONSISTS OF STANDARD CHARACTERS WITHOUT CLAIM TO ANY PARTICULAR FONT, STYLE, SIZE, OR COLOR.

NO CLAIM IS MADE TO THE EXCLUSIVE RIGHT TO USE "DOGGIE", APART FROM THE MARK AS SHOWN.
 FOR ANIMAL CARRIERS; ANIMAL HARNESSSES; CLOTHING FOR DOMESTIC PETS; COLLARS FOR PETS; COLLARS FOR PETS BEARING MEDICAL INFORMATION; DISPOSABLE PET DIAPERS; ELECTRONIC PET COLLARS; GARMENTS FOR PETS; LEGGINGS FOR ANIMALS; MATS AND PADS MADE OF FABRIC FOR USE WITH ANIMAL TRAINING; PET ACCESSORIES, NAMELY, CANVAS, VINYL AND LEATHER POUCHES FOR HOLDING DISPOSABLE BAGS TO PLACE PET WASTE IN; PET ACCESSORIES, NAMELY, SPECIALLY DESIGNED CANVAS, VINYL OR LEATHER BAGS ATTACHED TO ANIMAL LEASHES FOR HOLDING SMALL ITEMS SUCH AS KEYS, CREDIT CARDS, MONEY OR DISPOSABLE BAGS FOR DISPOSING OF PET WASTE; PET CLOTHING; PET COLLAR ACCESSORIES, NAMELY, BELLS, SILENCERS, SAFETY LIGHTS AND BLINKERS, PENDANTS AND CHARMS; PET COLLAR ACCESSORIES, NAMELY, BOWS AND CHARMS; PET HAIR ORNAMENTS; PET TAGS SPECIALLY ADAPTED FOR ATTACHING TO PET LEASHES OR COLLARS (U.S. CLS. 1, 2, 3, 22 AND 41).
 JORDAN BAKER, EXAMINING ATTORNEY

CLASS 18—(Continued).

SN 85-539,154. PURSEPUPPE, INC., YUCAIPA, CA. FILED 2-10-2012.



THE MARK CONSISTS OF A SIMPLE LINE DRAWING OF A BABY SEAL WITH THE STYLIZED TEXT "PURSEPUPPE" ARCHING AROUND THE BASE OF THE DRAWING.

FOR WATER RESISTANT BAGS FOR PROTECTING HANDBAGS (U.S. CLS. 1, 2, 3, 22 AND 41).
 DAVID H. STINE, EXAMINING ATTORNEY

SN 85-539,342. GIVEBONES, LLC, MANHATTAN BEACH, CA. FILED 2-10-2012.

MY DOG HAS A VOICE, TOO

THE MARK CONSISTS OF STANDARD CHARACTERS WITHOUT CLAIM TO ANY PARTICULAR FONT, STYLE, SIZE, OR COLOR.

FOR DOG COLLARS, COLLARS FOR PETS, DOG LEASHES, LEASHES FOR ANIMALS, PET CLOTHING (U.S. CLS. 1, 2, 3, 22 AND 41).
 KATHY DE JONGE, EXAMINING ATTORNEY

SN 85-539,356. GIVEBONES, LLC, MANHATTAN BEACH, CA. FILED 2-10-2012.

YOUR DOG HAS A VOICE, TOO

THE MARK CONSISTS OF STANDARD CHARACTERS WITHOUT CLAIM TO ANY PARTICULAR FONT, STYLE, SIZE, OR COLOR.

FOR DOG COLLARS, COLLARS FOR PETS, DOG LEASHES, LEASHES FOR ANIMALS, PET CLOTHING (U.S. CLS. 1, 2, 3, 22 AND 41).
 KATHY DE JONGE, EXAMINING ATTORNEY

CLASS 18—(Continued).

SN 85-540,469. NOLKE IVANA, LEAVENWORTH, KS. FILED 2-12-2012.

ThermoCoat

THE MARK CONSISTS OF STANDARD CHARACTERS WITHOUT CLAIM TO ANY PARTICULAR FONT, STYLE, SIZE, OR COLOR.

FOR CLOTHING FOR ANIMALS; CLOTHING FOR DOMESTIC PETS; DOG APPAREL; DOG CLOTHING; DOG COATS; DOG PARKAS; PET CLOTHING (U.S. CLS. 1, 2, 3, 22 AND 41).

FIRST USE 2-17-2003; IN COMMERCE 2-17-2003.
ALICE BENMAMAN, EXAMINING ATTORNEY

SN 85-548,744. GIVEBONES, LLC, MANHATTAN BEACH, CA. FILED 2-21-2012.



THE MARK CONSISTS OF THE WORD "GIVEBONES" TO THE LEFT OF A PAW PRINT.

FOR DOG COLLARS, COLLARS FOR PETS, DOG LEASHES, LEASHES FOR ANIMALS, PET CLOTHING (U.S. CLS. 1, 2, 3, 22 AND 41).

KATHY DE JONGE, EXAMINING ATTORNEY

SN 85-554,573. PAYLESS SHOESOURCE WORLDWIDE, INC., TOPEKA, KS. FILED 2-28-2012.

BRASH

THE MARK CONSISTS OF STANDARD CHARACTERS WITHOUT CLAIM TO ANY PARTICULAR FONT, STYLE, SIZE, OR COLOR.

OWNER OF U.S. REG. NOS. 3,238,076, 4,071,773 AND OTHERS.

FOR BACKPACKS; FANNY PACKS; TOTE BAGS; WAIST PACKS; WALLET(S) (U.S. CLS. 1, 2, 3, 22 AND 41).
DORITT L. CARROLL, EXAMINING ATTORNEY

CLASS 19—NON-METALLIC BUILDING MATERIALS

SN 85-301,310. OLDCASTLE BUILDING PRODUCTS, INC., ATLANTA, GA. FILED 4-21-2011.

CASTLE MANOR

THE MARK CONSISTS OF STANDARD CHARACTERS WITHOUT CLAIM TO ANY PARTICULAR FONT, STYLE, SIZE, OR COLOR.

FOR CONCRETE RETAINING WALLS (U.S. CLS. 1, 12, 33 AND 50).

ALICE BENMAMAN, EXAMINING ATTORNEY

SN 85-313,292. EASI-SET INDUSTRIES, MIDLAND, VA. FILED 5-5-2011.

EASI-SPAN

THE MARK CONSISTS OF STANDARD CHARACTERS WITHOUT CLAIM TO ANY PARTICULAR FONT, STYLE, SIZE, OR COLOR.

OWNER OF U.S. REG. NOS. 2,581,512, 2,657,514 AND OTHERS.

FOR EXPANDABLE AND TRANSPORTABLE PRE-CAST CONCRETE BUILDINGS (U.S. CLS. 1, 12, 33 AND 50).

FIRST USE 8-5-1995; IN COMMERCE 8-5-1995.

SHAILA SETTLES, EXAMINING ATTORNEY

SN 85-320,859. ELMICH PTE LTD., SINGAPORE 298899, SINGAPORE, FILED 5-13-2011.



OWNER OF SINGAPORE REG. NO. T1016420E, DATED 12-14-2010, EXPIRES 12-14-2020.

THE COLOR(S) WHITE, ORANGE, AND DARK GREY IS/ ARE CLAIMED AS A FEATURE OF THE MARK.

THE MARK CONSISTS OF A STYLIZED DESIGN COM-

CLASS 19—(Continued).

PRISED OF A DARK GRAY RECTANGLE WITHIN WHICH IS A PARALLELOGRAM CONSISTING OF TWO WHITE SLANTED VERTICAL BARS OF UNEQUAL WIDTHS THAT ARE SEPARATED BY A THIN DARK GRAY LINE, AND THREE ORANGE CIRCLES WHICH RUN PARALLEL TO THE RIGHT OF THE VERTICAL BARS. THE WORD "ELMICH" APPEARS IN DARK GRAY STYLIZED FONT BELOW THE DESIGN ELEMENT. THE MARK IN ITS ENTIRETY APPEARS ON A TRANSPARENT BACKGROUND.

FOR BUILDING WATERPROOFING PRODUCT, NAMELY, WATERPROOFING MEMBRANES FOR ROOFING, FLOORS AND WALLS; STORM WATER MANAGEMENT DEVICES, NAMELY, PLASTIC PAVERS FOR SOIL RETENTION AND GRASS SUPPORT; PLASTIC UNDERGROUND DRAINAGE MODULAR UNITS COMPRISED OF TRENCH DRAINS, DRAIN BASES AND GRATES; AND NON-METALLIC UNDERGROUND TANK STRUCTURES IN THE NATURE OF PLASTIC OIL AND DEBRIS TRAP FOR STORM DRAINAGE; GRASS PAVERS, NAMELY, INTERLOCKING NON-METAL PAVERS FOR USE IN STRUCTURE FOR SOIL RETENTION, GRASS SUPPORT AND ANTI-COMPACTATION; CONSTRUCTION MATERIALS IN THE NATURE OF NON-METAL FLOORING MATERIALS, NAMELY, PLASTIC PEDESTAL PAVER SUPPORTS FOR USE IN SUPPORTING AND ELEVATING FLOORS COMPRISED OF STONE PAVERS, TILES, AND TIMBER DECKING; NON-METAL TRELLISES FOR CREATING PLANT COVERED WALLS; NON-METAL TRELLISES FOR USE IN ROOF AND WALL GARDENING; PLASTIC UNDERGROUND DRAINAGE-MODULAR UNIT COMPRISED OF PLASTIC CONDUIT FOR DRAINAGE AND SUMP RESERVOIRS FOR USE IN THE CONSTRUCTION OF BASEMENT WATERPROOFING; UNDERGROUND LIQUID STORAGE TANKS OF MASONRY FOR HOUSEHOLD AND INDUSTRIAL PURPOSES (U.S. CLS. 1, 12, 33 AND 50).

GRETCHEN ULRICH, EXAMINING ATTORNEY

CLASS 19—(Continued).

SN 85-326,962. UMEHIKO (M) SDN BHD, KUCHING, MALAYSIA, AND KHO, KAK HEE, AKA ANDY KHO KAK HEE, KUCHING, MALAYSIA, AND KHO, JASMINE POH SHEUN, AKA JASMINE KHO, KUCHING, MALAYSIA, FILED 5-23-2011.



THE COLOR(S) MAROON, BLACK, AND GREEN IS/ARE CLAIMED AS A FEATURE OF THE MARK.

THE MARK CONSISTS OF THE STYLIZED WORDING "AHE" IN MAROON COLOR WITH SLOGAN "INNOVATION THROUGH NATURE" IN BLACK, AND A GRASS SYMBOL IN GREEN.

FOR BUILDING MATERIALS, NAMELY, CONCRETE-BASED SLABS MADE USING RECYCLED GLASS; BUILDING MATERIALS, NAMELY, MANUFACTURED BRICK VENEER FOR USE ON INTERIOR AND EXTERIOR WALLS, FLOORS AND SURFACES, PATIOS, POOL-SIDES AND DRIVEWAYS; CEMENTITIOUS MATERIAL FOR BUILDING PURPOSES; CONCRETE BUILDING MATERIALS, NAMELY, STAINART, ECO-FRIENDLY CONCRETE SPECIALTIES SEALERS AND POLYMER KORA TOP; CONSTRUCTION MATERIAL, NAMELY, FIBERGLASS BOARD; CONSTRUCTION MATERIALS, NAMELY, CONCRETE SLABS DESIGNED TO INCREASE ENERGY EFFICIENCY AND ENERGY CONSERVATION; GLASS MOSAICS FOR USE IN BUILDING CONSTRUCTION; GYPSUM; MARBLE; NON-METAL FORMING SYSTEMS FOR CONCRETE AND OTHER CURABLE CONSTRUCTION MATERIALS COMPRISED OF NON-METAL MODULAR CASTING FORMS; PAVEMENT INCORPORATING SILICON SOLAR CELL MATERIAL FOR ELECTRICAL ENERGY GENERATION; ROCK MATERIALS USED IN THE MANUFACTURE OF FLOORING, ROOFING, COUNTERTOPS, WALLS, CLADDING AND FIREPLACES; SEALER COATINGS SOLD AS AN INTEGRAL COMPONENT OF NON-METAL TILES, NATURAL STONE, AND MOLDED RESINS FOR CONSTRUCTION PURPOSES; STONE FOR BUILDING AND CONSTRUCTION; SYNTHETIC FLOORING MATERIALS OR WALL-CLADDINGS; TRAVERTINE FOR BUILDING AND CONSTRUCTION PURPOSES; WATERPROOF FABRIC USED IN BUILDING CONSTRUCTION FOR PROTECTION AGAINST FLOODS (U.S. CLS. 1, 12, 33 AND 50).

FIRST USE 3-28-2003; IN COMMERCE 3-28-2005.

JOHN E. MICHOS, EXAMINING ATTORNEY

CLASS 19—(Continued).

SN 85-369,538. EZ ON VINYL, LLC, SHELLEY, ID. FILED 7-12-2011.



THE MARK CONSISTS OF THE LETTERS "EZ " IN A DIAMOND SHAPED OUTLINE.
FOR FENCING PROTECTION PRODUCTS, NAMELY, VINYL EXTENDER INSULATORS (U.S. CLS. 1, 12, 33 AND 50).
NAAKWAMA ANKRAH, EXAMINING ATTORNEY

CLASS 19—(Continued).

SN 85-379,857. GIP INTERNATIONAL LIMITED, CENTRAL HONG KONG, SAR PRC, HONG KONG, FILED 7-25-2011.

GECKO

THE MARK CONSISTS OF STANDARD CHARACTERS WITHOUT CLAIM TO ANY PARTICULAR FONT, STYLE, SIZE, OR COLOR.
FOR LAMINATE FLOORING (U.S. CLS. 1, 12, 33 AND 50).
JAMES A. RAUEN, EXAMINING ATTORNEY

SN 85-377,589. CAST IN STONE LLC, WEST PALM BEACH, FL. FILED 7-21-2011.



NO CLAIM IS MADE TO THE EXCLUSIVE RIGHT TO USE "GREETING STONES", APART FROM THE MARK AS SHOWN.
THE MARK CONSISTS OF THE STYLIZED TERMS "GREETING STONES". ABOVE THE TERMS IS A STYLIZED CAKE WITH TWO LIT CANDLES AND FROSTING POSITIONED ON A PLATE.
FOR NATURAL STONES THAT ARE INSCRIBED WITH A NAME, QUOTATION AND/OR PHRASE (U.S. CLS. 1, 12, 33 AND 50).
FIRST USE 7-1-2011; IN COMMERCE 7-1-2011.
CORY BOONE, EXAMINING ATTORNEY

SN 85-379,882. GIP INTERNATIONAL LIMITED, CENTRAL HONG KONG, SAR PRC, HONG KONG, FILED 7-25-2011.



THE MARK CONSISTS OF A STYLIZED IMAGE OF A LIZARD.
FOR LAMINATE FLOORING (U.S. CLS. 1, 12, 33 AND 50).
JAMES A. RAUEN, EXAMINING ATTORNEY

CLASS 19—(Continued).

SN 85-380,734. ROYAL GROUP, INC., TORONTO, ONTARIO, CANADA, FILED 7-26-2011.



NO CLAIM IS MADE TO THE EXCLUSIVE RIGHT TO USE "CELLULAR EXTERIORS", APART FROM THE MARK AS SHOWN.

THE MARK CONSISTS OF A SQUARE CONTAINING AN ABSTRACT LETTER "C", WITH A RECTANGLE TO THE RIGHT OF THE SQUARE CONTAINING THE WORD "CELECT", AND WITH THE WORDS "CELLULAR EXTERIORS BY ROYAL" UNDERNEATH.

FOR VINYL SIDING (U.S. CLS. 1, 12, 33 AND 50).
BRIAN NEVILLE, EXAMINING ATTORNEY

SN 85-435,425. GIP INTERNATIONAL LIMITED, CENTRAL HONG KONG, SAR PRC, HONG KONG, FILED 9-29-2011.

INNOVATION AND DESIGN IN LUXURY FLOORING

THE MARK CONSISTS OF STANDARD CHARACTERS WITHOUT CLAIM TO ANY PARTICULAR FONT, STYLE, SIZE, OR COLOR.

NO CLAIM IS MADE TO THE EXCLUSIVE RIGHT TO USE "LUXURY FLOORING", APART FROM THE MARK AS SHOWN.

FOR LAMINATE FLOORING (U.S. CLS. 1, 12, 33 AND 50).
JAMES A. RAUEN, EXAMINING ATTORNEY

SN 85-436,874. ELMICH PTE LTD., SINGAPORE, SINGAPORE, FILED 9-30-2011.

SpiraPave

THE MARK CONSISTS OF STANDARD CHARACTERS WITHOUT CLAIM TO ANY PARTICULAR FONT, STYLE, SIZE, OR COLOR.

OWNER OF SINGAPORE REG. NO. T0910238B, DATED 9-14-2009, EXPIRES 9-14-2019.

FOR NON-METALLIC LANDSCAPING MATERIALS, NAMELY, PLASTIC PEDESTAL PAVER AND BEARER SUPPORTS (U.S. CLS. 1, 12, 33 AND 50).

MEGHAN REINHART, EXAMINING ATTORNEY

CLASS 19—(Continued).

SN 85-436,885. ELMICH PTE LTD., SINGAPORE, SINGAPORE, FILED 9-30-2011.

VERSIJACK

THE MARK CONSISTS OF STANDARD CHARACTERS WITHOUT CLAIM TO ANY PARTICULAR FONT, STYLE, SIZE, OR COLOR.

OWNER OF SINGAPORE REG. NO. T0520019C, DATED 10-14-2005, EXPIRES 10-14-2015.

FOR BUILDING MATERIALS OF PLASTIC MATERIAL FOR USE TO SUPPORT AND RAISE FLOORING MATERIALS INCLUDING STONE PAVERS, TILES AND TIMBER DECKING, NAMELY, PLASTIC PEDESTALS FOR ELEVATING PAVERS (U.S. CLS. 1, 12, 33 AND 50).
MEGHAN REINHART, EXAMINING ATTORNEY

SN 85-436,927. ELMICH PTE LTD., SINGAPORE, SINGAPORE, FILED 9-30-2011.

TURFPAVE

THE MARK CONSISTS OF STANDARD CHARACTERS WITHOUT CLAIM TO ANY PARTICULAR FONT, STYLE, SIZE, OR COLOR.

OWNER OF SINGAPORE REG. NO. T0302837G, DATED 3-3-2003, EXPIRES 3-3-2013.

FOR BUILDING MATERIALS, NAMELY, INTERLOCKING PLASTIC GRASS PAVER; NON-METALLIC RIGID PIPES FOR BUILDING; ASPHALT, PITCH AND BITUMEN; NON-METALLIC TRANSPORTABLE BUILDINGS; MONUMENTS, NOT OF METAL (U.S. CLS. 1, 12, 33 AND 50).

MEGHAN REINHART, EXAMINING ATTORNEY

SN 85-437,681. GENEST CONCRETE WORKS, INC, SANFORD, ME. FILED 10-3-2011.

COMFORT BLOCK

THE MARK CONSISTS OF STANDARD CHARACTERS WITHOUT CLAIM TO ANY PARTICULAR FONT, STYLE, SIZE, OR COLOR.

NO CLAIM IS MADE TO THE EXCLUSIVE RIGHT TO USE "BLOCK", APART FROM THE MARK AS SHOWN.

FOR CONCRETE BUILDING MATERIALS, NAMELY, CONCRETE PAVERS, INTERLOCKING CONCRETE PAVERS, SEGMENTED RETAINING WALLS, CONCRETE ROOF BALLASTS, CONCRETE WALL SEGMENTS, CONCRETE TILES, CONCRETE BLOCKS (U.S. CLS. 1, 12, 33 AND 50).

FIRST USE 9-26-2011; IN COMMERCE 9-26-2011.

JEFFREY LOOK, EXAMINING ATTORNEY

CLASS 19—(Continued).

SN 85-459,240. THE SPORT SCREEN LTD., KITCHENER, ONTARIO, CANADA, FILED 10-28-2011.

THE SPORT SCREEN

THE MARK CONSISTS OF STANDARD CHARACTERS WITHOUT CLAIM TO ANY PARTICULAR FONT, STYLE, SIZE, OR COLOR.

PRIORITY CLAIMED UNDER SEC. 44(D) ON CANADA APPLICATION NO. 1,525,725, FILED 4-29-2011.

NO CLAIM IS MADE TO THE EXCLUSIVE RIGHT TO USE "SCREEN", APART FROM THE MARK AS SHOWN.

FOR BARRIERS COMPOSED PRIMARILY OF NON-METAL MATERIAL FOR PROTECTING GARAGE DOORS AGAINST DAMAGE CAUSED BY IMPACT OF OBJECTS (U.S. CLS. 1, 12, 33 AND 50).

FIRST USE 4-0-2010; IN COMMERCE 6-0-2011.
TEJBIR SINGH, EXAMINING ATTORNEY

CLASS 19—(Continued).

SN 85-515,053. FNGS INC., COLUMBIA, MO. FILED 1-12-2012.



NO CLAIM IS MADE TO THE EXCLUSIVE RIGHT TO USE "WARNING" OR "THIS HOME IS PROTECTED BY", APART FROM THE MARK AS SHOWN.

THE COLOR(S) WHITE, BLUE AND RED IS/ARE CLAIMED AS A FEATURE OF THE MARK.

THE MARK CONSISTS OF A HAWK WITH OUT-STRETCHED WINGS AND A WHITE AND BLUE BODY AND THE WORDING "WARNING THIS HOME IS PROTECTED BY H.A.W.K." AND "WWW.HAWKDEFENSE.ORG" IN WHITE OVER A BLUE STAR, ALL SUPERIMPOSED ON A RED AND WHITE SHIELD.

FOR NON-LUMINOUS, NON-MECHANICAL SIGNS NOT OF METAL (U.S. CLS. 1, 12, 33 AND 50).

JULIE VEPPUMTHARA, EXAMINING ATTORNEY

SN 85-519,569. O'SHEA III, VINCENT, SOUTH SAN FRANCISCO, CA. FILED 1-18-2012.

Happy Rocks

THE MARK CONSISTS OF STANDARD CHARACTERS WITHOUT CLAIM TO ANY PARTICULAR FONT, STYLE, SIZE, OR COLOR.

NO CLAIM IS MADE TO THE EXCLUSIVE RIGHT TO USE "ROCKS", APART FROM THE MARK AS SHOWN.

FOR STONES (U.S. CLS. 1, 12, 33 AND 50).

EMILY CHUO, EXAMINING ATTORNEY

SN 85-489,492. CUSTOM BUILDING PRODUCTS, INC., SEAL BEACH, CA. FILED 12-7-2011.

FUSION PRO

THE MARK CONSISTS OF STANDARD CHARACTERS WITHOUT CLAIM TO ANY PARTICULAR FONT, STYLE, SIZE, OR COLOR.

FOR GROUTS (U.S. CLS. 1, 12, 33 AND 50).
SHAUNIA CARLYLE, EXAMINING ATTORNEY

SN 85-521,535. PINNACLE INTERIOR ELEMENTS, LTD., CARROLLTON, TX. FILED 1-20-2012.

HADLEIGH CLASSICS

THE MARK CONSISTS OF STANDARD CHARACTERS WITHOUT CLAIM TO ANY PARTICULAR FONT, STYLE, SIZE, OR COLOR.

NO CLAIM IS MADE TO THE EXCLUSIVE RIGHT TO USE "CLASSICS", APART FROM THE MARK AS SHOWN.

FOR HARDWOOD FLOORING (U.S. CLS. 1, 12, 33 AND 50).

JEAN IM, EXAMINING ATTORNEY

CLASS 19—(Continued).

SN 85-532,526. SIMONTON BUILDING PRODUCTS, INC., PARKERSBURG, WV. FILED 2-2-2012.

ASURE

THE MARK CONSISTS OF STANDARD CHARACTERS WITHOUT CLAIM TO ANY PARTICULAR FONT, STYLE, SIZE, OR COLOR.

FOR VINYL DOORS; VINYL WINDOWS (U.S. CLS. 1, 12, 33 AND 50).

EMILY CARLSEN, EXAMINING ATTORNEY

CLASS 19—(Continued).

SN 85-534,237. EVOLVE POLYMER PRODUCTS LLC, CO-LUMBIA, MD. FILED 2-5-2012.

MOD-PAD

THE MARK CONSISTS OF STANDARD CHARACTERS WITHOUT CLAIM TO ANY PARTICULAR FONT, STYLE, SIZE, OR COLOR.

OWNER OF U.S. REG. NO. 4,063,979.

FOR CONCRETE; CONCRETE BUILDING MATERIALS, NAMELY, CONCRETE SLABS (U.S. CLS. 1, 12, 33 AND 50).

JUSTINE D. PARKER, EXAMINING ATTORNEY

SN 85-533,713. DALEN PRODUCTS, INC., KNOXVILLE, TN. FILED 2-3-2012.

DURA-SHIELD

THE MARK CONSISTS OF STANDARD CHARACTERS WITHOUT CLAIM TO ANY PARTICULAR FONT, STYLE, SIZE, OR COLOR.

FOR GEOTEXTILES, NAMELY, FABRIC AND SHEETING FOR LANDSCAPING AND NURSERIES (U.S. CLS. 1, 12, 33 AND 50).

FIRST USE 2-1-2012; IN COMMERCE 2-1-2012.

MIDGE BUTLER, EXAMINING ATTORNEY

SN 85-534,930. SMITH & FONG CO., SAN FRANCISCO, CA. FILED 2-6-2012.

PLYBOODEX

THE MARK CONSISTS OF STANDARD CHARACTERS WITHOUT CLAIM TO ANY PARTICULAR FONT, STYLE, SIZE, OR COLOR.

FOR BUILDING MATERIALS, NAMELY, DECKING BOARDS; NON-METAL DECKING (U.S. CLS. 1, 12, 33 AND 50).

JACQUELINE A. LAVINE, EXAMINING ATTORNEY

SN 85-534,228. EVOLVE POLYMER PRODUCTS LLC, CO-LUMBIA, MD. FILED 2-5-2012.

EVO-LITE

THE MARK CONSISTS OF STANDARD CHARACTERS WITHOUT CLAIM TO ANY PARTICULAR FONT, STYLE, SIZE, OR COLOR.

OWNER OF U.S. REG. NO. 4,063,979.

FOR CONCRETE COATED POLYSTYRENE FOAM BLOCKS (U.S. CLS. 1, 12, 33 AND 50).

JUSTINE D. PARKER, EXAMINING ATTORNEY

SN 85-535,128. JOHNSONITE INC., CHAGRIN FALLS, OH. FILED 2-6-2012.

MICROTONE

THE MARK CONSISTS OF STANDARD CHARACTERS WITHOUT CLAIM TO ANY PARTICULAR FONT, STYLE, SIZE, OR COLOR.

FOR NON-METAL FLOORING, NAMELY, RUBBER FLOORING, NON-METAL FLOOR TILES, RUBBER FLOOR TILES (U.S. CLS. 1, 12, 33 AND 50).

LIEF MARTIN, EXAMINING ATTORNEY

CLASS 19—(Continued).

SN 85-535,144. TIMBER TRADING, INC., WORCESTER, MA.
FILED 2-6-2012.

SUPERPACK

THE MARK CONSISTS OF STANDARD CHARACTERS
WITHOUT CLAIM TO ANY PARTICULAR FONT, STYLE,
SIZE, OR COLOR.

FOR LUMBER (U.S. CLS. 1, 12, 33 AND 50).
ELISSA GARBER KON, EXAMINING ATTORNEY

SN 85-537,273. INNOVATIVE CONSTRUCTION MATERIALS
LTD., SHANGHAI, CHINA, FILED 2-8-2012.

MAXFELT

THE MARK CONSISTS OF STANDARD CHARACTERS
WITHOUT CLAIM TO ANY PARTICULAR FONT, STYLE,
SIZE, OR COLOR.

FOR ROOFING UNDERLAYMENT (U.S. CLS. 1, 12, 33
AND 50).
ASMAT KHAN, EXAMINING ATTORNEY

SN 85-539,288. COOL ANGLE LLC, FARMINGTON, UT.
FILED 2-10-2012.

COOL ANGLE

THE MARK CONSISTS OF STANDARD CHARACTERS
WITHOUT CLAIM TO ANY PARTICULAR FONT, STYLE,
SIZE, OR COLOR.

FOR NON-METAL SHINGLES (U.S. CLS. 1, 12, 33 AND
50).
ROBERT C. CLARK JR., EXAMINING ATTORNEY

CLASS 19—(Continued).

SN 85-540,075. THE REED CORPORATION, LYNNFIELD,
MA. FILED 2-10-2012.

ULTRACOBBLE

THE MARK CONSISTS OF STANDARD CHARACTERS
WITHOUT CLAIM TO ANY PARTICULAR FONT, STYLE,
SIZE, OR COLOR.

FOR MODULAR STONE FOR USE IN HARDSCAPES,
NAMELY, PATIOS, DECKS, VERANDAS, GAZEBOS,
BALCONIES, TERRACES, PORCHES, COURTYARDS,
DRIVEWAYS, WALKWAYS, WALLS, WATERFALLS,
FOUNTAINS, PONDS, POOLS, SPAS, HOT TUBS, FIRE
PLACES, FIRE PITS AND FOYERS (U.S. CLS. 1, 12, 33
AND 50).

ZACHARY BELLO, EXAMINING ATTORNEY

SN 85-542,238. GLASSCRAFT DOOR I, DBA GLASSCRAFT
DOOR COMPANY, HOUSTON, TX. FILED 2-14-2012.

BioFiberGlass

THE MARK CONSISTS OF STANDARD CHARACTERS
WITHOUT CLAIM TO ANY PARTICULAR FONT, STYLE,
SIZE, OR COLOR.

FOR NON-METAL DOOR UNITS MADE IN PART OF
FIBERGLASS; NON-METAL DOORS MADE IN PART OF
FIBERGLASS (U.S. CLS. 1, 12, 33 AND 50).
CURTIS FRENCH, EXAMINING ATTORNEY

SN 85-542,258. GLASSCRAFT DOOR I, DBA GLASSCRAFT
DOOR COMPANY, HOUSTON, TX. FILED 2-14-2012.

Exoskin

THE MARK CONSISTS OF STANDARD CHARACTERS
WITHOUT CLAIM TO ANY PARTICULAR FONT, STYLE,
SIZE, OR COLOR.

FOR NON-METAL DOORS (U.S. CLS. 1, 12, 33 AND
50).
CURTIS FRENCH, EXAMINING ATTORNEY

CLASS 19—(Continued).

SN 85-549,457. GLASSCRAFT DOOR I, DBA GLASSCRAFT DOOR COMPANY, HOUSTON, TX. FILED 2-22-2012.

Salento

THE MARK CONSISTS OF STANDARD CHARACTERS WITHOUT CLAIM TO ANY PARTICULAR FONT, STYLE, SIZE, OR COLOR.
 FOR INSULATED GLASS (U.S. CLS. 1, 12, 33 AND 50).
 FIRST USE 2-1-2012; IN COMMERCE 2-1-2012.
 CURTIS FRENCH, EXAMINING ATTORNEY

SN 85-549,494. GLASSCRAFT DOOR I, DBA GLASSCRAFT DOOR COMPANY, HOUSTON, TX. FILED 2-22-2012.

Renaissance Lites

THE MARK CONSISTS OF STANDARD CHARACTERS WITHOUT CLAIM TO ANY PARTICULAR FONT, STYLE, SIZE, OR COLOR.
 NO CLAIM IS MADE TO THE EXCLUSIVE RIGHT TO USE "LITES", APART FROM THE MARK AS SHOWN.
 FOR DECORATIVE GLASS PANELS FOR USE IN DOORS AND WINDOWS (U.S. CLS. 1, 12, 33 AND 50).
 FIRST USE 9-7-2010; IN COMMERCE 9-7-2010.
 CURTIS FRENCH, EXAMINING ATTORNEY

SN 85-549,531. GLASSCRAFT DOOR I, DBA GLASSCRAFT DOOR COMPANY, HOUSTON, TX. FILED 2-22-2012.

Casablanca

THE MARK CONSISTS OF STANDARD CHARACTERS WITHOUT CLAIM TO ANY PARTICULAR FONT, STYLE, SIZE, OR COLOR.
 FOR INSULATED GLASS (U.S. CLS. 1, 12, 33 AND 50).
 FIRST USE 1-1-2008; IN COMMERCE 1-1-2008.
 CURTIS FRENCH, EXAMINING ATTORNEY

CLASS 20—FURNITURE AND ARTICLES NOT OTHERWISE CLASSIFIED

SN 79-101,656. HENGE - S.R.L., ITALY, FILED 6-24-2011.

HENGE

THE MARK CONSISTS OF STANDARD CHARACTERS WITHOUT CLAIM TO ANY PARTICULAR FONT, STYLE, SIZE, OR COLOR.
 OWNER OF INTERNATIONAL REGISTRATION 1088270 DATED 6-24-2011, EXPIRES 6-24-2021.
 FOR FURNITURE, NAMELY, SIDEBARDS, COUCHES, BEDS, MATTRESSES, DESKS, CHAIRS, TABLES, BEDSIDE TABLES, CUPBOARDS, MIRRORS, PICTURE FRAMES, PILLOWS, ARMCHAIRS, SOFAS, CHAISE LOUNGES, FLOWER-POT PEDESTALS, SHELVES, CHEST FOR DRAWERS, GLASS SHOWCASES, STOOLS AND BOOKCASES (U.S. CLS. 2, 13, 22, 25, 32 AND 50).
 RONALD AIKENS, EXAMINING ATTORNEY

SN 79-105,548. GUANGZHOU; ONLEAD FURNITURE CO., LTD., CHINA, FILED 10-31-2011.

ONLEAD

OWNER OF INTERNATIONAL REGISTRATION 1097716 DATED 10-31-2011, EXPIRES 10-31-2021.
 THE MARK CONSISTS OF THE STYLIZED WORDS "ONLEAD".
 FOR OFFICE FURNITURE; BINS OF WOOD; BINS OF PLASTIC; DISPLAY BOARDS; FURNITURE FITTINGS, NOT OF METAL; MIRRORS; BAMBOO POLES; NON-METAL HAND-OPERATED GARDEN HOSE REELS; DECORATIVE MOBILES; CUSHIONS; INDOOR WINDOW BLINDS (U.S. CLS. 2, 13, 22, 25, 32 AND 50).
 CURTIS FRENCH, EXAMINING ATTORNEY

SN 79-109,260. LT OFFICE LINE AB, SWEDEN, FILED 2-1-2012.

LEI

THE MARK CONSISTS OF STANDARD CHARACTERS WITHOUT CLAIM TO ANY PARTICULAR FONT, STYLE, SIZE, OR COLOR.
 OWNER OF INTERNATIONAL REGISTRATION 1107110 DATED 2-1-2012, EXPIRES 2-1-2022.
 FOR FURNITURE; CHAIRS, OFFICE CHAIRS (U.S. CLS. 2, 13, 22, 25, 32 AND 50).
 ROBIN MITTLER, EXAMINING ATTORNEY

CLASS 20—(Continued).

SN 85-185,266. LIBERTY SPORT, INC., FAIRFIELD, NJ. FILED 11-25-2010.

RX SPORT ZONE

THE MARK CONSISTS OF STANDARD CHARACTERS WITHOUT CLAIM TO ANY PARTICULAR FONT, STYLE, SIZE, OR COLOR.

NO CLAIM IS MADE TO THE EXCLUSIVE RIGHT TO USE "RX SPORT", APART FROM THE MARK AS SHOWN.

FOR MERCHANDISE DISPLAY AND RACK FOR OPHTHALMIC FRAMES, SUNGLASSES, GOGGLES, AND EYEGLASSES; AFOREMENTIONED MERCHANDISE AND RACK SOLD THROUGH PROFESSIONAL OPHTHALMIC TRADE DISTRIBUTION CHANNELS (U.S. CLS. 2, 13, 22, 25, 32 AND 50).

JOHN KELLY, EXAMINING ATTORNEY

SN 85-197,732. BLU DOT DESIGN & MANUFACTURING, MINNEAPOLIS, MN. FILED 12-14-2010.



NO CLAIM IS MADE TO THE EXCLUSIVE RIGHT TO USE "BRAND", APART FROM THE MARK AS SHOWN.

THE MARK CONSISTS OF THE UNDERLINED WORDS "TEN SPRING STREET" IN VERTICAL WITH IMAGE OF A SHIELD OR SIGN WITH THE NUMBER "10" WITHIN AND AN IMAGE OF BIRD PERCHED ON TOP AND THE WORD BRAND BENEATH.

FOR FURNITURE FOR HOME AND OFFICE, NAMELY, DESKS, CHAIRS, STOOLS, BARSTOOLS, SOFAS, BENCHES, OTTOMANS, TABLES, DINING TABLES, COFFEE TABLES, END TABLES, ACCENT TABLES, OCCASIONAL TABLES, SIDE TABLES, CONSOLE TABLES, BOOKCASES, SHELVING, CREDENZAS, DRESSERS, NIGHTSTANDS, BEDS, DAYBEDS, FILING CABINETS, CABINETS, PILLOWS, MATTRESSES, COAT RACKS, MAGAZINE RACKS (U.S. CLS. 2, 13, 22, 25, 32 AND 50).

KELLY BOULTON, EXAMINING ATTORNEY

CLASS 20—(Continued).

SN 85-213,953. 1347805 ALBERTA LTD., HYTHE, ALBERTA, CANADA, FILED 1-10-2011.



PRIORITY CLAIMED UNDER SEC. 44(D) ON CANADA APPLICATION NO. 1504931, FILED 11-22-2010, REG. NO. TMA813925, DATED 12-13-2011, EXPIRES 12-13-2026.

NO CLAIM IS MADE TO THE EXCLUSIVE RIGHT TO USE "SAFETY FENCE" AND "FENCE", APART FROM THE MARK AS SHOWN.

THE MARK CONSISTS OF A STYLIZED CIRCLE PARTIALLY COVERED BY AN ENLARGED "T"; THE WORD "SAFE" SITS TO THE LEFT OF THE ENLARGED "T" AND THE WORD "FENCE" COVERS A PORTION OF THE ENLARGED "T"; THE WORD "MATE" IS POSITIONED ON THE RIGHT SIDE OF THE ENLARGED "T" BELOW THE WORD "FENCE"; THE PHRASE "THE FENCE CONNECTION" IS POSITIONED CENTRALLY BELOW THE OTHER PORTION OF THE MARK.

FOR PLASTIC FENCE FASTENERS, NAMELY, RESILIENT CLIPS FOR ATTACHING TEMPORARY PLASTIC FENCES TO POSTS (U.S. CLS. 2, 13, 22, 25, 32 AND 50).

DARRYL SPRUILL, EXAMINING ATTORNEY

SN 85-248,654. BOSTON TEA PARTY SHIP, INC., KEY WEST, FL. FILED 2-22-2011.

BOSTON TEA PARTY SHIPS & MUSEUM

THE MARK CONSISTS OF STANDARD CHARACTERS WITHOUT CLAIM TO ANY PARTICULAR FONT, STYLE, SIZE, OR COLOR.

NO CLAIM IS MADE TO THE EXCLUSIVE RIGHT TO USE "SHIPS & MUSEUM", APART FROM THE MARK AS SHOWN.

FOR SLEEPING BAGS; PLASTIC KEY CHAIN TAGS, PLASTIC KEY CHAINS, KEY FOBS NOT OF METAL, PLASTIC KEY TAGS, KEY RINGS AND KEY HOLDERS; WIND CHIMES, HANDHELD FOLDING FANS; HOLIDAY ORNAMENTS OF PLASTIC (U.S. CLS. 2, 13, 22, 25, 32 AND 50).

LESLIE RICHARDS, EXAMINING ATTORNEY

CLASS 20—(Continued).

SN 85-272,629. OLDCASTLE PRECAST, INC., AUBURN, WA. FILED 3-21-2011.

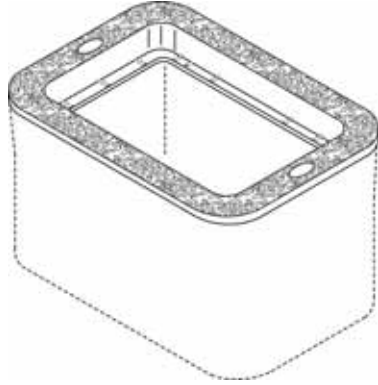

THE MARK CONSISTS OF A THREE DIMENSIONAL CONFIGURATION OF A RECTANGULAR PLASTIC CONCRETE UTILITY BOX CAP RING WITH ROUNDED CORNERS. THE TOP OF THE CAP CONTAINS NUMEROUS SMALL, RAISED IRREGULAR SHAPES OVER THE ENTIRETY OF ITS SURFACE. A SMALL OVAL IS CENTERED ON EACH SHORT SIDE OF THE RECTANGLE. THE DOTTED OUTLINE OF THE BOX SERVES TO SHOW POSITIONING OF THE MARK AND IS NOT PART OF THE MARK.

SEC. 2(F).
FOR CONSTRUCTION MATERIALS, NAMELY, PLASTIC CAP RINGS BEING AN INTEGRAL COMPONENT OF PRECAST CONCRETE UTILITY BOXES FOR IN GROUND USE (U.S. CLS. 2, 13, 22, 25, 32 AND 50).
FIRST USE 0-0-1978; IN COMMERCE 0-0-1978.
GRETCHEN ULRICH, EXAMINING ATTORNEY

SN 85-272,635. OLDCASTLE PRECAST, INC., AUBURN, WA. FILED 3-21-2011.

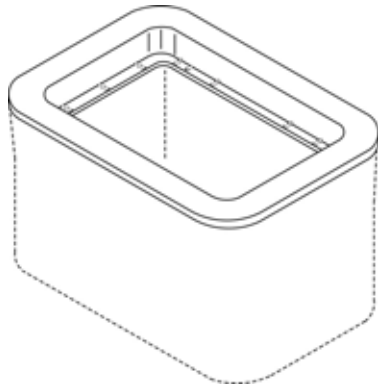

THE MARK CONSISTS OF A THREE DIMENSIONAL CONFIGURATION OF A RECTANGULAR PLASTIC CONCRETE UTILITY BOX CAP RING WITH ROUNDED CORNERS. THE DOTTED OUTLINE OF THE BOX SERVES TO SHOW POSITIONING OF THE MARK AND IS NOT PART OF THE MARK.

SEC. 2(F).
FOR CONSTRUCTION MATERIALS, NAMELY, PLASTIC CAP RINGS BEING AN INTEGRAL COMPONENT OF PRECAST CONCRETE UTILITY BOXES FOR IN GROUND USE (U.S. CLS. 2, 13, 22, 25, 32 AND 50).
FIRST USE 0-0-1978; IN COMMERCE 0-0-1978.
GRETCHEN ULRICH, EXAMINING ATTORNEY

CLASS 20—(Continued).

SN 85-300,227. THECATITUDE LLC, PLANTATION, FL. FILED 4-20-2011.

CATREESORT

THE MARK CONSISTS OF STANDARD CHARACTERS WITHOUT CLAIM TO ANY PARTICULAR FONT, STYLE, SIZE, OR COLOR.

FOR CAT PLAY AREAS CONSISTING OF CAT SCRATCHING TOWERS, CAT SCRATCHING POSTS, AND NON-METAL STEPS FOR ATTACHMENT TO THE AFOREMENTIONED GOODS (U.S. CLS. 2, 13, 22, 25, 32 AND 50).

PAM WILLIS, EXAMINING ATTORNEY

SN 85-304,136. INSTITUT PROSCHLAF E.U., SALZBURG, AUSTRIA, FILED 4-25-2011.

SPINEOTIC

THE MARK CONSISTS OF STANDARD CHARACTERS WITHOUT CLAIM TO ANY PARTICULAR FONT, STYLE, SIZE, OR COLOR.

OWNER OF AUSTRIA REG. NO. 261602, DATED 3-29-2011, EXPIRES 3-29-2021.

FOR FURNITURE, NAMELY, BEDS; MATTRESSES; BED SLATS NOT MADE OF METAL; PILLOWS (U.S. CLS. 2, 13, 22, 25, 32 AND 50).

SALLY SHIH, EXAMINING ATTORNEY

SN 85-318,968. OFS BRANDS INC., HUNTINGBURG, IN. FILED 5-12-2011.

ELEVEN

THE MARK CONSISTS OF STANDARD CHARACTERS WITHOUT CLAIM TO ANY PARTICULAR FONT, STYLE, SIZE, OR COLOR.

FOR FURNITURE (U.S. CLS. 2, 13, 22, 25, 32 AND 50).
GRETCHEN ULRICH, EXAMINING ATTORNEY

CLASS 20—(Continued).

SN 85-356,210. DAWSON, CHARLES, CUDAHY, WI. FILED 6-25-2011.

I GEL FUSION

THE MARK CONSISTS OF STANDARD CHARACTERS WITHOUT CLAIM TO ANY PARTICULAR FONT, STYLE, SIZE, OR COLOR.

NO CLAIM IS MADE TO THE EXCLUSIVE RIGHT TO USE "GEL", APART FROM THE MARK AS SHOWN.

FOR MEMORY FOAM MATTRESSES INFUSED WITH GEL (U.S. CLS. 2, 13, 22, 25, 32 AND 50).

STEPHANIE ALI, EXAMINING ATTORNEY

SN 85-393,726. RITCHEY MANUFACTURING COMPANY, BRIGHTON, CO. FILED 8-9-2011.

RITCHEY LIVESTOCK ID

THE MARK CONSISTS OF STANDARD CHARACTERS WITHOUT CLAIM TO ANY PARTICULAR FONT, STYLE, SIZE, OR COLOR.

OWNER OF U.S. REG. NO. 1,401,232.

NO CLAIM IS MADE TO THE EXCLUSIVE RIGHT TO USE "LIVESTOCK ID", APART FROM THE MARK AS SHOWN.

SEC. 2(F) AS TO "RITCHEY".

FOR PLASTIC EAR TAGS FOR ANIMALS, NAMELY, LIVESTOCK (U.S. CLS. 2, 13, 22, 25, 32 AND 50).

AMY KERTGATE, EXAMINING ATTORNEY

SN 85-399,305. ROCKLER COMPANIES, INC., MEDINA, MN. FILED 8-16-2011.

ISEMBLE

THE MARK CONSISTS OF STANDARD CHARACTERS WITHOUT CLAIM TO ANY PARTICULAR FONT, STYLE, SIZE, OR COLOR.

FOR FURNITURE; FURNITURE PARTS; READY TO ASSEMBLE FURNITURE (U.S. CLS. 2, 13, 22, 25, 32 AND 50).

KIM SAITO, EXAMINING ATTORNEY

CLASS 20—(Continued).

SN 85-406,706. HANGZHOU CHINASIA TEXTILE CO., LTD., ZHEJIANG PROVINCE, CHINA, FILED 8-25-2011.



NO CLAIM IS MADE TO THE EXCLUSIVE RIGHT TO USE THE NON-LATIN CHARACTERS THAT TRANSLITERATE TO "PIN", APART FROM THE MARK AS SHOWN.

THE COLOR(S) BLACK AND RED IS/ARE CLAIMED AS A FEATURE OF THE MARK.

THE MARK CONSISTS OF AN INCOMPLETE RED POLYGON DESIGN ON THE LEFT, FOUR CHINESE CHARACTERS IN BLACK WHICH TRANSLITERATE INTO "YI JU SHANG PIN" ON THE RIGHT, AND THE WORDING "IGSHOP.COM" IN RED BELOW THE CHINESE CHARACTERS.

THE WORDING "IGSHOP" HAS NO MEANING IN A FOREIGN LANGUAGE.

THE NON-LATIN CHARACTERS IN THE MARK TRANSLITERATE TO "YI"; "JU"; "SHANG"; "PIN" AND THIS MEANS "ONE"; "RESIDENCE"; "STILL"; "QUALITY" IN ENGLISH.

FOR BEDS; BENCHES; BOLSTERS; DOORS FOR FURNITURE; MATTRESSES; PILLOWS; SOFAS; SPRING MATTRESSES; TABLES (U.S. CLS. 2, 13, 22, 25, 32 AND 50).

FIRST USE 4-5-2009; IN COMMERCE 7-8-2010.

WILLIAM BRECKENFELD, EXAMINING ATTORNEY

SN 85-411,370. ELITE FURNITURE CO., LIMITED, KOWLOON, HONG KONG, HONG KONG, FILED 8-31-2011.



THE MARK CONSISTS OF "SICARTT" AND A STYLIZED DESIGN OF A FLEUR-DE-LIS.

THE WORDING "SICARTT" HAS NO MEANING IN A FOREIGN LANGUAGE.

FOR DISPLAY BOARDS; FIREGUARDS; FIXED TOWEL DISPENSERS NOT OF METAL; FURNITURE; FURNITURE PARTS; INDOOR WINDOW BLINDS; MIRROR FRAMES; NON-METAL BINS; WOOD BINS; WOODEN CRAFT STICKS (U.S. CLS. 2, 13, 22, 25, 32 AND 50).

FIRST USE 2-25-2008; IN COMMERCE 12-16-2009.

PAUL E. FAHRENKOPF, EXAMINING ATTORNEY

CLASS 20—(Continued).

SN 85-422,719. KIMSAPRINCESS INC., WOODLAND HILLS, CA. AND 2DIE4KOURT, WOODLAND HILLS, CA. AND KHLOMONEY INC., WOODLAND HILLS, CA. AND JENNER COMMUNICATIONS INC., WOODLAND HILLS, CA. FILED 9-14-2011.

KARDASHIAN KHAOS

THE MARK CONSISTS OF STANDARD CHARACTERS WITHOUT CLAIM TO ANY PARTICULAR FONT, STYLE, SIZE, OR COLOR.

THE NAME(S), PORTRAIT(S), AND/OR SIGNATURE(S) SHOWN IN THE MARK IDENTIFIES KIMBERLY "KARDASHIAN", KOURTNEY "KARDASHIAN" AND KHLOE "KARDASHIAN" ODOM, WHOSE CONSENT(S) TO REGISTER IS MADE OF RECORD.

FOR HAND FANS; NON-METAL AND NON-LEATHER KEY CHAINS; METAL STORAGE CUBES FOR HOUSEHOLD USE (U.S. CLS. 2, 13, 22, 25, 32 AND 50).

REBECCA EISINGER, EXAMINING ATTORNEY

CLASS 20—(Continued).

SN 85-435,985. SUNWAY INTERNATIONAL CO.,LTD, FOSHAN,GUANGDONG, CHINA, FILED 9-30-2011.



THE MARK CONSISTS OF THE WORDING "DOL-BE" WITH A DOLPHIN AND WAVE DEVICE.

THE WORDING "DOL-BE" HAS NO MEANING IN A FOREIGN LANGUAGE.

FOR BASSINETTES; INFANT WALKERS; HIGH CHAIRS FOR BABIES; PLAYPENS FOR BABIES; FURNITURE; YELLOW AMBER; DECK CHAIRS; MATS FOR INFANT PLAYPENS; LETTER BOXES, NOT OF METAL OR MASONRY (U.S. CLS. 2, 13, 22, 25, 32 AND 50).

STEVEN PEREZ, EXAMINING ATTORNEY

SN 85-429,877. ROCKLER COMPANIES, INC., MEDINA, MN. FILED 9-22-2011.

CENTER LINE

THE MARK CONSISTS OF STANDARD CHARACTERS WITHOUT CLAIM TO ANY PARTICULAR FONT, STYLE, SIZE, OR COLOR.

FOR FURNITURE HARDWARE, NAMELY, DRAWER SLIDES (U.S. CLS. 2, 13, 22, 25, 32 AND 50).

FIRST USE 1-0-2009; IN COMMERCE 1-0-2009.

KIM SAITO, EXAMINING ATTORNEY

SN 85-441,143. HUHTAMAKI, INC., DESOTO, KS. FILED 10-6-2011.

COMFORT CUP

THE MARK CONSISTS OF STANDARD CHARACTERS WITHOUT CLAIM TO ANY PARTICULAR FONT, STYLE, SIZE, OR COLOR.

OWNER OF U.S. REG. NOS. 3,350,378 AND 3,598,476. NO CLAIM IS MADE TO THE EXCLUSIVE RIGHT TO USE "CUP", APART FROM THE MARK AS SHOWN.

FOR PLASTIC LIDS (U.S. CLS. 2, 13, 22, 25, 32 AND 50).

FIRST USE 4-2-2001; IN COMMERCE 4-2-2001.

RAUL CORDOVA, EXAMINING ATTORNEY

SN 85-435,681. SERTA, INC., HOFFMAN ESTATES, IL. FILED 9-29-2011.

**INTELLIGENT COMFORT.
INDIVIDUAL SUPPORT**

THE MARK CONSISTS OF STANDARD CHARACTERS WITHOUT CLAIM TO ANY PARTICULAR FONT, STYLE, SIZE, OR COLOR.

NO CLAIM IS MADE TO THE EXCLUSIVE RIGHT TO USE "INDIVIDUAL SUPPORT", APART FROM THE MARK AS SHOWN.

FOR MATTRESSES FEATURING MEMORY FOAM AND ZONED INNERSPRING UNITS (U.S. CLS. 2, 13, 22, 25, 32 AND 50).

KELLY TRUSILO, EXAMINING ATTORNEY

SN 85-445,670. GUARDIAN INDUSTRIES CORP., AUBURN HILLS, MI. FILED 10-12-2011.

ULTRA MIRROR

THE MARK CONSISTS OF STANDARD CHARACTERS WITHOUT CLAIM TO ANY PARTICULAR FONT, STYLE, SIZE, OR COLOR.

OWNER OF U.S. REG. NOS. 3,006,709 AND 3,016,095. NO CLAIM IS MADE TO THE EXCLUSIVE RIGHT TO USE "MIRROR", APART FROM THE MARK AS SHOWN.

FOR MIRRORS (U.S. CLS. 2, 13, 22, 25, 32 AND 50).

FIRST USE 6-0-2004; IN COMMERCE 6-0-2004.

RONALD MCMORROW, EXAMINING ATTORNEY

CLASS 20—(Continued).

SN 85-519,148. PINNACLE FRAMES AND ACCENTS, INC., AUSTIN, TX. FILED 1-18-2012.

GALLERY SOLUTIONS

THE MARK CONSISTS OF STANDARD CHARACTERS WITHOUT CLAIM TO ANY PARTICULAR FONT, STYLE, SIZE, OR COLOR.

OWNER OF U.S. REG. NO. 3,459,400.

NO CLAIM IS MADE TO THE EXCLUSIVE RIGHT TO USE "GALLERY", APART FROM THE MARK AS SHOWN. FOR WALL DECOR, NAMELY, SHADOW BOXES, DISPLAY CASES AND SHELVING (U.S. CLS. 2, 13, 22, 25, 32 AND 50).

FIRST USE 7-1-2005; IN COMMERCE 7-1-2005.

ALEX KEAM, EXAMINING ATTORNEY

SN 85-522,458. HENSCHEL-STEINAU, INC., ALLENDALE, NJ. FILED 1-23-2012.

CONNECTING SHOPPERS AND BRANDS THROUGH INNOVATION

THE MARK CONSISTS OF STANDARD CHARACTERS WITHOUT CLAIM TO ANY PARTICULAR FONT, STYLE, SIZE, OR COLOR.

FOR POINT-OF-PURCHASE MERCHANDISE DISPLAYS, NAMELY, APPARATUS FOR THE DISPLAY AND SELECTIVE DISPENSING OF MERCHANDISE PACKAGES AT A POINT-OF-PURCHASE LOCATION (U.S. CLS. 2, 13, 22, 25, 32 AND 50).

FIRST USE 1-20-2012; IN COMMERCE 1-20-2012.

LAURA KOVALSKY, EXAMINING ATTORNEY

SN 85-522,513. TARGET BRANDS, INC., MINNEAPOLIS, MN. FILED 1-23-2012.

CLASSIC TIDINGS

THE MARK CONSISTS OF STANDARD CHARACTERS WITHOUT CLAIM TO ANY PARTICULAR FONT, STYLE, SIZE, OR COLOR.

OWNER OF U.S. REG. NOS. 4,009,130, 4,009,131 AND 4,009,132.

NO CLAIM IS MADE TO THE EXCLUSIVE RIGHT TO USE "CLASSIC", APART FROM THE MARK AS SHOWN.

FOR FURNITURE; WALL PLAQUES MADE OF PLASTIC OR WOOD (U.S. CLS. 2, 13, 22, 25, 32 AND 50).

NICHOLAS ALTREE, EXAMINING ATTORNEY

CLASS 20—(Continued).

SN 85-523,531. BROWN, JEFFREY WADE, AUSTIN, TX. FILED 1-24-2012.

Sculptorium Studios

THE MARK CONSISTS OF STANDARD CHARACTERS WITHOUT CLAIM TO ANY PARTICULAR FONT, STYLE, SIZE, OR COLOR.

NO CLAIM IS MADE TO THE EXCLUSIVE RIGHT TO USE "STUDIOS", APART FROM THE MARK AS SHOWN. FOR SCULPTURES OF PLASTER, WAX, OR WOOD (U.S. CLS. 2, 13, 22, 25, 32 AND 50).

FIRST USE 2-24-2000; IN COMMERCE 2-24-2000.

RENEE MCCRAY, EXAMINING ATTORNEY

SN 85-530,446. NINGBO MH INDUSTRY CO., LTD., ZHEJIANG 315192, CHINA, FILED 1-31-2012.



THE MARK CONSISTS OF THE STYLIZED WORD "HOMCOM" WITH THE ROOF-SHAPED DESIGN ABOVE THE CHARACTERS "OMCOM".

THE WORDING "HOMCOM" HAS NO MEANING IN A FOREIGN LANGUAGE.

FOR CUSHIONS; DOG KENNELS; FIGURES MADE OF RATTAN; FURNITURE; FURNITURE FITTINGS, NOT OF METAL; LETTER BOXES NOT OF METAL OR MASONRY; NON-METAL DOOR FITTINGS; PICTURE FRAMES; WORKS OF ART OF WOOD, WAX, PLASTER OR PLASTIC (U.S. CLS. 2, 13, 22, 25, 32 AND 50).

FIRST USE 4-1-2011; IN COMMERCE 5-1-2011.

SANJEEV VOHRA, EXAMINING ATTORNEY

CLASS 20—(Continued).

SN 85-530,898. SAFETYWHIPS.COM LLC, PHOENIX, AZ. FILED 2-1-2012.

SafetyWhips

THE MARK CONSISTS OF STANDARD CHARACTERS WITHOUT CLAIM TO ANY PARTICULAR FONT, STYLE, SIZE, OR COLOR.

FOR FLAGPOLES AND PLASTIC FLAGS AND ACCESSORIES FOR FLAGS AND FLAGPOLES SOLD TOGETHER AS A UNIT, NAMELY, RODS, ROD SUPPORTS AND COUPLERS, CONNECTORS, PINS, BRACKETS, CLAMPS, FASTENERS, NUTS AND BOLTS, AND POLE SUPPORTS (U.S. CLS. 2, 13, 22, 25, 32 AND 50).
FIRST USE 5-1-2004; IN COMMERCE 5-1-2004.

JOHN DALIER, EXAMINING ATTORNEY

SN 85-530,900. CHERY, RACHELLE, AUSTIN, TX. FILED 2-1-2012.

PLEZI-TREK

THE MARK CONSISTS OF STANDARD CHARACTERS WITHOUT CLAIM TO ANY PARTICULAR FONT, STYLE, SIZE, OR COLOR.

THE ENGLISH TRANSLATION OF "PLEZI" IN THE MARK IS FUN.

FOR PET RAMP (U.S. CLS. 2, 13, 22, 25, 32 AND 50).
JOHN DALIER, EXAMINING ATTORNEY

SN 85-531,175. BATTLE FOAM, LLC, GILBERT, AZ. FILED 2-1-2012.

X-BOARD FURY

THE MARK CONSISTS OF STANDARD CHARACTERS WITHOUT CLAIM TO ANY PARTICULAR FONT, STYLE, SIZE, OR COLOR.

FOR DISPLAY BOARDS (U.S. CLS. 2, 13, 22, 25, 32 AND 50).

JEAN IM, EXAMINING ATTORNEY

CLASS 20—(Continued).

SN 85-531,183. BATTLE FOAM, LLC, GILBERT, AZ. FILED 2-1-2012.

MAGNARACK

THE MARK CONSISTS OF STANDARD CHARACTERS WITHOUT CLAIM TO ANY PARTICULAR FONT, STYLE, SIZE, OR COLOR.

FOR METAL SHELVING (U.S. CLS. 2, 13, 22, 25, 32 AND 50).

JEAN IM, EXAMINING ATTORNEY

SN 85-531,723. KALCORP ENTERPRISES INCORPORATED, COLLEGE STATION, TX. FILED 2-2-2012.

MIX IT FRESH

THE MARK CONSISTS OF STANDARD CHARACTERS WITHOUT CLAIM TO ANY PARTICULAR FONT, STYLE, SIZE, OR COLOR.

FOR PLASTIC CONTAINERS AND COVERS FOR THE FOOD INDUSTRY (U.S. CLS. 2, 13, 22, 25, 32 AND 50).

CHRISTOPHER BUONGIORNO, EXAMINING ATTORNEY

SN 85-531,961. SPRINGS GLOBAL US, INC., FORT MILL, SC. FILED 2-2-2012.

SMART SOLUTIONS

THE MARK CONSISTS OF STANDARD CHARACTERS WITHOUT CLAIM TO ANY PARTICULAR FONT, STYLE, SIZE, OR COLOR.

FOR PILLOWS (U.S. CLS. 2, 13, 22, 25, 32 AND 50).

KAREN K. BUSH, EXAMINING ATTORNEY

CLASS 20—(Continued).

SN 85-532,549. AIRTEX DESIGN GROUP, INC., MINNEAPOLIS, MN. FILED 2-2-2012.

bump-i-doodle

THE MARK CONSISTS OF STANDARD CHARACTERS WITHOUT CLAIM TO ANY PARTICULAR FONT, STYLE, SIZE, OR COLOR.

FOR CUSHIONS, SEATS, UPHOLSTERED FURNITURE, PILLOWS (U.S. CLS. 2, 13, 22, 25, 32 AND 50).

FIRST USE 2-1-2009; IN COMMERCE 2-1-2009.

MARC LEIPZIG, EXAMINING ATTORNEY

SN 85-533,023. KALCORP ENTERPRISES INCORPORATED, COLLEGE STATION, TX. FILED 2-3-2012.

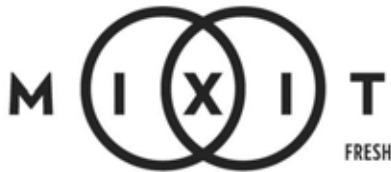

THE MARK CONSISTS OF THE TERM "MIXIT" IN CAPITAL LETTERS WITH TWO INTERLOCKING CIRCLES OVERLAPPING AROUND THE "X" AND ENCLosing THE FIRST AND SECOND "I" SO THAT THE FIRST CIRCLE ENCLOSES THE "IX" LETTERS AND THE SECOND CIRCLE ENCLOSES THE "XI." BELOW AND TO THE RIGHT OF THE TERM MIXIT IS THE TERM "FRESH" IN CAPITAL LETTERS AND IN A SMALLER FONT SIZE THAN MIXIT.

FOR PLASTIC CONTAINERS AND COVERS FOR THE FOOD INDUSTRY (U.S. CLS. 2, 13, 22, 25, 32 AND 50).

CHRISTOPHER BUONGIORNO, EXAMINING ATTORNEY

SN 85-534,114. BRAUNY CAT LLC, PORT LUDLOW, WA. FILED 2-4-2012.

COMFY PADLET

THE MARK CONSISTS OF STANDARD CHARACTERS WITHOUT CLAIM TO ANY PARTICULAR FONT, STYLE, SIZE, OR COLOR.

FOR BED PILLOWS; BED RESTS; BEDS FOR HOUSEHOLD PETS; CAT SCRATCHING PADS; PORTABLE BEDS FOR PETS (U.S. CLS. 2, 13, 22, 25, 32 AND 50).

WILLIAM P. SHANAHAN, EXAMINING ATTORNEY

CLASS 20—(Continued).

SN 85-535,081. ADDERLEY, KONRAD, BRONX, NY. FILED 2-6-2012.

HONEYMOON BED

THE MARK CONSISTS OF STANDARD CHARACTERS WITHOUT CLAIM TO ANY PARTICULAR FONT, STYLE, SIZE, OR COLOR.

NO CLAIM IS MADE TO THE EXCLUSIVE RIGHT TO USE "BED", APART FROM THE MARK AS SHOWN.

FOR BED FRAMES; BED HEADBOARDS; BED RAILS (U.S. CLS. 2, 13, 22, 25, 32 AND 50).

CYNTHIA TRIPI, EXAMINING ATTORNEY

SN 85-535,092. KEEN, MARTIN, JAMESTOWN, RI. FILED 2-6-2012.

FOCAL

THE MARK CONSISTS OF STANDARD CHARACTERS WITHOUT CLAIM TO ANY PARTICULAR FONT, STYLE, SIZE, OR COLOR.

FOR FURNITURE (U.S. CLS. 2, 13, 22, 25, 32 AND 50).

DARRYL SPRUILL, EXAMINING ATTORNEY

SN 85-535,693. SHADEADE, INC., SANTA BARBARA, CA. FILED 2-7-2012.

SHADEADE

THE MARK CONSISTS OF STANDARD CHARACTERS WITHOUT CLAIM TO ANY PARTICULAR FONT, STYLE, SIZE, OR COLOR.

FOR FURNITURE PARTS (U.S. CLS. 2, 13, 22, 25, 32 AND 50).

FRANK LATTUCA, EXAMINING ATTORNEY

CLASS 20—(Continued).

SN 85-535,707. SHADEADE, INC., SANTA BARBARA, CA.
FILED 2-7-2012.

SOLAR QUENCHER

THE MARK CONSISTS OF STANDARD CHARACTERS
WITHOUT CLAIM TO ANY PARTICULAR FONT, STYLE,
SIZE, OR COLOR.

FOR FURNITURE PARTS (U.S. CLS. 2, 13, 22, 25, 32
AND 50).

FRANK LATTUCA, EXAMINING ATTORNEY

SN 85-536,860. OEUF LLC, BROOKLYN, NY. FILED 2-8-2012.

OEUF

THE MARK CONSISTS OF STANDARD CHARACTERS
WITHOUT CLAIM TO ANY PARTICULAR FONT, STYLE,
SIZE, OR COLOR.

OWNER OF U.S. REG. NO. 3,180,051.

THE ENGLISH TRANSLATION OF "OEUF" IN THE
MARK IS "EGG".

FOR FURNITURE (U.S. CLS. 2, 13, 22, 25, 32 AND 50).

FIRST USE 8-19-2003; IN COMMERCE 8-19-2003.

ODESSA BIBBINS, EXAMINING ATTORNEY

SN 85-537,301. SALVATI, ANTONIO PLAZA, PHILADEL-
PHIA, PA. FILED 2-8-2012.

**ALUMINUM IN ITS MOST
SENSUAL FORM**

THE MARK CONSISTS OF STANDARD CHARACTERS
WITHOUT CLAIM TO ANY PARTICULAR FONT, STYLE,
SIZE, OR COLOR.

NO CLAIM IS MADE TO THE EXCLUSIVE RIGHT TO
USE "ALUMINUM", APART FROM THE MARK AS
SHOWN.

FOR FURNITURE AND WINE RACKS (U.S. CLS. 2, 13,
22, 25, 32 AND 50).

FIRST USE 4-1-2009; IN COMMERCE 4-1-2009.

TOBY BULLOFF, EXAMINING ATTORNEY

CLASS 20—(Continued).

SN 85-537,313. SALVATI, ANTONIO PLAZA, PHILADEL-
PHIA, PA. FILED 2-8-2012.

SALVATI MOBILI DESIGN

THE MARK CONSISTS OF STANDARD CHARACTERS
WITHOUT CLAIM TO ANY PARTICULAR FONT, STYLE,
SIZE, OR COLOR.

NO CLAIM IS MADE TO THE EXCLUSIVE RIGHT TO
USE "MOBILI DESIGN", APART FROM THE MARK AS
SHOWN.

THE ENGLISH TRANSLATION OF "MOBILI" IN THE
MARK IS "FURNITURE".

FOR FURNITURE AND WINE RACKS (U.S. CLS. 2, 13,
22, 25, 32 AND 50).

FIRST USE 4-1-2009; IN COMMERCE 4-1-2009.

TOBY BULLOFF, EXAMINING ATTORNEY

SN 85-538,350. COMPEL OFFICE FURNITURE, INC., FOR-
EST PARK, IL. FILED 2-9-2012.

COMPEL

THE MARK CONSISTS OF STANDARD CHARACTERS
WITHOUT CLAIM TO ANY PARTICULAR FONT, STYLE,
SIZE, OR COLOR.

FOR FURNITURE (U.S. CLS. 2, 13, 22, 25, 32 AND 50).

FIRST USE 3-1-2005; IN COMMERCE 3-1-2005.

JEFFREY LOOK, EXAMINING ATTORNEY

SN 85-538,935. MILLER, JASON B., KATY, TX. AND MIXON,
RICHARD C., INDEPENDENCE, LA. FILED 2-9-2012.

Sneaky Leaker

THE MARK CONSISTS OF STANDARD CHARACTERS
WITHOUT CLAIM TO ANY PARTICULAR FONT, STYLE,
SIZE, OR COLOR.

FOR PLASTIC URINARY DEVICE ENABLING USERS
TO STAND WHILE URINATING (U.S. CLS. 2, 13, 22, 25,
32 AND 50).

FIRST USE 1-2-1997; IN COMMERCE 10-15-2000.

BARBARA A. GOLD, EXAMINING ATTORNEY

CLASS 20—(Continued).

SN 85-539,968. JMH TRADING COMPANY INTERNATIONAL, DBA GATHERCRAFT, EL PASO, TX. FILED 2-10-2012.



THE MARK CONSISTS OF THE STYLIZED WORD "GATHERCRAFT" CENTERED BELOW A DRAWING OF TWO INCOMPLETE CONCENTRIC CIRCLES OPEN TO THE RIGHT WITH THE BOTTOM END POINT OF THE OUTSIDE CIRCLE FORMED INTO A LEAF REPRESENTING THE LETTERS "GC".

FOR FURNITURE; OUTDOOR FURNITURE; PATIO FURNITURE (U.S. CLS. 2, 13, 22, 25, 32 AND 50).
FIRST USE 7-1-2011; IN COMMERCE 7-1-2011.
LINDA M. KING, EXAMINING ATTORNEY

SN 85-540,308. D-GENERATION, INC., DAYTONA BEACH, FL. FILED 2-11-2012.

LIVE WELL, LAUGH OFTEN,
LOVE MUCH

THE MARK CONSISTS OF STANDARD CHARACTERS WITHOUT CLAIM TO ANY PARTICULAR FONT, STYLE, SIZE, OR COLOR.

OWNER OF U.S. REG. NO. 4,090,303.
FOR NON-METAL KEY RINGS; PICTURE AND PHOTOGRAPH FRAMES; PLASTIC KEY TAGS; VINYL APPLIQUES FOR ATTACHMENT TO WINDOWS, MIRRORS, AND OTHER SOLID SURFACES; WALL PLAQUES MADE OF PLASTER, PLASTIC, AND WOOD (U.S. CLS. 2, 13, 22, 25, 32 AND 50).

FIRST USE 9-4-2002; IN COMMERCE 9-4-2002.
CYNTHIA TRIPI, EXAMINING ATTORNEY

SN 85-540,553. MURANSKI, MICHAL G, PALATINE, IL. AND MURANSKI, RAE K, PALATINE, IL. FILED 2-12-2012.

IQMatics

THE MARK CONSISTS OF STANDARD CHARACTERS WITHOUT CLAIM TO ANY PARTICULAR FONT, STYLE, SIZE, OR COLOR.

FOR FURNITURE (U.S. CLS. 2, 13, 22, 25, 32 AND 50).
FIRST USE 7-1-2001; IN COMMERCE 7-1-2001.
CHRISTINE MARTIN, EXAMINING ATTORNEY

CLASS 20—(Continued).

SN 85-600,379. HNI TECHNOLOGIES INC., MUSCATINE, IA. FILED 4-17-2012.

CREDENTIALS

THE MARK CONSISTS OF STANDARD CHARACTERS WITHOUT CLAIM TO ANY PARTICULAR FONT, STYLE, SIZE, OR COLOR.

FOR FURNITURE; OFFICE FURNITURE (U.S. CLS. 2, 13, 22, 25, 32 AND 50).
MARGERY A. TIERNEY, EXAMINING ATTORNEY

SN 85-600,437. HNI TECHNOLOGIES INC., MUSCATINE, IA. FILED 4-17-2012.

CLARITY

THE MARK CONSISTS OF STANDARD CHARACTERS WITHOUT CLAIM TO ANY PARTICULAR FONT, STYLE, SIZE, OR COLOR.

FOR OFFICE CHAIRS (U.S. CLS. 2, 13, 22, 25, 32 AND 50).
MARGERY A. TIERNEY, EXAMINING ATTORNEY

CLASS 21—HOUSEWARES AND GLASS

SN 77-946,209. CALIFORNIA INNOVATIONS INC., TORONTO, ONTARIO, CANADA, FILED 2-26-2010.

HARDCORE

THE MARK CONSISTS OF STANDARD CHARACTERS WITHOUT CLAIM TO ANY PARTICULAR FONT, STYLE, SIZE, OR COLOR.

PRIORITY CLAIMED UNDER SEC. 44(D) ON CANADA APPLICATION NO. 1468301, FILED 2-3-2010, REG. NO. 818606, DATED 2-28-2012, EXPIRES 2-28-2027.

FOR INSULATED BAGS FOR FOOD AND BEVERAGES, NAMELY, SOFT-SIDED COOLERS WITH PLASTIC INTERIOR LINERS FOR DOMESTIC USE (U.S. CLS. 2, 13, 23, 29, 30, 33, 40 AND 50).

FIRST USE 12-31-2007; IN COMMERCE 12-31-2007.
ALYSSA STEEL, EXAMINING ATTORNEY

CLASS 21—(Continued).

SN 77-969,926. PAULIN, PETER, FORSYTH, IL. FILED 3-26-2010.



NO CLAIM IS MADE TO THE EXCLUSIVE RIGHT TO USE "PRESCRUB", APART FROM THE MARK AS SHOWN. THE MARK CONSISTS OF A DESIGN WITH A SHADED, STYLIZED GREEK CROSS CUT OPEN ON THE LEFT LOWER SIDE OUTLINED IN A LIGHT SHADE AT ITS EXTREMITIES AND CONTAINING A CADUCEUS SYMBOL IN ITS CENTER. A STYLIZED LINE THAT WIDENS INTO AN ARCH AS IT GOES FROM THE BROKEN LEFT SIDE OF THE CROSS TO REST ON TOP OF THE "B" IN THE WORD "PRESCRUB," IN STYLIZED LETTERING LOCATED TO THE RIGHT OF THE CROSS.

FOR NON-ABRASIVE CLEANING PAD (U.S. CLS. 2, 13, 23, 29, 30, 33, 40 AND 50).
 JILL C. ALT, EXAMINING ATTORNEY

CLASS 21—(Continued).

SN 85-108,822. SHANDONG HAIYUN ECOLOGICAL PAPER CO., LTD., SHANDONG PROVINCE, CHINA, FILED 8-17-2010.



THE MARK CONSISTS OF THE STYLIZED WORDING "HIEN" AND RIBBON LOOP DEVICE.

THE WORD(S) "HIEN" HAS NO MEANING IN A FOREIGN LANGUAGE.

FOR BOWLS, NAMELY, BASINS; BASINS, NAMELY, BOWLS; BASINS AND BOWLS; MESS-TINS; VEGETABLE DISHES; DISHES; PAPER PLATES; TRAYS FOR DOMESTIC PURPOSES, OF PAPER; TRAYS FOR DOMESTIC PURPOSES; CUPS; CUPS OF PAPER OR PLASTIC; LUNCH BOXES; DISPOSABLE TABLE PLATES (U.S. CLS. 2, 13, 23, 29, 30, 33, 40 AND 50).

ANDREW RHIM, EXAMINING ATTORNEY

SN 85-041,309. HUTZLER MANUFACTURING CO., INC., CANAAN, CT. FILED 5-18-2010.

Lemon / Lime Saver

THE MARK CONSISTS OF STANDARD CHARACTERS WITHOUT CLAIM TO ANY PARTICULAR FONT, STYLE, SIZE, OR COLOR.

NO CLAIM IS MADE TO THE EXCLUSIVE RIGHT TO USE "LEMON / LIME", APART FROM THE MARK AS SHOWN.

FOR CONTAINERS FOR HOUSEHOLD OR KITCHEN USE; CONTAINERS FOR HOUSEHOLD USE; HOUSEHOLD CONTAINERS FOR FOODS; PLASTIC STORAGE CONTAINERS FOR HOUSEHOLD OR DOMESTIC USE; PLASTIC STORAGE CONTAINERS FOR HOUSEHOLD USE; PORTABLE PLASTIC CONTAINERS FOR STORING HOUSEHOLD AND KITCHEN GOODS; SERVINGWARE FOR SERVING FOOD (U.S. CLS. 2, 13, 23, 29, 30, 33, 40 AND 50).

FIRST USE 3-1-2005; IN COMMERCE 3-1-2005.
 SARA BENJAMIN, EXAMINING ATTORNEY

SN 85-182,966. HALELUK, ROBERT, NEW YORK, NY. FILED 11-22-2010.



NO CLAIM IS MADE TO THE EXCLUSIVE RIGHT TO USE "DIPPER", APART FROM THE MARK AS SHOWN.

THE COLOR(S) BLUE, TAN, BROWN AND WHITE IS/ ARE CLAIMED AS A FEATURE OF THE MARK.

THE MARK CONSISTS OF A TAN ROUND SANDWICH COOKIE WITH DARKER TAN AND BROWN SPOKES IN A WHEEL PATTERN, OUTLINED IN BROWN WITH TAN, BROWN AND WHITE FILLING, APPEARING BETWEEN AND BEHIND WORDS "THE DIPPR", IN SMALL CASE LETTERS, WITH WORDS APPEARING IN BLUE OUTLINED IN WHITE.

FOR KITCHEN UTENSILS, NAMELY, A HOOK USED TO HOLD ITEMS WHILE SUBMERGING THEM IN LIQUIDS (U.S. CLS. 2, 13, 23, 29, 30, 33, 40 AND 50).

NAPOLEON SHARMA, EXAMINING ATTORNEY

CLASS 21—(Continued).

SN 85-280,335. ECOTENSIL, INC., LARKSPUR, CA. FILED 3-29-2011.

ECOSTIR

THE MARK CONSISTS OF STANDARD CHARACTERS WITHOUT CLAIM TO ANY PARTICULAR FONT, STYLE, SIZE, OR COLOR.

FOR BEVERAGE STIRRERS (U.S. CLS. 2, 13, 23, 29, 30, 33, 40 AND 50).

FIRST USE 2-21-2011; IN COMMERCE 2-21-2011.
ALAIN LAPTER, EXAMINING ATTORNEY

CLASS 21—(Continued).

SN 85-359,762. CONSUMER PSYCH LABS, INC., ITHACA, NY. FILED 6-29-2011.

SMARTER LUNCHROOMS

THE MARK CONSISTS OF STANDARD CHARACTERS WITHOUT CLAIM TO ANY PARTICULAR FONT, STYLE, SIZE, OR COLOR.

NO CLAIM IS MADE TO THE EXCLUSIVE RIGHT TO USE "LUNCHROOMS", APART FROM THE MARK AS SHOWN.

FOR TRAYS, NAMELY, LUNCH TRAYS, MEAL TRAYS, AND SERVING TRAYS; LUNCH BOXES; DINERWARE, DISHWARE, DRINKING GLASSES AND MUGS; SERVING FORKS; SERVING SPOONS; SERVING WARE FOR SERVING FOOD AND DRINKS; SERVING DISPENSERS, NAMELY, CONDIMENT PUMP DISPENSERS AND PORTABLE BEVERAGE DISPENSERS; FOOD RACKS, NAMELY, COOLING RACKS FOR BAKED GOODS; PORTABLE FOOD AND BEVERAGE DISPENSERS FOR DOMESTIC USE; SERVING GLOVES, NAMELY, PLASTIC GLOVES FOR USE IN THE FOOD SERVICE INDUSTRY (U.S. CLS. 2, 13, 23, 29, 30, 33, 40 AND 50).

AMY KERTGATE, EXAMINING ATTORNEY

SN 85-344,531. TEAM FAIRFAX 2013, FAIRFAX, VA. FILED 6-13-2011.



SN 85-372,409. DKH ENTERPRISES, LLC, HOUSTON, TX. FILED 7-15-2011.

DOKNOWHARM

THE MARK CONSISTS OF THE HEAD OF AN EAGLE WHERE THE EYE IS DEPICTED BY A STAR.

FOR CUPS, MUGS, DRINKING GLASSES, SHOT GLASSES, DRINKING STEINS; PLASTIC WATER BOTTLES, SOLD EMPTY; COMMEMORATIVE PLATES, CUPS AND MUGS; COASTERS NOT OF PAPER AND NOT BEING TABLE LINEN; PORTABLE COOLERS (U.S. CLS. 2, 13, 23, 29, 30, 33, 40 AND 50).

JOSETTE BEVERLY, EXAMINING ATTORNEY

THE MARK CONSISTS OF STANDARD CHARACTERS WITHOUT CLAIM TO ANY PARTICULAR FONT, STYLE, SIZE, OR COLOR.

FOR STAINLESS STEEL WATER BOTTLES SOLD EMPTY; CERAMIC MUGS (U.S. CLS. 2, 13, 23, 29, 30, 33, 40 AND 50).

ANDREW RHIM, EXAMINING ATTORNEY

CLASS 21—(Continued).

SN 85-410,438. NISBETS PLC, AVONMOUTH, BRISTOL, UNITED KINGDOM, FILED 8-30-2011.

VOGUE

THE MARK CONSISTS OF STANDARD CHARACTERS WITHOUT CLAIM TO ANY PARTICULAR FONT, STYLE, SIZE, OR COLOR.

FOR KITCHEN UTENSILS NOT OF PRECIOUS METAL, NAMELY, SERVING LADLES; ICE CREAM SCOOPS, SCOOPS; KITCHEN UTENSILS NOT OF PRECIOUS METAL, NAMELY, SERVING TONGS; HOUSEHOLD UTENSILS IN THE NATURE OF SERVING SPATULAS; COOKIE CUTTERS, HOUSEHOLD UTENSILS IN THE NATURE OF SIEVES, CUTTING BOARDS, FUNNELS, GRATERS FOR HOUSEHOLD PURPOSES, PASTRY CUTTERS, PEPPER MILLS, SCRAPERS BEING CLEANING UTENSILS FOR HOUSEHOLD PURPOSES, HOUSEHOLD UTENSILS IN THE NATURE OF SPATULAS, MIXING SPOONS, WHISKS, BAKEWARE, BASINS, BOWLS, COLANDERS, CUTLERY TRAYS NOT OF PRECIOUS METALS, DISHES, POTS, PANS, COOKERY MOULDS BEING KITCHEN UTENSILS, PASTRY MOULDS BEING KITCHEN UTENSILS; BASKETS OF WICKER, STRAW, WOOD OR CLOTH NOT OF METAL; CROCKERY DISHES, BEVERAGE GLASSWARE, SALT AND PEPPER POTS, TEAPOTS, COFFEE POTS, TRAYS FOR DOMESTIC PURPOSES NOT OF PRECIOUS METAL, NON-METAL TRASHCANS, BRUSHES FOR CLEANING AND SCOURING, BROOMS, BUCKETS, MOPS, PORTABLE BEVERAGE COOLERS, NON-ELECTRIC BLENDERS, FLY SWATTERS, NON-ELECTRIC GRIDDLES, NON-ELECTRIC JUICERS, NON-ELECTRIC PRESSURE COOKERS, BASINS BEING BOWLS; BASKETS OF WICKER, STRAW, WOOD OR CLOTH FOR DOMESTIC USE NOT OF PRECIOUS METAL, NON-ELECTRIC EGG BEATERS, HEAT INSULATED VESSELS FOR BEVERAGES, DUSTBINS, NON-ELECTRIC BLENDERS FOR HOUSEHOLD PURPOSES, BOTTLE OPENERS, REFRIGERATING BOTTLES BEING PORTABLE BEVERAGE COOLERS, GLASS BOWLS, BOXES OF METAL FOR DISPENSING PAPER TOWELS, BREAD BASKETS FOR DOMESTIC USE, BREAD BINS, BREAD BOARDS, DISH WASHING BRUSHES, SCRUBBING BRUSHES FOR CLEANING TANKS AND CONTAINERS, ELECTRIC SCRUBBING BRUSHES, BUTTER DISHES, BUTTER DISH COVERS, CAULDRONS, CHAMOIS LEATHER WIPING CLOTHS FOR CLEANING, CHEESE DISHES, CHEESE DISH COVERS, CHOPSTICKS, CLOTH FOR CLEANING, COASTERS NOT OF PAPER AND OTHER THAN TABLE LINEN, COCKTAIL BEVERAGE STIRRERS, NON-ELECTRIC COFFEE FILTERS NOT MADE OF PAPER, HAND OPERATED COFFEE GRINDERS, NON-ELECTRIC COFFEE PERCOLATORS, COFFEE SERVICES NOT OF PRECIOUS METAL, PORTABLE COLD BOXES, COOKING POT SETS, COOKING POTS, COOKING SKEWERS, PORTABLE COOLERS BEING ICE PAILS, COVERS FOR DISHES, CRUET STANDS FOR OIL AND VINEGAR NOT OF PRECIOUS METAL, EGG CUPS, FRUIT CUPS, CUPS OF PAPER OR PLASTIC, DRINKING GLASSES, DRINKING VESSELS, EARTHENWARE MUGS, FLASKS NOT OF PRECIOUS METAL, FLY CATCHERS, GLOVES FOR HOUSEHOLD PURPOSES, GOBLET NOT OF PRECIOUS METAL, NON-ELECTRIC GRIDDLES, HOT POTS NOT ELECTRICALLY HEATED, ICE CUBE MOULDS, GLASS STORAGE JARS, JUGS NOT OF PRECIOUS METAL, NON-ELECTRIC KETTLES, KITCHEN CONTAINERS NOT OF PRECIOUS METAL, KNIFE RESTS FOR THE TABLE, LUNCHBOXES, MENU CARD HOLDERS, COCKTAIL SHAKERS, MUGS NOT OF PRECIOUS METAL, FRYING PANS, PAPER PLATES, PIE SERVERS, FITTED PICNIC BASKETS, PORCELAINWARE MUGS, CERAMIC DISHES, DOMESTIC ROLLING PINS, SOLID BOWLS NOT OF PRECIOUS METAL, SALT CELLARS AND SHAKERS NOT OF PRECIOUS METAL, SAUCERS NOT OF PRECIOUS METAL, SERVING SCOOPS, TEA SER-

CLASS 21—(Continued).

VICES NOT OF PRECIOUS METAL; DINNER SERVICES NOT OF PRECIOUS METAL, NAMELY, PLATES, BOWLS, MUGS, TEACUPS, SAUCERS, CREAM JUG, SUGAR BOWL, TEAPOT, SERVING BOWL, SOUP BOWL, BUTTER DISH AND GRAVY BOAT; SHAKERS IN THE NATURE OF COCKTAIL, SALT AND PEPPER SHAKERS; STRAINERS FOR HOUSEHOLD PURPOSES, TABLE PLATES NOT OF PRECIOUS METAL; SERVING SPOONS, SERVING FORKS, HOUSEHOLD UTENSILS IN THE NATURE OF MIXING SPOONS, HAND TOOLS IN THE NATURE OF BARBECUE TONGS (U.S. CLS. 2, 13, 23, 29, 30, 33, 40 AND 50).

SCOTT BIBB, EXAMINING ATTORNEY

SN 85-414,768. ROONEY, NEIL, LITTLETON, CO. FILED 9-3-2011.

SOMBEERO

THE MARK CONSISTS OF STANDARD CHARACTERS WITHOUT CLAIM TO ANY PARTICULAR FONT, STYLE, SIZE, OR COLOR.

FOR PORTABLE BEVERAGE DISPENSERS; PERSONAL FLUID HYDRATION SYSTEMS COMPRISING A FLUID RESERVOIR, A DELIVERY TUBE, A MOUTHPIECE AND A LIQUID DISPENSING HAT; PERSONAL FLUID HYDRATION SYSTEMS COMPRISED OF A FLUID RESERVOIR, A DELIVERY TUBE, A MOUTHPIECE; DRINKING FLASKS FOR TRAVELERS; DRINKING VESSELS (U.S. CLS. 2, 13, 23, 29, 30, 33, 40 AND 50).

PAUL MORENO, EXAMINING ATTORNEY

SN 85-437,984. HUHTAMAKI, INC., DESOTO, KS. FILED 10-3-2011.

CHINET COLORS

THE MARK CONSISTS OF STANDARD CHARACTERS WITHOUT CLAIM TO ANY PARTICULAR FONT, STYLE, SIZE, OR COLOR.

OWNER OF U.S. REG. NOS. 684,589, 2,539,447 AND OTHERS.

NO CLAIM IS MADE TO THE EXCLUSIVE RIGHT TO USE "COLORS", APART FROM THE MARK AS SHOWN.

FOR MOLDED FIBER DINNERWARE, NAMELY, DISHES, PLATES, BOWLS, SERVING TRAYS AND PLATTERS (U.S. CLS. 2, 13, 23, 29, 30, 33, 40 AND 50).

RAUL CORDOVA, EXAMINING ATTORNEY

CLASS 21—(Continued).

SN 85-444,962. GUO, TZER-HUANG, KEELUNG CITY, TAIWAN, FILED 10-11-2011.



The logo for "Sandwich Cup" features the words "Sandwich Cup" in a stylized, bold, sans-serif font. A five-pointed star is positioned above the letter "I" in "Cup". A horizontal line underlines the word "Cup".

THE MARK CONSISTS OF THE WORD "SANDWICH-CUP" WITH A STAR ATOP OF THE LETTER "I" AND AN UNDERLINE FROM THE LETTER "S" TO THE LETTER "U".

FOR CUPS (U.S. CLS. 2, 13, 23, 29, 30, 33, 40 AND 50).
CARYN GLASSER, EXAMINING ATTORNEY

SN 85-505,253. BARBARA SCHECHTER, DBA BARBARA'S HANDMADE COOKIES, MANALPAN, NJ. FILED 12-28-2011.

EZPRESS

THE MARK CONSISTS OF STANDARD CHARACTERS WITHOUT CLAIM TO ANY PARTICULAR FONT, STYLE, SIZE, OR COLOR.

FOR A HAND-OPERATED PRESS FOR USE IN THE KITCHEN, NAMELY, FOR PRESSING THE DOUGH OF COOKIES, PIES, DONUTS, AND OTHER BAKED GOODS AND FOR PRESSING HERBS, SPICES AND MEATS TO MAKE THEM FLAT AND EVEN (U.S. CLS. 2, 13, 23, 29, 30, 33, 40 AND 50).

FIRST USE 3-1-2012; IN COMMERCE 3-1-2012.
NATALIE POLZER, EXAMINING ATTORNEY

SN 85-509,798. PACE, STEPHEN MICHAEL, BIG BEAR LAKE, CA. AND PACE, NANCIE ANNE, BIG BEAR LAKE, CA. AND PACE, AUGUST NICHOLAS, BIG BEAR LAKE, CA. AND PACE, AJA NOEL, BIG BEAR LAKE, CA. FILED 1-5-2012.

SUSHIPRO

THE MARK CONSISTS OF STANDARD CHARACTERS WITHOUT CLAIM TO ANY PARTICULAR FONT, STYLE, SIZE, OR COLOR.

FOR KITCHEN UTENSIL, NAMELY, NON-ELECTRIC DEVICE PRIMARILY COMPOSED OF PLASTIC OR WOOD ROLLERS FOR COMBINING SUSHI INGREDIENTS TO FORM A TRADITIONAL SUSHI ROLL (U.S. CLS. 2, 13, 23, 29, 30, 33, 40 AND 50).

TIMOTHY FINNEGAN, EXAMINING ATTORNEY

CLASS 21—(Continued).

SN 85-519,891. MARLECO, LLC, SAFETY HARBOR, FL. FILED 1-19-2012.

OB WAND

THE MARK CONSISTS OF STANDARD CHARACTERS WITHOUT CLAIM TO ANY PARTICULAR FONT, STYLE, SIZE, OR COLOR.

NO CLAIM IS MADE TO THE EXCLUSIVE RIGHT TO USE "WAND", APART FROM THE MARK AS SHOWN.

FOR DENTAL FLOSSERS (U.S. CLS. 2, 13, 23, 29, 30, 33, 40 AND 50).

JENNY PARK, EXAMINING ATTORNEY

SN 85-522,473. TARGET BRANDS, INC., MINNEAPOLIS, MN. FILED 1-23-2012.

CLASSIC TIDINGS

THE MARK CONSISTS OF STANDARD CHARACTERS WITHOUT CLAIM TO ANY PARTICULAR FONT, STYLE, SIZE, OR COLOR.

OWNER OF U.S. REG. NOS. 4,009,130, 4,009,131 AND 4,009,132.

NO CLAIM IS MADE TO THE EXCLUSIVE RIGHT TO USE "CLASSIC", APART FROM THE MARK AS SHOWN.

FOR VASES OF GLASS, CERAMIC OR METAL; SOAP DISPENSERS; BEVERAGE COASTERS NOT OF PAPER AND NOT BEING TABLE LINENS; PLASTIC STORAGE CONTAINERS FOR HOUSEHOLD USE; BASKETS OF WICKER, STRAW OR WOOD FOR HOUSEHOLD USE; PAPER PLATES AND PAPER CUPS (U.S. CLS. 2, 13, 23, 29, 30, 33, 40 AND 50).

FIRST USE 11-0-2008; IN COMMERCE 11-0-2008.
NICHOLAS ALTREE, EXAMINING ATTORNEY

SN 85-522,522. TARGET BRANDS, INC., MINNEAPOLIS, MN. FILED 1-23-2012.

BE MERRY

THE MARK CONSISTS OF STANDARD CHARACTERS WITHOUT CLAIM TO ANY PARTICULAR FONT, STYLE, SIZE, OR COLOR.

OWNER OF U.S. REG. NOS. 3,990,165, 3,990,167 AND OTHERS.

FOR VASES OF GLASS, CERAMIC OR METAL; SOAP DISPENSERS; SALT AND PEPPER SHAKERS; BEVERAGE COASTERS NOT OF PAPER AND NOT BEING TABLE LINENS; PLASTIC STORAGE CONTAINERS FOR HOUSEHOLD USE; BASKETS OF WICKER, STRAW OR WOOD FOR HOUSEHOLD USE; PAPER PLATES AND PAPER CUPS (U.S. CLS. 2, 13, 23, 29, 30, 33, 40 AND 50).

NICHOLAS ALTREE, EXAMINING ATTORNEY

CLASS 21—(Continued).

SN 85-522,544. FOX RUN HOLDINGS, INC, IVYLAND, PA. FILED 1-23-2012.

FOX RUN KITCHENS

THE MARK CONSISTS OF STANDARD CHARACTERS WITHOUT CLAIM TO ANY PARTICULAR FONT, STYLE, SIZE, OR COLOR.

OWNER OF U.S. REG. NOS. 2,502,538, 3,525,715 AND 3,628,735.

NO CLAIM IS MADE TO THE EXCLUSIVE RIGHT TO USE "KITCHENS", APART FROM THE MARK AS SHOWN.

FOR COOKIE CUTTERS; PASTRY CUTTERS, NAMELY, PIE TOP CUTTERS AND COOKIE CUTTER STAMPS; BAKING ACCESSORIES AND COOKWARE, NAMELY, COOKERY DESSERT MOLDS FOR CAKES, PASTRY MOLDS, PUDDING MOLDS AND COOKIE MOLDS; METAL AND GLASS PANS FOR COOKING, NAMELY, CAKE PANS, PIE PANS, MUFFIN PANS, TART PANS, TART TINS AND LOAF PANS; NON-ELECTRIC HOUSEHOLD KITCHEN UTENSILS TO CREATE AND DECORATE DESSERTS SUCH AS CAKES AND CUPCAKES, NAMELY, COOKIE AND DOUGH SCOOPS, SPATULAS AND WHISKS AND CONFECTIONERS' DECORATING BAGS AND TIPS AND COUPLERS BEING STRUCTURAL PARTS THEREOF; MIXING BOWLS; COOKING RACKS, NAMELY, COOLING RACKS AND OVEN TO TABLE COOKING RACKS BOTH FOR BAKED GOODS; NON-ELECTRIC EGG BEATERS; PASTRY BRUSHES; FLOUR SIFTERS; POT AND PAN SCRAPERS (U.S. CLS. 2, 13, 23, 29, 30, 33, 40 AND 50).

FIRST USE 7-31-1999; IN COMMERCE 7-31-1999.
DAVID YONTEF, EXAMINING ATTORNEY

SN 85-525,388. GLOBAL ENDEAVORS LLC, LAS VEGAS, NV. FILED 1-25-2012.

Bar Chute

THE MARK CONSISTS OF STANDARD CHARACTERS WITHOUT CLAIM TO ANY PARTICULAR FONT, STYLE, SIZE, OR COLOR.

NO CLAIM IS MADE TO THE EXCLUSIVE RIGHT TO USE "BAR", APART FROM THE MARK AS SHOWN.

FOR LAYERING UTENSIL OF STAINLESS STEEL USED SPECIFICALLY TO LAYER ALCOHOL AND BEER MIXES IN ALCOHOLIC AND BEER DRINKS (U.S. CLS. 2, 13, 23, 29, 30, 33, 40 AND 50).

WILLIAM VERHOSEK, EXAMINING ATTORNEY

CLASS 21—(Continued).

SN 85-525,492. EMILIA SULLIVAN, DBA EMILIA SULLIVAN, BAYONNE, NJ. FILED 1-25-2012.

CON DIOS TODO...SIN DIOS NADA

THE MARK CONSISTS OF STANDARD CHARACTERS WITHOUT CLAIM TO ANY PARTICULAR FONT, STYLE, SIZE, OR COLOR.

THE ENGLISH TRANSLATION OF "CON DIOS TODO SIN DIOS NADA" IN THE MARK IS "WITH GOD EVERYTHING WITHOUT GOD NOTHING".

FOR MUGS (U.S. CLS. 2, 13, 23, 29, 30, 33, 40 AND 50).
GEOFFREY FOSDICK, EXAMINING ATTORNEY

SN 85-530,087. PINSCO, INC., SANTA ANA, CA. FILED 1-31-2012.

Scoopy

THE MARK CONSISTS OF STANDARD CHARACTERS WITHOUT CLAIM TO ANY PARTICULAR FONT, STYLE, SIZE, OR COLOR.

FOR AN AID FOR DAILY LIVING, NAMELY, A SCOOP DISH TO ASSIST WITH FEEDING ONESELF (U.S. CLS. 2, 13, 23, 29, 30, 33, 40 AND 50).

FIRST USE 1-30-2012; IN COMMERCE 1-30-2012.
LYNDSEY KUYKENDALL, EXAMINING ATTORNEY

SN 85-530,906. LHS INTERNATIONAL LLC, LAKE FOREST, CA. FILED 2-1-2012.

SUPER EASY OPEN

THE MARK CONSISTS OF STANDARD CHARACTERS WITHOUT CLAIM TO ANY PARTICULAR FONT, STYLE, SIZE, OR COLOR.

OWNER OF U.S. REG. NO. 3,137,336.

NO CLAIM IS MADE TO THE EXCLUSIVE RIGHT TO USE "EASY OPEN", APART FROM THE MARK AS SHOWN. SEC. 2(F) AS TO "SUPER".

FOR ALL PURPOSE PORTABLE HOUSEHOLD CONTAINERS; CONTAINERS FOR HOUSEHOLD OR KITCHEN USE; HOUSEHOLD CONTAINERS FOR FOODS; PORTABLE PLASTIC CONTAINERS FOR STORING HOUSEHOLD AND KITCHEN GOODS (U.S. CLS. 2, 13, 23, 29, 30, 33, 40 AND 50).

FIRST USE 2-1-2005; IN COMMERCE 5-1-2005.
JOHN DALIER, EXAMINING ATTORNEY

CLASS 21—(Continued).

SN 85-531,510. JESSICA LIEBESKIND MAKE-UP ARTISTRY, LLC, NEW YORK, NY. FILED 2-1-2012.

VINTAGE BY JESSICA
LIEBESKIND

THE MARK CONSISTS OF STANDARD CHARACTERS WITHOUT CLAIM TO ANY PARTICULAR FONT, STYLE, SIZE, OR COLOR.

THE NAME(S), PORTRAIT(S), AND/OR SIGNATURE(S) SHOWN IN THE MARK IDENTIFIES "JESSICA LIEBESKIND", WHOSE CONSENT(S) TO REGISTER IS MADE OF RECORD.

FOR COSMETIC BRUSHES; MAKE-UP BRUSHES (U.S. CLS. 2, 13, 23, 29, 30, 33, 40 AND 50).
ANNE FARRELL, EXAMINING ATTORNEY

SN 85-531,632. POEHLMANN, CHRISTOPHER H, ANNAPO-
LIS, CA. FILED 2-1-2012.

TERMITAT

THE MARK CONSISTS OF STANDARD CHARACTERS WITHOUT CLAIM TO ANY PARTICULAR FONT, STYLE, SIZE, OR COLOR.

FOR INSECT HABITATS (U.S. CLS. 2, 13, 23, 29, 30, 33, 40 AND 50).
MICHAEL SOUDERS, EXAMINING ATTORNEY

SN 85-531,671. PATTERSON, DARREN, FARGO, ND. FILED
2-2-2012.

MIRACLE WHISK

THE MARK CONSISTS OF STANDARD CHARACTERS WITHOUT CLAIM TO ANY PARTICULAR FONT, STYLE, SIZE, OR COLOR.

NO CLAIM IS MADE TO THE EXCLUSIVE RIGHT TO USE "WHISK", APART FROM THE MARK AS SHOWN.

FOR WHISKS (U.S. CLS. 2, 13, 23, 29, 30, 33, 40 AND 50).
MICHELE SWAIN, EXAMINING ATTORNEY

CLASS 21—(Continued).

SN 85-532,282. SPRINGS GLOBAL US, INC., FORT MILL, SC. FILED 2-2-2012.

VINYL | 8MM

THE MARK CONSISTS OF THE WORD "VINYL" FOL-
LOWED BY VERTICAL LINE FOLLOWED BY "8MM".

FOR BAKEWARE; BATH ACCESSORIES, NAMELY, CUP HOLDERS; BOTTLES, SOLD EMPTY; BOWLS; COASTERS, NOT OF PAPER AND OTHER THAN TABLE LINEN; COLANDERS; CUPS AND MUGS; CUTTING BOARDS; DINNERWARE; DISHES; DISPENSERS FOR FACIAL TISSUES; DRINKING GLASSES; HOUSEHOLD UTENSILS, NAMELY, KITCHEN TONGS; MIXING BOWLS; NAPKIN HOLDERS; PITCHERS; PLATES; SERVING DISHES; SERVING FORKS; SERVING PLATTERS; SERVING SPOONS; SERVING TRAYS; SOAP DISHES; SOAP DISPENSERS; STEMWARE; TOILET BRUSH HOLDERS; TOILET BRUSHES; TOOTHBRUSH HOLDERS; WASTE BASKETS (U.S. CLS. 2, 13, 23, 29, 30, 33, 40 AND 50).

KAREN K. BUSH, EXAMINING ATTORNEY

SN 85-532,442. HS TM, LLC, NEWARK, DE. FILED 2-2-2012.

MAXICLENS

THE MARK CONSISTS OF STANDARD CHARACTERS WITHOUT CLAIM TO ANY PARTICULAR FONT, STYLE, SIZE, OR COLOR.

FOR SOAP AND HAND SANITIZER DISPENSERS (U.S. CLS. 2, 13, 23, 29, 30, 33, 40 AND 50).
BARBARA GAYNOR, EXAMINING ATTORNEY

SN 85-532,523. NATURE'S WA BIRD PRODUCTS, LLC,
CHAGRIN FALLS, OH. FILED 2-2-2012.

Nature's Way

THE MARK CONSISTS OF STANDARD CHARACTERS WITHOUT CLAIM TO ANY PARTICULAR FONT, STYLE, SIZE, OR COLOR.

FOR BIRD FEEDERS; BIRD HOUSES (U.S. CLS. 2, 13, 23, 29, 30, 33, 40 AND 50).
EMILY CARLSEN, EXAMINING ATTORNEY

CLASS 21—(Continued).

SN 85-533,793. XING, YAPING, LAKE CITY, FL. FILED 2-3-2012.

Mr. Stacky

THE MARK CONSISTS OF STANDARD CHARACTERS WITHOUT CLAIM TO ANY PARTICULAR FONT, STYLE, SIZE, OR COLOR.

FOR CLAY POTS; FLOWER AND PLANT CULTIVATION TRAYS; FLOWER POT HOLDERS; FLOWER POTS; HOLDERS FOR FLOWERS AND PLANTS; PLANT BASKETS; PLANTERS FOR FLOWERS AND PLANTS; PLASTIC LIDS FOR PLANT POTS; POTS; RAISED GARDEN BEDS, NAMELY, RAISED CONTAINERS FOR PLANTING CONTAINED GARDENS; RAISED GARDEN PLANTERS (U.S. CLS. 2, 13, 23, 29, 30, 33, 40 AND 50).

FIRST USE 4-1-2010; IN COMMERCE 4-1-2010.
JIM RINGLE, EXAMINING ATTORNEY

SN 85-534,103. BRYCE W. EDMONDS, REDONDO BEACH, CA. FILED 2-4-2012.

RECYCLE

THE MARK CONSISTS OF STANDARD CHARACTERS WITHOUT CLAIM TO ANY PARTICULAR FONT, STYLE, SIZE, OR COLOR.

FOR BOTTLES SOLD EMPTY, WATER BOTTLES SOLD EMPTY, SPORT BOTTLES SOLD EMPTY, SQUEEZE BOTTLES SOLD EMPTY, DRINKING VESSELS, PORTABLE BEVERAGE DISPENSERS, PERSONAL FLUID HYDRATION SYSTEMS COMPRISING A FLUID RESERVOIR, A DELIVERY TUBE, AND A MOUTHPIECE, AND PERSONAL FLUID HYDRATIONS SYSTEMS COMPRISING A FLUID RESERVOIR, A DELIVERY TUBE, A MOUTHPIECE AND A CARRYING PACK (U.S. CLS. 2, 13, 23, 29, 30, 33, 40 AND 50).

KATHY DE JONGE, EXAMINING ATTORNEY

SN 85-534,427. GOLDMAN, NEAL, PONTE VEDRA, FL. FILED 2-6-2012.

Eggster

THE MARK CONSISTS OF STANDARD CHARACTERS WITHOUT CLAIM TO ANY PARTICULAR FONT, STYLE, SIZE, OR COLOR.

FOR EGG CUPS (U.S. CLS. 2, 13, 23, 29, 30, 33, 40 AND 50).

LINDA ORNDORFF, EXAMINING ATTORNEY

CLASS 21—(Continued).

SN 85-534,558. JULIE STEITZ, GREENWOOD, IN. FILED 2-6-2012.

MY SIP

THE MARK CONSISTS OF STANDARD CHARACTERS WITHOUT CLAIM TO ANY PARTICULAR FONT, STYLE, SIZE, OR COLOR.

FOR IDENTIFYING RINGS PLACED ON DRINKING STRAWS USED FOR DIFFERENTIATING BETWEEN DIFFERENT CHILDREN'S BEVERAGES AT A GATHERING (U.S. CLS. 2, 13, 23, 29, 30, 33, 40 AND 50).

BRIAN NEVILLE, EXAMINING ATTORNEY

SN 85-534,816. STAINO, LLC, LONG EDDY, NY. FILED 2-6-2012.

MINIS

THE MARK CONSISTS OF STANDARD CHARACTERS WITHOUT CLAIM TO ANY PARTICULAR FONT, STYLE, SIZE, OR COLOR.

OWNER OF U.S. REG. NO. 3,270,551.

SEC. 2(F).

FOR INTERDENTAL BRUSHES (U.S. CLS. 2, 13, 23, 29, 30, 33, 40 AND 50).

FIRST USE 9-0-2006; IN COMMERCE 9-0-2006.

ELIZABETH KAJUBI, EXAMINING ATTORNEY

SN 85-535,675. ERICHSEN, STEPHEN, TEANECK, NJ. FILED 2-7-2012.

My Doggy Dumpster

THE MARK CONSISTS OF STANDARD CHARACTERS WITHOUT CLAIM TO ANY PARTICULAR FONT, STYLE, SIZE, OR COLOR.

FOR SCOOPS FOR THE DISPOSAL OF PET WASTE (U.S. CLS. 2, 13, 23, 29, 30, 33, 40 AND 50).

FIRST USE 4-1-2011; IN COMMERCE 11-3-2011.

GRETTA YAO, EXAMINING ATTORNEY

CLASS 21—(Continued).

SN 85-536,445. PRESTI, JOHN, SOUTH KENT, CT. FILED 2-7-2012.



THE MARK CONSISTS OF A STYLIZED LINE ART IMPRESSION OF A PIG'S SNOUT.

FOR PET FEEDING AND DRINKING BOWLS; PET FEEDING DISHES (U.S. CLS. 2, 13, 23, 29, 30, 33, 40 AND 50).

JIM RINGLE, EXAMINING ATTORNEY

CLASS 21—(Continued).

SN 85-538,075. LITTLE ANGELS, LLC, NEW YORK, NY. FILED 2-9-2012.



THE MARK CONSISTS OF DEPICTIONS OF EIGHT ANGELS WITH HALOS AND WINGS AND TWO CHILDREN ALL WITHIN A CLOUD.

FOR TABLEWARE, NAMELY, MUGS, CUPS AND SIPPY CUPS, TUMBLERS, DRINKING GLASSES, BOWLS AND PLATES; SPORTS BOTTLES SOLD EMPTY; LUNCH BOXES; LUNCH KITS COMPRISING OF LUNCH BOXES AND INSULATED BEVERAGE CONTAINERS; PORTABLE COOLERS; REMOVABLE INSULATING SLEEVE HOLDERS FOR BEVERAGE CANS AND BOTTLES; TOOTHBRUSHES AND TOOTHBRUSH HOLDERS; HAIR BRUSHES; HOUSEHOLD CONTAINERS FOR STORING FOOD (U.S. CLS. 2, 13, 23, 29, 30, 33, 40 AND 50).

ELIZABETH KAJUBI, EXAMINING ATTORNEY

SN 85-537,142. CAROLYN WOLF, SURPRISE, AZ. FILED 2-8-2012.

BottleCote

THE MARK CONSISTS OF STANDARD CHARACTERS WITHOUT CLAIM TO ANY PARTICULAR FONT, STYLE, SIZE, OR COLOR.

FOR BOTTLE SLEEVES COMPOSED OF LIQUID-ABSORBING MICRO FIBER FABRIC (U.S. CLS. 2, 13, 23, 29, 30, 33, 40 AND 50).

FIRST USE 1-15-2011; IN COMMERCE 11-15-2011.

LUCY ARANT, EXAMINING ATTORNEY

SN 85-539,047. CORNING INCORPORATED, CORNING, NY. FILED 2-10-2012.

WILLOW

THE MARK CONSISTS OF STANDARD CHARACTERS WITHOUT CLAIM TO ANY PARTICULAR FONT, STYLE, SIZE, OR COLOR.

FOR FLEXIBLE SEMI-FINISHED GLASS SUBSTRATES FOR USE IN ELECTRONIC DEVICES (U.S. CLS. 2, 13, 23, 29, 30, 33, 40 AND 50).

MIDGE BUTLER, EXAMINING ATTORNEY

CLASS 21—(Continued).

SN 85-539,065. YOUNG'S PLANT FARM, INC., AUBURN, AL. FILED 2-10-2012.

SolaRadiance

THE MARK CONSISTS OF STANDARD CHARACTERS WITHOUT CLAIM TO ANY PARTICULAR FONT, STYLE, SIZE, OR COLOR.
FOR PLANTERS FOR FLOWERS AND PLANTS (U.S. CLS. 2, 13, 23, 29, 30, 33, 40 AND 50).
KYLE PEETE, EXAMINING ATTORNEY

SN 85-539,748. MEDPORT, LLC, PROVIDENCE, RI. FILED 2-10-2012.

DIP N' DUNK

THE MARK CONSISTS OF STANDARD CHARACTERS WITHOUT CLAIM TO ANY PARTICULAR FONT, STYLE, SIZE, OR COLOR.
FOR PORTABLE PLASTIC CONTAINERS FOR STORING AND TRANSPORTING FOODS (U.S. CLS. 2, 13, 23, 29, 30, 33, 40 AND 50).
ALLISON SCHRODY, EXAMINING ATTORNEY

SN 85-544,774. DOSKOCIL MANUFACTURING COMPANY, INC., ARLINGTON, TX. FILED 2-16-2012.

Portion Right

THE MARK CONSISTS OF STANDARD CHARACTERS WITHOUT CLAIM TO ANY PARTICULAR FONT, STYLE, SIZE, OR COLOR.
OWNER OF U.S. REG. NO. 3,730,348.
NO CLAIM IS MADE TO THE EXCLUSIVE RIGHT TO USE "PORTION", APART FROM THE MARK AS SHOWN.
FOR ANIMAL FEEDER AND WATERER (U.S. CLS. 2, 13, 23, 29, 30, 33, 40 AND 50).
BRIAN PINO, EXAMINING ATTORNEY

CLASS 22—CORDAGE AND FIBERS

SN 85-434,842. Z-CONNECTOR, LLC, LAS VEGAS, NV. FILED 9-28-2011.

Z-connector

THE MARK CONSISTS OF STANDARD CHARACTERS WITHOUT CLAIM TO ANY PARTICULAR FONT, STYLE, SIZE, OR COLOR.
FOR APPARATUS IN THE NATURE OF LANYARDS FOR SECURING SMALL HANDHELD ELECTRONIC DEVICES TO THE PERSON, A PURSE, A CARRYING BAG OR CASE (U.S. CLS. 1, 2, 7, 19, 22, 42 AND 50).
FIRST USE 9-22-2011; IN COMMERCE 9-22-2011.
ALEX KEAM, EXAMINING ATTORNEY

SN 85-477,935. EASY AWNINGS SYSTEMS, INC., MIAMI, FL. FILED 11-21-2011.



NO CLAIM IS MADE TO THE EXCLUSIVE RIGHT TO USE "SHADE", APART FROM THE MARK AS SHOWN.
THE MARK CONSISTS OF THE WORDS "LAYZE SHADE" WITH THE DESIGN OF A TREE WITH THE TOP REPRESENTING AN AWNING IN BETWEEN THE TWO WORDS.
FOR AWNINGS (U.S. CLS. 1, 2, 7, 19, 22, 42 AND 50).
DOUGLAS LEE, EXAMINING ATTORNEY

SN 85-512,195. PROCURATOR SERVICE LLC, CLAYMONT, DE. FILED 1-9-2012.

Jholi

THE MARK CONSISTS OF STANDARD CHARACTERS WITHOUT CLAIM TO ANY PARTICULAR FONT, STYLE, SIZE, OR COLOR.
FOR AWNINGS; AWNINGS NOT OF METAL; AWNINGS OF FABRIC; AWNINGS OF PLASTIC; BED TENTS; LADDER TAPES FOR VENETIAN BLINDS; RAIN FLIES FOR TENTS; TENT FLIES; TENTS; TENTS FOR MOUNTAINING OR CAMPING; VENETIAN BLIND TAPES (U.S. CLS. 1, 2, 7, 19, 22, 42 AND 50).
CURTIS FRENCH, EXAMINING ATTORNEY

CLASS 22—(Continued).

SN 85-522,556. ORTLIEB, HARTMUT, HEILSBRONN, FED REP GERMANY, FILED 1-23-2012.



OWNER OF U.S. REG. NOS. 2,526,989 AND 4,062,846. NO CLAIM IS MADE TO THE EXCLUSIVE RIGHT TO USE "WATERPROOF", APART FROM THE MARK AS SHOWN.

THE MARK CONSISTS OF AN OVAL ON ITS SIDE, SPLIT LEFT-RIGHT SUBSTANTIALLY 60% - 40%. ON THE LEFT PORTION, A SHAPE OF ANOTHER OVAL WITH ITS LEFT SIDE BEING OF A CYLINDRICAL CONFIGURATION IS LAYING ON ITS SIDE, WITH THE WORD "ORTLIEB". THE RIGHT PORTION COMPRISES OF AN OVAL ON ITS SIDE WITH THE WORD "WATERPROOF". THE RIGHT OVAL FITS THE CONTOUR OF THE LEFT OVAL'S CYLINDRICAL SIDE.

FOR MOUNTAINEERING ROPES; CARGO SLINGS OF ROPE OR FABRIC; TENTS; PADDING MATERIALS NOT OF RUBBER, PAPER OR PLASTIC; STUFFING, NOT OF RUBBER OR PLASTIC (U.S. CLS. 1, 2, 7, 19, 22, 42 AND 50).

JIM RINGLE, EXAMINING ATTORNEY

SN 85-533,829. LIFTEX CORPORATION, WARMINSTER, PA. FILED 2-3-2012.

Pro Corner

THE MARK CONSISTS OF STANDARD CHARACTERS WITHOUT CLAIM TO ANY PARTICULAR FONT, STYLE, SIZE, OR COLOR.

FOR DEVICE USED TO PROTECT SLINGS USED IN RIGGING, NAMELY, AN EDGE PROTECTOR PAD MADE OF SYNTHETIC FIBERS THAT REDUCES DAMAGE AND WEAR TO A SLING; EDGE PROTECTOR PADS MADE OF SYNTHETIC FIBERS FOR USE WITH INDUSTRIAL SLINGS (U.S. CLS. 1, 2, 7, 19, 22, 42 AND 50).

ANNE E. GUSTASON, EXAMINING ATTORNEY

SN 85-534,889. DOWN LITE INTERNATIONAL, MASON, OH. FILED 2-6-2012.

X-TREME DOWN

THE MARK CONSISTS OF STANDARD CHARACTERS WITHOUT CLAIM TO ANY PARTICULAR FONT, STYLE, SIZE, OR COLOR.

NO CLAIM IS MADE TO THE EXCLUSIVE RIGHT TO USE "DOWN", APART FROM THE MARK AS SHOWN.

FOR DOWN AND FEATHER FILL FOR USE AS INSULATION, STUFFING, PADDING AND FILLING (U.S. CLS. 1, 2, 7, 19, 22, 42 AND 50).

THOMAS MANOR, EXAMINING ATTORNEY

CLASS 22—(Continued).

SN 85-569,170. DOWN LITE INTERNATIONAL, MASON, OH. FILED 3-14-2012.

DOWN-TRAC

THE MARK CONSISTS OF STANDARD CHARACTERS WITHOUT CLAIM TO ANY PARTICULAR FONT, STYLE, SIZE, OR COLOR.

FOR DOWN AND FEATHER FILL FOR USE AS INSULATION, STUFFING, PADDING AND FILLING (U.S. CLS. 1, 2, 7, 19, 22, 42 AND 50).

THOMAS MANOR, EXAMINING ATTORNEY

CLASS 23—YARNS AND THREADS

SN 79-106,922. FILIVIVI S.R.L., ITALY, FILED 9-21-2011.



OWNER OF INTERNATIONAL REGISTRATION 1100967 DATED 9-21-2011, EXPIRES 9-21-2021.

THE MARK CONSISTS OF THE STYLIZED WORD "FOLCO" IN CAPITAL BLOCK LETTERS, WHERE THE FIRST LETTER "O" IS REPRESENTED BY A BALL OF YARN.

FOR YARNS AND THREADS, FOR TEXTILE USE EXCEPT THREADS FOR TECHNICAL TEXTILES (U.S. CL. 43).

STEVEN JACKSON, EXAMINING ATTORNEY

CLASS 23—(Continued).

SN 85-530,527. TEX-RAY INDUSTRIAL CO., LTD., TAIPEI, TAIWAN, FILED 2-1-2012.



THE MARK CONSISTS OF A STYLIZED WORDING "AI-DRY" WITH TOP PORTION OF THE LETTER "I" SHAPED AS A FLOWER BEING OPEN INTO BLOSSOMS AND STEM OF THE FLOWER SHAPED AS AN ARC SPACED FROM TOP AND TOP LEFT PORTIONS OF THE LETTER "A" AND CONNECTED TO THE TRANSVERSE PORTION OF THE LETTER "A".

FOR CHEMICAL FIBER BASE MIXED THREAD AND YARN; CHEMICAL-FIBER THREADS AND YARNS FOR TEXTILE USE; CHENILLE YARN; ELASTIC THREAD; ELASTIC YARN; EMBROIDERY FLOSS; EMBROIDERY THREAD AND YARN; MIXED SPUN THREADS AND YARNS; PLASTIC THREAD FOR TEXTILE USE; REGENERATED FIBER THREAD AND YARN; RUBBER THREAD FOR TEXTILE USE; SEWING THREAD; SILK BASE MIXED THREAD AND YARN; SILK THREADS AND YARNS; SYNTHETIC FIBER THREAD AND YARN; SYNTHETIC THREAD; SYNTHETIC YARN; THREAD; TWISTED THREADS AND YARNS (U.S. CL. 43).

FIRST USE 12-9-2011; IN COMMERCE 12-9-2011. LEIGH CAROLINE CASE, EXAMINING ATTORNEY

CLASS 24—(Continued).

SN 85-229,320. EXCLUSIVE FABRICS & FURNISHINGS, LLC, PLEASANTON, CA. FILED 1-28-2011.



NO CLAIM IS MADE TO THE EXCLUSIVE RIGHT TO USE "EXCLUSIVE FABRICS" AND "FURNISHINGS", APART FROM THE MARK AS SHOWN.

THE MARK CONSISTS OF THE WORDS "EXCLUSIVE" AND "FABRICS" AND "FURNISHINGS" WITH A STYLIZED AMPERSAND APPEARING BELOW THE TERM "FABRICS" AND ABOVE THE TERM "FURNISHINGS". THE AMPERSAND HAS A SHADED CIRCLE BEHIND IT, A STYLIZED UPSIDE DOWN LETTER "F" ON ITS LEFT SIDE AND A STYLIZED RIGHT SIDE UP LETTER "F" ON ITS RIGHT SIDE.

FOR TEXTILE GOODS, NAMELY INTERIOR FABRIC WINDOW COVERINGS IN THE NATURE OF DRAPES AND CURTAINS (U.S. CLS. 42 AND 50).

FIRST USE 7-0-2007; IN COMMERCE 7-0-2007. KATHERINE CONNOLLY, EXAMINING ATTORNEY

SN 85-348,404. TISKIEWIC, HANA, BRADENTON, FL. FILED 6-16-2011.

CLASS 24—FABRICS

SN 85-220,845. PRYM CONSUMER USA INC., SPARTANBURG, SC. FILED 1-19-2011.

BABYVILLE BOUTIQUE

THE MARK CONSISTS OF STANDARD CHARACTERS WITHOUT CLAIM TO ANY PARTICULAR FONT, STYLE, SIZE, OR COLOR.

NO CLAIM IS MADE TO THE EXCLUSIVE RIGHT TO USE "BOUTIQUE", APART FROM THE MARK AS SHOWN.

FOR BABY ACCESSORIES, NAMELY, BABY ACCESSORY COMPONENTS FOR MAKING DIAPER COVERS, DIAPER BAGS, WET BAGS, CHANGING PADS AND BIBS, SOLD IN A KIT COMPRISING FABRIC, WATER-PROOF AND BREATHABLE FABRIC, POLYURETHANE LAMINATED FABRIC, INSTRUCTIONAL BOOKLETS, PLASTIC SNAPS, HOOK AND LOOP FASTENERS, BUTTONS, FABRIC APPLIQUES, FABRIC LABELS AND ELASTIC (U.S. CLS. 42 AND 50).

DAVID TAYLOR, EXAMINING ATTORNEY



NO CLAIM IS MADE TO THE EXCLUSIVE RIGHT TO USE "TOWEL", APART FROM THE MARK AS SHOWN.

THE COLOR(S) WHITE, BLUE, AND AQUA IS/ARE CLAIMED AS A FEATURE OF THE MARK.

THE MARK CONSISTS OF A RECTANGLE HAVING VARIOUS SHADES OF BLUE AND AQUA, WITH DARKER SHADES OF COLOR IN THE LOWER HALF OF THE RECTANGLE AND THE WORDS "DOODLE TOWEL" IN WHITE LETTERING ALSO IN THE LOWER HALF.

FOR CHILDREN'S BLANKETS; PILLOW CASES; PILLOW COVERS; THROWS DESIGNED TO ALSO BE WRAPPED AROUND A PERSON; TOWELS THAT MAY BE WORN AS A DRESS OR SIMILAR GARMENT; TRAVELLING BLANKETS (U.S. CLS. 42 AND 50).

FIRST USE 1-20-2010; IN COMMERCE 3-10-2010. KRISTINA MORRIS, EXAMINING ATTORNEY

CLASS 24—(Continued).

SN 85-439,206. THE LITTLE LINEN COMPANY, OAKLEIGH SOUTH, AUSTRALIA, FILED 10-4-2011.

Little Bamboo

THE MARK CONSISTS OF STANDARD CHARACTERS WITHOUT CLAIM TO ANY PARTICULAR FONT, STYLE, SIZE, OR COLOR.

OWNER OF AUSTRALIA REG. NO. 1171764, DATED 4-19-2007, EXPIRES 4-19-2017.

NO CLAIM IS MADE TO THE EXCLUSIVE RIGHT TO USE "BAMBOO", APART FROM THE MARK AS SHOWN.

FOR BABY BATH LINEN MADE IN WHOLE OR SUBSTANTIALLY IN PART OF BAMBOO (U.S. CLS. 42 AND 50).

ANDREA BUTLER, EXAMINING ATTORNEY

CLASS 24—(Continued).

SN 85-524,903. GOYA FOODS, INC., SECAUCUS, NJ. FILED 1-25-2012.

GOYA FOR KIDS

THE MARK CONSISTS OF STANDARD CHARACTERS WITHOUT CLAIM TO ANY PARTICULAR FONT, STYLE, SIZE, OR COLOR.

OWNER OF U.S. REG. NOS. 764,033, 966,178 AND OTHERS.

NO CLAIM IS MADE TO THE EXCLUSIVE RIGHT TO USE "FOR KIDS", APART FROM THE MARK AS SHOWN.

FOR OVEN MITTS; PLASTIC TABLE COVERS; POT HOLDERS; TABLE LINEN; TABLE LINEN, NAMELY, COASTERS, NAPKINS, AND PLACE MATS; TEXTILE NAPKINS; TOWELS (U.S. CLS. 42 AND 50).

KATHLEEN LORENZO, EXAMINING ATTORNEY

SN 85-511,217. HARRIS, CHARLES R., YOUNGSTOWN, OH. FILED 1-7-2012.

CERTIFIED DIEHARD

THE MARK CONSISTS OF STANDARD CHARACTERS WITHOUT CLAIM TO ANY PARTICULAR FONT, STYLE, SIZE, OR COLOR.

NO CLAIM IS MADE TO THE EXCLUSIVE RIGHT TO USE "CERTIFIED", APART FROM THE MARK AS SHOWN.

FOR KITCHEN TOWELS (U.S. CLS. 42 AND 50).

FIRST USE 9-1-2011; IN COMMERCE 9-1-2011.

DAWN HAN, EXAMINING ATTORNEY

SN 85-532,235. SPRINGS GLOBAL US, INC., FORT MILL, SC. FILED 2-2-2012.

VINYL | 8MM

THE MARK CONSISTS OF THE WORD "VINYL" FOLLOWED BY VERTICAL LINE FOLLOWED BY "8MM".

FOR BEACH TOWELS; BED BLANKETS; BED SHEETS; BED SKIRTS; BED SPREADS; BED THROWS; COMFORTERS; CURTAINS; DRAPERIES; DUVETS; FABRIC VALANCES; KITCHEN TOWELS; MATTRESS COVERS; MATTRESS PADS; PILLOW CASES; PILLOW SHAMS; PLACE MATS, NOT OF PAPER; SHOWER CURTAINS; TABLE LINEN; TABLE NAPKINS OF TEXTILE; TABLECLOTHS OF TEXTILES; TOWELS; WASH-CLOTHS (U.S. CLS. 42 AND 50).

KAREN K. BUSH, EXAMINING ATTORNEY

SN 85-522,470. TARGET BRANDS, INC., MINNEAPOLIS, MN. FILED 1-23-2012.

CLASSIC TIDINGS

THE MARK CONSISTS OF STANDARD CHARACTERS WITHOUT CLAIM TO ANY PARTICULAR FONT, STYLE, SIZE, OR COLOR.

OWNER OF U.S. REG. NOS. 4,009,130, 4,009,131 AND 4,009,132.

NO CLAIM IS MADE TO THE EXCLUSIVE RIGHT TO USE "CLASSIC", APART FROM THE MARK AS SHOWN.

FOR OVEN MITTS; TOWELS; BED BLANKETS AND THROWS (U.S. CLS. 42 AND 50).

FIRST USE 11-0-2011; IN COMMERCE 11-0-2011.

NICHOLAS ALTREE, EXAMINING ATTORNEY

SN 85-532,446. RES CAPTITAL LLC, NEW YORK, NY. FILED 2-2-2012.

HEPCOOL

THE MARK CONSISTS OF STANDARD CHARACTERS WITHOUT CLAIM TO ANY PARTICULAR FONT, STYLE, SIZE, OR COLOR.

THE WORDING "HEPCOOL" HAS NO MEANING IN A FOREIGN LANGUAGE.

FOR FABRICS FOR THE MANUFACTURE OF APPAREL (U.S. CLS. 42 AND 50).

BARBARA A. GOLD, EXAMINING ATTORNEY

CLASS 24—(Continued).

SN 85-532,462. RES CAPTITAL LLC, NEW YORK, NY. FILED 2-2-2012.

OXYFLO

THE MARK CONSISTS OF STANDARD CHARACTERS WITHOUT CLAIM TO ANY PARTICULAR FONT, STYLE, SIZE, OR COLOR.

THE WORDING "OXYFLO" HAS NO MEANING IN A FOREIGN LANGUAGE.

FOR FABRICS FOR THE MANUFACTURE OF APPAREL (U.S. CLS. 42 AND 50).

BARBARA A. GOLD, EXAMINING ATTORNEY

SN 85-534,978. DIVATEX HOME FASHION, INC., NEW YORK, NY. FILED 2-6-2012.

INSPIRED ELEGANCE

THE MARK CONSISTS OF STANDARD CHARACTERS WITHOUT CLAIM TO ANY PARTICULAR FONT, STYLE, SIZE, OR COLOR.

FOR BEDDING, NAMELY, BLANKETS, THROWS, COMFORTERS, QUILTS, COVERLETS, DUVET COVERS, SHEETS, PILLOW CASES AND SHAMS; WINDOW TREATMENTS, NAMELY, FABRIC TAILORED VALANCES, WINDOW SCARVES, CURTAINS, SWAGS, AND SHEERS; SHOWER CURTAINS, TOWELS (U.S. CLS. 42 AND 50).

KAREN K. BUSH, EXAMINING ATTORNEY

SN 85-535,589. GREEN WITHIN INC., MIAMI, FL. FILED 2-7-2012.

THE GREEN WITHIN

THE MARK CONSISTS OF STANDARD CHARACTERS WITHOUT CLAIM TO ANY PARTICULAR FONT, STYLE, SIZE, OR COLOR.

FOR BED LINEN; LINEN FOR HOUSEHOLD PURPOSES; TOWELS (U.S. CLS. 42 AND 50).

CHRISTOPHER LAW, EXAMINING ATTORNEY

CLASS 24—(Continued).

SN 85-535,638. NATSARFIN COMPANIES, LLC, SAN ANTONIO, TX. FILED 2-7-2012.



THE MARK CONSISTS OF A SOLID SILHOUETTE OF A SKELETON KEY HAVING A FANCIFUL HEART SHAPED HANDLE AND A LOCK ENGAGING END WITH THREE RECTANGULAR EXTENSIONS.

FOR BED BLANKETS; BED COVERS; BED SHEETS; BED SKIRTS; BED SPREADS; BED THROWS; COMFORTERS; DUVET COVERS; DUVETS; FITTED BED SHEETS; FLAT BED SHEETS; PILLOW CASES; PILLOW COVERS; PILLOW SHAMS (U.S. CLS. 42 AND 50).

DAVID MURRAY, EXAMINING ATTORNEY

SN 85-535,995. DORM COMPANY, CLARENCE, NY. FILED 2-7-2012.

COLLEGE AVE

THE MARK CONSISTS OF STANDARD CHARACTERS WITHOUT CLAIM TO ANY PARTICULAR FONT, STYLE, SIZE, OR COLOR.

FOR BED BLANKETS; BED SHEETS; BED SPREADS; BED THROWS; BEDSHEETS; COMFORTERS; COVERLETS; DUVET COVERS; DUVETS; FITTED BED SHEETS; FLAT BED SHEETS; MATTRESS COVERS; MATTRESS PADS; QUILT COVERS; QUILTS (U.S. CLS. 42 AND 50).

FIRST USE 12-12-2011; IN COMMERCE 2-1-2012.
MATTHEW KLINE, EXAMINING ATTORNEY

SN 85-537,228. TULLAHOMA INDUSTRIES, LLC, TULLAHOMA, TN. FILED 2-8-2012.

BAMBLUE

THE MARK CONSISTS OF STANDARD CHARACTERS WITHOUT CLAIM TO ANY PARTICULAR FONT, STYLE, SIZE, OR COLOR.

FOR COTTON BASE MIXED FABRICS; DENIM FABRIC; FABRICS FOR TEXTILE USE; JEANS FABRIC; TEXTILE FABRICS FOR THE MANUFACTURE OF CLOTHING (U.S. CLS. 42 AND 50).

HANNO RITTNER, EXAMINING ATTORNEY

CLASS 24—(Continued).

SN 85-538,058. LITTLE ANGELS, LLC, NEW YORK, NY. FILED 2-9-2012.



THE MARK CONSISTS OF DEPICTIONS OF EIGHT ANGELS WITH HALOS AND WINGS AND TWO CHILDREN ALL WITHIN A CLOUD.

FOR BED LINENS, NAMELY CHILDREN'S BED SHEETS, BED SKIRTS, BLANKET THROWS, COMFORTERS, CRIB BUMPERS, PILLOW CASES, AND PILLOW COVERS, RECEIVING BLANKETS; THROWS; FABRIC WINDOW TREATMENTS, NAMELY, CURTAINS, DRAPES, VALANCES, SWAGS; FABRIC FLAGS; BATH LINEN, NAMELY, HOODED TOWELS, BATH TOWELS, AND WASHCLOTHS; TABLE LINEN, NAMELY, TEXTILE NAPKINS, TEXTILE PLACE MATS, TEXTILE TABLECLOTHS (U.S. CLS. 42 AND 50).

ELIZABETH KAJUBI, EXAMINING ATTORNEY

SN 85-538,956. ALOK INTERNATIONAL INC., DALLAS, TX. FILED 2-9-2012.

Melrose Avenue

THE MARK CONSISTS OF STANDARD CHARACTERS WITHOUT CLAIM TO ANY PARTICULAR FONT, STYLE, SIZE, OR COLOR.

FOR BEDDING, NAMELY, BED LINEN, BED COVERS, BED CANOPIES, BED PADS, BED THROWS, BED BLANKETS, BED SHEETS, BED SKIRTS, BED SPREADS, COMFORTERS, COVERLETS, QUILTS, DUVETS; AND TOWELS (U.S. CLS. 42 AND 50).

AISHA SALEM, EXAMINING ATTORNEY

CLASS 24—(Continued).

SN 85-540,027. FRANCO MANUFACTURING COMPANY, INC., METUCHEN, NJ. FILED 2-10-2012.

B TEEN

THE MARK CONSISTS OF STANDARD CHARACTERS WITHOUT CLAIM TO ANY PARTICULAR FONT, STYLE, SIZE, OR COLOR.

NO CLAIM IS MADE TO THE EXCLUSIVE RIGHT TO USE "TEEN", APART FROM THE MARK AS SHOWN.

FOR BATH LINEN; BED LINEN; CURTAINS; HOUSEHOLD LINEN; TOWELS (U.S. CLS. 42 AND 50).

DAVID C. REIHNER, EXAMINING ATTORNEY

SN 85-540,039. FRANCO MANUFACTURING COMPANY, INC., METUCHEN, NJ. FILED 2-10-2012.

BEYOND FUN

THE MARK CONSISTS OF STANDARD CHARACTERS WITHOUT CLAIM TO ANY PARTICULAR FONT, STYLE, SIZE, OR COLOR.

FOR BATH LINEN; BED LINEN; CURTAINS; HOUSEHOLD LINEN; TOWELS (U.S. CLS. 42 AND 50).

DAVID C. REIHNER, EXAMINING ATTORNEY

SN 85-540,378. GIARDINI RICHARD J, ATHENS, GA. FILED 2-11-2012.

MrJacket

THE MARK CONSISTS OF STANDARD CHARACTERS WITHOUT CLAIM TO ANY PARTICULAR FONT, STYLE, SIZE, OR COLOR.

FOR LABELS OF TEXTILE FOR IDENTIFYING CLOTHING (U.S. CLS. 42 AND 50).

COLLEEN DOMBROW, EXAMINING ATTORNEY

CLASS 24—(Continued).

SN 85-976,552. MAHER, CHRISTOPHER, C, DBA FAITH BEYOND LP, ANNA, TX. FILED 4-25-2011.

Real X Gear

THE MARK CONSISTS OF STANDARD CHARACTERS WITHOUT CLAIM TO ANY PARTICULAR FONT, STYLE, SIZE, OR COLOR.

NO CLAIM IS MADE TO THE EXCLUSIVE RIGHT TO USE "GEAR", APART FROM THE MARK AS SHOWN, FOR FACE TOWELS (U.S. CLS. 42 AND 50).

TEJBIR SINGH, EXAMINING ATTORNEY

CLASS 25—(Continued).

SN 76-709,272. DAVID M. JONES JR., SOUTH BEND, IN. FILED 10-3-2011.



THE NAME "WARREN DRAKE" DOES NOT IDENTIFY A LIVING INDIVIDUAL.

THE MARK CONSISTS OF THE NAME "WARREN DRAKE", THE TERM "GAME" SURROUNDED BY AN OVAL LOCATED BELOW THE NAME, AND THE DESIGN OF A KNIGHT CHESS PIECE WITH THE LETTER "W" TO THE LEFT AND THE LETTER "D" TO THE RIGHT OF THE CHESS PIECE AND LAUREL BRANCHES ON EITHER SIDE LOCATED BELOW THE TERM "GAME".

FOR CLOTHING, NAMELY, T-SHIRTS, HATS, JACKETS, PANTS, SHOES; FOOTWEAR AND HEADWEAR (U.S. CLS. 22 AND 39).

DEIRDRE ROBERTSON, EXAMINING ATTORNEY

CLASS 25—CLOTHING

SN 76-708,107. PATENT CATEGORY CORPORATION, WALNUT, CA. FILED 6-23-2011.

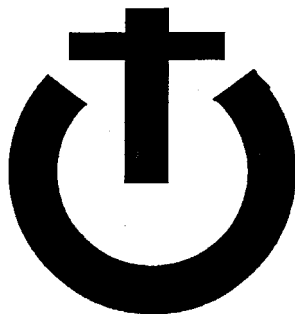

THE MARK CONSISTS OF A SEMI-CIRCLE CONTAINING A CROSS TAKING THE OVERALL SHAPE OF WHAT IS COMMONLY KNOWN AS THE UNIVERSAL SYMBOL FOR POWER, SLEEP OR STANDBY.

FOR CLOTHING, NAMELY, T-SHIRTS, SHIRTS, PANTS, HATS, JACKETS, SOCK AND SHOES (U.S. CLS. 22 AND 39).

SEAN CROWLEY, EXAMINING ATTORNEY

SN 76-710,021. ROFFE ACCESSORIES, INC., NEW YORK, NY. FILED 12-16-2011.

XMI

THE MARK CONSISTS OF STANDARD CHARACTERS WITHOUT CLAIM TO ANY PARTICULAR FONT, STYLE, SIZE, OR COLOR.

OWNER OF U.S. REG. NO. 1,705,121. FOR MEN'S, WOMEN'S AND CHILDREN'S APPAREL, NAMELY, NECK TIES, SHIRTS, SHOES, FOOTWEAR, SOCKS, HOSIERY, SCARVES, GLOVES, HATS, SUITS, JACKETS, COATS, AND OUTERWEAR IN THE NATURE OF JACKETS AND COATS (U.S. CLS. 22 AND 39).

MARCIE MILONE, EXAMINING ATTORNEY

CLASS 25—(Continued).

SN 76-710,564. GREEN TEE SHIRT COMPANY OF AMERICA, LLC, THE, LORAIN, OH. FILED 2-8-2012.

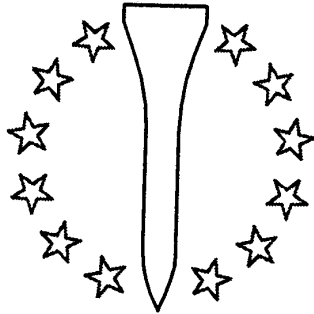

THE MARK COMPRISES THE PROFILE OF A GOLF TEE IN THE UPRIGHT POSITION WITH TWELVE STARS IN A SPACED APART RELATIONSHIP AND ORIENTED IN A CIRCLE AROUND THE GOLF TEE WITH SIX STARS ON EITHER SIDE OF THE GOLF TEE.

FOR ARTICLES OF CLOTHING, NAMELY, SHIRTS, T-SHIRTS, HATS CAPS AND VISORS (U.S. CLS. 22 AND 39).

SUZANNE BLANE, EXAMINING ATTORNEY

CLASS 25—(Continued).

SN 77-123,303. WARNER BROS. ENTERTAINMENT INC., BURBANK, CA. FILED 3-6-2007.

GOSSIP GIRL

THE MARK CONSISTS OF STANDARD CHARACTERS WITHOUT CLAIM TO ANY PARTICULAR FONT, STYLE, SIZE, OR COLOR.

OWNER OF U.S. REG. NOS. 3,043,178, 4,092,743 AND 4,143,208.

NO CLAIM IS MADE TO THE EXCLUSIVE RIGHT TO USE "GIRL", APART FROM THE MARK AS SHOWN.

FOR CLOTHING, NAMELY, SHIRTS (U.S. CLS. 22 AND 39).

FIRST USE 4-0-2008; IN COMMERCE 4-0-2008.
JAY BESCH, EXAMINING ATTORNEY

SN 77-926,407. POWERLIVING, SCARSDALE, NY. FILED 2-2-2010.

TOGETHER WE CAN

THE MARK CONSISTS OF STANDARD CHARACTERS WITHOUT CLAIM TO ANY PARTICULAR FONT, STYLE, SIZE, OR COLOR.

FOR T-SHIRTS AND SWEATSHIRTS (U.S. CLS. 22 AND 39).

MORGAN WYNNE, EXAMINING ATTORNEY

SN 76-710,648. THE GREEN TEE SHIRT COMPANY OF AMERICA, LLC, LORAIN, OH. FILED 2-17-2012.



THE MARK COMPRISES THE PROFILE OF A GOLF TEE IN THE UPRIGHT POSITION.

FOR ARTICLES OF CLOTHING, NAMELY, SHIRTS, T-SHIRTS, HATS CAPS AND VISORS (U.S. CLS. 22 AND 39).

SUZANNE BLANE, EXAMINING ATTORNEY

SN 77-937,681. SKECHERS U.S.A., INC. II, MANHATTAN BEACH, CA. FILED 2-17-2010.

KEWL BREEZE

THE MARK CONSISTS OF STANDARD CHARACTERS WITHOUT CLAIM TO ANY PARTICULAR FONT, STYLE, SIZE, OR COLOR.

FOR CHILDREN'S APPAREL, NAMELY, SHIRTS, PANTS, SHORTS, JACKETS, JUMPERS, DRESSES, SKIRTS, BEACHWEAR, SWIMSUITS, UNDERWEAR, SOCKS, BELTS, GLOVES, EVOKING THE APPLICANT'S KEWL BREEZE CHARACTER AS APPEARING IN APPLICANT'S ZEVO-3 TELEVISION SERIES FOR CHILDREN (U.S. CLS. 22 AND 39).

INGA ERVIN, EXAMINING ATTORNEY

CLASS 25—(Continued).

SN 79-094,959. DESIGN WORKS/RETAIL WORKS, C/O SUSANNE RAVN/OLFERT RAHBEK, DK-2900 HELLERUP, DENMARK, FILED 2-9-2011.

RAVN copenhagen

THE MARK CONSISTS OF STANDARD CHARACTERS WITHOUT CLAIM TO ANY PARTICULAR FONT, STYLE, SIZE, OR COLOR.

PRIORITY DATE OF 8-9-2010 IS CLAIMED.
OWNER OF INTERNATIONAL REGISTRATION 1070704 DATED 2-9-2011, EXPIRES 2-9-2021.

NO CLAIM IS MADE TO THE EXCLUSIVE RIGHT TO USE "COPENHAGEN", APART FROM THE MARK AS SHOWN.

FOR CLOTHING, NAMELY, SCARVES, GLOVES, JERSEYS, TOPS, PANTS, CARDIGANS, DRESSES, JACKETS; OUTERWEAR, NAMELY, COATS, OVERCOATS AND RAINCOATS; KNITWEAR, NAMELY, SWEATERS, KNIT SHORTS, KNIT JACKETS, KNIT CARDIGANS; LEGGINGS, SKIRTS, SHIRTS, T-SHIRTS, VESTS, BELTS; FOOTWEAR; HEADGEAR, NAMELY, HATS, CAPS (U.S. CLS. 22 AND 39).

MATTHEW EINSTEIN, EXAMINING ATTORNEY

CLASS 25—(Continued).

SN 79-106,995. WAJID HUSSAIN, UNITED KINGDOM, FILED 7-26-2011.

NUFF (NUFF LUV)

OWNER OF INTERNATIONAL REGISTRATION 1101171 DATED 7-26-2011, EXPIRES 7-26-2021.

THE MARK CONSISTS OF A HEART SHAPED LOGO WHICH REPRESENTS THE WORD LOVE AND THE WORD "NUFF" PLACED ON THE LEFT HAND SIDE OF THE LOGO; AT THE BOTTOM OF THE LOGO ARE THE WORDS "NUFF LUV" IN BRACKETS.

FOR CLOTHING, NAMELY, JACKETS, SHIRTS; HEADGEAR, NAMELY, CAPS, HATS (U.S. CLS. 22 AND 39).

SUZANNE BLANE, EXAMINING ATTORNEY

SN 79-105,857. SILVINI S.R.O., CZECH REPUBLIC, FILED 7-14-2011.

SILVINI

THE MARK CONSISTS OF STANDARD CHARACTERS WITHOUT CLAIM TO ANY PARTICULAR FONT, STYLE, SIZE, OR COLOR.

OWNER OF INTERNATIONAL REGISTRATION 0962296 DATED 3-18-2008, EXPIRES 3-18-2018.

FOR SPORTS CLOTHING, NAMELY, TROUSERS, T-SHIRTS, JERSEYS, ANORAKS, CAPS, SCARVES, GLOVES, FOOTWEAR, OVERALLS, SWEATSHIRTS, TRAINING SUITS, SHORTS, WAISTCOATS, LEGGINGS, GAITERS, WATERPROOF JACKETS AND PANTS, VESTS, JACKETS, BRACES, SOCKS, HEADBANDS, SWEATBANDS, SHAWLS, SCARVES, HEADGEAR, NAMELY, CAPS, BALACLAVAS; CLOTHING FOR CYCLING AND CYCLISTS, NAMELY, TROUSERS, T-SHIRTS, JERSEYS, ANORAKS, SCARVES, GLOVES, FOOTWEAR, OVERALLS, SWEATSHIRTS, TRAINING SUITS, SHORTS, WAISTCOATS, LEGGINGS, GAITERS, WATERPROOF JACKETS AND PANTS, VESTS, JACKETS, BRACES, SOCKS, HEADBANDS, SWEATBANDS, SHAWLS, SCARVES, HEADGEAR, NAMELY, CAPS, BALACLAVAS (U.S. CLS. 22 AND 39).

ROBERT STRUCK, EXAMINING ATTORNEY

SN 79-107,358. WENZHOUSHI PULAI SI XIEYE; YOUXIAN GONGSI, ZHEJIANG 325000, CHINA, FILED 12-7-2011.

DeHao

OWNER OF INTERNATIONAL REGISTRATION 1102159 DATED 12-7-2011, EXPIRES 12-7-2021.

THE WORDING "DEHAO" HAS NO MEANING IN A FOREIGN LANGUAGE.

FOR SHOES; GYMNASTIC SHOES; CLOTHING, NAMELY, PANTS, SHIRTS, JACKETS, SOCKS, DRESSES; LAYETTES; HATS; HOSIERY; GLOVES; NECKTIES; LEATHER BELTS; BATHING SUITS (U.S. CLS. 22 AND 39).

JOHN SCHUYLER YARD, EXAMINING ATTORNEY

CLASS 25—(Continued).

SN 79-107,392. POCHETTINI FASHION S.R.L., ITALY,
FILED 11-4-2011.



OWNER OF INTERNATIONAL REGISTRATION 1102237
DATED 11-4-2011, EXPIRES 11-4-2021.

THE MARK CONSISTS OF THE LETTERS "FP" IN
STYLIZED FONT WITH AN INCOMPLETE DOTTED CIR-
CLE DESIGN.

FOR CLOTHING, NAMELY, NECKTIES, BELTS,
SWEATERS, CARDIGANS, PULLOVERS, WAISTCOATS,
JACKETS, OVERCOATS, SHIRTS, GOLF SHIRTS,
COATS, BERMUDA SHORTS, PANTS, JEANS, RAIN-
COATS, SASHES, BLOUSES, SUITS, DRESSES, SKIRTS,
SHAWLS, SCARVES, GLOVES, FUR COATS, FUR JACK-
ETS, FUR STOLEES; LEATHER CLOTHING, NAMELY,
JACKETS, COATS, PANTS, BELTS, WAISTCOATS,
SKIRTS; IMITATION LEATHER CLOTHING, NAMELY,
JACKETS, COATS, PANTS, BELTS, WAISTCOATS,
SKIRTS; HEADGEAR, NAMELY, HATS, CAPS, VISORS
(U.S. CLS. 22 AND 39).

NATALIE POLZER, EXAMINING ATTORNEY

CLASS 25—(Continued).

SN 79-108,363. ROCKFORD MILLS B.V., NETHERLANDS,
FILED 8-5-2011.



PRIORITY DATE OF 7-20-2011 IS CLAIMED.

OWNER OF INTERNATIONAL REGISTRATION 1104788
DATED 8-5-2011, EXPIRES 8-5-2021.

THE MARK CONSISTS OF THE WORDING "RM" IN
STYLIZED FONT.

FOR CLOTHING, NAMELY, JEANS, PANTS, SHORTS,
TROUSERS, T-SHIRTS, SWEATERS, TOPS, VESTS,
JACKETS, DRESSES, SKIRTS, HOODED SWEATSHIRTS,
BLOUSES AND FOOTWEAR (U.S. CLS. 22 AND 39).

ROBERT STRUCK, EXAMINING ATTORNEY

SN 79-107,753. IVAX DEVELOPMENT CORPORATION LTD,
CYPRUS, FILED 12-8-2011.



PRIORITY DATE OF 11-25-2011 IS CLAIMED.

OWNER OF INTERNATIONAL REGISTRATION 1103133
DATED 12-8-2011, EXPIRES 12-8-2021.

THE COLOR(S) BLACK, GREY AND WHITE IS/ARE
CLAIMED AS A FEATURE OF THE MARK.

THE MARK CONSISTS OF THE WORDING "ANGELI E
DEMONI" IN BLACK SURROUNDED BY VINES OF
SCROLLWORK IN GREY AND ALL SET ON A WHITE
BACKGROUND.

THE ENGLISH TRANSLATION OF "ANGELI E DEMONI"
IN THE MARK IS "ANGELS AND DEMONS".

FOR CLOTHING, NAMELY, DRESSES, SKIRTS,
SHIRT, PANTS, TROUSERS, SHORTS, JACKETS,
SOCKS, UNDERWEAR; FOOTWEAR; HEADWEAR (U.S.
CLS. 22 AND 39).

CHARLOTTE CORWIN, EXAMINING ATTORNEY

SN 79-111,684. FIVE SEASONS REAL ESTATE S.R.L., ITALY,
FILED 2-9-2012.



PRIORITY DATE OF 1-20-2012 IS CLAIMED.

OWNER OF INTERNATIONAL REGISTRATION 1112894
DATED 2-9-2012, EXPIRES 2-9-2022.

THE TRADEMARK CONSISTS OF THE DESIGN OF TWO
WHITE SQUIRRELS IN PROFILE VIEW AND STANDING
IN FRONT OF EACH OTHER WHOSE FORELEG REST ON
TWO PARTIALLY SUPERIMPOSED HEARTS WITH A
WHITE BOW IN THEIR LOWER LEFT SIDE, THE COLOR
WHITE IS NOT PART OF THE MARK, THE COLOR BLACK
REPRESENTS BACKGROUND AREAS AND IS NOT PART
OF THE MARK.

FOR CLOTHING, NAMELY, T-SHIRTS, SHIRTS, JUM-
PERS, TROUSERS, SKIRTS, BATHING SUITS, JEANS,
JACKETS, UNDERCLOTHES, HATS AND CAPS, FOOT-
WEAR (U.S. CLS. 22 AND 39).

ROBERT STRUCK, EXAMINING ATTORNEY

CLASS 25—(Continued).

SN 79-112,239. FIVE SEASONS REAL ESTATE S.R.L., ITALY, FILED 12-7-2011.

ONLY FOR YOUR EYES

THE MARK CONSISTS OF STANDARD CHARACTERS WITHOUT CLAIM TO ANY PARTICULAR FONT, STYLE, SIZE, OR COLOR.

PRIORITY DATE OF 11-18-2011 IS CLAIMED.

OWNER OF INTERNATIONAL REGISTRATION 1114203 DATED 12-7-2011, EXPIRES 12-7-2021.

FOR CLOTHING, NAMELY, T-SHIRTS, SHIRTS, JUMPERS, TROUSERS, SKIRTS, BATHING SUITS, JEANS, JACKETS, UNDERCLOTHES, HATS AND CAPS, FOOTWEAR (U.S. CLS. 22 AND 39).

ROBERT STRUCK, EXAMINING ATTORNEY

SN 85-059,095. SECRET SPOT, S.L., BARCELONA, SPAIN, FILED 6-10-2010.



BRASILERAS

NO CLAIM IS MADE TO THE EXCLUSIVE RIGHT TO USE "LAS ORIGINALES BRASILERAS BRAZIL BRASILERAS", APART FROM THE MARK AS SHOWN.

THE COLOR(S) BLUE, WHITE AND BLACK IS/ARE CLAIMED AS A FEATURE OF THE MARK.

THE MARK CONSISTS OF A BLUE RECTANGLE WITHIN WHICH A WHITE AND BLUE OVAL APPEAR. THE CENTER WHITE OVAL IS OUTLINED IN BLUE AND THE WORD "BRASILERAS" EXTENDS ACROSS BOTH OVALS IN WHITE OUTLINED IN BLUE. THE WORDS "LAS ORIGINALES" AND "BRAZIL" APPEAR IN BLUE WITHIN THE CENTER OVAL. BELOW THE BLUE RECTANGLE, THE WORD "BRASILERAS" APPEARS IN BLACK.

THE ENGLISH TRANSLATION OF "LAS ORIGINALES BRASILERAS" IN THE MARK IS "THE ORIGINAL BRAZILIANS".

FOR FOOTWEAR, NAMELY, BOOTS, SHOES, SANDALS, AND BATH SLIPPERS; AND HEADGEAR, NAMELY, HATS AND CAPS (U.S. CLS. 22 AND 39).

JULIE WATSON, EXAMINING ATTORNEY

CLASS 25—(Continued).

SN 85-065,124. LEWIS, SR., RALPH A., PHILADELPHIA, PA. FILED 6-17-2010.



NO CLAIM IS MADE TO THE EXCLUSIVE RIGHT TO USE "GOLFERS ONLY", APART FROM THE MARK AS SHOWN.

THE MARK CONSISTS OF THE WORD "GOLFERS" ABOVE A SILHOUETTE OF A GOLFER SWINGING A GOLF CLUB WITH THE WORD "ONLY" BELOW.

FOR CLOTHING, NAMELY, MEN'S AND WOMEN'S APPAREL AND SPORTSWEAR, NAMELY, CAPS, HATS, VISORS, BANDANAS, SCARVES, HEADBANDS, MUFFLERS, NECKTIES, SOCKS, STOCKINGS, VESTS, SHIRTS, BLOUSES, TANK TOPS, GOLF SHIRTS, JERSEYS, KNIT SHIRTS, WOVEN SHIRTS, SWEAT SHIRTS, HOODED SWEATSHIRTS, PULLOVERS, HOODED PULLOVERS, T-SHIRTS, COATS, JACKETS, WIND JACKETS, OVERCOATS, SPORT COATS, RAINWEAR, SUITS, SPORT COATS, PANTS, SLACKS, SWEAT PANTS, YOGA PANTS, CAPRI PANTS, JEANS, SWEAT PANTS, SHORTS, BELTS, SKORTS, DRESSES, SKIRTS, SWEATERS, BRAS, BRIEFS, LOUNGE WEAR, NIGHT GOWNS, PAJAMAS, BATHING SUITS, BEACH WRAPS, SWIMWEAR, CLOGS, FLIP FLOPS, SANDALS, SHOES, SLIPPERS, SNEAKERS, AND FOOTWEAR (U.S. CLS. 22 AND 39).

LINDA ORNDORFF, EXAMINING ATTORNEY

SN 85-072,991. THE ALDO GROUP INC./LE GROUPE ALDO INC., SAINT-LAURENT, QUÉBEC, CANADA, FILED 6-28-2010.



PRIORITY CLAIMED UNDER SEC. 44(D) ON CANADA APPLICATION NO. 1482568, FILED 5-26-2010, REG. NO. TMA802969, DATED 7-26-2011, EXPIRES 7-26-2026.

THE MARK CONSISTS OF A STYLIZED VERSION OF THE WORDING "HAWKEN & BARLOW".

FOR FOOTWEAR, NAMELY, SHOES, BOOTS, ATHLETIC SHOES, SANDALS AND SLIPPERS (U.S. CLS. 22 AND 39).

BRENDAN REGAN, EXAMINING ATTORNEY

CLASS 25—(Continued).

SN 85-134,009. DISCOVERY COMMUNICATIONS, LLC, SILVER SPRING, MD. FILED 9-20-2010.

SAY YES TO THE DRESS

THE MARK CONSISTS OF STANDARD CHARACTERS WITHOUT CLAIM TO ANY PARTICULAR FONT, STYLE, SIZE, OR COLOR.

FOR CLOTHING, NAMELY, T-SHIRTS, PAJAMAS, NIGHT GOWNS, JACKETS, GLOVES, SHAWLS, TROUSERS, SHIRTS, SWEATERS, CARDIGANS, BLOUSES, DRESSES, SKIRTS; EXERCISE CLOTHING, NAMELY, GYM SUITS, RUNNING SUITS, SWEATSHIRTS AND SWEAT PANTS; EVENING WEAR, NAMELY, EVENING DRESSES, EVENING GOWNS, AND TUXEDOS; UNDERWEAR, UNDERGARMENTS, STOCKINGS, SOCKS, TIES, SCARVES, BELTS, SASHES; FOOTWEAR; HEADWEAR (U.S. CLS. 22 AND 39).

TIMOTHY FINNEGAN, EXAMINING ATTORNEY

SN 85-151,385. MIMRAN GROUP INC., TORONTO, ONTARIO, CANADA, FILED 10-13-2010.

MOON

THE MARK CONSISTS OF STANDARD CHARACTERS WITHOUT CLAIM TO ANY PARTICULAR FONT, STYLE, SIZE, OR COLOR.

PRIORITY CLAIMED UNDER SEC. 44(D) ON CANADA APPLICATION NO. 1484400, FILED 6-9-2010, REG. NO. TMA819102, DATED 3-5-2012, EXPIRES 3-5-2027.

OWNER OF U.S. REG. NO. 3,927,628.

FOR MEN'S CLOTHING, NAMELY, TAILORED AND SOFT CONSTRUCTION SUITS, SPORTS JACKETS, COORDINATED AND SEPARATE SLACKS, WALKING SHORTS, COATS, DRESS AND SPORT SHIRTS, SWEATERS, POLO SHIRTS AND T-SHIRTS (U.S. CLS. 22 AND 39).

JASON BLAIR, EXAMINING ATTORNEY

SN 85-156,368. WEST COAST NOVELTY CORPORATION, ALAMEDA, CA. FILED 10-19-2010.

SUPPORT THE CURE

THE MARK CONSISTS OF STANDARD CHARACTERS WITHOUT CLAIM TO ANY PARTICULAR FONT, STYLE, SIZE, OR COLOR.

FOR CLOTHING, NAMELY, T-SHIRTS, LONG SLEEVE SHIRTS, BASEBALL CAPS, KNIT HATS, SOCKS, SWEATSHIRTS, SWEAT PANTS, PAJAMA PANTS, PAJAMA SHIRTS, AND NIGHT SHIRTS (U.S. CLS. 22 AND 39).

FIRST USE 5-31-2005; IN COMMERCE 5-31-2005.

SOPHIA S. KIM, EXAMINING ATTORNEY

CLASS 25—(Continued).

SN 85-158,104. WEST COAST NOVELTY CORPORATION, ALAMEDA, CA. FILED 10-21-2010.



THE COLOR(S) PINK IS/ARE CLAIMED AS A FEATURE OF THE MARK.

THE MARK CONSISTS OF A PINK RIBBON DESIGN POSITIONED ON THE LEFT SIDE WITH STYLIZED PINK LETTERING "SUPPORT" POSITIONED TO THE RIGHT OF THE RIBBON AND STYLIZED PINK LETTERING "THE CURE" BELOW THE WORD "SUPPORT".

FOR CLOTHING, NAMELY, T-SHIRTS, LONG SLEEVE SHIRTS, BASEBALL CAPS, KNIT HATS, SOCKS, SWEATSHIRTS, SWEAT PANTS, PAJAMA PANTS, PAJAMA SHIRTS, AND NIGHT SHIRTS (U.S. CLS. 22 AND 39).

FIRST USE 5-31-2005; IN COMMERCE 5-31-2005.

SOPHIA S. KIM, EXAMINING ATTORNEY

SN 85-166,324. PINK SLIP RECORDS LLC, HOUSTON, TX. FILED 11-1-2010.

I'M ON IT! Clothing

THE MARK CONSISTS OF STANDARD CHARACTERS WITHOUT CLAIM TO ANY PARTICULAR FONT, STYLE, SIZE, OR COLOR.

NO CLAIM IS MADE TO THE EXCLUSIVE RIGHT TO USE "CLOTHING", APART FROM THE MARK AS SHOWN. FOR SHIRTS; SHIRTS AND SHORT-SLEEVED SHIRTS; SHORT-SLEEVED OR LONG-SLEEVED T-SHIRTS; SHORT-SLEEVED SHIRTS; T-SHIRTS; TEE SHIRTS (U.S. CLS. 22 AND 39).

FIRST USE 11-23-2008; IN COMMERCE 4-5-2009.

EUGENIA MARTIN, EXAMINING ATTORNEY

SN 85-182,926. FUSION RADIO NETWORKS, TUCSON, AZ. FILED 11-22-2010.

Sunday Nite Slow Jams

THE MARK CONSISTS OF STANDARD CHARACTERS WITHOUT CLAIM TO ANY PARTICULAR FONT, STYLE, SIZE, OR COLOR.

FOR T-SHIRTS (U.S. CLS. 22 AND 39).

FIRST USE 1-0-2002; IN COMMERCE 1-0-2002.

CHARLES L. JENKINS, EXAMINING ATTORNEY

CLASS 25—(Continued).

SN 85-202,442. CRISFER S.R.L., 10131 TORINO, ITALY, FILED 12-21-2010.

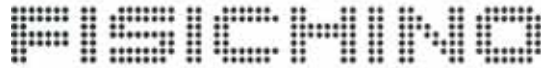

OWNER OF ITALY REG. NO. 1465880, DATED 11-22-2001, RENEWED AS REG. NO. 1465880, DATED 10-19-2011, EXPIRES 10-19-2021.

THE MARK CONSISTS OF THE TERM "FISICHINO" IN STYLIZED STIPPLING LETTERS.

FOR MEN'S AND WOMEN'S CLOTHING, NAMELY, DRESSES, SUITS, TROUSERS, JEANS, SHORTS, SKIRTS, VESTS, SHIRTS, BLOUSES, T-SHIRTS, JUMPERS, BLAZERS, JERKINS, JACKETS AND COATS, RAINCOATS, WAISTCOATS, BELTS, SOCKS, TIGHTS, NECKWEAR, TIES, SCARVES, FOULARDS, SHAWLS, GLOVES, BATH ROBES, SWIMMING SUITS, JOGGING SUITS, SPORT COATS, UNDERWEAR, LOUNGE WEAR, PAJAMAS, SHOES, BOOTS, SLIPPERS, HATS AND CAPS (U.S. CLS. 22 AND 39).

SKYE YOUNG, EXAMINING ATTORNEY

CLASS 25—(Continued).

SN 85-228,810. EFFIN CLOTHING CO., OTTAWA LAKE, MI, FILED 1-28-2011.



THE MARK CONSISTS OF THE STYLIZED WORDING "EFFINCLOTHINGCO". BELOW A STYLIZED REPRESENTATION OF THE LETTERS "EC" WITH TWO HORIZONTAL LINES ACROSS THE LETTERS, WITH THE UPPER LINE SHORTER THAN THE LOWER LINE, AND THE LOWER LINE DECLINING TO THE LOWER RIGHT AREA OF THE MARK

FOR HATS; JACKETS; PANTS; SWEATSHIRTS; T-SHIRTS (U.S. CLS. 22 AND 39).

ESTHER BELENKER, EXAMINING ATTORNEY

SN 85-224,338. YADIRA-CAMPOS, MARLENE, RICHMOND, CA. FILED 1-24-2011.

ONLY MY KIND

THE MARK CONSISTS OF STANDARD CHARACTERS WITHOUT CLAIM TO ANY PARTICULAR FONT, STYLE, SIZE, OR COLOR.

FOR WEARABLE GARMENTS AND CLOTHING, NAMELY, SHIRTS, JACKETS AND HATS (U.S. CLS. 22 AND 39).

FIRST USE 10-2-2008; IN COMMERCE 10-2-2008.
JOHN DWYER, EXAMINING ATTORNEY

SN 85-275,064. ALL OF THE ABOVE LLC, HONOLULU, HI, FILED 3-23-2011.



THE MARK CONSISTS OF THE LITERAL ELEMENTS "HI" IN SMALLER FONT AS SHOWN IN THE MARK.

FOR CLOTHING, NAMELY, TOPS, BOTTOMS, FOOTWEAR, HEADWEAR, T-SHIRTS, DENIMS (U.S. CLS. 22 AND 39).

FIRST USE 2-15-2007; IN COMMERCE 2-15-2007.
FONG HSU, EXAMINING ATTORNEY

SN 85-225,991. ROSE, MARY PAIGE, SPRINGFIELD, TN, FILED 1-25-2011.

SOBER PRINCESS

THE MARK CONSISTS OF STANDARD CHARACTERS WITHOUT CLAIM TO ANY PARTICULAR FONT, STYLE, SIZE, OR COLOR.

FOR CLOTHING, NAMELY, HOODED SWEATSHIRTS, SHIRTS, SWEATSHIRTS, T-SHIRTS, VESTS, FLEECE VESTS (U.S. CLS. 22 AND 39).

FIRST USE 9-17-2006; IN COMMERCE 9-17-2006.
DAVID C. REIHNER, EXAMINING ATTORNEY

SN 85-285,656. INTRACO, INC., DBA SOMETHING SPECIAL, COMMERCE, CA. FILED 4-4-2011.

MOZZAH

THE MARK CONSISTS OF STANDARD CHARACTERS WITHOUT CLAIM TO ANY PARTICULAR FONT, STYLE, SIZE, OR COLOR.

FOR HEADWEAR (U.S. CLS. 22 AND 39).
KIMBERLY PERRY, EXAMINING ATTORNEY

CLASS 25—(Continued).

SN 85-292,444. CHIANG CHIH CHUNG, KOWLOON, HONG KONG, FILED 4-12-2011.

VILLA ROUGE

THE MARK CONSISTS OF STANDARD CHARACTERS WITHOUT CLAIM TO ANY PARTICULAR FONT, STYLE, SIZE, OR COLOR.

PRIORITY CLAIMED UNDER SEC. 44(D) ON HONG KONG APPLICATION NO. 301855918, FILED 3-11-2011, REG. NO. 301855918, DATED 3-11-2011, EXPIRES 3-11-2021.

THE ENGLISH TRANSLATION OF "VILLA ROUGE" IN THE MARK IS "RED VILLA".

FOR WOMEN'S FOOTWEAR, NAMELY, DRESS SHOES, PUMPS, SLIPPERS, SANDALS, AND BOOTS; MEN'S FOOTWEAR, NAMELY, DRESS SHOES, LOAFERS, SLIPPERS, SANDALS AND BOOTS (U.S. CLS. 22 AND 39).

NELSON SNYDER, EXAMINING ATTORNEY

SN 85-301,073. SAUNDERS, MICHAEL J., OAKLAND, CA. FILED 4-21-2011.

AREA510

THE MARK CONSISTS OF STANDARD CHARACTERS WITHOUT CLAIM TO ANY PARTICULAR FONT, STYLE, SIZE, OR COLOR.

FOR GLOVES; HATS; HOODED PULLOVERS; HOODED SWEAT SHIRTS; JACKETS; SHORT-SLEEVED OR LONG-SLEEVED T-SHIRTS; SHORTS; SWEATSHIRTS; T-SHIRTS; TANK TOPS, ALL OF THE AFOREMENTIONED FOR RESIDENTS AND TOURISTS OF ALAMEDA COUNTY, CALIFORNIA (U.S. CLS. 22 AND 39).

FIRST USE 9-1-2010; IN COMMERCE 9-1-2010.
JOHN HWANG, EXAMINING ATTORNEY

SN 85-314,067. LILY & TAYLOR INC, NEW YORK, NY. FILED 5-6-2011.

SAPPHIRE COLLECTION

THE MARK CONSISTS OF STANDARD CHARACTERS WITHOUT CLAIM TO ANY PARTICULAR FONT, STYLE, SIZE, OR COLOR.

NO CLAIM IS MADE TO THE EXCLUSIVE RIGHT TO USE "COLLECTION", APART FROM THE MARK AS SHOWN.

FOR LADIES' APPAREL, NAMELY, SUITS, DRESSES AND SKIRTS (U.S. CLS. 22 AND 39).

STEPHANIE ALI, EXAMINING ATTORNEY

CLASS 25—(Continued).

SN 85-316,653. AGGRESSIVE APPAREL INC., NEW YORK, NY. FILED 5-10-2011.

STREET BALL CHAMPION

THE MARK CONSISTS OF STANDARD CHARACTERS WITHOUT CLAIM TO ANY PARTICULAR FONT, STYLE, SIZE, OR COLOR.

FOR APPAREL, NAMELY, DRESSES, SKIRTS, JEANS, JACKETS, SUITS, COATS, SWIMWEAR, HATS AND CAPS (U.S. CLS. 22 AND 39).

PAM WILLIS, EXAMINING ATTORNEY

SN 85-316,694. AGGRESSIVE APPAREL INC., NEW YORK, NY. FILED 5-10-2011.

STREETBALL LEGENDS

THE MARK CONSISTS OF STANDARD CHARACTERS WITHOUT CLAIM TO ANY PARTICULAR FONT, STYLE, SIZE, OR COLOR.

FOR APPAREL, NAMELY, DRESSES, SKIRTS, JEANS, JACKETS, SUITS, COATS, SWIMWEAR, HATS AND CAPS (U.S. CLS. 22 AND 39).

PAM WILLIS, EXAMINING ATTORNEY

SN 85-339,106. MYCOSKIE, LLC, SANTA MONICA, CA. FILED 6-6-2011.

ONE FOR ONE

THE MARK CONSISTS OF STANDARD CHARACTERS WITHOUT CLAIM TO ANY PARTICULAR FONT, STYLE, SIZE, OR COLOR.

FOR CLOTHING, NAMELY, HATS, SWEATSHIRTS, HOODED SWEATSHIRTS, T-SHIRTS AND SHOES (U.S. CLS. 22 AND 39).

FIRST USE 5-1-2008; IN COMMERCE 5-1-2008.

MEGHAN REINHART, EXAMINING ATTORNEY

CLASS 25—(Continued).

SN 85-343,779. BOO GIE GARMENT FACTORY LTD., NORTH POINT, HONG KONG, FILED 6-10-2011.

MOISELLE

OWNER OF HONG KONG REG. NO. 199806143, DATED 1-29-1996, RENEWED AS REG. NO. 199806143, DATED 6-19-1998, EXPIRES 1-29-2017.

THE MARK CONSISTS OF THE WORD "MOISELLE" IN SPECIAL FORM.

THE ENGLISH TRANSLATION OF "MOISELLE" IN THE MARK IS "DRAGONFLY".

FOR CLOTHING, NAMELY, BLOUSES, BOTTOMS, COATS, DRESSES, JACKETS, JEANS, KNIT TOPS, NECKWEAR, PANTS, SHIRTS, SHORTS, SKIRTS, SWEATERS, CARDIGANS, VESTS, T-SHIRTS, TOPS, SUITS, BLAZERS, BELTS, UNDERWEAR, LINGERIE, LOUNGEWEAR, SWIMWEAR, SLEEPWEAR, HOSIERY, SOCKS, STOCKINGS, GLOVES, MITTENS, SHAWLS; ALL OF THE FOREGOING EXCLUDING SPECIAL OCCASION CLOTHING IN THE NATURE OF PROM GOWNS, AND SPECIAL OCCASION DRESSES; FOOTWEAR; HEADGEAR, NAMELY, HATS, CAPS (U.S. CLS. 22 AND 39).
MATTHEW EINSTEIN, EXAMINING ATTORNEY

SN 85-344,537. TEAM FAIRFAX 2013, FAIRFAX, VA. FILED 6-13-2011.



THE MARK CONSISTS OF THE HEAD OF AN EAGLE WHERE THE EYE IS DEPICTED BY A STAR.

FOR SHIRTS AND UNIFORMS FOR JUDGES OF COMPETITIONS; SHIRTS AND UNIFORMS FOR TEAMS, SHORTS, SHIRTS, BLOUSES, TOPS, RAIN PONCHOS, NECKWEAR, TIES, SWEATSHIRTS, SWEATPANTS, T-SHIRTS, APRONS, WORKOUT AND SPORTS APPAREL, WRISTBANDS, BANDANNAS, HEADBANDS, HEADWEAR, CAPS, BASEBALL CAPS, HATS, VISORS, WORKOUT AND SPORTS APPAREL, NAMELY, SPORT SHIRTS, SPORT JERSEYS (U.S. CLS. 22 AND 39).
JOSETTE BEVERLY, EXAMINING ATTORNEY

CLASS 25—(Continued).

SN 85-354,594. IMOGENE AND WILLIE, LLC, NASHVILLE, TN. FILED 6-23-2011.

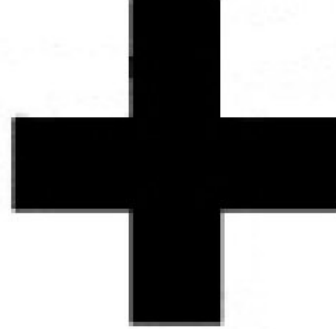

THE MARK CONSISTS OF A PLUS SIGN ("+") IN A BOLD FONT.

FOR CLOTHING, NAMELY, JEANS, SHIRTS, CAPS, BLOUSES, COATS AND NOT INCLUDING FOOTWEAR (U.S. CLS. 22 AND 39).

FIRST USE 1-23-2009; IN COMMERCE 1-23-2009.
KAREN K. BUSH, EXAMINING ATTORNEY

SN 85-354,596. IMOGENE AND WILLIE, LLC, NASHVILLE, TN. FILED 6-23-2011.

IMOGENE + WILLIE

THE MARK CONSISTS OF STANDARD CHARACTERS WITHOUT CLAIM TO ANY PARTICULAR FONT, STYLE, SIZE, OR COLOR.

FOR CLOTHING, NAMELY, JEANS, SHIRTS, CAPS, BLOUSES, COATS (U.S. CLS. 22 AND 39).

FIRST USE 1-23-2009; IN COMMERCE 1-23-2009.
KAREN K. BUSH, EXAMINING ATTORNEY

SN 85-361,480. FRITESNMEATS ENTERPRISES, INC., MIDDLE VILLAGE, NY. FILED 7-1-2011.

**FRITES 'N' MEATS
SAVING THE WORLD,
ONE BURGER AT A TIME**

THE MARK CONSISTS OF STANDARD CHARACTERS WITHOUT CLAIM TO ANY PARTICULAR FONT, STYLE, SIZE, OR COLOR.

OWNER OF U.S. REG. NO. 3,985,500.
FOR CLOTHING, NAMELY, T-SHIRTS, HATS, SWEATSHIRTS, AND APRONS (U.S. CLS. 22 AND 39).
JOHN E. MICHOS, EXAMINING ATTORNEY

CLASS 25—(Continued).

SN 85-364,668. IDEA FACTORY ASSOCIATES LLC, NEW YORK, NY. FILED 7-6-2011.

STUDIO 18

THE MARK CONSISTS OF STANDARD CHARACTERS WITHOUT CLAIM TO ANY PARTICULAR FONT, STYLE, SIZE, OR COLOR.

OWNER OF U.S. REG. NO. 1,145,472.
NO CLAIM IS MADE TO THE EXCLUSIVE RIGHT TO USE "STUDIO", APART FROM THE MARK AS SHOWN.
FOR BERMUDA SHORTS; CAPRIS; JEANS; PANTS; SHIRTS; SHORTS; SKIRTS; SWEATERS; T-SHIRTS; TANK TOPS (U.S. CLS. 22 AND 39).
FIRST USE 9-0-2010; IN COMMERCE 9-0-2010.
MARLENE BELL, EXAMINING ATTORNEY

SN 85-365,202. SLAZENGRS LIMITED, SHIREBROOK, UNITED KINGDOM, FILED 7-7-2011.



OWNER OF UNITED KINGDOM REG. NO. 2184322, DATED 12-11-1998, EXPIRES 12-11-2018.
OWNER OF U.S. REG. NOS. 1,472,361, 3,594,923 AND OTHERS.

THE MARK CONSISTS OF A PANTHER DESIGN.
FOR SPORTS CLOTHING, NAMELY, SHIRTS, SWEATSHIRTS, SHORTS, SWIMSUITS, PULLOVERS, SALOPETTES IN THE NATURE OF SKI SUITS, LONG UNDERWEAR, BRASSIERES, GAITERS, STOCKINGS, SOCKS, WAIST BANDS, GLOVES, PANTS, TROUSERS OUTERWEAR IN THE NATURE OF COATS, JACKETS AND ANORAKS, WATERPROOF CLOTHING IN THE NATURE OF COATS, JACKETS, ANORAKS, RAINCOATS AND PANTS, THERMAL CLOTHING IN THE NATURE OF PULLOVERS, PARKAS AND JACKETS, SPORTS COATS, SPORTS JACKETS, SKI TROUSERS AND SKI PANTS, SKI JACKETS, BREECHES FOR SPORTS, LIGHTWEIGHT CLOTHING, NAMELY, VESTS, FLEECE CLOTHING FOR OUTDOOR WEAR IN THE NATURE OF FLEECE PULLOVERS AND FLEECE JACKETS, PARKAS, WIND JACKETS, SPORTS SKIRTS, SPORTS DRESSES, SPORTS PANTIES, SPORTS BRIEFS, TRACKSUITS, WARM-UP SUITS, ABSORBENT BANDS FOR WEAR ON THE WRISTS AND HEADS IN THE NATURE OF SWEATBANDS, FOOTWEAR, SPORTS SHOES, TRAINING SHOES, BOOTS, WALKING BOOTS, FOOTBALL BOOTS, SHOES, CYCLING SHOES, TENNIS SHOES, GOLF SHOES, HEADGEAR IN THE NATURE OF HEADBANDS, HATS AND CAPS, BALACLAVAS, VISORS, BELTS (U.S. CLS. 22 AND 39).
KATHERINE CONNOLLY, EXAMINING ATTORNEY

CLASS 25—(Continued).

SN 85-368,446. CE SOIR LINGERIE CO., INC., VENTURA, CA. FILED 7-11-2011.

THE BRA...AND BEYOND

THE MARK CONSISTS OF STANDARD CHARACTERS WITHOUT CLAIM TO ANY PARTICULAR FONT, STYLE, SIZE, OR COLOR.

NO CLAIM IS MADE TO THE EXCLUSIVE RIGHT TO USE "THE BRA", APART FROM THE MARK AS SHOWN.
FOR LINGERIE AND LINGERIE ACCESSORIES, NAMELY, BREAST COVERS FOR COVERING THE NIPPLES IN THE NATURE OF PASTIES, BREAST ENHANCER PADS USED IN A BRA, BRAS, CAMISOLES (U.S. CLS. 22 AND 39).
MYRIAH HABEEB, EXAMINING ATTORNEY

SN 85-371,754. HERRERA, BRYANT, REDWOOD VALLEY, CA. AND RONCO, AUSTIN, REDWOOD VALLEY, CA. FILED 7-14-2011.



NO CLAIM IS MADE TO THE EXCLUSIVE RIGHT TO USE "DISC GOLF", APART FROM THE MARK AS SHOWN.
THE MARK CONSISTS OF "DGFL" IN UNIQUE SCRIPT WITH STARS IN THE "D" AND THE "F" ABOVE THE WORDS "DISC GOLF FOR LIFE".
FOR GOLF SHIRTS; HOODED SWEAT SHIRTS; HOODED SWEATSHIRTS; T-SHIRTS (U.S. CLS. 22 AND 39).

FIRST USE 6-1-2011; IN COMMERCE 6-1-2011.
NATALIE POLZER, EXAMINING ATTORNEY

CLASS 25—(Continued).

SN 85-372,376. RICO AUSTIN, SCOTTSDALE, AZ. FILED 7-15-2011.

HAVE A DOUBLE SHOT OF
REALITY

THE MARK CONSISTS OF STANDARD CHARACTERS WITHOUT CLAIM TO ANY PARTICULAR FONT, STYLE, SIZE, OR COLOR.

FOR CLOTHING, NAMELY, SHIRTS, T-SHIRTS, JACKETS, PANTS AND HATS (U.S. CLS. 22 AND 39).
BARBARA RUTLAND, EXAMINING ATTORNEY

CLASS 25—(Continued).

SN 85-377,816. TEAM RIDEHARD LLC, KAUKAUNA, WI. FILED 7-21-2011.

Team RIDEHARD
"SeRiOUs GeAr...For SeRiOUs RiDeRs"

THE MARK CONSISTS OF THE STYLIZED TEXT "TEAM RIDEHARD" ABOVE THE STYLIZED TEXT ""SERIOUS GEAR...FOR SERIOUS RIDERS"".

FOR HATS; HOODED SWEATSHIRTS; SHIRTS; SWEATPANTS; TANK TOPS (U.S. CLS. 22 AND 39).
FIRST USE 10-15-2010; IN COMMERCE 10-15-2010.
SHANNON TWOHIG, EXAMINING ATTORNEY

SN 85-372,425. DKH ENTERPRISES, LLC, HOUSTON, TX. FILED 7-15-2011.

SEE IT. CHANGE IT. SPEAK
IT.

THE MARK CONSISTS OF STANDARD CHARACTERS WITHOUT CLAIM TO ANY PARTICULAR FONT, STYLE, SIZE, OR COLOR.

FOR T-SHIRTS AND HATS MADE IN WHOLE OR IN SUBSTANTIAL PART OF ORGANIC FIBER; T-SHIRTS AND HATS MADE IN WHOLE OR IN SUBSTANTIAL PART OF RECYCLED MATERIALS (U.S. CLS. 22 AND 39).
ANDREW RHIM, EXAMINING ATTORNEY

SN 85-378,898. SUZANNE COLLINS, SANDY HOOK, CT. FILED 7-22-2011.

CATCHING FIRE

THE MARK CONSISTS OF STANDARD CHARACTERS WITHOUT CLAIM TO ANY PARTICULAR FONT, STYLE, SIZE, OR COLOR.

FOR CLOTHING, NAMELY, HEADWEAR, FOOTWEAR, SHIRTS, PANTS, SHORTS, DRESSES, SKIRTS, BLOUSES, JACKETS, COATS, SWEATERS, SCARVES, GLOVES, UNDERWEAR, FOUNDATION GARMENTS, HOSIERY, NECKTIES, NIGHTWEAR, SWEAT BANDS, SWIMWEAR, LEOTARDS, LEG WARMERS, BELTS, LAYETTES, APRONS, UNIFORMS, BOAS, HALLOWEEN COSTUMES, COSTUMES FOR USE IN ROLE-PLAYING GAMES, INFANTWEAR, RAINWEAR (U.S. CLS. 22 AND 39).
ALLISON HOLTZ, EXAMINING ATTORNEY

SN 85-374,729. LAROSA, DEREK ANGELO, PALM BEACH SHORES, FL. FILED 7-19-2011.

THE MARK CONSISTS OF HAND DRAWN GRAFFITI STYLE "FAMILY" WITH AN ARROW TRAILING FROM THE "Y".

FOR SHORT-SLEEVED OR LONG-SLEEVED T-SHIRTS (U.S. CLS. 22 AND 39).
GIANCARLO CASTRO, EXAMINING ATTORNEY

SN 85-379,301. ANGRAND, MONICA, SANTA MONICA, CA. FILED 7-24-2011.

KARMA GEDDON

THE MARK CONSISTS OF STANDARD CHARACTERS WITHOUT CLAIM TO ANY PARTICULAR FONT, STYLE, SIZE, OR COLOR.

FOR T-SHIRTS (U.S. CLS. 22 AND 39).
EDWARD NELSON, EXAMINING ATTORNEY

CLASS 25—(Continued).

SN 85-380,607. GOWORLD COMMERCE & TRADE COMPANY LIMITED, HONG KONG, HONG KONG, FILED 7-26-2011.

ioiom

THE MARK CONSISTS OF STANDARD CHARACTERS WITHOUT CLAIM TO ANY PARTICULAR FONT, STYLE, SIZE, OR COLOR.

THE WORDING "IOIOM" HAS NO MEANING IN A FOREIGN LANGUAGE.

FOR ATHLETIC FOOTWEAR; ATHLETIC UNIFORMS; BASEBALL CAPS; CYCLISTS' JERSEYS; GOWNS; PANTS; SHIRTS; SHOES; SUITS; WEDDING DRESSES; WEDDING GOWNS (U.S. CLS. 22 AND 39).

FIRST USE 7-2-2008; IN COMMERCE 4-28-2010.
HANNO RITTNER, EXAMINING ATTORNEY

SN 85-382,726. HUNTIN IS GOOD, INGLIS, FL. FILED 7-27-2011.

MERCHANDISE WITH A MESSAGE

THE MARK CONSISTS OF STANDARD CHARACTERS WITHOUT CLAIM TO ANY PARTICULAR FONT, STYLE, SIZE, OR COLOR.

NO CLAIM IS MADE TO THE EXCLUSIVE RIGHT TO USE "MERCHANDISE", APART FROM THE MARK AS SHOWN.

FOR CLOTHING, NAMELY, T-SHIRTS, HEAD WEAR, SHORTS, WARM-UP SUITS, GOLF SHIRTS, BELTS, AND FOOTWEAR (U.S. CLS. 22 AND 39).

IRA J. GOODSaid, EXAMINING ATTORNEY

SN 85-383,690. VANS, INC., CYPRESS, CA. FILED 7-28-2011.

SOLE OVER SUBSTANCE

THE MARK CONSISTS OF STANDARD CHARACTERS WITHOUT CLAIM TO ANY PARTICULAR FONT, STYLE, SIZE, OR COLOR.

FOR FOOTWEAR; MEN'S, WOMEN'S AND CHILDREN'S CLOTHING, NAMELY, SHIRTS, T-SHIRTS, TANK TOPS, SWEATERS, SWEATSHIRTS, HOODED SWEAT SHIRTS, FLEECE TOPS, FLEECE PULLOVERS, FLEECE BOTTOMS, JACKETS, PANTS, TROUSERS, DENIMS, LEGGINGS, SHORTS, BOARDSHORTS, SKIRTS, DRESSES, SWIMWEAR, SOCKS; BEANIES; HATS; BELTS FOR CLOTHING; BOXER SHORTS AND BRIEFS; MUKLUKS; SLIPPERS; SCARVES; GLOVES; MITTENS; SLEEPWEAR (U.S. CLS. 22 AND 39).

FIRST USE 7-1-2011; IN COMMERCE 7-1-2011.
LOURDES AYALA, EXAMINING ATTORNEY

CLASS 25—(Continued).

SN 85-402,165. DIEGO BINETTI INC, BOCA RATON, FL. FILED 8-19-2011.

LOVE BY DIEGO BINETTI

THE MARK CONSISTS OF STANDARD CHARACTERS WITHOUT CLAIM TO ANY PARTICULAR FONT, STYLE, SIZE, OR COLOR.

THE NAME "DIEGO BINETTI" IDENTIFIES A LIVING INDIVIDUAL WHOSE CONSENT IS OF RECORD.

FOR BLOUSES; CAMISOLES; COATS FOR MEN AND WOMEN; DRESSES; EVENING DRESSES; SKIRTS AND DRESSES; HATS; MEN AND WOMEN JACKETS, COATS, TROUSERS, VESTS; WOMEN'S UNDERWEAR; HOSIERY; MEN'S SUITS, WOMEN'S SUITS; CAPRI PANTS; DENIMS; PANTS; SHIRTS; SKIRTS; SOCKS AND STOCKINGS; DRESS SUITS; LADIES' UNDERWEAR; LINGERIE (U.S. CLS. 22 AND 39).

FIRST USE 8-15-2011; IN COMMERCE 8-15-2011.
JAMES LOVELACE, EXAMINING ATTORNEY

SN 85-415,795. DEWINE SEEDS-SILVER DOLLAR BASEBALL, LLC, ASHEVILLE, NC. FILED 9-6-2011.



THE MARK CONSISTS OF A STYLIZED LETTER "A".

FOR CLOTHING, NAMELY, APRONS, ATHLETIC UNIFORMS, BANDANAS, SHORTS, CAPS, CLOTH BABY BIBS, COATS, GOLF SHIRTS, GYM SHORTS, GYM SUITS, HATS, JACKETS, JERSEYS, JOGGING SUITS, KNIT SHIRTS, POLO SHIRTS, PONCHOS, PULLOVERS, RAIN COATS, RAINWEAR, SWEATERS, SWEAT PANTS, SWEAT SHIRTS, SWEAT SUITS, SOCKS, SPORT SHIRTS, T-SHIRTS, TANK TOPS, TIES, VISORS, WIND RESISTANT JACKETS AND WRISTBANDS (U.S. CLS. 22 AND 39).

FIRST USE 11-9-2010; IN COMMERCE 11-9-2010.
AMY KELLY, EXAMINING ATTORNEY

CLASS 25—(Continued).

SN 85-416,828. ACUSHNET COMPANY, FAIRHAVEN, MA.
FILED 9-7-2011.

LAYER UP

THE MARK CONSISTS OF STANDARD CHARACTERS WITHOUT CLAIM TO ANY PARTICULAR FONT, STYLE, SIZE, OR COLOR.

FOR PERFORMANCE OUTERWEAR, NAMELY, PULLOVERS, PANTS, SHORTS, SWEATERS, GOLF SHIRTS, LONG-SLEEVE SHIRTS, JACKETS, VESTS AND WEATHER RESISTANT ATHLETIC PANTS (U.S. CLS. 22 AND 39).

FIRST USE 8-0-2010; IN COMMERCE 8-0-2010.

VIVIAN MICZNIK FIRST, EXAMINING ATTORNEY

SN 85-418,307. PRO-GAIN TRADING LIMITED, HUNG HOM, KOWLOON, HONG KONG, FILED 9-9-2011.



NO CLAIM IS MADE TO THE EXCLUSIVE RIGHT TO USE "JEANS", APART FROM THE MARK AS SHOWN.

THE MARK CONSISTS OF THE STYLIZED WORDS "JEANS WARHEAD" WHERE THE WORD "JEANS" IS ABOVE THE LETTERS "ARHEAD" AND THE LETTER "W" IS IN BIGGER SIZE.

FOR BLOUSES; COATS; DRESSES; FABRIC BELTS; FOOTWEAR; GLOVES; HEADGEAR, NAMELY, HATS, CAPS; JACKETS; JEANS; PAJAMAS; RAINWEAR; SCARVES; SHIRTS; SHORTS; SOCKS; SWEATERS; SWIMWEAR; T-SHIRTS; TIES; TROUSERS; UNDERWEAR (U.S. CLS. 22 AND 39).

ARETHA SOMERVILLE, EXAMINING ATTORNEY

SN 85-419,556. SAMBA SOLEIL, INC., BEDFORD CORNERS, NY. FILED S.R. 9-10-2011; AM. P.R. 5-3-2012.

SAMBA SOLEIL

THE MARK CONSISTS OF STANDARD CHARACTERS WITHOUT CLAIM TO ANY PARTICULAR FONT, STYLE, SIZE, OR COLOR.

THE ENGLISH TRANSLATION OF THE WORD "SOLEIL" IN THE MARK IS "SUN".

FOR DRESSES (U.S. CLS. 22 AND 39).

FIRST USE 5-25-2010; IN COMMERCE 7-27-2010.

CIMMERIAN COLEMAN, EXAMINING ATTORNEY

CLASS 25—(Continued).

SN 85-422,026. CHRISTOPHER PORTER, DBA BRANDS PHENOMENAL GROUP LLC / NAQURA LLC, AUSTIN, TX. FILED 9-14-2011.

MONKS & MAVERICKS

THE MARK CONSISTS OF STANDARD CHARACTERS WITHOUT CLAIM TO ANY PARTICULAR FONT, STYLE, SIZE, OR COLOR.

FOR CLOTHING, NAMELY, DENIM AND LEATHER JEANS; JACKETS; SHIRTS, NAMELY, T-SHIRTS, SWEATSHIRTS, DRESS SHIRTS AND WOVEN AND KNITTED SHIRTS; AND SOCKS (U.S. CLS. 22 AND 39).

FIRST USE 12-4-2010; IN COMMERCE 12-4-2010.

ELLEN PERKINS, EXAMINING ATTORNEY

SN 85-425,951. COOP & ROOB LIMITED, WANCHAI, HONG KONG, FILED 9-19-2011.

TEQUILA KOALA

THE MARK CONSISTS OF STANDARD CHARACTERS WITHOUT CLAIM TO ANY PARTICULAR FONT, STYLE, SIZE, OR COLOR.

FOR FOOTWEAR; HOSIERY; SHOES; SLIPPERS; SOCKS; SANDALS (U.S. CLS. 22 AND 39).

ROBERT STRUCK, EXAMINING ATTORNEY

CLASS 25—(Continued).

SN 85-430,210. ZENITH MANAGEMENT CORPORATION, DORAL, FL. FILED 9-23-2011.



THE COLOR(S) BLACK, WHITE AND RED IS/ARE CLAIMED AS A FEATURE OF THE MARK.

THE MARK CONSISTS OF A BLACK AND WHITE SKULL WEARING A PIRATE HAT WITH A DAGGER BETWEEN ITS TEETH WITH SWORDS CROSSING BELOW THE SKULL AND RED BLOOD DRIPPING FROM THE DAGGER WITH THE WORD "SKETCHY".

FOR CLOTHING, NAMELY, SHIRTS, T-SHIRTS, SWEATSHIRTS, JACKETS, HATS, CAPS, PANTS, SHORTS AND SOCKS (U.S. CLS. 22 AND 39).

FIRST USE 5-15-2011; IN COMMERCE 5-15-2011.
CHRISTOPHER LAW, EXAMINING ATTORNEY

SN 85-434,335. CHEN, GRACE YEHUAI, SHANGHAI, CHINA, FILED 9-28-2011.

GRACE CHEN

THE MARK CONSISTS OF STANDARD CHARACTERS WITHOUT CLAIM TO ANY PARTICULAR FONT, STYLE, SIZE, OR COLOR.

THE NAME(S), PORTRAIT(S), AND/OR SIGNATURE(S) SHOWN IN THE MARK IDENTIFIES APPLICANT, WHOSE CONSENT(S) TO REGISTER IS MADE OF RECORD.

FOR ANKLE BOOTS; ANKLE SOCKS; ANKLETS; ANORAK; ANORAKS; APPAREL FOR DANCERS, NAMELY, TEE SHIRTS, SWEATSHIRTS, PANTS, LEGGINGS, SHORTS AND JACKETS; APRES-SKI SHOES; APRONS; ARTIFICIAL FLOWER HEADDRESSES; ASCOTS; A-SHIRTS; BABUSHKAS; BABY BIBS NOT OF PAPER; BABY BODYSUITS; BABY BOTTOMS; BABY BUNTING; BABY DOLL PYJAMAS; BABY LAYETTES FOR CLOTHING; BABY TOPS; BALACLAVAS; BALL GOWNS; BALLET SHOES; BALLET SLIPPERS; BALLON PANTS; BALLROOM DANCING SHOES; BALLROOM DANCING UNIFORMS; BANDANAS; BANDEAU TOPS; BANDEAUX; BASEBALL CAPS; BATH SLIPPERS; BATHING CAPS; BATHING COSTUMES; BATHING COSTUMES FOR WOMEN; BATHING SUITS; BATHING SUITS FOR MEN; BATHING TRUNKS; BATHROBES; BEACH COVERUPS; BEACH COVER-UPS; BEACH FOOTWEAR; BEACH SHOES; BEACHWEAR; BEANIES; BED JACKETS; BELTS; BELTS FOR CLOTHING; BELTS MADE FROM IMITATION LEATHER; BELTS MADE OF LEATHER; BELTS MADE OUT OF CLOTH; BELTS OF TEXTILE; BELTS THAT ARE DESIGNED TO ACCOMMODATE PREGNANCY SIZE CHANGES; BERETS; BERMUDA SHORTS; BIKINIS; BLAZERS; BLOOMERS; BLOUSES; BLOUSONS; BOARD SHORTS; BOAS; BOAT SHOES; BODICES; BODY LINEN; BODY SHAPERS; BODY SHIRTS; BODY STOCKINGS; BODY SUITS; BO-

CLASS 25—(Continued).

LEROS; BOLO TIES; BOMBER JACKETS; BONNETS; BOOTIES; BOOTS; BOTTOMS; BOW TIES; BRAS; BRASSIERES; BREECHES; BRIDESMAID DRESSES; BRIEFS; BRIEFS; BUCKET CAPS; BUSTIERS; BUSTLE HOLDER BANDS FOR OBI (OBIAGE); BUSTLES FOR OBI-KNOTS (OBIAGE-SHIN); BUTTON DOWN SHIRTS; BUTTON-FRONT ALOHA SHIRTS; CAFTANS; CAGOULES; CAMISETTES; CAMISOLES; CANVAS SHOES; CAP PEAKS; CAP VISORS; CAPELETS; CAPES; CAPRI PANTS; CAPRIS; CAPS; CAPS WITH VISORS; CARDIGANS; CARGO PANTS; CASSOCKS; CAT SUITS; CHEMISES; CHEMISETTES; CHILDREN'S AND INFANTS' CLOTH BIBS; CHILDREN'S AND INFANT'S APPAREL, NAMELY, JUMPERS, OVERALL SLEEPWEAR, PAJAMAS, ROMPERS AND ONE-PIECE GARMENTS; CHILDREN'S AND INFANTS' APPAREL TREATED WITH FIRE AND HEAT RETARDANTS, NAMELY, JUMPERS, OVERALL SLEEPWEAR, PAJAMAS, ROMPERS AND ONE-PIECE GARMENTS; CHILDREN'S CLOTH EATING BIBS; CHILDREN'S HEADWEAR; CHOIR ROBES; CLOAKS; CLOGS; CLOTH BIBS; CLOTH BIBS FOR ADULT DINERS; CLOTH BIBS FOR USE BY SENIOR CITIZENS OR PHYSICALLY- OR MENTALLY-CHALLENGED PERSONS; CLOTH DIAPERS; CLOTHING EXTENSION USED TO EXTEND THE NORMAL SIZE RANGE OF CLOTHING ITEMS TO ACCOMMODATE PREGNANCY SIZE CHANGES; CLOTHING FOR BABIES, TODDLERS AND CHILDREN, TREATED WITH FIRE AND HEAT RETARDANTS, NAMELY, PAJAMAS, JACKETS, SHIRTS, PANTS, JUMPERS; CLOTHING, NAMELY, BASE LAYERS; CLOTHING, NAMELY, COWLS AND SMOKE RING SCARVES; CLOTHING, NAMELY, FOLK COSTUMES; CLOTHING, NAMELY, HAND-WARMERS; CLOTHING, NAMELY, KHAKIS; CLOTHING, NAMELY, KNEE WARMERS; CLOTHING, NAMELY, WRAP-AROUNDS; COATS; COATS FOR MEN AND WOMEN; COATS MADE OF COTTON; COATS OF DENIM; COLLARED SHIRTS; COLLARS; COMBINATIONS; CORSELETS; CORSETS; COVERALLS; COVERUPS; CREW NECK SWEATERS; CREW NECKS; CROP PANTS; CROP TOPS; CROSS-COUNTRY GLOVES; CROSS-COUNTRY MITTENS; CUFFS; CULOTTES; CUMMERBUNDS; CUSTOM MADE TO MEASURE SUITS FOR MEN AND WOMEN; DANCE COSTUMES; DANCE SHOES; DANCE SLIPPERS; DENIM JACKETS; DENIMS; DETACHABLE NECKPIECES FOR KIMONOS (HANERI); DOWN JACKETS; DOWN SUITS; DRESS PANTS; DRESS SHIELDS; DRESS SHIRTS; DRESS SUITS; DRESSES; DRESSES MADE FROM SKINS; DRESSES THAT MAY ALSO BE USED AS TOWELS; DRESSING GOWNS; DRESSING GOWNS AND BATH ROBES; DRIVERS; DUNGAREES; DUST COATS; DUSTERS; EAR BANDS; EAR MUFFS; EAR WARMERS; EMBOSSED SOLES AND HEELS OF RUBBER OR OF PLASTIC MATERIALS; ESPADRILLES; EVENING DRESSES; EVENING GOWNS; EYESHADES; FABRIC BELTS; FINGERLESS GLOVES; FINISHED TEXTILE LININGS FOR GARMENTS; FITTED SHOE OR BOOT COVERING TO PROTECT THE SHOES OR BOOT FROM WATER OR OTHER DAMAGE; FITTED SWIMMING COSTUMES WITH BRA CUPS; FLEECE BOTTOMS; FLEECE PULLOVERS; FLEECE SHORTS; FLEECE TOPS; FLEECE VESTS; FOOTWEAR; FOOTWEAR; FOOTWEAR FOR MEN AND WOMEN; FOOTWEAR MADE OF WOOD; FOOTWEAR NOT FOR SPORTS; FOOTWEAR, NAMELY, PUMPS; FOOTWEAR, NAMELY, RUBBERS; FOOTWEAR, NAMELY, WORK BOOTS; FOULARDS; FOUNDATION GARMENTS; FOUNDATION GARMENTS WORN AROUND THE MIDSECTION OR THIGHS TO KEEP THE STOMACH IN AND CREATE A SLIMMING EFFECT; FROCKS; FUR CLOAKS; FUR COATS AND JACKETS; FUR HATS; FUR MUFFS; FUR STOLETS; GABERDINES; GAITERS; GAITERS OF LEATHER; GALOSHES; GARTER BELTS; GARTERS; GAUCHOS; GIFT PACKAGES SOLD AS A UNIT CONSISTING PRIMARILY OF A SWEATSHIRT AND ALSO INCLUDING A PHOTO FRAME, A COFFEE MUG, AND A TOTE BAG; GILETS; GIRDLES; GLOVES; GLOVES FOR APPAREL; GLOVES INCLUDING THOSE MADE OF SKIN, HIDE OR FUR; GOWNS; GREAT-COATS; GYM BOOTS; GYM PANTS; GYM SHORTS; GYM SUITS; GYMNASIIC SHOES; G-STRINGS; HALLOWEEN COSTUMES; HALTER TOPS; HAT BANDS; HATS; HATS FOR INFANTS, BABIES, TODDLERS AND CHILDREN; HEAD SCARVES; HEAD SWEATBANDS; HEAD WEAR; HEADBANDS; HEADBANDS AGAINST SWEATING; HEADBANDS FOR CLOTHING; HEAVY COATS; HEAVY JACKETS; HEEL INSERTS; HEEL

CLASS 25—(Continued).

PIECES FOR SHOES; HEELS; HIGH RAIN CLOGS (ASHIDA); HIKING BOOTS; HIP-GUARDS ESPECIALLY MADE FOR FISHING; HOCKEY SHOES; HOODED PULLOVERS; HOODED SWEAT SHIRTS; HOODED SWEATSHIRTS; HOODED SWEATSHIRTS; HOODS; HORSE-RIDING BOOTS; HOSIERY; HOUSECOATS; INFANT AND TODDLER ONE PIECE CLOTHING; INFANT CLOTH DIAPERS; INFANT DIAPER COVERS; INFANT SLEEPERS; INFANT WEAR; INFANT WEARABLE BLANKETS; INFANTS' SHOES AND BOOTS; INFANTS' TROUSERS; INFANTWEAR; JACKET LINERS; JACKETS AND SOCKS; JANDALS; JEANS; JEGGINGS, NAMELY, PANTS THAT ARE PARTIALLY JEANS AND PARTIALLY LEGGINGS; JERKINS; JERSEYS; JODHPURS; JOGGING OUTFITS; JOGGING PANTS; JOGGING SUITS; JUMP SUITS; JUMPER DRESSES; JUMPERS; JUMPSUITS; KAFTANS; KILTS; KIMONOS; KNEE HIGHS; KNEE-HIGH STOCKINGS; KNICKERS; KNIT BOTTOMS; KNIT DRESSES; KNIT FACE MASKS; KNIT JACKETS; KNIT SHIRTS; KNIT SKIRTS; KNIT TOPS; KNITTED CAPS; KNITTED GLOVES; KNITTED UNDERWEAR; KNOT CAPS; KNOTTED CAPS; LACE BOOTS; LADIES' BOOTS; LADIES' SUITS; LADIES' UNDERWEAR; LAYETTES; LEATHER BELTS; LEATHER BOOTS; LEATHER COATS; LEATHER HATS; LEATHER HEADWEAR; LEATHER JACKETS; LEATHER PANTS; LEATHER SHIRTS; LEATHER SHOES; LEATHER SKIRTS; LEATHER SLIPPERS; LEATHER VESTS; LEGGINGS; LEGGINS; LEGWARMERS; LEISURE SHOES; LEISURE SUITS; LEOTARDS; LEOTARDS AND TIGHTS FOR WOMEN, MEN AND CHILDREN OF NYLON, COTTON OR OTHER TEXTILE FIBERS; LIGHT-REFLECTING COATS; LIGHT-REFLECTING JACKETS; LINGERIE; LINGERIE ACCESSORIES, NAMELY, REMOVABLE SILICONE BREAST ENHANCER PADS USED IN A BRA; LIVERIES; LOAFERS; LONG JACKETS; LONG JOHNS; LONG SLEEVE PULLOVERS; LONG SLEEVED VESTS; LONG UNDERWEAR; LONG-SLEEVED SHIRTS; LOUNGE PANTS; LOUNGEWEAR; LOW WOODEN CLOGS (HIYORI-GETA); LOW WOODEN CLOGS (KOMA-GETA); MAILLOTS; MANIPLES; MANTILLAS; MANTLES; OBIS; ONE PIECE GARMENT FOR INFANTS AND TODDLERS; ONE-PIECE GARMENTS FOR CHILDREN; ONE-PIECE PLAY SUITS; OPEN-NECKED SHIRTS; OUTDOOR GLOVES; OUTDOOR MITTENS; OUTER JACKETS; OVER COATS; OVER SHIRTS; OVERALLS; OVERALLS FOR USE IN SALONS AND BARBER SHOPS; OVERSHOES; OVER-TROUSERS; PADDED JACKETS; PADDING JACKETS; PAJAMA BOTTOMS; PAJAMAS; PAJAMAS TREATED WITH FIRE AND HEAT RETARDANTS; PANTALOONS; PANTIES; PANTIES, SHORTS AND BRIEFS; PANTS; PANTSUITS; PANTY-HOSE; PARTS OF CLOTHING, NAMELY, GUSSETS FOR TIGHTS, GUSSETS FOR STOCKINGS, GUSSETS FOR BATHING SUITS, GUSSETS FOR UNDERWEAR, GUSSETS FOR LEOTARDS AND GUSSETS FOR FOOTLETS; PARTS OF CLOTHING, NAMELY, UNDERARM GUSSETS; PARTY HATS; PEACOATS; PEDICURE SANDALS; PEDICURE SLIPPERS; PETTICOATS; PETTI-PANTS; PIQUE SHIRTS; PLASTIC APRONS; PLASTIC BABY BIBS; PLAY SUITS; PLEATED SKIRTS FOR FORMAL KIMONOS (HAKAMA); POLO KNIT TOPS; POLO SHIRTS; PONCHOS; PRAM SUITS; PULLOVERS; PUMPS; PUTTEES AND GAITERS; PYJAMAS; QUILTED VESTS; RACE NUMBER BELTS THAT HOLD A PAPER NUMBER ON THE RACE PARTICIPANT'S FRONT OR BACK DURING COMPETITION; RAIN BOOTS; RAIN COATS; RAIN HATS; RAIN JACKETS; RAIN SLICKERS; RAIN SUITS; RAIN TROUSERS; RAIN WEAR; RAINPROOF JACKETS; RASH GUARDS; REDINGOTES; REMOVABLE COLLARS; REVERSIBLE JACKETS; RIDING BOOTS; RIDING COATS; RIDING GLOVES; RIDING SHOES; ROBES; ROMPERS; RUNNING SHOES; RUNNING SUITS; SABOTS; SAILOR SUITS; SALOPETTES; SANDALS; SANDALS AND BEACH SHOES; SANDAL-CLOGS; SAREES; SARIS; SARONGS; SASH BANDS FOR KIMONO (OBI); SASHES; SCARFS; SCARVES; SCHOOL UNIFORMS; SHAPEWEAR, NAMELY, GIRDLES, BRAS; SHAWLS; SHAWLS; STOLAS; SHELL JACKETS; SHIRTS; SHIRT FRONTS; SHIRT INSERTS, NAMELY, DICKIES; SHIRT YOKES; SHIRTS; SHIRTS AND SHORT-SLEEVED SHIRTS; SHIRTS AND SLIPS; SHIRTS FOR INFANTS, BABIES, TODDLERS AND CHILDREN; SHIRTS FOR SUITS; SHOE STRAPS; SHOES; SHORT OVERCOAT FOR KIMONO (HAORI); SHORT PETTICOATS; SHORT SETS; SHORT TROUSERS; SHORTALLS; SHORTS; SHORT-

CLASS 25—(Continued).

SLEEVED OR ; LONG-SLEEVED T-SHIRTS; SHORT-SLEEVED SHIRTS; SHOULDER SCARVES; SHOULDER WRAPS; SHOULDER WRAPS FOR CLOTHING; SHRUGS; SILK SCARVES; SINGLET; SKATING OUTFITS; SKIRT SUITS; SKIRTS; SKORTS; SKULL CAPS; SKULLIES; SLACKS; SLEEP MASKS; SLEEP PANTS; SLEEP SHIRTS; SLEEPING GARMENTS; SLEEPWEAR; SLEEPWEAR TREATED WITH FIRE AND HEAT RETARDANTS; SLEEVED OR SLEEVELESS JACKETS; SLEEVELESS JERSEYS; SLEEVES WORN SEPARATE AND APART FROM BLOUSES, SHIRTS AND OTHER TOPS; SLIDING SHORTS; SLIPOVERS; SLIPPER SOCKS; SLIPPER SOLES; SLIPPERS; SLIPS; SMALL HATS; SMOCKS; SMOKING JACKETS; SNAP CROTCH SHIRTS FOR INFANTS AND TODDLERS; SNEAKERS; SOCK SUSPENDERS; SOCKS AND STOCKINGS; SPATS; SPORT COATS; SPORT SHIRTS; SPORT STOCKINGS; SPORTS BRA; SPORTS BRAS; SPORTS CAPS AND HATS; SPORTS JACKETS; SPORTS JERSEYS; SPORTS JERSEYS AND BREECHES FOR SPORTS; SPORTS PANTS; SPORTS SHIRTS; SPORTS SHIRTS WITH SHORT SLEEVES; SPORTS VESTS; STILETTO HEELS; STOCKING SUSPENDERS, STOCKINGS, STOCKINGS, STRAPLESS BRAS, STRAPS FOR BRAS, STRETCH PANTS, STUDS FOR FOOTBALL BOOTS, STUFF JACKETS, SUEDE JACKETS; SUIT COATS; SUITS; SUITS OF LEATHER; SUN LEGGINGS; SUN PROTECTIVE CLOTHING, NAMELY, SHIRTS, PANTS; SUN SLEEVES; SUN VISORS; SUNDRESSES; SUNSUITS; SUSPENDER BELTS; SUSPENDER BELTS FOR MEN; SUSPENDER BELTS FOR WOMEN; SUSPENDERS; SUSPENDERS; SWADDLING CLOTHES; SWEAT BANDS; SWEAT JACKETS; SWEAT PANTS; SWEAT SHIRTS; SWEAT SHORTS; SWEAT SUITS; SWEATBANDS; SWEATERS; SWEAT-PANTS; SWEATSHIRTS; SWEATSHIRTS FOR BABIES, ADULTS, CHILDREN, WOMEN, MEN; SWEATSOCKS; SWEATSUITS; SWIM CAPS; SWIM SUITS; SWIM TRUNKS; SWIM WEAR; SWIM WEAR FOR GENTLEMEN AND LADIES; SWIMMING CAPS; SWIMMING CAPS; SWIMMING COSTUMES; SWIMMING TRUNKS; SWIMSUITS; SWIMWEAR; TANK TOPS; TANKINIS; TANK-TOPS; TAP PANTS; TAP SHOES; TEDDIES; TEE SHIRTS; TENNIS DRESSES; TENNIS SHOES; TENNIS WEAR; THERMAL SOCKS; THERMAL UNDERWEAR; THONGS; THONGS; TIES; TIGHTS; TIPS FOR FOOTWEAR; TOBOGGAN HATS, PANTS AND CAPS; TOGAS; TOP COATS; TOPS; TRACK AND FIELD SHOES; TRACK JACKETS; TRACK PANTS; TRACK SUITS; TRACKSUITS; TRAINING SHOES; TRAINING SUITS; TRAVEL CLOTHING CONTAINED IN A PACKAGE COMPRISING REVERSIBLE JACKETS, PANTS, SKIRTS, TOPS AND A BELT OR SCARF; TREKKING BOOTS; TRENCH COATS; TROUSERS; TROUSERS FOR SWEATING; TROUSERS OF LEATHER; TRUNKS; TUBE TOPS; TUNICS; TURTLE NECK SHIRTS; TURTLENECK PULLOVERS; TURTLENECK SWEATERS; TURTLENECKS; TUXEDO BELTS; TUXEDOS; TWIN SETS; T-SHIRTS; T-SHIRTS FOR BABIES, ADULTS, CHILDREN, WOMEN, MEN; UNDER GARMENTS; UNDERARM CLOTHING SHIELDS; UNDERCLOTHES; UNDERGARMENT ACCESSORIES, NAMELY, REMOVABLE SILICONE BUTTOCK ENHANCER PADS; UNDERGARMENTS; UNDERGARMENTS, NAMELY, WASPIES; UNDERPANTS; UNDERSHIRTS; UNDERSHIRTS FOR KIMONOS (JUBAN); UNDERSHIRTS FOR KIMONOS (KOSHIMAKI); UNDERSKIRTS; UNDERWEAR; UNDERWEAR, NAMELY, BOY SHORTS; UNIFORMS; UNION SUITS; UNITARDS; VEILS; VEST EXTENDERS; VESTED SUITS; VESTS; VISCOUS GEL POLYMER SOLD AS A COMPONENT OF FINISHED CUSTOM CUSHIONED FOOTWEAR FOR NON-ORTHOPEDIC PURPOSES AND APPAREL; VISORS; V-NECK SWEATERS; WAIST BANDS; WAIST BELTS; WAIST CINCHERS; WAIST STRINGS FOR KIMONOS (KOSHIMIMO); WAISTBAND EXTENDER CONSISTING OF A BUTTON AND BUTTON HOLE MOUNTED ON A STRIP OF FABRIC THAT IS INSERTED INTO THE EXISTING WAISTBAND OF A GARMENT; WAISTBANDS; WAISTCOATS; WALKING SHORTS; WARM UP OUTFITS; WARM UP SUITS; WARM-UP SUITS; WATER PROOF BOOTS; WATER REPELLING BOOTS; WATER REPELLING FOOTWEAR; WATER REPELLING LEATHER BOOTS; WATER REPELLING LEATHER SHOES AND BOOTS; WATERPROOF FOOTWEAR; WATERPROOF JACKETS AND PANTS; WATERPROOF LEATHER BOOTS; WATERPROOF LEATHER SHOES; WATERPROOF LEATHER SHOES AND BOOTS; WEARABLE BLANKETS IN THE NATURE OF BLANKETS WITH

CLASS 25—(Continued).

SLEEVES; WEARABLE GARMENTS AND CLOTHING, NAMELY, SHIRTS; WEDDING DRESSES; WEDDING GOWNS; WELTS FOR BOOTS AND SHOES; WET SUIT GLOVES; WET SUITS; WET SUITS FOR WATER-SKIING AND SUB-AQUA; WETSUITS; WETSUITS FOR WATER-SKIING; WIND COATS; WIND PANTS; WIND RESISTANT JACKETS; WIND SHIRTS; WIND VESTS; WIND-CHEATERS; WINDJAMMERS; WINDSHIRTS; WIND-JACKETS; WINTER BOOTS; WOMEN'S ATHLETIC TOPS WITH BUILT-IN BRAS; WOMEN'S CEREMONIAL DRESSES; WOMEN'S CLOTHING, NAMELY, SHIRTS, DRESSES, SKIRTS, BLOUSES; WOMEN'S FOLDABLE SLIPPERS; WOMEN'S HATS AND HOODS; WOMEN'S SHOES; WOMEN'S SHOES, NAMELY, FOLDABLE FLATS; WOMEN'S TOPS, NAMELY, CAMIS; WOMEN'S UNDERWEAR; WOODEN SHOES; WOOLLEN SOCKS; WOOLLEN TIGHTS, WOOLLY HATS, WORK SHOES AND BOOTS, WORKING OVERALLS, WOVEN BOTTOMS, WOVEN DRESSES, WOVEN OR KNITTED UNDERWEAR; WOVEN SKIRTS; WOVEN TOPS; WRAP BELTS FOR KIMONOS (DATEMAKI); WRAPS, WRIST BANDS, WRISTBANDS, WRISTBANDS CONTAINING A COOLING SUBSTANCE TO COOL THE WEARER; YOGA PANTS, YOGA SHIRTS (U.S. CLS. 22 AND 39).

FIRST USE 10-1-2009; IN COMMERCE 7-9-2011.
THOMAS MANOR, EXAMINING ATTORNEY

SN 85-441,122. PIN UP GIRL INC., ALTADENA, CA. FILED 10-6-2011.

Laura Byrnes

THE MARK CONSISTS OF STANDARD CHARACTERS WITHOUT CLAIM TO ANY PARTICULAR FONT, STYLE, SIZE, OR COLOR.

THE NAME(S), PORTRAIT(S), AND/OR SIGNATURE(S) SHOWN IN THE MARK IDENTIFIES "LAURA BYRNES", WHOSE CONSENT(S) TO REGISTER IS MADE OF RECORD.

FOR WOMEN'S CLOTHING, NAMELY, DRESSES, TOPS, SKIRTS, AND JACKETS (U.S. CLS. 22 AND 39).

FIRST USE 1-31-2011; IN COMMERCE 3-1-2011.
WILLIAM BRECKENFELD, EXAMINING ATTORNEY

CLASS 25—(Continued).

SN 85-441,504. KIMSAPRINCESS INC., WOODLAND HILLS, CA. AND 2DIE4KOURT, WOODLAND HILLS, CA. AND KHLOMONEY INC., WOODLAND HILLS, CA. FILED 10-6-2011.

KARDASHIAN KOLLECTION DENIM

THE MARK CONSISTS OF STANDARD CHARACTERS WITHOUT CLAIM TO ANY PARTICULAR FONT, STYLE, SIZE, OR COLOR.

NO CLAIM IS MADE TO THE EXCLUSIVE RIGHT TO USE "COLLECTION DENIM", APART FROM THE MARK AS SHOWN.

THE NAME(S), PORTRAIT(S), AND/OR SIGNATURE(S) SHOWN IN THE MARK IDENTIFIES KIMBERLY KARDASHIAN, KOURTNEY KARDASHIAN, KHLOE KARDASHIAN ODOM, WHOSE CONSENT(S) TO REGISTER IS MADE OF RECORD.

FOR WEARING APPAREL MADE PRIMARILY OF DENIM, NAMELY, LOUNGEWEAR, SWEATSHIRTS, JEANS, PANTS, KHAKI PANTS, GOLF TROUSERS, VESTS, SHORTS, SHIRTS, BLOUSES, SKIRTS, DRESSES, SWEATERS, FLEECE PULLOVERS, SWEAT SUITS, JOGGING SUITS, SUITS, TEE SHIRTS, KNIT SHIRTS, POLO SHIRTS, RUGBY SHIRTS, GOLF SHIRTS, TANK TOPS, JERSEYS, WOVEN SHIRTS, BLAZERS, HATS, SCARVES, TIGHTS, STOCKINGS, SHAWLS, LEOTARDS, UNDERGARMENTS, ROBES, OUTERGARMENT SHAPEWEAR MADE PRIMARILY OF DENIM, NAMELY, WOMEN'S SWIMSUITS, WOMEN'S HOSIERY, WOMEN'S BODY SUITS, AND WOMEN'S PANTY HOSE, UNITARDS, LINGERIE, BODY SUITS, LEG WARMERS, LEGGINGS, SOCKS, TIES, SWEATERS, STOCKINGS, SUSPENDERS, PARKAS, PONCHOS, RAIN SUITS, JACKETS, OVERCOATS, RAINCOATS, COATS, GLOVES, BELTS, WINTER SCARVES, ATHLETIC UNIFORMS, SLEEPWEAR, YOGA PANTS, YOGA SHIRTS, YOGA SHORTS, DENIM JEANS, DENIM SHORTS, DENIM JACKETS, DENIM SKIRTS, DENIM TOPS; ATHLETIC APPAREL MADE PRIMARILY OF DENIM, NAMELY, SHIRTS, PANTS, JACKETS, FOOTWEAR, HATS AND CAPS, ATHLETIC UNIFORMS; COMPRESSION GARMENTS MADE PRIMARILY OF DENIM FOR ATHLETIC OR OTHER NON-MEDICAL USE, NAMELY, COMPRESSION SOCKS, STOCKINGS, LEGGINGS, JERSEYS, VESTS, SHIRTS, TROUSERS; SWIMWEAR MADE PRIMARILY OF DENIM, NAMELY, TRUNKS, BOARD SHORTS, BIKINIS, TANKINIS, BATHING SUITS; FOOTWEAR MADE PRIMARILY OF DENIM, NAMELY, BOOTS, SLIPPERS, SANDALS, PUMPS, FLATS, ATHLETIC FOOTWEAR; HEADWEAR MADE PRIMARILY OF DENIM, NAMELY, HATS, CAPS, VISORS, HEAD BANDS; WRIST BANDS MADE PRIMARILY OF DENIM; TOPS MADE PRIMARILY OF DENIM; BOTTOMS MADE PRIMARILY OF DENIM (U.S. CLS. 22 AND 39).

MICHAEL SOUDERS, EXAMINING ATTORNEY

CLASS 25—(Continued).

SN 85-441,508. KIMSAPRINCESS INC., WOODLAND HILLS, CA. AND 2DIE4KOURT, WOODLAND HILLS, CA. AND KHLOMONEY INC., WOODLAND HILLS, CA. FILED 10-6-2011.



NO CLAIM IS MADE TO THE EXCLUSIVE RIGHT TO USE "COLLECTION DENIM", APART FROM THE MARK AS SHOWN.

THE MARK CONSISTS OF THE STYLIZED TEXT "KK KARDASHIAN KOLLECTION DENIM", THE FIRST "K" BEING BACKWARDS.

FOR WEARING APPAREL MADE PRIMARILY OF DENIM, NAMELY, LOUNGEWEAR, SWEATSHIRTS, JEANS, PANTS, KHAKI PANTS, GOLF TROUSERS, VESTS, SHORTS, SHIRTS, BLOUSES, SKIRTS, DRESSES, SWEATERS, FLEECE PULLOVERS, SWEAT SUITS, JOGGING SUITS, SUITS, TEE SHIRTS, KNIT SHIRTS, POLO SHIRTS, RUGBY SHIRTS, GOLF SHIRTS, TANK TOPS, JERSEYS, WOVEN SHIRTS, BLAZERS, HATS, SCARVES, TIGHTS, STOCKINGS, SHAWLS, LEOTARDS, UNDERGARMENTS, ROBES, OUTERGARMENT SHAPEWEAR MADE PRIMARILY OF DENIM, NAMELY, WOMEN'S SWIMSUITS, WOMEN'S HOSIERY, WOMEN'S BODY SUITS, AND WOMEN'S PANTY HOSE, UNITARDS, LINGERIE, BODY SUITS, LEG WARMERS, LEGGINGS, SOCKS, TIES, SWEATERS, STOCKINGS, SUSPENDERS, PARKAS, PONCHOS, RAIN SUITS, JACKETS, OVERCOATS, RAINCOATS, COATS, GLOVES, BELTS, WINTER SCARVES, ATHLETIC UNIFORMS, SLEEPWEAR, YOGA PANTS, YOGA SHIRTS, YOGA SHORTS, DENIM JEANS, DENIM SHORTS, DENIM JACKETS, DENIM SKIRTS, DENIM TOPS; ATHLETIC APPAREL MADE PRIMARILY OF DENIM, NAMELY, SHIRTS, PANTS, JACKETS, FOOTWEAR, HATS AND CAPS, ATHLETIC UNIFORMS; COMPRESSION GARMENTS MADE PRIMARILY OF DENIM FOR ATHLETIC OR OTHER NON-MEDICAL USE, NAMELY, COMPRESSION SOCKS, STOCKINGS, LEGGINGS, JERSEYS, VESTS, SHIRTS, TROUSERS; SWIMWEAR MADE PRIMARILY OF DENIM, NAMELY, TRUNKS, BOARD SHORTS, BIKINIS, TANKINIS, BATHING SUITS; FOOTWEAR MADE PRIMARILY OF DENIM, NAMELY, BOOTS, SLIPPERS, SANDALS, PUMPS, FLATS, ATHLETIC FOOTWEAR; HEADWEAR MADE PRIMARILY OF DENIM, NAMELY, HATS, CAPS, VISORS, HEAD BANDS; WRIST BANDS MADE PRIMARILY OF DENIM; TOPS MADE PRIMARILY OF DENIM; BOTTOMS MADE PRIMARILY OF DENIM (U.S. CLS. 22 AND 39).

MICHAEL SOUDERS, EXAMINING ATTORNEY

CLASS 25—(Continued).

SN 85-447,720. S.P.I.C. ENTERTAINMENT, LLC, MAITLAND, FL. FILED 10-14-2011.

SPICILICIOUS

THE MARK CONSISTS OF STANDARD CHARACTERS WITHOUT CLAIM TO ANY PARTICULAR FONT, STYLE, SIZE, OR COLOR.

FOR CLOTHING, NAMELY, SHIRTS, T-SHIRTS, POLO SHIRTS, GOLF SHIRTS, TANK TOPS, HATS, SHORTS, BABYDOLLS, LINGERIE, TEDDIES, BRAS, PANTIES, THONGS, GARTERS, G-STRINGS, GARTER BELTS, CHEMISES, CAMISOLES, CAMI SKIRT SETS, SKIRTS, BUSTIERS, CORSETS, SHOES, FOOTWEAR, SWEATSHIRTS, SWEATPANTS, BATHING SUITS, JERSEYS, BASEBALL SHIRTS, SWIM WEAR, DRESSES, JACKETS, PANTS, NIGHT SHIRTS, ROBES, CAPS, HATS, VISORS, BELTS, SHORTS, SOCKS, UNDERWEAR, BANDANNAS, JOGGING OUTFITS, NECKTIES, CAMP SHIRTS, BOXERS, SLEEP PANTS, SLEEP SHORTS, NIGHTGOWNS, YOGA/EXERCISE PANTS, AND LOUNGEWEAR (U.S. CLS. 22 AND 39).

CHRISTINA SOBRAL, EXAMINING ATTORNEY

SN 85-448,226. ARIZA, MARCUS, RIVERSIDE, CA. FILED 10-14-2011.

TU PONLE

THE MARK CONSISTS OF STANDARD CHARACTERS WITHOUT CLAIM TO ANY PARTICULAR FONT, STYLE, SIZE, OR COLOR.

THE ENGLISH TRANSLATION OF THE WORD "TU PONLE" IN THE MARK IS "GO FOR IT".

FOR JACKETS; PANTS; SHIRTS; SHOES (U.S. CLS. 22 AND 39).

DAVID MURRAY, EXAMINING ATTORNEY

SN 85-449,119. TOPS INTERNATIONAL INC, DBA TOPS INTERNATIONAL INC, HOUSTON, TX. FILED 10-17-2011.

TOPSPORT

THE MARK CONSISTS OF STANDARD CHARACTERS WITHOUT CLAIM TO ANY PARTICULAR FONT, STYLE, SIZE, OR COLOR.

FOR ATHLETIC APPAREL, NAMELY, SHIRTS, PANTS, JACKETS, FOOTWEAR, HATS AND CAPS, ATHLETIC UNIFORMS; ATHLETIC TIGHTS; CLOTHING FOR ATHLETIC USE, NAMELY, PADDED SHORTS; SWIMSUITS (U.S. CLS. 22 AND 39).

ALEX KEAM, EXAMINING ATTORNEY

CLASS 25—(Continued).

SN 85-451,448. BLANKENSHIP, JENE, DALLAS, TX. FILED 10-19-2011.

Jené Darene

THE MARK CONSISTS OF STANDARD CHARACTERS WITHOUT CLAIM TO ANY PARTICULAR FONT, STYLE, SIZE, OR COLOR.

"JENE DARENE" IS THE FIRST AND MIDDLE NAMES OF JENE BLANKENSHIP AND "JENÉ DARENE" IDENTIFIES A LIVING INDIVIDUAL WHOSE CONSENT IS OF RECORD.

FOR DRESSES; JEANS; PANTS; SKIRTS; TOPS (U.S. CLS. 22 AND 39).

MARY ROSSMAN, EXAMINING ATTORNEY

SN 85-454,763. BANSAL, JATINDER I.S., ILFORD, UNITED KINGDOM, FILED 10-24-2011.

JAWBREAKER

THE MARK CONSISTS OF STANDARD CHARACTERS WITHOUT CLAIM TO ANY PARTICULAR FONT, STYLE, SIZE, OR COLOR.

FOR CLOTHING, NAMELY, TOPS, BOTTOMS, PANTS, SHIRTS, T-SHIRTS, SHORTS, SWEATERS, SUITS, BATHING SUITS, BATHROBES, COATS, JACKETS, DRESSES, SHOES, SOCKS, RAINCOATS, SKIRTS, BLOUSES, SWEATSHIRTS, SWEATPANTS, UNDERWEAR, ATHLETIC FOOTWEAR, CAPS, HATS AND HEADBANDS (U.S. CLS. 22 AND 39).

ZACHARY BELLO, EXAMINING ATTORNEY

CLASS 25—(Continued).

SN 85-461,838. SCREEN, IRRIX, AKA D.U.O GEAR, WHITE PLAINS, NY. FILED 11-1-2011.



NO CLAIM IS MADE TO THE EXCLUSIVE RIGHT TO USE "GEAR", APART FROM THE MARK AS SHOWN.

THE COLOR(S) BLACK AND WHITE IS/ARE CLAIMED AS A FEATURE OF THE MARK.

THE MARK CONSISTS OF THE WORDING "D.U.O" IN A GRAFFITI STYLE FONT ABOVE A STYLIZED SKULL IMAGE; THE SKULL IS WEARING A SWEATER CAP AND A BARBELL NOSE RING AND BARBELL EARRINGS IN BOTH EARS. A THIN BLACK LINE FROM THE LEFT EYE GOES DOWN THE SKULL'S FACE; THE SKULL ALSO HAS A SMALL BALL PIERCING ITS LOWER LIP. THE WORDING "GEAR" APPEARS BELOW THE SKULL IN A GRAFFITI STYLE FONT.

FOR CLOTHING AND APPAREL, NAMELY, T-SHIRTS, HATS, SWEATSHIRTS, SHORTS, CAPS, PANTS, AND JACKETS (U.S. CLS. 22 AND 39).

SUZANNE BLANE, EXAMINING ATTORNEY

SN 85-462,958. GO THE DISTANCE BASEBALL, LLC, OAK LAWN, IL. FILED 11-2-2011.

ALL-STAR BALLPARK HEAVEN

THE MARK CONSISTS OF STANDARD CHARACTERS WITHOUT CLAIM TO ANY PARTICULAR FONT, STYLE, SIZE, OR COLOR.

FOR YOUTH, MEN'S, AND WOMEN'S APPAREL, NAMELY, TEE-SHIRTS, SWEATSHIRTS, CAPS, JACKETS, HATS, SOCKS, BELTS, PAJAMAS, SHOES, JERSEYS, BASEBALL UNIFORMS, WRISTBANDS, GLOVES, SCARVES, AND UNDERWEAR (U.S. CLS. 22 AND 39).

JULIE VEPPUMTHARA, EXAMINING ATTORNEY

CLASS 25—(Continued).

SN 85-463,438. CONDE, SAUL, DOWNEY, CA. FILED 11-3-2011.

Lodo

THE MARK CONSISTS OF STANDARD CHARACTERS WITHOUT CLAIM TO ANY PARTICULAR FONT, STYLE, SIZE, OR COLOR.

OWNER OF U.S. REG. NO. 3,607,584.
THE ENGLISH TRANSLATION OF "LODO" IN THE MARK IS "MUD".

FOR ATHLETIC APPAREL, NAMELY, SHIRTS, PANTS, JACKETS, FOOTWEAR, HATS AND CAPS, ATHLETIC UNIFORMS (U.S. CLS. 22 AND 39).

FIRST USE 11-12-2008; IN COMMERCE 11-12-2008.
STEVEN PEREZ, EXAMINING ATTORNEY

CLASS 25—(Continued).

SN 85-468,206. HERNANDEZ, JOSE, AMARILLO, TX. FILED 11-9-2011.

ANNIHILATION

THE MARK CONSISTS OF STANDARD CHARACTERS WITHOUT CLAIM TO ANY PARTICULAR FONT, STYLE, SIZE, OR COLOR.

FOR CLOTHING AND ATHLETIC APPAREL, NAMELY, SHIRTS, T-SHIRTS, SWEATSHIRTS, SHORTS, PANTS, SWEATS, HATS, BEANIES, JACKETS, SWEATERS, UNDERWEAR AND SOCKS; WRESTLING APPAREL, NAMELY, SINGLETS, SHOES, PANTS, JACKETS, FOOTWEAR, HATS, AND CAPS; ATHLETIC UNIFORMS; BOARD SHORTS; BODY SHIRTS; BOXER SHORTS; DRESS SHIRTS; FLEECE PULLOVERS; GYM SHORTS; HOODED SWEAT SHIRTS; JACKETS; KNIT SHIRTS; LIGHT-REFLECTING JACKETS; LONG-SLEEVED SHIRTS; MOISTURE-WICKING SPORTS PANTS; MOISTURE-WICKING SPORTS SHIRTS; OPEN-NECKED SHIRTS; POLO SHIRTS; SHIRTS; SHORT-SLEEVED OR LONG-SLEEVED T-SHIRTS; TOPS; BOTTOMS (U.S. CLS. 22 AND 39).

KATHLEEN LORENZO, EXAMINING ATTORNEY

SN 85-469,887. SKANNAL, DAVID I., MORENO VALLEY, CA. FILED 11-10-2011.

SN 85-464,647. THE COASTAL-LIFE LLC, GLEN ALLEN, VA. FILED 11-4-2011.

COASTAL WEAR



THE MARK CONSISTS OF STANDARD CHARACTERS WITHOUT CLAIM TO ANY PARTICULAR FONT, STYLE, SIZE, OR COLOR.

NO CLAIM IS MADE TO THE EXCLUSIVE RIGHT TO USE "WEAR", APART FROM THE MARK AS SHOWN.

FOR CLOTHING, NAMELY, BATHING SUITS; BIKINIS; BOARD SHORTS; CAPS; CHILDREN'S AND INFANT'S APPAREL, NAMELY, JUMPERS, OVERALL SLEEPWEAR, PAJAMAS, ROMPERS AND ONE-PIECE GARMENTS; COATS; COLLARED SHIRTS; FLEECE PULLOVERS; HATS; JACKETS; PANTIES; PANTS; SANDALS; SHIRTS; SHOES; SHORTS; SKIRTS AND DRESSES; SURF WEAR; SWEATERS; SWEATPANTS; SWEATSHIRTS; T-SHIRTS; UNDERWEAR; VISORS; WET SUITS; WIND RESISTANT JACKETS, AND ATHLETIC APPAREL, NAMELY, SHIRTS, PANTS, JACKETS, FOOTWEAR, HATS AND VISORS (U.S. CLS. 22 AND 39).

WILLIAM BRECKENFELD, EXAMINING ATTORNEY

THE MARK CONSISTS OF A RECTANGLE WITH A SLIT CUT OUT OF THE TOP, BOTTOM, AND RIGHT SIDES. IN THE CENTER OF THE RECTANGLE IS A STYLIZED LETTER "H" THAT IS CONNECTED TO THE INNER LEFT SIDE OF THE RECTANGLE BY A THICK BAR. THE UPPER RIGHT PORTION OF THE "H" IS CONNECTED TO THE INSIDE OF THE UPPER RIGHT CORNER OF THE RECTANGLE BY A THICK BAR, CREATING AN ARROW SHAPE. BELOW THE RECTANGLE IS THE STYLIZED TEXT "HONESTLY".

FOR HATS; JACKETS; T-SHIRTS; WRISTBANDS (U.S. CLS. 22 AND 39).

FIRST USE 7-1-2010; IN COMMERCE 9-15-2010.
DAVID ELTON, EXAMINING ATTORNEY

CLASS 25—(Continued).

SN 85-471,594. ANGELO GHAILIAN, LOS ANGELES, CA. FILED 11-14-2011.

WELL FACTORY CLOTHING

THE MARK CONSISTS OF STANDARD CHARACTERS WITHOUT CLAIM TO ANY PARTICULAR FONT, STYLE, SIZE, OR COLOR.

NO CLAIM IS MADE TO THE EXCLUSIVE RIGHT TO USE "FACTORY CLOTHING", APART FROM THE MARK AS SHOWN.

FOR CLOTHING, NAMELY, PANTS, JACKETS, SWEATERS, SWEATSHIRTS, TEE-SHIRTS, AND SHIRTS FOR MEN, WOMEN AND CHILDREN; DRESSES FOR WOMEN AND CHILDREN; AND ACCESSORIES, NAMELY, HATS AND BELTS (U.S. CLS. 22 AND 39).

TINA L. SNAPP, EXAMINING ATTORNEY

SN 85-474,087. FREEWAY APPAREL, INC., LOS ANGELES, CA. FILED 11-16-2011.

KRISTIN MILES

THE MARK CONSISTS OF STANDARD CHARACTERS WITHOUT CLAIM TO ANY PARTICULAR FONT, STYLE, SIZE, OR COLOR.

THE NAME(S), PORTRAIT(S), AND/OR SIGNATURE(S) SHOWN IN THE MARK DOES NOT IDENTIFY A PARTICULAR LIVING INDIVIDUAL.

FOR ATHLETIC APPAREL, NAMELY, SHIRTS, PANTS, JACKETS, FOOTWEAR, HATS AND CAPS, ATHLETIC UNIFORMS; BATHING SUITS; BELTS FOR CLOTHING; BLAZERS; BLOUSES; BODY SUITS; BOMBER JACKETS; CAMISOLES; CARDIGANS; CLOAKS; CLOTHING, NAMELY, WRAP-AROUNDS; COATS; CREW NECK SWEATERS; CROP TOPS; DENIM JACKETS; DRESS SHIRTS; DRESS SUITS; DRESSES; EVENING DRESSES; GLOVES; HALTER TOPS; HATS; HEAVY COATS; HEAVY JACKETS; HOODED SWEAT SHIRTS; JEANS; JEGGINGS, NAMELY, PANTS THAT ARE PARTIALLY JEANS AND PARTIALLY LEGGINGS; JOGGING PANTS; JOGGING SUITS; JUMPSUITS; KNIT SHIRTS; LADIES' SUITS; LEGGINGS; LEISURE SUITS; LINGERIE; LONG JACKETS; LOUNGE PANTS; LOUNGEWEAR; MOCK TURTLE-NECK SWEATERS; NIGHT GOWNS; NIGHT SHIRTS; OUTER JACKETS; OVER COATS; OVERALLS; PAJAMAS; PANTS; POLO SHIRTS; SHIRTS AND SHORT-SLEEVED SHIRTS; SHIRTS FOR SUITS; SHORT-SLEEVED OR LONG-SLEEVED T-SHIRTS; SHORT-SLEEVED SHIRTS; SHOULDER WRAPS; SKIRTS AND DRESSES; SLACKS; SLEEPWEAR; SLEEVED OR SLEEVELESS JACKETS; SUITS; SWEAT JACKETS; SWEAT PANTS; SWEAT SHIRTS; SWEAT SHORTS; SWEAT SUITS; SWEATERS; SWIM WEAR; T-SHIRTS; TANK TOPS; TUBE TOPS; TURTLENECK SWEATERS; VESTS; WARM UP SUITS; WOMEN'S CLOTHING, NAMELY, SHIRTS, DRESSES, SKIRTS, BLOUSES (U.S. CLS. 22 AND 39).

FIRST USE 9-1-2011; IN COMMERCE 9-1-2011.

HOWARD SMIGA, EXAMINING ATTORNEY

CLASS 25—(Continued).

SN 85-480,102. D'ARCE, JOSEPH M, MEDFORD, NY. FILED 11-23-2011.

DARCE CHOKE

THE MARK CONSISTS OF STANDARD CHARACTERS WITHOUT CLAIM TO ANY PARTICULAR FONT, STYLE, SIZE, OR COLOR.

THE NAME(S), PORTRAIT(S), AND/OR SIGNATURE(S) SHOWN IN THE MARK IDENTIFIES JOSEPH M. D'ARCE, WHOSE CONSENT(S) TO REGISTER IS MADE OF RECORD.

FOR HATS; HEADGEAR, NAMELY, HATS AND CAPS; HOODED SWEAT SHIRTS; JACKETS; MARTIAL ARTS UNIFORMS; MIXED MARTIAL ARTS SUITS; SHIRTS AND SHORT-SLEEVED SHIRTS; SHORT-SLEEVED OR LONG-SLEEVED T-SHIRTS; SWEAT SHIRTS; WEARABLE GARMENTS AND CLOTHING, NAMELY, SHIRTS (U.S. CLS. 22 AND 39).

LINDA MICKLEBURGH, EXAMINING ATTORNEY

SN 85-484,346. YOUNG, RICH C, ROSEMEAD, CA. FILED 11-30-2011.



NO CLAIM IS MADE TO THE EXCLUSIVE RIGHT TO USE "POLO", "AMERICA" OR "USA", APART FROM THE MARK AS SHOWN.

THE MARK CONSISTS OF THE PHRASE "THE POLO CLUB OF AMERICA" WITH SILHOUETTES OF POLO PLAYERS ON HORSES ON EITHER SIDE OF THIS WORDING WITH "USA" BELOW EACH HORSE; THE LEFT HORSE IS ENTIRELY IN SILHOUETTE EXCEPT FOR THE RIDER'S HELMET IS LINED TO SHOW DETAIL, AND THE RIGHT HORSE AND RIDER ARE FULLY LINED TO SHOW DETAIL.

FOR SHIRTS, POLO SHIRTS, TEE SHIRTS (U.S. CLS. 22 AND 39).

CHARLOTTE CORWIN, EXAMINING ATTORNEY

CLASS 25—(Continued).

SN 85-485,243. SCHMIDT, SHELLEY, GRANADA HILLS, CA.
FILED 12-1-2011.

travel pink

THE MARK CONSISTS OF STANDARD CHARACTERS WITHOUT CLAIM TO ANY PARTICULAR FONT, STYLE, SIZE, OR COLOR.

NO CLAIM IS MADE TO THE EXCLUSIVE RIGHT TO USE "PINK", APART FROM THE MARK AS SHOWN.

FOR BATHING SUITS; BRAS; GLOVES; HOODED SWEATSHIRTS; SHORTS; SOCKS; SWEATPANTS; T-SHIRTS; TANK TOPS; UNDERWEAR; WRISTBANDS (U.S. CLS. 22 AND 39).

PATRICIA EVANKO, EXAMINING ATTORNEY

SN 85-485,558. RUBANO, JULIE, MILFORD, CT. FILED 12-2-2011.

Two Cuffs and a Collar

THE MARK CONSISTS OF STANDARD CHARACTERS WITHOUT CLAIM TO ANY PARTICULAR FONT, STYLE, SIZE, OR COLOR.

NO CLAIM IS MADE TO THE EXCLUSIVE RIGHT TO USE "CUFFS" AND "COLLAR", APART FROM THE MARK AS SHOWN.

FOR COLLARS; CUFFS (U.S. CLS. 22 AND 39).
MARLENE BELL, EXAMINING ATTORNEY

SN 85-488,540. KIM OVITZ DESIGN INC., NEW YORK, NY.
FILED 12-6-2011.

O BY KIMBERLY OVITZ

THE MARK CONSISTS OF STANDARD CHARACTERS WITHOUT CLAIM TO ANY PARTICULAR FONT, STYLE, SIZE, OR COLOR.

THE NAME(S), PORTRAIT(S), AND/OR SIGNATURE(S) SHOWN IN THE MARK IDENTIFIES "KIMBERLY OVITZ", WHOSE CONSENT(S) TO REGISTER IS MADE OF RECORD.

FOR BELTS, SCARVES, PANTS, JEANS, FOOTWEAR (U.S. CLS. 22 AND 39).

FIRST USE 2-16-2012; IN COMMERCE 2-16-2012.
ANNE MADDEN, EXAMINING ATTORNEY

CLASS 25—(Continued).

SN 85-494,113. LULULEMON ATHLETICA CANADA INC., VANCOUVER, BC, CANADA, FILED 12-13-2011.

NAKEDSEAM

THE MARK CONSISTS OF STANDARD CHARACTERS WITHOUT CLAIM TO ANY PARTICULAR FONT, STYLE, SIZE, OR COLOR.

FOR ATHLETIC APPAREL, NAMELY, PANTS, SHORTS, CROPS, SKIRTS, TIGHTS, LEG WARMERS, LEGGINGS, BODYSUITS, DRESSES, SHIRTS, T-SHIRTS, TANK TOPS, LEOTARDS, SWEATSHIRTS, JACKETS, OUTERWEAR, NAMELY, COATS AND RAINCOATS, HEADWEAR, AND HEADBANDS (U.S. CLS. 22 AND 39).
NANCY CLARKE, EXAMINING ATTORNEY

SN 85-494,603. FINGERS CROSSED, INC., SANTA ANA, CA.
FILED 12-13-2011.

PAPIER

THE MARK CONSISTS OF STANDARD CHARACTERS WITHOUT CLAIM TO ANY PARTICULAR FONT, STYLE, SIZE, OR COLOR.

THE ENGLISH TRANSLATION OF "PAPIER" IN THE MARK IS "PAPER".

FOR CLOTHING AND WEARING APPAREL, NAMELY, SHIRTS, JEANS, JACKETS, SKIRTS, SLACKS, BLOUSES, DRESSES, VESTS, COATS, SWEATERS, SWEATSHIRTS, SCARVES, SWIMSUITS, UNDERWEAR, UNDERPANTS, SLIPS, CAMISOLES, BRAS, NIGHT-GOWNS, ROBES, T-SHIRTS, LONG SLEEVED SHIRTS, SHORTS, PANTS, JUMPERS, JUMPSUITS, OVERALLS, ONE-PIECE PLAYSUITS, PAJAMAS, TROUSERS, TWO- AND THREE-PIECE SUITS; MEN'S, WOMEN'S, CHILDREN'S AND INFANT'S HEADGEAR, NAMELY, HATS, CAPS AND VISORS; FOOTWEAR; HEADWEAR; BELTS (U.S. CLS. 22 AND 39).

SUSAN RICHARDS, EXAMINING ATTORNEY

SN 85-496,964. ANDREW M PETERSON, OMAHA, NE.
FILED 12-16-2011.

yoga for cancer

THE MARK CONSISTS OF STANDARD CHARACTERS WITHOUT CLAIM TO ANY PARTICULAR FONT, STYLE, SIZE, OR COLOR.

OWNER OF U.S. REG. NO. 3,881,129.

FOR ATHLETIC APPAREL, NAMELY, SHIRTS, PANTS, JACKETS, FOOTWEAR, HATS AND CAPS, ATHLETIC UNIFORMS (U.S. CLS. 22 AND 39).

AMY HELLA, EXAMINING ATTORNEY

CLASS 25—(Continued).

SN 85-501,785. THE W.E. BASSETT COMPANY, SHELTON, CT. FILED 12-22-2011.

PEDX

THE MARK CONSISTS OF STANDARD CHARACTERS WITHOUT CLAIM TO ANY PARTICULAR FONT, STYLE, SIZE, OR COLOR.

OWNER OF U.S. REG. NO. 3,228,478.
FOR INSOLES FOR FOOTWEAR AND SHOE INSERTS FOR PRIMARILY NON-ORTHOPEdic PURPOSES; PADDED RUB RELIEF STRIPS FOR NON-ORTHOPEdic PURPOSES IN THE NATURE OF BACK OF HEEL CUSHIONS, ARCH CUSHIONS, AND SHOE STRAP CUSHIONS (U.S. CLS. 22 AND 39).

FIRST USE 2-22-2006; IN COMMERCE 2-22-2006.
ELLEN PERKINS, EXAMINING ATTORNEY

SN 85-505,204. SEA LEVEL SUCKS, LLC, FLAGSTAFF, AZ. FILED 12-28-2011.



THE MARK CONSISTS OF MOUNTAINS WITH THREE PEAKS OF VARYING HEIGHTS OVER THE WORDS, "SEA LEVEL SUCKS" AND "BREATHE THIN AIR".

FOR ANORAKS; BASELAYER TOPS; BIB TIGHTS; BOXER SHORTS; CYCLING SHORTS; CYCLISTS' JERSEYS; FLEECE PULLOVERS; FLEECE TOPS; FLEECE VESTS; GAITERS; HATS; HOODED SWEAT SHIRTS; JACKETS; MITTENS; RAINWEAR; SHIRTS FOR INFANTS, BABIES, TODDLERS AND CHILDREN; SHORTS; SKI WEAR; SNOWBOARD GLOVES; SOCKS; SPORTS BRAS; SWEAT SHIRTS; SWIMSUITS; T-SHIRTS; TANK TOPS; TANKINIS; TRIATHLON CLOTHING, NAMELY, TRIATHLON TIGHTS, TRIATHLON SHORTS, TRIATHLON SINGLET, TRIATHLON SHIRTS, TRIATHLON SUITS; UNDERWEAR; VESTS; VISORS (U.S. CLS. 22 AND 39).

CHRISTOPHER LAW, EXAMINING ATTORNEY

SN 85-507,310. RECKLESS RECORDZ INC., AKA HUSTLERS UNION, SOUTH OZONE PARK, NY. FILED 1-2-2012.

Hustlers Union

THE MARK CONSISTS OF STANDARD CHARACTERS WITHOUT CLAIM TO ANY PARTICULAR FONT, STYLE, SIZE, OR COLOR.

FOR BASEBALL CAPS AND HATS (U.S. CLS. 22 AND 39).

LINDSEY RUBIN, EXAMINING ATTORNEY

CLASS 25—(Continued).

SN 85-508,480. IMPERIAL MOTION, LLC, TACOMA, WA. FILED 1-4-2012.



THE MARK CONSISTS OF A CREST DESIGN WITH THE WORD "NEVER" ABOVE IT, AND THE WORD "EST." BELOW IT.

FOR CLOTHING, NAMELY, PANTS, SHORTS, LEGGINGS, SHIRTS, TANK TOPS, SOCKS, BELTS, SWEATSHIRTS, T-SHIRTS AND HATS (U.S. CLS. 22 AND 39).

FIRST USE 8-31-2010; IN COMMERCE 8-31-2010.
AMEEN IMAM, EXAMINING ATTORNEY

SN 85-509,641. LANDAU UNIFORMS, INCORPORATED, OLIVE BRANCH, MS. FILED 1-5-2012.

SMITTEN

THE MARK CONSISTS OF STANDARD CHARACTERS WITHOUT CLAIM TO ANY PARTICULAR FONT, STYLE, SIZE, OR COLOR.

FOR BLOUSES; COATS; DRESSES; INSOLES FOR FOOTWEAR; JACKETS; LAB COATS; PANTS; SCRUBS NOT FOR MEDICAL PURPOSES; SHIRTS; SHOES; SKIRTS; SMOCKS; SWEATSHIRTS; T-SHIRTS; TOPS; TUNICS; UNIFORMS; VESTS (U.S. CLS. 22 AND 39).

FIRST USE 2-6-2012; IN COMMERCE 2-6-2012.
HENRY S. ZAK, EXAMINING ATTORNEY

SN 85-511,219. AUDREY NASAR, NEW YORK, NY. AND GLORIA ERANI, NEW YORK, NY. FILED 1-7-2012.



THE MARK CONSISTS OF THE STYLIZED WORDING "URBAN CRICKET." TO THE LEFT OF THE DESIGN OF A GARBAGE TRUCK THAT RESEMBLES A CRICKET WITH A PAIR OF ANTENNAE.

FOR T-SHIRTS (U.S. CLS. 22 AND 39).
FIRST USE 1-1-2009; IN COMMERCE 1-1-2009.
DAWN HAN, EXAMINING ATTORNEY

CLASS 25—(Continued).

SN 85-514,000. EDMOND, MIKE, SANTEE, CA. FILED 1-11-2012.

scalirags clothing

THE MARK CONSISTS OF STANDARD CHARACTERS WITHOUT CLAIM TO ANY PARTICULAR FONT, STYLE, SIZE, OR COLOR.

NO CLAIM IS MADE TO THE EXCLUSIVE RIGHT TO USE "CLOTHING", APART FROM THE MARK AS SHOWN. FOR BELTS; BOTTOMS; GLOVES; HATS; JACKETS; JERSEYS; OVERALLS; PANTS; SHIRTS; SHOES; SHORTS; SKIRTS; SOCKS; SWEATERS; SWEATPANTS; SWEATSHIRTS; SWIM SUITS; TOPS; UNDERWEAR (U.S. CLS. 22 AND 39).

DARRYL SPRULL, EXAMINING ATTORNEY

SN 85-515,581. DUCKWORTH, RANDALL, GRAPEVIEW, WA. FILED 1-12-2012.

ZIPPY CASHMAN



THE NAME "ZIPPY CASHMAN" DOES NOT IDENTIFY A LIVING INDIVIDUAL.

THE MARK CONSISTS OF THE STYLIZED TEXT "ZIPPY", WHICH IS STYLIZED AS ZIPPER TEETH. TO THE SIDE OF THE WORD "ZIPPY" IS STYLIZED LINE DRAWING OF SMILING MAN WEARING SUNGLASSES. BELOW THE WORD "ZIPPY" IS THE STYLIZED TEXT "CASHMAN".

FOR BELTS; JACKETS; PANTS; SCARVES; SKIRTS; TOPS (U.S. CLS. 22 AND 39).

AMEEN IMAM, EXAMINING ATTORNEY

SN 85-516,241. VINCENT DIMARTINO, ROCK TAVERN, NY. FILED 1-13-2012.

I'm not sayin' I'm just sayin'

THE MARK CONSISTS OF STANDARD CHARACTERS WITHOUT CLAIM TO ANY PARTICULAR FONT, STYLE, SIZE, OR COLOR.

FOR ATHLETIC APPAREL, NAMELY, SHIRTS, PANTS, JACKETS, FOOTWEAR, HATS AND CAPS, ATHLETIC UNIFORMS (U.S. CLS. 22 AND 39).

FIRST USE 12-5-2011; IN COMMERCE 12-5-2011.

ANDREW LEASER, EXAMINING ATTORNEY

CLASS 25—(Continued).

SN 85-517,605. BTGG, LLC, DBA SWAG17, WEST PALM BEACH, FL. FILED S.R. 1-16-2012; AM. P.R. 4-30-2012.



THE COLOR(S) BLACK AND RED IS/ARE CLAIMED AS A FEATURE OF THE MARK.

THE MARK CONSISTS OF THE WORDING "SWAG 17 START WITH ASKING GOD". THE LETTERS "SWA" IN THE WORD "SWAG" APPEAR IN BLACK, THE LETTER "G" IN THE WORD "SWAG" APPEARS IN RED, THE WORDING "17" APPEARS IN BLACK, THE WORDS "START" AND "ASKING" APPEAR IN BLACK, THE WORD "WITH" IS FORMED BY A TRANSPARENT AREA ON THE HAND PRINT DESIGN, AND THE WORD "GOD" APPEARS IN RED. A HAND PRINT DESIGN IN BLACK WITH A RED AREA IN THE PALM FORMS THE LETTER "W" IN THE WORD "SWAG". A DESIGN OF A BLACK SPIKE FORMS THE "1" IN "17". THE COLORS GRAY AND WHITE REPRESENT BACKGROUND, OUTLINING, SHADING AND/OR TRANSPARENT AREAS AND ARE NOT PART OF THE MARK.

FOR A-SHIRTS; ATHLETIC APPAREL, NAMELY, SHIRTS, PANTS, JACKETS, FOOTWEAR, HATS AND CAPS, ATHLETIC UNIFORMS; COLLARED SHIRTS; GOLF PANTS, SHIRTS AND SKIRTS; GOLF SHIRTS; HOODED SWEAT SHIRTS; KNIT SHIRTS; LONG-SLEEVED SHIRTS; POLO SHIRTS; SHORT-SLEEVED OR LONG-SLEEVED T-SHIRTS; SWEAT SHIRTS; T-SHIRTS; TEE SHIRTS; WEARABLE GARMENTS AND CLOTHING, NAMELY, SHIRTS (U.S. CLS. 22 AND 39).

FIRST USE 7-29-2010; IN COMMERCE 9-29-2010.

ELLEN BURNS, EXAMINING ATTORNEY

SN 85-518,409. THE WILLIAM THOMPSON COMPANY, LLC, SAN DIEGO, CA. FILED 1-17-2012.

Hydro-Shield



THE MARK CONSISTS OF A SHIELD WITH THE CAPITAL LETTER "T" CENTERED INSIDE IT ACCOMPANIED BY THE TERMS "HYDRO-SHIELD".

FOR SPECIALTY UNDERGARMENTS CREATED TO PROVIDE INCREASED LEVELS OF PERSPIRATION ABSORPTION, EVAPORATION, AND BARRIER (U.S. CLS. 22 AND 39).

LINDA M. KING, EXAMINING ATTORNEY

CLASS 25—(Continued).

SN 85-518,912. SEAHEAD ENTERPRISES, INC., JACKSONVILLE, FL. FILED 1-18-2012.

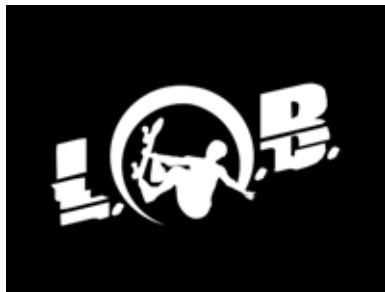

THE MARK CONSISTS THE INITIALS "L.O.B." THAT STAND FOR LIVE OVER BOARD. IT CONSISTS OF STYLIZED LETTERS "L" AND "B". IN ADDITION, THE MARK INCLUDES ART WORK FEATURING A SILHOUETTE OF A PERSON ON A SKATEBOARD STYLIZED WITHIN THE LETTER "O".

FOR MEN'S, WOMEN'S, CHILDREN'S, TODDLER'S AND INFANT'S CLOTHING, NAMELY, HATS, CAPS, BEANIES, HEAD BANDS, SHIRTS, T SHIRTS, TANK TOPS, UNDERWEAR, SOCKS, PANTS, SWEATERS, JACKETS, SANDALS, SHOES, FLIP FLOPS, BEACH SHOES, BOOTS, BATHING SUITS, BERMUDA SHORTS, WALKING SHORTS, WET SUITS, SWIM TRUNKS, CAPS WITH VISORS, VISORS, FLEECE PULLOVERS, HOODED SWEATSHIRTS, SWEAT SHIRTS, SURF WEAR, BRIEFS, BOXER BRIEFS, PANTIES, WIND RESISTANT JACKETS, INFANT AND TODDLER ONE PIECE CLOTHING (U.S. CLS. 22 AND 39).

CAROLINE WOOD, EXAMINING ATTORNEY

CLASS 25—(Continued).

SN 85-519,753. BUENAVENTURA, CHARLAN, SOUTHAVEN, MS. FILED 1-19-2012.

SLAMMEDENUFF?

THE MARK CONSISTS OF STANDARD CHARACTERS WITHOUT CLAIM TO ANY PARTICULAR FONT, STYLE, SIZE, OR COLOR.

FOR CLOTHING, NAMELY, T-SHIRTS, HOODED SWEAT SHIRTS, HATS, TANK TOPS, POLO SHIRTS, UNDERWEAR, PAJAMAS (U.S. CLS. 22 AND 39).

FIRST USE 7-10-2010; IN COMMERCE 7-13-2011.

JENNIFER VASQUEZ, EXAMINING ATTORNEY

SN 85-519,453. SUPERFICIALDOG.COM, KNOXVILLE, TN. FILED 1-18-2012.



THE COLOR(S) WHITE, BLACK, GRAY AND LIGHT BROWN IS/ARE CLAIMED AS A FEATURE OF THE MARK.

THE MARK CONSISTS OF A BUST OF A DOG WEARING A TUXEDO AND A BOWLER HAT. UNDERNEATH THE BUST IS THE WORD "SUPERFICIALDOG" WITH ".COM" UNDERNEATH SAID WORD. THE DOG SPORTS A MONOCLE AND A CIGARETTE HOLDER WITH A CIGARETTE. THE DOG IS LIGHT BROWN COLORED WITH BLACK MARKINGS. THE BOWLER HAT IS BLACK AS IS THE CIGARETTE HOLDER, THE TUXEDO TOP AND THE BOW TIE. THE MONOCLE IS GRAY. THE CIGARETTE IS WHITE AS IS THE TUXEDO SHIRT. THE LETTERING IS IN BLACK. ALL OF THIS IS ON A WHITE BACKGROUND.

FOR T-SHIRTS (U.S. CLS. 22 AND 39).

DOMINICK J. SALEMI, EXAMINING ATTORNEY

SN 85-519,917. FAQIRZADEH, SAID NASIR, DISCOVERY, CA. FILED 1-19-2012.

Free Urbanity Clothing

THE MARK CONSISTS OF STANDARD CHARACTERS WITHOUT CLAIM TO ANY PARTICULAR FONT, STYLE, SIZE, OR COLOR.

NO CLAIM IS MADE TO THE EXCLUSIVE RIGHT TO USE "CLOTHING", APART FROM THE MARK AS SHOWN.

FOR CLOTHING FOR MEN, WOMEN AND CHILDREN, NAMELY, TOPS, T-SHIRTS, POLO SHIRTS, TANK TOPS, HOODED SWEATSHIRTS, TIGHTS, LEGGINGS, BOTTOMS, SHOES, JEANS, VESTS, PANTS, DENIMS, SHORTS, SOCKS, UNDERWEAR, BRAS, HATS, TIES, JACKETS, DRESS SHIRTS, SCARVES, BATHING SUITS, BELTS, AND SUITS (U.S. CLS. 22 AND 39).

KEVIN DINALLO, EXAMINING ATTORNEY

CLASS 25—(Continued).

SN 85-520,030. O'LOUGHLIN, STEVEN PAUL, SHREWSBURY, MA. FILED 1-19-2012.

yo3dot

THE MARK CONSISTS OF STANDARD CHARACTERS WITHOUT CLAIM TO ANY PARTICULAR FONT, STYLE, SIZE, OR COLOR.

FOR WEARING APPAREL, NAMELY, LOUNGEWEAR, SWEATSHIRTS, JEANS, PANTS, KHAKI PANTS, GOLF TROUSERS, VESTS, SHORTS, SHIRTS, BLOUSES, SKIRTS, DRESSES, SWEATERS, FLEECE PULLOVERS, SWEAT SUITS, JOGGING SUITS, SUITS, TEE SHIRTS, KNIT SHIRTS, POLO SHIRTS, RUGBY SHIRTS, GOLF SHIRTS, TANK TOPS, JERSEYS, WOVEN SHIRTS, BLAZERS, HATS, SCARVES, TIGHTS, STOCKINGS, SHAWLS, LEOTARDS, UNDERGARMENTS, ROBES, SHAPEWEAR IN THE NATURE OF GIRDLES AND BRAS, UNITARDS, LINGERIE, BODY SUITS, LEG WARMERS, LEGGINGS, SOCKS, TIES, SUSPENDERS, PARKAS, PONCHOS, RAIN SUITS, JACKETS, OVERCOATS, RAINCOATS, COATS, GLOVES, BELTS, WINTER SCARVES, ATHLETIC UNIFORMS, SLEEPWEAR, YOGA PANTS, YOGA SHIRTS, YOGA SHORTS, DENIM JEANS, DENIM SHORTS, DENIM JACKETS, DENIM SKIRTS, DENIM TOPS; ATHLETIC APPAREL, NAMELY, SHIRTS, PANTS, JACKETS, FOOTWEAR, HATS AND CAPS, AND ATHLETIC UNIFORMS; COMPRESSION GARMENTS FOR ATHLETIC OR OTHER NON-MEDICAL USE, NAMELY, COMPRESSION SOCKS, STOCKINGS, LEGGINGS, JERSEYS, VESTS, SHIRTS, AND TROUSERS; SWIMWEAR, NAMELY, TRUNKS, BOARD SHORTS, BIKINIS, TANKINIS, AND BATHING SUITS; FOOTWEAR, NAMELY, BOOTS, SLIPPERS, SANDALS, PUMPS, FLATS, AND ATHLETIC FOOTWEAR; HEADWEAR, NAMELY, HATS, CAPS, VISORS, AND HEAD BANDS; WRISTBANDS (U.S. CLS. 22 AND 39).
DANNEAN HETZEL, EXAMINING ATTORNEY

SN 85-520,711. AMES, QIANA, REISTERSTOWN, MD. AND COATES III, CARL, REISTERSTOWN, MD. FILED 1-19-2012.

Naughty Teez

THE MARK CONSISTS OF STANDARD CHARACTERS WITHOUT CLAIM TO ANY PARTICULAR FONT, STYLE, SIZE, OR COLOR.

NO CLAIM IS MADE TO THE EXCLUSIVE RIGHT TO USE "TEEZ", APART FROM THE MARK AS SHOWN.
FOR T-SHIRTS (U.S. CLS. 22 AND 39).
MARILYN IZZI, EXAMINING ATTORNEY

CLASS 25—(Continued).

SN 85-520,848. ROMANOV, ALEXEY, SAINT-PETERSBURG, RUSSIAN FED., FILED 1-19-2012.

Arctic-Store

THE MARK CONSISTS OF STANDARD CHARACTERS WITHOUT CLAIM TO ANY PARTICULAR FONT, STYLE, SIZE, OR COLOR.

FOR FUR HATS; FUR MUFFS; FUR STOLES (U.S. CLS. 22 AND 39).
FIRST USE 1-1-2006; IN COMMERCE 1-1-2006.
LAURA KOVALSKY, EXAMINING ATTORNEY

SN 85-521,302. BOSTON DUCK TOURS, BOSTON, MA. FILED 1-20-2012.

Boston's Official
ChampionSHIP

THE MARK CONSISTS OF STANDARD CHARACTERS WITHOUT CLAIM TO ANY PARTICULAR FONT, STYLE, SIZE, OR COLOR.

NO CLAIM IS MADE TO THE EXCLUSIVE RIGHT TO USE "BOSTON'S OFFICIAL", APART FROM THE MARK AS SHOWN.

FOR SHIRTS; T-SHIRTS (U.S. CLS. 22 AND 39).
LOURDES AYALA, EXAMINING ATTORNEY

SN 85-521,894. DEVI RESORT WEAR LLC, ARLINGTON, MA. FILED 1-20-2012.



NO CLAIM IS MADE TO THE EXCLUSIVE RIGHT TO USE "RESORT WEAR", APART FROM THE MARK AS SHOWN.

THE MARK CONSISTS OF A LOTUS FLOWER DESIGN WITH A WOMAN CARICATURE SITTING IN MIDDLE IN A YOGA POSITION. BELOW THE DESIGN IS THE STYLIZED SCRIPT "DEVI" WITH THE WORDING "RESORT WEAR" BELOW THAT IN TYPEFACE.

THE ENGLISH TRANSLATION OF "DEVI" IN THE MARK IS "GODDESS".

FOR BEACH COVER-UPS; BEACHWEAR; DRESSES; EVENING DRESSES; KAFTANS; SANDALS; TUNICS (U.S. CLS. 22 AND 39).

FIRST USE 1-1-2009; IN COMMERCE 1-1-2010.

MATTHEW MCDOWELL, EXAMINING ATTORNEY

CLASS 25—(Continued).

SN 85-521,984. SEAHEAD ENTERPRISES, INC., JACKSONVILLE, FL. FILED 1-21-2012.



THE MARK CONSISTS THE INITIALS "L.O.B." THAT STAND FOR LIVE OVER BOARD. IT CONSISTS OF STYLIZED LETTERS "L" AND "B". IN ADDITION, THE MARK INCLUDES ART WORK FEATURING A SILHOUETTE OF A PERSON STANDING UP ON A PADDLE BOARD STYLIZED WITHIN THE LETTER "O".

FOR MEN'S, WOMEN'S, CHILDREN'S, TODDLER'S AND INFANT'S CLOTHING, NAMELY, HATS, CAPS, BEANIES, HEAD BANDS, SHIRTS, T SHIRTS, TANK TOPS, UNDERWEAR, SOCKS, PANTS, SWEATERS, JACKETS, SANDALS, SHOES, FLIP FLOPS, BEACH SHOES, BOOTS, BATHING SUITS, BERMUDA SHORTS, WALKING SHORTS, WET SUITS, SWIM TRUNKS, CAPS WITH VISORS, VISORS, FLEECE PULLOVERS, HOODED SWEATSHIRTS, SWEAT SHIRTS, SURF WEAR, BRIEFS, BOXER BRIEFS, PANTIES, WIND RESISTANT JACKETS, INFANT AND TODDLER ONE PIECE CLOTHING (U.S. CLS. 22 AND 39).

CAROLINE WOOD, EXAMINING ATTORNEY

CLASS 25—(Continued).

SN 85-521,993. SEAHEAD ENTERPRISES, INC., JACKSONVILLE, FL. FILED 1-21-2012.



THE MARK CONSISTS THE INITIALS "L.O.B." THAT STAND FOR LIVE OVER BOARD. IT CONSISTS OF STYLIZED LETTERS "L" AND "B". IN ADDITION, THE MARK INCLUDES ART WORK FEATURING A SILHOUETTE OF A PERSON ON A WAKE BOARD STYLIZED WITHIN THE LETTER "O".

FOR MEN'S, WOMEN'S, CHILDREN'S, TODDLER'S AND INFANT'S CLOTHING, NAMELY, HATS, CAPS, BEANIES, HEAD BANDS, SHIRTS, T SHIRTS, TANK TOPS, UNDERWEAR, SOCKS, PANTS, SWEATERS, JACKETS, SANDALS, SHOES, FLIP FLOPS, BEACH SHOES, BOOTS, BATHING SUITS, BERMUDA SHORTS, WALKING SHORTS, WET SUITS, SWIM TRUNKS, CAPS WITH VISORS, VISORS, FLEECE PULLOVERS, HOODED SWEATSHIRTS, SWEAT SHIRTS, SURF WEAR, BRIEFS, BOXER BRIEFS, PANTIES, WIND RESISTANT JACKETS, INFANT AND TODDLER ONE PIECE CLOTHING (U.S. CLS. 22 AND 39).

CAROLINE WOOD, EXAMINING ATTORNEY

SN 85-521,992. SEAHEAD ENTERPRISES, INC., JACKSONVILLE, FL. FILED 1-21-2012.



THE MARK CONSISTS THE INITIALS "L.O.B." THAT STAND FOR LIVE OVER BOARD. IT CONSISTS OF STYLIZED LETTERS "L" AND "B". IN ADDITION, THE MARK INCLUDES ART WORK FEATURING A SILHOUETTE OF A PERSON CROUCHING ON A SURF BOARD STYLIZED WITHIN THE LETTER "O".

FOR MEN'S, WOMEN'S, CHILDREN'S, TODDLER'S AND INFANT'S CLOTHING, NAMELY, HATS, CAPS, BEANIES, HEAD BANDS, SHIRTS, T SHIRTS, TANK TOPS, UNDERWEAR, SOCKS, PANTS, SWEATERS, JACKETS, SANDALS, SHOES, FLIP FLOPS, BEACH SHOES, BOOTS, BATHING SUITS, BERMUDA SHORTS, WALKING SHORTS, WET SUITS, SWIM TRUNKS, CAPS WITH VISORS, VISORS, FLEECE PULLOVERS, HOODED SWEATSHIRTS, SWEAT SHIRTS, SURF WEAR, BRIEFS, BOXER BRIEFS, PANTIES, WIND RESISTANT JACKETS, INFANT AND TODDLER ONE PIECE CLOTHING (U.S. CLS. 22 AND 39).

CAROLINE WOOD, EXAMINING ATTORNEY

SN 85-521,994. SEAHEAD ENTERPRISES, INC., JACKSONVILLE, FL. FILED 1-21-2012.



THE MARK CONSISTS THE INITIALS "L.O.B." THAT STAND FOR LIVE OVER BOARD. IT CONSISTS OF STYLIZED LETTERS "L" AND "B". IN ADDITION, THE MARK INCLUDES ART WORK FEATURING A SILHOUETTE OF A PERSON ON A SNOWBOARD STYLIZED WITHIN THE LETTER "O".

FOR MEN'S, WOMEN'S, CHILDREN'S, TODDLER'S AND INFANT'S CLOTHING, NAMELY, HATS, CAPS, BEANIES, HEAD BANDS, SHIRTS, T SHIRTS, TANK TOPS, UNDERWEAR, SOCKS, PANTS, SWEATERS, JACKETS, SANDALS, SHOES, FLIP FLOPS, BEACH SHOES, BOOTS, BATHING SUITS, BERMUDA SHORTS, WALKING SHORTS, WET SUITS, SWIM TRUNKS, CAPS WITH VISORS, VISORS, FLEECE PULLOVERS, HOODED SWEATSHIRTS, SWEAT SHIRTS, SURF WEAR, BRIEFS, BOXER BRIEFS, PANTIES, WIND RESISTANT JACKETS, INFANT AND TODDLER ONE PIECE CLOTHING (U.S. CLS. 22 AND 39).

CAROLINE WOOD, EXAMINING ATTORNEY

CLASS 25—(Continued).

SN 85-522,973. JETTER II, DAVID, STAMFORD, CT. FILED 1-23-2012.



OWNER OF U.S. REG. NO. 4,115,828.
 THE MARK CONSISTS OF TWO HUMAN FISTS SMASHING TOGETHER SURROUNDED BY A BLACK IMPACT DESIGN WITH BIRDLIKE CLAWS ATTACHED BELOW THEM AND LARGE EAGLE-LIKE WINGS COMING OUT ON EITHER SIDE WITH THE WORDS "ARTISTIC FLOW IN BATTLE" UNDERNEATH.
 FOR HATS; JACKETS; PANTS; SHORTS; SWEAT-SHIRTS; T-SHIRTS (U.S. CLS. 22 AND 39).
 FIRST USE 12-20-2010; IN COMMERCE 11-19-2011.
 ELIZABETH HUGHITT, EXAMINING ATTORNEY

SN 85-523,180. TUTTLE, MICHAEL, STOKESDALE, NC. AND PEARCE, CYTHERA, FUQUAY-VARINA, NC. FILED 1-23-2012.

SCENICWEAR

THE MARK CONSISTS OF STANDARD CHARACTERS WITHOUT CLAIM TO ANY PARTICULAR FONT, STYLE, SIZE, OR COLOR.
 FOR CLOTHING, NAMELY, FOOTWEAR, HEADWEAR, CAPS, TOPS, BOTTOMS, SHIRTS, PANTS, SOCKS, AND CUSTOM KNITTED AND IMPRINTED APPAREL ITEMS, NAMELY, SOCKS, SHIRTS, AND CAPS (U.S. CLS. 22 AND 39).
 JEFF DEFORD, EXAMINING ATTORNEY

CLASS 25—(Continued).

SN 85-523,190. KEELEY BROTHERS PARTNERSHIP, COLUSA, CA. FILED 1-23-2012.



NO CLAIM IS MADE TO THE EXCLUSIVE RIGHT TO USE "HABILIMENTS", APART FROM THE MARK AS SHOWN.
 THE MARK CONSISTS OF A STYLIZED DESIGN OF A CALIFORNIA GOLDEN POPPY WITH THE WORDING "CAN & ABEL HABILIMENTS" TO THE RIGHT OF THE DESIGN IN STYLIZED FORM, WITH NO SPACE BETWEEN THE POPPY DESIGN AND THE WORD "CAN".
 FOR JACKETS; PANTS; SHIRTS; SWEATERS; SWEAT-SHIRTS (U.S. CLS. 22 AND 39).
 JEFF DEFORD, EXAMINING ATTORNEY

SN 85-523,251. PEBBLES IN MY POCKET, LLC, LAS VEGAS, NV. FILED 1-23-2012.

PEBBLES IN MY POCKET

THE MARK CONSISTS OF STANDARD CHARACTERS WITHOUT CLAIM TO ANY PARTICULAR FONT, STYLE, SIZE, OR COLOR.
 FOR CHILDREN'S CLOTHING, NAMELY, LONG SLEEVE AND SHORT SLEEVE SHIRTS, JEANS, SHORTS, BEANIES, SOCKS, HATS, INFANT WEARABLE BLANKETS, BELTS (U.S. CLS. 22 AND 39).
 WILLIAM VERHOSEK, EXAMINING ATTORNEY

SN 85-523,426. DOLORES FONT CORTES, (CASTELLÓN), SPAIN, FILED 1-24-2012.

BLAUMAR

THE MARK CONSISTS OF STANDARD CHARACTERS WITHOUT CLAIM TO ANY PARTICULAR FONT, STYLE, SIZE, OR COLOR.
 OWNER OF SPAIN REG. NO. 2.661.819, DATED 2-10-2006, EXPIRES 7-13-2015.
 THE WORDING "BLAUMAR" HAS NO MEANING IN A FOREIGN LANGUAGE.
 FOR APPAREL FOR MEN, WOMEN, AND CHILDREN, NAMELY, SHIRTS, T-SHIRTS, TROUSERS, SHORTS, SKIRTS, PULLOVERS, SWEATERS, CARDIGANS, JACKETS, SWIMWEAR, COATS, ANORAKS, WRISTBANDS, SOCKS, UNDERWEAR (U.S. CLS. 22 AND 39).
 HANNO RITTNER, EXAMINING ATTORNEY

CLASS 25—(Continued).

SN 85-523,559. BIONATURAL INTERNATIONAL CORP., DORAL, FL. FILED 1-24-2012.



NO CLAIM IS MADE TO THE EXCLUSIVE RIGHT TO USE "SLIM", APART FROM THE MARK AS SHOWN.

THE COLOR(S) RED, GRAY, BLACK, GOLD AND WHITE IS/ARE CLAIMED AS A FEATURE OF THE MARK.

THE MARK CONSISTS OF THE WORDING FIR SLIM IN CURSIVE LETTERS IN RED COLOR WITH A BLACK SHADOW, ON A WHITE BACKGROUND WITH 7 GRAY LINES AND 1 GOLD LINE BEHIND THE TEXT.

FOR BODY SHAPERS; SHAPEWEAR, NAMELY, GIRDLES, HOSE, TIGHTS, SOCKS, BODY SHAPERS, BODYSUITS, CAMISOLES, BRAS, PANTIES, SLIPS, SHIRTS, PANTS, DRESSES, AND SKIRTS (U.S. CLS. 22 AND 39).

FIRST USE 10-1-2009; IN COMMERCE 4-10-2010.
ERNEST SHOSHO, EXAMINING ATTORNEY

CLASS 25—(Continued).

SN 85-525,204. PIEGE CO., CHATSWORTH, CA. FILED 1-25-2012.

JEWELS BY JEZEBEL

THE MARK CONSISTS OF STANDARD CHARACTERS WITHOUT CLAIM TO ANY PARTICULAR FONT, STYLE, SIZE, OR COLOR.

OWNER OF U.S. REG. NOS. 664,456, 3,273,529 AND OTHERS.

FOR LINGERIE, BRAS, PANTIES, CAMISOLES, BABY DOLL PAJAMAS, GARTER BELTS, CHEMISES AND BUSTIERS (U.S. CLS. 22 AND 39).

GEOFFREY FOSDICK, EXAMINING ATTORNEY

SN 85-526,610. KIN COLLECTIVE, INC., LOS ANGELES, CA. FILED 1-26-2012.

STITCH X STITCH

THE MARK CONSISTS OF STANDARD CHARACTERS WITHOUT CLAIM TO ANY PARTICULAR FONT, STYLE, SIZE, OR COLOR.

FOR CLOTHING, NAMELY, TOPS, BOTTOMS, AND DRESSES (U.S. CLS. 22 AND 39).

ANDREA HACK, EXAMINING ATTORNEY

SN 85-524,463. KOHLER, JACOB, BEND, OR. FILED 1-25-2012.



THE MARK CONSISTS OF THE LITERAL ELEMENTS "LIFE'S A GARDEN, KEEP YOUR HOE" WRITTEN IN STYLIZED FORM WHEREIN AN IMAGE OF A GIRL HOLDING A GARDEN HOE IS PLACED BENEATH THE WORDS "LIFE'S A GARDEN" AND BENEATH THE IMAGE OF A GIRL THE WORDS "KEEP YOUR HOE" IS WRITTEN AS SHOWN IN THE MARK.

FOR CLOTHING, NAMELY, TOPS, BOTTOMS, PANTS, SHIRTS, T-SHIRTS, JACKETS, HATS, SOCKS, SHOES (U.S. CLS. 22 AND 39).

CHRISTOPHER SIDOTI, EXAMINING ATTORNEY

SN 85-528,326. MAYASHEU, LLC, LAS VEGAS, NV. FILED 1-30-2012.



THE MARK CONSISTS OF FANCIFUL ARTISTIC REPRESENTATION OF THE LETTERS "M," "A," "Y," AND "K" ANGLED AND SUPERIMPOSED UPON ONE ANOTHER WITH FANCIFUL INTERIOR DESIGN CONSISTING OF ARCHES CREATING SOLID AND OPEN SPACES BOUNDED WITHIN A HEART-SHAPED FRAME.

FOR SHOES (U.S. CLS. 22 AND 39).
JANICE KIM, EXAMINING ATTORNEY

CLASS 25—(Continued).

SN 85-528,528. GENESIS PATTERN TECHNOLOGIES, LLC, LEXINGTON, NC. FILED 1-30-2012.



The logo for ICEKON features the word "ICEKON" in a bold, sans-serif font. The letter "I" is significantly larger than the other letters and is positioned to the left of the "C". The "K" is stylized with a vertical line through its center.

THE MARK CONSISTS OF THE WORD "ICEKON" WITH A LARGE ICICLE IN PLACE OF THE LETTER "I" AND A STYLIZED "K".

FOR CLOTHING, NAMELY, HEADWEAR, PANTS, SHIRTS, JACKETS, VESTS, FOOTWEAR (U.S. CLS. 22 AND 39).

FIRST USE 1-10-2012; IN COMMERCE 1-10-2012.
KAREN K. BUSH, EXAMINING ATTORNEY

CLASS 25—(Continued).

SN 85-529,336. LUNA, EDUARDO, NATIONAL CITY, CA. FILED 1-31-2012.



The logo for TIJUAS consists of the word "TIJUAS" in a bold, serif font.

THE MARK CONSISTS OF STANDARD CHARACTERS WITHOUT CLAIM TO ANY PARTICULAR FONT, STYLE, SIZE, OR COLOR.

THE WORDING "TIJUAS" HAS NO MEANING IN A FOREIGN LANGUAGE.

FOR BASEBALL CAPS; JACKETS; T-SHIRTS (U.S. CLS. 22 AND 39).

DAWN HAN, EXAMINING ATTORNEY

SN 85-528,711. FLY BOY CARNIVAL, LLC, DBA FLY BOY CARNIVAL, WAUWATOSA, WI. FILED 1-30-2012.



The logo for Fly Boy Carnival features the words "Fly Boy Carnival" in a serif font. "Fly" is on the top line, "Boy" is on the middle line, and "Carnival" is on the bottom line.

THE MARK CONSISTS OF STANDARD CHARACTERS WITHOUT CLAIM TO ANY PARTICULAR FONT, STYLE, SIZE, OR COLOR.

FOR SHIRTS (U.S. CLS. 22 AND 39).
FIRST USE 7-1-2007; IN COMMERCE 11-10-2007.
RONALD AIKENS, EXAMINING ATTORNEY

SN 85-529,685. MAYASHEU, LLC, LAS VEGAS, NV. FILED 1-31-2012.



The logo for MAYASHEU consists of the word "MAYASHEU" in a bold, serif font.

THE MARK CONSISTS OF STANDARD CHARACTERS WITHOUT CLAIM TO ANY PARTICULAR FONT, STYLE, SIZE, OR COLOR.

THE NAME(S), PORTRAIT(S), AND/OR SIGNATURE(S) SHOWN IN THE MARK IDENTIFIES NAAMAH ALVARADO, WHOSE CONSENT(S) TO REGISTER IS MADE OF RECORD.

FOR SHOES (U.S. CLS. 22 AND 39).
JANICE KIM, EXAMINING ATTORNEY

SN 85-529,104. COLLINS, SUZANNE, SANDY HOOK, CT. FILED 1-30-2012.



The logo for PEETA MELLARK consists of the words "PEETA MELLARK" in a bold, serif font.

THE MARK CONSISTS OF STANDARD CHARACTERS WITHOUT CLAIM TO ANY PARTICULAR FONT, STYLE, SIZE, OR COLOR.

THE NAME "PEETA MELLARK" DOES NOT IDENTIFY A LIVING INDIVIDUAL.

FOR CLOTHING, NAMELY, HEADWEAR, FOOTWEAR, SHIRTS, PANTS, SHORTS, DRESSES, SKIRTS, BLOUSES, JACKETS, COATS, SWEATERS, SCARVES, GLOVES, UNDERWEAR, FOUNDATION GARMENTS, HOSIERY, NECKTIES, NIGHTWEAR, SWEAT BANDS, SWIMWEAR, LEOTARDS, LEG WARMERS, BELTS, LAYETTES, APRONS, UNIFORMS, BOAS, HALLOWEEN COSTUMES, COSTUMES FOR USE IN ROLE-PLAYING GAMES, INFANTWEAR, RAINWEAR (U.S. CLS. 22 AND 39).

THEODORE MCBRIDE, EXAMINING ATTORNEY

SN 85-530,429. MELLAMED, MORRIS, LOS ANGELES, CA. FILED 1-31-2012.

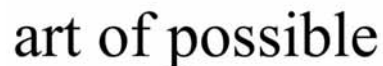

The logo for art of possible features the words "art of possible" in a lowercase, serif font.

THE MARK CONSISTS OF STANDARD CHARACTERS WITHOUT CLAIM TO ANY PARTICULAR FONT, STYLE, SIZE, OR COLOR.

FOR DENIMS; JACKETS; SHIRTS; SWEATERS (U.S. CLS. 22 AND 39).

FRED CARL, EXAMINING ATTORNEY

CLASS 25—(Continued).

SN 85-530,430. PENUELA, WINSTON, GLENDALE, CA.
FILED 1-31-2012.

Wise & Pretty

THE MARK CONSISTS OF STANDARD CHARACTERS WITHOUT CLAIM TO ANY PARTICULAR FONT, STYLE, SIZE, OR COLOR.

FOR BLOUSES; BRAS; DRESSES; GLOVES; HATS; JACKETS; JEANS; PANTIERS; PANTS; SCARVES; SHIRTS; SHOES; SKIRTS; SOCKS; SWEATERS; SWIMWEAR; TOPS; UNDERWEAR; COATS (U.S. CLS. 22 AND 39).
FRED CARL, EXAMINING ATTORNEY

CLASS 25—(Continued).

SN 85-530,572. LEONARD, BORIN C., MADISON HEIGHTS, MI. FILED 2-1-2012.

B.I.R.T.H.

THE MARK CONSISTS OF STANDARD CHARACTERS WITHOUT CLAIM TO ANY PARTICULAR FONT, STYLE, SIZE, OR COLOR.

FOR COATS; HEADGEAR, NAMELY, CAPS AND HATS; JACKETS; WEARABLE GARMENTS AND CLOTHING, NAMELY, SHIRTS (U.S. CLS. 22 AND 39).
KAREN BRACEY, EXAMINING ATTORNEY

SN 85-530,460. THOMPSON, CHRISTOPHER, CARLSBAD, CA. FILED 1-31-2012.

Original West Coast Player

THE MARK CONSISTS OF STANDARD CHARACTERS WITHOUT CLAIM TO ANY PARTICULAR FONT, STYLE, SIZE, OR COLOR.

FOR T-SHIRTS (U.S. CLS. 22 AND 39).
TINA MAI, EXAMINING ATTORNEY

SN 85-530,585. Q4 DESIGNS, LLC, NEW YORK, NY. FILED 2-1-2012.

V9 SOLUTIONS

THE MARK CONSISTS OF STANDARD CHARACTERS WITHOUT CLAIM TO ANY PARTICULAR FONT, STYLE, SIZE, OR COLOR.

FOR CLOTHING, NAMELY, TOPS, BOTTOMS, JACKETS, LINGERIE, SWIMWEAR (U.S. CLS. 22 AND 39).
WILLIAM P. SHANAHAN, EXAMINING ATTORNEY

SN 85-530,566. TODD, JOSEPHINE, ALEXANDRIA, VA. FILED 2-1-2012.

AFRITALI

THE MARK CONSISTS OF STANDARD CHARACTERS WITHOUT CLAIM TO ANY PARTICULAR FONT, STYLE, SIZE, OR COLOR.

THE WORDING "AFRITALI" HAS NO MEANING IN A FOREIGN LANGUAGE.

FOR DRESSES, BLOUSES, SKIRTS AND PANTS (U.S. CLS. 22 AND 39).
GRETTA YAO, EXAMINING ATTORNEY

SN 85-530,595. HBI BRANDED APPAREL ENTERPRISES, LLC, WINSTON-SALEM, NC. FILED 2-1-2012.

GET COZY

THE MARK CONSISTS OF STANDARD CHARACTERS WITHOUT CLAIM TO ANY PARTICULAR FONT, STYLE, SIZE, OR COLOR.

FOR BRAS; SHAPEWEAR, NAMELY, THIGH SLIMMERS, BRIEFS, BOXERS, CAMISOLES, TANK TOPS, BODY SUITS, TORSETTES AND SLIPS (U.S. CLS. 22 AND 39).
MARY CRAWFORD, EXAMINING ATTORNEY

CLASS 25—(Continued).

SN 85-530,614. GULFSTYLE INC., FORT WALTON BEACH, FL. FILED 2-1-2012.



THE MARK CONSISTS OF A STYLIZED DOLPHIN IN AN ARCHED POSITION SHOWING THE FULL TAIL WITH AN ACCENT ON ITS BACK RUNNING IN FRONT OF ITS DORSAL FIN.

FOR DRESS SHIRTS; PANTS; POLO SHIRTS; SHORTS; T-SHIRTS (U.S. CLS. 22 AND 39).
GEORGE LORENZO, EXAMINING ATTORNEY

SN 85-530,762. TEAMGEIST LTD, LONDON, UNITED KINGDOM, FILED 2-1-2012.

Tri-Eva

THE MARK CONSISTS OF STANDARD CHARACTERS WITHOUT CLAIM TO ANY PARTICULAR FONT, STYLE, SIZE, OR COLOR.

FOR BICYCLE GLOVES; CYCLING SHORTS; CYCLISTS' JERSEYS; SWIM SUITS; T-SHIRTS; TRIATHLON CLOTHING, NAMELY, TRIATHLON TIGHTS, TRIATHLON SHORTS, TRIATHLON SINGLET, TRIATHLON SHIRTS, TRIATHLON SUITS (U.S. CLS. 22 AND 39).

NICHOLAS ALTREE, EXAMINING ATTORNEY

SN 85-530,768. PANTOJA, REYNA, GALT, CA. FILED 2-1-2012.

SWAGGALICIOUS

THE MARK CONSISTS OF STANDARD CHARACTERS WITHOUT CLAIM TO ANY PARTICULAR FONT, STYLE, SIZE, OR COLOR.

FOR CLOTHING, NAMELY, TOPS, BOTTOMS, COMBINATIONS, T-SHIRTS, JEANS, PANTS, SHORTS, SKIRTS, DRESSES, SWEATERS, CORSETS, GLOVES, HATS, HEADBANDS, HOODS, JACKETS, COATS, JERSEYS, MONEY BELTS, BELTS, UNDERWEAR, BEACHWEAR, SLEEPWEAR, WRISTBANDS (U.S. CLS. 22 AND 39).

ROBERT C. CLARK JR., EXAMINING ATTORNEY

CLASS 25—(Continued).

SN 85-530,841. BAK AND BAQ, THOUSAND OAKS, CA. FILED 2-1-2012.

bak/baq

THE MARK CONSISTS OF STANDARD CHARACTERS WITHOUT CLAIM TO ANY PARTICULAR FONT, STYLE, SIZE, OR COLOR.

FOR BELTS; HATS; HOODED SWEAT SHIRTS; JACKETS; PANTS; SHIRTS; SHOES; SHORT-SLEEVED OR LONG-SLEEVED T-SHIRTS; SHORTS; SOCKS; SWEAT SHIRTS; T-SHIRTS; TANK TOPS; UNDERWEAR (U.S. CLS. 22 AND 39).

KELLY BOULTON, EXAMINING ATTORNEY

SN 85-530,862. JEREMY MORGAN, HIGHLANDS, TX. FILED 2-1-2012.

The Saltwater Swagger

THE MARK CONSISTS OF STANDARD CHARACTERS WITHOUT CLAIM TO ANY PARTICULAR FONT, STYLE, SIZE, OR COLOR.

FOR SHORT-SLEEVED OR LONG-SLEEVED T-SHIRTS; T-SHIRTS (U.S. CLS. 22 AND 39).

ELLEN PERKINS, EXAMINING ATTORNEY

SN 85-530,894. SHANE, RHONDA L, CHICAGO, IL, IL. FILED 2-1-2012.

ItsAGirlfriendThing

THE MARK CONSISTS OF STANDARD CHARACTERS WITHOUT CLAIM TO ANY PARTICULAR FONT, STYLE, SIZE, OR COLOR.

FOR CLOTHING, NAMELY, BASE LAYERS, TOPS, WEARABLE GARMENTS AND CLOTHING, NAMELY, SHIRTS, T-SHIRTS, SHORT-SLEEVED OR LONG-SLEEVED T-SHIRTS, THONGS, WOMEN'S UNDERWEAR, SLEEPWEAR, LOUNGEWEAR, WRIST BANDS, SOCKS (U.S. CLS. 22 AND 39).

ZACHARY BELLO, EXAMINING ATTORNEY

CLASS 25—(Continued).

SN 85-530,911. AQUATAILS, COLORADO SPRINGS, CO. FILED 2-1-2012.

AQUATAILS

THE MARK CONSISTS OF STANDARD CHARACTERS WITHOUT CLAIM TO ANY PARTICULAR FONT, STYLE, SIZE, OR COLOR.

FOR BATHING COSTUMES; BIKINIS; COSTUMES FOR USE IN CHILDREN'S DRESS UP PLAY; HALLOWEEN COSTUMES; SWIM WEAR; SWIM WEAR FOR GENTLEMEN AND LADIES; SWIMMING COSTUMES; SWIMMING TRUNKS; SWIMSUITS (U.S. CLS. 22 AND 39).

FIRST USE 10-19-2009; IN COMMERCE 2-28-2010.
KATINA MISTER, EXAMINING ATTORNEY

SN 85-530,954. AQUATAILS, COLORADO SPRINGS, CO. FILED 2-1-2012.



THE MARK CONSISTS OF THE STYLIZED WORD AQUATAILS IN A SCRIPT FONT WITH THE SILHOUETTE OF A MERMAID, THE HANDS OF THE MERMAID PLACED UPON THE "Q" AND HER HAIR AND TAIL FLOWING TO THE RIGHT AND ABOVE THE LETTERS "UAT".

FOR BATHING COSTUMES; BIKINIS; COSTUMES FOR USE IN CHILDREN'S DRESS UP PLAY; HALLOWEEN COSTUMES; SWIM WEAR; SWIM WEAR FOR GENTLEMEN AND LADIES; SWIMMING COSTUMES; SWIMMING TRUNKS; SWIMSUITS (U.S. CLS. 22 AND 39).

FIRST USE 2-23-2011; IN COMMERCE 2-23-2011.
KATINA MISTER, EXAMINING ATTORNEY

SN 85-531,035. MALAI S.A.S., MEDELLIN, ANTIOQUIA, COLOMBIA, FILED 2-1-2012.

Malai

THE MARK CONSISTS OF STANDARD CHARACTERS WITHOUT CLAIM TO ANY PARTICULAR FONT, STYLE, SIZE, OR COLOR.

FOR BATHING SUITS, BIKINIS, TEE-SHIRTS, SHIRTS, BEACH WRAP, BATHROBES, SKIRTS, PANTS, JEANS, SHORTS, DRESSES, HATS, CAPS, SHOES (U.S. CLS. 22 AND 39).

FIRST USE 6-1-2011; IN COMMERCE 6-1-2011.
JOHN DWYER, EXAMINING ATTORNEY

CLASS 25—(Continued).

SN 85-531,066. SPATULA DAD, LLC, AUSTIN, TX. FILED 2-1-2012.



THE MARK CONSISTS OF THE WORDS "SPATULA DAD," WITH A SPATULA FORMED FROM THE LETTER "L" OF THE WORD "SPATULA".

FOR T-SHIRTS, HATS AND APRONS (U.S. CLS. 22 AND 39).

FIRST USE 9-0-2011; IN COMMERCE 9-0-2011.
LESLIE RICHARDS, EXAMINING ATTORNEY

SN 85-531,140. JAMES AULTON BULGER, BAINBRIDGE, GA. FILED 2-1-2012.

CHRISTIAN LIFE

THE MARK CONSISTS OF STANDARD CHARACTERS WITHOUT CLAIM TO ANY PARTICULAR FONT, STYLE, SIZE, OR COLOR.

FOR COATS; HATS; JACKETS; SHIRTS; SWEAT SHIRTS; T-SHIRTS (U.S. CLS. 22 AND 39).

ELLEN PERKINS, EXAMINING ATTORNEY

SN 85-531,153. JENKS, JAME E., SAN MARCOS, CA. FILED 2-1-2012.

TOP DEAD CENTRE

THE MARK CONSISTS OF STANDARD CHARACTERS WITHOUT CLAIM TO ANY PARTICULAR FONT, STYLE, SIZE, OR COLOR.

FOR HATS; JACKETS; PANTS; SHIRTS; SHORTS; SWEAT SHIRTS; T-SHIRTS (U.S. CLS. 22 AND 39).

KATINA MISTER, EXAMINING ATTORNEY

CLASS 25—(Continued).

SN 85-531,170. MELANEY A. CORPSTEIN, PHOENIX, AZ. FILED 2-1-2012.

JUST ADORABLE

THE MARK CONSISTS OF STANDARD CHARACTERS WITHOUT CLAIM TO ANY PARTICULAR FONT, STYLE, SIZE, OR COLOR.

OWNER OF U.S. REG. NOS. 3,408,793, 3,616,541 AND 3,863,775.

FOR CLOTHING, NAMELY T-SHIRTS, BLOUSES, DRESSES AND SLEEP WEAR (U.S. CLS. 22 AND 39).
KATHERINE E. HALMEN, EXAMINING ATTORNEY

SN 85-531,240. STEVIE LANCASTER JR., DBA STEVE ELLÉ, BELLEVILLE, IL. FILED 2-1-2012.

Steve ELLÉ

THE MARK CONSISTS OF STANDARD CHARACTERS WITHOUT CLAIM TO ANY PARTICULAR FONT, STYLE, SIZE, OR COLOR.

THE NAME "STEVE ELLE" DOES NOT IDENTIFY A LIVING INDIVIDUAL.

FOR WEARABLE GARMENTS AND CLOTHING, NAMELY, SHIRTS (U.S. CLS. 22 AND 39).

FIRST USE 8-2-1999; IN COMMERCE 1-1-2010.

NAKIA HENRY, EXAMINING ATTORNEY

SN 85-531,299. TOP GUN INTELLECTUAL PROPERTIES, LLC, ASTORIA, NY. FILED 2-1-2012.



OWNER OF U.S. REG. NOS. 2,817,325, 3,297,277 AND OTHERS.

THE MARK CONSISTS OF AN ARROWHEAD POINTING UPWARD. THERE IS A SINGLE FIVE-POINT STAR CENTERED IN THE UPPER PART OF THE ARROWHEAD.

FOR BELTS; CAPS; FOOTWEAR; JACKETS; JEANS; LEATHER JACKETS; PANTS; SHIRTS; SWEATSHIRTS; T-SHIRTS; UNDERWEAR (U.S. CLS. 22 AND 39).

FIRST USE 11-30-2011; IN COMMERCE 12-15-2011.

KATHERINE CONNOLLY, EXAMINING ATTORNEY

CLASS 25—(Continued).

SN 85-531,305. DOPE LIFE, LLC, DEER PARK, NY. FILED 2-1-2012.

Dope Life

THE MARK CONSISTS OF STANDARD CHARACTERS WITHOUT CLAIM TO ANY PARTICULAR FONT, STYLE, SIZE, OR COLOR.

FOR HATS; SHIRTS; SWEATSHIRTS; T-SHIRTS (U.S. CLS. 22 AND 39).

B. PARADEWELAI, EXAMINING ATTORNEY

SN 85-531,367. SOULWRAPS LLC, LAS VEGAS, NV. FILED 2-1-2012.

Soulwraps

THE MARK CONSISTS OF STANDARD CHARACTERS WITHOUT CLAIM TO ANY PARTICULAR FONT, STYLE, SIZE, OR COLOR.

FOR RUANAS; SCARVES; SHOULDER WRAPS; WOVEN TOPS; WRAPS (U.S. CLS. 22 AND 39).

FIRST USE 12-8-2008; IN COMMERCE 4-11-2009.

KAREN BRACEY, EXAMINING ATTORNEY

SN 85-531,443. BENNETT, RACHEL, PORTLAND, OR. FILED 2-1-2012.

The Bagabond

THE MARK CONSISTS OF STANDARD CHARACTERS WITHOUT CLAIM TO ANY PARTICULAR FONT, STYLE, SIZE, OR COLOR.

FOR BOOT BAGS (U.S. CLS. 22 AND 39).

FIRST USE 6-1-2011; IN COMMERCE 10-1-2011.

CHERYL CLAYTON, EXAMINING ATTORNEY

CLASS 25—(Continued).

SN 85-531,483. MATTHEW WILLIAMS, EDWARDSVILLE, IL. FILED 2-1-2012.

RICH AND WINNING

THE MARK CONSISTS OF STANDARD CHARACTERS WITHOUT CLAIM TO ANY PARTICULAR FONT, STYLE, SIZE, OR COLOR.

FOR HATS; PANTS; SHIRTS; SKULL CAPS; SWEAT PANTS; SWEAT SHIRTS; T-SHIRTS (U.S. CLS. 22 AND 39).

DAVID COLLIER, EXAMINING ATTORNEY

SN 85-531,536. SIMPLY SWAGGER, TACOMA, WA. FILED 2-1-2012.



THE MARK CONSISTS OF THE STYLIZED TEXT "SS". FOR HATS; PANTS; SWIMWEAR; T-SHIRTS; UNDERWEAR (U.S. CLS. 22 AND 39).

LESLIE RICHARDS, EXAMINING ATTORNEY

SN 85-531,551. ACT-67 LLC, DARBY, PA. FILED 2-1-2012.

ACT 67

THE MARK CONSISTS OF STANDARD CHARACTERS WITHOUT CLAIM TO ANY PARTICULAR FONT, STYLE, SIZE, OR COLOR.

FOR CLOTHING, NAMELY, T-SHIRTS, SWEATSHIRTS, SWEAT PANTS, CARGO PANTS, JEANS, HOODED SWEATSHIRTS, JACKETS, BUTTON DOWN SHIRTS, THERMAL UNDERWEAR, THERMAL SHIRTS, THERMAL PANTS; BEANIES (U.S. CLS. 22 AND 39).

FIRST USE 1-1-2007; IN COMMERCE 1-1-2007.

JENNY PARK, EXAMINING ATTORNEY

CLASS 25—(Continued).

SN 85-531,564. SCOTT-RADOVANOVIC, COURTNEY, RIDGEWOOD, NY. FILED 2-1-2012.

FROM NY WITH LOVE

THE MARK CONSISTS OF STANDARD CHARACTERS WITHOUT CLAIM TO ANY PARTICULAR FONT, STYLE, SIZE, OR COLOR.

NO CLAIM IS MADE TO THE EXCLUSIVE RIGHT TO USE "NY", APART FROM THE MARK AS SHOWN.

FOR JACKETS; SHORT-SLEEVED OR LONG-SLEEVED T-SHIRTS; SWEAT SHIRTS; SWEATERS; WEARABLE GARMENTS AND CLOTHING, NAMELY, SHIRTS (U.S. CLS. 22 AND 39).

MICHAEL KEATING, EXAMINING ATTORNEY

SN 85-531,850. CIRCUIT OF THE AMERICAS LLC, AUSTIN, TX. FILED 2-2-2012.



THE MARK CONSISTS OF THE STYLIZED REPRESENTATION OF A FLAME.

FOR CLOTHING, NAMELY, SHIRTS, PANTS, SHORTS, TOPS AND BOTTOMS; SWEATSHIRTS; SWEATERS; FLEECE TOPS; FOOTWEAR; SHOES; SOCKS; BANDANAS; HATS; CAPS; HEADBANDS; HEAD-SCARVES; APRONS; ROBES; BATHING SUITS; SWIM-SUITS; BATHING TRUNKS; BELTS; BERETS; BIBS, NOT OF PAPER; BLAZERS; COATS; BRAS; UNDERWEAR; LINGERIE; HALLOWEEN COSTUMES; EAR MUFFS; GLOVES; JACKETS; JEANS; JERSEYS; LAYETTES; LEG-GINGS; MITTENS; MONEY BELTS; NECK SCARVES; NECKTIES; OVERALLS; OVERCOATS; POCKET SQUARES; PAJAMAS; RAINWEAR; SCARVES; SHAWLS; SHOULDER SASHES TO BE WORN OVER CLOTHING; SHOULDER WRAPS; SKIRTS; SLIPPERS; SMOCKS; SOCKS; SUN VISORS; TIGHTS; TRACKSUITS; UNIFORMS; VESTS; WRISTBANDS; EYESHADES; SWEAT-BANDS (U.S. CLS. 22 AND 39).

JOHN E. MICHOS, EXAMINING ATTORNEY

SN 85-531,877. DOUROS, DANIELLE, WEST PALM BEACH, FL. FILED 2-2-2012.

Go Big or Go Bust

THE MARK CONSISTS OF STANDARD CHARACTERS WITHOUT CLAIM TO ANY PARTICULAR FONT, STYLE, SIZE, OR COLOR.

FOR ATHLETIC APPAREL, NAMELY, SHIRTS, PANTS, JACKETS, FOOTWEAR, HATS AND CAPS, ATHLETIC UNIFORMS (U.S. CLS. 22 AND 39).

ALEX KEAM, EXAMINING ATTORNEY

CLASS 25—(Continued).

SN 85-531,921. LA FOI, LLC, GLENDALE, CA. FILED 2-2-2012.



THE MARK CONSISTS OF TWO CIRCLES WITH A THIRD CIRCLE IN BETWEEN CREATED BY NEGATIVE SPACE. INSIDE THE CENTER CIRCLE IS A HEAD OF A HORSE. BELOW THE IMAGES IS THE STYLIZED TEXT "LA FOI".

THE ENGLISH TRANSLATION OF "LA FOI" IN THE MARK IS "FAITH".

FOR DRESSES; HATS; JEANS; PANTS; TOPS; UNDERWEAR (U.S. CLS. 22 AND 39).

AHSEN KHAN, EXAMINING ATTORNEY

SN 85-531,925. LANDS' END DIRECT MERCHANTS, INC., RICHFIELD, MN. FILED 2-2-2012.

IRON KNEES

THE MARK CONSISTS OF STANDARD CHARACTERS WITHOUT CLAIM TO ANY PARTICULAR FONT, STYLE, SIZE, OR COLOR.

NO CLAIM IS MADE TO THE EXCLUSIVE RIGHT TO USE "KNEES", APART FROM THE MARK AS SHOWN.

FOR PANTS (U.S. CLS. 22 AND 39).

FIRST USE 4-1-2011; IN COMMERCE 4-1-2011.

AHSEN KHAN, EXAMINING ATTORNEY

SN 85-531,986. SWOLLEN MONKEY, LAS VEGAS, NV. FILED 2-2-2012.



THE MARK CONSISTS OF A STYLIZED MUSCULAR MONKEY WEARING PANTS AND SHOES STANDING ABOVE THE STYLIZED TEXT "SWOLLEN MONKEY".

FOR HATS; SHORTS; SWEATPANTS; T-SHIRTS (U.S. CLS. 22 AND 39).

GISELLE AGOSTO, EXAMINING ATTORNEY

CLASS 25—(Continued).

SN 85-532,113. STEPHENS, TERRY, VANCOUVER, WA. FILED 2-2-2012.

FOSTER'S RAINBOW PAWS

THE MARK CONSISTS OF STANDARD CHARACTERS WITHOUT CLAIM TO ANY PARTICULAR FONT, STYLE, SIZE, OR COLOR.

FOR CLOTHING, NAMELY, FOOTWEAR, HEADWEAR, HATS, TOPS, BOTTOMS, SHIRTS, T-SHIRTS, AND PANTS (U.S. CLS. 22 AND 39).

JOHN DALIER, EXAMINING ATTORNEY

SN 85-532,144. BIDNIS HOLDINGS, INC., MARINA DEL REY, CA. FILED 2-2-2012.

Rob Thomas

THE MARK CONSISTS OF STANDARD CHARACTERS WITHOUT CLAIM TO ANY PARTICULAR FONT, STYLE, SIZE, OR COLOR.

THE NAME(S), PORTRAIT(S), AND/OR SIGNATURE(S) SHOWN IN THE MARK IDENTIFIES "ROB THOMAS", WHOSE CONSENT(S) TO REGISTER IS MADE OF RECORD.

FOR CLOTHING, NAMELY, SHIRTS, SWEATSHIRTS, APRONS, JERSEYS, CAPS, HATS, SHOES, JACKETS, SCARFS (U.S. CLS. 22 AND 39).

HOWARD B. LEVINE, EXAMINING ATTORNEY

SN 85-532,179. REFORM PERFORMANCE LLC, NASHVILLE, TN. FILED 2-2-2012.

Who do you play for?

THE MARK CONSISTS OF STANDARD CHARACTERS WITHOUT CLAIM TO ANY PARTICULAR FONT, STYLE, SIZE, OR COLOR.

FOR ATHLETIC APPAREL, NAMELY, SHIRTS, PANTS, JACKETS, FOOTWEAR, HATS AND CAPS, ATHLETIC UNIFORMS; ATHLETIC FOOTWEAR; ATHLETIC UNIFORMS (U.S. CLS. 22 AND 39).

JEFF DEFORD, EXAMINING ATTORNEY

CLASS 25—(Continued).

SN 85-532,483. FITUMI, LLC, LOS ANGELES, CA. FILED 2-2-2012.

CHALET 19

THE MARK CONSISTS OF STANDARD CHARACTERS WITHOUT CLAIM TO ANY PARTICULAR FONT, STYLE, SIZE, OR COLOR.

FOR BASEBALL CAPS AND HATS (U.S. CLS. 22 AND 39).

EMILY CARLSEN, EXAMINING ATTORNEY

SN 85-532,589. DESERET BOOK COMPANY, SALT LAKE CITY, UT. FILED 2-2-2012.

PRETTY DARN FUNNY

THE MARK CONSISTS OF STANDARD CHARACTERS WITHOUT CLAIM TO ANY PARTICULAR FONT, STYLE, SIZE, OR COLOR.

FOR HATS; SHIRTS; SHIRTS AND SHORT-SLEEVED SHIRTS; SHORT-SLEEVED OR LONG-SLEEVED T-SHIRTS; SWEATSHIRTS; TOPS (U.S. CLS. 22 AND 39).

MARK T. MULLEN, EXAMINING ATTORNEY

SN 85-532,635. DARMAQ, INC., NEW YORK, NY. FILED 2-2-2012.

BORN IN SKIN

THE MARK CONSISTS OF STANDARD CHARACTERS WITHOUT CLAIM TO ANY PARTICULAR FONT, STYLE, SIZE, OR COLOR.

FOR JACKETS, HATS, T-SHIRTS, SWEATSHIRTS, HOODED SWEATSHIRTS, SWEATERS (U.S. CLS. 22 AND 39).

GIANCARLO CASTRO, EXAMINING ATTORNEY

CLASS 25—(Continued).

SN 85-532,656. DESERET BOOK COMPANY, SALT LAKE CITY, UT. FILED 2-2-2012.



THE MARK CONSISTS OF AN OVAL WITH STYLIZED WORDS "PRETTY DARN FUNNY!" INSIDE THE OVAL. IN THE WORD "PRETTY", A BOBBYPIN IS USED TO CROSS THE TWO LETTER "T"'S.

FOR HATS; SHIRTS; SHIRTS AND SHORT-SLEEVED SHIRTS; SHORT-SLEEVED OR LONG-SLEEVED T-SHIRTS; SWEATSHIRTS; TOPS (U.S. CLS. 22 AND 39).

MARK T. MULLEN, EXAMINING ATTORNEY

SN 85-532,718. KRIS MANUEL AGBAYANI, HONOLULU, HI. FILED 2-2-2012.

HI STANDARD

THE MARK CONSISTS OF STANDARD CHARACTERS WITHOUT CLAIM TO ANY PARTICULAR FONT, STYLE, SIZE, OR COLOR.

FOR HEADWEAR; SHIRTS (U.S. CLS. 22 AND 39).

JILL C. ALT, EXAMINING ATTORNEY

SN 85-532,722. 1ST ROUND SPORTS, LLC, LOS ANGELES, CA. FILED 2-2-2012.

energyDNA

THE MARK CONSISTS OF STANDARD CHARACTERS WITHOUT CLAIM TO ANY PARTICULAR FONT, STYLE, SIZE, OR COLOR.

FOR ATHLETIC APPAREL, NAMELY, SHIRTS, PANTS, JACKETS, FOOTWEAR, HATS AND CAPS; ATHLETIC FOOTWEAR; ATHLETIC SHOES; ATHLETIC TIGHTS; ATHLETIC UNIFORMS (U.S. CLS. 22 AND 39).

JILL C. ALT, EXAMINING ATTORNEY

CLASS 25—(Continued).

SN 85-532,735. FETISH GROUP, INC., VERNON, CA. FILED 2-2-2012.

TAG ELEMENTAL

THE MARK CONSISTS OF STANDARD CHARACTERS WITHOUT CLAIM TO ANY PARTICULAR FONT, STYLE, SIZE, OR COLOR.

FOR CLOTHING, NAMELY, JEANS, JACKETS, SHIRTS, SHORTS, SKIRTS, AND T-SHIRTS (U.S. CLS. 22 AND 39).

LINDSEY RUBIN, EXAMINING ATTORNEY

CLASS 25—(Continued).

SN 85-532,847. DOING HIS WORK FIRST, INC., JACKSON, TN. FILED 2-3-2012.



THE MARK CONSISTS OF THE STYLIZED "M" WHEREBY A "CROSS" IN THE CENTER OF THE MARK CONNECTS THE TWO ENDS AS SHOWN IN THE MARK.

FOR CLOTHING, NAMELY, FOOTWEAR, SHOES, HEADWEAR, HATS, CAPS, HEADBANDS, TOPS, BOTTOMS, SHIRTS, T-SHIRTS, ATHLETIC AND SPORTS SHIRTS, CASUAL SHIRTS, DRESS SHIRTS, CASUAL SHORTS, DRESS SHORTS, ATHLETIC AND SPORTS SHORTS, PANTS, LEISURE PANTS, ATHLETIC AND SPORTS PANTS, SOCKS, AND UNDERWEAR (U.S. CLS. 22 AND 39).

LAURIE KAUFMAN, EXAMINING ATTORNEY

SN 85-532,968. FEINBERG, BRIAN, PENN VALLEY, PA. FILED 2-3-2012.

REVERSUS

THE MARK CONSISTS OF STANDARD CHARACTERS WITHOUT CLAIM TO ANY PARTICULAR FONT, STYLE, SIZE, OR COLOR.

FOR ATHLETIC SHOES, SNEAKERS, SOCKS, T-SHIRTS, SHIRTS, JERSEYS, SWEAT SHIRTS, HOODED SWEAT SHIRTS, JACKETS, HOODED SWEAT JACKETS, SHORTS, PANTS, SWEAT PANTS, SWEAT SUITS, BASEBALL CAPS AND HATS (U.S. CLS. 22 AND 39).

HENRY S. ZAK, EXAMINING ATTORNEY

SN 85-532,846. DOING HIS WORK FIRST, INC., JACKSON, TN. FILED 2-3-2012.

FUMS

THE MARK CONSISTS OF STANDARD CHARACTERS WITHOUT CLAIM TO ANY PARTICULAR FONT, STYLE, SIZE, OR COLOR.

FOR CLOTHING, NAMELY, FOOTWEAR, SHOES, HEADWEAR, HATS, CAPS, HEADBANDS, TOPS, BOTTOMS, SHIRTS, T-SHIRTS, ATHLETIC AND SPORTS SHIRTS, CASUAL SHIRTS, DRESS SHIRTS, CASUAL SHORTS, DRESS SHORTS, ATHLETIC AND SPORTS SHORTS, PANTS, LEISURE PANTS, ATHLETIC AND SPORTS PANTS, SOCKS, AND UNDERWEAR (U.S. CLS. 22 AND 39).

LAURIE KAUFMAN, EXAMINING ATTORNEY

SN 85-533,004. GARDNER LANDRY COMMUNICATIONS LP, HOUSTON, TX. FILED 2-3-2012.

Dictator in Paradise

THE MARK CONSISTS OF STANDARD CHARACTERS WITHOUT CLAIM TO ANY PARTICULAR FONT, STYLE, SIZE, OR COLOR.

FOR SHIRTS (U.S. CLS. 22 AND 39).
JEFFREY LOOK, EXAMINING ATTORNEY

CLASS 25—(Continued).

SN 85-533,085. STONED SOCIETY, LLC, ATLANTA, GA. FILED 2-3-2012.

Stoned Society

THE MARK CONSISTS OF STANDARD CHARACTERS WITHOUT CLAIM TO ANY PARTICULAR FONT, STYLE, SIZE, OR COLOR.

FOR BUTTON DOWN SHIRTS; COLLARED SHIRTS; DENIM JACKETS; DENIMS; DRESS SHIRTS; HATS; JACKETS; MEN'S AND WOMEN'S JACKETS; COATS; TROUSERS; VESTS; PANTS; SHIRTS; SHOES; SHORT-SLEEVED OR LONG-SLEEVED T-SHIRTS; T-SHIRTS (U.S. CLS. 22 AND 39).

AMY C. KEAN, EXAMINING ATTORNEY

SN 85-533,153. SMITH, JAMES TODD, NEW YORK, NY. FILED 2-3-2012.

MAMA SAID KNOCK YOU OUT

THE MARK CONSISTS OF STANDARD CHARACTERS WITHOUT CLAIM TO ANY PARTICULAR FONT, STYLE, SIZE, OR COLOR.

FOR CLOTHING, NAMELY, T-SHIRTS, LOUNGEWEAR, SOCKS, SHORTS, PANTS, SWEATSHIRTS, SWEATPANTS, BANDANNAS, SCARVES, APRONS, JACKETS, JEAN JACKETS, TANK TOPS, VESTS, NECKTIES, JERSEYS, SHIRTS, SWEATERS, BABY DOLL T-SHIRTS, WIND RESISTANT JACKETS, INFANTWEAR, MOCK TURTLE NECKS, TRACK PANTS, PONCHOS, AND HOODED SHIRTS; HEADWEAR; FOOTWEAR; AND BELTS (U.S. CLS. 22 AND 39).

RAUL CORDOVA, EXAMINING ATTORNEY

SN 85-533,164. ROBERT KELLER, WATERTOWN, MA. FILED 2-3-2012.

DOWNWARD DUDE

THE MARK CONSISTS OF STANDARD CHARACTERS WITHOUT CLAIM TO ANY PARTICULAR FONT, STYLE, SIZE, OR COLOR.

FOR WEARING APPAREL, NAMELY, SHIRTS, SHORTS, HATS, PANTS, SWEATSHIRTS, SWEATPANTS (U.S. CLS. 22 AND 39).

LINDA ORNDORFF, EXAMINING ATTORNEY

CLASS 25—(Continued).

SN 85-533,171. JAMES POPP, MOORESVILLE, NC. FILED 2-3-2012.

BUNDAHEAD

THE MARK CONSISTS OF STANDARD CHARACTERS WITHOUT CLAIM TO ANY PARTICULAR FONT, STYLE, SIZE, OR COLOR.

FOR CLOTHING AND SPORTSWEAR, NAMELY, ANORAKS, BELTS, BLOUSES, BRACES, COATS, GLOVES, HOODED SHIRTS, JACKETS, NECKTIES, PANTS, SCARVES, SHIRTS, SHORTS, SKIRTS, SOCKS, SWEAT PANTS, SWEAT SHIRTS, SWEATERS, T-SHIRTS, TOPS, UNDERGARMENTS, UNIFORMS, VESTS, WIND-RESISTANT JACKETS, WRIST BANDS; HEADWEAR, NAMELY, CAPS, HATS, HEADBANDS, SUN VISORS; FOOTWEAR (U.S. CLS. 22 AND 39).

MICHELE SWAIN, EXAMINING ATTORNEY

SN 85-533,563. CHRYSLER GROUP LLC, AUBURN HILLS, MI. FILED 2-3-2012.

GET STUNG

THE MARK CONSISTS OF STANDARD CHARACTERS WITHOUT CLAIM TO ANY PARTICULAR FONT, STYLE, SIZE, OR COLOR.

FOR CLOTHING, NAMELY, SHIRTS, T-SHIRTS, SWEATSHIRTS, TANK TOPS, SWEATERS, PANTS, SWEATPANTS, SWEATBANDS, SHORTS, UNDERWEAR, JACKETS, SWEAT JACKETS, BELTS, SOCKS, GLOVES, SCARVES; INFANTWEAR; HEADGEAR, NAMELY, HATS AND CAPS; FOOTWEAR (U.S. CLS. 22 AND 39).

KARANENDRA S. CHHINA, EXAMINING ATTORNEY

SN 85-533,603. DONNA FRAME, OROVILLE, CA. FILED 2-3-2012.

THE GAME GIRLS

THE MARK CONSISTS OF STANDARD CHARACTERS WITHOUT CLAIM TO ANY PARTICULAR FONT, STYLE, SIZE, OR COLOR.

FOR GLOVES; HATS; HEADBANDS; JACKETS; PANTS; SCARVES; SHAWLS; SHIRTS; SLEEPWEAR; SWEATSHIRTS (U.S. CLS. 22 AND 39).

BARBARA RUTLAND, EXAMINING ATTORNEY

CLASS 25—(Continued).

SN 85-533,654. WEST MARINE PRODUCTS, INC., WATSON-VILLE, CA. FILED 2-3-2012.



THE MARK CONSISTS OF A SHARK.
FOR CLOTHING, NAMELY, WETSUITS, SHORTS, SWEATSHIRTS, JACKETS, PANTS, WOVEN SHIRTS, T-SHIRTS, RAIN SUITS, FLEECE JACKETS, FLEECE VESTS, HATS, CAPS, GLOVES, HEADWEAR, FISHING WADERS, SKIRTS, DRESSES, KNITTED HATS, AND SWEATERS, CLOTH BIBS, BIB OVERALLS, SWIMWEAR, RASH GUARDS, BOARD SHORTS, CAPRI PANTS, BELTS, FOOTWEAR INCLUDING BOOTS, ATHLETIC SHOES, SANDALS (U.S. CLS. 22 AND 39).
MATTHEW KLINE, EXAMINING ATTORNEY

SN 85-533,811. RHE HATCO, INC., GARLAND, TX. FILED 2-3-2012.



OWNER OF U.S. REG. NOS. 330,447, 3,726,716 AND OTHERS.
THE MARK CONSISTS OF THE WORDS "RESISTOL" AND "RANCH" WITH A BARBED WIRE DESIGN IN BETWEEN THE TERMS, AND THE LETTERS IN "RANCH" SEPARATED BY STARS, ALL INCLUDED WITHIN AN OVAL DESIGN.
FOR CAPS; COATS; HATS; JACKETS; SHIRTS; VESTS (U.S. CLS. 22 AND 39).
JUSTINE D. PARKER, EXAMINING ATTORNEY

SN 85-533,812. RHE HATCO, INC., GARLAND, TX. FILED 2-3-2012.

RESISTOL RANCH

THE MARK CONSISTS OF STANDARD CHARACTERS WITHOUT CLAIM TO ANY PARTICULAR FONT, STYLE, SIZE, OR COLOR.
OWNER OF U.S. REG. NOS. 330,447, 3,726,716 AND OTHERS.
FOR CAPS; COATS; HATS; JACKETS; SHIRTS; VESTS (U.S. CLS. 22 AND 39).
JUSTINE D. PARKER, EXAMINING ATTORNEY

CLASS 25—(Continued).

SN 85-533,819. MAWICKE,TRACY, CLEARWATER, FL. FILED 2-3-2012.

N-MATE

THE MARK CONSISTS OF STANDARD CHARACTERS WITHOUT CLAIM TO ANY PARTICULAR FONT, STYLE, SIZE, OR COLOR.
FOR CLOTHING, NAMELY, TOPS, BOTTOMS, TEE-SHIRTS, SWEATSHIRTS, HATS, PANTS (U.S. CLS. 22 AND 39).
LAURIE KAUFMAN, EXAMINING ATTORNEY

SN 85-533,839. HIBLER IV, CHRISTOPHER A., SANTA CLARITA, CA. FILED 2-3-2012.

Bermudables

THE MARK CONSISTS OF STANDARD CHARACTERS WITHOUT CLAIM TO ANY PARTICULAR FONT, STYLE, SIZE, OR COLOR.
FOR GOLF CAPS; GOLF CLEATS; GOLF PANTS, SHIRTS AND SKIRTS; GOLF SHOES; GOLF SHORTS; GOLF SPIKES; GOLF TROUSERS (U.S. CLS. 22 AND 39).
TEJBIR SINGH, EXAMINING ATTORNEY

SN 85-533,856. ANDERSON, NINA-JO, HUNTINGTON BEACH, CA. FILED 2-3-2012.

KALLUS r

THE MARK CONSISTS OF STANDARD CHARACTERS WITHOUT CLAIM TO ANY PARTICULAR FONT, STYLE, SIZE, OR COLOR.
FOR SOCKS; T-SHIRTS; UNDERWEAR (U.S. CLS. 22 AND 39).
JAMES LOVELACE, EXAMINING ATTORNEY

CLASS 25—(Continued).

SN 85-533,903. JOHNSON, ALBERTO, PINOLE, CA. FILED 2-3-2012.



THE MARK CONSISTS OF STYLIZED CAPITAL LETTER "P" AND A STYLIZED CAPITAL "X" IN THE WORD "PRESTIGEX".
FOR T-SHIRTS (U.S. CLS. 22 AND 39).
LAURIE KAUFMAN, EXAMINING ATTORNEY

SN 85-533,909. S.I.T., INC., SAN LEANDRO, CA. FILED 2-3-2012.

CHERRY TREE

THE MARK CONSISTS OF STANDARD CHARACTERS WITHOUT CLAIM TO ANY PARTICULAR FONT, STYLE, SIZE, OR COLOR.

FOR CHILDREN'S CLOTHING, NAMELY, SLEEPWEAR, JACKETS, COATS, PLAYSUITS, PANTS, OVERALLS, VESTS, HATS, MITTENS, PONCHOS, SWEATSHIRTS, AND SHORTS (U.S. CLS. 22 AND 39).
JUSTINE D. PARKER, EXAMINING ATTORNEY

SN 85-533,972. THE 17/21 GROUP, LLC, VERNON, CA. FILED 2-3-2012.

SOLD

THE MARK CONSISTS OF STANDARD CHARACTERS WITHOUT CLAIM TO ANY PARTICULAR FONT, STYLE, SIZE, OR COLOR.

OWNER OF U.S. REG. NO. 3,755,419.
FOR (BASED ON USE IN COMMERCE) APPAREL, NAMELY, JEANS, PANTS, SHORTS, SKIRTS, BOTTOMS, TROUSERS; (BASED ON INTENT TO USE) APPAREL, NAMELY, BATHING SUITS, BATHING TRUNKS, BATHROBES, BEACHWEAR, BELTS, BIKINIS, BLAZERS, BLOUSES, BODY SUITS, BOOTS, CAMISOLES, CAPS, CARDIGANS, COATS, COVERALLS, COVER UPS, DRESSES, DUNGAREES, FOOTWEAR, GLOVES, HATS, HEAD BANDS, HEAD WEAR, HOSIERY, JACKETS, JERSEYS, JUMPERS, JUMP SUITS, LINGERIE, NECKWEAR, OVERALLS, OVERCOATS, PAJAMAS, RAINWEAR, SANDALS, SCARVES, SHAWLS, SHIRTS, SHOES, SHORTALLS, SKI WEAR, SKORTS, SLACKS, SLEEP WEAR, SLIPPERS, SNEAKERS, SOCKS, SPORT COATS, SUITS, SURF WEAR, SWEAT PANTS, SWEATSHIRTS, SWEAT SUITS, SWEATERS, SWIM WEAR, T-SHIRTS, TOPS, TANK TOPS, UNDERWEAR, VESTS, VISORS AND WRIST BANDS (U.S. CLS. 22 AND 39).
FIRST USE 2-8-2010; IN COMMERCE 2-8-2010.
KAREN K. BUSH, EXAMINING ATTORNEY

CLASS 25—(Continued).

SN 85-534,051. JOHN HOLCOMB, SARASOTA, FL. AND BRENT KROMREI, SARASOTA, FL. FILED 2-4-2012.

IAATU

THE MARK CONSISTS OF STANDARD CHARACTERS WITHOUT CLAIM TO ANY PARTICULAR FONT, STYLE, SIZE, OR COLOR.

FOR CAPS; HATS; HOODED SWEAT SHIRTS; JACKETS; PANTS; SHIRTS; SHORTS; SWEAT SHIRTS; T-SHIRTS (U.S. CLS. 22 AND 39).
MARGARET POWER, EXAMINING ATTORNEY

SN 85-534,078. PARKER, AYANNA, BROOKLYN, NY. FILED 2-4-2012.

THRILL OF LIBERATION

THE MARK CONSISTS OF STANDARD CHARACTERS WITHOUT CLAIM TO ANY PARTICULAR FONT, STYLE, SIZE, OR COLOR.

FOR ATHLETIC APPAREL, NAMELY, SHIRTS, PANTS, JACKETS, FOOTWEAR, HATS AND CAPS, ATHLETIC UNIFORMS; DENIMS; HATS; HOODED SWEAT SHIRTS; POLO SHIRTS; SHORTS; SWEAT SHIRTS; T-SHIRTS; WOMEN'S UNDERWEAR (U.S. CLS. 22 AND 39).
FIRST USE 1-3-2012; IN COMMERCE 1-3-2012.
LAURIE KAUFMAN, EXAMINING ATTORNEY

SN 85-534,093. OPTIN, LLC, WESTON, CT. FILED 2-4-2012.

Xander

THE MARK CONSISTS OF STANDARD CHARACTERS WITHOUT CLAIM TO ANY PARTICULAR FONT, STYLE, SIZE, OR COLOR.

FOR DRESS SHIRTS; DRESSES; WOMEN'S CLOTHING, NAMELY, SHIRTS, DRESSES, SKIRTS, BLOUSES (U.S. CLS. 22 AND 39).
CHRISTOPHER SIDOTI, EXAMINING ATTORNEY

CLASS 25—(Continued).

SN 85-534,152. HALL, JASON, L, BROOKLYN, NY. FILED 2-4-2012.

Anti Social Life

THE MARK CONSISTS OF STANDARD CHARACTERS WITHOUT CLAIM TO ANY PARTICULAR FONT, STYLE, SIZE, OR COLOR.

FOR ATHLETIC APPAREL, NAMELY, SHIRTS, PANTS, JACKETS, FOOTWEAR, HATS AND CAPS, ATHLETIC UNIFORMS; HOODED SWEAT SHIRTS; JACKETS; POLO SHIRTS; RUGBY SHIRTS; SHIRTS AND SHORT-SLEEVED SHIRTS; SHIRTS FOR INFANTS, BABIES, TODDLERS AND CHILDREN; SHORT-SLEEVED OR LONG-SLEEVED T-SHIRTS; SWEAT SHIRTS; T-SHIRTS; T-SHIRTS FOR MEN, WOMEN, CHILDREN; TEE SHIRTS; WEARABLE GARMENTS AND CLOTHING, NAMELY, SHIRTS (U.S. CLS. 22 AND 39).

JACQUELINE A. LAVINE, EXAMINING ATTORNEY

SN 85-534,266. PHELPS, JANIS M., QUEEN CREEK, AZ. FILED 2-5-2012.

HAYPRON

THE MARK CONSISTS OF STANDARD CHARACTERS WITHOUT CLAIM TO ANY PARTICULAR FONT, STYLE, SIZE, OR COLOR.

FOR APRONS; COVERUPS (U.S. CLS. 22 AND 39).
SUSAN LESLIE DUBOIS, EXAMINING ATTORNEY

SN 85-534,281. ARTEMIEV PETER, DBA 20G, BROOKLYN, NY. FILED 2-5-2012.

20G

THE MARK CONSISTS OF STANDARD CHARACTERS WITHOUT CLAIM TO ANY PARTICULAR FONT, STYLE, SIZE, OR COLOR.

FOR A-SHIRTS; ADHESIVE BRAS; ADULT NOVELTY GAG CLOTHING ITEM, NAMELY, SOCKS; AFTER SKI BOOTS; ALBS; AMERICAN FOOTBALL BIBS; ANGLERS' SHOES; ANKLE BOOTS; ANKLE SOCKS; ANKLETS; ANORAK; ANORAKS; ANTI-PERSPIRANT SOCKS; APPAREL FOR DANCERS, NAMELY, TEE SHIRTS, SWEATSHIRTS, PANTS, LEGGINGS, SHORTS AND JACKETS; APRES-SKI SHOES; APRONS; AQUA SHOES; ARTIFICIAL FLOWER HEADDRESSES; ASCOTS; ATHLETIC APPAREL, NAMELY, SHIRTS, PANTS, JACKETS, FOOTWEAR, HATS AND CAPS, ATHLETIC UNIFORMS; ATHLETIC FOOTWEAR; ATHLETIC SHOES; BANDANAS; BASEBALL CAPS; BASEBALL CAPS AND HATS; BASEBALL UNIFORMS; BASKETBALL SNEAKERS; BEANIES; BELTS; BLAZERS; BOAT SHOES; BODY SHIRTS; BODY SUITS; BOMBER

CLASS 25—(Continued).

JACKETS; BOOTS; BRAS; BUCKET CAPS; BUTTON DOWN SHIRTS; CAMOUFLAGE GLOVES; CAMOUFLAGE JACKETS; CAMOUFLAGE PANTS; CAMOUFLAGE SHIRTS; CAMOUFLAGE VESTS; CLOTHING FOR ATHLETIC USE, NAMELY, PADDED PANTS; CLOTHING FOR ATHLETIC USE, NAMELY, PADDED SHIRTS; CLOTHING FOR ATHLETIC USE, NAMELY, PADDED SHORTS; CLOTHING ITEMS, NAMELY, ADHESIVE POCKETS THAT MAY BE AFFIXED DIRECTLY TO THE BODY AS A DECORATIVE PIECE OF CLOTHING WITH UTILITY; CLOTHING ITEMS, NAMELY, ADHESIVE POCKETS THAT MAY BE AFFIXED DIRECTLY TO THE INSIDE OF CLOTHING FOR STORAGE AND SAFEKEEPING OF PERSONAL ITEMS; COATS; COATS FOR MEN AND WOMEN; COATS MADE OF COTTON; COATS OF DENIM; COLLARS; CREW NECK SWEATERS; CREW NECKS; DENIM JACKETS; DENIMS; DOWN JACKETS; DOWN SUITS; DRESS PANTS; DRESS SHIELDS; DRESS SHIRTS; DRESS SUITS; EAR MUFFS; EAR WARMERS; EARBANDS; FABRIC BELTS; FINGERLESS GLOVES; FISHERMEN'S JACKETS; FLEECE BOTTOMS; FLEECE PULLOVERS; FLEECE SHORTS; FLEECE TOPS; FLEECE VESTS; FLIGHT SUITS; FOOTWEAR; FOOTWEAR FOR MEN; FOOTWEAR FOR MEN AND WOMEN; FOOTWEAR FOR WOMEN; FUR COATS; FUR COATS AND JACKETS; FUR HATS; FUR JACKETS; GLOVES; GLOVES AS CLOTHING; GLOVES FOR APPAREL; GLOVES FOR PERSONAL HAND CONDITIONING USE; GOLF CAPS; GOLF PANTS, SHIRTS AND SKIRTS; GOLF TROUSERS; GYM BOOTS; GYM PANTS; GYM SHORTS; GYM SUITS; HATS; HEADBANDS FOR CLOTHING; HEADWEAR; HEAVY COATS; HEAVY JACKETS; HIKING BOOTS; HOODED SWEATSHIRTS; HOODS; HUNTING JACKETS; HUNTING PANTS; HUNTING SHIRTS; HUNTING VESTS; INSOLES; JACKET LINERS; JACKETS; JAPANESE FOOTWEAR OF RICE STRAW (WARAJI); JAPANESE SLEEPING ROBES (NEMAKI); JAPANESE SPLIT-TOED WORK FOOTWEAR (JIKATABI); JAPANESE STYLE CLOGS AND SANDALS; JAPANESE STYLE SANDALS (ZORI); JAPANESE STYLE SANDALS OF FELT; JAPANESE STYLE SANDALS OF LEATHER; JAPANESE STYLE SOCKS (TABI COVERS); JAPANESE STYLE SOCKS (TABI); JAPANESE STYLE WOODEN CLOGS (GETA); JAPANESE TOE-STRAP SANDALS (ASAURA-ZORI); JEANS; JEGGINGS, NAMELY, PANTS THAT ARE PARTIALLY JEANS AND PARTIALLY LEGGINGS; JERSEYS; JOGGING OUTFITS; JOGGING PANTS; JOGGING SUITS; JUMP SUITS; JUMPSUITS; KERCHIEFS; KNEE HIGHS; KNEE-HIGH STOCKINGS; KNICKERS; KNIT BOTTOMS; KNIT FACE MASKS; KNIT JACKETS; KNIT SHIRTS; KNIT SKIRTS; KNIT TOPS; KNITTED CAPS; KNITTED GLOVES; KNITTED UNDERWEAR; KNOT CAPS; KNOTTED CAPS; LACE BOOTS; LADIES' BOOTS; LEATHER BELTS; LEATHER COATS; LEATHER HATS; LEATHER HEADWEAR; LEATHER JACKETS; LEATHER PANTS; LEATHER SHIRTS; LEATHER SHOES; LEATHER SKIRTS; LEATHER SLIPPERS; LEATHER VESTS; LEGGINGS; LEGGINS; LEISURE SHOES; LEISURE SUITS; LIGHT-REFLECTING COATS; LIGHT-REFLECTING JACKETS; LOAFERS; LONG JACKETS; LONG JOHNS; LONG SLEEVE PULLOVERS; LONG SLEEVED VESTS; LONG-SLEEVED SHIRTS; LOUNGE PANTS; MEN'S AND WOMEN'S JACKETS, COATS, TROUSERS, VESTS; MEN'S DRESS SOCKS; MEN'S SOCKS; MEN'S SUITS; MEN'S SUITS, WOMEN'S SUITS; MEN'S UNDERWEAR; NIGHTWEAR; OPEN-NECKED SHIRTS; OUTDOOR GLOVES; OUTDOOR MITTENS; OUTER JACKETS; OVER COATS; OVER SHIRTS; SKI BOOT CASES; SKI BOOTS; SKI GLOVES; SKI JACKETS; SKI MASKS; SKI PANTS; SKI SUITS; SKI SUITS FOR COMPETITION; SKI TROUSERS; SKIING SHOES; SKIRT SUITS; SKORTS; SKULL CAPS; SKULLIES; SLACKS; SNEAKERS; SOCKS; SOLES; SWEAT BANDS; SWEAT JACKETS; SWEAT PANTS; SWEATPANTS; SWEATSHIRTS; SWEATSOCKS; T-SHIRTS; T-SHIRTS FOR MEN, WOMEN, CHILDREN; TANK TOPS; TANK-TOPS; TEE SHIRTS; TOPS (U.S. CLS. 22 AND 39).

DAWN FELDMAN, EXAMINING ATTORNEY

CLASS 25—(Continued).

SN 85-534,362. ONE THOUSAND PETALS, INC., BROOKLYN, NY. FILED 2-6-2012.

ONE THOUSAND PETALS

THE MARK CONSISTS OF STANDARD CHARACTERS WITHOUT CLAIM TO ANY PARTICULAR FONT, STYLE, SIZE, OR COLOR.

FOR DRESSES; SWEAT JACKETS; SWEAT PANTS; SWEAT SHIRTS; SWEAT SHORTS; SWEAT SUITS; YOGA PANTS; YOGA SHIRTS (U.S. CLS. 22 AND 39).

ANDREW LEASER, EXAMINING ATTORNEY

SN 85-534,363. QUICK ACCESSORIES PTY LTD, DEVONPORT, AUSTRALIA, FILED 2-6-2012.

PITSLINGER

THE MARK CONSISTS OF STANDARD CHARACTERS WITHOUT CLAIM TO ANY PARTICULAR FONT, STYLE, SIZE, OR COLOR.

OWNER OF AUSTRALIA REG. NO. 1427268, DATED 9-9-2011, EXPIRES 5-25-2021.

FOR ATHLETIC APPAREL, NAMELY, SHIRTS, PANTS, JACKETS, FOOTWEAR, HATS AND CAPS, ATHLETIC UNIFORMS; BASEBALL CAPS AND HATS; HOODED SWEAT SHIRTS; SHORT-SLEEVED OR LONG-SLEEVED T-SHIRTS; SPORTS SHIRTS; SWEAT SHIRTS; T-SHIRTS (U.S. CLS. 22 AND 39).

ANDREW LEASER, EXAMINING ATTORNEY

SN 85-534,388. BOWEN, NATHALINE M., PHILADELPHIA, PA. AND BOWEN, ARTHURLINE S., PHILADELPHIA, PA. AND BOWEN, PRECIOUS P., PHILADELPHIA, PA. FILED 2-6-2012.

PLATINUM HEIRESS

THE MARK CONSISTS OF STANDARD CHARACTERS WITHOUT CLAIM TO ANY PARTICULAR FONT, STYLE, SIZE, OR COLOR.

FOR BLOUSES; COATS; CROP TOPS; DRESSES; FLEECE BOTTOMS; FLEECE SHORTS; FOOTWEAR; GLOVES; HATS; HEADBANDS; HEADWEAR; HOODED SWEAT SHIRTS; JACKETS; JEANS; LEGGINGS; LINGERIE; PANTS; SCARVES; SHIRTS; SHORTS; SKIRTS; SLEEPWEAR; SWEAT PANTS; SWEAT SHIRTS; SWEAT SUITS; SWEATERS; SWIMWEAR; T-SHIRTS; TANK TOPS; UNDERWEAR; VESTS (U.S. CLS. 22 AND 39).

APRIL ROACH, EXAMINING ATTORNEY

CLASS 25—(Continued).

SN 85-534,530. FIFTY-SIX HOPE ROAD MUSIC, LIMITED, CABLE BEACH, NASSAU, BAHAMAS, FILED 2-6-2012.

TUFF GONG WORLDWIDE

THE MARK CONSISTS OF STANDARD CHARACTERS WITHOUT CLAIM TO ANY PARTICULAR FONT, STYLE, SIZE, OR COLOR.

NO CLAIM IS MADE TO THE EXCLUSIVE RIGHT TO USE "WORLDWIDE", APART FROM THE MARK AS SHOWN.

FOR (BASED ON USE IN COMMERCE) T-SHIRTS-(BASED ON INTENT TO USE) HATS; SWEATSHIRTS (U.S. CLS. 22 AND 39).

FIRST USE 11-1-2010; IN COMMERCE 11-1-2010.

SUNG IN, EXAMINING ATTORNEY

SN 85-534,595. DECEPTION FIGHT GEAR, JACKSON SPRINGS, NC. FILED 2-6-2012.

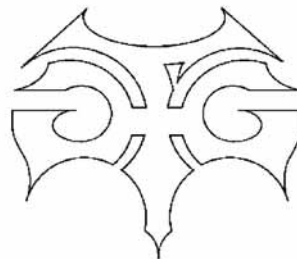

THE MARK CONSISTS OF AN ABSTRACT DESIGN. FOR HATS; HOODED SWEAT SHIRTS; PANTS; SHOES; SHORT-SLEEVED OR LONG-SLEEVED T-SHIRTS; SHORTS; SOCKS; SWEAT SHIRTS (U.S. CLS. 22 AND 39).

GEORGE LORENZO, EXAMINING ATTORNEY

SN 85-534,617. NICHOLAS MULLINS, DBA CAPTIVATE CLASSICS, COVINA, CA. FILED 2-6-2012.

CAPTIVATE CLASSICS

THE MARK CONSISTS OF STANDARD CHARACTERS WITHOUT CLAIM TO ANY PARTICULAR FONT, STYLE, SIZE, OR COLOR.

FOR T-SHIRTS (U.S. CLS. 22 AND 39).

FIRST USE 1-28-2010; IN COMMERCE 1-28-2010.

DEZMONA MIZELLE, EXAMINING ATTORNEY

CLASS 25—(Continued).

SN 85-534,724. LORRAINE MCGREGOR, CHICAGO, IL.
FILED 2-6-2012.

CHOCOLATE BUNNIES

THE MARK CONSISTS OF STANDARD CHARACTERS WITHOUT CLAIM TO ANY PARTICULAR FONT, STYLE, SIZE, OR COLOR.

FOR JACKETS; PANTS; SHIRTS (U.S. CLS. 22 AND 39).
JEFFREY LOOK, EXAMINING ATTORNEY

SN 85-534,740. WESTRIDGE PARTNERS, WILTON, CT.
FILED 2-6-2012.

DAY OF THE DEAD

THE MARK CONSISTS OF STANDARD CHARACTERS WITHOUT CLAIM TO ANY PARTICULAR FONT, STYLE, SIZE, OR COLOR.

FOR ATHLETIC APPAREL, NAMELY, SHIRTS, PANTS, JACKETS, FOOTWEAR, HATS AND CAPS, ATHLETIC UNIFORMS (U.S. CLS. 22 AND 39).

HEATHER THOMPSON, EXAMINING ATTORNEY

SN 85-534,744. RESHOD WALKING SHOES, LLC, ALOHA, OR.
FILED 2-6-2012.

Pushover

THE MARK CONSISTS OF STANDARD CHARACTERS WITHOUT CLAIM TO ANY PARTICULAR FONT, STYLE, SIZE, OR COLOR.

FOR FOOTWEAR (U.S. CLS. 22 AND 39).
HEATHER THOMPSON, EXAMINING ATTORNEY

SN 85-534,771. THE H.D. LEE COMPANY, INC., WILMINGTON, DE. FILED 2-6-2012.

HERITAGE BLUES

THE MARK CONSISTS OF STANDARD CHARACTERS WITHOUT CLAIM TO ANY PARTICULAR FONT, STYLE, SIZE, OR COLOR.

FOR BOTTOMS; TOPS (U.S. CLS. 22 AND 39).
SHAUNIA CARLYLE, EXAMINING ATTORNEY

CLASS 25—(Continued).

SN 85-535,005. ADAMS, IRENE, E, CAPE CORAL, FL. FILED 2-6-2012.

**"GBG"
GUIDED BY GOD**

THE MARK CONSISTS OF STANDARD CHARACTERS WITHOUT CLAIM TO ANY PARTICULAR FONT, STYLE, SIZE, OR COLOR.

FOR A-SHIRTS; APPAREL FOR DANCERS, NAMELY, TEE SHIRTS, SWEATSHIRTS, PANTS, LEGGINGS, SHORTS AND JACKETS; ATHLETIC APPAREL, NAMELY, SHIRTS, PANTS, JACKETS, FOOTWEAR, HATS AND CAPS, ATHLETIC UNIFORMS; BODY SHIRTS; BUTTON DOWN SHIRTS; BUTTON-FRONT ALOHA SHIRTS; CAMOUFLAGE SHIRTS; CAMP SHIRTS; CLOTHING FOR ATHLETIC USE, NAMELY, PADDED SHIRTS; CLOTHING SHIELDS, NAMELY, PADS APPLIED TO THE UNDERARMS OF SHIRTS, BLOUSES AND SWEATERS; DRESS SHIRTS; FISHING SHIRTS; GOLF PANTS, SHIRTS AND SKIRTS; GOLF SHIRTS; HOODED SWEAT SHIRTS; HUNTING SHIRTS; KNIT SHIRTS; LEATHER SHIRTS; MOISTURE-WICKING SPORTS SHIRTS; OPEN-NECKED SHIRTS; OVER SHIRTS; PIQUE SHIRTS; RUGBY SHIRTS; SCIENTIFIC AND TECHNOLOGICAL APPAREL, NAMELY, SHIRTS, PANTS, JACKETS, FOOTWEAR, HATS AND CAPS, UNIFORMS; SHIRT FRONTS; SHIRTS; SHIRTS AND SHORT-SLEEVED SHIRTS; SHIRTS FOR INFANTS, BABIES, TODDLERS AND CHILDREN; SHORT-SLEEVED OR LONG-SLEEVED T-SHIRTS; SHORT-SLEEVED SHIRTS; SLEEP SHIRTS; SPORT SHIRTS; SPORTS SHIRTS WITH SHORT SLEEVES; SWEAT SHIRTS; TEE SHIRTS; WIND SHIRTS; WOMEN'S CLOTHING, NAMELY, SHIRTS, DRESSES, SKIRTS, BLOUSES (U.S. CLS. 22 AND 39).

SAMUEL E. SHARPER JR., EXAMINING ATTORNEY

SN 85-535,057. FASHION STORMS, LLC, METAIRIE, LA.
FILED 2-6-2012.

DEATH VALLEY DIVA

THE MARK CONSISTS OF STANDARD CHARACTERS WITHOUT CLAIM TO ANY PARTICULAR FONT, STYLE, SIZE, OR COLOR.

FOR CLOTHING, NAMELY, PANTS, SHIRTS, BLOUSES, SHORTS, TOPS, DRESSES, T-SHIRTS, GOLF SHIRTS, SWEATPANTS, PAJAMAS, ONE PIECE UNDERGARMENTS FOR BABIES, COATS, SCARVES, AND JACKETS; CLOTH BIBS FOR INFANTS AND CHILDREN; FOOTWEAR; HEADGEAR, NAMELY, HATS AND CAPS; HALLOWEEN, MARDI GRAS, CHILDREN'S DRESS-UP, COSTUME PARTY, AND FOLK COSTUMES AND MASKS SOLD IN CONNECTION THEREWITH (U.S. CLS. 22 AND 39).

KATHLEEN KOLACZ, EXAMINING ATTORNEY

CLASS 25—(Continued).

SN 85-535,071. PICKRON, ADAM, ANDALUSIA, AL. FILED 2-6-2012.



THE MARK CONSISTS OF THE STYLIZED DESIGN OF A FISH SKELETON.
FOR BOTTOMS; CAPS; HATS; PANTS; SHIRTS; SHORTS; TOPS (U.S. CLS. 22 AND 39).
FIRST USE 4-15-2011; IN COMMERCE 4-15-2011.
MATTHEW PAPPAS, EXAMINING ATTORNEY

SN 85-535,307. COSBIE, DOUG, LOOMIS, CA. FILED 2-6-2012.



THE MARK CONSISTS OF AN ABSTRACT DESIGN WITH THE STYLIZED TEXT "WE GREATER THAN ME".
FOR HATS; SHIRTS; SHORTS; SWEATSHIRTS (U.S. CLS. 22 AND 39).
MARGERY A. TIERNEY, EXAMINING ATTORNEY

SN 85-535,349. MASTERS EQUESTRIAN LLC, MONTEBELLO, CA. FILED 2-6-2012.

Masters Equestrian

THE MARK CONSISTS OF STANDARD CHARACTERS WITHOUT CLAIM TO ANY PARTICULAR FONT, STYLE, SIZE, OR COLOR.

NO CLAIM IS MADE TO THE EXCLUSIVE RIGHT TO USE "EQUESTRIAN", APART FROM THE MARK AS SHOWN.

FOR HATS; HOODED SWEATSHIRTS; JACKETS; JEANS; JODHPURS; PANTS; POLO SHIRTS; SHORT-SLEEVED OR LONG-SLEEVED T-SHIRTS; SHORTS; SOCKS; SWEATSHIRTS; T-SHIRTS; TANK TOPS; UNDERWEAR; VESTS (U.S. CLS. 22 AND 39).

FIRST USE 8-23-2010; IN COMMERCE 2-3-2012.
EMILY CARLSEN, EXAMINING ATTORNEY

CLASS 25—(Continued).

SN 85-535,470. MUSCLES BY SARA, LLC, BEND, OR. FILED 2-7-2012.

REAL WOMEN HAVE MUSCLES

THE MARK CONSISTS OF STANDARD CHARACTERS WITHOUT CLAIM TO ANY PARTICULAR FONT, STYLE, SIZE, OR COLOR.

FOR CLOTHING, NAMELY, T-SHIRTS (U.S. CLS. 22 AND 39).

FIRST USE 1-1-2009; IN COMMERCE 11-1-2009.
TASHIA BUNCH, EXAMINING ATTORNEY

SN 85-535,524. U.O. MERCHANDISE, INC., PHILADELPHIA, PA. FILED 2-7-2012.

FAR AWAY FROM CLOSE

THE MARK CONSISTS OF STANDARD CHARACTERS WITHOUT CLAIM TO ANY PARTICULAR FONT, STYLE, SIZE, OR COLOR.

FOR SWEATERS (U.S. CLS. 22 AND 39).

FIRST USE 9-22-2011; IN COMMERCE 9-22-2011.
MARK T. MULLEN, EXAMINING ATTORNEY

SN 85-535,548. MARGARET I. HILLARY, DBA MEG HILLARY DESIGNS, EDEN PRAIRIE, MN. FILED 2-7-2012.



THE MARK CONSISTS OF THE WORD "COOKSHIRT" WITH A STYLIZED LETTER "T" REPRESENTING A COLLARED SHIRT, ALL SURROUNDED BY AN OVAL-SHAPED BORDER.

FOR APRONS (U.S. CLS. 22 AND 39).
HEATHER BIDDULPH, EXAMINING ATTORNEY

CLASS 25—(Continued).

SN 85-535,676. UNDERWOOD, RANDY C., MALVERN, AR. FILED 2-7-2012.

Cowboy Vanity

THE MARK CONSISTS OF STANDARD CHARACTERS WITHOUT CLAIM TO ANY PARTICULAR FONT, STYLE, SIZE, OR COLOR.

FOR BASEBALL CAPS AND HATS; BEANIES; BOOT ACCESSORIES, NAMELY, FITTED DECORATIVE COVERS FOR BOOTS; BOOTS; KNITTED CAPS; SCARVES; SHAWLS; SKULL CAPS (U.S. CLS. 22 AND 39).
MORGAN WYNNE, EXAMINING ATTORNEY



SN 85-535,759. OHAYO SANGYO LLC, TORRANCE, CA. FILED 2-7-2012.



THE MARK CONSISTS OF A STYLIZED LETTER "R". FOR ACTIVE SPORTSWEAR CLOTHING FOR MEN, WOMEN, AND CHILDREN, NAMELY, SHIRTS, SHORTS, SINGLETS, JACKETS, PANTS, TIGHTS, SWEAT SHIRTS, HATS, CAPS, SWIMWEAR, SOCKS, AND FOOTWEAR (U.S. CLS. 22 AND 39).
FIRST USE 1-1-1996; IN COMMERCE 1-1-1996.
KIM MONINGHOFF, EXAMINING ATTORNEY



SN 85-535,870. BASE APPAREL CO., LTD, GUANGZHOU, CHINA, FILED 2-7-2012.

BASE REVOLU

THE MARK CONSISTS OF STANDARD CHARACTERS WITHOUT CLAIM TO ANY PARTICULAR FONT, STYLE, SIZE, OR COLOR.

FOR CLOTHING, NAMELY, FOOTWEAR, SHOES, HEAD WEAR, HATS, TOPS, BOTTOMS, SHIRTS, T-SHIRTS, POLO SHIRTS, PANTS, JEANS, BELTS, JACKETS, AND SWEATERS (U.S. CLS. 22 AND 39).
FIRST USE 4-9-2006; IN COMMERCE 4-9-2006.
KEVON CHISOLM, EXAMINING ATTORNEY

CLASS 25—(Continued).

SN 85-536,046. P4P, LLC, KAILUA, HI. FILED 2-7-2012.

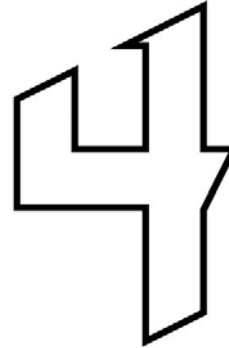

THE MARK CONSISTS OF A STYLIZED NUMBER "4", PRESENTED IN OUTLINE FORM.

FOR CLOTHING, NAMELY T-SHIRTS, HEADWEAR, SWEATSHIRTS, SWEAT PANTS, COLLARED SHIRTS, SHORTS, SWEAT BANDS, WRIST BANDS, FOOTWEAR, SOCKS, RASH GUARDS, GLOVES, UNDERWEAR AND JACKETS (U.S. CLS. 22 AND 39).
CURTIS FRENCH, EXAMINING ATTORNEY



SN 85-536,071. P4P, LLC, KAILUA, HI. FILED 2-7-2012.

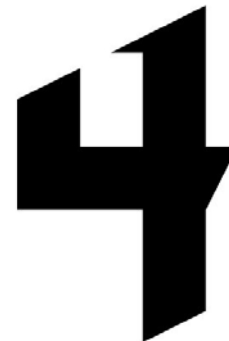

THE MARK CONSISTS OF A STYLIZED "4", PRESENTED IN SOLID FORM.

FOR CLOTHING, NAMELY T-SHIRTS, HEADWEAR, SWEATSHIRTS, SWEAT PANTS, COLLARED SHIRTS, SHORTS, SWEAT BANDS, WRIST BANDS, FOOTWEAR, SOCKS, RASH GUARDS, GLOVES, UNDERWEAR AND JACKETS (U.S. CLS. 22 AND 39).
CURTIS FRENCH, EXAMINING ATTORNEY

CLASS 25—(Continued).

SN 85-536,078. SHOESZOO FOOTWEAR, INC., BRITISH COLUMBIA, CANADA, FILED 2-7-2012.

CAROOO

THE MARK CONSISTS OF STANDARD CHARACTERS WITHOUT CLAIM TO ANY PARTICULAR FONT, STYLE, SIZE, OR COLOR.

FOR SHOES (U.S. CLS. 22 AND 39).
FIRST USE 0-0-2003; IN COMMERCE 0-0-2003.
EMILY CARLSEN, EXAMINING ATTORNEY

SN 85-536,104. TODAY'S DESIGNER FASHIONS INC, DBA TODAY'S DESIGNER FASHIONS INC, NORTH YORK, ONTARIO, CANADA, FILED 2-7-2012.

ZalaMería

THE MARK CONSISTS OF STANDARDIZED LETTERS EXCEPT FOR THE LETTER "I" WHICH IS IN ITS LATIN FORM. THE TRADEMARK IS ONE WORD AND THE LETTERS "Z" AND "M" ARE IN CAPITALS FOR STYLING PURPOSES ONLY.

THE ENGLISH TRANSLATION OF "ZALAMERÍA" IN THE MARK IS "FLATTERY" AND "SMOOTHNESS".

FOR BLOUSES; CAPES; CAPRIS; CARDIGANS; COATS; DRESS SUITS; DRESSES; DRESSING GOWNS; EVENING GOWNS; FOOTWEAR; HEADGEAR, NAMELY, HATS, CAPS; JACKETS; JEANS; LINGERIE; PANTS; PONCHOS; SHAWLS; SHIRTS; SHORTS; SKIRTS; SWEATERS; T-SHIRTS; TOPS; TROUSERS; TUNICS; VESTS; WAISTCOATS (U.S. CLS. 22 AND 39).
SAMUEL E. SHARPER JR., EXAMINING ATTORNEY

SN 85-536,105. MANZARO, DOMINIC B., WORCESTER, MA, FILED 2-7-2012.

greenomix

THE MARK CONSISTS OF STANDARD CHARACTERS WITHOUT CLAIM TO ANY PARTICULAR FONT, STYLE, SIZE, OR COLOR.

FOR T-SHIRTS (U.S. CLS. 22 AND 39).
VIVIAN MICZNIK FIRST, EXAMINING ATTORNEY

CLASS 25—(Continued).

SN 85-536,300. R&R ELITE MANAGEMENT, LLC, BEVERLY HILLS, CA. FILED 2-7-2012.

UNUM

THE MARK CONSISTS OF STANDARD CHARACTERS WITHOUT CLAIM TO ANY PARTICULAR FONT, STYLE, SIZE, OR COLOR.

FOR MEN'S, WOMEN'S AND CHILDREN'S CLOTHING, NAMELY, PANTS, SHIRTS, T-SHIRTS, SWEAT-SHIRTS, JACKETS, SUITS, DRESSES, COATS, TOPS, BOTTOMS, UNDERWEAR, SHOES, SOCKS, SLIPPERS, HEADWEAR, HATS, CAPS, SCARVES, SWEATERS, SWIMWEAR, SLEEPWEAR (U.S. CLS. 22 AND 39).
HELENE LIWINSKI, EXAMINING ATTORNEY

SN 85-536,338. ELMASRY, KERRY, BETHPAGE, NY. FILED 2-7-2012.

SLEEVETTES

THE MARK CONSISTS OF STANDARD CHARACTERS WITHOUT CLAIM TO ANY PARTICULAR FONT, STYLE, SIZE, OR COLOR.

FOR SLEEVES WORN SEPARATE AND APART FROM BLOUSES, SHIRTS AND OTHER TOPS (U.S. CLS. 22 AND 39).
APRIL ROACH, EXAMINING ATTORNEY

SN 85-536,390. GRIGGS, BILL, ROLLING HILLS ESTATES, CA. FILED 2-7-2012.

fear the tide

THE MARK CONSISTS OF STANDARD CHARACTERS WITHOUT CLAIM TO ANY PARTICULAR FONT, STYLE, SIZE, OR COLOR.

FOR SHIRTS; SWEAT PANTS; SWEAT SHIRTS; SWEAT SUITS; T-SHIRTS (U.S. CLS. 22 AND 39).
MARK T. MULLEN, EXAMINING ATTORNEY

CLASS 25—(Continued).

SN 85-536,428. CAREY, BRIAN F., DANVILLE, CA. FILED 2-7-2012.

T//A

THE MARK CONSISTS OF STANDARD CHARACTERS WITHOUT CLAIM TO ANY PARTICULAR FONT, STYLE, SIZE, OR COLOR.
FOR SHIRTS; T-SHIRTS (U.S. CLS. 22 AND 39).
FIRST USE 3-7-2012; IN COMMERCE 3-7-2012.
SUNG IN, EXAMINING ATTORNEY

SN 85-536,436. REFLUXX, BAYSHORE, NY. FILED 2-7-2012.



THE MARK CONSISTS OF THE STYLIZED TEXT "RXX".
FOR CLOTHING, NAMELY, T-SHIRTS, DRESS SHIRTS, LONG-SLEEVED KNIT SHIRTS, DENIM JEANS, CASUAL PANTS, JACKETS, HOODED SWEATSHIRTS, ONE-PIECE GARMENTS FOR CHILDREN, SHOES, AND SNEAKERS (U.S. CLS. 22 AND 39).
SUNG IN, EXAMINING ATTORNEY

SN 85-536,440. KOLLER III, FRANK, FAIRFIELD, CA. FILED 2-7-2012.

The only solution is to
obey the Constitution

THE MARK CONSISTS OF STANDARD CHARACTERS WITHOUT CLAIM TO ANY PARTICULAR FONT, STYLE, SIZE, OR COLOR.
FOR T-SHIRTS (U.S. CLS. 22 AND 39).
DAVID H. STINE, EXAMINING ATTORNEY

CLASS 25—(Continued).

SN 85-536,471. MAIKO INC., SOLANA BEACH, CA. FILED 2-7-2012.

ALOHA AINA, ALOHA KAI

THE MARK CONSISTS OF STANDARD CHARACTERS WITHOUT CLAIM TO ANY PARTICULAR FONT, STYLE, SIZE, OR COLOR.
THE ENGLISH TRANSLATION OF "ALOHA AINA, ALOHA KAI" IN THE MARK IS "LOVE THE LAND, LOVE THE SEA".
FOR BELTS; BLOUSES; COATS; DRESSES; HATS; JACKETS; PANTS; SHIRTS; SHOES; SHORTS; SKIRTS; SOCKS; SWEAT SHIRTS; SWEATERS; SWIMSUITS; T-SHIRTS; UNDERWEAR; VESTS (U.S. CLS. 22 AND 39).
SUNG IN, EXAMINING ATTORNEY

SN 85-536,516. HOYD, SHAWNEE, IRVINE, CA. FILED 2-7-2012.

CLIPPERTAINMENT TONIGHT

THE MARK CONSISTS OF STANDARD CHARACTERS WITHOUT CLAIM TO ANY PARTICULAR FONT, STYLE, SIZE, OR COLOR.
FOR APPAREL FOR DANCERS, NAMELY, TEE SHIRTS, SWEATSHIRTS, PANTS, LEGGINGS, SHORTS AND JACKETS; APRONS; ATHLETIC APPAREL, NAMELY, SHIRTS, PANTS, JACKETS, FOOTWEAR, HATS AND CAPS, ATHLETIC UNIFORMS; BASEBALL CAPS AND HATS; BEACH COVER-UPS; BERMUDA SHORTS; BIKINIS; BOXER SHORTS; CAPS WITH VISORS; CLOTH BIBS; CLOTHING FOR BABIES, TODDLERS AND CHILDREN, TREATED WITH FIRE AND HEAT RETARDANTS, NAMELY, PAJAMAS, JACKETS, SHIRTS, PANTS, JUMPERS; CROP TOPS; FLEECE TOPS; HATS; HATS FOR INFANTS, BABIES, TODDLERS AND CHILDREN; HOODED SWEAT SHIRTS; KNIT DRESSES; KNIT SHIRTS; NOVELTY HEADWEAR WITH ATTACHED WIGS; PAJAMAS; PANTS; POLO SHIRTS; RUGBY SHIRTS; SCARVES; SHIRTS; SHORT-SLEEVED OR LONG-SLEEVED T-SHIRTS; SHORTS; SKULL CAPS; SUN VISORS; SWEAT PANTS; SWEAT SHIRTS; SWEAT-SUITS; SWIMMING TRUNKS; SWIMSUITS; TANK TOPS; TIES; TOBOGGAN HATS, PANTS AND CAPS (U.S. CLS. 22 AND 39).
AISHA SALEM, EXAMINING ATTORNEY

CLASS 25—(Continued).

SN 85-536,554. AKM SHAMSUZZAMAN, ASTORIA, NY.
FILED 2-7-2012.

RANEEN

THE MARK CONSISTS OF STANDARD CHARACTERS WITHOUT CLAIM TO ANY PARTICULAR FONT, STYLE, SIZE, OR COLOR.

FOR T-SHIRTS FOR BABIES, ADULTS, CHILDREN, BOYS, GIRLS, WOMEN, MEN (U.S. CLS. 22 AND 39).
ROBIN CHOSID, EXAMINING ATTORNEY

SN 85-536,609. ALORAIFAN, AHMAD, KUWAIT, KUWAIT,
FILED 2-8-2012.

ZEOKI & PIERCE

THE MARK CONSISTS OF STANDARD CHARACTERS WITHOUT CLAIM TO ANY PARTICULAR FONT, STYLE, SIZE, OR COLOR.

FOR CLOTHING, NAMELY, TOPS, BOTTOMS, SHIRTS, T-SHIRTS, TANK TOPS, PANTS, JEANS, BLOUSES, SWEATSHIRTS, HOODED SWEATSHIRTS, SWEATPANTS, CAPS, HATS, JACKETS, COATS, SKIRTS, DRESSES, SOCKS, JERSEYS, LEATHER SHIRTS, LEATHER PANTS, LEATHER SKIRTS, LEATHER JACKETS, UNDERWEAR, SHOES AND BELTS (U.S. CLS. 22 AND 39).
EMILY CARLSEN, EXAMINING ATTORNEY

SN 85-536,617. ALORAIFAN, AHMAD, KUWAIT, KUWAIT,
FILED 2-8-2012.



THE MARK CONSISTS OF AN IMAGE OF A CROWN WITH A MOON AND A STAR AT THE TOP AS SHOWN IN THE MARK.

FOR CLOTHING, NAMELY, TOPS, BOTTOMS, SHIRTS, T-SHIRTS, TANK TOPS, PANTS, JEANS, BLOUSES, SWEATSHIRTS, HOODED SWEATSHIRTS, SWEATPANTS, CAPS, HATS, JACKETS, COATS, SKIRTS, DRESSES, SOCKS, JERSEYS, LEATHER SHIRTS, LEATHER PANTS, LEATHER SKIRTS, LEATHER JACKETS, UNDERWEAR, SHOES AND BELTS (U.S. CLS. 22 AND 39).
EMILY CARLSEN, EXAMINING ATTORNEY

CLASS 25—(Continued).

SN 85-536,684. TEXAS TECH UNIVERSITY SYSTEM, LUBBOCK, TX. FILED 2-8-2012.

GUNS UP

THE MARK CONSISTS OF STANDARD CHARACTERS WITHOUT CLAIM TO ANY PARTICULAR FONT, STYLE, SIZE, OR COLOR.

FOR CLOTHING AND HEADGEAR, NAMELY, SHORTS, T-SHIRTS, SWEATSHIRTS, SWEATPANTS, UNIFORMS, AND CAPS (U.S. CLS. 22 AND 39).
FIRST USE 12-0-2006; IN COMMERCE 12-0-2006.
ZACHARY BELLO, EXAMINING ATTORNEY

SN 85-536,694. TECHNICAL COLLEGE SYSTEM OF GEORGIA, ATLANTA, GA. FILED 2-8-2012.



THE MARK CONSISTS OF THE LETTERS "CTC" WITH A SOLID HORIZONTAL LINE BEGINNING AT THE FAR LEFT POINT OF THE SECOND "C" AND EVENTUALLY SPLITTING INTO THREE WAVY LINES.

FOR COLLEGIATE-THEMED CLOTHING, NAMELY, SHIRTS, T-SHIRTS, SWEAT SHIRTS, JACKETS, SHORTS, SWEAT PANTS, AND HATS (U.S. CLS. 22 AND 39).
HELENE LIWINSKI, EXAMINING ATTORNEY

CLASS 25—(Continued).

SN 85-536,741. PROC ENTERPRISES, VALLEY PARK, MO. FILED 2-8-2012.



THE MARK CONSISTS OF THE STYLIZED TEXT "PP" IN WHICH THE LETTERS ARE BACK TO BACK WITH A CROWN-STAR ON THE TOP.

FOR BELTS; HATS; HOODED SWEAT SHIRTS; JACKETS; JEANS; PANTS; SHIRTS; SHOES; SOCKS; SWEATERS; T-SHIRTS (U.S. CLS. 22 AND 39).

KATHERINE M. DUBRAY, EXAMINING ATTORNEY

CLASS 25—(Continued).

SN 85-536,914. PRO INDUSTRIAL CO. LTD., CHIANGMAI, THAILAND, FILED 2-8-2012.



THE MARK CONSISTS OF THE WORDING "ITAILOR" WITH STYLIZED LETTERING USING A LOWERCASE "I", AN UPPERCASE "T", AND LOWERCASE "AILOR".

FOR MEN'S SHIRTS, MEN'S SUITS, MEN'S PANTS, MEN'S VESTS, MEN'S JACKETS, MEN'S OVERCOATS, MEN'S TIES, MEN'S JEANS, MEN'S POLO SHIRTS, MEN'S SHOES, WOMEN'S BLOUSES, WOMEN'S JACKETS, WOMEN'S PANTS, WOMEN'S SKIRTS, WOMEN'S OVERCOATS, WOMEN'S SUITS, WOMEN'S JEANS, WOMEN'S POLO SHIRTS (U.S. CLS. 22 AND 39).

FIRST USE 5-1-2010; IN COMMERCE 6-1-2010.

GINA FINK, EXAMINING ATTORNEY

SN 85-537,034. THE CHEESE STEAK SHOP, INC., HERCULES, CA. FILED 2-8-2012.

HAPPY HOAGIE DAYS

THE MARK CONSISTS OF STANDARD CHARACTERS WITHOUT CLAIM TO ANY PARTICULAR FONT, STYLE, SIZE, OR COLOR.

FOR SHIRTS, JACKETS, SWEATERS AND HATS (U.S. CLS. 22 AND 39).

KEVIN DINALLO, EXAMINING ATTORNEY

SN 85-536,827. PRO INDUSTRIAL CO. LTD., CHIANGMAI, THAILAND, FILED 2-8-2012.



SN 85-537,055. MARSHALL, TIMOTHY, VAN NUYS, CA. FILED 2-8-2012.

Freedom Driven

THE MARK CONSISTS OF STANDARD CHARACTERS WITHOUT CLAIM TO ANY PARTICULAR FONT, STYLE, SIZE, OR COLOR.

FOR MEN'S SHIRTS, MEN'S SUITS, MEN'S PANTS, MEN'S VESTS, MEN'S JACKETS, MEN'S OVERCOATS, MEN'S TIES, MEN'S JEANS, MEN'S POLO SHIRTS, MEN'S SHOES, WOMEN'S BLOUSES, WOMEN'S JACKETS, WOMEN'S PANTS, WOMEN'S SKIRTS, WOMEN'S OVERCOATS, WOMEN'S SUITS, WOMEN'S JEANS, WOMEN'S POLO SHIRTS (U.S. CLS. 22 AND 39).

FIRST USE 5-1-2010; IN COMMERCE 6-1-2010.

GINA FINK, EXAMINING ATTORNEY

THE MARK CONSISTS OF STANDARD CHARACTERS WITHOUT CLAIM TO ANY PARTICULAR FONT, STYLE, SIZE, OR COLOR.

FOR WEARABLE GARMENTS AND CLOTHING, NAMELY, SHIRTS (U.S. CLS. 22 AND 39).

KATHERINE E. HALMEN, EXAMINING ATTORNEY

CLASS 25—(Continued).

SN 85-537,185. VOTARY LLC, FLORAL PARK, NY. FILED 2-8-2012.

VOTARY

THE MARK CONSISTS OF STANDARD CHARACTERS WITHOUT CLAIM TO ANY PARTICULAR FONT, STYLE, SIZE, OR COLOR.

FOR BELTS; BOTTOMS; COATS FOR MEN AND WOMEN; DRESSES; FOOTWEAR; GLOVES AS CLOTHING; HEADWEAR; JACKETS; MITTENS; NECKWEAR; SCARVES; SOCKS; TOPS; WEARABLE BLANKETS IN THE NATURE OF BLANKETS WITH SLEEVES (U.S. CLS. 22 AND 39).

SALLY SHIH, EXAMINING ATTORNEY

SN 85-537,321. FOWLER, KATHERINE, WILMINGTON, NC. FILED 2-8-2012.

THANK YOU FOR SEEING ME

THE MARK CONSISTS OF STANDARD CHARACTERS WITHOUT CLAIM TO ANY PARTICULAR FONT, STYLE, SIZE, OR COLOR.

FOR T-SHIRTS (U.S. CLS. 22 AND 39).
FIRST USE 3-1-2011; IN COMMERCE 3-1-2011.
MATTHEW KLINE, EXAMINING ATTORNEY

SN 85-537,338. NH TRIPLE PLAY, LLC, MANCHESTER, NH. FILED 2-8-2012.



OWNER OF U.S. REG. NO. 4,022,510.
NO CLAIM IS MADE TO THE EXCLUSIVE RIGHT TO USE "NEW HAMPSHIRE", APART FROM THE MARK AS SHOWN.

THE MARK CONSISTS OF NEW HAMPSHIRE PRIMARIES WITH ELEPHANT AND DONKEY HOLDING BATS WITH UNCLE SAM HATS.

FOR CLOTHING, NAMELY, ATHLETIC UNIFORMS, CAPS, HATS, JERSEYS, POLO SHIRTS, SWEAT PANTS, SWEAT SHIRTS, T-SHIRTS, VISORS (U.S. CLS. 22 AND 39).

DEIRDRE ROBERTSON, EXAMINING ATTORNEY

CLASS 25—(Continued).

SN 85-537,366. BRANDENBURG PROPERTIES, LLC, SAN JOSE, CA. FILED 2-8-2012.



THE MARK CONSISTS OF CONCENTRIC CIRCLES WITH A FLAG POLE IN CENTER WITH A FLAG AND THE LETTERS/NUMBER "USP3" UNDERNEATH THE CIRCLES.

FOR ATHLETIC APPAREL, NAMELY, SHIRTS, PANTS, JACKETS, FOOTWEAR, HATS AND CAPS, ATHLETIC UNIFORMS (U.S. CLS. 22 AND 39).

JOHN KELLY, EXAMINING ATTORNEY

SN 85-537,428. VLADY CORNATEANU, LOS ANGELES, CA. AND SHAWN CHEEK, LOS ANGELES, CA. FILED 2-8-2012.

TRUE AFFAIR

THE MARK CONSISTS OF STANDARD CHARACTERS WITHOUT CLAIM TO ANY PARTICULAR FONT, STYLE, SIZE, OR COLOR.

FOR BELTS; BOTTOMS; DRESSES; HATS; JACKETS; PANTS; SCARVES; SKIRTS; SOCKS; T-SHIRTS; TOPS; UNDERGARMENTS (U.S. CLS. 22 AND 39).

DEIRDRE ROBERTSON, EXAMINING ATTORNEY

SN 85-537,452. LISETTE LIMOGES AGENCIES INC., MONTREAL, QUEBEC, CANADA, FILED 2-8-2012.

LISETTE L.

THE MARK CONSISTS OF STANDARD CHARACTERS WITHOUT CLAIM TO ANY PARTICULAR FONT, STYLE, SIZE, OR COLOR.

THE NAME "LISETTE L." IDENTIFIES A LIVING INDIVIDUAL WHOSE CONSENT IS OF RECORD.

FOR BOTTOMS; DRESSES; FOOTWEAR; HEADWEAR; JACKETS; TOPS (U.S. CLS. 22 AND 39).

LINDSEY RUBIN, EXAMINING ATTORNEY

CLASS 25—(Continued).

SN 85-537,472. ITALIAN CONNECTION INC., LOS ANGELES, CA. FILED 2-8-2012.



THE MARK CONSISTS OF A FLYING DOVE AND FLOWER DESIGN. THE DOVE APPEARS HOLDING THE FLOWER IN ITS BEAK WHILE FLYING FROM RIGHT TO LEFT.

FOR CLOTHING AND APPAREL, NAMELY, SHIRTS, JACKETS, T-SHIRTS, BLOUSES, JEANS, SKIRTS, DRESSES, SWEATERS, PANTS AND SCARVES (U.S. CLS. 22 AND 39).

YAT SYE, LEE, EXAMINING ATTORNEY

SN 85-537,502. GONZALES, NOMSA, DBA SECOND PIECES, HYATTSVILLE, MD. FILED 2-8-2012.

second pieces

THE MARK CONSISTS OF STANDARD CHARACTERS WITHOUT CLAIM TO ANY PARTICULAR FONT, STYLE, SIZE, OR COLOR.

FOR WOMEN'S CLOTHING, NAMELY, SHIRTS, DRESSES, SKIRTS, BLOUSES (U.S. CLS. 22 AND 39).

JOHN E. MICHOS, EXAMINING ATTORNEY

SN 85-537,571. F.I.N.E.W., LLC, NOTTINGHAM, MD. FILED 2-8-2012.

**F.I.N.E.W. Financially,
Independent, Neat, and
Educated Women**

THE MARK CONSISTS OF STANDARD CHARACTERS WITHOUT CLAIM TO ANY PARTICULAR FONT, STYLE, SIZE, OR COLOR.

FOR T-SHIRTS (U.S. CLS. 22 AND 39).

SUSAN BILLHEIMER, EXAMINING ATTORNEY

CLASS 25—(Continued).

SN 85-537,592. BREAUD, ALEC, LULING, LA. FILED 2-8-2012.



THE MARK CONSISTS OF THE STYLIZED TEXT "REDICULOUS" SET IN A STYLIZED OUTLINE OF A RED DRUM FISH.

FOR FISHING SHIRTS, FISHING HATS (U.S. CLS. 22 AND 39).

BARBARA BROWN, EXAMINING ATTORNEY

SN 85-537,686. JENNIFER FLORES, NORTH BERGEN, NJ. FILED 2-8-2012.

Roll Responsibly

THE MARK CONSISTS OF STANDARD CHARACTERS WITHOUT CLAIM TO ANY PARTICULAR FONT, STYLE, SIZE, OR COLOR.

FOR BEANIES; HATS; HOODED SWEATSHIRTS; JACKETS; PANTS; SHIRTS; SHORT-SLEEVED OR LONG-SLEEVED T-SHIRTS; SHORTS; SWEATERS; SWEATSHIRTS; T-SHIRTS; TANK TOPS (U.S. CLS. 22 AND 39).

LESLIE RICHARDS, EXAMINING ATTORNEY

SN 85-537,891. ARLEDGE, JASON, GREENVILLE, SC. FILED 2-9-2012.

Gone Coastal

THE MARK CONSISTS OF STANDARD CHARACTERS WITHOUT CLAIM TO ANY PARTICULAR FONT, STYLE, SIZE, OR COLOR.

FOR HATS; T-SHIRTS (U.S. CLS. 22 AND 39).

JEFF DEFORD, EXAMINING ATTORNEY

CLASS 25—(Continued).

SN 85-537,893. MACE, JUSTIN, HESPERIA, CA. FILED 2-9-2012.

TOWER OVER

THE MARK CONSISTS OF THE STYLIZED TEXT "TOWER OVER".

FOR BEANIES; CAPS; HATS; HOODED SWEAT SHIRTS; SHIRTS; SWEAT SHIRTS; T-SHIRTS; TANK TOPS (U.S. CLS. 22 AND 39).

KEVEN MITTLER, EXAMINING ATTORNEY

SN 85-538,064. VASQUEZ, MANUEL, YORBA LINDA, CA. FILED 2-9-2012.

AWWP
A World With Possibilities

THE MARK CONSISTS OF STANDARD CHARACTERS WITHOUT CLAIM TO ANY PARTICULAR FONT, STYLE, SIZE, OR COLOR.

FOR CAPS; COLLARED SHIRTS; DRESS SHIRTS; FISHING SHIRTS; HATS; HOODED SWEAT SHIRTS; JEANS; JOGGING PANTS; LONG-SLEEVED SHIRTS; PANTS; POLO SHIRTS; SHIRTS; SHIRTS AND SHORT-SLEEVED SHIRTS; SHIRTS FOR SUITS; SKI PANTS; SPORTS PANTS; SWEATSHIRTS; T-SHIRTS; WOMEN'S CLOTHING, NAMELY, SHIRTS, DRESSES, SKIRTS, BLOUSES (U.S. CLS. 22 AND 39).

JILL PRATER, EXAMINING ATTORNEY

SN 85-538,076. HELM JR, RICHARD N., WESTMINSTER, CO. FILED 2-9-2012.

Overdone By The Fun

THE MARK CONSISTS OF STANDARD CHARACTERS WITHOUT CLAIM TO ANY PARTICULAR FONT, STYLE, SIZE, OR COLOR.

FOR JACKETS; SWEATSHIRTS; T-SHIRTS (U.S. CLS. 22 AND 39).

FIRST USE 4-1-2010; IN COMMERCE 4-1-2010.
EDWARD NELSON, EXAMINING ATTORNEY

CLASS 25—(Continued).

SN 85-538,127. L.A. GEAR, INC., LOS ANGELES, CA. FILED 2-9-2012.

GET IN GEAR

THE MARK CONSISTS OF STANDARD CHARACTERS WITHOUT CLAIM TO ANY PARTICULAR FONT, STYLE, SIZE, OR COLOR.

FOR FOOTWEAR (U.S. CLS. 22 AND 39).
ZACHARY BELLO, EXAMINING ATTORNEY

SN 85-538,381. PARIS ACCESSORIES, INC., NEW YORK, NY. FILED 2-9-2012.

PRESCOT BAY

THE MARK CONSISTS OF STANDARD CHARACTERS WITHOUT CLAIM TO ANY PARTICULAR FONT, STYLE, SIZE, OR COLOR.

OWNER OF U.S. REG. NOS. 3,295,763 AND 3,450,572.
FOR FOOTWEAR, NAMELY, SLIPPERS AND ZORIS (U.S. CLS. 22 AND 39).

ANDREA HACK, EXAMINING ATTORNEY

SN 85-538,397. MOSES, OFER, LOS ANGELES, CA. FILED 2-9-2012.

Open Minded

THE MARK CONSISTS OF STANDARD CHARACTERS WITHOUT CLAIM TO ANY PARTICULAR FONT, STYLE, SIZE, OR COLOR.

FOR MEN'S AND WOMEN'S APPAREL, NAMELY, T-SHIRTS, POLO SHIRTS, WESTERN SHIRTS, SWEATERS, SWEATSHIRTS, SWEATPANTS, JERSEYS, JUMPERS, JACKETS, COATS, SHAWLS, TOPS, BLOUSES, TANK TOPS, VESTS, DRESSES, SKIRTS, PANTS, SHORTS, SOCKS, GLOVES, WRISTBANDS, SLEEPWEAR, UNDERWEAR, BELTS, PAJAMAS; HEADWEAR AND NECKWEAR, NAMELY, CAPS, VISORS, HATS, BANDANAS, TIES, SCARVES, HEADBANDS; FOOTWEAR, NAMELY, ATHLETIC SHOES, SANDALS, SLIPPERS, BOOTS (U.S. CLS. 22 AND 39).

MICHAEL ENGEL, EXAMINING ATTORNEY

CLASS 25—(Continued).

SN 85-538,400. DRUCKER FAMILY TRUST, LAGUNA BEACH, CA. FILED 2-9-2012.

DEBORAH DRUCKER

THE MARK CONSISTS OF STANDARD CHARACTERS WITHOUT CLAIM TO ANY PARTICULAR FONT, STYLE, SIZE, OR COLOR.

THE NAME(S), PORTRAIT(S), AND/OR SIGNATURE(S) SHOWN IN THE MARK IDENTIFIES A LIVING PERSON, WHOSE CONSENT(S) TO REGISTER IS MADE OF RECORD.

FOR BELTS; BLOUSES; BOOTS; CAMISOLES; CAPS; COATS; DRESSES; FOOTWEAR; HATS; JACKETS; JEANS; KNIT BOTTOMS; KNIT DRESSES; KNIT JACKETS; KNIT SHIRTS; KNIT SKIRTS; KNIT TOPS; LINGERIE; LOUNGEWEAR; PANTS; ROBES; SCARVES; SHAWLS; SHIRTS; SHORTS; SHRUGS; SKIRTS; SLEEPWEAR; SWEATERS; SWIM WEAR; T-SHIRTS; TANK TOPS; TOPS (U.S. CLS. 22 AND 39).

MICHAEL ENGEL, EXAMINING ATTORNEY

CLASS 25—(Continued).

SN 85-538,412. FLEET WHOLESALE SUPPLY CO., INC., APPLETON, WI. FILED 2-9-2012.



OWNER OF U.S. REG. NOS. 3,152,297 AND 3,894,562.
 THE MARK CONSISTS OF THE WORDS "LAKES N RIVERS" WRITTEN IN A STYLIZED FORMAT.
 FOR FOOTWEAR, NAMELY, SHOES AND BOOTS (U.S. CLS. 22 AND 39).
 MARGERY A. TIERNEY, EXAMINING ATTORNEY

SN 85-538,401. FLEET WHOLESALE SUPPLY CO., INC., APPLETON, WI. FILED 2-9-2012.

LAKES N RIVERS

THE MARK CONSISTS OF STANDARD CHARACTERS WITHOUT CLAIM TO ANY PARTICULAR FONT, STYLE, SIZE, OR COLOR.

OWNER OF U.S. REG. NOS. 3,152,297 AND 3,894,562.
 FOR FOOTWEAR, NAMELY, SHOES AND BOOTS (U.S. CLS. 22 AND 39).

MARGERY A. TIERNEY, EXAMINING ATTORNEY

SN 85-538,502. THOMAS BACHINI, WOBURN, MA. AND JOHN FRANCIS BACHINI, WOBURN, MA. FILED 2-9-2012.

ZIPFLAG

THE MARK CONSISTS OF STANDARD CHARACTERS WITHOUT CLAIM TO ANY PARTICULAR FONT, STYLE, SIZE, OR COLOR.

FOR CLOTHING, NAMELY, SHIRTS, PANTS, SHORTS, SKIRTS, TIGHTS, JERSEYS, SOCKS, GLOVES, MITTENS, JACKETS, COATS, SHOES, BOOTS, HATS, CAPS (U.S. CLS. 22 AND 39).

SALLY SHIH, EXAMINING ATTORNEY

CLASS 25—(Continued).

SN 85-538,581. ADRIENNE VITTADINI, LLC, COLUMBUS, OH. FILED 2-9-2012.



OWNER OF U.S. REG. NOS. 1,988,490, 3,725,903 AND OTHERS.

THE MARK CONSISTS OF THE STYLIZED LETTERS "AV".

FOR CLOTHING, NAMELY, PANTS, SHIRTS, JACKETS, DRESSES AND SKIRTS; FOOTWEAR (U.S. CLS. 22 AND 39).

TARAH HARDY, EXAMINING ATTORNEY

SN 85-538,591. ADRIENNE VITTADINI, LLC, COLUMBUS, OH. FILED 2-9-2012.

AV ADRIENNE VITTADINI

THE MARK CONSISTS OF STANDARD CHARACTERS WITHOUT CLAIM TO ANY PARTICULAR FONT, STYLE, SIZE, OR COLOR.

OWNER OF U.S. REG. NOS. 1,241,274, 1,988,490 AND OTHERS.

THE NAME "ADRIENNE VITTADINI" IDENTIFIES A LIVING INDIVIDUAL WHOSE CONSENT IS OF RECORD.

FOR CLOTHING, NAMELY, PANTS, SHIRTS, JACKETS, DRESSES AND SKIRTS; FOOTWEAR (U.S. CLS. 22 AND 39).

TARAH HARDY, EXAMINING ATTORNEY

SN 85-538,693. KOYONO CO., LYNDBURST, OH. FILED 2-9-2012.

NUTS & NIPPLES

THE MARK CONSISTS OF STANDARD CHARACTERS WITHOUT CLAIM TO ANY PARTICULAR FONT, STYLE, SIZE, OR COLOR.

FOR SHIRTS (U.S. CLS. 22 AND 39).

MARY CRAWFORD, EXAMINING ATTORNEY

CLASS 25—(Continued).

SN 85-538,717. K-SWISS INC., WESTLAKE VILLAGE, CA. FILED 2-9-2012.

GLACIATOR

THE MARK CONSISTS OF STANDARD CHARACTERS WITHOUT CLAIM TO ANY PARTICULAR FONT, STYLE, SIZE, OR COLOR.

FOR SHOES (U.S. CLS. 22 AND 39).

FIRST USE 11-15-2000; IN COMMERCE 11-15-2000.

FRED CARL, EXAMINING ATTORNEY

SN 85-538,739. EPYON ROYAL, LLC, MACOMB, MI. FILED 2-9-2012.

Epyon Royal

THE MARK CONSISTS OF STANDARD CHARACTERS WITHOUT CLAIM TO ANY PARTICULAR FONT, STYLE, SIZE, OR COLOR.

FOR BEANIES; BELTS; HATS; HOODED SWEATSHIRTS; JACKETS; PANTS; SHIRTS; SOCKS; SWEATSHIRTS; T-SHIRTS (U.S. CLS. 22 AND 39).

FIRST USE 6-1-2009; IN COMMERCE 5-10-2010.

CAROLINE WOOD, EXAMINING ATTORNEY

SN 85-538,773. BLAIR HOLDINGS, INC., NEWARK, DE. FILED 2-9-2012.

BLAIRWIK

THE MARK CONSISTS OF STANDARD CHARACTERS WITHOUT CLAIM TO ANY PARTICULAR FONT, STYLE, SIZE, OR COLOR.

OWNER OF U.S. REG. NOS. 1,283,914, 1,563,972 AND OTHERS.

FOR CLOTHING, NAMELY SHIRTS, SHORTS, PANTS, JACKETS, COATS, PARKAS, SWEATSHIRTS, JOGGING SUITS, UNDERGARMENTS, SLEEPWEAR, LOUNGEWEAR, SWIMWEAR, SOCKS, ROBES, HEADBANDS, WRISTBANDS, HATS AND GLOVES (U.S. CLS. 22 AND 39).

AISHA SALEM, EXAMINING ATTORNEY

CLASS 25—(Continued).

SN 85-538,829. COLEMAN, DAN L., DUNN, NC. FILED 2-9-2012.

PIER PILOT

THE MARK CONSISTS OF STANDARD CHARACTERS WITHOUT CLAIM TO ANY PARTICULAR FONT, STYLE, SIZE, OR COLOR.

FOR CLOTHING, NAMELY, SHIRTS, PANTS, SWEATERS, SWEATSHIRTS, SWEAT PANTS, PARKAS, ANORAKS, COATS, JACKETS, SLACKS, RAIN COATS, CAPS, HATS, HEADBANDS, VISORS, RUNNING SHOES, SWIMSUITS, SWIM TRUNKS, PAJAMAS, GLOVES, ROBES, SANDALS, SLIPPERS, SHOWER SHOES, NECKTIES, SCARVES, SOCKS (U.S. CLS. 22 AND 39).

FIRST USE 10-12-1999; IN COMMERCE 10-12-1999.
JAMES A. RAUEN, EXAMINING ATTORNEY

CLASS 25—(Continued).

SN 85-539,086. SOLOMON, KIMBERLY, LEAWOOD, KS. FILED 2-10-2012.

FUN STRAPS

THE MARK CONSISTS OF STANDARD CHARACTERS WITHOUT CLAIM TO ANY PARTICULAR FONT, STYLE, SIZE, OR COLOR.

NO CLAIM IS MADE TO THE EXCLUSIVE RIGHT TO USE "STRAPS", APART FROM THE MARK AS SHOWN.

FOR SHOE STRAPS (U.S. CLS. 22 AND 39).
MICHAEL SOUDERS, EXAMINING ATTORNEY

SN 85-538,859. BLACK CLOVER ENTERPRISES LLC, DRAPER, UT. FILED 2-9-2012.

HUNT LUCKY

THE MARK CONSISTS OF STANDARD CHARACTERS WITHOUT CLAIM TO ANY PARTICULAR FONT, STYLE, SIZE, OR COLOR.

FOR HEADWEAR; PANTS; SHIRTS; SHORTS (U.S. CLS. 22 AND 39).

ZACHARY BELLO, EXAMINING ATTORNEY

SN 85-539,153. SHELTON, DANIEL, GILBERT, AZ. FILED 2-10-2012.

notusme

THE MARK CONSISTS OF STANDARD CHARACTERS WITHOUT CLAIM TO ANY PARTICULAR FONT, STYLE, SIZE, OR COLOR.

FOR HATS; PANTS; PULLOVERS; SHIRTS; SHORTS; SWEATSHIRTS (U.S. CLS. 22 AND 39).

KEVON CHISOLM, EXAMINING ATTORNEY

SN 85-539,042. ASHLEY BURTON, DBA ASHLEY HEARTS, BALTIMORE, MD. FILED 2-10-2012.

UNTAMED HEARTS

THE MARK CONSISTS OF STANDARD CHARACTERS WITHOUT CLAIM TO ANY PARTICULAR FONT, STYLE, SIZE, OR COLOR.

FOR APPAREL FOR DANCERS, NAMELY, TEE SHIRTS, SWEATSHIRTS, PANTS, LEGGINGS, SHORTS AND JACKETS; BABIES' PANTS; BUTTON DOWN SHIRTS; CAPRI PANTS; COLLARED SHIRTS; DRESS SHIRTS; HOODED SWEAT SHIRTS; KNIT SHIRTS; LONG-SLEEVED SHIRTS; OPEN-NECKED SHIRTS; PIQUE SHIRTS; POLO SHIRTS; RUGBY SHIRTS; SHIRTS; SHIRTS AND SHORT-SLEEVED SHIRTS; SHIRTS FOR INFANTS, BABIES, TODDLERS AND CHILDREN; SHORT-SLEEVED OR LONG-SLEEVED T-SHIRTS; SHORT-SLEEVED SHIRTS; SWEATPANTS; T-SHIRTS; T-SHIRTS FOR WOMEN, CHILDREN; TEE SHIRTS; WOMEN'S CLOTHING, NAMELY, SHIRTS, DRESSES, SKIRTS, BLOUSES (U.S. CLS. 22 AND 39).

FIRST USE 12-23-2011; IN COMMERCE 1-24-2012.
ELISSA GARBER KON, EXAMINING ATTORNEY

SN 85-539,158. BRADFORD, LARUE, CHICAGO, IL. FILED 2-10-2012.



THE MARK CONSISTS OF THE TEXT "BARBERZ" WITH THE LETTER "B" HAVING A BARBER POLE ATTACHED TO IT AND THE LETTER "Z" CONNECTED TO CLIPPERS.

FOR T-SHIRTS (U.S. CLS. 22 AND 39).
KATHERINE E. HALMEN, EXAMINING ATTORNEY

CLASS 25—(Continued).

SN 85-539,171. BENITZ, BRIAN, PHOENIX, AZ. FILED 2-10-2012.

Pars Are Fore Pussies

THE MARK CONSISTS OF STANDARD CHARACTERS WITHOUT CLAIM TO ANY PARTICULAR FONT, STYLE, SIZE, OR COLOR.

FOR SHIRTS (U.S. CLS. 22 AND 39).
DAVID H. STINE, EXAMINING ATTORNEY

CLASS 25—(Continued).

SN 85-539,461. TRADITIONAL SALES AND MARKETING INC., KINNELON, NJ. FILED 2-10-2012.

LITTLE DELTA

THE MARK CONSISTS OF STANDARD CHARACTERS WITHOUT CLAIM TO ANY PARTICULAR FONT, STYLE, SIZE, OR COLOR.

FOR JACKETS, NAMELY WOOLEN HUNTING JACKETS, VESTS AND HUNTING SHIRTS (U.S. CLS. 22 AND 39).
ALEX KEAM, EXAMINING ATTORNEY

SN 85-539,223. TRISTAR PRODUCTS, INC., FAIRFIELD, NJ. FILED 2-10-2012.

SILLY SLIPPEEZ

THE MARK CONSISTS OF STANDARD CHARACTERS WITHOUT CLAIM TO ANY PARTICULAR FONT, STYLE, SIZE, OR COLOR.

FOR FOOTWEAR; SLIPPERS (U.S. CLS. 22 AND 39).
WON TEAK OH, EXAMINING ATTORNEY

SN 85-539,469. TRADITIONAL SALES AND MARKETING INC., KINNELON, NJ. FILED 2-10-2012.

GROUSEHAVEN

THE MARK CONSISTS OF STANDARD CHARACTERS WITHOUT CLAIM TO ANY PARTICULAR FONT, STYLE, SIZE, OR COLOR.

FOR JACKETS, NAMELY WOOLEN HUNTING JACKETS, VESTS AND HUNTING SHIRTS (U.S. CLS. 22 AND 39).
ALEX KEAM, EXAMINING ATTORNEY

SN 85-539,236. SACK, SCOTT, SAN FRANCISCO, CA. FILED 2-10-2012.

TOP 5

THE MARK CONSISTS OF STANDARD CHARACTERS WITHOUT CLAIM TO ANY PARTICULAR FONT, STYLE, SIZE, OR COLOR.

FOR GOLF SHIRTS; HEADGEAR, NAMELY, HATS AND CAPS; PANTS; SHIRTS; SHORTS; SWEAT SHIRTS; T-SHIRTS; TANK TOPS (U.S. CLS. 22 AND 39).
FRANK LATTUCA, EXAMINING ATTORNEY

SN 85-539,521. BRAZEAU BROWN, MARY, WISCONSIN RAPIDS, WI. FILED 2-10-2012.

CRAN DO

THE MARK CONSISTS OF STANDARD CHARACTERS WITHOUT CLAIM TO ANY PARTICULAR FONT, STYLE, SIZE, OR COLOR.

FOR T-SHIRTS (U.S. CLS. 22 AND 39).
JEFFREY LOOK, EXAMINING ATTORNEY

CLASS 25—(Continued).

SN 85-539,594. JERROD CORNISH, LOS ANGELES, CA.
FILED 2-10-2012.

LUE

THE MARK CONSISTS OF STANDARD CHARACTERS WITHOUT CLAIM TO ANY PARTICULAR FONT, STYLE, SIZE, OR COLOR.

FOR BOTTOMS; COATS FOR MEN AND WOMEN; FOOTWEAR FOR WOMEN; JACKETS; MEN'S AND WOMEN'S JACKETS, COATS, TROUSERS, VESTS; T-SHIRTS FOR MEN AND WOMEN; TOPS; WOMEN'S CLOTHING, NAMELY, SHIRTS, DRESSES, SKIRTS, BLOUSES (U.S. CLS. 22 AND 39).

FIRST USE 1-31-2012; IN COMMERCE 1-31-2012.
BENJAMIN OKEKE, EXAMINING ATTORNEY

SN 85-539,676. THE JOYCE HAWKINS COMPANY, LLC,
ATLANTA, GA. FILED 2-10-2012.

TEAM BREEZY

THE MARK CONSISTS OF STANDARD CHARACTERS WITHOUT CLAIM TO ANY PARTICULAR FONT, STYLE, SIZE, OR COLOR.

FOR CLOTHING, NAMELY, SHIRTS, LONG-SLEEVED SHIRTS, T-SHIRTS, UNDER SHIRTS, NIGHT SHIRTS, RUGBY SHIRTS, POLO SHIRTS, CARDIGANS, JERSEYS, SCRUBS NOT FOR MEDICAL PURPOSES, SMOCKS, PANTS, JEANS, CARGO PANTS, STRETCH PANTS, DENIM JEANS, SHORTS, BOXER SHORTS, TOPS, STRETCH TOPS, CROP TOPS, TANK TOPS, TANKINIS, SWEAT SHIRTS, HOODED SWEAT SHIRTS, SWEAT JACKETS, SWEAT SHORTS, SWEAT PANTS, WARM-UP SUITS, TRACK SUITS, SWEATERS, VESTS, FLEECE VESTS, PULLOVERS, JACKETS, REVERSIBLE JACKETS, WIND-RESISTANT JACKETS, SHELL JACKETS, SPORTS JACKETS, JEAN JACKETS, COATS, TURTLENECKS, SWIMWEAR, BEACHWEAR, TENNIS WEAR, LAYETTES, INFANTWEAR, INFANTS SLEEPERS, BOOTIES, CAPS, HATS, VISORS, HEADBANDS, WRIST BANDS, SWEAT BANDS, HEADWEAR, EAR MUFFS, APRONS, SCARVES, BANDANAS, BELTS, NECKWEAR, UNDERWEAR, SOCKS, LOUNGEWEAR, ROBES, UNDERCLOTHES, PAJAMAS, SLEEPWEAR, HOSIERY, GLOVES, MITTENS, RAIN SLICKERS, RAINWEAR, FOOTWEAR, SNEAKERS, SHOES, SANDALS, FLIP-FLOPS, AND SLIPPERS (U.S. CLS. 22 AND 39).

JILL PRATER, EXAMINING ATTORNEY

CLASS 25—(Continued).

SN 85-539,702. MARTIN ROSAS, COUNCIL BLUFFS, IA.
FILED 2-10-2012.



THE MARK CONSISTS OF THE WORDS "COUNCIL TUCKY TRAILER TRASH". THE WORDS "COUNCIL TUCKY" CURVE AROUND THE TOP OF THE DESIGN, AND THE WORDS "TRAILER TRASH" CURVE AROUND THE BOTTOM OF THE DESIGN. A MOTORCYCLE IS PLACED IN THE CENTER OF THE WORDS.

FOR CLOTHING—NAMELY, SHIRTS, T-SHIRTS, SWEATSHIRTS, POLO SHIRTS, GOLF SHIRTS, JERSEYS, SPORT SHIRTS, CREW SHIRTS, COLLARED SHIRTS, SWEATERS, BLOUSES, TANK TOPS, TURTLENECKS, HATS, CAPS, HEADBANDS, WOOL HATS, VISORS, JACKETS, VESTS, COATS, RAINWEAR, PONCHOS, COATS, SKIRTS, SHORTS, BOXER SHORTS, PANTS, SWEATPANTS, UNIFORMS, GLOVES, HEADWEAR, SOCKS, AND UNDERGARMENTS (U.S. CLS. 22 AND 39).

ANTHONY RINKER, EXAMINING ATTORNEY

SN 85-539,723. OTHELL WELCH, MCALLEN, TX. FILED 2-10-2012.

CORRAL

THE MARK CONSISTS OF STANDARD CHARACTERS WITHOUT CLAIM TO ANY PARTICULAR FONT, STYLE, SIZE, OR COLOR.

FOR LINGERIE; SLEEPWEAR; SWIMWEAR (U.S. CLS. 22 AND 39).

DAVID MURRAY, EXAMINING ATTORNEY

SN 85-539,728. VITALE, DICK, BRADENTON, FL. FILED 2-10-2012.

DIAPER DANDY

THE MARK CONSISTS OF STANDARD CHARACTERS WITHOUT CLAIM TO ANY PARTICULAR FONT, STYLE, SIZE, OR COLOR.

FOR T-SHIRTS AND HATS (U.S. CLS. 22 AND 39).
PATRICIA EVANKO, EXAMINING ATTORNEY

CLASS 25—(Continued).

SN 85-539,757. OHELL WELCH, MCALLEN, TX. FILED 2-10-2012.

CORRAL

THE MARK CONSISTS OF STANDARD CHARACTERS WITHOUT CLAIM TO ANY PARTICULAR FONT, STYLE, SIZE, OR COLOR.

OWNER OF U.S. REG. NOS. 2,438,068, 3,811,903 AND OTHERS.

FOR CLOTHING, NAMELY DENIM SKIRTS AND SHORTS (U.S. CLS. 22 AND 39).

DAVID MURRAY, EXAMINING ATTORNEY

SN 85-539,761. MARY GARIPPO, BOSTON, MA. FILED 2-10-2012.

BE FREE BE GLOBAL

THE MARK CONSISTS OF STANDARD CHARACTERS WITHOUT CLAIM TO ANY PARTICULAR FONT, STYLE, SIZE, OR COLOR.

FOR BABY BODYSUITS; BABY TOPS; BANDANAS; BASEBALL CAPS AND HATS; FLEECE TOPS; HATS FOR INFANTS, BABIES, TODDLERS AND CHILDREN; HEADBANDS; HOODED SWEATSHIRTS; KNITTED CAPS; MATERNITY CLOTHING, NAMELY, SHIRTS AND PANTS; SWEATSHIRTS; T-SHIRTS; TANK TOPS; YOGA PANTS; YOGA SHIRTS (U.S. CLS. 22 AND 39).

JENNIFER WILLISTON, EXAMINING ATTORNEY

SN 85-539,777. OHELL WELCH, MCALLEN, TX. FILED 2-10-2012.

CORRAL

THE MARK CONSISTS OF STANDARD CHARACTERS WITHOUT CLAIM TO ANY PARTICULAR FONT, STYLE, SIZE, OR COLOR.

OWNER OF U.S. REG. NOS. 2,438,068, 3,811,903 AND OTHERS.

FOR CLOTHING, NAMELY, SHIRTS (U.S. CLS. 22 AND 39).

DAVID MURRAY, EXAMINING ATTORNEY

CLASS 25—(Continued).

SN 85-539,807. MCAFEE, PATRICK J, BROWNSBURG, IN. FILED 2-10-2012.

BOOMSTICK

THE MARK CONSISTS OF STANDARD CHARACTERS WITHOUT CLAIM TO ANY PARTICULAR FONT, STYLE, SIZE, OR COLOR.

FOR ATHLETIC APPAREL, NAMELY, SHIRTS, PANTS, JACKETS, FOOTWEAR, HATS AND CAPS, ATHLETIC UNIFORMS (U.S. CLS. 22 AND 39).

HENRY S. ZAK, EXAMINING ATTORNEY

SN 85-539,808. GUTIERREZ, FRANCISCO, CHULA VISTA, CA. FILED 2-10-2012.

DEAD QUEEN CLOTHING

THE MARK CONSISTS OF STANDARD CHARACTERS WITHOUT CLAIM TO ANY PARTICULAR FONT, STYLE, SIZE, OR COLOR.

NO CLAIM IS MADE TO THE EXCLUSIVE RIGHT TO USE "CLOTHING", APART FROM THE MARK AS SHOWN.

FOR CHILDREN'S AND INFANT'S APPAREL, NAMELY, JUMPERS, OVERALL SLEEPWEAR, PAJAMAS, ROMPERS AND ONE-PIECE GARMENTS; HATS; JACKETS; MEN'S AND WOMEN'S JACKETS, COATS, TROUSERS, VESTS; MEN'S UNDERWEAR; PANTS; SHIRTS FOR INFANTS, BABIES, TODDLERS AND CHILDREN; SHORT-SLEEVED OR LONG-SLEEVED T-SHIRTS; SWEAT PANTS; SWEAT SHIRTS; T-SHIRTS; UNDERWEAR; WOMEN'S CLOTHING, NAMELY, SHIRTS, DRESSES, SKIRTS, BLOUSES; WOMEN'S UNDERWEAR (U.S. CLS. 22 AND 39).

HENRY S. ZAK, EXAMINING ATTORNEY

SN 85-539,861. WOODLAND TRADING, INC., NEW YORK, NY. FILED 2-10-2012.

Irreplaceable

THE MARK CONSISTS OF STANDARD CHARACTERS WITHOUT CLAIM TO ANY PARTICULAR FONT, STYLE, SIZE, OR COLOR.

FOR (BASED ON USE IN COMMERCE) CORSETS; TOPS; WOMEN'S CLOTHING, NAMELY, SHIRTS, DRESSES, SKIRTS, BLOUSES (BASED ON INTENT TO USE) DRESSES; JACKETS; JERSEYS; PANTS; WEARABLE GARMENTS AND CLOTHING, NAMELY, SHIRTS (U.S. CLS. 22 AND 39).

FIRST USE 8-18-2010; IN COMMERCE 10-20-2010.

LINDA MICKLEBURGH, EXAMINING ATTORNEY

CLASS 25—(Continued).

SN 85-539,961. HEELING SPORTS LIMITED, CARROLLTON, TX. FILED 2-10-2012.

SIDEWALKSPORTS

THE MARK CONSISTS OF STANDARD CHARACTERS WITHOUT CLAIM TO ANY PARTICULAR FONT, STYLE, SIZE, OR COLOR.

FOR FOOTWEAR, NAMELY, ATHLETIC SHOES AND APPAREL, NAMELY, T-SHIRTS AND CAPS (U.S. CLS. 22 AND 39).

LINDA M. KING, EXAMINING ATTORNEY

SN 85-540,036. DISTRÖYA SPIRITS, NEW YORK, NY. FILED 2-10-2012.

Diströya

THE MARK CONSISTS OF STANDARD CHARACTERS WITHOUT CLAIM TO ANY PARTICULAR FONT, STYLE, SIZE, OR COLOR.

FOR BEANIES; BOXER SHORTS; GLOVES; HATS; HOODED SWEATSHIRTS; JACKETS; PANTIES; SHORTS; SKIRTS; SOCKS; SWEATERS; SWIMWEAR; T-SHIRTS; TANK TOPS; THONGS; TUBE TOPS (U.S. CLS. 22 AND 39).

LAURIE KAUFMAN, EXAMINING ATTORNEY

SN 85-540,271. SIMS, CHARLES L, NEW KENSINGTON, PA. FILED 2-11-2012.

NERD BOY RICH

THE MARK CONSISTS OF STANDARD CHARACTERS WITHOUT CLAIM TO ANY PARTICULAR FONT, STYLE, SIZE, OR COLOR.

FOR CLOTHING, NAMELY, SHIRTS, SWEATSHIRTS, AND HATS (U.S. CLS. 22 AND 39).

MATTHEW PAPPAS, EXAMINING ATTORNEY

CLASS 25—(Continued).

SN 85-540,735. BRZOWSKI, ALEXANDRA, NEW YORK, NY. FILED 2-13-2012.



CABBAGES & KINGS
EST. 2012

NO CLAIM IS MADE TO THE EXCLUSIVE RIGHT TO USE "EST. 2012", APART FROM THE MARK AS SHOWN.

THE MARK CONSISTS OF A CABBAGE WEARING A CROWN WITH "CABBAGES & KINGS" BELOW IT IN STYLIZED FONT WITH "EST. 2012" BELOW THIS WORDING IN SMALLER STYLIZED FONT.

FOR DRESSES; HATS; JACKETS; PANTS; SHIRTS; SKIRTS; SLIDING SHORTS; SOCKS; SWEATERS; SWEATSHIRTS; UNDERWEAR (U.S. CLS. 22 AND 39).

CHRISTINE MARTIN, EXAMINING ATTORNEY

SN 85-540,838. SHOES FOR CREWS, LLC, WEST PALM BEACH, FL. FILED 2-13-2012.



THE MARK CONSISTS OF THE WORD "CREWS" IN LOWER CASE LETTERS FOLLOWED BY FOUR SMALL INDIVIDUAL SQUARES THAT FORM A LARGER SQUARE.

FOR SLIP RESISTANT FOOTWEAR (U.S. CLS. 22 AND 39).

KEVON CHISOLM, EXAMINING ATTORNEY

SN 85-540,874. GOOD MOM DESIGN, LLC, SAUNDERS-TOWN, RI. FILED 2-13-2012.

the good mom

THE MARK CONSISTS OF STANDARD CHARACTERS WITHOUT CLAIM TO ANY PARTICULAR FONT, STYLE, SIZE, OR COLOR.

FOR CLOTHING, NAMELY, T-SHIRTS, POLO SHIRTS, HATS AND PANTS (U.S. CLS. 22 AND 39).

ELISSA GARBER KON, EXAMINING ATTORNEY

CLASS 25—(Continued).

SN 85-540,881. SHOES FOR CREWS, LLC, WEST PALM BEACH, FL. FILED 2-13-2012.

TOPcrews 

THE MARK CONSISTS OF THE LETTERS "TOP" IN CAPITAL LETTERS WITH A BOLD FONT AND "CREWS" IN LOWER CASE LETTERS FOLLOWED BY THE OUTLINE OF FOUR SMALL INDIVIDUAL SQUARES THAT FORM A LARGER SQUARE.

FOR SLIP RESISTANT FOOTWEAR (U.S. CLS. 22 AND 39).

KEVON CHISOLM, EXAMINING ATTORNEY

SN 85-540,901. FRAZIER, TERRANCE, BALTIMORE, MD. FILED 2-13-2012.

city of gods

THE MARK CONSISTS OF STANDARD CHARACTERS WITHOUT CLAIM TO ANY PARTICULAR FONT, STYLE, SIZE, OR COLOR.

FOR CLOTHING, NAMELY, T-SHIRTS, HOODED SWEATSHIRTS, HATS, JEANS, SOCKS, SWEATERS, OUTERWEAR JACKETS, DRESS SHIRTS, DRESSES, SHORTS, PANTS, BELTS, NECKTIES AND SCARVES (U.S. CLS. 22 AND 39).

FIRST USE 6-1-2007; IN COMMERCE 6-1-2007.
SUNG IN, EXAMINING ATTORNEY

SN 85-541,535. JORDAN, TOMMY, LANCASTER, TX. FILED 2-13-2012.

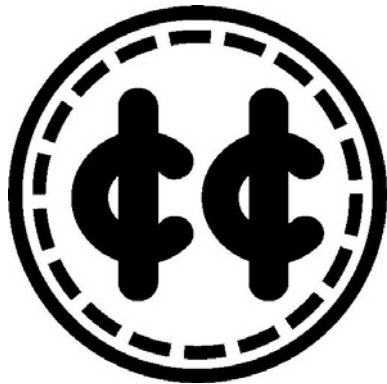

THE MARK CONSISTS OF A COIN WITH THE STYLIZED TEXT "cc".

FOR BASEBALL CAPS; BEANIES; BUTTON DOWN SHIRTS; DENIM JACKETS; DENIMS; JACKETS; PANTS; SHOES; T-SHIRTS; TANK TOPS; TIES; TROUSERS (U.S. CLS. 22 AND 39).

SUSAN RICHARDS, EXAMINING ATTORNEY

CLASS 25—(Continued).

SN 85-542,128. UNIVERSAL CITY STUDIOS LLC, UNIVERSAL CITY, CA. FILED 2-14-2012.

DESPICABLE ME MINION MAYHEM

THE MARK CONSISTS OF STANDARD CHARACTERS WITHOUT CLAIM TO ANY PARTICULAR FONT, STYLE, SIZE, OR COLOR.

FOR CLOTHING, FOOTWEAR, AND HEADWEAR, NAMELY, T-SHIRTS, TANK TOPS, SWEATSHIRTS, SWEATPANTS, SHORTS, PAJAMAS, NIGHTGOWNS, ROBES, COATS, JACKETS, PULLOVERS, SHIRTS, BLOUSES, DRESSES, OVERALLS, SOCKS, SCARVES, GLOVES, CAPS, BEANIES, HATS, SHOES, BOOTS, SLIPPERS, CLOTH BIBS, INFANTWEAR, APRONS, SWEATERS, HALLOWEEN COSTUMES, COSTUMES FOR USE IN CHILDREN'S DRESS UP OR PLAY (U.S. CLS. 22 AND 39).

DOMINIC J. FERRAIUOLO, EXAMINING ATTORNEY

SN 85-549,076. NAME DROP SARL, LUXEMBOURG, LUXEMBOURG, FILED 2-22-2012.

FITMAN

THE MARK CONSISTS OF STANDARD CHARACTERS WITHOUT CLAIM TO ANY PARTICULAR FONT, STYLE, SIZE, OR COLOR.

FOR CLOTHING, NAMELY, SHIRTS, SKIRTS, PANTS, TROUSERS, JACKETS, COATS, SWEATERS, JEANS, JUMPERS, DRESSES, UNDERWEAR, HOSIERY, VESTS, T-SHIRTS, CULOTTES, BLOUSES, SHORTS, JUMPSUITS; FOOTWEAR; HEADGEAR, NAMELY, CAPS, HATS, BASEBALL CAPS (U.S. CLS. 22 AND 39).

MATTHEW EINSTEIN, EXAMINING ATTORNEY

SN 85-560,989. ALQUIZAR, SONNY CHRISTOPHER S., SAN DIEGO, CA. AND MANALANSAN, JAYSON, SAN DIEGO, CA. AND VICENTE, JASON, SAN DIEGO, CA. FILED 3-5-2012.

EQVLNT

THE MARK CONSISTS OF STANDARD CHARACTERS WITHOUT CLAIM TO ANY PARTICULAR FONT, STYLE, SIZE, OR COLOR.

FOR HEADWEAR; T-SHIRTS FOR MEN, WOMEN, KIDS, AND BABIES; WEARABLE GARMENTS AND CLOTHING, NAMELY, SHIRTS (U.S. CLS. 22 AND 39).

ZACHARY CROMER, EXAMINING ATTORNEY

CLASS 25—(Continued).

SN 85-568,302. NATIONAL ASSOCIATION OF PROFESSIONAL BASEBALL LEAGUES, INC., ST. PETERSBURG, FL. FILED 3-13-2012.

MADISON MUSKIES

THE MARK CONSISTS OF STANDARD CHARACTERS WITHOUT CLAIM TO ANY PARTICULAR FONT, STYLE, SIZE, OR COLOR.

FOR CLOTHING, NAMELY, T-SHIRTS (U.S. CLS. 22 AND 39).

FIRST USE 8-15-2011; IN COMMERCE 8-15-2011.
ALAIN LAPTER, EXAMINING ATTORNEY

SN 85-583,157. NAME DROP SARL, LUXEMBOURG, LUXEMBOURG, FILED 3-29-2012.

**put a pair on. take a load
off**

THE MARK CONSISTS OF STANDARD CHARACTERS WITHOUT CLAIM TO ANY PARTICULAR FONT, STYLE, SIZE, OR COLOR.

FOR CLOTHING, NAMELY, SHIRTS, SKIRTS, PANTS, TROUSERS, JACKETS, COATS, SWEATERS, JEANS, JUMPERS, DRESSES, UNDERWEAR, HOSIERY, VESTS, T-SHIRTS, CULOTTES, BLOUSES, SHORTS, JUMPSUITS; FOOTWEAR AND HEADGEAR, NAMELY, CAPS, HATS, BASEBALL CAPS (U.S. CLS. 22 AND 39).
MATTHEW EINSTEIN, EXAMINING ATTORNEY

SN 85-583,194. NAME DROP SARL, LUXEMBOURG, LUXEMBOURG, FILED 3-29-2012.

FITFLOP FF2

THE MARK CONSISTS OF STANDARD CHARACTERS WITHOUT CLAIM TO ANY PARTICULAR FONT, STYLE, SIZE, OR COLOR.

OWNER OF U.S. REG. NOS. 3,360,622, 3,775,348 AND OTHERS.

FOR CLOTHING, NAMELY, SHIRTS, SKIRTS, PANTS, TROUSERS, JACKETS, COATS, SWEATERS, JEANS, JUMPERS, DRESSES, UNDERWEAR, HOSIERY, VESTS, T-SHIRTS, CULOTTES, BLOUSES, SHORTS, JUMPSUITS; FOOTWEAR AND HEADGEAR, NAMELY, CAPS, HATS, BASEBALL CAPS (U.S. CLS. 22 AND 39).

MATTHEW EINSTEIN, EXAMINING ATTORNEY

CLASS 25—(Continued).

SN 85-583,223. NAME DROP SARL, LUXEMBOURG, LUXEMBOURG, FILED 3-29-2012.

SPECIAL FF2

THE MARK CONSISTS OF STANDARD CHARACTERS WITHOUT CLAIM TO ANY PARTICULAR FONT, STYLE, SIZE, OR COLOR.

FOR CLOTHING, NAMELY, SHIRTS, SKIRTS, PANTS, TROUSERS, JACKETS, COATS, SWEATERS, JEANS, JUMPERS, DRESSES, UNDERWEAR, HOSIERY, VESTS, T-SHIRTS, CULOTTES, BLOUSES, SHORTS, JUMPSUITS; FOOTWEAR AND HEADGEAR, NAMELY, CAPS, HATS, BASEBALL CAPS (U.S. CLS. 22 AND 39).

MATTHEW EINSTEIN, EXAMINING ATTORNEY

SN 85-594,747. WOLVERINE WORLD WIDE, INC., ROCKFORD, MI. FILED 4-11-2012.

DURALOCK

THE MARK CONSISTS OF STANDARD CHARACTERS WITHOUT CLAIM TO ANY PARTICULAR FONT, STYLE, SIZE, OR COLOR.

FOR FOOTWEAR; GLOVES; HATS; HEADWEAR; SHORTS; SOCKS; SWEATERS; VESTS (U.S. CLS. 22 AND 39).

EDWARD NELSON, EXAMINING ATTORNEY

SN 85-600,514. PICKIN' COTTON COMMUNICATIONS, LLC, LAFAYETTE, LA. FILED 4-17-2012.

NEW ORLEANS REVELERS

THE MARK CONSISTS OF STANDARD CHARACTERS WITHOUT CLAIM TO ANY PARTICULAR FONT, STYLE, SIZE, OR COLOR.

NO CLAIM IS MADE TO THE EXCLUSIVE RIGHT TO USE "NEW ORLEANS", APART FROM THE MARK AS SHOWN.

FOR ATHLETIC APPAREL, NAMELY, SHIRTS, PANTS, JACKETS, FOOTWEAR, HATS AND CAPS, ATHLETIC UNIFORMS; ATHLETIC FOOTWEAR; BASKETBALL SNEAKERS; HEADBANDS AGAINST SWEATING; HOODED SWEATSHIRTS; JERSEYS; SLEEVELESS JERSEYS; SPORT SHIRTS; SPORTS CAPS AND HATS; SPORTS JACKETS; SPORTS JERSEYS; SPORTS JERSEYS AND BREECHES FOR SPORTS; SPORTS OVER UNIFORMS; SWEATPANTS; SWEATSHIRTS; WRISTBANDS (U.S. CLS. 22 AND 39).

MELISSA VALLILLO, EXAMINING ATTORNEY

CLASS 25—(Continued).

SN 85-608,680. HBI BRANDED APPAREL ENTERPRISES, LLC, WINSTON-SALEM, NC. FILED 4-26-2012.

PERFORMAX

THE MARK CONSISTS OF STANDARD CHARACTERS WITHOUT CLAIM TO ANY PARTICULAR FONT, STYLE, SIZE, OR COLOR.

OWNER OF U.S. REG. NO. 3,440,864.
FOR BRASSIERES; SHORTS; SOCKS; SWEATSHIRTS; TANK TOPS (U.S. CLS. 22 AND 39).
MARY CRAWFORD, EXAMINING ATTORNEY

CLASS 26—(Continued).

SN 85-426,538. XUCHANG HENGYUAN HAIR PRODUCTS, INC., HENAN PROVINCE, CHINA, FILED 9-19-2011.

**CLASS 26—FANCY GOODS**

SN 79-107,346. HARDCORE HOLDING B.V., NETHERLANDS, FILED 10-21-2011.

FATTIES

THE MARK CONSISTS OF STANDARD CHARACTERS WITHOUT CLAIM TO ANY PARTICULAR FONT, STYLE, SIZE, OR COLOR.

PRIORITY DATE OF 7-12-2011 IS CLAIMED.
OWNER OF INTERNATIONAL REGISTRATION 1102127 DATED 10-21-2011, EXPIRES 10-21-2021.

FOR LACE AND EMBROIDERY, RIBBONS AND BRAID; BUTTONS, HOOKS AND EYES, AND NEEDLES; ARTIFICIAL FLOWERS; SHOE LACES (U.S. CLS. 37, 39, 40, 42 AND 50).
ALEX KEAM, EXAMINING ATTORNEY

NO CLAIM IS MADE TO THE EXCLUSIVE RIGHT TO USE "HAIR", APART FROM THE MARK AS SHOWN.

THE MARK CONSISTS OF THE STYLIZED WORDS "H & Y HAIR & YARD" WHERE THE WORDS "HAIR & YARD" ARE BELOW THE WORDS "H & Y".

FOR ARTIFICIAL FLOWERS; CLOTHING HOOKS; FALSE BEARDS; FALSE HAIR; HAIR BANDS; HAIR ORNAMENTS; HAIR PIECES; TOUPEES (U.S. CLS. 37, 39, 40, 42 AND 50).
ESTHER A. BORSUK, EXAMINING ATTORNEY

SN 85-449,432. KNITPRO INTERNATIONAL, DBA KNITPRO INTERNATIONAL, JAIPUR, INDIA, FILED 10-18-2011.

SN 85-310,128. TOP SECRET HAIRCESSORY, VALLEY VILLAGE, CA. FILED 5-2-2011.

Faux Hawk

THE MARK CONSISTS OF STANDARD CHARACTERS WITHOUT CLAIM TO ANY PARTICULAR FONT, STYLE, SIZE, OR COLOR.

NO CLAIM IS MADE TO THE EXCLUSIVE RIGHT TO USE "FAUX", APART FROM THE MARK AS SHOWN.

FOR WIGS, HAIRPIECES, AND ADD-IN AND ADD-ON HAIR ACCESSORIES CONSTRUCTED PRIMARILY OF SYNTHETIC AND/OR HUMAN HAIR (U.S. CLS. 37, 39, 40, 42 AND 50).
ALICIA COLLINS, EXAMINING ATTORNEY

DREAMZ

THE MARK CONSISTS OF STANDARD CHARACTERS WITHOUT CLAIM TO ANY PARTICULAR FONT, STYLE, SIZE, OR COLOR.

FOR BUTTONS, HOOKS AND EYES, KNITTING PINS AND NEEDLES (U.S. CLS. 37, 39, 40, 42 AND 50).
FIRST USE 8-30-2011; IN COMMERCE 8-30-2011.
WILLIAM JACKSON, EXAMINING ATTORNEY

CLASS 26—(Continued).

SN 85-533,805. BOSCOV'S INVESTMENT COMPANY, INC., WILMINGTON, DE. FILED 2-3-2012.

ASHLEY COOPER

THE MARK CONSISTS OF STANDARD CHARACTERS WITHOUT CLAIM TO ANY PARTICULAR FONT, STYLE, SIZE, OR COLOR.

THE NAME(S), PORTRAIT(S), AND/OR SIGNATURE(S) SHOWN IN THE MARK DOES NOT IDENTIFY A PARTICULAR LIVING INDIVIDUAL.

FOR ARTIFICIAL FLOWER ARRANGEMENTS; ARTIFICIAL FLOWER ARRANGEMENTS IN CONTAINERS; ARTIFICIAL FLOWER WREATHS; ARTIFICIAL FLOWERS; ARTIFICIAL FLOWERS OF PAPER; ARTIFICIAL FLOWERS OF PLASTICS; ARTIFICIAL FLOWERS OF TEXTILE; ARTIFICIAL FRUIT; ARTIFICIAL GARLANDS; ARTIFICIAL GARLANDS AND WREATHS; ARTIFICIAL PLANTS; ARTIFICIAL TOPIARIES; ARTIFICIAL TREES; ARTIFICIAL WREATHS (U.S. CLS. 37, 39, 40, 42 AND 50).

FIRST USE 1-0-2005; IN COMMERCE 1-0-2005.
MICHAEL WIENER, EXAMINING ATTORNEY

CLASS 26—(Continued).

SN 85-538,285. HAIRADK LLC, LAS VEGAS, NV. FILED 2-9-2012.

HAIRADK

THE MARK CONSISTS OF STANDARD CHARACTERS WITHOUT CLAIM TO ANY PARTICULAR FONT, STYLE, SIZE, OR COLOR.

FOR HAIR EXTENSIONS (U.S. CLS. 37, 39, 40, 42 AND 50).

FIRST USE 6-0-2011; IN COMMERCE 6-0-2011.
JUDITH HELFMAN, EXAMINING ATTORNEY

SN 85-534,607. HEARST COMMUNICATIONS, INC., NEW YORK, NY. FILED 2-6-2012.

COSMOPOLITAN

THE MARK CONSISTS OF STANDARD CHARACTERS WITHOUT CLAIM TO ANY PARTICULAR FONT, STYLE, SIZE, OR COLOR.

OWNER OF U.S. REG. NOS. 630,028, 3,453,669 AND OTHERS.

FOR HAIR BANDS; HAIR BARRETTES; HAIR BOWS; HAIR CLIPS; HAIR PINS AND GRIPS; HAIR RIBBONS (U.S. CLS. 37, 39, 40, 42 AND 50).

ELI HELLMAN, EXAMINING ATTORNEY

SN 85-539,524. PENN EMBLEM COMPANY, PHILADELPHIA, PA. FILED 2-10-2012.

PENNDIRECT

THE MARK CONSISTS OF STANDARD CHARACTERS WITHOUT CLAIM TO ANY PARTICULAR FONT, STYLE, SIZE, OR COLOR.

FOR EMBROIDERED EMBLEMS AND PATCHES MADE OF FABRIC, WOVEN EMBLEMS AND PATCHES MADE OF FABRIC (U.S. CLS. 37, 39, 40, 42 AND 50).

MARGERY A. TIERNEY, EXAMINING ATTORNEY

SN 85-538,223. SUN TAIYANG CO., LTD., CARLSTADT, NJ. FILED 2-9-2012.

Up Do U

THE MARK CONSISTS OF STANDARD CHARACTERS WITHOUT CLAIM TO ANY PARTICULAR FONT, STYLE, SIZE, OR COLOR.

FOR HAIR EXTENSIONS; HAIR PIECES; HAIR PIECES AND WIGS; WIG CAPS; WIGS; WIGS, HAIRPIECES, AND ADD-IN AND ADD-ON HAIR ACCESSORIES CONSTRUCTED PRIMARILY OF SYNTHETIC AND/OR HUMAN HAIR (U.S. CLS. 37, 39, 40, 42 AND 50).

GILBERT SWIFT, EXAMINING ATTORNEY

SN 85-539,719. CELEBRITY SIGNATURES INTERNATIONAL, INC., KANSAS CITY, MO. FILED 2-10-2012.

POP PUTONPIECES

THE MARK CONSISTS OF STANDARD CHARACTERS WITHOUT CLAIM TO ANY PARTICULAR FONT, STYLE, SIZE, OR COLOR.

OWNER OF U.S. REG. NOS. 2,616,906 AND 3,943,778.
FOR WIGS, HAIRPIECES, AND ADD-IN AND ADD-ON HAIR ACCESSORIES CONSTRUCTED PRIMARILY OF SYNTHETIC AND/OR HUMAN HAIR (U.S. CLS. 37, 39, 40, 42 AND 50).

FIRST USE 8-0-2005; IN COMMERCE 8-0-2005.
EUGENIA MARTIN, EXAMINING ATTORNEY

CLASS 26—(Continued).

SN 85-590,793. CHEN, KEVIN, TAICHUNG CITY, TAIWAN, FILED 4-6-2012.

atop

THE MARK CONSISTS OF STANDARD CHARACTERS WITHOUT CLAIM TO ANY PARTICULAR FONT, STYLE, SIZE, OR COLOR.

FOR METAL FASTENERS FOR SHOES AND BOOTS; SHOE LACES; BOBBIN LACE; LACES FOR FOOTWEAR; BUTTONS; SHOE BUCKLES; HAT BUCKLES; RIBBONS; BRAIDS (U.S. CLS. 37, 39, 40, 42 AND 50).

FIRST USE 9-3-2008; IN COMMERCE 3-23-2009.
MORGAN WYNNE, EXAMINING ATTORNEY

CLASS 27—(Continued).

SN 85-521,947. MORTIER, EMMANUELLE, ARCANGUES, FRANCE, FILED 1-21-2012.



THE MARK CONSISTS OF A DESIGN CONSISTING OF THE SILHOUETTE OF A MAN WITH HIS ARMS RAISED FLANKED BY A BACKWARDS FACING LETTER "P" ON THE LEFT SIDE AND A LETTER "P" ON THE RIGHT SIDE OF THE MAN.

FOR ARTIFICIAL TURF FOR LAYING ON THE SURFACES OF RECREATIONAL AREAS; CARPETS AND RUGS; CARPETS, RUGS, MATS AND MATTING, LINOLEUM FOR COVERING EXISTING FLOORS; DOOR MATS; GYMNASIUM EXERCISE MATS; GYMNASIUM MATS; SYNTHETIC GRASS; TEXTILE FLOOR MATS FOR USE IN THE HOME (U.S. CLS. 19, 20, 37, 42 AND 50).

FIRST USE 11-15-2011; IN COMMERCE 11-15-2011.
TARAH HARDY, EXAMINING ATTORNEY

CLASS 27—FLOOR COVERINGS

SN 76-709,721. AMERICAN HARLEQUIN CORPORATION, MOORESTOWN, NJ. FILED 11-15-2011.

AERODECK

THE MARK CONSISTS OF STANDARD CHARACTERS WITHOUT CLAIM TO ANY PARTICULAR FONT, STYLE, SIZE, OR COLOR.

FOR HARD SURFACE FLOOR COVERINGS USED ON STAGES, DANCE FLOORS AND SPORTS ARENAS (U.S. CLS. 19, 20, 37, 42 AND 50).

FIRST USE 7-11-2011; IN COMMERCE 7-11-2011.
CARYN GLASSER, EXAMINING ATTORNEY

SN 85-522,467. TARGET BRANDS, INC., MINNEAPOLIS, MN. FILED 1-23-2012.

CLASSIC TIDINGS

THE MARK CONSISTS OF STANDARD CHARACTERS WITHOUT CLAIM TO ANY PARTICULAR FONT, STYLE, SIZE, OR COLOR.

OWNER OF U.S. REG. NOS. 4,009,130, 4,009,131 AND 4,009,132.

NO CLAIM IS MADE TO THE EXCLUSIVE RIGHT TO USE "CLASSIC", APART FROM THE MARK AS SHOWN.

FOR RUGS (U.S. CLS. 19, 20, 37, 42 AND 50).

FIRST USE 11-0-2011; IN COMMERCE 11-0-2011.
NICHOLAS ALTREE, EXAMINING ATTORNEY

CLASS 27—(Continued).

SN 85-533,973. BRECKINRIDGE TAYLOR LLC, DALLAS, TX. FILED 2-3-2012.



THE MARK CONSISTS OF THE SHAPE OF A SOLID COLOR CAPITAL LETTER "B" CONTAINING THE SHAPE OF A CAPITAL LETTER "T" ANGLED AT APPROXIMATELY 45 DEGREES TO THE LEFT IN THE UPPER PORTION OF THE SOLID LETTER "B", WITH THE "T" SHOWN IN A LIGHT SHADED CONTRASTING COLOR OR SHOWN IN THE NEGATIVE AS THE ABSENCE OF THE DARK COLOR USED FOR THE "B" (IF USED ON A COLORED BACKGROUND).

FOR AREA RUGS; BATH MATS; CARPETS AND RUGS; CARPETS, RUGS, MATS AND MATTING, LINOLEUM FOR COVERING EXISTING FLOORS; FLOOR MATS; FUR RUGS; NON-TEXTILE WALL COVERINGS; RESILIENT HARD SURFACE COVERING FOR FLOORS, WALLS AND OTHER SURFACES; RUGS, NAMELY, FLOOR RUNNERS; TEXTILE FLOOR MATS FOR USE IN THE HOME; WALLPAPER; WALLPAPER IN THE NATURE OF ROOMSIZE DECORATIVE ADHESIVE WALL COVERINGS (U.S. CLS. 19, 20, 37, 42 AND 50).

FIRST USE 12-0-2010; IN COMMERCE 12-0-2010.
JOHN DALIER, EXAMINING ATTORNEY

SN 85-534,700. GREGORY PAUL, MALIBU, CA. FILED 2-6-2012.

HAIR YA GO!

THE MARK CONSISTS OF STANDARD CHARACTERS WITHOUT CLAIM TO ANY PARTICULAR FONT, STYLE, SIZE, OR COLOR.

FOR BATH MATS; FLOOR MATS; PET LITTER PAN FLOOR MATS; TEXTILE BATH MATS; TEXTILE FLOOR MATS FOR USE IN THE HOME (U.S. CLS. 19, 20, 37, 42 AND 50).

JIM RINGLE, EXAMINING ATTORNEY

CLASS 27—(Continued).

SN 85-539,278. RUCZECH INT'L, INC., PALM COAST, FL. FILED 2-10-2012.

THE WAIVER MAT

THE MARK CONSISTS OF STANDARD CHARACTERS WITHOUT CLAIM TO ANY PARTICULAR FONT, STYLE, SIZE, OR COLOR.

NO CLAIM IS MADE TO THE EXCLUSIVE RIGHT TO USE "MAT", APART FROM THE MARK AS SHOWN.

FOR DOOR MATS; FLOOR MATS (U.S. CLS. 19, 20, 37, 42 AND 50).

JACQUELINE A. LAVINE, EXAMINING ATTORNEY

CLASS 28—TOYS AND SPORTING GOODS

SN 76-710,506. AIT, INC., GLASTONBURY, CT. FILED 2-2-2012.

PLUM ISLAND PARASITES

THE MARK CONSISTS OF STANDARD CHARACTERS WITHOUT CLAIM TO ANY PARTICULAR FONT, STYLE, SIZE, OR COLOR.

FOR TOY FIGURES (U.S. CLS. 22, 23, 38 AND 50).

LAKEISHA LEWIS, EXAMINING ATTORNEY

SN 79-100,560. MEDIA LABORATORY CO., LTD., TOKYO 120-0015, JAPAN, FILED 6-29-2011.

c o n i c o n i

PRIORITY DATE OF 5-26-2011 IS CLAIMED.
OWNER OF INTERNATIONAL REGISTRATION 1085521 DATED 6-29-2011, EXPIRES 6-29-2021.

THE WORD(S) "CONI CONI" HAS NO MEANING IN A FOREIGN LANGUAGE.

FOR GO GAMES; JAPANESE PLAYING CARDS (UTAGARUTA); JAPANESE CHESS (SHOGI GAMES); DICE; JAPANESE DICE GAMES (SUGOROKU); PLAYING CARDS; JAPANESE PLAYING CARDS (HANAFUDA); MAH-JONG; CARDS FOR GAMES (U.S. CLS. 22, 23, 38 AND 50).

GINA FINK, EXAMINING ATTORNEY

CLASS 28—(Continued).

SN 79-107,410. TAF PLASTIC PRODUCTS LTD, ISRAEL, FILED 11-20-2011.

Baby Steps

THE MARK CONSISTS OF STANDARD CHARACTERS WITHOUT CLAIM TO ANY PARTICULAR FONT, STYLE, SIZE, OR COLOR.

PRIORITY DATE OF 8-8-2011 IS CLAIMED.

OWNER OF INTERNATIONAL REGISTRATION 1102291 DATED 11-20-2011, EXPIRES 11-20-2021.

FOR TOYS AND PLAYTHINGS, NAMELY, CRIB TOYS, INFANT TOYS, BABY MULTIPLE ACTIVITY TOYS, MUSICAL TOYS, BATHTUB TOYS, PLAY MATS CONTAINING INFANT TOYS, PLUSH TOYS, STUFFED TOYS, SQUEEZABLE SQUEAKING TOYS, PLASTIC CHARACTER TOYS, STACKING TOYS, RIDE-ON TOYS, SOFT-SCULPTURE TOYS (U.S. CLS. 22, 23, 38 AND 50).
STEVEN R. FINE, EXAMINING ATTORNEY

CLASS 28—(Continued).

SN 79-110,162. PROFESSIONAL GOLF EUROPE LTD, UNITED KINGDOM, FILED 11-29-2011.



OWNER OF INTERNATIONAL REGISTRATION 1109762 DATED 11-29-2011, EXPIRES 11-29-2021.

THE MARK CONSISTS OF THE STYLIZED WORD "UNITED".

FOR APPARATUS FOR USE IN THE GAME OF GOLF, NAMELY, BALL MARKERS AND DIVOT TOOLS; GOLF GLOVES; CADDIE BAGS FOR GOLF CLUBS; GOLF BALL MARKERS; GOLF BALLS; GOLF CLUBS; GOLF PUTTERS; GOLF DRIVING PRACTICE MATS; GOLF TEES; GOLF TEE BAGS (U.S. CLS. 22, 23, 38 AND 50).
TASHIA BUNCH, EXAMINING ATTORNEY

SN 85-046,067. TINCO TOYS COMPANY LIMITED, KOWLOON, HONG KONG, FILED 5-24-2010.

SN 79-107,552. TOSY ROBOTICS JOINT STOCK COMPANY, VIETNAM, AND HO VINII HOANG, VIETNAM, FILED 10-24-2011.



PRIORITY DATE OF 8-24-2011 IS CLAIMED.

OWNER OF INTERNATIONAL REGISTRATION 1102609 DATED 10-24-2011, EXPIRES 10-24-2021.

THE MARK CONSISTS OF TWO STYLIZED ALIEN FACES.

FOR FLYING DISCS; PARLOR GAMES; QUILTS; SPINNING TOPS; TOYS, NAMELY, SPINNING TOPS WITH LIGHTS, ELECTRONIC SPINNING TOPS, ELECTRIC ACTION TOYS, ELECTRIC EDUCATIONAL TOY USED TO DEMONSTRATE ALTERNATIVE ENERGY SOURCES, ELECTRIC TOY TRAIN TRANSFORMERS, ELECTRONIC ACTION TOYS, ELECTRONIC LEARNING TOYS, ELECTRONIC TOY VEHICLES, ELECTRONICALLY OPERATED TOY MOTOR VEHICLES, ELECTRONIC TOY BUILDING BLOCKS THAT LIGHT UP AS A NIGHT LIGHT; APPARATUS FOR ELECTRONIC GAMES OTHER THAN THOSE ADAPTED FOR USE WITH AN EXTERNAL DISPLAY SCREEN OR MONITOR (U.S. CLS. 22, 23, 38 AND 50).
GINA FINK, EXAMINING ATTORNEY



OWNER OF U.S. REG. NOS. 3,787,995, 3,819,122 AND 3,819,693.

NO CLAIM IS MADE TO THE EXCLUSIVE RIGHT TO USE "HAND PUPPET" AND "ORGANIC, RECYCLED AND SUSTAINABLE MATERIALS", APART FROM THE MARK AS SHOWN.

THE COLOR(S) RED, BLUE, AND WHITE IS/ARE CLAIMED AS A FEATURE OF THE MARK.

THE MARK CONSISTS OF A THREE-DIMENSIONAL CONFIGURATION OF PACKAGING FOR THE GOODS CONSISTING OF A RED BAG WITH AN APPLE SHAPE CUT OUT OF THE MIDDLE AND A BLUE INTERIOR. THE WORDING "APPLE PARK PICNIC PAL" IN WHITE ABOVE THE WORDING "PICNIC PAL HAND PUPPET" ALL ABOVE THE WORDING "MADE WITH LOVE AND ORGANIC, RECYCLED AND SUSTAINABLE MATERIALS". THE FOLLOWING MATTER DEPICTED AS DOTTED-LINES IN THE AMENDED DRAWING ATTACHED THAT IS NOT A PART OF THE MARK IS AS FOLLOWS: THE ROPE HANDLE, THE OUTLINE OF THE SHAPE OF THE CONTAINER, AND THE TAG ATTACHED TO THE CONTAINER.

FOR ORGANIC PLUSH TOYS (U.S. CLS. 22, 23, 38 AND 50).

MATTHEW EINSTEIN, EXAMINING ATTORNEY

CLASS 28—(Continued).

SN 85-047,751. WAKEFIT, LLC, ATHENS, GA. FILED 5-25-2010.

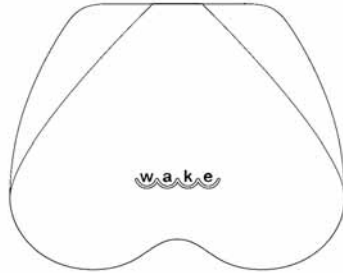

NO CLAIM IS MADE TO THE EXCLUSIVE RIGHT TO USE THE MARK CONSISTS OF A STYLIZED, TWO DIMENSIONAL IMAGE IN THE SHAPE OF AN EXERCISE CUSHION AND A SYMBOL OF A 'WAVE' UNDERNEATH THE WORD "WAKE"., APART FROM THE MARK AS SHOWN.

THE MARK CONSISTS OF THE SHAPE OF AN EXERCISE CUSHION AND A SYMBOL OF A 'WAVE' UNDERNEATH THE WORD "WAKE".

FOR EXERCISE EQUIPMENT, NAMELY, ABDOMINAL EXERCISE CUSHIONS FOR USE IN SUPPORTING THE BACK WHILE EXERCISING (U.S. CLS. 22, 23, 38 AND 50).

RICHARD WHITE, EXAMINING ATTORNEY

CLASS 28—(Continued).

SN 85-271,620. DIAMOND TECH INTERNATIONAL, TAMPA, FL. FILED 3-20-2011.



NO CLAIM IS MADE TO THE EXCLUSIVE RIGHT TO USE "MOSAICS", APART FROM THE MARK AS SHOWN.

THE COLOR(S) BLACK, ORANGE, RED, GREEN, PURPLE AND YELLOW IS/ARE CLAIMED AS A FEATURE OF THE MARK.

THE MARK CONSISTS OF THE STYLIZED WORDS "JENNIFER'S" IN BLACK AND "MOSAICS" IN ORANGE AND YELLOW AND OUTLINED IN BLACK NEXT TO A TRIANGULAR GLASS MOSAIC IN ORANGE, GREEN, PURPLE AND RED.

SEC. 2(F).

FOR HOBBY CRAFT KITS COMPRISING STAINED GLASS FOR MAKING COASTER AND TRIVETS (U.S. CLS. 22, 23, 38 AND 50).

FIRST USE 9-28-1998; IN COMMERCE 9-28-1998.

HOWARD B. LEVINE, EXAMINING ATTORNEY

SN 85-130,017. CJ 4DPLEX CO., LTD., SEOUL, REPUBLIC OF KOREA, FILED 9-15-2010.

4DPLEX

THE MARK CONSISTS OF STANDARD CHARACTERS WITHOUT CLAIM TO ANY PARTICULAR FONT, STYLE, SIZE, OR COLOR.

PRIORITY CLAIMED UNDER SEC. 44(D) ON REPUBLIC OF KOREA APPLICATION NO. 40-2010-4770, FILED 9-10-2010, REG. NO. 0914935, DATED 4-10-2012, EXPIRES 4-10-2022.

FOR AMUSEMENT PARK RIDES; GAME APPARATUS AND EQUIPMENT, NAMELY, AMUSEMENT APPARATUS INCORPORATING A TELEVISION MONITOR, AMUSEMENT APPARATUS INCORPORATING A VIDEO MONITOR, AMUSEMENT APPARATUS INCORPORATING A TELEVISION SCREEN; AMUSEMENT PARK RIDES INCORPORATING APPARATUS AND EQUIPMENT FOR MOVIES AUDIENCE EFFECTS IN CINEMAS WITH SPECIAL EFFECTS SUCH AS WIND, SCENT, WATER SPRAY, MOTION, VIBRATION, SMOKE, BUBBLE, LASER OR FLASH; TOY DOLLS; APPARATUS FOR ELECTRONIC GAMES OTHER THAN THOSE ADAPTED FOR USE WITH TELEVISION RECEIVERS (U.S. CLS. 22, 23, 38 AND 50).

RON FAIRBANKS, EXAMINING ATTORNEY

SN 85-291,287. CAMERA CREATURES LIMITED LIABILITY COMPANY, ANNANDALE, NJ. FILED 4-11-2011.

CAMERA CREATURES

THE MARK CONSISTS OF STANDARD CHARACTERS WITHOUT CLAIM TO ANY PARTICULAR FONT, STYLE, SIZE, OR COLOR.

NO CLAIM IS MADE TO THE EXCLUSIVE RIGHT TO USE "CAMERA", APART FROM THE MARK AS SHOWN.

FOR STUFFED TOY ANIMALS FOR ATTACHMENT TO CAMERA LENSES TO PROVIDE A COLORFUL AND FUN ATTENTION POINT FOR THE SUBJECT OF A PHOTO OR VIDEO (U.S. CLS. 22, 23, 38 AND 50).

FIRST USE 1-1-2001; IN COMMERCE 1-1-2001.

TIMOTHY FINNEGAN, EXAMINING ATTORNEY

CLASS 28—(Continued).

SN 85-313,811. KINLEA HOLDINGS PTY LTD, CASTLE HILL NSW 2154, AUSTRALIA, FILED 5-5-2011.



OWNER OF AUSTRALIA REG. NO. 1393243, DATED 9-6-2011, EXPIRES 11-9-2020.

OWNER OF U.S. REG. NO. 2,489,918.

THE MARK CONSISTS OF THE STYLIZED WORDING "WILD! LIFE" IN FRONT OF A DESIGN INCORPORATING INSECTS, LEAVES, DEW DROPS AND A CIRCULAR DESIGN IN THE BACKGROUND.

FOR CHILDREN'S TOYS, GAMES AND PLAYTHINGS, NAMELY, EDUCATIONAL AND ENTERTAINMENT HOBBY CRAFT SETS FOR CONDUCTING EXPERIMENTS AND PROVIDING DEMONSTRATIONS OF A SCIENTIFIC NATURE; EDUCATIONAL TOYS, GAMES AND PLAYTHINGS FOR THE PURPOSE OF TEACHING CHILDREN ABOUT THE NATURE AND LIFE CYCLE OF PLANTS, ANIMALS, INSECTS AND OTHER BIOLOGICAL ORGANISMS AND FOR TEACHING CHILDREN ABOUT BOTANICAL, ZOOLOGICAL AND ECOLOGICAL PRINCIPLES AND ENVIRONMENTAL AWARENESS; ECOLOGICAL TOYS, NAMELY, KITS FOR GROWING PLANTS AND PRESERVING PLANTS, KITS FOR CONSTRUCTING ANIMAL OR INSECT HABITATS, KITS FOR RAISING LIVE INSECTS, KITS FOR GROWING CRYSTALS; TOY HABITATS FOR ANIMALS AND INSECTS; TOY INSECT FARMS; TOY ANT FARMS; TOYS BEING FOR SALE IN KIT FORM, NAMELY, KITS FOR CONDUCTING EXPERIMENTS AND PROVIDING DEMONSTRATIONS OF A SCIENTIFIC NATURE, KITS FOR GROWING PLANTS AND PRESERVING PLANTS, KITS FOR CONSTRUCTING ANIMAL OR INSECT HABITATS, KITS FOR RAISING LIVE INSECTS, KITS FOR GROWING CRYSTALS; PLASTIC TOY PARTS, NAMELY, COMPONENTS OF THE ABOVEMENTIONED KITS; ALL OF THE FOREGOING NOT RELATED TO KITES (U.S. CLS. 22, 23, 38 AND 50).

TINA L. SNAPP, EXAMINING ATTORNEY

CLASS 28—(Continued).

SN 85-327,383. CJ 4DPLEX CO., LTD., SEOUL, REPUBLIC OF KOREA, FILED 5-23-2011.

4DX

THE MARK CONSISTS OF STANDARD CHARACTERS WITHOUT CLAIM TO ANY PARTICULAR FONT, STYLE, SIZE, OR COLOR.

PRIORITY CLAIMED UNDER SEC. 44(D) ON REPUBLIC OF KOREA APPLICATION NO. 40-2010-6159, FILED 11-30-2010, REG. NO. 0902120, DATED 2-3-2012, EXPIRES 2-3-2022.

FOR AMUSEMENT PARK RIDES; GAME APPARATUS AND EQUIPMENT, NAMELY, AMUSEMENT APPARATUS INCORPORATING A TELEVISION MONITOR, AMUSEMENT APPARATUS INCORPORATING A VIDEO MONITOR, AMUSEMENT APPARATUS INCORPORATING A TELEVISION SCREEN; AMUSEMENT PARK RIDES INCORPORATING APPARATUS AND EQUIPMENT FOR MOVIES AUDIENCE EFFECTS IN CINEMAS WITH SPECIAL EFFECTS SUCH AS WIND, SCENT, WATER SPRAY, MOTION, VIBRATION, SMOKE, BUBBLE, LASER OR FLASH; TOY DOLLS; APPARATUS FOR ELECTRONIC GAMES OTHER THAN THOSE ADAPTED FOR USE WITH TELEVISION RECEIVERS (U.S. CLS. 22, 23, 38 AND 50).

PATRICIA EVANKO, EXAMINING ATTORNEY

SN 85-337,515. LEGEND PICTURES, LLC, BURBANK, CA. FILED 6-3-2011.

OWNER OF U.S. REG. NOS. 3,412,677, 3,621,043 AND 3,656,926.

THE MARK CONSISTS OF THE WORD "LEGENDARY" WITH A KNOT DESIGN.

FOR TOY ACTION FIGURES AND ACCESSORIES THEREOF; TOY ANIMAL FIGURES AND ACCESSORIES THEREOF; DOLLS AND DOLL ACCESSORIES THEREOF; STUFFED AND PLUSH TOYS (U.S. CLS. 22, 23, 38 AND 50).

LESLIE RICHARDS, EXAMINING ATTORNEY

CLASS 28—(Continued).

SN 85-337,925. LEGEND PICTURES, LLC, BURBANK, CA. FILED 6-3-2011.



OWNER OF U.S. REG. NOS. 3,412,677, 3,621,043 AND 3,656,926.

THE MARK CONSISTS OF THE WORD "LEGENDARY" AND A KNOT DESIGN ON TOP.

FOR TOY ACTION FIGURES AND ACCESSORIES THEREOF; TOY ANIMAL FIGURES AND ACCESSORIES THEREOF; DOLLS AND DOLL ACCESSORIES THEREOF; STUFFED AND PLUSH TOYS (U.S. CLS. 22, 23, 38 AND 50).

LESLIE RICHARDS, EXAMINING ATTORNEY

CLASS 28—(Continued).

SN 85-396,990. SCHWALLER, INC., VANCOUVER, WA. FILED 8-12-2011.

SCHWALLER

THE MARK CONSISTS OF STANDARD CHARACTERS WITHOUT CLAIM TO ANY PARTICULAR FONT, STYLE, SIZE, OR COLOR.

SEC. 2(F).

FOR BAGS SPECIALLY ADAPTED FOR SPORTS EQUIPMENT; STORAGE RACKS FOR ATHLETIC EQUIPMENT (U.S. CLS. 22, 23, 38 AND 50).

FIRST USE 1-1-2006; IN COMMERCE 1-1-2006.

LINDA E. BLOHM, EXAMINING ATTORNEY

SN 85-365,645. MATTEL, INC., EL SEGUNDO, CA. FILED 7-7-2011.

FLAME DROP

THE MARK CONSISTS OF STANDARD CHARACTERS WITHOUT CLAIM TO ANY PARTICULAR FONT, STYLE, SIZE, OR COLOR.

OWNER OF U.S. REG. NOS. 3,157,089, 3,337,461 AND 3,696,551.

FOR TOY VEHICLE TRACK SETS AND ACCESSORIES THEREFOR (U.S. CLS. 22, 23, 38 AND 50).

STEPHANIE ALI, EXAMINING ATTORNEY

SN 85-409,043. DK WILDLIFE INDUSTRIES, INC., MOBILE, AL. FILED 8-27-2011.

AntlerMagnet

THE MARK CONSISTS OF STANDARD CHARACTERS WITHOUT CLAIM TO ANY PARTICULAR FONT, STYLE, SIZE, OR COLOR.

FOR PASSIVE ANTLER REMOVAL DEVICE FOR SPORTSMEN AND COLLECTORS CONSISTING OF A ROD AND BRACKET TO BE ATTACHED TO A FEEDER, TREE OR OTHER OBJECT TO FACILITATE THE PASSIVE SHEDDING OF ANTLERS (U.S. CLS. 22, 23, 38 AND 50).

DAWN FELDMAN, EXAMINING ATTORNEY

SN 85-366,710. SECOND CHANCE LIFESTYLES, LLC, SULLIVAN, IL. FILED 7-8-2011.

SECOND CHANCE

THE MARK CONSISTS OF STANDARD CHARACTERS WITHOUT CLAIM TO ANY PARTICULAR FONT, STYLE, SIZE, OR COLOR.

FOR PORTABLE, DUAL WHEELED RESISTANCE EXERCISE DEVICE WITH ATTACHMENT POINT (U.S. CLS. 22, 23, 38 AND 50).

DOMINIC J. FERRAIUOLO, EXAMINING ATTORNEY

SN 85-430,006. MIKA BOBLITZ ZACHARY, AKA MIA ZACHARY, GLEN BURNIE, MD. FILED 9-22-2011.

Writing Blocks Idea Dice

THE MARK CONSISTS OF STANDARD CHARACTERS WITHOUT CLAIM TO ANY PARTICULAR FONT, STYLE, SIZE, OR COLOR.

NO CLAIM IS MADE TO THE EXCLUSIVE RIGHT TO USE "IDEA DICE", APART FROM THE MARK AS SHOWN. FOR DICE; DICE GAMES (U.S. CLS. 22, 23, 38 AND 50).

FIRST USE 9-20-2010; IN COMMERCE 11-9-2011.

JOHN GARTNER, EXAMINING ATTORNEY

CLASS 28—(Continued).

SN 85-434,992. AERIAL ACTION SPORTS LLC, SAN DIEGO, CA. FILED 9-29-2011.

100% USA

THE MARK CONSISTS OF STANDARD CHARACTERS WITHOUT CLAIM TO ANY PARTICULAR FONT, STYLE, SIZE, OR COLOR.

NO CLAIM IS MADE TO THE EXCLUSIVE RIGHT TO USE "USA", APART FROM THE MARK AS SHOWN.

FOR BAGS FOR SKATEBOARDS; BALL BEARINGS FOR SKATEBOARDS; NUTS AND BOLTS FOR SKATEBOARDS; PROTECTIVE PADDING FOR SKATEBOARDING; PROTECTIVE PADDING FOR SNOWBOARDING; SKATEBOARD DECKS; SKATEBOARD GRIP TAPES; SKATEBOARD RAILS; SKATEBOARD RISER PADS; SKATEBOARD TRUCKS; SKATEBOARD WAX; SKATEBOARD WHEELS; SKATEBOARDS; SNOWBOARD DECKS; SNOWBOARDS; SURFBOARDS (U.S. CLS. 22, 23, 38 AND 50).

BILL DAWE, EXAMINING ATTORNEY

SN 85-437,015. ALL FISHIN LLC, DEL MAR, CA. FILED 9-30-2011.



NO CLAIM IS MADE TO THE EXCLUSIVE RIGHT TO USE "MEGABAIT", APART FROM THE MARK AS SHOWN. THE MARK CONSISTS OF A STYLIZED FISH FEATURING THE WORDS "MEGABAIT" RUNNING ACROSS THE CENTER OF THE FISH.

FOR FISHING LURES (U.S. CLS. 22, 23, 38 AND 50). FIRST USE 12-1-1999; IN COMMERCE 11-1-2009. SIMON TENG, EXAMINING ATTORNEY

CLASS 28—(Continued).

SN 85-437,774. SCG POWER RANGERS LLC, LOS ANGELES, CA. FILED 10-3-2011.

POWER RANGERS MEGAFORCE

THE MARK CONSISTS OF STANDARD CHARACTERS WITHOUT CLAIM TO ANY PARTICULAR FONT, STYLE, SIZE, OR COLOR.

OWNER OF U.S. REG. NOS. 1,893,768, 2,506,454 AND OTHERS.

FOR TOYS, GAMES, PLAYTHINGS, AND SPORTING GOODS, NAMELY, BASKETBALL BACKBOARDS; TOY AND NON-MOTORIZED SCOOTERS; SKATEBOARDS AND SKATEBOARD BAGS; BENDABLE PLAY FIGURES AND ACCESSORIES THEREFOR; TOY ACTION FIGURES AND ACCESSORIES THEREFOR; SPORTS BOARD GAMES; BALLS FOR GAMES; BASKETBALLS; PLAYGROUND BALLS; RUBBER BALLS; SPORTS BALLS; FOAM ACTION BALLS; TOY HOOP SETS; TOY BANKS; TOY WATCHES; BATH TUB TOYS; CHILDREN'S MULTIPLE ACTIVITY TOYS; TOY MAGIC TRICKS; WATER SQUIRTING TOYS; WIND-UP TOYS; SQUEEZE TOYS; JUMP ROPES; SLING SHOTS; TOY WALKIE-TALKIES; ACTION SKILL GAMES; TALKING DOLLS; TOY 3-D VIEWERS AND REELS; BOARD GAMES; CARD GAMES; HAND HELD UNITS FOR PLAYING ELECTRONIC GAMES ADAPTED FOR USE WITH AN EXTERNAL DISPLAY SCREEN OR MONITOR AND OTHER THAN THOSE ADAPTED FOR USE WITH AN EXTERNAL DISPLAY SCREEN OR MONITOR; STAND ALONE VIDEOGAME MACHINES AND PROGRAMS THEREFORE SOLD AS A UNIT; ELECTRONIC GAME EQUIPMENT WITH A WATCH FUNCTION; HAND HELD LCD GAME MACHINES; COIN AND NON-COIN OPERATED VIDEO GAME TABLES; PINBALL MACHINES AND PINBALL-TYPE GAMES; JIGSAW PUZZLES; MANIPULATIVE PUZZLES; MECHANICAL ACTION TOYS; BATTERY-OPERATED ACTION TOYS; PUPPETS; DOLLS; PLAYSETS FOR DOLLS; DOLL CLOTHING; DOLL COSTUMES; CHILDREN'S PLAY COSMETICS; ROLE PLAYING GAMES; ACTION-TYPE TARGET SHOOTING GAME SETS COMPRISING TOY GUN, TOY SUCTION DARTS AND TARGET; TOY WEAPONS; SQUIRT GUNS; KITES; PAPER AND PLASTIC PARTY FAVORS IN THE NATURE OF SMALL TOYS AND NOISEMAKERS; BALLOONS; STUFFED AND PLUSH TOYS; LATEX SQUEEZE TOY FIGURES; MUSICAL TOYS; INFLATABLE BATH TOYS; SWIMMING AND INFLATABLE RIDE-IN TOYS; TOY VEHICLES; TRANSFORMING ROBOTIC TOY VEHICLES; NON-MOTORIZED RIDE-IN TOYS; INFLATABLE PLAY SWIMMING POOLS; TOY PLAY HOUSES AND TOY PLAY TENTS; SURF BOARDS, KICK BOARD FLOATATION DEVICES, BODY BOARDS AND LEASHES THEREFOR FOR RECREATIONAL USE; TOY SAND BOXES AND SAND TOYS; SNOW SLEDS, TOBOGGANS, SNOW SAUCERS AND SNOW BOARDS FOR RECREATIONAL USE; TOY BUILDING BLOCKS; MOBILES FOR CHILDREN; CHRISTMAS TREE ORNAMENTS THAT ARE NEITHER CONFECTIONERY NOR ILLUMINATED; TOY CRAFT KITS COMPRISING MOLDS AND MOULDINGS FOR MAKING TOY FIGURES; PLASTIC ACTION FIGURE MODELS; FLYING DISCS; PET TOYS; MARBLES; YO-YOS; AND PLAYING CARDS; PAPER PARTY HATS (U.S. CLS. 22, 23, 38 AND 50).

MARIA-VICTORIA SUAREZ, EXAMINING ATTORNEY

CLASS 28—(Continued).

SN 85-447,161. HOT TOYS, INC., DBA HOT TOYS, INC., OAK FOREST, IL. FILED 10-13-2011.



THE COLOR(S) RED, YELLOW, WHITE, BLACK, AND GRAY IS/ARE CLAIMED AS A FEATURE OF THE MARK. THE MARK CONSISTS OF THE STYLIZED WORDING "SEXXTIONS" AND "THE PARTY GAME THAT TURNS T.M.I. INTO TOO MUCH FUN!!!" IN YELLOW AGAINST A RED BACKGROUND THAT HAS DARKER RED QUESTION MARKS (?) SCATTERED RANDOMLY ACROSS IT. THE LETTERS IN THE WORDING "SEXXTIONS" APPEAR TO BE SLIGHTLY CURVED AND THREE DIMENSIONAL AS THE BEGINNING AS THE LETTERS GO FROM SMALL TO LARGE WITH THE BEGINNING AND ENDING LETTERS "S" BEING SMALL AND EACH LETTER GETTING PROGRESSIVELY LARGER WITH THE THIRD "X" BEING THE LARGEST LETTER. ADDITIONALLY, ALL OF THE LETTERS IN "SEXXTIONS" HAVE YELLOW SHADING BEHIND THEM TO SHOW DEPTH AND EACH LETTER CASTS A GRAY SHADOW. ABOVE THE WORDING "SEXXTIONS" ARE FIVE PEOPLE, TWO MEN AND THREE WOMEN, ALL VISIBLE ONLY FROM THE JUST BELOW THE SHOULDERS UP. ALL ARE LAUGHING, AND ALL ARE WHITE WITH BLACK OUTLINES DEFINING THEIR BODIES, HAIR, FACIAL EXPRESSIONS, AND CLOTHING. EACH OF THE FIGURES ALSO HAS GRAY TO SHOW SHADING. THE MAN AND WOMAN ON THE LEFT ARE TURNED TO THEIR LEFT, THE MAN IN THE CENTER AND THE WOMAN TO HIS LEFT ARE TURNED TO THE LEFT, WHILE THE WOMAN ON THE END OF THE WORDING IS FACING FORWARD AND HAS HER RIGHT HAND FACING UP AND OUT AND HER LEFT HAND IS COVERING HER FACE FROM HER NOSE TO HER FOREHEAD WITH THE FINGERS PARTED SO THAT HER RIGHT EYE SHOWS. UNDER THE LETTERS "XXTIO" IS A MAN LAUGHING AND LAYING ON HIS BACK IN A CHAIR WITH HIS LEGS GOING OPPOSITE DIRECTIONS AND HIS HANDS ON HIS STOMACH. THIS MAN IS WHITE WITH ALL OF THE DETAILS OF HIS HAIR, FACE AND BODY DETAILED IN BLACK. GRAY IS USED TO PROVIDE SHADING ON THE MAN AND CHAIR AND AS A SHADOW BEHIND THE MAN AND CHAIR. THE WORDING "THE PARTY GAME THAT TURNS T.M.I. INTO TOO MUCH FUN!!!" IS ABOVE ALL OF THE PEOPLE AND THE WORDING "SEXXTIONS".

FOR EQUIPMENT SOLD AS A UNIT FOR PLAYING BOARD GAMES; GAME EQUIPMENT SOLD AS A UNIT FOR PLAYING MIND-BODY EMOTIONAL AND PSYCHOLOGICAL GAMES FOR ADULT COUPLES AND INDIVIDUALS (U.S. CLS. 22, 23, 38 AND 50).

KATHLEEN KOLACZ, EXAMINING ATTORNEY

CLASS 28—(Continued).

SN 85-461,587. SYNERGY SPORTZ LLC, DBA YUKON CHARLIES, POCASSET, MA. FILED 11-1-2011.



OWNER OF U.S. REG. NO. 4,084,609.
NO CLAIM IS MADE TO THE EXCLUSIVE RIGHT TO USE "SNOWSHOES", APART FROM THE MARK AS SHOWN.
FOR SNOWSHOES, TREKKING POLES, BAGS FOR CARRYING SNOWSHOES (U.S. CLS. 22, 23, 38 AND 50).
FIRST USE 1-0-2011; IN COMMERCE 9-0-2011.
MARY CRAWFORD, EXAMINING ATTORNEY

SN 85-474,176. CLB ASSETS LLC, DBA C. L. BAILEY CO., MARIONVILLE, MO. FILED 11-16-2011.



NO CLAIM IS MADE TO THE EXCLUSIVE RIGHT TO USE "CO" AND "MARIONVILLE, MISSOURI", APART FROM THE MARK AS SHOWN.

THE COLOR(S) GREEN, BLACK AND WHITE IS/ARE CLAIMED AS A FEATURE OF THE MARK.

THE MARK CONSISTS OF "THE C. L. BAILEY CO" IS DARK GREEN AND CENTERED WITHIN A DECORATIVE FRAME OR CARRIER WHICH IS IN BLACK. BELOW IN A SMALLER FONT IS "MARIONVILLE, MISSOURI" IN DARK GREEN AND CENTERED IN A DECORATIVE BLACK BANNER CARRIER. THE AREAS BEHIND THE FONTS AND DECORATIVE BORDERS ARE WHITE.

FOR BILLIARD BALLS; BILLIARD CHALK; BILLIARD CUE RACKS; BILLIARD CUES; BILLIARD EQUIPMENT; BILLIARD GAME PLAYING EQUIPMENT; BILLIARD TABLES; BILLIARD TALLY BALLS; BILLIARD TRIANGLES; CHALK FOR BILLIARD CUES; CUE STICKS; FOOSBALL TABLES; GAME TABLES; GAMING TABLES (U.S. CLS. 22, 23, 38 AND 50).
FIRST USE 7-25-1998; IN COMMERCE 2-15-1999.
MARY ROSSMAN, EXAMINING ATTORNEY

CLASS 28—(Continued).

SN 85-478,764. LEAPFROG ENTERPRISES, INC., EMERYVILLE, CA. FILED 11-22-2011.

LETTER FACTORY PHONICS

THE MARK CONSISTS OF STANDARD CHARACTERS WITHOUT CLAIM TO ANY PARTICULAR FONT, STYLE, SIZE, OR COLOR.

OWNER OF U.S. REG. NO. 3,353,172.

NO CLAIM IS MADE TO THE EXCLUSIVE RIGHT TO USE "LETTER" AND "PHONICS", APART FROM THE MARK AS SHOWN.

FOR ELECTRONIC LEARNING TOYS (U.S. CLS. 22, 23, 38 AND 50).

SUE LAWRENCE, EXAMINING ATTORNEY

SN 85-485,519. WILDLIFE RESEARCH CENTER, INC., RAMSEY, MN. FILED 12-2-2011.

HUNT DRY

THE MARK CONSISTS OF STANDARD CHARACTERS WITHOUT CLAIM TO ANY PARTICULAR FONT, STYLE, SIZE, OR COLOR.

NO CLAIM IS MADE TO THE EXCLUSIVE RIGHT TO USE "HUNT", APART FROM THE MARK AS SHOWN.

FOR SCENT ELIMINATION PRODUCTS, NAMELY, SPRAYS FOR USE ASSOCIATED WITH HUNTING AND OUTDOOR RECREATION; HUNTERS' SCENT CAMOUFLAGE TO MASK AND COVER HUMAN ODOR (U.S. CLS. 22, 23, 38 AND 50).

FIRST USE 3-30-2012; IN COMMERCE 3-30-2012.
JAMES GRIFFIN, EXAMINING ATTORNEY

SN 85-485,931. THINKY TINK, LLC, ANN ARBOR, MI. FILED 12-2-2011.

POMZ

THE MARK CONSISTS OF STANDARD CHARACTERS WITHOUT CLAIM TO ANY PARTICULAR FONT, STYLE, SIZE, OR COLOR.

FOR CLIP-ON COLLECTIBLE TOY FIGURINE WITH INTERCHANGEABLE FACES, SOLD INDIVIDUALLY, IN GROUPS OR WITH ACCESSORIES SUCH AS STORAGE BAGS, CASES, AND PLAY DISPLAYS (U.S. CLS. 22, 23, 38 AND 50).

GINA FINK, EXAMINING ATTORNEY

CLASS 28—(Continued).

SN 85-487,265. US 2, INC., CHICAGO, IL. FILED 12-5-2011.



NO CLAIM IS MADE TO THE EXCLUSIVE RIGHT TO USE "GAME" AND "CARD", APART FROM THE MARK AS SHOWN.

THE MARK CONSISTS OF A LARGE LOWER CASE "U" IN BOLD FACE TYPE ABOVE THE PHRASE "A MYSTERIOUS GAME OF PSYCHIC CARD SHUFFLE" IN ALL CAPITAL LETTERS.

FOR BOARD GAMES (U.S. CLS. 22, 23, 38 AND 50).
REGINA DRUMMOND, EXAMINING ATTORNEY

SN 85-495,261. JOE CASALI, FRANKLIN LAKES, NJ. FILED 12-14-2011.

KID CONSTRUCTIONS

THE MARK CONSISTS OF STANDARD CHARACTERS WITHOUT CLAIM TO ANY PARTICULAR FONT, STYLE, SIZE, OR COLOR.

NO CLAIM IS MADE TO THE EXCLUSIVE RIGHT TO USE "KID", APART FROM THE MARK AS SHOWN.

FOR TOY VEHICLES; TOY VEHICLES AND ACCESSORIES THEREFOR (U.S. CLS. 22, 23, 38 AND 50).
CHARLOTTE CORWIN, EXAMINING ATTORNEY

SN 85-499,235. MATTEL, INC., EL SEGUNDO, CA. FILED 12-19-2011.

HOWLEEN WOLF

THE MARK CONSISTS OF STANDARD CHARACTERS WITHOUT CLAIM TO ANY PARTICULAR FONT, STYLE, SIZE, OR COLOR.

FOR DOLLS, DOLL CLOTHING AND DOLL ACCESSORIES (U.S. CLS. 22, 23, 38 AND 50).

BRIAN PINO, EXAMINING ATTORNEY

CLASS 28—(Continued).

SN 85-501,193. TANNER, ANDRE, 8834 SCHINDELLEGI, SWITZERLAND, FILED 12-21-2011.

ALPRAUSCH

THE MARK CONSISTS OF STANDARD CHARACTERS WITHOUT CLAIM TO ANY PARTICULAR FONT, STYLE, SIZE, OR COLOR.

OWNER OF U.S. REG. NOS. 3,002,229, 3,036,135 AND 3,725,042.

THE WORDING "ALPRAUSCH" HAS NO MEANING IN A FOREIGN LANGUAGE.

FOR FOOT BAGS USED IN A KICKING GAME, WATER SQUIRTING TOYS, AND NOISEMAKERS; SNOW SLEDS FOR RECREATIONAL USE; SNOWBOARDS, SKIS, SKI AND SNOWBOARD BINDINGS (U.S. CLS. 22, 23, 38 AND 50).

MARK RADEMACHER, EXAMINING ATTORNEY

SN 85-502,821. IMAGINE SURF, LLC, SAN CLEMENTE, CA. FILED 12-23-2011.



THE MARK CONSISTS OF A STYLIZED WAVE WITHIN A CIRCLE.

FOR SURFBOARDS, PADDLEBOARDS, STAND UP PADDLEBOARDS, AND ACCESSORIES THEREFOR, NAMELY, FINS, LEASHES, PADDLES, PADDLE CLIPS, SEATS FOR PADDLEBOARDS, AND WHEEL ASSEMBLIES FOR PADDLEBOARDS (U.S. CLS. 22, 23, 38 AND 50).

FIRST USE 0-0-2008; IN COMMERCE 0-0-2008. YAT SYE, LEE, EXAMINING ATTORNEY

CLASS 28—(Continued).

SN 85-506,210. EMICK DANIEL W, WILLIAMSPORT, PA. FILED 12-30-2011.

PULL FORCE center pull handles

THE MARK CONSISTS OF STANDARD CHARACTERS WITHOUT CLAIM TO ANY PARTICULAR FONT, STYLE, SIZE, OR COLOR.

NO CLAIM IS MADE TO THE EXCLUSIVE RIGHT TO USE "PULL" AND "CENTER PULL HANDLES", APART FROM THE MARK AS SHOWN.

FOR EXERCISE EQUIPMENT, NAMELY, CENTER PULL HANDLES FOR ATTACHMENT TO RESISTANCE CABLE EXERCISE MACHINES (U.S. CLS. 22, 23, 38 AND 50).

FIRST USE 6-1-2011; IN COMMERCE 6-1-2011. SARA BENJAMIN, EXAMINING ATTORNEY

SN 85-510,019. NU-GAMING VENTURES INC., PEARL RIVER, NY. FILED 1-5-2012.

SuperPeek

THE MARK CONSISTS OF STANDARD CHARACTERS WITHOUT CLAIM TO ANY PARTICULAR FONT, STYLE, SIZE, OR COLOR.

FOR CARD GAMES (U.S. CLS. 22, 23, 38 AND 50).

FIRST USE 2-14-2010; IN COMMERCE 2-14-2010. BRENDAN REGAN, EXAMINING ATTORNEY

SN 85-511,141. BATON ROUGE STOCK EXCHANGE, SHREVEPORT, LA. FILED 1-7-2012.

Skate Buds Strap-on Heel Skates

THE MARK CONSISTS OF STANDARD CHARACTERS WITHOUT CLAIM TO ANY PARTICULAR FONT, STYLE, SIZE, OR COLOR.

NO CLAIM IS MADE TO THE EXCLUSIVE RIGHT TO USE "SKATE" AND "STRAP-ON HEEL SKATES", APART FROM THE MARK AS SHOWN.

FOR ROLLER SKATES (U.S. CLS. 22, 23, 38 AND 50). FIRST USE 8-10-2006; IN COMMERCE 9-1-2008.

DAWN FELDMAN, EXAMINING ATTORNEY

CLASS 28—(Continued).

SN 85-515,723. HEAVENLY HOLIDAYS, LLC, SAN MATEO, CA. FILED 1-13-2012.

TREE CLASSICS

THE MARK CONSISTS OF STANDARD CHARACTERS WITHOUT CLAIM TO ANY PARTICULAR FONT, STYLE, SIZE, OR COLOR.

OWNER OF U.S. REG. NO. 1,597,630.

NO CLAIM IS MADE TO THE EXCLUSIVE RIGHT TO USE "TREE", APART FROM THE MARK AS SHOWN. SEC. 2(F).

FOR ARTIFICIAL CHRISTMAS TREES, ARTIFICIAL CHRISTMAS WREATHS, AND ARTIFICIAL CHRISTMAS GARLANDS (U.S. CLS. 22, 23, 38 AND 50).

FIRST USE 1-2-1986; IN COMMERCE 1-2-1986.
MARY ROSSMAN, EXAMINING ATTORNEY

SN 85-516,022. BREZINSKI CORP, LOS ANGELES, CA. FILED 1-13-2012.

ANDALE BEARINGS

THE MARK CONSISTS OF STANDARD CHARACTERS WITHOUT CLAIM TO ANY PARTICULAR FONT, STYLE, SIZE, OR COLOR.

NO CLAIM IS MADE TO THE EXCLUSIVE RIGHT TO USE "BEARINGS", APART FROM THE MARK AS SHOWN.

THE ENGLISH TRANSLATION OF "ANDALE" IN THE MARK IS "COME ON".

FOR SKATEBOARD WHEELS; BALL BEARINGS FOR SKATEBOARDS (U.S. CLS. 22, 23, 38 AND 50).
KRISTINA MORRIS, EXAMINING ATTORNEY

SN 85-519,081. CERPOK, MICHAEL L., FOUNTAIN HILLS, AZ. FILED 1-18-2012.

BAKIBALL

THE MARK CONSISTS OF STANDARD CHARACTERS WITHOUT CLAIM TO ANY PARTICULAR FONT, STYLE, SIZE, OR COLOR.

THE WORDING "BAKI" HAS NO MEANING IN A FOREIGN LANGUAGE.

FOR BALLS FOR SPORTS (U.S. CLS. 22, 23, 38 AND 50).

FIRST USE 3-3-2010; IN COMMERCE 3-3-2010.
MELISSA VALLILLO, EXAMINING ATTORNEY

CLASS 28—(Continued).

SN 85-519,122. CERPOK, MICHAEL L., FOUNTAIN HILLS, AZ. FILED 1-18-2012.

BAKIBOARD

THE MARK CONSISTS OF STANDARD CHARACTERS WITHOUT CLAIM TO ANY PARTICULAR FONT, STYLE, SIZE, OR COLOR.

THE WORDING "BAKI" HAS NO MEANING IN A FOREIGN LANGUAGE.

FOR BACKBOARD FOR SPORTS GAME (U.S. CLS. 22, 23, 38 AND 50).

FIRST USE 3-3-2010; IN COMMERCE 3-3-2010.

MELISSA VALLILLO, EXAMINING ATTORNEY

SN 85-521,323. TRADEMARK GAMES, INC, LORAIN, OH. FILED 1-20-2012.



NO CLAIM IS MADE TO THE EXCLUSIVE RIGHT TO USE "RIDER", APART FROM THE MARK AS SHOWN.

THE MARK CONSISTS OF A CARTOON TIRE WITH A HORIZONTAL FLAME BURSTING FROM IT AND THE STYLIZED WORDS "LIL' RIDER" IN FRONT OF THE FLAME.

FOR RIDE-ON TOYS; RIDE-ON TOYS AND ACCESSORIES THEREFOR; RIDEABLE TOY VEHICLES; RIDEABLE TOYS AND ACCESSORIES THEREFOR (U.S. CLS. 22, 23, 38 AND 50).

FIRST USE 1-11-2011; IN COMMERCE 4-13-2011.

COLLEEN DOMBROW, EXAMINING ATTORNEY

SN 85-521,336. TRADEMARK GAMES, INC, LORAIN, OH. FILED 1-20-2012.



THE COLOR(S) BEIGE, BROWN, AND RED IS/ARE CLAIMED AS A FEATURE OF THE MARK.

THE MARK CONSISTS OF A BEIGE AND BROWN HORIZONTAL CARTOON ARROW WITH THE RED STYLIZED WORDS "HAPPY TRAILS" SEEN HORIZONTALLY ACROSS THE ARROW WITH A RED STAR ABOVE THE LETTER "I" IN THE WORD "TRAILS".

FOR PLUSH TOYS; STUFFED AND PLUSH TOYS; STUFFED TOY ANIMALS; STUFFED TOYS; TOY ANIMALS (U.S. CLS. 22, 23, 38 AND 50).

FIRST USE 3-30-2011; IN COMMERCE 4-4-2011.

COLLEEN DOMBROW, EXAMINING ATTORNEY

CLASS 28—(Continued).

SN 85-521,371. CERPOK, MICHAEL L., FOUNTAIN HILLS, AZ. FILED 1-20-2012.

BAKIPIN

THE MARK CONSISTS OF STANDARD CHARACTERS WITHOUT CLAIM TO ANY PARTICULAR FONT, STYLE, SIZE, OR COLOR.

THE WORDING "BAKI" HAS NO MEANING IN A FOREIGN LANGUAGE.

FOR GOAL PINS FOR SPORTS GAME (U.S. CLS. 22, 23, 38 AND 50).

FIRST USE 3-3-2010; IN COMMERCE 3-3-2010.

MELISSA VALLILLO, EXAMINING ATTORNEY

SN 85-522,912. NEW BREED MUSKY BAIT, LLC, ST. FRANCIS, WI. FILED 1-23-2012.

NEW BREED MUSKY BAITS

THE MARK CONSISTS OF STANDARD CHARACTERS WITHOUT CLAIM TO ANY PARTICULAR FONT, STYLE, SIZE, OR COLOR.

NO CLAIM IS MADE TO THE EXCLUSIVE RIGHT TO USE "MUSKY BAITS", APART FROM THE MARK AS SHOWN.

FOR FISHING LURES (U.S. CLS. 22, 23, 38 AND 50).

H. M. FISHER, EXAMINING ATTORNEY

SN 85-523,247. DIBOS, NICOLE, SAN MARCOS, CA. FILED 1-23-2012.

Holy Up, Catholic Memory Game

THE MARK CONSISTS OF STANDARD CHARACTERS WITHOUT CLAIM TO ANY PARTICULAR FONT, STYLE, SIZE, OR COLOR.

NO CLAIM IS MADE TO THE EXCLUSIVE RIGHT TO USE "CATHOLIC MEMORY GAME", APART FROM THE MARK AS SHOWN.

FOR MEMORY GAMES (U.S. CLS. 22, 23, 38 AND 50).

KAREN K. BUSH, EXAMINING ATTORNEY

CLASS 28—(Continued).

SN 85-524,555. ARES GAMES S.R.L., CAPEZZANO PIA-NORE, ITALY, FILED 1-25-2012.

Sails of Glory

THE MARK CONSISTS OF STANDARD CHARACTERS WITHOUT CLAIM TO ANY PARTICULAR FONT, STYLE, SIZE, OR COLOR.

FOR BOARD GAMES; CARD GAMES; GAME CARDS; GAME TABLES; PLAYING PIECES IN THE NATURE OF MINIATURE ACTION FIGURES AND TOY MODEL VEHICLES FOR USE WITH TABLE TOP HOBBY BATTLE GAMES IN THE NATURE OF BATTLE, WAR AND SKIRMISH GAMES, AND FANTASY GAMES; PROMOTIONAL GAME MATERIALS; ROLE PLAYING GAMES; SCALE MODEL VEHICLES; TABLETOP GAMES; TABLETOP HOBBY BATTLE GAMES IN THE NATURE OF BATTLE, WAR AND SKIRMISH GAMES, AND FANTASY GAMES, AND PLAYING EQUIPMENT SOLD AS A UNIT THEREWITH (U.S. CLS. 22, 23, 38 AND 50).

DEBORAH LOBO, EXAMINING ATTORNEY

SN 85-526,833. STRETCHSCORE INC., WILMINGTON, DE. FILED 1-27-2012.

Stretchscore

THE MARK CONSISTS OF STANDARD CHARACTERS WITHOUT CLAIM TO ANY PARTICULAR FONT, STYLE, SIZE, OR COLOR.

FOR PHYSICAL FITNESS EQUIPMENT, NAMELY, FLEXIBILITY EVALUATION AND TREATMENT DEVICE CONSISTING OF A HANDLE, SUPPORT AND CONNECTING STRAP USED FOR STRETCHING THAT PROVIDES AN EXTREMITY FLEXIBILITY NUMBER (U.S. CLS. 22, 23, 38 AND 50).

CAROLYN CATALDO, EXAMINING ATTORNEY

CLASS 28—(Continued).

SN 85-527,697. FOX, MARY, AIKEN, SC. FILED 1-27-2012.



NO CLAIM IS MADE TO THE EXCLUSIVE RIGHT TO USE "BEARS", APART FROM THE MARK AS SHOWN.

THE STIPPLING IS FOR SHADING PURPOSES ONLY.

THE MARK CONSISTS OF TWO TEDDY BEARS. ONE IS STANDING ON TOP OF THE OTHER ONE AND HOLDING A SIGN THAT READS "HOLLY-KINS". BELOW THERE IS THE STYLIZED TEXT "BEARS".

FOR STUFFED TEDDY BEARS (U.S. CLS. 22, 23, 38 AND 50).

FIRST USE 12-8-1997; IN COMMERCE 12-8-1997.

SAIMA MAKHDOOM, EXAMINING ATTORNEY

SN 85-529,108. COLLINS, SUZANNE, SANDY HOOK, CT. FILED 1-30-2012.

PEETA MELLARK

THE MARK CONSISTS OF STANDARD CHARACTERS WITHOUT CLAIM TO ANY PARTICULAR FONT, STYLE, SIZE, OR COLOR.

THE NAME "PEETA MELLARK" DOES NOT IDENTIFY A LIVING INDIVIDUAL.

FOR TARGET GAMES, BOARD GAMES AND CARD GAMES, KITES, TOY ACTION FIGURES, DISC-TYPE TOSS TOYS, BOWS AND ARROWS, BALLS OF ALL KINDS, DOLLS, DOLL PLAY SETS, PLUSH TOYS, TOY VEHICLES, TOY BUCKET AND SHOVEL SETS, ROLLER SKATES, TOY MODEL HOBBY CRAFT KITS, TOY ROCKETS, TOY GUNS, TOY HOLSTERS, MUSICAL TOYS, JIGSAW PUZZLES, BADMINTON SETS, BUBBLE MAKING WANDS AND SOLUTION SETS, MODELED TOY FIGURINES, TOY BANKS, PUPPETS, TOY BALLOONS, YO-YOS, SKATEBOARDS, TOY SCOOTERS, FACE MASKS, STAND ALONE VIDEO GAME MACHINES, LCD GAME MACHINES; HAND HELD UNIT FOR PLAYING ELECTRONIC GAMES OTHER THAN THOSE ADAPTED FOR USE WITH AN EXTERNAL DISPLAY SCREEN OR MONITOR BUT SPECIFICALLY EXCLUDING DICE GAMES AND COMPUTER SOFTWARE GAMES, LOTTERY TICKETS AND SCRATCH CARDS FOR PLAYING LOTTERY GAMES; CONFETTI; COIN-OPERATED AMUSEMENT MACHINES, PLAYING CARDS, PAPER PARTY HATS (U.S. CLS. 22, 23, 38 AND 50).

THEODORE MCBRIDE, EXAMINING ATTORNEY

CLASS 28—(Continued).

SN 85-529,350. WICKED BEAN, LLC, PONTE VEDRA BEACH, FL. FILED 1-31-2012.

Wicked Bean

THE MARK CONSISTS OF STANDARD CHARACTERS WITHOUT CLAIM TO ANY PARTICULAR FONT, STYLE, SIZE, OR COLOR.

FOR SURFBOARD WAX (U.S. CLS. 22, 23, 38 AND 50).
LOURDES AYALA, EXAMINING ATTORNEY

SN 85-530,308. IGT, RENO, NV. FILED 1-31-2012.

ASPEN GOLD

THE MARK CONSISTS OF STANDARD CHARACTERS WITHOUT CLAIM TO ANY PARTICULAR FONT, STYLE, SIZE, OR COLOR.

FOR GAMING MACHINES, NAMELY, DEVICES WHICH ACCEPT A WAGER (U.S. CLS. 22, 23, 38 AND 50).

ERIN FALK, EXAMINING ATTORNEY

SN 85-530,599. KING SHOW GAMES, INC., MINNETONKA, MN. FILED 2-1-2012.

JADE EMPRESS

THE MARK CONSISTS OF STANDARD CHARACTERS WITHOUT CLAIM TO ANY PARTICULAR FONT, STYLE, SIZE, OR COLOR.

FOR ELECTRONIC GAMING MACHINES, NAMELY, DEVICES WHICH ACCEPT A WAGER; GAMING DEVICES, NAMELY, GAMING MACHINES, SLOT MACHINES, BINGO MACHINES, WITH OR WITHOUT VIDEO OUTPUT; GAMING EQUIPMENT, NAMELY, SLOT MACHINES WITH OR WITHOUT VIDEO OUTPUT; GAMING MACHINES; GAMING MACHINES FEATURING A DEVICE THAT ACCEPTS WAGERS; GAMING MACHINES INCLUDING SLOT MACHINES OR VIDEO LOTTERY TERMINALS; GAMING MACHINES THAT GENERATE OR DISPLAY WAGER OUTCOMES; GAMING MACHINES, NAMELY SLOT MACHINES AND VIDEO LOTTERY TERMINALS; GAMING MACHINES, NAMELY, DEVICES WHICH ACCEPT A WAGER; GAMING MACHINES, NAMELY, ELECTRONIC SLOT AND BINGO MACHINES (U.S. CLS. 22, 23, 38 AND 50).

MORGAN WYNNE, EXAMINING ATTORNEY

CLASS 28—(Continued).

SN 85-530,610. KING SHOW GAMES, INC., MINNETONKA, MN. FILED 2-1-2012.

FIRE PEARL

THE MARK CONSISTS OF STANDARD CHARACTERS WITHOUT CLAIM TO ANY PARTICULAR FONT, STYLE, SIZE, OR COLOR.

FOR GAMING DEVICES, NAMELY, GAMING MACHINES, SLOT MACHINES, BINGO MACHINES, WITH OR WITHOUT VIDEO OUTPUT; GAMING EQUIPMENT, NAMELY, SLOT MACHINES WITH OR WITHOUT VIDEO OUTPUT; GAMING MACHINES FEATURING A DEVICE THAT ACCEPTS WAGERS; GAMING MACHINES INCLUDING SLOT MACHINES OR VIDEO LOTTERY TERMINALS; GAMING MACHINES THAT GENERATE OR DISPLAY WAGER OUTCOMES; GAMING MACHINES, NAMELY SLOT MACHINES AND VIDEO LOTTERY TERMINALS; GAMING MACHINES, NAMELY, DEVICES WHICH ACCEPT A WAGER; GAMING MACHINES, NAMELY, ELECTRONIC SLOT AND BINGO MACHINES (U.S. CLS. 22, 23, 38 AND 50).

MORGAN WYNNE, EXAMINING ATTORNEY

CLASS 28—(Continued).

SN 85-531,734. ARMORED FITNESS EQUIPMENT, LLC, PLANO, TX. FILED 2-2-2012.

XPO-Sled

THE MARK CONSISTS OF STANDARD CHARACTERS WITHOUT CLAIM TO ANY PARTICULAR FONT, STYLE, SIZE, OR COLOR.

FOR PHYSICAL FITNESS EQUIPMENT, NAMELY, POWER SLEDS (U.S. CLS. 22, 23, 38 AND 50).

LAURIE MAYES, EXAMINING ATTORNEY

SN 85-530,996. HOWARD PET PRODUCTS LLC, LANDING, NJ. FILED 2-1-2012.

KETTLEDOG

THE MARK CONSISTS OF STANDARD CHARACTERS WITHOUT CLAIM TO ANY PARTICULAR FONT, STYLE, SIZE, OR COLOR.

FOR PET TOYS (U.S. CLS. 22, 23, 38 AND 50).

GIANCARLO CASTRO, EXAMINING ATTORNEY

SN 85-531,784. ELIE TAHARI, MILLBURN, NJ. FILED 2-2-2012.

TAHARI

THE MARK CONSISTS OF STANDARD CHARACTERS WITHOUT CLAIM TO ANY PARTICULAR FONT, STYLE, SIZE, OR COLOR.

OWNER OF U.S. REG. NOS. 1,489,405, 2,681,767 AND OTHERS.

FOR CHRISTMAS TREE ORNAMENTS AND DECORATIONS (U.S. CLS. 22, 23, 38 AND 50).

JEFFREY LOOK, EXAMINING ATTORNEY

SN 85-531,387. LAMKIN CORPORATION, SAN DIEGO, CA. FILED 2-1-2012.

CROSSLINE

THE MARK CONSISTS OF STANDARD CHARACTERS WITHOUT CLAIM TO ANY PARTICULAR FONT, STYLE, SIZE, OR COLOR.

OWNER OF U.S. REG. NO. 2,196,076.

FOR GOLF GRIPS, NAMELY, HAND GRIPS FOR GOLF CLUBS (U.S. CLS. 22, 23, 38 AND 50).

FIRST USE 6-1-1997; IN COMMERCE 6-1-1997.

MORGAN WYNNE, EXAMINING ATTORNEY

SN 85-532,068. KENYA'S WORLD, LLC., SHAKOPEE, MN. FILED 2-2-2012.

KEYSHIA

THE MARK CONSISTS OF STANDARD CHARACTERS WITHOUT CLAIM TO ANY PARTICULAR FONT, STYLE, SIZE, OR COLOR.

FOR DOLLS AND ACCESSORIES THEREFOR (U.S. CLS. 22, 23, 38 AND 50).

MATTHEW KLINE, EXAMINING ATTORNEY

CLASS 28—(Continued).

SN 85-532,169. MULTIMEDIA GAMES, INC., AUSTIN, TX.
FILED 2-2-2012.

ELIXIR

THE MARK CONSISTS OF STANDARD CHARACTERS WITHOUT CLAIM TO ANY PARTICULAR FONT, STYLE, SIZE, OR COLOR.

FOR GAMING MACHINES THAT GENERATE OR DISPLAY WAGER OUTCOMES; GAMING MACHINES, NAMELY, ELECTRONIC SLOT AND BINGO MACHINES (U.S. CLS. 22, 23, 38 AND 50).

PRISCILLA MILTON, EXAMINING ATTORNEY

CLASS 28—(Continued).

SN 85-532,650. CLARK, RANDY, STRATHMORE, CA. FILED
2-2-2012.

BATTLE LIGHTS

THE MARK CONSISTS OF STANDARD CHARACTERS WITHOUT CLAIM TO ANY PARTICULAR FONT, STYLE, SIZE, OR COLOR.

FOR TOYS IN THE NATURE OF DRAWING TOYS THAT USE ELECTROMAGNETIC RADIATION SOURCES TO WRITE ON SPECIALIZED SURFACES AND COATINGS (U.S. CLS. 22, 23, 38 AND 50).

TRACY FLETCHER, EXAMINING ATTORNEY

SN 85-532,453. DOVE, WILLIAM MARK, ELBERTON, GA.
FILED 2-2-2012.

Pentapus

THE MARK CONSISTS OF STANDARD CHARACTERS WITHOUT CLAIM TO ANY PARTICULAR FONT, STYLE, SIZE, OR COLOR.

FOR ARTIFICIAL FISHING LURES; FISHING LURES (U.S. CLS. 22, 23, 38 AND 50).

BARBARA A. GOLD, EXAMINING ATTORNEY

SN 85-532,674. CLARK, RANDY, STRATHMORE, CA. FILED
2-2-2012.

FIGHT WITH LIGHT

THE MARK CONSISTS OF STANDARD CHARACTERS WITHOUT CLAIM TO ANY PARTICULAR FONT, STYLE, SIZE, OR COLOR.

FOR TOYS IN THE NATURE OF DRAWING TOYS THAT USE ELECTROMAGNETIC RADIATION SOURCES TO WRITE ON SPECIALIZED SURFACES AND COATINGS (U.S. CLS. 22, 23, 38 AND 50).

TRACY FLETCHER, EXAMINING ATTORNEY

SN 85-532,558. EXCELL MARKETING, L.C., DES MOINES,
IA. FILED 2-2-2012.

Zombie Pets

THE MARK CONSISTS OF STANDARD CHARACTERS WITHOUT CLAIM TO ANY PARTICULAR FONT, STYLE, SIZE, OR COLOR.

NO CLAIM IS MADE TO THE EXCLUSIVE RIGHT TO USE "PETS", APART FROM THE MARK AS SHOWN.

FOR MODELED PLASTIC TOY FIGURINES; MOLDED TOY FIGURES; SOFT SCULPTURE PLUSH TOYS (U.S. CLS. 22, 23, 38 AND 50).

PAM WILLIS, EXAMINING ATTORNEY

SN 85-532,723. WINNMEDIA, LLC, LEXINGTON, KY. FILED
2-2-2012.

Colt

THE MARK CONSISTS OF STANDARD CHARACTERS WITHOUT CLAIM TO ANY PARTICULAR FONT, STYLE, SIZE, OR COLOR.

FOR POMMEL HORSES, NAMELY, REDUCED-SIZED POMMEL HORSES FOR PRACTICE AND TRAINING PURPOSES IN THE FIELD OF GYMNASTICS (U.S. CLS. 22, 23, 38 AND 50).

JUDITH HELFMAN, EXAMINING ATTORNEY

CLASS 28—(Continued).

SN 85-532,764. PATRICK O'TOOLE, BROOMFIELD, CO.
FILED 2-2-2012.

SKATE START

THE MARK CONSISTS OF STANDARD CHARACTERS WITHOUT CLAIM TO ANY PARTICULAR FONT, STYLE, SIZE, OR COLOR.

NO CLAIM IS MADE TO THE EXCLUSIVE RIGHT TO USE "SKATE", APART FROM THE MARK AS SHOWN.

FOR SKATEBOARDS (U.S. CLS. 22, 23, 38 AND 50).
JENNIFER RICHARDSON, EXAMINING ATTORNEY

SN 85-532,796. HOLMAN, CASSANDRA, SYRACUSE, NY.
FILED 2-2-2012.

Good toys make good people

THE MARK CONSISTS OF STANDARD CHARACTERS WITHOUT CLAIM TO ANY PARTICULAR FONT, STYLE, SIZE, OR COLOR.

FOR BENDABLE TOYS; CASES FOR TOY STRUCTURES; CHILDREN'S MULTIPLE ACTIVITY TOYS; TOY BUILDING BLOCKS; TOY BUILDING BLOCKS CAPABLE OF INTERCONNECTION; TOY BUILDING STRUCTURES AND TOY VEHICLE TRACKS; TOY CONSTRUCTION BLOCKS; TOY CONSTRUCTION SETS; TOY SETS OF CARPENTERS' TOOLS; TOY TOOLS (U.S. CLS. 22, 23, 38 AND 50).

FIRST USE 8-3-2009; IN COMMERCE 8-3-2009.
HENRY S. ZAK, EXAMINING ATTORNEY

CLASS 28—(Continued).

SN 85-532,894. KING SHOW GAMES, INC., MINNETONKA, MN. FILED 2-3-2012.

FISHING BOB

THE MARK CONSISTS OF STANDARD CHARACTERS WITHOUT CLAIM TO ANY PARTICULAR FONT, STYLE, SIZE, OR COLOR.

THE NAME(S), PORTRAIT(S), AND/OR SIGNATURE(S) SHOWN IN THE MARK DOES NOT IDENTIFY A PARTICULAR LIVING INDIVIDUAL.

FOR ELECTRONIC GAMING MACHINES, NAMELY, DEVICES WHICH ACCEPT A WAGER; GAMING DEVICES, NAMELY, GAMING MACHINES, SLOT MACHINES, BINGO MACHINES, WITH OR WITHOUT VIDEO OUTPUT; GAMING EQUIPMENT, NAMELY, SLOT MACHINES WITH OR WITHOUT VIDEO OUTPUT; GAMING MACHINES; GAMING MACHINES FEATURING A DEVICE THAT ACCEPTS WAGERS; GAMING MACHINES INCLUDING SLOT MACHINES OR VIDEO LOTTERY TERMINALS; GAMING MACHINES THAT GENERATE OR DISPLAY WAGER OUTCOMES; GAMING MACHINES, NAMELY SLOT MACHINES AND VIDEO LOTTERY TERMINALS; GAMING MACHINES, NAMELY, DEVICES WHICH ACCEPT A WAGER; GAMING MACHINES, NAMELY, ELECTRONIC SLOT AND BINGO MACHINES (U.S. CLS. 22, 23, 38 AND 50).

MORGAN WYNNE, EXAMINING ATTORNEY

SN 85-533,207. BARNETT OUTDOORS, LLC, TARPON SPRINGS, FL. FILED 2-3-2012.

ZOMBIE

THE MARK CONSISTS OF STANDARD CHARACTERS WITHOUT CLAIM TO ANY PARTICULAR FONT, STYLE, SIZE, OR COLOR.

FOR CROSSBOWS (U.S. CLS. 22, 23, 38 AND 50).

MARIA-VICTORIA SUAREZ, EXAMINING ATTORNEY

SN 85-533,223. BARNETT OUTDOORS, LLC, TARPON SPRINGS, FL. FILED 2-3-2012.

VILLAIN

THE MARK CONSISTS OF STANDARD CHARACTERS WITHOUT CLAIM TO ANY PARTICULAR FONT, STYLE, SIZE, OR COLOR.

FOR ARCHERY EQUIPMENT, NAMELY, BROADHEADS; CROSSBOWS (U.S. CLS. 22, 23, 38 AND 50).

MARIA-VICTORIA SUAREZ, EXAMINING ATTORNEY

CLASS 28—(Continued).

SN 85-533,631. JET IMPORTS LLC, OTTUMWA, IA. FILED 2-3-2012.

COOLJET

THE MARK CONSISTS OF STANDARD CHARACTERS WITHOUT CLAIM TO ANY PARTICULAR FONT, STYLE, SIZE, OR COLOR.

FOR TENNIS BAGS (U.S. CLS. 22, 23, 38 AND 50).
ANDREA K. NADELMAN, EXAMINING ATTORNEY

SN 85-534,239. CUSTOM LEATHERCRAFT MANUFACTURING CO., INC., SOUTH GATE, CA. FILED 2-5-2012.

**THINK OUTSIDE THE TACKLE
BOX**

THE MARK CONSISTS OF STANDARD CHARACTERS WITHOUT CLAIM TO ANY PARTICULAR FONT, STYLE, SIZE, OR COLOR.

FOR FISHING TACKLE BAGS; FISHING TACKLE BOXES; FISHING TACKLE CONTAINERS; SPORTSMAN'S FISHING BAGS (U.S. CLS. 22, 23, 38 AND 50).
JAMES A. RAUEN, EXAMINING ATTORNEY

SN 85-534,447. GEOFFREY, LLC, WAYNE, NJ. FILED 2-6-2012.

HAIRMONIES

THE MARK CONSISTS OF STANDARD CHARACTERS WITHOUT CLAIM TO ANY PARTICULAR FONT, STYLE, SIZE, OR COLOR.

FOR MUSICAL DOLLS AND DOLL ACCESSORIES, DOLL HAIR BRUSHES AND TOY MUSICAL INSTRUMENTS (U.S. CLS. 22, 23, 38 AND 50).
WILLIAM VERHOSEK, EXAMINING ATTORNEY

CLASS 28—(Continued).

SN 85-534,656. KASWIT, INC., LA QUINTA, CA. FILED 2-6-2012.

PILATES POWER GYM PRO

THE MARK CONSISTS OF STANDARD CHARACTERS WITHOUT CLAIM TO ANY PARTICULAR FONT, STYLE, SIZE, OR COLOR.

OWNER OF U.S. REG. NO. 3,486,169.
NO CLAIM IS MADE TO THE EXCLUSIVE RIGHT TO USE "PILATES" AND "GYM", APART FROM THE MARK AS SHOWN.

FOR EXERCISE MACHINES; MANUALLY-OPERATED EXERCISE EQUIPMENT (U.S. CLS. 22, 23, 38 AND 50).

JAMES MACFARLANE, EXAMINING ATTORNEY

SN 85-534,815. HONG KONG CITY TOYS FACTORY LIMITED, CANTON ROAD, KOWLOON, HONG KONG, FILED 2-6-2012.

HAIRPLAY

THE MARK CONSISTS OF STANDARD CHARACTERS WITHOUT CLAIM TO ANY PARTICULAR FONT, STYLE, SIZE, OR COLOR.

FOR DOLLS, DOLL CLOTHING, DOLL PLAYSETS AND DOLL ACCESSORIES (U.S. CLS. 22, 23, 38 AND 50).
BILL DAWE, EXAMINING ATTORNEY

SN 85-535,165. ARISTOCRAT TECHNOLOGIES AUSTRALIA PTY LTD, NORTH RYDE, NSW, AUSTRALIA, FILED 2-6-2012.

AFRICAN SAFARI

THE MARK CONSISTS OF STANDARD CHARACTERS WITHOUT CLAIM TO ANY PARTICULAR FONT, STYLE, SIZE, OR COLOR.

OWNER OF U.S. REG. NOS. 3,470,266 AND 3,563,181.
FOR ELECTRONIC GAMING MACHINES, NAMELY, DEVICES WHICH ACCEPT A WAGER (U.S. CLS. 22, 23, 38 AND 50).
JOHN SCHUYLER YARD, EXAMINING ATTORNEY

CLASS 28—(Continued).

SN 85-535,201. LUCKY CRAFT CO., LTD., OYABE-SHI, TOYAMA, JAPAN, FILED 2-6-2012.

ROSIE

THE MARK CONSISTS OF STANDARD CHARACTERS WITHOUT CLAIM TO ANY PARTICULAR FONT, STYLE, SIZE, OR COLOR.
FOR FISHING LURES (U.S. CLS. 22, 23, 38 AND 50).
GISELLE AGOSTO, EXAMINING ATTORNEY

SN 85-535,630. FANTASMA TOYS, INC., NEW YORK, NY. FILED 2-7-2012.

TEXT ZEP

THE MARK CONSISTS OF STANDARD CHARACTERS WITHOUT CLAIM TO ANY PARTICULAR FONT, STYLE, SIZE, OR COLOR.
FOR RADIO CONTROLLED TOY VEHICLES (U.S. CLS. 22, 23, 38 AND 50).
JUHI KAVEESHVAR, EXAMINING ATTORNEY

SN 85-535,755. JEROME GEATHERS, HUNTERSVILLE, NC. FILED 2-7-2012.

J-LuckBears

THE MARK CONSISTS OF STANDARD CHARACTERS WITHOUT CLAIM TO ANY PARTICULAR FONT, STYLE, SIZE, OR COLOR.
FOR STUFFED DOLLS AND ANIMALS (U.S. CLS. 22, 23, 38 AND 50).
FIRST USE 1-16-2011; IN COMMERCE 9-22-2011.
JIM RINGLE, EXAMINING ATTORNEY

CLASS 28—(Continued).

SN 85-535,910. RUSTY SLUSSER, VAN NUYS, CA. FILED 2-7-2012.

Rusty Slusser

THE MARK CONSISTS OF STANDARD CHARACTERS WITHOUT CLAIM TO ANY PARTICULAR FONT, STYLE, SIZE, OR COLOR.
THE NAME(S), PORTRAIT(S), AND/OR SIGNATURE(S) SHOWN IN THE MARK IDENTIFIES "RUSTY SLUSSER", WHOSE CONSENT(S) TO REGISTER IS MADE OF RECORD.
FOR CARNIVAL MASKS; COSTUME MASKS; FACE MASKS; THEATRICAL MASKS; TOY AND NOVELTY FACE MASKS; TOY MASKS (U.S. CLS. 22, 23, 38 AND 50).
DANIEL CAPSHAW, EXAMINING ATTORNEY

SN 85-536,227. REQUISITE SOLUTIONS INC., CHICAGO, IL. FILED 2-7-2012.

Piece Out

THE MARK CONSISTS OF STANDARD CHARACTERS WITHOUT CLAIM TO ANY PARTICULAR FONT, STYLE, SIZE, OR COLOR.
FOR MANIPULATIVE TOYS, NAMELY, PUZZLES FOR CHILDREN AND/OR ADULTS (U.S. CLS. 22, 23, 38 AND 50).
KRISTIN DAHLING, EXAMINING ATTORNEY

SN 85-536,233. CELEBRITY PET TOYS CO. LTD., PIEDMONT, SD. FILED 2-7-2012.

LET US ENTERTAIN YOU AND YOUR PET

THE MARK CONSISTS OF STANDARD CHARACTERS WITHOUT CLAIM TO ANY PARTICULAR FONT, STYLE, SIZE, OR COLOR.
FOR TOYS FOR PETS (U.S. CLS. 22, 23, 38 AND 50).
DEZMONA MIZELLE, EXAMINING ATTORNEY

CLASS 28—(Continued).

SN 85-536,330. BARNETT OUTDOORS, LLC, TARPON SPRINGS, FL. FILED 2-7-2012.

TOMCAT

THE MARK CONSISTS OF STANDARD CHARACTERS WITHOUT CLAIM TO ANY PARTICULAR FONT, STYLE, SIZE, OR COLOR.
FOR ARCHERY BOWS (U.S. CLS. 22, 23, 38 AND 50).
MARIA-VICTORIA SUAREZ, EXAMINING ATTORNEY

CLASS 28—(Continued).

SN 85-536,839. MATTEL, INC., EL SEGUNDO, CA. FILED 2-8-2012.

SECRET MISSION

THE MARK CONSISTS OF STANDARD CHARACTERS WITHOUT CLAIM TO ANY PARTICULAR FONT, STYLE, SIZE, OR COLOR.
FOR TOY VEHICLES AND ACCESSORIES THEREFOR; TOY VEHICLE PLAYSETS AND ACCESSORIES THEREFOR (U.S. CLS. 22, 23, 38 AND 50).
CAROLYN CATALDO, EXAMINING ATTORNEY

SN 85-536,702. THE UNITED STATES PLAYING CARD COMPANY, ERLANGER, KY. FILED 2-8-2012.

Maiden Back

THE MARK CONSISTS OF STANDARD CHARACTERS WITHOUT CLAIM TO ANY PARTICULAR FONT, STYLE, SIZE, OR COLOR.
FOR PLAYING CARDS (U.S. CLS. 22, 23, 38 AND 50).
ANDREA K. NADELMAN, EXAMINING ATTORNEY

SN 85-536,841. MATTEL, INC., EL SEGUNDO, CA. FILED 2-8-2012.

THE MIGHTY SPECTOR

THE MARK CONSISTS OF STANDARD CHARACTERS WITHOUT CLAIM TO ANY PARTICULAR FONT, STYLE, SIZE, OR COLOR.
FOR TOY ACTION FIGURES AND ACCESSORIES THEREFOR (U.S. CLS. 22, 23, 38 AND 50).
FIRST USE 5-15-2012; IN COMMERCE 5-15-2012.
CAROLYN CATALDO, EXAMINING ATTORNEY

SN 85-536,811. RAWLINGS SPORTING GOODS COMPANY, INC., ST LOUIS, MO. FILED 2-8-2012.

PROTEGE

THE MARK CONSISTS OF STANDARD CHARACTERS WITHOUT CLAIM TO ANY PARTICULAR FONT, STYLE, SIZE, OR COLOR.
FOR SPORTING GOODS, NAMELY BASEBALL BATS; SOFTBALL BATS (U.S. CLS. 22, 23, 38 AND 50).
CAROLYN CATALDO, EXAMINING ATTORNEY

SN 85-536,843. MATTEL, INC., EL SEGUNDO, CA. FILED 2-8-2012.

ROVER DRIVER

THE MARK CONSISTS OF STANDARD CHARACTERS WITHOUT CLAIM TO ANY PARTICULAR FONT, STYLE, SIZE, OR COLOR.
FOR TOY VEHICLES AND ACCESSORIES THEREFOR (U.S. CLS. 22, 23, 38 AND 50).
CAROLYN CATALDO, EXAMINING ATTORNEY

CLASS 28—(Continued).

SN 85-536,846. MATTEL, INC., EL SEGUNDO, CA. FILED 2-8-2012.

PAZETTE

THE MARK CONSISTS OF STANDARD CHARACTERS WITHOUT CLAIM TO ANY PARTICULAR FONT, STYLE, SIZE, OR COLOR.

FOR DOLLS, DOLL CLOTHING AND DOLL ACCESSORIES (U.S. CLS. 22, 23, 38 AND 50).

CAROLYN CATALDO, EXAMINING ATTORNEY

CLASS 28—(Continued).

SN 85-537,450. RIEDELL SHOES, INC., RED WING, MN. FILED 2-8-2012.

RECKLESS

THE MARK CONSISTS OF STANDARD CHARACTERS WITHOUT CLAIM TO ANY PARTICULAR FONT, STYLE, SIZE, OR COLOR.

FOR ROLLER SKATE WHEELS (U.S. CLS. 22, 23, 38 AND 50).

FIRST USE 7-21-2011; IN COMMERCE 7-21-2011.

CHRISTINE MARTIN, EXAMINING ATTORNEY

SN 85-536,847. MATTEL, INC., EL SEGUNDO, CA. FILED 2-8-2012.

GIRLS' NIGHT IN!

THE MARK CONSISTS OF STANDARD CHARACTERS WITHOUT CLAIM TO ANY PARTICULAR FONT, STYLE, SIZE, OR COLOR.

FOR DOLLS, DOLL CLOTHING AND DOLL ACCESSORIES; DOLL FURNITURE AND ACCESSORIES THEREFOR (U.S. CLS. 22, 23, 38 AND 50).

CAROLYN CATALDO, EXAMINING ATTORNEY

SN 85-537,489. ALTMAN, EDWARD, PARADISE VALLEY, AZ. FILED 2-8-2012.

Bad Santa

SN 85-537,200. PLAYCHANGER, LLC, LA QUINTA, CA. FILED 2-8-2012.

JENI'S OPEN HOUSE

THE MARK CONSISTS OF STANDARD CHARACTERS WITHOUT CLAIM TO ANY PARTICULAR FONT, STYLE, SIZE, OR COLOR.

NO CLAIM IS MADE TO THE EXCLUSIVE RIGHT TO USE "HOUSE", APART FROM THE MARK AS SHOWN.

THE NAME(S), PORTRAIT(S), AND/OR SIGNATURE(S) SHOWN IN THE MARK DOES NOT IDENTIFY A PARTICULAR LIVING INDIVIDUAL.

FOR DOLL ACCESSORIES; DOLL CLOTHING; DOLL FURNITURE; DOLL HOUSE FURNISHINGS; DOLL HOUSES; DOLLS; DOLLS AND ACCESSORIES THEREFOR; DOLLS AND DOLL ACCESSORIES, NAMELY, CLOTHING FOR DOLLS, DOLL ROOMS, DOLL BEDS, DOLL HOUSES, TOY FABRICS AND LINENS FOR DOLLS AND STROLLERS FOR DOLLS; DOLLS AND DOLLS' CLOTHING; DOLLS AND PLAYSETS THEREFOR; FURNITURE FOR DOLL'S HOUSES; PLAYSETS FOR DOLLS (U.S. CLS. 22, 23, 38 AND 50).

ANDREA HACK, EXAMINING ATTORNEY

THE MARK CONSISTS OF STANDARD CHARACTERS WITHOUT CLAIM TO ANY PARTICULAR FONT, STYLE, SIZE, OR COLOR.

FOR PLAYING CARDS AND CARD GAMES (U.S. CLS. 22, 23, 38 AND 50).

WANDA KAY PRICE, EXAMINING ATTORNEY

CLASS 28—(Continued).

SN 85-537,519. VRSECKY III, ANTHONY JOSEPH, AKA JOEY, WINSTON - SALEM, NC. FILED 2-8-2012.



THE MARK CONSISTS OF THE WORD "BASSTERBAIT" IN STYLIZED FONT, THE FIRST "B" INCORPORATES THE IMAGE OF A FISHING ROD.

FOR ARTIFICIAL FISHING BAIT; ARTIFICIAL FISHING LURES; ARTIFICIAL FISHING WORMS; FISH ATTRACTANTS; FISH HOOK REMOVERS; FISH HOOKS; FISHING AID WHICH SINKS TO THE BOTTOM OF ANY BODY OF WATER IN WHICH IT IS PLACED AND STANDS VERTICALLY FROM THE BOTTOM WITH FISH LINE ATTACHED A FEW INCHES FROM THE HOOK INTENDED TO CATCH THE FISH; FISHING BAIT HOLDER; FISHING EQUIPMENT, NAMELY, FISHING LURE RETRIEVER; FISHING FLIES; FISHING FLOATS; FISHING FLY BOXES; FISHING HOOKS; FISHING LEADERS; FISHING LINES; FISHING LURE BOXES; FISHING LURE PARTS; FISHING LURES; FISHING LURES, NAMELY, LEECHES; FISHING LURES, NAMELY, PLASTIC WORMS; FISHING LURES, NAMELY, SPOONS; FISHING PLUGS; FISHING POLE HOLDERS WORN ON THE BODY; FISHING POLES; FISHING ROD BLANKS; FISHING ROD CASES; FISHING ROD HANDLES; FISHING ROD HOLDERS; FISHING ROD RACKS; FISHING RODS; FISHING SINKERS; FISHING SPINNERS; FISHING TACKLE; FISHING TACKLE BAGS; FISHING TACKLE BOXES; FISHING TACKLE CONTAINERS; FISHING TACKLE, NAMELY, BOBBERS; FISHING TACKLE, NAMELY, LIGHTED BOBBERS; FISHING WEIGHTS; FLIES FOR USE IN FISHING; FLOATS FOR FISHING; HAND-HELD FISHING NETS; HAND-HELD FISHING NETS FOR SPORTSMEN; INFLATABLE FLOAT TUBES FOR FISHING; LEADER ORGANIZERS, NAMELY, BAGS SPECIALLY ADAPTED FOR FISHING LEADERS; LINES FOR FISHING; LURES FOR FISHING; LURES FOR HUNTING OR FISHING; RODS FOR FISHING; SCENT LURES FOR HUNTING OR FISHING; SPORTSMAN'S FISHING BAGS; TERMINAL TACKLE (U.S. CLS. 22, 23, 38 AND 50).

FLORENTINA BLANDU, EXAMINING ATTORNEY

SN 85-537,968. UNCLE LEO LLC., MERRICK, NY. FILED 2-9-2012.

THE STATUS QUO STINKS

THE MARK CONSISTS OF STANDARD CHARACTERS WITHOUT CLAIM TO ANY PARTICULAR FONT, STYLE, SIZE, OR COLOR.

FOR STUFFED AND PLUSH TOYS (U.S. CLS. 22, 23, 38 AND 50).

JENNY PARK, EXAMINING ATTORNEY

CLASS 28—(Continued).

SN 85-537,976. ANOMIA PRESS LLC, ROSLINDALE, MA. FILED 2-9-2012.



THE MARK CONSISTS OF STANDARD CHARACTERS WITHOUT CLAIM TO ANY PARTICULAR FONT, STYLE, SIZE, OR COLOR.

FOR CARD GAMES; PLAYING CARDS AND CARD GAMES (U.S. CLS. 22, 23, 38 AND 50).

FIRST USE 11-12-2009; IN COMMERCE 11-12-2009. DEIRDRE ROBERTSON, EXAMINING ATTORNEY

SN 85-537,984. UNCLE LEO LLC, MERRICK, NY. FILED 2-9-2012.

THE STATUS QUO MUST GO

THE MARK CONSISTS OF STANDARD CHARACTERS WITHOUT CLAIM TO ANY PARTICULAR FONT, STYLE, SIZE, OR COLOR.

FOR STUFFED AND PLUSH TOYS (U.S. CLS. 22, 23, 38 AND 50).

JENNY PARK, EXAMINING ATTORNEY

SN 85-538,109. ANOMIA PRESS LLC, ROSLINDALE, MA. FILED 2-9-2012.



THE MARK CONSISTS OF STANDARD CHARACTERS WITHOUT CLAIM TO ANY PARTICULAR FONT, STYLE, SIZE, OR COLOR.

FOR CARD GAMES; PLAYING CARDS AND CARD GAMES (U.S. CLS. 22, 23, 38 AND 50).

DEIRDRE ROBERTSON, EXAMINING ATTORNEY

CLASS 28—(Continued).

SN 85-538,460. FROGGER, LLC, SAN MATEO, CA. FILED 2-9-2012.

ARC ANGEL

THE MARK CONSISTS OF STANDARD CHARACTERS WITHOUT CLAIM TO ANY PARTICULAR FONT, STYLE, SIZE, OR COLOR.

FOR GOLF TRAINING APPARATUS, NAMELY, DEVICES USED TO HELP GROOVE A REPETITIVE PUTTING STROKE (U.S. CLS. 22, 23, 38 AND 50).

SOPHIA S. KIM, EXAMINING ATTORNEY

CLASS 28—(Continued).

SN 85-539,433. BARNETT OUTDOORS, LLC, TARPON SPRINGS, FL. FILED 2-10-2012.

ZOMBIE HUNTER

THE MARK CONSISTS OF STANDARD CHARACTERS WITHOUT CLAIM TO ANY PARTICULAR FONT, STYLE, SIZE, OR COLOR.

FOR ARCHERY BOWS, SLINGSHOTS, BROADHEADS, CROSSBOWS (U.S. CLS. 22, 23, 38 AND 50).

MARIA-VICTORIA SUAREZ, EXAMINING ATTORNEY

SN 85-538,545. MGA ENTERTAINMENT, INC., VAN NUYS, CA. FILED 2-9-2012.



OWNER OF U.S. REG. NOS. 2,789,216, 3,080,450 AND OTHERS.

THE MARK CONSISTS OF "BRATZILLAZ" POSITIONED OVER "GLAM GET WICKED" ALL WITHIN AN IRREGULARLY SHAPED FRAME.

FOR ACTION FIGURES AND PLAYSETS THEREFOR, ACTION SKILL GAMES, ARCADE GAMES, BALLOONS, BEAN BAG DOLLS, BOARD GAMES, BODY BOARDS, CARD GAMES, CHILDREN'S PLAY COSMETICS, CHRISTMAS TREE ORNAMENTS, EXCEPT CONFECTIONERY OR ILLUMINATION ARTICLES, DOLLS, DOLL CLOTHING, DOLL ACCESSORIES, PLAYING CARDS, PLUSH TOYS, PUPPETS, PUZZLES, TOY ACTION FIGURES AND ACCESSORIES THEREFOR, TOY VEHICLES AND PLAYSETS THEREFOR, AND TOY SCOOTERS (U.S. CLS. 22, 23, 38 AND 50).

JEFF DEFORD, EXAMINING ATTORNEY

SN 85-539,450. BARNETT OUTDOORS, LLC, TARPON SPRINGS, FL. FILED 2-10-2012.

ZOMBIE

THE MARK CONSISTS OF STANDARD CHARACTERS WITHOUT CLAIM TO ANY PARTICULAR FONT, STYLE, SIZE, OR COLOR.

FOR ARCHERY BOWS, SLINGSHOTS, BROADHEADS (U.S. CLS. 22, 23, 38 AND 50).

MARIA-VICTORIA SUAREZ, EXAMINING ATTORNEY

SN 85-538,895. STRONG, JARED, SAN DIEGO, CA. FILED 2-9-2012.

1UPP

THE MARK CONSISTS OF STANDARD CHARACTERS WITHOUT CLAIM TO ANY PARTICULAR FONT, STYLE, SIZE, OR COLOR.

FOR WATERSKIS AND WAKEBOARDS AND THEIR ACCESSORIES, NAMELY, BINDINGS, BRIDLES, CARRYING CASES, GLOVES, HANDLES, TWO ROPES, TOW HARNESSES AND LUBRICANTS (U.S. CLS. 22, 23, 38 AND 50).

COLLEEN KEARNEY, EXAMINING ATTORNEY

SN 85-539,663. BENCHMARK ENTERTAINMENT, L.C., HYPOLUXO, FL. FILED 2-10-2012.

Monster Drop

THE MARK CONSISTS OF STANDARD CHARACTERS WITHOUT CLAIM TO ANY PARTICULAR FONT, STYLE, SIZE, OR COLOR.

FOR AMUSEMENT GAME MACHINES (U.S. CLS. 22, 23, 38 AND 50).

FIRST USE 1-1-2011; IN COMMERCE 1-1-2011.

CHRISTINE MARTIN, EXAMINING ATTORNEY

CLASS 28—(Continued).

SN 85-539,839. BENCHMARK ENTERTAINMENT, L.C., HYPOLUXO, FL. FILED 2-10-2012.

Slam-A-Winner

THE MARK CONSISTS OF STANDARD CHARACTERS WITHOUT CLAIM TO ANY PARTICULAR FONT, STYLE, SIZE, OR COLOR.

FOR AMUSEMENT GAME MACHINES (U.S. CLS. 22, 23, 38 AND 50).

FIRST USE 3-1-2009; IN COMMERCE 3-1-2009.

CHRISTINE MARTIN, EXAMINING ATTORNEY

SN 85-539,866. MIANO, LORRAINE I, WAKE FOREST, NC. AND MIANO, RICHARD A, WAKE FOREST, NC. FILED 2-10-2012.

EarthKins

THE MARK CONSISTS OF STANDARD CHARACTERS WITHOUT CLAIM TO ANY PARTICULAR FONT, STYLE, SIZE, OR COLOR.

FOR DOLL ACCESSORIES; DOLL CLOTHING; DOLL COSTUMES; DOLLS; DOLLS AND ACCESSORIES THEREFOR; DOLLS AND DOLLS' CLOTHING (U.S. CLS. 22, 23, 38 AND 50).

KRISTINA MORRIS, EXAMINING ATTORNEY

SN 85-540,042. IGT, RENO, NV. FILED 2-10-2012.

ENDURING WILDS

THE MARK CONSISTS OF STANDARD CHARACTERS WITHOUT CLAIM TO ANY PARTICULAR FONT, STYLE, SIZE, OR COLOR.

OWNER OF U.S. REG. NOS. 3,471,939, 4,019,959 AND 4,028,724.

FOR A FEATURE OF GAMING MACHINES, NAMELY, DEVICES WHICH ACCEPT A WAGER (U.S. CLS. 22, 23, 38 AND 50).

FIRST USE 11-29-2011; IN COMMERCE 11-29-2011.

ERIN FALK, EXAMINING ATTORNEY

CLASS 28—(Continued).

SN 85-540,107. FRANK, ERSKINE J, DBA RED OUTDOOR EQUIPMENT COMPANY, ANCHORAGE, AK. FILED 2-10-2012.

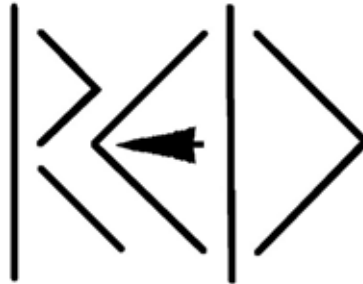

THE MARK CONSISTS OF A STYLIZED VERSION OF THE WORD "RED"; THE CENTER LINE IN THE LETTER "E" IS COMPOSED OF A SIDEWAYS TREE; WHEN THE ENTIRE MARK IS TURNED SIDEWAYS THE WORDING APPEARS TO BE A SIMPLE LANDSCAPE; WITH THE LETTER "R" ACTING AS THE SKY, THE LETTER "E" ACTING AS A MOUNTAIN AND A TREE, AND THE LETTER "D" ACTING AS A SURFACE WITH THE REFLECTION OF THE MOUNTAIN MADE BY THE LETTER "E".

FOR LONGBOARD WHEELS; LONGBOARDS; MONO-SKIS; MOUNTAINEERING AND ROCK CLIMBING EQUIPMENT, NAMELY, CLIMBING CAMS AND ANCHORS MADE OF METAL; MOUNTAINEERING EQUIPMENT, NAMELY, HOOK AND RING COMBINATIONS; ORDINARY PLAYING CARDS; SKATEBOARD DECKS; SKATEBOARD GRIP TAPES; SKATEBOARD RISER PADS; SKATEBOARD TRUCKS; SKATEBOARD WAX; SKATEBOARD WHEELS; SKATEBOARDS; SKI BAGS; SKI BINDINGS; SKI BINDINGS AND PARTS THEREFOR; SKI BRAKES; SKI CASES; SKI COVERS; SKI EDGES; SKI POLES; SKI ROPES; SKI SCRAPERS; SKI STICKS; SKI WAX; SKIS; SNOW BOARDS; SNOW SKIS; SNOWBOARD BINDINGS; SNOWBOARD DECKS; SNOWBOARD WAX; SNOWBOARDS; WAKEBOARDS; WATER SKIS; WATERSKI BINDINGS; WATERSKI BRIDLES; WATERSKI CARRYING CASES; WATERSKI GLOVES; WATERSKI HANDLES; WATERSKI ROPE BRIDLES; WATERSKI ROPE HANDLES; WATERSKI ROPES; WATERSKI TOW HARNESSSES; WATERSKI TOW ROPES; WATERSKIS; WAX FOR SKIS (U.S. CLS. 22, 23, 38 AND 50).

JOHN E. MICHOS, EXAMINING ATTORNEY

SN 85-540,281. NGUYEN, DIANA D. P., WOODBRIDGE, VA. AND NGUYEN, JENNIFER D.P., PENNINGTON, NJ. FILED 2-11-2012.

SNACS by 5 shapes. numbers. alphabet. colors. sounds

THE MARK CONSISTS OF STANDARD CHARACTERS WITHOUT CLAIM TO ANY PARTICULAR FONT, STYLE, SIZE, OR COLOR.

FOR CARD GAMES; EQUIPMENT SOLD AS A UNIT FOR PLAYING A MEMORY GAME; EQUIPMENT SOLD AS A UNIT FOR PLAYING CARD GAMES; GAME CARDS; MANIPULATIVE GAMES; MEMORY GAMES (U.S. CLS. 22, 23, 38 AND 50).

FIRST USE 10-12-2011; IN COMMERCE 2-7-2012.

CHRISTINE MARTIN, EXAMINING ATTORNEY

CLASS 28—(Continued).

SN 85-540,692. BBEC, INC., CLEARLAKE, SD. FILED 2-13-2012.

SO, YOU THINK YOU'RE RIGHT?

THE MARK CONSISTS OF STANDARD CHARACTERS WITHOUT CLAIM TO ANY PARTICULAR FONT, STYLE, SIZE, OR COLOR.
FOR BOARD GAMES (U.S. CLS. 22, 23, 38 AND 50).
CHRISTINE MARTIN, EXAMINING ATTORNEY

SN 85-546,384. IGT, RENO, NV. FILED 2-17-2012.

GOLDEN MEMORIES

THE MARK CONSISTS OF STANDARD CHARACTERS WITHOUT CLAIM TO ANY PARTICULAR FONT, STYLE, SIZE, OR COLOR.
FOR GAMING MACHINES, NAMELY, DEVICES WHICH ACCEPT A WAGER (U.S. CLS. 22, 23, 38 AND 50).
ERIN FALK, EXAMINING ATTORNEY

SN 85-546,827. VTECH ELECTRONICS NORTH AMERICA, LLC, ARLINGTON HEIGHTS, IL. FILED 2-19-2012.

SORT & SING SCHOOL

THE MARK CONSISTS OF STANDARD CHARACTERS WITHOUT CLAIM TO ANY PARTICULAR FONT, STYLE, SIZE, OR COLOR.
FOR BABY MULTIPLE ACTIVITY TOYS; CHILDREN'S MULTIPLE ACTIVITY TOYS; ELECTRONIC LEARNING TOYS; INFANT DEVELOPMENT TOYS; INFANT TOYS; MUSICAL TOYS (U.S. CLS. 22, 23, 38 AND 50).
GEORGE LORENZO, EXAMINING ATTORNEY

CLASS 28—(Continued).

SN 85-546,941. VTECH ELECTRONICS NORTH AMERICA, LLC, ARLINGTON HEIGHTS, IL. FILED 2-19-2012.

COGSLEY

THE MARK CONSISTS OF STANDARD CHARACTERS WITHOUT CLAIM TO ANY PARTICULAR FONT, STYLE, SIZE, OR COLOR.
FOR CHILDREN'S MULTIPLE ACTIVITY TOYS; ELECTRONIC ACTION TOYS; ELECTRONIC LEARNING TOYS; MECHANICAL ACTION TOYS; TOY ROBOTS (U.S. CLS. 22, 23, 38 AND 50).
GEORGE LORENZO, EXAMINING ATTORNEY

SN 85-557,876. EBSCO INDUSTRIES, INC., BIRMINGHAM, AL. FILED 3-1-2012.

DOUBLE UP

THE MARK CONSISTS OF STANDARD CHARACTERS WITHOUT CLAIM TO ANY PARTICULAR FONT, STYLE, SIZE, OR COLOR.
FOR FISHING LURES (U.S. CLS. 22, 23, 38 AND 50).
FIRST USE 2-10-2012; IN COMMERCE 2-10-2012.
MARTHA FROMM, EXAMINING ATTORNEY

SN 85-557,888. EBSCO INDUSTRIES, INC., BIRMINGHAM, AL. FILED 3-1-2012.

YUMBRELLA

THE MARK CONSISTS OF STANDARD CHARACTERS WITHOUT CLAIM TO ANY PARTICULAR FONT, STYLE, SIZE, OR COLOR.
FOR FISHING LURES (U.S. CLS. 22, 23, 38 AND 50).
FIRST USE 12-14-2011; IN COMMERCE 12-14-2011.
MARTHA FROMM, EXAMINING ATTORNEY

CLASS 28—(Continued).

SN 85-564,516. HALLMARK LICENSING LLC, KANSAS CITY, MO. FILED 3-8-2012.

GRAB-N-GABS

THE MARK CONSISTS OF STANDARD CHARACTERS WITHOUT CLAIM TO ANY PARTICULAR FONT, STYLE, SIZE, OR COLOR.

FOR PARLOR GAMES AND HAND-HELD, ELECTRONIC GAMES FEATURING ACTIVITIES AND PROMPTS DESIGNED TO SPARK DISCUSSIONS, START CONVERSATIONS, TRIGGER STORYTELLING AND FOSTER CONNECTIONS AMONG THE PLAYERS (U.S. CLS. 22, 23, 38 AND 50).

LEIGH LOWRY, EXAMINING ATTORNEY

SN 85-571,855. FMR LLC, BOSTON, MA. FILED 3-16-2012.

TRACK SELECTOR GAME

THE MARK CONSISTS OF STANDARD CHARACTERS WITHOUT CLAIM TO ANY PARTICULAR FONT, STYLE, SIZE, OR COLOR.

NO CLAIM IS MADE TO THE EXCLUSIVE RIGHT TO USE "GAME", APART FROM THE MARK AS SHOWN. FOR CARD GAMES (U.S. CLS. 22, 23, 38 AND 50). FIRST USE 2-28-2012; IN COMMERCE 2-28-2012. TINA MAI, EXAMINING ATTORNEY

SN 85-581,857. EBSCO INDUSTRIES, INC., BIRMINGHAM, AL. FILED 3-28-2012.

DOUBLE UP

THE MARK CONSISTS OF STANDARD CHARACTERS WITHOUT CLAIM TO ANY PARTICULAR FONT, STYLE, SIZE, OR COLOR.

FOR FISHING TACKLE (U.S. CLS. 22, 23, 38 AND 50). FIRST USE 2-10-2012; IN COMMERCE 2-10-2012. MARTHA FROMM, EXAMINING ATTORNEY

CLASS 28—(Continued).

SN 85-582,161. LANTOS EMERY, AKA LANTOS IMRE, SARASOTA, FL. FILED 3-28-2012.



THE COLOR(S) GREEN, ORANGE, RED, BROWN, YELLOW, BLACK AND WHITE IS/ARE CLAIMED AS A FEATURE OF THE MARK.

THE MARK CONSISTS OF PENTAGON PROPORTIONALLY DIVIDED INTO FIVE EQUAL SPACES AND OCCUPIED BY THE COLORS, STARTING AT THE BOTTOM CENTER AND GOING CLOCKWISE, GREEN, ORANGE, RED, BROWN AND YELLOW WITH LETTER "G" IN BLACK LOCATED INSIDE A WHITE CIRCLE IN THE CENTER OF THE PENTAGON. THE WORDING "GORBYX" APPEARS IN BLACK TO THE RIGHT OF THE PENTAGON.

FOR PLAYING CARDS AND CARD GAMES (U.S. CLS. 22, 23, 38 AND 50).

JEFFREY LOOK, EXAMINING ATTORNEY

CLASS 29—MEATS AND PROCESSED FOODS

SN 76-708,576. CHEESE CULTURE INC., PEMBROKE PINES, FL. FILED 8-1-2011.



NO CLAIM IS MADE TO THE EXCLUSIVE RIGHT TO USE "CHEESE", APART FROM THE MARK AS SHOWN.

THE MARK CONSISTS OF A DESIGN OF A GOAT PLAYING A VIOLIN OVER THE WORDING "CHEESE CULTURE".

FOR GIFT BASKETS PRIMARILY CONTAINING CHEESE BUT WHICH MAY CONTAIN OTHER EDIBLE PRODUCTS AND/OR BEVERAGES (U.S. CL. 46).

FIRST USE 5-1-2011; IN COMMERCE 5-1-2011.

DOMINIC J. FERRAIUOLO, EXAMINING ATTORNEY

CLASS 29—(Continued).

SN 76-710,079. TERFLOTH TRADE MARKS LIMITED, HAMILTON HM LX, BERMUDA, FILED 12-21-2011.

COCO-CALYPSO

FOR CANNED COOKED MEAT, NAMELY, LUNCHEON MEAT, CORNED BEEF, VIENNA SAUSAGES; POULTRY; FROZEN MEATS; MEAT EXTRACTS; PRESERVED, DRIED AND COOKED CANNED VEGETABLES; PRESERVED, DRIED AND COOKED CANNED FRUITS INCLUDING CRANBERRIES, BLUEBERRIES AND OTHER FRUITS; CANNED AND PREPARED FROZEN FISH, NAMELY, TUNA, MACKEREL, SARDINES, HERRING, SALMON; CANNED SEAFOOD, NAMELY, SHRIMP, OYSTERS, MUSSELS, CRAB, LOBSTER; SOUPS, NAMELY, CHICKEN NOODLE SOUP, CANNED SOUPS, DRIED SOUPS AND SOUP MIXES; JAMS; JELLIES; MARMALADES; DAIRY DERIVED PRODUCTS, NAMELY, PROCESSED CHEESE AND BUTTER; SOUR CREAM; WHIPPING CREAM; YOGURT; MILK PRODUCTS, NAMELY, MILK, CONDENSED MILK AND EVAPORATED MILK; MILK BASED DRINKS, NAMELY, FLAVORED MILK; PEANUT BUTTER; COCONUT CREAM; EDIBLE OILS AND FATS, NAMELY, OLIVE OIL, CANOLA OIL; PASTES, NAMELY, FRUIT PASTES, VEGETABLES PASTES, MEAT PASTES, TOMATO PASTE AND HOT PEPPER PASTE; PROCESSED PULSES, NAMELY, LENTILS, PEAS, BEANS; PICKLES; FRUIT SAUCES, NAMELY, CRANBERRY SAUCE, APPLE SAUCE; CANNED CORN, NAMELY, WHOLE KERNEL CORN AND CORN ON THE COB; POTATO CRISPS AND POTATO CHIPS; NUT MEATS; HOT PEPPER OIL EXTRACTS; FROZEN, PREPARED AND PACKAGED READY TO EAT MEALS CONSISTING PRIMARILY OF MEAT, FISH, POULTRY AND/OR VEGETABLES (U.S. CL. 46).

MEGHAN REINHART, EXAMINING ATTORNEY

CLASS 29—(Continued).

SN 85-348,478. THE GOOD BEAN, LLC, BERKELEY, CA. FILED 6-16-2011.



OWNER OF U.S. REG. NO. 4,009,546.

NO CLAIM IS MADE TO THE EXCLUSIVE RIGHT TO USE "BEAN" AND "ALL NATURAL ROASTED CHICKPEA SNACKS", APART FROM THE MARK AS SHOWN.

THE MARK CONSISTS OF A STYLIZED ILLUSTRATION OF A CHICKPEA WITH THE WORDS "THE GOOD BEAN" APPEARING INSIDE IT, AND THE WORDS "ALL NATURAL ROASTED CHICKPEA SNACKS!" APPEARING AROUND THE BOTTOM OF THE IMAGE.

FOR (BASED ON USE IN COMMERCE) PROCESSED GARBANZO BEANS; VEGETABLE-BASED SNACK FOODS (BASED ON INTENT TO USE) FRUIT-BASED SNACK FOOD; PROCESSED BEANS; PROTEIN BASED, NUTRIENT-DENSE SNACK FOODS (U.S. CL. 46).

FIRST USE 9-1-2010; IN COMMERCE 9-1-2010.

MARCIE MILONE, EXAMINING ATTORNEY

SN 79-104,097. CONSERVAS EMILIA, S.L., SPAIN, FILED 9-27-2011.



OWNER OF INTERNATIONAL REGISTRATION 1019961 DATED 10-29-2009, EXPIRES 10-29-2019.

NO CLAIM IS MADE TO THE EXCLUSIVE RIGHT TO USE "CONSERVAS", APART FROM THE MARK AS SHOWN.

THE MARK CONSISTS OF THE WORDS "CONSERVAS EMILIA" ON AN OVAL BACKGROUND BENEATH A STAR AND WITHIN AN ORNATE INCOMPLETE OVAL BORDER.

THE ENGLISH TRANSLATION OF "CONSERVAS" IN THE MARK IS "PRESERVES".

FOR FISH PRESERVES AND SEMI-PRESERVES AND SALTED FISH (U.S. CL. 46).

JOHN WILKE, EXAMINING ATTORNEY

SN 85-350,706. KOELLING, ALAN D, ORD, NE. FILED 6-20-2011.



NO CLAIM IS MADE TO THE EXCLUSIVE RIGHT TO USE "SUNFLOWER", APART FROM THE MARK AS SHOWN.

THE COLOR(S) YELLOW AND BLACK IS/ARE CLAIMED AS A FEATURE OF THE MARK.

THE MARK CONSISTS OF THE WORDS SIMPLY SUNFLOWER IN YELLOW THAT GRADUALLY GETS DARKER AT THE BOTTOM OF THE LETTERS. THE "S" IN SIMPLY INTERTWINES WITH THE "S" IN SUNFLOWER. THE "L" IN SIMPLY CONNECTS WITH THE "L" IN SUNFLOWER TO FORM A SUNFLOWER STEM WITH A SUNFLOWER HEAD AT THE TOP. THE LETTERS AND SUNFLOWER DESIGN ARE IN YELLOW AND HAVE A BLACK SHADOW.

FOR SUNFLOWER OIL (U.S. CL. 46).

CHRIS WELLS, EXAMINING ATTORNEY

CLASS 29—(Continued).

SN 85-353,865. ANNIE'S HOMEGROWN, INC., BERKELEY, CA. FILED 6-23-2011.

ANNIE'S HOMEGROWN GUMMY
BUNNIES

THE MARK CONSISTS OF STANDARD CHARACTERS WITHOUT CLAIM TO ANY PARTICULAR FONT, STYLE, SIZE, OR COLOR.

OWNER OF U.S. REG. NOS. 2,023,195, 3,914,822 AND OTHERS.

NO CLAIM IS MADE TO THE EXCLUSIVE RIGHT TO USE "GUMMY BUNNIES", APART FROM THE MARK AS SHOWN.

FOR FRUIT SNACKS, NAMELY, FRUIT-BASED SNACK FOODS (U.S. CL. 46).

SANJEEV VOHRA, EXAMINING ATTORNEY

SN 85-353,935. PATZER, FERDINAND, SYKE, FED REP GERMANY, FILED 6-23-2011.

Knüppel

THE MARK CONSISTS OF STANDARD CHARACTERS WITHOUT CLAIM TO ANY PARTICULAR FONT, STYLE, SIZE, OR COLOR.

THE ENGLISH TRANSLATION OF "KNÜPPEL" IN THE MARK IS "STICK", "CLUB", "CUDGEL" OR "TRUNCH-EON".

FOR SAUSAGE AND MEAT, IN PARTICULAR HARD CURED SAUSAGE (U.S. CL. 46).

JEFFREY LOOK, EXAMINING ATTORNEY

SN 85-358,282. LINK SNACKS, INC., MINONG, WI. FILED 6-28-2011.

BIG DIPPERS

THE MARK CONSISTS OF STANDARD CHARACTERS WITHOUT CLAIM TO ANY PARTICULAR FONT, STYLE, SIZE, OR COLOR.

FOR MEAT SNACKS (U.S. CL. 46).

JANICE KIM, EXAMINING ATTORNEY

CLASS 29—(Continued).

SN 85-359,802. THE IRISH DAIRY BOARD CO-OPERATIVE LIMITED, DUBLIN, 2, IRELAND, FILED 6-29-2011.



OWNER OF U.S. REG. NOS. 2,319,632, 3,548,579 AND 3,638,970.

NO CLAIM IS MADE TO THE EXCLUSIVE RIGHT TO USE "100% NATURAL CHEESE", APART FROM THE MARK AS SHOWN.

THE MARK CONSISTS OF THE WORDING "DUBLINER 100% NATURAL CHEESE" AND A DEPICTION OF A BICYCLE. THE WORD "DUBLINER" IS REPEATED ON THE BICYCLE. COLOR IS NOT CLAIMED AS A FEATURE OF THE MARK. THE COLOR GRAY IN THE MARK IS FOR SHADING AND CONTRAST ONLY.

FOR CHEESE (U.S. CL. 46).

DEIRDRE ROBERTSON, EXAMINING ATTORNEY

SN 85-373,630. SPOLETINI/PALUMBO INC., CALGARY, AB T2G 0T3, CANADA, FILED 7-18-2011.

SPOLUMBO'S

THE MARK CONSISTS OF STANDARD CHARACTERS WITHOUT CLAIM TO ANY PARTICULAR FONT, STYLE, SIZE, OR COLOR.

FOR SAUSAGES (U.S. CL. 46).

ANN E. SAPPENFIELD, EXAMINING ATTORNEY

SN 85-381,608. PARR, JASON J, DBA KING KALIBUR LLC, EAGLE, WI. FILED 7-26-2011.

King Kalibur

THE MARK CONSISTS OF STANDARD CHARACTERS WITHOUT CLAIM TO ANY PARTICULAR FONT, STYLE, SIZE, OR COLOR.

FOR MEAT, BEEF JERKY, JERKY, BEEF STICKS, MEAT STICKS AND SAUSAGES (U.S. CL. 46).

FIRST USE 5-1-1998; IN COMMERCE 5-1-1998.

KELLY TRUSILO, EXAMINING ATTORNEY

CLASS 29—(Continued).

SN 85-405,887. GRUMA CORPORATION, IRVING, TX. FILED 8-24-2011.

RUMBA

THE MARK CONSISTS OF STANDARD CHARACTERS WITHOUT CLAIM TO ANY PARTICULAR FONT, STYLE, SIZE, OR COLOR.

FOR CHIPS, NAMELY, PLANTAIN CHIPS, YUCCA CHIPS, TORTILLA CHIPS; FLAVORED NUTS (U.S. CL. 46).

TASHIA BUNCH, EXAMINING ATTORNEY

CLASS 29—(Continued).

WITH A GREEN AND WHITE ABSTRACT DESIGN RESEMBLING A BUTTERFLY. ON THE RIGHT, "PROBIOTICO Y FIBRA" APPEARS VERTICALLY AGAINST THE YELLOW FIELD WITH "PROBIOTICO" ON ONE LINE IN BROWN, STYLIZED, UPPER-AND-LOWER-CASE LETTERING, AND "Y FIBRA" IN WHITE STYLIZED LETTERING OUTLINED IN BROWN, BELOW IT. THE LOWER PORTION OF THE BOTTLE SHOWS THREE PURPLE PRUNES RESTING IN WHITE LIQUID, WITH TWO STALKS OF GOLD WHEAT SHOWING ABOVE THE PRUNES ON THE RIGHT.

THE ENGLISH TRANSLATION OF "PROBIOTICO Y FIBRA" IN THE MARK IS "PROBIOTIC AND FIBER".

FOR DRINKING YOGURTS AND YOGURT CONTAINING PROBIOTICS AND FIBER (U.S. CL. 46).

JILL C. ALT, EXAMINING ATTORNEY

SN 85-412,444. IBE BUSINESS ENTERPRISE AG, ZUG, SWITZERLAND, FILED 8-31-2011.

SN 85-412,430. IBE BUSINESS ENTERPRISE AG, ZUG, SWITZERLAND, FILED 8-31-2011.



OWNER OF U.S. REG. NOS. 3,319,712, 3,766,897 AND OTHERS.

NO CLAIM IS MADE TO THE EXCLUSIVE RIGHT TO USE "PROBIOTICO Y FIBRA", APART FROM THE MARK AS SHOWN.

THE COLOR(S) GREEN, ORANGE, YELLOW, BROWN, WHITE, COPPER, GOLD, AND PURPLE IS/ARE CLAIMED AS A FEATURE OF THE MARK.

THE MARK CONSISTS OF A BOTTLE WITH VERTICAL, SLIGHTLY INDENTED SIDES, ROUNDED SOMEWHAT AT THE BOTTOM AND THE TOP, WITH A WIDE MOUTH CAPPED IN A COPPER COLOR WITH A REPEATING PATTERN OF "LALA BIOBALAN.CE" IN BROWN LETTERS ABOVE A WHITE COLLAR. THE LEFT SIDE OF THE BOTTLE IS PRIMARILY GREEN, THE RIGHT SIDE, ORANGE WITH AN IRREGULAR YELLOW FIELD IN THE CENTER, THE EDGES OF WHICH FEED INTO THE GREEN AND ORANGE FIELDS. THE WORDING "BIOBALAN.CE" APPEARS VERTICALLY AGAINST THE YELLOW FIELD ON THE RIGHT WITH "BIO" IN WHITE, STYLIZED, UPPER-AND-LOWER-CASE LETTERS, AND "BALAN.CE" IN BROWN, UPPER-AND-LOWER-CASE LETTERS. ABOVE THE "AN" IN "BALAN.CE", IS THE TERM "LALA", IN GREEN STYLIZED LETTERS, OUTLINED IN WHITE,

OWNER OF U.S. REG. NOS. 3,319,712, 3,766,897 AND OTHERS.

NO CLAIM IS MADE TO THE EXCLUSIVE RIGHT TO USE "PROBIOTICO Y FIBRA", APART FROM THE MARK AS SHOWN.

THE COLOR(S) GREEN, ORANGE, YELLOW, BROWN, WHITE, COPPER, BLACK, CORAL-ORANGE AND GOLD IS/ARE CLAIMED AS A FEATURE OF THE MARK.

THE MARK CONSISTS OF A BOTTLE WITH VERTICAL, SLIGHTLY INDENTED SIDES, ROUNDED SOMEWHAT AT THE BOTTOM AND THE TOP WHICH HAS A WIDE MOUTH CAPPED IN COPPER COLOR WITH A REPEATING PATTERN OF "LALA BIOBALAN.CE" IN BROWN LETTERS ABOVE A WHITE COLLAR. THE LEFT SIDE OF THE BOTTLE IS PRIMARILY GREEN. THE RIGHT SIDE IS ORANGE. THERE IS AN IRREGULAR YELLOW FIELD IN THE CENTER BETWEEN THE TWO, THE EDGES OF WHICH FEED INTO THE GREEN AND ORANGE FIELDS. THE WORDING "BIOBALAN.CE" APPEARS VERTICALLY AGAINST THE YELLOW FIELD ON THE RIGHT, WITH "BIO" IN WHITE, STYLIZED, UPPER-AND-LOWER-CASE LETTERS AND "BALAN.CE" IN BROWN UPPER-AND-LOWER-CASE LETTERS. ABOVE THE "AN" IN "BALAN.CE" IS THE TERM "LALA" IN GREEN, STYLIZED LETTERS, OUTLINED IN WHITE WITH A GREEN AND WHITE ABSTRACT DESIGN RESEMBLING A BUTTERFLY. ON THE RIGHT, "PROBIOTICO Y FIBRA" APPEARS VERTICALLY AGAINST THE YELLOW FIELD WITH

CLASS 29—(Continued).

"PROBIOTICO" ON ONE LINE, IN BROWN STYLIZED UPPER-AND-LOWER CASE LETTERING AND "Y FIBRA" IN WHITE, STYLIZED LETTERING OUTLINED IN BROWN, BELOW IT. THE LOWER PART OF THE BOTTLE SHOWS HALF AN ORANGE, IN ORANGE WITH WHITE MEMBRANE, ON THE LEFT, AND HALF A CORAL-ORANGE PAPAYA WITH BLACK SEEDS, ON THE RIGHT, AND TWO GOLD STALKS OF WHEAT SHOWING FROM BEHIND THE PAPAYA, ALL POSED AGAINST AN IRREGULAR FIELD OF WHITE LIQUID.

THE ENGLISH TRANSLATION OF "PROBIÓTICO Y FIBRA" IN THE MARK IS "PROBIOTIC AND FIBER".

FOR DRINKING YOGURTS AND YOGURT CONTAINING PROBIOTICS AND FIBER (U.S. CL. 46).

JILL C. ALT, EXAMINING ATTORNEY

SN 85-413,400. IBE BUSINESS ENTERPRISE AG, ZUG, SWITZERLAND, FILED 9-1-2011.



OWNER OF U.S. REG. NOS. 3,319,712, 3,766,897 AND OTHERS.

NO CLAIM IS MADE TO THE EXCLUSIVE RIGHT TO USE "PROBIÓTICO Y FIBRA", APART FROM THE MARK AS SHOWN.

THE COLOR(S) GREEN, ORANGE, YELLOW, BROWN, WHITE, GOLD, AND PURPLE IS/ARE CLAIMED AS A FEATURE OF THE MARK.

THE MARK CONSISTS OF A CONTAINER WITH GRADUALLY WIDENING SIDES. THE LEFT SIDE OF THE CONTAINER IS PRIMARILY GREEN, THE RIGHT SIDE IS PRIMARILY ORANGE, AND THERE IS AN IRREGULAR YELLOW FIELD IN THE CENTER, THE EDGES OF WHICH BLEED INTO THE GREEN AND ORANGE FIELDS. "BIO-BALAN.CE" APPEARS HORIZONTALLY ACROSS THE FRONT WITH "BIO" IN WHITE, STYLIZED LETTERS, AND "BALAN.CE" IN STYLIZED BROWN LETTERS. BELOW "BALAN.CE" "PROBIOTICO" APPEARS IN BROWN, STYLIZED LETTERS, AND BELOW THAT, "Y FIBRA" APPEARS IN WHITE LETTERS OUTLINED IN BROWN ABOVE THE TWO STALKS OF GOLD WHEAT. "LALA" APPEARS ABOVE "BIOBALAN.CE" IN YELLOW STYLIZED LETTERS OUTLINED IN WHITE, WITH A YELLOW AND WHITE ABSTRACT DESIGN SUGGESTIVE OF A BUTTERFLY. THE BOTTOM OF THE LABEL DISPLAYS SEVEN PURPLE PRUNES AND THE STALKS OF GOLD WHEAT AGAINST AN IRREGULAR FIELD OF WHITE LIQUID.

THE ENGLISH TRANSLATION OF "PROBIÓTICO Y FIBRA" IN THE MARK IS "PROBIOTIC AND FIBER".

FOR YOGURT CONTAINING PROBIOTICS AND FIBER (U.S. CL. 46).

JILL C. ALT, EXAMINING ATTORNEY

CLASS 29—(Continued).

SN 85-415,926. JULIE A. LARSON, MINDORO, WI. AND PAUL L. LARSON, MINDORO, WI. FILED 9-6-2011.

SUNRAY FARMSTEAD CREAMERY

THE MARK CONSISTS OF STANDARD CHARACTERS WITHOUT CLAIM TO ANY PARTICULAR FONT, STYLE, SIZE, OR COLOR.

NO CLAIM IS MADE TO THE EXCLUSIVE RIGHT TO USE "FARMSTEAD CREAMERY", APART FROM THE MARK AS SHOWN.

FOR MILK, CREAM, YOGURT, BEEF AND MEATS (U.S. CL. 46).

SUSAN RICHARDS, EXAMINING ATTORNEY

SN 85-418,150. NEW ALBERTSON'S, INC., BOISE, ID. FILED 9-8-2011.

STEAKHOUSE CHOICE

THE MARK CONSISTS OF STANDARD CHARACTERS WITHOUT CLAIM TO ANY PARTICULAR FONT, STYLE, SIZE, OR COLOR.

NO CLAIM IS MADE TO THE EXCLUSIVE RIGHT TO USE "CHOICE", APART FROM THE MARK AS SHOWN.

FOR MEAT (U.S. CL. 46).

MELISSA VALLILLO, EXAMINING ATTORNEY

SN 85-419,786. EIEIO, INC., AUSTIN, TX. FILED 9-11-2011.



NO CLAIM IS MADE TO THE EXCLUSIVE RIGHT TO USE "WHIP", APART FROM THE MARK AS SHOWN.

THE MARK CONSISTS OF THE WORD "WHIPTOPPER" WITH A WHIPPED TOPPING ANIMATED CHARACTER WEARING A TUXEDO AND HOLDING A WHISK AND HAT.

FOR WHIPPED TOPPING (U.S. CL. 46).

FIRST USE 12-20-2010; IN COMMERCE 1-1-2011.

ROBIN CHOSID, EXAMINING ATTORNEY

CLASS 29—(Continued).

SN 85-461,264. CROWN VALLEY WINERY, INC., STE GENEVIEVE, MO. FILED 11-1-2011.

Big Bison

THE MARK CONSISTS OF STANDARD CHARACTERS WITHOUT CLAIM TO ANY PARTICULAR FONT, STYLE, SIZE, OR COLOR.
 NO CLAIM IS MADE TO THE EXCLUSIVE RIGHT TO USE "BISON", APART FROM THE MARK AS SHOWN.
 FOR PACKAGED MEATS MADE IN WHOLE OR SIGNIFICANT PART OF BISON (U.S. CL. 46).
 FIRST USE 8-1-2008; IN COMMERCE 8-1-2008.
 MYRIAH HABEEB, EXAMINING ATTORNEY

CLASS 29—(Continued).

SN 85-466,763. GREATER OMAHA PACKING CO., INC., OMAHA, NE. FILED 11-8-2011.



SN 85-461,297. ORIGIN FOOD GROUP, LLC, STATESVILLE, NC. FILED 11-1-2011.



NO CLAIM IS MADE TO THE EXCLUSIVE RIGHT TO USE "NATURAL" AND "QUALITY ASSURANCE", APART FROM THE MARK AS SHOWN.
 THE MARK CONSISTS OF A CIRCLE CONTAINING A CHECKMARK WITH THE TEXT "G.O. NATURAL" ABOVE AND THE TEXT "QUALITY ASSURANCE" BELOW.
 FOR MEAT (U.S. CL. 46).
 FIRST USE 6-20-2011; IN COMMERCE 6-20-2011.
 HAI-LY LAM, EXAMINING ATTORNEY

SN 85-466,784. GREATER OMAHA PACKING CO., INC., OMAHA, NE. FILED 11-8-2011.

THE MARK CONSISTS OF THE STYLIZED WORD "FRUSH" WITH THREE SMALL CIRCLES IN A PYRAMID SHAPE OVER THE LETTER "U".
 FOR DRINKABLE YOGURT (U.S. CL. 46).
 DOMINICK J. SALEMI, EXAMINING ATTORNEY



SN 85-462,381. ZITELMAN, SHELBY, PHILADELPHIA, PA. FILED 11-2-2011.

SOOM

THE MARK CONSISTS OF STANDARD CHARACTERS WITHOUT CLAIM TO ANY PARTICULAR FONT, STYLE, SIZE, OR COLOR.
 FOR TAHINI-CONTAINING FOOD PRODUCTS, NAMELY, PLAIN TAHINI PASTE, TAHINI-HONEY SPREAD AND TAHINI-DATE SYRUP SPREAD (U.S. CL. 46).
 JAMES GRIFFIN, EXAMINING ATTORNEY

NO CLAIM IS MADE TO THE EXCLUSIVE RIGHT TO USE "HUMANE" AND "SUSTAINABLE", APART FROM THE MARK AS SHOWN.
 THE MARK CONSISTS OF AN IMAGE OF A BARN WITH A WEATHER VANE FEATURING A CHICKEN AND A WINDOW ABOVE THE TEXT "HUMANE" ABOVE THE SYMBOL "+" ABOVE THE TEXT "SUSTAINABLE".
 FOR MEAT (U.S. CL. 46).
 FIRST USE 6-20-2011; IN COMMERCE 6-20-2011.
 HAI-LY LAM, EXAMINING ATTORNEY

CLASS 29—(Continued).

SN 85-468,696. SIGNATURE BRANDS LLC, OCALA, FL. FILED 11-9-2011.

HARVEST SELECTS

THE MARK CONSISTS OF STANDARD CHARACTERS WITHOUT CLAIM TO ANY PARTICULAR FONT, STYLE, SIZE, OR COLOR.

NO CLAIM IS MADE TO THE EXCLUSIVE RIGHT TO USE "SELECTS", APART FROM THE MARK AS SHOWN. FOR FRUIT TOPPING (U.S. CL. 46).

KATHLEEN M. VANSTON, EXAMINING ATTORNEY

CLASS 29—(Continued).

SN 85-479,565. SHANDONG ORIENTAL OCEAN SCI-TECH CO.,LTD, YANTAI, SHANDONG, CHINA, FILED 11-22-2011.



東方海洋
ORIENTAL OCEAN

SN 85-474,352. STOVIT GROUP SP. Z.O.O., BYDGOSZCZ, POLAND, FILED 11-16-2011.



OWNER OF ERPN CMNTY TM OFC REG. NO. 9841974, DATED 7-21-2011, EXPIRES 3-25-2021.

NO CLAIM IS MADE TO THE EXCLUSIVE RIGHT TO USE "PRESERVE" AND THE IMAGES OF THE CHERRIES, APART FROM THE MARK AS SHOWN.

THE COLOR(S) BLUE, RED, GREEN, YELLOW, AND BROWN IS/ARE CLAIMED AS A FEATURE OF THE MARK.

THE MARK CONSISTS OF THE STYLIZED WORD "STOVIT" WITHIN A BLUE RECTANGLE WITH A HALF CIRCLE APPEARING IN YELLOW AND OUTLINED IN BLUE ABOVE IT AND THE STYLIZED WORDS "GRANDMA'S PRESERVE" APPEARING IN RED WITHIN AN IRREGULAR SHAPE OUTLINED IN YELLOW AND BROWN WITH TWO RED CHERRIES TO ITS RIGHT BELOW THE WORD "STOVIT". THE WORDING DESIGNS APPEAR WITHIN A RING OF RED CHERRIES WITH GREEN STEMS AND LEAVES AND OUTLINED WITH BROWN ARC DESIGNS AND ENCIRCLED IN RED. THE COLOR WHITE APPEARING IN THE BACKGROUND OF THE MARK REPRESENTS TRANSPARENT AREAS AND THEREFORE IS NOT PART OF THE MARK.

FOR COMPOTES; EDIBLE OILS AND FATS; FROZEN FRUITS; FROZEN VEGETABLES; JELLIES AND JAMS; MARMALADES; PICKLES; PRESERVED, DRIED AND COOKED FRUIT AND VEGETABLES; PRESERVED, DRIED AND COOKED OLIVES (U.S. CL. 46).

ARETHA SOMERVILLE, EXAMINING ATTORNEY

NO CLAIM IS MADE TO THE EXCLUSIVE RIGHT TO USE "ORIENTAL" AND THE NON-LATIN CHARACTERS THAT TRANSLITERATE TO "DONG FANG", APART FROM THE MARK AS SHOWN.

THE MARK CONSISTS OF THE CHINESE CHARACTER DONG FANG HAI YANG WITH STYLIZED WORDING "ORIENTAL OCEAN" AND A SPECIAL DESIGN "H" AND OCEAN WAVE CRINKLE SURROUNDED BY A ROUND CIRCLE ON UPPER SIDE.

THE NON-LATIN CHARACTERS IN THE MARK TRANSLITERATE TO "DONG FANG HAI YANG" AND THIS MEANS "ORIENTAL OCEAN" IN ENGLISH.

FOR ALGAE FOOD BEVERAGES, NAMELY, SEAWEED DRINKS; BEVERAGES CONSISTING PRINCIPALLY OF MILK; BEVERAGES HAVING A MILK BASE; CANNED FISH; DRIED EDIBLE ALGAE; EDIBLE FATS; EGGS; FISH PRESERVES; FLAKES OF DRIED FISH MEAT (KEZURI-BUSHI); FOOD ADDITIVES, NAMELY, NATURAL FOOD EXTRACTS DERIVED FROM FISH, FISH OIL, FISH PROTEIN, ALGAE, SEAWEED, FISH OR SHARK CARTILAGE, OR SEASHELLS NOT FOR MEDICINAL PURPOSES AND FOR HUMAN CONSUMPTION; FRUIT-BASED SNACK FOOD; MARINATED FISH; MEAT; MILK BEVERAGES WITH HIGH MILK CONTENT; MILK-BASED BEVERAGES WITH HIGH MILK CONTENT; PREPARED FOOD KITS COMPOSED OF MEAT, POULTRY, FISH, SEAFOOD, AND/OR VEGETABLES AND ALSO INCLUDING SAUCES OR SEASONINGS, READY FOR COOKING AND ASSEMBLY AS A MEAL; PRESERVED FISH; PROCESSED ALGAE FOR HUMAN CONSUMPTION; PROCESSED FISH; PROCESSED FISH ROE; PROCESSED FISH SPAWN; PROCESSED SEAFOOD, NAMELY, FISH; PROCESSED, EDIBLE SEAWEED; TINNED FISH; VEGETABLES, NAMELY, PRESERVED (U.S. CL. 46).

FIRST USE 8-1-2005; IN COMMERCE 8-1-2005.

JENNIFER WILLISTON, EXAMINING ATTORNEY

CLASS 29—(Continued).

SN 85-499,781. JONMOR INVESTMENTS, INC., WILMINGTON, DE. FILED 12-20-2011.



OWNER OF U.S. REG. NOS. 1,054,792, 3,169,028 AND OTHERS.

NO CLAIM IS MADE TO THE EXCLUSIVE RIGHT TO USE "SINCE 1827" AND "SPECIAL RESERVE", APART FROM THE MARK AS SHOWN.

THE NAME(S), PORTRAIT(S), AND/OR SIGNATURE(S) SHOWN IN THE MARK DOES NOT IDENTIFY A PARTICULAR LIVING INDIVIDUAL.

THE COLOR(S) RED, BLACK, GOLD AND WHITE IS/ARE CLAIMED AS A FEATURE OF THE MARK.

THE MARK CONSISTS OF A CURVED RECTANGULAR SHAPED DESIGN WITH AN ALTERNATING BLACK, GOLD, BLACK, GOLD BORDER. A HORIZONTAL GOLD BAR WITH ALTERNATING BLACK AND GOLD BORDERS DIVIDES THE RECTANGLE INTO TWO HALVES. A RED BANNER WITH GOLD BORDER OVERLAYS THE GOLD BAR IN THE MIDDLE. THE TOP HALF OF THE RECTANGLE HAS A BLACK BACKGROUND WITH THE WORDS "SINCE 1827" IN GOLD STYLIZED LETTERING, "JOHN MORRELL" IN WHITE AND GOLD STYLIZED LETTERING AND "SPECIAL RESERVE" IN GOLD STYLIZED LETTERING. THE BOTTOM HALF OF THE MARK IS RED WITH BLACK SHADING AROUND THE EDGES.

FOR HAM; MEAT (U.S. CL. 46).
FIRST USE 10-31-2011; IN COMMERCE 10-31-2011.
CHRISTOPHER LAW, EXAMINING ATTORNEY

SN 85-499,787. JONMOR INVESTMENTS, INC., WILMINGTON, DE. FILED 12-20-2011.



OWNER OF U.S. REG. NOS. 1,054,792, 3,169,028 AND OTHERS.

NO CLAIM IS MADE TO THE EXCLUSIVE RIGHT TO USE "SINCE 1827" AND "SPECIAL RESERVE", APART FROM THE MARK AS SHOWN.

THE NAME(S), PORTRAIT(S), AND/OR SIGNATURE(S) SHOWN IN THE MARK DOES NOT IDENTIFY A PARTICULAR LIVING INDIVIDUAL.

THE COLOR(S) RED, BLACK, GOLD AND WHITE IS/ARE CLAIMED AS A FEATURE OF THE MARK.

THE MARK CONSISTS OF A CURVED SQUARE WITH AN ALTERNATING BLACK, GOLD, BLACK, GOLD BORDER. THE SQUARE FEATURES A BLACK BACKGROUND ON THE INSIDE WITH A HORIZONTAL GOLD BAR WITH ALTERNATING BLACK AND GOLD BORDER DIVIDING

CLASS 29—(Continued).

THE SQUARE INTO TWO HALVES. A RED BANNER WITH GOLD BORDER OVERLAYS THE GOLD BAR IN THE MIDDLE. THE TOP HALF OF THE SQUARE CONTAINS THE WORDS "SINCE 1827" IN GOLD STYLIZED LETTERING, "JOHN MORRELL" IN WHITE AND GOLD STYLIZED LETTERING AND "SPECIAL RESERVE" IN GOLD STYLIZED LETTERING. A RED RIBBON WITH BLACK SHADING AROUND THE EDGES AND AN ALTERNATING BLACK, GOLD, BLACK GOLD BORDER EXTENDS FROM THE RIGHT SIDE OF THE BLACK SQUARE.

FOR HAM; MEAT (U.S. CL. 46).
CHRISTOPHER LAW, EXAMINING ATTORNEY

SN 85-519,229. DEAN FOODS COMPANY, DALLAS, TX. FILED 1-18-2012.

PURE PROTECT BOTTLE

THE MARK CONSISTS OF STANDARD CHARACTERS WITHOUT CLAIM TO ANY PARTICULAR FONT, STYLE, SIZE, OR COLOR.

NO CLAIM IS MADE TO THE EXCLUSIVE RIGHT TO USE "BOTTLE", APART FROM THE MARK AS SHOWN.

FOR DAIRY PRODUCTS, NAMELY, MILK, REDUCED FAT MILK, LOW FAT MILK AND FAT FREE MILK PACKAGED IN LIGHT BLOCKING BOTTLES (U.S. CL. 46).

MEGHAN REINHART, EXAMINING ATTORNEY

SN 85-521,102. WISCONSIN CHEESE GROUP, MONROE, WI. FILED 1-20-2012.

YA SALUD

THE MARK CONSISTS OF STANDARD CHARACTERS WITHOUT CLAIM TO ANY PARTICULAR FONT, STYLE, SIZE, OR COLOR.

OWNER OF U.S. REG. NOS. 3,355,299 AND 3,355,301.

NO CLAIM IS MADE TO THE EXCLUSIVE RIGHT TO USE "SALUD", APART FROM THE MARK AS SHOWN.

THE ENGLISH TRANSLATION OF "YA SALUD" IS "GET HEALTH".

FOR PROBIOTIC DRINKS, NAMELY, DAIRY BASED BEVERAGES (U.S. CL. 46).

DAVID ELTON, EXAMINING ATTORNEY

CLASS 29—(Continued).

SN 85-521,112. WISCONSIN CHEESE GROUP, MONROE, WI.
FILED 1-20-2012.

JELLY JOY

THE MARK CONSISTS OF STANDARD CHARACTERS WITHOUT CLAIM TO ANY PARTICULAR FONT, STYLE, SIZE, OR COLOR.

NO CLAIM IS MADE TO THE EXCLUSIVE RIGHT TO USE "JELLY", APART FROM THE MARK AS SHOWN.

FOR PROBIOTIC DRINKS, NAMELY, DAIRY BASED BEVERAGES (U.S. CL. 46).

DAVID ELTON, EXAMINING ATTORNEY

SN 85-521,788. GREENWAVE FOODS, LLC, BERKELEY, CA.
FILED 1-20-2012.

CRUNCHAMA-ME

THE MARK CONSISTS OF STANDARD CHARACTERS WITHOUT CLAIM TO ANY PARTICULAR FONT, STYLE, SIZE, OR COLOR.

FOR DRIED VEGETABLES; PROCESSED EDAMAME (U.S. CL. 46).

FIRST USE 1-1-2011; IN COMMERCE 1-1-2011.

KRISTINA MORRIS, EXAMINING ATTORNEY

SN 85-522,944. WESTBRAE NATURAL, INC., MELVILLE, NY. FILED 1-23-2012.

ALMOND DREAM

THE MARK CONSISTS OF STANDARD CHARACTERS WITHOUT CLAIM TO ANY PARTICULAR FONT, STYLE, SIZE, OR COLOR.

OWNER OF U.S. REG. NOS. 3,455,011 AND 3,945,208.

NO CLAIM IS MADE TO THE EXCLUSIVE RIGHT TO USE "ALMOND", APART FROM THE MARK AS SHOWN.

FOR NON-DAIRY YOGURT, ALMOND BASED NON-DAIRY YOGURT (U.S. CL. 46).

FIRST USE 1-16-2012; IN COMMERCE 1-16-2012.

GEOFFREY FOSDICK, EXAMINING ATTORNEY

CLASS 29—(Continued).

SN 85-523,269. PRINCE, BRIAN, BEVERLY HILLS, CA.
FILED 1-23-2012.

THE CHAIRMAN'S SELECT

THE MARK CONSISTS OF STANDARD CHARACTERS WITHOUT CLAIM TO ANY PARTICULAR FONT, STYLE, SIZE, OR COLOR.

NO CLAIM IS MADE TO THE EXCLUSIVE RIGHT TO USE "SELECT", APART FROM THE MARK AS SHOWN.

FOR ARTIFICIAL FISH ROES; BOTTLED COOKED MEAT; CANNED COOKED MEAT; CANNED FISH;

CHOW MEIN; COMBINATION MEAL CONSISTING PRIMARILY OF A MEAT OR VEGETABLE-BASED

ENTREE AND A SOUP OR SALAD FOR CONSUMPTION ON OR OFF THE PREMISES; CONFIT IN THE NATURE

OF A COOKED MEAT, SEAFOOD, FISH, POULTRY, VEGETABLE BASED SPREAD; DRIED MEAT; DRIED

SEAFOOD IN POWDER FORM; EDIBLE DECORATIONS FOR MEATS; EDIBLE OILS AND FATS, FISH AND

MEAT PRESERVES; EXTRACTS OF MEAT; FISH; FISH AND CHIPS; FISH AND MEAT PRESERVES; FISH

BURGER PATTIES; FISH CAKES; FISH CROQUETTES; FISH FILLETS; FISH MOUSSE; FISH PRESERVES; FISH

SAUSAGES; FISH STOCK; FISH, NAMELY, SALOM, COD, BASS, HALBUT, WHITE FISH, TROUT; FLAKES

OF DRIED FISH MEAT (KEZURI-BUSHI); FOOD ADITIVES IN THE NATURE OF FAT ACIDS MADE

FROM MEAT, FISH, FRUITS, VEGETABLES, EGGS, MILK AND EDIBLE OILS AND FATS; FOOD PACKAGE

COMBINATIONS CONSISTING PRIMARILY OF CHEESE, MEAT AND/OR PROCESSED FRUIT;

FORMED TEXTURED VEGETABLE PROTEIN FOR USE AS A MEAT SUBSTITUTE; FRANKFURTERS;

FRESH MEAT; FRIED MEAT; FROZEN APPETIZERS CONSISTING PRIMARILY OF CHICKEN OR SEAFOOD;

FROZEN PRE-PACKAGED ENTREES CONSISTING PRIMARILY OF SEAFOOD; HAMBURGER; HEAD CHEESE;

HOT DOGS; LUNCHEON MEATS; MARINATED MEAT, SEAFOOD, FISH, POULTRY, VEGETABLE; MEAT;

MEAT; MEAT AND MEAT EXTRACTS; MEAT BOILED DOWN IN SOY SAUCE (TSUKUDANI MEAT); MEAT

EXTRACT; MEAT EXTRACTS; MEAT JELLIES; MEAT JUICES; MEAT PASTE; MEAT PRESERVES; MEAT

SUBSTITUTES; MEAT, FISH, FRUIT AND VEGETABLE JELLIES; MEAT, FISH, FRUIT AND VEGETABLE

PRESERVES; MEAT, FISH, POULTRY AND GAME; MEAT, FISH, POULTRY AND GAME PRESERVES; MEAT,

FROZEN; MEAT, FRUIT AND VEGETABLE JELLIES, JAMS; MEAT, FRUIT AND VEGETABLE JELLIES,

JAMS, EGGS; MEAT, POULTRY AND GAME; MEAT-BASED MOUSSE; MEAT-BASED SNACK FOODS; MEAT-

BASED SPREADS; NUT MEATS; PACKAGED MEATS; PICKLED FISH; POTTED MEATS; PRE-PACKAGED

DINNERS CONSISTING OF MEAT, SEAFOOD, FISH, POULTRY, WITH PASTA, RICE AND VEGETABLES;

PREPARED AND PREPACKAGED MEALS AND ENTREES CONSISTING PRIMARILY OF EGG WITH ONE

OR MORE OF MEAT, FISH, POULTRY, VEGETABLE, CHEESE OR ONION; PREPARED ENTREES

CONSISTING PRIMARILY OF SEAFOOD; PREPARED ENTREES CONSISTING PRIMARILY OF LOBSTER

MEAT DIPPED IN BATTER AND FRIED; PREPARED FOOD KITS COMPOSED OF MEAT, POULTRY,

FISH, SEAFOOD, AND/OR VEGETABLES AND ALSO INCLUDING SAUCES OR SEASONINGS, READY

FOR COOKING AND ASSEMBLY AS A MEAL; PREPARED MEALS CONSISTING PRIMARILY OF

MEAT SUBSTITUTES; PREPARED MEAT; PRESERVED FISH; PRESERVED MEATS AND SAUSAGES;

PROCESSED FISH; PROCESSED FISH ROE; PROCESSED FISH SPAWN; PROCESSED MEAT;

PROCESSED MEAT; PROCESSED MEAT, NAMELY, KIDNEYS; PROCESSED MEAT, NAMELY,

STEAK, BRICKETS, TRI TIP, GROUND BEEF, CHUCK, HAM, TURKEY, LAMB, VEAL; PROCESSED

SEAFOOD; PROCESSED SEAFOOD, NAMELY, FISH; REFRIGERATED FOOD PACKAGE

COMBINATIONS CONSISTING PRIMARILY OF MEAT, CHEESE OR PROCESSED VEGETABLES

FOR PURPOSES OF CREATING A SAND-

CLASS 29—(Continued).

WICH; SALTED MEAT; SEAFOOD; SEAFOOD, NAMELY, FISH, SHRIMP, COD, SALOM, BASS, HAL-BUT, WHITE FISH, TROUT; SEAFOODS BOILED DOWN IN SOY SAUCE (TSUKUDANI); SEASONED MEAT, SEAFOOD, FISH, POULTRY; SLICED MEAT; SMOKED FISH; STEAMED CAKES OF SMASHED FISH AND YAM (HAMPEN); STEAMED OR TOASTED CAKES OF FISH PASTE (KAMABOKO); TEMPURA SEAFOOD; TEXTURED VEGETABLE PROTEIN FOR USE AS A MEAT EXTENDER; TINNED FISH; TINNED MEAT; TINNED MEAT, FISH, VEGETABLES AND FRUITS; TINNED SEAFOOD; TUBE-SHAPED TOASTED CAKES OF FISH PASTE (CHIKUWA); TUNA FISH; TUNA FISH; VEGETABLE-BASED MEAT SUBSTITUTES; VIETNAMESE COOKED MEATS, NAMELY, HAM (JAMBON); VIETNAMESE COOKED MEATS, NAMELY, PORK HOT DOGS (CHA LUA); FROZEN, PREPARED, PACKAGED ENTREES CONSISTING PRIMARILY OF MEAT, FISH, POULTRY OR VEGETABLES; FROZEN, PREPARED, PACKAGED MEALS CONSISTING PRIMARILY OF MEAT, FISH, POULTRY OR VEGETABLES; MEAT, FISH, CHICKEN, POULTRY, SEAFOOD CROQUETTES; MEAT, FISH, SEAFOOD, POULTRY, CHICKEN SOUFLÉS (U.S. CL. 46).

WILLIAM VERHOSEK, EXAMINING ATTORNEY

SN 85-524,381. YAOWAMARN CHIRALERSPONG, CHON-BURI 20160, THAILAND, FILED 1-24-2012.

PIONEER FARMS

THE MARK CONSISTS OF STANDARD CHARACTERS WITHOUT CLAIM TO ANY PARTICULAR FONT, STYLE, SIZE, OR COLOR.

NO CLAIM IS MADE TO THE EXCLUSIVE RIGHT TO USE "FARMS", APART FROM THE MARK AS SHOWN.

FOR CANNED PEANUTS; FLAVORED NUTS; NUT-BASED SNACK FOODS; PROCESSED ALMONDS; PROCESSED NUTS; PROCESSED PEANUTS; ROASTED NUTS; SHELLED NUTS; VEGETABLE-BASED SNACK FOODS; VEGETABLES, NAMELY, PROCESSED GREEN PEAS (U.S. CL. 46).

HOWARD B. LEVINE, EXAMINING ATTORNEY

SN 85-524,477. BASIS HOLDINGS LLC, NEW YORK, NY. FILED 1-25-2012.

FARM TO CHEF

THE MARK CONSISTS OF STANDARD CHARACTERS WITHOUT CLAIM TO ANY PARTICULAR FONT, STYLE, SIZE, OR COLOR.

OWNER OF U.S. REG. NOS. 3,703,459 AND 3,872,107.

FOR BUTTER; EGGS; MILK (U.S. CL. 46).

FIRST USE 1-1-2006; IN COMMERCE 1-1-2006.

DAVID COLLIER, EXAMINING ATTORNEY

CLASS 29—(Continued).

SN 85-525,108. GOYA FOODS, INC., SECAUCUS, NJ. FILED 1-25-2012.

GOYA FOR KIDS

THE MARK CONSISTS OF STANDARD CHARACTERS WITHOUT CLAIM TO ANY PARTICULAR FONT, STYLE, SIZE, OR COLOR.

OWNER OF U.S. REG. NOS. 764,033, 966,178 AND OTHERS.

NO CLAIM IS MADE TO THE EXCLUSIVE RIGHT TO USE "FOR KIDS", APART FROM THE MARK AS SHOWN.

FOR APPLESAUCE; BANANA CHIPS; BOUILLON; BUTTER; CHEESE; CHILI; CRANBERRY SAUCE; DRIED FRUITS; DRIED VEGETABLES; EDIBLE FATS; EDIBLE OILS; FISH; FRUIT CHIPS; FRUIT PRESERVES; JAMS; JELLIES; LARD; MEAT; MEAT EXTRACTS; MILK; MILK BEVERAGES CONTAINING FRUITS; PICKLES; PORK; PORK RINDS; POTATO CHIPS; POULTRY; PREPARATIONS FOR MAKING BOUILLON; PREPARED COCONUT; PROCESSED ARTICHOKE; PROCESSED EDIBLE SEEDS; PROCESSED GARLIC; PROCESSED NUTS; PROCESSED OLIVES; PROCESSED PEPPERS; PROCESSED PIMIENTOS; PROCESSED SEAFOOD; SEAFOOD; SNACK DIPS; SNACK MIX CONSISTING PRIMARILY OF PROCESSED FRUITS, PROCESSED NUTS AND/OR RAISINS; SOUPS; TOMATO PASTE; VEGETABLE CHIPS; VEGETABLE-BASED SNACK FOODS; YUCCA CHIPS; FROZEN, PREPARED OR PACKAGED ENTREES CONSISTING PRIMARILY OF MEAT, FISH, POULTRY OR VEGETABLES; VEGETABLE, FISH OR MEAT CROQUETTES (U.S. CL. 46).

KATHLEEN LORENZO, EXAMINING ATTORNEY

SN 85-528,034. SHUNG KEE FOOD CO. LTD., NEW YORK, NY. FILED 1-29-2012.



THE MARK CONSIST OF A SHADED OBLONG CONTAINING THE LETTER "K" AND AN OVAL ALL BISECTED BY A HORIZONTAL LINE, AND CONTAINED IN AN OBLONG.

FOR PREPARED FOOD PRODUCTS, NAMELY, FISH BALLS AND FISH CAKES (U.S. CL. 46).

FIRST USE 1-5-1982; IN COMMERCE 1-5-1982.

DAVID C. REIHNER, EXAMINING ATTORNEY

CLASS 29—(Continued).

SN 85-531,015. MELTZER, STEVEN MARC, WASHINGTON, DC. FILED 2-1-2012.

Smokey Mary

THE MARK CONSISTS OF STANDARD CHARACTERS WITHOUT CLAIM TO ANY PARTICULAR FONT, STYLE, SIZE, OR COLOR.

FOR CANNED, COOKED OR OTHERWISE PROCESSED TOMATOES (U.S. CL. 46).

WANDA KAY PRICE, EXAMINING ATTORNEY

SN 85-531,106. SANTOS HÉCTOR MANUEL, GUADALAJARA, MEXICO, FILED 2-1-2012.

HERENCIA DE MI TIERRA

THE MARK CONSISTS OF STANDARD CHARACTERS WITHOUT CLAIM TO ANY PARTICULAR FONT, STYLE, SIZE, OR COLOR.

THE ENGLISH TRANSLATION OF "HERENCIA DE MI TIERRA" IN THE MARK IS "MY LAND'S HERITAGE".

FOR BEEF; BEEF SLICES; CANNED, COOKED OR OTHERWISE PROCESSED TOMATOES; CHEESE; COTTAGE CHEESE; FRESH MEAT; FRESH UNRIPENED CHEESES; MEAT; MEAT, FROZEN; MILK POWDER; PORK; PORK CUTLETS; PROCESSED AVOCADOS; PROCESSED LEMONS; PROCESSED PEPPERS; RIPENED CHEESE; RIPENED CHEESES; SLICED MEAT; SOFT CHEESE; SOFT WHITE CHEESE; SOFT-RIPENED CHEESE; STRAINED CHEESE; STRAINED SOFT WHITE CHEESES; WHITE CHEESE (U.S. CL. 46).

HAI-LY LAM, EXAMINING ATTORNEY

SN 85-532,008. MJ PARTNERS LLC, NORTH HOLLYWOOD, CA. FILED 2-2-2012.

MAHJ MIX

THE MARK CONSISTS OF STANDARD CHARACTERS WITHOUT CLAIM TO ANY PARTICULAR FONT, STYLE, SIZE, OR COLOR.

NO CLAIM IS MADE TO THE EXCLUSIVE RIGHT TO USE "MIX", APART FROM THE MARK AS SHOWN.

FOR PROCESSED NUTS AND NUT MIXES; TRAIL MIX CONSISTING PRIMARILY OF PROCESSED NUTS, SEEDS, DRIED FRUIT AND ALSO INCLUDING CHOCOLATE; SNACK MIX CONSISTING PRIMARILY OF PROCESSED NUTS, SEEDS, DRIED FRUIT AND ALSO INCLUDING CHOCOLATE (U.S. CL. 46).

TEJBIR SINGH, EXAMINING ATTORNEY

CLASS 29—(Continued).

SN 85-532,079. BENEVOLENCE FOOD PRODUCTS, LLC, AKA BENEVOLENCE NESTS, LONG PHUNG YEN, LOS ANGELES, CA. FILED 2-2-2012.

Better Nest, Better Health, Better You.

THE MARK CONSISTS OF STANDARD CHARACTERS WITHOUT CLAIM TO ANY PARTICULAR FONT, STYLE, SIZE, OR COLOR.

FOR EDIBLE BIRD'S NESTS (U.S. CL. 46).
FIRST USE 4-30-2011; IN COMMERCE 4-30-2011.
SEAN CROWLEY, EXAMINING ATTORNEY

SN 85-532,152. MIO FOODS INC., NEWPORT BEACH, CA. FILED 2-2-2012.

RANCHO VIEJO

THE MARK CONSISTS OF STANDARD CHARACTERS WITHOUT CLAIM TO ANY PARTICULAR FONT, STYLE, SIZE, OR COLOR.

THE ENGLISH TRANSLATION OF "RANCHO VIEJO" IN THE MARK IS "OLD RANCH".

FOR CHEESE (U.S. CL. 46).
FIRST USE 1-15-2012; IN COMMERCE 1-15-2012.
DORITT L. CARROLL, EXAMINING ATTORNEY

SN 85-532,214. NIGEL NORTON, MIAMI BEACH, FL. FILED 2-2-2012.

GINZINGA

THE MARK CONSISTS OF STANDARD CHARACTERS WITHOUT CLAIM TO ANY PARTICULAR FONT, STYLE, SIZE, OR COLOR.

FOR YOGURT DRINKS (U.S. CL. 46).
LAURIE KAUFMAN, EXAMINING ATTORNEY

CLASS 29—(Continued).

SN 85-532,279. GEORGODIS S.A., VELESTINO, MAGNISIA, GREECE, FILED 2-2-2012.

**GEORGODIS PARTHENON
DELIGHTS**

THE MARK CONSISTS OF STANDARD CHARACTERS WITHOUT CLAIM TO ANY PARTICULAR FONT, STYLE, SIZE, OR COLOR.

FOR PROCESSED OLIVES (U.S. CL. 46).
APRIL ROACH, EXAMINING ATTORNEY

SN 85-532,318. J&B WHOLESALE DISTRIBUTING, INC., ST. MICHAEL, MN. FILED 2-2-2012.



NO CLAIM IS MADE TO THE EXCLUSIVE RIGHT TO USE THE PICTORIAL REPRESENTATION OF THE STATE OF MINNESOTA AND "PREMIUM QUALITY", APART FROM THE MARK AS SHOWN.

THE MARK CONSISTS OF A RECTANGULAR DESIGN WITH CURVED HORIZONTAL EDGES. A SLIGHTLY CURVED BAR BEARING THE WORDS "MINNESOTA FARMS" CROSSES THE RECTANGLE. AN OBLONG DESIGN APPEARS ON EITHER SIDE OF THE WORD "FARMS". UNDERNEATH THE BAR THERE APPEARS A PICTURE OF THE SHAPE OF THE STATE OF "MINNESOTA", WITH THE UNDERLINED WORDS "PREMIUM QUALITY" APPEARING ON EITHER SIDE OF THE PICTURE.

SEC. 2(F) AS TO "MINNESOTA FARMS".
FOR MEAT; BEEF; POULTRY; PORK (U.S. CL. 46).
FIRST USE 0-0-1985. THE MARK WAS FIRST USED ANYWHERE IN A DIFFERENT FORM OTHER THAN THAT SOUGHT TO BE REGISTERED AT LEAST AS EARLY AS 00/00/1985; IN COMMERCE 0-0-1985, THE MARK WAS FIRST USED IN COMMERCE IN A DIFFERENT FORM OTHER THAN THAT SOUGHT TO BE REGISTERED AT LEAST AS EARLY AS 00/00/1985.

SAMUEL E. SHARPER JR., EXAMINING ATTORNEY

SN 85-532,319. ALLIED OLD ENGLISH, INC., PORT READING, NJ. FILED 2-2-2012.

EXCLUSIVE

THE MARK CONSISTS OF STANDARD CHARACTERS WITHOUT CLAIM TO ANY PARTICULAR FONT, STYLE, SIZE, OR COLOR.

FOR JAMS, JELLIES, PRESERVES, FRUIT SPREADS, FRUIT TOPPINGS, SPREADABLE FRUITS, CONSERVES AND MARMALADES (U.S. CL. 46).

ANDREA HACK, EXAMINING ATTORNEY

CLASS 29—(Continued).

SN 85-532,327. ALLIED OLD ENGLISH, INC., PORT READING, NJ. FILED 2-2-2012.

EXCLUSIVELY

THE MARK CONSISTS OF STANDARD CHARACTERS WITHOUT CLAIM TO ANY PARTICULAR FONT, STYLE, SIZE, OR COLOR.

FOR JAMS, JELLIES, PRESERVES, FRUIT SPREADS, FRUIT TOPPINGS, SPREADABLE FRUITS, CONSERVES AND MARMALADES (U.S. CL. 46).

ANDREA HACK, EXAMINING ATTORNEY

SN 85-533,677. JEFF RAGAN, OKLAHOMA CITY, OK. FILED 2-3-2012.

KIZE

THE MARK CONSISTS OF STANDARD CHARACTERS WITHOUT CLAIM TO ANY PARTICULAR FONT, STYLE, SIZE, OR COLOR.

FOR NUT-BASED SNACK FOOD ALSO CONTAINING WHEY OR SOY PROTEIN (U.S. CL. 46).

JILL C. ALT, EXAMINING ATTORNEY

SN 85-533,703. COSI, INC., DEERFIELD, IL. FILED 2-3-2012.

TASTE TWO

THE MARK CONSISTS OF STANDARD CHARACTERS WITHOUT CLAIM TO ANY PARTICULAR FONT, STYLE, SIZE, OR COLOR.

FOR COMBINATION MEALS, CONSISTING PRIMARILY OF SOUP, A SANDWICH OR A SALAD FOR CONSUMPTION ON OR OFF PREMISES (U.S. CL. 46).

FIRST USE 1-9-2012; IN COMMERCE 1-9-2012.

DAVID MURRAY, EXAMINING ATTORNEY

CLASS 29—(Continued).

SN 85-534,333. MONSIEUR SINGH, LLC, NEW YORK, NY. FILED 2-6-2012.

Monsieur Singh

THE MARK CONSISTS OF STANDARD CHARACTERS WITHOUT CLAIM TO ANY PARTICULAR FONT, STYLE, SIZE, OR COLOR.

FOR BEVERAGES CONSISTING PRINCIPALLY OF MILK; BEVERAGES HAVING A MILK BASE; BEVERAGES MADE FROM YOGHURT; BEVERAGES MADE WITH YOGHURT; DAIRY-BASED BEVERAGES; MILK BEVERAGES CONTAINING FRUITS; YOGURT-BASED BEVERAGES (U.S. CL. 46).

FIRST USE 7-9-2011; IN COMMERCE 2-2-2012.
ANDREW LEASER, EXAMINING ATTORNEY

SN 85-534,346. MONSIEUR SINGH, LLC, NEW YORK, NY. FILED 2-6-2012.

Endorsed Daily by a Billion Indians

THE MARK CONSISTS OF STANDARD CHARACTERS WITHOUT CLAIM TO ANY PARTICULAR FONT, STYLE, SIZE, OR COLOR.

FOR BEVERAGES HAVING A MILK BASE; BEVERAGES MADE FROM YOGHURT; BEVERAGES MADE WITH YOGHURT; DAIRY-BASED BEVERAGES; MILK BASED BEVERAGES CONTAINING FRUIT JUICE; MILK BEVERAGES CONTAINING FRUITS; SOY-BASED FOOD BEVERAGE USED AS A MILK SUBSTITUTE; YOGURT-BASED BEVERAGES (U.S. CL. 46).

FIRST USE 7-9-2011; IN COMMERCE 2-2-2012.
ANDREW LEASER, EXAMINING ATTORNEY

SN 85-534,399. TASTE PROVISIONS, LLC, BRIDGEPORT, CT. FILED 2-6-2012.

EPIC PIES

THE MARK CONSISTS OF STANDARD CHARACTERS WITHOUT CLAIM TO ANY PARTICULAR FONT, STYLE, SIZE, OR COLOR.

NO CLAIM IS MADE TO THE EXCLUSIVE RIGHT TO USE "PIES", APART FROM THE MARK AS SHOWN.

FOR PRE-PACKAGED DINNERS CONSISTING PRIMARILY OF MEAT, SEAFOOD, POULTRY, AND VEGETABLES (U.S. CL. 46).

DAVID C. REIHNER, EXAMINING ATTORNEY

CLASS 29—(Continued).

SN 85-535,868. CHARLITO, LLC, RALEIGH, NC. FILED 2-7-2012.



THE MARK CONSISTS OF A DRAWING OF A HEAD OF A PIG IN A CIRCLE.

FOR CHARCUTERIE (U.S. CL. 46).
FIRST USE 9-1-2011; IN COMMERCE 9-1-2011.
BRIAN PINO, EXAMINING ATTORNEY

SN 85-535,913. PHILP, CHARLES, DENVER, CO. FILED 2-7-2012.

SNEAKZ

THE MARK CONSISTS OF STANDARD CHARACTERS WITHOUT CLAIM TO ANY PARTICULAR FONT, STYLE, SIZE, OR COLOR.

FOR MILK-BASED BEVERAGES, NAMELY, MILK AND FRUIT BLENDED DRINKS WITH ADDED NUTRIENTS, MILK-BASED BEVERAGES WITH ADDED NUTRIENTS, MILK-BASED ENERGY DRINKS (U.S. CL. 46).

VERNA BETH RIRIE, EXAMINING ATTORNEY

SN 85-536,002. KELLOGG NORTH AMERICA COMPANY, BATTLE CREEK, MI. FILED 2-7-2012.

CHIC-KETTS

THE MARK CONSISTS OF STANDARD CHARACTERS WITHOUT CLAIM TO ANY PARTICULAR FONT, STYLE, SIZE, OR COLOR.

FOR MEAT SUBSTITUTES (U.S. CL. 46).
FIRST USE 12-31-1972; IN COMMERCE 12-31-1972.
LINDA ORNDORFF, EXAMINING ATTORNEY

CLASS 29—(Continued).

SN 85-536,011. KELLOGG NORTH AMERICA COMPANY, BATTLE CREEK, MI. FILED 2-7-2012.

CHOPLETS

THE MARK CONSISTS OF STANDARD CHARACTERS WITHOUT CLAIM TO ANY PARTICULAR FONT, STYLE, SIZE, OR COLOR.
FOR MEAT SUBSTITUTES (U.S. CL. 46).
FIRST USE 12-30-1946; IN COMMERCE 12-30-1946.
LINDA ORNDORFF, EXAMINING ATTORNEY

SN 85-536,305. AVERY INNOVATIONS LLC, CHICAGO, IL. FILED 2-7-2012.

BIG FORK

THE MARK CONSISTS OF STANDARD CHARACTERS WITHOUT CLAIM TO ANY PARTICULAR FONT, STYLE, SIZE, OR COLOR.
FOR MEAT (U.S. CL. 46).
HELENE LIWINSKI, EXAMINING ATTORNEY

SN 85-536,868. BERNALSILVA RICHARD, SPRINGFIELD, NJ. FILED 2-8-2012.

DISCO FRIES

THE MARK CONSISTS OF STANDARD CHARACTERS WITHOUT CLAIM TO ANY PARTICULAR FONT, STYLE, SIZE, OR COLOR.
NO CLAIM IS MADE TO THE EXCLUSIVE RIGHT TO USE "FRIES", APART FROM THE MARK AS SHOWN.
FOR FRENCH FRY FOOD ITEM CONSISTING PRIMARILY OF FRENCH FRIES, BUT ALSO INCLUDING GRAVY AND TOPPINGS (U.S. CL. 46).
ODESSA BIBBINS, EXAMINING ATTORNEY

CLASS 29—(Continued).

SN 85-537,264. EAST MEADOW CORP., DBA UNCLE GIUSEPPE'S, FARMINGDALE, NY. FILED 2-8-2012.

UNCLE GIUSEPPE'S

THE MARK CONSISTS OF STANDARD CHARACTERS WITHOUT CLAIM TO ANY PARTICULAR FONT, STYLE, SIZE, OR COLOR.
OWNER OF U.S. REG. NOS. 4,052,777, 4,082,817 AND OTHERS.
FOR MARINATED VEGETABLES (U.S. CL. 46).
FIRST USE 11-1-1998; IN COMMERCE 11-1-1998.
DORITT L. CARROLL, EXAMINING ATTORNEY

SN 85-538,535. S-L SNACKS NATIONAL, LLC, CHARLOTTE, NC. FILED 2-9-2012.

HOME OF RIDICULOUSLY GOOD CHIPS

THE MARK CONSISTS OF STANDARD CHARACTERS WITHOUT CLAIM TO ANY PARTICULAR FONT, STYLE, SIZE, OR COLOR.
FOR POTATO CHIPS (U.S. CL. 46).
YAT SYE, LEE, EXAMINING ATTORNEY

SN 85-538,827. JARVICO, INC, HOLLYWOOD, FL. FILED 2-9-2012.

The Chef's Source

THE MARK CONSISTS OF STANDARD CHARACTERS WITHOUT CLAIM TO ANY PARTICULAR FONT, STYLE, SIZE, OR COLOR.
FOR SEAFOOD (U.S. CL. 46).
FIRST USE 10-3-2011; IN COMMERCE 10-3-2011.
JESSICA A. POWERS, EXAMINING ATTORNEY

CLASS 29—(Continued).

SN 85-540,065. GOYA FOODS, INC., SECAUCUS, NJ. FILED 2-10-2012.

GOYA FIESTA

THE MARK CONSISTS OF STANDARD CHARACTERS WITHOUT CLAIM TO ANY PARTICULAR FONT, STYLE, SIZE, OR COLOR.

OWNER OF U.S. REG. NOS. 2,155,280, 2,502,127 AND OTHERS.

FOR APPLESAUCE; BOUILLON; BROTH; BUTTER; CANNED PORK AND BEANS; CANNED PROCESSED OLIVES; CANNED, COOKED OR OTHERWISE PROCESSED TOMATOES; CHEESE; CHEESE AND CRACKER COMBINATIONS; CHEESE FOOD; CHEESE SPREADS; CHICKEN CROQUETTES; COCONUT-BASED BEVERAGE USED AS A MILK SUBSTITUTE; CONDENSED MILK; CRANBERRY SAUCE; DRIED BEANS; DRIED FRUIT AND VEGETABLES; DRIED FRUIT MIXES; DRIED FRUITS; DRIED MILK POWDER; DRIED VEGETABLES; EDIBLE OILS AND EDIBLE FATS; FISH; FISH CAKES; FISH CROQUETTES; FRUIT PRESERVES; FRUIT-BASED FOOD BEVERAGE; FRUIT-BASED SPREADS; GUACAMOLE; GUAVA PASTE; JELLIES, JAMS; LARD; MEAT AND MEAT EXTRACTS; MEAT, FISH, POULTRY AND GAME; MILK; MILK BEVERAGES CONTAINING FRUITS; MILK-BASED BEVERAGES WITH CHOCOLATE; PICKLES; PORK; PORK RINDS; PREPARATIONS FOR MAKING BOUILLON; PREPARED COCONUT; PREPARED ENTREES CONSISTING PRIMARILY OF VEGETABLES, SOUPS, FRUIT SALADS AND VEGETABLE SALADS; PRESERVED FRUIT AND VEGETABLES; PRESERVED, DRIED AND COOKED FRUIT AND VEGETABLES; PRESERVED, DRIED AND COOKED OLIVES; PROCESSED ARTICHOKE; PROCESSED AVOCADOS; PROCESSED BEANS; PROCESSED CACTUS FOR FOOD PURPOSES; PROCESSED COCONUT; PROCESSED EDIBLE SEEDS; PROCESSED FISH; PROCESSED FRUITS; PROCESSED GARBANZO BEANS; PROCESSED GARLIC; PROCESSED HEARTS OF PALM; PROCESSED MEAT; PROCESSED NUTS; PROCESSED OLIVES; PROCESSED PEPPERS; PROCESSED PIMIENTOS; PROCESSED SEAFOOD; PROCESSED SEAFOOD, NAMELY, FISH; PROCESSED STUFFED OLIVES; PROCESSED VEGETABLES; PROCESSED VEGETABLES AND FRUITS; RAISINS; SEAFOOD; SNACK MIX CONSISTING PRIMARILY OF PROCESSED FRUITS, PROCESSED NUTS AND/OR RAISINS; SOUPS; SOUPS AND PREPARATIONS FOR MAKING SOUPS; TOMATO PASTE; VEGETABLE-BASED SNACK FOODS; FROZEN, PREPARED OR PACKAGED ENTREES CONSISTING PRIMARILY OF MEAT, FISH, POULTRY OR VEGETABLES; MEAT CROQUETTES (U.S. CL. 46).

CURTIS FRENCH, EXAMINING ATTORNEY

CLASS 29—(Continued).

SN 85-547,414. SARGENTO FOODS, INC., PLYMOUTH, WI. FILED 2-20-2012.

4 STATE CHEDDAR

THE MARK CONSISTS OF STANDARD CHARACTERS WITHOUT CLAIM TO ANY PARTICULAR FONT, STYLE, SIZE, OR COLOR.

NO CLAIM IS MADE TO THE EXCLUSIVE RIGHT TO USE "CHEDDAR", APART FROM THE MARK AS SHOWN, FOR CHEESE CONSISTING PRIMARILY OF CHEDDAR CHEESE (U.S. CL. 46).

HANNO RITTNER, EXAMINING ATTORNEY

SN 85-563,985. J&J SNACK FOODS CORP., PENNSAUKEN, NJ. FILED 3-8-2012.

TATER STUFFERS

THE MARK CONSISTS OF STANDARD CHARACTERS WITHOUT CLAIM TO ANY PARTICULAR FONT, STYLE, SIZE, OR COLOR.

NO CLAIM IS MADE TO THE EXCLUSIVE RIGHT TO USE "TATER", APART FROM THE MARK AS SHOWN.

FOR HASH BROWN POTATOES SEASONED OR STUFFED WITH EGG AND CHEESE (U.S. CL. 46).

DORITT L. CARROLL, EXAMINING ATTORNEY

CLASS 30—STAPLE FOODS

SN 76-685,455. CRANBERRY SWEETS, INC., COOS BAY, OR. FILED 1-2-2008.

VINEYARD SWEETS

THE MARK CONSISTS OF STANDARD CHARACTERS WITHOUT CLAIM TO ANY PARTICULAR FONT, STYLE, SIZE, OR COLOR.

OWNER OF U.S. REG. NOS. 2,526,336, 2,627,382 AND OTHERS.

NO CLAIM IS MADE TO THE EXCLUSIVE RIGHT TO USE "SWEETS", APART FROM THE MARK AS SHOWN.

FOR CONFECTIONARIES, NAMELY, CANDIES (U.S. CL. 46).

FIRST USE 6-15-2004; IN COMMERCE 6-15-2004.
GINA FINK, EXAMINING ATTORNEY

CLASS 30—(Continued).

SN 77-159,945. J&J SNACK FOODS CORP., PENNSAUKEN, NJ. FILED 4-18-2007.

WholeFruit

OWNER OF U.S. REG. NOS. 3,190,932 AND 3,413,540.
THE MARK CONSISTS OF A STYLIZED DEPICTION OF THE WORD "WHOLEFRUIT".
SEC. 2(F).
FOR READY TO EAT, CEREAL DERIVED FOOD BARS (U.S. CL. 46).
ROBERT STRUCK, EXAMINING ATTORNEY

CLASS 30—(Continued).

SN 77-885,642. SALTWORKS.COM, LLC, WASHINGTON, DC. FILED 12-3-2009.

AYO.COM

THE MARK CONSISTS OF STANDARD CHARACTERS WITHOUT CLAIM TO ANY PARTICULAR FONT, STYLE, SIZE, OR COLOR.
FOR SEA SALT FOR COOKING (U.S. CL. 46).
ADA HAN, EXAMINING ATTORNEY

SN 77-877,133. KAPLAN, DAVID, NOVATO, CA. FILED 11-20-2009.

DIVINE ORGANICS

THE MARK CONSISTS OF STANDARD CHARACTERS WITHOUT CLAIM TO ANY PARTICULAR FONT, STYLE, SIZE, OR COLOR.
NO CLAIM IS MADE TO THE EXCLUSIVE RIGHT TO USE "ORGANICS", APART FROM THE MARK AS SHOWN.
FOR ORGANIC FOODS, NAMELY, VANILLA; CACAO; CANDY; BREAKFAST CEREAL; CRACKERS; COOKIES; ICE CREAM; VANILLA BEANS (U.S. CL. 46).
FIRST USE 9-14-2007; IN COMMERCE 10-31-2007.
GIANCARLO CASTRO, EXAMINING ATTORNEY

SN 77-962,207. HI T GLOBAL LLC, LAS VEGAS, NV. FILED 3-18-2010.

HI-T

SN 77-885,628. SALTWORKS.COM, LLC, WASHINGTON, DC. FILED 12-3-2009.

AYO

THE MARK CONSISTS OF STANDARD CHARACTERS WITHOUT CLAIM TO ANY PARTICULAR FONT, STYLE, SIZE, OR COLOR.
FOR SEA SALT FOR COOKING (U.S. CL. 46).
ADA HAN, EXAMINING ATTORNEY

THE MARK CONSISTS OF STANDARD CHARACTERS WITHOUT CLAIM TO ANY PARTICULAR FONT, STYLE, SIZE, OR COLOR.
FOR NON ALCOHOLIC ORGANIC HEMP AND TEA BASED BEVERAGES (U.S. CL. 46).
TINA L. SNAPP, EXAMINING ATTORNEY

CLASS 30—(Continued).

SN 79-102,893. ÇELIKLER GIDA SANAYI VE TICARET LIMITED SIRKETI, TURKEY, FILED 4-25-2011.



OWNER OF INTERNATIONAL REGISTRATION 1091589 DATED 4-25-2011, EXPIRES 4-25-2021.

THE COLOR(S) DARK KHAKI, WHITE AND BLACK IS/ ARE CLAIMED AS A FEATURE OF THE MARK.

THE MARK CONSISTS OF THE WORDING "TURKANA" IN STYLIZED FONT IN THE COLOR DARK KHAKI CENTERED ABOVE THE WORDING "VALLEY" WHICH APPEARS IN A SMALLER STYLIZED FONT ALSO IN THE COLOR DARK KHAKI. THE WORDING IS CENTERED IN AN ABSTRACT DESIGN APPEARING IN THE COLOR WHITE WITH BLACK BORDERS.

FOR COFFEE, COCOA, COFFEE BASED BEVERAGES; COCOA-BASED BEVERAGES; CHOCOLATE FOOD BEVERAGES NOT BEING DAIRY-BASED OR VEGETABLE BASED; MACARONI, MEAT PIES, VERMICELLI, PASTRIES, PETIT FOURS, TARTS, CAKES; BAKERY DESERT MADE OF FLOUR; HONEY, PROPOLIS FOR FOOD PURPOSES; FLAVOURINGS FOR FOODS; YEAST, BAKING-POWDER; FLAVOURING ADDITIVES FOR NON-NUTRITIONAL PURPOSES, FLOUR, PROCESSED SEMOLINA, FOOD STARCH; SUGAR, POWDERED SUGAR; TEA, ICED TEA; CONFECTIONERY, NAMELY, PASTILLES, FONDANTS, FRUIT JELLY CANDY; CHOCOLATES, BISCUITS, CRACKERS, WAFLES, CHEWING GUM, ICE CREAM, EDIBLE ICES; SALT; BREAKFAST CEREALS (U.S. CL. 46).

DAVID I, EXAMINING ATTORNEY

SN 79-103,655. ÇELIKLER GIDA SANAYI VE TICARET LIMITED SIRKETI, TURKEY, FILED 4-25-2011.

turkana

OWNER OF INTERNATIONAL REGISTRATION 1093534 DATED 4-25-2011, EXPIRES 4-25-2021.

THE WORDING "TURKANA" HAS NO MEANING IN A FOREIGN LANGUAGE.

FOR COFFEE, COCOA, COFFEE BASED BEVERAGES; COCOA-BASED BEVERAGES; CHOCOLATE FOOD BEVERAGES NOT BEING DAIRY-BASED OR VEGETABLE BASED; MACARONI, MEAT PIES, VERMICELLI, PASTRIES, PETIT FOURS, TARTS, CAKES; BAKERY DESERT MADE OF FLOUR; HONEY, PROPOLIS FOR FOOD PURPOSES; FLAVOURINGS FOR FOODS; YEAST, BAKING-POWDER; FLAVOURING ADDITIVES FOR NON-NUTRITIONAL PURPOSES, FLOUR, PROCESSED SEMOLINA, FOOD STARCH; SUGAR, POWDERED SUGAR; TEA, ICED TEA; CONFECTIONERY, NAMELY, PASTILLES, FONDANTS, FRUIT JELLY CANDY; CHOCOLATES, BISCUITS, CRACKERS, WAFLES, CHEWING GUM, ICE CREAM, EDIBLE ICES; SALT; BREAKFAST CEREALS (U.S. CL. 46).

DAVID I, EXAMINING ATTORNEY

CLASS 30—(Continued).

SN 79-109,524. NEWBY TEAS (U.K.) LIMITED, UNITED KINGDOM, FILED 12-20-2011.

DARRLING

THE MARK CONSISTS OF STANDARD CHARACTERS WITHOUT CLAIM TO ANY PARTICULAR FONT, STYLE, SIZE, OR COLOR.

PRIORITY DATE OF 7-11-2011 IS CLAIMED.

OWNER OF INTERNATIONAL REGISTRATION 1107747 DATED 12-20-2011, EXPIRES 12-20-2021.

THE WORDING "DARRLING" HAS NO MEANING IN A FOREIGN LANGUAGE.

FOR TEA, TEA PRODUCTS IN THE NATURE OF TEA BAGS, TEA BASED BEVERAGES; ICED TEA; TEA FOR INFUSIONS; AND INFUSIONS, NOT MEDICINAL, NAMELY, HERBAL INFUSIONS, AND INFUSIONS FOR TEA (U.S. CL. 46).

SEAN CROWLEY, EXAMINING ATTORNEY

SN 85-192,478. THE MEDITERRANEAN SNACK FOOD COMPANY, LLC, BOONTON, NJ. FILED 12-7-2010.



NO CLAIM IS MADE TO THE EXCLUSIVE RIGHT TO USE "SNACKS", APART FROM THE MARK AS SHOWN.

THE COLOR(S) YELLOW, DARK BROWN, LIGHT BROWN, BLACK, GREEN, LIGHT GREEN, CREAM, WHITE, LIGHT BLUE, AND LIGHT TAN IS/ARE CLAIMED AS A FEATURE OF THE MARK.

THE MARK CONSISTS OF A PASTORAL SCENE CONTAINING YELLOW SUNFLOWERS WITH A DARK BROWN CENTER IN THE FOREGROUND AND BLACK SHADOWING; ROWS OF GREEN CROPS WITH LIGHT BROWN DIRT AND BLACK SHADOWING; A CREAM BUILDING CLUSTER WITH DARK BROWN ROOFS WITH BLACK WINDOWS AND SHADOWS ON A LIGHT GREEN HILLSIDE WITH GREEN TREES AND ROWS OF GREEN BUSHES AND BLACK SHADOWING; LIGHT BROWN MOUNTAINS AND BLACK SHADOWING AND A LIGHT BLUE SKY WITH WHITE CLOUDS AT THE TOP ALL ENCOMPASSED IN A TWO TONE FRAME, THE TOP PORTION OF THE FRAME IN LIGHT BROWN AND THE BOTTOM PORTION IN DARK BROWN, WITH THE LITERAL ELEMENT "MEDITERRANEAN SNACKS" IN LIGHT TAN BELOW THE SCENE WITHIN THE DARK BROWN PORTION OF THE FRAME AND THE WHOLE OUTER EDGE OF THE FRAME IN LIGHT TAN WITH LIGHT BROWN BEADS.

SEC. 2(F) AS TO "MEDITERRANEAN SNACKS".

FOR CORN-BASED SNACK FOODS; CRACKERS; GRAIN-BASED CHIPS; MULTIGRAIN-BASED SNACK FOODS; POPPED POPCORN; PROCESSED GRAINS; PUFFED CORN SNACKS; PUFFED RICE; RICE-BASED SNACK FOODS; WHEAT-BASED SNACK FOODS (U.S. CL. 46).

FIRST USE 6-1-2007; IN COMMERCE 6-1-2007.

NICHOLAS COLEMAN, EXAMINING ATTORNEY

CLASS 30—(Continued).

SN 85-196,217, 2178918 ONTARIO LTD., ST. THOMAS, ONTARIO, CANADA, FILED 12-13-2010.



THE MARK CONSISTS OF THE VERTICALLY ARRANGED LETTERS COMPRISING THE WORD "LOVA" AND A SWIRL DESIGN ASSOCIATED WITH THE LETTER "O".

THE ENGLISH TRANSLATION OF THE WORD "LOVA" IN THE MARK IS WIND UP, CURL UP AND/OR COIL UP. FOR TEA (U.S. CL. 46).

MEGHAN REINHART, EXAMINING ATTORNEY

CLASS 30—(Continued).

SN 85-213,227, AMERICAN LICORICE CO., BEND, OR, FILED 1-7-2011.



THE MARK CONSISTS OF STANDARD CHARACTERS WITHOUT CLAIM TO ANY PARTICULAR FONT, STYLE, SIZE, OR COLOR.

OWNER OF U.S. REG. NO. 2,827,194, FOR CANDY-COATED HOLLOW LICORICE PIECES, NOT PEPPERMINT CANDY (U.S. CL. 46).

FIRST USE 12-0-1935; IN COMMERCE 12-0-1935. KIM MONINGHOFF, EXAMINING ATTORNEY

SN 85-219,322, GLORIA S.A., LIMA, PERU, FILED 1-17-2011.

SN 85-202,163, GARNER, CRAIG A., DBA BFC INC., NASHVILLE, TN, FILED 12-20-2010.



NO CLAIM IS MADE TO THE EXCLUSIVE RIGHT TO USE "BBQ", "WHITE SAUCE", "AS SERVED AT HOG HEAVEN IN NASHVILLE, TENNESSEE" AND "MUSIC CITY ORIGINAL", APART FROM THE MARK AS SHOWN.

THE MARK CONSISTS OF A CHICKEN, STANDING IN FRONT OF A CLOUD OF SMOKE, WEARING A KARATE UNIFORM, ABOVE THE WORDS "KICKIN' CHICKEN" "WHITE SAUCE" "AS SERVED AT HOG HEAVEN IN NASHVILLE TENNESSEE" AND "A MUSIC CITY ORIGINAL", AND BENEATH THE WORDS "OFTEN IMITATED!" "BBQ FIGHT CLUB", AND "NEVER DUPLICATED!", WITH A FORK TO THE LEFT OF THE CHICKEN AND A SPATULA TO THE RIGHT OF THE CHICKEN.

FOR BARBEQUE SAUCE (U.S. CL. 46). FIRST USE 7-17-1986; IN COMMERCE 7-17-1986. ARETHA SOMERVILLE, EXAMINING ATTORNEY



NO CLAIM IS MADE TO THE EXCLUSIVE RIGHT TO USE "PANETÓN" AND THE ILLUSTRATIONS OF THE LOAF OF BREAD, THE MILK, THE BUTTER, THE EGGS, THE FLOUR, THE RAISINS, AND ASSORTED DRIED FRUIT, APART FROM THE MARK AS SHOWN.

THE COLOR(S) BLUE, BEIGE, RED, YELLOW, GREEN, BLACK, WHITE, BROWN AND GOLD IS/ARE CLAIMED AS A FEATURE OF THE MARK.

THE MARK CONSISTS OF THE WORDING "GLORIA" IN STYLIZED LETTERS, BELOW OF WHICH APPEARS A ROUND RED FLOWER IN WHOSE MIDDLE APPEARS THE FACE OF A COW. BELOW THE RED FLOWER APPEAR A SET OF STARS AND BELOW IT THE WORDING "PANETÓN CON LA RECETA DE ORO". IN THE BOTTOM AREA OF THE DESIGN APPEARS A FRUIT CAKE SURROUNDED BY A STACK OF FLOUR, RAISINS, PIECES OF DRIED FRUITS, A JAR FILLED WITH MILK, THREE EGGS AND A BAR OF BUTTER ON A RECTANGULAR PLATE, ALL STANDING ON A BEIGE SURFACE. THE COLOR BLUE APPEARS IN THE BACKGROUND. THE COLOR GREEN APPEARS IN THE DRIED FRUITS. THE COLOR YELLOW APPEARS IN THE DRIED FRUITS, IN THE BUTTER BAR AND IN THE INSIDE AREA OF THE FRUIT CAKE. THE COLOR RED APPEARS IN THE ROSE AND IN THE DRIED FRUITS. THE COLOR BLACK APPEARS IN THE COW FACE AND IN THE RAISINS. THE COLOR

CLASS 30—(Continued).

WHITE APPEARS IN THE MILK, IN THE FLOUR, IN THE BUTTER PLATE, IN THE STARS AND IN THE COW'S FACE. THE COLOR BROWN APPEARS IN OUTER AREA OF THE FRUIT CAKE. THE COLOR GOLD APPEARS IN THE WORDS "GLORIA", "PANETON" AND "CON LA RECETA DE ORO". THE COLOR BEIGE APPEARS IN THE EGGS AND IN THE BOTTOM STRIPE THAT SERVES AS THE SURFACE ON WHICH THE FRUIT CAKE AND ITS INGREDIENTS STAND. ALL OF THE ABOVE APPEARS AGAINST A BLUE BACKGROUND.

THE ENGLISH TRANSLATION OF "GLORIA", "PANETON" AND "CON LA RECETA DE ORO" IN THE MARK IS "GLORI BREAD" OR "GLORIA BREAD" AND "WITH THE RECIPE OF GOLD".

FOR BAKERY GOODS; BAKERY PRODUCTS; BREAD; CAKES; FRUIT BREADS; FRUIT CAKES; PASTRIES (U.S. CL. 46).

DAVID I, EXAMINING ATTORNEY

CLASS 30—(Continued).

SN 85-348,658. HANGZHOU WELLONG FOOD CO., LTD., HANGZHOU, ZHEJIANG, CHINA, FILED 6-17-2011.

SN 85-228,136. CHRISTY, MARTHA, TEMPE, AZ. AND CHRISTY, JOSEPH, TEMPE, AZ. FILED 1-27-2011.

SlimSweet



THE MARK CONSISTS OF STANDARD CHARACTERS WITHOUT CLAIM TO ANY PARTICULAR FONT, STYLE, SIZE, OR COLOR.

FOR NATURAL SWEETENER (U.S. CL. 46).
FIRST USE 4-24-2000; IN COMMERCE 4-24-2000.
KRISTIN DAHLING, EXAMINING ATTORNEY

SN 85-250,379. HERSHEY CHOCOLATE & CONFECTIONERY CORPORATION, WHEAT RIDGE, CO. FILED 2-24-2011.

TWIZTED STRAWBERRY BLAST

THE MARK CONSISTS OF STANDARD CHARACTERS WITHOUT CLAIM TO ANY PARTICULAR FONT, STYLE, SIZE, OR COLOR.

OWNER OF U.S. REG. NOS. 2,986,697, 4,120,463 AND OTHERS.

NO CLAIM IS MADE TO THE EXCLUSIVE RIGHT TO USE "STRAWBERRY", APART FROM THE MARK AS SHOWN.

SEC. 2(F) AS TO "TWIZTED".
FOR CANDY (U.S. CL. 46).
FIRST USE 2-28-2007; IN COMMERCE 2-28-2007.
TINA L. SNAPP, EXAMINING ATTORNEY

NO CLAIM IS MADE TO THE EXCLUSIVE RIGHT TO USE THE NON-LATIN CHARACTERS THAT TRANSLITERATE TO "MAI", APART FROM THE MARK AS SHOWN.

THE MARK CONSISTS OF STYLIZED CHINESE CHARACTERS WHICH ARE IN AN IRREGULAR RECTANGLE.

THE ENGLISH TRANSLATION OF "MAI XIANG CUN" IN THE MARK IS "WHEAT FRAGRANT VILLAGE".

THE NON-LATIN CHARACTERS IN THE MARK TRANSLITERATE TO MAI XIANG CUN AND THIS MEANS WHEAT FRAGRANT VILLAGE IN ENGLISH.

FOR BISCUITS; CEREAL BASED SNACK FOOD; COFFEE AND TEA; EDIBLE FLOUR; MACARONI; NOODLES; POWDERED STARCH SYRUP; RICE FLOUR; RICE PUDDING; SPAGHETTI; SUGAR; WHEAT FLOUR (U.S. CL. 46).

FIRST USE 6-17-2009; IN COMMERCE 6-17-2009.
LYDIA BELZER, EXAMINING ATTORNEY

CLASS 30—(Continued).

SN 85-348,667. HANGZHOU WELLONG FOOD CO., LTD., HANGZHOU, ZHEJIANG, CHINA, FILED 6-17-2011.

CLASS 30—(Continued).

SN 85-354,243. HART INDUSTRIES, INC., PUYALLUP, WA. FILED 6-23-2011.

TeaHealthy



THE MARK CONSISTS OF STANDARD CHARACTERS WITHOUT CLAIM TO ANY PARTICULAR FONT, STYLE, SIZE, OR COLOR.

FOR ARTIFICIAL COFFEE AND TEA; BEVERAGES MADE OF TEA; BEVERAGES WITH A TEA BASE; BLACK TEA; CHAI TEA; COFFEE AND TEA; DISPOSABLE CUPS WITH A TEA-FILLED POUCH ULTRASONICALLY WELDED TO ONE SIDE OF THE BOTTOM OF THE CUP, WHICH ALLOWS THE NATURAL FIBER POUCH TO FLOAT NEAR THE BOTTOM; FLAVOURINGS OF TEA; FRUIT TEAS; GINSENG TEA; GREEN TEA; HERB TEA; HERBAL TEA; ICED TEA; INSTANT TEA; JAPANESE GREEN TEA; LIME TEA; MIXES IN THE NATURE OF CONCENTRATES, SYRUPS OR POWDERS USED IN THE PREPARATION OF TEA BASED BEVERAGES; OOLONG TEA; SAGE TEA; SYRUPS FOR MAKING TEA; TEA; TEA BAGS; TEA EXTRACTS; TEA FOR INFUSIONS; TEA OF PARCHED POWDER OF BARLEY WITH HUSK (MUGI-CHA); TEA OF SALTY KELP POWDER (KOMBU-CHA); TEA PODS; TEA SUBSTITUTES; TEA-BASED BEVERAGES; TEA-BASED BEVERAGES WITH FRUIT FLAVORING; THEINE-FREE TEA SWEETENED WITH SWEETENERS (U.S. CL. 46).

FIRST USE 4-1-2011; IN COMMERCE 4-1-2011.
JEFF DEFORD, EXAMINING ATTORNEY

SN 85-358,385. NISSIN FOODS HOLDINGS CO., LTD., OSAKA, JAPAN, FILED 6-28-2011.



NO CLAIM IS MADE TO THE EXCLUSIVE RIGHT TO USE "WHEAT" OR THE NON-LATIN CHARACTERS THAT TRANSLITERATE TO "MAI", APART FROM THE MARK AS SHOWN.

THE MARK CONSISTS OF TWO ENGLISH WORDS "WHEAT VILLAGE" IN THE LEFT WHICH IS SURROUNDED INCOMPLETELY BY DISCONTINUOUS LINES AND THREE CHINESE CHARACTERS IN THE RIGHT WHICH IS SURROUNDED INCOMPLETELY BY TWO WAVED LINES.

THE ENGLISH TRANSLATION OF "MAI TIAN CUN" IN THE MARK IS "WHEAT FIELD VILLAGE".

THE NON-LATIN CHARACTERS IN THE MARK TRANSLITERATE TO MAI TIAN CUN AND THIS MEANS WHEAT FIELD VILLAGE IN ENGLISH.

FOR BISCUITS; CEREAL BASED SNACK FOOD; COFFEE AND TEA; EDIBLE FLOUR; MACARONI; NOODLES; POWDERED STARCH SYRUP; RICE FLOUR; RICE PUDDING; SPAGHETTI; SUGAR; WHEAT FLOUR (U.S. CL. 46).

FIRST USE 6-10-2009; IN COMMERCE 6-10-2009.
LYDIA BELZER, EXAMINING ATTORNEY

OWNER OF U.S. REG. NO. 2,087,260.

THE MARK CONSISTS OF A SEMI-CIRCLE WITH JAPANESE CHARACTERS.

THE NON-LATIN CHARACTERS IN THE MARK TRANSLITERATE TO "NISSIN-NO-DONBEI" AND THIS MEANS "NISSIN'S DONBEI" IN ENGLISH.

FOR NOODLES, INSTANT NOODLES (U.S. CL. 46).
FIRST USE 8-0-1976; IN COMMERCE 8-0-1976.
RON FAIRBANKS, EXAMINING ATTORNEY

CLASS 30—(Continued).

SN 85-366,556. CENTERS, JAMES A., CHARLESTON, IL.
FILED 7-8-2011.



NO CLAIM IS MADE TO THE EXCLUSIVE RIGHT TO USE "WIENER", APART FROM THE MARK AS SHOWN.

THE MARK CONSISTS OF A CIRCLE WITH THE WORDS "BE HAPPY" CURVED TO FIT INSIDE THE TOP OF THE CIRCLE AND THE WORDS "EAT A WIENER" CURVED TO FIT INSIDE THE BOTTOM OF THE CIRCLE. A CARICATURE OF THE HEAD OF A SMALL BOY APPEARS IN THE CENTER OF THE CIRCLE.

FOR HOT DOG SANDWICHES (U.S. CL. 46).
FIRST USE 7-5-2011; IN COMMERCE 7-5-2011.
LESLEY LAMOTHE, EXAMINING ATTORNEY

SN 85-367,796. DEWANE, TERENCE M., NOVATO, CA.
FILED 7-11-2011.

Peloton Coffee Roasters

THE MARK CONSISTS OF STANDARD CHARACTERS WITHOUT CLAIM TO ANY PARTICULAR FONT, STYLE, SIZE, OR COLOR.

NO CLAIM IS MADE TO THE EXCLUSIVE RIGHT TO USE "COFFEE ROASTERS", APART FROM THE MARK AS SHOWN.

FOR COFFEE (U.S. CL. 46).
FIRST USE 1-1-2011; IN COMMERCE 1-1-2011.
SHAUNIA CARLYLE, EXAMINING ATTORNEY

CLASS 30—(Continued).

SN 85-371,529. HSIEH, TSUNG-TSE, TAINAN CITY, TAIWAN, FILED 7-14-2011.



NO CLAIM IS MADE TO THE EXCLUSIVE RIGHT TO USE "TEA SHOP" AND "INTERNATIONAL TEA CHAIN CO. LTD.", APART FROM THE MARK AS SHOWN.

THE MARK CONSISTS OF THE DESIGN OF A SUN WITH THE WORDS "RED SUN TEA SHOP" THEREIN AS WELL AS THE WORDS "RED SUN" WITH THE WORDS "RED SUN INTERNATIONAL TEA CHAIN CO. LTD." UNDERNEATH.

FOR BEER VINEGAR; CHOCOLATE-BASED BEVERAGES; COCOA-BASED BEVERAGES; STARCH-BASED BINDING AGENTS FOR ICE CREAM; CHOCOLATE; CHOCOLATE BEVERAGES WITH MILK; COCOA; COCOA BEVERAGES WITH MILK; COCOA PRODUCTS, NAMELY, COCOA EXTRACTS, COCOA POWDER; ICE CREAM; EDIBLE ICES; FLAVORINGS, OTHER THAN ESSENTIAL OILS, FOR BEVERAGES; FROZEN YOGURT; ICE FOR REFRESHMENT; NATURAL OR ARTIFICIAL ICE; POWDER FOR EDIBLE ICES; PUDDINGS; SHERBETS (U.S. CL. 46).

REBECCA EISINGER, EXAMINING ATTORNEY

SN 85-375,118. TANGERINE CONFECTIONERY LTD.,
BLACKPOOL, UNITED KINGDOM, FILED 7-19-2011.

BUTTERKIST

THE MARK CONSISTS OF STANDARD CHARACTERS WITHOUT CLAIM TO ANY PARTICULAR FONT, STYLE, SIZE, OR COLOR.

OWNER OF ERPN CMNTY TM OFC REG. NO. 7311533, DATED 5-14-2009, EXPIRES 10-14-2018.

FOR CONFECTIONERY, NAMELY, SWEETS, CHOCOLATE, CHOCOLATES, CHEWING GUMS, GUM SWEETS AND SUGAR CONFECTIONERY; CARAMEL COATED POPCORN WITH CANDIED NUTS, FLAVOURED POPCORN, POPCORN, POPPED POPCORN, SALT FOR POPCORN (U.S. CL. 46).

KEVON CHISOLM, EXAMINING ATTORNEY

SN 85-405,132. GARY HIMELFARB, BETHESDA, MD. FILED
8-23-2011.

Doctor Dread

THE MARK CONSISTS OF STANDARD CHARACTERS WITHOUT CLAIM TO ANY PARTICULAR FONT, STYLE, SIZE, OR COLOR.

THE NAME(S), PORTRAIT(S), AND/OR SIGNATURE(S) SHOWN IN THE MARK IDENTIFIES GARY HIMELFARB, WHOSE CONSENT(S) TO REGISTER IS MADE OF RECORD.

FOR SEASONING, RUBS AND SAUCES (U.S. CL. 46).
FIRST USE 1-1-2011; IN COMMERCE 1-1-2011.
ANNE MADDEN, EXAMINING ATTORNEY

CLASS 30—(Continued).

SN 85-426,081. NISSIM, BETTYE LYNN, SANDY SPRINGS, GA. FILED 9-19-2011.



NO CLAIM IS MADE TO THE EXCLUSIVE RIGHT TO USE "AMERICAN" AND "COFFEE", APART FROM THE MARK AS SHOWN.

THE COLOR(S) BROWN, RED, WHITE, BLUE AND YELLOW IS/ARE CLAIMED AS A FEATURE OF THE MARK.

THE MARK CONSISTS OF THE LITERAL ELEMENTS "AMERICAN STAR COFFEE" WRITTEN IN THE COLOR BLACK. ABOVE THE WORDING APPEARS THE DESIGN OF A WHITE SAUCER AND A WHITE CUP FILLED WITH BROWN COFFEE. IN THE CENTER OF THE CUP APPEARS A STAR DESIGN SHOWING AN AMERICAN FLAG IMAGE IN RED AND WHITE COLOR STRIPES WITH WHITE STARS IN THE UPPER LEFT BLUE PORTION OF THE CUP-CENTERED STAR DESIGN. LIGHT BROWN WISPS OF STEAM ARE SHOWN RISING FROM THE COFFEE CUP. THE WORDING AND DESIGN ELEMENTS APPEAR ON A YELLOW BACKGROUND.

FOR COFFEE (U.S. CL. 46).

JOHN DALIER, EXAMINING ATTORNEY

SN 85-437,595. MEGA ALIMENTOS S.A. DE C.V., SANTA CATARINA, N.L., MEXICO, FILED 10-3-2011.



THE COLOR(S) RED, BLUE AND WHITE IS/ARE CLAIMED AS A FEATURE OF THE MARK.

THE MARK CONSISTS OF THE WORDS "STAR VALUE" IN WHICH THE WORD "STAR" IS WRITTEN IN BLUE, "VALUE" IS WRITTEN IN RED WITH THE CUTOUT OF A WHITE STAR DESIGN WITHIN THE "V" THEREOF AND THE WORDS HAVE A RED OBLONG BORDER AROUND THEM.

FOR FLOUR, KETCHUP, MAYONNAISE, MUSTARD, SAUCES, SPICES (U.S. CL. 46).

ASMAT KHAN, EXAMINING ATTORNEY

CLASS 30—(Continued).

SN 85-440,316. 5L BAKING COMPANY, L.L.C., COLLEGE STATION, TX. FILED 10-5-2011.



NO CLAIM IS MADE TO THE EXCLUSIVE RIGHT TO USE "KOLACHE", APART FROM THE MARK AS SHOWN. THE NAME "ROLF" IN THE MARK IDENTIFIES "ROLF" LARSON, A LIVING INDIVIDUAL WHOSE CONSENT IS OF RECORD.

THE MARK CONSISTS OF A DRAWING OF A MAN WEARING A VEST AND LARGE COWBOY HAT RIDING A SMILING, BRIDLED PIG, WITH THE STYLIZED WORD "KOLACHE" POSITIONED TO THE LEFT OF THE DRAWING AND THE STYLIZED WORD "ROLF'S" POSITIONED TO THE RIGHT OF THE DRAWING, THE WORDS "KOLACHE" AND "ROLF'S" ARRANGED IN AN ARCH.

FOR MICROWAVABLE FROZEN KOLACHES AND CINNAMON ROLLS SOLD IN THE FROZEN FOOD SECTION OF GROCERY AND CONVENIENCE STORES (U.S. CL. 46).

STEVEN PEREZ, EXAMINING ATTORNEY

SN 85-440,704. SUGARDADDY'S SUMPTUOUS SWEETIES, LLC, COLUMBUS, OH. FILED 10-6-2011.

THE EDGELESS BROWNIE

THE MARK CONSISTS OF STANDARD CHARACTERS WITHOUT CLAIM TO ANY PARTICULAR FONT, STYLE, SIZE, OR COLOR.

OWNER OF U.S. REG. NO. 3,022,181.

NO CLAIM IS MADE TO THE EXCLUSIVE RIGHT TO USE "BROWNIE", APART FROM THE MARK AS SHOWN.

SEC. 2(F).

FOR BAKERY GOODS (U.S. CL. 46).

FIRST USE 9-0-2005; IN COMMERCE 9-0-2005.

MICHELLE DUBOIS, EXAMINING ATTORNEY

SN 85-443,209. GRUMA CORPORATION, IRVING, TX. FILED 10-10-2011.

LA CIMA

THE MARK CONSISTS OF STANDARD CHARACTERS WITHOUT CLAIM TO ANY PARTICULAR FONT, STYLE, SIZE, OR COLOR.

THE ENGLISH TRANSLATION OF "LA CIMA" IN THE MARK IS "TOP OF THE MOUNTAIN".

FOR TORTILLAS, TORTILLA PRODUCTS, NAMELY, TACO SHELLS, TACO KITS CONSISTING OF TACO SHELLS, TACO SAUCE AND SEASONING, TOSTADAS, GORDITAS, WRAPS, TORTILLA CHIPS, CORN-BASED SNACK FOODS (U.S. CL. 46).

JANICE L. MCMORROW, EXAMINING ATTORNEY

CLASS 30—(Continued).

SN 85-462,554. IBARRA AGUILAR, ALBERTO ARATH, COCULA, JALISCO, MEXICO, FILED 11-2-2011.



THE COLOR(S) GREEN, WHITE, YELLOW, RED, BLACK AND BROWN IS/ARE CLAIMED AS A FEATURE OF THE MARK.

THE MARK CONSISTS OF THE WORDS "CAMPO VERDE" IN WHITE WITH A BLACK OUTLINE, PICTURED ON A DIVIDED GREEN AND YELLOW BACKGROUND IN THE SHAPE OF AN ARCHED RECTANGLE. ABOVE THE WORDING THERE ARE TWO GREEN AND WHITE LEAVES DEPICTED WITH THREE BROWN CIRCLES OUTLINED IN WHITE BELOW THEM. THE GREEN AND YELLOW RECTANGULAR BACKGROUND IS OUTLINED IN WHITE AND BLACK. BELOW THIS ENTIRE DESIGN IS A SOLID RED RECTANGLE. ALL OF THESE ELEMENTS ARE ENCLOSED IN A SQUARE CARRIER OUTLINED IN BLACK WITH RADIATING GREEN LINES DEPICTED OVER A GREEN AND YELLOW BACKGROUND.

THE ENGLISH TRANSLATION OF "CAMPO VERDE" IN THE MARK IS GREEN FIELD.

FOR COFFEE; RICE; SOYA BEAN PASTE; SPICES; SUGAR (U.S. CL. 46).

TINA L. SNAPP, EXAMINING ATTORNEY

CLASS 30—(Continued).

SN 85-470,240. ASIA GOLDEN RICE CO., LTD., CHA-CHEANGSAO 24130, THAILAND, FILED 11-11-2011.



NO CLAIM IS MADE TO THE EXCLUSIVE RIGHT TO USE "SIAM" OR "FINEST RICE" OR THE NON-LATIN CHARACTERS THAT TRANSLITERATE TO TAI HAO MI, APART FROM THE MARK AS SHOWN.

THE MARK CONSISTS OF AN IMAGE OF A BOWL OF RICE WITH A LEAF DESIGN ON THE RIGHT OUTSIDE OF THE BOWL, AND HAVING A DISK PROTRUDING FROM BEHIND THE RICE, THE DISK INCLUDING THE WORDING "SIAM PURICE", AND A LEAF-LIKE DESIGN TO THE LEFT OF THE WORDING, WITH THE WORDS "THE FINEST RICE" APPEARING BENEATH THE LEAF; ON THE RIGHT SIDE OF THE DISK ARE 3 ORIENTAL SYMBOLS.

THE NON-LATIN CHARACTERS IN THE MARK TRANSLITERATE TO "TAI HAO MI" AND THIS MEANS "THAI FINE RICE" IN ENGLISH.

FOR RICE (U.S. CL. 46).

ADA HAN, EXAMINING ATTORNEY

SN 85-467,357. WIESEN, KENNETH, BROOKVILLE, NY, FILED 11-8-2011.

REED'S

THE MARK CONSISTS OF STANDARD CHARACTERS WITHOUT CLAIM TO ANY PARTICULAR FONT, STYLE, SIZE, OR COLOR.

SEC. 2(F).

FOR CANDIES; CANDY; CANDY MINTS; SWEETS (U.S. CL. 46).

PAUL MORENO, EXAMINING ATTORNEY

SN 85-473,415. HAPPY DAY GOURMET, LLC, SALT LAKE CITY, UT, FILED 11-15-2011.

POP ART

THE MARK CONSISTS OF STANDARD CHARACTERS WITHOUT CLAIM TO ANY PARTICULAR FONT, STYLE, SIZE, OR COLOR.

FOR SALTY SNACKS, NAMELY, POPCORN; POPCORN SEASONING, UNPOPPED POPCORN KERNELS; READY TO EAT POPCORN (U.S. CL. 46).

ODESSA BIBBINS, EXAMINING ATTORNEY

CLASS 30—(Continued).

SN 85-483,220. LOAGUE, CYRIL, IRVING, TX. AND GUARDADO, NOEMI, IRVING, TX. FILED 11-30-2011.

DOÑA LUISA'S HOT SAUCE

THE MARK CONSISTS OF STANDARD CHARACTERS WITHOUT CLAIM TO ANY PARTICULAR FONT, STYLE, SIZE, OR COLOR.

NO CLAIM IS MADE TO THE EXCLUSIVE RIGHT TO USE "HOT SAUCE", APART FROM THE MARK AS SHOWN.

THE ENGLISH TRANSLATION OF "DOÑA" IN THE MARK IS "MRS".

FOR HOT SAUCE (U.S. CL. 46).

JACLYN KIDWELL WALKER, EXAMINING ATTORNEY

SN 85-489,357. BENSON'S, INC., BOGART, GA. FILED 12-7-2011.



NO CLAIM IS MADE TO THE EXCLUSIVE RIGHT TO USE "CAKE", APART FROM THE MARK AS SHOWN.

THE MARK CONSISTS OF THE TOP OF A GLASS SODA BOTTLE CAP SHOWING TWO AIR BUBBLES ON THE TOP PORTION AND THE WORDS "SODA SHOP CAKE" ON THE BOTTOM PORTION.

FOR BAKERY GOODS, NAMELY, CAKES WITH VARIOUS BEVERAGE FLAVORS (U.S. CL. 46).

SEAN CROWLEY, EXAMINING ATTORNEY

CLASS 30—(Continued).

SN 85-493,190. GRAND SUPERCENTER INC., LYNDHURST, NJ. FILED 12-12-2011.



NO CLAIM IS MADE TO THE EXCLUSIVE RIGHT TO USE "ORGANIC FARM" AND THE NON-LATIN CHARACTER THAT TRANSLITERATE TO "YU KI NONG JANG", APART FROM THE MARK AS SHOWN.

THE COLOR(S) BLACK, WHITE, GOLD, BROWN, YELLOW IS/ARE CLAIMED AS A FEATURE OF THE MARK.

THE MARK CONSISTS OF AN OVAL DESIGN WITH A BORDER IN THE COLOR GOLD WITH WHITE LINING. A BANNER IN THE COLOR BROWN WITH GOLD EDGES EXTENDS ACROSS AND OVERLAPS A LOWER PORTION OF THE OVAL DESIGN. THE WORDING "ORGANIC FARM" APPEARS IN WHITE LETTERING WITHIN THE BANNER, KOREAN LETTER CHARACTERS IN THE COLOR BLACK ON A WHITE BACKGROUND, APPEAR CENTRALLY WITHIN THE OVAL DESIGN, A FARM HOUSE AND A BARN SCENE FEATURING TREES, SUN, BIRDS, FENCING AND LANDSCAPE IN GOLD AND WHITE ON A WHITE BACKGROUND POSITIONED ABOVE THE BLACK KOREAN LETTER CHARACTERS, A GARLAND, IN THE COLOR YELLOW, APPEARS ON EITHER SIDE OF THE OVAL AND KOREAN LETTER CHARACTERS IN BLACK APPEAR WITHIN THE UPPER PORTION OF THE BORDER.

THE NON-LATIN CHARACTERS WITHIN THE OVAL TRANSLITERATE TO "YU KI NONG JANG", AND THIS MEANS "ORGANIC FARM" IN ENGLISH. THE NON-LATIN CHARACTERS IN THE MARK WITHIN THE TOP BORDER TRANSLITERATE TO "GA GUT HAN JA YEON" AND "KUN KANG HAN SARAM DEOL", AND THIS MEANS "FRESH NATURE" AND "HEALTHY PEOPLE", RESPECTIVELY, IN ENGLISH.

FOR COOKED RICE; RICE; STEAMED RICE; WHOLE-MEAL RICE; ALL OF THE FOREGOING BEING ORGANIC (U.S. CL. 46).

KATHLEEN M. VANSTON, EXAMINING ATTORNEY

SN 85-496,086. SPRINGER, AL, DRIPPING SPRINGS, TX. AND WELCH, TIM, DRIPPING SPRINGS, TX. FILED 12-15-2011.

BLACK TIE

THE MARK CONSISTS OF STANDARD CHARACTERS WITHOUT CLAIM TO ANY PARTICULAR FONT, STYLE, SIZE, OR COLOR.

FOR PASTA; PASTA SAUCE (U.S. CL. 46).

RAMONA ORTIGA, EXAMINING ATTORNEY

CLASS 30—(Continued).

SN 85-501,646. SIMPLYCULTIVATED GROUP, HORSE-HEADS, NY. FILED 12-21-2011.



NO CLAIM IS MADE TO THE EXCLUSIVE RIGHT TO USE "JIRIDEN NATURAL", APART FROM THE MARK AS SHOWN.

THE COLOR(S) WHITE, BLACK, GREEN IS/ARE CLAIMED AS A FEATURE OF THE MARK.

THE MARK CONSISTS OF THE WORDING "JIRIDEN" IN WHITE WITH A GREEN AND WHITE LEAF AS THE "DOT" OVER THE SECOND "I". THE WORDING APPEARS IN A BLACK RECTANGULAR BOX WITH GREEN AND WHITE OUTLINING. THE WORD "NATURAL" APPEARS IN GREEN BELOW THE BLACK RECTANGLE.

THE ENGLISH TRANSLATION OF "JIRIDEN" IN THE MARK IS "FRUIT".

FOR BEVERAGES MADE OF COFFEE; BEVERAGES MADE OF TEA; CAFFEINE-FREE COFFEE; CHOCOLATE; CHOCOLATE AND CHOCOLATES; CHOCOLATE BARK CONTAINING GROUND COFFEE BEANS; CHOCOLATE BARS; CHOCOLATE CANDIES; COCOA; COCOA; COCOA MIXES; COCOA POWDER; COCOA-BASED BEVERAGES; COFFEE; COFFEE; COFFEE AND TEA; COFFEE BEANS; FRUIT TEAS; GINSENG TEA; GREEN TEA; GROUND COFFEE BEANS; HERBAL TEA; HOT CHOCOLATE; ROASTED COFFEE BEANS; TEA; ALL THE ABOVE GOODS MADE IN WHOLE OR SUBSTANTIAL PART OF NATURAL INGREDIENTS (U.S. CL. 46).

ANDREA HACK, EXAMINING ATTORNEY

SN 85-505,318. NGUYEN, JENNY, PERTH, AUSTRALIA, FILED 12-29-2011.

REVIVE COFFEE

THE MARK CONSISTS OF STANDARD CHARACTERS WITHOUT CLAIM TO ANY PARTICULAR FONT, STYLE, SIZE, OR COLOR.

NO CLAIM IS MADE TO THE EXCLUSIVE RIGHT TO USE "COFFEE", APART FROM THE MARK AS SHOWN.

FOR COFFEE; ARTIFICIAL COFFEE; UNROASTED COFFEE; COFFEE BEVERAGES WITH MILK; GROUND COFFEE BEANS; COFFEE SUBSTITUTES; COFFEE-BASED BEVERAGES; COFFEE BEANS (U.S. CL. 46).

JERI J. FICKES, EXAMINING ATTORNEY

CLASS 30—(Continued).

SN 85-506,077. MARIA DE LOURDES SOBRINO, IRVINE, CA. FILED 12-29-2011.

LULU'S DESSERT

THE MARK CONSISTS OF STANDARD CHARACTERS WITHOUT CLAIM TO ANY PARTICULAR FONT, STYLE, SIZE, OR COLOR.

OWNER OF U.S. REG. NO. 3,111,311.

NO CLAIM IS MADE TO THE EXCLUSIVE RIGHT TO USE "DESSERT", APART FROM THE MARK AS SHOWN.

FOR FLAVORED, SWEETENED GELATIN DESSERTS, FLAN, PUDDING, TAPIOCA (U.S. CL. 46).

FIRST USE 7-1-1982; IN COMMERCE 7-1-1982.

SUZANNE BLANE, EXAMINING ATTORNEY

SN 85-511,958. DANNY CASH UNLIMITED, AKA BRANDED SAUCES, ENGLEWOOD, CO. FILED 1-9-2012.

BRANDED SAUCES

THE MARK CONSISTS OF STANDARD CHARACTERS WITHOUT CLAIM TO ANY PARTICULAR FONT, STYLE, SIZE, OR COLOR.

NO CLAIM IS MADE TO THE EXCLUSIVE RIGHT TO USE "SAUCES", APART FROM THE MARK AS SHOWN.

FOR CONDIMENT, NAMELY, PEPPER SAUCE (U.S. CL. 46).

FIRST USE 1-1-2008; IN COMMERCE 1-1-2008.

SUSAN LESLIE DUBOIS, EXAMINING ATTORNEY

SN 85-515,000. CLR ROASTERS LLC, MIAMI, FL. FILED 1-12-2012.

CAFÉ ALMA

THE MARK CONSISTS OF STANDARD CHARACTERS WITHOUT CLAIM TO ANY PARTICULAR FONT, STYLE, SIZE, OR COLOR.

NO CLAIM IS MADE TO THE EXCLUSIVE RIGHT TO USE "CAFÉ", APART FROM THE MARK AS SHOWN.

THE ENGLISH TRANSLATION OF "ALMA" IN THE MARK IS "SOUL".

FOR COFFEE BEANS; GROUND COFFEE BEANS; ROASTED COFFEE BEANS (U.S. CL. 46).

DAVID TAYLOR, EXAMINING ATTORNEY

CLASS 30—(Continued).

SN 85-517,689. ACE BAKERY, LLC, BROWNSBURG, IN.
FILED 1-17-2012.

RIVER ROAD BAKEHOUSE

THE MARK CONSISTS OF STANDARD CHARACTERS
WITHOUT CLAIM TO ANY PARTICULAR FONT, STYLE,
SIZE, OR COLOR.

NO CLAIM IS MADE TO THE EXCLUSIVE RIGHT TO
USE "BAKEHOUSE", APART FROM THE MARK AS
SHOWN.

FOR BAKERY PRODUCTS INCLUDING BREAD (U.S.
CL. 46).

GENE MACIOL, EXAMINING ATTORNEY

SN 85-517,980. KRISTIAN REGALE, INC., PARAMUS, NJ.
FILED 1-17-2012.

KRISTIAN REGALE

THE MARK CONSISTS OF STANDARD CHARACTERS
WITHOUT CLAIM TO ANY PARTICULAR FONT, STYLE,
SIZE, OR COLOR.

OWNER OF U.S. REG. NO. 3,212,987.

THE NAME, "KRISTIAN REGALE", SHOWN IN THE
MARK DOES NOT IDENTIFY A PARTICULAR LIVING
INDIVIDUAL.

FOR TEA-BASED BEVERAGES (U.S. CL. 46).

BARBARA A. GOLD, EXAMINING ATTORNEY

SN 85-518,439. ALOHA HAWAIIAN STORES, INC., KAILUA
KONA, HI. FILED 1-17-2012.

NUMB NUTS

THE MARK CONSISTS OF STANDARD CHARACTERS
WITHOUT CLAIM TO ANY PARTICULAR FONT, STYLE,
SIZE, OR COLOR.

FOR CHOCOLATE COVERED NUTS, CANDIES, AND
CRACKERS. ALL WITH HOT OR SPICY FLAVORINGS
ADDED (U.S. CL. 46).

FIRST USE 1-17-2012; IN COMMERCE 1-17-2012.

CHRISTINE MARTIN, EXAMINING ATTORNEY

CLASS 30—(Continued).

SN 85-518,803. DIZZY WHIZZ, INC., LOUISVILLE, KY.
FILED 1-18-2012.

WHIZZBURGER

THE MARK CONSISTS OF STANDARD CHARACTERS
WITHOUT CLAIM TO ANY PARTICULAR FONT, STYLE,
SIZE, OR COLOR.

FOR SANDWICHES, NAMELY, HAMBURGERS AND
CHEESEBURGERS (U.S. CL. 46).

FIRST USE 12-31-1951; IN COMMERCE 12-31-1951.

KAELIE KUNG, EXAMINING ATTORNEY

SN 85-522,561. GOODWIN, DAVID, AMARILLO, TX. FILED
1-23-2012.

**GOODY'S WORLD FAMOUS
POPCORN**

THE MARK CONSISTS OF STANDARD CHARACTERS
WITHOUT CLAIM TO ANY PARTICULAR FONT, STYLE,
SIZE, OR COLOR.

NO CLAIM IS MADE TO THE EXCLUSIVE RIGHT TO
USE "WORLD FAMOUS POPCORN", APART FROM THE
MARK AS SHOWN.

FOR POPCORN (U.S. CL. 46).

FIRST USE 1-3-2012; IN COMMERCE 1-3-2012.

ROBERT C. CLARK JR., EXAMINING ATTORNEY

SN 85-524,716. GRUMA CORPORATION, IRVING, TX.
FILED 1-25-2012.



OWNER OF U.S. REG. NOS. 1,216,032, 3,897,072 AND
OTHERS.

THE MARK CONSISTS OF THE WORD "MISSION" IN A
RECTANGLE DESIGN. BELOW THE RECTANGLE CON-
TAINING THE WORD "MISSION" IS A BANNER DESIGN
STARTING FROM UNDERNEATH THE LEFT HAND SIDE
OF THE RECTANGLE AND ENDING JUST PAST THE
RIGHT HAND END CORNER OF THE RECTANGLE.
ABOVE THE RECTANGLE IS AN ARCH DESIGN CON-
TAINING A BELL IN AN OPENING WITH A FLOWER-
LIKE DESIGN ON EITHER SIDE OF THE OPENING.

FOR TACO SHELLS (U.S. CL. 46).

FIRST USE 2-0-2011; IN COMMERCE 2-0-2011.

MAUREEN DALL, EXAMINING ATTORNEY

CLASS 30—(Continued).

SN 85-524,747. CHATEAU POE, LLC, BEAVERTON, OR.
FILED 1-25-2012.

SMOKEY POE'S BBQ SAUCE

THE MARK CONSISTS OF STANDARD CHARACTERS WITHOUT CLAIM TO ANY PARTICULAR FONT, STYLE, SIZE, OR COLOR.

NO CLAIM IS MADE TO THE EXCLUSIVE RIGHT TO USE "BBQ SAUCE", APART FROM THE MARK AS SHOWN.

FOR BARBEQUE SAUCE (U.S. CL. 46).
FIRST USE 1-1-2012; IN COMMERCE 1-1-2012.
ELLEN B. AWRICH, EXAMINING ATTORNEY

SN 85-524,755. GRUMA CORPORATION, IRVING, TX.
FILED 1-25-2012.



OWNER OF U.S. REG. NOS. 1,216,032, 3,897,072 AND OTHERS.

THE MARK CONSISTS OF THE WORD "MISSION" IN A RECTANGLE DESIGN. BELOW THE RECTANGLE CONTAINING THE WORD "MISSION" IS A TWO-PART BANNER DESIGN STARTING FROM UNDERNEATH THE LEFT HAND SIDE OF THE RECTANGLE AND ENDING JUST PAST THE RIGHT HAND END CORNER OF THE RECTANGLE. ABOVE THE RECTANGLE IS AN ARCH DESIGN CONTAINING A BELL IN AN OPENING WITH A FLOWER-LIKE DESIGN ON EITHER SIDE OF THE OPENING.

FOR TACO SHELLS (U.S. CL. 46).
FIRST USE 2-0-2011; IN COMMERCE 2-0-2011.
MAUREEN DALL, EXAMINING ATTORNEY

CLASS 30—(Continued).

SN 85-525,168. GOYA FOODS, INC., SECAUCUS, NJ. FILED
1-25-2012.

GOYA FOR KIDS

THE MARK CONSISTS OF STANDARD CHARACTERS WITHOUT CLAIM TO ANY PARTICULAR FONT, STYLE, SIZE, OR COLOR.

OWNER OF U.S. REG. NOS. 764,033, 966,178 AND OTHERS.

NO CLAIM IS MADE TO THE EXCLUSIVE RIGHT TO USE "FOR KIDS", APART FROM THE MARK AS SHOWN.

FOR ALIMENTARY PASTE (PASTAS AND NOODLES); BAKERY GOODS; BAKERY PRODUCTS; BARBECUE SAUCE; BISCUITS AND BREAD; BREADCRUMBS; BURRITOS; CANDY; CAPERS; CEREAL BASED SNACK FOOD; CHILI SAUCE; CHILI SEASONING; CHIMICHURRI SAUCE; CHOCOLATE; COCOA; COFFEE; COOKIES; CORN CHIPS; CORN FLOUR; CORN FRITTERS; CORN MEAL; CRACKERS; CUSTARD; DRY SEASONING MIXES FOR HISPANIC STYLE FOODS; EMPANADAS; ENCHILADAS; EXTRACTS USED AS FLAVORING; FAJITAS; FLAVORED, SWEETENED GELATIN DESSERTS; FLAVORING SYRUP; FLOUR; FOOD STARCH; FROZEN CONFECTIONS; GRAIN-BASED FOOD BEVERAGES; HOMINY; HONEY; HOT CHILI PEPPER SAUCE; HOT PEPPER POWDER; HOT SAUCE; KETCHUP; MARINADE MIXES; MARINADES; MINCED GARLIC; MIXES FOR BAKERY GOODS; NOODLES; NOODLES AND SAUCE MIXES COMBINED IN UNITARY PACKAGES; PACKAGED MEAL MIXES CONSISTING PRIMARILY OF PASTA OR RICE; PEPPER; PICANTE SAUCE; PICO DE GALLO SAUCE; PROCESSED GARLIC FOR USE AS SEASONING; RICE; RICE AND SEASONING MIX COMBINED IN UNITARY PACKAGES; SALAD DRESSING; SALSA; SALT; SAUCES; SEASONING MIXES; SEASONINGS; SPICE BLENDS; SPICES; TABLE SYRUP; TACO CHIPS; TACO SEASONING; TAMALES; TAPIOCA; TOMATO SAUCE; TORTILLA CHIPS; TORTILLA SHELLS; TORTILLAS; TREACLE; VINEGAR; WINE VINEGAR; YEAST; FROZEN, PREPARED OR PACKAGED ENTREES CONSISTING PRIMARILY OF PASTA OR RICE (U.S. CL. 46).

KATHLEEN LORENZO, EXAMINING ATTORNEY

SN 85-530,139. COOPER, ALLEN, POWELL, WY. FILED 1-31-2012.

Beaver Coffee Company

THE MARK CONSISTS OF STANDARD CHARACTERS WITHOUT CLAIM TO ANY PARTICULAR FONT, STYLE, SIZE, OR COLOR.

NO CLAIM IS MADE TO THE EXCLUSIVE RIGHT TO USE "COFFEE COMPANY", APART FROM THE MARK AS SHOWN.

FOR COFFEE AND TEA (U.S. CL. 46).
FIRST USE 2-16-2012; IN COMMERCE 4-26-2012.
BRIDGETT SMITH, EXAMINING ATTORNEY

CLASS 30—(Continued).

SN 85-530,690. URBAN BELLY, LLC, LINCOLNSHIRE, IL. FILED 2-1-2012.

BELLY FIRE

THE MARK CONSISTS OF STANDARD CHARACTERS WITHOUT CLAIM TO ANY PARTICULAR FONT, STYLE, SIZE, OR COLOR.
FOR SAUCES (U.S. CL. 46).
DEBORAH LOBO, EXAMINING ATTORNEY

SN 85-530,709. URBAN BELLY, LLC, LINCOLNSHIRE, IL. FILED 2-1-2012.

BELLY BOMB

THE MARK CONSISTS OF STANDARD CHARACTERS WITHOUT CLAIM TO ANY PARTICULAR FONT, STYLE, SIZE, OR COLOR.
FOR SAUCES (U.S. CL. 46).
DEBORAH LOBO, EXAMINING ATTORNEY

SN 85-530,933. EARTHGRAINS BAKING COMPANIES, INC., DOWNERS GROVE, IL. FILED 2-1-2012.

SO GOOD, IT'S GONE

THE MARK CONSISTS OF STANDARD CHARACTERS WITHOUT CLAIM TO ANY PARTICULAR FONT, STYLE, SIZE, OR COLOR.
FOR BAKERY PRODUCTS (U.S. CL. 46).
FRANK LATTUCA, EXAMINING ATTORNEY

SN 85-531,071. HEB GROCERY COMPANY, LP, SAN ANTONIO, TX. FILED 2-1-2012.

CHEWOMP!

THE MARK CONSISTS OF STANDARD CHARACTERS WITHOUT CLAIM TO ANY PARTICULAR FONT, STYLE, SIZE, OR COLOR.
FOR CANDY BARS (U.S. CL. 46).
ANGELA M. MICHELI, EXAMINING ATTORNEY

CLASS 30—(Continued).

SN 85-531,437. JAMARA LICENSING, LLC, CAMARILLO, CA. FILED 2-1-2012.

Amoretti

OWNER OF U.S. REG. NOS. 1,659,954, 2,586,461 AND OTHERS.
THE MARK CONSISTS OF "AMORETTI" IN STYLIZED FORM.

THE ENGLISH TRANSLATION OF "AMORETTI" IN THE MARK IS "LITTLE LOVE".
FOR FLAVORING SYRUPS; VINEGAR; VINAIGRETTE (U.S. CL. 46).
FIRST USE 3-22-2011; IN COMMERCE 3-22-2011.
LAURIE KAUFMAN, EXAMINING ATTORNEY

SN 85-531,765. MJ7 TRADE LLC, PHILADELPHIA, PA. FILED 2-2-2012.

MAD JET-7

THE MARK CONSISTS OF STANDARD CHARACTERS WITHOUT CLAIM TO ANY PARTICULAR FONT, STYLE, SIZE, OR COLOR.
FOR CANDY (U.S. CL. 46).
GISELLE AGOSTO, EXAMINING ATTORNEY

SN 85-531,786. SCHOENING, MICHAEL, WALDFEUCHT, FED REP GERMANY, FILED 2-2-2012.

ALMOOZ

THE MARK CONSISTS OF STANDARD CHARACTERS WITHOUT CLAIM TO ANY PARTICULAR FONT, STYLE, SIZE, OR COLOR.
FOR COOKIES (U.S. CL. 46).
JEFFREY LOOK, EXAMINING ATTORNEY

CLASS 30—(Continued).

SN 85-531,949. COLEMAN, CHRISTINE, DBA BUDDHA'S SANCTUARY, HULUALOA, HI. FILED 2-2-2012.

BUDDHA'S CUP

THE MARK CONSISTS OF STANDARD CHARACTERS WITHOUT CLAIM TO ANY PARTICULAR FONT, STYLE, SIZE, OR COLOR.

FOR COFFEE (U.S. CL. 46).
FIRST USE 10-0-2004; IN COMMERCE 10-0-2004.
JAY FLOWERS, EXAMINING ATTORNEY



SN 85-532,265. SOUTHERN CLASSIC FOOD GROUP, LLC, BRUNDIDGE, AL. FILED 2-2-2012.



THE COLOR(S) GREEN, WHITE, YELLOW AND BLACK IS/ARE CLAIMED AS A FEATURE OF THE MARK.

THE MARK CONSISTS OF THE ARTISTIC RENDERING OF A MAGNOLIA IN GREEN, WHITE, YELLOW AND BLACK.

FOR MAYONNAISE, SALAD DRESSINGS, BARBEQUE SAUCE, HONEY MUSTARD SAUCE, TARTAR SAUCE, COCKTAIL SAUCE (U.S. CL. 46).

FIRST USE 0-0-2001; IN COMMERCE 0-0-2001.
KATHLEEN M. VANSTON, EXAMINING ATTORNEY



SN 85-532,338. ANDREA K. PEDERSEN, PALATINE, IL. FILED 2-2-2012.

Chocolasses

THE MARK CONSISTS OF STANDARD CHARACTERS WITHOUT CLAIM TO ANY PARTICULAR FONT, STYLE, SIZE, OR COLOR.

FOR FLAVORINGS, NAMELY, MOLASSES BASED SYRUPS AND POWDERS USED TO FLAVOR WATER, DAIRY PRODUCTS, COFFEES, TEAS, SOFT DRINKS, LIQUOR, FOODS AND PASTRIES (U.S. CL. 46).
ANDREA HACK, EXAMINING ATTORNEY

CLASS 30—(Continued).

SN 85-532,349. ANDREA K. PEDERSEN, PALATINE, IL. FILED 2-2-2012.

Cocolasses

THE MARK CONSISTS OF STANDARD CHARACTERS WITHOUT CLAIM TO ANY PARTICULAR FONT, STYLE, SIZE, OR COLOR.

FOR FLAVORINGS, NAMELY, MOLASSES BASED SYRUPS AND POWDERS USED TO FLAVOR WATER, DAIRY PRODUCTS, COFFEES, TEAS, SOFT DRINKS, LIQUOR, FOODS AND PASTRIES (U.S. CL. 46).
ANDREA HACK, EXAMINING ATTORNEY



SN 85-532,430. MCILHENNY COMPANY, AVERY ISLAND, LA. FILED 2-2-2012.

ARE YOU ONE OF US?

THE MARK CONSISTS OF STANDARD CHARACTERS WITHOUT CLAIM TO ANY PARTICULAR FONT, STYLE, SIZE, OR COLOR.

FOR CONDIMENTS, NAMELY PEPPER SAUCE (U.S. CL. 46).
BRIAN NEVILLE, EXAMINING ATTORNEY



SN 85-532,477. HEB GROCERY COMPANY, LP, SAN ANTONIO, TX. FILED 2-2-2012.

That's the way the Kooky crumbles

THE MARK CONSISTS OF STANDARD CHARACTERS WITHOUT CLAIM TO ANY PARTICULAR FONT, STYLE, SIZE, OR COLOR.

FOR CANDY BARS (U.S. CL. 46).
ANGELA M. MICHELI, EXAMINING ATTORNEY

CLASS 30—(Continued).

SN 85-532,491. HEB GROCERY COMPANY, LP, SAN ANTONIO, TX. FILED 2-2-2012.

A real Cloud pleaser

THE MARK CONSISTS OF STANDARD CHARACTERS WITHOUT CLAIM TO ANY PARTICULAR FONT, STYLE, SIZE, OR COLOR.

FOR CANDY BARS (U.S. CL. 46).
ANGELA M. MICHELI, EXAMINING ATTORNEY



SN 85-532,627. MICHAEL WARD, ELMHURST, IL. FILED 2-2-2012.

Teaconut

THE MARK CONSISTS OF STANDARD CHARACTERS WITHOUT CLAIM TO ANY PARTICULAR FONT, STYLE, SIZE, OR COLOR.

FOR BEVERAGES MADE OF TEA (U.S. CL. 46).
FLORENTINA BLANDU, EXAMINING ATTORNEY



SN 85-532,978. ERNESTINE'S FOOD GALLERY, HAMMOND, IN. FILED 2-3-2012.

ERNESTINE'S

THE MARK CONSISTS OF STANDARD CHARACTERS WITHOUT CLAIM TO ANY PARTICULAR FONT, STYLE, SIZE, OR COLOR.

FOR BAKERY DESSERTS (U.S. CL. 46).
SUE LAWRENCE, EXAMINING ATTORNEY



SN 85-533,284. GIT-R-DONE PRODUCTIONS, INC., ATLANTA, GA. FILED 2-3-2012.

LARRY THE CABLE GUY

THE MARK CONSISTS OF STANDARD CHARACTERS WITHOUT CLAIM TO ANY PARTICULAR FONT, STYLE, SIZE, OR COLOR.

FOR BREAD MIXES (U.S. CL. 46).
FIRST USE 9-30-2011; IN COMMERCE 9-30-2011.
GIANCARLO CASTRO, EXAMINING ATTORNEY

CLASS 30—(Continued).

SN 85-533,312. GIT-R-DONE PRODUCTIONS, INC., ATLANTA, GA. FILED 2-3-2012.

LARRY THE CABLE GUY

THE MARK CONSISTS OF STANDARD CHARACTERS WITHOUT CLAIM TO ANY PARTICULAR FONT, STYLE, SIZE, OR COLOR.

FOR CORN BREAD; MUFFIN MIXES (U.S. CL. 46).
FIRST USE 9-30-2011; IN COMMERCE 9-30-2011.
GIANCARLO CASTRO, EXAMINING ATTORNEY



SN 85-533,338. GIT-R-DONE PRODUCTIONS, INC., ATLANTA, GA. FILED 2-3-2012.

LARRY THE CABLE GUY

THE MARK CONSISTS OF STANDARD CHARACTERS WITHOUT CLAIM TO ANY PARTICULAR FONT, STYLE, SIZE, OR COLOR.

FOR MEAL KITS CONSISTING PRIMARILY OF NOODLES; PACKAGED MEAL KITS CONSISTING PRIMARILY OF PASTA OR RICE; PACKAGED MEAL MIXES CONSISTING PRIMARILY OF PASTA OR RICE (U.S. CL. 46).

FIRST USE 9-30-2011; IN COMMERCE 9-30-2011.
GIANCARLO CASTRO, EXAMINING ATTORNEY



SN 85-533,356. GIT-R-DONE PRODUCTIONS, INC., ATLANTA, GA. FILED 2-3-2012.

LARRY THE CABLE GUY

THE MARK CONSISTS OF STANDARD CHARACTERS WITHOUT CLAIM TO ANY PARTICULAR FONT, STYLE, SIZE, OR COLOR.

FOR MIXES FOR MAKING BATTERS FOR FRIED FOODS (U.S. CL. 46).
FIRST USE 9-30-2011; IN COMMERCE 9-30-2011.
GIANCARLO CASTRO, EXAMINING ATTORNEY

CLASS 30—(Continued).

SN 85-533,546. WM. WRIGLEY JR. COMPANY, CHICAGO, IL. FILED 2-3-2012.



THE MARK CONSISTS OF THE HORIZONTAL SILHOUETTE OF AN APPLE AND COFFEE-TO-GO-CUP. FOR CHEWING GUM (U.S. CL. 46).
MARK RADEMACHER, EXAMINING ATTORNEY

CLASS 30—(Continued).

SN 85-534,682. AMPC, INC., AMES, IA. FILED 2-6-2012.

FLAVORONE

THE MARK CONSISTS OF STANDARD CHARACTERS WITHOUT CLAIM TO ANY PARTICULAR FONT, STYLE, SIZE, OR COLOR.

FOR EXTRACTS USED AS FLAVORING; FLAVORING ADDITIVES FOR NON-NUTRITIONAL PURPOSES (U.S. CL. 46).

IRA J. GOODSaid, EXAMINING ATTORNEY

SN 85-533,725. VIRGINIA WILLIS CULINARY PRODUCTIONS, LLC, DBA MY SOUTHERN PANTRY, ATLANTA, GA. FILED 2-3-2012.

My Southern Pantry

THE MARK CONSISTS OF STANDARD CHARACTERS WITHOUT CLAIM TO ANY PARTICULAR FONT, STYLE, SIZE, OR COLOR.

FOR GRITS; MIXES FOR BAKERY GOODS; SALT; SEASONING MIXES; SPICE RUBS (U.S. CL. 46).

FIRST USE 6-9-2010; IN COMMERCE 11-1-2010.
ANDREA HACK, EXAMINING ATTORNEY

SN 85-534,720. CARGO MANAGEMENT ENTERPRISES, INC., DBA THE SOIREE COMPANY, CLIFTON, NJ. FILED 2-6-2012.

INTICE

THE MARK CONSISTS OF STANDARD CHARACTERS WITHOUT CLAIM TO ANY PARTICULAR FONT, STYLE, SIZE, OR COLOR.

FOR FLAVORED WATER PROVIDED IN FREEZABLE CONTAINERS FOR MAKING ICE (U.S. CL. 46).

WANDA KAY PRICE, EXAMINING ATTORNEY

SN 85-534,492. SCHWAN'S IP, LLC, MARSHALL, MN. FILED 2-6-2012.

SASQUATCH

THE MARK CONSISTS OF STANDARD CHARACTERS WITHOUT CLAIM TO ANY PARTICULAR FONT, STYLE, SIZE, OR COLOR.

FOR PIZZA (U.S. CL. 46).

LESLEY LAMOTHE, EXAMINING ATTORNEY

SN 85-534,789. PROCULINE, INC., NEWARK, DE. FILED 2-6-2012.

STANZA

THE MARK CONSISTS OF STANDARD CHARACTERS WITHOUT CLAIM TO ANY PARTICULAR FONT, STYLE, SIZE, OR COLOR.

FOR COFFEE, TEA, BAKERY PRODUCTS, PASTRIES, CONFECTIONARY PRODUCTS, NAMELY BAKERY DESSERTS, CANDY AND FROZEN CONFECTIONS; CHOCOLATES AND BONBONS (U.S. CL. 46).

MORGAN WYNNE, EXAMINING ATTORNEY

CLASS 30—(Continued).

SN 85-535,348. AOBA BIOTECH CORPORATION, TAOYUAN COUNTY, TAIWAN, FILED 2-6-2012.

AOBA

THE MARK CONSISTS OF STANDARD CHARACTERS WITHOUT CLAIM TO ANY PARTICULAR FONT, STYLE, SIZE, OR COLOR.

FOR BEVERAGES MADE OF TEA; FRUIT TEAS; GINSENG TEA; GREEN TEA; HERB TEA; ICED TEA; OOLONG TEA; TEA; TEA BAGS; TEA-BASED BEVERAGES (U.S. CL. 46).

EMILY CARLSEN, EXAMINING ATTORNEY

CLASS 30—(Continued).

SN 85-536,127. KRYSTAL TRADEMARK COMPANY, LAS VEGAS, NV. FILED 2-7-2012.

CORN PUP

THE MARK CONSISTS OF STANDARD CHARACTERS WITHOUT CLAIM TO ANY PARTICULAR FONT, STYLE, SIZE, OR COLOR.

OWNER OF U.S. REG. NO. 1,809,407.

NO CLAIM IS MADE TO THE EXCLUSIVE RIGHT TO USE "CORN", APART FROM THE MARK AS SHOWN. SEC. 2(F).

FOR MINIATURE FRANKFURTERS, ENCASED IN A BREAD CRUST ON A STICK (U.S. CL. 46).

FIRST USE 3-30-1992; IN COMMERCE 3-30-1992.

BRIAN CALLAGHAN, EXAMINING ATTORNEY

SN 85-535,763. POPPER FOODS LLC, LAS VEGAS, NV. FILED 2-7-2012.

SUSHI POPPER

THE MARK CONSISTS OF STANDARD CHARACTERS WITHOUT CLAIM TO ANY PARTICULAR FONT, STYLE, SIZE, OR COLOR.

NO CLAIM IS MADE TO THE EXCLUSIVE RIGHT TO USE "SUSHI", APART FROM THE MARK AS SHOWN.

FOR SUSHI (U.S. CL. 46).

FIRST USE 3-22-2009; IN COMMERCE 7-2-2009.

MARK SHINER, EXAMINING ATTORNEY

SN 85-536,255. KRYSTAL TRADEMARK COMPANY, LAS VEGAS, NV. FILED 2-7-2012.

CHIK

THE MARK CONSISTS OF STANDARD CHARACTERS WITHOUT CLAIM TO ANY PARTICULAR FONT, STYLE, SIZE, OR COLOR.

OWNER OF U.S. REG. NOS. 2,232,312 AND 2,535,180.

SEC. 2(F).

FOR SPECIALLY PREPARED SANDWICHES (U.S. CL. 46).

FIRST USE 3-30-1998; IN COMMERCE 3-30-1998.

BRIAN CALLAGHAN, EXAMINING ATTORNEY

SN 85-535,921. THE SNACK FACTORY, INC., PRINCETON, NJ. FILED 2-7-2012.

PC JUNIORS

THE MARK CONSISTS OF STANDARD CHARACTERS WITHOUT CLAIM TO ANY PARTICULAR FONT, STYLE, SIZE, OR COLOR.

FOR PRETZEL CRACKERS (U.S. CL. 46).

VERNA BETH RIRIE, EXAMINING ATTORNEY

SN 85-536,448. FINALLY FOODS, LLC, TEANECK, NJ. FILED 2-7-2012.

FINALLY

THE MARK CONSISTS OF STANDARD CHARACTERS WITHOUT CLAIM TO ANY PARTICULAR FONT, STYLE, SIZE, OR COLOR.

FOR BAKERY GOODS; CHOCOLATE (U.S. CL. 46).

THEODORE MCBRIDE, EXAMINING ATTORNEY

CLASS 30—(Continued).

SN 85-536,520. 40 DAYS, LLC, ROGERS, AR. FILED 2-7-2012.

Continental Divide

THE MARK CONSISTS OF STANDARD CHARACTERS WITHOUT CLAIM TO ANY PARTICULAR FONT, STYLE, SIZE, OR COLOR.
FOR COFFEE (U.S. CL. 46).
FIRST USE 8-1-2011; IN COMMERCE 11-15-2011.
ALLISON SCHRODY, EXAMINING ATTORNEY

SN 85-536,890. CEREALS Y PASTAS, S.A. DE C.V., CELAYA GUANJUATO, MEXICO, FILED 2-8-2012.

GOLDEN FIT

THE MARK CONSISTS OF STANDARD CHARACTERS WITHOUT CLAIM TO ANY PARTICULAR FONT, STYLE, SIZE, OR COLOR.
OWNER OF MEXICO REG. NO. 1233975, DATED 4-6-2011, EXPIRES 4-6-2021.
FOR PROCESSED CEREAL-BASED FOOD TO BE USED AS A BREAKFAST FOOD, SNACK FOOD OR INGREDIENT FOR MAKING OTHER FOODS (U.S. CL. 46).
LINDA POWELL, EXAMINING ATTORNEY

SN 85-536,913. INDIANA SUGARS, INC., GARY, IN. FILED 2-8-2012.

MILLIANA

THE MARK CONSISTS OF STANDARD CHARACTERS WITHOUT CLAIM TO ANY PARTICULAR FONT, STYLE, SIZE, OR COLOR.
FOR BROWN SUGAR; POWDERED SUGAR; SUGAR (U.S. CL. 46).
FIRST USE 1-1-1985; IN COMMERCE 1-1-1985.
GINA FINK, EXAMINING ATTORNEY

CLASS 30—(Continued).

SN 85-537,186. HARRIS TEETER, INC., MATTHEWS, NC. FILED 2-8-2012.

CHILLY VANILLY

THE MARK CONSISTS OF STANDARD CHARACTERS WITHOUT CLAIM TO ANY PARTICULAR FONT, STYLE, SIZE, OR COLOR.
FOR ICE CREAM (U.S. CL. 46).
SALLY SHIH, EXAMINING ATTORNEY

SN 85-537,637. THE ASHLAND CUPCAKE CAR, ASHLAND, VA. FILED 2-8-2012.

**"Taste the Creamy Center
of the Universe!"**

THE MARK CONSISTS OF STANDARD CHARACTERS WITHOUT CLAIM TO ANY PARTICULAR FONT, STYLE, SIZE, OR COLOR.
FOR CUP CAKES (U.S. CL. 46).
FIRST USE 9-19-2011; IN COMMERCE 9-19-2011.
CHRISIE B. KING, EXAMINING ATTORNEY

SN 85-538,002. LITTLE ANGELS, LLC, NEW YORK, NY. FILED 2-9-2012.



THE MARK CONSISTS OF DEPICTIONS OF EIGHT ANGELS WITH HALOS AND WINGS AND TWO CHILDREN ALL WITHIN A CLOUD.
FOR CONFECTIONERY, NAMELY, CANDY; ICE CREAM, CRACKERS, COOKIES (U.S. CL. 46).
ELIZABETH KAJUBI, EXAMINING ATTORNEY

CLASS 30—(Continued).

SN 85-538,160. FULL CIRCLE EXCHANGE, LLC, EAGLE, ID.
FILED 2-9-2012.

CAN CHOCOLATE CHANGE THE
WORLD?

THE MARK CONSISTS OF STANDARD CHARACTERS WITHOUT CLAIM TO ANY PARTICULAR FONT, STYLE, SIZE, OR COLOR.

FOR BLACK TEA; CAFFEINE-FREE COFFEE; CHAI TEA; CHOCOLATE; CHOCOLATE AND CHOCOLATES; CHOCOLATE BARK CONTAINING GROUND COFFEE BEANS; CHOCOLATE BARS; CHOCOLATE CANDIES; CHOCOLATE COVERED FRUIT; CHOCOLATE COVERED NUTS; CHOCOLATE COVERED ROASTED COFFEE BEANS; CHOCOLATE POWDER; CHOCOLATES AND CHOCOLATE BASED READY TO EAT CANDIES AND SNACKS; COFFEE; COFFEE AND TEA; COFFEE BEANS; CONFECTIONERIES, NAMELY, SNACK FOODS, NAMELY, CHOCOLATE; FILLED CHOCOLATE; FRUIT TEAS; GREEN TEA; GROUND COFFEE BEANS; HOT CHOCOLATE; ICED COFFEE; ICED TEA; INSTANT COFFEE; INSTANT TEA; JAPANESE GREEN TEA; MILK CHOCOLATE; OOLONG TEA; ROASTED COFFEE BEANS; SAGE TEA; SNACK FOODS, NAMELY, CHOCOLATE-BASED SNACK FOODS; SUGAR-COATED COFFEE BEANS; TEA; TEA BAGS; TEA EXTRACTS; TEA FOR INFUSIONS; UNROASTED COFFEE (U.S. CL. 46).

FIRST USE 10-15-2009; IN COMMERCE 10-15-2009.
NAAKWAMA ANKRAH, EXAMINING ATTORNEY

SN 85-538,169. FULL CIRCLE EXCHANGE, LLC, EAGLE, ID.
FILED 2-9-2012.

IS YOUR CHOCOLATE FREE?

THE MARK CONSISTS OF STANDARD CHARACTERS WITHOUT CLAIM TO ANY PARTICULAR FONT, STYLE, SIZE, OR COLOR.

FOR BLACK TEA; CAFFEINE-FREE COFFEE; CHAI TEA; CHOCOLATE; CHOCOLATE AND CHOCOLATES; CHOCOLATE BARK CONTAINING GROUND COFFEE BEANS; CHOCOLATE BARS; CHOCOLATE CANDIES; CHOCOLATE COVERED FRUIT; CHOCOLATE COVERED NUTS; CHOCOLATE COVERED ROASTED COFFEE BEANS; CHOCOLATE POWDER; CHOCOLATES AND CHOCOLATE BASED READY TO EAT CANDIES AND SNACKS; COFFEE; COFFEE AND TEA; COFFEE BEANS; CONFECTIONERIES, NAMELY, SNACK FOODS, NAMELY, CHOCOLATE; FILLED CHOCOLATE; FRUIT TEAS; GREEN TEA; GROUND COFFEE BEANS; HOT CHOCOLATE; ICED COFFEE; ICED TEA; INSTANT COFFEE; INSTANT TEA; JAPANESE GREEN TEA; MILK CHOCOLATE; OOLONG TEA; ROASTED COFFEE BEANS; SAGE TEA; SNACK FOODS, NAMELY, CHOCOLATE-BASED SNACK FOODS; SUGAR-COATED COFFEE BEANS; TEA; TEA BAGS; TEA EXTRACTS; TEA FOR INFUSIONS; UNROASTED COFFEE (U.S. CL. 46).

FIRST USE 10-15-2009; IN COMMERCE 10-15-2009.
NAAKWAMA ANKRAH, EXAMINING ATTORNEY

CLASS 30—(Continued).

SN 85-538,349. HINT MINT, INC., LOS ANGELES, CA. FILED
2-9-2012.

A GESTURE OF KINDNESS

THE MARK CONSISTS OF STANDARD CHARACTERS WITHOUT CLAIM TO ANY PARTICULAR FONT, STYLE, SIZE, OR COLOR.

FOR CANDY MINTS (U.S. CL. 46).
FIRST USE 2-15-2000; IN COMMERCE 2-15-2000.
AMY HELLA, EXAMINING ATTORNEY

SN 85-538,357. SWEET CANDY COMPANY, SALT LAKE
CITY, UT. FILED 2-9-2012.

SQUISHY FISHY

THE MARK CONSISTS OF STANDARD CHARACTERS WITHOUT CLAIM TO ANY PARTICULAR FONT, STYLE, SIZE, OR COLOR.

FOR CANDY (U.S. CL. 46).
FIRST USE 1-15-2012; IN COMMERCE 1-15-2012.
LINDA E. BLOHM, EXAMINING ATTORNEY

SN 85-538,377. HINT MINT, INC., LOS ANGELES, CA. FILED
2-9-2012.

YOU NEED THIS MINT

THE MARK CONSISTS OF STANDARD CHARACTERS WITHOUT CLAIM TO ANY PARTICULAR FONT, STYLE, SIZE, OR COLOR.

FOR CANDY MINTS (U.S. CL. 46).
FIRST USE 2-15-2000; IN COMMERCE 2-15-2000.
AMY HELLA, EXAMINING ATTORNEY

CLASS 30—(Continued).

SN 85-538,554. S-L SNACKS NATIONAL, LLC, CHARLOTTE, NC. FILED 2-9-2012.

HOME OF RIDICULOUSLY GOOD
CHIPS

THE MARK CONSISTS OF STANDARD CHARACTERS WITHOUT CLAIM TO ANY PARTICULAR FONT, STYLE, SIZE, OR COLOR.
FOR GRAIN-BASED CHIPS (U.S. CL. 46).
YAT SYE, LEE, EXAMINING ATTORNEY

SN 85-538,652. HINT MINT, INC., LOS ANGELES, CA. FILED 2-9-2012.



THE MARK CONSISTS OF THE DESIGN OF A LEAF. FOR CANDY MINTS (U.S. CL. 46).
FIRST USE 2-15-2000; IN COMMERCE 2-15-2000.
AMY HELLA, EXAMINING ATTORNEY

SN 85-538,696. DONATOS PIZZERIA, LLC, COLUMBUS, OH. FILED 2-9-2012.

DOUGH MADE WITH LOVE
NOURISHES THE SOUL

THE MARK CONSISTS OF STANDARD CHARACTERS WITHOUT CLAIM TO ANY PARTICULAR FONT, STYLE, SIZE, OR COLOR.
FOR PIZZA DOUGH AND PIZZA (U.S. CL. 46).
SETH A. RAPPAPORT, EXAMINING ATTORNEY

CLASS 30—(Continued).

SN 85-539,057. STEVE'S ORIGINAL LLC, PENNSAUKEN, NJ. FILED 2-10-2012.

PALEOCHEF

THE MARK CONSISTS OF STANDARD CHARACTERS WITHOUT CLAIM TO ANY PARTICULAR FONT, STYLE, SIZE, OR COLOR.
FOR SALAD DRESSINGS AND MARINADES (U.S. CL. 46).
TRACY FLETCHER, EXAMINING ATTORNEY

SN 85-539,147. WICKED CONFECTIONS, FORT LAUDERDALE, FL. FILED 2-10-2012.

Bite Responsibly.

THE MARK CONSISTS OF STANDARD CHARACTERS WITHOUT CLAIM TO ANY PARTICULAR FONT, STYLE, SIZE, OR COLOR.
FOR BAKERY GOODS, NAMELY, PETITE CAKES SERVED IN SHOT CUPS AND CAKE POPS (U.S. CL. 46).
FIRST USE 8-0-2011; IN COMMERCE 8-0-2011.
KEVON CHISOLM, EXAMINING ATTORNEY

SN 85-539,915. HOLTZBERRY FARMS, LLC, WINTER HAVEN, FL. FILED 2-10-2012.

CAMO

THE MARK CONSISTS OF STANDARD CHARACTERS WITHOUT CLAIM TO ANY PARTICULAR FONT, STYLE, SIZE, OR COLOR.
FOR DOUGH (U.S. CL. 46).
TIMOTHY FINNEGAN, EXAMINING ATTORNEY

CLASS 30—(Continued).

SN 85-540,104. RICH ICE CREAM COMPANY, INC., WEST PALM BEACH, FL. FILED 2-10-2012.

POLAR POLE

THE MARK CONSISTS OF STANDARD CHARACTERS WITHOUT CLAIM TO ANY PARTICULAR FONT, STYLE, SIZE, OR COLOR.
FOR ICE CREAM AND FROZEN CONFECTIONS (U.S. CL. 46).
FIRST USE 2-26-1999; IN COMMERCE 4-25-2000.
BRIDGETT SMITH, EXAMINING ATTORNEY

CLASS 30—(Continued).

SN 85-540,809. DON'T CRY FOR ME EMPANADA, LLC, AUSTIN, TX. FILED 2-13-2012.

DON'T CRY FOR ME EMPANADA

THE MARK CONSISTS OF STANDARD CHARACTERS WITHOUT CLAIM TO ANY PARTICULAR FONT, STYLE, SIZE, OR COLOR.
FOR DOUGH-ENROBED FOODS CONSISTING OF A DOUGH-BASED WRAPPER WITH FILLINGS CONSISTING PRIMARILY OF MEATS, POULTRY, FISH, FRUITS AND VEGETABLES AND CHEESE; FROZEN FOODS, NAMELY, GRAIN AND BREAD BASED APPETIZERS, HORS D'OEUVRES, AND CANAPÉS (U.S. CL. 46).
JENNIFER VASQUEZ, EXAMINING ATTORNEY

SN 85-540,115. GHIRINGHELLI BROTHERS PIZZA INC., SAN PABLO, CA. FILED 2-10-2012.

MR. G'S

THE MARK CONSISTS OF STANDARD CHARACTERS WITHOUT CLAIM TO ANY PARTICULAR FONT, STYLE, SIZE, OR COLOR.
FOR GARLIC SAUCE (U.S. CL. 46).
FIRST USE 3-16-2001; IN COMMERCE 5-14-2002.
SAMUEL E. SHARPER JR., EXAMINING ATTORNEY

SN 85-541,561. SPICE, LLC, SAUSALITO, CA. FILED 2-13-2012.

tran Doori

THE MARK CONSISTS OF STANDARD CHARACTERS WITHOUT CLAIM TO ANY PARTICULAR FONT, STYLE, SIZE, OR COLOR.
FOR DRY SPICE RUB FOR MEATS AND FISH; EDIBLE SPICES; SPICE BLENDS; SPICE RUBS; SPICES (U.S. CL. 46).
FIRST USE 1-3-2011; IN COMMERCE 1-3-2011.
THOMAS MANOR, EXAMINING ATTORNEY

SN 85-540,376. APPLE VILLA FROZEN APPLE PANCAKE, INC., HOFFMAN ESTATES, IL. FILED 2-11-2012.

APPLE VILLA

THE MARK CONSISTS OF STANDARD CHARACTERS WITHOUT CLAIM TO ANY PARTICULAR FONT, STYLE, SIZE, OR COLOR.
NO CLAIM IS MADE TO THE EXCLUSIVE RIGHT TO USE "APPLE", APART FROM THE MARK AS SHOWN.
FOR PANCAKES (U.S. CL. 46).
MICHAEL WIENER, EXAMINING ATTORNEY

SN 85-545,838. MIGHTY LEAF TEA, SAN RAFAEL, CA. FILED 2-17-2012.

MIGHTY LEAF ORIGINS

THE MARK CONSISTS OF STANDARD CHARACTERS WITHOUT CLAIM TO ANY PARTICULAR FONT, STYLE, SIZE, OR COLOR.
OWNER OF U.S. REG. NOS. 2,423,886, 2,800,766 AND OTHERS.
FOR TEA; HERBAL TEA FOR FOOD PURPOSES; TEA BAGS; TEA EXTRACTS; TEA SUBSTITUTES; TEA-BASED BEVERAGES (U.S. CL. 46).
JESSICA A. POWERS, EXAMINING ATTORNEY

CLASS 30—(Continued).

SN 85-551,037. GRUMA CORPORATION, IRVING, TX.
FILED 2-23-2012.

MISSION HEARTY GRAINS

THE MARK CONSISTS OF STANDARD CHARACTERS WITHOUT CLAIM TO ANY PARTICULAR FONT, STYLE, SIZE, OR COLOR.

OWNER OF U.S. REG. NOS. 3,073,914, 4,034,776 AND OTHERS.

NO CLAIM IS MADE TO THE EXCLUSIVE RIGHT TO USE "HEARTY GRAINS", APART FROM THE MARK AS SHOWN.

FOR TORTILLAS (U.S. CL. 46).
MAUREEN DALL, EXAMINING ATTORNEY

CLASS 30—(Continued).

SN 85-555,184. WASATCH BRANDING CONCEPTS, LLC,
DBA PROBIOTIX FOODS, NORTH LOGAN, UT. FILED 2-
28-2012.

ACTIVE DELIGHTS

THE MARK CONSISTS OF STANDARD CHARACTERS WITHOUT CLAIM TO ANY PARTICULAR FONT, STYLE, SIZE, OR COLOR.

FOR CANDY; CHOCOLATE; ICE CREAM (U.S. CL. 46).
KRISTINA MORRIS, EXAMINING ATTORNEY

SN 85-560,333. WHOLE EARTH SWEETENER COMPANY
LLC, CHICAGO, IL. FILED 3-5-2012.

SN 85-554,170. J&J SNACK FOODS CORP., PENNSAUKEN,
NJ. FILED 2-27-2012.

THE WILD SIDE OF SWEET**I'M A LITTLE TWISTED**

THE MARK CONSISTS OF STANDARD CHARACTERS WITHOUT CLAIM TO ANY PARTICULAR FONT, STYLE, SIZE, OR COLOR.

OWNER OF U.S. REG. NO. 2,774,864.
FOR SOFT PRETZELS (U.S. CL. 46).
DORITT L. CARROLL, EXAMINING ATTORNEY

THE MARK CONSISTS OF STANDARD CHARACTERS WITHOUT CLAIM TO ANY PARTICULAR FONT, STYLE, SIZE, OR COLOR.

NO CLAIM IS MADE TO THE EXCLUSIVE RIGHT TO USE "SWEET", APART FROM THE MARK AS SHOWN.

FOR NATURAL SWEETENERS; SWEETENERS PRINCIPALLY COMPRISED OF NATURAL SWEETENERS; SUGAR SUBSTITUTES; SUGAR SUBSTITUTES, PRINCIPALLY OF NATURAL SWEETENERS; NATURAL LOW-CALORIE SWEETENERS PRINCIPALLY OF HERBAL EXTRACTS; NATURAL SWEETENERS FEATURING STEVIA OR STEVIA EXTRACTS; NATURAL SWEETENERS FEATURING SUGAR ALCOHOLS (U.S. CL. 46).
RONALD AIKENS, EXAMINING ATTORNEY

SN 85-555,164. WASATCH BRANDING CONCEPTS, LLC,
DBA PROBIOTIX FOODS, NORTH LOGAN, UT. FILED 2-
28-2012.

SN 85-566,593. JODY'S INC., VIRGINIA BEACH, VA. FILED
3-12-2012.

ACTIVE D'LITES

THE MARK CONSISTS OF STANDARD CHARACTERS WITHOUT CLAIM TO ANY PARTICULAR FONT, STYLE, SIZE, OR COLOR.

FOR CANDY; CHOCOLATE; ICE CREAM (U.S. CL. 46).
KRISTINA MORRIS, EXAMINING ATTORNEY

Popzilla

THE MARK CONSISTS OF STANDARD CHARACTERS WITHOUT CLAIM TO ANY PARTICULAR FONT, STYLE, SIZE, OR COLOR.

FOR POPCORN; POPPED POPCORN; PROCESSED POPCORN (U.S. CL. 46).
FIRST USE 5-0-2011; IN COMMERCE 7-0-2011.
DARRYL SPRUILL, EXAMINING ATTORNEY

CLASS 30—(Continued).

SN 85-574,295. GRUMA CORPORATION, IRVING, TX.
FILED 3-20-2012.

GUERRERO

THE MARK CONSISTS OF STANDARD CHARACTERS WITHOUT CLAIM TO ANY PARTICULAR FONT, STYLE, SIZE, OR COLOR.

OWNER OF U.S. REG. NOS. 1,705,245, 4,031,758 AND OTHERS.

THE ENGLISH TRANSLATION OF "GUERRERO" IS "WARRIOR".

FOR CRACKERS (U.S. CL. 46).

MAUREEN DALL, EXAMINING ATTORNEY

SN 85-574,307. GRUMA CORPORATION, IRVING, TX.
FILED 3-20-2012.

UN PEDACITO DE MEXICO

THE MARK CONSISTS OF STANDARD CHARACTERS WITHOUT CLAIM TO ANY PARTICULAR FONT, STYLE, SIZE, OR COLOR.

OWNER OF U.S. REG. NOS. 2,591,406, 3,994,115 AND OTHERS.

THE ENGLISH TRANSLATION OF "UN PEDACITO DE MEXICO" IS "A LITTLE PIECE OF MEXICO".

FOR CRACKERS (U.S. CL. 46).

MAUREEN DALL, EXAMINING ATTORNEY

SN 85-576,935. GREEN MOUNTAIN COFFEE ROASTERS, INC., WATERBURY, VT. FILED 3-22-2012.

BREWING A BETTER WORLD

THE MARK CONSISTS OF STANDARD CHARACTERS WITHOUT CLAIM TO ANY PARTICULAR FONT, STYLE, SIZE, OR COLOR.

FOR COFFEE (U.S. CL. 46).

FIRST USE 9-30-2008; IN COMMERCE 9-30-2008.

ELLEN B. AWRICH, EXAMINING ATTORNEY

CLASS 30—(Continued).

SN 85-607,965. EARTHGRAINS BAKING COMPANIES, INC., HORSHAM, PA. FILED 4-25-2012.

SMART THINS

THE MARK CONSISTS OF STANDARD CHARACTERS WITHOUT CLAIM TO ANY PARTICULAR FONT, STYLE, SIZE, OR COLOR.

FOR BAKERY PRODUCTS (U.S. CL. 46).

FRANK LATTUCA, EXAMINING ATTORNEY

CLASS 31—NATURAL AGRICULTURAL PRODUCTS

SN 76-707,479. SILVER VASE, INC., MIAMI, FL. FILED 5-3-2011.



NO CLAIM IS MADE TO THE EXCLUSIVE RIGHT TO USE "SILVER VASE", APART FROM THE MARK AS SHOWN.

THE MARK CONSISTS OF THE WORDING "SILVER VASE" IN A STYLIZED FONT WITH THE REPRESENTATION OF A VASE AND COMPRISED OF THE LETTERS "SV" CENTERED BETWEEN THE WORDS, THE VASE HAVING LEAVES, A STEM, AND FOUR FLOWERS.

FOR LIVE PLANTS AND FLOWERS (U.S. CLS. 1 AND 46).

FIRST USE 1-21-2011; IN COMMERCE 1-21-2011.

ERIN FALK, EXAMINING ATTORNEY

SN 79-100,795. ANCO ORCHIDEEËN B.V., NETHERLANDS, FILED 5-13-2011.

ANCO

THE MARK CONSISTS OF STANDARD CHARACTERS WITHOUT CLAIM TO ANY PARTICULAR FONT, STYLE, SIZE, OR COLOR.

OWNER OF INTERNATIONAL REGISTRATION 1086081 DATED 5-13-2011, EXPIRES 5-13-2021.

FOR LIVING PLANTS AND PARTS OF LIVING PLANTS; SOWING SEEDS; CUT FLOWERS (U.S. CLS. 1 AND 46).

MIDGE BUTLER, EXAMINING ATTORNEY

CLASS 31—(Continued).

SN 85-263,658. WEST CENTRAL COOPERATIVE, RALSTON, IA. FILED 3-10-2011.

GOLD STANDARD

THE MARK CONSISTS OF STANDARD CHARACTERS WITHOUT CLAIM TO ANY PARTICULAR FONT, STYLE, SIZE, OR COLOR.

FOR DAIRY FEED INGREDIENTS, NAMELY, SOY-BEAN MEAL; DAIRY FEED INGREDIENTS, NAMELY, SOYBEAN MEAL SOLD AS AN INTEGRAL INGREDIENT OF ANIMAL FEED (U.S. CLS. 1 AND 46).

FIRST USE 0-0-1996; IN COMMERCE 0-0-1996.
SHANNON TWOHIG, EXAMINING ATTORNEY

SN 85-451,337. GREENHOUSE GROWN FOODS INC., DELTA, BC, CANADA, FILED 10-19-2011.

CONCERTO

THE MARK CONSISTS OF STANDARD CHARACTERS WITHOUT CLAIM TO ANY PARTICULAR FONT, STYLE, SIZE, OR COLOR.

FOR FRESH VEGETABLES; FRESH TOMATOES (U.S. CLS. 1 AND 46).

FIRST USE 2-27-2006; IN COMMERCE 7-11-2007.
SUSAN STIGLITZ, EXAMINING ATTORNEY

SN 85-455,711. NOVA MICROBIAL TECHNOLOGIES, LLC, OMAHA, NE. FILED 10-25-2011.

EQUI-JUST

THE MARK CONSISTS OF STANDARD CHARACTERS WITHOUT CLAIM TO ANY PARTICULAR FONT, STYLE, SIZE, OR COLOR.

FOR NON-MEDICATED ADDITIVES FOR HORSE FEED (U.S. CLS. 1 AND 46).

BARBARA GAYNOR, EXAMINING ATTORNEY

CLASS 31—(Continued).

SN 85-464,232. DISTRIBUIDORA CUSCATLAN INC, WASHINGTON, DC. FILED 11-3-2011.

ABEJA REINA

THE MARK CONSISTS OF STANDARD CHARACTERS WITHOUT CLAIM TO ANY PARTICULAR FONT, STYLE, SIZE, OR COLOR.

THE ENGLISH TRANSLATION OF "ABEJA REINA" IN THE MARK IS "QUEEN BEE".

FOR UNPROCESSED BEANS (U.S. CLS. 1 AND 46).

FIRST USE 3-5-2003; IN COMMERCE 3-5-2003.

LESLEY LAMOTHE, EXAMINING ATTORNEY

SN 85-482,082. WE ARE COMMUNITY FOUNDATION, ONTARIO, CA. FILED 11-28-2011.

Plant A Tree For Life

THE MARK CONSISTS OF STANDARD CHARACTERS WITHOUT CLAIM TO ANY PARTICULAR FONT, STYLE, SIZE, OR COLOR.

NO CLAIM IS MADE TO THE EXCLUSIVE RIGHT TO USE "TREE", APART FROM THE MARK AS SHOWN.

FOR LIVE PLANTS (U.S. CLS. 1 AND 46).

FIRST USE 3-7-2011; IN COMMERCE 4-1-2011.

KATHERINE STOIDES, EXAMINING ATTORNEY

SN 85-506,336. DJ FORRY COMPANY INC., NOVATO, CA. FILED 12-30-2011.



NO CLAIM IS MADE TO THE EXCLUSIVE RIGHT TO USE "KERN RIVER CALIFORNIA FRESH POMEGRANATES", APART FROM THE MARK AS SHOWN.

THE STIPPLING IS FOR SHADING PURPOSES ONLY.

THE MARK CONSISTS OF THREE POMEGRANATES TO THE LEFT AND RIGHT OF THE STYLIZED TEXT "KERN RIVER". BELOW THERE IS THE STYLIZED TEXT "CALIFORNIA FRESH POMEGRANATES". ON THE TOP OF EVERYTHING THERE ARE STRIPES THAT START AT THE TOP OF THE LOGO AND DESCEND IN SIZE TOWARD THE TOP OF THE TEXT.

FOR FRESH FRUIT (U.S. CLS. 1 AND 46).

FIRST USE 9-15-2011; IN COMMERCE 9-15-2011.

TOBY BULLOFF, EXAMINING ATTORNEY

CLASS 31—(Continued).

SN 85-523,661. RICH-PAK FARMS, LLC, BAKERSFIELD, CA. FILED 1-24-2012.

MR. G

THE MARK CONSISTS OF STANDARD CHARACTERS WITHOUT CLAIM TO ANY PARTICULAR FONT, STYLE, SIZE, OR COLOR.
THE NAME "MR. G" DOES NOT IDENTIFY A LIVING INDIVIDUAL.
FOR FRESH FRUITS (U.S. CLS. 1 AND 46).
FIRST USE 9-1-1998; IN COMMERCE 9-1-1998.
JAY FLOWERS, EXAMINING ATTORNEY

SN 85-526,640. SABIN, LORI, WILMINGTON, DE. FILED 1-26-2012.

blizzard in a bone

THE MARK CONSISTS OF STANDARD CHARACTERS WITHOUT CLAIM TO ANY PARTICULAR FONT, STYLE, SIZE, OR COLOR.
NO CLAIM IS MADE TO THE EXCLUSIVE RIGHT TO USE "BONE", APART FROM THE MARK AS SHOWN.
FOR PET TREATS (U.S. CLS. 1 AND 46).
FIRST USE 1-26-2012; IN COMMERCE 1-26-2012.
ANDREW RHIM, EXAMINING ATTORNEY

SN 85-528,930. MANN PACKING CO., INC., SALINAS, CA. FILED 1-30-2012.

ARCADIAN HARVEST CLASSIC

THE MARK CONSISTS OF STANDARD CHARACTERS WITHOUT CLAIM TO ANY PARTICULAR FONT, STYLE, SIZE, OR COLOR.
OWNER OF U.S. REG. NO. 4,136,700.
FOR FRESH VEGETABLES, NAMELY, LETTUCE (U.S. CLS. 1 AND 46).
LINDA MICKLEBURGH, EXAMINING ATTORNEY

CLASS 31—(Continued).

SN 85-530,733. GENERAL NUTRITION INVESTMENT COMPANY, PHOENIX, AZ. FILED 2-1-2012.

COAT-TASTIC

THE MARK CONSISTS OF STANDARD CHARACTERS WITHOUT CLAIM TO ANY PARTICULAR FONT, STYLE, SIZE, OR COLOR.
FOR PET TREATS (U.S. CLS. 1 AND 46).
KATHERINE CHANG, EXAMINING ATTORNEY

SN 85-530,734. GENERAL NUTRITION INVESTMENT COMPANY, PHOENIX, AZ. FILED 2-1-2012.

CALM-TASTIC

THE MARK CONSISTS OF STANDARD CHARACTERS WITHOUT CLAIM TO ANY PARTICULAR FONT, STYLE, SIZE, OR COLOR.
FOR PET TREATS (U.S. CLS. 1 AND 46).
KATHERINE CHANG, EXAMINING ATTORNEY

SN 85-530,736. GENERAL NUTRITION INVESTMENT COMPANY, PHOENIX, AZ. FILED 2-1-2012.

HIP-TASTIC

THE MARK CONSISTS OF STANDARD CHARACTERS WITHOUT CLAIM TO ANY PARTICULAR FONT, STYLE, SIZE, OR COLOR.
FOR PET TREATS (U.S. CLS. 1 AND 46).
KATHERINE CHANG, EXAMINING ATTORNEY

SN 85-530,738. GENERAL NUTRITION INVESTMENT COMPANY, PHOENIX, AZ. FILED 2-1-2012.

MULTI-TASTIC

THE MARK CONSISTS OF STANDARD CHARACTERS WITHOUT CLAIM TO ANY PARTICULAR FONT, STYLE, SIZE, OR COLOR.
FOR PET TREATS (U.S. CLS. 1 AND 46).
KATHERINE CHANG, EXAMINING ATTORNEY

CLASS 31—(Continued).

SN 85-530,740. GENERAL NUTRITION INVESTMENT COMPANY, PHOENIX, AZ. FILED 2-1-2012.

TOOTH-TASTIC

THE MARK CONSISTS OF STANDARD CHARACTERS WITHOUT CLAIM TO ANY PARTICULAR FONT, STYLE, SIZE, OR COLOR.

FOR PET TREATS (U.S. CLS. 1 AND 46).
KATHERINE CHANG, EXAMINING ATTORNEY

SN 85-531,137. SANTOS HECTOR MANUEL, GUADALAJARA, MEXICO, FILED 2-1-2012.

HERENCIA DE MI TIERRA

THE MARK CONSISTS OF STANDARD CHARACTERS WITHOUT CLAIM TO ANY PARTICULAR FONT, STYLE, SIZE, OR COLOR.

THE ENGLISH TRANSLATION OF "HERENCIA DE MI TIERRA" IN THE MARK IS "MY LAND INHERITANCE".

FOR FRESH AVOCADOS; FRESH CUCUMBERS; FRESH FRUIT AND VEGETABLES; FRESH GRAPE CHERRY TOMATOES; FRESH LEMONS; FRESH PEPPERS; FRESH TOMATOES; FRESH ZUCCHINI; FRUITS, NAMELY, FRESH BLACKBERRIES AND BLUEBERRIES; RAW AVOCADOS; RAW LEMONS; RAW PEPPERS; RAW TOMATOES; RAW ZUCCHINI; UNPROCESSED AVOCADOS; UNPROCESSED LEMONS; UNPROCESSED PEPPERS; UNPROCESSED TOMATOES; UNPROCESSED ZUCCHINI (U.S. CLS. 1 AND 46).

MARY CRAWFORD, EXAMINING ATTORNEY

SN 85-531,638. THE QUEEN'S FLOWERS, INC., MIAMI, FL. FILED 2-1-2012.

THE QUEEN'S FLOWERS

THE MARK CONSISTS OF STANDARD CHARACTERS WITHOUT CLAIM TO ANY PARTICULAR FONT, STYLE, SIZE, OR COLOR.

NO CLAIM IS MADE TO THE EXCLUSIVE RIGHT TO USE "FLOWERS", APART FROM THE MARK AS SHOWN.

FOR FRESH CUT FLOWERS (U.S. CLS. 1 AND 46).
FIRST USE 12-31-1983; IN COMMERCE 12-31-1983.
PAUL MORENO, EXAMINING ATTORNEY

CLASS 31—(Continued).

SN 85-532,592. GENERAL NUTRITION INVESTMENT COMPANY, PHOENIX, AZ. FILED 2-2-2012.

FRESH-TASTIC

THE MARK CONSISTS OF STANDARD CHARACTERS WITHOUT CLAIM TO ANY PARTICULAR FONT, STYLE, SIZE, OR COLOR.

FOR PET TREATS (U.S. CLS. 1 AND 46).
KATHERINE CHANG, EXAMINING ATTORNEY

SN 85-534,580. GENERAL NUTRITION INVESTMENT COMPANY, PHOENIX, AZ. FILED 2-6-2012.

VITA-TASTIC

THE MARK CONSISTS OF STANDARD CHARACTERS WITHOUT CLAIM TO ANY PARTICULAR FONT, STYLE, SIZE, OR COLOR.

FOR PET TREATS (U.S. CLS. 1 AND 46).
KATHERINE CHANG, EXAMINING ATTORNEY

SN 85-534,857. DARFORD INDUSTRIES LTD., VERNON, BC, CANADA, FILED 2-6-2012.

THE RECIPE FOR A LONG & HAPPY LIFE TOGETHER

THE MARK CONSISTS OF STANDARD CHARACTERS WITHOUT CLAIM TO ANY PARTICULAR FONT, STYLE, SIZE, OR COLOR.

FOR PET FOOD; EDIBLE PET TREATS (U.S. CLS. 1 AND 46).

FIRST USE 4-14-2012; IN COMMERCE 4-14-2012.
KEVIN DINALLO, EXAMINING ATTORNEY

SN 85-536,882. MERRICK PET CARE, INC., AMARILLO, TX. FILED 2-8-2012.

WHOLE HEALTH MADE RIGHT

THE MARK CONSISTS OF STANDARD CHARACTERS WITHOUT CLAIM TO ANY PARTICULAR FONT, STYLE, SIZE, OR COLOR.

FOR PET FOOD (U.S. CLS. 1 AND 46).
LINDA POWELL, EXAMINING ATTORNEY

CLASS 31—(Continued).

SN 85-537,363. JAMES SCOTT, CAPE NEDDICK, ME. FILED 2-8-2012.

RAWSOME

THE MARK CONSISTS OF STANDARD CHARACTERS WITHOUT CLAIM TO ANY PARTICULAR FONT, STYLE, SIZE, OR COLOR.
FOR PET FOOD (U.S. CLS. 1 AND 46).
AHSEN KHAN, EXAMINING ATTORNEY

CLASS 31—(Continued).

SN 85-538,697. MIDWESTERN PET FOODS, INC., EVANSVILLE, IN. FILED 2-9-2012.

UPC'S FOR VETERANS

THE MARK CONSISTS OF STANDARD CHARACTERS WITHOUT CLAIM TO ANY PARTICULAR FONT, STYLE, SIZE, OR COLOR.
OWNER OF U.S. REG. NO. 3,815,425.
FOR PET FOOD; PET TREATS (U.S. CLS. 1 AND 46).
SETH A. RAPPAPORT, EXAMINING ATTORNEY

SN 85-538,034. HEB GROCERY COMPANY, LP, SAN ANTONIO, TX. FILED 2-9-2012.



OWNER OF U.S. REG. NOS. 1,519,398, 1,867,930 AND OTHERS.

THE COLOR(S) RED AND WHITE IS/ARE CLAIMED AS A FEATURE OF THE MARK.

THE MARK CONSISTS OF THE LETTERS "H-E-B" IN WHITE LETTERS WITHIN A RED OVAL DESIGN.

FOR LIVE PLANTS, PET FOOD, PET TREATS, FLOWERS, CUT FLOWERS, SHRUBS, LIVE TREES (U.S. CLS. 1 AND 46).

FIRST USE 4-5-1998; IN COMMERCE 4-5-1998.
ANGELA M. MICHELL, EXAMINING ATTORNEY

SN 85-538,699. MIDWESTERN PET FOODS, INC., EVANSVILLE, IN. FILED 2-9-2012.

UPC'S FOR HEROES

THE MARK CONSISTS OF STANDARD CHARACTERS WITHOUT CLAIM TO ANY PARTICULAR FONT, STYLE, SIZE, OR COLOR.

OWNER OF U.S. REG. NO. 3,815,425.
FOR PET FOOD; PET TREATS (U.S. CLS. 1 AND 46).
SETH A. RAPPAPORT, EXAMINING ATTORNEY

SN 85-538,355. PACIFIC MOUNTAIN PRODUCTS, LLC, KETCHUM, ID. FILED 2-9-2012.

MAKE A WREATH

THE MARK CONSISTS OF STANDARD CHARACTERS WITHOUT CLAIM TO ANY PARTICULAR FONT, STYLE, SIZE, OR COLOR.

FOR LIVE WREATHS AND DRIED FLOWER WREATHS (U.S. CLS. 1 AND 46).

APRIL ROACH, EXAMINING ATTORNEY

SN 85-540,777. GREEN FUSE BOTANICALS, INC., SANTA MONICA, CA. FILED 2-13-2012.

SWIFTY

THE MARK CONSISTS OF STANDARD CHARACTERS WITHOUT CLAIM TO ANY PARTICULAR FONT, STYLE, SIZE, OR COLOR.

FOR LIVE PLANTS EXCLUDING CORN AND ORANGES (U.S. CLS. 1 AND 46).

BRENDAN MCCAULEY, EXAMINING ATTORNEY

CLASS 31—(Continued).

SN 85-540,903. GREEN FUSE BOTANICALS, INC., SANTA MONICA, CA. FILED 2-13-2012.

LUNAR

THE MARK CONSISTS OF STANDARD CHARACTERS WITHOUT CLAIM TO ANY PARTICULAR FONT, STYLE, SIZE, OR COLOR.

FOR LIVE PLANTS, NAMELY, GAILLARDIA (U.S. CLS. 1 AND 46).

BRENDAN MCCAULEY, EXAMINING ATTORNEY

SN 85-540,929. GREEN FUSE BOTANICALS, INC., SANTA MONICA, CA. FILED 2-13-2012.

FIRST LIGHT

THE MARK CONSISTS OF STANDARD CHARACTERS WITHOUT CLAIM TO ANY PARTICULAR FONT, STYLE, SIZE, OR COLOR.

FOR LIVE PLANTS EXCLUDING HEBE, SUNFLOWER AND HELIANTHUS (U.S. CLS. 1 AND 46).

BRENDAN MCCAULEY, EXAMINING ATTORNEY

SN 85-555,417. OMS INVESTMENTS, INC., LOS ANGELES, CA. FILED 2-28-2012.



THE MARK CONSISTS OF A FLOWER DESIGN BETWEEN THE "O" AND "A" IN THE WORD GROABLES.

FOR PLANTING AND GARDENING KITS COMPRISED PRIMARILY OF SEEDS FOR FRUIT, SEEDS FOR VEGETABLES, SEEDS FOR HERBS, SEEDS FOR FLOWERS AND LIVE PLANTS AND ALSO INCLUDING GROWING MEDIA, SOIL, MULCH, FERTILIZER, AND POTS AND CONTAINERS; MULCH, TOP SOIL; PEAT MOSS; SEED MAT, NAMELY, PRE-SEEDED MULCH MATS COMPRISED PRIMARILY OF SEEDS FOR GROWING PLANTS AND FLOWERS; SEEDS, NAMELY, SEEDS FOR FRUIT, SEEDS FOR VEGETABLES, SEEDS FOR HERBS, SEEDS FOR FLOWERS; BULBS FOR DOMESTIC AND HORTICULTURAL PURPOSES; LIVE PLANTS; GARDENING KITS FOR INDOOR AND OUTDOOR PLANTING COMPRISED PRIMARILY OF SEEDS FOR FRUIT, SEEDS FOR VEGETABLES, SEEDS FOR HERBS, SEEDS FOR FLOWERS AND LIVE PLANTS AND ALSO INCLUDING GROWING MEDIA, SOIL, MULCH AND FERTILIZER (U.S. CLS. 1 AND 46).

MICHAEL GAAFAR, EXAMINING ATTORNEY

CLASS 31—(Continued).

SN 85-574,095. ALLTECH, INC., LEXINGTON, KY. FILED 3-20-2012.

ACTIGEN

THE MARK CONSISTS OF STANDARD CHARACTERS WITHOUT CLAIM TO ANY PARTICULAR FONT, STYLE, SIZE, OR COLOR.

FOR YEAST AND YEAST EXTRACTS FOR ANIMAL CONSUMPTION (U.S. CLS. 1 AND 46).

FIRST USE 4-8-2009; IN COMMERCE 4-8-2009.

KELLEY WELLS, EXAMINING ATTORNEY

SN 85-574,124. ALLTECH, INC., LEXINGTON, KY. FILED 3-20-2012.



THE COLOR(S) GREY AND BLUE IS/ARE CLAIMED AS A FEATURE OF THE MARK.

THE MARK CONSISTS OF THE WORD "ACTIGEN" IN STYLIZED FORM WITH THE LETTERS "A", "C", "T", "I" IN GREY AND THE DOT OF THE "I", "G", "E", AND "N" IN BLUE.

FOR YEAST AND YEAST EXTRACTS FOR ANIMAL CONSUMPTION (U.S. CLS. 1 AND 46).

KELLEY WELLS, EXAMINING ATTORNEY

SN 85-584,732. TIBBOTT, GIRARD W., NORTHERN CAMBRIA, PA. FILED 3-30-2012.

THE BEARDED BUCK

THE MARK CONSISTS OF STANDARD CHARACTERS WITHOUT CLAIM TO ANY PARTICULAR FONT, STYLE, SIZE, OR COLOR.

NO CLAIM IS MADE TO THE EXCLUSIVE RIGHT TO USE "BUCK", APART FROM THE MARK AS SHOWN.

FOR ANIMAL FEED; WILDLIFE SEED MIXTURES (U.S. CLS. 1 AND 46).

DOUGLAS LEE, EXAMINING ATTORNEY

CLASS 31—(Continued).

SN 85-594,695. OMT, INC., PALO ALTO, CA. FILED 4-11-2012.

OMNIMOUSE

THE MARK CONSISTS OF STANDARD CHARACTERS WITHOUT CLAIM TO ANY PARTICULAR FONT, STYLE, SIZE, OR COLOR.

FOR LIVE LABORATORY ANIMALS (U.S. CLS. 1 AND 46).

REBECCA GILBERT, EXAMINING ATTORNEY

CLASS 32—LIGHT BEVERAGES

SN 77-026,913. REACTOR SPIRITS NORWAY LTD, SANDVIKA, NORWAY, FILED 10-23-2006.

REACTOR ENERGY

THE MARK CONSISTS OF STANDARD CHARACTERS WITHOUT CLAIM TO ANY PARTICULAR FONT, STYLE, SIZE, OR COLOR.

NO CLAIM IS MADE TO THE EXCLUSIVE RIGHT TO USE "ENERGY", APART FROM THE MARK AS SHOWN.

FOR ENERGY DRINKS (U.S. CLS. 45, 46 AND 48).

CHARISMA HAMPTON, EXAMINING ATTORNEY

SN 79-099,291. KURT BRAUNHOFER, AUSTRIA, FILED 6-21-2011.

alpurel

THE MARK CONSISTS OF STANDARD CHARACTERS WITHOUT CLAIM TO ANY PARTICULAR FONT, STYLE, SIZE, OR COLOR.

PRIORITY DATE OF 12-27-2010 IS CLAIMED. OWNER OF INTERNATIONAL REGISTRATION 1082379 DATED 6-21-2011, EXPIRES 6-21-2021.

THE WORDING "ALPUREL" HAS NO MEANING IN A FOREIGN LANGUAGE.

FOR MINERAL AND AERATED WATERS; NON-ALCOHOLIC COCKTAILS; NON-ALCOHOLIC BEVERAGES, NAMELY, CARBONATED BEVERAGES; FRUIT DRINKS AND FRUIT JUICES; SYRUPS FOR BEVERAGES; PREPARATIONS FOR MAKING BEVERAGES, NAMELY, FRUIT DRINKS; CONCENTRATES, SYRUPS OR POWDERS FOR MAKING SOFT DRINKS OR TEA-FLAVORED BEVERAGES (U.S. CLS. 45, 46 AND 48).

SKYE YOUNG, EXAMINING ATTORNEY

CLASS 32—(Continued).

SN 79-101,796. SANPURO VERTRIEB GMBH, FED REP GERMANY, FILED 7-6-2011.

PRIORITY DATE OF 1-14-2011 IS CLAIMED. OWNER OF INTERNATIONAL REGISTRATION 1088637 DATED 7-6-2011, EXPIRES 7-6-2021.

THE MARK CONSISTS OF THE WORDING "SANPURO" IN STYLIZED FONT WITH TWO PARALLEL VERTICAL LINES PLACED TO THE LOWER RIGHT OF THE LETTER "O".

THE WORDING "SANPURO" HAS NO MEANING IN A FOREIGN LANGUAGE.

FOR DRINKING WATER, MINERAL WATER, SPRING WATER, STILL WATER, OXYGENATED WATER IN THE NATURE OF DRINKING WATER, TABLE WATER (U.S. CLS. 45, 46 AND 48).

STEVEN PEREZ, EXAMINING ATTORNEY

SN 79-102,235. SANPURO VERTRIEB GMBH, FED REP GERMANY, FILED 7-6-2011.

Sanpuro

THE MARK CONSISTS OF STANDARD CHARACTERS WITHOUT CLAIM TO ANY PARTICULAR FONT, STYLE, SIZE, OR COLOR.

PRIORITY DATE OF 1-13-2011 IS CLAIMED. OWNER OF INTERNATIONAL REGISTRATION 1089863 DATED 7-6-2011, EXPIRES 7-6-2021.

THE WORDING "SANPURO" HAS NO MEANING IN A FOREIGN LANGUAGE.

FOR DRINKING WATER, MINERAL WATER, SPRING WATER, STILL WATER, OXYGENATED WATER IN THE NATURE OF DRINKING WATER, TABLE WATER (U.S. CLS. 45, 46 AND 48).

STEVEN PEREZ, EXAMINING ATTORNEY

SN 79-104,682. "BROUWERIJ FRANK BOON"; NAAMLOZE VENNOOTSCHAP, B-1502 LEMBEEK, BELGIUM, FILED 6-12-2011.

MARIAGE PARFAIT

OWNER OF INTERNATIONAL REGISTRATION 0461719 DATED 6-11-1981, EXPIRES 6-11-2021.

THE ENGLISH TRANSLATION OF "MARIAGE PARFAIT" IN THE MARK IS "PERFECT MARRIAGE" OR "PERFECT BLEND".

FOR BEER, ALE AND PORTER; MINERAL AND AERATED WATERS; SYRUPS AND OTHER PREPARATIONS FOR MAKING BEVERAGES, NAMELY, BEERS, ALE AND PORTER (U.S. CLS. 45, 46 AND 48).

HEATHER BIDDULPH, EXAMINING ATTORNEY

CLASS 32—(Continued).

SN 85-184,024. BONITA'S MIXES, LLC, ALBUQUERQUE, NM. FILED 11-23-2010.



THE MARK CONSISTS OF A SILHOUETTE OF A FEMALE WITH LONG HAIR AND A HOOP EARRING HOLDING A DRINK WITH A PIECE OF FRUIT AND WEARING A STRAPLESS DRESS AND A BRACELET ON HER WRIST.

FOR NON-ALCOHOLIC PREPARATIONS FOR MAKING BEVERAGES, NAMELY, COCKTAIL MIXES (U.S. CLS. 45, 46 AND 48).

REGINA DRUMMOND, EXAMINING ATTORNEY

SN 85-213,632. RYAN SOWARDS, PLEASANTON, CA. FILED 1-9-2011.

PRIME US STANDARD TABLE WATER

THE MARK CONSISTS OF STANDARD CHARACTERS WITHOUT CLAIM TO ANY PARTICULAR FONT, STYLE, SIZE, OR COLOR.

NO CLAIM IS MADE TO THE EXCLUSIVE RIGHT TO USE "PRIME US" AND "TABLE WATER", APART FROM THE MARK AS SHOWN.

FOR BOTTLED ARTESIAN WATER; BOTTLED DRINKING WATER; BOTTLED WATER; DRINKING WATER; MINERAL WATER; SPARKLING WATER; SPRING WATER (U.S. CLS. 45, 46 AND 48).

PRISCILLA MILTON, EXAMINING ATTORNEY

SN 85-320,092. ZOOM TAN, LLC, NAPLES, FL. FILED 5-13-2011.

ZOOM

THE MARK CONSISTS OF STANDARD CHARACTERS WITHOUT CLAIM TO ANY PARTICULAR FONT, STYLE, SIZE, OR COLOR.

FOR ENERGY DRINK SOLD SOLELY THROUGH COMPANY-OWNED TANNING SALONS (U.S. CLS. 45, 46 AND 48).

ALAIN LAPTER, EXAMINING ATTORNEY

CLASS 32—(Continued).

SN 85-336,382. MILLERCOORS LLC, CHICAGO, IL. FILED 6-2-2011.

HERE'S TO YOU

THE MARK CONSISTS OF STANDARD CHARACTERS WITHOUT CLAIM TO ANY PARTICULAR FONT, STYLE, SIZE, OR COLOR.

FOR BEER (U.S. CLS. 45, 46 AND 48).
SUSAN RICHARDS, EXAMINING ATTORNEY

SN 85-340,040. UINTA BREWING COMPANY, SALT LAKE CITY, UT. FILED 6-7-2011.

SKIPPING STONE

THE MARK CONSISTS OF STANDARD CHARACTERS WITHOUT CLAIM TO ANY PARTICULAR FONT, STYLE, SIZE, OR COLOR.

FOR BEER (U.S. CLS. 45, 46 AND 48).
GRETCHEN ULRICH, EXAMINING ATTORNEY

SN 85-358,561. NCN BEVERAGES, LLC, SYRACUSE, NY. FILED 6-28-2011.

URBAN CHIC

THE MARK CONSISTS OF STANDARD CHARACTERS WITHOUT CLAIM TO ANY PARTICULAR FONT, STYLE, SIZE, OR COLOR.

FOR CONCENTRATES, SYRUPS OR POWDERS USED IN THE PREPARATION OF SOFT DRINKS; FRUIT FLAVORED DRINKS; FRUIT FLAVORED SOFT DRINKS; FRUIT JUICES AND FRUIT DRINKS; NON-ALCOHOLIC BEVERAGES WITH TEA FLAVOR; NON-ALCOHOLIC BEVERAGES, NAMELY, CARBONATED BEVERAGES; SOFT DRINKS; SOFT DRINKS FLAVORED WITH TEA; SYRUPS FOR MAKING NON-ALCOHOLIC BEVERAGES (U.S. CLS. 45, 46 AND 48).

KIM SAITO, EXAMINING ATTORNEY

CLASS 32—(Continued).

SN 85-369,444. GLOBAL DRUMZ, LOS ANGELES, CA. FILED 7-12-2011.

Q-MAMI WATA

THE MARK CONSISTS OF STANDARD CHARACTERS WITHOUT CLAIM TO ANY PARTICULAR FONT, STYLE, SIZE, OR COLOR.

NO CLAIM IS MADE TO THE EXCLUSIVE RIGHT TO USE "WATER", APART FROM THE MARK AS SHOWN.

FOR BOTTLED DRINKING WATER; TABLE WATER (U.S. CLS. 45, 46 AND 48).

LINDA E. BLOHM, EXAMINING ATTORNEY

CLASS 32—(Continued).

SN 85-419,780. EIEIO, INC., AUSTIN, TX. FILED 9-11-2011.



NO CLAIM IS MADE TO THE EXCLUSIVE RIGHT TO USE "FRUIT SMOOTHIES", APART FROM THE MARK AS SHOWN.

THE MARK CONSISTS OF THE WORDS "TROPICOW FRUIT SMOOTHIES" ASIDE A COW IN A HULA SKIRT IN THE FOREGROUND WITH PALM TREES IN THE BACKGROUND.

FOR SMOOTHIES (U.S. CLS. 45, 46 AND 48).

FIRST USE 2-22-2010; IN COMMERCE 3-15-2010.

ROBIN CHOSID, EXAMINING ATTORNEY

SN 85-405,254. BOBA TEA COMPANY, INC., ALBUQUERQUE, NM. FILED 8-23-2011.

nunu yummys

THE MARK CONSISTS OF STANDARD CHARACTERS WITHOUT CLAIM TO ANY PARTICULAR FONT, STYLE, SIZE, OR COLOR.

NO CLAIM IS MADE TO THE EXCLUSIVE RIGHT TO USE "NUNU", APART FROM THE MARK AS SHOWN.

FOR NON-ALCOHOLIC BEVERAGES WITH TEA FLAVOR; PREPARATIONS FOR MAKING BEVERAGES, NAMELY, TEA BASED BEVERAGES CONTAINING INGREDIENTS MADE WITH VARIOUS FRUIT FLAVORS AND TAPIOCA (U.S. CLS. 45, 46 AND 48).

FIRST USE 5-22-2011; IN COMMERCE 5-22-2011.
BARNEY CHARLON, EXAMINING ATTORNEY

SN 85-427,949. SANDRA HOYOS, CORAL GABLES, FL. FILED 9-21-2011.

EL COPEY AGUA MINERAL

THE MARK CONSISTS OF STANDARD CHARACTERS WITHOUT CLAIM TO ANY PARTICULAR FONT, STYLE, SIZE, OR COLOR.

NO CLAIM IS MADE TO THE EXCLUSIVE RIGHT TO USE "AGUA MINERAL", APART FROM THE MARK AS SHOWN.

THE ENGLISH TRANSLATION OF THE WORDS "AGUA MINERAL" IN THE MARK IS "MINERAL WATER".

FOR DRINKING WATERS (U.S. CLS. 45, 46 AND 48).
CURTIS FRENCH, EXAMINING ATTORNEY

SN 85-419,778. EIEIO, INC., AUSTIN, TX. FILED 9-11-2011.

Tropicow

THE MARK CONSISTS OF STANDARD CHARACTERS WITHOUT CLAIM TO ANY PARTICULAR FONT, STYLE, SIZE, OR COLOR.

FOR SMOOTHIES (U.S. CLS. 45, 46 AND 48).
FIRST USE 2-22-2010; IN COMMERCE 3-15-2010.
ROBIN CHOSID, EXAMINING ATTORNEY

SN 85-469,223. BOULEVARD BREWING ASSOCIATES LIMITED PARTNERSHIP, DBA BOULEVARD BREWING COMPANY, KANSAS CITY, MO. FILED 11-10-2011.

REVERB IMPERIAL PILSNER

THE MARK CONSISTS OF STANDARD CHARACTERS WITHOUT CLAIM TO ANY PARTICULAR FONT, STYLE, SIZE, OR COLOR.

NO CLAIM IS MADE TO THE EXCLUSIVE RIGHT TO USE "IMPERIAL PILSNER", APART FROM THE MARK AS SHOWN.

FOR BEER, ALE AND MALT LIQUOR (U.S. CLS. 45, 46 AND 48).
BRIAN PINO, EXAMINING ATTORNEY

CLASS 32—(Continued).

SN 85-476,536. MOCKTAIL BEVERAGES, INC., WENHAM, MA. FILED 11-18-2011.



NO CLAIM IS MADE TO THE EXCLUSIVE RIGHT TO USE "MOCKTAILS BRAND NON-ALCOHOLIC COCKTAIL", APART FROM THE MARK AS SHOWN.

THE MARK CONSISTS OF THE WORD "MOCKTAILS" WITH THE "I" REPRESENTED BY A COCKTAIL SHAKER ABOVE THE WORDS "BRAND NON-ALCOHOLIC COCKTAIL" ABOVE A STYLIZED CAPITAL "M" WITH A CIRCLE ABOVE THE CENTER OF THE "M" AND A DRAWING BELOW AT THE BOTTOM OF THE CENTER OF THE "M" REPRESENTING THE STEM OF A COCKTAIL GLASS ABOVE THE WORDS "CELEBRATE TOGETHER".

FOR NON-ALCOHOLIC COCKTAILS (U.S. CLS. 45, 46 AND 48).

GENE MACIOL, EXAMINING ATTORNEY

SN 85-476,555. MOCKTAIL BEVERAGES, INC., WENHAM, MA. FILED 11-18-2011.



NO CLAIM IS MADE TO THE EXCLUSIVE RIGHT TO USE "MOCKTAIL BEVERAGES, INC.", APART FROM THE MARK AS SHOWN.

THE MARK CONSISTS OF THE WORD "MOCKTAIL" WITH THE STYLIZED CAPITAL "M" HAVING A CIRCLE ABOVE THE CENTER OF THE "M" AND A DRAWING BELOW AT THE BOTTOM OF THE CENTER OF THE "M" REPRESENTING THE STEM OF A COCKTAIL GLASS AND THE "I" REPRESENTED BY A COCKTAIL SHAKER, WITH THE WORDS "CELEBRATE TOGETHER" ABOVE THE "M" AND THE WORDS "BEVERAGES, INC." BELOW THE WORD "MOCKTAIL".

FOR NON-ALCOHOLIC COCKTAILS (U.S. CLS. 45, 46 AND 48).

GENE MACIOL, EXAMINING ATTORNEY

CLASS 32—(Continued).

SN 85-477,156. LA CENTRO AMERICANA CORP., BAY SHORE, NY. FILED 11-19-2011.

GUANACOCO

THE MARK CONSISTS OF STANDARD CHARACTERS WITHOUT CLAIM TO ANY PARTICULAR FONT, STYLE, SIZE, OR COLOR.

THE WORDING "GUANACOCO" HAS NO MEANING IN A FOREIGN LANGUAGE.

FOR COCONUT WATER (U.S. CLS. 45, 46 AND 48).
CHRISTINA SOBRAL, EXAMINING ATTORNEY

SN 85-482,771. HOPUNION, L.L.C., YAKIMA, WA. FILED 11-29-2011.

FALCONER'S FLIGHT 7C'S

THE MARK CONSISTS OF STANDARD CHARACTERS WITHOUT CLAIM TO ANY PARTICULAR FONT, STYLE, SIZE, OR COLOR.

OWNER OF U.S. REG. NO. 4,039,720.
FOR PROCESSED HOPS, NAMELY, PELLETIZED HOPS (U.S. CLS. 45, 46 AND 48).

FIRST USE 10-28-2011; IN COMMERCE 10-28-2011.
SEAN CROWLEY, EXAMINING ATTORNEY

SN 85-508,405. EXKLUSIVE, LLC., MIAMI, FL. FILED 1-4-2012.

Carat

PRECIOUS GOLD WATER

NO CLAIM IS MADE TO THE EXCLUSIVE RIGHT TO USE "GOLD WATER", APART FROM THE MARK AS SHOWN.

THE COLOR(S) BLACK AND GOLD IS/ARE CLAIMED AS A FEATURE OF THE MARK.

THE MARK CONSISTS OF THE WORD "CARAT" IN LARGE BLACK LETTERS WITH A GOLD DROPLET OUTLINED IN BLACK INSIDE THE LETTER "C". BELOW THAT IS THE WORDING "PRECIOUS GOLD WATER" IN GOLD LETTERING.

FOR BOTTLED DRINKING WATER CONTAINING GOLD FLAKES (U.S. CLS. 45, 46 AND 48).

FIRST USE 11-1-2011; IN COMMERCE 11-1-2011.
TASHIA BUNCH, EXAMINING ATTORNEY

CLASS 32—(Continued).

SN 85-512,453. RUCKUS LIFE LLC, NEW HARTFORD, NY.
FILED 1-10-2012.



THE MARK CONSISTS OF DESIGN OF A DEMON WITH LARGE HEAD, HORNS, POINTED EARS, OPEN MOUTH, BODY WITH STICK LEGS, ARMS AKIMBO, AND S-SHAPED TAIL

FOR FRUIT-FLAVORED NON-ALCOHOLIC BEVERAGE, NAMELY, A NON-ALCOHOLIC MIX SOLD IN A CONTAINER TO WHICH THE PURCHASER MAY ADD A LIQUOR (U.S. CLS. 45, 46 AND 48).

GENE MACIOL, EXAMINING ATTORNEY

SN 85-519,624. ABBEY BEVERAGE COMPANY, LLC, SANTE FE, NM. FILED 1-18-2012.

MONKS' TRIPEL

THE MARK CONSISTS OF STANDARD CHARACTERS WITHOUT CLAIM TO ANY PARTICULAR FONT, STYLE, SIZE, OR COLOR.

OWNER OF U.S. REG. NOS. 3,056,340, 4,034,565 AND OTHERS.

NO CLAIM IS MADE TO THE EXCLUSIVE RIGHT TO USE "TRIPLE", APART FROM THE MARK AS SHOWN.

FOR BEER AND ALE (U.S. CLS. 45, 46 AND 48).

FIRST USE 5-31-2011; IN COMMERCE 5-31-2011.

GENE MACIOL, EXAMINING ATTORNEY

SN 85-519,641. ABBEY BEVERAGE COMPANY, LLC, SANTE FE, NM. FILED 1-18-2012.

REAL BEERS FROM REAL MONKS

THE MARK CONSISTS OF STANDARD CHARACTERS WITHOUT CLAIM TO ANY PARTICULAR FONT, STYLE, SIZE, OR COLOR.

OWNER OF U.S. REG. NOS. 3,056,340, 4,034,565 AND OTHERS.

FOR BEER AND ALE (U.S. CLS. 45, 46 AND 48).

GENE MACIOL, EXAMINING ATTORNEY

CLASS 32—(Continued).

SN 85-519,647. ABBEY BEVERAGE COMPANY, LLC, SANTE FE, NM. FILED 1-18-2012.

MONKS' ALES

THE MARK CONSISTS OF STANDARD CHARACTERS WITHOUT CLAIM TO ANY PARTICULAR FONT, STYLE, SIZE, OR COLOR.

OWNER OF U.S. REG. NOS. 3,056,340, 4,034,565 AND OTHERS.

NO CLAIM IS MADE TO THE EXCLUSIVE RIGHT TO USE "ALES", APART FROM THE MARK AS SHOWN.

FOR BEER AND ALE (U.S. CLS. 45, 46 AND 48).

GENE MACIOL, EXAMINING ATTORNEY

SN 85-519,654. ABBEY BEVERAGE COMPANY, LLC, SANTE FE, NM. FILED 1-18-2012.

MONKS' DUBBEL

THE MARK CONSISTS OF STANDARD CHARACTERS WITHOUT CLAIM TO ANY PARTICULAR FONT, STYLE, SIZE, OR COLOR.

OWNER OF U.S. REG. NOS. 3,056,340, 4,034,565 AND OTHERS.

NO CLAIM IS MADE TO THE EXCLUSIVE RIGHT TO USE "DUBBEL", APART FROM THE MARK AS SHOWN.

FOR BEER AND ALE (U.S. CLS. 45, 46 AND 48).

GENE MACIOL, EXAMINING ATTORNEY

SN 85-519,892. NERKO DEVELOPMENT GROUP, LTD., WILLISTON PARK, NY. FILED 1-19-2012.

Applause Beer

THE MARK CONSISTS OF STANDARD CHARACTERS WITHOUT CLAIM TO ANY PARTICULAR FONT, STYLE, SIZE, OR COLOR.

NO CLAIM IS MADE TO THE EXCLUSIVE RIGHT TO USE "BEER", APART FROM THE MARK AS SHOWN.

FOR ALCOHOL-FREE BEERS; BEER; BEER MAKING KIT; BEER WORT; BEER, ALE AND LAGER; BEER, ALE AND PORTER; BEER, ALE, LAGER, STOUT AND PORTER; BEER, ALE, LAGER, STOUT, PORTER, SHANDY; BEER-BASED COOLERS; BEERS; BLACK BEER; BREWED MALT-BASED ALCOHOLIC BEVERAGE IN THE NATURE OF A BEER; COFFEE-FLAVORED BEER; DE-ALCOHOLISED BEER; EXTRACTS OF HOPS FOR MAKING BEER; FLAVORED BEERS; GINGER BEER; HOP EXTRACTS FOR MANUFACTURING BEER; IMITATION BEER; MALT BEER; MALT EXTRACTS FOR MAKING BEER; MALT LIQUOR; NON-ALCOHOLIC BEER; PALE BEER; PORTER (U.S. CLS. 45, 46 AND 48).

JESSICA A. POWERS, EXAMINING ATTORNEY

CLASS 32—(Continued).

SN 85-521,289. URSTUFF, LLC, GURNEE, IL. FILED 1-20-2012.

BODA

THE MARK CONSISTS OF STANDARD CHARACTERS WITHOUT CLAIM TO ANY PARTICULAR FONT, STYLE, SIZE, OR COLOR.

THE ENGLISH TRANSLATION OF THE WORD "BODA" IN THE MARK IS "WEDDING".

FOR FLAVOR ENHANCED WATER, NAMELY, ENERGY SUPPLEMENT DRINKS ENHANCED WITH ARONIA, GREEN TEA EXTRACT AND/OR VITAMINS (U.S. CLS. 45, 46 AND 48).

FIRST USE 7-28-2010; IN COMMERCE 7-28-2010.
ROBIN MITTLER, EXAMINING ATTORNEY

SN 85-521,380. URSTUFF, LLC, GURNEE, IL. FILED 1-20-2012.

THE MARK CONSISTS OF "BODA" AND ENLARGED LETTER "B".

THE ENGLISH TRANSLATION OF THE WORD "BODA" IN THE MARK IS "WEDDING".

FOR FLAVORED ENHANCED WATER, NAMELY, ENERGY SUPPLEMENT DRINKS ENHANCED WITH ARONIA GREEN TEA EXTRACT AND/OR VITAMINS (U.S. CLS. 45, 46 AND 48).

FIRST USE 7-28-2010; IN COMMERCE 7-28-2010.
ROBIN MITTLER, EXAMINING ATTORNEY

SN 85-524,172. DUST BOWL BREWING CO., HILMAR, CA. FILED 1-24-2012.

FRUIT TRAMP

THE MARK CONSISTS OF STANDARD CHARACTERS WITHOUT CLAIM TO ANY PARTICULAR FONT, STYLE, SIZE, OR COLOR.

NO CLAIM IS MADE TO THE EXCLUSIVE RIGHT TO USE "FRUIT", APART FROM THE MARK AS SHOWN.

FOR BEER (U.S. CLS. 45, 46 AND 48).

KEVON CHISOLM, EXAMINING ATTORNEY

CLASS 32—(Continued).

SN 85-524,683. TWELVETWONINE, DBA CHRISTMAS MILK, FRISCO, TX. FILED 1-25-2012.

Grinch Juice

THE MARK CONSISTS OF STANDARD CHARACTERS WITHOUT CLAIM TO ANY PARTICULAR FONT, STYLE, SIZE, OR COLOR.

NO CLAIM IS MADE TO THE EXCLUSIVE RIGHT TO USE "JUICE", APART FROM THE MARK AS SHOWN.

FOR FRUIT BEVERAGES; FRUIT DRINKS; FRUIT DRINKS AND FRUIT JUICES; FRUIT DRINKS AND JUICES; FRUIT FLAVORED DRINKS; FRUIT FLAVORED DRINKS; FRUIT JUICE; FRUIT JUICES; FRUIT JUICES AND FRUIT DRINKS; LEMONADE-FLAVORED FRUIT JUICE DRINKS; FRUIT-BASED BEVERAGES; FRUIT-FLAVORED BEVERAGES; FRUIT-FLAVORED BEVERAGES; NON-ALCOHOLIC FRUIT JUICE BEVERAGES (U.S. CLS. 45, 46 AND 48).

KATHY DE JONGE, EXAMINING ATTORNEY

SN 85-525,192. GOYA FOODS, INC., SECAUCUS, NJ. FILED 1-25-2012.

GOYA FOR KIDS

THE MARK CONSISTS OF STANDARD CHARACTERS WITHOUT CLAIM TO ANY PARTICULAR FONT, STYLE, SIZE, OR COLOR.

OWNER OF U.S. REG. NOS. 764,033, 966,178 AND OTHERS.

NO CLAIM IS MADE TO THE EXCLUSIVE RIGHT TO USE "FOR KIDS", APART FROM THE MARK AS SHOWN.

FOR BOTTLED WATER; COCONUT WATER; FRUIT BEVERAGES; FRUIT DRINKS AND JUICES; FRUIT NECTARS; NON-ALCOHOLIC MALT BEVERAGE; SMOOTHIES; SOFT DRINKS; SYRUPS FOR MAKING SOFT DRINKS; VEGETABLE JUICE; WATER BEVERAGES (U.S. CLS. 45, 46 AND 48).

KATHLEEN LORENZO, EXAMINING ATTORNEY

SN 85-530,003. CILURZO, VINNIE, SANTA ROSA, CA. AND CILURZO, NATALIE, SANTA ROSA, CA. FILED 1-31-2012.

AMASA

THE MARK CONSISTS OF STANDARD CHARACTERS WITHOUT CLAIM TO ANY PARTICULAR FONT, STYLE, SIZE, OR COLOR.

FOR BEER (U.S. CLS. 45, 46 AND 48).

MICHAEL WEBSTER, EXAMINING ATTORNEY

CLASS 32—(Continued).

SN 85-530,445. GREATHEAD BREW LLC, LAGUNA NI-GUEL, CA. FILED 1-31-2012.

GREATHEAD

THE MARK CONSISTS OF STANDARD CHARACTERS WITHOUT CLAIM TO ANY PARTICULAR FONT, STYLE, SIZE, OR COLOR.

FOR BEER (U.S. CLS. 45, 46 AND 48).
CHARLES L. JENKINS, EXAMINING ATTORNEY

SN 85-530,575. KOSMATKA, GREGORY R., GROSSE POINTE FARMS, MI. FILED 2-1-2012.

F N

THE MARK CONSISTS OF STANDARD CHARACTERS WITHOUT CLAIM TO ANY PARTICULAR FONT, STYLE, SIZE, OR COLOR.

FOR ALCOHOL-FREE BEERS; BEER; BEER MAKING KIT; BEER WORT; BEER, ALE AND LAGER; BEER, ALE AND PORTER; BEER, ALE, LAGER, STOUT AND PORTER; BEER, ALE, LAGER, STOUT, PORTER, SHANDY; BEER-BASED COOLERS; BEERS; BLACK BEER; BREWED MALT-BASED ALCOHOLIC BEVERAGE IN THE NATURE OF A BEER; COFFEE-FLAVORED BEER (U.S. CLS. 45, 46 AND 48).
DEBORAH LOBO, EXAMINING ATTORNEY

SN 85-531,019. MARCH MADNESS ATHLETIC ASSOCIATION LLC, BLOOMINGTON, IL. FILED 2-1-2012.

ENJOY MORE MADNESS

THE MARK CONSISTS OF STANDARD CHARACTERS WITHOUT CLAIM TO ANY PARTICULAR FONT, STYLE, SIZE, OR COLOR.

FOR NON-ALCOHOLIC BEVERAGES, NAMELY, WATER, FRUIT DRINKS AND FRUIT JUICES, SPORT DRINKS, SOFT DRINKS, AND CONCENTRATES FOR MAKING THE SAME (U.S. CLS. 45, 46 AND 48).
DAVID TAYLOR, EXAMINING ATTORNEY

CLASS 32—(Continued).

SN 85-531,555. GORDON, ROMAINE, EAST HAMPTON, NY. FILED 2-1-2012.

Hydrate 2 Help

THE MARK CONSISTS OF STANDARD CHARACTERS WITHOUT CLAIM TO ANY PARTICULAR FONT, STYLE, SIZE, OR COLOR.

FOR DRINKING WATER (U.S. CLS. 45, 46 AND 48).
BRIDGETT SMITH, EXAMINING ATTORNEY

SN 85-531,833. BOYLAN BOTTLING CO., TETERBORO, NJ. FILED 2-2-2012.

SPRING FEVER

THE MARK CONSISTS OF STANDARD CHARACTERS WITHOUT CLAIM TO ANY PARTICULAR FONT, STYLE, SIZE, OR COLOR.

FOR NON-ALCOHOLIC BEVERAGES, NAMELY, SOFT DRINKS (U.S. CLS. 45, 46 AND 48).
ALEX KEAM, EXAMINING ATTORNEY

SN 85-532,168. SONES, AARON, LOS ANGELES, CA. FILED 2-2-2012.

ZENJII

THE MARK CONSISTS OF STANDARD CHARACTERS WITHOUT CLAIM TO ANY PARTICULAR FONT, STYLE, SIZE, OR COLOR.

FOR SOFT DRINKS (U.S. CLS. 45, 46 AND 48).
YAT SYE, LEE, EXAMINING ATTORNEY

CLASS 32—(Continued).

SN 85-532,176. SONES, AARON, LOS ANGELES, CA. FILED 2-2-2012.



THE MARK CONSISTS OF A STYLIZED LETTER "Z" INSIDE A CIRCLE.
FOR SOFT DRINKS (U.S. CLS. 45, 46 AND 48).
YAT SYE, LEE, EXAMINING ATTORNEY

SN 85-532,594. PORTLAND BOTTLING COMPANY, PORTLAND, OR. FILED 2-2-2012.

TASMANIAN FORCE

THE MARK CONSISTS OF STANDARD CHARACTERS WITHOUT CLAIM TO ANY PARTICULAR FONT, STYLE, SIZE, OR COLOR.
FOR NON-ALCOHOLIC BEVERAGES, NAMELY, ENERGY DRINKS (U.S. CLS. 45, 46 AND 48).
FIRST USE 2-13-2008; IN COMMERCE 2-13-2008.
RONALD MCMORROW, EXAMINING ATTORNEY

SN 85-532,868. SUMMIT BREWING COMPANY, ST. PAUL, MN. FILED 2-3-2012.

SAGA IPA

THE MARK CONSISTS OF STANDARD CHARACTERS WITHOUT CLAIM TO ANY PARTICULAR FONT, STYLE, SIZE, OR COLOR.
NO CLAIM IS MADE TO THE EXCLUSIVE RIGHT TO USE "IPA", APART FROM THE MARK AS SHOWN.
FOR BEER (U.S. CLS. 45, 46 AND 48).
SUE LAWRENCE, EXAMINING ATTORNEY

CLASS 32—(Continued).

SN 85-533,520. IN-STYLE INC., NEW CITY, NY. FILED 2-3-2012.

iSkinny

THE MARK CONSISTS OF STANDARD CHARACTERS WITHOUT CLAIM TO ANY PARTICULAR FONT, STYLE, SIZE, OR COLOR.
FOR ENERGY DRINKS (U.S. CLS. 45, 46 AND 48).
FONG HSU, EXAMINING ATTORNEY

SN 85-534,110. MEENAXI ENTERPRISE, INC., DBA MEE-NAXI ENTERPRISE, INC., SOUTH PLAINFIELD, NJ. FILED 2-4-2012.

Limca

THE MARK CONSISTS OF STANDARD CHARACTERS WITHOUT CLAIM TO ANY PARTICULAR FONT, STYLE, SIZE, OR COLOR.
THE WORDING LIMCA HAS NO MEANING IN A FOREIGN LANGUAGE.
FOR CONCENTRATES, SYRUPS OR POWDERS USED IN THE PREPARATION OF SOFT DRINKS; SOFT DRINKS, NAMELY, SODAS (U.S. CLS. 45, 46 AND 48).
FIRST USE 1-1-2008; IN COMMERCE 1-1-2008.
GINA HAYES, EXAMINING ATTORNEY

SN 85-534,116. MEENAXI ENTERPRISE, INC., DBA MEE-NAXI ENTERPRISE, INC., SOUTH PLAINFIELD, NJ. FILED 2-4-2012.

Thums Up

THE MARK CONSISTS OF STANDARD CHARACTERS WITHOUT CLAIM TO ANY PARTICULAR FONT, STYLE, SIZE, OR COLOR.
FOR COLAS; CONCENTRATES, SYRUPS OR POWDERS USED IN THE PREPARATION OF SOFT DRINKS; SOFT DRINKS, NAMELY, SODAS (U.S. CLS. 45, 46 AND 48).
FIRST USE 1-1-2008; IN COMMERCE 1-1-2008.
GINA HAYES, EXAMINING ATTORNEY

CLASS 32—(Continued).

SN 85-534,212. K1DRINK.COM B.V., DE MEERN, NETHERLANDS, FILED 2-5-2012.

White Widow

THE MARK CONSISTS OF STANDARD CHARACTERS WITHOUT CLAIM TO ANY PARTICULAR FONT, STYLE, SIZE, OR COLOR.
FOR ENERGY DRINKS; SPORTS DRINKS, NAMELY, ENERGY DRINKS; SPORTS DRINKS, NAMELY, PERFORMANCE DRINKS (U.S. CLS. 45, 46 AND 48).
HELENE LIWINSKI, EXAMINING ATTORNEY

CLASS 32—(Continued).

SN 85-535,526. STAVRAKIS, FILIPPOS, FOREST HILL, MD. FILED 2-7-2012.

**YOU ONLY GET ONE
BODY...FUEL IT RIGHT**

THE MARK CONSISTS OF STANDARD CHARACTERS WITHOUT CLAIM TO ANY PARTICULAR FONT, STYLE, SIZE, OR COLOR.
FOR SPORTS DRINKS (U.S. CLS. 45, 46 AND 48).
CHARISMA HAMPTON, EXAMINING ATTORNEY

SN 85-535,136. POLAR CORP., WORCESTER, MA. FILED 2-6-2012.

A FLAVOR FOR EVERY TASTE

THE MARK CONSISTS OF STANDARD CHARACTERS WITHOUT CLAIM TO ANY PARTICULAR FONT, STYLE, SIZE, OR COLOR.
FOR CARBONATED WATERS; FRUIT FLAVOURED CARBONATED DRINKS (U.S. CLS. 45, 46 AND 48).
FIRST USE 9-0-2002; IN COMMERCE 9-0-2002.
JESSICA A. POWERS, EXAMINING ATTORNEY

SN 85-535,701. CAHILL, KURT E, FLOWER MOUND, TX. FILED 2-7-2012.

FruitPrint

THE MARK CONSISTS OF STANDARD CHARACTERS WITHOUT CLAIM TO ANY PARTICULAR FONT, STYLE, SIZE, OR COLOR.
FOR CONCENTRATED FRUIT JUICE (U.S. CLS. 45, 46 AND 48).
MICHAEL ENGEL, EXAMINING ATTORNEY

SN 85-535,498. STJ PARTNERS, LLC, ROCKVILLE CENTER, NY. FILED 2-7-2012.

BREWSA

THE MARK CONSISTS OF STANDARD CHARACTERS WITHOUT CLAIM TO ANY PARTICULAR FONT, STYLE, SIZE, OR COLOR.
FOR BEER (U.S. CLS. 45, 46 AND 48).
MIDGE BUTLER, EXAMINING ATTORNEY

SN 85-535,848. ROMANO, JAMES, WHITE CITY, OR. FILED 2-7-2012.

FIRE CIRKL

THE MARK CONSISTS OF STANDARD CHARACTERS WITHOUT CLAIM TO ANY PARTICULAR FONT, STYLE, SIZE, OR COLOR.
FOR BEER (U.S. CLS. 45, 46 AND 48).
JENNIFER RICHARDSON, EXAMINING ATTORNEY

CLASS 32—(Continued).

SN 85-536,411. SOCIETE DES PRODUITS NESTLE S.A., 1800 VEVEY, SWITZERLAND, FILED 2-7-2012.



THE COLOR(S) PINK, GREY AND WHITE IS/ARE CLAIMED AS A FEATURE OF THE MARK.

THE MARK CONSISTS OF A SHIELD DESIGN IN PINK, GREY AND WHITE. THE SHIELD IS WHITE AT THE UPPER RIGHT CORNER, ACROSS THE SHIELD, AND AT THE LEFT SIDE. THE SHIELD IS GREY AT THE UPPER LEFT CORNER, ACROSS THE SHIELD, AND AT THE RIGHT SIDE AND BOTTOM. THE WORD "PROTECT" APPEARS IN PINK AT THE CENTER OF THE SHIELD.

FOR AERATED WATER; DRINKING WATER; STILL WATER; TABLE WATER; SPRING WATER; SPARKLING WATER; MINERAL WATER; FLAVORED WATERS; FRUIT BEVERAGES; FRUIT-FLAVORED BEVERAGES; FRUIT DRINKS; FRUIT FLAVORED SOFT DRINKS; FRUIT JUICES; ENERGY DRINKS; ISOTONIC DRINKS; SOFT DRINKS; SPORT DRINKS; NON-ALCOHOLIC BEVERAGES, NAMELY, CARBONATED BEVERAGES (U.S. CLS. 45, 46 AND 48).

WENDY JUN, EXAMINING ATTORNEY

SN 85-536,556. DOS AMIGOS BRANDS LLC, SAN DIEGO, CA. FILED 2-7-2012.

TROPILICIOUS

THE MARK CONSISTS OF STANDARD CHARACTERS WITHOUT CLAIM TO ANY PARTICULAR FONT, STYLE, SIZE, OR COLOR.

FOR SOFT DRINKS (U.S. CLS. 45, 46 AND 48).
HOWARD SMIGA, EXAMINING ATTORNEY

CLASS 32—(Continued).

SN 85-536,958. 4 HANDS BREWING COMPANY, LLC, SAINT LOUIS, MO. FILED 2-8-2012.

SINGLE SPEED SESSION

THE MARK CONSISTS OF STANDARD CHARACTERS WITHOUT CLAIM TO ANY PARTICULAR FONT, STYLE, SIZE, OR COLOR.

FOR BEER (U.S. CLS. 45, 46 AND 48).
FIRST USE 11-11-2011; IN COMMERCE 11-11-2011.
MICHAEL WEBSTER, EXAMINING ATTORNEY

SN 85-537,095. PEPSICO, INC., PURCHASE, NY. FILED 2-8-2012.

DEW TOUGH

THE MARK CONSISTS OF STANDARD CHARACTERS WITHOUT CLAIM TO ANY PARTICULAR FONT, STYLE, SIZE, OR COLOR.

OWNER OF U.S. REG. NOS. 820,362, 3,687,364 AND OTHERS.
FOR SOFT DRINKS (U.S. CLS. 45, 46 AND 48).
DOMINIC FATHY, EXAMINING ATTORNEY

SN 85-537,830. VIAVIV LLC, SANFORD, FL. FILED 2-9-2012.



THE COLOR(S) BLUE AND RED IS/ARE CLAIMED AS A FEATURE OF THE MARK.

THE MARK CONSISTS OF BLUE WATER SPLASH WITH VIAVIV IN RED STYLIZED LETTERS TO THE RIGHT OF THE SPLASH.

FOR BOTTLED WATER; FLAVORED BOTTLED WATER; SPARKLING WATER (U.S. CLS. 45, 46 AND 48).
VIVIAN MICZNIK FIRST, EXAMINING ATTORNEY

CLASS 32—(Continued).

SN 85-538,039. GRAPETTE INTERNATIONAL, INC., ROCK-PORT, AR. FILED 2-9-2012.

ORANGETTE

THE MARK CONSISTS OF STANDARD CHARACTERS WITHOUT CLAIM TO ANY PARTICULAR FONT, STYLE, SIZE, OR COLOR.
OWNER OF U.S. REG. NO. 730,872.
FOR SOFT DRINKS; CONCENTRATES FOR MAKING SOFT DRINKS (U.S. CLS. 45, 46 AND 48).
FIRST USE 0-0-1947; IN COMMERCE 0-0-1947.
HELENE LIWINSKI, EXAMINING ATTORNEY

CLASS 32—(Continued).

SN 85-539,319. 313ENERGY, FRANKLIN, MI. FILED 2-10-2012.

313Energy

THE MARK CONSISTS OF STANDARD CHARACTERS WITHOUT CLAIM TO ANY PARTICULAR FONT, STYLE, SIZE, OR COLOR.
FOR ENERGY DRINKS (U.S. CLS. 45, 46 AND 48).
FIRST USE 1-19-2012; IN COMMERCE 2-9-2012.
ANDREW LEASER, EXAMINING ATTORNEY

SN 85-538,490. ABBEY BEVERAGE COMPANY, LLC, SANTE FE, NM. FILED 2-9-2012.

REAL BEERS. REAL MONKS.

THE MARK CONSISTS OF STANDARD CHARACTERS WITHOUT CLAIM TO ANY PARTICULAR FONT, STYLE, SIZE, OR COLOR.
OWNER OF U.S. REG. NOS. 3,056,340, 4,034,565 AND OTHERS.
FOR BEER AND ALE (U.S. CLS. 45, 46 AND 48).
GENE MACIOL, EXAMINING ATTORNEY

SN 85-540,197. LOGGERHEAD BREWING COMPANY, LLC, PALM BEACH GARDENS, FL. FILED 2-11-2012.

LOGGERHEAD

THE MARK CONSISTS OF STANDARD CHARACTERS WITHOUT CLAIM TO ANY PARTICULAR FONT, STYLE, SIZE, OR COLOR.
FOR BEER, ALE, LAGER, STOUT AND PORTER (U.S. CLS. 45, 46 AND 48).
GIANCARLO CASTRO, EXAMINING ATTORNEY

SN 85-538,999. SAKS, CONRAD, DBA LIMONITZ, LOS ANGELES, CA. FILED 2-10-2012.

Limonitz

THE MARK CONSISTS OF STANDARD CHARACTERS WITHOUT CLAIM TO ANY PARTICULAR FONT, STYLE, SIZE, OR COLOR.
FOR NON-ALCOHOLIC FRUIT JUICE BEVERAGES (U.S. CLS. 45, 46 AND 48).
DAVID C. REIHNER, EXAMINING ATTORNEY

SN 85-541,520. COATS INTERNATIONAL HOLDINGS, INC., DBA COATS ALOE INTERNATIONAL, INC., DALLAS, TX. FILED 2-13-2012.

AloeRITA

FOR NON-ALCOHOLIC COCKTAIL MIXES (U.S. CLS. 45, 46 AND 48).
RONALD MCMORROW, EXAMINING ATTORNEY

CLASS 32—(Continued).

SN 85-551,197. OREGON BREWING COMPANY, NEWPORT, OR. FILED 2-23-2012.

541

THE MARK CONSISTS OF STANDARD CHARACTERS WITHOUT CLAIM TO ANY PARTICULAR FONT, STYLE, SIZE, OR COLOR.

FOR BEER (U.S. CLS. 45, 46 AND 48).
FLORENTINA BLANDU, EXAMINING ATTORNEY

SN 85-555,720. SPORTSMAN SCENT SOLUTIONS, INC., BRIDGEPORT, NY. FILED 2-29-2012.



THE COLOR(S) GREEN AND SILVER IS/ARE CLAIMED AS A FEATURE OF THE MARK.

THE MARK CONSISTS OF THE STYLIZED WORDING "SLAY" WITH THE LETTERS "SL" AND "Y" IN GREEN WITH SILVER OUTLINING AND THE LETTER "A" IN SILVER.

FOR ENERGY DRINKS; SPORTS DRINKS (U.S. CLS. 45, 46 AND 48).
AMY C. KEAN, EXAMINING ATTORNEY

SN 85-564,240. BOSTON BEER CORPORATION, BOSTON, MA. FILED 3-8-2012.

SAMUEL ADAMS NORSE LEGEND

THE MARK CONSISTS OF STANDARD CHARACTERS WITHOUT CLAIM TO ANY PARTICULAR FONT, STYLE, SIZE, OR COLOR.

OWNER OF U.S. REG. NOS. 1,987,062, 2,597,646 AND OTHERS.

THE NAME(S), PORTRAIT(S), AND/OR SIGNATURE(S) SHOWN IN THE MARK DOES NOT IDENTIFY A PARTICULAR LIVING INDIVIDUAL.

FOR ALE; BEER (U.S. CLS. 45, 46 AND 48).
AMY KELLY, EXAMINING ATTORNEY

CLASS 32—(Continued).

SN 85-564,373. BOSTON BEER CORPORATION, BOSTON, MA. FILED 3-8-2012.

SAMUEL ADAMS VERLOREN

THE MARK CONSISTS OF STANDARD CHARACTERS WITHOUT CLAIM TO ANY PARTICULAR FONT, STYLE, SIZE, OR COLOR.

OWNER OF U.S. REG. NOS. 1,987,062, 2,597,646 AND OTHERS.

THE NAME(S), PORTRAIT(S), AND/OR SIGNATURE(S) SHOWN IN THE MARK DOES NOT IDENTIFY A PARTICULAR LIVING INDIVIDUAL.

THE ENGLISH TRANSLATION OF "VERLOREN" IN THE MARK IS "LOST".

FOR ALE; BEER (U.S. CLS. 45, 46 AND 48).
AMY KELLY, EXAMINING ATTORNEY

CLASS 33—WINES AND SPIRITS

SN 77-947,593. PROHIBITION DISTILLERY LLC, PALISADES, NY. FILED 3-1-2010.

BOOTLEGGER 21

THE MARK CONSISTS OF STANDARD CHARACTERS WITHOUT CLAIM TO ANY PARTICULAR FONT, STYLE, SIZE, OR COLOR.

FOR ALCOHOLIC BEVERAGES EXCEPT BEERS AND WINES (U.S. CLS. 47 AND 49).

HANNO RITTNER, EXAMINING ATTORNEY

SN 79-100,936. SH AVENIR, F-33850 LEOGNAN, FRANCE, FILED 6-30-2011.

PERLITA

THE MARK CONSISTS OF STANDARD CHARACTERS WITHOUT CLAIM TO ANY PARTICULAR FONT, STYLE, SIZE, OR COLOR.

PRIORITY DATE OF 3-22-2011 IS CLAIMED.

OWNER OF INTERNATIONAL REGISTRATION 1086447 DATED 6-30-2011, EXPIRES 6-30-2021.

FOR AOC WINES, NAMELY, WINES WITH PROTECTED APPELLATION OF ORIGIN (U.S. CLS. 47 AND 49).

KRISTIN CARLSON, EXAMINING ATTORNEY

CLASS 33—(Continued).

SN 79-101,184. HEREDAD UGARTE, S.A., SPAIN, FILED 6-29-2011.

UGARTE

THE MARK CONSISTS OF STANDARD CHARACTERS WITHOUT CLAIM TO ANY PARTICULAR FONT, STYLE, SIZE, OR COLOR.

OWNER OF INTERNATIONAL REGISTRATION 1087076 DATED 6-29-2011, EXPIRES 6-29-2021.

OWNER OF U.S. REG. NO. 3,601,344. SEC. 2(F).
FOR ALCOHOLIC BEVERAGES, NAMELY, WINES (U.S. CLS. 47 AND 49).
SARA BENJAMIN, EXAMINING ATTORNEY

CLASS 33—(Continued).

SN 85-096,281. REDWOOD VISTA, LLC, NAPA, CA. FILED 7-29-2010.

GOLDROCK RIDGE

THE MARK CONSISTS OF STANDARD CHARACTERS WITHOUT CLAIM TO ANY PARTICULAR FONT, STYLE, SIZE, OR COLOR.

FOR ALCOHOLIC BEVERAGES EXCEPT BEERS (U.S. CLS. 47 AND 49).
AMY HELLA, EXAMINING ATTORNEY

SN 79-104,672. AVEZE SAS, NUIITS-SAINT-GEORGES, FRANCE, FILED 6-24-2011.

AVÈZE

OWNER OF INTERNATIONAL REGISTRATION 0271690 DATED 7-12-1963, EXPIRES 7-12-2013.

THE MARK CONSISTS OF THE STYLIZED WORDING "AVÈZE".

THE WORDING "AVÈZE" HAS NO MEANING IN A FOREIGN LANGUAGE.

FOR APERITIFS, ALCOHOLS, NAMELY, LIQUEURS AND SPIRITS, EXCLUDING WINES (U.S. CLS. 47 AND 49).

COURTNEY ALVAREZ, EXAMINING ATTORNEY

SN 85-154,596. ROCHA, GABRIEL, LOS ANGELES, CA. FILED 10-18-2010.

EL PADRE

THE MARK CONSISTS OF STANDARD CHARACTERS WITHOUT CLAIM TO ANY PARTICULAR FONT, STYLE, SIZE, OR COLOR.

THE ENGLISH TRANSLATION OF "EL PADRE" IN THE MARK IS "THE FATHER".

FOR ALCOHOLIC BEVERAGES, NAMELY, TEQUILA (U.S. CLS. 47 AND 49).

RONALD MCMORROW, EXAMINING ATTORNEY

SN 79-108,945. LE CONTESSE S.R.L., ITALY, FILED 1-25-2012.

LUNA D'OR

THE MARK CONSISTS OF STANDARD CHARACTERS WITHOUT CLAIM TO ANY PARTICULAR FONT, STYLE, SIZE, OR COLOR.

OWNER OF INTERNATIONAL REGISTRATION 1106242 DATED 1-25-2012, EXPIRES 1-25-2022.

THE ENGLISH TRANSLATION OF "LUNA D'OR" IN THE MARK IS "GOLDEN MOON".

FOR ALCOHOLIC BEVERAGES EXCEPT BEERS (U.S. CLS. 47 AND 49).

COLLEEN DOMBROW, EXAMINING ATTORNEY

SN 85-196,381. ST. LUCIA DISTILLERS LTD., CASTRIES, ST. LUCIA, FILED 12-13-2010.

CHAIRMAN'S RESERVE

THE MARK CONSISTS OF STANDARD CHARACTERS WITHOUT CLAIM TO ANY PARTICULAR FONT, STYLE, SIZE, OR COLOR.

NO CLAIM IS MADE TO THE EXCLUSIVE RIGHT TO USE "RESERVE", APART FROM THE MARK AS SHOWN.

FOR RUM (U.S. CLS. 47 AND 49).
FIRST USE 10-1-2009; IN COMMERCE 10-1-2009.

MAUREEN DALL, EXAMINING ATTORNEY

CLASS 33—(Continued).

SN 85-212,592. PROJECT O, LLC, MIAMI BEACH, FL. FILED 1-7-2011.



SupraFruta
RED SANGRIA

NO CLAIM IS MADE TO THE EXCLUSIVE RIGHT TO USE "RED SANGRIA", APART FROM THE MARK AS SHOWN.

THE MARK CONSISTS OF THE WORDS "EPPA SUPRAFRUTA RED SANGRIA" AND A DESIGN CONSISTING OF TWO SMALL CIRCLES, TWO HALF CIRCLES AND A SPIRAL CONNECTING TO THE FIRST "P" IN "EPPA" TO THE HALF CIRCLES.

THE WORDING "EPPA" AND "SUPRAFRUTA" HAS NO MEANING IN A FOREIGN LANGUAGE.

FOR WINES; WINE-BASED DRINKS (U.S. CLS. 47 AND 49).

MAYUR VAGHANI, EXAMINING ATTORNEY

SN 85-242,665. CANOPY MANAGEMENT, LLC, NAPA, CA. FILED 2-15-2011.

NAPA UNDERGROUND

THE MARK CONSISTS OF STANDARD CHARACTERS WITHOUT CLAIM TO ANY PARTICULAR FONT, STYLE, SIZE, OR COLOR.

NO CLAIM IS MADE TO THE EXCLUSIVE RIGHT TO USE "NAPA", APART FROM THE MARK AS SHOWN.

FOR WINES DERIVED FROM GRAPES GROWN IN NAPA COUNTY, CALIFORNIA, LABELED AND ADVERTISED IN COMPLIANCE WITH UNITED STATES LAWS FOR THE NAPA COUNTY APPELLATION OF ORIGIN OR THE NAPA VALLEY AMERICAN VITICULTURAL AREA APPELLATION OF ORIGIN (U.S. CLS. 47 AND 49).

CHRISTINA SOBRAL, EXAMINING ATTORNEY

CLASS 33—(Continued).

SN 85-281,084. LES VINS GEORGES DUBOEUF, LA CHAPPELLE DE GUINCHAY, FRANCE, FILED 3-30-2011.



PRIORITY CLAIMED UNDER SEC. 44(D) ON FRANCE APPLICATION NO. 113808318, FILED 2-22-2011, REG. NO. 113808318, DATED 2-22-2011, EXPIRES 2-21-2021.

OWNER OF U.S. REG. NOS. 3,180,291, 3,311,993 AND OTHERS.

THE NAME "GEORGES DUBOEUF" IDENTIFIES A LIVING INDIVIDUAL WHOSE CONSENT IS OF RECORD.

THE COLOR(S) BLACK, BLUE, WHITE, YELLOW, RED AND GREEN IS/ARE CLAIMED AS A FEATURE OF THE MARK.

THE MARK CONSISTS OF THE WORD "GEORGES" ABOVE THE WORD "DUBOEUF" WITH A HORIZONTAL LINE BETWEEN THEM, IN WHITE, BOUNDED BY A BLACK BOX. BELOW THE BOX IS A DESIGN ELEMENT OF THREE FLOWERS, FROM LEFT TO RIGHT THE FLOWERS ARE BLUE, WHITE WITH A YELLOW CENTER THEN RED. GREEN LEAVES SURROUND THE FLOWERS. FOR WINES (U.S. CLS. 47 AND 49).

MARTHA SANTOMARTINO, EXAMINING ATTORNEY

SN 85-314,517. SPIRITS OF GOLD AB, 5 TR. STOCKHOLM, SWEDEN, FILED 5-6-2011.

KARLSSON'S
GOLD

OWNER OF U.S. REG. NO. 3,699,231.

THE MARK CONSISTS OF THE WORDING "KARLSSON'S GOLD" IN STYLIZED FORM, INCORPORATING THE STYLIZED REPRESENTATION OF A POTATO AS THE LETTER "O" IN "KARLSSON'S".

FOR ALCOHOLIC BEVERAGES, EXCEPT BEERS; VODKA (U.S. CLS. 47 AND 49).

FIRST USE 6-1-2007; IN COMMERCE 6-1-2007.

DAVID H. STINE, EXAMINING ATTORNEY

CLASS 33—(Continued).

SN 85-351,068. ICRE8IT MARKETING, INC., SCOTTSDALE, AZ. FILED S.R. 6-20-2011; AM. P.R. 4-19-2012.

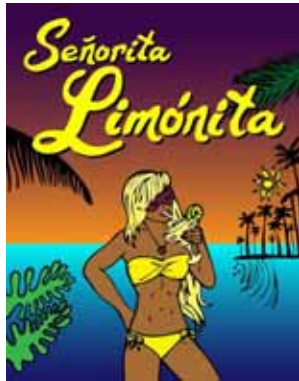

THE NAME "SEÑORITA LIMÓNITA" DOES NOT IDENTIFY A LIVING INDIVIDUAL.

THE COLOR(S) YELLOW, TAN, PURPLE, ORANGE, BLACK, GREEN, AND BLUE IS/ARE CLAIMED AS A FEATURE OF THE MARK.

THE MARK CONSISTS OF THE STYLIZED WORDING "SEÑORITA LIMÓNITA" IN THE COLOR YELLOW. BELOW THE WORDING IS THE DESIGN OF A TAN WOMAN WEARING A YELLOW BIKINI. THE WOMAN HAS YELLOW HAIR AND IS WEARING PURPLE SUNGLASSES. IN HER HAND SHE IS HOLDING A YELLOW DRINK. THE BACKGROUND CONSISTS OF A PURPLE AND ORANGE SKY, BLUE WATER, A YELLOW SUN OUTLINED IN BLACK, THE BLACK SILHOUETTES OF SEVERAL PALM TREES, GREEN PALM FRONDS AND PLANT LEAVES, AND THE BLACK SILHOUETTE OF A PALM FROND.

FOR MARGARITA MIX (U.S. CLS. 47 AND 49).
FIRST USE 5-24-2011; IN COMMERCE 6-20-2011.
BARBARA GAYNOR, EXAMINING ATTORNEY

SN 85-364,538. PAN AMERICAN PROPERTIES CORP., GUAYNABO, PUERTO RICO, FILED 7-6-2011.

GASOLINA LIMONCILLO

THE MARK CONSISTS OF STANDARD CHARACTERS WITHOUT CLAIM TO ANY PARTICULAR FONT, STYLE, SIZE, OR COLOR.

OWNER OF U.S. REG. NOS. 3,181,903, 3,818,800 AND OTHERS.

NO CLAIM IS MADE TO THE EXCLUSIVE RIGHT TO USE "LIMONCILLO", APART FROM THE MARK AS SHOWN.

THE ENGLISH TRANSLATION OF "GASOLINA LIMONCILLO" IN THE MARK IS "GASOLINE" AND "SMALL LEMON".

FOR PREPARED ALCOHOLIC COCKTAIL (U.S. CLS. 47 AND 49).
ALEXANDER L. POWERS, EXAMINING ATTORNEY

CLASS 33—(Continued).

SN 85-368,822. 750 ML, LLC, MILFORD, DE. FILED 7-12-2011.

L'EXOTIQUE DE DOMAINE DE CANTON

THE MARK CONSISTS OF STANDARD CHARACTERS WITHOUT CLAIM TO ANY PARTICULAR FONT, STYLE, SIZE, OR COLOR.

OWNER OF U.S. REG. NOS. 1,376,192, 1,759,223 AND 3,891,726.

NO CLAIM IS MADE TO THE EXCLUSIVE RIGHT TO USE "DOMAINE", APART FROM THE MARK AS SHOWN.

THE ENGLISH TRANSLATION OF "L'EXOTIQUE" IN THE MARK IS "THE EXOTIC". THE ENGLISH TRANSLATION OF "DOMAINE" IN THE MARK IS "DOMAIN".

FOR LIQUEURS (U.S. CLS. 47 AND 49).
JAMES GRIFFIN, EXAMINING ATTORNEY

SN 85-379,478. SUNTORY HOLDINGS LIMITED, OSAKASHI, OSAKA, JAPAN, FILED 7-24-2011.

MIDORI SKINNY MARGARITA

THE MARK CONSISTS OF STANDARD CHARACTERS WITHOUT CLAIM TO ANY PARTICULAR FONT, STYLE, SIZE, OR COLOR.

OWNER OF U.S. REG. NO. 1,119,389.

NO CLAIM IS MADE TO THE EXCLUSIVE RIGHT TO USE "SKINNY MARGARITA", APART FROM THE MARK AS SHOWN.

THE ENGLISH TRANSLATION OF "MIDORI" IN THE MARK IS "GREEN".

FOR ALCOHOLIC BEVERAGES EXCEPT BEERS (U.S. CLS. 47 AND 49).
BRIAN PINO, EXAMINING ATTORNEY

SN 85-380,709. ALMA - THE SOUL OF ITALIAN WINE, BAL HARBOUR, FL. FILED 7-26-2011.



OWNER OF ERPN CMNTY TM OFC REG. NO. 009709965, DATED 6-27-2011, EXPIRES 2-3-2021.

THE MARK CONSISTS OF THE WORD "BEANDO" WRITTEN IN A STYLIZED SCRIPT APPEARING IN THE COLOR BLACK AND WITH THE LETTER "O" FORMING A PART OF A WINE GLASS WHICH CONTAINS RED WINE.

THE WORDING "BEANDO" HAS NO MEANING IN A FOREIGN LANGUAGE.
FOR WINE (U.S. CLS. 47 AND 49).
RICHARD WHITE, EXAMINING ATTORNEY

CLASS 33—(Continued).

SN 85-380,730. ALMA - THE SOUL OF ITALIAN WINE, BAL HARBOUR, FL. FILED 7-26-2011.

SETTERÈ

THE MARK CONSISTS OF STANDARD CHARACTERS WITHOUT CLAIM TO ANY PARTICULAR FONT, STYLE, SIZE, OR COLOR.

OWNER OF ERPNTY CMNTY TM OFC REG. NO. 009727231, DATED 5-26-2011, EXPIRES 2-10-2021.

THE WORDING "SETTERÈ" HAS NO MEANING IN A FOREIGN LANGUAGE.

FOR WINE (U.S. CLS. 47 AND 49).

RICHARD WHITE, EXAMINING ATTORNEY

CLASS 33—(Continued).

SN 85-403,004. VAN BRUNT STILLHOUSE LLC, DBA VAN BRUNT STILLHOUSE, BROOKLYN, NY. FILED 8-20-2011.

Van Brunt Stillhouse

THE MARK CONSISTS OF STANDARD CHARACTERS WITHOUT CLAIM TO ANY PARTICULAR FONT, STYLE, SIZE, OR COLOR.

NO CLAIM IS MADE TO THE EXCLUSIVE RIGHT TO USE "STILLHOUSE", APART FROM THE MARK AS SHOWN.

FOR LIQUOR (U.S. CLS. 47 AND 49).

JULIE GUTTADAURO, EXAMINING ATTORNEY

SN 85-380,743. ALMA - THE SOUL OF ITALIAN WINE, BAL HARBOUR, FL. FILED 7-26-2011.

ARBETA

THE MARK CONSISTS OF STANDARD CHARACTERS WITHOUT CLAIM TO ANY PARTICULAR FONT, STYLE, SIZE, OR COLOR.

OWNER OF ERPNTY CMNTY TM OFC REG. NO. 009762824, DATED 6-27-2011, EXPIRES 2-24-2021.

THE WORDING "ARBETA" HAS NO MEANING IN A FOREIGN LANGUAGE.

FOR WINE (U.S. CLS. 47 AND 49).

RICHARD WHITE, EXAMINING ATTORNEY

SN 85-432,696. VINNICO EXPORT S.L., JAVEA (ALICANTE), SPAIN, FILED 9-27-2011.

LA TURISTA

SN 85-388,754. CHOLAME VALLEY VINEYARD LLC, SANTA ANA, CA. FILED 8-3-2011.



NO CLAIM IS MADE TO THE EXCLUSIVE RIGHT TO USE "CHOLAME VALLEY VINEYARD", APART FROM THE MARK AS SHOWN.

THE MARK CONSISTS OF THE WORD "CHOLAME" ABOVE A SQUARE BOX CONTAINING A FANCIFUL CIRCULAR REPRESENTATION WITH THE WORDS "VALLEY VINEYARD" BELOW THE BOX.

FOR WINES (U.S. CLS. 47 AND 49).

ELLEN PERKINS, EXAMINING ATTORNEY

THE MARK CONSISTS OF STANDARD CHARACTERS WITHOUT CLAIM TO ANY PARTICULAR FONT, STYLE, SIZE, OR COLOR.

PRIORITY CLAIMED UNDER SEC. 44(D) ON ERPNTY CMNTY TM OFC APPLICATION NO. 010242493, FILED 9-6-2011, REG. NO. 010242493, DATED 1-26-2012, EXPIRES 9-6-2021.

THE ENGLISH TRANSLATION OF "LA TURISTA" IN THE MARK IS "THE TOURIST".

FOR WINE (U.S. CLS. 47 AND 49).

JASON BLAIR, EXAMINING ATTORNEY

CLASS 33—(Continued).

SN 85-443,029. RHUM DAMOISEAU SAS, DBA RHUM DAMOISEAU SAS, LE MOULE (97160 FWI, FRANCE, FILED 10-10-2011.



OWNER OF FRANCE REG. NO. 093689613, DATED 11-6-2009, EXPIRES 11-6-2018.

NO CLAIM IS MADE TO THE EXCLUSIVE RIGHT TO USE "RHUM" AND "VIRGIN CANE RUM", APART FROM THE MARK AS SHOWN.

THE COLOR(S) WHITE, BLUE, GREEN IS/ARE CLAIMED AS A FEATURE OF THE MARK.

THE MARK CONSISTS OF A CENTRAL OBLONG DARK BLUE DESIGN WITH A GREEN INNER BORDER CONTAINING THE WORD "DAMOISEAU" IN WHITE STYLIZED FONT. ABOVE THE OBLONG IS A DARK BLUE DESIGN OF TWO MEN IN SILHOUETTE CARRYING A LARGE DARK BLUE BARREL BEARING THE WORD "RHUM" IN STYLIZED WHITE FONT. AT THE BOTTOM OF THE MARK IS THE WORDING "VIRGIN CANE RUM" IS STYLIZED FONT WITH THE WORDS "VIRGIN" AND "RHUM" IN BLUE AND THE WORD "CANE" IN GREEN.

THE ENGLISH TRANSLATION OF "RHUM DAMOISEAU" IN THE MARK IS "RUM SQUIRE".

FOR SUGAR CANE JUICE RUM (U.S. CLS. 47 AND 49).

STEVEN PEREZ, EXAMINING ATTORNEY

CLASS 33—(Continued).

SN 85-483,216. CAL RANCH, INC., CLAYTON, CA. FILED 11-30-2011.

CAL RANCH WINES

THE MARK CONSISTS OF STANDARD CHARACTERS WITHOUT CLAIM TO ANY PARTICULAR FONT, STYLE, SIZE, OR COLOR.

NO CLAIM IS MADE TO THE EXCLUSIVE RIGHT TO USE "CAL" AND "WINES", APART FROM THE MARK AS SHOWN.

FOR WINES (U.S. CLS. 47 AND 49).

FIRST USE 7-1-2011; IN COMMERCE 10-15-2011.

JOSEPH PAPPAFOTIS, EXAMINING ATTORNEY

SN 85-519,194. NO MAX BEVERAGES, LLC, STAMFORD, CT. FILED 1-18-2012.

COCOMAMBU

THE MARK CONSISTS OF STANDARD CHARACTERS WITHOUT CLAIM TO ANY PARTICULAR FONT, STYLE, SIZE, OR COLOR.

FOR ALCOHOLIC BEVERAGES, NAMELY, LIQUEUR MADE WITH RUM AND COCONUT WATER MIXED WITH NATURAL FLAVORS (U.S. CLS. 47 AND 49).

KATHERINE CHANG, EXAMINING ATTORNEY

SN 85-475,807. FINE ESTATES FROM SPAIN, INC., DEDHAM, MA. FILED 11-17-2011.

ZERRAN

THE MARK CONSISTS OF STANDARD CHARACTERS WITHOUT CLAIM TO ANY PARTICULAR FONT, STYLE, SIZE, OR COLOR.

THE WORDING "ZERRAN" HAS NO MEANING IN A FOREIGN LANGUAGE.

FOR WINE (U.S. CLS. 47 AND 49).

MARK RADEMACHER, EXAMINING ATTORNEY

SN 85-519,705. KINNEY FAMILY VINTNERS LLC, DBA OCCASIO WINERY, DANVILLE, CA. FILED 1-18-2012.

Apotheosis

THE MARK CONSISTS OF STANDARD CHARACTERS WITHOUT CLAIM TO ANY PARTICULAR FONT, STYLE, SIZE, OR COLOR.

FOR RED WINE; RED WINES; TABLE WINES; WINE; WINES DERIVED FROM GRAPES GROWN IN LIVERMORE AVA, LABELED AND ADVERTISED IN COMPLIANCE WITH TTB AND CA ABC LAWS FOR CALIFORNIA (U.S. CLS. 47 AND 49).

MARK SHINER, EXAMINING ATTORNEY

CLASS 33—(Continued).

SN 85-520,353. PEIRANO ESTATE VINEYARDS, LODI, CA.
FILED 1-19-2012.

THE IMMORTAL ZIN

THE MARK CONSISTS OF STANDARD CHARACTERS
WITHOUT CLAIM TO ANY PARTICULAR FONT, STYLE,
SIZE, OR COLOR.

NO CLAIM IS MADE TO THE EXCLUSIVE RIGHT TO
USE "ZIN", APART FROM THE MARK AS SHOWN.

FOR WINES (U.S. CLS. 47 AND 49).

FIRST USE 12-30-2009; IN COMMERCE 12-30-2009.

NELSON SNYDER, EXAMINING ATTORNEY

SN 85-525,599. ODFJELL VINEYARDS S.A., PADRE HUR-
TADO SANTIAGO, CHILE, FILED 1-26-2012.

FAMILY SAGA

THE MARK CONSISTS OF STANDARD CHARACTERS
WITHOUT CLAIM TO ANY PARTICULAR FONT, STYLE,
SIZE, OR COLOR.

FOR WINE (U.S. CLS. 47 AND 49).

MARLENE BELL, EXAMINING ATTORNEY

SN 85-525,970. TCHOLAKOV, MIROSLAV I., DBA MIRO
CELLARS, CLOVERDALE, CA. FILED 1-26-2012.



THE MARK CONSISTS OF A MOUNTED HORSEMAN
HOLDING A WINE GLASS AND A SPEAR, WHICH
PIERCES A LION LYING BELOW THE HORSE.

FOR ALCOHOLIC BEVERAGES EXCEPT BEERS;
WINES (U.S. CLS. 47 AND 49).

FIRST USE 2-4-2004; IN COMMERCE 2-4-2004.

DAVID HOFFMAN, EXAMINING ATTORNEY

CLASS 33—(Continued).

SN 85-529,609. MANUEL MANZANEQUE, S.L., BOADILLA
DEL MONTE, SPAIN, FILED 1-31-2012.

MANUEL MANZANEQUE

THE MARK CONSISTS OF STANDARD CHARACTERS
WITHOUT CLAIM TO ANY PARTICULAR FONT, STYLE,
SIZE, OR COLOR.

THE NAME "MANUEL MANZANEQUE" IDENTIFIES A
LIVING INDIVIDUAL WHOSE CONSENT IS OF RECORD.

FOR WINES (U.S. CLS. 47 AND 49).

FIRST USE 1-1-1997; IN COMMERCE 1-1-1997.

GEORGE LORENZO, EXAMINING ATTORNEY

SN 85-530,154. YAHARA BAY DISTILLERS, INC., MADI-
SON, WI. FILED 1-31-2012.

OFF THE CLOCK SPIRITS

THE MARK CONSISTS OF STANDARD CHARACTERS
WITHOUT CLAIM TO ANY PARTICULAR FONT, STYLE,
SIZE, OR COLOR.

NO CLAIM IS MADE TO THE EXCLUSIVE RIGHT TO
USE "SPIRITS", APART FROM THE MARK AS SHOWN.

FOR DISTILLED SPIRITS (U.S. CLS. 47 AND 49).

BRIDGETT SMITH, EXAMINING ATTORNEY

SN 85-530,620. FIESTA FOREVER, LLC, FORT LAUDER-
DALE, FL. FILED 2-1-2012.

ÜNIQ Mood

THE MARK CONSISTS OF STANDARD CHARACTERS
WITHOUT CLAIM TO ANY PARTICULAR FONT, STYLE,
SIZE, OR COLOR.

FOR ALCOHOLIC BEVERAGES EXCEPT BEERS (U.S.
CLS. 47 AND 49).

BARBARA BROWN, EXAMINING ATTORNEY

CLASS 33—(Continued).

SN 85-530,695. THE WINE GROUP LLC, TRACY, CA. FILED 2-1-2012.

SYNC

THE MARK CONSISTS OF STANDARD CHARACTERS WITHOUT CLAIM TO ANY PARTICULAR FONT, STYLE, SIZE, OR COLOR.
FOR LIQUEURS; PREPARED ALCOHOLIC COCKTAIL; PREPARED WINE COCKTAILS; SPIRITS; WINE; WINE-BASED DRINKS (U.S. CLS. 47 AND 49).
JUSTINE D. PARKER, EXAMINING ATTORNEY

SN 85-530,882. JD WINE CONCEPTS LLC, ORLANDO, FL. FILED 2-1-2012.

QUANTUM LEAP

THE MARK CONSISTS OF STANDARD CHARACTERS WITHOUT CLAIM TO ANY PARTICULAR FONT, STYLE, SIZE, OR COLOR.
FOR WINES (U.S. CLS. 47 AND 49).
MARY CRAWFORD, EXAMINING ATTORNEY

SN 85-530,992. BELLOLI, GIANCARLO, SAN JOSE, CA. FILED 2-1-2012.

La Iglesia de Isabel

THE MARK CONSISTS OF STANDARD CHARACTERS WITHOUT CLAIM TO ANY PARTICULAR FONT, STYLE, SIZE, OR COLOR.
THE ENGLISH TRANSLATION OF "LA IGLESIA DE ISABEL" IN THE MARK IS "THE CHURCH OF ISABEL".
FOR ALCOHOLIC BEVERAGES EXCLUDING BEER (U.S. CLS. 47 AND 49).
KARANENDRA S. CHHINA, EXAMINING ATTORNEY

CLASS 33—(Continued).

SN 85-531,168. SANTOS HECTOR MANUEL, GUADALAJARA, MEXICO, FILED 2-1-2012.

HERENCIA DE MI TIERRA

THE MARK CONSISTS OF STANDARD CHARACTERS WITHOUT CLAIM TO ANY PARTICULAR FONT, STYLE, SIZE, OR COLOR.
THE ENGLISH TRANSLATION OF "HERENCIA DE MI TIERRA" IN THE MARK IS "MY LAND INHERITANCE".
FOR TEQUILA (U.S. CLS. 47 AND 49).
MARY CRAWFORD, EXAMINING ATTORNEY

SN 85-531,558. CHAMISAL VINEYARDS, LLC, NAPA, CA. FILED 2-1-2012.

RETORT

THE MARK CONSISTS OF STANDARD CHARACTERS WITHOUT CLAIM TO ANY PARTICULAR FONT, STYLE, SIZE, OR COLOR.
FOR WINE (U.S. CLS. 47 AND 49).
WILLIAM P. SHANAHAN, EXAMINING ATTORNEY

SN 85-531,561. LOCAL WINE AND SPIRITS, LLC, CHICAGO, IL. FILED 2-1-2012.

ANGEL'S WING

THE MARK CONSISTS OF STANDARD CHARACTERS WITHOUT CLAIM TO ANY PARTICULAR FONT, STYLE, SIZE, OR COLOR.
FOR WINE (U.S. CLS. 47 AND 49).
WILLIAM P. SHANAHAN, EXAMINING ATTORNEY

CLASS 33—(Continued).

SN 85-531,725. GAVILAN VINEYARDS, LLC, MIAMI, FL. FILED 2-2-2012.

PERSPECTIVE

THE MARK CONSISTS OF STANDARD CHARACTERS WITHOUT CLAIM TO ANY PARTICULAR FONT, STYLE, SIZE, OR COLOR.

FOR WINE (U.S. CLS. 47 AND 49).
CHRISTOPHER BUONGIORNO, EXAMINING ATTORNEY

SN 85-531,883. WOOD DUCK SPIRITS, FRISCO, TX. FILED 2-2-2012.

vKe

THE MARK CONSISTS OF STANDARD CHARACTERS WITHOUT CLAIM TO ANY PARTICULAR FONT, STYLE, SIZE, OR COLOR.

FOR VODKA (U.S. CLS. 47 AND 49).
WILLIAM VERHOSEK, EXAMINING ATTORNEY

SN 85-531,915. ANTHONY TRUCHARD, NAPA, CA. FILED 2-2-2012.

TOPSOIL

THE MARK CONSISTS OF STANDARD CHARACTERS WITHOUT CLAIM TO ANY PARTICULAR FONT, STYLE, SIZE, OR COLOR.

FOR WINE (U.S. CLS. 47 AND 49).
AHSEN KHAN, EXAMINING ATTORNEY

SN 85-531,980. WOOD DUCK SPIRITS, FRISCO, TX. FILED 2-2-2012.

wKe

THE MARK CONSISTS OF STANDARD CHARACTERS WITHOUT CLAIM TO ANY PARTICULAR FONT, STYLE, SIZE, OR COLOR.

FOR WHISKEY (U.S. CLS. 47 AND 49).
WILLIAM VERHOSEK, EXAMINING ATTORNEY

CLASS 33—(Continued).

SN 85-531,996. VICO NEVE LLC, BAYSHORE, NY. FILED 2-2-2012.

Altaneve

THE MARK CONSISTS OF STANDARD CHARACTERS WITHOUT CLAIM TO ANY PARTICULAR FONT, STYLE, SIZE, OR COLOR.

FOR WINE AND SPARKLING WINE (U.S. CLS. 47 AND 49).
GISELLE AGOSTO, EXAMINING ATTORNEY

SN 85-532,243. WOOD DUCK SPIRITS, FRISCO, TX. FILED 2-2-2012.



THE MARK CONSISTS OF INTERLOCKING TRIQUETRA, THREE-SIDED, THREE-POINTED CELTIC KNOT, WITH THREE CORRESPONDING SWIRL ELEMENTS BRANCHING OFF OF THE CENTRAL KNOTTED FORM, CULMINATING AT THE END OF EACH IN A DUCK-SILHOUETTE.

FOR SPIRITS; VODKA; WHISKEY (U.S. CLS. 47 AND 49).
WILLIAM VERHOSEK, EXAMINING ATTORNEY

CLASS 33—(Continued).

SN 85-532,268. WOOD DUCK SPIRITS, FRISCO, TX. FILED 2-2-2012.



THE MARK CONSISTS OF TWO SWIRLS, ONE COMPRISING THE MAIN BODY, AND ON FORMING POINT OF A QUESTION-MARK SHAPE.
FOR SPIRITS; VODKA; WHISKEY (U.S. CLS. 47 AND 49).
WILLIAM VERHOSEK, EXAMINING ATTORNEY

SN 85-532,701. CATHERINE-ELIZABETH, INC., SEBASTOPOL, CA. FILED 2-2-2012.

Bodega Station

THE MARK CONSISTS OF STANDARD CHARACTERS WITHOUT CLAIM TO ANY PARTICULAR FONT, STYLE, SIZE, OR COLOR.
NO CLAIM IS MADE TO THE EXCLUSIVE RIGHT TO USE "BODEGA", APART FROM THE MARK AS SHOWN.
THE ENGLISH TRANSLATION OF "BODEGA" IN THE MARK IS "WINE CELLAR".
FOR ALCOHOLIC BEVERAGES EXCEPT BEERS; WINES (U.S. CLS. 47 AND 49).
AMEEN IMAM, EXAMINING ATTORNEY

SN 85-532,710. CATHERINE-ELIZABETH, INC., SEBASTOPOL, CA. FILED 2-2-2012.

Occidental

THE MARK CONSISTS OF STANDARD CHARACTERS WITHOUT CLAIM TO ANY PARTICULAR FONT, STYLE, SIZE, OR COLOR.
OWNER OF U.S. REG. NO. 4,041,690.
FOR ALCOHOLIC BEVERAGES EXCEPT BEERS; WINES (U.S. CLS. 47 AND 49).
AMEEN IMAM, EXAMINING ATTORNEY

CLASS 33—(Continued).

SN 85-532,809. O'NEILL BEVERAGE CO., LTD., PARLIER, CA. FILED 2-2-2012.

SPUR RANCH

THE MARK CONSISTS OF STANDARD CHARACTERS WITHOUT CLAIM TO ANY PARTICULAR FONT, STYLE, SIZE, OR COLOR.
FOR WINES (U.S. CLS. 47 AND 49).
MARK SHINER, EXAMINING ATTORNEY

SN 85-532,840. SMITH, ALEX, NEW YORK, NY. FILED 2-3-2012.

RONDA

THE MARK CONSISTS OF STANDARD CHARACTERS WITHOUT CLAIM TO ANY PARTICULAR FONT, STYLE, SIZE, OR COLOR.
FOR WINES (U.S. CLS. 47 AND 49).
GENE MACIOL, EXAMINING ATTORNEY

SN 85-533,088. BARABOO CANDY COMPANY, LLC, BARABOO, WI. FILED 2-3-2012.

COW PIE

THE MARK CONSISTS OF STANDARD CHARACTERS WITHOUT CLAIM TO ANY PARTICULAR FONT, STYLE, SIZE, OR COLOR.
OWNER OF U.S. REG. NO. 2,106,087.
FOR DISTILLED SPIRITS; LIQUEURS (U.S. CLS. 47 AND 49).
AMY C. KEAN, EXAMINING ATTORNEY

CLASS 33—(Continued).

SN 85-533,287. TAPLIN CELLARS, LLC, WALNUT CREEK, CA. FILED 2-3-2012.

TERRA 9

THE MARK CONSISTS OF STANDARD CHARACTERS WITHOUT CLAIM TO ANY PARTICULAR FONT, STYLE, SIZE, OR COLOR.

FOR ALCOHOLIC BEVERAGES EXCEPT BEERS (U.S. CLS. 47 AND 49).

NICHOLAS COLEMAN, EXAMINING ATTORNEY

CLASS 33—(Continued).

SN 85-533,369. PACIFIC RIM WINEMAKERS, INC., DBA VINMOTION, PORTLAND, OR. FILED 2-3-2012.

SN 85-533,306. TAKARA HOLDINGS INC., KYOTO, JAPAN, FILED 2-3-2012.



THE COLOR(S) RED AND BLACK IS/ARE CLAIMED AS A FEATURE OF THE MARK.

THE MARK CONSISTS OF A KABUKI FACE IN RED AND BLACK, WHERE THE COLOR BLACK IS USED FOR UPPER EYELIDS AND PORTIONS OF LOWER EYELIDS AND MOUTH, AND THE COLOR RED IS USED FOR OTHER PARTS.

FOR SAKE; WINES; JAPANESE WHITE LIQUOR (SHOCHU); SPIRITS; LIQUEURS; PREPARED ALCOHOLIC COCKTAIL; JAPANESE SHOCHU-BASED MIXED LIQUOR (MIRIN) (U.S. CLS. 47 AND 49).

FIRST USE 10-1-2006; IN COMMERCE 10-1-2006.

GIANCARLO CASTRO, EXAMINING ATTORNEY

SN 85-533,344. COATS INTERNATIONAL HOLDINGS, INC., DBA COATS ALOE INTERNATIONAL, INC., DALLAS, TX. FILED 2-3-2012.

ALOERITA

THE MARK CONSISTS OF STANDARD CHARACTERS WITHOUT CLAIM TO ANY PARTICULAR FONT, STYLE, SIZE, OR COLOR.

FOR PREPARED ALCOHOLIC COCKTAIL (U.S. CLS. 47 AND 49).

RONALD MCMORROW, EXAMINING ATTORNEY



NO CLAIM IS MADE TO THE EXCLUSIVE RIGHT TO USE "SWEET PINK WINE", APART FROM THE MARK AS SHOWN.

THE COLOR(S) GREEN, RED, PINK, WHITE, TAN, BROWN IS/ARE CLAIMED AS A FEATURE OF THE MARK.

THE MARK CONSISTS OF A DRAWING OF A RED STRAWBERRY WITH TAN SEEDS, GREEN HULL AND STEM GROWING FROM TOP OF THE FRUIT, AND A GREEN LEAF BEHIND THE BERRY. THE BOTTOM OF THE STRAWBERRY IS COVERED WITH WHITE AND TAN MELTED CHOCOLATE DRIPPING AT THE BOTTOM. BELOW THE FRUIT ARE THE WORDS SWEET PINK WINE IN PINK AND WHITE. THE LITERAL ELEMENT AND THE FRUIT SIT ON A WHITE BACKGROUND INSIDE A BROWN RECTANGULAR BORDER.

FOR WINE (U.S. CLS. 47 AND 49).

FIRST USE 12-15-2010; IN COMMERCE 12-15-2010.

KEVON CHISOLM, EXAMINING ATTORNEY

CLASS 33—(Continued).

SN 85-533,382. PACIFIC RIM WINEMAKERS, INC., DBA VINMOTION, PORTLAND, OR. FILED 2-3-2012.



NO CLAIM IS MADE TO THE EXCLUSIVE RIGHT TO USE "SWEET RED WINE", APART FROM THE MARK AS SHOWN.

THE COLOR(S) RED, BROWN, GREEN, YELLOW, WHITE IS/ARE CLAIMED AS A FEATURE OF THE MARK.

THE MARK CONSISTS OF A DRAWING OF A RED CHERRY WITH A GREEN, BROWN AND YELLOW STEM GROWING FROM THE TOP CENTER OF THE FRUIT. THE BOTTOM HALF OF THE FRUIT IS COVERED WITH BROWN MELTED CHOCOLATE DRIPPING AT THE BOTTOM. BELOW THE FRUIT ARE THE WORDS SWEET RED WINE IN RED AND WHITE. THE LITERAL ELEMENT AND THE FRUIT SIT ON A WHITE BACKGROUND INSIDE A BROWN RECTANGULAR BORDER.

FOR WINE (U.S. CLS. 47 AND 49).
FIRST USE 8-19-2010; IN COMMERCE 8-19-2010.
KEVON CHISOLM, EXAMINING ATTORNEY

CLASS 33—(Continued).

SN 85-533,418. INTERCONTINENTAL PACKAGING CO., ST. PAUL, MN. FILED 2-3-2012.

FIRECRACKER BLUE

THE MARK CONSISTS OF STANDARD CHARACTERS WITHOUT CLAIM TO ANY PARTICULAR FONT, STYLE, SIZE, OR COLOR.

FOR WINES AND SPARKLING WINES (U.S. CLS. 47 AND 49).
DOUGLAS LEE, EXAMINING ATTORNEY

SN 85-533,779. INTERNATIONAL DISTILLERS AND VINTERS LTD., EVERETT, WA. FILED 2-3-2012.

NORTH RANGE

THE MARK CONSISTS OF STANDARD CHARACTERS WITHOUT CLAIM TO ANY PARTICULAR FONT, STYLE, SIZE, OR COLOR.

FOR WHISKY (U.S. CLS. 47 AND 49).
JUSTINE D. PARKER, EXAMINING ATTORNEY

SN 85-533,397. INTERCONTINENTAL PACKAGING CO., ST. PAUL, MN. FILED 2-3-2012.

FIRECRACKER WHITE

SN 85-533,820. QUINTESSENTIAL, L.L.C., NAPA, CA. FILED 2-3-2012.

LIKE IT

THE MARK CONSISTS OF STANDARD CHARACTERS WITHOUT CLAIM TO ANY PARTICULAR FONT, STYLE, SIZE, OR COLOR.

NO CLAIM IS MADE TO THE EXCLUSIVE RIGHT TO USE "WHITE", APART FROM THE MARK AS SHOWN.

FOR WINES AND SPARKLING WINES (U.S. CLS. 47 AND 49).
DOUGLAS LEE, EXAMINING ATTORNEY

THE MARK CONSISTS OF STANDARD CHARACTERS WITHOUT CLAIM TO ANY PARTICULAR FONT, STYLE, SIZE, OR COLOR.

FOR WINES (U.S. CLS. 47 AND 49).
JUSTINE D. PARKER, EXAMINING ATTORNEY

CLASS 33—(Continued).

SN 85-534,113. DAUCOURT JEAN MARC, DALLAS, TX.
FILED 2-4-2012.

ROI Henry VIII

THE MARK CONSISTS OF STANDARD CHARACTERS WITHOUT CLAIM TO ANY PARTICULAR FONT, STYLE, SIZE, OR COLOR.

THE ENGLISH TRANSLATION OF "ROI" IN THE MARK IS "KING".

FOR DISTILLED SPIRITS (U.S. CLS. 47 AND 49).
LESLEY LAMOTHE, EXAMINING ATTORNEY

SN 85-534,347. NOSIO SPA, MEZZOCORONA, ITALY, FILED
2-6-2012.

CLIFFHANGER

THE MARK CONSISTS OF STANDARD CHARACTERS WITHOUT CLAIM TO ANY PARTICULAR FONT, STYLE, SIZE, OR COLOR.

FOR WINES AND SPARKLING WINES (U.S. CLS. 47 AND 49).

ANDREW LEASER, EXAMINING ATTORNEY

CLASS 33—(Continued).

SN 85-534,883. BROOKSIDE WINERY LLC, RANCHO SANTA FE, CA. FILED 2-6-2012.



THE MARK CONSISTS OF A STYLIZED NUMERAL "7" WITH A PARTIAL LOOP EXTENDING FROM THE TOP-MOST PORTION OF THE NUMBER DOWN AND THROUGH THE ANGLED-PORTION OF THE NUMBER, WITH A GENERALLY "WAVY" LINE BISECTING THE ANGLED-PORTION OF THE NUMBER.

FOR APERITIF WINES; APERITIFS WITH A WINE BASE; COOKING WINE; FORTIFIED WINES; FRUIT WINE; GRAPE WINE; HONEY WINE; NATURAL SPARKLING WINES; PORT WINES; PREPARED WINE COCKTAILS; RED WINE; RED WINES; SPARKLING FRUIT WINE; SPARKLING GRAPE WINE; SPARKLING WINES; STILL WINES; STRAWBERRY WINE; SWEET WINES; TABLE WINES; TONIC SWEET GRAPE WINE CONTAINING EXTRACTS FROM GINSENG AND CONCHONA BARK (NINJIN-KINATETSU WINE); WHITE WINE; WINE; WINE COOLERS; WINE PUNCH; WINE PUNCHES; WINE-BASED DRINKS; WINES; WINES AND FORTIFIED WINES; WINES AND LIQUEURS; WINES AND SPARKLING WINES (U.S. CLS. 47 AND 49).

THOMAS MANOR, EXAMINING ATTORNEY

SN 85-535,237. J. PORTUGAL RAMOS VINHOS, S.A., 7100-149
ESTREMOZ, PORTUGAL, FILED 2-6-2012.

LIMA - BY JOÃO PORTUGAL
RAMOS

THE MARK CONSISTS OF STANDARD CHARACTERS WITHOUT CLAIM TO ANY PARTICULAR FONT, STYLE, SIZE, OR COLOR.

OWNER OF U.S. REG. NO. 3,158,860.

THE NAME(S), PORTRAIT(S), AND/OR SIGNATURE(S) SHOWN IN THE MARK IDENTIFIES A LIVING INDIVIDUAL, WHOSE CONSENT(S) TO REGISTER IS MADE OF RECORD.

FOR WINES (U.S. CLS. 47 AND 49).

BRIDGETT SMITH, EXAMINING ATTORNEY

CLASS 33—(Continued).

SN 85-535,320. IMPEX CONSULTING GROUP, CARMICHAEL, CA. FILED 2-6-2012.



NO CLAIM IS MADE TO THE EXCLUSIVE RIGHT TO USE "SPIRITS", APART FROM THE MARK AS SHOWN.

THE COLOR(S) RED IS/ARE CLAIMED AS A FEATURE OF THE MARK.

THE MARK CONSISTS OF THE LITERAL ELEMENTS RED DRAGON SPIRITS IN BETWEEN OF THE WORDING THERE IS AN IMAGE OF THE DRAGON IN RED COLOR IN THE UPPER SIDE OF THE IMAGE WORDS RED DRAGON IS PLACED IN RED COLOR AND BELOW THE IMAGE WORDS SPIRITS IS PLACED IN RED COLOR AS SHOWN IN THE MARK.

FOR SPIRITS; VODKA; GIN; WHISKY; BRANDY (U.S. CLS. 47 AND 49).

MIDGE BUTLER, EXAMINING ATTORNEY

SN 85-535,370. JOLFAL, FARSHAD, DBA PANTERA SPIRITS, BREA, CA. FILED 2-6-2012.

PSI PANTERA

THE MARK CONSISTS OF STANDARD CHARACTERS WITHOUT CLAIM TO ANY PARTICULAR FONT, STYLE, SIZE, OR COLOR.

THE ENGLISH TRANSLATION OF "PANTERA" IN THE MARK IS "PANTHER".

FOR TEQUILA (U.S. CLS. 47 AND 49).

JOHN DWYER, EXAMINING ATTORNEY

SN 85-535,450. ADLER FELS WINERY, LLC, SANTA ROSA, CA. FILED 2-7-2012.

GLASS SLIPPER

THE MARK CONSISTS OF STANDARD CHARACTERS WITHOUT CLAIM TO ANY PARTICULAR FONT, STYLE, SIZE, OR COLOR.

FOR WINES (U.S. CLS. 47 AND 49).

KAREN K. BUSH, EXAMINING ATTORNEY

CLASS 33—(Continued).

SN 85-535,613. AZIENDA VINICOLA FARINA S.R.L., SAN PIETRO IN CARIANO, ITALY, FILED 2-7-2012.

GODO

THE MARK CONSISTS OF STANDARD CHARACTERS WITHOUT CLAIM TO ANY PARTICULAR FONT, STYLE, SIZE, OR COLOR.

OWNER OF ERP N CMNTY TM OFC REG. NO. 008362337, DATED 1-7-2010, EXPIRES 6-15-2019.

THE ENGLISH TRANSLATION OF "GODO" IN THE MARK IS "ENJOY".

FOR (BASED ON INTENT TO USE) WINES (BASED ON 44(E)) WINES (U.S. CLS. 47 AND 49).

PATRICIA EVANKO, EXAMINING ATTORNEY

SN 85-535,632. SEAMUS JAMES, LLC, CORAL SPRINGS, FL. FILED 2-7-2012.

GYPSY MISTRESS

THE MARK CONSISTS OF STANDARD CHARACTERS WITHOUT CLAIM TO ANY PARTICULAR FONT, STYLE, SIZE, OR COLOR.

FOR DISTILLED SPIRITS (U.S. CLS. 47 AND 49).

KATHRYN COWARD, EXAMINING ATTORNEY

SN 85-535,733. STOLLER WHOLESALE WINE & SPIRITS, INC., DBA MARSALLE COMPANY, FRANKLIN PARK, IL. FILED 2-7-2012.

DEVIL'S BREATH

THE MARK CONSISTS OF STANDARD CHARACTERS WITHOUT CLAIM TO ANY PARTICULAR FONT, STYLE, SIZE, OR COLOR.

FOR ALCOHOLIC BEVERAGES, NAMELY, GRAIN ALCOHOL (U.S. CLS. 47 AND 49).

MARK SHINER, EXAMINING ATTORNEY

CLASS 33—(Continued).

SN 85-535,750. ENGELMAN, BRET, DBA ENGELMANN CELLARS, FRESNO, CA. FILED 2-7-2012.

ZINAZ

THE MARK CONSISTS OF STANDARD CHARACTERS WITHOUT CLAIM TO ANY PARTICULAR FONT, STYLE, SIZE, OR COLOR.

THE WORDING ZINAZ HAS NO MEANING IN A FOREIGN LANGUAGE.

FOR WINE (U.S. CLS. 47 AND 49).
FIRST USE 5-31-2002; IN COMMERCE 5-31-2002.
HANNO RITTNER, EXAMINING ATTORNEY



SN 85-536,067. RODEMS, SABRINE M., BEN LOMOND, CA. FILED 2-7-2012.

SCRATCH

THE MARK CONSISTS OF STANDARD CHARACTERS WITHOUT CLAIM TO ANY PARTICULAR FONT, STYLE, SIZE, OR COLOR.

FOR WINES (U.S. CLS. 47 AND 49).
KIM MONINGHOFF, EXAMINING ATTORNEY



SN 85-536,117. H.D.D. LLC, DBA TRUETT HURST WINERY, HEALDSBURG, CA. FILED 2-7-2012.

BY LOCALS. FOR LOCALS

THE MARK CONSISTS OF STANDARD CHARACTERS WITHOUT CLAIM TO ANY PARTICULAR FONT, STYLE, SIZE, OR COLOR.

FOR ALCOHOLIC BEVERAGES EXCEPT BEERS (U.S. CLS. 47 AND 49).
FIRST USE 9-30-2011; IN COMMERCE 9-30-2011.
WILLIAM BRECKENFELD, EXAMINING ATTORNEY

CLASS 33—(Continued).

SN 85-536,866. HENRY STEELE IMPORTS LLC, BROOKLYN, NY. FILED 2-8-2012.

el Buho

THE MARK CONSISTS OF STANDARD CHARACTERS WITHOUT CLAIM TO ANY PARTICULAR FONT, STYLE, SIZE, OR COLOR.

THE ENGLISH TRANSLATION OF "EL BUHO" IN THE MARK IS "THE OWL".

FOR ALCOHOLIC BEVERAGES EXCEPT BEERS (U.S. CLS. 47 AND 49).

FIRST USE 12-6-2011; IN COMMERCE 12-6-2011.
ODESSA BIBBINS, EXAMINING ATTORNEY



SN 85-536,879. INTERCONTINENTAL PACKAGING CO., ST. PAUL, MN. FILED 2-8-2012.

GRATE RED

THE MARK CONSISTS OF STANDARD CHARACTERS WITHOUT CLAIM TO ANY PARTICULAR FONT, STYLE, SIZE, OR COLOR.

NO CLAIM IS MADE TO THE EXCLUSIVE RIGHT TO USE "RED", APART FROM THE MARK AS SHOWN.

FOR ALCOHOLIC BEVERAGES EXCEPT BEERS (U.S. CLS. 47 AND 49).

DOUGLAS LEE, EXAMINING ATTORNEY



SN 85-537,012. E.L. PARKER LLC, ADVANCE, NC. FILED 2-8-2012.



THE MARK CONSISTS OF A SILHOUETTE OF THE BACKSIDE OF A DOG ON A LEASH, A MAN HOLDING THE LEASH IN THE MAN'S LEFT HAND AND A BOY HOLDING THE MAN'S RIGHT HAND.

FOR FRUIT WINE; GRAPE WINE; RED WINE; ROSE WINE; SPARKLING FRUIT WINE; SWEET WINES; TABLE WINES; WINE (U.S. CLS. 47 AND 49).
JAY BESCH, EXAMINING ATTORNEY

CLASS 33—(Continued).

SN 85-537,380. KOBRAND CORPORATION, PURCHASE, NY. FILED 2-8-2012.

FISHNET STOCKINGS

THE MARK CONSISTS OF STANDARD CHARACTERS WITHOUT CLAIM TO ANY PARTICULAR FONT, STYLE, SIZE, OR COLOR.

FOR WINE (U.S. CLS. 47 AND 49).
LIEF MARTIN, EXAMINING ATTORNEY

SN 85-537,402. KOBRAND CORPORATION, PURCHASE, NY. FILED 2-8-2012.

PINKADELICK

THE MARK CONSISTS OF STANDARD CHARACTERS WITHOUT CLAIM TO ANY PARTICULAR FONT, STYLE, SIZE, OR COLOR.

FOR WINE (U.S. CLS. 47 AND 49).
LIEF MARTIN, EXAMINING ATTORNEY

SN 85-537,550. DONATY, JILL, SHERMAN OAKS, CA. FILED 2-8-2012.

Candybox Wine

THE MARK CONSISTS OF STANDARD CHARACTERS WITHOUT CLAIM TO ANY PARTICULAR FONT, STYLE, SIZE, OR COLOR.

NO CLAIM IS MADE TO THE EXCLUSIVE RIGHT TO USE "WINE", APART FROM THE MARK AS SHOWN.
FOR WINES (U.S. CLS. 47 AND 49).
BARBARA BROWN, EXAMINING ATTORNEY

SN 85-537,561. NEVADA WINE CELLARS, INC., PAHRUMP, NV. FILED 2-8-2012.

Desert Ridge

THE MARK CONSISTS OF STANDARD CHARACTERS WITHOUT CLAIM TO ANY PARTICULAR FONT, STYLE, SIZE, OR COLOR.

FOR WINE (U.S. CLS. 47 AND 49).
SUSAN BILLHEIMER, EXAMINING ATTORNEY

CLASS 33—(Continued).

SN 85-537,564. HAYES, CHARLES, MURRIETA, CA. FILED 2-8-2012.

Devil's Water

THE MARK CONSISTS OF STANDARD CHARACTERS WITHOUT CLAIM TO ANY PARTICULAR FONT, STYLE, SIZE, OR COLOR.

FOR VODKA (U.S. CLS. 47 AND 49).
CHRISTINE MARTIN, EXAMINING ATTORNEY

SN 85-537,594. DONATY, JILL, SHERMAN OAKS, CA. FILED 2-8-2012.

Jewelbox Wines

THE MARK CONSISTS OF STANDARD CHARACTERS WITHOUT CLAIM TO ANY PARTICULAR FONT, STYLE, SIZE, OR COLOR.

NO CLAIM IS MADE TO THE EXCLUSIVE RIGHT TO USE "WINES", APART FROM THE MARK AS SHOWN.
FOR WINE (U.S. CLS. 47 AND 49).
BARBARA BROWN, EXAMINING ATTORNEY

SN 85-537,596. HUMBOLDT CRAFT DISTILLERS, LLC, EUREKA, CA. FILED 2-8-2012.

Redwood Redemption

THE MARK CONSISTS OF STANDARD CHARACTERS WITHOUT CLAIM TO ANY PARTICULAR FONT, STYLE, SIZE, OR COLOR.

FOR ALCOHOLIC BEVERAGES, NAMELY, FLAVOR-INFUSED WHISKEY; BOURBON; BOURBON WHISKY; BRANDY; BRANDY SPIRITS; GIN; VODKA; WHISKEY (U.S. CLS. 47 AND 49).

BARBARA BROWN, EXAMINING ATTORNEY

CLASS 33—(Continued).

SN 85-537,665. HOUDINI, INC., FULLERTON, CA. FILED 2-8-2012.

ROCK FALLS

THE MARK CONSISTS OF STANDARD CHARACTERS WITHOUT CLAIM TO ANY PARTICULAR FONT, STYLE, SIZE, OR COLOR.
FOR WINE (U.S. CLS. 47 AND 49).
CHARISMA HAMPTON, EXAMINING ATTORNEY

SN 85-537,890. SAWABINI, JACOB, NEW YORK, NY. FILED 2-9-2012.

Scarlet's Heart

THE MARK CONSISTS OF STANDARD CHARACTERS WITHOUT CLAIM TO ANY PARTICULAR FONT, STYLE, SIZE, OR COLOR.
FOR DISTILLED SPIRITS (U.S. CLS. 47 AND 49).
JEFF DEFORD, EXAMINING ATTORNEY

SN 85-537,940. BLACKMAR, MATT, NAPERVILLE, IL. FILED 2-9-2012.

The Dapper Gentleman

THE MARK CONSISTS OF A HANDWRITTEN FONT SPELLING OUT "THE DAPPER GENTLEMAN".
FOR WINE (U.S. CLS. 47 AND 49).
ROSELLE HERRERA, EXAMINING ATTORNEY

CLASS 33—(Continued).

SN 85-538,152. ORSINI, MASSIMILIANO, PORTLAND, OR. FILED 2-9-2012.

BEST UNKNOWN

THE MARK CONSISTS OF STANDARD CHARACTERS WITHOUT CLAIM TO ANY PARTICULAR FONT, STYLE, SIZE, OR COLOR.
FOR WINE (U.S. CLS. 47 AND 49).
MEGHAN REINHART, EXAMINING ATTORNEY

SN 85-538,210. JACKSON FAMILY FARMS, LLC, SANTA ROSA, CA. FILED 2-9-2012.

GALERIE

THE MARK CONSISTS OF STANDARD CHARACTERS WITHOUT CLAIM TO ANY PARTICULAR FONT, STYLE, SIZE, OR COLOR.
THE ENGLISH TRANSLATION OF "GALERIE" IN THE MARK IS "GALLERY".
FOR ALCOHOLIC BEVERAGES EXCEPT BEERS (U.S. CLS. 47 AND 49).
PAM WILLIS, EXAMINING ATTORNEY

SN 85-538,753. CHRISTOPHER CONDOS, SANTA ROSA, CA. FILED 2-9-2012.

Farmstead

THE MARK CONSISTS OF STANDARD CHARACTERS WITHOUT CLAIM TO ANY PARTICULAR FONT, STYLE, SIZE, OR COLOR.
FOR WINE (U.S. CLS. 47 AND 49).
CURTIS FRENCH, EXAMINING ATTORNEY

CLASS 33—(Continued).

SN 85-538,820. CONDOS, CHRISTOPHER, SANTA ROSA, CA.
FILED 2-9-2012.

The Gardener

THE MARK CONSISTS OF STANDARD CHARACTERS
WITHOUT CLAIM TO ANY PARTICULAR FONT, STYLE,
SIZE, OR COLOR.
FOR WINE (U.S. CLS. 47 AND 49).
JESSICA A. POWERS, EXAMINING ATTORNEY

SN 85-538,858. CONDOS, CHRISTOPHER, SANTA ROSA, CA.
FILED 2-9-2012.

Draft Horse

THE MARK CONSISTS OF STANDARD CHARACTERS
WITHOUT CLAIM TO ANY PARTICULAR FONT, STYLE,
SIZE, OR COLOR.
FOR WINE (U.S. CLS. 47 AND 49).
JESSICA A. POWERS, EXAMINING ATTORNEY

SN 85-539,100. VERTICAL SOLUTIONS, INC., RALSTON,
NE. FILED 2-10-2012.

SKINNY GINNY

THE MARK CONSISTS OF STANDARD CHARACTERS
WITHOUT CLAIM TO ANY PARTICULAR FONT, STYLE,
SIZE, OR COLOR.
FOR ALCOHOLIC BEVERAGES, NAMELY PRE-
MIXED ALCOHOLIC COCKTAILS (U.S. CLS. 47 AND
49).
KEVIN DINALLO, EXAMINING ATTORNEY

CLASS 33—(Continued).

SN 85-539,286. SIERRA MADRE RANCH HOLDINGS, LLC,
PLACENTIA, CA. FILED 2-10-2012.

SIERRA MADRE ESTATE

THE MARK CONSISTS OF STANDARD CHARACTERS
WITHOUT CLAIM TO ANY PARTICULAR FONT, STYLE,
SIZE, OR COLOR.
OWNER OF U.S. REG. NO. 2,791,612.
NO CLAIM IS MADE TO THE EXCLUSIVE RIGHT TO
USE "ESTATE", APART FROM THE MARK AS SHOWN.
FOR WINE (U.S. CLS. 47 AND 49).
LINDA M. KING, EXAMINING ATTORNEY

SN 85-539,408. LC TM HOLDING, LLC, SANTA ROSA, CA.
FILED 2-10-2012.

SHELL RIDGE

THE MARK CONSISTS OF STANDARD CHARACTERS
WITHOUT CLAIM TO ANY PARTICULAR FONT, STYLE,
SIZE, OR COLOR.
FOR ALCOHOLIC BEVERAGES EXCEPT BEERS (U.S.
CLS. 47 AND 49).
FIRST USE 1-15-2011; IN COMMERCE 1-15-2011.
TINA L. SNAPP, EXAMINING ATTORNEY

SN 85-539,517. SCHINDLER WEISSMAN CO., LLC, DBA
WINEMONGER, SAN ANSELMO, CA. FILED 2-10-2012.

EASKOOT

THE MARK CONSISTS OF STANDARD CHARACTERS
WITHOUT CLAIM TO ANY PARTICULAR FONT, STYLE,
SIZE, OR COLOR.
FOR WINE (U.S. CLS. 47 AND 49).
FIRST USE 10-9-2008; IN COMMERCE 10-9-2008.
MARGERY A. TIERNEY, EXAMINING ATTORNEY

CLASS 33—(Continued).

SN 85-540,103. JACKSON WINE ESTATES INTERNATIONAL LIMITED, LOUGHLINSTOWN, COUNTY, IRELAND, FILED 2-10-2012.

IRONHEART

THE MARK CONSISTS OF STANDARD CHARACTERS WITHOUT CLAIM TO ANY PARTICULAR FONT, STYLE, SIZE, OR COLOR.

FOR ALCOHOLIC BEVERAGES EXCEPT BEERS (U.S. CLS. 47 AND 49).

CARYN GLASSER, EXAMINING ATTORNEY

SN 85-540,155. JACKSON WINE ESTATES INTERNATIONAL LIMITED, LOUGHLINSTOWN, DUBLIN, IRELAND, FILED 2-10-2012.



OWNER OF U.S. REG. NO. 3,219,811.
THE MARK CONSISTS OF A STYLIZED LETTER J.
FOR ALCOHOLIC BEVERAGES EXCEPT BEERS (U.S. CLS. 47 AND 49).

FIRST USE 1-1-2010; IN COMMERCE 1-1-2010.
CARYN GLASSER, EXAMINING ATTORNEY

SN 85-540,180. RUM RUNNERS, INC., PORTLAND, OR. FILED 2-10-2012.

S7RENS

THE MARK CONSISTS OF STANDARD CHARACTERS WITHOUT CLAIM TO ANY PARTICULAR FONT, STYLE, SIZE, OR COLOR.

FOR DISTILLED SPIRITS (U.S. CLS. 47 AND 49).
ROBIN CHOSID, EXAMINING ATTORNEY

CLASS 33—(Continued).

SN 85-540,183. RUM RUNNERS, INC., PORTLAND, OR. FILED 2-10-2012.



THE MARK CONSISTS OF THE DESIGN OF A SIREN BODY CURLED AROUND A STAR.

FOR DISTILLED SPIRITS (U.S. CLS. 47 AND 49).
ROBIN CHOSID, EXAMINING ATTORNEY

SN 85-540,198. BRANDI, GRACE KIM, FONTANA, CA. FILED 2-11-2012.

DEADHEAD RUM

THE MARK CONSISTS OF STANDARD CHARACTERS WITHOUT CLAIM TO ANY PARTICULAR FONT, STYLE, SIZE, OR COLOR.

NO CLAIM IS MADE TO THE EXCLUSIVE RIGHT TO USE "RUM", APART FROM THE MARK AS SHOWN.

FOR ALCOHOLIC BEVERAGES EXCEPT BEERS; RUM (U.S. CLS. 47 AND 49).

GIANCARLO CASTRO, EXAMINING ATTORNEY

SN 85-540,695. DIAGEO CHATEAU & ESTATE WINES COMPANY, NAPA, CA. FILED 2-13-2012.

STARK RAVING

THE MARK CONSISTS OF STANDARD CHARACTERS WITHOUT CLAIM TO ANY PARTICULAR FONT, STYLE, SIZE, OR COLOR.

FOR ALCOHOLIC BEVERAGES EXCEPT BEERS (U.S. CLS. 47 AND 49).

SUSAN STIGLITZ, EXAMINING ATTORNEY

CLASS 33—(Continued).

SN 85-540,699. DIAGEO CHATEAU & ESTATE WINES COMPANY, NAPA, CA. FILED 2-13-2012.

STARK RAVING MAD

THE MARK CONSISTS OF STANDARD CHARACTERS WITHOUT CLAIM TO ANY PARTICULAR FONT, STYLE, SIZE, OR COLOR.
FOR ALCOHOLIC BEVERAGES EXCEPT BEERS (U.S. CLS. 47 AND 49).
SUSAN STIGLITZ, EXAMINING ATTORNEY

CLASS 33—(Continued).

SN 85-550,648. CRISPIN CIDER COMPANY, MINNEAPOLIS, MN. FILED 2-23-2012.

FOX BARREL

THE MARK CONSISTS OF STANDARD CHARACTERS WITHOUT CLAIM TO ANY PARTICULAR FONT, STYLE, SIZE, OR COLOR.
OWNER OF U.S. REG. NO. 3,221,350.
FOR HARD CIDER (U.S. CLS. 47 AND 49).
FIRST USE 11-20-2004; IN COMMERCE 11-20-2004.
GINA HAYES, EXAMINING ATTORNEY

SN 85-541,533. COATS INTERNATIONAL HOLDINGS, INC., DBA COATS ALOE INTERNATIONAL, INC., DALLAS, TX. FILED 2-13-2012.

*Aloe***RITA**

FOR PREPARED ALCOHOLIC COCKTAIL (U.S. CLS. 47 AND 49).
RONALD MCMORROW, EXAMINING ATTORNEY

SN 85-556,386. GREENBRIER IA, INC., WHITE SULPHUR SPRING, WV. FILED 2-29-2012.

SPRINGS 1778

THE MARK CONSISTS OF STANDARD CHARACTERS WITHOUT CLAIM TO ANY PARTICULAR FONT, STYLE, SIZE, OR COLOR.
FOR VODKA (U.S. CLS. 47 AND 49).
MATTHEW MCDOWELL, EXAMINING ATTORNEY

SN 85-546,866. AUGUSTA WINE COMPANY, AUGUSTA, MO. FILED 2-19-2012.

BED OF ROSES

THE MARK CONSISTS OF STANDARD CHARACTERS WITHOUT CLAIM TO ANY PARTICULAR FONT, STYLE, SIZE, OR COLOR.
FOR WINE (U.S. CLS. 47 AND 49).
CHRISTOPHER SIDOTI, EXAMINING ATTORNEY

SN 85-556,430. GREENBRIER IA, INC., WHITE SULPHUR SPRING, WV. FILED 2-29-2012.



THE MARK CONSISTS OF THE WORD "SPRINGS" IN A STYLIZED SCRIPT OVER THE NUMBER "1778" IN LARGER FONT.
FOR VODKA (U.S. CLS. 47 AND 49).
MATTHEW MCDOWELL, EXAMINING ATTORNEY

CLASS 33—(Continued).

SN 85-560,213. E. & J. GALLO WINERY, MODESTO, CA.
FILED 3-5-2012.



THE MARK CONSISTS OF THREE RINGS SURROUNDING A CIRCLE. A STYLIZED LETTER "F" AND A STYLIZED LETTER "B" APPEAR IN THE CENTER OF THE CIRCLE.

FOR ALCOHOLIC BEVERAGES EXCEPT BEERS (U.S. CLS. 47 AND 49).

FIRST USE 11-29-2011; IN COMMERCE 11-29-2011.

DAVID H. STINE, EXAMINING ATTORNEY

CLASS 33—(Continued).

SN 85-591,650. SHAMOOIL, MASOOD, BEVERLY HILLS, CA.
FILED 4-6-2012.

TEQUI COOLER

THE MARK CONSISTS OF STANDARD CHARACTERS WITHOUT CLAIM TO ANY PARTICULAR FONT, STYLE, SIZE, OR COLOR.

NO CLAIM IS MADE TO THE EXCLUSIVE RIGHT TO USE "COOLER", APART FROM THE MARK AS SHOWN.

FOR ALCOHOLIC APERITIF BITTERS; ALCOHOLIC BEVERAGE PRODUCED FROM A BREWED MALT BASE WITH NATURAL FLAVORS; ALCOHOLIC BEVERAGES CONTAINING FRUIT; ALCOHOLIC BEVERAGES EXCEPT BEERS; ALCOHOLIC BEVERAGES OF FRUIT; ALCOHOLIC BEVERAGES, NAMELY, DIGESTIFS; ALCOHOLIC BEVERAGES, NAMELY, FLAVOR-INFUSED WHISKEY; ALCOHOLIC BEVERAGES, NAMELY, TEQUILA; ALCOHOLIC BITTERS; ALCOHOLIC CARBONATED BEVERAGES, EXCEPT BEER; ALCOHOLIC COCKTAIL MIXES; ALCOHOLIC COCKTAIL MIXES, NAMELY, TEQUILA MIXES; ALCOHOLIC COCKTAILS CONTAINING MILK; ALCOHOLIC COCKTAILS IN THE FORM OF CHILLED GELATINS; ALCOHOLIC COCKTAILS IN THE FORM OF FROZEN POPS; ALCOHOLIC COFFEE-BASED BEVERAGE; ALCOHOLIC CORDIALS; ALCOHOLIC EGG NOG; ALCOHOLIC ENERGY DRINKS; ALCOHOLIC ESSENCES; ALCOHOLIC EXTRACTS; ALCOHOLIC FRUIT COCKTAIL DRINKS; ALCOHOLIC FRUIT EXTRACTS; ALCOHOLIC MALT COOLERS; ALCOHOLIC MIXED BEVERAGES EXCEPT BEERS; ALCOHOLIC PUNCH; ALCOHOLIC PUNCHES; ALCOHOLIC TEA-BASED BEVERAGE; APERITIFS WITH A DISTILLED ALCOHOLIC LIQUOR BASE; FLAVORED BREWED MALT BEVERAGE; LIQUOR AND LIQUEUR BEVERAGES, NAMELY, TEQUILA; PREPARED ALCOHOLIC COCKTAIL; RICE ALCOHOL; RUM; SPIRITS; WINE-BASED BEVERAGE, NAMELY, PIQUETTE (U.S. CLS. 47 AND 49).

RONALD MCMORROW, EXAMINING ATTORNEY

SN 85-584,444. CRISPIN CIDER COMPANY, MINNEAPOLIS, MN. FILED 3-30-2012.

PEAR NAKED

THE MARK CONSISTS OF STANDARD CHARACTERS WITHOUT CLAIM TO ANY PARTICULAR FONT, STYLE, SIZE, OR COLOR.

FOR HARD CIDER (U.S. CLS. 47 AND 49).

GINA HAYES, EXAMINING ATTORNEY

SN 85-584,452. CRISPIN CIDER COMPANY, MINNEAPOLIS, MN. FILED 3-30-2012.

BARE NAKED

THE MARK CONSISTS OF STANDARD CHARACTERS WITHOUT CLAIM TO ANY PARTICULAR FONT, STYLE, SIZE, OR COLOR.

FOR HARD CIDER (U.S. CLS. 47 AND 49).

GINA HAYES, EXAMINING ATTORNEY

CLASS 33—(Continued).

SN 85-591,655. SHAMOOL, MASOOD, BEVERLY HILLS, CA. FILED 4-6-2012.

TEQUI MIX

THE MARK CONSISTS OF STANDARD CHARACTERS WITHOUT CLAIM TO ANY PARTICULAR FONT, STYLE, SIZE, OR COLOR.

NO CLAIM IS MADE TO THE EXCLUSIVE RIGHT TO USE "MIX", APART FROM THE MARK AS SHOWN.

FOR ALCOHOLIC APERITIF BITTERS; ALCOHOLIC BEVERAGE PRODUCED FROM A BREWED MALT BASE WITH NATURAL FLAVORS; ALCOHOLIC BEVERAGES CONTAINING FRUIT; ALCOHOLIC BEVERAGES EXCEPT BEERS; ALCOHOLIC BEVERAGES OF FRUIT; ALCOHOLIC BEVERAGES, NAMELY, DIGESTIFS; ALCOHOLIC BEVERAGES, NAMELY, FLAVOR-INFUSED WHISKEY; ALCOHOLIC BEVERAGES, NAMELY, TEQUILA; ALCOHOLIC BITTERS; ALCOHOLIC CARBONATED BEVERAGES, EXCEPT BEER; ALCOHOLIC COCKTAIL MIXES; ALCOHOLIC COCKTAIL MIXES, NAMELY, TEQUILA MIXES; ALCOHOLIC COCKTAILS CONTAINING MILK; ALCOHOLIC COCKTAILS IN THE FORM OF CHILLED GELATINS ; ALCOHOLIC COCKTAILS IN THE FORM OF FROZEN POPS; ALCOHOLIC COFFEE-BASED BEVERAGE; ALCOHOLIC CORDIALS; ALCOHOLIC EGG NOG; ALCOHOLIC ENERGY DRINKS; ALCOHOLIC ESSENCES; ALCOHOLIC EXTRACTS; ALCOHOLIC FRUIT COCKTAIL DRINKS; ALCOHOLIC FRUIT EXTRACTS; ALCOHOLIC MALT COOLERS; ALCOHOLIC MIXED BEVERAGES EXCEPT BEERS; ALCOHOLIC PUNCH; ALCOHOLIC PUNCHES; ALCOHOLIC TEA-BASED BEVERAGE; APERITIFS WITH A DISTILLED ALCOHOLIC LIQUOR BASE; FLAVORED BREWED MALT BEVERAGE; LIQUOR AND LIQUEUR BEVERAGES, NAMELY, TEQUILA; PREPARED ALCOHOLIC COCKTAIL; RICE ALCOHOL; RUM; SPIRITS; WINE-BASED BEVERAGE, NAMELY, PIQUETTE (U.S. CLS. 47 AND 49).

RONALD MCMORROW, EXAMINING ATTORNEY

SN 85-597,570. SAN ANTONIO WINERY, INC., LOS ANGELES, CA. FILED 4-13-2012.

THE WINE HAND

THE MARK CONSISTS OF STANDARD CHARACTERS WITHOUT CLAIM TO ANY PARTICULAR FONT, STYLE, SIZE, OR COLOR.

NO CLAIM IS MADE TO THE EXCLUSIVE RIGHT TO USE "WINE", APART FROM THE MARK AS SHOWN.

FOR WINE (U.S. CLS. 47 AND 49).
BRIAN NEVILLE, EXAMINING ATTORNEY

CLASS 33—(Continued).

SN 85-608,034. JACKSON WINE ESTATES INTERNATIONAL LIMITED, COUNTY DUBLIN, IRELAND, FILED 4-25-2012.

ARCANUM

THE MARK CONSISTS OF STANDARD CHARACTERS WITHOUT CLAIM TO ANY PARTICULAR FONT, STYLE, SIZE, OR COLOR.

OWNER OF U.S. REG. NO. 3,080,331.
FOR ALCOHOLIC BEVERAGES EXCEPT BEERS (U.S. CLS. 47 AND 49).

FIRST USE 2-28-2004; IN COMMERCE 2-28-2004.
CARYN GLASSER, EXAMINING ATTORNEY

SN 85-608,090. JACKSON WINE ESTATES INTERNATIONAL LIMITED, COUNTY DUBLIN, IRELAND, FILED 4-25-2012.

ARCENO

THE MARK CONSISTS OF STANDARD CHARACTERS WITHOUT CLAIM TO ANY PARTICULAR FONT, STYLE, SIZE, OR COLOR.

OWNER OF U.S. REG. NO. 3,668,621.
FOR ALCOHOLIC BEVERAGES EXCEPT BEERS (U.S. CLS. 47 AND 49).

FIRST USE 5-21-2001; IN COMMERCE 5-21-2001.
CARYN GLASSER, EXAMINING ATTORNEY

SN 85-608,480. JACKSON WINE ESTATES INTERNATIONAL LIMITED, COUNTY DUBLIN, IRELAND, FILED 4-25-2012.

HIGH SANDS

THE MARK CONSISTS OF STANDARD CHARACTERS WITHOUT CLAIM TO ANY PARTICULAR FONT, STYLE, SIZE, OR COLOR.

OWNER OF U.S. REG. NO. 3,486,521.
FOR ALCOHOLIC BEVERAGES EXCEPT BEERS (U.S. CLS. 47 AND 49).

FIRST USE 1-1-2008; IN COMMERCE 1-1-2008.
CARYN GLASSER, EXAMINING ATTORNEY

CLASS 34—SMOKERS' ARTICLES

SN 76-709,616. P.T. DJARUM, KUDUS, 59317, INDONESIA,
FILED 11-2-2011.



OWNER OF U.S. REG. NO. 2,119,330 AND OTHERS.
THE COLOR(S) GOLD, BLACK, WHITE AND RED IS/ARE CLAIMED AS A FEATURE OF THE MARK.
THE MARK CONSISTS OF THE WORD "DJARUM" IN A STYLIZED GOLD FONT ABOVE THE WORD "BLACK". THE LETTERS "B", "L", "C" AND "K" IN THE WORD "BLACK" ARE IN A STYLIZED WHITE FONT. THE "A" IN THE WORD "BLACK" IS A STYLIZED SOLID RED TRIANGLE ("A"). ALL OF THE AFOREMENTIONED ARE ON A BLACK BACKGROUND WHICH IS TRIMMED IN A DARKER SHADE OF BLACK. ABOVE THE AFOREMENTIONED WORDS "DJARUM BLACK" IS A CIRCLE WHICH CONTAINS A NEEDLE DESIGN. THE CIRCLE AND THE NEEDLE DESIGN ARE IN GOLD ON THE SAME BLACK BACKGROUND WHICH IS ALSO TRIMMED IN A DARKER SHADE OF BLACK.
THE ENGLISH TRANSLATION OF "DJARUM" IN THE MARK IS "NEEDLE".
SEC. 2(F) AS TO "BLACK".
FOR CIGARS CONTAINING TOBACCO AND CLOVES (U.S. CLS. 2, 8, 9 AND 17).
FIRST USE 4-24-2009; IN COMMERCE 4-24-2009.
RICHARD WHITE, EXAMINING ATTORNEY

SN 76-710,188. P.T. DJARUM, KUDUS, 59317, INDONESIA,
FILED 1-6-2012.



OWNER OF U.S. REG. NO. 2,119,330 AND OTHERS.
NO CLAIM IS MADE TO THE EXCLUSIVE RIGHT TO USE "CHERRY", APART FROM THE MARK AS SHOWN.
THE COLORS GOLD, WHITE, BLACK, RED AND DARK RED ARE CLAIMED AS A FEATURE OF THE MARK.
THE MARK CONSISTS OF THE WORD "DJARUM" IN A STYLIZED GOLD FONT ABOVE THE WORD "BLACK". THE LETTERS "B", "L", "C" AND "K" IN THE WORD

CLASS 34—(Continued).

"BLACK" ARE IN A STYLIZED WHITE FONT. THE "A" IN THE WORD "BLACK" IS A STYLIZED SOLID RED TRIANGLE ("A"). BELOW THIS APPEARS THE WORD "CHERRY" IN A DIFFERENT STYLIZED GOLD FONT. ALL OF THE AFOREMENTIONED ARE ON A BLACK BACKGROUND WHICH IS TRIMMED IN RED AND DARK RED. ABOVE THE AFOREMENTIONED WORDS "DJARUM BLACK CHERRY" IS A CIRCLE WHICH CONTAINS A NEEDLE DESIGN. THE CIRCLE AND THE NEEDLE DESIGN ARE IN GOLD ON THE SAME BLACK BACKGROUND.
THE ENGLISH TRANSLATION OF "DJARUM" IN THE MARK IS "NEEDLE".
SEC. 2(F) AS TO "BLACK".
FOR CIGARS CONTAINING TOBACCO AND CLOVES (U.S. CLS. 2, 8, 9 AND 17).
FIRST USE 6-24-2009; IN COMMERCE 6-24-2009.
RICHARD WHITE, EXAMINING ATTORNEY

SN 76-710,189. P.T. DJARUM, KUDUS, 59317, INDONESIA,
FILED 1-6-2012.



OWNER OF U.S. REG. NO. 2,119,330 AND OTHERS.
NO CLAIM IS MADE TO THE EXCLUSIVE RIGHT TO USE "VANILLA", APART FROM THE MARK AS SHOWN.
THE COLORS GOLD, WHITE, RED, BLACK, AND DARK GOLD ARE CLAIMED AS A FEATURE OF THE MARK.
THE MARK CONSISTS OF THE WORD "DJARUM" IN A STYLIZED GOLD FONT ABOVE THE WORD "BLACK". THE LETTERS "B", "L", "C" AND "K" IN THE WORD "BLACK" ARE IN A STYLIZED WHITE FONT. THE "A" IN THE WORD "BLACK" IS A STYLIZED SOLID RED TRIANGLE ("A"). BELOW THIS APPEARS THE WORD "VANILLA" IN A DIFFERENT STYLIZED GOLD FONT. ALL OF THE AFOREMENTIONED ARE ON A BLACK BACKGROUND WHICH IS TRIMMED IN GOLD AND DARK GOLD. ABOVE THE AFOREMENTIONED WORDS "DJARUM BLACK VANILLA" IS A CIRCLE WHICH CONTAINS A NEEDLE DESIGN. THE CIRCLE AND THE NEEDLE DESIGN ARE IN GOLD ON THE SAME BLACK BACKGROUND.
THE ENGLISH TRANSLATION OF "DJARUM" IN THE MARK IS "NEEDLE".
SEC. 2(F) AS TO "BLACK".
FOR CIGARS CONTAINING TOBACCO AND CLOVES (U.S. CLS. 2, 8, 9 AND 17).
FIRST USE 6-26-2009; IN COMMERCE 6-26-2009.
RICHARD WHITE, EXAMINING ATTORNEY

CLASS 34—(Continued).

SN 76-710,193. P.T. DJARUM, KUDUS, 59317, INDONESIA, FILED 1-6-2012.



OWNER OF U.S. REG. NO. 2,119,330 AND OTHERS.
NO CLAIM IS MADE TO THE EXCLUSIVE RIGHT TO USE "MENTHOL", APART FROM THE MARK AS SHOWN.
THE COLORS GOLD, WHITE, GREEN, DARK GREEN AND BLACK ARE CLAIMED AS A FEATURE OF THE MARK.

THE MARK CONSISTS OF THE WORD "DJARUM" IN A STYLIZED GOLD FONT ABOVE THE WORD "BLACK". THE LETTERS "B", "L", "C" AND "K" IN THE WORD "BLACK" ARE IN A STYLIZED WHITE FONT. THE "A" IN THE WORD "BLACK" IS A STYLIZED SOLID GREEN TRIANGLE ("A"). BELOW THIS APPEARS THE WORD "MENTHOL" IN A DIFFERENT STYLIZED GOLD FONT. ALL OF THE AFOREMENTIONED ARE ON A BLACK BACKGROUND WHICH IS TRIMMED IN GREEN AND DARK GREEN. ABOVE THE AFOREMENTIONED WORDS "DJARUM BLACK MENTHOL" IS A CIRCLE WHICH CONTAINS A NEEDLE DESIGN. THE CIRCLE AND THE NEEDLE DESIGN ARE IN GOLD ON THE SAME BLACK BACKGROUND.

THE ENGLISH TRANSLATION OF "DJARUM" IN THE MARK IS "NEEDLE".

SEC. 2(F) AS TO "BLACK".
FOR CIGARS CONTAINING TOBACCO AND CLOVES (U.S. CLS. 2, 8, 9 AND 17).

FIRST USE 2-16-2010; IN COMMERCE 2-16-2010.
RICHARD WHITE, EXAMINING ATTORNEY

SN 85-218,303. FANTASIA DISTRIBUTION, INC., ANAHEIM, CA. FILED 1-14-2011.

YAGER BOMB

THE MARK CONSISTS OF STANDARD CHARACTERS WITHOUT CLAIM TO ANY PARTICULAR FONT, STYLE, SIZE, OR COLOR.

FOR HOOKAH TOBACCO; MOLASSES TOBACCO; SMOKING TOBACCO; TOBACCO (U.S. CLS. 2, 8, 9 AND 17).

FIRST USE 11-24-2009; IN COMMERCE 11-24-2009.
ANNE E. GUSTASON, EXAMINING ATTORNEY

CLASS 34—(Continued).

SN 85-477,430. ROCKY PATEL PREMIUM CIGARS, INC., BONITA SPRINGS, FL. FILED 11-21-2011.

XEN BY NISH PATEL

THE MARK CONSISTS OF STANDARD CHARACTERS WITHOUT CLAIM TO ANY PARTICULAR FONT, STYLE, SIZE, OR COLOR.

THE NAME(S), PORTRAIT(S), AND/OR SIGNATURE(S) SHOWN IN THE MARK IDENTIFIES "NISH PATEL", WHOSE CONSENT(S) TO REGISTER IS MADE OF RECORD.

FOR CIGARS (U.S. CLS. 2, 8, 9 AND 17).
FIRST USE 10-0-2011; IN COMMERCE 10-0-2011.
BRIAN NEVILLE, EXAMINING ATTORNEY

SN 85-507,424. TABLE 36, LLC, ST. LOUIS, MO. FILED 1-3-2012.



THE MARK CONSISTS OF THE WORDING "TABLE 36" CONTAINED WITHIN A BROKEN CIRCLE.

FOR CIGAR BOXES; CIGAR TUBES; CIGARS (U.S. CLS. 2, 8, 9 AND 17).

FIRST USE 12-5-2011; IN COMMERCE 1-1-2012.
FRED CARL, EXAMINING ATTORNEY

SN 85-508,993. DAVIDOFF CAPITAL GROUP INTERNATIONAL, LOS ANGELES, CA. FILED 1-5-2012.

RAFAELI'S CIGARS

THE MARK CONSISTS OF STANDARD CHARACTERS WITHOUT CLAIM TO ANY PARTICULAR FONT, STYLE, SIZE, OR COLOR.

NO CLAIM IS MADE TO THE EXCLUSIVE RIGHT TO USE "CIGARS", APART FROM THE MARK AS SHOWN.
FOR CIGARS (U.S. CLS. 2, 8, 9 AND 17).

SUSAN LESLIE DUBOIS, EXAMINING ATTORNEY

CLASS 34—(Continued).

SN 85-516,430. J.C. NEWMAN CIGAR COMPANY, TAMPA, FL. FILED 1-13-2012.

TAMPA TROLLEYS

THE MARK CONSISTS OF STANDARD CHARACTERS WITHOUT CLAIM TO ANY PARTICULAR FONT, STYLE, SIZE, OR COLOR.

NO CLAIM IS MADE TO THE EXCLUSIVE RIGHT TO USE "TAMPA", APART FROM THE MARK AS SHOWN.

FOR CIGARS (U.S. CLS. 2, 8, 9 AND 17).

FIRST USE 1-12-2012; IN COMMERCE 1-12-2012.

BRENDAN REGAN, EXAMINING ATTORNEY

CLASS 34—(Continued).

SN 85-529,153. LOPEZ-TABAK TOBACALERO COMPANY, DBA LA VIDA CIGARS, TAMPA, FL. FILED 1-30-2012.



THE COLOR(S) BLUE, WHITE, AND BLACK IS/ARE CLAIMED AS A FEATURE OF THE MARK.

THE MARK CONSISTS OF AN UPRIGHT TOBACCO LEAF IN THE COLOR WHITE USING IMPLIED LINES WITH A TRIBAL STYLE, WITH THE WORDING "LA VIDA" IN THE COLOR BLUE IN STYLIZED FONT, ALL UPON A BLACK BACKGROUND.

THE ENGLISH TRANSLATION OF "LA VIDA" IN THE MARK IS "THE LIFE".

FOR CIGARS (U.S. CLS. 2, 8, 9 AND 17).

FIRST USE 8-9-2010; IN COMMERCE 0-0-2011.

ADA HAN, EXAMINING ATTORNEY

SN 85-521,564. PITG WORLDWIDE, FRESNO, CA. FILED 1-20-2012.



NO CLAIM IS MADE TO THE EXCLUSIVE RIGHT TO USE "FREEZABLE PIPES", APART FROM THE MARK AS SHOWN.

THE COLOR(S) PURPLE, GREEN, YELLOW, BLUE, RED AND WHITE IS/ARE CLAIMED AS A FEATURE OF THE MARK.

THE MARK CONSISTS OF THE WORDS "IGLOW FREEZABLE PIPES". THE LETTERS IN "IGLOW" ARE PRESENTED IN MULTI COLORS AND ARE AS FOLLOWS THE "I" IS PURPLE, THE "G" IS GREEN, THE "L" IS YELLOW, THE "O" IS BLUE AND THE "W" IS RED. "FREEZABLE PIPES" IS IN A STYLIZED WHITE FONT. THE WORD "IGLOW" ALSO HAS WHITE SNOW ON THE LETTERS AS WELL AS BELOW THE LETTERS. THE COLOR BLACK SERVES AS BACKGROUND ONLY AND IS NOT PART OF THE MARK.

FOR TOBACCO WATER PIPES (U.S. CLS. 2, 8, 9 AND 17).

FIRST USE 11-0-2011; IN COMMERCE 11-0-2011.

SUSAN STIGLITZ, EXAMINING ATTORNEY

SN 85-532,190. NEW IMAGE GLOBAL, INC., CORONA, CA. FILED 2-2-2012.

QUAD

THE MARK CONSISTS OF STANDARD CHARACTERS WITHOUT CLAIM TO ANY PARTICULAR FONT, STYLE, SIZE, OR COLOR.

FOR CIGARETTE PAPERS; CIGARETTE ROLLING PAPERS; CIGAR PAPERS; CIGAR ROLLING PAPERS; TOBACCO ROLLING PAPERS; CIGARETTES; CIGARILLOS; CIGARS; CHEWING TOBACCO; TOBACCO; TOBACCO LEAVES; CIGARETTE TUBES; CIGAR TUBES; FILTER-TIPPED CIGARETTES; HAND-ROLLING TOBACCO; PIPE TOBACCO; ROLL YOUR OWN TOBACCO; TOBACCO; TOBACCO PIPES (U.S. CLS. 2, 8, 9 AND 17).

FRANK LATTUCA, EXAMINING ATTORNEY

CLASS 34—(Continued).

SN 85-532,457. KT & G CORPORATION, DAEJEON, REPUBLIC OF KOREA, FILED 2-2-2012.

ESSE SENSE

THE MARK CONSISTS OF STANDARD CHARACTERS WITHOUT CLAIM TO ANY PARTICULAR FONT, STYLE, SIZE, OR COLOR.

OWNER OF U.S. REG. NO. 3,430,972.
THE ENGLISH TRANSLATION OF "ESSE" IN THE MARK IS "TO BE".

FOR ASHTRAYS FOR SMOKERS; ASHTRAYS, NOT OF PRECIOUS METAL; CIGAR CUTTERS; CIGARETTE CASES NOT OF PRECIOUS METAL; CIGARETTE FILTERS; CIGARETTE LIGHTERS NOT OF PRECIOUS METAL; CIGARETTE PAPERS; CIGARETTES; CIGARS; MATCHES; SNUFF; TOBACCO; TOBACCO PIPE CLEANERS; TOBACCO PIPES; TOBACCO POUCHES (U.S. CLS. 2, 8, 9 AND 17).

FLORENTINA BLANDU, EXAMINING ATTORNEY

CLASS 34—(Continued).

SN 85-535,748. ELOY HERNANDEZ, OCALA, FL. FILED 2-7-2012.

DUJO

THE MARK CONSISTS OF STANDARD CHARACTERS WITHOUT CLAIM TO ANY PARTICULAR FONT, STYLE, SIZE, OR COLOR.

FOR CIGARS (U.S. CLS. 2, 8, 9 AND 17).
HANNO RITTNER, EXAMINING ATTORNEY

SN 85-536,678. SOCIAL SMOKE, INC., ARLINGTON, TX. FILED 2-8-2012.

SN 85-534,418. CIGARS INTERNATIONAL, INC., BETHLEHEM, PA. FILED 2-6-2012.

THE WRECK

THE MARK CONSISTS OF STANDARD CHARACTERS WITHOUT CLAIM TO ANY PARTICULAR FONT, STYLE, SIZE, OR COLOR.

FOR CIGARS (U.S. CLS. 2, 8, 9 AND 17).
LINDA ORNDORFF, EXAMINING ATTORNEY

VEGAS BOMB

THE MARK CONSISTS OF STANDARD CHARACTERS WITHOUT CLAIM TO ANY PARTICULAR FONT, STYLE, SIZE, OR COLOR.

FOR TOBACCO (U.S. CLS. 2, 8, 9 AND 17).
FIRST USE 11-4-2011; IN COMMERCE 11-4-2011.
KATINA MISTER, EXAMINING ATTORNEY

SN 85-534,794. BRAINBOX INDUSTRIES, LLC, LAS VEGAS, NV. FILED 2-6-2012.

CIGAVETTE

THE MARK CONSISTS OF STANDARD CHARACTERS WITHOUT CLAIM TO ANY PARTICULAR FONT, STYLE, SIZE, OR COLOR.

FOR ELECTRIC CIGARETTES; SMOKELESS CIGARETTE VAPORIZER PIPE (U.S. CLS. 2, 8, 9 AND 17).
FIRST USE 6-28-2011; IN COMMERCE 6-28-2011.
JAY FLOWERS, EXAMINING ATTORNEY

SN 85-537,837. ELOY HERNANDEZ, OCALA, FL. FILED 2-9-2012.

COABEY

THE MARK CONSISTS OF STANDARD CHARACTERS WITHOUT CLAIM TO ANY PARTICULAR FONT, STYLE, SIZE, OR COLOR.

FOR CIGARS (U.S. CLS. 2, 8, 9 AND 17).
HANNO RITTNER, EXAMINING ATTORNEY

CLASS 34—(Continued).

SN 85-556,562. GREEN, MATT, SAN DIEGO, CA. FILED 2-29-2012.

420 PINK

THE MARK CONSISTS OF STANDARD CHARACTERS WITHOUT CLAIM TO ANY PARTICULAR FONT, STYLE, SIZE, OR COLOR.

FOR TOBACCO PIPE CLEANERS; CLEANERS FOR CLEANING TOBACCO WATER PIPES, SMOKING PIPES AND HOOKAHS (U.S. CLS. 2, 8, 9 AND 17).

ROBERT STRUCK, EXAMINING ATTORNEY

SN 85-582,030. CHRISTIAN LUIS EIROA, PINECREST, FL. FILED 3-28-2012.

FTW CIGAR COMPANY

THE MARK CONSISTS OF STANDARD CHARACTERS WITHOUT CLAIM TO ANY PARTICULAR FONT, STYLE, SIZE, OR COLOR.

NO CLAIM IS MADE TO THE EXCLUSIVE RIGHT TO USE "CIGAR COMPANY", APART FROM THE MARK AS SHOWN.

FOR CIGARS, AND CIGAR TOBACCO LEAF; SMOKERS' ACCESSORIES, NAMELY, LIGHTERS NOT OF PRECIOUS METAL, ASH TRAYS NOT OF PRECIOUS METAL, CIGAR CUTTERS, AND HUMIDORS (U.S. CLS. 2, 8, 9 AND 17).

SANI KHOURI, EXAMINING ATTORNEY

SN 85-592,595. JENUWINE ARTICLES, INC., TROY, MI. FILED 4-9-2012.

Black Witch

THE MARK CONSISTS OF STANDARD CHARACTERS WITHOUT CLAIM TO ANY PARTICULAR FONT, STYLE, SIZE, OR COLOR.

FOR CIGARS (U.S. CLS. 2, 8, 9 AND 17).

LINDA E. BLOHM, EXAMINING ATTORNEY

CLASS 34—(Continued).

SN 85-593,955. CHRISTIAN LUIS EIROA, PINECREST, FL. FILED 4-10-2012.

WYNWOOD CIGARS

THE MARK CONSISTS OF STANDARD CHARACTERS WITHOUT CLAIM TO ANY PARTICULAR FONT, STYLE, SIZE, OR COLOR.

NO CLAIM IS MADE TO THE EXCLUSIVE RIGHT TO USE "CIGARS", APART FROM THE MARK AS SHOWN.

FOR CIGARS, AND CIGAR TOBACCO LEAF; SMOKERS' ACCESSORIES, NAMELY, LIGHTERS NOT OF PRECIOUS METAL, ASH TRAYS NOT OF PRECIOUS METAL, CIGAR CUTTERS, AND HUMIDORS (U.S. CLS. 2, 8, 9 AND 17).

SANI KHOURI, EXAMINING ATTORNEY

SERVICE MARKS

CLASS 35—ADVERTISING AND BUSINESS

SN 76-683,739. GROUP KAITU, LLC, RICHMOND, VA. FILED 11-7-2007.

EROS SHEMALE ESCORTS

THE MARK CONSISTS OF STANDARD CHARACTERS WITHOUT CLAIM TO ANY PARTICULAR FONT, STYLE, SIZE, OR COLOR.

OWNER OF U.S. REG. NOS. 2,793,831, 3,134,894 AND OTHERS.

NO CLAIM IS MADE TO THE EXCLUSIVE RIGHT TO USE "SHEMALE ESCORTS", APART FROM THE MARK AS SHOWN.

FOR PROMOTING THE GOODS AND SERVICES OF OTHERS BY PROVIDING A WEBSITE FEATURING ADVERTISEMENTS, BANNERS AND LINKS TO THE WEBSITES OF OTHERS IN THE FIELD OF ADULT-THEMED PRODUCTS, SERVICES AND ENTERTAINMENT; PROVIDING DISSEMINATION OF ADVERTISING FOR THE GOODS AND SERVICES OF OTHERS VIA A GLOBAL COMPUTER NETWORK; PROVIDING DIRECTORY INFORMATION SERVICES IN THE AREA OF ADULT-THEMED PRODUCTS, SERVICES AND ENTERTAINMENT VIA A GLOBAL COMPUTER NETWORK, PROVIDING AN ONLINE COMPUTER DATABASE IN THE AREA OF ADULT-THEMED PRODUCTS, SERVICES, AND ENTERTAINMENT VIA A GLOBAL COMPUTER NETWORK (U.S. CLS. 100, 101 AND 102).

FIRST USE 9-28-2007; IN COMMERCE 9-28-2007.

LEIGH LOWRY, EXAMINING ATTORNEY

CLASS 35—(Continued).

SN 76-710,203. COMPETITIVE SERVICES INTERNATIONAL INC., KANSAS CITY, MO. FILED 1-6-2012.

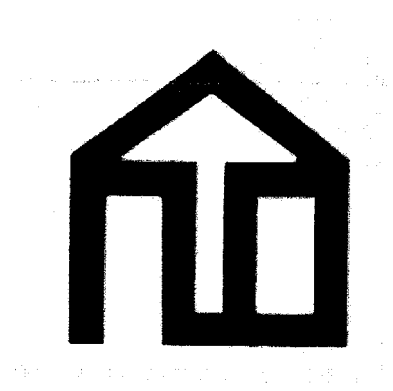

THE MARK CONSISTS OF A STYLIZED DESIGN OF A HOUSE.

FOR RETAIL STORE SERVICES FEATURING DOOR AND WINDOW PARTS AND HARDWARE; ON-LINE RETAIL STORE SERVICES FEATURING DOOR AND WINDOW PARTS AND HARDWARE (U.S. CLS. 100, 101 AND 102).

FIRST USE 8-0-2011; IN COMMERCE 8-0-2011.
JOHN DWYER, EXAMINING ATTORNEY

CLASS 35—(Continued).

SN 77-213,602. CHEWING BRANDS, LLC, BOSTON, MA. FILED 6-22-2007.

취영루

THE MARK CONSISTS OF KOREAN CHARACTERS. THE NON-LATIN CHARACTER(S) IN THE MARK TRANSLITERATES INTO "CHU YOUNG RU", AND THIS MEANS "GATHER, HERO, PLACE" OR "A GATHERING PLACE OF HEROES" IN ENGLISH.

FOR CONSULTATION IN THE FIELD OF MARKETING AND BUSINESS MANAGEMENT STRATEGIES, RELATED TO RESTAURANTS; BUSINESS INTERMEDIARY SERVICES IN THE FIELD OF SELLING PRODUCTS AND RENDERING SERVICES FOR THIRD PARTIES; ADVERTISING AND MARKETING, INTERMEDIARY ADVERTISING AND MARKETING SERVICES, ADVERTISING CONSULTATION, DISTRIBUTION OF GOODS FOR ADVERTISING PURPOSES; MARKET RESEARCH AND ANALYSIS; RETAIL STORE SERVICES FEATURING FOOD PRODUCTS; FRANCHISE SERVICES, NAMELY, OFFERING BUSINESS MANAGEMENT ASSISTANCE IN THE ESTABLISHMENT AND OPERATION OF RESTAURANTS; WHOLESALE DISTRIBUTORSHIP FEATURING FOOD PRODUCTS AND FRANCHISE SERVICES, NAMELY, BUSINESS MANAGEMENT ASSISTANCE IN THE ESTABLISHMENT AND OPERATION OF RESTAURANTS, FOOD STORES AND SELLING FOOD PRODUCTS (U.S. CLS. 100, 101 AND 102).

PAULA MAHONEY, EXAMINING ATTORNEY

SN 76-710,540. VISAGE MOBILE, INC., SAN FRANCISCO, CA. FILED 2-6-2012.

MOBILITYCENTRAL

THE MARK CONSISTS OF STANDARD CHARACTERS WITHOUT CLAIM TO ANY PARTICULAR FONT, STYLE, SIZE, OR COLOR.

FOR SERVICES OF PROVIDING COST ANALYSIS SERVICES TO CUSTOMERS, NAMELY, AUTOMATED MONITORING OF MOBILE COMMUNICATIONS SPENDING IN ORDER TO MANAGE MOBILE COMMUNICATIONS AND REDUCE MOBILE COMMUNICATIONS COSTS (U.S. CLS. 100, 101 AND 102).

FIRST USE 12-1-2007; IN COMMERCE 12-1-2007.
PAUL MORENO, EXAMINING ATTORNEY

CLASS 35—(Continued).

SN 77-311,996. GROUP KAITU, LLC, RICHMOND, VA. FILED 10-24-2007.

EROS NETWORKS

THE MARK CONSISTS OF STANDARD CHARACTERS WITHOUT CLAIM TO ANY PARTICULAR FONT, STYLE, SIZE, OR COLOR.

OWNER OF U.S. REG. NOS. 2,549,369, 3,134,894 AND OTHERS.

NO CLAIM IS MADE TO THE EXCLUSIVE RIGHT TO USE "NETWORKS", APART FROM THE MARK AS SHOWN.

FOR PROMOTING THE GOODS AND SERVICES OF OTHERS BY PROVIDING A WEBSITE FEATURING ADVERTISEMENTS, BANNERS AND LINKS TO THE WEBSITES OF OTHERS IN THE FIELD OF ADULT-THEMED PRODUCTS, SERVICES AND ENTERTAINMENT; PROVIDING DISSEMINATION OF ADVERTISING FOR THE GOODS AND SERVICES OF OTHERS VIA A GLOBAL COMPUTER NETWORK; PROVIDING DIRECTORY INFORMATION SERVICES IN THE AREA OF ADULT-THEMED PRODUCTS, SERVICES AND ENTERTAINMENT VIA A GLOBAL COMPUTER NETWORK; PROVIDING AN ON-LINE COMPUTER DATABASE IN THE AREA OF ADULT-THEMED PRODUCTS, SERVICES AND ENTERTAINMENT VIA A GLOBAL COMPUTER NETWORK; PROVIDING ONLINE RETAIL STORE SERVICES FEATURING ADULT-THEMED PRODUCTS, SERVICES AND ENTERTAINMENT VIA A GLOBAL COMPUTER NETWORK; PROVIDING A WEBSITE WHERE USERS CAN POST RATINGS, REVIEWS AND RECOMMENDATIONS ON PRODUCTS AND SERVICES (U.S. CLS. 100, 101 AND 102).

LEIGH LOWRY, EXAMINING ATTORNEY

SN 77-414,683. BINNIE WIKANE, SAN DIEGO, CA. FILED 3-6-2008.

fabspots

THE MARK CONSISTS OF STANDARD CHARACTERS WITHOUT CLAIM TO ANY PARTICULAR FONT, STYLE, SIZE, OR COLOR.

FOR ADVERTISING SERVICES, NAMELY, PROMOTING AND MARKETING THE GOODS AND SERVICES OF OTHERS IN THE FIELD OF UPSCALE CHOICES SUCH AS CULTURAL EVENTS, RESTAURANTS, SHOPPING, AND TRAVEL VIA PRINT AND ELECTRONIC MEDIA (U.S. CLS. 100, 101 AND 102).

FIRST USE 5-22-2009; IN COMMERCE 5-22-2009.

MARK PILARO, EXAMINING ATTORNEY

CLASS 35—(Continued).

SN 79-102,436. XI'AN FAR EAST IMPORT & EXPORT CO., LTD., CHINA, FILED 8-26-2011.

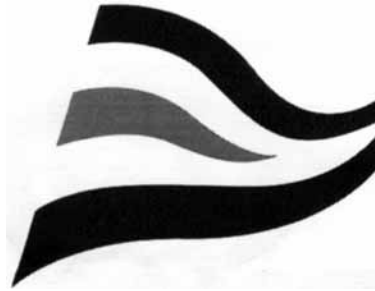

OWNER OF INTERNATIONAL REGISTRATION 1090434 DATED 8-26-2011, EXPIRES 8-26-2021.

THE MARK CONSISTS OF THREE WAVY BANDS RESEMBLING A TRIANGULAR FLAG.

FOR IMPORT-EXPORT AGENCIES; SALES PROMOTION FOR OTHERS; ADVERTISING; BUSINESS INFORMATION; PROFESSIONAL BUSINESS CONSULTANCY; PROFESSIONAL BUSINESS CONSULTANCY; SYSTEMIZATION OF INFORMATION INTO COMPUTER DATABASES; COMPUTERIZED FILE MANAGEMENT; ADMINISTRATIVE PROCESSING OF PURCHASE ORDERS; PROCUREMENT SERVICES FOR OTHERS, NAMELY, PURCHASING OFFICE FURNITURE FOR OTHERS (U.S. CLS. 100, 101 AND 102).

MELISSA VALLILLO, EXAMINING ATTORNEY

SN 79-103,229. TORDINI SOCIETA' A RESPONSABILITA LIMITATA - UNIPERSONALE, I-62012 CIVITANOVA MARCHE (MC), ITALY, FILED 6-27-2011.

SHOWROOM MARCONA 3

THE MARK CONSISTS OF STANDARD CHARACTERS WITHOUT CLAIM TO ANY PARTICULAR FONT, STYLE, SIZE, OR COLOR.

PRIORITY DATE OF 6-8-2011 IS CLAIMED.

OWNER OF INTERNATIONAL REGISTRATION 1092490 DATED 6-27-2011, EXPIRES 6-27-2021.

NO CLAIM IS MADE TO THE EXCLUSIVE RIGHT TO USE "SHOWROOM.", APART FROM THE MARK AS SHOWN.

FOR THE BRINGING TOGETHER, FOR THE BENEFIT OF OTHERS, OF A VARIETY OF GOODS, NAMELY, HOROLOGICAL INSTRUMENTS, GLASSES, GLASS FRAMES, SUNGLASSES, GLASS CASES, GLASS CHAINS, GLASS STRINGS - ENABLING CUSTOMERS TO CONVENIENTLY VIEW AND PURCHASE THOSE GOODS; ON-LINE RETAIL STORE SERVICES FEATURING HOROLOGICAL INSTRUMENTS, GLASSES, GLASS FRAMES, SUNGLASSES, GLASS CASES, GLASS CHAINS, GLASS STRINGS; ADVERTISING AND ADVERTISEMENT SERVICES; BUSINESS MANAGEMENT ASSISTANCE; BUSINESS ADMINISTRATION; PROVIDING OFFICE FUNCTIONS (U.S. CLS. 100, 101 AND 102).

PRISCILLA MILTON, EXAMINING ATTORNEY

CLASS 35—(Continued).

SN 79-103,477. ON ASSIGNMENT, INC., DELAWARE CORPORATION, UNITED STATES, FILED 12-22-2010.

VALESTA

THE MARK CONSISTS OF STANDARD CHARACTERS WITHOUT CLAIM TO ANY PARTICULAR FONT, STYLE, SIZE, OR COLOR.

OWNER OF INTERNATIONAL REGISTRATION 0999900 DATED 7-15-2008, EXPIRES 7-15-2018.

THE WORDING "VALESTA" HAS NO MEANING IN A FOREIGN LANGUAGE.

FOR PERSONNEL PLACEMENT SERVICES, NAMELY, PROVIDING AND SELECTING PERSONNEL; EMPLOYMENT AND CONSULTANCY AGENCIES FOR MATTERS RELATING TO PERSONNEL AND PERSONNEL MATTERS, NAMELY, PERSONNEL PLACEMENT AND PERSONNEL RELOCATION; BUSINESS MIDDLEMAN SERVICES BETWEEN THOSE LOOKING FOR AND THOSE PROVIDING SERVICES, NAMELY, FACILITATING TRANSACTIONS BETWEEN BUYERS AND SELLERS BY PROVIDING BUYERS WITH INFORMATION ABOUT SELLERS, GOODS AND SERVICES AND PROVIDING SELLERS WITH INFORMATION ABOUT POTENTIAL BUYERS; COMMERCIAL LOBBYING SERVICES, NAMELY, LOBBYING FOR BUSINESS PURPOSES; ORGANIZATION OF EXHIBITIONS AND TRADE SHOWS FOR COMMERCIAL OR ADVERTISING PURPOSES; PUBLIC RELATIONS; COMPUTER FILE MANAGEMENT; INFORMATION AND CONSULTING IN THE FIELDS OF PERSONNEL PLACEMENT AND RELOCATION SERVICES, EMPLOYMENT SERVICES, AND COMMERCIAL LOBBYING SERVICES (U.S. CLS. 100, 101 AND 102).

DAVID MURRAY, EXAMINING ATTORNEY

CLASS 35—(Continued).

SN 79-103,781. WEDDING DANCE DIRECTORY INTERNATIONAL PTY LTD, ST MARYS SOUTH, AUSTRALIA, FILED 8-30-2011.



PRIORITY DATE OF 5-8-2011 IS CLAIMED.

OWNER OF INTERNATIONAL REGISTRATION 1093876 DATED 8-30-2011, EXPIRES 8-30-2021.

NO CLAIM IS MADE TO THE EXCLUSIVE RIGHT TO USE "WEDDING DANCE DIRECTORY", APART FROM THE MARK AS SHOWN.

THE COLOR(S) GOLD OR GOLDISH YELLOW, BLACK, AND WHITE IS/ARE CLAIMED AS A FEATURE OF THE MARK.

THE MARK CONSISTS OF THE WORDING "WEDDING" IN GOLD OR GOLDISH YELLOW, THE WORDING "DANCE DIRECTORY" IN BLACK, AND A DESIGN OF A GLOBE IN GOLD OR GOLDISH YELLOW WITH THE REPRESENTATION OF THE CONTINENTS IN WHITE, AND A GOLD OR GOLDISH YELLOW SCROLL-LIKE LINE.

FOR ADVERTISING SERVICES PROVIDED OVER THE INTERNET (U.S. CLS. 100, 101 AND 102).

SUSAN RICHARDS, EXAMINING ATTORNEY

SN 79-103,632. AERO INVENTORY (UK) LIMITED, UNITED KINGDOM, FILED 9-12-2011.

AEROINV.COM

THE MARK CONSISTS OF STANDARD CHARACTERS WITHOUT CLAIM TO ANY PARTICULAR FONT, STYLE, SIZE, OR COLOR.

PRIORITY DATE OF 5-26-2011 IS CLAIMED.

OWNER OF INTERNATIONAL REGISTRATION 1093472 DATED 9-12-2011, EXPIRES 9-12-2021.

FOR THE BRINGING TOGETHER, FOR THE BENEFIT OF OTHERS, OF A VARIETY OF GOODS, ENABLING CUSTOMERS TO CONVENIENTLY VIEW AND PURCHASE, NAMELY, GOODS CONNECTED TO THE REPAIR AND MAINTENANCE OF AIRCRAFT, AIRCRAFT PARTS, AIRCRAFT COMPONENTS, AIRCRAFT FITTINGS, ENGINES, WHEELS, BRAKES, LIGHTING, AND PARTS AND FITTINGS FOR THE AFORESAID; RETAIL AND WHOLESALE STORE SERVICES FEATURING AIRCRAFT PARTS, FITTINGS AND COMPONENTS; THE PROVISION OF BUSINESS INFORMATIONAL, ADVISORY, CONSULTANCY, AND OFFICE SUPPORT STAFF SERVICES TO CUSTOMERS BEFORE, DURING AND AFTER THEIR PURCHASE OF THE AFOREMENTIONED FEATURED AIRCRAFT PARTS, FITTINGS AND COMPONENTS; PROVISION OF ALL AFOREMENTIONED SERVICES BY ELECTRONIC MEANS, INCLUDING VIA THE INTERNET (U.S. CLS. 100, 101 AND 102).

WILLIAM ROSSMAN, EXAMINING ATTORNEY

SN 79-107,717. FALKE KGAA, FED REP GERMANY, FILED 9-6-2011.

FALKE

THE MARK CONSISTS OF STANDARD CHARACTERS WITHOUT CLAIM TO ANY PARTICULAR FONT, STYLE, SIZE, OR COLOR.

PRIORITY DATE OF 3-30-2011 IS CLAIMED.

OWNER OF INTERNATIONAL REGISTRATION 1103054 DATED 9-6-2011, EXPIRES 9-6-2021.

OWNER OF U.S. REG. NOS. 1,201,185, 3,602,663 AND OTHERS.

THE ENGLISH TRANSLATION OF "FALKE" IS "FALCON".

FOR WHOLESALE AND RETAIL STORE SERVICES FEATURING SOAPS FOR COSMETIC PURPOSES, SOAPS FOR TEXTILES, PERFUMERIES, ETHEREAL OILS, PRODUCTS FOR PERSONAL HYGIENE AND BEAUTY, PRODUCTS TO CLEAN, CARE FOR AND BEAUTIFY THE SKIN, SCALP AND HAIR, TOILET ARTICLES, DEODORANTS FOR PERSONAL USE, PRE-SHAVE AND AFTER-SHAVE PRODUCTS, EYEGLASSES AND EYEGLASS FRAMES, JEWELLERY AND WATCHES, LEATHER AND IMITATIONS OF LEATHER, NAMELY, SUITCASES, BAGS, SMALL LEATHER ARTICLES INCLUDED, ESPECIALLY PURSES, WALLETS, KEY CASES UMBRELLAS AND SUNSHADES, SHOES, CLOTHING AND HEADGEAR, BELTS, SPORTS ARTICLES, GAMES AND TOYS (U.S. CLS. 100, 101 AND 102).

DAVID HOFFMAN, EXAMINING ATTORNEY

CLASS 35—(Continued).

SN 79-107,963. NORWOOD PROMOTIONAL PRODUCTS EUROPE S.L., SPAIN, FILED 9-12-2011.



PRIORITY DATE OF 6-14-2011 IS CLAIMED.
OWNER OF INTERNATIONAL REGISTRATION 1103787 DATED 9-12-2011, EXPIRES 9-12-2021.

NO CLAIM IS MADE TO THE EXCLUSIVE RIGHT TO USE "BRAND EXPO", APART FROM THE MARK AS SHOWN.

THE COLOR(S) BLACK AND GREY IS/ARE CLAIMED AS A FEATURE OF THE MARK.

THE MARK CONSISTS OF THE STYLIZED WORDING "BRAND EXPO" WITH "BRAND" IN GREY AND "EXPO" IN BLACK WITH A CURVED SQUARE IN GREY TO THE LEFT OF THE WORDING.

FOR ADVERTISING; BUSINESS MANAGEMENT; BUSINESS ADMINISTRATION; OFFICE FUNCTIONS; RETAIL STORES SERVICES, ONLINE RETAIL STORES SERVICES AND DISTRIBUTORSHIP SERVICES IN THE FIELD OF PRINTED PUBLICITY MATERIAL AND PROMOTIONAL PRODUCTS, NAMELY, SOAPS, PERFUMERY, ESSENTIAL OILS, COSMETICS, HAIR LOTIONS, DENTIFRICES, PHARMACEUTICAL PREPARATIONS SANITARY PREPARATIONS FOR MEDICAL PURPOSES, PLASTERS, MATERIALS FOR DRESSINGS, DENTAL WAX, DISINFECTANTS, IRON-MONGERY, SMALL ITEMS OF METAL HARDWARE, HAND TOOLS AND HAND OPERATED IMPLEMENTS, CUTLERY, RAZORS, APPARATUS FOR RECORDING, TRANSMISSION OR REPRODUCTION OF SOUND OR IMAGES, MAGNETIC DATA CARRIERS, RECORDING DISCS, CALCULATING MACHINES, DATA PROCESSING EQUIPMENT AND COMPUTERS, MEDICAL AND DENTAL APPARATUS AND INSTRUMENTS, APPARATUS FOR LIGHTING, HEATING, STEAM GENERATING, COOKING, REFRIGERATING, DRYING, VENTILATING, WATER SUPPLY AND SANITARY PURPOSES, FIREWORKS, JEWELLERY, PRECIOUS STONES, HOROLOGICAL AND CHRONOMETRIC INSTRUMENTS, MUSICAL INSTRUMENTS, PRINTED PAPER, PLASTIC, WOOD, CARDBOARD PRODUCTS, PHOTOGRAPHS, STATIONERY, ADHESIVES FOR STATIONERY OR HOUSEHOLD PURPOSES, ARTISTS' MATERIALS, TYPEWRITERS AND OFFICE REQUISITES, LEATHER AND IMITATIONS OF LEATHER, AND CLOTHING, LUGGAGE, HAND BAGS, SHOPPING BAGS, BRIEFCASES, WALLETS, BACKPACKS MADE OF THESE MATERIALS, TRUNKS AND TRAVELLING BAGS, BAGS, UMBRELLAS, FURNITURE, MIRRORS, PICTURE FRAMES, ORNAMENTS OF WOOD, CORK, REED, CANE, WICKER, HORN, BONE, IVORY, WHALE-BONE, SHELL, AMBER, MOTHER-OF-PEARL, MEERSCHAUM AND SUBSTITUTES FOR ALL THESE MATERIALS, OR OF PLASTICS, HOUSEHOLD OR KITCHEN UTENSILS AND CONTAINERS, INCLUDING PORTABLE BEVERAGE COOLERS, COMBS AND SPONGES, BRUSHES EXCEPT PAINT BRUSHES, ARTICLES FOR CLEANING PURPOSES, GLASSWARE, PORCELAIN AND EARTHENWARE, TEXTILES AND TEXTILE GOODS, BED AND TABLE COVERS, CLOTHING, FOOTWEAR, HEADGEAR, GAMES AND PLAY-THINGS, GYMNAS TIC AND SPORTING ARTICLES, DECORATIONS FOR CHRISTMAS TREES, SMOKERS' ARTICLES AND MATCHES (U.S. CLS. 100, 101 AND 102).

DOUGLAS LEE, EXAMINING ATTORNEY

CLASS 35—(Continued).

SN 85-193,297. ELECTRONIC ARTS INC., REDWOOD CITY, CA. FILED 12-8-2010.

ORIGIN

THE MARK CONSISTS OF STANDARD CHARACTERS WITHOUT CLAIM TO ANY PARTICULAR FONT, STYLE, SIZE, OR COLOR.

OWNER OF U.S. REG. NO. 2,523,085.

FOR ELECTRONIC COMMERCE SERVICES, NAMELY, PROVIDING INFORMATION ABOUT VIDEO GAME AND COMPUTER GAME SOFTWARE PRODUCTS VIA TELECOMMUNICATION NETWORKS FOR ADVERTISING AND SALES PURPOSES; ON-LINE RETAIL STORE SERVICES FEATURING VIDEO GAME AND COMPUTER GAME SOFTWARE PRODUCTS AND SERVICES (U.S. CLS. 100, 101 AND 102).

KRISTINA MORRIS, EXAMINING ATTORNEY

SN 85-213,252. WINKIT, LLC, STILLWATER, MN. FILED 1-7-2011.



THE COLOR(S) DARK GREEN, LIGHT GREEN, AND WHITE IS/ARE CLAIMED AS A FEATURE OF THE MARK.

THE MARK CONSISTS OF A DESIGN OF A GREEN SQUARE WITH ROUNDED CORNERS THAT IS SHADED FROM TOP TO MIDDLE IN DARK GREEN TO LIGHT GREEN, AND FROM MIDDLE TO BOTTOM IN DARK GREEN TO LIGHT GREEN. IN THE CENTER OF THE SQUARE IS A WHITE DESIGN RESEMBLING THE LETTER "W".

FOR ONLINE RETAIL STORE SERVICES FEATURING APPAREL, FOOTWEAR, ACCESSORIES IN THE NATURE OF JEWELRY, HOME GOODS AND BEAUTY PRODUCTS OF OTHERS AS THEY HAVE APPEARED ON TELEVISION, FILM OR ONLINE SOCIAL MEDIA BROADCASTS; ADVERTISING, MARKETING AND PROMOTING THE GOODS AND SERVICES OF OTHERS VIA TELEVISION, FILM, VIDEO, ONLINE AND ONLINE SOCIAL MEDIA; PROMOTING THE GOODS AND SERVICES OF OTHERS BY MEANS OF OPERATING AN ONLINE SHOPPING MALL WITH LINKS TO THE RETAIL WEB SITES OF OTHERS (U.S. CLS. 100, 101 AND 102).

KHANH LE, EXAMINING ATTORNEY

CLASS 35—(Continued).

SN 85-220,635. THE PLANNING SHOP INTERNATIONAL, INC., JAMISON, PA. FILED 1-19-2011.

GOALSTATES

THE MARK CONSISTS OF STANDARD CHARACTERS WITHOUT CLAIM TO ANY PARTICULAR FONT, STYLE, SIZE, OR COLOR.

FOR MARKETING AND ADVERTISING SERVICES; MARKETING AND ADVERTISING RESEARCH; CONSUMER RESEARCH AND MARKETING SERVICES, NAMELY, CONDUCTING MARKETING RESEARCH, MARKETING STUDIES, MARKETING ANALYSIS, CONDUCTING BRAND IDENTIFICATION SERVICES IN THE NATURE OF BRAND EVALUATION, BRAND RESEARCH, AND BRAND DEVELOPMENT, AND CONDUCTING BRAND AND MARKETING POSITIONING RESEARCH; AND RELATED SERVICES, NAMELY, ADVERTISING CONSULTATION, MARKETING CONSULTATION, CONSUMER MARKETING RESEARCH CONSULTATION (U.S. CLS. 100, 101 AND 102).
MARY CRAWFORD, EXAMINING ATTORNEY

CLASS 35—(Continued).

SN 85-229,167. EXCLUSIVE FABRICS & FURNISHINGS, LLC, PLEASANTON, CA. FILED 1-28-2011.



NO CLAIM IS MADE TO THE EXCLUSIVE RIGHT TO USE "HALF PRICE DRAPES", APART FROM THE MARK AS SHOWN.

THE MARK CONSISTS OF STYLIZED VINES ABOVE THE STYLIZED LETTERS "HPD" AND THE WORDS "HALF" AND "PRICE", AND "DRAPES" BELOW THE LETTERS, ALL APPEARING ON A SHADED RECTANGULAR BACKGROUND.

FOR ONLINE RETAIL STORE SERVICES FEATURING INTERIOR WINDOW COVERINGS, HARDWARE, AND ACCESSORIES (U.S. CLS. 100, 101 AND 102).
FIRST USE 5-0-2009; IN COMMERCE 5-0-2009.

KATHERINE CONNOLLY, EXAMINING ATTORNEY

SN 85-229,329. EXCLUSIVE FABRICS & FURNISHINGS, LLC, PLEASANTON, CA. FILED 1-28-2011.

SN 85-228,120. DINSMORE SIERRA, LLC, DBA CROWDBRITE, RENO, NV. FILED 1-27-2011.

REQUEST FOR GENIUS

THE MARK CONSISTS OF STANDARD CHARACTERS WITHOUT CLAIM TO ANY PARTICULAR FONT, STYLE, SIZE, OR COLOR.

FOR BUSINESS COLLABORATION SERVICES, NAMELY, PROVIDING A NETWORKING WEB SITE IN THE FIELD OF PLANNING AND LAND DEVELOPMENT FOR THE GOVERNMENT, DESIGNERS, ARCHITECTS, ENGINEERS, AND THE GENERAL PUBLIC TO COLLABORATE ACROSS DISCIPLINES TO CREATE ENVIRONMENTALLY FRIENDLY, SUSTAINABLE LAND USE DESIGNS RELATED TO A VARIETY OF PRIVATE AND PUBLIC PROJECTS (U.S. CLS. 100, 101 AND 102).
TEJBIR SINGH, EXAMINING ATTORNEY



NO CLAIM IS MADE TO THE EXCLUSIVE RIGHT TO USE "EXCLUSIVE FABRICS" AND "FURNISHINGS", APART FROM THE MARK AS SHOWN.

THE MARK CONSISTS OF THE WORDS "EXCLUSIVE" AND "FABRICS" AND "FURNISHINGS" WITH A STYLIZED AMPERSAND APPEARING BELOW THE TERM "FABRICS" AND ABOVE THE TERM "FURNISHINGS". THE AMPERSAND HAS A SHADED CIRCLE BEHIND IT, A STYLIZED UPSIDE DOWN LETTER "F" ON ITS LEFT SIDE AND A STYLIZED RIGHT SIDE UP LETTER "F" ON ITS RIGHT SIDE, ALL APPEARING ON A SHADED RECTANGULAR BACKGROUND.

FOR ONLINE WHOLESALE AND RETAIL STORE SERVICES FEATURING FABRICS, INTERIOR WINDOW COVERINGS, AND RELATED ACCESSORIES (U.S. CLS. 100, 101 AND 102).
FIRST USE 7-0-2007; IN COMMERCE 7-0-2007.

KATHERINE CONNOLLY, EXAMINING ATTORNEY

CLASS 35—(Continued).

SN 85-230,205. OPTIONSXPRESS HOLDINGS, INC., CHICAGO, IL. FILED 1-31-2011.

OXSOCIAL

THE MARK CONSISTS OF STANDARD CHARACTERS WITHOUT CLAIM TO ANY PARTICULAR FONT, STYLE, SIZE, OR COLOR.

OWNER OF U.S. REG. NO. 4,132,850.

THE WORD(S) "OX" OR "OXSOCIAL" HAS NO MEANING IN A FOREIGN LANGUAGE.

FOR PROVIDING BUSINESS INFORMATION TO EDUCATE PEOPLE IN THE FIELDS OF FINANCE AND SECURITIES TRADING AND PROVIDING FINANCIAL INDICES OF SELECT BONDS AND SECURITIES TO ENABLE CONSUMERS TO EVALUATE INVESTMENTS AND MARKET TRENDS IN THE BOND AND SECURITIES MARKET (U.S. CLS. 100, 101 AND 102).

FIRST USE 4-27-2011; IN COMMERCE 4-27-2011.

ELISSA GARBER KON, EXAMINING ATTORNEY

SN 85-236,393. BOUCHARD, PHILIP J, DBA TRUSTED PEER INC., SAN FRANCISCO, CA. FILED 2-8-2011.

TrustedPeer

THE MARK CONSISTS OF STANDARD CHARACTERS WITHOUT CLAIM TO ANY PARTICULAR FONT, STYLE, SIZE, OR COLOR.

FOR PROVIDING A WEBSITE FEATURING AN ONLINE MARKETPLACE FOR THE EXCHANGE OF THE SERVICES OF ACCOUNTING CONSULTING, ACQUISITION AND MERGER CONSULTING, ADVERTISING CONSULTING, MARKETING CONSULTING, PROMOTION CONSULTING, BRAND IMAGERY CONSULTING, BUSINESS ACQUISITION AND MERGER CONSULTING, COMMERCIAL CONSULTING, EMPLOYMENT RECRUITMENT CONSULTING, ENERGY EFFICIENCY CONSULTING, HUMAN RESOURCES CONSULTING, INTERNET MARKETING CONSULTING, INTELLECTUAL PROPERTY MANAGEMENT CONSULTING, PUBLICITY CONSULTING, FOREIGN TRADE CONSULTING, HUMAN RESOURCES CONSULTING, TAX CONSULTING, NEW BUSINESS VENTURE DEVELOPMENT AND FORMATION CONSULTING, PERSONNEL MANAGEMENT CONSULTING, AND PROCUREMENT CONSULTATION; PROVIDING ONLINE DATABASES FEATURING INFORMATION RELATING TO EMPLOYERS AND EMPLOYEES AND PLACES OF EMPLOYMENT (U.S. CLS. 100, 101 AND 102).

MICHAEL ENGEL, EXAMINING ATTORNEY

CLASS 35—(Continued).

SN 85-236,671. MAXPOINT INTERACTIVE, INC., CARY, NC. FILED 2-8-2011.

MAXPOINT

THE MARK CONSISTS OF STANDARD CHARACTERS WITHOUT CLAIM TO ANY PARTICULAR FONT, STYLE, SIZE, OR COLOR.

FOR ONLINE ADVERTISING SERVICES PROVIDED TO MEDIA BUYERS, NAMELY, DIGITAL MEDIA BUYING SERVICES IN THE NATURE OF IDENTIFYING IDEAL TARGET AUDIENCE FOR ONLINE ADVERTISING CAMPAIGNS (U.S. CLS. 100, 101 AND 102).

WENDY JUN, EXAMINING ATTORNEY

SN 85-245,099. VGM GROUP, INC., WATERLOO, IA. FILED 2-17-2011.



NO CLAIM IS MADE TO THE EXCLUSIVE RIGHT TO USE "ACCESSIBLE HOME IMPROVEMENT OF AMERICA", APART FROM THE MARK AS SHOWN.

THE MARK CONSISTS OF THE WORDS "ACCESSIBLE HOME", POSITIONED HORIZONTALLY IN BOLD-STYLED LETTERING. DIRECTLY BENEATH "ACCESSIBLE HOME" ARE THE WORDS "IMPROVEMENT OF AMERICA" IN SMALLER SIZED, BOLD-STYLED LETTERING. TO THE LEFT OF THE WORDS IS AN OUTLINE OF A HOUSE, WHICH CONSISTS OF TWO VERTICAL LINES TOPPED BY A ROOF. INSIDE THE HOUSE IS A STYLIZED SILHOUETTE OF A PERSON IN A WHEELCHAIR, FACING RIGHT. ALONG THE BOTTOM OF THE MARK, BEGINNING TO THE LEFT OF THE HOUSE AND EXTENDING BELOW THE HOUSE AND THE WORDS "IMPROVEMENT OF AMERICA", IS A SOLID LINE, VARYING IN THICKNESS, REPRESENTING THE GROUND.

FOR MEMBERSHIP CLUB SERVICES, NAMELY, PROVIDING DISCOUNTS ON GOODS AND SERVICES OF OTHERS TO MEMBERS WHO ARE PART OF A NETWORK OF INDEPENDENTLY OWNED AND OPERATED, CERTIFIED PROFESSIONALS AND CONTRACTORS WHO PROVIDE HOME MODIFICATIONS AND RELATED PRODUCTS AND SERVICES TO ENHANCE ACCESSIBILITY AND INDEPENDENT LIVING FOR THE ELDERLY AND DISABLED (U.S. CLS. 100, 101 AND 102).

FIRST USE 3-31-2009; IN COMMERCE 3-31-2009.

TINA MAI, EXAMINING ATTORNEY

CLASS 35—(Continued).

SN 85-246,594. RICHTER, HANS W., SAN RAFAEL, CA. FILED 2-18-2011.



NO CLAIM IS MADE TO THE EXCLUSIVE RIGHT TO USE "SAUSAGE GRILL", APART FROM THE MARK AS SHOWN.

THE NAME(S), PORTRAIT(S), AND/OR SIGNATURE(S) SHOWN IN THE MARK DOES NOT IDENTIFY A PARTICULAR LIVING INDIVIDUAL.

THE COLOR(S) RED, BLACK, YELLOW, WHITE IS/ARE CLAIMED AS A FEATURE OF THE MARK.

THE MARK CONSISTS OF A YELLOW RECTANGLE; RED LETTERING WITH WORDS "OSKAR'S SAUSAGE GRILL" APPEAR WITH BLACK SHADOWING; TO THE RIGHT OF THE TEXT APPEARS A WHITE CHEF'S HAT WITH A BLACK OUTLINE.

FOR CONCESSION STANDS FEATURING FOOD AND DRINKS; MOBILE STREET VENDOR SERVICES FEATURING FOOD AND DRINK; MOBILE VENDING IN THE FIELD OF FOOD AND DRINKS (U.S. CLS. 100, 101 AND 102).

JASON TURNER, EXAMINING ATTORNEY

CLASS 35—(Continued).

SN 85-251,603. METHODOLOGIE, INC., SEATTLE, WA. FILED 2-25-2011.

METHODOLOGIE

THE MARK CONSISTS OF STANDARD CHARACTERS WITHOUT CLAIM TO ANY PARTICULAR FONT, STYLE, SIZE, OR COLOR.

FOR CONSULTING SERVICES IN THE FIELDS OF BRAND AND COMMUNICATIONS STRATEGY AND GRAPHIC DESIGN, NAMELY, CREATING, DEVELOPING AND IMPLEMENTING BRANDS AND CORPORATE IDENTITY SYSTEMS, PRINTED AND ELECTRONIC COMMUNICATIONS, SIGNAGE, ADVERTISING, INTERACTIVE WEB SITES, KIOSKS, PRODUCT DEMONSTRATION AND TRAINING MODULES, MOBILE APPLICATIONS, AND, FOR CONSULTING SERVICES, GRAPHICS AND INTERACTIVE COMMUNICATIONS IN THE FIELDS OF CORPORATE SOCIAL RESPONSIBILITY, MARKETING AND INVESTOR COMMUNICATIONS (U.S. CLS. 100, 101 AND 102).

FIRST USE 10-1-1999; IN COMMERCE 10-1-1999.

FRED CARL, EXAMINING ATTORNEY

SN 85-316,569. DUSSICH, GEORGE, MERRITTE ISLAND, FL. FILED 5-10-2011.

SN 85-246,636. MAXPOINT INTERACTIVE, INC., CARY, NC. FILED 2-18-2011.

MAXPOINT INTERACTIVE



THE MARK CONSISTS OF STANDARD CHARACTERS WITHOUT CLAIM TO ANY PARTICULAR FONT, STYLE, SIZE, OR COLOR.

NO CLAIM IS MADE TO THE EXCLUSIVE RIGHT TO USE "INTERACTIVE", APART FROM THE MARK AS SHOWN.

FOR ONLINE ADVERTISING SERVICES PROVIDED TO MEDIA BUYERS, NAMELY, DIGITAL MEDIA BUYING SERVICES IN THE NATURE OF IDENTIFYING IDEAL TARGET AUDIENCE FOR ONLINE ADVERTISING CAMPAIGNS (U.S. CLS. 100, 101 AND 102).

WENDY JUN, EXAMINING ATTORNEY

NO CLAIM IS MADE TO THE EXCLUSIVE RIGHT TO USE "STORM WATER FILTER", APART FROM THE MARK AS SHOWN.

THE COLOR(S) GRAY, GREEN, YELLOW, BLUE, BLACK AND WHITE IS/ARE CLAIMED AS A FEATURE OF THE MARK.

THE MARK CONSISTS OF A GREEN STYLIZED FISH WITH BLUE FINS, BLUE TAIL, AND YELLOW LIPS, BLACK AND WHITE EYES AND BLACK EYEBROWS. THE FISH IS HUGGING A WHITE JAR WITH A BLACK

CLASS 35—(Continued).

STRIPE ACROSS THE TOP. THE JAR IS OUTLINED IN GRAY AND BLACK. BELOW THE BLACK LINE ARE THE BLACK LETTERS "ESI" ABOVE THE BLACK WORDS "STORM WATER" ABOVE THE BLACK WORD "FILTER". BELOW THE WORD "FILTER" IS A STYLIZED IMAGE OF A CIRCLE OUTLINED IN BLACK AND WHITE WITH THE TOP HALF BLUE AND BOTTOM HALF GREEN. BELOW THE JAR ARE THE BLACK WORDS "YOUR COMMUNITY", ABOVE THE BLACK WORDS "OUR COMMITMENT", IN STYLIZED FONT.

FOR PROMOTING PUBLIC AWARENESS OF ENVIRONMENTALLY FRIENDLY RESTAURANTS, BARS, HOTELS, MOTELS, EXERCISE ESTABLISHMENTS, HOSPITAL AND MEDICAL CENTERS, LIBRARIES, SCHOOLS AND UNIVERSITIES, BANKS, SPORTS COMPLEXES, MANUFACTURING FACILITIES, PAINT COMPANIES AND STORES, INSECTICIDE AND FERTILIZER SALES AND APPLICATIONS FACILITIES, NEWS PAPER PRINTING FACILITIES, CRUISE SHIP TERMINALS, AIRPORTS, PARKING TERMINALS, AUTO REPAIR AND OIL CHANGE FACILITIES, GAS STATION, MALL GROCERY STORE AND SHOPPING CENTER PARKING LOTS, AND GOVERNMENT BUILDING COMPLEXES (U.S. CLS. 100, 101 AND 102).

HOWARD B. LEVINE, EXAMINING ATTORNEY

SN 85-319,297. CH INTERNATIONAL TRADING CORP., STATEN ISLAND, NY. FILED 5-12-2011.

創意電器

NO CLAIM IS MADE TO THE EXCLUSIVE RIGHT TO USE "THE NON-LATIN CHARACTERS THAT TRANSLITERATE TO DIAN QI AND TRANSLATE INTO ENGLISH AS ELECTRIC APPLIANCES", APART FROM THE MARK AS SHOWN.

THE COLOR(S) RED IS/ARE CLAIMED AS A FEATURE OF THE MARK.

THE MARK CONSISTS OF CHINESE CHARACTERS, WHICH TRANSLATE TO CREATIVE IDEA APPLIANCES, APPEARING IN RED.

THE NON-LATIN CHARACTERS IN THE MARK TRANSLITERATE TO CHUANG YI DIAN QI AND THIS MEANS CREATIVE IDEA ELECTRIC APPLIANCES IN ENGLISH.

FOR WHOLESALE AND RETAIL STORE SERVICES FEATURING APPLIANCES (U.S. CLS. 100, 101 AND 102).

NAKWAMA ANKRAH, EXAMINING ATTORNEY

CLASS 35—(Continued).

SN 85-321,748. COOKING MATTERS, LLC, NASHUA, NH. FILED 5-16-2011.

Cooking Matters

THE MARK CONSISTS OF STANDARD CHARACTERS WITHOUT CLAIM TO ANY PARTICULAR FONT, STYLE, SIZE, OR COLOR.

NO CLAIM IS MADE TO THE EXCLUSIVE RIGHT TO USE "COOKING", APART FROM THE MARK AS SHOWN.

FOR RETAIL STORE SERVICES FEATURING GOURMET FOODS, SPECIALTY FOODS, IN-STORE PREPARED FOODS AND KITCHENWARE ITEMS (U.S. CLS. 100, 101 AND 102).

FIRST USE 11-14-2002; IN COMMERCE 4-21-2003.
MATTHEW EINSTEIN, EXAMINING ATTORNEY

SN 85-322,945. AVADO, INC., BELLEVUE, WA, WA. FILED 5-17-2011.

avado

THE MARK CONSISTS OF STANDARD CHARACTERS WITHOUT CLAIM TO ANY PARTICULAR FONT, STYLE, SIZE, OR COLOR.

FOR ELECTRONIC DATA COLLECTION AND DATA SUBMISSION SERVICES FOR BUSINESS PURPOSES IN THE FIELDS OF MEDICINE AND HEALTHCARE (U.S. CLS. 100, 101 AND 102).

FIRST USE 4-30-2011; IN COMMERCE 4-30-2011.
SANI KHOURI, EXAMINING ATTORNEY

SN 85-323,061. THE CHURCHPLAZA COMPANIES, INC., SARASOTA, FL. FILED 5-17-2011.

ChurchPlaza

THE MARK CONSISTS OF STANDARD CHARACTERS WITHOUT CLAIM TO ANY PARTICULAR FONT, STYLE, SIZE, OR COLOR.

OWNER OF U.S. REG. NO. 2,555,356.

FOR RETAIL SERVICES BY DIRECT SOLICITATION BY SALES AGENTS FEATURING CHURCH CHAIRS, PULPITS, FOLDING FURNITURE, NAMELY, FOLDING CHAIRS AND FOLDING TABLES, AND RELATED PRODUCTS, NAMELY, WOOD COMMUNION TABLES, WOOD PULPIT CHAIRS, CHANCEL FURNITURE, TITHE BOXES, AND SIGNS (U.S. CLS. 100, 101 AND 102).

FONG HSU, EXAMINING ATTORNEY

CLASS 35—(Continued).

SN 85-323,066. THE CHURCHPLAZA COMPANIES, INC., SARASOTA, FL. FILED 5-17-2011.



THE MARK CONSISTS OF A CHURCH STEEPLE DESIGN. THE BLACK BACKGROUND IS NOT PART OF THE MARK.

FOR RETAIL SERVICES BY DIRECT SOLICITATION BY SALES AGENTS FEATURING CHURCH CHAIRS, PULPITS, FOLDING FURNITURE, NAMELY, FOLDING CHAIRS AND FOLDING TABLES, AND RELATED PRODUCTS, NAMELY, WOOD COMMUNION TABLES, WOOD PULPIT CHAIRS, CHANCEL FURNITURE, TITHE BOXES, AND SIGNS (U.S. CLS. 100, 101 AND 102).
FONG HSU, EXAMINING ATTORNEY

SN 85-327,210. POINT 2 RUNNING, LLC, NEWPORT NEWS, VA. FILED 5-23-2011.

Point2 Running Company

THE MARK CONSISTS OF STANDARD CHARACTERS WITHOUT CLAIM TO ANY PARTICULAR FONT, STYLE, SIZE, OR COLOR.

NO CLAIM IS MADE TO THE EXCLUSIVE RIGHT TO USE "RUNNING COMPANY", APART FROM THE MARK AS SHOWN.

FOR RETAIL STORE SERVICES FEATURING FOOTWEAR, TOPS, BOTTOMS, JACKETS, SWEATERS, GLOVES, SHORTS, SHIRTS, TANK-TOPS, SOCKS, SWEAT BANDS, UNDERWEAR, BRAS, PANTS, HEADGEAR IN THE NATURE OF HATS, CAPS, VISORS, HEADBANDS, AND BANDANNAS, SWIMWEAR, WATER BOTTLES, ENERGY DRINKS, ENERGY BARS, ENERGY GELS, WATCHES, SUNGLASSES, AND SPORTING GOODS (U.S. CLS. 100, 101 AND 102).

FIRST USE 5-16-2011; IN COMMERCE 5-16-2011.
SUNG IN, EXAMINING ATTORNEY

CLASS 35—(Continued).

SN 85-329,854. BOBO MARKET, INC., BROOKLYN, NY. FILED 5-25-2011.



THE COLOR(S) BLUE, RED, GOLD AND WHITE IS/ARE CLAIMED AS A FEATURE OF THE MARK.

THE MARK CONSISTS OF THE WORD "BOBO", WHICH FIRST APPEARS IN ALL CAPITAL LETTERS, IN "ADOBE GARAMOND PRO BOLD" FONT, IN TECHNORATI BLUE COLOR, FOLLOWED BY A RED PAINT SPLASH. AFTER THE RED SPLASH, AND CONNECTED TO THE RED SPLASH, IS A BALL. THE BALL IS SIMILAR IN APPEARANCE TO A SOCCER BALL. THE BALL CONSISTS OF 4 EQUAL SIZED RED SEMI-CIRCLES APPEARING AROUND THE OUTSIDE OF THE BALL, AND A CURVED GOLD DIAMOND IN THE CENTER OF THE BALL. HOWEVER, THE OUTER EDGE OF EACH SEMI-CIRCLE WHICH WOULD NORMALLY BE STRAIGHT, IS CONVEX RATHER THAN STRAIGHT. THE FOUR SEMI-CIRCLES MAKE THE ROUND OUTER OUTLINE OF THE BALL. THE INSIDE OF THE BALL IS A GOLD DIAMOND WITH OUTER EDGES OF THE DIAMOND CURVING SLIGHTLY INWARD (CONCAVE RATHER THAN STRAIGHT). A THIN WHITE OUTLINE IN THE SHAPE OF THE CONCAVE DIAMOND, APPEARS AROUND THE GOLD CONCAVE DIAMOND, OUTLINING THE GOLD DIAMOND, HOWEVER, EACH POINT OF THE WHITE OUTLINE, RATHER THAN STOPPING AT THE END POINTS OF THE DIAMOND, RUNS TO THE OUTER EDGE OF THE BALL, THUS SEPARATING EACH RED SEMI-CIRCLE IN THE BALL.

THE ENGLISH TRANSLATION OF "BOBO" IN THE MARK IS "PRECIOUS PRECIOUS".

FOR EXPORT AND IMPORT AGENCIES (U.S. CLS. 100, 101 AND 102).

FIRST USE 2-2-2007; IN COMMERCE 2-2-2007.
CIMMERIAN COLEMAN, EXAMINING ATTORNEY

SN 85-330,333. MORRIS FURNITURE CO., INC., DBA MORRIS HOME FURNISHINGS, FAIRBORN, OH. FILED 5-25-2011.

THE BETTER SLEEP SHOP

THE MARK CONSISTS OF STANDARD CHARACTERS WITHOUT CLAIM TO ANY PARTICULAR FONT, STYLE, SIZE, OR COLOR.

NO CLAIM IS MADE TO THE EXCLUSIVE RIGHT TO USE "SHOP", APART FROM THE MARK AS SHOWN.

FOR RETAIL STORE SERVICES FEATURING FURNITURE, MATTRESSES, BEDDING AND ACCESSORIES, AND PROVIDING CONSUMER ADVICE RELATING TO THE FOREGOING; ON-LINE RETAIL STORE SERVICES FEATURING FURNITURE, MATTRESSES, BEDDING AND ACCESSORIES, AND PROVIDING CONSUMER ADVICE RELATING TO THE FOREGOING (U.S. CLS. 100, 101 AND 102).

FIRST USE 0-0-2008; IN COMMERCE 0-0-2008.
KAELIE KUNG, EXAMINING ATTORNEY

CLASS 35—(Continued).

SN 85-331,578. MSS MEDIA, AKA UNIVERSITY ADVERTISING, MIAMI, FL. FILED 5-26-2011.

MSS media

THE MARK CONSISTS OF STANDARD CHARACTERS WITHOUT CLAIM TO ANY PARTICULAR FONT, STYLE, SIZE, OR COLOR.

NO CLAIM IS MADE TO THE EXCLUSIVE RIGHT TO USE "MEDIA", APART FROM THE MARK AS SHOWN.

FOR OUT-OF-HOME ADVERTISING SERVICES, NAMELY, RENTAL OF ADVERTISING SPACE, AND PREPARING AND PLACING ADVERTISEMENTS FOR OTHERS; PROVIDING ADVERTISING SPACE ON BILLBOARDS AND IN KIOSKS; PROVIDING ADVERTISING SPACE ON FREE-STANDING VISUAL ADVERTISING SYSTEMS FEATURING THE GOODS AND SERVICES OF OTHERS; PROVIDING ADVERTISING, MARKETING AND PROMOTIONAL SERVICES, NAMELY, DEVELOPMENT OF ADVERTISING CAMPAIGNS PROVIDED THROUGH CABLE TELEVISION BROADCAST, WEB CASTS, RADIO BROADCASTS, NEWSPAPERS, MAGAZINES, ONLINE BANNERS, OUTDOOR BILLBOARDS, WILD POSTINGS, BUS AND SUBWAY ADS (U.S. CLS. 100, 101 AND 102).

FIRST USE 1-1-2006; IN COMMERCE 1-1-2006.
B. PARADEWELAI, EXAMINING ATTORNEY

SN 85-339,018. PREMIER SPECIALTY NETWORK, COLUMBIA, MO. FILED 6-6-2011.



NO CLAIM IS MADE TO THE EXCLUSIVE RIGHT TO USE "NETWORK", APART FROM THE MARK AS SHOWN. THE COLOR(S) GREEN, BLUE, YELLOW AND WHITE IS/ARE CLAIMED AS A FEATURE OF THE MARK.

THE MARK CONSISTS OF THE WORDING "PREMIER SPECIALTY NETWORK" IN BLUE WITH A BLUE UNDERLINE. TO THE LEFT OF THE WORDING IS A CROSS THAT IS YELLOW IN THE UPPER LEFT THIRD, THEN GREEN IN THE MIDDLE, AND BLUE ON THE BOTTOM THIRD. INSIDE THE CROSS ARE THE LETTERS "PSN" IN WHITE. SEC. 2(F) AS TO "PREMIER SPECIALTY NETWORK".

FOR PROVIDING HOSPITAL AND HEALTH CARE SERVICES TO RURAL HEALTHCARE SYSTEMS AND CRITICAL ACCESS HOSPITALS, NAMELY, HOSPITAL MANAGEMENT AND MANAGEMENT OF HEALTH CARE CLINICS FOR OTHERS; MANAGING A RELATIONSHIP BETWEEN MEDICAL AND SURGICAL PHYSICIANS AND RURAL HEALTHCARE SYSTEMS AND CRITICAL ACCESS HOSPITALS, NAMELY, HEALTHCARE MANAGEMENT SERVICE ORGANIZATION (MSO) SERVICES, NAMELY, PROVIDING PRACTICE ORGANIZATION, MANAGEMENT AND ADMINISTRATIVE SUPPORT SERVICES TO INDIVIDUAL PHYSICIANS OR SMALL GROUP PRACTICES; PROVIDING ONLINE DIRECTORY OF MEDICAL AND SURGICAL PHYSICIANS AVAILABLE TO RURAL HEALTHCARE SYSTEMS AND CRITICAL ACCESS HOSPITALS (U.S. CLS. 100, 101 AND 102).

FIRST USE 11-1-2011; IN COMMERCE 11-1-2011.
LINDSEY RUBIN, EXAMINING ATTORNEY

CLASS 35—(Continued).

SN 85-344,540. TEAM FAIRFAX 2013, FAIRFAX, VA. FILED 6-13-2011.



THE MARK CONSISTS OF THE HEAD OF AN EAGLE WHERE THE EYE IS DEPICTED BY A STAR.

FOR ADVERTISING THE GOODS AND SERVICES OF OTHERS THROUGH PROMOTIONS INVOLVING SELECTION FOR AND PARTICIPATION WITH A TEAM FOR AN ELITE ATHLETIC EVENT; ADMINISTRATION OF A DISCOUNT PROGRAM FOR ENABLING MEMBER PARTICIPANTS TO OBTAIN DISCOUNTS FOR THE GOODS AND SERVICES OF OTHERS THROUGH USE OF A DISCOUNT MEMBERSHIP CARD; RETAIL STORE SERVICES, MAIL ORDER AND ON-LINE CATALOG SERVICES FEATURING A WIDE VARIETY OF MERCHANDISE; PROMOTING THE GOODS AND SERVICES OF OTHERS BY ARRANGING FOR SPONSORS TO AFFILIATE THEIR GOODS AND SERVICES WITH SPORT EVENTS AND SPORTS ORGANIZATIONS (U.S. CLS. 100, 101 AND 102).

JOSETTE BEVERLY, EXAMINING ATTORNEY

SN 85-348,990. DEAL FRENZY, INC., MARKHAM, ONTARIO, CANADA, FILED 6-17-2011.



THE MARK CONSISTS OF "DEALFRENZY" WITH A CIRCLE ABOVE "FRENZY" CONTAINING A HAND AND FINGERS FORMING THE THUMBS UP.

FOR PROMOTING THE GOODS AND SERVICES OF OTHERS BY PROVIDING A WEBSITE FEATURING COUPONS, REBATES, PRICE-COMPARISON INFORMATION, PRODUCT REVIEWS, LINKS TO THE RETAIL WEBSITES OF OTHERS, AND DISCOUNT INFORMATION (U.S. CLS. 100, 101 AND 102).

BILL DAWE, EXAMINING ATTORNEY

CLASS 35—(Continued).

SN 85-351,210. BIGMOUTH LLC, SAN FRANCISCO, CA. FILED 6-21-2011.

BIGMOUTH

THE MARK CONSISTS OF STANDARD CHARACTERS WITHOUT CLAIM TO ANY PARTICULAR FONT, STYLE, SIZE, OR COLOR.

FOR ADVERTISING AND BRANDING CONSULTANCY, NAMELY, CONDUCTING BUSINESS RESEARCH AND BUSINESS STRATEGY DEVELOPMENT TO DEFINE AND GROW BRANDS OF OTHERS (U.S. CLS. 100, 101 AND 102).

FIRST USE 10-1-1994; IN COMMERCE 5-1-1999.
LEIGH LOWRY, EXAMINING ATTORNEY

SN 85-351,290. MDG, INC., HOLLISTON, MA. FILED 6-21-2011.

MDG

THE MARK CONSISTS OF STANDARD CHARACTERS WITHOUT CLAIM TO ANY PARTICULAR FONT, STYLE, SIZE, OR COLOR.

FOR BRANDING SERVICES, NAMELY, CONSULTING, DEVELOPMENT, MANAGEMENT AND MARKETING OF CONSUMER BRANDS FOR BUSINESSES, OTHER THAN IN THE FIELD OF MEDICINE OR PROVIDED TO MEDICAL SERVICE PROVIDERS OR MEDICAL PRODUCT MANUFACTURERS (U.S. CLS. 100, 101 AND 102).

FIRST USE 6-23-2004; IN COMMERCE 12-31-2004.
RON FAIRBANKS, EXAMINING ATTORNEY

SN 85-351,335. HOMEVESTORS OF AMERICA, INC., DALLAS, TX. FILED 6-21-2011.



NO CLAIM IS MADE TO THE EXCLUSIVE RIGHT TO USE "MARKETING SERVICES", APART FROM THE MARK AS SHOWN.

THE COLOR(S) WHITE, RED, AQUA GREEN AND BLACK IS/ARE CLAIMED AS A FEATURE OF THE MARK. THE MARK CONSISTS OF THE WORD "ADVESTORS" APPEARING OVER THE TERMS "HVA MARKETING SERVICES". THE FIRST TWO LETTERS OF "ADVESTORS"

CLASS 35—(Continued).

, NAMELY, "AD", APPEAR AS WHITE LETTERS INSIDE A RED HOUSE-SHAPED DESIGN. THE "A" AND "D" ARE BOTH CAPITAL LETTERS WITH THE LETTER "A" APPEARING IN A LARGER FONT SIZE THAN THE LETTER "D". THE REMAINING LETTERS OF THE TERM "ADVESTORS", NAMELY, "VESTORS", APPEAR IN AN AQUA GREEN COLOR WITH THE LETTER "V" APPEARING IN A LARGER FONT SIZE THAN THE REMAINING LETTERS. THE TERMS "HVA MARKETING SERVICES" APPEAR IN ALL CAPITAL LETTERS AND ARE BLACK IN COLOR.

FOR ADVERTISING SERVICES (U.S. CLS. 100, 101 AND 102).

LINDA MICKLEBURGH, EXAMINING ATTORNEY

SN 85-352,020. ALLPACK ASSEMBLY, INC., DBA ALLPACK FULFILLMENT, DURHAM, NC. FILED 6-21-2011.

ALLPACK FULFILLMENT

THE MARK CONSISTS OF STANDARD CHARACTERS WITHOUT CLAIM TO ANY PARTICULAR FONT, STYLE, SIZE, OR COLOR.

NO CLAIM IS MADE TO THE EXCLUSIVE RIGHT TO USE "FULFILLMENT", APART FROM THE MARK AS SHOWN.

FOR PROVIDING ORDER FULFILLMENT; PROVIDING ORDER MANAGEMENT, NAMELY, ELECTRONIC PROCESSING OF ORDERS FOR OTHERS; INVENTORY MANAGEMENT (U.S. CLS. 100, 101 AND 102).

FIRST USE 9-15-2008; IN COMMERCE 9-15-2008.
JENNIFER WILLISTON, EXAMINING ATTORNEY

SN 85-352,071. ALLPACK ASSEMBLY, INC., DBA ALLPACK, DURHAM, NC. FILED 6-21-2011.



THE MARK CONSISTS OF THE WRITTEN UNDERLINED TEXT "ALLPACK" PLUS THE DESIGN OF A PACKAGE/BOX CONTAINING THE IMAGE OF AN ALPACA.

FOR PROVIDING ORDER FULFILLMENT; PROVIDING ORDER MANAGEMENT, NAMELY, ELECTRONIC PROCESSING OF ORDERS FOR OTHERS; INVENTORY MANAGEMENT (U.S. CLS. 100, 101 AND 102).

FIRST USE 3-2-2005; IN COMMERCE 3-2-2005.
JENNIFER WILLISTON, EXAMINING ATTORNEY

CLASS 35—(Continued).

SN 85-356,021. CENTSABLE MOMMA LLC, LIVONIA, MI. FILED 6-24-2011.

"CENTS"ABLE MOMMA

THE MARK CONSISTS OF STANDARD CHARACTERS WITHOUT CLAIM TO ANY PARTICULAR FONT, STYLE, SIZE, OR COLOR.

FOR PROMOTING THE GOODS AND SERVICES OF OTHERS BY PROVIDING A WEBSITE FEATURING COUPONS, REBATES, VOUCHERS AND SPECIAL OFFERS FOR THE GOODS AND SERVICES OF OTHERS (U.S. CLS. 100, 101 AND 102).

FIRST USE 9-0-2008; IN COMMERCE 9-0-2008.
SUSAN STIGLITZ, EXAMINING ATTORNEY

SN 85-356,841. WAY TO BE DESIGNS, LLC, HAYWARD, CA. FILED 6-27-2011.

FRESH FASHIONS AND MORE

THE MARK CONSISTS OF STANDARD CHARACTERS WITHOUT CLAIM TO ANY PARTICULAR FONT, STYLE, SIZE, OR COLOR.

NO CLAIM IS MADE TO THE EXCLUSIVE RIGHT TO USE "FASHIONS", APART FROM THE MARK AS SHOWN.

FOR CATALOG ORDERING SERVICE FEATURING APPAREL, GIFT ITEMS, CORPORATE BRANDED AND LOGO MERCHANDISE (U.S. CLS. 100, 101 AND 102).

FIRST USE 1-1-2000; IN COMMERCE 1-1-2000.
LINDA M. KING, EXAMINING ATTORNEY

SN 85-358,555. ROI VENTURES, LLC, CHICAGO, IL. FILED 6-28-2011.

Theory of Radiating Impact

THE MARK CONSISTS OF STANDARD CHARACTERS WITHOUT CLAIM TO ANY PARTICULAR FONT, STYLE, SIZE, OR COLOR.

NO CLAIM IS MADE TO THE EXCLUSIVE RIGHT TO USE "THEORY", APART FROM THE MARK AS SHOWN.

FOR BUSINESS CONSULTING SERVICES, NAMELY, CONSULTING BUSINESSES AND ENTREPRENEURS TO DEVELOP AND LAUNCH BUSINESS VENTURES, IDEAS, PRODUCTS AND SERVICES IN NON-PROFIT AND FOR-PROFIT ORGANIZATIONS (U.S. CLS. 100, 101 AND 102).

TIMOTHY FINNEGAN, EXAMINING ATTORNEY

CLASS 35—(Continued).

SN 85-359,753. NOVANTAS, LLC, NEW YORK, NY. FILED 6-29-2011.



OWNER OF U.S. REG. NOS. 3,605,284 AND 3,726,420.
THE COLOR(S) GOLD, DARK BLUE AND LIGHT BLUE IS/ARE CLAIMED AS A FEATURE OF THE MARK.

THE MARK CONSISTS OF A GOLD "RAMS HORN" FOLLOWED BY THE WORD "STRATA" IN DARK BLUE BOLD CAPITAL LETTERS AND THE WORD "SCAPE" IN NON-BOLD LIGHT BLUE CAPITAL LETTERS.

FOR BUSINESS ADVISORY, CONSULTING AND INFORMATION SERVICES IN THE FIELD OF STRATEGY, MARKETING, SALES, OPERATION, AND NETWORK DESIGN TAILORED TO THE FINANCIAL SERVICES INDUSTRY SPECIALIZING IN THE USE OF ANALYTIC AND STATISTICAL MODELS FOR THE UNDERSTANDING AND PRIORITIZATION OF MARKET OPPORTUNITIES (U.S. CLS. 100, 101 AND 102).

FIRST USE 1-1-2010; IN COMMERCE 1-1-2010.
KATHERINE E. HALMEN, EXAMINING ATTORNEY

SN 85-360,686. SALVATORE RONDINELLI, NEW PALTZ, NY. FILED 6-30-2011.

www.BestofNewPaltz.com

THE MARK CONSISTS OF STANDARD CHARACTERS WITHOUT CLAIM TO ANY PARTICULAR FONT, STYLE, SIZE, OR COLOR.

FOR ADVERTISING AND DIRECTORY SERVICES, NAMELY, PROMOTING THE SERVICES OF OTHERS BY PROVIDING A WEB PAGE FEATURING LINKS TO THE WEBSITES OF OTHERS; ADVERTISING SERVICES, NAMELY, PROMOTING AND MARKETING THE GOODS AND SERVICES OF OTHERS IN THE FIELD OF RESTAURANTS VIA PRINT AND ELECTRONIC MEDIA; CONVENTION AND VISITORS BUREAU SERVICES, NAMELY, PROMOTING BUSINESS AND TOURISM IN THE NEW PALTZ NY AREA AND HUDSON VALLEY AREA OF NY STATE AREA; ORGANIZING, PROMOTING AND CONDUCTING EXHIBITIONS AND TRADE SHOWS FOR BUSINESS PURPOSES FEATURING BOOTHS AND DISPLAYS RELATING TO ANTIQUES AND COLLECTIBLES; PROMOTING TOURISM IN NEW PALTZ NY AREA AND HUDSON VALLEY AREA OF NY STATE AREA; PROMOTING, ADVERTISING AND MARKETING OF THE BRANDS, PRODUCTS, SERVICES AND ONLINE WEBSITES OF INDIVIDUALS, BUSINESSES AND NONPROFIT ORGANIZATIONS; PROMOTIONAL SERVICES, NAMELY, PROMOTING THE GOODS OF OTHERS BY MEANS OF PROVIDING ONLINE RESTAURANT MENUS; RETAIL APPAREL STORES (U.S. CLS. 100, 101 AND 102).

SAMUEL E. SHARPER JR., EXAMINING ATTORNEY

CLASS 35—(Continued).

SN 85-363,727. NOSHPLANET PTY LTD, GEELONG, VIC 3220, AUSTRALIA, FILED 7-6-2011.

NoshPlanet

THE MARK CONSISTS OF STANDARD CHARACTERS WITHOUT CLAIM TO ANY PARTICULAR FONT, STYLE, SIZE, OR COLOR.

PRIORITY CLAIMED UNDER SEC. 44(D) ON AUSTRALIA APPLICATION NO. 15004469, FILED 7-6-2011, REG. NO. 1435236, DATED 5-17-2012, EXPIRES 7-6-2021.

FOR PROVIDING A SEARCHABLE ONLINE ADVERTISING INFORMATIONAL REFERRAL DINING GUIDE FEATURING THE FOOD PRODUCTS AND DINING SERVICES OF OTHER VENDORS VIA THE INTERNET FOR USERS OF COMPUTERS AND MOBILE DEVICES (U.S. CLS. 100, 101 AND 102).

SIMON TENG, EXAMINING ATTORNEY

SN 85-369,792. BERNARD, NATHAN L, DBA UNDENEYEABLE, SAINT PETERS, MO. FILED 7-13-2011.

Undeneyeable

THE MARK CONSISTS OF STANDARD CHARACTERS WITHOUT CLAIM TO ANY PARTICULAR FONT, STYLE, SIZE, OR COLOR.

FOR MUSIC SALES PROMOTION SERVICES; SALES PROMOTION SERVICES (U.S. CLS. 100, 101 AND 102).

MAYUR VAGHANI, EXAMINING ATTORNEY

SN 85-370,210. SCIENCEWORKS INTERNATIONAL, LLC, WASHINGTON, DC. FILED 7-13-2011.

ScienceWorks

THE COLOR(S) RED IS/ARE CLAIMED AS A FEATURE OF THE MARK.

THE MARK CONSISTS OF THE WORD "SCIENCEWORKS" IN THE COLOR RED WITH THE "I" BEING A HALF FILLED TEST TUBE WITH FOUR SOLID RED CIRCLE BUBBLES AS DOTS ABOVE THE "I"; THE "W" IN "WORKS" IS CAPITALIZED; THE WORD "SCIENCEWORKS" IS UNDERLINED WITH A RED LINE.

FOR BUSINESS CONSULTATION IN THE FIELD OF SCIENTIFIC AND ENGINEERING RESEARCH AND EDUCATION (U.S. CLS. 100, 101 AND 102).

FIRST USE 5-15-2011; IN COMMERCE 11-4-2011.

RICHARD WHITE, EXAMINING ATTORNEY

CLASS 35—(Continued).

SN 85-370,275. ZT WEALTH, INC., PEARLAND, TX. FILED 7-13-2011.



NO CLAIM IS MADE TO THE EXCLUSIVE RIGHT TO USE "HEALTHCARE MANAGEMENT SERVICES", APART FROM THE MARK AS SHOWN.

THE COLOR(S) GOLD, YELLOW AND DARK PURPLE IS/ARE CLAIMED AS A FEATURE OF THE MARK.

THE MARK CONSISTS OF A CHEVRON WITH A RIGHT YELLOW SIDE AND A LEFT GOLD SIDE, "ALTUS" IN DARK PURPLE AND "HEALTHCARE MANAGEMENT SERVICES" IN GOLD. THE "A" IN "ALTUS" IS STYLIZED. THE CHEVRON IS LOCATED ABOVE "ALTUS" AND "ALTUS" IS LOCATED ABOVE "HEALTHCARE MANAGEMENT SERVICES".

FOR HEALTHCARE MANAGEMENT SERVICE ORGANIZATION (MSO) SERVICES, NAMELY, PROVIDING PRACTICE ORGANIZATION, MANAGEMENT AND ADMINISTRATIVE SUPPORT SERVICES TO INDIVIDUAL PHYSICIANS OR SMALL GROUP PRACTICES; HOSPITAL MANAGEMENT; HOSPITAL ADMINISTRATION SERVICES (U.S. CLS. 100, 101 AND 102).

FIRST USE 6-30-2010; IN COMMERCE 6-30-2010.

ALEX KEAM, EXAMINING ATTORNEY

SN 85-375,998. THE CHEFS' WAREHOUSE, RIDGEFIELD, CT. FILED 7-20-2011.



THE MARK CONSISTS OF THE LETTER "C" PARTIALLY ENCLOSING A SMALLER LETTER "W".

SEC. 2(F).

FOR WHOLESALE DISTRIBUTORSHIPS FEATURING FOOD AND FOOD INGREDIENTS (U.S. CLS. 100, 101 AND 102).

FIRST USE 12-1-1997; IN COMMERCE 12-1-1997.

ALYSSA STEEL, EXAMINING ATTORNEY

CLASS 35—(Continued).

SN 85-378,329. COMADRE COMMERCE LLC, COPPELL, TX. FILED 7-22-2011.



THE COLOR(S) MAROON AND BROWN IS/ARE CLAIMED AS A FEATURE OF THE MARK.

THE MARK CONSISTS OF STYLIZED WORD "COMADRE" IS IN MAROON AND THE "O" FOR "COMADRE" IS DESIGNED AS A CUP WITH STEAM EMANATING FROM THE CUP DESIGNED IN A CONCENTRIC CIRCLE DEPICTED IN THE COLOR BROWN.

THE ENGLISH TRANSLATION OF "COMADRE" IN THE MARK IS "GODMOTHER".

FOR COMPUTERIZED ON-LINE RETAIL STORE SERVICES IN THE FIELD OF GENERAL MERCHANDISE; PROVIDING HOME SHOPPING SERVICES IN THE FIELD OF GENERAL MERCHANDISE BY MEANS OF TELEVISION (U.S. CLS. 100, 101 AND 102).

BRIDGETT SMITH, EXAMINING ATTORNEY

CLASS 35—(Continued).

SN 85-380,611. GOWORLD COMMERCE & TRADE COMPANY LIMITED, HONG KONG, HONG KONG, FILED 7-26-2011.

ioiom

THE MARK CONSISTS OF STANDARD CHARACTERS WITHOUT CLAIM TO ANY PARTICULAR FONT, STYLE, SIZE, OR COLOR.

THE WORDING "IOIOM" HAS NO MEANING IN A FOREIGN LANGUAGE.

FOR AUCTIONEERING; BUSINESS INVESTIGATIONS; BUSINESS MANAGEMENT; BUSINESS ORGANIZATION AND OPERATION CONSULTANCY; CONDUCTING AND ADMINISTERING A PROGRAM FOR PARTICIPATING HEALTH AND FITNESS CLUBS FEATURING DISCOUNTS ON CLUB MEMBERSHIP FOR ACCESS TO THE CLUBS TO PROGRAM MEMBERS; CONDUCTING MARKETING STUDIES; DIRECT MAIL ADVERTISING SERVICES; DISSEMINATION OF ADVERTISING MATTER; DISTRIBUTION OF PROSPECTUSES AND SAMPLES; GOODS IMPORT-EXPORT AGENCIES; ONLINE ADVERTISEMENTS; ONLINE ADVERTISING AND PROMOTIONAL SERVICES; PRESENTATION OF GOODS ON COMMUNICATION MEDIA FOR RETAIL PURPOSES; PROMOTING THE GOODS AND SERVICES OF OTHERS BY MEANS OF OPERATING AN ON-LINE SHOPPING MALL WITH LINKS TO THE RETAIL WEB SITES OF OTHERS; PROVIDING LISTINGS OF BUSINESSES FOR SALE; SALES PROMOTION FOR OTHERS PROVIDED THROUGH THE DISTRIBUTION AND THE ADMINISTRATION OF PRIVILEGED USER CARDS; SALES PROMOTION SERVICES (U.S. CLS. 100, 101 AND 102).

FIRST USE 7-2-2008; IN COMMERCE 4-28-2010.
HANNO RITTNER, EXAMINING ATTORNEY

SN 85-384,248. HUGH P. SHANNONHOUSE, THE WOODLANDS, TX. FILED 7-29-2011.

PREVA

THE MARK CONSISTS OF STANDARD CHARACTERS WITHOUT CLAIM TO ANY PARTICULAR FONT, STYLE, SIZE, OR COLOR.

THE WORD(S) "PREVA" HAS NO MEANING IN A FOREIGN LANGUAGE.

FOR HEALTHCARE MANAGEMENT SERVICES, NAMELY, PROVIDING BUSINESS ORGANIZATION SERVICES, BRANDING SERVICES IN THE NATURE OF BRAND DEVELOPMENT AND EVALUATION, MARKETING CONSULTING SERVICES, MEDICAL PRACTICE BUSINESS MANAGEMENT AND ADMINISTRATIVE SUPPORT SERVICES, BUSINESS ADMINISTRATION SERVICES, AND FACILITATING GROUP PURCHASING, ALL FOR PHYSICIANS TO ENABLE THEM TO PRACTICE INDEPENDENTLY IN A COOPERATIVE AND COLLABORATIVE ORGANIZATIONAL STRUCTURE (U.S. CLS. 100, 101 AND 102).

SHAILA SETTLES, EXAMINING ATTORNEY

CLASS 35—(Continued).

SN 85-385,908. TRINARY MEDIA GROUP L.L.C., DALLAS, TX. FILED 8-1-2011.



NO CLAIM IS MADE TO THE EXCLUSIVE RIGHT TO USE "PARTY" OR ".COM", APART FROM THE MARK AS SHOWN.

THE MARK CONSISTS OF THE WORD "PARTY" FOLLOWED BY 3 ARROWS POINTING TO THE LEFT, FOLLOWED BY THE WORD "CHASER", THEN A HORIZONTAL LINE BENEATH, AND THE TEXT ".COM" AT THE RIGHT END OF THE LINE.

FOR PROMOTING THE NIGHT CLUBS OF OTHERS; ONLINE ADVERTISING AND MARKETING SERVICES, NAMELY, PROMOTING THE GOODS AND SERVICES OF OTHERS (U.S. CLS. 100, 101 AND 102).

FIRST USE 3-22-2003; IN COMMERCE 3-22-2003.
DOUGLAS LEE, EXAMINING ATTORNEY

CLASS 35—(Continued).

SN 85-390,738. FRIENDS OF THE SEA LION, INC., DBA PACIFIC MARINE MAMMAL CENTER, LAGUNA BEACH, CA. FILED 8-5-2011.



NO CLAIM IS MADE TO THE EXCLUSIVE RIGHT TO USE "MARINE MAMMAL CENTER", APART FROM THE MARK AS SHOWN.

THE MARK CONSISTS OF TWO SEA LION SILHOUETTES ABOVE THE STYLIZED TEXT "PACIFIC MARINE MAMMAL CENTER".

FOR RETAIL GIFT SHOPS AVAILABLE ON-SITE AND ONLINE (U.S. CLS. 100, 101 AND 102).

FIRST USE 1-1-2005; IN COMMERCE 1-1-2005.
NORA BUCHANAN WILL, EXAMINING ATTORNEY

SN 85-387,053. TRENDEST, INC., STUDIO CITY, CA. FILED 8-2-2011.

HAULSTARS

THE MARK CONSISTS OF STANDARD CHARACTERS WITHOUT CLAIM TO ANY PARTICULAR FONT, STYLE, SIZE, OR COLOR.

FOR PROVIDING A PRODUCT COMPARISON WEBSITE FEATURING PRICE COMPARISONS, PRODUCT INFORMATION, AND REVIEWS FROM USERS OF PRODUCTS FEATURED ON THE WEBSITE (U.S. CLS. 100, 101 AND 102).

JASON TURNER, EXAMINING ATTORNEY

SN 85-392,716. INTERNATIONAL FOUNDATION FOR ONLINE RESPONSIBILITY, WASHINGTON, DC. FILED 8-8-2011.

IFFOR

THE MARK CONSISTS OF STANDARD CHARACTERS WITHOUT CLAIM TO ANY PARTICULAR FONT, STYLE, SIZE, OR COLOR.

FOR PUBLIC ADVOCACY TO PROMOTE AWARENESS OF THE NEED FOR CORPORATE ONLINE RESPONSIBILITY, BEST PRACTICES AND EDUCATION IN THE AREA OF CHILD PROTECTION, USER EMPOWERMENT TOOLS, FREE EXPRESSION, PRIVACY, SECURITY AND CONSUMER RIGHTS (U.S. CLS. 100, 101 AND 102).

FIRST USE 3-23-2004; IN COMMERCE 5-1-2011.
JASON TURNER, EXAMINING ATTORNEY

CLASS 35—(Continued).

SN 85-392,724. INTERNATIONAL FOUNDATION FOR ONLINE RESPONSIBILITY, WASHINGTON, DC. FILED 8-8-2011.



THE MARK CONSISTS OF THE LETTERS "I" "F" "F" "O" "R" ALONG WITH A HALF CRESCENT MOON SHAPE THAT SURROUNDS THE "I" AND TOUCHES UPON THE BOTTOM PART OF THE FIRST "F" AND CONTINUES ON THE TOP OF ALL OF THE LETTERS AND ENDS AT THE BEGINNING OF THE "R". THE "I" HAS A SPECIALIZED CIRCULAR DOT AT THE TOP OF IT.

FOR PUBLIC ADVOCACY TO PROMOTE AWARENESS OF THE NEED FOR CORPORATE ONLINE RESPONSIBILITY, BEST PRACTICES AND EDUCATION IN THE AREA OF CHILD PROTECTION, USER EMPOWERMENT TOOLS, FREE EXPRESSION, PRIVACY, SECURITY AND CONSUMER RIGHTS (U.S. CLS. 100, 101 AND 102).

FIRST USE 3-23-2004; IN COMMERCE 5-1-2011.
JASON TURNER, EXAMINING ATTORNEY

CLASS 35—(Continued).

SN 85-394,931. MEDIA BULLDOGS, LLC, CORAL SPRINGS, FL. FILED 8-10-2011.

Digital Bulldogs

SN 85-392,965. MOVING HOUND, LLC, WICHITA FALLS, TX. FILED 8-9-2011.



OWNER OF U.S. REG. NO. 4,031,970.

NO CLAIM IS MADE TO THE EXCLUSIVE RIGHT TO USE "MOVING", APART FROM THE MARK AS SHOWN.

THE MARK CONSISTS OF THE WORDS "MOVING-HOUND" WITH THE "MOVING" TERM POSITIONED TO THE LEFT OF A PROFILE IMAGE OF A DOG IN A RUNNING POSE. THE BACK LEGS OF THE DOG ARE EXTENDED OUTWARD AND APPEAR UNDER A LATTER PORTION OF "MOVING". THE TAIL OF THE DOG EXTENDS OUT FROM THE DOG AND ABOVE THE LATTER PORTION OF "MOVING". THE "HOUND" TERM IS POSITIONED WITHIN THE BODY OF THE DOG AND THE HEAD AND FRONT LEGS OF THE DOG EXTEND OUT AND TO THE RIGHT OF "HOUND".

FOR PROVIDING A WEBSITE FEATURING INFORMATION ON MOVING AND RELOCATION OF HOMES AND OFFICES, NAMELY, PROVIDING BIDDING QUOTATIONS, PRICE COMPARISONS, AND INFORMATION RELATING TO THE BENEFITS AND ADVANTAGES OF RELOCATION SERVICE VENDORS, LABORERS, SUPPLIES, EQUIPMENT, STORAGE ALTERNATIVES, FOR-HIRE TRANSPORTATION AND TRUCK RENTAL ALTERNATIVES IN ORDER TO ALLOW A CUSTOMER TO PURCHASE DESIRED SELECTIONS TOGETHER; PROVIDING BUSINESS RELOCATION MANAGEMENT SERVICES, NAMELY, PLANNING, COORDINATING AND IMPLEMENTING A CUSTOMER'S RELOCATION OF HOMES AND OFFICES (U.S. CLS. 100, 101 AND 102).

FIRST USE 5-17-2011; IN COMMERCE 5-17-2011.
WILLIAM JACKSON, EXAMINING ATTORNEY

THE MARK CONSISTS OF STANDARD CHARACTERS WITHOUT CLAIM TO ANY PARTICULAR FONT, STYLE, SIZE, OR COLOR.

NO CLAIM IS MADE TO THE EXCLUSIVE RIGHT TO USE "DIGITAL", APART FROM THE MARK AS SHOWN.

FOR ADVERTISING AND MARKETING SERVICES PROVIDED BY MEANS OF INDIRECT METHODS OF MARKETING COMMUNICATIONS, NAMELY, SOCIAL MEDIA, SEARCH ENGINE MARKETING, INQUIRY MARKETING, INTERNET MARKETING, MOBILE MARKETING, BLOGGING AND OTHER FORMS OF PASSIVE, SHARABLE OR VIRAL COMMUNICATIONS CHANNELS; ADVERTISING ON THE INTERNET FOR OTHERS; ADVERTISING, PROMOTION AND MARKETING SERVICES IN THE NATURE OF E-MAIL BLAST CAMPAIGNS FOR OTHERS; CONSULTING SERVICES IN THE FIELD OF INTERNET MARKETING; THE BRINGING TOGETHER, FOR THE BENEFIT OF OTHERS, OF A VARIETY OF GOODS AND SERVICES, ENABLING CUSTOMERS TO CONVENIENTLY VIEW AND PURCHASE THOSE GOODS AND SERVICES FROM AN INTERNET WEB SITE PARTICULARLY SPECIALIZING IN THE MARKETING OF THE SALE OF GOODS AND SERVICES OF OTHERS (U.S. CLS. 100, 101 AND 102).

ALEXANDER L. POWERS, EXAMINING ATTORNEY

CLASS 35—(Continued).

SN 85-398,524. SKY DIGITAL (SHENZHEN) CO., LTD., SHENZHEN, CHINA, FILED 8-15-2011.

星天空数码
SKY DIGITAL

NO CLAIM IS MADE TO THE EXCLUSIVE RIGHT TO USE "DIGITAL", APART FROM THE MARK AS SHOWN.

THE MARK CONSISTS OF FIVE CHINESE CHARACTERS AND ENGLISH WORDING "SKY DIGITAL" BENEATH IN STYLIZED FONT.

THE ENGLISH TRANSLATION OF CHINESE CHARACTERS IN THE MARK IS "SKY DIGITAL".

THE NON-LATIN CHARACTERS IN THE MARK TRANSLITERATE TO XING TIAN KONG SHU MA AND THIS MEANS STAR, DAY, SPATIAL, NUMBER AND CODE IN ENGLISH.

FOR ADVERTISING AND PUBLICITY SERVICES; ASSISTANCE WITH BUSINESS MANAGEMENT AND PLANNING; COMMERCIAL ADMINISTRATION OF THE LICENSING OF THE GOODS AND SERVICES OF OTHERS; GOODS IMPORT-EXPORT AGENCIES; MANAGEMENT OF PERFORMING ARTISTS; PRESENTATION OF GOODS ON COMMUNICATION MEDIA FOR RETAIL PURPOSES; PURCHASING AND PROCUREMENT SERVICES, NAMELY, PROCURING OF CONTRACTS FOR OTHERS FOR THE PURCHASE OF GOODS AND LABOR CONTRACTING SERVICES; RELOCATION SERVICES FOR BUSINESS; SALES PROMOTION FOR OTHERS PROVIDED THROUGH THE DISTRIBUTION AND THE ADMINISTRATION OF PRIVILEGED USER CARDS; SPONSORSHIP SEARCH (U.S. CLS. 100, 101 AND 102).

FIRST USE 10-1-2010; IN COMMERCE 10-1-2010.
ELLEN B. AWRICH, EXAMINING ATTORNEY

SN 85-399,928. L & E ATOMIC, INC., BELTSVILLE, MD. FILED 8-17-2011.

ATOMIC MUSIC

THE MARK CONSISTS OF STANDARD CHARACTERS WITHOUT CLAIM TO ANY PARTICULAR FONT, STYLE, SIZE, OR COLOR.

NO CLAIM IS MADE TO THE EXCLUSIVE RIGHT TO USE "MUSIC", APART FROM THE MARK AS SHOWN.

FOR PROVIDING A BUY-BACK AND TRADE IN PROGRAM FOR USED MUSICAL INSTRUMENTS; SECOND HAND DEALERSHIPS FOR BUYING BACK AND TRADING IN MUSICAL INSTRUMENTS; RETAIL STORE SERVICES FEATURING MUSICAL INSTRUMENTS AND SOUND SYSTEMS (U.S. CLS. 100, 101 AND 102).

FIRST USE 8-12-1994; IN COMMERCE 8-12-1994.
APRIL ROACH, EXAMINING ATTORNEY

CLASS 35—(Continued).

SN 85-405,809. HALLBOURG, CRAIG, MESA, AZ. FILED 8-24-2011.

ALTA
Mining & Technical Recruiting Services

NO CLAIM IS MADE TO THE EXCLUSIVE RIGHT TO USE "MINING & TECHNICAL RECRUITING SERVICES", APART FROM THE MARK AS SHOWN.

THE MARK CONSISTS OF THE STYLIZED WORDING "ALTA MINING & TECHNICAL RECRUITING SERVICES" WITH A HORIZONTAL LINE SEPARATING THE WORD "ALTA" FROM THE REMAINING WORDING, AND A DESIGN TO THE LEFT OF THE WORDING COMPRISED OF A SHADED SQUARE FEATURING A DEPICTION OF TWO MOUNTAIN PEAKS, A SILHOUETTE OF A MINER'S HELMET WITH A LIGHT ON IT, TWO RAYS OF LIGHT, AND TWO CRESCENT-SHAPED CURVED BANDS.

THE ENGLISH TRANSLATION OF "ALTA" IN THE MARK IS "HIGH".

FOR EXECUTIVE SEARCH AND PLACEMENT SERVICES (U.S. CLS. 100, 101 AND 102).

FIRST USE 5-13-2011; IN COMMERCE 5-13-2011.
CYNTHIA TRIPI, EXAMINING ATTORNEY

SN 85-408,653. PATAGONIA, INC., VENTURA, CA. FILED 8-26-2011.

PATAGONIA TIN SHED

THE MARK CONSISTS OF STANDARD CHARACTERS WITHOUT CLAIM TO ANY PARTICULAR FONT, STYLE, SIZE, OR COLOR.

OWNER OF U.S. REG. NOS. 2,260,188, 2,392,685 AND 2,662,619.

FOR RETAIL STORES SERVICES FEATURING OUTDOOR CLOTHING, FOOTWEAR, AND GEAR, AND FOODSTUFFS FOR OUTDOOR ACTIVITIES; ONLINE STORE SERVICES FEATURING OUTDOOR CLOTHING, FOOTWEAR, AND GEAR, AND FOODSTUFFS FOR OUTDOOR ACTIVITIES (U.S. CLS. 100, 101 AND 102).

JOHN DWYER, EXAMINING ATTORNEY

CLASS 35—(Continued).

SN 85-409,947. ADASIM INC., CULVER CITY, CA. FILED 8-29-2011.

MOBILE GENIUS

THE MARK CONSISTS OF STANDARD CHARACTERS WITHOUT CLAIM TO ANY PARTICULAR FONT, STYLE, SIZE, OR COLOR.

NO CLAIM IS MADE TO THE EXCLUSIVE RIGHT TO USE "MOBILE", APART FROM THE MARK AS SHOWN.

FOR PROVIDING INFORMATION IN THE FIELD OF MOBILE PHONE ADVERTISING FOR BUSINESS PURPOSES (U.S. CLS. 100, 101 AND 102).

GIANCARLO CASTRO, EXAMINING ATTORNEY

SN 85-412,844. NATIONAL BLACK LEADERSHIP COMMISSION ON AIDS, INC., NEW YORK, NY. FILED 9-1-2011.



THE COLOR(S) YELLOW, RED, WHITE, PURPLE, BLACK, GREEN AND BEIGE IS/ARE CLAIMED AS A FEATURE OF THE MARK.

THE MARK CONSISTS OF A RIBBON THAT IS DIVIDED IN HALF ALONG ITS LENGTH, WITH ONE HALF OF THE RIBBON BEING RED AND THE OTHER HALF IN THE GEOMETRIC PATTERN OF A TRADITIONAL AFRICAN KENTE CLOTH WITH GREEN, RED, WHITE, PURPLE AND BLACK RECTANGLES AND STRIPES AND YELLOW TRIANGLES AND GREEN TRIANGLES, AND A RECTANGULAR BACKGROUND OF FOUR STRIPES BEHIND THE RIBBON IN SHADES OF YELLOW AND BEIGE.

FOR PROVIDING A WEBSITE FEATURING INFORMATION TO PROMOTE PUBLIC AWARENESS OF HIV/AIDS (U.S. CLS. 100, 101 AND 102).

FIRST USE 0-0-2001; IN COMMERCE 0-0-2001.
SARA BENJAMIN, EXAMINING ATTORNEY

CLASS 35—(Continued).

SN 85-412,849. NATIONAL BLACK LEADERSHIP COMMISSION ON AIDS, INC., NEW YORK, NY. FILED 9-1-2011.



THE COLOR(S) YELLOW, RED, WHITE, PURPLE, BLACK, GREEN AND BEIGE IS/ARE CLAIMED AS A FEATURE OF THE MARK.

THE MARK CONSISTS OF A RIBBON THAT IS DIVIDED IN HALF ALONG ITS LENGTH, WITH ONE HALF OF THE RIBBON BEING RED AND THE OTHER HALF IN THE GEOMETRIC PATTERN OF A TRADITIONAL AFRICAN KENTE CLOTH WITH GREEN, RED, WHITE, PURPLE AND BLACK RECTANGLES AND STRIPES AND YELLOW TRIANGLES AND GREEN TRIANGLES, AND A RECTANGULAR BACKGROUND OF FOUR STRIPES BEHIND THE RIBBON IN SHADES OF YELLOW AND BEIGE.

FOR PROMOTING PUBLIC AWARENESS OF HIV/AIDS, PARTICULARLY IN THE BLACK COMMUNITY, THROUGH EDUCATIONAL PROGRAMS (U.S. CLS. 100, 101 AND 102).

FIRST USE 12-0-1987; IN COMMERCE 12-0-1987.
SARA BENJAMIN, EXAMINING ATTORNEY

SN 85-418,310. PRO-GAIN TRADING LIMITED, HUNG HOM, KOWLOON, HONG KONG, FILED 9-9-2011.



NO CLAIM IS MADE TO THE EXCLUSIVE RIGHT TO USE "JEANS", APART FROM THE MARK AS SHOWN.

THE MARK CONSISTS OF THE STYLIZED WORDS "JEANS WARHEAD" WHERE THE WORD "JEANS" IS ABOVE THE LETTERS "ARHEAD" AND THE LETTER "W" IS IN BIGGER SIZE.

FOR ON-LINE RETAIL STORE SERVICES FEATURING A WIDE VARIETY OF CONSUMER GOODS OF OTHERS; RETAIL STORE SERVICES FEATURING A WIDE VARIETY OF CONSUMER GOODS OF OTHERS; WHOLESALE AND RETAIL STORE SERVICES FEATURING CLOTHING, JEWELRY (U.S. CLS. 100, 101 AND 102).

ARETHA SOMERVILLE, EXAMINING ATTORNEY

CLASS 35—(Continued).

SN 85-423,658. U.S. DEPARTMENT OF HEALTH AND HUMAN SERVICES, BETHESDA, MD. FILED 9-15-2011.

GTR

THE MARK CONSISTS OF STANDARD CHARACTERS WITHOUT CLAIM TO ANY PARTICULAR FONT, STYLE, SIZE, OR COLOR.

FOR MAINTAINING A FEDERAL REGISTRY OF GENETIC TESTS FOR INHERITED AND SOMATIC GENETIC VARIATIONS (U.S. CLS. 100, 101 AND 102).
 JASON BLAIR, EXAMINING ATTORNEY

SN 85-428,535. CONNEXIONS LOYALTY TRAVEL SOLUTIONS, LLC, MINNEAPOLIS, MN. FILED 9-21-2011.

LOUNGE FIRST

THE MARK CONSISTS OF STANDARD CHARACTERS WITHOUT CLAIM TO ANY PARTICULAR FONT, STYLE, SIZE, OR COLOR.

NO CLAIM IS MADE TO THE EXCLUSIVE RIGHT TO USE "LOUNGE", APART FROM THE MARK AS SHOWN.

FOR ADMINISTERING A CONSUMER MEMBERSHIP PROGRAM FOR ENABLING PARTICIPANTS TO OBTAIN AIR TRAVEL CLUB SERVICES, NAMELY, DISCOUNTS, COUPONS, VOUCHERS, SAVINGS AND REBATES FOR ACCESS TO AIRPORT TRAVEL LOUNGES, FOOD, BEVERAGES, COMPUTER AND WI-FI ACCESS (U.S. CLS. 100, 101 AND 102).

BRIAN CALLAGHAN, EXAMINING ATTORNEY

SN 85-429,782. PINNACLE APARTMENTS INVESTORS LLC, ATLANTA, GA. FILED 9-22-2011.

ROSWELL EAST

THE MARK CONSISTS OF STANDARD CHARACTERS WITHOUT CLAIM TO ANY PARTICULAR FONT, STYLE, SIZE, OR COLOR.

FOR REAL ESTATE MARKETING SERVICES IN THE FIELD OF MIXED-USE DEVELOPMENT (U.S. CLS. 100, 101 AND 102).

FIRST USE 1-1-2006; IN COMMERCE 1-1-2006.
 JULIE GUTTADAURO, EXAMINING ATTORNEY

CLASS 35—(Continued).

SN 85-431,533. SERVIENTREGA S.A., BOGOTÁ, COLOMBIA, FILED 9-26-2011.



OWNER OF U.S. REG. NO. 2,913,596.
 NO CLAIM IS MADE TO THE EXCLUSIVE RIGHT TO USE "CENTRO DE SOLUCIONES", APART FROM THE MARK AS SHOWN.

THE MARK CONSISTS OF A STYLIZED LETTER "S" INSIDE A SQUARE WHOSE LEFT AND RIGHT SIDES ARE SLANTED, BELOW OF WHICH APPEARS THE WORD "SERVIENTREGA", AND BELOW IT THE WORDING "CENTRO DE SOLUCIONES", ALL IN STYLIZED LETTERS.

THE ENGLISH TRANSLATION OF "CENTRO DE SOLUCIONES" IN THE MARK IS "SOLUTIONS CENTER". THE WORDING "SERVIENTREGA" HAS NO MEANING IN A FOREIGN LANGUAGE.

FOR ADVERTISING SERVICES; BUSINESS ADMINISTRATION AND MANAGEMENT; COMMERCIAL MANAGEMENT; OFFICE ADMINISTRATION SERVICES; PROVIDING OFFICE FUNCTIONS (U.S. CLS. 100, 101 AND 102).

DAVID H. STINE, EXAMINING ATTORNEY

SN 85-431,898. NETWORK, INC., VENTURA, CA. FILED 9-26-2011.



THE COLOR(S) BLACK, PURPLE, DARK PURPLE, LIGHT PURPLE, PINK, GREY AND WHITE IS/ARE CLAIMED AS A FEATURE OF THE MARK.

THE MARK CONSISTS OF A RABBIT STANDING UPRIGHT, WEARING SUNGLASSES, WITH HIS ARMS CROSSED IN FRONT OF HIS CHEST. THE RABBIT'S EARS ARE PURPLE WITH THE INNER PORTION BEING LIGHT PURPLE. THE UPPER PORTION OF THE RABBIT'S HEAD IS PURPLE AND THE EYEBROWS ARE DARK PURPLE. BLACK AND GREY SUNGLASSES COVER THE RABBIT'S EYES. THE LOWER PORTION OF THE RABBIT'S HEAD IS

CLASS 35—(Continued).

WHITE AND GREY WITH PINK ON THE MUZZLE. THE RABBIT'S NOSE IS BLACK WITH GREY HIGHLIGHTS AND THE RABBIT'S WHISKERS ARE WHITE. THE MOUTH OPENING IS BLACK AND THE TWO TEETH ARE WHITE AND GREY. THE RABBIT'S TORSO AND ARMS ARE PURPLE, EXCEPT FOR THE CHEST, WHICH IS GREY AND WHITE. THE RABBIT'S HANDS ARE PINK, GREY AND WHITE. THE RABBIT'S LEGS ARE PURPLE WITH LIGHT PURPLE AND PINK HIGHLIGHTS, AND THE RABBIT'S FEET ARE GREY AND WHITE.

FOR ADVERTISING AND DIRECTORY SERVICES, NAMELY, PROMOTING THE SERVICES OF OTHERS BY PROVIDING A WEB PAGE FEATURING LINKS TO THE WEBSITES OF OTHERS; ADVERTISING AND MARKETING SERVICES PROVIDED BY MEANS OF INDIRECT METHODS OF MARKETING COMMUNICATIONS, NAMELY, SOCIAL MEDIA, SEARCH ENGINE MARKETING, INQUIRY MARKETING, INTERNET MARKETING, MOBILE MARKETING, BLOGGING AND OTHER FORMS OF PASSIVE, SHARABLE OR VIRAL COMMUNICATIONS CHANNELS (U.S. CLS. 100, 101 AND 102).

FIRST USE 6-1-2011, THE MARK WAS FIRST USED ANYWHERE IN A DIFFERENT FORM OTHER THAN THAT SOUGHT TO BE REGISTERED AT LEAST AS EARLY AS 07/01/2001.; IN COMMERCE 6-1-2011, THE MARK WAS FIRST USED IN COMMERCE IN A DIFFERENT FORM OTHER THAN THAT SOUGHT TO BE REGISTERED AT LEAST AS EARLY AS 07/27/2001..

NELSON SNYDER, EXAMINING ATTORNEY

SN 85-433,099. MOTOR CONSULTANTS OF AMERICA, INC., DBA MCA INC., FLINT, MI. FILED 9-27-2011.

CLASS 35—(Continued).

SN 85-433,935. ONE STOP MAILING, LLC, DBA OSM WORLDWIDE, BENSENVILLE, IL. FILED 9-28-2011.



THE COLOR(S) RED, WHITE AND GRAY IS/ARE CLAIMED AS A FEATURE OF THE MARK.

THE MARK CONSISTS OF THE WORDING "OSMART" IN STYLIZED LETTERING. THE CAPITAL LETTERS "O" AND "M" APPEAR IN RED, "S" APPEARS IN WHITE, AND "OSM" IS BISECTED AT THE MIDPOINT WITH A HORIZONTAL WHITE LINE. THE LETTERS "ART" APPEAR IN GRAY.

FOR BUSINESS SERVICES, NAMELY, FREIGHT INFORMATION MANAGEMENT SERVICES, SHIPMENT PROCESSING, PREPARING SHIPPING DOCUMENTS AND INVOICES, TRACKING DOCUMENTS, PACKAGES AND FREIGHT OVER COMPUTER NETWORKS, INTRANETS AND INTERNETS; COMPUTERIZED TRACKING AND TRACING OF PACKAGES IN TRANSIT; INFORMATION MANAGEMENT SERVICES, NAMELY, SHIPMENT PROCESSING, PREPARING SHIPPING DOCUMENTS AND INVOICES, TRACKING DOCUMENTS, PACKAGES AND FREIGHT OVER COMPUTER NETWORKS, INTRANETS AND INTERNETS (U.S. CLS. 100, 101 AND 102).

FIRST USE 6-1-2009; IN COMMERCE 6-1-2009.
ALICE BENMAMAN, EXAMINING ATTORNEY

SN 85-434,974. FIRST DATA CORPORATION, GREENWOOD VILLAGE, CO. FILED 9-29-2011.

We Are About You!

BUSINESS TRACK

THE MARK CONSISTS OF STANDARD CHARACTERS WITHOUT CLAIM TO ANY PARTICULAR FONT, STYLE, SIZE, OR COLOR.

FOR BUSINESS MANAGEMENT CONSULTING; BUSINESS CONSULTATION; BUSINESS MANAGEMENT CONSULTING, STRATEGIC PLANNING AND BUSINESS ADVISORY SERVICES PROVIDED TO THE CONSTRUCTION INDUSTRY, AUTOMOTIVE INDUSTRY, MEDICAL PROFESSION, NON-PROFIT CORPORATIONS, ACADEMIC INSTITUTIONS, INSURANCE INDUSTRY, BANKING INDUSTRY AND RETAIL BUSINESS ENTITIES (U.S. CLS. 100, 101 AND 102).

FIRST USE 6-1-2002; IN COMMERCE 8-5-2011.
JANICE KIM, EXAMINING ATTORNEY

THE MARK CONSISTS OF STANDARD CHARACTERS WITHOUT CLAIM TO ANY PARTICULAR FONT, STYLE, SIZE, OR COLOR.

NO CLAIM IS MADE TO THE EXCLUSIVE RIGHT TO USE "BUSINESS", APART FROM THE MARK AS SHOWN.

FOR PROVIDING A WEB-BASED ONLINE PORTAL FEATURING COMMERCIAL SALES INFORMATION, SALES TRANSACTIONS AND ACCOUNTS RECEIVABLE INFORMATION AND BUSINESS ANALYTICAL REPORTS FOR RETAILERS, FINANCIAL INSTITUTIONS, PROCESSORS AND INDEPENDENT SALES ORGANIZATIONS (U.S. CLS. 100, 101 AND 102).

FIRST USE 7-31-2011; IN COMMERCE 7-31-2011.
MICHELE SWAIN, EXAMINING ATTORNEY

CLASS 35—(Continued).

SN 85-441,654. SOCIAL BRAND U, LLC, WOODSTOCK, GA. FILED 10-7-2011.

Social Brand U

THE MARK CONSISTS OF STANDARD CHARACTERS WITHOUT CLAIM TO ANY PARTICULAR FONT, STYLE, SIZE, OR COLOR.

NO CLAIM IS MADE TO THE EXCLUSIVE RIGHT TO USE "SOCIAL BRAND", APART FROM THE MARK AS SHOWN.

FOR BUSINESS CONSULTATION SERVICES, NAMELY, PROVIDING BUSINESS STRATEGIES FOR USE IN SOCIAL MEDIA; MARKETING CONSULTANCY IN THE FIELD OF HELPING CLIENTS CREATE AND EXTEND THEIR PRODUCT AND BRAND STRATEGIES BY BUILDING VIRALLY ENGAGING MARKETING SOLUTIONS (U.S. CLS. 100, 101 AND 102).

FIRST USE 12-1-2010; IN COMMERCE 12-1-2010.
TRACY WHITTAKER-BROWN, EXAMINING ATTORNEY

SN 85-442,834. LEMIS MARKETING CONSULTANTS, INC., DBA PROMODATA, OAKBROOK TERRACE, IL. FILED 10-8-2011.

PROMODATA

THE MARK CONSISTS OF STANDARD CHARACTERS WITHOUT CLAIM TO ANY PARTICULAR FONT, STYLE, SIZE, OR COLOR.

FOR MARKETING RESEARCH SERVICES (U.S. CLS. 100, 101 AND 102).

FIRST USE 1-1-1988; IN COMMERCE 1-1-1988.
ALAIN LAPTEY, EXAMINING ATTORNEY

SN 85-444,467. THE COMPANY COACH LLC, SOUTHLAKE, TX. FILED 10-11-2011.

THE COMPANY COACH

THE MARK CONSISTS OF STANDARD CHARACTERS WITHOUT CLAIM TO ANY PARTICULAR FONT, STYLE, SIZE, OR COLOR.

OWNER OF U.S. REG. NO. 2,750,855.

NO CLAIM IS MADE TO THE EXCLUSIVE RIGHT TO USE "COMPANY", APART FROM THE MARK AS SHOWN.

FOR PROFESSIONAL BUSINESS CONSULTING FOR STRATEGIC PLANNING SERVICES AND SUCCESSION BY IDENTIFYING, GROWING AND TRANSFERRING COMPANY VALUE BY UTILIZING THE ELEMENTS OF CORPORATE ASSET PROTECTION, TAX PLANNING, AND EXIT STRATEGIES; PROFESSIONAL BUSINESS CONSULTING; BUSINESS SUCCESSION PLANNING; BUSINESS STRATEGIC PLANNING SERVICES (U.S. CLS. 100, 101 AND 102).

FIRST USE 9-26-2001; IN COMMERCE 9-26-2001.
EDWARD NELSON, EXAMINING ATTORNEY

CLASS 35—(Continued).

SN 85-445,572. FII - NATIONAL, DBA FAMILY INDEPENDENCE INITIATIVE, OAKLAND, CA. FILED 10-12-2011.

Family Independence Initiative

THE MARK CONSISTS OF STANDARD CHARACTERS WITHOUT CLAIM TO ANY PARTICULAR FONT, STYLE, SIZE, OR COLOR.

SEC. 2(F).

FOR CHARITABLE SERVICES, NAMELY, ORGANIZING AND DEVELOPING PROJECTS THAT AIM TO IMPROVE THE LIVES OF UNDERPRIVILEGED AND IMPOVERISHED PEOPLE (U.S. CLS. 100, 101 AND 102).

FIRST USE 1-1-2001; IN COMMERCE 1-1-2001.

ALICE BENMAMAN, EXAMINING ATTORNEY

SN 85-445,794. TAXSEARCH INCORPORATED, TULSA, OK. FILED 10-12-2011.

TAXSEARCH

THE MARK CONSISTS OF STANDARD CHARACTERS WITHOUT CLAIM TO ANY PARTICULAR FONT, STYLE, SIZE, OR COLOR.

OWNER OF U.S. REG. NO. 1,646,230.

FOR PERSONNEL PLACEMENT SERVICES (U.S. CLS. 100, 101 AND 102).

FIRST USE 1-2-1990; IN COMMERCE 1-2-1990.

BILL DAWE, EXAMINING ATTORNEY

SN 85-446,092. TEXAS MARKET RESEARCH GROUP, LLC, HOUSTON, TX. FILED 10-12-2011.

Reconnaissance Market Research

THE MARK CONSISTS OF STANDARD CHARACTERS WITHOUT CLAIM TO ANY PARTICULAR FONT, STYLE, SIZE, OR COLOR.

NO CLAIM IS MADE TO THE EXCLUSIVE RIGHT TO USE "MARKET RESEARCH", APART FROM THE MARK AS SHOWN.

FOR PRIMARY MARKET RESEARCH, INCLUDING USING QUALITATIVE AND QUANTITATIVE METHODS. MARKET RESEARCH SERVICES; MARKET RESEARCH CONSULTATION; CONDUCTING BUSINESS AND MARKET RESEARCH SURVEYS; CONSUMER SURVEY SERVICES; BUSINESS RESEARCH USING FOCUS GROUPS; CONDUCTING ON-LINE BUSINESS AND MARKETING RESEARCH SURVEYS; MARKET OPINION POLLING STUDIES; ANALYSIS OF MARKET RESEARCH DATA AND STATISTICS (U.S. CLS. 100, 101 AND 102).

ERNEST SHOSHO, EXAMINING ATTORNEY

CLASS 35—(Continued).

SN 85-447,890. 1-800 CONTACTS, INC., DRAPER, UT. FILED 10-14-2011.



NO CLAIM IS MADE TO THE EXCLUSIVE RIGHT TO USE "GLASSES.COM", APART FROM THE MARK AS SHOWN.

THE COLOR(S) WHITE, NAVY BLUE, AND LIGHT BLUE IS/ARE CLAIMED AS A FEATURE OF THE MARK.

THE MARK CONSISTS OF A WHITE OUTLINE OF AN EYEGASS LENS INSIDE A NAVY BLUE EYEGASS-SHAPED SEMI-CIRCLE FOLLOWED BY THE WORD "GLASSES" IN NAVY BLUE AND THE WORDING ".COM" IN LIGHT BLUE.

FOR ON-LINE RETAIL STORE SERVICES FEATURING SPECTACLES AND RELATED PRODUCTS (U.S. CLS. 100, 101 AND 102).

FIRST USE 7-15-2011; IN COMMERCE 7-15-2011.
JERI J. FICKES, EXAMINING ATTORNEY

SN 85-448,376. GENERICSWEB PTY LTD, SYDNEY, AUSTRALIA, FILED 10-16-2011.

ARK PHARMA INTELLIGENCE

THE MARK CONSISTS OF STANDARD CHARACTERS WITHOUT CLAIM TO ANY PARTICULAR FONT, STYLE, SIZE, OR COLOR.

NO CLAIM IS MADE TO THE EXCLUSIVE RIGHT TO USE "PHARMA INTELLIGENCE", APART FROM THE MARK AS SHOWN.

FOR COMMERCIAL INFORMATION SERVICES IN THE HEALTHCARE, BIOTECHNOLOGY AND PHARMACEUTICAL FIELDS PROVIDED VIA A COMPUTER DATABASE; COMMERCIAL RESEARCH AND BUSINESS INFORMATION SERVICES IN THE HEALTHCARE, BIOTECHNOLOGY AND PHARMACEUTICAL FIELDS PROVIDED VIA AN ONLINE PORTAL; COMMERCIAL RESEARCH AND BUSINESS INFORMATION SERVICES IN THE HEALTHCARE, BIOTECHNOLOGY AND PHARMACEUTICAL FIELDS PROVIDED VIA A COMPUTER DATABASE; COMMERCIAL RESEARCH AND BUSINESS INFORMATION SERVICES RELATING TO THE MARKETING OF PRODUCTS IN THE HEALTHCARE, BIOTECHNOLOGY AND PHARMACEUTICAL FIELDS (U.S. CLS. 100, 101 AND 102).

KATINA MISTER, EXAMINING ATTORNEY

CLASS 35—(Continued).

SN 85-461,598. ABBASI, SOFIA, WHIT PLAINS, NY. FILED 11-1-2011.

FRUGALO

THE MARK CONSISTS OF STANDARD CHARACTERS WITHOUT CLAIM TO ANY PARTICULAR FONT, STYLE, SIZE, OR COLOR.

THE WORDING "FRUGALO" HAS NO MEANING IN A FOREIGN LANGUAGE.

FOR PROMOTING THE GOODS AND SERVICES OF OTHERS BY PROVIDING A WEBSITE FEATURING COUPONS, REBATES, PRICE-COMPARISON INFORMATION, PRODUCT REVIEWS, LINKS TO THE RETAIL WEBSITES OF OTHERS, AND DISCOUNT INFORMATION (U.S. CLS. 100, 101 AND 102).

WILLIAM VERHOSEK, EXAMINING ATTORNEY

SN 85-462,163. EINIGER, SCOTT, MONTIBELLO, NY. FILED 11-2-2011.

RSVP

THE MARK CONSISTS OF STANDARD CHARACTERS WITHOUT CLAIM TO ANY PARTICULAR FONT, STYLE, SIZE, OR COLOR.

FOR DISCOUNT PROGRAMS, NAMELY, ENABLING RESTAURANT OWNERS TO OFFER GROUP PURCHASING AND DISCOUNTS TO CONSUMERS (U.S. CLS. 100, 101 AND 102).

FRANK LATTUCA, EXAMINING ATTORNEY

SN 85-462,498. LOVE'S TRAVEL STOPS & COUNTRY STORES, INC., OKLAHOMA CITY, OK. FILED 11-2-2011.



OWNER OF U.S. REG. NOS. 1,269,485, 1,497,197 AND OTHERS.

THE COLOR(S) RED, YELLOW, ORANGE AND BLACK IS/ARE CLAIMED AS A FEATURE OF THE MARK.

THE MARK CONSISTS OF A WAVE STRIPE DESIGN WITH THE COLORS YELLOW, RED AND ORANGE FORMING THE STRIPES. THE WORD "LOVE'S" IN BLACK WITH A RED HEART AS THE APOSTROPHE IS POSITIONED ON THE YELLOW BACKGROUND. AN ECHOING HEARTS DESIGN IN RED, YELLOW AND ORANGE IS POSITIONED TO THE LEFT OF THE WORD "LOVE'S".

FOR RETAIL CONVENIENCE STORE SERVICES, RETAIL GASOLINE STATION SERVICES, RETAIL DIESEL FUELING STATION SERVICES, RETAIL TRUCK AND TRAVEL STOP SERVICES FEATURING CONVENIENCE STORE ITEMS AND GASOLINE (U.S. CLS. 100, 101 AND 102).

FIRST USE 3-30-2010; IN COMMERCE 3-30-2010.
SUZANNE BLANE, EXAMINING ATTORNEY

CLASS 35—(Continued).

SN 85-462,804. LOVE'S TRAVEL STOPS & COUNTRY STORES, INC., OKLAHOMA CITY, OK. FILED 11-2-2011.



OWNER OF U.S. REG. NOS. 1,269,485, 1,497,197 AND OTHERS.

THE MARK CONSISTS OF A SERIES OF HORIZONTAL WAVE STRIPES, WITH THE WORD "LOVE'S" HAVING A HEART AS THE APOSTROPHE APPEARING WITHIN THE BROADEST STRIPE, WHICH IS ALSO THE TOP STRIPE, AND A SMALL ECHOING HEARTS DESIGN POSITIONED TO THE LEFT OF THE WORD "LOVE'S".

FOR RETAIL CONVENIENCE STORE SERVICES, RETAIL GASOLINE STATION SERVICES, RETAIL DIESEL FUELING STATION SERVICES, RETAIL TRUCK AND TRAVEL STOP SERVICES FEATURING CONVENIENCE STORE ITEMS AND GASOLINE (U.S. CLS. 100, 101 AND 102).

FIRST USE 3-30-2010; IN COMMERCE 3-30-2010.
SUZANNE BLANE, EXAMINING ATTORNEY

SN 85-463,126. VIVA ENTERTAINMENT, LLC, DBA VIVA CREATIVE, ROCKVILLE, MD. FILED 11-3-2011.

VIVA CREATIVE

THE MARK CONSISTS OF STANDARD CHARACTERS WITHOUT CLAIM TO ANY PARTICULAR FONT, STYLE, SIZE, OR COLOR.

NO CLAIM IS MADE TO THE EXCLUSIVE RIGHT TO USE "CREATIVE", APART FROM THE MARK AS SHOWN.

FOR ADVERTISING, MARKETING, AND BUSINESS SERVICES, NAMELY, BUSINESS MARKETING CONSULTING; BUSINESS CONSULTING SERVICES, NAMELY, PROVIDING ASSISTANCE IN DEVELOPMENT OF BUSINESS STRATEGIES AND CREATIVE IDEATION, MARKETING SERVICES, EXPERIENTIAL MARKETING SERVICES, DIGITAL MARKETING SERVICES, VIDEO PRODUCTION SERVICES IN THE FIELD OF ADVERTISING AND MARKETING, PRODUCTION OF EVENTS FOR COMMERCIAL OR ADVERTISING PURPOSES (U.S. CLS. 100, 101 AND 102).

JAMES LOVELACE, EXAMINING ATTORNEY

CLASS 35—(Continued).

SN 85-463,129. VIVA ENTERTAINMENT, LLC, DBA VIVA CREATIVE, ROCKVILLE, MD. FILED 11-3-2011.

AGENCY OF RESULTS

THE MARK CONSISTS OF STANDARD CHARACTERS WITHOUT CLAIM TO ANY PARTICULAR FONT, STYLE, SIZE, OR COLOR.

FOR ADVERTISING, ADVERTISING AGENCIES, DIRECT MAIL ADVERTISING, ON-LINE ADVERTISING ON A COMPUTER NETWORK, ORGANIZATION OF EXHIBITIONS FOR COMMERCIAL OR ADVERTISING PURPOSES, ORGANIZATION OF TRADE FAIRS FOR COMMERCIAL OR ADVERTISING PURPOSES, OUTDOOR ADVERTISING, RADIO ADVERTISING, TELEVISION ADVERTISING, BUSINESS CONSULTING SERVICES, NAMELY, PROVIDING ASSISTANCE IN DEVELOPMENT OF BUSINESS STRATEGIES AND CREATIVE IDEATION, MARKETING SERVICES, EXPERIENTIAL MARKETING SERVICES, DIGITAL MARKETING SERVICES, VIDEO PRODUCTION SERVICES IN THE FIELD OF ADVERTISING AND MARKETING, PRODUCTION OF EVENTS FOR COMMERCIAL OR ADVERTISING PURPOSES (U.S. CLS. 100, 101 AND 102).

JAMES LOVELACE, EXAMINING ATTORNEY

SN 85-464,710. JUVENILE JUSTICE PROBATION OFFICERS' ASSOCIATION, LAS VEGAS, NV. FILED 11-4-2011.



NO CLAIM IS MADE TO THE EXCLUSIVE RIGHT TO USE "EST. 2011" AND " JUVENILE JUSTICE PROBATION OFFICERS ASSOCIATION", APART FROM THE MARK AS SHOWN.

THE MARK CONSISTS OF A SHIELD WITH "JJPOA" WRITTEN ON A BANNER ACROSS THE SHIELD, WITH "UNITED" WRITTEN BELOW ON ANOTHER BANNER ACROSS THE SHIELD. THE WORDS "EST. 2011" APPEAR ON A MEDALLION BELOW THE TWO BANNERS. LAURELS ENCIRCLE THE MEDALLION. TWO MORE LAURELS ARE POSITIONED ON THE BOTTOM SIDES OF THE SHIELD. THE SIDES OF THE SHIELDS ALSO HAVE A BLACK BORDER, WITH TWELVE CIRCLES POSITIONED BETWEEN THE BLACK BORDER AND THE OUTER EDGE OF THE SHIELD. ABOVE THE SHIELD ARE AN EAGLE'S HEAD AND WINGS. THE WORDS "JUVENILE JUSTICE PROBATION OFFICERS ASSOCIATION" ARE WRITTEN BELOW THE SHIELD IN A SEMI-CIRCULAR SHAPE, AROUND THE SHIELD. ALL OF THE ABOVE IS ENCLOSED WITHIN A CIRCLE.

FOR ASSOCIATION SERVICES, NAMELY, PROMOTING THE INTERESTS OF PROBATION OFFICERS; LABOR UNIONS (U.S. CLS. 100, 101 AND 102).

C. DIONNE CLYBURN, EXAMINING ATTORNEY

CLASS 35—(Continued).

SN 85-465,587. WHITE, MICHAEL COLE, THE COLONY, TX. FILED 11-6-2011.

bid4me

THE MARK CONSISTS OF STANDARD CHARACTERS WITHOUT CLAIM TO ANY PARTICULAR FONT, STYLE, SIZE, OR COLOR.

FOR PROVIDING PRICE COMPARISON SERVICES IN THE FIELD OF HOTEL RATES, BED AND BREAKFAST RATES, AIRFARE, AND CAR RENTAL RATES VIA THE INTERNET (U.S. CLS. 100, 101 AND 102).

DAVID TAYLOR, EXAMINING ATTORNEY

SN 85-467,874. RESOURCE FURNITURE, LLC, NEW YORK, NY. FILED 11-9-2011.

RESOURCE FURNITURE

 SPACE. REINVENTED.

NO CLAIM IS MADE TO THE EXCLUSIVE RIGHT TO USE "FURNITURE", APART FROM THE MARK AS SHOWN.

THE MARK CONSISTS OF THE WORDS "RESOURCE FURNITURE" OVER NINE SOLID SQUARES. A LINE APPEARS BELOW THE SQUARES, WITH THE WORDS "SPACE. REINVENTED." UNDERNEATH.

FOR WHOLESALE AND RETAIL STORES IN THE FIELD OF FURNITURE (U.S. CLS. 100, 101 AND 102).

FIRST USE 5-0-2011; IN COMMERCE 5-0-2011.

WILLIAM VERHOSEK, EXAMINING ATTORNEY

SN 85-470,115. GRO LIVING, DOVER, DE. FILED 11-11-2011.

 green real organic

NO CLAIM IS MADE TO THE EXCLUSIVE RIGHT TO USE "GREEN" AND "ORGANIC", APART FROM THE MARK AS SHOWN.

THE COLOR(S) DARK GREEN, GREEN, AND LIGHT GREEN IS/ARE CLAIMED AS A FEATURE OF THE MARK.

THE MARK CONSISTS OF THE WORD "GRO" IN STYLIZED, COLOR FONT. THE LETTER "G" IS SET IN

CLASS 35—(Continued).

DARK GREEN FONT, THE LETTER "R" IS SET IN GREEN FONT, AND THE LETTER "O" IS SET IN LIGHT GREEN FONT. A STYLIZED GREEN ASTERISK APPEARS ABOVE, AND TO THE RIGHT, OF THE LETTER "O". THE PHRASE "GREEN REAL ORGANIC" APPEARS BELOW THE WORD "GRO" AND IS OFFSET TO THE RIGHT. THE WORD "GREEN" IS SET IN A LOWER-CASE, DARK GREEN FONT. THE WORD "REAL" IS SET IN A LOWER-CASE, GREEN FONT. THE WORD "ORGANIC" IS SET IN A LOWER-CASE, DARK GREEN FONT.

FOR MOBILE RETAIL STORE SERVICES FEATURING ORGANIC, GREEN AND ECO-FRIENDLY PRODUCTS IN THE NATURE OF APPAREL, CLOTHING, FASHION ACCESSORIES, COSMETICS, PERFUMES, BODY CARE, JEWELRY, HOME GOODS, LIGHTING, FURNITURE, BOOKS, MUSIC, ART, VINTAGE PRODUCTS, AND GOURMET FOODS; ON-LINE RETAIL STORE SERVICES FEATURING ORGANIC, GREEN AND ECO-FRIENDLY PRODUCTS IN THE NATURE OF APPAREL, CLOTHING, FASHION ACCESSORIES, COSMETICS, PERFUMES, BODY CARE, JEWELRY, HOME GOODS, LIGHTING, FURNITURE, BOOKS, MUSIC, ART, VINTAGE PRODUCTS, AND GOURMET FOODS; RETAIL STORE SERVICES FEATURING ORGANIC, GREEN AND ECO-FRIENDLY PRODUCTS IN THE NATURE OF APPAREL, CLOTHING, FASHION ACCESSORIES, COSMETICS, PERFUMES, BODY CARE, JEWELRY, HOME GOODS, LIGHTING, FURNITURE, BOOKS, MUSIC, ART, VINTAGE PRODUCTS, AND GOURMET FOODS (U.S. CLS. 100, 101 AND 102).

JILL PRATER, EXAMINING ATTORNEY

SN 85-472,149. RELATIONSHIP AUDITS LTD., LONDON, ENGLAND, FILED 11-14-2011.

Tenprature Test

THE MARK CONSISTS OF STANDARD CHARACTERS WITHOUT CLAIM TO ANY PARTICULAR FONT, STYLE, SIZE, OR COLOR.

FOR BUSINESS ADMINISTRATION; BUSINESS APPRAISAL AND BUSINESS RESEARCH SERVICES RELATING TO THE MEASUREMENT OF BUSINESS RELATIONSHIPS; BUSINESS ADMINISTRATION, BUSINESS APPRAISAL AND BUSINESS RESEARCH SERVICES RELATING TO THE MEASUREMENT OF SUPPLIER, CUSTOMER, CLIENT AND INTRA-BUSINESS RELATIONSHIPS; PROVIDING BUSINESS INFORMATION IN THE FIELD OF THE MEASUREMENT OF SUPPLIER, CUSTOMER, CLIENT AND INTRA-BUSINESS RELATIONSHIPS VIA COMPUTER DATABASES; SYSTEMIZATION OF BUSINESS INFORMATION INTO COMPUTER DATABASES, NAMELY, COMPUTERIZED DATABASE MANAGEMENT; BUSINESS CONSULTING SERVICES UTILIZING BUSINESS RELATIONSHIP MODELING TO ANALYZE THE MARKET OPPORTUNITIES OF A GIVEN SOLUTION; PROVIDING STATISTICAL INFORMATION FOR BUSINESS PURPOSES (U.S. CLS. 100, 101 AND 102).

FIRST USE 1-1-2006; IN COMMERCE 1-1-2006.

DAVID I, EXAMINING ATTORNEY

CLASS 35—(Continued).

SN 85-472,355. SLOANE TWO RODEO, LLC, BEVERLY HILLS, CA. FILED 11-14-2011.



NO CLAIM IS MADE TO THE EXCLUSIVE RIGHT TO USE "VIA RODEO", APART FROM THE MARK AS SHOWN. THE MARK CONSISTS OF THE WORDS "VIA RODEO" ENCLOSED BY AN OBLONG, STYLIZED BORDER IN THE FORM OF AN OLD FASHIONED STREET SIGN.

THE ENGLISH TRANSLATION OF "VIA" IN THE MARK IS DRIVE.

FOR BUSINESS OPERATIONS FOR SHOPPING MALLS; RETAIL SHOPPING MALL SERVICES, NAMELY, PROVIDING RETAIL STORE SERVICES IN THE FIELD OF LUXURY GOODS (U.S. CLS. 100, 101 AND 102).

FIRST USE 1-1-2003; IN COMMERCE 1-1-2003.
SEAN CROWLEY, EXAMINING ATTORNEY

SN 85-472,510. SHOPBISTRO (USA), INC., NEW YORK, NY. FILED 11-15-2011.

SHOPBISTRO BUY THE WORLD

THE MARK CONSISTS OF STANDARD CHARACTERS WITHOUT CLAIM TO ANY PARTICULAR FONT, STYLE, SIZE, OR COLOR.

OWNER OF U.S. REG. NO. 3,296,364.
FOR DIRECT MARKETING VIA THE INTERNET AND TELEVISION; INTERACTIVE RETAIL STORE SERVICES PROVIDED VIA THE INTERNET AND TELEVISION, FEATURING GENERAL MERCHANDISE (U.S. CLS. 100, 101 AND 102).
DEZMONA MIZELLE, EXAMINING ATTORNEY

SN 85-472,515. SHOPBISTRO (USA), INC., JERICHO, NY. FILED 11-15-2011.

BUY THE WORLD

THE MARK CONSISTS OF STANDARD CHARACTERS WITHOUT CLAIM TO ANY PARTICULAR FONT, STYLE, SIZE, OR COLOR.

FOR DIRECT MARKETING VIA THE INTERNET AND TELEVISION; INTERACTIVE RETAIL STORE SERVICES PROVIDED VIA THE INTERNET AND TELEVISION, FEATURING GENERAL MERCHANDISE (U.S. CLS. 100, 101 AND 102).
DEZMONA MIZELLE, EXAMINING ATTORNEY

CLASS 35—(Continued).

SN 85-472,518. SHOPBISTRO (USA), INC., JERICHO, NY. FILED 11-15-2011.



THE MARK CONSISTS OF A MISCELLANEOUS DESIGN WITH AN OVERALL CIRCULAR SHAPE WITH A HANGER IN THE CENTER, AND PROCEEDING CLOCKWISE OUTWARD FROM THE HANGER, A SMALL STAR, A TELEPHONE, A SMALL STAR, A SHIRT, A LEAF, A SMALL STAR, A BARBELL, A CAR, A PAIR OF SCISSORS, THE LETTER "B", A PLANE, A SMALL STAR, A MEDIUM STAR, THE LETTER "S", A PUZZLE PIECE, A SMALL STAR, A DIAMOND, A KEY, A MEDIUM STAR, A SHOPPING CART WITH A STAR IN THE BASKET, A HIGH-HEELED SHOE, A SMALL STAR, A DOG, A SMALL STAR, LIPS AND A COMB.

FOR DIRECT TO CONSUMER MARKETING VIA THE INTERNET AND TELEVISION (U.S. CLS. 100, 101 AND 102).

DEZMONA MIZELLE, EXAMINING ATTORNEY

SN 85-472,524. SHOPBISTRO (USA), INC., JERICHO, NY. FILED 11-15-2011.

ANY WARE AND EVERYWHERE

THE MARK CONSISTS OF STANDARD CHARACTERS WITHOUT CLAIM TO ANY PARTICULAR FONT, STYLE, SIZE, OR COLOR.

FOR DIRECT MARKETING VIA THE INTERNET AND TELEVISION; INTERACTIVE RETAIL STORE SERVICES PROVIDED VIA THE INTERNET AND TELEVISION, FEATURING GENERAL MERCHANDISE (U.S. CLS. 100, 101 AND 102).
DEZMONA MIZELLE, EXAMINING ATTORNEY

CLASS 35—(Continued).

SN 85-474,286. DEALERS UNITED, LLC, SARASOTA, FL. FILED 11-16-2011.



THE MARK CONSISTS OF STYLIZED SHIELD WITH A "D" INSIDE THE SHIELD.

FOR BUSINESS INFORMATION MANAGEMENT, NAMELY, ELECTRONIC REPORTING OF BUSINESS INFORMATION, NAMELY, BUSINESS INVESTIGATIONS, INFORMATION AND RESEARCH FOR AUTOMOBILE DEALERS IN THE NATURE OF EVALUATING VENDORS OF A PARTICULAR GOOD OR SERVICE AND VETTING THE VENDORS; COMMERCIAL EVALUATION AND RATING OF CONSUMER GOODS FOR OTHERS PRIOR TO PURCHASE TO DETERMINE IF A MINIMUM NUMBER OF AUTOMOBILE DEALERS DESIRE THE GOODS OR SERVICES PROVIDED BY THE VENDOR (U.S. CLS. 100, 101 AND 102).

FIRST USE 10-3-2011; IN COMMERCE 10-3-2011.
CHARISMA HAMPTON, EXAMINING ATTORNEY

CLASS 35—(Continued).

SN 85-476,542. OKLAHOMA STATE REGENTS FOR HIGHER EDUCATION, OKLAHOMA CITY, OK. FILED 11-18-2011.

OWNER OF U.S. REG. NOS. 2,951,647 AND 2,959,733.
THE MARK CONSISTS OF THE WORD "EDGE" IN STYLIZED LETTERS.

FOR PROMOTING BUSINESS AND ECONOMIC DEVELOPMENT IN THE STATE OF OKLAHOMA, INCLUDING PROMOTING OKLAHOMA'S SCIENTIFIC AND TECHNOLOGICAL ADVANTAGES FOR BUSINESS (U.S. CLS. 100, 101 AND 102).

FIRST USE 11-0-2009; IN COMMERCE 11-0-2009.
KRISTINA MORRIS, EXAMINING ATTORNEY

SN 85-474,882. SWAPS MONITOR PUBLICATIONS, INC., NEW YORK, NY. FILED 11-17-2011.



NO CLAIM IS MADE TO THE EXCLUSIVE RIGHT TO USE "FINANCIAL CALENDAR", APART FROM THE MARK AS SHOWN.

THE MARK CONSISTS OF A DESIGN OF THE SUN AND MOON WITH THE SUN COMPOSED OF CURVED CONCENTRIC BANDS AND THE MOON COMPOSED OF CONCENTRIC CIRCLES AND THE WORDS "FINANCIAL CALENDAR".

FOR PROVIDING DATA CONCERNING HOLIDAYS, TRADING HOURS, TIME ZONES, EXPIRATION DATES AND TIMES FOR FUTURES AND OPTIONS, AND OTHER INFORMATION THAT MAY AFFECT THE TRADING SCHEDULE OF FINANCIAL MARKET TRANSACTIONS (U.S. CLS. 100, 101 AND 102).

FIRST USE 9-0-2010, THE MARK WAS FIRST USED ANYWHERE IN A DIFFERENT FORM OTHER THAN THAT SOUGHT TO BE REGISTERED AT LEAST AS EARLY AS 00/00/1998.; IN COMMERCE 9-0-2010, THE MARK WAS FIRST USED IN COMMERCE IN A DIFFERENT FORM OTHER THAN THAT SOUGHT TO BE REGISTERED AT LEAST AS EARLY AS 00/00/1998..

AMY HELLA, EXAMINING ATTORNEY

SN 85-478,048. RAAB SALES, INC., LENEXA, KS. FILED 11-21-2011.

THE MARK CONSISTS OF STANDARD CHARACTERS WITHOUT CLAIM TO ANY PARTICULAR FONT, STYLE, SIZE, OR COLOR.

OWNER OF U.S. REG. NO. 3,229,883.
NO CLAIM IS MADE TO THE EXCLUSIVE RIGHT TO USE "SALES", APART FROM THE MARK AS SHOWN.
SEC. 2(F).

FOR DISTRIBUTORSHIPS IN THE FIELD OF LABELING EQUIPMENT, CODING EQUIPMENT, MARKING EQUIPMENT AND SHIPPING ROOM SUPPLIES (U.S. CLS. 100, 101 AND 102).

FIRST USE 0-0-1960; IN COMMERCE 0-0-1960.
ERIN FALK, EXAMINING ATTORNEY

CLASS 35—(Continued).

SN 85-481,749. EDUCATIONAL DATA SYSTEMS INCORPORATED, DEARBORN, MI. FILED 11-28-2011.

EDSI Solutions

THE MARK CONSISTS OF STANDARD CHARACTERS WITHOUT CLAIM TO ANY PARTICULAR FONT, STYLE, SIZE, OR COLOR.

NO CLAIM IS MADE TO THE EXCLUSIVE RIGHT TO USE "SOLUTIONS", APART FROM THE MARK AS SHOWN.

FOR CONSULTATION AND ANALYSIS REGARDING EMPLOYMENT AND JOB SKILLS, NAMELY, CONSULTATION IN THE FIELD OF HUMAN RESOURCES AND WORKFORCE DEVELOPMENT IN THE NATURE OF PERSONNEL MANAGEMENT (U.S. CLS. 100, 101 AND 102).

FIRST USE 1-31-2009; IN COMMERCE 1-31-2009.
LINDA ESTRADA, EXAMINING ATTORNEY

CLASS 35—(Continued).

SN 85-482,433. CAMOFIRE, L.L.C., HIGHLAND, UT. FILED 11-29-2011.

BLACKOVIS

THE MARK CONSISTS OF STANDARD CHARACTERS WITHOUT CLAIM TO ANY PARTICULAR FONT, STYLE, SIZE, OR COLOR.

FOR ON-LINE RETAIL STORE SERVICES FEATURING HUNTING-RELATED MERCHANDISE (U.S. CLS. 100, 101 AND 102).

JASON TURNER, EXAMINING ATTORNEY

SN 85-482,559. ACE HARDWARE CORPORATION, OAK BROOK, IL. FILED 11-29-2011.

PROUDLY LOCAL

THE MARK CONSISTS OF STANDARD CHARACTERS WITHOUT CLAIM TO ANY PARTICULAR FONT, STYLE, SIZE, OR COLOR.

NO CLAIM IS MADE TO THE EXCLUSIVE RIGHT TO USE "LOCAL", APART FROM THE MARK AS SHOWN.

FOR RETAIL STORE SERVICES IN THE FIELD OF HARDWARE AND RELATED GOODS (U.S. CLS. 100, 101 AND 102).

KATHLEEN LORENZO, EXAMINING ATTORNEY

SN 85-484,470. DISCOUNT OPTICS, INC. BOCA RATON, FL. FILED 12-1-2011.

I want to give everything
away, but my wife won't
let me!

THE MARK CONSISTS OF STANDARD CHARACTERS WITHOUT CLAIM TO ANY PARTICULAR FONT, STYLE, SIZE, OR COLOR.

FOR WHOLESALE DISTRIBUTORSHIPS FEATURING OPTICAL SUPPLIES, DENTAL SUPPLIES, AND MEDICAL SUPPLIES, NAMELY, PROVIDING PRODUCTS AND PROMOTIONAL SERVICES FOR OPTICAL OFFICES, MEDICAL OFFICES, RETAIL STORES, AND DENTAL OFFICES (U.S. CLS. 100, 101 AND 102).

FIRST USE 0-0-1993; IN COMMERCE 0-0-1993.
DORITT L. CARROLL, EXAMINING ATTORNEY

SN 85-481,970. VIRGINBEE INC., LAS VEGAS, NV. FILED S.R. 11-28-2011; AM. P.R. 11-28-2011.



VIRGINBEE

THE MARK CONSISTS OF A COMB SHAPED LOGO (HEXAGON), INSIDE THE LETTER "V" IN THE MIDDLE AND THE WORD VIRGINBEE OUTSIDE.

FOR ON-LINE RETAIL GIFT SHOPS; ON-LINE RETAIL STORE SERVICES FEATURING A WIDE VARIETY OF CONSUMER GOODS OF OTHERS; ON-LINE RETAIL STORE SERVICES FEATURING ORIGINAL AND UNIQUE DESIGNED ITEMS SUCH AS JEWELRY AND EMBROIDERED PATCHES; OPERATING AN ON-LINE SHOPPING SITE IN THE FIELD OF GOODS SUCH AS JEWELRY, EMBROIDERED PATCHES, WATCHES, GIFTS AND COLLECTIBLES; RETAIL APPAREL STORES; RETAIL GIFT SHOPS; RETAIL JEWELRY STORES (U.S. CLS. 100, 101 AND 102).

FIRST USE 1-1-2010; IN COMMERCE 1-1-2010.
ROBIN CHOSID, EXAMINING ATTORNEY

CLASS 35—(Continued).

SN 85-486,614. MAVERICK ANGELS, LLC, AGOURA HILLS, CA. FILED 12-4-2011.

Maverick Angels Virtual Investor Network

THE MARK CONSISTS OF STANDARD CHARACTERS WITHOUT CLAIM TO ANY PARTICULAR FONT, STYLE, SIZE, OR COLOR.

OWNER OF U.S. REG. NO. 3,932,682.

NO CLAIM IS MADE TO THE EXCLUSIVE RIGHT TO USE "VIRTUAL INVESTOR NETWORK", APART FROM THE MARK AS SHOWN.

FOR BUSINESS SERVICES, NAMELY, MATCHING POTENTIAL PRIVATE INVESTORS WITH ENTREPRENEURS NEEDING FUNDING; ALL THE FOREGOING NOT RELATING TO SPORTS OR A SPORTS TEAM (U.S. CLS. 100, 101 AND 102).

WILLIAM VERHOSEK, EXAMINING ATTORNEY

SN 85-488,940. CONCIERGE AUCTIONS LLC, NEW YORK, NY. FILED 12-6-2011.

INSTANT GAVEL

THE MARK CONSISTS OF STANDARD CHARACTERS WITHOUT CLAIM TO ANY PARTICULAR FONT, STYLE, SIZE, OR COLOR.

FOR REAL ESTATE AUCTION SERVICES; ON-LINE AUCTION SERVICES; ON-LINE REAL ESTATE AUCTION SERVICES (U.S. CLS. 100, 101 AND 102).

FIRST USE 6-30-2011; IN COMMERCE 6-30-2011.

REGINA DRUMMOND, EXAMINING ATTORNEY

SN 85-488,941. CANOE VENTURES, LLC, NEW YORK, NY. FILED 12-6-2011.



OWNER OF U.S. REG. NOS. 3,832,479 AND 3,832,480.
THE MARK CONSISTS OF CANOE WITH OVERLAPPING SQUARES DESIGN AROUND THE LETTERS C, A AND N.
FOR ADVERTISING SERVICES OVER TELECOMMUNICATIONS NETWORKS (U.S. CLS. 100, 101 AND 102).
ZACHARY CROMER, EXAMINING ATTORNEY

CLASS 35—(Continued).

SN 85-489,321. CANCER CAN'T GET ME, LEESBURG, VA. FILED 12-7-2011.

CANCER CAN'T GET ME

THE MARK CONSISTS OF STANDARD CHARACTERS WITHOUT CLAIM TO ANY PARTICULAR FONT, STYLE, SIZE, OR COLOR.

FOR CHARITABLE SERVICES, NAMELY, ORGANIZING AND COORDINATING VOLUNTEER PROGRAMS TO SUPPORT CANCER PATIENTS AND THEIR FAMILIES (U.S. CLS. 100, 101 AND 102).

CHRISTOPHER LAW, EXAMINING ATTORNEY

SN 85-489,336. CANCER CAN'T GET ME, LEESBURG, VA. FILED 12-7-2011.



THE MARK CONSISTS OF A BULLSEYE SURROUNDED BY A WREATH OF LOOPED RIBBONS AND TWO CIRCLES WITH THE WORDS "CANCER CAN'T GET ME" BETWEEN THEM.

FOR CHARITABLE SERVICES, NAMELY, ORGANIZING AND COORDINATING VOLUNTEER PROGRAMS TO SUPPORT CANCER PATIENTS AND THEIR FAMILIES (U.S. CLS. 100, 101 AND 102).

CHRISTOPHER LAW, EXAMINING ATTORNEY

CLASS 35—(Continued).

SN 85-489,374. BARRY SHORE, SANTA MONICA, CA. FILED 12-7-2011.



THE MARK CONSISTS OF LETTERS "YNL" ABOVE AN ELONGATED RIBBON WITH A BOW IN THE MIDDLE AND THE WORDS "YOU NEVER LOSE.COM" BELOW THE RIBBON.

FOR ON-LINE RETAIL STORE SERVICES FEATURING GIFT CARDS FOR USE AT VARIOUS THIRD PARTY MERCHANTS; AUCTIONING OF GIFT CARDS FOR USE AT VARIOUS THIRD PARTY MERCHANTS VIA THE INTERNET (U.S. CLS. 100, 101 AND 102).
PAM WILLIS, EXAMINING ATTORNEY

SN 85-489,471. SWITCH MONKEY LLC, PALM BEACH GARDENS, FL. FILED 12-7-2011.



THE COLOR(S) RED, ORANGE, YELLOW, TAN, BROWN, FUCHSIA, BLACK, WHITE IS/ARE CLAIMED AS A FEATURE OF THE MARK.

THE MARK CONSISTS OF THE WORDS "SWITCH MONKEY" LAID OUT HORIZONTALLY, IN STYLIZED TEXT, CONSISTING OF UPPER AND LOWER CASE LETTERS AS EXACTLY SHOWN HERE: "SWITCH MONKEY". THE WORD "SWITCH" DISPLAYS A COLOR TRANSITION FROM TOP TO BOTTOM IN THIS ORDER: RED TO ORANGE TO YELLOW, AND THE WORD "MONKEY" DISPLAYS A COLOR TRANSITION FROM BOTTOM TO TOP IN THIS ORDER: YELLOW TO ORANGE TO RED. AN ILLUSTRATED IMAGE OF A MONKEY SEPARATES THE WORDS "SWITCH" AND "MONKEY". THE ILLUSTRATED MONKEY IS CREATED IN THE COLORS OF BROWN, TAN, WHITE, BLACK AND FUCHSIA. THE MONKEY HAS A TAN FACE OUTLINED IN BROWN. THE FACE IS SEPARATED INTO UPPER AND LOWER AREAS. IN THE LOWER AREA, THE MONKEY'S MOUTH IS OPEN DISPLAYING A SMILE AND A WHITE TONGUE ON A FUCHSIA BACKGROUND. IN THE UPPER AREA, THE MONKEY HAS TWO BLACK EYES AND THREE BROWN TRIANGLES ON TOP OF ITS HEAD INDICATING SPIKES OF BROWN FUR. THE MONKEY HAS TWO TAN EARS OUTLINED IN BROWN. THE MONKEY HAS TWO ARMS AND TWO HANDS. LOOKING AT THE MONKEY, THE LEFT ARM IS CURVED AND REACHES OVERHEAD. THE FOREFINGER ON THE LEFT HAND POINTS TO THE RIGHT. THE RIGHT ARM IS CURVED AND REACHES DOWNWARD. THE FOREFINGER ON THE RIGHT HAND POINTS TO THE LEFT.

FOR PROVIDING A WEBSITE FEATURING AN ON-LINE MARKETPLACE FOR EXCHANGING GOODS AND SERVICES WITH OTHER USERS; PROVIDING A WEBSITE FOR CONNECTING SELLERS WITH BUYERS (U.S. CLS. 100, 101 AND 102).
LAKEISHA LEWIS, EXAMINING ATTORNEY

CLASS 35—(Continued).

SN 85-492,382. FOGG LLC, DENVER, CO. FILED 12-11-2011.

make ideas real

THE MARK CONSISTS OF STANDARD CHARACTERS WITHOUT CLAIM TO ANY PARTICULAR FONT, STYLE, SIZE, OR COLOR.

FOR BUSINESS CONSULTATION SERVICES (U.S. CLS. 100, 101 AND 102).

FIRST USE 12-11-2011; IN COMMERCE 12-11-2011.

KAREN K. BUSH, EXAMINING ATTORNEY

SN 85-493,313. THIRD STREET WORKS, LLC, SAN FRANCISCO, CA. FILED 12-12-2011.

Farm + Cellar

THE MARK CONSISTS OF STANDARD CHARACTERS WITHOUT CLAIM TO ANY PARTICULAR FONT, STYLE, SIZE, OR COLOR.

FOR ADVERTISING AND MARKETING SERVICES, NAMELY, PROMOTING THE GOODS AND SERVICES OF OTHERS (U.S. CLS. 100, 101 AND 102).

FIRST USE 5-23-2011; IN COMMERCE 5-23-2011.

CHRISTINA SOBRAL, EXAMINING ATTORNEY

SN 85-493,966. INTERNATIONAL COLORED GEMSTONE ASSOCIATION, NEW YORK, NY. FILED 12-13-2011.

International Colored Gemstone Association

THE MARK CONSISTS OF STANDARD CHARACTERS WITHOUT CLAIM TO ANY PARTICULAR FONT, STYLE, SIZE, OR COLOR.

NO CLAIM IS MADE TO THE EXCLUSIVE RIGHT TO USE "COLORED GEMSTONE ASSOCIATION", APART FROM THE MARK AS SHOWN.

SEC. 2(F).

FOR PROVIDING A WEBSITE FEATURING INFORMATION RELATED TO BUSINESS ISSUES IN THE COLORED GEMSTONE INDUSTRY; PROVIDING A WEBSITE WHICH PROMOTES THE PUBLIC AWARENESS OF ISSUES CONCERNING THE COLORED GEMSTONE, MINING, GEMOLOGY, JEWELRY AND FASHION INDUSTRIES (U.S. CLS. 100, 101 AND 102).

FIRST USE 4-30-1984; IN COMMERCE 4-30-1984.

JEFFREY LOOK, EXAMINING ATTORNEY

CLASS 35—(Continued).

SN 85-494,460. KELLY-SCHIPPER, KIRSTIE, EL SEGUNDO, CA. FILED 12-13-2011.

BORROW ME

THE MARK CONSISTS OF STANDARD CHARACTERS WITHOUT CLAIM TO ANY PARTICULAR FONT, STYLE, SIZE, OR COLOR.

FOR MAIL ORDER SERVICES FEATURING BRIDAL WEAR, BRIDESMAID WEAR, MOTHER OF THE BRIDE WEAR, FLOWER GIRL WEAR (U.S. CLS. 100, 101 AND 102).

ANGELA DUONG, EXAMINING ATTORNEY

SN 85-496,933. BLUEHORNET NETWORKS, INC., SAN DIEGO, CA. FILED 12-15-2011.

SocialLoop

THE MARK CONSISTS OF STANDARD CHARACTERS WITHOUT CLAIM TO ANY PARTICULAR FONT, STYLE, SIZE, OR COLOR.

FOR ADVERTISING SERVICES IN THE NATURE OF PROVIDING INFORMATION ABOUT GOODS AND SERVICES OF OTHERS THROUGH SOFTWARE THAT PROVIDES A PLATFORM OF WIDGETS FOR SHARING E-MAILS AND SUBSCRIBING TO E-MAIL LISTS; DESIGNING FOR OTHERS OF ADVERTISING AND MARKETING MATERIALS DELIVERED VIA E-MAIL OR THE INTERNET; TRANSMISSION OF ADVERTISING AND MARKETING TRANSACTIONAL MESSAGES OF OTHERS VIA EMAIL OR THE INTERNET WITH SEGMENTATION BASED ON SHARING ACTIVITIES OF E-MAIL SUBSCRIBERS IN ON-LINE COMMUNITIES; COMPUTER SERVICES, NAMELY, ELECTRONICALLY MONITORING, REPORTING, AND ANALYZING E-MAIL SHARING ACTIVITIES OF SUBSCRIBERS IN ON-LINE COMMUNITIES IN CONNECTION WITH ADVERTISING, MARKETING, AND PROMOTIONAL CAMPAIGNS OR OTHERS (U.S. CLS. 100, 101 AND 102).

FIRST USE 7-15-2010; IN COMMERCE 11-16-2010.

AISHA CLARKE, EXAMINING ATTORNEY

CLASS 35—(Continued).

SN 85-497,582. LE GARAGE SALE, L.L.C., AUSTIN, TX. FILED 12-16-2011.

Le Garage Sale

THE MARK CONSISTS OF STANDARD CHARACTERS WITHOUT CLAIM TO ANY PARTICULAR FONT, STYLE, SIZE, OR COLOR.

THE ENGLISH TRANSLATION OF "LE" IN THE MARK IS THE.

FOR THE BRINGING TOGETHER, FOR THE BENEFIT OF OTHERS, OF A VARIETY OF GOODS FROM LOCAL RETAIL CLOTHING BOUTIQUES, AND ENABLING CUSTOMERS TO CONVENIENTLY VIEW AND PURCHASE SUCH GOODS IN A CONVENTION ARENA SETTING (U.S. CLS. 100, 101 AND 102).

FIRST USE 12-6-2010; IN COMMERCE 12-6-2010.

DAVID ELTON, EXAMINING ATTORNEY

SN 85-498,332. WOODBURY AUTOMOTIVE WAREHOUSE, LLC, AMITYVILLE, NY. FILED 12-19-2011.

**WOODBURY AUTOMOTIVE
WAREHOUSE**

THE MARK CONSISTS OF STANDARD CHARACTERS WITHOUT CLAIM TO ANY PARTICULAR FONT, STYLE, SIZE, OR COLOR.

NO CLAIM IS MADE TO THE EXCLUSIVE RIGHT TO USE "AUTOMOTIVE WAREHOUSE", APART FROM THE MARK AS SHOWN.

SEC. 2(F).

FOR DISTRIBUTORSHIP SERVICES IN THE FIELD OF AUTOMOBILE REPLACEMENT PARTS (U.S. CLS. 100, 101 AND 102).

FIRST USE 1-1-1971; IN COMMERCE 1-1-1971.

MYRIAH HABEEB, EXAMINING ATTORNEY

CLASS 35—(Continued).

SN 85-498,382. DIGITAL AUTOMOTIVE TECHNOLOGIES, INC., HICKORY, NC. FILED 12-19-2011.

PROSPECT VISION

THE MARK CONSISTS OF STANDARD CHARACTERS WITHOUT CLAIM TO ANY PARTICULAR FONT, STYLE, SIZE, OR COLOR.

NO CLAIM IS MADE TO THE EXCLUSIVE RIGHT TO USE "PROSPECT", APART FROM THE MARK AS SHOWN. FOR BUSINESS MARKETING CONSULTING, NAMELY, DEVELOPING MARKETING PROGRAMS FOR VEHICLE DEALERS THAT INVOLVE ASSESSING A POTENTIAL CUSTOMER'S EQUITY IN AN EXISTING VEHICLE AND THEN CONTACTING THAT CUSTOMER WITH TARGETED MARKETING MESSAGES REGARDING THE PURCHASE OF A NEW VEHICLE (U.S. CLS. 100, 101 AND 102).

FIRST USE 2-12-2002; IN COMMERCE 6-1-2002.
DORITT L. CARROLL, EXAMINING ATTORNEY

CLASS 35—(Continued).

SN 85-503,202. DATA RESEARCH NETWORK, INC., ELK GROVE, CA. FILED 12-23-2011.

eDimensionCRM

THE MARK CONSISTS OF STANDARD CHARACTERS WITHOUT CLAIM TO ANY PARTICULAR FONT, STYLE, SIZE, OR COLOR.

FOR BUSINESS MANAGEMENT SERVICES; BUSINESS MANAGEMENT CONSULTATION SERVICES; CUSTOMER RELATIONSHIP MANAGEMENT SERVICES; MARKETING SERVICES; MARKETING RESEARCH SERVICES; BUSINESS MANAGEMENT SERVICES IN THE FIELD OF EMPLOYEE EFFICIENCY; PROVIDING A WEBSITE FEATURING INFORMATION IN THE FIELDS OF ADVERTISING AND MARKETING (U.S. CLS. 100, 101 AND 102).

FIRST USE 6-1-2010; IN COMMERCE 6-1-2010.
HOWARD B. LEVINE, EXAMINING ATTORNEY

SN 85-502,606. ICHRISTIANBIZ INC., GRANT PARK, IL. FILED 12-22-2011.

**iChristianbiz.com God's
people at your service**

THE MARK CONSISTS OF STANDARD CHARACTERS WITHOUT CLAIM TO ANY PARTICULAR FONT, STYLE, SIZE, OR COLOR.

NO CLAIM IS MADE TO THE EXCLUSIVE RIGHT TO USE "ICHRISTIANBIZ.COM", APART FROM THE MARK AS SHOWN.

FOR PROVIDING AN ON-LINE CHRISTIAN BUSINESS DIRECTORY, WHERE CHRISTIAN BUSINESS OWNERS LIST THEIR BUSINESS AND SERVICES SO CUSTOMERS CAN FIND THEM ONLINE (U.S. CLS. 100, 101 AND 102).

WARREN L. OLANDRIA, EXAMINING ATTORNEY

SN 85-503,627. MYPERFECTGIFT.COM, LLC, NAPA, CA. FILED 12-25-2011.

**It's better to give than
to guess**

THE MARK CONSISTS OF STANDARD CHARACTERS WITHOUT CLAIM TO ANY PARTICULAR FONT, STYLE, SIZE, OR COLOR.

FOR GIFT REGISTRY SERVICES (U.S. CLS. 100, 101 AND 102).

FIRST USE 12-22-2011; IN COMMERCE 12-22-2011.
FRANK LATTUCA, EXAMINING ATTORNEY

CLASS 35—(Continued).

SN 85-504,380. DGWB, INC., SANTA ANA, CA. FILED 12-27-2011.

TRUSTPULSE INDEX

THE MARK CONSISTS OF STANDARD CHARACTERS WITHOUT CLAIM TO ANY PARTICULAR FONT, STYLE, SIZE, OR COLOR.

NO CLAIM IS MADE TO THE EXCLUSIVE RIGHT TO USE "INDEX", APART FROM THE MARK AS SHOWN.

FOR BUSINESS RESEARCH AND SURVEYS IN THE FIELDS OF BUSINESS DEVELOPMENT, MARKETING AND CUSTOMER RELATIONSHIP MANAGEMENT; BUSINESS AND MARKET ANALYSIS AND RESEARCH SERVICES; BUSINESS CONSULTING SERVICES IN THE FIELDS OF BUSINESS DEVELOPMENT, MARKETING AND CUSTOMER RELATIONSHIP MANAGEMENT; BUSINESS EVALUATION OF THE DEVELOPMENT, STABILITY AND MAINTENANCE OF RELATIONSHIPS BETWEEN BUSINESS BRAND OWNERS AND THEIR CUSTOMERS, AND BUSINESS EVALUATION OF CUSTOMERS' PERCEPTIONS OF SUCH BUSINESS BRAND OWNERS AND BRAND EVALUATION SERVICES (U.S. CLS. 100, 101 AND 102).

CHARISMA HAMPTON, EXAMINING ATTORNEY

SN 85-505,774. ITS FINANCIAL, LLC, DAYTON, OH. FILED 12-29-2011.

EVERYBODY GETS A CHECK

THE MARK CONSISTS OF STANDARD CHARACTERS WITHOUT CLAIM TO ANY PARTICULAR FONT, STYLE, SIZE, OR COLOR.

FOR INCOME TAX CONSULTATION; INCOME TAX PREPARATION (U.S. CLS. 100, 101 AND 102).

FIRST USE 12-31-2009; IN COMMERCE 12-31-2009.
CHRISTOPHER SIDOTI, EXAMINING ATTORNEY

SN 85-506,830. LACEY, DANIEL V., BUDD LAKE, NJ. FILED 12-31-2011.

**BUY HERE PAY HERE \$75
WEEKLY PAYMENTS EMPIRE
AUTO SALES**

THE MARK CONSISTS OF STANDARD CHARACTERS WITHOUT CLAIM TO ANY PARTICULAR FONT, STYLE, SIZE, OR COLOR.

NO CLAIM IS MADE TO THE EXCLUSIVE RIGHT TO USE "BUY HERE PAY HERE \$75 WEEKLY PAYMENTS" AND "AUTO SALES", APART FROM THE MARK AS SHOWN.

FOR AUTOMOBILE DEALERSHIPS (U.S. CLS. 100, 101 AND 102).

FIRST USE 9-1-2011; IN COMMERCE 9-1-2011.
DAVID MURRAY, EXAMINING ATTORNEY

CLASS 35—(Continued).

SN 85-507,589. SUCCESSETC.COM LLC, BOISE, ID. FILED 1-3-2012.

SuccessEtc

THE MARK CONSISTS OF STANDARD CHARACTERS WITHOUT CLAIM TO ANY PARTICULAR FONT, STYLE, SIZE, OR COLOR.

FOR ON-LINE RETAIL STORE SERVICES FEATURING BOOKS, E-BOOKS AND MANUALS IN THE FIELD OF MARKETING, INVESTING AND BUSINESS, AND PROVIDING AN INTERNET WEBSITE PORTAL IN THE FIELD OF MARKETING AND BUSINESS; PROMOTING THE GOODS AND SERVICES OF OTHERS BY PROVIDING A WEBSITE FEATURING DISCOUNT VOUCHERS, REBATES, PRICE-COMPARISON INFORMATION, PRODUCT AND SERVICE REVIEWS AND DISCOUNT INFORMATION (U.S. CLS. 100, 101 AND 102).

FIRST USE 2-1-2011; IN COMMERCE 5-1-2011.
RENEE MCCRAY, EXAMINING ATTORNEY

SN 85-508,968. LENIA JONES, DBA THE GREAT JONES COMPANY, NEW YORK, NY. FILED 1-4-2012.

THE COLOR(S) BLACK AND PURPLISH-GRAY IS/ARE CLAIMED AS A FEATURE OF THE MARK.

THE MARK CONSISTS OF THE WORDING "GREAT JONES" IN A STYLIZED FONT WITH THE WORD "JONES" SPACED OUT IN BLACK LETTERS AND THE WORD "GREAT" IN SMALLER-SIZED FONT IN A PURPLISH GRAY COLOR AND POSITIONED DIAGONALLY AGAINST THE "N" IN "JONES".

FOR ADVERTISING AGENCIES; ADVERTISING AGENCIES, NAMELY, PROMOTING THE GOODS AND SERVICES OF OTHERS; ADVERTISING AND PROMOTION SERVICES AND RELATED CONSULTING; ADVERTISING COPYWRITING; ADVERTISING SERVICES; ADVERTISING SERVICES, NAMELY, CREATING CORPORATE AND BRAND IDENTITY FOR OTHERS; ADVERTISING SERVICES, NAMELY, PROMOTING THE BRANDS, GOODS AND SERVICES OF OTHERS; BRAND CONCEPT AND BRAND DEVELOPMENT SERVICES FOR CORPORATE AND INDIVIDUAL CLIENTS; BRAND IMAGERY CONSULTING SERVICES; BRANDING SERVICES, NAMELY, CONSULTING, DEVELOPMENT, MANAGEMENT AND MARKETING OF BRANDS FOR BUSINESSES; BUSINESS CONSULTING SERVICES, NAMELY, PROVIDING ASSISTANCE IN DEVELOPMENT OF BUSINESS STRATEGIES AND CREATIVE IDEATION; CREATING AND UPDATING ADVERTISING MATERIAL; DESIGN OF ADVERTISING MATERIALS FOR OTHERS; MARKETING AND BRANDING SERVICES, NAMELY, PROVIDING CUSTOMIZED COMMUNICATION PROGRAMS TO OBTAIN CONSUMER INSIGHTS AND DEVELOP BRANDING STRATEGIES; PROVIDING ADVERTISING, MARKETING AND PROMOTIONAL SERVICES, NAMELY, DEVELOPMENT OF ADVERTISING CAMPAIGNS FOR PRINT MEDIA AND TELEVISION (U.S. CLS. 100, 101 AND 102).

RENEE MCCRAY, EXAMINING ATTORNEY

CLASS 35—(Continued).

SN 85-509,375. GROCERY OUTLET INC., BERKELEY, CA. FILED 1-5-2012.

AMELIA'S GROCERY OUTLET

THE MARK CONSISTS OF STANDARD CHARACTERS WITHOUT CLAIM TO ANY PARTICULAR FONT, STYLE, SIZE, OR COLOR.

NO CLAIM IS MADE TO THE EXCLUSIVE RIGHT TO USE "GROCERY OUTLET", APART FROM THE MARK AS SHOWN.

FOR RETAIL AND WHOLESALE GROCERY STORE SERVICES (U.S. CLS. 100, 101 AND 102).

FIRST USE 8-31-1989; IN COMMERCE 8-31-1989.
JENNIFER VASQUEZ, EXAMINING ATTORNEY

SN 85-510,382. TERESA M. WHITE, MIDDLEBURG, FL. FILED S.R. 1-6-2012; AM. P.R. 4-19-2012.

MartiniRedd

NO CLAIM IS MADE TO THE EXCLUSIVE RIGHT TO USE "MARTINI", APART FROM THE MARK AS SHOWN.

THE MARK CONSISTS OF THE PHRASE "MARTINIREDD". THE "M" IN "MARTINIREDD" IS CAPITALIZED. THE SECOND "R" IN "MARTINIREDD" IS CAPITALIZED.

FOR ADVERTISING, MARKETING AND PROMOTIONAL SERVICES RELATED TO ALL INDUSTRIES FOR THE PURPOSE OF FACILITATING NETWORKING AND SOCIALIZING OPPORTUNITIES FOR BUSINESS PURPOSES (U.S. CLS. 100, 101 AND 102).

FIRST USE 9-19-2011; IN COMMERCE 9-19-2011.
ELI HELLMAN, EXAMINING ATTORNEY

SN 85-511,580. GRANZOW INC., CHARLOTTE, NC. FILED 1-9-2012.

GRANZOW

THE MARK CONSISTS OF STANDARD CHARACTERS WITHOUT CLAIM TO ANY PARTICULAR FONT, STYLE, SIZE, OR COLOR.

SEC. 2(F).
FOR INDEPENDENT SALES REPRESENTATIVES IN THE FIELD OF FLUID CONTROLS (U.S. CLS. 100, 101 AND 102).

FIRST USE 4-1-1979; IN COMMERCE 4-1-1979.
RONALD MCMORROW, EXAMINING ATTORNEY

CLASS 35—(Continued).

SN 85-512,092. VALPAK DIRECT MARKETING SYSTEMS, INC., LARGO, FL. FILED 1-9-2012.

GREAT SAVINGS FOR A GREAT CAUSE

THE MARK CONSISTS OF STANDARD CHARACTERS WITHOUT CLAIM TO ANY PARTICULAR FONT, STYLE, SIZE, OR COLOR.

FOR ADVERTISING FOR CHARITIES; PROMOTING CHARITIES VIA THE WEB; ADVERTISING SERVICES FOR THE PROMOTION AND SALE OF GOODS, PRODUCTS AND/OR SERVICES OF OTHERS (U.S. CLS. 100, 101 AND 102).

JAMES GRIFFIN, EXAMINING ATTORNEY

SN 85-513,354. SALES SOLVE EVERYTHING LLC, PLANO, TX. FILED 1-10-2012.

SALES SOLVE EVERYTHING

THE MARK CONSISTS OF STANDARD CHARACTERS WITHOUT CLAIM TO ANY PARTICULAR FONT, STYLE, SIZE, OR COLOR.

NO CLAIM IS MADE TO THE EXCLUSIVE RIGHT TO USE "SALES", APART FROM THE MARK AS SHOWN.

FOR CONSULTING IN SALES TECHNIQUES AND SALES PROGRAMMES; CONSULTING IN THE FIELD OF SALES METHODS, SALES MANAGEMENT, AND SALES IMPROVEMENT (U.S. CLS. 100, 101 AND 102).

JEFFREY LOOK, EXAMINING ATTORNEY

SN 85-514,358. CALDERÓN, BYRON, EL PASO, TX. AND BLANCO, JERÓNIMO, CHULA VISTA, CA. AND CALLEROS, EDWARD, ESCONDIDO, CA. FILED 1-11-2012.

Brown Beret National Organization - Los Brown Berets

THE MARK CONSISTS OF STANDARD CHARACTERS WITHOUT CLAIM TO ANY PARTICULAR FONT, STYLE, SIZE, OR COLOR.

NO CLAIM IS MADE TO THE EXCLUSIVE RIGHT TO USE "NATIONAL ORGANIZATION", APART FROM THE MARK AS SHOWN.

FOR ASSOCIATION SERVICES, NAMELY, PROMOTING PUBLIC AWARENESS OF CIVIL RIGHTS AND SOCIAL JUSTICE ISSUES; PUBLIC ADVOCACY TO PROMOTE AWARENESS OF THE IMPORTANCE OF CIVIL RIGHTS AND SOCIAL JUSTICE (U.S. CLS. 100, 101 AND 102).

FIRST USE 9-21-1968; IN COMMERCE 9-21-1968.
ODESSA BIBBINS, EXAMINING ATTORNEY

CLASS 35—(Continued).

SN 85-516,222. SEEGRID CORPORATION, PITTSBURGH, PA. FILED 1-13-2012.

SEEGRID VIEW

THE MARK CONSISTS OF STANDARD CHARACTERS WITHOUT CLAIM TO ANY PARTICULAR FONT, STYLE, SIZE, OR COLOR.

FOR BUSINESS CONSULTING SERVICES IN THE FIELD OF FORKLIFT UTILIZATION AND WORKFLOW PATTERNS (U.S. CLS. 100, 101 AND 102).

ANDREW LEASER, EXAMINING ATTORNEY

SN 85-516,236. SEEGRID CORPORATION, PITTSBURGH, PA. FILED 1-13-2012.

VIEW

THE MARK CONSISTS OF STANDARD CHARACTERS WITHOUT CLAIM TO ANY PARTICULAR FONT, STYLE, SIZE, OR COLOR.

FOR BUSINESS CONSULTING SERVICES IN THE FIELD OF FORKLIFT UTILIZATION AND WORKFLOW PATTERNS (U.S. CLS. 100, 101 AND 102).

ANDREW LEASER, EXAMINING ATTORNEY

SN 85-516,286. NEW YORK NUMISMATIC CLUB, NEW YORK, NY. FILED 1-13-2012.

THE NEW YORK NUMISMATIC CLUB

THE MARK CONSISTS OF STANDARD CHARACTERS WITHOUT CLAIM TO ANY PARTICULAR FONT, STYLE, SIZE, OR COLOR.

NO CLAIM IS MADE TO THE EXCLUSIVE RIGHT TO USE "NUMISMATIC CLUB", APART FROM THE MARK AS SHOWN.

SEC. 2(F).

FOR ASSOCIATION SERVICES FOR PROMOTING THE INTERESTS OF COLLECTORS OF NUMISMATIC ITEMS AND FOR PROMOTING THE STUDY OF NUMISMATICS, NAMELY: COINS, MEDALS, PAPER CURRENCY, ORDERS, DECORATIONS, CERTIFICATES AND OTHER NUMISMATIC AND NUMISMATIC RELATED ITEMS (U.S. CLS. 100, 101 AND 102).

FIRST USE 12-11-1908; IN COMMERCE 12-11-1908.

JOHN E. MICHOS, EXAMINING ATTORNEY

CLASS 35—(Continued).

SN 85-516,778. BONOFFSKI, MELISSA, DBA STYLISH BLOOMS, BRISTOL, CT. FILED 1-14-2012.

Stylish Blooms

THE MARK CONSISTS OF STANDARD CHARACTERS WITHOUT CLAIM TO ANY PARTICULAR FONT, STYLE, SIZE, OR COLOR.

NO CLAIM IS MADE TO THE EXCLUSIVE RIGHT TO USE "BLOOMS", APART FROM THE MARK AS SHOWN. FOR RETAIL FLORIST SHOPS (U.S. CLS. 100, 101 AND 102).

FIRST USE 8-1-2008; IN COMMERCE 8-1-2008.

ESTHER A. BORSUK, EXAMINING ATTORNEY

SN 85-517,062. TOP PROMOTIONS, INC., MIDDLETON, WI. FILED 1-16-2012.

TOP PROMOTIONS

THE MARK CONSISTS OF STANDARD CHARACTERS WITHOUT CLAIM TO ANY PARTICULAR FONT, STYLE, SIZE, OR COLOR.

NO CLAIM IS MADE TO THE EXCLUSIVE RIGHT TO USE "PROMOTIONS", APART FROM THE MARK AS SHOWN.

FOR ADVERTISING, MARKETING, AND PROMOTING THE GOODS AND SERVICES OF OTHERS THROUGH THE DISTRIBUTION OF PROMOTIONAL MERCHANDISE; INVENTORY MANAGEMENT; ORDER FULFILLMENT SERVICES; WHOLESALE DISTRIBUTORSHIPS FEATURING GIFTS, APPAREL AND RELATED ACCESSORIES (U.S. CLS. 100, 101 AND 102).

FIRST USE 1-1-1983; IN COMMERCE 1-1-1983.

DEBORAH LOBO, EXAMINING ATTORNEY

CLASS 35—(Continued).

SN 85-517,442. OSTENFELD, LORI A., HOBOKEN, NJ. FILED 1-16-2012.



NO CLAIM IS MADE TO THE EXCLUSIVE RIGHT TO USE "HR CONCIERGE", APART FROM THE MARK AS SHOWN.

THE COLOR(S) DARK PURPLE, LAVENDER IS/ARE CLAIMED AS A FEATURE OF THE MARK.

THE MARK CONSISTS OF THE STYLIZED WORDING "THEHRCONCIERGE", WITH THE WORDING "THE" AND "CONCIERGE" APPEARING IN DARK PURPLE AND THE LETTERING "HR" APPEARING IN LAVENDER, ALL SET ABOVE THE STYLIZED WORDING "CREATIVE HR SOLUTIONS THAT IGNITE VISION, COLLABORATION AND CLIENT SATISFACTION" IN DARK PURPLE.

FOR CONSULTING SERVICES IN THE FIELDS OF BUSINESS MANAGEMENT, HUMAN RESOURCES, AND BUSINESS ORGANIZATIONAL DESIGN (U.S. CLS. 100, 101 AND 102).

FIRST USE 1-8-2012; IN COMMERCE 1-8-2012.
MICHAEL GAFFAR, EXAMINING ATTORNEY

CLASS 35—(Continued).

SN 85-519,036. INTERNATIONAL PAPER COMPANY, MEMPHIS, TN. FILED 1-18-2012.

HEALTHY CAMPUS

THE MARK CONSISTS OF STANDARD CHARACTERS WITHOUT CLAIM TO ANY PARTICULAR FONT, STYLE, SIZE, OR COLOR.

FOR BUSINESS CONSULTATION SERVICES IN THE FIELD OF JANITORIAL SERVICES AND FACILITY SUPPLIES, NAMELY, CLEANING AND JANITORIAL PRODUCTS; DISTRIBUTORSHIP SERVICES IN THE FIELD OF FACILITY SUPPLIES, NAMELY, CLEANING AND JANITORIAL PRODUCTS (U.S. CLS. 100, 101 AND 102).

MARC LEIPZIG, EXAMINING ATTORNEY

SN 85-519,052. INTERNATIONAL PAPER COMPANY, MEMPHIS, TN. FILED 1-18-2012.

HEALTHY FACILITY

THE MARK CONSISTS OF STANDARD CHARACTERS WITHOUT CLAIM TO ANY PARTICULAR FONT, STYLE, SIZE, OR COLOR.

FOR BUSINESS CONSULTATION SERVICES IN THE FIELD OF JANITORIAL SERVICES AND FACILITY SUPPLIES, NAMELY, CLEANING AND JANITORIAL PRODUCTS; DISTRIBUTORSHIP SERVICES IN THE FIELD OF FACILITY SUPPLIES, NAMELY, CLEANING AND JANITORIAL PRODUCTS (U.S. CLS. 100, 101 AND 102).

MARC LEIPZIG, EXAMINING ATTORNEY

SN 85-519,018. INTERNATIONAL PAPER COMPANY, MEMPHIS, TN. FILED 1-18-2012.

SN 85-519,649. MINERVA WORLDWIDE, INC., CARLSBAD, CA. FILED 1-18-2012.

HEALTHY BUILDING

ULTRA SMART DIET

THE MARK CONSISTS OF STANDARD CHARACTERS WITHOUT CLAIM TO ANY PARTICULAR FONT, STYLE, SIZE, OR COLOR.

FOR BUSINESS CONSULTATION SERVICES IN THE FIELD OF JANITORIAL SERVICES AND FACILITY SUPPLIES, NAMELY, CLEANING AND JANITORIAL PRODUCTS; DISTRIBUTORSHIP SERVICES IN THE FIELD OF FACILITY SUPPLIES, NAMELY, CLEANING AND JANITORIAL PRODUCTS (U.S. CLS. 100, 101 AND 102).

MARC LEIPZIG, EXAMINING ATTORNEY

THE MARK CONSISTS OF STANDARD CHARACTERS WITHOUT CLAIM TO ANY PARTICULAR FONT, STYLE, SIZE, OR COLOR.

NO CLAIM IS MADE TO THE EXCLUSIVE RIGHT TO USE "DIET", APART FROM THE MARK AS SHOWN.

FOR ON-LINE RETAIL STORE SERVICES FEATURING DIETARY, NUTRITIONAL, WEIGHT LOSS AND WELLNESS PRODUCTS; ON-LINE WHOLESALE STORE SERVICES FEATURING DIETARY, NUTRITIONAL, WEIGHT LOSS AND WELLNESS PRODUCTS (U.S. CLS. 100, 101 AND 102).

KAREN BRACEY, EXAMINING ATTORNEY

CLASS 35—(Continued).

SN 85-519,669. LEE BROOKE ROY, HALEIWA, HI. FILED 1-18-2012.

THE GROWING KEIKI

THE MARK CONSISTS OF STANDARD CHARACTERS WITHOUT CLAIM TO ANY PARTICULAR FONT, STYLE, SIZE, OR COLOR.

NO CLAIM IS MADE TO THE EXCLUSIVE RIGHT TO USE "KEIKI", APART FROM THE MARK AS SHOWN.

THE ENGLISH TRANSLATION OF "KEIKI" IN THE MARK IS "BABY" OR "CHILD".

FOR ON-LINE RETAIL STORE SERVICES FEATURING CHILDREN'S CLOTHING, BOOKS, AND GIFTS; RETAIL CLOTHING BOUTIQUES; RETAIL GIFT SHOPS; RETAIL STORE SERVICES FEATURING CHILDREN'S CLOTHING, BOOKS, AND GIFTS (U.S. CLS. 100, 101 AND 102).

FIRST USE 4-1-1987; IN COMMERCE 4-1-1987.
GENE MACIOL, EXAMINING ATTORNEY

CLASS 35—(Continued).

SN 85-519,922. KRAMER STAFFING SERVICES, WASHINGTON, DC. FILED 1-19-2012.



NO CLAIM IS MADE TO THE EXCLUSIVE RIGHT TO USE "STAFFING SERVICES", APART FROM THE MARK AS SHOWN.

THE MARK CONSISTS OF THE WORD "KRAMER" OVER THE WORDS "STAFFING SERVICES". TO THE RIGHT OF THE WORDS IS A STYLIZED PERSON AND A BRIEFCASE.

FOR EMPLOYMENT COUNSELING AND RECRUITING; EMPLOYMENT HIRING, RECRUITING, PLACEMENT, STAFFING AND CAREER NETWORKING SERVICES; PERSONNEL PLACEMENT AND RECRUITMENT; RECRUITMENT AND PLACEMENT OF PERSONNEL IN THE FIELDS OF LAW, TECHNOLOGY, ACCOUNTING, FINANCE, GOVERNMENT CONTRACTORS, NON-PROFITS, TRADE ASSOCIATIONS, HOSPITAL AND HEALTH CARE, REAL ESTATE, EDUCATION, HOSPITALITY (U.S. CLS. 100, 101 AND 102).

KEVIN DINALLO, EXAMINING ATTORNEY

SN 85-519,901. ABREU, DAVID BENJAMIN, BRONX, NY. FILED 1-19-2012.

Resume Body Shop

THE MARK CONSISTS OF STANDARD CHARACTERS WITHOUT CLAIM TO ANY PARTICULAR FONT, STYLE, SIZE, OR COLOR.

NO CLAIM IS MADE TO THE EXCLUSIVE RIGHT TO USE "RESUME", APART FROM THE MARK AS SHOWN.

FOR RESUME PREPARATION (U.S. CLS. 100, 101 AND 102).

MORGAN WYNNE, EXAMINING ATTORNEY

SN 85-519,965. BAUMGARTNER, TIMOTHY H., GLEN ALLEN, VA. FILED 1-19-2012.

iSpy iWant

THE MARK CONSISTS OF STANDARD CHARACTERS WITHOUT CLAIM TO ANY PARTICULAR FONT, STYLE, SIZE, OR COLOR.

FOR ON-LINE RETAIL STORE SERVICES FEATURING OUTDOOR EQUIPMENT, INSECTICIDES, PERSONAL ANTISEPTICS AND CONSUMER ELECTRONIC PRODUCTS (U.S. CLS. 100, 101 AND 102).

FIRST USE 1-1-2006; IN COMMERCE 7-1-2010.
ROSELLE HERRERA, EXAMINING ATTORNEY

CLASS 35—(Continued).

SN 85-520,793. THE SLEEP TRAIN, INC., ROCKLIN, CA.
FILED 1-19-2012.

CLASS 35—(Continued).

SN 85-520,803. THE SLEEP TRAIN, INC., ROCKLIN, CA.
FILED 1-19-2012.

THE MARK CONSISTS OF A LOCOMOTIVE WITH A LIGHT AND WITH STEAM EMITTING FROM THE TOP OF THE ENGINE IN A CIRCLE BACKGROUND.

FOR RETAIL FURNITURE STORES (U.S. CLS. 100, 101 AND 102).

FIRST USE 3-0-2008; IN COMMERCE 3-0-2008.
AMY KELLY, EXAMINING ATTORNEY

OWNER OF U.S. REG. NOS. 1,714,531, 1,715,817 AND 2,924,879.

NO CLAIM IS MADE TO THE EXCLUSIVE RIGHT TO USE "MATTRESS CENTERS", APART FROM THE MARK AS SHOWN.

THE MARK CONSISTS OF THE WORDS "SLEEP TRAIN" ABOVE THE WORDS "MATTRESS CENTERS", AND BETWEEN THE WORDS "SLEEP TRAIN" IS AN IMAGE OF THE FRONT OF A LOCOMOTIVE WITH STEAM EMITTING FROM THE TOP WITHIN A CIRCLE BACKGROUND. FOR RETAIL FURNITURE STORES (U.S. CLS. 100, 101 AND 102).

FIRST USE 2-0-2008; IN COMMERCE 2-0-2008.
AMY KELLY, EXAMINING ATTORNEY

SN 85-520,796. THE SLEEP TRAIN, INC., ROCKLIN, CA.
FILED 1-19-2012.

SN 85-520,853. FRANKLIN RESOURCE GROUP, INC., BOULDER, CO. FILED 1-19-2012.



FRANKLIN RETAIL SOLUTIONS

OWNER OF U.S. REG. NOS. 1,714,531 AND 1,715,817.
NO CLAIM IS MADE TO THE EXCLUSIVE RIGHT TO USE "OUTLET DEPOT STORE", APART FROM THE MARK AS SHOWN.

THE MARK CONSISTS OF THE WORDS "SLEEP TRAIN" ABOVE A RECTANGLE BOX DISPLAYING THE WORDING "OUTLET DEPOT STORE", WITH "DEPOT" IN STYLIZED FONT.

FOR RETAIL FURNITURE STORES (U.S. CLS. 100, 101 AND 102).

FIRST USE 2-0-2007; IN COMMERCE 2-0-2007.
AMY KELLY, EXAMINING ATTORNEY

THE MARK CONSISTS OF STANDARD CHARACTERS WITHOUT CLAIM TO ANY PARTICULAR FONT, STYLE, SIZE, OR COLOR.

NO CLAIM IS MADE TO THE EXCLUSIVE RIGHT TO USE "RETAIL SOLUTIONS", APART FROM THE MARK AS SHOWN.

FOR CONSULTING SERVICES, NAMELY, MARKETING AND SALES CONSULTING SERVICES TO RETAILERS OF SPORTING GOODS AND RECREATIONAL EQUIPMENT (U.S. CLS. 100, 101 AND 102).

FIRST USE 5-1-2010; IN COMMERCE 5-1-2010.
LAURA KOVALSKY, EXAMINING ATTORNEY

CLASS 35—(Continued).

SN 85-521,057. EZCFO, NEWARK, NJ. FILED 1-20-2012.



THE MARK CONSISTS OF THE WORDING "EZCFO" TO RIGHT OF A DESIGN THAT CONSISTS OF TWO CURVED CHECK MARKS AND THREE SHADED SQUARES.

FOR ACCOUNTING SERVICES; ADMINISTRATION OF BUSINESS PAYROLL FOR OTHERS; BOOKKEEPING; BUSINESS CONSULTING AND INFORMATION SERVICES (U.S. CLS. 100, 101 AND 102).

FIRST USE 10-10-2009; IN COMMERCE 1-1-2010.

SETH A. RAPPAPORT, EXAMINING ATTORNEY

SN 85-521,058. CRK II, LLC, ASHEVILLE, NC. FILED 1-20-2012.

FOOD MATTERS MARKET

THE MARK CONSISTS OF STANDARD CHARACTERS WITHOUT CLAIM TO ANY PARTICULAR FONT, STYLE, SIZE, OR COLOR.

NO CLAIM IS MADE TO THE EXCLUSIVE RIGHT TO USE "FOOD" AND "MARKET", APART FROM THE MARK AS SHOWN.

FOR RETAIL GROCERY STORE SERVICES (U.S. CLS. 100, 101 AND 102).

AMY HELLA, EXAMINING ATTORNEY

CLASS 35—(Continued).

SN 85-521,190. NATIONAL ORGANIZATION FOR THE PROFESSIONAL ADVANCEMENT OF BLACK CHEMISTS AND CHEMICAL ENGINEERS, INC., AKA NOBCCHE, AUSTELL, GA. FILED 1-20-2012.



OWNER OF U.S. REG. NO. 3,168,025.

NO CLAIM IS MADE TO THE EXCLUSIVE RIGHT TO USE "RESEARCH", APART FROM THE MARK AS SHOWN.

THE MARK CONSISTS OF TWO CONCENTRIC CIRCLES, WITH THE OUTER CIRCLE CONSISTING OF THE WORDS IN ALL CAPS FONT "WISDOM", "RESEARCH" AND "KNOWLEDGE" FROM CLOCKWISE LEFT TO RIGHT; WITHIN THE INNER CIRCLE IS THE INFINITY SYMBOL FOR WHICH IN ITS CENTER IS AN IMAGE OF A SMALL TEST TUBE.

FOR ASSOCIATION SERVICES, NAMELY, PROMOTING THE INTERESTS OF AFRICAN-AMERICAN CHEMISTS, CHEMICAL ENGINEERS AND STUDENTS OF THOSE DISCIPLINES (U.S. CLS. 100, 101 AND 102).

FIRST USE 4-0-1972; IN COMMERCE 3-0-1974.

TARAH HARDY, EXAMINING ATTORNEY

SN 85-521,876. DIABETICSUPPLIES.COM, INC., DBA SOCKS2SHOES, BATTLE GROUND, WA. FILED 1-20-2012.

Style Meets Comfort.

THE MARK CONSISTS OF STANDARD CHARACTERS WITHOUT CLAIM TO ANY PARTICULAR FONT, STYLE, SIZE, OR COLOR.

FOR ONLINE RETAIL STORE SERVICES AND RETAIL STORE SERVICES FEATURING FOOTWEAR, FOOT CARE PRODUCTS AND SOCKS (U.S. CLS. 100, 101 AND 102).

PAULA MAHONEY, EXAMINING ATTORNEY

CLASS 35—(Continued).

SN 85-522,595. 7TH INNING CORP, COOPERSTOWN, NY.
FILED 1-23-2012.



NO CLAIM IS MADE TO THE EXCLUSIVE RIGHT TO USE "COOPERSTOWN", APART FROM THE MARK AS SHOWN.

THE COLOR(S) RED, WHITE, AND BLUE IS/ARE CLAIMED AS A FEATURE OF THE MARK.

THE MARK CONSISTS OF "COOPERSTOWN" IN UPPER CASE AND BLUE WITH WHITE AND BLUE OUTLINE. THE "O" AFTER THE LETTER "T" IN "COOPERSTOWN" IS REPLACED WITH A WHITE BASEBALL WITH RED LACES. THE WORD "CONNECTION" IS UPPER CASE AND IS RED WITH WHITE AND BLUE OUTLINE.

FOR ON-LINE RETAIL STORE SERVICES FEATURING SPORTS MEMORABILIA; RETAIL STORE SERVICES FEATURING SPORTS MEMORABILIA (U.S. CLS. 100, 101 AND 102).

FIRST USE 5-6-2011; IN COMMERCE 5-6-2011.
KIMBERLY FRYE, EXAMINING ATTORNEY

SN 85-522,688. CALIFON PRODUCTIONS, INC., CULVER CITY, CA. FILED 1-23-2012.

WHEEL DEALS

THE MARK CONSISTS OF STANDARD CHARACTERS WITHOUT CLAIM TO ANY PARTICULAR FONT, STYLE, SIZE, OR COLOR.

OWNER OF U.S. REG. NOS. 950,508 AND 1,491,571.

NO CLAIM IS MADE TO THE EXCLUSIVE RIGHT TO USE "DEALS", APART FROM THE MARK AS SHOWN.

FOR PROVIDING INCENTIVE AWARD PROGRAMS DESIGNED TO REWARD PARTICIPANTS IN A LOYALTY PROGRAM DESIGNED TO PROMOTE VIEWERSHIP OF TELEVISION PROGRAMS (U.S. CLS. 100, 101 AND 102).

FIRST USE 10-26-2011; IN COMMERCE 10-26-2011.
REBECCA GILBERT, EXAMINING ATTORNEY

SN 85-522,835. SPAD'S TWISTERS SOFT-SERVE ICE CREAM, INC., EAST LANSING, MI. FILED 1-23-2012.

SPAD'S TWISTERS SOFT-SERVE ICE CREAM

THE MARK CONSISTS OF STANDARD CHARACTERS WITHOUT CLAIM TO ANY PARTICULAR FONT, STYLE, SIZE, OR COLOR.

NO CLAIM IS MADE TO THE EXCLUSIVE RIGHT TO USE "SOFT-SERVE ICE CREAM", APART FROM THE MARK AS SHOWN.

FOR RETAIL STORE SERVICES FEATURING ICE CREAM (U.S. CLS. 100, 101 AND 102).

KIMBERLY PERRY, EXAMINING ATTORNEY

CLASS 35—(Continued).

SN 85-523,198. TDR ANALYTICS LLC, LANCASTER, PA.
FILED 1-23-2012.

Time Domain Reflective Analytics

THE MARK CONSISTS OF STANDARD CHARACTERS WITHOUT CLAIM TO ANY PARTICULAR FONT, STYLE, SIZE, OR COLOR.

NO CLAIM IS MADE TO THE EXCLUSIVE RIGHT TO USE "TIME DOMAIN" AND "ANALYTICS", APART FROM THE MARK AS SHOWN.

FOR BUSINESS INTELLIGENCE ANALYTICS (U.S. CLS. 100, 101 AND 102).

FIRST USE 12-1-2011; IN COMMERCE 12-1-2011.
JEFF DEFORD, EXAMINING ATTORNEY

SN 85-523,458. SHOPTIMIZE LLC, WEST HARTFORD, CT.
FILED 1-24-2012.

SHOPTIMIZE.ORG

THE MARK CONSISTS OF STANDARD CHARACTERS WITHOUT CLAIM TO ANY PARTICULAR FONT, STYLE, SIZE, OR COLOR.

FOR ON-LINE RETAIL STORE SERVICES FEATURING A WIDE VARIETY OF CONSUMER GOODS OF OTHERS; ON-LINE RETAIL STORE SERVICES FEATURING PRODUCTS MARKETED TOWARDS WOMEN'S AFFINITY GROUPS AND PRODUCTS MADE IN AMERICA (U.S. CLS. 100, 101 AND 102).

IRA J. GOODSAD, EXAMINING ATTORNEY

SN 85-523,490. FAUCETT SOCIAL DESIGN, LLC, SPRINGFIELD, MO. FILED 1-24-2012.



THE MARK CONSISTS OF AN EMPTY SPEECH BALLOON ADJACENT TO THE LOWERCASE WORD "ENGAGE" NEXT TO THE NUMBER "5" AND THE LOWERCASE LETTER "W".

FOR BUSINESS MARKETING CONSULTING SERVICES; BUSINESS MARKETING SERVICES (U.S. CLS. 100, 101 AND 102).

FIRST USE 11-30-2011; IN COMMERCE 11-30-2011.
BRIAN NEVILLE, EXAMINING ATTORNEY

CLASS 35—(Continued).

SN 85-523,609. BAKHIET, MASTORA, INDIANAPOLIS, IN. FILED 1-24-2012.

RE-SHIFTING TEENAGERS

THE MARK CONSISTS OF STANDARD CHARACTERS WITHOUT CLAIM TO ANY PARTICULAR FONT, STYLE, SIZE, OR COLOR.

NO CLAIM IS MADE TO THE EXCLUSIVE RIGHT TO USE "TEENAGERS", APART FROM THE MARK AS SHOWN.

FOR PROMOTING PUBLIC AWARENESS OF IMMIGRANT COMMUNITIES, SUSTAINABLE DEVELOPMENT, SOCIAL CHANGE, AND CONFLICT TRANSFORMATION BASED ON WOMEN'S EMPOWERMENT (U.S. CLS. 100, 101 AND 102).

AHSEN KHAN, EXAMINING ATTORNEY

SN 85-523,979. MAMASAUCE PRODUCTIONS, INC., LOS ANGELES, CA. FILED 1-24-2012.



NO CLAIM IS MADE TO THE EXCLUSIVE RIGHT TO USE "PRODUCTION", APART FROM THE MARK AS SHOWN.

THE MARK CONSISTS OF A RING MADE UP OF FOUR CONCENTRIC CIRCLES WITH A GAP BETWEEN THE SECOND AND THIRD CIRCLES. ARCHING INSIDE THIS GAP AT THE TOP IS THE STYLIZED TEXT "GORGEOUS LADIES" AND ARCHING INSIDE THE GAP AT THE BOTTOM OF THE RING IS THE STYLIZED TEXT "OF PRODUCTION". CROSSING THE CENTER OF THE RING IS THE STYLIZED TEXT "G.L.O.P.". IN THE CENTER OF THE RING INSIDE THE INNERMOST CIRCLE ARE TWO SETS OF TWO PARALLEL LINES WHICH BORDER THE TEXT "G.L.O.P." ON THE TOP AND BOTTOM. THERE ARE THREE STARS ABOVE THE TOPMOST SET OF LINES AND THREE STARS BELOW THE LOWER SET OF LINES.

FOR ASSOCIATION SERVICES, NAMELY, PROMOTING THE INTERESTS OF WOMEN IN THE ENTERTAINMENT INDUSTRY (U.S. CLS. 100, 101 AND 102).

EDWARD FENNESSY, EXAMINING ATTORNEY

CLASS 35—(Continued).

SN 85-524,528. UNIVERSAL PROTEIN SUPPLEMENTS CORPORATION, DBA UNIVERSAL NUTRITION, NEW BRUNSWICK, NJ. FILED 1-25-2012.

ANIMALPAK.COM THE SHOP

THE MARK CONSISTS OF STANDARD CHARACTERS WITHOUT CLAIM TO ANY PARTICULAR FONT, STYLE, SIZE, OR COLOR.

OWNER OF U.S. REG. NOS. 2,437,306, 3,439,799 AND OTHERS.

NO CLAIM IS MADE TO THE EXCLUSIVE RIGHT TO USE "THE SHOP", APART FROM THE MARK AS SHOWN.

FOR ON-LINE RETAIL STORE SERVICES FEATURING HEALTH FOOD PRODUCTS, CLOTHING, AND SPORTS GEAR (U.S. CLS. 100, 101 AND 102).

FIRST USE 3-6-2001; IN COMMERCE 3-6-2001.

DAVID COLLIER, EXAMINING ATTORNEY

SN 85-524,530. UNIVERSAL PROTEIN SUPPLEMENTS CORPORATION, DBA UNIVERSAL NUTRITION, NEW BRUNSWICK, NJ. FILED 1-25-2012.

ANIMALPAK.COM

THE MARK CONSISTS OF STANDARD CHARACTERS WITHOUT CLAIM TO ANY PARTICULAR FONT, STYLE, SIZE, OR COLOR.

OWNER OF U.S. REG. NOS. 2,437,306, 3,439,799 AND OTHERS.

FOR ON-LINE RETAIL STORE SERVICES FEATURING HEALTH FOOD PRODUCTS, CLOTHING, AND SPORTS GEAR (U.S. CLS. 100, 101 AND 102).

FIRST USE 3-6-2001; IN COMMERCE 3-6-2001.

DAVID COLLIER, EXAMINING ATTORNEY

SN 85-524,621. AMERICAN EXPRESS MARKETING & DEVELOPMENT CORP., NEW YORK, NY. FILED 1-25-2012.

DINING BOOST

THE MARK CONSISTS OF STANDARD CHARACTERS WITHOUT CLAIM TO ANY PARTICULAR FONT, STYLE, SIZE, OR COLOR.

NO CLAIM IS MADE TO THE EXCLUSIVE RIGHT TO USE "DINING", APART FROM THE MARK AS SHOWN.

FOR ADMINISTRATION OF A CUSTOMER LOYALTY PROGRAM WHICH PROVIDES EXTRA REWARDS POINTS FOR USE OF CREDIT AND CHARGE CARDS (U.S. CLS. 100, 101 AND 102).

KIMBERLY FRYE, EXAMINING ATTORNEY

CLASS 35—(Continued).

SN 85-524,625. AMERICAN EXPRESS MARKETING & DEVELOPMENT CORP., NEW YORK, NY. FILED 1-25-2012.

GROCERY BOOST

THE MARK CONSISTS OF STANDARD CHARACTERS WITHOUT CLAIM TO ANY PARTICULAR FONT, STYLE, SIZE, OR COLOR.

NO CLAIM IS MADE TO THE EXCLUSIVE RIGHT TO USE "GROCERY", APART FROM THE MARK AS SHOWN. FOR ADMINISTRATION OF A CUSTOMER LOYALTY PROGRAM WHICH PROVIDES EXTRA REWARDS POINTS FOR USE OF CREDIT AND CHARGE CARDS (U.S. CLS. 100, 101 AND 102).

KIMBERLY FRYE, EXAMINING ATTORNEY

SN 85-524,631. AMERICAN EXPRESS MARKETING & DEVELOPMENT CORP., NEW YORK, NY. FILED 1-25-2012.

GREEN BOOST

THE MARK CONSISTS OF STANDARD CHARACTERS WITHOUT CLAIM TO ANY PARTICULAR FONT, STYLE, SIZE, OR COLOR.

NO CLAIM IS MADE TO THE EXCLUSIVE RIGHT TO USE "GREEN", APART FROM THE MARK AS SHOWN.

FOR ADMINISTRATION OF A CUSTOMER LOYALTY PROGRAM WHICH PROVIDES EXTRA REWARDS POINTS FOR USE OF CREDIT AND CHARGE CARDS (U.S. CLS. 100, 101 AND 102).

KIMBERLY FRYE, EXAMINING ATTORNEY

SN 85-524,638. AMERICAN EXPRESS MARKETING & DEVELOPMENT CORP., NEW YORK, NY. FILED 1-25-2012.

DIGITAL BOOST

THE MARK CONSISTS OF STANDARD CHARACTERS WITHOUT CLAIM TO ANY PARTICULAR FONT, STYLE, SIZE, OR COLOR.

NO CLAIM IS MADE TO THE EXCLUSIVE RIGHT TO USE "DIGITAL", APART FROM THE MARK AS SHOWN.

FOR ADMINISTRATION OF A CUSTOMER LOYALTY PROGRAM WHICH PROVIDES EXTRA REWARDS POINTS FOR USE OF CREDIT AND CHARGE CARDS (U.S. CLS. 100, 101 AND 102).

KIMBERLY FRYE, EXAMINING ATTORNEY

CLASS 35—(Continued).

SN 85-525,187. DOMAIN PROFESSIONALS, LLC, MIAMI BEACH, FL. FILED 1-25-2012.

Traffic Factory

THE MARK CONSISTS OF STANDARD CHARACTERS WITHOUT CLAIM TO ANY PARTICULAR FONT, STYLE, SIZE, OR COLOR.

NO CLAIM IS MADE TO THE EXCLUSIVE RIGHT TO USE "TRAFFIC", APART FROM THE MARK AS SHOWN.

FOR AD SERVING, NAMELY, PLACING ADVERTISEMENTS ON WEBSITES FOR OTHERS USING SPECIALIZED COMPUTER SOFTWARE; ADVERTISEMENT FOR OTHERS ON THE INTERNET; ONLINE ADVERTISING VIA A COMPUTER COMMUNICATIONS NETWORK; PLACING ADVERTISEMENTS FOR OTHERS (U.S. CLS. 100, 101 AND 102).

SIMON TENG, EXAMINING ATTORNEY

SN 85-526,383. TABLETOP MEDIA, LLC, DALLAS, TX. FILED 1-26-2012.

ZCOMMERCE

THE MARK CONSISTS OF STANDARD CHARACTERS WITHOUT CLAIM TO ANY PARTICULAR FONT, STYLE, SIZE, OR COLOR.

OWNER OF U.S. REG. NO. 3,838,504.

FOR COMPUTER SERVICES, NAMELY, PROVIDING AN INTERACTIVE, ONLINE PORTAL FROM A TABLESIDE POINT-OF-SALE (POS) RESTAURANT DEVICE TO ENABLE USERS TO PARTICIPATE IN CUSTOMER LOYALTY PROGRAM ACCESS AND INFORMATION, SATISFACTION SURVEYS, AND PRODUCT AND SERVICE PROMOTIONS AND PURCHASE OPPORTUNITIES (U.S. CLS. 100, 101 AND 102).

VIVIAN MICZNIK FIRST, EXAMINING ATTORNEY

SN 85-526,472. SUBQUAL, L.L.C., TEMPE, AZ. FILED 1-26-2012.

SUBQUAL

THE MARK CONSISTS OF STANDARD CHARACTERS WITHOUT CLAIM TO ANY PARTICULAR FONT, STYLE, SIZE, OR COLOR.

FOR BUSINESS SERVICES, NAMELY, PROVIDING DATABASES FEATURING TRADE INFORMATION IN THE FIELD OF CONSTRUCTION AND SCREENING OF CONTRACTORS ON BEHALF OF OTHERS (U.S. CLS. 100, 101 AND 102).

FIRST USE 9-18-2007; IN COMMERCE 9-18-2007.

GISELLE AGOSTO, EXAMINING ATTORNEY

CLASS 35—(Continued).

SN 85-526,951. TDR ANALYTICS, HIGHLAND PARK, IL. FILED 1-27-2012.

TDR Analytics

THE MARK CONSISTS OF STANDARD CHARACTERS WITHOUT CLAIM TO ANY PARTICULAR FONT, STYLE, SIZE, OR COLOR.

NO CLAIM IS MADE TO THE EXCLUSIVE RIGHT TO USE "ANALYTICS", APART FROM THE MARK AS SHOWN.

FOR BUSINESS INTELLIGENCE ANALYTICS (U.S. CLS. 100, 101 AND 102).

FIRST USE 11-1-2011; IN COMMERCE 11-1-2011.

JEFF DEFORD, EXAMINING ATTORNEY

SN 85-529,285. AGAINST THE GRAIN GOURMET FOODS, LLC, BRATTLEBORO, VT. FILED 1-31-2012.

AGAINST THE GRAIN

THE MARK CONSISTS OF STANDARD CHARACTERS WITHOUT CLAIM TO ANY PARTICULAR FONT, STYLE, SIZE, OR COLOR.

FOR RETAIL GLUTEN-FREE BAKERY SHOPS; RETAIL SHOPS FEATURING GLUTEN-FREE BAKED GOODS; RETAIL SHOPS FEATURING GLUTEN-FREE BAKED GOODS AND OTHER FOODS AND BEVERAGES; RETAIL GROCERY STORE SERVICES, NAMELY, A SECTION OF A RETAIL GROCERY STORE FEATURING GLUTEN-FREE BAKED GOODS; RETAIL GROCERY STORE SERVICES, NAMELY, A SECTION OF A RETAIL GROCERY STORE FEATURING GLUTEN-FREE BAKED GOODS AND OTHER FOODS AND BEVERAGES (U.S. CLS. 100, 101 AND 102).

COLLEEN MULCRONE, EXAMINING ATTORNEY

SN 85-530,530. BEAVOR, KAREN, ATLANTA, GA. FILED 2-1-2012.

GIVE TO THE MAX DAY

THE MARK CONSISTS OF STANDARD CHARACTERS WITHOUT CLAIM TO ANY PARTICULAR FONT, STYLE, SIZE, OR COLOR.

FOR CHARITABLE SERVICES, NAMELY, PROMOTING PUBLIC AWARENESS OF THE NEED FOR SUPPORT OF NON-PROFIT ORGANIZATIONS IN GEORGIA; PROMOTING PUBLIC AWARENESS IN THE FIELD OF SOCIAL WELFARE (U.S. CLS. 100, 101 AND 102).

APRIL ROACH, EXAMINING ATTORNEY

CLASS 35—(Continued).

SN 85-530,755. ANDERSON, HILLARY MCKENNA, KETCHUM, ID. FILED 2-1-2012.

SHOP BY INTENTION

THE MARK CONSISTS OF STANDARD CHARACTERS WITHOUT CLAIM TO ANY PARTICULAR FONT, STYLE, SIZE, OR COLOR.

FOR ON-LINE RETAIL STORE SERVICES FEATURING A WIDE VARIETY OF CONSUMER GOODS OF OTHERS (U.S. CLS. 100, 101 AND 102).

CHRISTOPHER BUONGIORNO, EXAMINING ATTORNEY

SN 85-530,763. STELUJAN ENTERPRISES, LLC, MYRTLE BEACH, SC. FILED 2-1-2012.

TO GIVE EVERY DAY IS LIVING

THE MARK CONSISTS OF STANDARD CHARACTERS WITHOUT CLAIM TO ANY PARTICULAR FONT, STYLE, SIZE, OR COLOR.

FOR CHARITABLE SERVICES, NAMELY, ORGANIZING AND CONDUCTING VOLUNTEER PROGRAMS AND COMMUNITY SERVICE PROJECTS (U.S. CLS. 100, 101 AND 102).

FIRST USE 10-31-2011; IN COMMERCE 10-31-2011.

NICHOLAS ALTREE, EXAMINING ATTORNEY

SN 85-530,787. SILPADA DESIGNS LLC, LENEXA, KS. FILED 2-1-2012.

Giving Back in Style

THE MARK CONSISTS OF STANDARD CHARACTERS WITHOUT CLAIM TO ANY PARTICULAR FONT, STYLE, SIZE, OR COLOR.

FOR PRODUCT MERCHANDISING; RETAIL SERVICES BY DIRECT SOLICITATION BY SALES AGENTS, SHOP AT HOME PARTIES, TELEPHONE ORDERING SERVICES, MAIL ORDER CATALOG SERVICES, AND ON-LINE ORDERING SERVICES, ALL FEATURING JEWELRY, GIFT ITEMS, HANDBAGS, WATCHES, BELTS AND OTHER FASHION ACCESSORIES; DIRECT SALES ORGANIZATION AND PLANNING, NAMELY, OFFERING BUSINESS MANAGEMENT ASSISTANCE IN THE ESTABLISHMENT AND/OR OPERATION OF A RETAIL HOME PARTY BUSINESS; ADMINISTRATION OF AN INCENTIVE AWARDS PROGRAM TO PROMOTE THE SALE OF PRODUCTS OF OTHERS (U.S. CLS. 100, 101 AND 102).

FIRST USE 8-1-2011; IN COMMERCE 11-1-2011.

MATTHEW EINSTEIN, EXAMINING ATTORNEY

CLASS 35—(Continued).

SN 85-530,852. ARTICULATED BRANDS, LOS ANGELES, CA. FILED 2-1-2012.

Articulated Brands

THE MARK CONSISTS OF STANDARD CHARACTERS WITHOUT CLAIM TO ANY PARTICULAR FONT, STYLE, SIZE, OR COLOR.

NO CLAIM IS MADE TO THE EXCLUSIVE RIGHT TO USE "BRANDS", APART FROM THE MARK AS SHOWN, FOR ADVERTISING AND MARKETING SERVICES, NAMELY, PROMOTING THE GOODS AND SERVICES OF OTHERS; ADVERTISING SERVICES (U.S. CLS. 100, 101 AND 102).

FIRST USE 2-17-2008; IN COMMERCE 2-17-2008.
REBECCA SMITH, EXAMINING ATTORNEY

CLASS 35—(Continued).

SN 85-531,043. CHARLES H. ROSS, JR., NEW YORK, NY. FILED 2-1-2012.

SUPERMASSIVE

THE MARK CONSISTS OF STANDARD CHARACTERS WITHOUT CLAIM TO ANY PARTICULAR FONT, STYLE, SIZE, OR COLOR.

FOR RETAIL STORE SERVICES AND ONLINE RETAIL STORE SERVICES IN THE FIELD OF APPAREL (U.S. CLS. 100, 101 AND 102).

WILLIAM ROSSMAN, EXAMINING ATTORNEY

SN 85-531,053. FEED ADAM LLC, ORANGE CITY, IA. FILED 2-1-2012.

FEED ADAM

SN 85-530,956. NTIRETY, INC., DEDHAM, MA. FILED 2-1-2012.

OPTIMIZEDDB

THE MARK CONSISTS OF STANDARD CHARACTERS WITHOUT CLAIM TO ANY PARTICULAR FONT, STYLE, SIZE, OR COLOR.

FOR DATABASE ADMINISTRATION FOR OTHERS, NAMELY, DATABASE MANAGEMENT (U.S. CLS. 100, 101 AND 102).

FIRST USE 1-10-2012; IN COMMERCE 1-30-2012.
HAI-LY LAM, EXAMINING ATTORNEY

THE MARK CONSISTS OF STANDARD CHARACTERS WITHOUT CLAIM TO ANY PARTICULAR FONT, STYLE, SIZE, OR COLOR.

FOR ON-LINE RETAIL STORE SERVICES FEATURING FOOD PRODUCTS; ON-LINE WHOLESALE STORE SERVICES FEATURING FOOD PRODUCTS; RETAIL STORE SERVICES FEATURING FOOD PRODUCTS; WHOLESALE FOOD DISTRIBUTORSHIP SERVICES; WHOLESALE STORE SERVICES FEATURING FOOD PRODUCTS (U.S. CLS. 100, 101 AND 102).

FIRST USE 7-0-2011; IN COMMERCE 7-0-2011.
APRIL HESIK, EXAMINING ATTORNEY

SN 85-531,059. SOCIAL GOODIES, LLC, PASADENA, CA. FILED 2-1-2012.

SOCIAL GOODIES

SN 85-531,027. DENNING, CHAD, NEW LONDON, NH. FILED 2-1-2012.

STATE OF ADVENTURE

THE MARK CONSISTS OF STANDARD CHARACTERS WITHOUT CLAIM TO ANY PARTICULAR FONT, STYLE, SIZE, OR COLOR.

FOR PROMOTING RECREATION AND TOURISM IN NEW HAMPSHIRE (U.S. CLS. 100, 101 AND 102).

DAVID TAYLOR, EXAMINING ATTORNEY

THE MARK CONSISTS OF STANDARD CHARACTERS WITHOUT CLAIM TO ANY PARTICULAR FONT, STYLE, SIZE, OR COLOR.

FOR ON-LINE RETAIL STORE SERVICES FEATURING NATIONAL RETAILER DISCOUNT AND PROMOTIONAL CODES WITH A PERCENTAGE OF THE PROCEEDS BEING CONTRIBUTED TO CHARITY (U.S. CLS. 100, 101 AND 102).

FIRST USE 5-23-2011; IN COMMERCE 5-23-2011.
GEOFFREY FOSDICK, EXAMINING ATTORNEY

CLASS 35—(Continued).

SN 85-531,165. JOSE PENSO, HOMESTEAD, FL. FILED 2-1-2012.

Liketing

THE MARK CONSISTS OF STANDARD CHARACTERS WITHOUT CLAIM TO ANY PARTICULAR FONT, STYLE, SIZE, OR COLOR.

FOR ADVERTISING AND MARKETING; ADVERTISING AND MARKETING CONSULTANCY; ADVERTISING AND MARKETING SERVICES, NAMELY, PROMOTING THE GOODS AND SERVICES OF OTHERS; ADVERTISING SERVICES, NAMELY, PROMOTING AND MARKETING THE GOODS AND SERVICES OF OTHERS THROUGH ALL PUBLIC COMMUNICATION MEANS; ADVERTISING, MARKETING AND PROMOTION SERVICES; ADVICE IN THE FIELD OF BUSINESS MANAGEMENT AND MARKETING; ANALYSIS OF MARKET RESEARCH DATA AND STATISTICS; ARRANGING AND CONDUCTING MARKETING PROMOTIONAL EVENTS FOR OTHERS; BRANDING SERVICES, NAMELY, CONSULTING, DEVELOPMENT, MANAGEMENT AND MARKETING OF BRANDS FOR BUSINESSES; BUSINESS ADVICE AND ANALYSIS OF MARKETS; BUSINESS CONSULTATION AND MANAGEMENT REGARDING MARKETING ACTIVITIES AND LAUNCHING OF NEW PRODUCTS; BUSINESS CONSULTING SERVICES, NAMELY, PROVIDING A TURNKEY BUSINESS SOLUTION FOR REVIEWING PRODUCTS AND SERVICES, PLANNING DOCUMENTATION AND WORKFLOW, HIRING TECHNICAL WRITERS, MANAGING PROJECTS FOR BUSINESS PURPOSES, TRACKING USER SATISFACTION, AND RUNNING USABILITY STUDIES FOR BUSINESS PURPOSES; BUSINESS MANAGEMENT CONSULTING WITH RELATION TO STRATEGY, MARKETING, PRODUCTION, PERSONNEL AND RETAIL SALE MATTERS; BUSINESS MARKETING CONSULTING SERVICES; BUSINESS MARKETING SERVICES; COLLECTION OF MARKET RESEARCH INFORMATION; CONDUCTING BUSINESS AND MARKET RESEARCH SURVEYS; CONDUCTING MARKET SURVEYS; CONDUCTING MARKETING STUDIES; CONSULTATION SERVICES, NAMELY, CREATIVE AND STRATEGIC CONSULTATION REGARDING DEVELOPMENT AND PRODUCTION OF MARKETING CAMPAIGNS FOR OTHERS; CONSULTING SERVICES IN THE FIELD OF INTERNET MARKETING; CONSUMER MARKETING RESEARCH AND CONSULTING RELATED THERETO; CUSTOM WRITING SERVICES COMPRISING PUBLIC RELATIONS AND MARKETING MATERIALS FOR THE AUDIO, VIDEO AND TECHNOLOGY INDUSTRIES; DEVELOPMENT OF MARKETING STRATEGIES AND CONCEPTS; DEVELOPMENT OF MARKETING STRATEGIES, CONCEPTS AND TACTICS, NAMELY, AUDIENCE DEVELOPMENT, BRAND AWARENESS, ONLINE COMMUNITY BUILDING AND DIGITAL WORD OF MOUTH COMMUNICATIONS; DIRECT MARKETING ADVERTISING FOR OTHERS; DIRECT MARKETING CONSULTING SERVICES; DIRECT MARKETING SERVICES; ENTERTAINMENT MARKETING SERVICES, NAMELY, MARKETING, PROMOTION AND ADVERTISING FOR RECORDING AND PERFORMING ARTISTS; EVENT PLANNING AND MANAGEMENT FOR MARKETING, BRANDING, PROMOTING OR ADVERTISING THE GOODS AND SERVICES OF OTHERS; MARKET ANALYSIS; MARKET ANALYSIS AND RESEARCH SERVICES; MARKET ASSESSMENT SERVICES; MARKET MANIPULATION RESEARCH AND ANALYSIS, WHETHER OR NOT VIA THE INTERNET; MARKET OPINION POLLING STUDIES; MARKET REPORTS AND STUDIES; MARKET RESEARCH; MARKET RESEARCH AND BUSINESS ANALYSES; MARKET RESEARCH AND MARKET INTELLIGENCE SERVICES; MARKET RESEARCH BY MEANS OF A COMPUTER DATABASE; MARKET RESEARCH CONSULTATION; MARKET RESEARCH SERVICES; MARKET RESEARCH STUDIES; MARKET SEGMENTATION CONSULTATION; MARKET STUDY AND ANALYSIS OF MARKET

CLASS 35—(Continued).

STUDIES; MARKETING ANALYSIS SERVICES; MARKETING AND BRANDING SERVICES, NAMELY, PROVIDING CUSTOMIZED COMMUNICATION PROGRAMS TO OBTAIN CONSUMER INSIGHTS AND DEVELOP BRANDING STRATEGIES; MARKETING AND CONSULTING SERVICES IN THE FIELD OF PROMOTING AND TRACKING THE GOODS, SERVICES, AND BRANDS OF OTHERS THROUGH ALL PUBLIC COMMUNICATION MEANS; MARKETING CONSULTING; MARKETING CONSULTING SERVICES RELATING TO LONG-TERM BUSINESS STRATEGY DEVELOPMENT FOR NON-PROFIT ORGANIZATIONS; MARKETING PLAN DEVELOPMENT; MARKETING RESEARCH SERVICES; MARKETING SERVICES; MARKETING SERVICES, NAMELY, CONDUCTING CONSUMER TRACKING BEHAVIOR RESEARCH AND CONSUMER TREND ANALYSIS; MARKETING SERVICES, NAMELY, CONSUMER MARKETING RESEARCH; MARKETING SERVICES, NAMELY, PROMOTING OR ADVERTISING THE GOODS AND SERVICES OF OTHERS; MARKETING, ADVERTISING, AND PROMOTING THE RETAIL GOODS AND SERVICES OF OTHERS THROUGH WIRELESS ELECTRONIC DEVICES; MARKETING, PROMOTIONAL AND ADVERTISING SERVICES PROVIDED BY MOBILE TELEPHONE CONNECTIONS; MEDIA PLANNING, NAMELY, ADVISING THE CLIENT ON THE CORRECT TIMES AND STATIONS TO ADVERTISE BASED ON MEDIA ANALYSIS OF THE MARKET FOR THAT MEDIA; MEMBERSHIP CLUB SERVICES, NAMELY, PROVIDING ON-LINE INFORMATION TO MEMBERS IN THE FIELDS OF BRANDING, BUSINESS DEVELOPMENT, BUSINESS MARKETING, AND MARKETING; MULTI-LEVEL MARKETING SERVICES; ON-LINE ADVERTISING AND MARKETING SERVICES; PROMOTING THE GOODS AND SERVICES OF OTHERS BY MEANS OF WORD-OF-MOUTH AND NONTRADITIONAL MARKETING PROGRAMS; PROMOTING, ADVERTISING AND MARKETING OF THE BRANDS, PRODUCTS, SERVICES AND ONLINE WEBSITES OF INDIVIDUALS, BUSINESSES AND NONPROFIT ORGANIZATIONS; PROMOTING, MARKETING AND ADVERTISING THE BRANDS AND GOODS OF OTHERS RELATED TO ALL INDUSTRIES, THROUGH ALL PUBLIC AND PRIVATE COMMUNICATION MEANS, NAMELY, PROMOTING THE BRANDS AND GOODS OF OTHERS MADE IN THE UNITED STATES; PROMOTION AND MARKETING SERVICES AND RELATED CONSULTING; PROMOTIONAL MARKETING AND REPRESENTATION SERVICES FOR SALES TO THE PUBLIC SECTOR; PROMOTIONAL MARKETING SERVICES USING AUDIOVISUAL MEDIA; PROMOTIONAL SERVICES, NAMELY, GUERRILLA MARKETING SERVICES; PROVIDING ADVERTISING, MARKETING AND PROMOTIONAL SERVICES, NAMELY, DEVELOPMENT OF ADVERTISING CAMPAIGNS PROVIDED THROUGH CABLE TELEVISION BROADCAST, WEB CASTS, RADIO BROADCASTS, NEWSPAPERS, MAGAZINES, ONLINE BANNERS, OUTDOOR BILLBOARDS, WILD POSTINGS, BUS AND SUBWAY ADS; PROVIDING MARKETING AND PROMOTION OF SPECIAL EVENTS; PROVIDING ONLINE BUSINESS MANAGEMENT SERVICES INCLUDING ACCOUNTING, MARKETING, BUSINESS PROJECT MANAGEMENT, AND BUSINESS DEVELOPMENT; PROVIDING PUBLIC SECTOR BUSINESS AND MARKET INTELLIGENCE; PROVIDING PUBLIC SECTOR GO-TO-MARKET ADVICE AND STRATEGIES; PROVISION OF MARKET RESEARCH INFORMATION; PROVISION OF MARKETING REPORTS; PUBLIC RELATIONS; RENTAL OF ALL PUBLICITY AND MARKETING PRESENTATION MATERIALS; SOCIAL MEDIA STRATEGY AND MARKETING CONSULTANCY FOCUSING ON HELPING CLIENTS CREATE AND EXTEND THEIR PRODUCT AND BRAND STRATEGIES BY BUILDING VIRALLY ENGAGING MARKETING SOLUTIONS (U.S. CLS. 100, 101 AND 102).

MATTHEW GALAN, EXAMINING ATTORNEY

CLASS 35—(Continued).

SN 85-531,427. CON CERRO, INC., SAN DIEGO, CA. FILED 2-1-2012.

ACUITY BY EXCEPTION

THE MARK CONSISTS OF STANDARD CHARACTERS WITHOUT CLAIM TO ANY PARTICULAR FONT, STYLE, SIZE, OR COLOR.

FOR BUSINESS STAFFING CONSULTING SERVICES FOR PROVIDING SCHEDULING DECISIONS FOR EMPLOYEES BASED ON STAFFING EFFECTIVENESS STANDARDS AND REGULATIONS, FOR PREDICTIVE SCHEDULING, AND FOR USING HISTORICAL DATA TO MODEL PREDICTIVE STAFFING NEEDS; STAFFING CONSULTING SERVICES FOR MANAGING THE PRACTICE AND SCHEDULING OF HEALTH CARE PROFESSIONALS, NAMELY, FOR ALIGNING STAFFING TO WORKLOAD DEMAND BASED ON CARE REQUIREMENTS OF A PATIENT POPULATION; ASSIGNING, MATCHING, AND DEPLOYING HEALTHCARE PROFESSIONALS WHERE PATIENT DEMAND IS GREATEST; AND MAXIMIZING STAFFING EFFICIENCY (U.S. CLS. 100, 101 AND 102).

ALLISON SCHRODY, EXAMINING ATTORNEY

SN 85-531,455. PROPARO, LLC, PERKASIE, PA. FILED 2-1-2012.

theGAAPpost.com

THE MARK CONSISTS OF THE STYLIZED TEXT "THE-GAAPPOST.COM" WITH THE LETTERS "GAAP" CAPITALIZED.

FOR ON-LINE RETAIL STORE SERVICES FEATURING SOFTWARE FOR ACCOUNTING (U.S. CLS. 100, 101 AND 102).

JOHN DALIER, EXAMINING ATTORNEY

SN 85-531,479. CON CERRO, INC., SAN DIEGO, CA. FILED 2-1-2012.

SHIFTREWARDS

THE MARK CONSISTS OF STANDARD CHARACTERS WITHOUT CLAIM TO ANY PARTICULAR FONT, STYLE, SIZE, OR COLOR.

FOR BUSINESS STAFFING CONSULTING SERVICES FOR PROVIDING SCHEDULING DECISIONS FOR EMPLOYEES IN AN INSTITUTIONAL SETTING NAMELY USING INCENTIVE-BASED STAFFING (U.S. CLS. 100, 101 AND 102).

FIRST USE 7-1-2005; IN COMMERCE 7-1-2005.
ALLISON SCHRODY, EXAMINING ATTORNEY

CLASS 35—(Continued).

SN 85-531,562. VA LOAN CAPTAIN, UNION CITY, NJ. FILED 2-1-2012.

VaLoanCaptain.com

THE MARK CONSISTS OF STANDARD CHARACTERS WITHOUT CLAIM TO ANY PARTICULAR FONT, STYLE, SIZE, OR COLOR.

FOR ADVERTISING AND MARKETING SERVICES, NAMELY, PROMOTING THE GOODS AND SERVICES OF OTHERS; CHARITABLE SERVICES, NAMELY, ORGANIZING AND CONDUCTING VOLUNTEER PROGRAMS AND COMMUNITY SERVICE PROJECTS AIMED AT INCREASING SUPPORT AND MORALE OF FAMILIES OF DECEASED WAR VETERANS, WAR VETERANS, CURRENT MEMBERS AND FUTURE MEMBERS OF THE U.S. MILITARY (U.S. CLS. 100, 101 AND 102).

WILLIAM P. SHANAHAN, EXAMINING ATTORNEY

SN 85-531,573. NONTOXIQUE BEAUTY, LLC, MINNEAPOLIS, MN. FILED 2-1-2012.

reThinkSpa

THE MARK CONSISTS OF STANDARD CHARACTERS WITHOUT CLAIM TO ANY PARTICULAR FONT, STYLE, SIZE, OR COLOR.

FOR BUSINESS MANAGEMENT AND CONSULTATION IN THE FIELD OF COSMETOLOGY AND SPAS (U.S. CLS. 100, 101 AND 102).

FIRST USE 12-15-2011; IN COMMERCE 12-15-2011.
TINA MAI, EXAMINING ATTORNEY

SN 85-531,680. BOWMAN, THERESA CLARE, MYAREE, AUSTRALIA, FILED 2-2-2012.

THE SUCCESS EQUATION

THE MARK CONSISTS OF STANDARD CHARACTERS WITHOUT CLAIM TO ANY PARTICULAR FONT, STYLE, SIZE, OR COLOR.

FOR BUSINESS CONSULTING AND INFORMATION SERVICES; BUSINESS CONSULTING SERVICES, NAMELY, CONSULTING FOR BUSINESSES AND ENTREPRENEURS TO MAXIMIZE PERFORMANCE POTENTIAL (U.S. CLS. 100, 101 AND 102).

KATHERINE CHANG, EXAMINING ATTORNEY

CLASS 35—(Continued).

SN 85-531,703. HEALTHY PET PRODUCTS LLC, PITTSBURGH, PA. FILED 2-2-2012.

HELPING PETS THRIVE

THE MARK CONSISTS OF STANDARD CHARACTERS WITHOUT CLAIM TO ANY PARTICULAR FONT, STYLE, SIZE, OR COLOR.

FOR RETAIL STORE SERVICES FEATURING PET FOOD AND PET PRODUCTS (U.S. CLS. 100, 101 AND 102).

KELLY BOULTON, EXAMINING ATTORNEY

SN 85-531,758. LANA MANAGEMENT & BUSINESS RESEARCH INTERNATIONAL, LLC, ACTON, MA. FILED 2-2-2012.

LMBRI

THE MARK CONSISTS OF STANDARD CHARACTERS WITHOUT CLAIM TO ANY PARTICULAR FONT, STYLE, SIZE, OR COLOR.

FOR BUSINESS STRATEGIC PLANNING SERVICES; BUSINESS RISK MANAGEMENT CONSULTATION; MARKET ANALYSIS AND RESEARCH SERVICES; BUSINESS ADVICE AND ANALYSIS OF MARKETS; CUSTOMER RELATIONSHIP MANAGEMENT; PROVIDING BUSINESS MANAGEMENT INFORMATION IN CONNECTION WITH CONSULTING AND ADVISORY SERVICES IN THE FIELD OF STRATEGIC PLANNING; BUSINESS MANAGEMENT CONSULTANCY AS WELL AS DEVELOPMENT OF PROCESSES FOR THE ANALYSIS AND THE IMPLEMENTATION OF STRATEGY PLANS AND MANAGEMENT PROJECTS; PROVIDING INFORMATION AND NEWS IN THE FIELD OF BUSINESS, NAMELY, INFORMATION AND NEWS ON CURRENT EVENTS AND ON ECONOMIC, LEGISLATIVE, AND REGULATORY DEVELOPMENTS AS IT RELATES TO AND CAN IMPACT BUSINESSES; BUSINESS CONSULTING AND MANAGEMENT IN THE FIELD OF CLINICAL TRIALS, NAMELY, CLINICAL DATA AND REGULATORY SUBMISSION MANAGEMENT ON BEHALF OF MEDICAL, BIOPHARMACEUTICAL AND BIOTECHNOLOGY COMPANIES TO ASSIST THEM WITH CLINICAL RESEARCH, CLINICAL TRIALS AND APPLICATIONS FOR DRUG APPROVAL; ADVICE CONCERNING CHEMICAL PRODUCT MARKETING; PROVIDING CONSULTING SERVICES IN THE FIELD OF REGULATORY SUBMISSION MANAGEMENT TO MEDICAL COMPANIES TO ASSIST THEM WITH APPLICATIONS FOR MEDICAL DEVICE APPROVAL; PROMOTING COLLABORATION WITHIN THE SCIENTIFIC, RESEARCH AND MEDICAL COMMUNITIES TO ACHIEVE ADVANCES IN THE FIELD OF HEALTHCARE (U.S. CLS. 100, 101 AND 102).

FIRST USE 5-0-2009; IN COMMERCE 5-0-2009.

ELISSA GARBER KON, EXAMINING ATTORNEY

CLASS 35—(Continued).

SN 85-531,805. TARGET BRANDS, INC., MINNEAPOLIS, MN. FILED 2-2-2012.

SCHOOL TAKES A LOT. TARGET HAS IT ALL.

THE MARK CONSISTS OF STANDARD CHARACTERS WITHOUT CLAIM TO ANY PARTICULAR FONT, STYLE, SIZE, OR COLOR.

OWNER OF U.S. REG. NOS. 845,193, 2,793,901 AND OTHERS.

FOR RETAIL STORE SERVICES FEATURING A WIDE VARIETY OF CONSUMER GOODS; ONLINE RETAIL STORE SERVICES FEATURING A WIDE VARIETY OF CONSUMER GOODS (U.S. CLS. 100, 101 AND 102).

MICHAEL W. BAIRD, EXAMINING ATTORNEY

SN 85-531,831. JOHNNY BENCH 5, INC., CINCINNATI, OH. FILED 2-2-2012.



THE NAME JOHNNY BENCH IDENTIFIES A LIVING INDIVIDUAL WHOSE CONSENT IS OF RECORD.

THE MARK CONSISTS OF THE NUMBER 5 WITH A CROUCHING CATCHER OVER A LINE ATOP JOHNNY ATOP BENCH OVER A LINE ATOP "CATCH YA LATER!"

FOR ON-LINE RETAIL STORE SERVICES FEATURING BASEBALL MEMORABILIA AND COLLECTIBLES, INCLUDING JOHNNY BENCH MEMORABILIA AND COLLECTIBLES (U.S. CLS. 100, 101 AND 102).

FIRST USE 1-30-2012; IN COMMERCE 1-30-2012.

TRICIA SONNEBORN, EXAMINING ATTORNEY

CLASS 35—(Continued).

SN 85-531,863. LAWRENCE, KEN, MERIDEN, CT. FILED 2-2-2012.

PEEPSPLUS.COM THE INFO YOU
WANT FROM THE PEOPLE YOU
TRUST

THE MARK CONSISTS OF STANDARD CHARACTERS WITHOUT CLAIM TO ANY PARTICULAR FONT, STYLE, SIZE, OR COLOR.
FOR ADVERTISING AND PROMOTIONAL SERVICES (U.S. CLS. 100, 101 AND 102).
FIRST USE 1-0-2012; IN COMMERCE 1-0-2012.
JOHN E. MICHOS, EXAMINING ATTORNEY

SN 85-531,962. CLEAR GROUP INTERNATIONAL, LLC, BRIDGEPORT, CT. FILED 2-2-2012.

Ports of Cause

THE MARK CONSISTS OF STANDARD CHARACTERS WITHOUT CLAIM TO ANY PARTICULAR FONT, STYLE, SIZE, OR COLOR.
FOR PROMOTING PUBLIC AWARENESS OF PRESERVING AND ENHANCING THE ECOSPHERE OF THE OCEANS, SEAS AND INLAND NAVIGABLE WATERS OF THE WORLD AND BROAD SPECTRUM OF URGENT ISSUES AROUND THE WORLD (U.S. CLS. 100, 101 AND 102).
FIRST USE 11-1-2011; IN COMMERCE 11-1-2011.
JAY FLOWERS, EXAMINING ATTORNEY

SN 85-532,016. RESCUE SOCIAL CHANGE GROUP, LLC, SAN DIEGO, CA. FILED 2-2-2012.

BLACKLIST

THE MARK CONSISTS OF STANDARD CHARACTERS WITHOUT CLAIM TO ANY PARTICULAR FONT, STYLE, SIZE, OR COLOR.
FOR DEVELOPING ADVERTISING, PROMOTIONAL CAMPAIGNS AND PROMOTIONAL EVENTS FOR OTHERS GEARED TOWARDS TOBACCO PREVENTION AND CESSATION (U.S. CLS. 100, 101 AND 102).
JULIE WATSON, EXAMINING ATTORNEY

CLASS 35—(Continued).

SN 85-532,019. RESCUE SOCIAL CHANGE GROUP, LLC, SAN DIEGO, CA. FILED 2-2-2012.

HAVOC

THE MARK CONSISTS OF STANDARD CHARACTERS WITHOUT CLAIM TO ANY PARTICULAR FONT, STYLE, SIZE, OR COLOR.
FOR DEVELOPING ADVERTISING, PROMOTIONAL CAMPAIGNS AND PROMOTIONAL EVENTS FOR OTHERS GEARED TOWARDS TOBACCO PREVENTION AND CESSATION (U.S. CLS. 100, 101 AND 102).
JULIE WATSON, EXAMINING ATTORNEY

SN 85-532,026. RESCUE SOCIAL CHANGE GROUP, LLC, SAN DIEGO, CA. FILED 2-2-2012.

COMMUNE

THE MARK CONSISTS OF STANDARD CHARACTERS WITHOUT CLAIM TO ANY PARTICULAR FONT, STYLE, SIZE, OR COLOR.
FOR DEVELOPING ADVERTISING, PROMOTIONAL CAMPAIGNS AND PROMOTIONAL EVENTS FOR OTHERS GEARED TOWARDS TOBACCO PREVENTION AND CESSATION (U.S. CLS. 100, 101 AND 102).
JULIE WATSON, EXAMINING ATTORNEY

SN 85-532,033. RESCUE SOCIAL CHANGE GROUP, LLC, SAN DIEGO, CA. FILED 2-2-2012.

EVOLVEMENT

THE MARK CONSISTS OF STANDARD CHARACTERS WITHOUT CLAIM TO ANY PARTICULAR FONT, STYLE, SIZE, OR COLOR.
FOR DEVELOPING ADVERTISING, PROMOTIONAL CAMPAIGNS, ONLINE PROMOTIONAL CAMPAIGNS, PROMOTIONAL EVENTS FOR OTHERS GEARED TOWARDS SOCIAL CHANGE CAUSES, YOUTH ACTIVISM AND YOUNG ADULT SOCIAL ISSUES (U.S. CLS. 100, 101 AND 102).
JULIE WATSON, EXAMINING ATTORNEY

CLASS 35—(Continued).

SN 85-532,047. YESSTYLE.COM, LIMITED, KWAI CHUNG, NEW TERR., HONG KONG, FILED 2-2-2012.

YESWALKER.COM

THE MARK CONSISTS OF STANDARD CHARACTERS WITHOUT CLAIM TO ANY PARTICULAR FONT, STYLE, SIZE, OR COLOR.

FOR ON-LINE ORDERING SERVICES FEATURING COSMETIC PRODUCTS, SKINCARE PRODUCTS, CLOTHING, INTIMATE WEAR, SPORTSWEAR, FOOTWEAR, BAGS, HEADGEAR, JEWELRY PRODUCTS, WATCHES, PRECIOUS METAL, ORNAMENTAL OBJECTS, HOME DECORATION PRODUCTS, HOUSEWARES, ELECTRONICS, BATH AND BEDDING PRODUCTS, BOOKS, MAGAZINES, GIFTS, SOUVENIRS, FASHION ACCESSORIES; ON-LINE RETAIL STORE SERVICES FEATURING COSMETIC PRODUCTS, SKINCARE PRODUCTS, CLOTHING, INTIMATE WEAR, SPORTSWEAR, FOOTWEAR, BAGS, HEADGEAR, JEWELRY PRODUCTS, WATCHES, PRECIOUS METAL, ORNAMENTAL OBJECTS, HOME DECORATION PRODUCTS, HOUSEWARES, ELECTRONICS, BATH AND BEDDING PRODUCTS, BOOKS, MAGAZINES, GIFTS, SOUVENIRS, FASHION ACCESSORIES (U.S. CLS. 100, 101 AND 102).

BERYL GARDNER, EXAMINING ATTORNEY

SN 85-532,092. DREAMCLOSET.COM INC, LOS ANGELES, CA. FILED 2-2-2012.

DreamCloset

THE MARK CONSISTS OF STANDARD CHARACTERS WITHOUT CLAIM TO ANY PARTICULAR FONT, STYLE, SIZE, OR COLOR.

FOR ON-LINE RETAIL CONSIGNMENT STORES FEATURING CLOTHING AND FASHION ACCESSORIES; OPERATING ON-LINE MARKETPLACES FEATURING THE SALE AND CONSIGNMENT OF CLOTHING AND FASHION ACCESSORIES; PROVIDING AN ON-LINE DIRECTORY INFORMATION SERVICE FEATURING INFORMATION REGARDING ON-LINE AND OFFLINE RETAIL CONSIGNMENT STORES FEATURING CLOTHING AND FASHION ACCESSORIES (U.S. CLS. 100, 101 AND 102).

CHRIS WELLS, EXAMINING ATTORNEY

CLASS 35—(Continued).

SN 85-532,277. FEED ADAM LLC, ORANGE CITY, IA. FILED 2-2-2012.

EATING AWAY AT POVERTY

THE MARK CONSISTS OF STANDARD CHARACTERS WITHOUT CLAIM TO ANY PARTICULAR FONT, STYLE, SIZE, OR COLOR.

FOR ON-LINE RETAIL STORE SERVICES FEATURING FOOD PRODUCTS; RETAIL STORE SERVICES FEATURING FOOD PRODUCTS; WHOLESALE FOOD DISTRIBUTORSHIP SERVICES; WHOLESALE STORE SERVICES FEATURING FOOD PRODUCTS (U.S. CLS. 100, 101 AND 102).

FIRST USE 7-0-2011; IN COMMERCE 7-0-2011.

APRIL HESIK, EXAMINING ATTORNEY

SN 85-532,295. FRIEDMAN, MARK, CENTERVILLE, OH. FILED 2-2-2012.

pow-word

THE MARK CONSISTS OF STANDARD CHARACTERS WITHOUT CLAIM TO ANY PARTICULAR FONT, STYLE, SIZE, OR COLOR.

FOR COPY WRITING FOR ADVERTISING AND PROMOTIONAL PURPOSES (U.S. CLS. 100, 101 AND 102).

KIMBERLY PERRY, EXAMINING ATTORNEY

SN 85-532,303. HIEBERT, TIMOTHY H., BOSTON, MA. FILED 2-2-2012.

MILDLY ARTISTIC

THE MARK CONSISTS OF STANDARD CHARACTERS WITHOUT CLAIM TO ANY PARTICULAR FONT, STYLE, SIZE, OR COLOR.

NO CLAIM IS MADE TO THE EXCLUSIVE RIGHT TO USE "ARTISTIC", APART FROM THE MARK AS SHOWN. FOR ON-LINE ART GALLERIES (U.S. CLS. 100, 101 AND 102).

FIRST USE 6-16-2010; IN COMMERCE 6-16-2010.

KATHLEEN M. VANSTON, EXAMINING ATTORNEY

CLASS 35—(Continued).

SN 85-532,425. JURISTAFF, INC., PHILADELPHIA, PA. FILED 2-2-2012.

JURISOLUTIONS

THE MARK CONSISTS OF STANDARD CHARACTERS WITHOUT CLAIM TO ANY PARTICULAR FONT, STYLE, SIZE, OR COLOR.

OWNER OF U.S. REG. NOS. 2,216,292 AND 3,480,451. FOR LEGAL PERSONNEL EMPLOYMENT AGENCY SERVICES (U.S. CLS. 100, 101 AND 102). JOHN DWYER, EXAMINING ATTORNEY

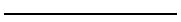

SN 85-532,518. ZEPHYR PARTNERS, LLC, LAS VEGAS, NV. FILED 2-2-2012.

"Outsourcing within your community"

THE MARK CONSISTS OF STANDARD CHARACTERS WITHOUT CLAIM TO ANY PARTICULAR FONT, STYLE, SIZE, OR COLOR.

FOR OPERATION OF TELEPHONE CALL CENTERS FOR OTHERS (U.S. CLS. 100, 101 AND 102). LINDA ESTRADA, EXAMINING ATTORNEY

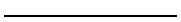

SN 85-532,632. PREMYODHIN, CHARN, BUENA PARK, CA. FILED 2-2-2012.

vape revolution

THE MARK CONSISTS OF THE STYLIZED TEXT "VAPE REVOLUTION".

FOR RETAIL STORE SERVICES FEATURING ELECTRONIC CIGARETTES AND PERSONAL VAPORIZERS; WHOLESALE STORE SERVICES FEATURING ELECTRONIC CIGARETTES AND PERSONAL VAPORIZERS (U.S. CLS. 100, 101 AND 102). GIANCARLO CASTRO, EXAMINING ATTORNEY

CLASS 35—(Continued).

SN 85-532,699. MCELROY, JOHN, BLAKESLEE, PA. FILED 2-2-2012.

We cool our beer with the sun

THE MARK CONSISTS OF STANDARD CHARACTERS WITHOUT CLAIM TO ANY PARTICULAR FONT, STYLE, SIZE, OR COLOR.

FOR RETAIL CONVENIENCE STORES (U.S. CLS. 100, 101 AND 102). FIRST USE 6-1-2011; IN COMMERCE 6-1-2011. LEIGH CAROLINE CASE, EXAMINING ATTORNEY

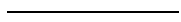

SN 85-532,747. UNITEDHEALTH GROUP INCORPORATED, MINNETONKA, MN. FILED 2-2-2012.

MYX

THE MARK CONSISTS OF STANDARD CHARACTERS WITHOUT CLAIM TO ANY PARTICULAR FONT, STYLE, SIZE, OR COLOR.

FOR ONLINE RETAIL STORE SERVICES FEATURING DOWNLOADABLE COMPUTER SOFTWARE APPLICATIONS PROVIDED VIA THE INTERNET AND OTHER COMPUTER AND ELECTRONIC COMMUNICATIONS NETWORKS; ONLINE RETAIL STORE SERVICES FEATURING DOWNLOADABLE COMPUTER SOFTWARE APPLICATIONS FOR USE ON HANDHELD MOBILE DIGITAL ELECTRONIC DEVICES AND OTHER CONSUMER ELECTRONICS; PROVIDING AN ON-LINE SEARCHABLE DATABASE FEATURING PRODUCT INFORMATION IN THE FIELD OF COMPUTER SOFTWARE APPLICATIONS; OPERATING ON-LINE MARKETPLACES FOR BUYING, SELLING AND EXCHANGING COMPUTER SOFTWARE APPLICATIONS; PROMOTING THE USE OF THE SECURITY ASSURANCE BEST PRACTICES OF OTHERS IN THE FIELD OF CLOUD COMPUTING; ELECTRONIC MEDICAL RECORDS MANAGEMENT (U.S. CLS. 100, 101 AND 102). MATTHEW EINSTEIN, EXAMINING ATTORNEY

CLASS 35—(Continued).

SN 85-532,935. WEAVER, MICHELLE, HOUSTON, TX. AND WEAVER, RICK, HOUSTON, TX. FILED 2-3-2012.

What's On Your Wall?

THE MARK CONSISTS OF STANDARD CHARACTERS WITHOUT CLAIM TO ANY PARTICULAR FONT, STYLE, SIZE, OR COLOR.

FOR ADVERTISING AND MARKETING SERVICES PROVIDED BY MEANS OF INDIRECT METHODS OF MARKETING COMMUNICATIONS, NAMELY, SOCIAL MEDIA, SEARCH ENGINE MARKETING, INQUIRY MARKETING, INTERNET MARKETING, MOBILE MARKETING, BLOGGING AND OTHER FORMS OF PASSIVE, SHARABLE OR VIRAL COMMUNICATIONS CHANNELS (U.S. CLS. 100, 101 AND 102).

IRA J. GOODSAD, EXAMINING ATTORNEY

CLASS 35—(Continued).

SN 85-532,987. BIG DOT OF HAPPINESS, LLC, MENOMONIE, WI. FILED 2-3-2012.

WHERE DOG OWNERS GET PARTY TRAINED

THE MARK CONSISTS OF STANDARD CHARACTERS WITHOUT CLAIM TO ANY PARTICULAR FONT, STYLE, SIZE, OR COLOR.

FOR RETAIL AND ON-LINE RETAIL STORE SERVICES FEATURING PET PRODUCTS; RETAIL AND ON-LINE RETAIL STORE SERVICES FEATURING PARTY SUPPLIES FOR PET PARTIES AND PETS; RETAIL AND ON-LINE RETAIL STORE SERVICES FEATURING INVITATIONS, THEMED PRODUCTS, PARTY FAVORS, PARTY DECORATIONS, PARTY BALLOONS AND BANNERS, PARTY TABLEWARE, PARTY FOODS AND TREATS, PARTY GAMES, PARTY BOOKS, PET FOODS AND SNACKS, PET CLOTHES, PET COLLARS, PET SUPPLIES, PARTY FAVORS FOR PETS, TOYS FOR PETS (U.S. CLS. 100, 101 AND 102).

DAVID I, EXAMINING ATTORNEY

SN 85-533,040. TIGERBEAR HOLDINGS GMBH, LOS ANGELES, CA. FILED 2-3-2012.

TRADE-UP

THE MARK CONSISTS OF STANDARD CHARACTERS WITHOUT CLAIM TO ANY PARTICULAR FONT, STYLE, SIZE, OR COLOR.

FOR BARTER EXCHANGE SERVICES, NAMELY, PROVIDING COMMERCIAL BARTER AND TRADE EXCHANGE OF PRODUCTS AND SERVICES VIA A GLOBAL COMPUTER INFORMATION NETWORK; ON-LINE TRADING SERVICES IN WHICH SELLER POSTS PRODUCTS TO BE AUCTIONED AND BIDDING IS DONE VIA THE INTERNET (U.S. CLS. 100, 101 AND 102).

SALLY SHIH, EXAMINING ATTORNEY

SN 85-532,983. BIG DOT OF HAPPINESS, LLC, MENOMONIE, WI. FILED 2-3-2012.

WHEN POOCH COMES TO SHOVE

THE MARK CONSISTS OF STANDARD CHARACTERS WITHOUT CLAIM TO ANY PARTICULAR FONT, STYLE, SIZE, OR COLOR.

FOR RETAIL AND ON-LINE RETAIL STORE SERVICES FEATURING PET PRODUCTS; RETAIL AND ON-LINE RETAIL STORE SERVICES FEATURING PARTY SUPPLIES FOR PET PARTIES AND PETS; RETAIL AND ON-LINE RETAIL STORE SERVICES FEATURING INVITATIONS, THEMED PRODUCTS, PARTY FAVORS, PARTY DECORATIONS, PARTY BALLOONS AND BANNERS, PARTY TABLEWARE, PARTY FOODS AND TREATS, PARTY GAMES, PARTY BOOKS, PET FOODS AND SNACKS, PET CLOTHES, PET COLLARS, PET SUPPLIES, PARTY FAVORS FOR PETS, TOYS FOR PETS (U.S. CLS. 100, 101 AND 102).

DAVID I, EXAMINING ATTORNEY

SN 85-533,064. MCPHAUL, JONAH T., DBA LOUD MOUTH, LLC, OKLAHOMA CITY, OK. FILED 2-3-2012.



THE MARK CONSISTS OF CELL PHONE IMAGE, TWO ANTENNA'S STICKING OUT CURVING UP TO THE RIGHT AND CURVING UP TO THE LEFT WITH LITTLE BALLS/CIRCLES AT THE TOP OF THE ANTENNA. TWO BIG CIRCLES FORM THE EYES WITH TWO SMALL CENTER CIRCLE AS THE EYES PUPIL. THERE IS A SMALL DIAMETER OF SPACE BETWEEN THE OUTER CIRCLE AND INNER CIRCLE THAT REPRESENT THE EYES. THE MOUTH STRETCHES OPEN WITH TWO TEETH

CLASS 35—(Continued).

AT THE TOP WITH A SPLIT DOWN THE MIDDLE, THE UPPER/INNER MOUTH PALETTE HAS A LITTLE WIGGLY THING SHOWING THE THROAT. THE TONGUE IS DOWN AT THE BOTTOM OF THE MOUTH. THERE ARE SOUND BITES COMING OUT FROM THE LOWER MOUTH PORTION NEXT TO THE OPENING OF THE MOUTH ON BOTH SIDES SEPARATED WITH SPACES. THE WORDS "LOUD MOUTH" AND THE PHRASE "WE GET THE WORD OUT" WRITTEN BELOW THE NAME LOUD MOUTH ARE ALL WRITTEN NEXT TO THE IMAGE/MARK ON THE RIGHT FACING SIDE OF IMAGE NEAR THE EYES.

FOR PROMOTING AND MARKETING THE GOODS AND SERVICES OF OTHERS BY DISTRIBUTING ADVERTISING MATERIAL, COUPONS AND DISCOUNT OFFERS VIA TEXT MESSAGES (U.S. CLS. 100, 101 AND 102).

SUE LAWRENCE, EXAMINING ATTORNEY

SN 85-533,103. SQUARESPOT CORP., YONKERS, NY. FILED 2-3-2012.

SQUARECARD

THE MARK CONSISTS OF STANDARD CHARACTERS WITHOUT CLAIM TO ANY PARTICULAR FONT, STYLE, SIZE, OR COLOR.

FOR PROMOTING THE GOODS AND SERVICES OF OTHERS BY MEANS OF THE ISSUANCE OF DISCOUNT AND EXCLUSIVE BENEFITS CARDS (U.S. CLS. 100, 101 AND 102).

FIRST USE 1-0-2012; IN COMMERCE 1-0-2012.
AMY C. KEAN, EXAMINING ATTORNEY

SN 85-533,257. STERISPHERE APPLICATION SERVICES, LLC, AUSTIN, TX. AND MCLEAN , EMILY, AUSTIN, TX. FILED 2-3-2012.

STERISPHERE

THE MARK CONSISTS OF STANDARD CHARACTERS WITHOUT CLAIM TO ANY PARTICULAR FONT, STYLE, SIZE, OR COLOR.

FOR DISTRIBUTORSHIP SERVICES IN THE FIELD OF CLEANING PRODUCTS (U.S. CLS. 100, 101 AND 102).

TEJBIR SINGH, EXAMINING ATTORNEY

CLASS 35—(Continued).

SN 85-533,265. U.S. MARINE CORPS, A COMPONENT OF THE U.S. DEPARTMENT OF THE NAVY, WASHINGTON, DC. FILED 2-3-2012.



THE COLOR(S) RED AND BLUE IS/ARE CLAIMED AS A FEATURE OF THE MARK.

THE MARK CONSISTS OF THE WORDS THE NEW (IN RED) SITTING ATOP A BLUE LETTER X, WITH A RED HORIZONTAL BAND ACROSS THE MIDDLE OF THE X, AND THE WORDS WE'VE TRANSFORMED! (IN RED) BENEATH THE X.

FOR RETAIL DEPARTMENT STORE SERVICES (U.S. CLS. 100, 101 AND 102).

FIRST USE 11-19-2008; IN COMMERCE 11-19-2008.
MATTHEW KLINE, EXAMINING ATTORNEY

SN 85-533,363. SAVEMED.COM, LLC, DELRAY BEACH, FL. FILED 2-3-2012.



THE MARK CONSISTS OF A BRIEFCASE WITH A CROSS IN ITS CENTER, FOLLOWED IMMEDIATELY BY THE WORD "SAVEMED".

FOR RETAIL STORE SERVICES FEATURING DURABLE MEDICAL EQUIPMENT, DISPOSABLE MEDICAL SUPPLIES, HOUSEHOLD HEALTH AND BATHROOM SUPPLIES AND ACCESSORIES, VITAMINS AND NUTRITIONAL SUPPLEMENTS, AND A VARIETY OF OTHER CONSUMER GOODS OF OTHERS ACCESSIBLE ON-LINE AND BY TELEPHONE, FACSIMILE AND MAIL ORDER (U.S. CLS. 100, 101 AND 102).

TINA MAI, EXAMINING ATTORNEY

CLASS 35—(Continued).

SN 85-533,378. FARM COUNTRY TRADER, INC., INWOOD, IA. FILED 2-3-2012.



THE MARK CONSISTS OF THE STYLIZED LETTERS "D", "C", AND "H". THE "D" SHOWN AS THE RIGHT HALF OF A CIRCLE, THE "C" BEING THE LEFT HALF OF A CIRCLE, AND THE "H" BEING THE TWO HALF-CIRCLES CONNECTING.

FOR ADVERTISING SERVICES, NAMELY, DEVELOPMENT, OPERATION AND ADMINISTRATION OF DIGITAL ADVERTISING SYSTEMS FOR OTHERS, NAMELY, PROVIDING ADVERTISING SPACE BY ELECTRONIC MEANS AND GLOBAL COMPUTER INFORMATION NETWORKS, INVENTORY MANAGEMENT (U.S. CLS. 100, 101 AND 102).

FIRST USE 1-30-2012; IN COMMERCE 1-30-2012.
ANDREA HACK, EXAMINING ATTORNEY

SN 85-533,383. PRETTY BROWN GIRL L.L.C., NOVI, MI. FILED 2-3-2012.

PRETTY BROWN GIRL

THE MARK CONSISTS OF STANDARD CHARACTERS WITHOUT CLAIM TO ANY PARTICULAR FONT, STYLE, SIZE, OR COLOR.

FOR ON-LINE RETAIL STORE SERVICES FEATURING A WIDE VARIETY OF CONSUMER GOODS OF OTHERS (U.S. CLS. 100, 101 AND 102).

FIRST USE 10-30-2011; IN COMMERCE 10-30-2011.
C. DIONNE CLYBURN, EXAMINING ATTORNEY

CLASS 35—(Continued).

SN 85-533,481. PROMOSHADE INC, SCOTTSDALE, AZ. FILED 2-3-2012.

PROMOLOGOMUGS

THE MARK CONSISTS OF STANDARD CHARACTERS WITHOUT CLAIM TO ANY PARTICULAR FONT, STYLE, SIZE, OR COLOR.

FOR PREPARATION OF CUSTOMIZED PROMOTIONAL AND MERCHANDISING MATERIALS FOR OTHERS (U.S. CLS. 100, 101 AND 102).

FIRST USE 12-26-2007; IN COMMERCE 12-26-2007.
BILL DAWE, EXAMINING ATTORNEY

SN 85-533,501. WANNABEESOCIAL, LLC, LAKE LAND, FL. FILED 2-3-2012.

WannaBeeSocial

THE MARK CONSISTS OF STANDARD CHARACTERS WITHOUT CLAIM TO ANY PARTICULAR FONT, STYLE, SIZE, OR COLOR.

FOR ADVERTISING AND MARKETING SERVICES PROVIDED BY MEANS OF INDIRECT METHODS OF MARKETING COMMUNICATIONS, NAMELY, SOCIAL MEDIA, SEARCH ENGINE MARKETING, INQUIRY MARKETING, INTERNET MARKETING, MOBILE MARKETING, BLOGGING AND OTHER FORMS OF PASSIVE, SHARABLE OR VIRAL COMMUNICATIONS CHANNELS; SOCIAL MEDIA STRATEGY AND MARKETING CONSULTANCY FOCUSING ON HELPING CLIENTS CREATE AND EXTEND THEIR PRODUCT AND BRAND STRATEGIES BY BUILDING VIRALLY ENGAGING MARKETING SOLUTIONS (U.S. CLS. 100, 101 AND 102).

FIRST USE 2-15-2010; IN COMMERCE 2-15-2010.
JOSETTE BEVERLY, EXAMINING ATTORNEY

SN 85-533,526. YADEGAR BROTHERS INC., COMPTON, CA. FILED 2-3-2012.



THE MARK CONSISTS OF THE WORDS "THE PRICE TAG", AND BELOW IT THE WORDS "CHIC FOR LESS," WITH THE OUTLINE OF A PRICE TAG OVERLYING THE WORD "PRICE".

FOR ON-LINE RETAIL STORE SERVICES FEATURING CLOTHING (U.S. CLS. 100, 101 AND 102).

FIRST USE 1-28-2011; IN COMMERCE 1-28-2011.
ANGELA DUONG, EXAMINING ATTORNEY

CLASS 35—(Continued).

SN 85-533,554. AUSTIN ADVISORY GROUP, NEW YORK, NY. FILED 2-3-2012.

FRAGRANCE CREATION, FROM
THE SOURCE

THE MARK CONSISTS OF STANDARD CHARACTERS WITHOUT CLAIM TO ANY PARTICULAR FONT, STYLE, SIZE, OR COLOR.

NO CLAIM IS MADE TO THE EXCLUSIVE RIGHT TO USE "FRAGRANCE", APART FROM THE MARK AS SHOWN.

FOR DEVELOPMENT OF MARKETING STRATEGIES AND CONCEPTS IN THE FIELD OF FRAGRANCES, PERFUMES, COLOGNES, AND COSMETICS; ADVERTISING SERVICES, NAMELY, PROMOTING AND MARKETING THE GOODS OF OTHERS IN THE FIELD OF FRAGRANCES, PERFUMES, COLOGNES, AND COSMETICS VIA PRINT, ELECTRONIC MEDIA, TELEVISION, VIDEO, AND MULTIMEDIA PRODUCTION; BRANDING SERVICES, NAMELY, CONSULTING, DEVELOPMENT, MANAGEMENT, AND MARKETING OF BRANDS FOR BUSINESSES IN THE FIELD OF FRAGRANCES, PERFUMES, COLOGNES, AND COSMETICS (U.S. CLS. 100, 101 AND 102).

GRETCHEN ULRICH, EXAMINING ATTORNEY

SN 85-533,558. SCRUBS & BEYOND, LLC, BRENTWOOD, MO. FILED 2-3-2012.

ALWAYS FIRST IN FASHION

THE MARK CONSISTS OF STANDARD CHARACTERS WITHOUT CLAIM TO ANY PARTICULAR FONT, STYLE, SIZE, OR COLOR.

FOR RETAIL STORE, ONLINE RETAIL STORE, AND MAIL ORDER CATALOG SERVICES FEATURING MEDICAL SCRUB APPAREL AND RELATED PRODUCTS, NAMELY, SCRUB TOPS, KNIT TOPS, SCRUB BOTTOMS, SCRUB JACKETS, SHOES, AND MEDICAL ACCESSORIES, NAMELY, BLOOD PRESSURE CUFFS, NURSE KITS, PROTECTIVE EYEWEAR, MEDICAL SCISSORS, THERMOMETERS AND STETHOSCOPES (U.S. CLS. 100, 101 AND 102).

MARK RADEMACHER, EXAMINING ATTORNEY

CLASS 35—(Continued).

SN 85-533,628. HISCOCK, CAMERON C., MISSISSAUGA, ONTARIO, CANADA, FILED 2-3-2012.

energy

THE MARK CONSISTS OF STANDARD CHARACTERS WITHOUT CLAIM TO ANY PARTICULAR FONT, STYLE, SIZE, OR COLOR.

FOR ENERGY AUDITING; HOME ENERGY ASSESSMENT SERVICES FOR THE PURPOSE OF DETERMINING ENERGY EFFICIENCY OR USAGE MANAGEMENT (U.S. CLS. 100, 101 AND 102).

FIRST USE 1-1-2003; IN COMMERCE 1-1-2003.

JENNIFER VASQUEZ, EXAMINING ATTORNEY

SN 85-533,639. DAVINCI VIRTUAL LLC, SALT LAKE CITY, UT. FILED 2-3-2012.

DAVINCI VIRTUAL WORKSPACES

THE MARK CONSISTS OF STANDARD CHARACTERS WITHOUT CLAIM TO ANY PARTICULAR FONT, STYLE, SIZE, OR COLOR.

OWNER OF U.S. REG. NOS. 3,546,421, 3,730,474 AND 3,861,328.

NO CLAIM IS MADE TO THE EXCLUSIVE RIGHT TO USE "VIRTUAL WORKSPACES", APART FROM THE MARK AS SHOWN.

FOR PROVIDING VIRTUAL OFFICE SUPPORT STAFF SERVICES FOR BUSINESSES; OFFICE ADMINISTRATION SERVICES; PROVIDING OFFICE SUPPORT STAFF SERVICES; SECRETARIAL AND CLERICAL SERVICES; TELEPHONE ANSWERING SERVICES AND TELEPHONE RECEPTIONIST SERVICES FOR OTHERS (U.S. CLS. 100, 101 AND 102).

LESLIE RICHARDS, EXAMINING ATTORNEY

SN 85-533,770. BETTER BUSINESS BUREAU OF METROPOLITAN HOUSTON, INC., HOUSTON, TX. FILED 2-3-2012.

TRUSTTRACKER

THE MARK CONSISTS OF STANDARD CHARACTERS WITHOUT CLAIM TO ANY PARTICULAR FONT, STYLE, SIZE, OR COLOR.

FOR BUSINESS INVESTIGATIONS AND BUSINESS INFORMATION SERVICES IN THE FIELD OF BUSINESS AND TRADE PRACTICES (U.S. CLS. 100, 101 AND 102).

DAVID H. STINE, EXAMINING ATTORNEY

CLASS 35—(Continued).

SN 85-533,914. O'NEILL, NICHOLAS E, SAN FRANCISCO, CA. FILED 2-3-2012.

StartupScore

THE MARK CONSISTS OF STANDARD CHARACTERS WITHOUT CLAIM TO ANY PARTICULAR FONT, STYLE, SIZE, OR COLOR.

FOR ONLINE BUSINESS RESEARCH SERVICES THAT ALLOW USERS TO ANALYZE TRENDS OF RECENTLY CREATED VENTURES (U.S. CLS. 100, 101 AND 102).

ALAIN LAPTER, EXAMINING ATTORNEY

SN 85-533,990. BUSINESS INSTINCTS GROUP INC., CALGARY, ALBERTA, CANADA, FILED 2-4-2012.

RIPKIT

THE MARK CONSISTS OF STANDARD CHARACTERS WITHOUT CLAIM TO ANY PARTICULAR FONT, STYLE, SIZE, OR COLOR.

FOR BUSINESS CONSULTING SERVICES, NAMELY, THE SUPPLY OF BUSINESS SERVICES DESIGNED TO CREATE, CLARIFY AND ALIGN A BUSINESS' GOALS AND THE IMPLEMENTATION OF MANAGEMENT PROCESSES, MARKETING AND INTERNET-BASED STRATEGIES AND MEASUREMENT SYSTEMS DESIGNED TO ADVANCE AND MEASURE THE BUSINESS' GOALS (U.S. CLS. 100, 101 AND 102).

FIRST USE 4-4-2010; IN COMMERCE 3-19-2011.

DAVID I, EXAMINING ATTORNEY

SN 85-534,056. NETWORK ASSOCIATES, INC., MOUNT PLEASANT, SC. FILED 2-4-2012.

MLN

THE MARK CONSISTS OF STANDARD CHARACTERS WITHOUT CLAIM TO ANY PARTICULAR FONT, STYLE, SIZE, OR COLOR.

OWNER OF U.S. REG. NOS. 1,661,941 AND 2,226,373.

FOR PROVIDING A WEB SITE WHICH FEATURES ADVERTISEMENTS FOR THE GOODS AND SERVICES OF OTHERS ON A GLOBAL COMPUTER NETWORK (U.S. CLS. 100, 101 AND 102).

FIRST USE 10-30-2005; IN COMMERCE 10-30-2005.

KATHRYN COWARD, EXAMINING ATTORNEY

CLASS 35—(Continued).

SN 85-534,372. GHIGLIAZZA, RICARDO ANDRES, BUENOS AIRES, ARGENTINA, FILED 2-6-2012.



OWNER OF ARGENTINA REG. NO. 2348699, DATED 2-25-2010, EXPIRES 2-25-2020.

THE COLOR(S) GREY, GREEN, BLUE AND BLACK IS/ARE CLAIMED AS A FEATURE OF THE MARK.

THE MARK CONSISTS OF THE LITERAL ELEMENT "HUMAN" IN BLACK, THE LITERAL ELEMENT "SCORING" IN GREY, AND THERE ARE FOUR REPRESENTATIONS OF PERSONS. STARTING FROM THE LEFT, THE FIRST PERSON IS BLACK, THE SECOND IS BLUE, THE THIRD ONE IS GREEN AND THE LAST ONE IS GREY.

FOR HUMAN RESOURCE ANALYSIS AND CONSULTING SERVICES; HUMAN RESOURCES SERVICES, NAMELY, PERSONNEL SELECTION FOR OTHERS (U.S. CLS. 100, 101 AND 102).

ANDREW LEASER, EXAMINING ATTORNEY

SN 85-534,449. HAGEN, DARREN, NEW YORK, NY. FILED 2-6-2012.



THE MARK CONSISTS OF THE STYLIZED TEXT "ARBORLAND" IN WHICH THE LETTER "A" IS ENCLOSED IN A QUADRANGLE BORDER. THE LETTER "O" IS REPRESENTED BY A SOLID CIRCLE WITH A STEM AT THE BOTTOM CREATING A TREE-LIKE IMAGE.

FOR MANAGEMENT OF PERFORMING AND RECORDING ARTISTS (U.S. CLS. 100, 101 AND 102).

FIRST USE 5-14-2008; IN COMMERCE 5-14-2008.

JORDAN BAKER, EXAMINING ATTORNEY

SN 85-534,481. TRIAD DIGITAL MEDIA, LLC, SOUTHFIELD, MI. FILED 2-6-2012.

ENDLESS AISLE

THE MARK CONSISTS OF STANDARD CHARACTERS WITHOUT CLAIM TO ANY PARTICULAR FONT, STYLE, SIZE, OR COLOR.

FOR ADVERTISING AND MARKETING SERVICES (U.S. CLS. 100, 101 AND 102).

RONALD AIKENS, EXAMINING ATTORNEY

CLASS 35—(Continued).

SN 85-534,516. LBV HOLDINGS, LLC, ATLANTA, GA. FILED 2-6-2012.

PURVEYORS OF THE BEAUTIFUL
LIFE

THE MARK CONSISTS OF STANDARD CHARACTERS WITHOUT CLAIM TO ANY PARTICULAR FONT, STYLE, SIZE, OR COLOR.
FOR WHOLESALE AND RETAIL STORE SERVICES FEATURING CLOTHING (U.S. CLS. 100, 101 AND 102).
FIRST USE 1-8-2012; IN COMMERCE 1-8-2012.
WILLIAM ROSSMAN, EXAMINING ATTORNEY

SN 85-534,560. HEALTHQX LLC, WAYNE, PA. FILED 2-6-2012.

HEALTHQX

THE MARK CONSISTS OF STANDARD CHARACTERS WITHOUT CLAIM TO ANY PARTICULAR FONT, STYLE, SIZE, OR COLOR.
FOR BUSINESS SERVICES PROVIDED TO THE HEALTHCARE INDUSTRY, NAMELY, THE COLLECTION, REPORTING, AND ANALYSIS OF HEALTHCARE QUALITY DATA FOR BUSINESS PURPOSES (U.S. CLS. 100, 101 AND 102).
KATHRYN COWARD, EXAMINING ATTORNEY

SN 85-534,598. UNITY PRODUCTIONS FOUNDATION, AKA UPF, WASHINGTON, DC. FILED 2-6-2012.

MOST

THE MARK CONSISTS OF STANDARD CHARACTERS WITHOUT CLAIM TO ANY PARTICULAR FONT, STYLE, SIZE, OR COLOR.
FOR PROMOTING PUBLIC AWARENESS OF THE NEED AND MEANS OF PURSUING PEACE AND CULTURAL UNDERSTANDING THROUGH MEDIA (U.S. CLS. 100, 101 AND 102).
FIRST USE 2-15-2007; IN COMMERCE 2-15-2007.
DAVID TAYLOR, EXAMINING ATTORNEY

CLASS 35—(Continued).

SN 85-534,636. TRAVISWOLFF LLP, DALLAS, TX. FILED 2-6-2012.

We
Know.

THE MARK CONSISTS OF A STYLIZED CAPITAL "W", SMALL "E", SPACE, CAPITAL "K", SMALL "NOW", AND A PERIOD AT THE END.
FOR ACCOUNTING SERVICES; BUSINESS APPRAISALS AND EVALUATIONS IN BUSINESS MATTERS; BUSINESS AUDITING; FORENSIC ACCOUNTING SERVICES; TAX ADVISORY SERVICES (U.S. CLS. 100, 101 AND 102).
FIRST USE 8-26-2011; IN COMMERCE 8-26-2011.
ANNE MADDEN, EXAMINING ATTORNEY

SN 85-534,668. TSUNAMI JIM'S, LLC, CINCINNATI, OH. FILED 2-6-2012.

Tsunami Jim's

THE MARK CONSISTS OF STANDARD CHARACTERS WITHOUT CLAIM TO ANY PARTICULAR FONT, STYLE, SIZE, OR COLOR.
FOR RETAIL STORE SERVICES FEATURING SWIMMING POOLS AND ACCESSORIES THEREFOR, HOT TUBS, SPAS, SAUNAS AND ACCESSORIES THEREFOR, LANDSCAPING ARTICLES AND ACCESSORIES THEREFOR (U.S. CLS. 100, 101 AND 102).
FIRST USE 1-31-2012; IN COMMERCE 1-31-2012.
TAMARA FRAZIER, EXAMINING ATTORNEY

CLASS 35—(Continued).

SN 85-534,672. NO JUDGES, INC., BELVIDERE, IL. FILED 2-6-2012.



THE MARK CONSISTS OF A SILHOUETTE OF A MAN WITH HIS ARMS CROSSED ABOVE THE LETTERS "N J". FOR RETAIL STORE SERVICES FEATURING CLOTHING SPECIFICALLY TARGETED AT MMA FIGHT FANS (U.S. CLS. 100, 101 AND 102).

TAMARA FRAZIER, EXAMINING ATTORNEY

SN 85-534,800. APRIA HEALTHCARE GROUP INC., LAKE FOREST, CA. FILED 2-6-2012.

APRIADIRECT

THE MARK CONSISTS OF STANDARD CHARACTERS WITHOUT CLAIM TO ANY PARTICULAR FONT, STYLE, SIZE, OR COLOR.

FOR ONLINE RETAIL STORE SERVICES FEATURING HOME HEALTHCARE PRODUCTS AND ACCESSORIES (U.S. CLS. 100, 101 AND 102).

FIRST USE 10-23-2010; IN COMMERCE 10-23-2010.

JAY FLOWERS, EXAMINING ATTORNEY

SN 85-534,820. DETROIT HYDROPONICS, INC., DBA THE CULTIVATION STATION, ST. CLAIRE SHORES, MI. FILED 2-6-2012.

YOU GROW IT, WE KNOW IT!

THE MARK CONSISTS OF STANDARD CHARACTERS WITHOUT CLAIM TO ANY PARTICULAR FONT, STYLE, SIZE, OR COLOR.

FOR ON-LINE RETAIL STORE SERVICES FEATURING HYDROPONIC AND GARDENING SUPPLIES; RETAIL STORE SERVICES FEATURING HYDROPONIC AND GARDENING SUPPLIES (U.S. CLS. 100, 101 AND 102).

FIRST USE 8-5-1998; IN COMMERCE 8-5-1998.

SALLY SHIH, EXAMINING ATTORNEY

CLASS 35—(Continued).

SN 85-534,822. DETROIT HYDROPONICS, INC., DBA THE CULTIVATION STATION, ST. CLAIRE SHORES, MI. FILED 2-6-2012.

THE CULTIVATION STATION

THE MARK CONSISTS OF STANDARD CHARACTERS WITHOUT CLAIM TO ANY PARTICULAR FONT, STYLE, SIZE, OR COLOR.

FOR ON-LINE RETAIL STORE SERVICES FEATURING HYDROPONIC AND GARDENING SUPPLIES; RETAIL STORE SERVICES FEATURING HYDROPONIC AND GARDENING SUPPLIES (U.S. CLS. 100, 101 AND 102).

FIRST USE 8-5-1998; IN COMMERCE 8-5-1998.

SALLY SHIH, EXAMINING ATTORNEY

SN 85-534,918. DJH MARKETING, LLC, NORFOLK, VA. FILED 2-6-2012.

This Is How We Hewitt

THE MARK CONSISTS OF STANDARD CHARACTERS WITHOUT CLAIM TO ANY PARTICULAR FONT, STYLE, SIZE, OR COLOR.

FOR CONSULTATION SERVICES, NAMELY, CREATIVE AND STRATEGIC CONSULTATION REGARDING DEVELOPMENT AND PRODUCTION OF MARKETING CAMPAIGNS FOR OTHERS (U.S. CLS. 100, 101 AND 102).

EDWARD NELSON, EXAMINING ATTORNEY

SN 85-534,967. SHOP LOCAL CLUB, INC., ORLANDO, FL. FILED 2-6-2012.

TOWNEEZ

THE MARK CONSISTS OF STANDARD CHARACTERS WITHOUT CLAIM TO ANY PARTICULAR FONT, STYLE, SIZE, OR COLOR.

FOR PROMOTING THE GOODS AND SERVICES OF OTHERS BY PROVIDING A WEBSITE FEATURING COUPONS, REBATES, PRICE-COMPARISON INFORMATION, PRODUCT REVIEWS, LINKS TO THE RETAIL WEBSITES OF OTHERS AND DISCOUNT INFORMATION; PROVIDING ADVICE TO SMALL BUSINESS OWNERS IN THE NATURE OF MARKETING, ADVERTISING, MANAGEMENT AND CUSTOMER SERVICE (U.S. CLS. 100, 101 AND 102).

KATHERINE M. DUBRAY, EXAMINING ATTORNEY

CLASS 35—(Continued).

SN 85-534,995. LOLI AND THE BEAN, INCORPORATED, TALLAHASSEE, FL. FILED 2-6-2012.

Loli&theBean

THE MARK CONSISTS OF STANDARD CHARACTERS WITHOUT CLAIM TO ANY PARTICULAR FONT, STYLE, SIZE, OR COLOR.

FOR RETAIL STORE SERVICES FEATURING GIFTS (U.S. CLS. 100, 101 AND 102).

FIRST USE 8-0-2006; IN COMMERCE 8-0-2006.

KATHLEEN LORENZO, EXAMINING ATTORNEY

SN 85-535,034. BHASKARAN, SUNIL, CAPITOLA, CA. FILED 2-6-2012.

CAHAYA MIND

THE MARK CONSISTS OF STANDARD CHARACTERS WITHOUT CLAIM TO ANY PARTICULAR FONT, STYLE, SIZE, OR COLOR.

THE ENGLISH TRANSLATION OF "CAHAYA" IN THE MARK IS "LIGHT" OR "GLOW" OR "GLEAM IN MALAY".

FOR BUSINESS CONSULTING SERVICES, NAMELY, PROVIDING ASSISTANCE IN DEVELOPMENT OF BUSINESS STRATEGIES AND MARKETING; PROVIDING CONSULTING SERVICES IN THE NATURE OF DEVELOPMENT OF BUSINESS STRATEGIES AND MARKETING TO ENTREPRENEURS (U.S. CLS. 100, 101 AND 102).

JENNIFER VASQUEZ, EXAMINING ATTORNEY

SN 85-535,113. ITX CORP., PITTSFORD, NY. FILED 2-6-2012.

THE NEW HOW

THE MARK CONSISTS OF STANDARD CHARACTERS WITHOUT CLAIM TO ANY PARTICULAR FONT, STYLE, SIZE, OR COLOR.

FOR TECHNOLOGY-RELATED ADVERTISING AND PROMOTION SERVICES AND RELATED CONSULTING; TECHNOLOGY-RELATED ADVERTISING SERVICES, NAMELY, CREATING CORPORATE AND BRAND IDENTITY FOR OTHERS; CONSULTING SERVICES IN THE FIELD OF INTERNET MARKETING; TECHNOLOGY-RELATED BUSINESS MARKETING CONSULTING SERVICES; TECHNOLOGY-RELATED MARKETING CONSULTING; PLANNING, DESIGN, DEVELOPMENT, MAINTENANCE, TRACKING AND REPORTING OF ONLINE MARKETING ACTIVITIES FOR THIRD PARTIES; PROMOTING THE TECHNOLOGY-RELATED GOODS AND SERVICES OF OTHERS THROUGH SEARCH ENGINE REFERRAL TRAFFIC ANALYSIS AND REPORTING; PROVIDING TECHNOLOGY-RELATED ADVERTISING, MARKETING AND PROMOTIONAL SERVICES, NAMELY, DEVELOPMENT OF ADVERTISING CAMPAIGNS PROVIDED THROUGH

CLASS 35—(Continued).

CABLE TELEVISION BROADCAST, WEB CASTS, RADIO BROADCASTS, NEWSPAPERS, MAGAZINES, ONLINE BANNERS, OUTDOOR BILLBOARDS, WILD POSTINGS, BUS AND SUBWAY ADS; PROVIDING ONLINE, TECHNOLOGY-RELATED BUSINESS MANAGEMENT SERVICES FOR OTHERS, NAMELY, ACCOUNTING, MARKETING, BUSINESS PROJECT MANAGEMENT, AND BUSINESS DEVELOPMENT; DESIGN OF TECHNOLOGY-RELATED ADVERTISING MATERIALS FOR OTHERS; TECHNOLOGY-RELATED BUSINESS MANAGEMENT CONSULTING WITH RELATION TO STRATEGY, MARKETING, SALES, OPERATION, PRODUCT DESIGN PARTICULARLY SPECIALIZING IN THE USE OF ANALYTIC AND STATISTIC MODELS FOR THE UNDERSTANDING AND PREDICTING OF CONSUMERS, BUSINESSES, AND MARKET TRENDS AND ACTIONS; PROVIDING AN ONLINE BUSINESS ACCOUNT ADMINISTRATION SERVICE FOR OTHERS IN THE FIELD OF HOSTING AND MANAGEMENT OF COMPUTER HARDWARE, COMPUTER OPERATING SYSTEMS, AND COMPUTER APPLICATION INFRASTRUCTURE; CUSTOMER SERVICES, NAMELY, RESPONDING TO CUSTOMERS INQUIRIES FOR OTHERS IN THE FIELD OF WEBSITE HOSTING SERVICES; CUSTOMER SERVICES, NAMELY, RESPONDING TO CUSTOMERS INQUIRIES FOR OTHERS IN THE FIELD OF LEASING AND CUSTOMIZING COMPUTER HARDWARE, OPERATING SYSTEMS, AND COMPUTER SOFTWARE APPLICATION INFRASTRUCTURE; CUSTOMER SERVICES, NAMELY, RESPONDING TO CUSTOMERS INQUIRIES FOR OTHERS IN THE FIELD OF BANDWIDTH PROVISION TO OTHERS. CUSTOMER SERVICES, NAMELY, RESPONDING TO CUSTOMERS INQUIRIES FOR OTHERS IN THE FIELD OF LEASING SPACE TO HOUSE COMPUTER HARDWARE, OPERATING SYSTEMS, AND SOFTWARE APPLICATION INFRASTRUCTURE IN DATA CENTERS WITH A STABLE OPERATING ENVIRONMENT; CUSTOMER SERVICES, NAMELY, RESPONDING TO CUSTOMERS INQUIRIES FOR OTHERS IN THE FIELD OF MANAGED COMPUTER STORAGE (U.S. CLS. 100, 101 AND 102).

FIRST USE 0-0-2001; IN COMMERCE 0-0-2002.

LUCY ARANT, EXAMINING ATTORNEY

SN 85-535,120. GONZALEZ, JUAN PABLO, BOGOTA, COLOMBIA, FILED 2-6-2012.

THE COLOR(S) ORANGE AND GRAY IS/ARE CLAIMED AS A FEATURE OF THE MARK.

THE MARK CONSISTS OF THE STYLIZED WORD JINGLESMAST IN ORANGE WITH A MICROPHONE DESIGN IN GRAY APPEARING BEHIND THE LETTER S OF SMART TO FORM A MUSICAL NOTE. THE COLOR WHITE APPEARING IN THE BACKGROUND OF THE MARK REPRESENTS TRANSPARENT AREAS AND THEREFORE IS NOT PART OF THE MARK.

FOR PROMOTING THE GOODS AND SERVICES OF OTHERS BY PROVIDING A WEBSITE FEATURING INFORMATION ABOUT WRITERS, COMPOSERS AND PROJECTS IN THE FIELDS OF ADVERTISEMENT, MUSIC, MUSIC COMPOSITIONS AND JINGLES; PROVIDING A SEARCHABLE ONLINE ADVERTISING WEBSITE AND INFORMATIONAL GUIDE FEATURING THE GOODS AND SERVICES OF OTHER VENDORS VIA THE INTERNET IN THE FIELD OF ADVERTISEMENT, MUSIC, MUSIC COMPOSITIONS AND JINGLES; PROVIDING ON-LINE EMPLOYMENT INFORMATION IN THE FIELD OF ADVERTISEMENT, MUSIC, MUSIC COMPOSITIONS AND JINGLES; RECRUITMENT AND PLACEMENT OF PERSONNEL IN THE FIELD OF ADVERTISEMENT, MUSIC, MUSIC COMPOSITIONS AND JINGLES (U.S. CLS. 100, 101 AND 102).

WILLIAM BRECKENFELD, EXAMINING ATTORNEY

CLASS 35—(Continued).

SN 85-535,196. JORDAN, VEDRIC L., ALBANY, GA. FILED 2-6-2012.

LIGHTWAY PRODUCTS

THE MARK CONSISTS OF STANDARD CHARACTERS WITHOUT CLAIM TO ANY PARTICULAR FONT, STYLE, SIZE, OR COLOR.

NO CLAIM IS MADE TO THE EXCLUSIVE RIGHT TO USE "PRODUCTS", APART FROM THE MARK AS SHOWN. FOR ON-LINE RETAIL STORE SERVICES FEATURING A WIDE VARIETY OF CONSUMER GOODS OF OTHERS (U.S. CLS. 100, 101 AND 102).

FIRST USE 10-15-2010; IN COMMERCE 10-15-2010.
GISELLE AGOSTO, EXAMINING ATTORNEY

SN 85-535,232. ELISSA BURDA, MONROE, MI. FILED 2-6-2012.

BOOM BUCKS

THE MARK CONSISTS OF STANDARD CHARACTERS WITHOUT CLAIM TO ANY PARTICULAR FONT, STYLE, SIZE, OR COLOR.

FOR ARRANGING AND CONDUCTING INCENTIVE REWARD PROGRAMS TO PROMOTE THE SALE OF FIREWORKS (U.S. CLS. 100, 101 AND 102).

FIRST USE 6-28-2010; IN COMMERCE 6-28-2010.
DOMINIC J. FERRAIUOLO, EXAMINING ATTORNEY

SN 85-535,278. GIVE IT UP LLC, INDIANAPOLIS, IN. FILED 2-6-2012.



THE COLOR(S) BLACK, LIGHT BLUE, DEEP ORANGE, WHITE, BLUE IS/ARE CLAIMED AS A FEATURE OF THE MARK.

THE MARK CONSISTS OF A STYLIZED GLOBE WITH BLACK LAND MASSES, BLACK LONGITUDE AND LATITUDE LINES, AND LIGHT BLUE IN THE AREAS COVERED WITH WATER. REACHING AROUND THE GLOBE

CLASS 35—(Continued).

ARE TWO DEEP ORANGE ARMS REACHING FOR EACH OTHER. ON THE ARM ON THE LEFT IS THE STYLIZED TEXT "GIVE" IN WHITE. TO THE RIGHT IS THE STYLIZED TEXT "IT" IN WHITE WRITTEN ON THE AFRICAN CONTINENT, FOLLOWED THE STYLIZED TEXT "UP!" IN WHITE WRITTEN ON THE ARM ON THE RIGHT. ARCHING ABOVE THE GLOBE IS THE STYLIZED TEXT "IF EVERYONE GIVES A LITTLE," IN BLUE, AND ARCHING BELOW THE GLOBE IS THE STYLIZED TEXT "WE ALL GET A LOT," IN BLUE.

FOR PROMOTING THE CHARITABLE SERVICES OF OTHERS, NAMELY, PROVIDING INDIVIDUALS WITH INFORMATION ABOUT VARIOUS CHARITIES FOR THE PURPOSE OF MAKING DONATIONS TO CHARITIES (U.S. CLS. 100, 101 AND 102).

FIRST USE 11-22-2011; IN COMMERCE 12-22-2011.
KATHRYN COWARD, EXAMINING ATTORNEY

SN 85-535,300. SWEETBOTTOMS BABY BOUTIQUE, LLC, RALEIGH, NC. FILED 2-6-2012.

SWEETBOTTOMS

THE MARK CONSISTS OF STANDARD CHARACTERS WITHOUT CLAIM TO ANY PARTICULAR FONT, STYLE, SIZE, OR COLOR.

FOR COMPUTERIZED ON-LINE ORDERING FEATURING GENERAL MERCHANDISE AND GENERAL CONSUMER GOODS (U.S. CLS. 100, 101 AND 102).

FIRST USE 3-17-2010; IN COMMERCE 3-17-2010.
SUZANNE BLANE, EXAMINING ATTORNEY

SN 85-535,438. JDALEXANDER ENTERPRISES, LLC, ATLANTA, GA. FILED 2-6-2012.

NOWONCAMPUS

THE MARK CONSISTS OF STANDARD CHARACTERS WITHOUT CLAIM TO ANY PARTICULAR FONT, STYLE, SIZE, OR COLOR.

FOR PROMOTING THE PARTIES AND SPECIAL EVENTS OF OTHERS (U.S. CLS. 100, 101 AND 102).

FIRST USE 4-12-2011; IN COMMERCE 4-12-2011.
KAREN K. BUSH, EXAMINING ATTORNEY

CLASS 35—(Continued).

SN 85-535,605. COLOR, INC., HOLLISTON, MA. FILED 2-7-2012.

ROSTER

THE MARK CONSISTS OF STANDARD CHARACTERS WITHOUT CLAIM TO ANY PARTICULAR FONT, STYLE, SIZE, OR COLOR.

FOR RETAIL STORE SERVICES OF FASHION SPORTS APPAREL, FOR OTHERS; RETAIL STORE SERVICES FEATURING GENUINE SPORTS TEAM BRANDED ITEMS, FOR OTHERS (U.S. CLS. 100, 101 AND 102).

FIRST USE 10-3-2009; IN COMMERCE 10-3-2009.
MARK T. MULLEN, EXAMINING ATTORNEY

CLASS 35—(Continued).

TION POINT IS AN ELLIPTICAL SHAPE REPRESENTING A SHADOW. INSIDE THE UPPER PART OF THE EXCLAMATION POINT IS A CIRCULAR SHAPE AND INSIDE THAT IS A SECOND SMALLER CIRCULAR SHAPE WHICH PARTLY OVERLAPS AN OVAL SHAPE WHICH IS ALSO WITHIN THE LARGER CIRCLE. BELOW THE LETTERS SNA ARE THE LETTERS SNAPOPON.COM, WITH THE LOWER-CASE LETTERS SNAP FOLLOWED BY A STYLIZED UPPER-CASE Q, FOLLOWED BY THE LOWER-CASE LETTERS PON, FOLLOWED BY A PERIOD, FOLLOWED BY THE LOWER-CASE LETTERS COM.

FOR PROMOTING THE GOODS AND SERVICES OF BUSINESSES GEARED TOWARD THE GAY COMMUNITY BY PROVIDING A WEBSITE FEATURING COUPONS, REBATES, DAILY SPECIAL DEALS, PRICE-COMPARISON INFORMATION, PRODUCT REVIEWS, LINKS TO THE RETAIL WEB SITES OF OTHERS, AND DISCOUNT INFORMATION (U.S. CLS. 100, 101 AND 102).

FIRST USE 11-17-2011; IN COMMERCE 1-30-2012.
CHRISTINA SOBRAL, EXAMINING ATTORNEY

SN 85-535,685. AKESO CONSULTING, VIENNA, VA. FILED 2-7-2012.



THE COLOR(S) PURPLE AND IVORY IS/ARE CLAIMED AS A FEATURE OF THE MARK.

THE MARK CONSISTS OF A PURPLE ART DECO-STYLE SEATED PROFILE PICTURE OF THE GREEK GODDESS AKESO, WITH IVORY OUTLINES.

FOR PUBLIC POLICY CONSULTANCY SERVICES; PUBLIC POLICY RESEARCH SERVICES (U.S. CLS. 100, 101 AND 102).

FIRST USE 10-27-2011; IN COMMERCE 10-27-2011.
MIDGE BUTLER, EXAMINING ATTORNEY

SN 85-535,749. CARETOTELL LLC, REDLANDS, CA. FILED 2-7-2012.

Care To Tell

THE MARK CONSISTS OF STANDARD CHARACTERS WITHOUT CLAIM TO ANY PARTICULAR FONT, STYLE, SIZE, OR COLOR.

FOR MARKET RESEARCH SERVICES (U.S. CLS. 100, 101 AND 102).

HANNO RITTNER, EXAMINING ATTORNEY

SN 85-535,739. OUTLOUD ENTERPRISES, CORAL SPRINGS, FL. FILED 2-7-2012.



THE MARK CONSISTS OF THE LETTERS SNAP WITH AN UPPER-CASE S FOLLOWED BY THE LOWERCASE LETTERS NAP. TO THE RIGHT OF THESE LETTERS IS A STYLIZED EXCLAMATION POINT WHICH DOES NOT HAVE THE TRADITIONAL DOT BELOW THE UPPER PART OF THE EXCLAMATION POINT. NEAR THE BOTTOM OF AND PARTIALLY COVERED BY THE EXCLAMA-

SN 85-535,857. ARTON SOUTH, INC., MEMPHIS, TN. FILED 2-7-2012.

EYKON

THE MARK CONSISTS OF STANDARD CHARACTERS WITHOUT CLAIM TO ANY PARTICULAR FONT, STYLE, SIZE, OR COLOR.

FOR WHOLESALE DISTRIBUTORSHIPS FEATURING WALL COVERINGS (U.S. CLS. 100, 101 AND 102).

FIRST USE 7-1-2000; IN COMMERCE 7-1-2000.
KATHY DE JONGE, EXAMINING ATTORNEY

CLASS 35—(Continued).

SN 85-535,938. FERRO, ZACHARY, TALLAHASSEE, FL. FILED 2-7-2012.

POSITIVE INFLUENCE

THE MARK CONSISTS OF STANDARD CHARACTERS WITHOUT CLAIM TO ANY PARTICULAR FONT, STYLE, SIZE, OR COLOR.

FOR ON-LINE RETAIL STORE SERVICES FEATURING CLOTHING, MUGS, AUDIO CDS, MUSIC DVDS, PHOTOS (U.S. CLS. 100, 101 AND 102).

FIRST USE 2-1-2012; IN COMMERCE 2-1-2012.
VERNA BETH RIRIE, EXAMINING ATTORNEY

CLASS 35—(Continued).

SN 85-536,181. ASCEND OCG, INC., PHOENIX, AZ. FILED 2-7-2012.

ASCEND

THE MARK CONSISTS OF STANDARD CHARACTERS WITHOUT CLAIM TO ANY PARTICULAR FONT, STYLE, SIZE, OR COLOR.

FOR CONSULTING IN THE FIELD OF HUMAN RESOURCES; PERSONNEL PLACEMENT AND RECRUITMENT (U.S. CLS. 100, 101 AND 102).

FIRST USE 1-31-2010; IN COMMERCE 1-31-2010.
DOUGLAS LEE, EXAMINING ATTORNEY

SN 85-536,004. AB UNLIMITED, LOS ANGELES, CA. FILED 2-7-2012.

AB Unlimited

THE MARK CONSISTS OF STANDARD CHARACTERS WITHOUT CLAIM TO ANY PARTICULAR FONT, STYLE, SIZE, OR COLOR.

FOR PREPARATION OF CUSTOMIZED PROMOTIONAL AND MERCHANDISING MATERIALS FOR OTHERS (U.S. CLS. 100, 101 AND 102).

FIRST USE 9-1-2004; IN COMMERCE 9-1-2009.
BRIDGETT SMITH, EXAMINING ATTORNEY

SN 85-536,259. PENZEYS, LTD., BROOKFIELD, WI. FILED 2-7-2012.

KINDNESS WORKS

THE MARK CONSISTS OF STANDARD CHARACTERS WITHOUT CLAIM TO ANY PARTICULAR FONT, STYLE, SIZE, OR COLOR.

FOR MAIL ORDER CATALOG SERVICES FEATURING SPICES, SPICE BLENDS, SEASONINGS, PROCESSED HERBS, EXTRACTS USED FOR FLAVORING AND GIFT BOXES FEATURING SPICES, SPICE BLENDS, SEASONINGS, PROCESSED HERBS, EXTRACTS USED FOR FLAVORING; RETAIL STORE AND ONLINE RETAIL STORE SERVICES FEATURING SPICES, SPICE BLENDS, SEASONINGS, PROCESSED HERBS, EXTRACTS USED FOR FLAVORING AND GIFT BOXES FEATURING SPICES, SPICE BLENDS, SEASONINGS, PROCESSED HERBS, EXTRACTS USED FOR FLAVORING (U.S. CLS. 100, 101 AND 102).

DAWN HAN, EXAMINING ATTORNEY

SN 85-536,086. KAVANAGH, KEVIN, PALMER LAKE, CO. FILED 2-7-2012.

2BRICK

THE MARK CONSISTS OF STANDARD CHARACTERS WITHOUT CLAIM TO ANY PARTICULAR FONT, STYLE, SIZE, OR COLOR.

FOR ADVISORY SERVICES FOR OTHERS FOR BUSINESS PURPOSES IN THE FIELDS OF ARCHITECTURE, INTERIOR DESIGN AND URBAN PLANNING DESIGN; BUSINESS ADVISORY SERVICES IN THE FIELDS OF ARCHITECTURE, INTERIOR DESIGN AND URBAN PLANNING DESIGN; BUSINESS CONSULTATION SERVICES, NAMELY, BUSINESS PROCESS IMPROVEMENT AND ENTERPRISE ARCHITECTURE DESIGN; PROJECT MANAGEMENT SERVICES FOR OTHERS FOR BUSINESS PURPOSES IN THE FIELDS OF ARCHITECTURE, INTERIOR DESIGN, URBAN PLANNING DESIGN; ADVERTISING SERVICES; BRANDING SERVICES, NAMELY, CONSULTING, DEVELOPMENT, MANAGEMENT AND MARKETING OF BRANDS FOR BUSINESSES (U.S. CLS. 100, 101 AND 102).

EMILY CARLSEN, EXAMINING ATTORNEY

SN 85-536,298. MERELINDA FARM, LLC, WHITMORE LAKE, MI. FILED 2-7-2012.

House of AlpacaWear

THE MARK CONSISTS OF STANDARD CHARACTERS WITHOUT CLAIM TO ANY PARTICULAR FONT, STYLE, SIZE, OR COLOR.

OWNER OF U.S. REG. NOS. 2,588,250, 3,743,540 AND OTHERS.

SEC. 2(F) AS TO "ALPACAWEAR".

FOR RETAIL AND WHOLESALE STORE SERVICES FEATURING CLOTHING MADE OF ALPACA FLEECE, ACCESSIBLE ON-LINE AND BY TELEPHONE, FACSIMILE, AND MAIL ORDER (U.S. CLS. 100, 101 AND 102).

FIRST USE 1-1-2002; IN COMMERCE 1-1-2002.
KATINA MISTER, EXAMINING ATTORNEY

CLASS 35—(Continued).

SN 85-536,392. PLATINUM PEOPLE LLC, HERMITAGE, TN. FILED 2-7-2012.

Platinum People

THE MARK CONSISTS OF STANDARD CHARACTERS WITHOUT CLAIM TO ANY PARTICULAR FONT, STYLE, SIZE, OR COLOR.

FOR EMPLOYMENT STAFFING IN THE FIELD OF INFORMATION TECHNOLOGY; TALENT RECRUITING SERVICES IN THE FIELD OF INFORMATION TECHNOLOGY (U.S. CLS. 100, 101 AND 102).

FIRST USE 11-22-2006; IN COMMERCE 11-22-2006.
IRA J. GOODSaid, EXAMINING ATTORNEY

CLASS 35—(Continued).

SN 85-536,539. DOO, SHIRLEY, HUNTINGTON BEACH, CA. FILED 2-7-2012.

MedParlor

THE MARK CONSISTS OF STANDARD CHARACTERS WITHOUT CLAIM TO ANY PARTICULAR FONT, STYLE, SIZE, OR COLOR.

FOR AD SERVING, NAMELY, PLACING ADVERTISEMENTS ON WEBSITES FOR OTHERS USING SPECIALIZED COMPUTER SOFTWARE; ADVERTISING AND DIRECTORY SERVICES, NAMELY, PROMOTING THE SERVICES OF OTHERS BY PROVIDING A WEB PAGE FEATURING LINKS TO THE WEBSITES OF OTHERS; ON-LINE PROMOTION OF COMPUTER NETWORKS AND WEBSITES; ONLINE MEDIA MONITORING SERVICES USING COMPUTER SOFTWARE TO AUTOMATICALLY MONITOR INTERNET WEBSITES AND ONLINE PUBLICATIONS FOR CUSTOMER-SPECIFIED TOPICS AND TO CAPTURE RELEVANT CONTENT ON THOSE TOPICS, AND PROVIDING DOCUMENTATION AND ANALYSIS OF THAT ONLINE CONTENT TO OTHERS FOR BUSINESS PURPOSES; PROVIDING A WEBSITE FOR DENTAL AND MEDICAL PRACTICE MANAGEMENT AND ADMINISTRATIVE SUPPORT SERVICES TO INDIVIDUAL DENTISTS, MEDICAL DOCTORS OR MEDICAL GROUP PRACTICES (U.S. CLS. 100, 101 AND 102).

JOHN WILKE, EXAMINING ATTORNEY

SN 85-536,479. ATR HOLDINGS LTD., VIRGINIA BEACH, VA. FILED 2-7-2012.

promcity.com

THE MARK CONSISTS OF STANDARD CHARACTERS WITHOUT CLAIM TO ANY PARTICULAR FONT, STYLE, SIZE, OR COLOR.

FOR ON-LINE RETAIL STORE SERVICES FEATURING PROM AND SPECIAL OCCASION DRESSES, GOWNS AND ACCESSORIES; RETAIL STORE SERVICES FEATURING PROM AND SPECIAL OCCASION DRESSES, GOWNS AND ACCESSORIES (U.S. CLS. 100, 101 AND 102).

FIRST USE 10-30-1999; IN COMMERCE 12-15-2011.
SUNG IN, EXAMINING ATTORNEY

SN 85-536,555. MAHESH SHARMA, DBA THINK BUSINESS ANALYTICS, SANTA BARBARA, CA. FILED 2-7-2012.

ThinkBA

THE MARK CONSISTS OF STANDARD CHARACTERS WITHOUT CLAIM TO ANY PARTICULAR FONT, STYLE, SIZE, OR COLOR.

FOR INFORMATION, ADVISORY AND CONSULTANCY SERVICES RELATING TO BUSINESS AND MANAGEMENT OR BUSINESS ADMINISTRATION, INCLUDING SUCH SERVICES PROVIDED ON LINE OR VIA THE INTERNET; MANAGEMENT CONSULTING AND ADVISORY SERVICES IN THE AREAS OF CORPORATE GROWTH STRATEGY, INNOVATION AND GROWTH PROCESSES, ORGANIZATIONAL TRANSFORMATION, AND TALENT MANAGEMENT AND DEVELOPMENT STRATEGIES; MARKETING CONSULTING SERVICES RELATING TO LONG-TERM BUSINESS STRATEGY DEVELOPMENT FOR NON-PROFIT ORGANIZATIONS (U.S. CLS. 100, 101 AND 102).

GRETCHEN ULRICH, EXAMINING ATTORNEY

CLASS 35—(Continued).

SN 85-536,641. EXACTCOST, INC., MCLEAN, VA. FILED 2-8-2012.



THE MARK CONSISTS OF A CAPITALIZED LETTER "M" WITH A SUPERSCRIPED "2" TO THE RIGHT AND A LOWER CASE "X" ALSO TO THE RIGHT.

FOR COMPUTERIZED DATABASE MANAGEMENT; DATA PROCESSING SERVICES, NAMELY, COMPUTERIZED DATABASE MANAGEMENT IN THE FIELD OF HEALTHCARE; AND SYSTEMATIZATION OF INFORMATION IN THE FIELD OF HEALTHCARE INTO A COMPUTERIZED DATABASE; PROVIDING HEALTH CARE COST ANALYSIS INFORMATION VIA COMMUNICATION NETWORKS (U.S. CLS. 100, 101 AND 102).
JOSETTE BEVERLY, EXAMINING ATTORNEY

SN 85-536,724. STARK, WILLIAM R., TAMPA, FL. FILED 2-8-2012.

think.change.think again.

THE MARK CONSISTS OF STANDARD CHARACTERS WITHOUT CLAIM TO ANY PARTICULAR FONT, STYLE, SIZE, OR COLOR.

FOR MANAGEMENT CONSULTING AND ADVISORY SERVICES IN THE AREAS OF CORPORATE GROWTH STRATEGY, INNOVATION AND GROWTH PROCESSES, ORGANIZATIONAL TRANSFORMATION, AND TALENT MANAGEMENT AND DEVELOPMENT STRATEGIES (U.S. CLS. 100, 101 AND 102).

FIRST USE 9-1-1999; IN COMMERCE 1-5-2000.
NAPOLEON SHARMA, EXAMINING ATTORNEY

CLASS 35—(Continued).

SN 85-536,803. YEXT, INC., NEW YORK, NY. FILED 2-8-2012.

FELIX

THE MARK CONSISTS OF STANDARD CHARACTERS WITHOUT CLAIM TO ANY PARTICULAR FONT, STYLE, SIZE, OR COLOR.

FOR ADVERTISING, MARKETING AND PROMOTION SERVICES; ON-LINE ADVERTISING AND MARKETING SERVICES; ONLINE MARKETING SERVICES, NAMELY, AFFILIATE MARKETING SERVICES WHEREBY AN AFFILIATE IS REWARDED FOR EACH VISITOR OR CUSTOMER BROUGHT ABOUT BY THE AFFILIATE'S OWN MARKETING SERVICES; DISSEMINATION OF ADVERTISING FOR OTHERS VIA THE INTERNET AND MOBILE COMMUNICATIONS DEVICES; ANALYSIS OF ADVERTISING RESPONSE; ANALYZING AND COMPILING DATA FOR MEASURING RESPONSES RECEIVED FROM ONLINE ADVERTISEMENTS, ONLINE ADVERTISING GUIDES AND ONLINE COMMERCIAL INFORMATION DIRECTORIES; ADVERTISING AND COMMERCIAL INFORMATION SERVICES, VIA THE INTERNET AND MOBILE COMMUNICATION DEVICES; PROVIDING A SEARCHABLE ONLINE ADVERTISING GUIDE FEATURING THE GOODS AND SERVICES OF OTHERS; PROVIDING BUSINESS INFORMATION, NAMELY, PROVIDING PHONE NUMBERS, MAILING ADDRESSES, ELECTRONIC MAIL ADDRESSES, BUSINESS PROFILES AND WEBSITE LINKS FOR A WIDE VARIETY OF LOCAL BUSINESSES AND ORGANIZATIONS VIA THE INTERNET AND MOBILE COMMUNICATION DEVICES; BUSINESS SERVICES, NAMELY, TRACKING AND MONITORING OF PHONE CALLS OF OTHERS IN RESPONSE TO ADVERTISING, AND TRANSCRIPTION OF SUCH PHONE CALLS FOR OTHERS; PAY PER CALL ADVERTISING MANAGEMENT SERVICES (U.S. CLS. 100, 101 AND 102).

FIRST USE 4-9-2012; IN COMMERCE 4-9-2012.
NAKIA HENRY, EXAMINING ATTORNEY

SN 85-536,814. ECOACH, LLC, LEXINGTON, KY. FILED 2-8-2012.

eCoachSports

THE MARK CONSISTS OF STANDARD CHARACTERS WITHOUT CLAIM TO ANY PARTICULAR FONT, STYLE, SIZE, OR COLOR.

FOR RESELLER SERVICES, NAMELY, DISTRIBUTORSHIP SERVICES IN THE FIELD OF COMPUTER HARDWARE AND SOFTWARE FOR MOTION ANALYSIS, ATHLETIC TRAINING, AND ATHLETIC INSTRUCTION (U.S. CLS. 100, 101 AND 102).

SUNG IN, EXAMINING ATTORNEY

CLASS 35—(Continued).

SN 85-536,955. WALLACE, DANA, WALDORF, MD. FILED 2-8-2012.

**S.O.E.-ing Seeds of HOPE
One Woman At A Time**

THE MARK CONSISTS OF STANDARD CHARACTERS WITHOUT CLAIM TO ANY PARTICULAR FONT, STYLE, SIZE, OR COLOR.

FOR CHARITABLE SERVICES, NAMELY, ORGANIZING WOMEN'S GROUPS TO UNDERTAKE PROJECTS WHICH BENEFIT THE HOMELESS, ABUSED, AT RISK WOMEN AND WOMEN IN TRANSITION AND IN PAIN, WHILE ENCOURAGING EMPOWERMENT AMONG WOMEN OF ALL AGES AND ETHNICITIES (U.S. CLS. 100, 101 AND 102).

ANDREW LEASER, EXAMINING ATTORNEY

SN 85-536,991. CVOX GROUP LLC, MIAMI, FL. FILED 2-8-2012.

CVOX

THE MARK CONSISTS OF STANDARD CHARACTERS WITHOUT CLAIM TO ANY PARTICULAR FONT, STYLE, SIZE, OR COLOR.

FOR ADVERTISING AND MARKETING CONSULTANCY; ADVERTISING AND MARKETING SERVICES PROVIDED BY MEANS OF INDIRECT METHODS OF MARKETING COMMUNICATIONS, NAMELY, SOCIAL MEDIA, SEARCH ENGINE MARKETING, INQUIRY MARKETING, INTERNET MARKETING, MOBILE MARKETING, BLOGGING AND OTHER FORMS OF PASSIVE, SHARABLE OR VIRAL COMMUNICATIONS CHANNELS; ADVERTISING AND MARKETING SERVICES, NAMELY, PROMOTING THE GOODS AND SERVICES OF OTHERS; CONSULTATION SERVICES, NAMELY, CREATIVE AND STRATEGIC CONSULTATION REGARDING DEVELOPMENT AND PRODUCTION OF MARKETING CAMPAIGNS FOR OTHERS; PUBLIC RELATIONS; PUBLICITY CONSULTATION (U.S. CLS. 100, 101 AND 102).

FIRST USE 7-31-2007; IN COMMERCE 7-31-2007.

JAY BESCH, EXAMINING ATTORNEY

CLASS 35—(Continued).

SN 85-537,023. STARCOM MEDIAVEST GROUP, INC., CHICAGO, IL. FILED 2-8-2012.

LOCATIONiq

THE MARK CONSISTS OF STANDARD CHARACTERS WITHOUT CLAIM TO ANY PARTICULAR FONT, STYLE, SIZE, OR COLOR.

FOR MARKETING SERVICES, NAMELY, COMPILATION AND ONGOING MANAGEMENT OF LOCAL BUSINESS-LEVEL DATA FOR THE PURPOSE OF ORGANIC CONTENT MANAGEMENT ACROSS ONLINE, MOBILE, TABLET AND NAVIGATION DEVICES (U.S. CLS. 100, 101 AND 102).

FIRST USE 9-30-2011; IN COMMERCE 9-30-2011.

KEVIN DINALLO, EXAMINING ATTORNEY

SN 85-537,119. VF OUTLET, INC., WYOMISSING, PA. FILED 2-8-2012.

**GENUINE VALUE . . . EVERY
DAY.**

THE MARK CONSISTS OF STANDARD CHARACTERS WITHOUT CLAIM TO ANY PARTICULAR FONT, STYLE, SIZE, OR COLOR.

FOR RETAIL STORE SERVICES IN THE FIELD OF APPAREL AND ACCESSORIES, BEDDING, LINENS, SHOES AND FURNITURE; PROVIDING CONSUMER PRODUCT INFORMATION VIA THE INTERNET (U.S. CLS. 100, 101 AND 102).

FIRST USE 12-22-2011; IN COMMERCE 12-22-2011.

WILLIAM ROSSMAN, EXAMINING ATTORNEY

CLASS 35—(Continued).

SN 85-537,208. HUMMEL, DENISE PIRROTI, DBA UNIVERSAL CONSENSUS, CARLSBAD, CA. FILED 2-8-2012.



OWNER OF U.S. REG. NO. 4,005,945.

THE COLOR(S) ORANGE, LIGHT GREEN, DARK GREEN, BLACK AND TAN IS/ARE CLAIMED AS A FEATURE OF THE MARK.

THE MARK CONSISTS OF A STYLIZED EYE, WITH ORANGE EYELIDS AND A GREEN PUPIL IN THE SHAPE OF PANGAEA, WITH THE LAND PORTIONS IN LIGHT GREEN AND THE OCEAN PORTIONS IN DARK GREEN, WITH THE WORD "UNIVERSAL" IN BLACK, THE WORD "CONSENSUS" IN TAN, AND THE PHRASE "LEVERAGING THE POWER OF CULTURE TO OPTIMIZE THE BOTTOM LINE." ALSO IN BLACK.

FOR ASSISTANCE AND ADVICE REGARDING BUSINESS ORGANIZATION AND MANAGEMENT; BUSINESS ORGANIZATION ADVICE; BUSINESS ORGANIZATION AND MANAGEMENT CONSULTANCY INCLUDING PERSONNEL MANAGEMENT; BUSINESS ORGANIZATION AND MANAGEMENT CONSULTING; BUSINESS ORGANIZATION AND OPERATION CONSULTANCY; BUSINESS ORGANIZATION CONSULTING (U.S. CLS. 100, 101 AND 102).

FIRST USE 2-1-2009; IN COMMERCE 2-1-2009.
HANNO RITTNER, EXAMINING ATTORNEY

CLASS 35—(Continued).

SN 85-537,221. CAPINTELLECT COMMUNICATIONS, INC., LAS VEGAS, NV. FILED 2-8-2012.



OWNER OF U.S. REG. NOS. 3,859,696 AND 3,859,697.

THE MARK CONSISTS OF THE WORD "LETIZIA" SUPERIMPOSED OVER A ZIG ZAG LINE.

FOR ADVERTISING AND MARKET RESEARCH SERVICES (U.S. CLS. 100, 101 AND 102).

FIRST USE 4-12-2012; IN COMMERCE 4-12-2012.
HANNO RITTNER, EXAMINING ATTORNEY

SN 85-537,209. THE LARUE CORPORATION, NASHVILLE, TN. FILED 2-8-2012.

COCO LARUE

THE MARK CONSISTS OF STANDARD CHARACTERS WITHOUT CLAIM TO ANY PARTICULAR FONT, STYLE, SIZE, OR COLOR.

THE NAME "COCO LARUE" IDENTIFIES A LIVING INDIVIDUAL WHOSE CONSENT IS OF RECORD.

FOR ON-LINE RETAIL STORE SERVICES FEATURING CLOTHING, FASHION ACCESSORIES, AND HAIRPIECES; RETAIL CLOTHING BOUTIQUES; RETAIL STORE SERVICES FEATURING CLOTHING, FASHION ACCESSORIES, AND HAIRPIECES (U.S. CLS. 100, 101 AND 102).

FIRST USE 0-0-2008; IN COMMERCE 0-0-2008.
JENNY PARK, EXAMINING ATTORNEY

SN 85-537,271. BBC SYSTEMS, INC., OVIEDO, FL. FILED 2-8-2012.

JVZOO

THE MARK CONSISTS OF STANDARD CHARACTERS WITHOUT CLAIM TO ANY PARTICULAR FONT, STYLE, SIZE, OR COLOR.

FOR PROVIDING A SEARCHABLE WEBSITE FEATURING THE GOODS AND SERVICES OF OTHER VENDORS (U.S. CLS. 100, 101 AND 102).

FIRST USE 3-0-2011; IN COMMERCE 3-0-2011.
MIAH ROSENBERG, EXAMINING ATTORNEY

CLASS 35—(Continued).

SN 85-537,415. GOODGOOD, LLC, BOSTON, MA. FILED 2-8-2012.

goodgood

THE MARK CONSISTS OF STANDARD CHARACTERS WITHOUT CLAIM TO ANY PARTICULAR FONT, STYLE, SIZE, OR COLOR.

FOR ADVERTISING AND PUBLICITY SERVICES, NAMELY, PROMOTING THE GOODS, SERVICES, BRAND IDENTITY AND COMMERCIAL INFORMATION AND NEWS OF THIRD PARTIES THROUGH PRINT, AUDIO, VIDEO, DIGITAL AND ON-LINE MEDIUM; ADVERTISING SERVICES, NAMELY, CREATING CORPORATE AND BRAND IDENTITY FOR OTHERS; ARRANGING AND CONDUCTING TRADE SHOW EXHIBITIONS IN THE FIELD OF ART AND GRAPHIC DESIGN; BRAND CONCEPT AND BRAND DEVELOPMENT SERVICES FOR CORPORATE AND INDIVIDUAL CLIENTS; BRAND EVALUATION SERVICES; BRAND POSITIONING SERVICES; BRANDING SERVICES, NAMELY, CONSULTING, DEVELOPMENT, MANAGEMENT AND MARKETING OF BRANDS FOR BUSINESSES; BUSINESS CARD DESIGN SERVICES; BUSINESS SERVICES FOR FUNDRAISING PROGRAMS, NAMELY, DEVELOPING FUNDRAISING PROGRAM CATALOGS, BROCHURES, PRICE SHEETS, ORDER FORMS, AND OTHER DOCUMENTS FOR NOT-FOR-PROFIT ORGANIZATIONS; COMMISSIONING OF WORKS OF ART; CREATIVE MARKETING DESIGN SERVICES; DESIGN OF ADVERTISING BROCHURES FOR OTHERS; DESIGN OF ADVERTISING FLYERS FOR OTHERS; DESIGN OF ADVERTISING MATERIALS FOR OTHERS; DEVELOPMENT OF MARKETING STRATEGIES, CONCEPTS AND TACTICS, NAMELY, AUDIENCE DEVELOPMENT, BRAND AWARENESS, ONLINE COMMUNITY BUILDING AND DIGITAL WORD OF MOUTH COMMUNICATIONS; DISSEMINATION OF ADVERTISEMENTS AND OF ADVERTISING MATERIAL; RETAIL SHOP WINDOW DISPLAY ARRANGEMENT SERVICES; SOCIAL MEDIA STRATEGY AND MARKETING CONSULTANCY FOCUSING ON HELPING CLIENTS CREATE AND EXTEND THEIR PRODUCT AND BRAND STRATEGIES BY BUILDING VIRALLY ENGAGING MARKETING SOLUTIONS (U.S. CLS. 100, 101 AND 102).

FIRST USE 5-1-2008; IN COMMERCE 5-1-2009.
NELSON SNYDER, EXAMINING ATTORNEY

SN 85-537,443. MGH INC., OWINGS MILLS, MD. FILED 2-8-2012.

Stat Happy

THE MARK CONSISTS OF STANDARD CHARACTERS WITHOUT CLAIM TO ANY PARTICULAR FONT, STYLE, SIZE, OR COLOR.

FOR CONDUCTING BUSINESS AND MARKET RESEARCH SURVEYS; CONDUCTING BUSINESS RESEARCH AND SURVEYS; CONDUCTING BUSINESS SURVEYS (U.S. CLS. 100, 101 AND 102).

JENNIFER MARTIN, EXAMINING ATTORNEY

CLASS 35—(Continued).

SN 85-537,511. CONSCIOUS LEADER NETWORK, AGOURA HILLS, CA. FILED 2-8-2012.

LEADING CONSCIOUSLY.
LIVING CONSCIOUSLY.

THE MARK CONSISTS OF STANDARD CHARACTERS WITHOUT CLAIM TO ANY PARTICULAR FONT, STYLE, SIZE, OR COLOR.

FOR CONSULTING SERVICES IN BUSINESS LEADERSHIP DEVELOPMENT AND BUSINESS MANAGEMENT; PROVIDING INFORMATION ABOUT COMMERCIAL BUSINESS AND COMMERCIAL INFORMATION VIA THE GLOBAL COMPUTER NETWORK; BUSINESS CONSULTATION IN THE FIELD OF BUSINESS LEADERSHIP DEVELOPMENT; BUSINESS SERVICES, NAMELY PROVIDING AN ONLINE NETWORK FOR BUSINESS LEADERS TO DEVELOP BUSINESS LEADERSHIP SKILLS; MEMBERSHIP SERVICES, NAMELY, PROVIDING INFORMATION TO MEMBERS IN THE FIELD OF BUSINESS DEVELOPMENT, BUSINESS LEADERSHIP AND MARKETING (U.S. CLS. 100, 101 AND 102).

FIRST USE 1-1-2012; IN COMMERCE 1-1-2012.
JOHN E. MICHOS, EXAMINING ATTORNEY

SN 85-537,528. FRESH NATION LLC, GREENWICH, CT. FILED 2-8-2012.

FRESH NATION

THE MARK CONSISTS OF STANDARD CHARACTERS WITHOUT CLAIM TO ANY PARTICULAR FONT, STYLE, SIZE, OR COLOR.

FOR ADVERTISING AND MARKETING SERVICES, NAMELY, PROMOTING THE GOODS AND SERVICES OF OTHERS (U.S. CLS. 100, 101 AND 102).

FIRST USE 10-25-2011; IN COMMERCE 10-25-2011.
FLORENTINA BLANDU, EXAMINING ATTORNEY

SN 85-537,679. GEEKDOM LC, SAN ANTONIO, TX. FILED 2-8-2012.

geekdom

THE MARK CONSISTS OF THE STYLIZED COMBINATION OF THE WORD "GEEK" WITH THE SUFFIX "DOM" WHERE THE "O" IS CAPPED WITH A CROWN COMPRISING A CROWN BODY RISING TO A PLURALITY OF POINTS TERMINATED WITH VARIOUS SIZED SPHERES.

FOR INCUBATION SERVICES, NAMELY, PROVIDING WORK SPACE CONTAINING BUSINESS EQUIPMENT TO FREELANCERS, START-UPS, EXISTING BUSINESSES AND NON-PROFITS (U.S. CLS. 100, 101 AND 102).

FIRST USE 11-5-2011; IN COMMERCE 12-20-2011.
SIMON TENG, EXAMINING ATTORNEY

CLASS 35—(Continued).

SN 85-537,720. CITY OF PALM BEACH GARDENS, PALM BEACH GARDENS, FL. FILED 2-8-2012.

"A UNIQUE PLACE TO LIVE,
LEARN, WORK & PLAY"

THE MARK CONSISTS OF STANDARD CHARACTERS WITHOUT CLAIM TO ANY PARTICULAR FONT, STYLE, SIZE, OR COLOR.

FOR MUNICIPAL SERVICES, NAMELY, BUSINESS MARKETING AND PROMOTING THE ECONOMIC DEVELOPMENT AND GROWTH OF PALM BEACH GARDENS, FLORIDA; PROMOTING BUSINESS AND TOURISM IN THE CITY OF PALM BEACH GARDENS, FLORIDA (U.S. CLS. 100, 101 AND 102).

FIRST USE 9-29-2011; IN COMMERCE 10-6-2011.
DORITT L. CARROLL, EXAMINING ATTORNEY

CLASS 35—(Continued).

SN 85-537,854. BELFOR FRANCHISE GROUP LLC, BIRMINGHAM, MI. FILED 2-9-2012.

FRANTEGRITY

THE MARK CONSISTS OF STANDARD CHARACTERS WITHOUT CLAIM TO ANY PARTICULAR FONT, STYLE, SIZE, OR COLOR.

FOR FRANCHISE SERVICES, NAMELY, OFFERING BUSINESS MANAGEMENT ASSISTANCE IN THE ESTABLISHMENT AND OPERATION OF CLEANING, REMEDIATION AND RESTORATION BUSINESS; FRANCHISING, NAMELY, OFFERING BUSINESS MANAGEMENT ASSISTANCE IN THE ESTABLISHMENT AND/OR OPERATION OF CLEANING, REMEDIATION AND RESTORATION BUSINESS (U.S. CLS. 100, 101 AND 102).

KARANENDRA S. CHHINA, EXAMINING ATTORNEY

SN 85-537,731. QUIXBY, LLC, AKRON, OH. FILED 2-8-2012.

QUIXBY

THE MARK CONSISTS OF STANDARD CHARACTERS WITHOUT CLAIM TO ANY PARTICULAR FONT, STYLE, SIZE, OR COLOR.

FOR OPERATING AN ON-LINE SHOPPING SITE IN THE FIELD OF COMPUTER HARDWARE (U.S. CLS. 100, 101 AND 102).

ELI HELLMAN, EXAMINING ATTORNEY

SN 85-537,895. LIPSCOMBE, PATRICIA A., NIPOMO, CA. FILED 2-9-2012.

MANY HANDS GALLERY & STUDIO

THE MARK CONSISTS OF STANDARD CHARACTERS WITHOUT CLAIM TO ANY PARTICULAR FONT, STYLE, SIZE, OR COLOR.

NO CLAIM IS MADE TO THE EXCLUSIVE RIGHT TO USE "GALLERY & STUDIO", APART FROM THE MARK AS SHOWN.

FOR ART GALLERY SERVICES; ON-LINE ART GALLERIES (U.S. CLS. 100, 101 AND 102).

DORITT L. CARROLL, EXAMINING ATTORNEY

SN 85-537,825. CAPITAL - E, WASHINGTON, DC. FILED 2-9-2012.

Greening Our Built World

THE MARK CONSISTS OF STANDARD CHARACTERS WITHOUT CLAIM TO ANY PARTICULAR FONT, STYLE, SIZE, OR COLOR.

FOR CONSULTING SERVICES IN THE FIELDS OF ENERGY CONSUMPTION AND USAGE CONSERVATION TO IMPROVE ENERGY EFFICIENCY (U.S. CLS. 100, 101 AND 102).

FIRST USE 1-1-2010; IN COMMERCE 1-1-2010.
GIANCARLO CASTRO, EXAMINING ATTORNEY

SN 85-537,900. FOX, RICHARD, DIAMOND BAR, CA. FILED 2-9-2012.

STILJ STANDIN'

THE MARK CONSISTS OF THE STYLIZED TEXT "STILL STANDIN'" IN WHICH THE SECOND "L" IS BACKWARDS FACING THE FIRST "L" WHICH LOOKS LIKE TWO LEGS STANDING PIGEON TOED. THE "I" IN "STILL" IT IS DOTTED WITH A FIST AS IF HOLDING A CANE.

FOR ADVERTISING AND MARKETING (U.S. CLS. 100, 101 AND 102).

RICHARD WHITE, EXAMINING ATTORNEY

CLASS 35—(Continued).

SN 85-538,016. WAYNE J. SUMMERS, OVERLAND PARK, KS. FILED 2-9-2012.

WORDS FOR WISHES

THE MARK CONSISTS OF STANDARD CHARACTERS WITHOUT CLAIM TO ANY PARTICULAR FONT, STYLE, SIZE, OR COLOR.

FOR ON-LINE RETAIL STORE SERVICES FEATURING BOOKS (U.S. CLS. 100, 101 AND 102).
JUDITH HELFMAN, EXAMINING ATTORNEY

SN 85-538,030. ALEJO, ROMEO, CHESAPEAKE, VA. FILED 2-9-2012.

R&R NEW AND USED TIRES & RIMS

THE MARK CONSISTS OF STANDARD CHARACTERS WITHOUT CLAIM TO ANY PARTICULAR FONT, STYLE, SIZE, OR COLOR.

NO CLAIM IS MADE TO THE EXCLUSIVE RIGHT TO USE "NEW AND USED TIRES & RIMS", APART FROM THE MARK AS SHOWN.

FOR RETAIL STORE SERVICES FEATURING TIRES AND WHEEL RIMS (U.S. CLS. 100, 101 AND 102).
FIRST USE 12-5-2011; IN COMMERCE 12-5-2011.
CHARLES L. JENKINS, EXAMINING ATTORNEY

SN 85-538,123. SHADOW INDUSTRIES, INC., CYPRESS, CA. FILED 2-9-2012.

Kings of Wheels

THE MARK CONSISTS OF STANDARD CHARACTERS WITHOUT CLAIM TO ANY PARTICULAR FONT, STYLE, SIZE, OR COLOR.

FOR ON-LINE RETAIL STORE SERVICES FEATURING AUTOMOTIVE WHEELS, TIRES FOR TRAILERS, TRACTORS, ATVS, OFF ROAD VEHICLES, CARS, TRUCKS, GOLF CARTS, SEMI-TRAILERS, AND MOTORCYCLES (U.S. CLS. 100, 101 AND 102).

FIRST USE 1-12-2008; IN COMMERCE 1-12-2008.
DEIRDRE ROBERTSON, EXAMINING ATTORNEY

CLASS 35—(Continued).

SN 85-538,140. FALLING UP CONSULTING, INC., MIAMI, FL. FILED 2-9-2012.

FALLING UP

THE MARK CONSISTS OF STANDARD CHARACTERS WITHOUT CLAIM TO ANY PARTICULAR FONT, STYLE, SIZE, OR COLOR.

FOR BUSINESS CONSULTANCY; PROFESSIONAL BUSINESS CONSULTING (U.S. CLS. 100, 101 AND 102).
DAWN FELDMAN, EXAMINING ATTORNEY

SN 85-538,317. THE LORD'S CHIPS, BEND, OR. FILED 2-9-2012.

THE LORD'S CHIPS

THE MARK CONSISTS OF STANDARD CHARACTERS WITHOUT CLAIM TO ANY PARTICULAR FONT, STYLE, SIZE, OR COLOR.

FOR CHARITABLE SERVICES, NAMELY, ORGANIZING AND DEVELOPING PROJECTS THAT AIM TO IMPROVE THE LIVES OF UNDERPRIVILEGED AND IMPOVERISHED PEOPLE (U.S. CLS. 100, 101 AND 102).
ANGELA M. MICHELI, EXAMINING ATTORNEY

SN 85-538,376. RAMKO DISTRIBUTORS, INC., TOLEDO, OH. FILED 2-9-2012.

RAMKO

THE MARK CONSISTS OF STANDARD CHARACTERS WITHOUT CLAIM TO ANY PARTICULAR FONT, STYLE, SIZE, OR COLOR.

FOR WHOLESALE DISTRIBUTORSHIPS FEATURING CONSUMER ELECTRONICS (U.S. CLS. 100, 101 AND 102).

FIRST USE 5-0-1989; IN COMMERCE 5-0-1989.
PATRICIA EVANKO, EXAMINING ATTORNEY

CLASS 35—(Continued).

SN 85-538,429. SAGA COMMUNICATIONS, INC., GROSSE
POINTE FARMS, MI. FILED 2-9-2012.

Click2Save

THE MARK CONSISTS OF STANDARD CHARACTERS WITHOUT CLAIM TO ANY PARTICULAR FONT, STYLE, SIZE, OR COLOR.

FOR PROMOTING THE GOODS AND SERVICES OF OTHERS BY PROVIDING A WEBSITE FEATURING COUPONS, REBATES, PRICE-COMPARISON INFORMATION, PRODUCT REVIEWS, LINKS TO THE RETAIL WEBSITES OF OTHERS AND DISCOUNT INFORMATION (U.S. CLS. 100, 101 AND 102).

ANDREA HACK, EXAMINING ATTORNEY

CLASS 35—(Continued).

SN 85-538,534. BOXSTAR, LLC, DBA BOXSTAR, DALLAS,
TX. FILED 2-9-2012.

STORE TO DOOR

THE MARK CONSISTS OF STANDARD CHARACTERS WITHOUT CLAIM TO ANY PARTICULAR FONT, STYLE, SIZE, OR COLOR.

FOR ADVERTISING AGENCIES SPECIALIZING IN PLACING ADVERTISEMENTS ON BOXES OF ITEMS BEING SHIPPED; MARKETING CONSULTING, NAMELY, TEACHING OTHERS HOW TO EFFECTIVELY ADVERTISE BY PLACING ADVERTISEMENTS ON BOXES BEING SHIPPED (U.S. CLS. 100, 101 AND 102).

FIRST USE 9-1-2011; IN COMMERCE 1-1-2012.
RENEE MCCRAY, EXAMINING ATTORNEY

SN 85-538,434. ORIGINAL MATTRESS COMPANY LLC,
CLEVELAND, OH. FILED 2-9-2012.



OWNER OF U.S. REG. NOS. 3,292,065, 4,002,101 AND OTHERS.

THE MARK CONSISTS OF A STYLIZED COIL CHARACTER WEARING A SQUARE GRADUATION CAP HAVING A TASSEL, WITH A RIGHT AND LEFT HAND, THE LEFT HAND HOLDING A POINTER IN AN UPRIGHT POSITION.

FOR WHOLESALE AND RETAIL STORE SERVICES FEATURING BOX SPRINGS AND MATTRESSES, AND OTHER BEDDING (U.S. CLS. 100, 101 AND 102).

FIRST USE 6-30-2007; IN COMMERCE 6-30-2007.
SUE LAWRENCE, EXAMINING ATTORNEY

SN 85-538,721. MODERNIZED MEDIA, SALT LAKE CITY,
UT. FILED 2-9-2012.



THE MARK CONSISTS OF STYLIZED M.

FOR ADVERTISING AND PUBLICITY SERVICES, NAMELY, PROMOTING THE GOODS, SERVICES, BRAND IDENTITY AND COMMERCIAL INFORMATION OF THIRD PARTIES THROUGH PRINT, AUDIO, VIDEO, DIGITAL AND ON-LINE MEDIA (U.S. CLS. 100, 101 AND 102).

FIRST USE 7-20-2010; IN COMMERCE 7-20-2010.
SUSAN STIGLITZ, EXAMINING ATTORNEY

CLASS 35—(Continued).

SN 85-538,805. JULIE KREBS, DBA VIRTUAL BRAND ADVISORS, AURORA, OH. FILED 2-9-2012.

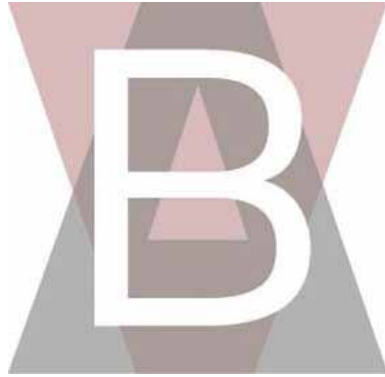

THE COLOR(S) WHITE, GRAY, MAROON AND DARK GRAY IS/ARE CLAIMED AS A FEATURE OF THE MARK. THE MARK CONSISTS OF A WHITE LETTER "B" OVERLAYING A GRAY PYRAMID WITH A TRIANGLE REMOVED FROM THE CENTER TO DEPICT THE LETTER "A," AND AN UPSIDE-DOWN MAROON PYRAMID TO DEPICT THE LETTER "V." THE OVERLAPPING PORTIONS OF THE PYRAMIDS WHICH ARE NOT COVERED BY THE WHITE LETTER "B" ARE DARK GRAY.

FOR MARKETING CONSULTING, NAMELY, BRAND DEVELOPMENT AND CREATION FOR OTHERS, AND DESIGN, DEVELOPMENT AND EXECUTION OF MARKETING AND MEDIA PLANS FOR OTHERS, AND ALL FORMS OF MASS AND ONE-TO-ONE COMMUNICATIONS THEREIN (U.S. CLS. 100, 101 AND 102).
FIRST USE 8-24-2011; IN COMMERCE 8-30-2011.
JULIE GUTTADAURO, EXAMINING ATTORNEY

SN 85-538,809. GRAHAM, JAREN, MITCHELLVILLE, MD. AND RIDLEY, DEREK, BOWIE, MD. AND KENT II, RONALD, LANHAM, MD. AND NNABUGWU, CHIMEREZE, BOWIE, MD. FILED 2-9-2012.

FSM&M

THE MARK CONSISTS OF STANDARD CHARACTERS WITHOUT CLAIM TO ANY PARTICULAR FONT, STYLE, SIZE, OR COLOR.
FOR BUSINESS MANAGEMENT (U.S. CLS. 100, 101 AND 102).
JULIE GUTTADAURO, EXAMINING ATTORNEY

CLASS 35—(Continued).

SN 85-538,833. ENDERSEN, SHARINE, MESA, AZ. FILED 2-9-2012.



THE MARK CONSISTS OF THE TEXT "WE" IN THE UPPER LEFT, "PROUDLY" IN THE MIDDLE, AND "PRESENT" IN THE LOWER RIGHT IN FANCY CURSIVE FONT. FOR ADVERTISING AGENCIES, NAMELY, PROMOTING THE GOODS AND SERVICES OF OTHERS (U.S. CLS. 100, 101 AND 102).
FIRST USE 7-28-1992; IN COMMERCE 7-28-1992.
JAMES A. RAUEN, EXAMINING ATTORNEY

SN 85-538,937. INTERNATIONAL SOCIETY FOR WEALTH AFTER GRADUATION, AKA ISWAG, HUTTO, TX. FILED 2-9-2012.

iSWAG

THE MARK CONSISTS OF STANDARD CHARACTERS WITHOUT CLAIM TO ANY PARTICULAR FONT, STYLE, SIZE, OR COLOR.
FOR PROVIDING CAREER INFORMATION (U.S. CLS. 100, 101 AND 102).
FIRST USE 7-30-2010; IN COMMERCE 7-30-2010.
MARK SHINER, EXAMINING ATTORNEY

SN 85-538,981. VALENCIANO-MOONEY, TIARE, SHERMAN OAKS, CA. FILED 2-10-2012.

pinkpackage

THE MARK CONSISTS OF STANDARD CHARACTERS WITHOUT CLAIM TO ANY PARTICULAR FONT, STYLE, SIZE, OR COLOR.
FOR RETAIL STORE SERVICES FEATURING INTIMATES, FEMININE CARE, PERSONAL CARE AND BEAUTY CARE PRODUCTS ACCESSIBLE ON-LINE AND BY TELEPHONE, FACSIMILE AND MAIL ORDER (U.S. CLS. 100, 101 AND 102).
KATINA MISTER, EXAMINING ATTORNEY

CLASS 35—(Continued).

SN 85-539,082. NATHALIE SOKOLOFF-SCHAFFER, DARTMOUTH, CT. AND BEN CRUZ, BROOKLYN, NY. FILED 2-10-2012.

A Different Kind of Animal

THE MARK CONSISTS OF STANDARD CHARACTERS WITHOUT CLAIM TO ANY PARTICULAR FONT, STYLE, SIZE, OR COLOR.

FOR ADVERTISING AND BUSINESS SERVICES, NAMELY, SECURING AIRTIME ON ALL FORMS OF MEDIA COMMUNICATIONS STATIONS, SYSTEMS, NETWORKS, AND SERVICES FOR THE PURPOSE OF PROMOTING THE GOODS AND SERVICES OF OTHERS; ADVERTISING AND COMMERCIAL INFORMATION SERVICES, VIA THE INTERNET; ADVERTISING AND MARKETING SERVICES PROVIDED BY MEANS OF INDIRECT METHODS OF MARKETING COMMUNICATIONS, NAMELY, SOCIAL MEDIA, SEARCH ENGINE MARKETING, INQUIRY MARKETING, INTERNET MARKETING, MOBILE MARKETING, BLOGGING AND OTHER FORMS OF PASSIVE, SHARABLE OR VIRAL COMMUNICATIONS CHANNELS; ADVERTISING AND MARKETING SERVICES, NAMELY, PROMOTING THE GOODS AND SERVICES OF OTHERS; ADVERTISING AND PUBLICITY SERVICES (U.S. CLS. 100, 101 AND 102).

KAPIL BHANOT, EXAMINING ATTORNEY

SN 85-539,150. SANCHEZ, KRISTOFER J, DBA UBERFACTS, BROOKLYN, NY. FILED 2-10-2012.

UberFacts

THE MARK CONSISTS OF STANDARD CHARACTERS WITHOUT CLAIM TO ANY PARTICULAR FONT, STYLE, SIZE, OR COLOR.

FOR ADVERTISING AND MARKETING SERVICES PROVIDED BY MEANS OF INDIRECT METHODS OF MARKETING COMMUNICATIONS, NAMELY, SOCIAL MEDIA, SEARCH ENGINE MARKETING, INQUIRY MARKETING, INTERNET MARKETING, MOBILE MARKETING, BLOGGING AND OTHER FORMS OF PASSIVE, SHARABLE OR VIRAL COMMUNICATIONS CHANNELS (U.S. CLS. 100, 101 AND 102).

FIRST USE 1-1-2010; IN COMMERCE 1-10-2012.
KEVON CHISOLM, EXAMINING ATTORNEY

CLASS 35—(Continued).

SN 85-539,242. TRUTH LLC, BARBOURSVILLE, VA. FILED 2-10-2012.

Prepare. React. Survive.

THE MARK CONSISTS OF STANDARD CHARACTERS WITHOUT CLAIM TO ANY PARTICULAR FONT, STYLE, SIZE, OR COLOR.

FOR ON-LINE RETAIL STORE SERVICES FEATURING SURVIVAL EQUIPMENT AND SUPPLIES, TACTICAL AND OUTDOOR CLOTHING, T-SHIRTS, BACK PACKING EQUIPMENT AND SUPPLIES, TACTICAL WEAPON ACCESSORIES, FIRST AID SUPPLIES, LONG TERM FOOD AND WATER RATIONS, AND SURVIVAL AND EXPEDITIONARY RELATED MEDIA AND LITERATURE; RETAIL STORE SERVICES FEATURING SURVIVAL EQUIPMENT AND SUPPLIES, TACTICAL AND OUTDOOR CLOTHING, T-SHIRTS, BACK PACKING EQUIPMENT AND SUPPLIES, TACTICAL WEAPON ACCESSORIES, FIRST AID SUPPLIES, LONG TERM FOOD AND WATER RATIONS, AND SURVIVAL AND EXPEDITIONARY RELATED MEDIA AND LITERATURE (U.S. CLS. 100, 101 AND 102).

BRENDAN MCCAULEY, EXAMINING ATTORNEY

SN 85-539,253. ANTLER AGENCY, LLC, BOSTON, MA. FILED 2-10-2012.

Antler

THE MARK CONSISTS OF STANDARD CHARACTERS WITHOUT CLAIM TO ANY PARTICULAR FONT, STYLE, SIZE, OR COLOR.

FOR ADVERTISING AGENCIES SPECIALIZING IN DIGITAL MARKETING AND SOCIAL MEDIA SERVICES, EVENT MARKETING AND PRODUCTION SERVICES, WEBSITE DESIGN AND DEVELOPMENT SERVICES, PROMOTIONAL SERVICES, MARKETING STRATEGY AND CONSULTING SERVICES, CREATIVE DESIGN AND ADVERTISING PRODUCTION SERVICES, MEDIA RELATIONS AND MEDIA BUYING SERVICES, INTERACTIVE TECHNOLOGY SERVICES, BRAND DEVELOPMENT AND BRAND DESIGN SERVICES CONSISTING OF DEVELOPMENT AND DESIGN OF LOGOS, PRODUCT PACKAGING, AND BUSINESS IDENTITY OF THIRD PARTY CLIENTS; ADVERTISING AGENCY SPECIALIZING IN THE DESIGN AND EXECUTION OF WORD OF MOUTH, VIRAL, BUZZ AND EXPERIENTIAL MARKETING PROGRAMS; ADVERTISING AND MARKETING; ADVERTISING AND MARKETING SERVICES PROVIDED BY MEANS OF INDIRECT METHODS OF MARKETING COMMUNICATIONS, NAMELY, SOCIAL MEDIA, SEARCH ENGINE MARKETING, INQUIRY MARKETING, INTERNET MARKETING, MOBILE MARKETING, BLOGGING AND OTHER FORMS OF PASSIVE, SHARABLE OR VIRAL COMMUNICATIONS CHANNELS; ADVERTISING AND MARKETING SERVICES, NAMELY, PROMOTING THE GOODS AND SERVICES OF OTHERS; ADVERTISING, MARKETING AND PROMOTION SERVICES; ADVERTISING, MARKETING, AND PROMOTING THE GOODS AND SERVICES OF OTHERS VIA PROMOTIONAL EVENTS, CONTESTS AND SWEEPSTAKES, SOCIAL MEDIA, INTERACTIVE TECHNOLOGIES, AND EXPERIENTIAL TACTICS; ARRANGING AND CONDUCTING MARKETING PROMOTIONAL EVENTS FOR OTHERS; BRANDING SERVICES, NAMELY, CONSULTING,

CLASS 35—(Continued).

DEVELOPMENT, MANAGEMENT AND MARKETING OF BRANDS FOR BUSINESSES; BUSINESS MARKETING SERVICES; CONSULTATION SERVICES, NAMELY, CREATIVE AND STRATEGIC CONSULTATION REGARDING DEVELOPMENT AND PRODUCTION OF MARKETING CAMPAIGNS FOR OTHERS; CREATIVE MARKETING DESIGN SERVICES; DEVELOPMENT OF MARKETING STRATEGIES AND CONCEPTS; DEVELOPMENT OF MARKETING STRATEGIES, CONCEPTS AND TACTICS, NAMELY, AUDIENCE DEVELOPMENT, BRAND AWARENESS, ONLINE COMMUNITY BUILDING AND DIGITAL WORD OF MOUTH COMMUNICATIONS; EVENT PLANNING AND MANAGEMENT FOR MARKETING, BRANDING, PROMOTING OR ADVERTISING THE GOODS AND SERVICES OF OTHERS; MARKETING CONSULTING; MARKETING SERVICES, NAMELY, PROMOTING OR ADVERTISING THE GOODS AND SERVICES OF OTHERS; PROMOTING, ADVERTISING AND MARKETING OF THE BRANDS, PRODUCTS, SERVICES AND ONLINE WEBSITES OF INDIVIDUALS, BUSINESSES AND NONPROFIT ORGANIZATIONS; PROMOTION AND MARKETING SERVICES AND RELATED CONSULTING; PROVIDING MARKETING AND PROMOTION OF SPECIAL EVENTS; SOCIAL MEDIA STRATEGY AND MARKETING CONSULTANCY FOCUSING ON HELPING CLIENTS CREATE AND EXTEND THEIR PRODUCT AND BRAND STRATEGIES BY BUILDING VIRALLY ENGAGING MARKETING SOLUTIONS (U.S. CLS. 100, 101 AND 102).
FIRST USE 1-1-2010; IN COMMERCE 2-26-2010.
FRANK LATTUCA, EXAMINING ATTORNEY

SN 85-539,454. ARCANA ACADEMY, LLC., LOS ANGELES, CA. FILED 2-10-2012.

ARCANA ACADEMY

THE MARK CONSISTS OF STANDARD CHARACTERS WITHOUT CLAIM TO ANY PARTICULAR FONT, STYLE, SIZE, OR COLOR.
FOR ADVERTISING SERVICES (U.S. CLS. 100, 101 AND 102).
FIRST USE 11-11-2011; IN COMMERCE 11-15-2011.
ALEX KEAM, EXAMINING ATTORNEY

SN 85-539,708. LIFESTYLES CREATED, L.L.C., LEAWOOD, KS. FILED 2-10-2012.

LIFESTYLES CREATED

THE MARK CONSISTS OF STANDARD CHARACTERS WITHOUT CLAIM TO ANY PARTICULAR FONT, STYLE, SIZE, OR COLOR.
FOR RETAIL STORE SERVICES FEATURING CLOTHING; ONLINE RETAIL STORE SERVICES FEATURING CLOTHING (U.S. CLS. 100, 101 AND 102).
PATRICIA EVANKO, EXAMINING ATTORNEY

CLASS 35—(Continued).

SN 85-539,852. JOYCE, JAMES, NEEDHAM, MA. FILED 2-10-2012.

CARDFLY

THE MARK CONSISTS OF STANDARD CHARACTERS WITHOUT CLAIM TO ANY PARTICULAR FONT, STYLE, SIZE, OR COLOR.

FOR ON-LINE RETAIL STORE SERVICES FEATURING A WEBSITE THAT ALLOWS USERS TO DESIGN AND PURCHASE STICKERS THAT ARE MADE OF A LIGHT CLOTH WITH A PHOTO PRINT AND A GEL BACKING THAT STICKS TO THE BACK OF A SMART PHONE OR ANY HARD SUBSTANCE (U.S. CLS. 100, 101 AND 102).

JESSICA A. POWERS, EXAMINING ATTORNEY

SN 85-540,029. PRATT, BRIAN, WALKERSVILLE, MD. FILED 2-10-2012.

kidzen

THE MARK CONSISTS OF STANDARD CHARACTERS WITHOUT CLAIM TO ANY PARTICULAR FONT, STYLE, SIZE, OR COLOR.

FOR ON-LINE RETAIL STORE SERVICES FEATURING VARIOUS FORMS OF ARTWORK (U.S. CLS. 100, 101 AND 102).

LAURIE KAUFMAN, EXAMINING ATTORNEY

SN 85-540,079. STEINS AND VINES, SIOUX FALLS, SD. FILED 2-10-2012.

STEINS & VINES

THE MARK CONSISTS OF STANDARD CHARACTERS WITHOUT CLAIM TO ANY PARTICULAR FONT, STYLE, SIZE, OR COLOR.

FOR RETAIL STORE SERVICES FEATURING HOME BREWING SUPPLIES AND INGREDIENTS AND GARDEN SUPPLIES (U.S. CLS. 100, 101 AND 102).

FIRST USE 6-1-2010; IN COMMERCE 6-1-2010.
ZACHARY BELLO, EXAMINING ATTORNEY

CLASS 35—(Continued).

SN 85-540,162. NATURAL WONDERS GALLERY, INC., BELLEVUE, WA. FILED 2-10-2012.



THE MARK CONSISTS OF A TREE BRANCH WITH LEAVES AND FLOWERS.
FOR ART GALLERY SERVICES; ON-LINE ART GALLERIES (U.S. CLS. 100, 101 AND 102).
FIRST USE 12-1-2011; IN COMMERCE 12-1-2011.
RON FAIRBANKS, EXAMINING ATTORNEY

SN 85-540,165. NATURAL WONDERS GALLERY, INC., BELLEVUE, WA. FILED 2-10-2012.

Inspired By Nature, Defined By The Collector

THE MARK CONSISTS OF STANDARD CHARACTERS WITHOUT CLAIM TO ANY PARTICULAR FONT, STYLE, SIZE, OR COLOR.
FOR ART GALLERIES; ON-LINE ART GALLERIES (U.S. CLS. 100, 101 AND 102).
FIRST USE 11-1-2010; IN COMMERCE 11-1-2010.
RON FAIRBANKS, EXAMINING ATTORNEY

SN 85-540,272. NOAH & JAMAL INTERNATIONAL, INC., MIAMI, FL. FILED 2-11-2012.

MY MOTHER PLANET

THE MARK CONSISTS OF STANDARD CHARACTERS WITHOUT CLAIM TO ANY PARTICULAR FONT, STYLE, SIZE, OR COLOR.
FOR ADVERTISING, MARKETING AND PROMOTION SERVICES (U.S. CLS. 100, 101 AND 102).
JENNIFER MARTIN, EXAMINING ATTORNEY

CLASS 35—(Continued).

SN 85-540,323. THE ARTIVIST NETWORK, HOLLYWOOD, CA. FILED 2-11-2012.

A GREATER YOU, A GREATER WORLD.

THE MARK CONSISTS OF STANDARD CHARACTERS WITHOUT CLAIM TO ANY PARTICULAR FONT, STYLE, SIZE, OR COLOR.
FOR ON-LINE RETAIL STORE SERVICES FEATURING A WIDE VARIETY OF CONSUMER GOODS OF OTHERS (U.S. CLS. 100, 101 AND 102).
FIRST USE 5-3-2011; IN COMMERCE 5-3-2011.
CYNTHIA TRIPI, EXAMINING ATTORNEY

SN 85-540,411. PEER SOLUTIONS INC., PHOENIX, AZ. FILED 2-12-2012.

STAND & SERVE

THE MARK CONSISTS OF STANDARD CHARACTERS WITHOUT CLAIM TO ANY PARTICULAR FONT, STYLE, SIZE, OR COLOR.
FOR PUBLIC ADVOCACY TO PROMOTE AWARENESS OF CHILD ABUSE, SEXUAL VIOLENCE, SUBSTANCE ABUSE, RELATIONSHIP VIOLENCE, BULLYING, HOMELESSNESS, GANG AND GUN VIOLENCE, OPPRESSION (U.S. CLS. 100, 101 AND 102).
FIRST USE 6-1-1996; IN COMMERCE 6-1-1996.
LOURDES AYALA, EXAMINING ATTORNEY

SN 85-540,501. MEETINGS & EVENTS INTERNATIONAL, INC, EVANSVILLE, IN. FILED 2-12-2012.

MEIMEET

THE MARK CONSISTS OF STANDARD CHARACTERS WITHOUT CLAIM TO ANY PARTICULAR FONT, STYLE, SIZE, OR COLOR.
FOR BUSINESS MEETING PLANNING (U.S. CLS. 100, 101 AND 102).
FIRST USE 3-1-2011; IN COMMERCE 3-1-2011.
LINDA LAVACHE, EXAMINING ATTORNEY

CLASS 35—(Continued).

SN 85-540,527. GOLDEN OPENINGS, INC., URBAN DALE, IA. FILED 2-12-2012.

Golden Openings

THE MARK CONSISTS OF STANDARD CHARACTERS WITHOUT CLAIM TO ANY PARTICULAR FONT, STYLE, SIZE, OR COLOR.

FOR COMPUTERIZED ON-LINE RETAIL STORE SERVICES IN THE FIELD OF CEREMONIAL PRODUCTS (U.S. CLS. 100, 101 AND 102).

FIRST USE 2-27-1997; IN COMMERCE 2-27-1997.
KIMBERLY PERRY, EXAMINING ATTORNEY

SN 85-540,568. KALKSTEIN, LAWRENCE, RIDGEFIELD, CT. FILED 2-12-2012.

OCO V

THE MARK CONSISTS OF STANDARD CHARACTERS WITHOUT CLAIM TO ANY PARTICULAR FONT, STYLE, SIZE, OR COLOR.

FOR PROVIDING A WEBSITE FEATURING INFORMATION ABOUT POLITICAL ISSUES; PROVIDING AN INTERNET WEBSITE FEATURING NEWS AND INFORMATION IN THE FIELD OF NATIONAL AND INTERNATIONAL POLITICS; PROVIDING AN ON-LINE SEARCHABLE DATABASE FOR POLITICAL CAMPAIGNS AT WHICH USERS CAN COLLECT AND ANALYZE POLITICAL INFORMATION ELECTRONICALLY; PROVIDING INFORMATION REGARDING POLITICAL ISSUES, KNOWING HOW TO VOTE AND KNOWING HOW TO REGISTER TO VOTE (U.S. CLS. 100, 101 AND 102).

ESTHER A. BORSUK, EXAMINING ATTORNEY

SN 85-540,815. NATIONAL DENTAL ASSOCIATION, INC., WASHINGTON, DC. FILED 2-13-2012.

NATIONAL DENTAL ASSOCIATION

THE MARK CONSISTS OF STANDARD CHARACTERS WITHOUT CLAIM TO ANY PARTICULAR FONT, STYLE, SIZE, OR COLOR.

NO CLAIM IS MADE TO THE EXCLUSIVE RIGHT TO USE "ASSOCIATION", APART FROM THE MARK AS SHOWN.

SEC. 2(F).

FOR ASSOCIATION SERVICES, NAMELY, PROMOTING THE INTERESTS OF DENTAL PROFESSIONALS AND DISSEMINATING INFORMATION ABOUT ORAL HEALTH TO THE PUBLIC (U.S. CLS. 100, 101 AND 102).

FIRST USE 5-12-1937; IN COMMERCE 5-12-1937.
RON FAIRBANKS, EXAMINING ATTORNEY

CLASS 35—(Continued).

SN 85-540,970. INCENTIVIZE, INC., HUDSON, FL. FILED 2-13-2012.

CONTENT LOCKER

THE MARK CONSISTS OF STANDARD CHARACTERS WITHOUT CLAIM TO ANY PARTICULAR FONT, STYLE, SIZE, OR COLOR.

FOR ADVERTISING, MARKETING AND PROMOTION SERVICES (U.S. CLS. 100, 101 AND 102).

FIRST USE 2-1-2012; IN COMMERCE 2-1-2012.
MAYUR VAGHANI, EXAMINING ATTORNEY

SN 85-541,316. SOCIETE DES PRODUITS NESTLE S.A., 1800 VEVEY, SWITZERLAND, FILED 2-13-2012.

ONE GOOD TURN

THE MARK CONSISTS OF STANDARD CHARACTERS WITHOUT CLAIM TO ANY PARTICULAR FONT, STYLE, SIZE, OR COLOR.

FOR ARRANGING AND CONDUCTING INCENTIVE REWARD PROGRAMS TO PROMOTE THE SALE OF FOOD (U.S. CLS. 100, 101 AND 102).

FIRST USE 7-31-2011; IN COMMERCE 7-31-2011.
WENDY JUN, EXAMINING ATTORNEY

SN 85-553,840. JARVIS, GARY, BLUE POINT, NY. FILED 2-27-2012.

THE ARCHITECT'S CHOICE

THE MARK CONSISTS OF STANDARD CHARACTERS WITHOUT CLAIM TO ANY PARTICULAR FONT, STYLE, SIZE, OR COLOR.

NO CLAIM IS MADE TO THE EXCLUSIVE RIGHT TO USE "ARCHITECT'S", APART FROM THE MARK AS SHOWN.

FOR ON-LINE RETAIL STORE SERVICES AND RETAIL STORE SERVICES FEATURING WINDOW SHADING SYSTEMS, NAMELY, WINDOW SHADES AND COMPONENT PARTS ALL SOLD AS A UNIT (U.S. CLS. 100, 101 AND 102).

SUSAN RICHARDS, EXAMINING ATTORNEY

CLASS 35—(Continued).

SN 85-554,104. GENE GRAHAM, SHERWOOD, AR. FILED 2-27-2012.

ILWED

THE MARK CONSISTS OF STANDARD CHARACTERS WITHOUT CLAIM TO ANY PARTICULAR FONT, STYLE, SIZE, OR COLOR.

FOR BUSINESS CONSULTANCY; BUSINESS CONSULTATION SERVICES (U.S. CLS. 100, 101 AND 102).
ALLISON SCHRODY, EXAMINING ATTORNEY

SN 85-556,112. MICHAEL KEANE, BLACKLICK, OH. FILED 2-29-2012.

HEROIC MISSION

THE MARK CONSISTS OF STANDARD CHARACTERS WITHOUT CLAIM TO ANY PARTICULAR FONT, STYLE, SIZE, OR COLOR.

FOR BUSINESS MANAGEMENT CONSULTANCY, ALSO VIA THE INTERNET (U.S. CLS. 100, 101 AND 102).
FIRST USE 10-19-2011; IN COMMERCE 10-19-2011.
JACQUELINE A. LAVINE, EXAMINING ATTORNEY

SN 85-556,842. AMERICAN COUNCIL ON EDUCATION, WASHINGTON, DC. FILED 2-29-2012.

ACE WOMEN'S Network

OWNER OF U.S. REG. NOS. 2,484,476, 3,721,844 AND OTHERS.

NO CLAIM IS MADE TO THE EXCLUSIVE RIGHT TO USE "WOMEN'S NETWORK", APART FROM THE MARK AS SHOWN.

THE MARK CONSISTS OF THE WORDS "ACE WOMEN'S" ABOVE A CURVING, HORIZONTAL LINE AND THE WORD "NETWORK".

FOR DEVELOPING PROGRAMS THAT IDENTIFY, DEVELOP, ENCOURAGE, ADVANCE, LINK, AND SUPPORT WOMEN IN HIGHER EDUCATION CAREERS (U.S. CLS. 100, 101 AND 102).

PRISCILLA MILTON, EXAMINING ATTORNEY

CLASS 35—(Continued).

SN 85-561,841. FOX FACTORY, INC., SCOTTS VALLEY, CA. FILED 3-6-2012.

RIDE FOX

THE MARK CONSISTS OF STANDARD CHARACTERS WITHOUT CLAIM TO ANY PARTICULAR FONT, STYLE, SIZE, OR COLOR.

FOR ADVERTISING, MARKETING AND PROMOTIONAL SERVICES FOR DEALERS AND DISTRIBUTORS OF VEHICLE SUSPENSION SYSTEMS INCLUDING SHOCK ABSORBERS FOR VEHICLES (U.S. CLS. 100, 101 AND 102).

KATHERINE CONNOLLY, EXAMINING ATTORNEY

SN 85-561,859. FOX FACTORY, INC., SCOTTS VALLEY, CA. FILED 3-6-2012.

FOX COUNTRY

THE MARK CONSISTS OF STANDARD CHARACTERS WITHOUT CLAIM TO ANY PARTICULAR FONT, STYLE, SIZE, OR COLOR.

FOR ADVERTISING, MARKETING AND PROMOTIONAL SERVICES FOR DEALERS AND DISTRIBUTORS OF VEHICLE SUSPENSION SYSTEMS INCLUDING SHOCK ABSORBERS FOR VEHICLES (U.S. CLS. 100, 101 AND 102).

KATHERINE CONNOLLY, EXAMINING ATTORNEY

SN 85-565,320. MASTERCARD INTERNATIONAL INCORPORATED, PURCHASE, NY. FILED 3-9-2012.

KOY

THE MARK CONSISTS OF STANDARD CHARACTERS WITHOUT CLAIM TO ANY PARTICULAR FONT, STYLE, SIZE, OR COLOR.

FOR PROMOTING THE GOODS AND SERVICES OF OTHERS BY MEANS OF DISCOUNTS, ADVERTISEMENTS, INCENTIVES AND REBATES GENERATED IN CONNECTION WITH THE USE OF CREDIT AND DEBIT CARDS AND MOBILE PAYMENT DEVICES, INCLUDING RADIO FREQUENCY IDENTIFICATION DEVICES; PROMOTING THE USAGE OF CREDIT AND DEBIT CARDS THROUGH MARKETING OFFERS AND CARDHOLDER INCENTIVES (U.S. CLS. 100, 101 AND 102).

SUNG IN, EXAMINING ATTORNEY

CLASS 35—(Continued).

SN 85-569,722. FREELIFE INTERNATIONAL HOLDINGS, LLC, PHOENIX, AZ. FILED 3-14-2012.

THE HEALTHIEST CHALLENGE
ON THE PLANET!

THE MARK CONSISTS OF STANDARD CHARACTERS WITHOUT CLAIM TO ANY PARTICULAR FONT, STYLE, SIZE, OR COLOR.

FOR ONLINE ORDERING SERVICES FEATURING NUTRITIONAL SUPPLEMENTS, DIETARY SUPPLEMENTS, VITAMIN, MINERAL AND HERBAL SUPPLEMENTS, WEIGHT LOSS PRODUCTS, NUTRITIOUS FOODS, BEVERAGES, COSMETICS, TOILETRIES, CLEANERS, SOAPS, AIR FRESHENERS, AND HOUSEHOLD CLEANSERS; DISTRIBUTORSHIP SERVICES IN THE FIELDS OF NUTRITIONAL PRODUCTS, PERSONAL CARE PRODUCTS, AND HOME CARE PRODUCTS (U.S. CLS. 100, 101 AND 102).

ANDREW RHIM, EXAMINING ATTORNEY

SN 85-572,856. FULL SAIL, LLC, WINTER PARK, FL. FILED 3-19-2012.

SPARK STUDENT PRODUCTION
AGENCY AT FULL SAIL

THE MARK CONSISTS OF STANDARD CHARACTERS WITHOUT CLAIM TO ANY PARTICULAR FONT, STYLE, SIZE, OR COLOR.

OWNER OF U.S. REG. NOS. 3,715,282, 3,813,722 AND 3,813,724.

FOR ADVERTISING AGENCY SERVICES (U.S. CLS. 100, 101 AND 102).

EDWARD NELSON, EXAMINING ATTORNEY

SN 85-572,971. AMERICAN EXPRESS MARKETING & DEVELOPMENT CORP., NEW YORK, NY. FILED 3-19-2012.

SOURCEWISE

THE MARK CONSISTS OF STANDARD CHARACTERS WITHOUT CLAIM TO ANY PARTICULAR FONT, STYLE, SIZE, OR COLOR.

FOR BUSINESS CONSULTING SERVICES IN THE FIELD OF PARTNERING WITH MERCHANTS TO HELP SMALL BUSINESS OWNERS GAIN ACCESS TO SIGNIFICANT SAVINGS THROUGH THE PURCHASE OF VOUCHERS FOR A BROAD RANGE OF PRODUCTS AND SERVICES RELEVANT TO THEIR BUSINESS (U.S. CLS. 100, 101 AND 102).

KIMBERLY FRYE, EXAMINING ATTORNEY

CLASS 35—(Continued).

SN 85-574,353. MANSFIELD OIL COMPANY OF GAINESVILLE, INC., GAINESVILLE, GA. FILED 3-20-2012.

GAS TO GALLONS

THE MARK CONSISTS OF STANDARD CHARACTERS WITHOUT CLAIM TO ANY PARTICULAR FONT, STYLE, SIZE, OR COLOR.

FOR LOGISTICS MANAGEMENT IN THE FIELD OF FUELS, INCLUDING NATURAL GAS (U.S. CLS. 100, 101 AND 102).

AMY ALFIERI, EXAMINING ATTORNEY

SN 85-575,366. ACE HARDWARE CORPORATION, OAK BROOK, IL. FILED 3-21-2012.

BULBS ARE CHANGING. ACE
WILL LIGHT THE WAY.

THE MARK CONSISTS OF STANDARD CHARACTERS WITHOUT CLAIM TO ANY PARTICULAR FONT, STYLE, SIZE, OR COLOR.

OWNER OF U.S. REG. NOS. 1,464,025, 3,879,761 AND OTHERS.

FOR RETAIL STORE SERVICES FEATURING LIGHT BULBS AND LIGHTING SUPPLIES (U.S. CLS. 100, 101 AND 102).

JORDAN BAKER, EXAMINING ATTORNEY

CLASS 35—(Continued).

SN 85-576,252. BRECKINRIDGE TAYLOR LLC, DALLAS, TX. FILED 3-21-2012.



THE MARK CONSISTS OF THE SHAPE OF A SOLID COLOR CAPITAL LETTER "B" CONTAINING THE SHAPE OF A CAPITAL LETTER "T" ANGLED AT APPROXIMATELY 45 DEGREES TO THE LEFT IN THE UPPER PORTION OF THE SOLID LETTER "B", WITH THE "T" SHOWN IN A LIGHT SHADED CONTRASTING COLOR OR SHOWN IN THE NEGATIVE AS THE ABSENCE OF THE DARK COLOR USED FOR THE "B" (IF USED ON A COLORED BACKGROUND).

FOR ON-LINE RETAIL STORE SERVICES FEATURING FURNITURE, HOME FURNISHINGS, HOME AND OFFICE ACCESSORIES AND DECORATIVE ITEMS; RETAIL FURNITURE STORES; RETAIL STORE SERVICES FEATURING FURNITURE, HOME FURNISHINGS, HOME AND OFFICE ACCESSORIES AND DECORATIVE ITEMS (U.S. CLS. 100, 101 AND 102).

FIRST USE 12-0-2010; IN COMMERCE 12-0-2010.
JOHN DALIER, EXAMINING ATTORNEY

SN 85-587,708. JEPSON, LAEL COUPER, DBA SHE-CHANGES, PORTLAND, ME. FILED 4-3-2012.

SheChanges

THE MARK CONSISTS OF STANDARD CHARACTERS WITHOUT CLAIM TO ANY PARTICULAR FONT, STYLE, SIZE, OR COLOR.

FOR CONSULTING SERVICES IN BUSINESS LEADERSHIP DEVELOPMENT AND BUSINESS MANAGEMENT (U.S. CLS. 100, 101 AND 102).

FIRST USE 1-1-2006; IN COMMERCE 5-1-2007.
SKYE YOUNG, EXAMINING ATTORNEY

CLASS 35—(Continued).

SN 85-605,306. MASTERCARD INTERNATIONAL INCORPORATED, PURCHASE, NY. FILED 4-23-2012.

THE APP THAT SAVES YOU
EVERY DAY

THE MARK CONSISTS OF STANDARD CHARACTERS WITHOUT CLAIM TO ANY PARTICULAR FONT, STYLE, SIZE, OR COLOR.

FOR PROMOTING THE GOODS AND SERVICES OF OTHERS BY MEANS OF DISCOUNTS, ADVERTISEMENTS, INCENTIVES AND REBATES GENERATED IN CONNECTION WITH THE USE OF CREDIT AND DEBIT CARDS AND MOBILE PAYMENT DEVICES, INCLUDING RADIO FREQUENCY IDENTIFICATION DEVICES; PROMOTING THE USAGE OF CREDIT AND DEBIT CARDS THROUGH MARKETING OFFERS AND CARDHOLDER INCENTIVES (U.S. CLS. 100, 101 AND 102).

SUNG IN, EXAMINING ATTORNEY

SN 85-605,327. MASTERCARD INTERNATIONAL INCORPORATED, PURCHASE, NY. FILED 4-23-2012.

KOY, THE APP THAT SAVES
YOU EVERY DAY

THE MARK CONSISTS OF STANDARD CHARACTERS WITHOUT CLAIM TO ANY PARTICULAR FONT, STYLE, SIZE, OR COLOR.

FOR PROMOTING THE GOODS AND SERVICES OF OTHERS BY MEANS OF DISCOUNTS, ADVERTISEMENTS, INCENTIVES AND REBATES GENERATED IN CONNECTION WITH THE USE OF CREDIT AND DEBIT CARDS AND MOBILE PAYMENT DEVICES, INCLUDING RADIO FREQUENCY IDENTIFICATION DEVICES; PROMOTING THE USAGE OF CREDIT AND DEBIT CARDS THROUGH MARKETING OFFERS AND CARDHOLDER INCENTIVES (U.S. CLS. 100, 101 AND 102).

SUNG IN, EXAMINING ATTORNEY

CLASS 36—INSURANCE AND FINANCIAL

SN 76-710,345. THE PRINCETON CORPORATION, KENTLAND, IN. FILED 1-24-2012.

LOYAL YEARS

THE MARK CONSISTS OF STANDARD CHARACTERS WITHOUT CLAIM TO ANY PARTICULAR FONT, STYLE, SIZE, OR COLOR.

OWNER OF U.S. REG. NOS. 3,052,542 AND 3,307,911. FOR ADMINISTERING INSURANCE PROGRAMS FOR OTHERS (U.S. CLS. 100, 101 AND 102). FIRST USE 10-3-2011; IN COMMERCE 10-3-2011. ELLEN PERKINS, EXAMINING ATTORNEY

SN 77-983,030. EUROP ASSISTANCE HOLDING, PARIS, FRANCE, FILED 8-25-2009.

NETGLOBERS

THE MARK CONSISTS OF STANDARD CHARACTERS WITHOUT CLAIM TO ANY PARTICULAR FONT, STYLE, SIZE, OR COLOR.

OWNER OF FRANCE REG. NO. 093646393, DATED 4-24-2009. EXPIRES 4-24-2019.

FOR INSURANCE, NAMELY, INSURANCE UNDERWRITING SERVICES, NAMELY, HEALTH INSURANCE UNDERWRITING, ACCIDENT INSURANCE UNDERWRITING, CAR INSURANCE UNDERWRITING, TRAVEL INSURANCE UNDERWRITING, REINSURANCE UNDERWRITING, INSURANCE BROKERAGE SERVICES; ALL OPERATIONS OF AID, ASSISTANCE, INFORMATION OR ADVICE WHICH MAY BE USED AND PROVIDED BY AN ORGANIZATION WHOSE PRINCIPAL PURPOSE IS TO AID, ASSIST AND ADVISE ITS SUBSCRIBERS DURING THEIR TRAVEL IN FRANCE OR ABROAD AND, GENERALLY, TO COME TO THEIR AID ON THE OCCASION OF ANY UNFORESEEN EVENT, INCIDENT, OR ILLNESS ARISING DURING THEIR TRAVEL, NAMELY, INFORMATION ON INSURANCE ASSUMPTION OF COSTS BY SOCIAL SECURITY, FINANCIAL SERVICES, NAMELY, ADVANCING OF FUNDS IN CASE OF LOSS OR THEFT, ADVANCING OF FUNDS FOR MEDICAL, FUNERAL, HOSPITALIZATION, ACCOMMODATION, LAWYER, BAIL, TRANSPORT, SEARCH, EMERGENCY, RESCUE AND ANY OTHER COSTS CAUSED BY AN INCIDENT, ILLNESS OR ANY OTHER UNFORESEEN EVENT (U.S. CLS. 100, 101 AND 102).

FLORENTINA BLANDU, EXAMINING ATTORNEY

CLASS 36—(Continued).

SN 77-983,107. MING PAO FINANCE LIMITED, TORTOLA, BR. VIRGIN ISLANDS, FILED 12-6-2007.



OWNER OF HONG KONG REG. NO. 301016216, DATED 12-18-2007, EXPIRES 12-18-2017.

NO CLAIM IS MADE TO THE EXCLUSIVE RIGHT TO USE "CHINESE", APART FROM THE MARK AS SHOWN. THE COLOR(S) BLACK, GREEN, RED AND WHITE IS/ARE CLAIMED AS A FEATURE OF THE MARK.

THE MARK CONSISTS OF TWO CHINESE CHARACTERS IN BLACK, A HORIZONTAL BLACK LINE BELOW THEM, AND TWO MORE CHINESE CHARACTERS BELOW THE LINE. THE CHARACTER ON THE LEFT IS GREEN, AND THE CHARACTER ON THE RIGHT IS BLACK. BELOW THAT IS A RED RECTANGLE WITH TWO CHINESE CHARACTERS IN WHITE AND THE WORDS "MEDIA CHINESE" IN WHITE.

THE FOREIGN WORDING IN THE MARK TRANSLATES INTO ENGLISH AS CHINESE LANGUAGE IN THE WORLD MASS MEDIA.

THE NON-LATIN CHARACTER(S) IN THE MARK TRANSLITERATES INTO SHI, JIE, HUA, WEN, MEI, TI, AND THIS MEANS CHINESE LANGUAGE IN THE WORLD MASS MEDIA IN ENGLISH.

FOR FINANCIAL AND INVESTMENT SERVICES, NAMELY, FINANCIAL ANALYSIS, FINANCIAL RESEARCH, MANAGEMENT OF FINANCIAL AFFAIRS AND INVESTMENT ADVISORY SERVICES; CAPITAL INVESTMENT SERVICES; FINANCIAL AND INVESTMENT ADVISORY SERVICES; FINANCIAL ADVISORY SERVICES RELATED TO MERGERS AND ACQUISITION; FINANCIAL AFFAIRS, NAMELY, VALUATION OF PERSONAL PROPERTY, AND REAL ESTATE; FINANCIAL CONSULTATION; FUNDS INVESTMENTS; FUNDRAISING SERVICES, NAMELY, CHARITABLE FUNDRAISING SERVICES; FINANCIAL MANAGEMENT; MONETARY EXCHANGE SERVICES; STOCKS AND BONDS BROKERAGE; FISCAL ASSESSMENTS AND VALUATIONS; CONSULTATION SERVICES RELATING TO FINANCIAL OR MONETARY MATTERS; PROVISION OF FINANCIAL INFORMATION; AND PROVISION OF INFORMATION FROM A COMPUTER DATABASE, BY ELECTRONIC MEANS OR THE INTERNET RELATING TO STOCK EXCHANGE PRICES, STOCK EXCHANGE INDICES, EXCHANGE RATES, FINANCIAL ANALYSIS AND FINANCIAL REPORTS (U.S. CLS. 100, 101 AND 102).

KATHERINE CHANG, EXAMINING ATTORNEY

CLASS 36—(Continued).

SN 77-983,108. MING PAO FINANCE LIMITED, TORTOLA, BR. VIRGIN ISLANDS, FILED 12-6-2007.



OWNER OF HONG KONG REG. NO. 301016216, DATED 12-18-2007, EXPIRES 12-18-2017.

NO CLAIM IS MADE TO THE EXCLUSIVE RIGHT TO USE "CHINESE", APART FROM THE MARK AS SHOWN.

THE COLOR(S) BLACK, GREEN, RED AND WHITE IS/ARE CLAIMED AS A FEATURE OF THE MARK.

THE MARK CONSISTS OF TWO CHINESE CHARACTERS IN BLACK, A HORIZONTAL BLACK LINE BELOW THEM, AND TWO MORE CHINESE CHARACTERS BELOW THE LINE, THE CHARACTER ON THE LEFT IS RED, AND THE CHARACTER ON THE RIGHT IS BLACK. BELOW THAT IS A GREEN RECTANGLE WITH TWO CHINESE CHARACTERS IN WHITE AND THE WORDS "MEDIA CHINESE" IN WHITE.

THE FOREIGN WORDING IN THE MARK TRANSLATES INTO ENGLISH AS CHINESE LANGUAGE IN THE WORLD MASS MEDIA.

THE NON-LATIN CHARACTER(S) IN THE MARK TRANSLITERATES INTO SHI, JIE, HUA, WEN, MEI, TI, AND THIS MEANS CHINESE LANGUAGE IN THE WORLD MASS MEDIA IN ENGLISH.

FOR FINANCIAL AND INVESTMENT SERVICES, NAMELY, FINANCIAL ANALYSIS, FINANCIAL RESEARCH, MANAGEMENT OF FINANCIAL AFFAIRS AND INVESTMENT ADVISORY SERVICES; CAPITAL INVESTMENT SERVICES; FINANCIAL AND INVESTMENT ADVISORY SERVICES; FINANCIAL ADVISORY SERVICES RELATED TO MERGERS AND ACQUISITION; FINANCIAL AFFAIRS, NAMELY, VALUATION OF PERSONAL PROPERTY, AND REAL ESTATE; FINANCIAL CONSULTATION; FUNDS INVESTMENTS; FUNDRAISING SERVICES, NAMELY, CHARITABLE FUNDRAISING SERVICES; FINANCIAL MANAGEMENT; MONETARY EXCHANGE SERVICES; STOCKS AND BONDS BROKERAGE; FISCAL ASSESSMENTS AND VALUATIONS; CONSULTATION SERVICES RELATING TO FINANCIAL OR MONETARY MATTERS; PROVISION OF FINANCIAL INFORMATION; AND PROVISION OF INFORMATION FROM A COMPUTER DATABASE, BY ELECTRONIC MEANS OR THE INTERNET RELATING TO STOCK EXCHANGE PRICES, STOCK EXCHANGE INDICES, EXCHANGE RATES, FINANCIAL ANALYSIS AND FINANCIAL REPORTS (U.S. CLS. 100, 101 AND 102).

KATHERINE CHANG, EXAMINING ATTORNEY

CLASS 36—(Continued).

SN 79-093,993. RAIFFEISEN ZENTRALBANK ÖSTERREICH AKTIENGESELLSCHAFT, AUSTRIA, FILED 12-3-2010.



PRIORITY DATE OF 9-3-2010 IS CLAIMED.

OWNER OF INTERNATIONAL REGISTRATION 1068215 DATED 12-3-2010, EXPIRES 12-3-2020.

THE COLOR(S) BLACK AND YELLOW IS/ARE CLAIMED AS A FEATURE OF THE MARK.

THE MARK CONSISTS OF THE LITERAL ELEMENT "RBI" IN BLACK WITH THE DESIGN OF A SQUARE OUTLINED IN BLACK TO THE LEFT; INSIDE THE SQUARE IS A STYLIZED GABLE CROSS IN THE FORM OF TWO HORSE-HEADS IN BLACK; THE BACKGROUND OF THE SQUARE IS IN YELLOW.

FOR TRADE FINANCING FOR IMPORTS AND EXPORTS (U.S. CLS. 100, 101 AND 102).

CHRISIE B. KING, EXAMINING ATTORNEY

SN 85-155,226. IRVING OIL OPERATIONS G.P., NEW BRUNSWICK, CANADA, FILED 10-18-2010.

FUEL THE CARE

THE MARK CONSISTS OF STANDARD CHARACTERS WITHOUT CLAIM TO ANY PARTICULAR FONT, STYLE, SIZE, OR COLOR.

PRIORITY CLAIMED UNDER SEC. 44(D) ON CANADA APPLICATION NO. 1497949, FILED 9-30-2010, REG. NO. TMA809,209, DATED 10-17-2011, EXPIRES 10-17-2026.

FOR CHARITABLE FUNDRAISING SERVICES TO PROVIDE FINANCIAL SUPPORT TO FAMILIES WHO TRAVEL BETWEEN HOME AND HOSPITAL WHEN THEIR CHILDREN REQUIRE MEDICAL TREATMENT (U.S. CLS. 100, 101 AND 102).

FIRST USE 11-0-2002; IN COMMERCE 11-0-2003.

TAMARA FRAZIER, EXAMINING ATTORNEY

CLASS 36—(Continued).

SN 85-197,328. THE PINK FUND, BEVERLY HILLS, MI. FILED 12-14-2010.



NO CLAIM IS MADE TO THE EXCLUSIVE RIGHT TO USE "FUND", APART FROM THE MARK AS SHOWN.

THE COLOR(S) PINK IS/ARE CLAIMED AS A FEATURE OF THE MARK.

THE MARK CONSISTS OF THE WORD "PINK" ARRANGED HORIZONTALLY OVER THE WORD "FUND", THE WORD "THE" ARRANGED VERTICALLY IN FRONT OF THE WORD "PINK", AND A HEART LOGO ARRANGED ADJACENT THE END OF THE WORD "PINK". THE ENTIRE MARK APPEARS IN THE COLOR PINK.

FOR CHARITABLE FUNDRAISING SERVICES, NAMELY, PROVIDING FINANCIAL ASSISTANCE IN THE NATURE OF PAYMENT OF BILLS AND EXPENSES OF OTHERS FOR THOSE UNDERGOING MEDICAL TREATMENT AND THEIR FAMILIES (U.S. CLS. 100, 101 AND 102).

FIRST USE 10-1-2006; IN COMMERCE 10-1-2006.
JULIE WATSON, EXAMINING ATTORNEY

SN 85-223,416. GOODHAVEN CAPITAL MANAGEMENT, LLC, CORAL GABLES, FL. FILED 1-21-2011.



THE MARK CONSISTS OF THE DESIGN OF A BASKET OF EGGS ADORNED WITH DOLLAR SIGNS CENTERED ABOVE THE WORD "GOODHAVEN" IN LARGE STYLIZED LETTERING WITH THE WORDING "OUR MONEY WITH YOURS" UNDERNEATH IN SMALLER LETTERING.

FOR INVESTMENT MANAGEMENT SERVICES, INVESTMENT ADVISORY SERVICES, AND FUND SERVICES, NAMELY, OPERATION AND MANAGEMENT OF MUTUAL FUNDS (U.S. CLS. 100, 101 AND 102).

SALLY SHIH, EXAMINING ATTORNEY

CLASS 36—(Continued).

SN 85-223,421. GOODHAVEN CAPITAL MANAGEMENT, LLC, CORAL GABLES, FL. FILED 1-21-2011.



THE MARK CONSISTS OF THE DESIGN OF DIAGONAL LINES AND AN ARC CENTERED ABOVE THE WORD "GOODHAVEN" IN LARGE STYLIZED LETTERING WITH THE WORDING "OUR MONEY WITH YOURS" UNDERNEATH IN SMALLER LETTERING.

FOR INVESTMENT MANAGEMENT SERVICES, INVESTMENT ADVISORY SERVICES, AND FUND SERVICES, NAMELY, OPERATION AND MANAGEMENT OF MUTUAL FUNDS (U.S. CLS. 100, 101 AND 102).

SALLY SHIH, EXAMINING ATTORNEY

SN 85-230,848. THOMAS, WADE, KANSAS CITY, MO. FILED 2-1-2011.

THE RIVALRY RUN

THE MARK CONSISTS OF STANDARD CHARACTERS WITHOUT CLAIM TO ANY PARTICULAR FONT, STYLE, SIZE, OR COLOR.

NO CLAIM IS MADE TO THE EXCLUSIVE RIGHT TO USE "RUN", APART FROM THE MARK AS SHOWN.

FOR CHARITABLE FUNDRAISING SERVICES, NAMELY, ORGANIZING AND CONDUCTING FUNDRAISING EVENTS (U.S. CLS. 100, 101 AND 102).

FIRST USE 4-3-2009; IN COMMERCE 4-22-2010.
PAULA MAHONEY, EXAMINING ATTORNEY

SN 85-232,957. PAY MY TAXES, LLC, GLASTONBURY, CT. FILED 2-3-2011.

PAY MY TAXES

THE MARK CONSISTS OF STANDARD CHARACTERS WITHOUT CLAIM TO ANY PARTICULAR FONT, STYLE, SIZE, OR COLOR.

FOR PROVIDING TAX ESCROW AND TAX PAYMENT PROCESSING SERVICES (U.S. CLS. 100, 101 AND 102).

FIRST USE 10-5-2009; IN COMMERCE 12-1-2009.
MICHAEL SOUDERS, EXAMINING ATTORNEY

CLASS 36—(Continued).

SN 85-235,690. STERLING NATIONAL BANK, NEW YORK, NY. FILED 2-7-2011.

STERLING FACTORS

THE MARK CONSISTS OF STANDARD CHARACTERS WITHOUT CLAIM TO ANY PARTICULAR FONT, STYLE, SIZE, OR COLOR.

OWNER OF U.S. REG. NOS. 3,717,824, 3,800,217 AND 3,873,890.

SEC. 2(F) AS TO "FACTORS".

FOR ACCOUNTS RECEIVABLE FINANCING; PROVIDING LETTERS OF CREDIT FOR THE FINANCING OF THE IMPORT AND EXPORT OF GOODS; CUSTOMER CREDIT PROTECTION SERVICES, NAMELY, MONITORING PAYMENTS AND PURSUING COLLECTIONS OF OUTSTANDING DEBTS (U.S. CLS. 100, 101 AND 102).

FIRST USE 12-31-1960; IN COMMERCE 12-31-1960.
ZACHARY BELLO, EXAMINING ATTORNEY

CLASS 36—(Continued).

SN 85-274,432. BEAZER HOMES HOLDINGS CORP., ATLANTA, GA. FILED 3-23-2011.



PRE-OWNED

OWNER OF U.S. REG. NOS. 2,758,954 AND 2,972,199.
NO CLAIM IS MADE TO THE EXCLUSIVE RIGHT TO USE "HOMES PRE-OWNED", APART FROM THE MARK AS SHOWN.

THE MARK CONSISTS OF A SQUARE ENCLOSING THE IMAGE OF TWO LEAVES, BELOW WHICH THE TERM "BEAZER HOMES" APPEARS. BELOW THE SQUARE, A STRAIGHT LINE APPEARS, BELOW WHICH THE TERM "PRE-OWNED" APPEARS.

FOR LEASING OF RESIDENTIAL REAL ESTATE, NAMELY, LEASING OF PRE-EXISTING HOMES WITH LEASE-TO-OWN OPTIONS (U.S. CLS. 100, 101 AND 102).
MARTHA FROMM, EXAMINING ATTORNEY

SN 85-259,823. METROPOLITAN LIFE INSURANCE COMPANY, NEW YORK, NY. FILED S.R. 3-7-2011; AM. P.R. 6-23-2011.



THE COLOR(S) OLIVE GREEN, RED, ORANGE, YELLOW, GREEN, BLUE AND PURPLE IS/ARE CLAIMED AS A FEATURE OF THE MARK.

THE MARK CONSISTS OF THE STYLIZED WORDING "PLANNING WITH PRIDE." THE COLOR OLIVE GREEN APPEARS IN THE WORDING "PLANNING WITH." THE COLOR RED APPEARS IN THE LEFT PORTION OF THE "P" IN "PRIDE" AND FADES TO ORANGE ON THE RIGHT SIDE OF THE "P." THE COLOR ORANGE APPEARS IN THE LEFT SIDE OF THE "R" IN "PRIDE" AND FADES TO YELLOW ON THE RIGHT SIDE OF THE "R." THE COLOR YELLOW APPEARS IN THE LEFT SIDE OF THE "I" IN "PRIDE" AND FADES TO GREEN ON THE RIGHT SIDE OF THE "I." THE COLOR GREEN APPEARS ON THE LEFT SIDE OF THE "D" IN "PRIDE" AND FADES TO BLUE ON THE RIGHT SIDE OF THE "D." THE COLOR BLUE APPEARS IN THE LEFT SIDE OF THE "E" IN "PRIDE" AND FADES TO PURPLE ON THE RIGHT SIDE OF THE "E." THE WHITE IN THE DRAWING REPRESENTS BACKGROUND AREAS ONLY AND IS NOT PART OF THE MARK.

FOR INSURANCE AND FINANCIAL ADVISORY AND CONSULTANCY SERVICES FOR THE LESBIAN, GAY, BISEXUAL AND TRANSGENDER (LGBT) COMMUNITY (U.S. CLS. 100, 101 AND 102).

FIRST USE 2-21-2011; IN COMMERCE 2-21-2011.
MAUREEN DALL, EXAMINING ATTORNEY

SN 85-305,095. PREP FOR PREP, NEW YORK, NY. FILED 4-26-2011.



NO CLAIM IS MADE TO THE EXCLUSIVE RIGHT TO USE "FOUNDED 1978", APART FROM THE MARK AS SHOWN.

THE MARK CONSISTS OF A SEAL CONTAINING THE WORDS "PREP FOR PREP", "FOUNDED 1978" AND TWO SMALL SOLID BLACK DOTS; A DIAMOND WITHIN A DIAMOND; A PARTIAL SUN WITH SUNRAYS AND CLOUDS; A CHARIOT, A CHARIOTEER, AND THREE HORSES OVERLAYING THE SUNRAYS; AND THE WORDS "EXCELLENCE", "INTEGRITY", "COMMITMENT" AND "COURAGE".

FOR CHARITABLE FUNDRAISING SERVICES, NAMELY, RAISING FUNDS TO SUPPORT THE LEADERSHIP DEVELOPMENT OF TALENTED MINORITY STUDENTS (U.S. CLS. 100, 101 AND 102).

FIRST USE 2-28-1984; IN COMMERCE 2-28-1984.
DAVID C. REIHNER, EXAMINING ATTORNEY

CLASS 36—(Continued).

SN 85-310,999. ITS, INC., JOHNSTON, IA. FILED 5-3-2011.



THE MARK CONSISTS OF A LIGHTNING BOLT ACROSS A HEXAGON SHAPE.

FOR PROVIDING PAYMENT MANAGEMENT SERVICES TO CUSTOMERS IN THE NATURE OF DEBIT CARD ACCOUNT SET-UP, PAYMENTS, ALERTS, BALANCE INQUIRIES AND ACCOUNT MANAGEMENT IN THE NATURE OF FINANCIAL ADMINISTRATION OF DEBIT CARD ACCOUNTS (U.S. CLS. 100, 101 AND 102).
KATHLEEN LORENZO, EXAMINING ATTORNEY

CLASS 36—(Continued).

SN 85-334,349. U.S. MERCHANT SYSTEMS LLC, FREMONT, CA. FILED 5-31-2011.

MERCHANT SYSTEMS.COM

THE MARK CONSISTS OF STANDARD CHARACTERS WITHOUT CLAIM TO ANY PARTICULAR FONT, STYLE, SIZE, OR COLOR.

SEC. 2(F).
FOR MERCHANT SERVICES, NAMELY, PAYMENT TRANSACTION PROCESSING SERVICES (U.S. CLS. 100, 101 AND 102).

FIRST USE 7-23-1999; IN COMMERCE 7-23-1999.
H. M. FISHER, EXAMINING ATTORNEY

SN 85-342,817. SMITH, DANIELLE, KIRKLAND, WA. FILED 6-10-2011.

PRIVE' PROPERTIES

THE MARK CONSISTS OF STANDARD CHARACTERS WITHOUT CLAIM TO ANY PARTICULAR FONT, STYLE, SIZE, OR COLOR.

NO CLAIM IS MADE TO THE EXCLUSIVE RIGHT TO USE "PROPERTIES", APART FROM THE MARK AS SHOWN.

THE ENGLISH TRANSLATION OF "PRIVE" IN THE MARK IS "PRIVATE".

FOR LEASING OF REAL ESTATE, REAL ESTATE AGENCIES, REAL ESTATE BROKERAGE, REAL ESTATE MANAGEMENT, RENTAL OF OFFICES (U.S. CLS. 100, 101 AND 102).

BERNICE MIDDLETON, EXAMINING ATTORNEY

SN 85-328,258. CJ 4DPLEX CO., LTD., SEOUL, REPUBLIC OF KOREA, FILED 5-24-2011.

4DX

THE MARK CONSISTS OF STANDARD CHARACTERS WITHOUT CLAIM TO ANY PARTICULAR FONT, STYLE, SIZE, OR COLOR.

PRIORITY CLAIMED UNDER SEC. 44(D) ON REPUBLIC OF KOREA APPLICATION NO. 41-2010-3068, FILED 11-30-2010, REG. NO. 0226356, DATED 2-13-2012, EXPIRES 2-13-2022.

FOR BUILDING LEASING; RENTAL OF OFFICE SPACE; LEASING OF SHOPPING MALL SPACE; RENTAL OF THEATRES; RENTAL OF THEATRES FEATURING MOVIES AUDIENCE EFFECTS SUCH AS WIND, SCENT, WATER SPRAY, MOTION, VIBRATION, SMOKE, BUBBLE, LASER OR FLASH; INSURANCE INFORMATION; INSURANCE SERVICES, NAMELY, UNDERWRITING LIFE INSURANCE, UNDERWRITING HEALTH INSURANCE, UNDERWRITING ACCIDENT INSURANCE, UNDERWRITING FIRE INSURANCE; BANKING; ART APPRAISAL; LEASING OF REAL ESTATE; CUSTOMS BROKERAGE; GUARANTEE ASSURANCE UNDERWRITING; CHARITABLE FUNDRAISING SERVICES; FACTORING AGENCY SERVICES; LENDING AGAINST SECURITY (U.S. CLS. 100, 101 AND 102).
PATRICIA EVANKO, EXAMINING ATTORNEY

SN 85-344,275. HUDSON FINANCIAL ADVISORS, INC., STREETSBORO, OH. FILED 6-13-2011.

The Financial Masterpiece Program

THE MARK CONSISTS OF STANDARD CHARACTERS WITHOUT CLAIM TO ANY PARTICULAR FONT, STYLE, SIZE, OR COLOR.

NO CLAIM IS MADE TO THE EXCLUSIVE RIGHT TO USE "FINANCIAL" AND "PROGRAM", APART FROM THE MARK AS SHOWN.

FOR PROVIDING FINANCIAL PLANNING SERVICES FOR INDIVIDUALS (U.S. CLS. 100, 101 AND 102).

FIRST USE 8-7-2002; IN COMMERCE 8-7-2002.
KAREN M. STRZYZ, EXAMINING ATTORNEY

CLASS 36—(Continued).

SN 85-351,028. ROYAL BANK OF CANADA, MONTREAL, QUEBEC, CANADA, FILED 6-20-2011.

ASCERO

THE MARK CONSISTS OF STANDARD CHARACTERS WITHOUT CLAIM TO ANY PARTICULAR FONT, STYLE, SIZE, OR COLOR.

THE WORDING "ASCERO" HAS NO MEANING IN A FOREIGN LANGUAGE.

FOR FINANCIAL SERVICES IN THE NATURE OF RISK, ATTRIBUTION AND QUANTITATIVE SYSTEM, NAMELY, PROVIDING FINANCIAL INFORMATION IN THE NATURE OF FINANCIAL MARKET DATA AND STATISTICS, MARKET SURVEILLANCE AND ANALYSIS AND MEASUREMENT OF PERFORMANCE, RISKS AND EXPECTED RETURNS OF FINANCIAL INSTRUMENTS TO HELP FINANCIAL PORTFOLIOS MANAGERS TO ASSESS, ANALYZE AND MANAGE RISK WITHIN THEIR RESPECTIVE PORTFOLIOS (U.S. CLS. 100, 101 AND 102).

LINDA ESTRADA, EXAMINING ATTORNEY

SN 85-356,470. WOUNDED WARRIOR PROJECT, INC., JACKSONVILLE, FL. FILED 6-26-2011.

WOUNDED WARRIOR PROJECT

THE MARK CONSISTS OF STANDARD CHARACTERS WITHOUT CLAIM TO ANY PARTICULAR FONT, STYLE, SIZE, OR COLOR.

OWNER OF U.S. REG. NOS. 3,001,447 AND 3,841,207.

NO CLAIM IS MADE TO THE EXCLUSIVE RIGHT TO USE "PROJECT", APART FROM THE MARK AS SHOWN. SEC. 2(F).

FOR CHARITABLE FUNDRAISING SERVICES (U.S. CLS. 100, 101 AND 102).

FIRST USE 7-0-2003; IN COMMERCE 7-0-2003.

LINDSEY RUBIN, EXAMINING ATTORNEY

SN 85-361,041. UNIVERSITY OF KANSAS, LAWRENCE, KS. FILED 6-30-2011.

FAR ABOVE: THE CAMPAIGN FOR KANSAS

THE MARK CONSISTS OF STANDARD CHARACTERS WITHOUT CLAIM TO ANY PARTICULAR FONT, STYLE, SIZE, OR COLOR.

OWNER OF U.S. REG. NO. 2,073,857.

FOR CHARITABLE FUNDRAISING SERVICES, NAMELY, RAISING FUNDS FOR UNIVERSITY EDUCATION COSTS, NAMELY, SCHOLARSHIPS, PAY FOR FACULTY, EDUCATIONAL PROGRAMS, CAPITAL, AND ENDOWMENT (U.S. CLS. 100, 101 AND 102).

FIRST USE 11-16-2011; IN COMMERCE 11-16-2011.

KIM MONINGHOFF, EXAMINING ATTORNEY

CLASS 36—(Continued).

SN 85-361,047. UNIVERSITY OF KANSAS, LAWRENCE, KS. FILED 6-30-2011.

FAR ABOVE THE CAMPAIGN FOR KANSAS

THE MARK CONSISTS OF STANDARD CHARACTERS WITHOUT CLAIM TO ANY PARTICULAR FONT, STYLE, SIZE, OR COLOR.

OWNER OF U.S. REG. NO. 2,073,857.

FOR CHARITABLE FUNDRAISING SERVICES, NAMELY, RAISING FUNDS FOR UNIVERSITY EDUCATION COSTS, NAMELY, SCHOLARSHIPS, PAY FOR FACULTY, EDUCATIONAL PROGRAMS, CAPITAL, AND ENDOWMENT (U.S. CLS. 100, 101 AND 102).

FIRST USE 11-16-2011; IN COMMERCE 11-16-2011.

KIM MONINGHOFF, EXAMINING ATTORNEY

SN 85-368,517. AAM, LLC, TEMPE, AZ. FILED 7-11-2011.

LIVING BETTER TOGETHER

THE MARK CONSISTS OF STANDARD CHARACTERS WITHOUT CLAIM TO ANY PARTICULAR FONT, STYLE, SIZE, OR COLOR.

FOR PROVIDING REAL ESTATE MANAGEMENT, REAL PROPERTY MANAGEMENT, AND RELATED REAL ESTATE CONSULTING SERVICES, AS WELL AS INVESTMENT SERVICES IN THE NATURE OF FINANCIAL ASSET MANAGEMENT SERVICES, TO RESIDENTIAL, MASTER PLANNED DEVELOPMENT, CONDOMINIUM AND COMMERCIAL ASSOCIATIONS (U.S. CLS. 100, 101 AND 102).

BARBARA BROWN, EXAMINING ATTORNEY

CLASS 36—(Continued).

SN 85-373,637. FIRST PACTRUST BANCORP, INC., CHULA VISTA, CA. FILED 7-18-2011.



NO CLAIM IS MADE TO THE EXCLUSIVE RIGHT TO USE "FIRST" AND "BANCORP, INC.", APART FROM THE MARK AS SHOWN.

THE MARK CONSISTS OF A CIRCLE WITH A BORDER OF FOUR CURVED LINES WITH EACH LINE CURVING INTO THE CIRCLE WITH FLAT EDGES. THE CURVED LINES DO NOT TOUCH. THE LINES ARE SHADED. THE CIRCLE IS ON THE LEFT-HAND SIDE OF THE WORDS "FIRST" AND "PACTRUST" WITH "FIRST" APPEARING ABOVE "PACTRUST" IN SMALLER FONT EVEN WITH THE "PA." THE WORDS "BANCORP, INC." APPEAR BELOW "PACTRUST" IN SMALLER FONT STARTING WITH THE STRAIGHT LINE IN THE "A" THROUGH "T".

FOR BANK HOLDING COMPANY SERVICES, NAMELY, BANKING SERVICES (U.S. CLS. 100, 101 AND 102).

FIRST USE 4-27-2011; IN COMMERCE 4-27-2011.
H. M. FISHER, EXAMINING ATTORNEY

SN 85-374,645. STEVEN SCOTT MANAGEMENT, INC., ST. LOUIS PARK, MN. FILED 7-19-2011.

STEVEN SCOTT

THE MARK CONSISTS OF STANDARD CHARACTERS WITHOUT CLAIM TO ANY PARTICULAR FONT, STYLE, SIZE, OR COLOR.

THE NAME(S), PORTRAIT(S), AND/OR SIGNATURE(S) SHOWN IN THE MARK DOES NOT IDENTIFY A PARTICULAR LIVING INDIVIDUAL.

FOR REAL ESTATE SERVICES, NAMELY, RENTAL PROPERTY MANAGEMENT; APARTMENT RENTAL AGENCY (U.S. CLS. 100, 101 AND 102).

FIRST USE 4-27-1992; IN COMMERCE 4-27-1992.
FRED CARL, EXAMINING ATTORNEY

CLASS 36—(Continued).

SN 85-383,962. BMO HARRIS BANK NATIONAL ASSOCIATION, CHICAGO, IL. FILED 7-28-2011.

HELPFUL STEPS FOR PARENTS

THE MARK CONSISTS OF STANDARD CHARACTERS WITHOUT CLAIM TO ANY PARTICULAR FONT, STYLE, SIZE, OR COLOR.

OWNER OF U.S. REG. NO. 3,932,837.

NO CLAIM IS MADE TO THE EXCLUSIVE RIGHT TO USE "FOR PARENTS", APART FROM THE MARK AS SHOWN.

FOR BANKING (U.S. CLS. 100, 101 AND 102).

FIRST USE 10-31-2011; IN COMMERCE 10-31-2011.

TRACY FLETCHER, EXAMINING ATTORNEY

SN 85-384,139. HSD HOLDINGS, INC., PLANTATION, FL. FILED 7-28-2011.

DEBT SUCKS

THE MARK CONSISTS OF STANDARD CHARACTERS WITHOUT CLAIM TO ANY PARTICULAR FONT, STYLE, SIZE, OR COLOR.

NO CLAIM IS MADE TO THE EXCLUSIVE RIGHT TO USE "DEBT", APART FROM THE MARK AS SHOWN.

FOR CONSULTATION AND FINANCIAL COUNSELING SERVICES IN THE FIELD OF CREDIT AND DEBT MANAGEMENT; DEBT COUNSELING SERVICES; CREDIT COUNSELING SERVICES; DEBT MANAGEMENT SERVICES; HOUSING COUNSELING SERVICES, NAMELY, FINANCIAL ADVICE RELATED TO HOME PURCHASES AND HOUSING DEBT; HOUSING COUNSELING SERVICES, NAMELY, DEBT COUNSELING FOR HOME OWNERS EXPERIENCING FINANCIAL DIFFICULTIES (U.S. CLS. 100, 101 AND 102).

CHERYL CLAYTON, EXAMINING ATTORNEY

SN 85-385,076. JADARA CAPITAL PARTNERS LP, BRIDGEHAMPTON, NY. FILED 7-29-2011.

JADARA

THE MARK CONSISTS OF STANDARD CHARACTERS WITHOUT CLAIM TO ANY PARTICULAR FONT, STYLE, SIZE, OR COLOR.

FOR FINANCIAL PORTFOLIO MANAGEMENT FOR INDIVIDUALS; INVESTMENT ADVISORY SERVICES FOR INDIVIDUALS; INVESTMENT MANAGEMENT FOR INDIVIDUALS; INVESTMENT OF FUNDS FOR INDIVIDUAL INVESTORS (U.S. CLS. 100, 101 AND 102).

TOBY BULLOFF, EXAMINING ATTORNEY

CLASS 36—(Continued).

SN 85-385,486. JADARA CAPITAL PARTNERS LP, BRIDGE-HAMPTON, NY. FILED 7-31-2011.

جدارة

THE MARK CONSISTS OF AN ARABIC WORD THAT IS TRANSLITERATED IN ENGLISH AS "JADARA".

THE NON-LATIN CHARACTERS IN THE MARK TRANSLITERATE TO "JADARA" AND THIS MEANS MERIT OR COMPETENCE IN ENGLISH.

FOR FINANCIAL PORTFOLIO MANAGEMENT FOR INDIVIDUALS; INVESTMENT ADVISORY SERVICES FOR INDIVIDUALS; INVESTMENT MANAGEMENT FOR INDIVIDUALS; INVESTMENT OF FUNDS FOR INDIVIDUAL INVESTORS (U.S. CLS. 100, 101 AND 102).
TOBY BULLOFF, EXAMINING ATTORNEY

SN 85-391,433. ASHA FOR EDUCATION, EMMAUS, PA. FILED 8-6-2011.

Asha for Education

THE MARK CONSISTS OF STANDARD CHARACTERS WITHOUT CLAIM TO ANY PARTICULAR FONT, STYLE, SIZE, OR COLOR.

NO CLAIM IS MADE TO THE EXCLUSIVE RIGHT TO USE "EDUCATION", APART FROM THE MARK AS SHOWN.

FOR CHARITABLE SERVICES, NAMELY, ORGANIZING FUNDRAISING SERVICES AND EVENTS TO RAISE FUNDS IN THE FIELD OF EDUCATION (U.S. CLS. 100, 101 AND 102).

FIRST USE 7-8-1996; IN COMMERCE 5-9-1999.
MARIA-VICTORIA SUAREZ, EXAMINING ATTORNEY

SN 85-396,614. SENIOR MARKET SALES, INC., OMAHA, NE. FILED 8-12-2011.

SMS

THE MARK CONSISTS OF THE LETTERS "SMS" IN A STYLIZED FORMAT.

FOR INSURANCE BROKERAGE AND FINANCIAL PLANNING SERVICES IN THE FIELDS OF LIFE, MEDICAL, LONG-TERM CARE, DENTAL, DISABILITY, ACCIDENT, HEALTH AND SAFETY, ANNUITY, AND SUPPLEMENTAL MEDICARE INSURANCE AND RETIREMENT PLANNING (U.S. CLS. 100, 101 AND 102).

FIRST USE 5-7-2005; IN COMMERCE 5-7-2005.
DEZMONA MIZELLE, EXAMINING ATTORNEY

CLASS 36—(Continued).

SN 85-397,152. MACGILLIVRAY FREEMAN FILMS, LAGUNA BEACH, CA. FILED 8-12-2011.

One World One Ocean
Foundation

THE MARK CONSISTS OF STANDARD CHARACTERS WITHOUT CLAIM TO ANY PARTICULAR FONT, STYLE, SIZE, OR COLOR.

NO CLAIM IS MADE TO THE EXCLUSIVE RIGHT TO USE "FOUNDATION", APART FROM THE MARK AS SHOWN.

FOR CHARITABLE FUNDRAISING SERVICES, NAMELY, FOR OCEAN EDUCATION AND CONSERVATION PROJECTS (U.S. CLS. 100, 101 AND 102).

KIMBERLY PERRY, EXAMINING ATTORNEY

SN 85-425,612. AMERICAN NATIONAL INSURANCE COMPANY, GALVESTON, TX. FILED 9-19-2011.



OWNER OF U.S. REG. NOS. 1,243,114, 1,837,021 AND OTHERS.

THE MARK CONSISTS OF A RECTANGULAR BOX WITH "AMERICAN NATIONAL" DISPLAYED INSIDE; BELOW WORDING, INSIDE THE RECTANGULAR BOX IS THE FRONT OF A BOAT PROTRUDING OUT PAST THE RECTANGULAR BOX.

SEC. 2(F) AS TO "AMERICAN NATIONAL".
FOR UNDERWRITING MARINE PROPERTY AND CASUALTY INSURANCE (U.S. CLS. 100, 101 AND 102).
FIRST USE 6-0-2011; IN COMMERCE 6-0-2011.
STEVEN PEREZ, EXAMINING ATTORNEY

CLASS 36—(Continued).

SN 85-431,674. NATIONAL TRUST FOR THE WOUNDED WARRIORS, INC., MCLEAN, VA. FILED 9-26-2011.



NO CLAIM IS MADE TO THE EXCLUSIVE RIGHT TO USE "NATIONAL TRUST FOR THE WOUNDED WARRIOR", APART FROM THE MARK AS SHOWN.

THE MARK CONSISTS OF THE WORDS "NATIONAL TRUST FOR THE WOUNDED WARRIORS" TOGETHER WITH A STYLIZED EAGLE AND STAR DESIGN.

FOR CHARITABLE FOUNDATION SERVICES, NAMELY, PROVIDING FUNDRAISING ACTIVITIES AND/OR FINANCIAL ASSISTANCE FOR ORGANIZATIONS WHO PROVIDE SERVICES AND SUPPORT FOR MEMBERS OF THE MILITARY THAT SERVED IN IRAQ AND AFGHANISTAN AND THEIR FAMILIES (U.S. CLS. 100, 101 AND 102).

FIRST USE 3-0-2011; IN COMMERCE 3-0-2011.
DANIEL CAPSHAW, EXAMINING ATTORNEY

CLASS 36—(Continued).

SN 85-433,202. INTERNATIONAL FELLOWSHIP OF CHRISTIANS & JEWS, INC., CHICAGO, IL. FILED 9-27-2011.



NO CLAIM IS MADE TO THE EXCLUSIVE RIGHT TO USE "ISRAEL", APART FROM THE MARK AS SHOWN.

THE MARK CONSISTS OF A SILHOUETTE OF AN UPRIGHT LION AND THE WORDS "SHOMRAY YISRAEL" INSIDE OF A CREST OR SHIELD, NEXT TO THE WORDS "GUARDIANS OF ISRAEL".

THE ENGLISH TRANSLATION OF "SHOMRAY YISRAEL" IN THE MARK IS "GUARDIANS OF ISRAEL".

FOR CHARITABLE FUNDRAISING SERVICES; PROVIDING GRANTS TO CHARITABLE AND HUMANITARIAN ORGANIZATIONS, COMMUNITY CENTERS, EDUCATIONAL INSTITUTIONS, RELIGIOUS ORGANIZATIONS, AND GOVERNMENTAL ENTITIES IN ISRAEL TO PROVIDE FOOD, CLOTHING, BASIC HOUSEHOLD APPLIANCES, SHELTER, SOCIAL WELFARE PROGRAMS, EDUCATION PROGRAMS, MEDICAL AND HEALTH CARE SERVICES, COUNSELING SERVICES, JOB TRAINING PROGRAMS, HEATING FUEL, BLANKETS, AND EMERGENCY ASSISTANCE TO FAMILIES, THE ELDERLY, CHILDREN, HOLOCAUST SURVIVORS, SOLDIERS, VICTIMS OF WAR AND TERROR, AND NEEDY PEOPLE IN ISRAEL; PROVIDING INFORMATION AND NEWS VIA A GLOBAL COMMUNICATIONS NETWORK ABOUT PROVISION OF GRANTS TO CHARITABLE AND HUMANITARIAN ORGANIZATIONS, COMMUNITY CENTERS, EDUCATIONAL INSTITUTIONS, RELIGIOUS ORGANIZATIONS, AND GOVERNMENTAL ENTITIES IN ISRAEL TO PROVIDE FOOD, CLOTHING, BASIC HOUSEHOLD APPLIANCES, SHELTER, SOCIAL WELFARE PROGRAMS, EDUCATION PROGRAMS, MEDICAL AND HEALTH CARE SERVICES, COUNSELING SERVICES, JOB TRAINING PROGRAMS, HEATING FUEL, BLANKETS, AND EMERGENCY ASSISTANCE TO FAMILIES, THE ELDERLY, CHILDREN, HOLOCAUST SURVIVORS, SOLDIERS, VICTIMS OF WAR AND TERROR, AND NEEDY PEOPLE IN ISRAEL (U.S. CLS. 100, 101 AND 102).

FIRST USE 12-1-2006; IN COMMERCE 12-1-2006.
DEZMONA MIZELLE, EXAMINING ATTORNEY

SN 85-437,667. FIRST PACTRUST BANCORP, INC., CHULA VISTA, CA. FILED 10-3-2011.

**FIRST PACTRUST BANCORP,
INC.**

THE MARK CONSISTS OF STANDARD CHARACTERS WITHOUT CLAIM TO ANY PARTICULAR FONT, STYLE, SIZE, OR COLOR.

NO CLAIM IS MADE TO THE EXCLUSIVE RIGHT TO USE "FIRST" AND "BANCORP, INC.", APART FROM THE MARK AS SHOWN.

FOR BANK HOLDING COMPANY SERVICES, NAMELY, BANKING SERVICES (U.S. CLS. 100, 101 AND 102).

FIRST USE 4-27-2011; IN COMMERCE 4-27-2011.
H. M. FISHER, EXAMINING ATTORNEY

CLASS 36—(Continued).

SN 85-444,508. MIDWEST BUILDERS' CASUALTY MUTUAL COMPANY, KANSAS CITY, MO. FILED 10-11-2011.



NO CLAIM IS MADE TO THE EXCLUSIVE RIGHT TO USE "CASUALTY INSURANCE", APART FROM THE MARK AS SHOWN.

THE MARK CONSISTS OF THE WORDING "THE RIGHT DIRECTION IN CASUALTY INSURANCE" ABOVE THE LETTER "N" WHICH IS IN TURN ABOVE A STYLIZED DEPICTION OF A COMPASS COMPRISED OF AN EIGHT-POINTED STAR.

FOR INSURANCE SERVICES, NAMELY, UNDERWRITING IN THE FIELD OF WORKERS' COMPENSATION INSURANCE; PROVIDING INSURANCE INFORMATION AND INSURANCE CONSULTATION IN THE FIELD OF WORKERS' COMPENSATION; FINANCIAL RISK MANAGEMENT IN THE FIELD OF WORKERS' COMPENSATION; INSURANCE SERVICES IN THE NATURE OF LOSS CONTROL MANAGEMENT FOR OTHERS (U.S. CLS. 100, 101 AND 102).

FIRST USE 1-22-2008; IN COMMERCE 1-22-2008.
JIM RINGLE, EXAMINING ATTORNEY

SN 85-445,524. AMERICAN ECONOMIC PLANNING GROUP, INC., WARREN, NJ. FILED 10-12-2011.

ACCOUNTABLE ADVOCATE

THE MARK CONSISTS OF STANDARD CHARACTERS WITHOUT CLAIM TO ANY PARTICULAR FONT, STYLE, SIZE, OR COLOR.

FOR ADMINISTRATION OF EMPLOYEE BENEFIT PLANS CONCERNING INSURANCE AND FINANCE; CONSULTING AND INFORMATION CONCERNING INSURANCE; CONSULTING SERVICES IN THE FIELD OF RETIREMENT PLAN ADMINISTRATION AND FIDUCIARY COMPLIANCE; CONSULTING SERVICES IN THE FIELD OF STATE AND FEDERAL EMPLOYEE BENEFIT PLANS CONCERNING INSURANCE AND FINANCE; DESIGN AND DEVELOPMENT OF INSURANCE POLICIES FOR OTHERS; ESTATE PLANNING; ESTATE TRUST PLANNING; FINANCIAL ADMINISTRATION OF RETIREMENT PLANS; FINANCIAL PLANNING; FINANCIAL PLANNING AND INVESTMENT ADVISORY SERVICES; FINANCIAL PLANNING CONSULTATION; INSURANCE ADMINISTRATION; INSURANCE BROKERAGE; INSURANCE INFORMATION AND CONSULTANCY; INVESTMENT MANAGEMENT; PROVIDING INFORMATION IN THE FIELD OF EMPLOYEE FINANCIAL BENEFIT PLANS (U.S. CLS. 100, 101 AND 102).

FIRST USE 6-2-2011; IN COMMERCE 6-2-2011.
DEIRDRE ROBERTSON, EXAMINING ATTORNEY

CLASS 36—(Continued).

SN 85-447,860. ONEMAIN FINANCIAL HOLDINGS, INC., WILMINGTON, DE. FILED 10-14-2011.

ONEMAIN SOLUTIONS

THE MARK CONSISTS OF STANDARD CHARACTERS WITHOUT CLAIM TO ANY PARTICULAR FONT, STYLE, SIZE, OR COLOR.

NO CLAIM IS MADE TO THE EXCLUSIVE RIGHT TO USE "SOLUTIONS", APART FROM THE MARK AS SHOWN.

FOR FINANCIAL SERVICES, NAMELY, CONSUMER LENDING SERVICES, CREDIT AND LOAN SERVICES, AND FINANCING SERVICES; CREDIT INSURANCE UNDERWRITING AND ADMINISTRATION SERVICES (U.S. CLS. 100, 101 AND 102).

JAY BESCH, EXAMINING ATTORNEY

SN 85-447,871. ONEMAIN FINANCIAL HOLDINGS, INC., WILMINGTON, DE. FILED 10-14-2011.



NO CLAIM IS MADE TO THE EXCLUSIVE RIGHT TO USE "SOLUTIONS", APART FROM THE MARK AS SHOWN.

THE MARK CONSISTS OF THE WORD "ONEMAIN" WITH A DESIGN OF 5 HOUSES POINTING TO THE CENTER OF A CIRCLE, WITH THE WORD "SOLUTIONS" UNDERNEATH.

FOR FINANCIAL SERVICES, NAMELY, CONSUMER LENDING SERVICES, CREDIT AND LOAN SERVICES, AND FINANCING SERVICES; CREDIT INSURANCE UNDERWRITING AND ADMINISTRATION SERVICES (U.S. CLS. 100, 101 AND 102).

JAY BESCH, EXAMINING ATTORNEY

SN 85-447,878. ONEMAIN FINANCIAL HOLDINGS, INC., WILMINGTON, DE. FILED 10-14-2011.

ONEMAIN ALLIANCE

THE MARK CONSISTS OF STANDARD CHARACTERS WITHOUT CLAIM TO ANY PARTICULAR FONT, STYLE, SIZE, OR COLOR.

NO CLAIM IS MADE TO THE EXCLUSIVE RIGHT TO USE "ALLIANCE", APART FROM THE MARK AS SHOWN.

FOR FINANCIAL SERVICES, NAMELY, CONSUMER LENDING SERVICES, CREDIT AND LOAN SERVICES, AND FINANCING SERVICES; CREDIT INSURANCE UNDERWRITING AND ADMINISTRATION SERVICES (U.S. CLS. 100, 101 AND 102).

JAY BESCH, EXAMINING ATTORNEY

CLASS 36—(Continued).

SN 85-447,887. ONEMAIN FINANCIAL HOLDINGS, INC., WILMINGTON, DE. FILED 10-14-2011.

ONEMAIN INSURANCE SERVICES

THE MARK CONSISTS OF STANDARD CHARACTERS WITHOUT CLAIM TO ANY PARTICULAR FONT, STYLE, SIZE, OR COLOR.

NO CLAIM IS MADE TO THE EXCLUSIVE RIGHT TO USE "INSURANCE SERVICES", APART FROM THE MARK AS SHOWN.

FOR FINANCIAL SERVICES, NAMELY, CONSUMER LENDING SERVICES, CREDIT AND LOAN SERVICES, AND FINANCING SERVICES; CREDIT INSURANCE UNDERWRITING AND ADMINISTRATION SERVICES (U.S. CLS. 100, 101 AND 102).

JAY BESCH, EXAMINING ATTORNEY

SN 85-447,895. ONEMAIN FINANCIAL HOLDINGS, INC., WILMINGTON, DE. FILED 10-14-2011.

ONEMAIN ASSURANCE

THE MARK CONSISTS OF STANDARD CHARACTERS WITHOUT CLAIM TO ANY PARTICULAR FONT, STYLE, SIZE, OR COLOR.

NO CLAIM IS MADE TO THE EXCLUSIVE RIGHT TO USE "ASSURANCE", APART FROM THE MARK AS SHOWN.

FOR FINANCIAL SERVICES, NAMELY, CONSUMER LENDING SERVICES, CREDIT AND LOAN SERVICES, AND FINANCING SERVICES; CREDIT INSURANCE UNDERWRITING AND ADMINISTRATION SERVICES (U.S. CLS. 100, 101 AND 102).

JAY BESCH, EXAMINING ATTORNEY

CLASS 36—(Continued).

SN 85-448,503. ALPASLAN, BURAK N., WOODBRIDGE, NJ. FILED 10-17-2011.

VITAL PLANNING GROUP

THE MARK CONSISTS OF STANDARD CHARACTERS WITHOUT CLAIM TO ANY PARTICULAR FONT, STYLE, SIZE, OR COLOR.

NO CLAIM IS MADE TO THE EXCLUSIVE RIGHT TO USE "PLANNING GROUP", APART FROM THE MARK AS SHOWN.

FOR ADMINISTRATION OF EMPLOYEE BENEFIT PLANS CONCERNING INSURANCE AND FINANCE; ADMINISTRATION OF EMPLOYEE PENSION PLANS; ADMINISTRATION OF EMPLOYEE WELFARE BENEFIT PLANS CONCERNING INSURANCE AND FINANCE; ADMINISTRATION OF PRE-PAID HEALTH CARE PLANS; ADMINISTRATION OF EMPLOYEE BENEFIT PLANS CONCERNING INSURANCE AND FINANCE; CONSULTING SERVICES IN THE FIELD OF RETIREMENT PLAN ADMINISTRATION AND FIDUCIARY COMPLIANCE; CONSULTING SERVICES IN THE FIELD OF STATE AND FEDERAL EMPLOYEE BENEFIT PLANS CONCERNING INSURANCE AND FINANCE; ESTATE PLANNING; ESTATE TRUST MANAGEMENT; ESTATE TRUST PLANNING; FINANCIAL ADMINISTRATION OF RETIREMENT PLANS; FINANCIAL ADMINISTRATION OF RETIREMENT PLANS; FINANCIAL CONSULTATION IN THE FIELD OF ENVIRONMENTAL MANAGEMENT, NAMELY, ADVISING BUSINESS AND INDIVIDUALS ON ISSUES OF PORTFOLIO PLANNING AND INVESTMENT PLANNING; FINANCIAL CONSULTING SERVICES IN THE FIELD OF PLANNED GIVING FOR NON-PROFIT AND CHARITABLE ORGANIZATIONS; FINANCIAL PLANNING; FINANCIAL PLANNING AND INVESTMENT ADVISORY SERVICES; FINANCIAL PLANNING CONSULTATION; FINANCIAL PLANNING FOR RETIREMENT; FINANCIAL PLANNING SERVICES, NAMELY, DEVELOPING AND MANAGING CHARITABLE GIVING PROGRAMS ON BEHALF OF WEALTHY INDIVIDUALS OR FAMILIES; FINANCIAL PLANNING, NAMELY, CREATING PERSONALIZED STRATEGIES ACHIEVING FINANCIAL INDEPENDENCE; FINANCIAL SERVICES, NAMELY, ADMINISTRATION OF TRANSACTIONS INVOLVING FUNDS DRAWN FROM SECURITIES, STOCKS, FUNDS, EQUITIES, BONDS, CASH, OR OTHER TYPES OF FINANCIAL INVESTMENTS IN RETIREMENT PLANS USING A CHECK OR NEGOTIABLE ORDER OF WITHDRAWAL OVER A GLOBAL DATA NETWORK; FINANCIAL SERVICES, NAMELY, ADMINISTRATION OF TRANSACTIONS INVOLVING FUNDS DRAWN FROM SECURITIES, STOCKS, FUNDS, EQUITIES, BONDS, CASH, OR OTHER TYPES OF FINANCIAL INVESTMENTS IN RETIREMENT PLANS USING A CREDIT OR DEBIT CARD OVER A GLOBAL DATA NETWORK; FINANCIAL TRUST PLANNING; ORGANIZING PRE-PAID HEALTH CARE PLANS; PROCESSING, ADMINISTERING AND MANAGING EMPLOYEE BENEFIT PLANS CONCERNING INSURANCE AND FINANCE; PROVIDING INFORMATION IN THE FIELD OF EMPLOYEE FINANCIAL BENEFIT PLANS; PROVIDING INFORMATION IN THE FIELD OF EMPLOYEE FINANCIAL BENEFIT PLANS AND ADMINISTRATION OF EMPLOYEE FINANCIAL BENEFIT PLANS FOR CLIENTS VIA THE INTERNET; PROVIDING ONLINE INFORMATION IN THE FIELD OF CHARITABLE MONETARY GIVING THROUGH FINANCIAL AND ESTATE PLANNING (U.S. CLS. 100, 101 AND 102).

FIRST USE 3-1-2008; IN COMMERCE 3-1-2008.

LINDA ESTRADA, EXAMINING ATTORNEY

CLASS 36—(Continued).

SN 85-452,414. HAWKER BEECHCRAFT CORPORATION, WICHITA, KS. FILED 10-20-2011.

SUPPORT PLUS

THE MARK CONSISTS OF STANDARD CHARACTERS WITHOUT CLAIM TO ANY PARTICULAR FONT, STYLE, SIZE, OR COLOR.

NO CLAIM IS MADE TO THE EXCLUSIVE RIGHT TO USE "SUPPORT", APART FROM THE MARK AS SHOWN.

FOR PROVIDING EXTENDED SERVICE AND MAINTENANCE CONTRACTS FOR AIRCRAFT (U.S. CLS. 100, 101 AND 102).

FIRST USE 0-0-2002; IN COMMERCE 0-0-2002.
SANJEEV VOHRA, EXAMINING ATTORNEY

SN 85-455,772. LYNDON INSURANCE GROUP, INC., ST. LOUIS, MO. FILED 10-25-2011.

PREMIUM MARINE PROTECTION

THE MARK CONSISTS OF STANDARD CHARACTERS WITHOUT CLAIM TO ANY PARTICULAR FONT, STYLE, SIZE, OR COLOR.

OWNER OF U.S. REG. NOS. 3,170,273 AND 3,188,977.

NO CLAIM IS MADE TO THE EXCLUSIVE RIGHT TO USE "MARINE PROTECTION", APART FROM THE MARK AS SHOWN.

SEC. 2(F).

FOR INSURANCE UNDERWRITING SERVICES, NAMELY, EXTENDED SERVICE CONTRACTS SOLD THROUGH DEALERS TO VEHICLE AND WATERCRAFT PURCHASERS TO COVER EXPENSES INCURRED IN CONNECTION WITH MECHANICAL BREAKDOWN (U.S. CLS. 100, 101 AND 102).

FIRST USE 1-0-1994; IN COMMERCE 1-0-1994.
WILLIAM JACKSON, EXAMINING ATTORNEY

CLASS 36—(Continued).

SN 85-462,026. CHINAFUTURE GROUP LIMITED, HONG KONG, HONG KONG, FILED 11-1-2011.



NO CLAIM IS MADE TO THE EXCLUSIVE RIGHT TO USE "CHINA", APART FROM THE MARK AS SHOWN.

THE MARK CONSISTS OF THE EARTH INSIDE THE LETTER "C" AND THE LETTER "F" INSIDE A RECTANGLE FOR THE WORDING "CHINA FUTURE".

FOR AGENCIES OR BROKERAGE FOR TRADING OF SECURITIES, SECURITIES INDEX FUTURES, SECURITIES OPTIONS, AND OVERSEAS MARKET SECURITIES FUTURES; ASSESSMENT AND MANAGEMENT OF REAL ESTATE; BANKING AND FINANCING SERVICES; BANKING CONSULTATION; BILL PAYMENT SERVICES PROVIDED THROUGH A WEBSITE; CAPITAL INVESTMENT CONSULTING; ELECTRONIC COMMERCE PAYMENT SERVICES, NAMELY, ESTABLISHING FUNDED ACCOUNTS USED TO PURCHASE GOODS AND SERVICES ON THE INTERNET; ELECTRONIC FINANCIAL TRADING SERVICES; ELECTRONIC FUNDS TRANSFER; FINANCIAL ADVICE AND CONSULTANCY SERVICES; FINANCIAL ANALYSIS AND CONSULTATION; FINANCIAL AND INVESTMENT SERVICES, NAMELY, MANAGEMENT AND BROKERAGE IN THE FIELDS OF STOCKS, BONDS, OPTIONS, COMMODITIES, FUTURES AND OTHER SECURITIES, AND THE INVESTMENT OF FUNDS OF OTHERS; FINANCIAL CONSULTANCY AND INSURANCE CONSULTANCY; FINANCIAL COUNSELING SERVICES, NAMELY, HELPING OTHERS BUILD A BETTER WORKING RELATIONSHIP WITH THEIR MONEY; FINANCIAL CREDIT SCORING SERVICES; FINANCIAL INFORMATION AND ADVISORY SERVICES; FINANCIAL INVESTMENT IN THE FIELD OF EDUCATION; FINANCIAL SERVICES, NAMELY, INVESTMENT FUND TRANSFER AND TRANSACTION SERVICES; FINANCIAL SERVICES, NAMELY, PROVIDING A VIRTUAL CURRENCY FOR USE BY MEMBERS OF AN ON-LINE COMMUNITY VIA A GLOBAL COMPUTER NETWORK; PROVIDING ELECTRONIC PROCESSING OF ELECTRONIC FUNDS TRANSFER, ACH, CREDIT CARD, DEBIT CARD, ELECTRONIC CHECK AND ELECTRONIC PAYMENTS; PROVIDING MULTIPLE PAYMENT OPTIONS BY MEANS OF CUSTOMER-OPERATED ELECTRONIC TERMINALS AVAILABLE ON-SITE IN RETAIL STORES; PROVISION AND FINANCIAL ADMINISTRATION OF A DEBIT CARD SAVINGS PROGRAM; REAL ESTATE AGENCIES; TRUSTEESHIP REPRESENTATIVES (U.S. CLS. 100, 101 AND 102).

ANGELA DUONG, EXAMINING ATTORNEY

SN 85-463,338. STERLING CURRENCY GROUP, LLC, ATLANTA, GA. FILED 11-3-2011.

Sterling Currency Group

THE MARK CONSISTS OF STANDARD CHARACTERS WITHOUT CLAIM TO ANY PARTICULAR FONT, STYLE, SIZE, OR COLOR.

NO CLAIM IS MADE TO THE EXCLUSIVE RIGHT TO USE "CURRENCY GROUP", APART FROM THE MARK AS SHOWN.

FOR CURRENCY TRADING, NAMELY, TRADING OF FOREIGN CURRENCIES (U.S. CLS. 100, 101 AND 102).

FIRST USE 10-1-2004; IN COMMERCE 10-1-2004.
GINA HAYES, EXAMINING ATTORNEY

CLASS 36—(Continued).

SN 85-463,872. STERLING CURRENCY GROUP, LLC, ATLANTA, GA. FILED 11-3-2011.

Sterling Currency Group

THE MARK CONSISTS OF STANDARD CHARACTERS WITHOUT CLAIM TO ANY PARTICULAR FONT, STYLE, SIZE, OR COLOR.

NO CLAIM IS MADE TO THE EXCLUSIVE RIGHT TO USE "CURRENCY GROUP", APART FROM THE MARK AS SHOWN.

FOR FINANCIAL SERVICES, NAMELY, PRECIOUS METALS TRADING (U.S. CLS. 100, 101 AND 102).
GINA HAYES, EXAMINING ATTORNEY

SN 85-465,761. GORDON, DANIEL L., LIVONIA, MI. FILED 11-7-2011.

MISSION FOR LIFE

THE MARK CONSISTS OF STANDARD CHARACTERS WITHOUT CLAIM TO ANY PARTICULAR FONT, STYLE, SIZE, OR COLOR.

FOR INSURANCE CONSULTING IN THE FIELD OF LIFE INSURANCE (U.S. CLS. 100, 101 AND 102).

FIRST USE 3-18-2011; IN COMMERCE 9-12-2011.
MARY ROSSMAN, EXAMINING ATTORNEY

SN 85-478,043. DAVID I. WEISS, PLANTATION, FL. FILED 11-21-2011.

LIDS FOR KIDS

THE MARK CONSISTS OF STANDARD CHARACTERS WITHOUT CLAIM TO ANY PARTICULAR FONT, STYLE, SIZE, OR COLOR.

NO CLAIM IS MADE TO THE EXCLUSIVE RIGHT TO USE "FOR KIDS", APART FROM THE MARK AS SHOWN.

FOR CHARITABLE FOUNDATION SERVICES, NAMELY, PROVIDING FUNDRAISING ACTIVITIES TO SUPPORT MEDICAL RESEARCH AND PROCEDURES FOR THOSE IN NEED (U.S. CLS. 100, 101 AND 102).

DAWN HAN, EXAMINING ATTORNEY

CLASS 36—(Continued).

SN 85-481,558. CARIBE REALTY, ORANGE BEACH, AL. FILED S.R. 11-28-2011; AM. P.R. 3-26-2012.



NO CLAIM IS MADE TO THE EXCLUSIVE RIGHT TO USE "CARIBE THE RESORT", APART FROM THE MARK AS SHOWN.

THE COLOR(S) BLUE, ORANGE, GREEN, AQUA, WHITE, BLACK, AND YELLOW IS/ARE CLAIMED AS A FEATURE OF THE MARK.

THE MARK CONSISTS OF THE STYLIZED WORDING "CARIBE THE RESORT" AND A STYLIZED FROG. THE BEGINNING TOP LEFT CORNER OF THE MARK IS A STYLED CAPITAL LETTER "C" IN THE COLOR BLUE WITH A GREEN TREE FROG ON TOP OF THE LETTER. THE GREEN FROG FEATURES ORANGE FEET AND EYES, WITH BLACK SLITS AND IS TRIMMED IN BLACK. THE FROG HAS A YELLOW MOUTH AND A BELLY THAT IS WHITE IN THE CENTER AND FADES TO YELLOW AROUND THE EDGES. THE FROG'S LEGS ARE GREEN WITH BLUE SHADING AT THE JOINTS, AND THE BACK LEGS HAVE YELLOW AND WHITE SHADING. THE REMAINDER OF THE STYLIZED WORD "CARIBE" IS IN THE SAME COLOR BLUE AS THE CAPITAL "C". UNDER THE WORD "CARIBE" AND POSITIONED TO THE RIGHT SIDE, IS THE STYLIZED CAPITAL WORDING "THE RESORT" IN AQUA BLUE.

THE ENGLISH TRANSLATION OF "CARIBE" IN THE MARK IS "CARIBBEAN".

FOR REAL ESTATE SERVICES, NAMELY, VACATION HOME RENTAL MANAGEMENT SERVICES (U.S. CLS. 100, 101 AND 102).

FIRST USE 9-2-1996; IN COMMERCE 9-21-1996.
MARCIE MILONE, EXAMINING ATTORNEY

SN 85-483,863. NAVYARMY COMMUNITY CREDIT UNION, CORPUS CHRISTI, TX. FILED 11-30-2011.

DOES YOUR BANK DO THAT?

THE MARK CONSISTS OF STANDARD CHARACTERS WITHOUT CLAIM TO ANY PARTICULAR FONT, STYLE, SIZE, OR COLOR.

FOR INSURANCE AND FINANCIAL SERVICES, NAMELY, CHECKING ACCOUNT SERVICES, ARRANGING AND PROVIDING AUTO LOANS, ARRANGING AND PROVIDING HOME EQUITY LOANS AND MORTGAGE LENDING; TERM SHARES, NAMELY, BANKING SERVICES FEATURING THE PROVISION OF CERTIFICATES OF DEPOSIT; SAVINGS ACCOUNT SERVICES; INTEREST RATES, NAMELY, PROVIDING INFORMATION IN THE FIELDS OF INTEREST RATE PRODUCTS VIA THE INTERNET AND INTRANET SYSTEMS; ATM BANKING SERVICES; ATM REIMBURSEMENT SERVICES, NAMELY, PROCESSING ELECTRONIC PAYMENTS MADE THROUGH AUTOMATED TELLER MACHINE CARDS (U.S. CLS. 100, 101 AND 102).

FIRST USE 1-1-2010; IN COMMERCE 1-1-2010.
MICHAEL TANNER, EXAMINING ATTORNEY

CLASS 36—(Continued).

SN 85-494,041. REVERSE MORTGAGE SOLUTIONS, INC., SPRING, TX. FILED 12-13-2011.



OWNER OF U.S. REG. NOS. 3,523,171, 3,550,915 AND 3,558,675.

THE MARK CONSISTS OF THE STYLIZED WORDING "RMPATH" WITH A PAIR OF ARROWS BEHIND THE WORDING POINTING IN OPPOSITE DIRECTIONS.

FOR FINANCING AND LOAN SERVICES, NAMELY, ORIGINATION, ACQUISITION, SERVICING, SECURITIZATION AND BROKERAGE OF MORTGAGE LOANS; ORIGINATION OF REVERSE MORTGAGES AND REVERSE MORTGAGE ADMINISTRATION AND MANAGEMENT SERVICES, NAMELY, ORIGINATION, ACQUISITION, SERVICING, SECURITIZATION AND BROKERAGE OF REVERSE MORTGAGE LOANS; WHOLESALE LENDING SERVICES; REAL ESTATE AND HOME EQUITY LENDING SERVICES, NAMELY, HOME EQUITY LOANS, MORTGAGE LENDING AND MORTGAGE REFINANCING (U.S. CLS. 100, 101 AND 102).

FIRST USE 10-18-2011; IN COMMERCE 10-18-2011. MICHAEL TANNER, EXAMINING ATTORNEY

CLASS 36—(Continued).

SN 85-505,694. ITS FINANCIAL, LLC, DAYTON, OH. FILED 12-29-2011.

EVERYBODY GETS A CHECK

THE MARK CONSISTS OF STANDARD CHARACTERS WITHOUT CLAIM TO ANY PARTICULAR FONT, STYLE, SIZE, OR COLOR.

FOR TEMPORARY LOANS (U.S. CLS. 100, 101 AND 102).

FIRST USE 12-31-2009; IN COMMERCE 12-31-2009. CHRISTOPHER SIDOTI, EXAMINING ATTORNEY

SN 85-510,284. LUGO, RONALD, ORLAND PARK, IL. FILED 1-6-2012.



THE MARK CONSISTS OF STANDARD CHARACTERS WITHOUT CLAIM TO ANY PARTICULAR FONT, STYLE, SIZE, OR COLOR.

THE WORDING "VODDO" HAS NO MEANING IN A FOREIGN LANGUAGE.

FOR CHARITABLE FUNDRAISING SERVICES BY MEANS OF SELLING GOODS TO RAISE FUNDS; CHARITABLE FUNDRAISING SERVICES BY MEANS OF SELLING GOODS TO RAISE FUNDS FOR VICTIMS OF DRUNK DRIVING (U.S. CLS. 100, 101 AND 102).

FRED CARL, EXAMINING ATTORNEY

SN 85-499,943. ASPENCROSS INSURANCE SERVICES, INC., WESTBOROUGH, MA. FILED 12-20-2011.

EINSURANCENOW

THE MARK CONSISTS OF STANDARD CHARACTERS WITHOUT CLAIM TO ANY PARTICULAR FONT, STYLE, SIZE, OR COLOR.

FOR INTERNET-BASED ADMINISTRATION OF EMPLOYEE BENEFIT PLANS CONCERNING INSURANCE AND FINANCE; INTERNET-BASED INSURANCE AGENCY AND BROKERAGE SERVICES (U.S. CLS. 100, 101 AND 102).

TEJBIR SINGH, EXAMINING ATTORNEY

SN 85-510,317. LUGO, RONALD, ORLAND PARK, IL. FILED 1-6-2012.

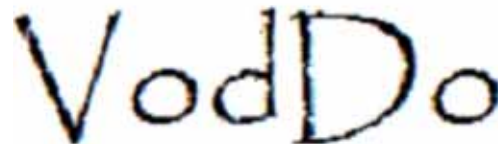

THE MARK CONSISTS OF THE WORD "VODDO" IN STYLIZED LETTERS.

THE WORDING "VODDO" HAS NO MEANING IN A FOREIGN LANGUAGE.

FOR CHARITABLE FUNDRAISING SERVICES BY MEANS OF SELLING GOODS TO RAISE FUNDS; CHARITABLE FUNDRAISING SERVICES BY MEANS OF SELLING GOODS TO RAISE FUNDS FOR VICTIMS OF DRUNK DRIVING (U.S. CLS. 100, 101 AND 102).

FRED CARL, EXAMINING ATTORNEY

CLASS 36—(Continued).

SN 85-515,463. DAILYACCESS CORPORATION, MOBILE, AL. FILED 1-12-2012.



NO CLAIM IS MADE TO THE EXCLUSIVE RIGHT TO USE "BENEFITS DESIGN", APART FROM THE MARK AS SHOWN.

THE COLOR(S) BLUE AND RED IS/ARE CLAIMED AS A FEATURE OF THE MARK.

THE MARK CONSISTS OF THE WORDS "RESOLUTION BENEFITS DESIGN" IN BLUE, WITH A BLUE DIAMOND BETWEEN THE WORDS "BENEFITS" AND "DESIGN". TO THE LEFT OF THE WORDING IS A BLUE FOUR SIDED DIAMOND AND TWO RED TRIANGLES THAT INTERSECT AT THE APEX OF THE TRIANGLES.

FOR CONSULTING SERVICES IN THE FIELD OF EMPLOYEE HEALTH AND WELFARE BENEFIT PLANS CONCERNING INSURANCE AND FINANCE; ADMINISTRATION OF EMPLOYEE HEALTH AND WELFARE BENEFIT PLANS CONCERNING INSURANCE AND FINANCE (U.S. CLS. 100, 101 AND 102).

FIRST USE 6-8-2009; IN COMMERCE 6-8-2009.
HENRY S. ZAK, EXAMINING ATTORNEY

SN 85-515,846. VACATION FISH LLC, SOUTH JORDAN, UT. FILED 1-13-2012.



NO CLAIM IS MADE TO THE EXCLUSIVE RIGHT TO USE "VACATION", APART FROM THE MARK AS SHOWN.

THE COLOR(S) BLUE, YELLOW, ORANGE, GREEN, WHITE, AND BLACK IS/ARE CLAIMED AS A FEATURE OF THE MARK.

THE MARK CONSISTS OF A CARTOON FISH THAT IS PRIMARILY BLUE IN COLOR WITH YELLOW AND ORANGE FINS WHO IS CARRYING A GREEN SUITCASE; THE FISH HAS A WHITE EYE WITH A BLACK PUPIL AND APPEARS TO BE JUMPING FROM A BLUE WATER SOURCE; TO THE RIGHT OF THE FISH ARE THE WORDS "VACATION FISH" IN ALL LOWER CASE LETTERING; THE WORD "VACATION" IS IN A BLACK THIN FONT AND THE WORD "FISH" IS IN A BLUE BOLD FONT.

FOR REAL ESTATE SERVICES, NAMELY, RENTAL OF VACATION HOMES (U.S. CLS. 100, 101 AND 102).
DARRYL SPRUILL, EXAMINING ATTORNEY

CLASS 36—(Continued).

SN 85-516,919. DILATO POINT CAPITAL LLC, WOODLAND HILLS, CA. FILED 1-15-2012.

DILATO POINT CAPITAL

THE MARK CONSISTS OF STANDARD CHARACTERS WITHOUT CLAIM TO ANY PARTICULAR FONT, STYLE, SIZE, OR COLOR.

NO CLAIM IS MADE TO THE EXCLUSIVE RIGHT TO USE "CAPITAL", APART FROM THE MARK AS SHOWN.

FOR ACCOUNTS RECEIVABLES FINANCING; BUSINESS FINANCE PROCUREMENT SERVICES; PROVIDING WORKING CAPITAL FINANCING TO SMALL BUSINESSES AND SMALL BUSINESS OWNERS (U.S. CLS. 100, 101 AND 102).

FIRST USE 7-8-2011; IN COMMERCE 7-8-2011.
TRICIA SONNEBORN, EXAMINING ATTORNEY

SN 85-517,035. DGSE COMPANIES, INC., DALLAS, TX. FILED 1-16-2012.

BULLION EXPRESS

THE MARK CONSISTS OF STANDARD CHARACTERS WITHOUT CLAIM TO ANY PARTICULAR FONT, STYLE, SIZE, OR COLOR.

NO CLAIM IS MADE TO THE EXCLUSIVE RIGHT TO USE "BULLION", APART FROM THE MARK AS SHOWN.

FOR PROVIDING MONETARY EXCHANGE SERVICES IN THE NATURE OF TRADING IN GOLD, SILVER, PLATINUM, AND PALLADIUM BULLION (U.S. CLS. 100, 101 AND 102).

FIRST USE 6-0-2011; IN COMMERCE 6-0-2011.
JEFF DEFORD, EXAMINING ATTORNEY

SN 85-520,187. THINKQUITY LLC, SAN FRANCISCO, CA. FILED 1-19-2012.

THINKASSET MANAGEMENT

THE MARK CONSISTS OF STANDARD CHARACTERS WITHOUT CLAIM TO ANY PARTICULAR FONT, STYLE, SIZE, OR COLOR.

OWNER OF U.S. REG. NOS. 3,156,343 AND 3,223,888.

NO CLAIM IS MADE TO THE EXCLUSIVE RIGHT TO USE "MANAGEMENT", APART FROM THE MARK AS SHOWN.

FOR INVESTMENT ADVISORY SERVICES (U.S. CLS. 100, 101 AND 102).
KATHLEEN LORENZO, EXAMINING ATTORNEY

CLASS 36—(Continued).

SN 85-520,259. THE MEDICAL PROTECTIVE COMPANY, FORT WAYNE, IN. FILED 1-19-2012.



THE MARK CONSISTS OF THE LITERAL ELEMENT "FIRMPRO" WITH THE FANCIFUL DESIGN OF A GAVEL APPEARING ABOVE THE LETTERS "PRO".

FOR INSURANCE SERVICES, NAMELY, UNDERWRITING, ISSUING AND ADMINISTRATION OF INSURANCE, NAMELY, PROFESSIONAL, MANAGEMENT, AND EMPLOYER LIABILITY INSURANCE (U.S. CLS. 100, 101 AND 102).

JASON BLAIR, EXAMINING ATTORNEY

SN 85-520,274. NATIONWIDE MUTUAL INSURANCE COMPANY, COLUMBUS, OH. FILED 1-19-2012.

HARLEYSVILLE SECURETERM

THE MARK CONSISTS OF STANDARD CHARACTERS WITHOUT CLAIM TO ANY PARTICULAR FONT, STYLE, SIZE, OR COLOR.

OWNER OF U.S. REG. NOS. 2,708,595, 3,915,715 AND OTHERS.

SEC. 2(F) AS TO "HARLEYSVILLE".

FOR INSURANCE SERVICES, NAMELY, UNDERWRITING TERM LIFE INSURANCE COVERAGE AND A TERM LIFE INSURANCE PRODUCT (U.S. CLS. 100, 101 AND 102).

MARK SHINER, EXAMINING ATTORNEY

SN 85-520,276. NATIONWIDE MUTUAL INSURANCE COMPANY, COLUMBUS, OH. FILED 1-19-2012.

HARLEYSVILLE BUILDER UL

THE MARK CONSISTS OF STANDARD CHARACTERS WITHOUT CLAIM TO ANY PARTICULAR FONT, STYLE, SIZE, OR COLOR.

OWNER OF U.S. REG. NOS. 2,708,595, 3,915,715 AND OTHERS.

NO CLAIM IS MADE TO THE EXCLUSIVE RIGHT TO USE "UL", APART FROM THE MARK AS SHOWN.

SEC. 2(F) AS TO "HARLEYSVILLE".

FOR INSURANCE SERVICES, NAMELY, UNDERWRITING LIFE INSURANCE AND LIFE INSURANCE PRODUCTS (U.S. CLS. 100, 101 AND 102).

MARK SHINER, EXAMINING ATTORNEY

CLASS 36—(Continued).

SN 85-520,435. ESECLENDING, INC., BOSTON, MA. FILED 1-19-2012.

PROXYVALUE

THE MARK CONSISTS OF STANDARD CHARACTERS WITHOUT CLAIM TO ANY PARTICULAR FONT, STYLE, SIZE, OR COLOR.

FOR FINANCING SERVICES, DESIGNED TO FACILITATE THE LENDING OF SECURITIES FOR SHORT-TERM INVESTING, DIRECTED TO SECURITIES INVESTORS, CONDUCTED VIA THE INTERNET (U.S. CLS. 100, 101 AND 102).

REBECCA SMITH, EXAMINING ATTORNEY

SN 85-520,533. CALVERT SOCIAL INVESTMENT FOUNDATION, AKA CALVERT FOUNDATION, BETHESDA, MD. FILED 1-19-2012.

WIN-WIN

THE MARK CONSISTS OF STANDARD CHARACTERS WITHOUT CLAIM TO ANY PARTICULAR FONT, STYLE, SIZE, OR COLOR.

FOR INVESTMENT MANAGEMENT, NAMELY, HELPING CONNECT WOMEN INVESTORS WITH WOMEN ENTREPRENEURS IN THE DEVELOPING WORLD FOR ECONOMIC PURPOSES AND BUSINESS DEVELOPMENT (U.S. CLS. 100, 101 AND 102).

FIRST USE 10-27-2011; IN COMMERCE 10-27-2011.

LOURDES AYALA, EXAMINING ATTORNEY

CLASS 36—(Continued).

SN 85-521,202. PETROLEUM INDUSTRY RESEARCH ASSOCIATES, INC., DBA PIRA ENERGY GROUP, NEW YORK, NY. FILED 1-20-2012.

Forward Insight Commodities

THE MARK CONSISTS OF STANDARD CHARACTERS WITHOUT CLAIM TO ANY PARTICULAR FONT, STYLE, SIZE, OR COLOR.

NO CLAIM IS MADE TO THE EXCLUSIVE RIGHT TO USE "COMMODITIES", APART FROM THE MARK AS SHOWN.

FOR ENERGY BROKERAGE SERVICES; CONSULTANCY CONCERNING ENERGY BROKERAGE; BROKERAGE SERVICES IN THE FIELDS OF COMMODITIES AND FUTURES; COMMODITY FUTURES BROKERAGE SERVICES; ENERGY FUTURES BROKERAGE SERVICES; PROVIDING AN ON-LINE SEARCHABLE DATABASE FEATURING INFORMATION IN THE FIELDS OF ENERGY, COMMODITIES, AND FUTURES BROKERAGE; FINANCIAL INFORMATION SERVICES PROVIDED ON-LINE FROM A COMPUTER DATABASE OR A GLOBAL COMPUTER NETWORK, NAMELY, PROVIDING INFORMATION IN THE FIELDS OF ENERGY, COMMODITIES, AND FUTURES BROKERAGE; ON-LINE BROKERAGE OF ENERGY, COMMODITIES, AND FUTURES TRADES (U.S. CLS. 100, 101 AND 102).
ANDREW LEASER, EXAMINING ATTORNEY

SN 85-522,669. SKT VENTURES, LLC, AUSTIN, TX. FILED 1-23-2012.



THE MARK CONSISTS OF STANDARD CHARACTERS WITHOUT CLAIM TO ANY PARTICULAR FONT, STYLE, SIZE, OR COLOR.

NO CLAIM IS MADE TO THE EXCLUSIVE RIGHT TO USE "ADVISORS, INC.", APART FROM THE MARK AS SHOWN.
FOR CAPITAL INVESTMENT CONSULTING; FINANCIAL ADVICE; FINANCIAL PLANNING; FINANCIAL SERVICES, NAMELY, WEALTH MANAGEMENT SERVICES; INSURANCE ADMINISTRATION; INVESTMENT MANAGEMENT (U.S. CLS. 100, 101 AND 102).
FIRST USE 2-6-2008; IN COMMERCE 2-6-2008.
EDWARD NELSON, EXAMINING ATTORNEY

CLASS 36—(Continued).

SN 85-522,738. U.S. RISK INSURANCE GROUP, INC., DALLAS, TX. FILED 1-23-2012.



THE MARK CONSISTS OF A MOVIE CLAPPER BOARD DIRECTLY ABOVE THE WORD "TAKE" AND NUMERAL "1". BELOW "TAKE1" IS THE WORD "INSURANCE", WITH A HORIZONTAL LINE SEPARATING "TAKE1" AND "INSURANCE".

NO CLAIM IS MADE TO THE EXCLUSIVE RIGHT TO USE "INSURANCE", APART FROM THE MARK AS SHOWN.
FOR INSURANCE BROKERAGE AND INSURANCE UNDERWRITING SERVICES IN THE FIELDS OF PROPERTY, CASUALTY, AND PROFESSIONAL LIABILITY INSURANCE (U.S. CLS. 100, 101 AND 102).
FIRST USE 1-1-2005; IN COMMERCE 1-1-2005.
MICHAEL KEATING, EXAMINING ATTORNEY

SN 85-523,132. AHC ADVISORS, INC., SAINT CHARLES, IL. FILED 1-23-2012.

AHC Advisors, Inc.

THE MARK CONSISTS OF STANDARD CHARACTERS WITHOUT CLAIM TO ANY PARTICULAR FONT, STYLE, SIZE, OR COLOR.

NO CLAIM IS MADE TO THE EXCLUSIVE RIGHT TO USE "ADVISORS, INC.", APART FROM THE MARK AS SHOWN.

FOR CAPITAL INVESTMENT CONSULTING; FINANCIAL ADVICE; FINANCIAL PLANNING; FINANCIAL SERVICES, NAMELY, WEALTH MANAGEMENT SERVICES; INSURANCE ADMINISTRATION; INVESTMENT MANAGEMENT (U.S. CLS. 100, 101 AND 102).
FIRST USE 2-6-2008; IN COMMERCE 2-6-2008.
EDWARD NELSON, EXAMINING ATTORNEY

CLASS 36—(Continued).

SN 85-524,266. FNB BANCORP, INC., NEWTOWN, PA.
FILED 1-24-2012.



NO CLAIM IS MADE TO THE EXCLUSIVE RIGHT TO USE "NATIONAL BANK AND TRUST COMPANY OF NEWTOWN", APART FROM THE MARK AS SHOWN.

THE STIPPLING IS FOR SHADING PURPOSES ONLY.

THE MARK CONSISTS OF A RECTANGLE DIVIDED IN TWO, WITH A CLOCK FACE IN THE LEFT HALF AND THE STYLIZED TEXT "THE FIRST NATIONAL BANK AND TRUST COMPANY OF NEWTOWN" STACKED IN THE RIGHT HALF; THE CLOCK FACE REPRESENTS THE ORIGINAL CLOCK THAT SITS AT THE MAIN LOCATION.

FOR BANKING SERVICES; FINANCIAL TRUST OPERATIONS (U.S. CLS. 100, 101 AND 102).

FIRST USE 1-1-2009; IN COMMERCE 1-1-2009.

GEOFFREY FOSDICK, EXAMINING ATTORNEY

CLASS 36—(Continued).

SN 85-525,428. SHANNON CARRILLO, LA HABRA, CA.
FILED 1-25-2012.

GO GREEN ♥ GIVE CHARITY

NO CLAIM IS MADE TO THE EXCLUSIVE RIGHT TO USE "CHARITY", APART FROM THE MARK AS SHOWN.

THE MARK CONSISTS OF THE WORDS "GO GREEN" FOLLOWED BY A HEART, WHICH IS FOLLOWED BY THE WORDS "GIVE CHARITY".

FOR CHARITABLE FUNDRAISING SERVICES BY MEANS OF DONATING CLOTH DIAPERS TO BABIES IN NEED IN THIRD WORLD COUNTRIES (U.S. CLS. 100, 101 AND 102).

FIRST USE 12-14-2011; IN COMMERCE 12-14-2011.

MICHAEL KEATING, EXAMINING ATTORNEY

SN 85-525,350. DIVERSIFIED PORTFOLIO, LLC, DBA PROPERTY TAX LENDER, SUGAR LAND, TX. FILED 1-25-2012.



AEQUITAS CAPITAL

NO CLAIM IS MADE TO THE EXCLUSIVE RIGHT TO USE "DIVERSIFIED PORTFOLIO LLC PROPERTY TAX LENDER", APART FROM THE MARK AS SHOWN.

THE COLOR(S) GREY, WHITE AND GREEN IS/ARE CLAIMED AS A FEATURE OF THE MARK.

THE MARK CONSISTS OF THE DESIGN OF A GREEN HOUSE OUTLINED IN WHITE INSIDE A SHADED GREEN AND WHITE ROUND EDGED SQUARE WITH GREEN ON THE BOTTOM TWO THIRDS OF THE SQUARE FADING INTO PROGRESSIVELY LIGHTER GREEN THEN WHITE AT THE TOP, INSIDE A BORDERING GREY AND WHITE ROUND EDGED SQUARE, ALL TO THE LEFT OF A STRAIGHT VERTICAL LINE WHICH IS TO THE LEFT OF THE WORDING, "DIVERSIFIED" IN GREEN, "PORTFOLIO" IN GREY, "LLC" IN GREEN AND "PROPERTY TAX LENDER" IN GREY.

FOR FINANCING AND LOAN SERVICES (U.S. CLS. 100, 101 AND 102).

FIRST USE 12-10-2009; IN COMMERCE 12-10-2009.

BARBARA A. GOLD, EXAMINING ATTORNEY

THE MARK CONSISTS OF STANDARD CHARACTERS WITHOUT CLAIM TO ANY PARTICULAR FONT, STYLE, SIZE, OR COLOR.

NO CLAIM IS MADE TO THE EXCLUSIVE RIGHT TO USE "CAPITAL", APART FROM THE MARK AS SHOWN.

FOR INVESTMENT MANAGEMENT SERVICES; INVESTMENT PRODUCT DEVELOPMENT SERVICES, NAMELY, CUSTOM DESIGN OF CAPITAL INVESTMENT VEHICLES AND CAPITAL INVESTMENT FUNDS FOR CUSTOMERS; INVESTMENT SERVICES, NAMELY, ASSET ACQUISITION, CONSULTATION, DEVELOPMENT AND MANAGEMENT SERVICES; MANAGEMENT OF CAPITAL INVESTMENT VEHICLES AND CAPITAL INVESTMENT FUNDS; FINANCIAL CONSULTING; COMMERCIAL LENDING SERVICES, OTHER THAN REAL ESTATE MORTGAGES (U.S. CLS. 100, 101 AND 102).

FIRST USE 3-31-2005; IN COMMERCE 3-31-2005.

JULIE WATSON, EXAMINING ATTORNEY

CLASS 36—(Continued).

SN 85-526,592. AEQUITAS CAPITAL MANAGEMENT, INC., LAKE OSWEGO, OR. FILED 1-26-2012.



NO CLAIM IS MADE TO THE EXCLUSIVE RIGHT TO USE "CAPITAL", APART FROM THE MARK AS SHOWN.

THE MARK CONSISTS OF THE STYLIZED WORDS "AEQUITAS CAPITAL".

FOR INVESTMENT MANAGEMENT SERVICES; INVESTMENT PRODUCT DEVELOPMENT SERVICES, NAMELY, CUSTOM DESIGN OF CAPITAL INVESTMENT VEHICLES AND CAPITAL INVESTMENT FUNDS FOR CUSTOMERS; INVESTMENT SERVICES, NAMELY, ASSET ACQUISITION, CONSULTATION, DEVELOPMENT AND MANAGEMENT SERVICES; MANAGEMENT OF CAPITAL INVESTMENT VEHICLES AND CAPITAL INVESTMENT FUNDS; FINANCIAL CONSULTING; COMMERCIAL LENDING SERVICES, OTHER THAN REAL ESTATE MORTGAGES (U.S. CLS. 100, 101 AND 102).

FIRST USE 3-5-2011; IN COMMERCE 3-5-2011.
JULIE WATSON, EXAMINING ATTORNEY

SN 85-530,492. GUESA USA LLC, SEDALIA, MO. FILED 2-1-2012.

Guesa

THE MARK CONSISTS OF STANDARD CHARACTERS WITHOUT CLAIM TO ANY PARTICULAR FONT, STYLE, SIZE, OR COLOR.

THE WORDING GUESA HAS NO MEANING IN A FOREIGN LANGUAGE.

FOR FINANCIAL AND INVESTMENT SERVICES, NAMELY, ASSET AND INVESTMENT ACQUISITION, CONSULTATION, ADVISORY AND DEVELOPMENT (U.S. CLS. 100, 101 AND 102).

FIRST USE 12-22-2009; IN COMMERCE 12-22-2009.
KHANH LE, EXAMINING ATTORNEY

CLASS 36—(Continued).

SN 85-530,507. DANGLE INCENTIVES INC., AKA DANGLE, VANCOUVER, BC, CANADA, FILED 2-1-2012.



THE COLOR(S) ORANGE AND GREEN IS/ARE CLAIMED AS A FEATURE OF THE MARK.

THE MARK CONSISTS OF A CARROT WITH AN ORANGE TAPROOT AND GREEN STALKS WITH THE STYLIZED WORDING "DANGLE", IN WHICH THE LETTERS ARE IN ORANGE.

FOR ELECTRONIC COMMERCE PAYMENT SERVICES, NAMELY, ESTABLISHING FUNDED ACCOUNTS USED TO PURCHASE GOODS AND SERVICES ON THE INTERNET (U.S. CLS. 100, 101 AND 102).

LUCY ARANT, EXAMINING ATTORNEY

SN 85-530,557. AMERICAN UNITED LIFE INSURANCE COMPANY, INDIANAPOLIS, IN. FILED 2-1-2012.

RETIREMENT IN MOTION

THE MARK CONSISTS OF STANDARD CHARACTERS WITHOUT CLAIM TO ANY PARTICULAR FONT, STYLE, SIZE, OR COLOR.

FOR FINANCIAL PLANNING AND INVESTMENT ADVISORY SERVICES (U.S. CLS. 100, 101 AND 102).

APRIL ROACH, EXAMINING ATTORNEY

SN 85-530,621. SOKOLOWSKI, GREGORY, DBA DEBTAHOLIC.COM, CHICAGO, IL. FILED 2-1-2012.

Financial Sobriety, One Day at a Time

THE MARK CONSISTS OF STANDARD CHARACTERS WITHOUT CLAIM TO ANY PARTICULAR FONT, STYLE, SIZE, OR COLOR.

FOR FINANCIAL COUNSELING SERVICES, NAMELY, HELPING OTHERS BUILD A BETTER WORKING RELATIONSHIP WITH THEIR MONEY; FINANCIAL INFORMATION PROVIDED BY ELECTRONIC MEANS; FINANCIAL SERVICES, NAMELY, CREDIT REPAIR AND RESTORATION; PROVIDING A WEB SITE FEATURING PERSONAL FINANCIAL INFORMATION AND FINANCIAL ADVICE; PROVIDING EMERGENCY FINANCIAL ASSISTANCE FOR INDIVIDUALS AND FAMILIES (U.S. CLS. 100, 101 AND 102).

FIRST USE 2-1-2012; IN COMMERCE 2-1-2012.
LINDA MICKLEBURGH, EXAMINING ATTORNEY

CLASS 36—(Continued).

SN 85-530,639. THE CAPE COD FIVE CENTS SAVINGS BANK, ORLEANS, MA. FILED 2-1-2012.

**Trust Earned. Prudence
Employed.**

THE MARK CONSISTS OF STANDARD CHARACTERS WITHOUT CLAIM TO ANY PARTICULAR FONT, STYLE, SIZE, OR COLOR.

FOR FINANCIAL PLANNING AND INVESTMENT ADVISORY SERVICES (U.S. CLS. 100, 101 AND 102).
FIRST USE 9-1-2004; IN COMMERCE 9-1-2004.
COLLEEN MULCRONE, EXAMINING ATTORNEY

SN 85-530,653. THE CAPE COD FIVE CENTS SAVINGS BANK, ORLEANS, MA. FILED 2-1-2012.

**Defiantly Independent.
Exceptionally Strong.
Unquestionably Committed.**

THE MARK CONSISTS OF STANDARD CHARACTERS WITHOUT CLAIM TO ANY PARTICULAR FONT, STYLE, SIZE, OR COLOR.

FOR BANKING AND FINANCING SERVICES (U.S. CLS. 100, 101 AND 102).
FIRST USE 9-1-2004; IN COMMERCE 9-1-2004.
COLLEEN MULCRONE, EXAMINING ATTORNEY

SN 85-530,820. HALPERN, ALEX, DBA POST FACTORYNY, NEW YORK, NY. FILED 2-1-2012.

Filmmakers for Filmmakers.

THE MARK CONSISTS OF STANDARD CHARACTERS WITHOUT CLAIM TO ANY PARTICULAR FONT, STYLE, SIZE, OR COLOR.

FOR RENTAL OF OFFICE SPACE (U.S. CLS. 100, 101 AND 102).
SUSAN BILLHEIMER, EXAMINING ATTORNEY

CLASS 36—(Continued).

SN 85-530,889. THE AMERICAN INDIAN CANCER FOUNDATION, MINNEAPOLIS, MN. FILED 2-1-2012.

POWWOW FOR HOPE

THE MARK CONSISTS OF STANDARD CHARACTERS WITHOUT CLAIM TO ANY PARTICULAR FONT, STYLE, SIZE, OR COLOR.

FOR CHARITABLE FUNDRAISING SERVICES BY MEANS OF A COMMUNITY EVENT HAVING AS ITS FOCUS FUNDRAISING FOR AMERICAN INDIAN CANCER EDUCATION AND SERVICES (U.S. CLS. 100, 101 AND 102).
RENEE MCCRAY, EXAMINING ATTORNEY

SN 85-531,347. SEABURY ASSET MANAGEMENT LLC, NEW YORK, NY. FILED 2-1-2012.

SALT

THE MARK CONSISTS OF STANDARD CHARACTERS WITHOUT CLAIM TO ANY PARTICULAR FONT, STYLE, SIZE, OR COLOR.

FOR FINANCIAL SERVICES, NAMELY, OPERATION AND MANAGEMENT OF AN INVESTMENT FUND RELATED TO AIRCRAFT LEASING (U.S. CLS. 100, 101 AND 102).
SUSAN BILLHEIMER, EXAMINING ATTORNEY

SN 85-531,527. BLUE VINE FINANCIAL, LLC, ALPHARETTA, GA. FILED 2-1-2012.

BLUE VINE FINANCIAL

THE MARK CONSISTS OF STANDARD CHARACTERS WITHOUT CLAIM TO ANY PARTICULAR FONT, STYLE, SIZE, OR COLOR.

NO CLAIM IS MADE TO THE EXCLUSIVE RIGHT TO USE "FINANCIAL", APART FROM THE MARK AS SHOWN.

FOR ADVICE RELATING TO INVESTMENTS; INVESTMENT ADVICE; INVESTMENT ADVISORY SERVICES; INVESTMENT CONSULTATION (U.S. CLS. 100, 101 AND 102).
FIRST USE 12-19-2011; IN COMMERCE 1-2-2012.
MIAH ROSENBERG, EXAMINING ATTORNEY

CLASS 36—(Continued).

SN 85-531,820. BANK OF COMMERCE INC, CHARLOTTE, NC. FILED 2-2-2012.

The Bank that comes to
your business

THE MARK CONSISTS OF STANDARD CHARACTERS WITHOUT CLAIM TO ANY PARTICULAR FONT, STYLE, SIZE, OR COLOR.
FOR BANKING SERVICES (U.S. CLS. 100, 101 AND 102).
ALEX KEAM, EXAMINING ATTORNEY

CLASS 36—(Continued).

SN 85-532,115. MINNESOTA CREDIT UNION NETWORK, INC., ST. PAUL, MN. FILED 2-2-2012.

BANKZIETY

THE MARK CONSISTS OF STANDARD CHARACTERS WITHOUT CLAIM TO ANY PARTICULAR FONT, STYLE, SIZE, OR COLOR.
FOR CREDIT UNIONS (U.S. CLS. 100, 101 AND 102).
JORDAN BAKER, EXAMINING ATTORNEY

SN 85-531,901. D.K. PIERCE & ASSOCIATES, INC., ZIONS-VILLE, IN. FILED 2-2-2012.

DKP Critical Insights

THE MARK CONSISTS OF STANDARD CHARACTERS WITHOUT CLAIM TO ANY PARTICULAR FONT, STYLE, SIZE, OR COLOR.
FOR PROVIDING A DATABASE FOR TRACKING, MONITORING, AND GENERATING REPORTS ON INFORMATION AND STATISTICS ABOUT PATIENT REIMBURSEMENT AND INSURANCE COVERAGE FOR PHARMACEUTICALS AND MEDICAL DEVICES (U.S. CLS. 100, 101 AND 102).
FIRST USE 10-31-2011; IN COMMERCE 10-31-2011.
MARILYN IZZI, EXAMINING ATTORNEY

SN 85-532,141. BRECKSVILLE LASER EYE CENTER, LLC, DBA CLEAR CHOICE CUSTOM LASIK CENTER, BRECKSVILLE, OH. FILED 2-2-2012.

MR. ISEE

THE MARK CONSISTS OF STANDARD CHARACTERS WITHOUT CLAIM TO ANY PARTICULAR FONT, STYLE, SIZE, OR COLOR.
FOR CHARITABLE FUNDRAISING SERVICES (U.S. CLS. 100, 101 AND 102).
HOWARD SMIGA, EXAMINING ATTORNEY

SN 85-532,106. SUPPORT OUR TROOPS FOUNDATION, INC, DAYTONA BEACH, FL. FILED 2-2-2012.



THE MARK CONSISTS OF A GROUP OF SOLDIERS STANDING SIDE BY SIDE, FACING THE VIEWER, EACH HOLDING A GUN, AND WITH ONE SOLDIER SQUATTING AT EACH END.
FOR CHARITABLE FUNDRAISING (U.S. CLS. 100, 101 AND 102).
FIRST USE 10-2-2005; IN COMMERCE 10-2-2005.
JOHN DALIER, EXAMINING ATTORNEY

SN 85-532,143. AMERICA FIRST CREDIT UNION, OGDEN, UT. FILED 2-2-2012.

SPEECHACCESS

THE MARK CONSISTS OF STANDARD CHARACTERS WITHOUT CLAIM TO ANY PARTICULAR FONT, STYLE, SIZE, OR COLOR.
OWNER OF U.S. REG. NO. 2,660,949.
SEC. 2(F).
FOR CREDIT UNION SERVICES, NAMELY, PROVIDING PERSONAL ACCOUNT INFORMATION TO CREDIT UNION MEMBERS VIA TELEPHONE (U.S. CLS. 100, 101 AND 102).
FIRST USE 7-1-2002; IN COMMERCE 7-1-2002.
SETH A. RAPPAPORT, EXAMINING ATTORNEY

CLASS 36—(Continued).

SN 85-532,183. APRON, INC., LOUISVILLE, KY. FILED 2-2-2012.



THE MARK CONSISTS OF THE IMAGE OF AN APRON WITH THE WORD "APRON" ACROSS THE FRONT OF THE APRON DESIGN.

FOR CHARITABLE SERVICES, NAMELY, PROVIDING TEMPORARY AND LIMITED FINANCIAL ASSISTANCE TO PROFESSIONAL FOOD INDUSTRY WORKERS IN LOUISVILLE, KENTUCKY AND IN SURROUNDING AREAS WHO WORK AT LOCALLY OWNED ESTABLISHMENTS AND WHO ARE EXPERIENCING FINANCIAL DISTRESS DUE TO ILLNESS, INJURY OR OTHER HEALTH RELATED ISSUES, AN ACCIDENT OR ACCIDENTS, FAMILY EMERGENCIES OR OTHER EMERGENCIES, CRIMINAL ACTS COMMITTED AGAINST SUCH WORKER, OR OTHER CATASTROPHIC EVENTS (U.S. CLS. 100, 101 AND 102).
SUSAN LESLIE DUBOIS, EXAMINING ATTORNEY

SN 85-532,485. FIRST WESTERN FINANCIAL, INC., DENVER, CO. FILED 2-2-2012.

A CONNECTED VIEW

THE MARK CONSISTS OF STANDARD CHARACTERS WITHOUT CLAIM TO ANY PARTICULAR FONT, STYLE, SIZE, OR COLOR.

FOR FULL SERVICE BANKING SERVICES, NAMELY, CHECKING, SAVINGS AND MORTGAGE BANKING SERVICES; TRUST SERVICES, NAMELY, ESTATE TRUST MANAGEMENT SERVICES AND REAL ESTATE TRUSTEE SERVICES; FINANCIAL SERVICES, NAMELY, FINANCIAL ANALYSIS AND CONSULTATION, FINANCIAL FORECASTING, FINANCIAL INFORMATION PROVIDED BY ELECTRONIC MEANS, COMMERCIAL AND PRIVATE FINANCIAL LENDING SERVICES, CONSTRUCTION LOANS, HOME EQUITY LOANS, LINES OF CREDIT, CREDIT CARD SERVICES, LETTERS OF CREDIT AND FINANCIAL INVESTMENT ADVISORY SERVICES (U.S. CLS. 100, 101 AND 102).

FIRST USE 2-1-2012; IN COMMERCE 2-1-2012.
JESSICA A. POWERS, EXAMINING ATTORNEY

CLASS 36—(Continued).

SN 85-532,493. FIRST WESTERN FINANCIAL, INC., DENVER, CO. FILED 2-2-2012.

ConnectView

THE MARK CONSISTS OF STANDARD CHARACTERS WITHOUT CLAIM TO ANY PARTICULAR FONT, STYLE, SIZE, OR COLOR.

FOR FULL SERVICE BANKING SERVICES, NAMELY, CHECKING, SAVINGS AND MORTGAGE BANKING SERVICES; TRUST SERVICES, NAMELY, ESTATE TRUST MANAGEMENT SERVICES AND REAL ESTATE TRUSTEE SERVICES; FINANCIAL SERVICES, NAMELY, FINANCIAL ANALYSIS AND CONSULTATION, FINANCIAL FORECASTING, FINANCIAL INFORMATION PROVIDED BY ELECTRONIC MEANS, COMMERCIAL AND PRIVATE FINANCIAL LENDING SERVICES, CONSTRUCTION LOANS, HOME EQUITY LOANS, LINES OF CREDIT, CREDIT CARD SERVICES, LETTERS OF CREDIT AND FINANCIAL INVESTMENT ADVISORY SERVICES (U.S. CLS. 100, 101 AND 102).

FIRST USE 2-1-2012; IN COMMERCE 2-1-2012.
JESSICA A. POWERS, EXAMINING ATTORNEY

SN 85-532,495. RUSSELL INSURANCE GROUP, INC., WESTMINSTER, MD. FILED 2-2-2012.

POOLPRO

THE MARK CONSISTS OF STANDARD CHARACTERS WITHOUT CLAIM TO ANY PARTICULAR FONT, STYLE, SIZE, OR COLOR.

FOR INSURANCE UNDERWRITING IN THE FIELD OF ACCIDENT, PROPERTY, CASUALTY, GENERAL LIABILITY, AUTOMOBILE, EMPLOYMENT PRACTICE LIABILITY, DIRECTORS AND OFFICERS LIABILITY, WORKER'S COMPENSATION, CRIME, AND UMBRELLA INSURANCE; INSURANCE BROKERAGE; INSURANCE ADMINISTRATION (U.S. CLS. 100, 101 AND 102).
JERI J. FICKES, EXAMINING ATTORNEY

SN 85-532,693. AR LOGIX INC, READING, PA. FILED 2-2-2012.

AR ·Logix

THE MARK CONSISTS OF STANDARD CHARACTERS WITHOUT CLAIM TO ANY PARTICULAR FONT, STYLE, SIZE, OR COLOR.

FOR FINANCIAL AFFAIRS AND MONETARY AFFAIRS, NAMELY, FINANCIAL INFORMATION, MANAGEMENT AND ANALYSIS SERVICES (U.S. CLS. 100, 101 AND 102).

FIRST USE 11-17-2011; IN COMMERCE 11-17-2011.
STEVEN PEREZ, EXAMINING ATTORNEY

CLASS 36—(Continued).

SN 85-532,789. INDEPENDENT RETIREMENT ADVISERS LLC, SHAMONG, NJ. FILED 2-2-2012.

401K Tune-Up

THE MARK CONSISTS OF STANDARD CHARACTERS WITHOUT CLAIM TO ANY PARTICULAR FONT, STYLE, SIZE, OR COLOR.

NO CLAIM IS MADE TO THE EXCLUSIVE RIGHT TO USE "401K", APART FROM THE MARK AS SHOWN.

FOR ADVICE RELATING TO INVESTMENTS (U.S. CLS. 100, 101 AND 102).

FIRST USE 2-21-2011; IN COMMERCE 2-21-2011.

HOWARD B. LEVINE, EXAMINING ATTORNEY

SN 85-533,000. NATIONAL JEWISH HEALTH, DENVER, CO. FILED 2-3-2012.

BEHIND THE SCENES CARE AND DISCOVERY AT NATIONAL JEWISH HEALTH

THE MARK CONSISTS OF STANDARD CHARACTERS WITHOUT CLAIM TO ANY PARTICULAR FONT, STYLE, SIZE, OR COLOR.

OWNER OF U.S. REG. NOS. 2,155,433 AND 3,512,437.

FOR CHARITABLE FUNDRAISING SERVICES BY MEANS OF ORGANIZING AND CONDUCTING TOURS AND SPECIAL EVENTS (U.S. CLS. 100, 101 AND 102).

FIRST USE 2-1-2012; IN COMMERCE 2-1-2012.

JEFFREY LOOK, EXAMINING ATTORNEY

SN 85-533,011. THE PENN MUTUAL LIFE INSURANCE COMPANY, HORSHAM, PA. FILED 2-3-2012.



THE COLOR(S) DARK GREEN AND LIGHT GREEN IS/ ARE CLAIMED AS A FEATURE OF THE MARK.

THE MARK CONSISTS OF STYLIZED IMAGES OF SKYSCRAPERS RISING FROM BEHIND A V-SHAPED WALL. THE LEFT FACES OF THE SKYSCRAPERS AND THE RIGHT FACE OF THE WALL BEING IN DARK GREEN AND THE RIGHT FACES OF THE SKYSCRAPERS AND THE LEFT FACE OF THE WALL BEING IN LIGHT GREEN.

FOR INSURANCE AGENCIES (U.S. CLS. 100, 101 AND 102).

KIM SAITO, EXAMINING ATTORNEY

CLASS 36—(Continued).

SN 85-533,013. THE JOHN MCNICHOLAS PEDIATRIC BRAIN TUMOR FOUNDATION, AKA LIVELIKEJOHN.ORG, CHICAGO, IL. FILED 2-3-2012.

Go Gray in May

THE MARK CONSISTS OF STANDARD CHARACTERS WITHOUT CLAIM TO ANY PARTICULAR FONT, STYLE, SIZE, OR COLOR.

FOR CHARITABLE FUNDRAISING SERVICES BY MEANS OF SELLING GOODS TO RAISE FUNDS FOR PEDIATRIC BRAIN TUMOR RESEARCH; CHARITABLE FUNDRAISING SERVICES FOR PROMOTING RESEARCH, EDUCATION AND OTHER ACTIVITIES RELATING TO PEDIATRIC BRAIN TUMORS; CHARITABLE FUNDRAISING TO SUPPORT RESEARCH INTO THE TREATMENT AND CURE OF PEDIATRIC BRAIN TUMORS (U.S. CLS. 100, 101 AND 102).

FIRST USE 4-18-2011; IN COMMERCE 4-18-2011.

GENE MACIOL, EXAMINING ATTORNEY

SN 85-533,169. ENVESTNET ASSET MANAGEMENT, INC., CHICAGO, IL. FILED 2-3-2012.



OWNER OF U.S. REG. NOS. 2,593,459, 3,900,770 AND 3,943,973.

THE MARK CONSISTS OF THREE OVERLAPPING ARROWS TO THE LEFT OF THE WORD "ENVESTNET".

FOR INVESTMENT MANAGEMENT AND CONSULTING SERVICES DELIVERED ELECTRONICALLY VIA THE INTERNET, NAMELY, FINANCIAL ADVICE AND INVESTMENT MANAGEMENT FOR INVESTORS, AND INVESTMENT MANAGEMENT SUPPORT TO INDEPENDENT ADVISERS (U.S. CLS. 100, 101 AND 102).

KATHERINE CHANG, EXAMINING ATTORNEY

CLASS 36—(Continued).

SN 85-533,186. ENVESTNET ASSET MANAGEMENT, INC., CHICAGO, IL. FILED 2-3-2012.



OWNER OF U.S. REG. NOS. 2,593,459, 3,900,770 AND 3,943,973.

THE MARK CONSISTS OF THREE OVERLAPPING ARROWS ABOVE THE WORD "ENVESTNET".

FOR INVESTMENT MANAGEMENT AND CONSULTING SERVICES DELIVERED ELECTRONICALLY VIA THE INTERNET, NAMELY, FINANCIAL ADVICE AND INVESTMENT MANAGEMENT FOR INVESTORS, AND INVESTMENT MANAGEMENT SUPPORT TO INDEPENDENT ADVISERS (U.S. CLS. 100, 101 AND 102).

KATHERINE CHANG, EXAMINING ATTORNEY

SN 85-533,385. THE RICHMOND ASSOCIATION OF REALTORS, INCORPORATED, RICHMOND, VA. FILED 2-3-2012.

We are the R

THE MARK CONSISTS OF STANDARD CHARACTERS WITHOUT CLAIM TO ANY PARTICULAR FONT, STYLE, SIZE, OR COLOR.

FOR REAL ESTATE BROKERAGE (U.S. CLS. 100, 101 AND 102).

C. DIONNE CLYBURN, EXAMINING ATTORNEY

SN 85-533,675. MEMONEYS, INC., SARASOTA, FL. FILED 2-3-2012.

MEBUYZ

THE MARK CONSISTS OF STANDARD CHARACTERS WITHOUT CLAIM TO ANY PARTICULAR FONT, STYLE, SIZE, OR COLOR.

FOR ADMINISTRATION OF SAVINGS ACCOUNTS; SAVINGS ACCOUNT SERVICES; SAVINGS BANK SERVICES (U.S. CLS. 100, 101 AND 102).

COLLEEN DOMBROW, EXAMINING ATTORNEY

CLASS 36—(Continued).

SN 85-533,700. MEMONEYS, INC., SARASOTA, FL. FILED 2-3-2012.

MEGIVEZ

THE MARK CONSISTS OF STANDARD CHARACTERS WITHOUT CLAIM TO ANY PARTICULAR FONT, STYLE, SIZE, OR COLOR.

FOR SAVINGS ACCOUNT SERVICES; SAVINGS BANK SERVICES; ADMINISTRATION OF SAVINGS ACCOUNTS; FINANCIAL SERVICES, NAMELY, PROVIDING SAVINGS ACCUMULATION SERVICES FOR CHARITY IN THE NATURE OF PROVIDING ON-LINE STORED VALUE ACCOUNTS IN AN ELECTRONIC ENVIRONMENT FOR CHARITABLE GIVING PURPOSES; FINANCIAL SERVICES, NAMELY, ADMINISTRATION OF SAVINGS ACCOUNTS FOR CHARITABLE GIVING PURPOSES; FINANCIAL ADMINISTRATION OF A DEBIT CARD SAVINGS PROGRAM FOR GIFT GIVING; CHARITABLE CONTRIBUTION SERVICES PROVIDED THROUGH ELECTRONIC MEANS, NAMELY, ACCEPTING MONETARY CHARITABLE CONTRIBUTIONS THROUGH ELECTRONIC MEANS (U.S. CLS. 100, 101 AND 102).

COLLEEN DOMBROW, EXAMINING ATTORNEY

SN 85-534,069. CROWDFUNDING OFFERINGS, LIMITED, SILVERTON, CO. FILED 2-4-2012.



THE COLOR(S) BLACK, WHITE, GREY AND SILVER IS/ ARE CLAIMED AS A FEATURE OF THE MARK.

THE MARK CONSISTS OF THE LETTERS "CF" IN BLACK CENTERED UPON A ROUND COIN THAT HAS GRAY AND WHITE SURFACE AND A BLACK, WHITE, GREY AND SILVER BASE.

FOR FINANCIAL ADMINISTRATION OF STOCK EXCHANGE TRADING OF SHARES AND OTHER FINANCIAL SECURITIES IN FINANCIAL MARKETS (U.S. CLS. 100, 101 AND 102).

ANDREA HACK, EXAMINING ATTORNEY

CLASS 36—(Continued).

SN 85-534,218. HELWIG, ALEX J, FLAGSTAFF, AZ. FILED 2-5-2012.

Gold To Green

THE MARK CONSISTS OF STANDARD CHARACTERS WITHOUT CLAIM TO ANY PARTICULAR FONT, STYLE, SIZE, OR COLOR.

FOR PROVIDING MONETARY EXCHANGE SERVICES, NAMELY, EXCHANGING GOLD OF OTHERS FOR CASH (U.S. CLS. 100, 101 AND 102).

TOBY BULLOFF, EXAMINING ATTORNEY

SN 85-534,358. POVIENG, DONALD, HUNTINGTON BEACH, CA. FILED 2-6-2012.

InvestRent

THE MARK CONSISTS OF STANDARD CHARACTERS WITHOUT CLAIM TO ANY PARTICULAR FONT, STYLE, SIZE, OR COLOR.

FOR EVALUATION OF REAL PROPERTY; FINANCIAL DUE DILIGENCE SERVICES IN THE FIELD OF REAL ESTATE; FINANCIAL INVESTMENT IN THE FIELD OF REAL ESTATE SECURITIES; REAL ESTATE ACQUISITION SERVICES; REAL ESTATE BROKERAGE; REAL ESTATE EQUITY SHARING, NAMELY, MANAGING AND ARRANGING FOR CO-OWNERSHIP OF REAL ESTATE; REAL ESTATE FUNDS INVESTMENT SERVICES; REAL ESTATE INVESTMENT SERVICES; REAL ESTATE INVESTMENT TRUST SERVICES; REAL ESTATE RENTAL SERVICES, NAMELY, RENTAL OF RESIDENTIAL HOUSING; REAL ESTATE SYNDICATION; REAL ESTATE TIME-SHARING (U.S. CLS. 100, 101 AND 102).

FIRST USE 2-6-2012; IN COMMERCE 3-29-2012.
ANDREW LEASER, EXAMINING ATTORNEY

SN 85-534,504. TMX FINANCE LLC, SAVANNAH, GA. FILED 2-6-2012.

TITLELOANPLACE

THE MARK CONSISTS OF STANDARD CHARACTERS WITHOUT CLAIM TO ANY PARTICULAR FONT, STYLE, SIZE, OR COLOR.

FOR FINANCIAL SERVICES, NAMELY, AUTOMOBILE TITLE PAWN LOANS AND AUTOMOBILE TITLE PLEDGE LOANS (U.S. CLS. 100, 101 AND 102).

CHRISTINA SOBRAL, EXAMINING ATTORNEY

CLASS 36—(Continued).

SN 85-534,568. VERACITY PAYMENT SOLUTIONS, INC., ATLANTA, GA. FILED 2-6-2012.

PayValet

THE MARK CONSISTS OF STANDARD CHARACTERS WITHOUT CLAIM TO ANY PARTICULAR FONT, STYLE, SIZE, OR COLOR.

FOR ELECTRONIC CREDIT CARD TRANSACTIONS; ELECTRONIC PAYMENT, NAMELY, ELECTRONIC PROCESSING AND TRANSMISSION OF BILL PAYMENT DATA; FINANCIAL SERVICES RENDERED IN CONNECTION WITH THE ISSUANCE, RECEIPT AND TRANSFER OF LINES OF CREDIT, NAMELY, CREDIT PROCESSING SERVICES; FINANCIAL TRANSACTION SERVICES, NAMELY, PROVIDING SECURE COMMERCIAL TRANSACTIONS AND PAYMENT OPTIONS USING A MOBILE DEVICE AT A POINT OF SALE; PAYMENT PROCESSING SERVICES, NAMELY, CREDIT CARD AND DEBIT CARD TRANSACTION PROCESSING SERVICES; PROVIDING ELECTRONIC PROCESSING OF ACH AND CREDIT CARD TRANSACTIONS AND ELECTRONIC PAYMENTS VIA A GLOBAL COMPUTER NETWORK; PROVIDING ELECTRONIC PROCESSING OF ELECTRONIC FUNDS TRANSFER, ACH, CREDIT CARD, DEBIT CARD, ELECTRONIC CHECK AND ELECTRONIC PAYMENTS (U.S. CLS. 100, 101 AND 102).

COLLEEN MULCRONE, EXAMINING ATTORNEY

SN 85-534,628. APMEX, INC., OKLAHOMA CITY, OK. FILED 2-6-2012.

APMEXDIRECT

THE MARK CONSISTS OF STANDARD CHARACTERS WITHOUT CLAIM TO ANY PARTICULAR FONT, STYLE, SIZE, OR COLOR.

OWNER OF U.S. REG. NOS. 3,443,217, 3,561,946 AND 3,984,960.

FOR COMMODITIES EXCHANGE SERVICES FEATURING ASSURANCES OF AUTHENTICITY (U.S. CLS. 100, 101 AND 102).

WILLIAM ROSSMAN, EXAMINING ATTORNEY

CLASS 36—(Continued).

SN 85-534,675. COLLINS COMMUNITY CREDIT UNION, CEDAR RAPIDS, IA. FILED 2-6-2012.

All You Need is Us!

THE MARK CONSISTS OF STANDARD CHARACTERS WITHOUT CLAIM TO ANY PARTICULAR FONT, STYLE, SIZE, OR COLOR.

FOR CREDIT UNION SERVICES (U.S. CLS. 100, 101 AND 102).

FIRST USE 1-1-1982; IN COMMERCE 1-1-1982.
INGA ERVIN, EXAMINING ATTORNEY

SN 85-534,824. ROMANI, GABRIELLA FRANCINE, CORONA DEL MAR, CA. FILED 2-6-2012.

KIDS WITH COINS

THE MARK CONSISTS OF STANDARD CHARACTERS WITHOUT CLAIM TO ANY PARTICULAR FONT, STYLE, SIZE, OR COLOR.

FOR CHARITABLE FUNDRAISING TO SUPPORT CHARITABLE CAMPAIGNS OF INTEREST TO AND FUNDED BY CHILDREN (U.S. CLS. 100, 101 AND 102).
SALLY SHIH, EXAMINING ATTORNEY

SN 85-534,834. HEARING CHARITIES OF AMERICA, KANSAS CITY, MO. FILED 2-6-2012.

**CELEBRATE SOUND DON'T WALK
IN SILENCE**

THE MARK CONSISTS OF STANDARD CHARACTERS WITHOUT CLAIM TO ANY PARTICULAR FONT, STYLE, SIZE, OR COLOR.

OWNER OF U.S. REG. NO. 3,687,035.
FOR CHARITABLE FUNDRAISING SERVICES (U.S. CLS. 100, 101 AND 102).
JAY BESCH, EXAMINING ATTORNEY

CLASS 36—(Continued).

SN 85-535,031. WOMEN FOR WOMEN INTERNATIONAL, WASHINGTON, DC. FILED 2-6-2012.

JOIN ME ON THE BRIDGE

THE MARK CONSISTS OF STANDARD CHARACTERS WITHOUT CLAIM TO ANY PARTICULAR FONT, STYLE, SIZE, OR COLOR.

FOR CHARITABLE FUNDRAISING SERVICES TO ASSIST WOMEN VICTIMS OF WAR AND CIVIL STRIFE; ESTABLISHING AND ADMINISTERING MONETARY CHARITABLE PROGRAMS TO PROVIDE INCOME-GENERATING SUPPORT AND MICRO CREDIT LOANS TO BENEFIT WOMEN VICTIMS OF WAR AND CIVIL STRIFE (U.S. CLS. 100, 101 AND 102).

FIRST USE 1-1-2010; IN COMMERCE 1-1-2010.
MATTHEW PAPPAS, EXAMINING ATTORNEY

SN 85-535,100. ALLY FINANCIAL INC., DETROIT, MI. FILED 2-6-2012.

HOME STARTS HERE

THE MARK CONSISTS OF STANDARD CHARACTERS WITHOUT CLAIM TO ANY PARTICULAR FONT, STYLE, SIZE, OR COLOR.

FOR REAL ESTATE MORTGAGE BANKING AND LENDING SERVICES; LOAN ORIGINATION AND FINANCING VIA A GLOBAL COMMUNICATIONS NETWORK (U.S. CLS. 100, 101 AND 102).

WILLIAM BRECKENFELD, EXAMINING ATTORNEY

SN 85-535,418. AVERIS INTERNATIONAL LLC, MEDFORD, OR. FILED 2-6-2012.

AVERIS

THE MARK CONSISTS OF STANDARD CHARACTERS WITHOUT CLAIM TO ANY PARTICULAR FONT, STYLE, SIZE, OR COLOR.

FOR REAL ESTATE BROKERAGE; REAL ESTATE MANAGEMENT SERVICES; REAL ESTATE SERVICE, NAMELY, RENTAL PROPERTY MANAGEMENT; REAL ESTATE SERVICES, NAMELY, PROPERTY MANAGEMENT SERVICES FOR CONDOMINIUM ASSOCIATIONS, HOMEOWNER ASSOCIATIONS AND APARTMENT BUILDINGS (U.S. CLS. 100, 101 AND 102).
ODESSA BIBBINS, EXAMINING ATTORNEY

CLASS 36—(Continued).

SN 85-535,435. MOKA.EMEKA, CHICAGO, IL. FILED 2-6-2012.

Forexperts

THE MARK CONSISTS OF STANDARD CHARACTERS WITHOUT CLAIM TO ANY PARTICULAR FONT, STYLE, SIZE, OR COLOR.
FOR CURRENCY TRADING (U.S. CLS. 100, 101 AND 102).
HELENE LIWINSKI, EXAMINING ATTORNEY

SN 85-535,509. RAPID CASH ADVANCES, INC. AKA RAPID CASH PAYDAY LOANS, ORLANDO, FL. FILED 2-7-2012.

XTRA CASH

THE MARK CONSISTS OF STANDARD CHARACTERS WITHOUT CLAIM TO ANY PARTICULAR FONT, STYLE, SIZE, OR COLOR.
NO CLAIM IS MADE TO THE EXCLUSIVE RIGHT TO USE "CASH", APART FROM THE MARK AS SHOWN.
FOR CHECK CASHING; FINANCIAL SERVICES, NAMELY, VEHICLE TITLE LOANS; INSTALLMENT LOANS (U.S. CLS. 100, 101 AND 102).
FIRST USE 2-10-2012; IN COMMERCE 2-10-2012.
JUSTINE D. PARKER, EXAMINING ATTORNEY

SN 85-535,625. NGAM DISTRIBUTION, L.P., BOSTON, MA. FILED 2-7-2012.

DURABLE PORTFOLIOS. DURABLE BUSINESS.

THE MARK CONSISTS OF STANDARD CHARACTERS WITHOUT CLAIM TO ANY PARTICULAR FONT, STYLE, SIZE, OR COLOR.
FOR INVESTMENT MANAGEMENT AND ADVISORY SERVICES (U.S. CLS. 100, 101 AND 102).
JENNIFER VASQUEZ, EXAMINING ATTORNEY

CLASS 36—(Continued).

SN 85-535,694. CDRE TM LLC, MISSION VIEJO, CA. FILED 2-7-2012.



THE COLOR(S) GREEN, BLUE, LIGHT BLUE AND DARK BLUE IS/ARE CLAIMED AS A FEATURE OF THE MARK.
THE MARK CONSISTS OF THE PHRASE "NEW WAVE", WITH THE WORD "NEW" IN GREEN AND THE WORD "WAVE" IN BLUE, AND A STYLIZED LIGHT BLUE WAVE BEHIND THE WORD "WAVE", ALL ABOVE THE PHRASE "OF REAL ESTATE" IN DARK BLUE.
FOR REAL ESTATE BROKERAGE (U.S. CLS. 100, 101 AND 102).
FIRST USE 7-12-2011; IN COMMERCE 7-12-2011.
LYNDSEY KUYKENDALL, EXAMINING ATTORNEY

SN 85-536,474. MOZIDO, LLC, DALLAS, TX. FILED 2-7-2012.

MOBILEVAULT

THE MARK CONSISTS OF STANDARD CHARACTERS WITHOUT CLAIM TO ANY PARTICULAR FONT, STYLE, SIZE, OR COLOR.
FOR FINANCIAL SERVICES PROVIDED BY MOBILE TELEPHONE CONNECTIONS, INTERACTIVE VOICE RESPONSE OVER TELEPHONE CONNECTIONS, RETAIL POINT-OF-SALE CONNECTIONS AND THE INTERNET, NAMELY, MOBILE BANKING, MOBILE MONEY TRANSFERS, MOBILE PURCHASING, NAMELY, PROVIDING ELECTRONIC PROCESSING OF CREDIT/DEBIT CARD TRANSACTIONS AND ELECTRONIC PAYMENTS VIA MOBILE PHONE FOR ALLOWING BUSINESSES TO PURCHASE GOODS AND SERVICES OF OTHERS, MOBILE MULTICHANNEL PAYMENTS, NAMELY, BILL PAYMENT SERVICES AND LOAN PAYMENT SERVICES; FINANCIAL SERVICES, NAMELY, STORED-VALUE CASH OR DEBIT CARD SERVICES, NAMELY, LOADING, MANAGING, AND PAYMENT PROCESSING, PROVIDED BY MOBILE TELEPHONE CONNECTIONS, INTERACTIVE VOICE RESPONSE OVER TELEPHONE CONNECTIONS, RETAIL POINT-OF-SALE CONNECTIONS AND THE INTERNET (U.S. CLS. 100, 101 AND 102).
SETH A. RAPPAPORT, EXAMINING ATTORNEY

CLASS 36—(Continued).

SN 85-536,480. MOZIDO, LLC, DALLAS, TX. FILED 2-7-2012.

MVAULT

THE MARK CONSISTS OF STANDARD CHARACTERS WITHOUT CLAIM TO ANY PARTICULAR FONT, STYLE, SIZE, OR COLOR.

FOR FINANCIAL SERVICES PROVIDED BY MOBILE TELEPHONE CONNECTIONS, INTERACTIVE VOICE RESPONSE OVER TELEPHONE CONNECTIONS, RETAIL POINT-OF-SALE CONNECTIONS AND THE INTERNET, NAMELY, MOBILE BANKING, MOBILE MONEY TRANSFERS, MOBILE PURCHASING, NAMELY, PROVIDING ELECTRONIC PROCESSING OF CREDIT/DEBIT CARD TRANSACTIONS AND ELECTRONIC PAYMENTS VIA MOBILE PHONE FOR ALLOWING BUSINESSES TO PURCHASE GOODS AND SERVICES OF OTHERS, MOBILE MULTICHANNEL PAYMENTS, NAMELY, BILL PAYMENT SERVICES AND LOAN PAYMENT SERVICES; FINANCIAL SERVICES, NAMELY, STORED-VALUE CASH OR DEBIT CARD SERVICES, NAMELY, LOADING, MANAGING, AND PAYMENT PROCESSING, PROVIDED BY MOBILE TELEPHONE CONNECTIONS, INTERACTIVE VOICE RESPONSE OVER TELEPHONE CONNECTIONS, RETAIL POINT-OF-SALE CONNECTIONS AND THE INTERNET (U.S. CLS. 100, 101 AND 102).

SETH A. RAPPAPORT, EXAMINING ATTORNEY

SN 85-536,483. MOZIDO, LLC, DALLAS, TX. FILED 2-7-2012.

B2BMVAULT

THE MARK CONSISTS OF STANDARD CHARACTERS WITHOUT CLAIM TO ANY PARTICULAR FONT, STYLE, SIZE, OR COLOR.

FOR FINANCIAL SERVICES PROVIDED BY MOBILE TELEPHONE CONNECTIONS, INTERACTIVE VOICE RESPONSE OVER TELEPHONE CONNECTIONS, RETAIL POINT-OF-SALE CONNECTIONS AND THE INTERNET, NAMELY, MOBILE BANKING, MOBILE MONEY TRANSFERS, MOBILE PURCHASING, NAMELY, PROVIDING ELECTRONIC PROCESSING OF CREDIT/DEBIT CARD TRANSACTIONS AND ELECTRONIC PAYMENTS VIA MOBILE PHONE FOR ALLOWING BUSINESSES TO PURCHASE GOODS AND SERVICES OF OTHERS, MOBILE MULTICHANNEL PAYMENTS, NAMELY, BILL PAYMENT SERVICES AND LOAN PAYMENT SERVICES; FINANCIAL SERVICES, NAMELY, STORED-VALUE CASH OR DEBIT CARD SERVICES, NAMELY, LOADING, MANAGING, AND PAYMENT PROCESSING, PROVIDED BY MOBILE TELEPHONE CONNECTIONS, INTERACTIVE VOICE RESPONSE OVER TELEPHONE CONNECTIONS, RETAIL POINT-OF-SALE CONNECTIONS AND THE INTERNET (U.S. CLS. 100, 101 AND 102).

SETH A. RAPPAPORT, EXAMINING ATTORNEY

CLASS 36—(Continued).

SN 85-536,626. GOEMERCHANT, LLC, FORT WORTH, TX. FILED 2-8-2012.

M+TERMINAL

THE MARK CONSISTS OF STANDARD CHARACTERS WITHOUT CLAIM TO ANY PARTICULAR FONT, STYLE, SIZE, OR COLOR.

FOR FACILITATING POINT OF SALE FINANCIAL TRANSACTIONS VIA MOBILE PHONES AND A GLOBAL COMPUTER NETWORK, NAMELY, PROVIDING SECURE COMMERCIAL TRANSACTIONS AND PAYMENT OPTIONS USING A MOBILE DEVICE AT A POINT OF SALE (U.S. CLS. 100, 101 AND 102).

CHRISTINE MARTIN, EXAMINING ATTORNEY

SN 85-537,351. TECIMER, NATALIE, PALOS VERDES ESTATES, CA. FILED 2-8-2012.

ENDING ALL ROADS TO SILENCE

THE MARK CONSISTS OF STANDARD CHARACTERS WITHOUT CLAIM TO ANY PARTICULAR FONT, STYLE, SIZE, OR COLOR.

FOR CHARITABLE FUNDRAISING SERVICES, NAMELY, RAISING FUNDS FOR PROVIDING DEAF AND HARD OF HEARING CHILDREN WITH HEARING AIDS, AUDIOLOGICAL SERVICES, SPEECH THERAPY, AND HEALTH CARE SERVICES (U.S. CLS. 100, 101 AND 102).

FIRST USE 9-1-2011; IN COMMERCE 9-1-2011.

NICHOLAS ALTREE, EXAMINING ATTORNEY

SN 85-537,361. LVW ADVISORS, LLC, NEW YORK, NY. FILED 2-8-2012.

Your financial gps with a moral compass.

THE MARK CONSISTS OF STANDARD CHARACTERS WITHOUT CLAIM TO ANY PARTICULAR FONT, STYLE, SIZE, OR COLOR.

FOR FINANCIAL SERVICES, NAMELY, WEALTH MANAGEMENT, EMPLOYEE BENEFIT AND INVESTMENT CONSULTING SERVICES (U.S. CLS. 100, 101 AND 102).

SUE LAWRENCE, EXAMINING ATTORNEY

CLASS 36—(Continued).

SN 85-537,826. 1ST ADVANTAGE FEDERAL CREDIT UNION, NEWPORT NEWS, VA. FILED 2-9-2012.



OWNER OF U.S. REG. NO. 4,091,147.
THE COLOR(S) GREY AND BLUE IS/ARE CLAIMED AS A FEATURE OF THE MARK.
THE MARK CONSISTS OF THE LETTER "A" IN GREY WITH A CUTOUT OF A BLUE STAR INSIDE A BLUE SHIELD OUTLINED IN GREY.

FOR INSURANCE SERVICES, NAMELY, UNDERWRITING HOMEOWNERS, AUTOMOBILE, COMMERCIAL PROPERTY, BUILDERS RISK, AND GENERAL LIABILITY INSURANCE (U.S. CLS. 100, 101 AND 102).
VIVIAN MICZNIK FIRST, EXAMINING ATTORNEY

CLASS 36—(Continued).

SN 85-537,851. SOUTHCITY BANK, VESTAVIA HILLS, AL. FILED 2-9-2012.



THE MARK CONSISTS OF A STYLIZED "P" RADIATING IN A CIRCLE FROM A SHARED POINT IN THE CENTER. FOR BANKING SERVICES (U.S. CLS. 100, 101 AND 102).

FIRST USE 2-8-2012; IN COMMERCE 2-8-2012.
KARANENDRA S. CHHINA, EXAMINING ATTORNEY

SN 85-537,908. DEBBIE DOGRUL ASSOCIATES, LLC, FAIRFAX, VA. FILED 2-9-2012.

SN 85-537,849. 1ST AMERICAN LEASING, LLC, SARASOTA, FL. FILED 2-9-2012.



THE COLOR(S) BLUE AND GREEN IS/ARE CLAIMED AS A FEATURE OF THE MARK.

THE MARK CONSISTS OF A STYLIZED LOWER CASE LETTER E IN BLUE FOLLOWED BY THE STYLIZED UPPER CASE LETTERS CE IN GREEN.

FOR MERCHANT SERVICES, NAMELY, PAYMENT TRANSACTION PROCESSING SERVICES (U.S. CLS. 100, 101 AND 102).

FIRST USE 2-6-2012; IN COMMERCE 2-6-2012.
JEAN IM, EXAMINING ATTORNEY



THE COLOR(S) RED AND WHITE IS/ARE CLAIMED AS A FEATURE OF THE MARK.

THE MARK CONSISTS OF A STYLIZED RED HOUSE CONTAINING A STYLIZED WHITE LETTER "D". FOR RESIDENTIAL REAL ESTATE AGENCY SERVICES (U.S. CLS. 100, 101 AND 102).

FIRST USE 12-0-2011; IN COMMERCE 12-0-2011.
WILLIAM VERHOSEK, EXAMINING ATTORNEY

CLASS 36—(Continued).

SN 85-538,105. STRATHSPEY CROWN LLC, LAGUNA BEACH, CA. FILED 2-9-2012.

STRATHSPEY CROWN

THE MARK CONSISTS OF STANDARD CHARACTERS WITHOUT CLAIM TO ANY PARTICULAR FONT, STYLE, SIZE, OR COLOR.

FOR INVESTMENT OF FUNDS FOR OTHERS; MANAGEMENT OF A CAPITAL INVESTMENT FUND; MANAGEMENT OF PRIVATE EQUITY FUNDS; FINANCIAL SERVICES, NAMELY, PROVIDING A PRIVATE EQUITY FUND AND SPECIAL PURPOSE ACQUISITION (U.S. CLS. 100, 101 AND 102).

ANGELA DUONG, EXAMINING ATTORNEY

SN 85-538,312. RODGERS LEMON & MCCLUNG LLC, WESTLAKE, OH. FILED 2-9-2012.



THE MARK CONSISTS OF A DOUBLE-BLADED BATTLE AXE AND A BROAD SWORD CROSSED DIAGONALLY IN FRONT OF A SHIELD, WHICH IS DIVIDED BY A CROSS INTO FOUR PANELS, WITH EACH PANEL DECORATED IN TARTAN PLAID.

FOR ACCOUNTS PAYABLE DEBITING SERVICES; COLLECTION OF DEBTS (U.S. CLS. 100, 101 AND 102).

FIRST USE 12-1-2010; IN COMMERCE 12-1-2010.
ANGELA M. MICHELI, EXAMINING ATTORNEY

SN 85-538,483. HAROLD ROBINSON FOUNDATION, INC., LOS ANGELES, CA. FILED 2-9-2012.

PEDAL ON THE PIER

THE MARK CONSISTS OF STANDARD CHARACTERS WITHOUT CLAIM TO ANY PARTICULAR FONT, STYLE, SIZE, OR COLOR.

FOR CHARITABLE FUNDRAISING SERVICES (U.S. CLS. 100, 101 AND 102).

FIRST USE 6-5-2011; IN COMMERCE 6-5-2011.
SALLY SHIH, EXAMINING ATTORNEY

CLASS 36—(Continued).

SN 85-538,538. MCALLISTER, ROBERT J, SOLANA BEACH, CA. FILED 2-9-2012.

MONSTER CARD

THE MARK CONSISTS OF STANDARD CHARACTERS WITHOUT CLAIM TO ANY PARTICULAR FONT, STYLE, SIZE, OR COLOR.

NO CLAIM IS MADE TO THE EXCLUSIVE RIGHT TO USE "CARD", APART FROM THE MARK AS SHOWN.

FOR CREDIT CARD AND PAYMENT CARD SERVICES (U.S. CLS. 100, 101 AND 102).

ALYSSA STEEL, EXAMINING ATTORNEY

SN 85-538,957. SUPPORT COLLECTORS INC, DBA SUMMIT ACCOUNT RESOLUTION, CHAMPLIN, MN. FILED 2-9-2012.

We help the cash flow

THE MARK CONSISTS OF STANDARD CHARACTERS WITHOUT CLAIM TO ANY PARTICULAR FONT, STYLE, SIZE, OR COLOR.

FOR DEBT RECOVERY AND COLLECTION AGENCIES (U.S. CLS. 100, 101 AND 102).

FIRST USE 10-13-2008; IN COMMERCE 10-13-2008.
DORITT L. CARROLL, EXAMINING ATTORNEY

SN 85-539,095. MICHIGAN MUTUAL, INC., DBA FIRST PREFERRED MORTGAGE COMPANY, PORT HURON, MI. FILED 2-10-2012.

THINK BIGGER. EXPECT MORE.

THE MARK CONSISTS OF STANDARD CHARACTERS WITHOUT CLAIM TO ANY PARTICULAR FONT, STYLE, SIZE, OR COLOR.

FOR MORTGAGE LENDING (U.S. CLS. 100, 101 AND 102).

SETH A. RAPPAPORT, EXAMINING ATTORNEY

CLASS 36—(Continued).

SN 85-539,859. RITE LEND, INC., IRVINE, CA. FILED 2-10-2012.

RiteLend

THE MARK CONSISTS OF STANDARD CHARACTERS WITHOUT CLAIM TO ANY PARTICULAR FONT, STYLE, SIZE, OR COLOR.

FOR MORTGAGE BANKING SERVICES, NAMELY, ORIGINATION, ACQUISITION, SERVICING, SECURITIZATION AND BROKERAGE OF MORTGAGE LOANS (U.S. CLS. 100, 101 AND 102).

FIRST USE 9-1-2010; IN COMMERCE 9-1-2010.
JANICE L. MCMORROW, EXAMINING ATTORNEY

CLASS 36—(Continued).

SN 85-550,895. GIVEBONES, LLC, MANHATTAN BEACH, CA. FILED 2-23-2012.

GIVEBONES

THE MARK CONSISTS OF STANDARD CHARACTERS WITHOUT CLAIM TO ANY PARTICULAR FONT, STYLE, SIZE, OR COLOR.

FOR CHARITABLE FUND-RAISING FOR ANIMAL WELFARE (U.S. CLS. 100, 101 AND 102).
KATHY DE JONGE, EXAMINING ATTORNEY

SN 85-540,068. RITE LEND, INC., IRVINE, CA. FILED 2-10-2012.



THE MARK CONSISTS OF STYLIZED R WITH A CIRCLE AROUND IT, VERTICAL SEPARATION LINE, RITELEND, FOR MORTGAGE BANKING SERVICES, NAMELY, ORIGINATION, ACQUISITION, SERVICING, SECURITIZATION AND BROKERAGE OF MORTGAGE LOANS (U.S. CLS. 100, 101 AND 102).

FIRST USE 9-1-2010; IN COMMERCE 9-1-2010.
JANICE L. MCMORROW, EXAMINING ATTORNEY

SN 85-550,927. GIVEBONES, LLC, MANHATTAN BEACH, CA. FILED 2-23-2012.



THE MARK CONSISTS OF THE WORD "GIVEBONES" TO THE LEFT OF A PAW PRINT.

FOR CHARITABLE FUNDRAISING FOR ANIMAL WELFARE (U.S. CLS. 100, 101 AND 102).
KATHY DE JONGE, EXAMINING ATTORNEY

SN 85-540,673. GOEMERCHANT, LLC, FORT WORTH, TX. FILED 2-13-2012.



THE MARK CONSISTS OF A STYLIZED IMAGE OF A HUMAN HAND HOLDING A CREDIT CARD.

FOR FACILITATING POINT OF SALE FINANCIAL TRANSACTIONS VIA MOBILE PHONES AND A GLOBAL COMPUTER NETWORK, NAMELY, PROVIDING SECURE COMMERCIAL TRANSACTIONS AND PAYMENT OPTIONS USING A MOBILE DEVICE AT A POINT OF SALE (U.S. CLS. 100, 101 AND 102).

CHRISTINE MARTIN, EXAMINING ATTORNEY

SN 85-554,563. PAYMENT ALLIANCE INTERNATIONAL, INC., LOUISVILLE, KY. FILED 2-28-2012.

TermPAY

THE MARK CONSISTS OF STANDARD CHARACTERS WITHOUT CLAIM TO ANY PARTICULAR FONT, STYLE, SIZE, OR COLOR.

FOR FINANCIAL SERVICES, NAMELY, ELECTRONIC REMOTE CHECK DEPOSIT SERVICES (U.S. CLS. 100, 101 AND 102).

FIRST USE 2-22-2012; IN COMMERCE 2-22-2012.
CYNTHIA TRIPI, EXAMINING ATTORNEY

CLASS 36—(Continued).

SN 85-559,775. ALLSTATE INSURANCE COMPANY, NORTHBROOK, IL. FILED 3-5-2012.

MAYHEM IS EVERYWHERE

THE MARK CONSISTS OF STANDARD CHARACTERS WITHOUT CLAIM TO ANY PARTICULAR FONT, STYLE, SIZE, OR COLOR.

OWNER OF U.S. REG. NO. 4,137,610.
FOR INSURANCE SERVICES, NAMELY, WRITING AND UNDERWRITING INSURANCE IN THE FIELDS OF PROPERTY, LIABILITY, LIFE, AND CASUALTY, AND PROVIDING ANCILLARY SERVICES THERETO, NAMELY, ADMINISTRATION AND CLAIMS ADJUSTMENT; FINANCIAL SPONSORSHIP OF ATHLETIC EVENTS; FINANCIAL SPONSORSHIP OF CHARITABLE ORGANIZATIONS (U.S. CLS. 100, 101 AND 102).
ZACHARY BELLO, EXAMINING ATTORNEY

SN 85-565,332. MASTERCARD INTERNATIONAL INCORPORATED, PURCHASE, NY. FILED 3-9-2012.

KOY

THE MARK CONSISTS OF STANDARD CHARACTERS WITHOUT CLAIM TO ANY PARTICULAR FONT, STYLE, SIZE, OR COLOR.

FOR FINANCIAL SERVICES, NAMELY, PROVIDING CREDIT CARD AND DEBIT CARD SERVICES; FINANCIAL TRANSACTION AUTHORIZATION AND SETTLEMENT SERVICES; PROVISION OF FINANCIAL INFORMATION PROCESSING SERVICES BY MEANS OF A GLOBAL COMPUTER NETWORK OR THE INTERNET (U.S. CLS. 100, 101 AND 102).
SUNG IN, EXAMINING ATTORNEY

CLASS 36—(Continued).

SN 85-597,302. BANK INDEPENDANT, SHEFFIELD, AL. FILED 4-13-2012.



NO CLAIM IS MADE TO THE EXCLUSIVE RIGHT TO USE THE DESIGN OF THE QUICK RESPONSE CODE, APART FROM THE MARK AS SHOWN.

THE MARK CONSISTS OF A QUICK RESPONSE DESIGN CODE WITH A BUILDING FRONT HAVING SIX COLUMNS IN THE CENTER.
FOR ARRANGING AND PROVISION OF CREDIT, LOANS, INSURANCE, CURRENCY EXCHANGE AND TRAVELLERS CHEQUES; ATM BANKING SERVICES; BANKING AND FINANCING SERVICES; CASH MANAGEMENT; CREDIT AND CASH CARD SERVICES; FUNDS INVESTMENT; INVESTMENT BROKERAGE; MORTGAGE BANKING; ON-LINE BANKING SERVICES; SAFE DEPOSIT BOX SERVICES (U.S. CLS. 100, 101 AND 102).
COLLEEN KEARNEY, EXAMINING ATTORNEY

SN 85-605,346. MASTERCARD INTERNATIONAL INCORPORATED, PURCHASE, NY. FILED 4-23-2012.

KOY, THE APP THAT SAVES YOU EVERY DAY

THE MARK CONSISTS OF STANDARD CHARACTERS WITHOUT CLAIM TO ANY PARTICULAR FONT, STYLE, SIZE, OR COLOR.

FOR FINANCIAL SERVICES, NAMELY, PROVIDING CREDIT CARD AND DEBIT CARD SERVICES; FINANCIAL TRANSACTION AUTHORIZATION AND SETTLEMENT SERVICES; PROVISION OF FINANCIAL INFORMATION PROCESSING SERVICES BY MEANS OF A GLOBAL COMPUTER NETWORK OR THE INTERNET (U.S. CLS. 100, 101 AND 102).
SUNG IN, EXAMINING ATTORNEY

CLASS 36—(Continued).

SN 85-605,373. MASTERCARD INTERNATIONAL INCORPORATED, PURCHASE, NY. FILED 4-23-2012.

THE APP THAT SAVES YOU
EVERY DAY

THE MARK CONSISTS OF STANDARD CHARACTERS WITHOUT CLAIM TO ANY PARTICULAR FONT, STYLE, SIZE, OR COLOR.

FOR FINANCIAL SERVICES, NAMELY, PROVIDING CREDIT CARD AND DEBIT CARD SERVICES; FINANCIAL TRANSACTION AUTHORIZATION AND SETTLEMENT SERVICES; PROVISION OF FINANCIAL INFORMATION PROCESSING SERVICES BY MEANS OF A GLOBAL COMPUTER NETWORK OR THE INTERNET (U.S. CLS. 100, 101 AND 102).

SUNG IN, EXAMINING ATTORNEY

CLASS 37—(Continued).

SN 76-710,604. LASERLINE NATIONAL LLC, VERSAILLES, OH. FILED 2-13-2012.

LASERLINE

THE COLOR(S) RED AND BLUE IS/ARE CLAIMED AS A FEATURE OF THE MARK.

THE MARK CONSISTS OF THE WORD "LASERLINE" IN A STYLIZED BLUE FONT WITH A RED LINE SUPERIMPOSED OVER THE LOWER HALF OF THE WORD.

FOR VEHICLE REPAIR AND MAINTENANCE (U.S. CLS. 100, 103 AND 106).

FIRST USE 5-15-2001; IN COMMERCE 5-15-2001.
MELISSA VALLILLO, EXAMINING ATTORNEY

SN 85-254,540. A AND A QUALITY APPLIANCE, INC., DENVER, CO. FILED 3-1-2011.



NO CLAIM IS MADE TO THE EXCLUSIVE RIGHT TO USE "APPLIANCE", APART FROM THE MARK AS SHOWN.

THE MARK CONSISTS OF THE WORDING "APPLIANCE FACTORY OUTLET" ON A PRICE TAG DESIGN WITH A STRIPE AT THE BOTTOM. THE WORDING "OUTLET" APPEARS IN THE STRIPE AT THE BOTTOM OF THE TAG. THE LETTER "O" IN THE WORDING "FACTORY" IS REPLACED BY A DESIGN OF A WASHING MACHINE.

SEC. 2(F) AS TO "APPLIANCE FACTORY OUTLET", FOR INSTALLATION OF MAJOR HOUSEHOLD APPLIANCES (U.S. CLS. 100, 103 AND 106).

FIRST USE 2-18-2011; IN COMMERCE 2-18-2011.
EMILY CARLSEN, EXAMINING ATTORNEY

CLASS 37—CONSTRUCTION AND REPAIR

SN 76-708,758. EMPOWER ELECTRIC, LLC, NASHVILLE, TN. FILED 8-17-2011.



THE MARK CONSISTS OF A SQUARE DESIGN WITH A CAPITAL LETTER "E" TILTED COUNTERCLOCKWISE APPROXIMATELY 45 DEGREES AND A SUPERSCRIPED NUMBER "2" IN THE UPPER RIGHT CORNER OF THE SQUARE.

FOR ELECTRICAL CONTRACTING AND ELECTRICAL CONTRACTOR SERVICES INCLUDING ELECTRICAL REPAIRS, MAINTENANCE, AND INSTALLATION OF ELECTRICAL WIRING, OUTLETS, LIGHT FIXTURES, AND ELECTRICAL PANELS (U.S. CLS. 100, 103 AND 106).

FIRST USE 12-8-2008; IN COMMERCE 12-8-2008.
JAMES GRIFFIN, EXAMINING ATTORNEY

SN 85-317,314. COUNTRY WIDE PROSERV, NORTH LAS VEGAS, NV. FILED 5-10-2011.

PROSERV

THE MARK CONSISTS OF STANDARD CHARACTERS WITHOUT CLAIM TO ANY PARTICULAR FONT, STYLE, SIZE, OR COLOR.

FOR INSTALLATION, REPAIR AND MAINTENANCE OF RESIDENTIAL HEATING SYSTEMS, AIR CONDITIONING SYSTEMS, PLUMBING SYSTEMS, ELECTRICAL SYSTEMS, HOUSEHOLD APPLIANCES (U.S. CLS. 100, 103 AND 106).

FIRST USE 3-1-2009; IN COMMERCE 2-28-2010.
JOSETTE BEVERLY, EXAMINING ATTORNEY

CLASS 37—(Continued).

SN 85-328,262. CJ 4DPLEX CO., LTD., SEOUL, REPUBLIC OF KOREA, FILED 5-24-2011.

4DX

THE MARK CONSISTS OF STANDARD CHARACTERS WITHOUT CLAIM TO ANY PARTICULAR FONT, STYLE, SIZE, OR COLOR.

PRIORITY CLAIMED UNDER SEC. 44(D) ON REPUBLIC OF KOREA APPLICATION NO. 41-2010-3068, FILED 11-30-2010, REG. NO. 0229082, DATED 3-26-2012, EXPIRES 3-26-2022.

FOR CONSTRUCTION OF BUILDINGS; REPAIR OF BUILDINGS; BUILDING OF THEATRES; INSTALLATION OF THEATRE PLANTS; BUILDING OF THEATRES FEATURING MOVIES AUDIENCE EFFECTS SUCH AS WIND, SCENT, WATER SPRAY, MOTION, VIBRATION, SMOKE, BUBBLE, LASER OR FLASH; INSTALLATION OF THEATRE PLANTS FOR MOVIES AUDIENCE EFFECTS SUCH AS WIND, SCENT, WATER SPRAY, MOTION, VIBRATION, SMOKE, BUBBLE, LASER OR FLASH; BUILDING CONSTRUCTION SUPERVISION; DRILLING OF WELLS; CLEANING OF BUILDING EXTERIOR SURFACES; HEATING EQUIPMENT INSTALLATION AND REPAIR; INSTALLATION, MAINTENANCE AND REPAIR OF MACHINERY FOR MOVIES AUDIENCE EFFECTS IN CINEMA; FILM PROJECTOR REPAIR; SAFE MAINTENANCE AND REPAIR; FURNITURE RESTORATION; REPAIR OF MUSICAL INSTRUMENTS (U.S. CLS. 100, 103 AND 106).

PATRICIA EVANKO, EXAMINING ATTORNEY

SN 85-345,042. MCLELLAN, DWIGHT, AVONDALE, AZ. FILED 6-13-2011.



NO CLAIM IS MADE TO THE EXCLUSIVE RIGHT TO USE "WELL PATH", APART FROM THE MARK AS SHOWN.

THE STIPPLING IS FOR SHADING PURPOSES ONLY.

THE MARK CONSISTS OF THE STYLIZED WORDING "WELLPATH SOLUTIONS". THE DESIGN OF AN OIL WELL GOES THROUGH THE "W" IN "WELLPATH" AND THE DESIGN OF A PIPE GOES FROM THE BOTTOM OF THE WELL DESIGN THROUGH THE WORD "SOLUTIONS". THE BACKGROUND CONSISTS OF A VIEW FROM THE CENTER OF THE EARTH LOOKING UP WITH VARIOUS GEOLOGICAL STRATA. AN OIL RIG IS AT THE TOP CENTER OF THE MARK WITH TWO OIL PIPES LINES RUNNING DOWN FROM THE OIL RIG.

FOR OIL AND GAS DRILLING (U.S. CLS. 100, 103 AND 106).

FIRST USE 3-4-2007; IN COMMERCE 6-25-2008.

KIM SAITO, EXAMINING ATTORNEY

CLASS 37—(Continued).

SN 85-351,667. NATIONWIDE SECURITY SOLUTIONS, VANCOUVER, WA. FILED 6-21-2011.



NO CLAIM IS MADE TO THE EXCLUSIVE RIGHT TO USE "SECURITY SOLUTIONS", APART FROM THE MARK AS SHOWN.

THE COLOR(S) BLACK AND BLUE IS/ARE CLAIMED AS A FEATURE OF THE MARK.

THE MARK CONSISTS OF THE WORDS "NATIONWIDE SECURITY SOLUTIONS" IN A STYLIZED FONT. THE "N" IN "NATIONWIDE" IS IN THE LARGEST FONT AND IS STYLIZED WITH POINTED ARROWS IN A NORTHERLY DIRECTION. "NATIONWIDE" IS IN A BLACK FONT AND "SECURITY SOLUTIONS" IS A BLACK FONT UNDERNEATH THE WORD "NATIONWIDE". IN THE BACKGROUND BEHIND THE LARGE STYLIZED "N" IS A CIRCULAR MAP WITH THE COLOR BLUE. WHITE IS PRESENTED IN THE BACKGROUND OF THE MARK AND IS NOT CLAIMED AS PART OF THE TRADEMARK.

SEC. 2(F) AS TO "NATIONWIDE SECURITY SOLUTIONS".

FOR INSTALLATION AND MAINTENANCE OF BURGLAR AND/OR FIRE ALARMS; INSTALLATION OF SECURITY SYSTEM (U.S. CLS. 100, 103 AND 106).

FIRST USE 5-0-2006; IN COMMERCE 5-0-2006.

ANGELA DUONG, EXAMINING ATTORNEY

SN 85-371,638. TBRC INC., AKA TBRC ROOFING COMPANY, DALLAS, TX. FILED 7-14-2011.

TBRC Roofing Company

THE MARK CONSISTS OF STANDARD CHARACTERS WITHOUT CLAIM TO ANY PARTICULAR FONT, STYLE, SIZE, OR COLOR.

NO CLAIM IS MADE TO THE EXCLUSIVE RIGHT TO USE "ROOFING COMPANY", APART FROM THE MARK AS SHOWN.

FOR ROOFING CONSULTATION; ROOFING CONTRACTING; ROOFING INSTALLATION; ROOFING REPAIR; ROOFING SERVICES (U.S. CLS. 100, 103 AND 106).

FIRST USE 5-1-2004; IN COMMERCE 5-1-2004.

REBECCA SMITH, EXAMINING ATTORNEY

CLASS 37—(Continued).

SN 85-381,339. NEW JERSEY TURNPIKE AUTHORITY, WOODBRIDGE, NJ. FILED 7-26-2011.

NEW JERSEY TURNPIKE

THE MARK CONSISTS OF STANDARD CHARACTERS WITHOUT CLAIM TO ANY PARTICULAR FONT, STYLE, SIZE, OR COLOR.

OWNER OF U.S. REG. NO. 2,873,593.

NO CLAIM IS MADE TO THE EXCLUSIVE RIGHT TO USE "TURNPIKE", APART FROM THE MARK AS SHOWN. SEC. 2(F).

FOR HIGHWAY MANAGEMENT AND MAINTENANCE SERVICES, NAMELY, MAINTENANCE AND REPAIR OF HIGHWAY GUIDE RAILS, HIGHWAY SIGNS, TOLL BOOTHS, PEDESTRIAN WALKWAYS AND OVERPASSES, ROADS, SERVICE AREAS, REST AREAS, COMMUTER PARKING LOTS, TOLL COLLECTION EQUIPMENT, AND TOLL COLLECTION FACILITIES (U.S. CLS. 100, 103 AND 106).

FIRST USE 0-0-1951; IN COMMERCE 0-0-1951.

CHRISIE B. KING, EXAMINING ATTORNEY

CLASS 37—(Continued).

SN 85-435,435. FLORIDA PIPE-LINING SOLUTIONS, LLC, SARASOTA, FL. FILED 9-29-2011.



NO CLAIM IS MADE TO THE EXCLUSIVE RIGHT TO USE "FLORIDA PIPE-LINING SOLUTIONS, LLC", APART FROM THE MARK AS SHOWN.

THE COLOR(S) BLUE, GREEN, AND BLACK IS/ARE CLAIMED AS A FEATURE OF THE MARK.

THE MARK CONSISTS OF THE WORDS "FLORIDA PIPE-LINING SOLUTIONS, LLC" WHICH ARE BLACK AND THE LOGO INCLUDES A BLACK ROUND PIPE LIKE IMAGE WITH BLUE AND GREEN WAVES/WATER COMING FROM WITHIN THE ROUND PIPE LIKE IMAGE.

FOR NON DESTRUCTIVE REPAIR AND REHABILITATION OF CORRODED AND LEAKING PIPES THROUGH PIPELINING UTILIZING SAFE AND PROFESSIONALLY APPROVED EPOXY AND RELATED APPLICATIONS (U.S. CLS. 100, 103 AND 106).

MARY ROSSMAN, EXAMINING ATTORNEY

SN 85-406,855. HIPPO ROOFING, INC., MELBOURNE, FL. FILED 8-25-2011.

HIPPO ROOFING

THE MARK CONSISTS OF STANDARD CHARACTERS WITHOUT CLAIM TO ANY PARTICULAR FONT, STYLE, SIZE, OR COLOR.

NO CLAIM IS MADE TO THE EXCLUSIVE RIGHT TO USE "ROOFING", APART FROM THE MARK AS SHOWN.

FOR ROOFING CONTRACTING; ROOFING INSTALLATION; ROOFING REPAIR; INSTALLATION OF BUILDING INSULATION, SOFFITS, SIDING, AND FASCIA (U.S. CLS. 100, 103 AND 106).

FIRST USE 5-0-2008; IN COMMERCE 5-0-2008.

NATALIE POLZER, EXAMINING ATTORNEY

SN 85-456,551. ALL PRO PEST SERVICES, INC., MARIETTA, GA. FILED 10-26-2011.



NO CLAIM IS MADE TO THE EXCLUSIVE RIGHT TO USE "PEST SERVICES", APART FROM THE MARK AS SHOWN.

THE MARK CONSISTS OF "ALL-PRO" ABOVE A SHADED RECTANGLE THAT INCLUDES THE WORDS "PEST SERVICES".

FOR TERMITE AND PEST CONTROL (U.S. CLS. 100, 103 AND 106).

FIRST USE 3-0-2011; IN COMMERCE 3-0-2011.

NAKWAMA ANKRAH, EXAMINING ATTORNEY

CLASS 37—(Continued).

SN 85-465,612. MANIZANI, HOSSEIN F., DBA DOCTOR PAINTER, NORTHRIDGE, CA. FILED 11-7-2011.

Doctor Painter

THE MARK CONSISTS OF STANDARD CHARACTERS WITHOUT CLAIM TO ANY PARTICULAR FONT, STYLE, SIZE, OR COLOR.

NO CLAIM IS MADE TO THE EXCLUSIVE RIGHT TO USE "PAINTER", APART FROM THE MARK AS SHOWN.

FOR CONSULTATION RELATING TO PAINTING OF BUILDINGS; DECORATIVE PAINTING SERVICES; DRYWALL AND PAINTING CONTRACTOR SERVICES; HOUSE PAINTING; PAINTING; PAINTING AND APPLYING COATINGS TO BUILDING INTERIORS AND BUILDING EXTERIORS; PAINTING AND VARNISHING; PAINTING CONTRACTOR SERVICES; PAINTING IN THE FIELD OF COMMERCIAL, INDUSTRIAL AND RESIDENTIAL PROPERTIES; SIGN PAINTING (U.S. CLS. 100, 103 AND 106).

FIRST USE 7-15-2011; IN COMMERCE 8-1-2011.
MARILYN IZZI, EXAMINING ATTORNEY

SN 85-466,298. SHARON A. & ASSOCIATES, INC., MIAMI BEACH, FL. FILED 11-7-2011.



INGENERAM SYSTEMS

NO CLAIM IS MADE TO THE EXCLUSIVE RIGHT TO USE THE TRIANGULAR ARROW SHAPE, A RECYCLING SYMBOL, APART FROM THE MARK AS SHOWN.

THE MARK CONSISTS OF THE WORDS "INGENERAM SYSTEMS" ON THE BOTTOM OF A CIRCLE WITH THREE PARTITIONS; ON THE TOP PARTITION A PLANT, ON THE BOTTOM LEFT THREE GEARS, AND ON THE BOTTOM RIGHT A RECYCLE SIGN.

FOR SERVICES OF USING HIGH PRESSURE WATER AND STEAM TO EXTRACT OIL DEPOSITS (U.S. CLS. 100, 103 AND 106).

HENRY S. ZAK, EXAMINING ATTORNEY

CLASS 37—(Continued).

SN 85-476,739. FIRE STOP TECHNOLOGIES, INC., ST. LOUIS, MO. FILED 11-18-2011.



NO CLAIM IS MADE TO THE EXCLUSIVE RIGHT TO USE "FIRE STOP TECHNOLOGIES INC.", APART FROM THE MARK AS SHOWN.

THE COLOR(S) RED AND BLACK IS/ARE CLAIMED AS A FEATURE OF THE MARK.

THE MARK CONSISTS OF THE WORD "FIRE" ATOP THE WORD "STOP" IN MUCH LARGER TYPE, BOTH FADING FROM RED TO WHITE, BELOW "FIRE STOP" IS THE WORDING "TECHNOLOGIES INC." SHOWN IN THE COLOR RED ALL ON A BLACK BACKGROUND, SURROUNDED BY AN OCTAGONAL RED BORDER.

FOR INSTALLATION OF FIRE RETARDANT COMPOSITIONS IN COMMERCIAL, INDUSTRIAL AND RESIDENTIAL BUILDINGS TO INHIBIT THE SCOPE OF FIRE (U.S. CLS. 100, 103 AND 106).

FIRST USE 1-3-1994; IN COMMERCE 1-3-1994.
LINDA E. BLOHM, EXAMINING ATTORNEY

SN 85-482,101. GDCA, INC., LIVERMORE, CA. FILED 11-28-2011.

GDCA

THE MARK CONSISTS OF STANDARD CHARACTERS WITHOUT CLAIM TO ANY PARTICULAR FONT, STYLE, SIZE, OR COLOR.

FOR REPAIR OF EMBEDDED ELECTRONIC PRODUCTS THAT MEET OEM SPECIFICATIONS (U.S. CLS. 100, 103 AND 106).

FIRST USE 6-30-2011; IN COMMERCE 6-30-2011.
CHARLES L. JENKINS, EXAMINING ATTORNEY

CLASS 37—(Continued).

SN 85-483,851. HF GROUP, LLC, CHESTERLAND, OH. FILED 11-30-2011.



NO CLAIM IS MADE TO THE EXCLUSIVE RIGHT TO USE "RECORDSAVE" AND "GOVERNMENT RECORDS PRESERVATION", APART FROM THE MARK AS SHOWN.

THE COLOR(S) RED, WHITE, LIGHT GRAY AND DARK GRAY IS/ARE CLAIMED AS A FEATURE OF THE MARK.

THE MARK CONSISTS OF A SHIELD WITH A SINGLE LINE IN LIGHT GRAY AND DARK GRAY COLORING FORMING THE SHIELD; IN THE UPPER LEFT CORNER OF THE SHIELD IS THE BLOCK LETTER "R" IN WHITE ON A RED BACKGROUND AND ON THE BOTTOM RIGHT OF THE SHIELD IS THE BLOCK LETTER "S" IN WHITE ON A RED BACKGROUND; THE UPPER RIGHT AND BOTTOM LEFT OF THE SHIELD ARE IN WHITE. TO THE RIGHT OF THE SHIELD IS THE WORD "RECORD" IN BLOCK RED LETTERS FOLLOWED WITHOUT A SPACE BY THE WORD "SAVE" IN DARK GRAY BLOCK LETTERS, BOTH APPEARING OVER THE WORDS "GOVERNMENT RECORDS PRESERVATION", ALL IN DARK GRAY LETTERS.

FOR BOOK REPAIR AND RESTORATION (U.S. CLS. 100, 103 AND 106).

FIRST USE 11-30-2011; IN COMMERCE 11-30-2011.
SHAILA SETTLES, EXAMINING ATTORNEY

SN 85-504,227. SKY GLOBAL PARTNERS, LLC, FORMERLY BLUE SKY ENERGY, LLC, HOUSTON, TX. FILED 12-27-2011.



NO CLAIM IS MADE TO THE EXCLUSIVE RIGHT TO USE "GLOBAL", APART FROM THE MARK AS SHOWN.

THE COLOR(S) LIGHT BLUE, GREEN, DARK BLUE, GOLDEN, WHITE, BLACK IS/ARE CLAIMED AS A FEATURE OF THE MARK.

THE MARK CONSISTS OF A CIRCULAR DESIGN WITH THE FOLLOWING COLORS SEPARATED BY WHITE BORDERS AND A WHITE INTERIOR CIRCUMFERENCE LINE: LIGHT BLUE (REPRESENTING SKY), GREEN (REPRESENTING EARTH), AND DARK BLUE (REPRESENTING WATER) RUNNING THROUGH THE CIRCULAR DESIGN, WITH A GOLDEN GLOW AROUND THE CIRCLE AND WITH THE WORDS "SKY GLOBAL PARTNERS" IN BLACK ON THE RIGHT SIDE OF CIRCULAR DESIGN.

FOR REAL ESTATE DEVELOPMENT, NAMELY, DEVELOPING ENERGY PRODUCTION FACILITIES (U.S. CLS. 100, 103 AND 106).

FIRST USE 12-12-2011; IN COMMERCE 12-12-2011.
KARANENDRA S. CHHINA, EXAMINING ATTORNEY

CLASS 37—(Continued).

SN 85-509,788. GRIER ROOFING, INMAN, SC. FILED 1-5-2012.



NO CLAIM IS MADE TO THE EXCLUSIVE RIGHT TO USE "ROOFING, LLC", APART FROM THE MARK AS SHOWN.

THE COLOR(S) RED AND BLUE IS/ARE CLAIMED AS A FEATURE OF THE MARK.

THE MARK CONSISTS OF THE STYLIZED LETTERS "GR", OF WHICH "G" IS IN RED COLOR OUTLINED IN BLUE AND "R" IS IN BLUE COLOR. BELOW THIS IS THE STYLIZED WORDING "GRIER ROOFING, LLC" IN BLUE COLOR OUTLINED IN RED.

FOR ROOFING SERVICES (U.S. CLS. 100, 103 AND 106).

FIRST USE 3-0-1995; IN COMMERCE 3-0-1995.
DAWN HAN, EXAMINING ATTORNEY

SN 85-522,628. CHOICE ONE RESTORATION, INC., BENSALEM, PA. FILED 1-23-2012.

TRI STATE WATER RESTORATION

THE MARK CONSISTS OF STANDARD CHARACTERS WITHOUT CLAIM TO ANY PARTICULAR FONT, STYLE, SIZE, OR COLOR.

NO CLAIM IS MADE TO THE EXCLUSIVE RIGHT TO USE "WATER RESTORATION", APART FROM THE MARK AS SHOWN.

FOR RESTORATION SERVICES IN THE FIELD OF WATER AND SMOKE DAMAGE (U.S. CLS. 100, 103 AND 106).

FIRST USE 12-15-2011; IN COMMERCE 12-15-2011.
DEIRDRE ROBERTSON, EXAMINING ATTORNEY

CLASS 37—(Continued).

SN 85-524,429. GREEN DRY PRESS LLC, DBA LOTS OF CLEAN, BELLEVILLE, NJ. FILED 1-24-2012.



NO CLAIM IS MADE TO THE EXCLUSIVE RIGHT TO USE "CLEAN", APART FROM THE MARK AS SHOWN.

THE COLOR(S) DARK BLUE, LIGHT BLUE, GREEN AND WHITE IS/ARE CLAIMED AS A FEATURE OF THE MARK.

THE MARK CONSISTS OF A HANGER CREATING TWO CIRCLES, IN DARK BLUE, LIGHT BLUE AND GREEN, CONTAINING THE WORDS "LOTS OF CLEAN". "LOTS" APPEARS IN DARK BLUE, "CLEAN" IN A LIGHTER BLUE COLOR, AND "OF" IN WHITE, CONTAINED WITHIN A GREEN LEAF.

FOR DRY CLEANING (U.S. CLS. 100, 103 AND 106).

FIRST USE 1-24-2012; IN COMMERCE 1-24-2012.

GISELLE AGOSTO, EXAMINING ATTORNEY

SN 85-528,318. GREEN LIGHT SOLAR COMPANY, LLC, ASPERS, PA. FILED 1-30-2012.

Harvest the Sun Enjoy a
Greener Tomorrow

THE MARK CONSISTS OF STANDARD CHARACTERS WITHOUT CLAIM TO ANY PARTICULAR FONT, STYLE, SIZE, OR COLOR.

FOR INSTALLATION OF SOLAR ENERGY SYSTEMS AND ALTERNATIVE ENERGY PRODUCTS FOR RESIDENTIAL AND COMMERCIAL USE (U.S. CLS. 100, 103 AND 106).

FIRST USE 7-15-2011; IN COMMERCE 7-15-2011.

JANICE KIM, EXAMINING ATTORNEY

CLASS 37—(Continued).

SN 85-531,411. MARANA AEROSPACE SOLUTIONS, INC., MARANA, AZ. FILED 2-1-2012.

DELIVERING MORE

THE MARK CONSISTS OF STANDARD CHARACTERS WITHOUT CLAIM TO ANY PARTICULAR FONT, STYLE, SIZE, OR COLOR.

FOR AIRCRAFT MAINTENANCE, REPAIR, AND REFUELING (U.S. CLS. 100, 103 AND 106).

ALAIN LAPTER, EXAMINING ATTORNEY

SN 85-531,882. LILLIE, MICHAEL, DBA COUNTY CONSTRUCTION OF MARIN, NOVATO, CA. FILED 2-2-2012.

HELPING PEOPLE LOVE WHERE
THEY LIVE

THE MARK CONSISTS OF STANDARD CHARACTERS WITHOUT CLAIM TO ANY PARTICULAR FONT, STYLE, SIZE, OR COLOR.

FOR CONSTRUCTION AND REMODELING OF RESIDENTIAL PROPERTY (U.S. CLS. 100, 103 AND 106).

AISHA CLARKE, EXAMINING ATTORNEY

SN 85-531,911. PERKINS, ANDREW W., LAS CRUCES, NM. FILED 2-2-2012.



THE MARK CONSISTS OF A CIRCLE WITH A POLAR BEAR WITHIN THE CIRCLE, FORMED BY THE LETTERS "F" AND "R". THE HORIZONTAL "BARS" OF THE "F" JOIN TO THE LEFT VERTICAL "BAR" OF THE "R". THE POLAR BEAR'S HEAD IS AT THE END OF THE LOOP OF THE "R" WHILE THREE LEGS OF THE POLAR BEAR ARE FORMED BY THE BOTTOM "PILLARS" OF THE "F" AND "R".

FOR INSTALLATION AND REPAIR OF HEATING, VENTILATING AND AIR CONDITIONING EQUIPMENT (U.S. CLS. 100, 103 AND 106).

FIRST USE 1-17-2012; IN COMMERCE 1-17-2012.

GISELLE AGOSTO, EXAMINING ATTORNEY

CLASS 37—(Continued).

SN 85-532,193. HOTELIER CONSULTING SERVICES LLC, DBA HOTELIER LINEN SERVICES LLC, MIAMI LAKES, FL. FILED 2-2-2012.

HOTELIER

THE MARK CONSISTS OF STANDARD CHARACTERS WITHOUT CLAIM TO ANY PARTICULAR FONT, STYLE, SIZE, OR COLOR.
FOR LAUNDRY SERVICES (U.S. CLS. 100, 103 AND 106).
FIRST USE 1-1-2008; IN COMMERCE 1-1-2008.
FRANK LATTUCA, EXAMINING ATTORNEY

SN 85-533,091. BENCHMARK PEST CONTROL, INC, BAKERSFIELD, CA. FILED 2-3-2012.



THE COLOR(S) GOLD, WHITE, BLACK, AND RED IS/ ARE CLAIMED AS A FEATURE OF THE MARK.
THE MARK CONSISTS OF AN ANGRY BEE IN GOLD, WHITE, BLACK, AND RED.
FOR PEST CONTROL; ANIMAL CONTROL SERVICES, NAMELY, RODENT CONTROL AND TRAPPING (U.S. CLS. 100, 103 AND 106).
FIRST USE 1-1-2008; IN COMMERCE 1-1-2008.
AMY C. KEAN, EXAMINING ATTORNEY

SN 85-534,470. AXIA ACQUISITION CORPORATION, DULUTH, GA. FILED 2-6-2012.

SERVICE BEYOND REPAIR

THE MARK CONSISTS OF STANDARD CHARACTERS WITHOUT CLAIM TO ANY PARTICULAR FONT, STYLE, SIZE, OR COLOR.
FOR RENTAL SERVICES OF DRYWALL TAPING AND FINISHING TOOLS (U.S. CLS. 100, 103 AND 106).
JASON BLAIR, EXAMINING ATTORNEY

CLASS 37—(Continued).

SN 85-535,522. EVERDRY MARKETING & MANAGEMENT, INC., MACEDONIA, OH. FILED 2-7-2012.

EVER DRY

OWNER OF U.S. REG. NOS. 1,412,615, 3,196,495 AND OTHERS.
THE MARK CONSISTS OF THE WORDS "EVER" AND "DRY" WITH A STYLIZED WATER DROPLET POSITIONED BETWEEN THE TWO WORDS.
FOR BASEMENT AND BELOW GRADE WATER-PROOFING SERVICES (U.S. CLS. 100, 103 AND 106).
FIRST USE 12-31-1998; IN COMMERCE 12-31-1998.
ALYSSA STEEL, EXAMINING ATTORNEY

SN 85-535,684. HOLMES, CHRISTOPHER, FORT LAUDERDALE, FL. FILED 2-7-2012.

ProjectPerfect

THE MARK CONSISTS OF STANDARD CHARACTERS WITHOUT CLAIM TO ANY PARTICULAR FONT, STYLE, SIZE, OR COLOR.
FOR MARINE CONSTRUCTION CONTRACTING (U.S. CLS. 100, 103 AND 106).
APRIL HESIK, EXAMINING ATTORNEY

SN 85-536,795. KIRLIN GROUP, LLC, ROCKVILLE, MD. FILED 2-8-2012.



THE MARK CONSISTS OF STYLIZED LETTERS J, J AND K INTERTWINED.
FOR BUILDING CONSTRUCTION SERVICES (U.S. CLS. 100, 103 AND 106).
FIRST USE 1-1-1970; IN COMMERCE 1-1-1970.
FRANK LATTUCA, EXAMINING ATTORNEY

CLASS 37—(Continued).

SN 85-536,833. PIERCE BUILDING, CANTON, OH. FILED 2-8-2012.

YouRoom

THE MARK CONSISTS OF STANDARD CHARACTERS WITHOUT CLAIM TO ANY PARTICULAR FONT, STYLE, SIZE, OR COLOR.

FOR CONSTRUCTING SUNROOMS (U.S. CLS. 100, 103 AND 106).

WILLIAM P. SHANAHAN, EXAMINING ATTORNEY

SN 85-537,610. GARDEN GLASS PATIOS, LLC, HOUSTON, TX. FILED 2-8-2012.



NO CLAIM IS MADE TO THE EXCLUSIVE RIGHT TO USE "GLASS PATIOS", APART FROM THE MARK AS SHOWN.

THE MARK CONSISTS OF THE WORDS "GARDEN GLASS PATIOS," AND THE "L" IN "GLASS" IS A TREE.

FOR INSTALLATION OF PATIO ROOFS AND AWNINGS (U.S. CLS. 100, 103 AND 106).

DARRYL SPRUILL, EXAMINING ATTORNEY

SN 85-540,207. GVI GUTTER-VAC INTERNATIONAL PTY LTD, DBA G-VAC, ALBION, AUSTRALIA, FILED 2-11-2012.



OWNER OF U.S. REG. NO. 3,946,157.

THE MARK CONSISTS OF THE STYLIZED WORDING OF "G-VAC" WITH A LINE DRAWING OF A ROOF TOP WITH A CHIMNEY OVER THE "VAC" LETTERS.

FOR CLEANING SERVICES, NAMELY, CLEANING OF RESIDENTIAL AND COMMERCIAL PROPERTIES (U.S. CLS. 100, 103 AND 106).

FIRST USE 8-23-2010; IN COMMERCE 8-23-2010.

KIM SAITO, EXAMINING ATTORNEY

CLASS 37—(Continued).

SN 85-561,296. NISSAN JIDOSHA KABUSHIKI KAISHA, TA NISSAN MOTOR CO., LTD., YOKOHAMA-SHI, KANAGAWA, JAPAN, FILED 3-6-2012.

SHIFT_

THE MARK CONSISTS OF STANDARD CHARACTERS WITHOUT CLAIM TO ANY PARTICULAR FONT, STYLE, SIZE, OR COLOR.

OWNER OF U.S. REG. NOS. 2,895,040, 3,142,488 AND 3,960,293.

FOR MOTOR VEHICLE REPAIR AND MAINTENANCE SERVICES (U.S. CLS. 100, 103 AND 106).

AMEEN IMAM, EXAMINING ATTORNEY

SN 85-578,890. DISH NETWORK L.L.C., ENGLEWOOD, CO. FILED 3-23-2012.

DISH

THE MARK CONSISTS OF STANDARD CHARACTERS WITHOUT CLAIM TO ANY PARTICULAR FONT, STYLE, SIZE, OR COLOR.

OWNER OF U.S. REG. NO. 3,440,594.

SEC. 2(F).

FOR INSTALLATION SERVICES FOR RESIDENTIAL AND COMMERCIAL SATELLITE RECEIVERS; INSTALLATION OF HOME THEATRES AND RELATED STRUCTURED WIRING; INSTALLATION OF COMPUTER NETWORKING HARDWARE (U.S. CLS. 100, 103 AND 106).

FIRST USE 5-0-1996; IN COMMERCE 5-0-1996.

ANDREW RHIM, EXAMINING ATTORNEY

CLASS 38—COMMUNICATION

SN 85-260,337. T2 LABS, INC., WILMINGTON, DE. FILED 3-7-2011.

LIGHTBOX

THE MARK CONSISTS OF STANDARD CHARACTERS WITHOUT CLAIM TO ANY PARTICULAR FONT, STYLE, SIZE, OR COLOR.

PRIORITY CLAIMED UNDER SEC. 44(D) ON UNITED KINGDOM APPLICATION NO. 009728536, FILED 2-10-2011, REG. NO. 009728536, DATED 9-29-2011, EXPIRES 2-10-2021.

OWNER OF U.S. REG. NO. 2,870,252.

FOR COMMUNICATIONS BY MEANS OF TELEPHONE, CABLE, BROADBAND, FIBER-OPTIC AND WIRELESS NETWORKS; TELECOMMUNICATION SERVICES, NAMELY, TRANSMISSION OF VOICE, DATA, GRAPHICS AND VIDEO BY MEANS OF TELEPHONE, CABLE, BROADBAND, FIBER-OPTIC AND WIRELESS NETWORKS; ELECTRONIC MAIL SERVICES; ELECTRONIC TRANSMISSION OF DATA, MESSAGE, IMAGES, AND DOCUMENTS; PROVIDING ONLINE CHAT ROOMS; ELECTRONIC TRANSMISSION OF VOICE, DATA AND IMAGES BY TELEVISION AND VIDEO BROADCASTING; WEBCASTING SERVICES; PROVIDING ONLINE FORUMS AND CHAT ROOMS FOR THE TRANSMISSION OF MESSAGES, COMMENTS AND MULTIMEDIA CONTENT AMONG USERS INCLUDING IMAGES, PHOTOS AND VIDEOS (U.S. CLS. 100, 101 AND 104).

CAROLINE WOOD, EXAMINING ATTORNEY

CLASS 38—(Continued).

SN 85-308,082. SOLER, FRANCISCO SAPENA, LLEIDA, SPAIN, FILED 4-29-2011.



Lleida.net

NO CLAIM IS MADE TO THE EXCLUSIVE RIGHT TO USE "LLEIDA.NET", APART FROM THE MARK AS SHOWN.

THE COLOR(S) RED, GREEN, ORANGE, BLUE, WHITE, BLACK AND GRAY IS/ARE CLAIMED AS A FEATURE OF THE MARK.

THE MARK CONSISTS OF A CIRCLE DIVIDED INTO QUARTERS IN THE COLORS RED, GREEN, ORANGE AND BLUE WITH AN INNER CONCENTRIC CIRCLE IN THE COLORS BLACK, RED, BLUE AND GRAY DIVIDED AMONG THE CIRCLE'S QUARTERS, IN THE CENTER OF WHICH IS A WHITE LETTER "N"; BENEATH THE DESIGN FEATURE IS THE TERM, "LLEIDA.NET" IN THE COLOR BLACK.

FOR PROVIDING SHORT MESSAGE SERVICE (SMS), MULTIMEDIA MESSAGE SERVICE (MMS), AND E-MAIL SERVICES FOR PERSONS, BUSINESSES, OTHER CARRIERS OF THESE SERVICES AND OTHER ENTITIES (U.S. CLS. 100, 101 AND 104).

BARNEY CHARLON, EXAMINING ATTORNEY

SN 85-327,423. CJ 4DPLEX CO., LTD., SEOUL, REPUBLIC OF KOREA, FILED 5-23-2011.

4DX

THE MARK CONSISTS OF STANDARD CHARACTERS WITHOUT CLAIM TO ANY PARTICULAR FONT, STYLE, SIZE, OR COLOR.

PRIORITY CLAIMED UNDER SEC. 44(D) ON REPUBLIC OF KOREA APPLICATION NO. 41-2010-3068, FILED 11-30-2010, REG. NO. 0226357, DATED 2-13-2012, EXPIRES 2-13-2022.

FOR BROADCASTING MOVIES; BROADCASTING MOVIES FEATURING MOVIES AUDIENCE EFFECTS SUCH AS WIND, SCENT, WATER SPRAY, MOTION, VIBRATION, SMOKE, BUBBLE, LASER OR FLASH; CABLE TELEVISION BROADCASTING; RADIO BROADCASTING; TELEVISION BROADCASTING; PROVIDING TELECOMMUNICATIONS CONNECTIONS TO A GLOBAL COMPUTER NETWORK; TELEPHONE SERVICES; COMPUTER-AIDED TRANSMISSION OF MESSAGES AND IMAGES; WIRELESS BROADBAND COMMUNICATION SERVICES (U.S. CLS. 100, 101 AND 104).

PATRICIA EVANKO, EXAMINING ATTORNEY

CLASS 38—(Continued).

SN 85-354,517. TEXTPOWER, INC., SAN JUAN CAPISTRANO, CA. FILED 6-23-2011.

10-CODE

THE MARK CONSISTS OF STANDARD CHARACTERS WITHOUT CLAIM TO ANY PARTICULAR FONT, STYLE, SIZE, OR COLOR.

FOR TELECOMMUNICATION SERVICE TO ALLOW CUSTOMERS TO RESERVE A 10-DIGIT PHONE NUMBER ADDRESS ASSOCIATED WITH A TEXT MESSAGE SERVICE (U.S. CLS. 100, 101 AND 104).

FIRST USE 6-13-2011; IN COMMERCE 6-13-2011.
EDWARD NELSON, EXAMINING ATTORNEY

SN 85-354,559. TEXTPOWER, INC., SAN JUAN CAPISTRANO, CA. FILED 6-23-2011.

TCARD

THE MARK CONSISTS OF STANDARD CHARACTERS WITHOUT CLAIM TO ANY PARTICULAR FONT, STYLE, SIZE, OR COLOR.

FOR TELECOMMUNICATIONS SERVICES TO ALLOW INDIVIDUALS TO USE CELLULAR TELEPHONES TO ACCESS A BUSINESS CARD THAT IS DEFINED BY THE BUSINESS CARD HOLDER VIA THE SENDING OF A TEXT MESSAGE (U.S. CLS. 100, 101 AND 104).

FIRST USE 6-13-2011; IN COMMERCE 6-13-2011.
EDWARD NELSON, EXAMINING ATTORNEY

SN 85-365,875. TEXTPOWER, INC., SAN JUAN CAPISTRANO, CA. FILED 7-7-2011.

TEXTKEY

THE MARK CONSISTS OF STANDARD CHARACTERS WITHOUT CLAIM TO ANY PARTICULAR FONT, STYLE, SIZE, OR COLOR.

FOR TELECOMMUNICATIONS SERVICES TO ALLOW INDIVIDUALS TO USE CELLULAR TELEPHONES TO ACCESS TEXT MESSAGES DESIGNATED FOR AN ALTERNATIVE TO SHORT CODES WHERE THE CUSTOMER'S CELLULAR SERVICE PROVIDER MAY NOT UTILIZE THE USE OF SHORT CODES FOR TEXTING (U.S. CLS. 100, 101 AND 104).

FIRST USE 11-16-2010; IN COMMERCE 11-16-2010.
EDWARD NELSON, EXAMINING ATTORNEY

CLASS 38—(Continued).

SN 85-409,995. VIRGIN ISLANDS PUBLIC TELEVISION SYSTEM, CHAROTTE AMALIE, US VIRGIN ISLANDS, FILED 8-29-2011.

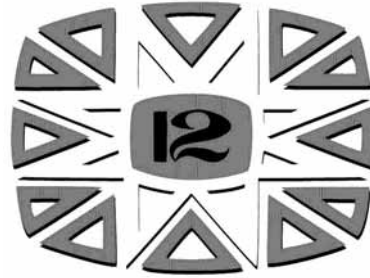

NO CLAIM IS MADE TO THE EXCLUSIVE RIGHT TO USE "12", APART FROM THE MARK AS SHOWN.

THE MARK CONSISTS OF A RECTANGLE ENCOMPASSING A NUMBER OF INTERSECTING TRIANGLES, WITH A RECTANGLE WITH CURVED SIDES IN THE CENTER ENCLOSING THE STYLIZED NUMBER "12".

FOR STREAMING OF AUDIOVISUAL MATERIAL ON THE INTERNET; TELECOMMUNICATION SERVICES, NAMELY, TRANSMISSION OF PODCASTS; TELEVISION BROADCASTING (U.S. CLS. 100, 101 AND 104).

FIRST USE 8-22-2003; IN COMMERCE 8-22-2003.
ANDREA HACK, EXAMINING ATTORNEY

SN 85-453,244. CUP O' DIRT L.L.C., BRANDON, SD. FILED 10-21-2011.



NO CLAIM IS MADE TO THE EXCLUSIVE RIGHT TO USE "RADIO", APART FROM THE MARK AS SHOWN.

THE MARK CONSISTS OF A SUN WITH 13 RAYS. THE SUN HAS A BIG SMILE, SLOTTED 80'S STYLE SUNGLASSES, AND A CURVED NOSE. TO THE RIGHT IS THE STYLIZED TEXT "SUNNY" ABOVE THE STYLIZED TEXT "RADIO". UNDER THE SUN AND THE PREVIOUS TEXT IS STYLIZED TEXT "WHERE IT'S ALWAYS IN THE 80'S!".

FOR RADIO BROADCASTING (U.S. CLS. 100, 101 AND 104).
FIRST USE 12-1-2010; IN COMMERCE 12-1-2010.
EMILY CARLSEN, EXAMINING ATTORNEY

CLASS 38—(Continued).

SN 85-469,977. EPSTEIN, JESSE C, DBA LOVEOPOLIS, INC., BURLINGTON, VT. FILED 11-10-2011.

CIRCLE IT

THE MARK CONSISTS OF STANDARD CHARACTERS WITHOUT CLAIM TO ANY PARTICULAR FONT, STYLE, SIZE, OR COLOR.

FOR PROVIDING AN ON-LINE FORUM FOR SOCIAL NETWORKING, COMMUNICATIONS ON TOPICS OF GENERAL INTEREST, FOR TRANSMISSION OF MESSAGES AMONG COMPUTER USERS (U.S. CLS. 100, 101 AND 104).

FIRST USE 2-1-2011; IN COMMERCE 2-1-2011.
CURTIS FRENCH, EXAMINING ATTORNEY

SN 85-473,315. VALLEY TELEPHONE COOPERATIVE, INC., RAYMONDVILLE, TX. FILED 11-15-2011.

CONNECT. SELECT. ENABLE.

THE MARK CONSISTS OF STANDARD CHARACTERS WITHOUT CLAIM TO ANY PARTICULAR FONT, STYLE, SIZE, OR COLOR.

FOR AUDIO AND VIDEO BROADCASTING SERVICES OVER THE INTERNET; BROADCASTING OF VIDEO AND AUDIO PROGRAMMING OVER THE INTERNET; BROADCASTING SERVICES AND PROVISION OF TELECOMMUNICATION ACCESS TO FILMS AND TELEVISION PROGRAMMES PROVIDED VIA A VIDEO-ON-DEMAND SERVICE; CALL SCREENING SERVICES; COMMUNICATION SERVICES, NAMELY, TRANSMISSION OF VOICE, AUDIO, VISUAL IMAGES AND DATA BY TELECOMMUNICATIONS NETWORKS, WIRELESS COMMUNICATION NETWORKS, THE INTERNET, INFORMATION SERVICES NETWORKS AND DATA NETWORKS; COMMUNICATIONS BY TELEPHONE; COMMUNICATIONS VIA FIBER-OPTIC NETWORKS; COMPUTERISED TELEPHONY SERVICES; DIGITAL NETWORK TELECOMMUNICATIONS SERVICES; INTERNET TELEPHONY SERVICES; LOCAL AND LONG DISTANCE TELEPHONE SERVICES; PROVIDING ACCESS TO TELECOMMUNICATION NETWORKS; PROVIDING ACCESS TO THE INTERNET; PROVIDING TELECOMMUNICATIONS CONNECTIONS TO THE INTERNET OR DATABASES; PROVIDING VOICE COMMUNICATION SERVICES VIA THE INTERNET; PROVISION OF ACCESS TO THE INTERNET; SUBSCRIPTION TELEVISION BROADCASTING; TELECOMMUNICATION ACCESS SERVICES; TELECOMMUNICATION SERVICES, NAMELY, LOCAL AND LONG DISTANCE TRANSMISSION OF VOICE, DATA, GRAPHICS AND VIDEO BY MEANS OF BROADBAND OPTICAL OR WIRELESS NETWORKS; TELECOMMUNICATION SERVICES, NAMELY, PROVIDING INTERNET ACCESS VIA BROADBAND OPTICAL OR WIRELESS NETWORKS; TELECOMMUNICATIONS SERVICES, NAMELY, PROVIDING FIBER OPTIC NETWORK SERVICES; TELEPHONE COMMUNICATION SERVICES; TELEVISION BROADCASTING; VIDEO ON DEMAND TRANSMISSIONS (U.S. CLS. 100, 101 AND 104).

MICHELE SWAIN, EXAMINING ATTORNEY

CLASS 38—(Continued).

SN 85-485,284. OIC BOOKS, LLC, CARMEL, CA. FILED 12-1-2011.

NEW VIEWS INTO THE WORLD

THE MARK CONSISTS OF STANDARD CHARACTERS WITHOUT CLAIM TO ANY PARTICULAR FONT, STYLE, SIZE, OR COLOR.

FOR (BASED ON INTENT TO USE) STREAMING OF VIDEO CONTENT VIA A GLOBAL COMPUTER NETWORK; VIDEO BROADCASTING; STREAMING OF AUDIO CONTENT VIA A GLOBAL COMPUTER NETWORK; AUDIO BROADCASTING; SUBSCRIPTION VIDEO BROADCASTING VIA A GLOBAL COMPUTER NETWORK; SUBSCRIPTION AUDIO BROADCASTING VIA A GLOBAL COMPUTER NETWORK; ELECTRONIC TRANSMISSION OF AUDIO AND VIDEO FILES VIA COMMUNICATIONS NETWORKS; PROVIDING AN ON-LINE FORUM FOR USERS TO EXCHANGE VIEWS ON BOOKS, ELECTRONIC BOOKS, E-BOOKS, MULTIMEDIA BOOKS, AUDIO BOOKS, ONLINE BOOKS, PUBLICATIONS, ELECTRONIC PUBLICATIONS, PERIODICALS, MAGAZINES, NEWSLETTERS, BOOKLETS, MANUALS, JOURNALS AND AUDIO, VIDEO, AUDIO/VIDEO AND MULTIMEDIA CONTENT AND OTHER TOPICS OF GENERAL INTEREST; PROVIDING AN ONLINE FORUM FOR TRANSMISSION OF MESSAGES AMONG COMPUTER USERS CONCERNING BOOKS, ELECTRONIC BOOKS, E-BOOKS, MULTIMEDIA BOOKS, AUDIO BOOKS, ONLINE BOOKS, PUBLICATIONS, ELECTRONIC PUBLICATIONS, PERIODICALS, MAGAZINES, NEWSLETTERS, BOOKLETS, MANUALS, JOURNALS, AND OTHER TOPICS OF GENERAL INTEREST; (BASED ON USE IN COMMERCE) PROVIDING ONLINE COMMUNICATIONS LINKS WHICH TRANSFER THE WEBSITE USER TO OTHER LOCAL AND GLOBAL WEB PAGES (U.S. CLS. 100, 101 AND 104).

FIRST USE 10-15-2011; IN COMMERCE 10-15-2011.
ANDREW RHIM, EXAMINING ATTORNEY

SN 85-494,542. BRYTE LIGHT ENTERPRISES LLC, DEL MAR, CA. FILED 12-13-2011.

TEXT N GO

THE MARK CONSISTS OF STANDARD CHARACTERS WITHOUT CLAIM TO ANY PARTICULAR FONT, STYLE, SIZE, OR COLOR.

NO CLAIM IS MADE TO THE EXCLUSIVE RIGHT TO USE "TEXT", APART FROM THE MARK AS SHOWN.

FOR WIRELESS ELECTRONIC TRANSMISSION OF CONTENT FOR PROCESSING ORDERS FOR GOOD AND SERVICES USING MOBILE COMMUNICATIONS DEVICES; PROVIDING E-MAIL SERVICES; TELECOMMUNICATION SERVICES, NAMELY, WIRELESS TRANSMISSION OF DATA TO ENABLE USERS TO SEND AND/OR RECEIVE MESSAGES THROUGH A WIRELESS DATA NETWORK; ONE-WAY AND TWO-WAY PAGING SERVICES; TELECOMMUNICATION SERVICES, NAMELY, ELECTRONIC AND DIGITAL TRANSMISSION AND RECEPTION OF VOICE COMMUNICATIONS BY MEANS OF WIRELESS COMMUNICATION NETWORKS (U.S. CLS. 100, 101 AND 104).

FIRST USE 10-1-2011; IN COMMERCE 10-1-2011.
CHRISTOPHER LAW, EXAMINING ATTORNEY

CLASS 38—(Continued).

SN 85-502,933. GLOBAL CHRISTIAN NETWORK, INC., LOGANVILLE, GA. FILED 12-23-2011.



NO CLAIM IS MADE TO THE EXCLUSIVE RIGHT TO USE "NETWORK", APART FROM THE MARK AS SHOWN. THE MARK CONSISTS OF THE LETTERS "G","C","N" NEXT TO A GLOBE OVER THE WORDS "GLOBAL CHRISTIAN NETWORK".

SEC. 2(F) AS TO "GLOBAL CHRISTIAN NETWORK". FOR CABLE TELEVISION BROADCASTING; TELEVISION BROADCASTING (U.S. CLS. 100, 101 AND 104). FIRST USE 9-1-2005; IN COMMERCE 9-1-2005. ROSELLE HERRERA, EXAMINING ATTORNEY

CLASS 38—(Continued).

SN 85-519,885. JOHNSON, ERNEST L., BATON ROUGE, LA. FILED 1-19-2012.

THOUGHT NETWORK BROADCASTING GROUP

THE MARK CONSISTS OF STANDARD CHARACTERS WITHOUT CLAIM TO ANY PARTICULAR FONT, STYLE, SIZE, OR COLOR.

NO CLAIM IS MADE TO THE EXCLUSIVE RIGHT TO USE "NETWORK BROADCASTING GROUP", APART FROM THE MARK AS SHOWN.

FOR TELECOMMUNICATION SERVICES, NAMELY, TRANSMISSION OF VOICE, DATA, GRAPHICS, IMAGES, AUDIO AND VIDEO BY MEANS OF TELECOMMUNICATIONS NETWORKS, WIRELESS COMMUNICATION NETWORKS, AND THE INTERNET; TELECOMMUNICATION SERVICES, NAMELY, TRANSMISSION OF WEBCASTS; TELEVISION AND RADIO BROADCASTING SERVICES; TELEVISION BROADCASTING; TELEVISION PROGRAMME BROADCASTING; TELEVISION PROGRAMME BROADCASTING VIA CABLE; TRANSMISSION OF RADIO AND TELEVISION PROGRAMMES BY SATELLITE (U.S. CLS. 100, 101 AND 104).

MORGAN WYNNE, EXAMINING ATTORNEY

SN 85-505,962. UNIVISION RADIO, INC., DALLAS, TX. FILED 12-29-2011.

LATINO MIX

THE MARK CONSISTS OF STANDARD CHARACTERS WITHOUT CLAIM TO ANY PARTICULAR FONT, STYLE, SIZE, OR COLOR.

OWNER OF U.S. REG. NO. 1,852,658. SEC. 2(F). FOR RADIO BROADCASTING SERVICES (U.S. CLS. 100, 101 AND 104). FIRST USE 8-0-1999; IN COMMERCE 8-4-1999. AMY C. KEAN, EXAMINING ATTORNEY

SN 85-532,896. NATIONAL ASSOCIATION OF PROFESSIONALLY ACCREDITED CONTRACTORS LLC, GREAT FALLS, VA. FILED 2-3-2012.

CleanClose

THE MARK CONSISTS OF STANDARD CHARACTERS WITHOUT CLAIM TO ANY PARTICULAR FONT, STYLE, SIZE, OR COLOR.

FOR ELECTRONIC MESSAGE SERVICES, NAMELY, THE TRACKING, VERIFICATION AND SUBSEQUENT TRANSMISSION OF ELECTRONIC DOCUMENTATION AND MESSAGES IN THE REMODELING AND HOME IMPROVEMENT INDUSTRY (U.S. CLS. 100, 101 AND 104).

KELLY TRUSILO, EXAMINING ATTORNEY

CLASS 38—(Continued).

SN 85-534,306. CONFERNET PTY LTD, SYDNEY, AUSTRALIA, FILED 2-5-2012.

confernet

THE MARK CONSISTS OF STANDARD CHARACTERS WITHOUT CLAIM TO ANY PARTICULAR FONT, STYLE, SIZE, OR COLOR.

FOR TELECOMMUNICATION SERVICES, NAMELY, TRANSMISSION OF VOICE, DATA, GRAPHICS, IMAGES, AUDIO AND VIDEO BY MEANS OF TELECOMMUNICATIONS NETWORKS, WIRELESS COMMUNICATION NETWORKS, AND THE INTERNET (U.S. CLS. 100, 101 AND 104).

FIRST USE 1-13-2012; IN COMMERCE 1-13-2012.
DAVID I, EXAMINING ATTORNEY

SN 85-534,791. RETIREMENT LIVING TV, LLC, BALTIMORE, MD. FILED 2-6-2012.



THE COLOR(S) GOLD, DARKER GOLD AND BLACK IS/ ARE CLAIMED AS A FEATURE OF THE MARK.

THE MARK CONSISTS OF THE LETTERS "RLTV" ON THE FIRST LINE WITH THE WORDS "REDEFINE LIFE," WITH A DASH BEFORE AND AFTER, ON THE SECOND LINE CENTERED BELOW; THE LITERAL AND OTHER ELEMENTS OF THE MARK ARE IN THE COLOR GOLD ON THE FACE OF THE LETTERS OF THE LITERAL ELEMENT OF THE MARK AND THE DASHES, WITH A THIN BLACK LINE ON THE LEFT AND UNDERSIDE OF THE LETTERS OF THE LITERAL ELEMENT AND THE DASHES, AND A SOLID DARKER GOLD THIN LINE ON PARTS OF THE RIGHT SIDE AND UPPER PORTIONS OF THE LETTERS OF THE LITERAL ELEMENT AND THE DASHES.

FOR CABLE TELEVISION BROADCASTING SERVICES (U.S. CLS. 100, 101 AND 104).
FIRST USE 10-20-2011; IN COMMERCE 10-20-2011.
JAY FLOWERS, EXAMINING ATTORNEY

CLASS 38—(Continued).

SN 85-535,036. ALLCOMM WIRELESS, INC., BIRMINGHAM, AL. FILED 2-6-2012.

TRBOCOMM

THE MARK CONSISTS OF STANDARD CHARACTERS WITHOUT CLAIM TO ANY PARTICULAR FONT, STYLE, SIZE, OR COLOR.

FOR TELECOMMUNICATION SERVICES, NAMELY PROVIDING ACCESS TO TWO-WAY RADIO USERS ON A WIDE AREA NETWORK (U.S. CLS. 100, 101 AND 104).
NAPOLEON SHARMA, EXAMINING ATTORNEY

SN 85-535,048. PAVLOV MEDIA, INC., CHAMPAIGN, IL. FILED 2-6-2012.

**Simply Exceptional
Connections**

THE MARK CONSISTS OF STANDARD CHARACTERS WITHOUT CLAIM TO ANY PARTICULAR FONT, STYLE, SIZE, OR COLOR.

FOR INTERNET SERVICE PROVIDER (ISP); INTERNET TELEPHONY SERVICES; TELEVISION TRANSMISSION SERVICES (U.S. CLS. 100, 101 AND 104).

FIRST USE 3-2-2010; IN COMMERCE 3-2-2010.
DAVID TAYLOR, EXAMINING ATTORNEY

SN 85-535,104. ITX CORP., PITTSFORD, NY. FILED 2-6-2012.

THE NEW HOW

THE MARK CONSISTS OF STANDARD CHARACTERS WITHOUT CLAIM TO ANY PARTICULAR FONT, STYLE, SIZE, OR COLOR.

FOR E-MAIL DATA SERVICES; PROVIDING MULTIPLE USER DIAL-UP AND DEDICATED ACCESS TO THE INTERNET (U.S. CLS. 100, 101 AND 104).

FIRST USE 0-0-2001; IN COMMERCE 0-0-2002.
LUCY ARANT, EXAMINING ATTORNEY

CLASS 38—(Continued).

SN 85-535,305. ADIR INTERNATIONAL, LLC, LOS ANGELES, CA. FILED 2-6-2012.

CURATEL

THE MARK CONSISTS OF STANDARD CHARACTERS WITHOUT CLAIM TO ANY PARTICULAR FONT, STYLE, SIZE, OR COLOR.

FOR TELECOMMUNICATION SERVICES, NAMELY, LOCAL AND LONG DISTANCE TRANSMISSION OF VOICE, DATA, GRAPHICS BY MEANS OF TELEPHONE, TELEGRAPHIC, CABLE, SATELLITE TRANSMISSIONS, AND PROVIDING INTERNET ACCESS VIA BROADBAND OPTICAL OR WIRELESS NETWORKS (U.S. CLS. 100, 101 AND 104).

FIRST USE 12-15-2001; IN COMMERCE 1-1-2005.
LINDSEY RUBIN, EXAMINING ATTORNEY

SN 85-536,911. CLEARWIRE COMMUNICATIONS LLC, BELLEVUE, WA. FILED 2-8-2012.



OWNER OF U.S. REG. NO. 3,782,759.
THE COLOR(S) GRAY, GREEN AND WHITE IS/ARE CLAIMED AS A FEATURE OF THE MARK.

THE MARK CONSISTS OF THE WORD CLEAR IN GRAY TO THE LEFT OF A GREEN SPHERE WITH A WHITE SPIRAL DESIGN.

FOR TELECOMMUNICATIONS SERVICES, NAMELY, PROVIDING HIGH-SPEED ACCESS TO AREA NETWORKS AND GLOBAL COMPUTER INFORMATION NETWORKS; ELECTRONIC, ELECTRIC AND DIGITAL TRANSMISSION OF DATA, IMAGES, VOICE, SIGNALS, AND MESSAGES (U.S. CLS. 100, 101 AND 104).

FIRST USE 4-8-2009; IN COMMERCE 4-8-2009.
DOMINICK J. SALEMI, EXAMINING ATTORNEY

SN 85-536,941. CLEARWIRE COMMUNICATIONS LLC, BELLEVUE, WA. FILED 2-8-2012.

THE WAY THE INTERNET SHOULD BE

THE MARK CONSISTS OF STANDARD CHARACTERS WITHOUT CLAIM TO ANY PARTICULAR FONT, STYLE, SIZE, OR COLOR.

FOR TELECOMMUNICATIONS SERVICES, NAMELY, PROVIDING HIGH-SPEED ACCESS TO AREA NETWORKS AND GLOBAL COMPUTER INFORMATION NETWORKS; ELECTRONIC, ELECTRIC AND DIGITAL TRANSMISSION OF DATA, IMAGES, VOICE, SIGNALS, AND MESSAGES (U.S. CLS. 100, 101 AND 104).

DOMINICK J. SALEMI, EXAMINING ATTORNEY

CLASS 38—(Continued).

SN 85-537,852. SOMOSTV, LLC, MIAMI, FL. FILED 2-9-2012.

THE COLOR(S) YELLOW AND BLACK IS/ARE CLAIMED AS A FEATURE OF THE MARK.

THE MARK CONSISTS OF KLAVO IN STYLIZED YELLOW LETTERS ON A BLACK BACKGROUND.

FOR TELEVISION BROADCASTING (U.S. CLS. 100, 101 AND 104).

KARANENDRA S. CHHINA, EXAMINING ATTORNEY

SN 85-538,347. NGC, INC., DBA NEXT GENERATION COMMUNICATIONS, CHANTILLY, VA. FILED 2-9-2012.

CALLINGO

THE MARK CONSISTS OF STANDARD CHARACTERS WITHOUT CLAIM TO ANY PARTICULAR FONT, STYLE, SIZE, OR COLOR.

FOR TELECOMMUNICATION SERVICES, NAMELY, WIRELESS TELEPHONE SERVICES; TELECOMMUNICATIONS SERVICES, NAMELY, PROVIDING PREPAID MINUTES FOR USE ON CELL PHONES ABROAD; TELEPHONE COMMUNICATION SERVICES; WIRELESS TELEPHONE TELECOMMUNICATIONS SERVICES, NAMELY, WIRELESS MOBILE TELEPHONE CALLING PLANS (U.S. CLS. 100, 101 AND 104).

FIRST USE 0-0-2005; IN COMMERCE 5-0-2007.
JEFFREY LOOK, EXAMINING ATTORNEY

CLASS 38—(Continued).

SN 85-543,560. LEVEL 3 COMMUNICATIONS, LLC, BROOMFIELD, CO. FILED 2-15-2012.

STEEL THREAD

THE MARK CONSISTS OF STANDARD CHARACTERS WITHOUT CLAIM TO ANY PARTICULAR FONT, STYLE, SIZE, OR COLOR.

FOR INTERNET ACCESS PROVIDER SERVICES; PROVIDING INTERNET ACCESS; PROVIDING MULTIPLE USER DIAL-UP AND DEDICATED ACCESS TO THE INTERNET; PROVIDING MULTIPLE-USER ACCESS TO A GLOBAL COMPUTER INFORMATION NETWORK; PROVIDING REMOTE INTERNET ACCESS; PROVIDING USER ACCESS TO A GLOBAL COMPUTER NETWORK; PROVISION OF ACCESS TO A GLOBAL COMPUTER NETWORK (U.S. CLS. 100, 101 AND 104).
YAT SYE, LEE, EXAMINING ATTORNEY

SN 85-549,125. PROCONGPS, INC., KNOXVILLE, TN. FILED 2-22-2012.



OWNER OF U.S. REG. NOS. 3,535,177, 3,723,503 AND OTHERS.

NO CLAIM IS MADE TO THE EXCLUSIVE RIGHT TO USE "GPS", APART FROM THE MARK AS SHOWN.

THE COLOR(S) GOLD, BLACK AND GRAY IS/ARE CLAIMED AS A FEATURE OF THE MARK.

THE MARK CONSISTS OF THE WORD "GOLDSTARGPS", WHEREIN "GOLD" IS IN GOLD BLOCK LETTERS, "STAR" IS IN BLACK BLOCK LETTERS, AND "GPS" IS IN GOLD BLOCK LETTERS THAT ARE SMALLER THAN THE LETTERS OF "GOLDSTAR", AND A STYLIZED FIVE-POINT GOLD STAR DISPOSED ABOVE "GPS", WHEREIN THE TOP-LEFT POINT OF THE STAR FORMS AN ARC OVER THE LETTERS "TAR" IN "GOLDSTAR", AND THE PHRASE "GUIDED BY SPIREON" DISPOSED BELOW "GOLDSTARGPS" AND RIGHT-JUSTIFIED THEREWITH, WHEREIN "GUIDED BY" IS IN SMALL GRAY BLOCK LETTERS AND "SPIREON" IS IN SMALL BLACK BLOCK LETTERS WITH THE LETTER "I" DOTTED BY A GRAY TRIANGLE.

FOR SUBSCRIPTION BASED SERVICES, NAMELY, ELECTRONIC TRANSMISSION OF DATA AND INFORMATION VIA A GLOBAL COMPUTER NETWORK FOR TRACKING THE LOCATION OF A WIRELESS DEVICE AND FOR MONITORING OR CONTROLLING FUNCTIONS OF A MOBILE ASSET ON WHICH THE WIRELESS DEVICE IS INSTALLED, SUCH AS AN AUTOMOBILE, TRUCK, FLEET VEHICLE, TRAILER, OR CARGO CONTAINER (U.S. CLS. 100, 101 AND 104).
FRANK LATTUCA, EXAMINING ATTORNEY

CLASS 39—TRANSPORTATION AND STORAGE

SN 76-710,073. RED BUG MOTORS, LLC, JEKYLL ISLAND, GA. FILED 12-20-2011.



NO CLAIM IS MADE TO THE EXCLUSIVE RIGHT TO USE "MOTORS" AND "JEKYLL ISLAND", APART FROM THE MARK AS SHOWN.

THE COLOR(S) BLACK, RED AND WHITE IS/ARE CLAIMED AS A FEATURE OF THE MARK.

THE MARK CONSISTS OF THE WORDING "RED BUG MOTORS JEKYLL ISLAND" IN STYLIZED UPPERCASE LETTERING. THE WORDING "RED BUG MOTORS" APPEARS IN BLACK ARCHED ABOVE A DESIGN OF A RED CAR HAVING BLACK TIRES. THE WORDING "JEKYLL ISLAND" APPEARS IN WHITE INSIDE A RED CURVED BAND APPEARING UNDERNEATH THE RED CAR DESIGN.

FOR RENTAL OF ELECTRIC LOW SPEED VEHICLES (U.S. CLS. 100 AND 105).

FIRST USE 4-15-2006; IN COMMERCE 4-15-2006.
HAI-LY LAM, EXAMINING ATTORNEY

SN 77-003,477. FLORIDA DEPARTMENT OF TRANSPORTATION, TALLAHASSEE, FL. FILED 9-20-2006.

MY FLORIDA 511

THE MARK CONSISTS OF STANDARD CHARACTERS WITHOUT CLAIM TO ANY PARTICULAR FONT, STYLE, SIZE, OR COLOR.

NO CLAIM IS MADE TO THE EXCLUSIVE RIGHT TO USE "FLORIDA 511", APART FROM THE MARK AS SHOWN.

FOR TRAVEL INFORMATION SERVICES FEATURING ROUTE-SPECIFIC INFORMATION ON CURRENT TRAFFIC AND HIGHWAY CONDITIONS (U.S. CLS. 100 AND 105).

JULIE VEPPUMTHARA, EXAMINING ATTORNEY

CLASS 39—(Continued).

SN 79-104,947. APM TERMINALS B.V., NETHERLANDS, FILED 9-2-2011.



PRIORITY DATE OF 5-30-2011 IS CLAIMED.
OWNER OF INTERNATIONAL REGISTRATION 1096516
DATED 9-2-2011, EXPIRES 9-2-2021.

THE COLOR(S) ORANGE IS/ARE CLAIMED AS A FEATURE OF THE MARK.

THE MARK CONSISTS OF THE WORDING "LIFTING GLOBAL TRADE" IN ORANGE WITH THREE DIAGONAL LINES APPEARING IN ORANGE ABOVE THE "L" IN "LIFTING".

FOR TRANSPORT AND STORAGE OF GOODS; PACKAGING OF GOODS FOR TRANSPORT; DELIVERY OF GOODS; STEVEDORING IN THE NATURE OF CARGO LOADING AND UNLOADING OF SHIPS; FREIGHT FORWARDING; STORAGE, CARGO AND RECYCLING CONTAINER RENTAL; WAREHOUSE RENTAL AND STORE ROOM RENTAL IN THE NATURE OF WAREHOUSE SPACE RENTAL; INFORMATION REGARDING TRANSPORTATION AND STORAGE OF GOODS; LOGISTICS SERVICES, NAMELY, STORAGE, TRANSPORTATION AND DELIVERY OF GOODS FOR OTHERS BY AIR, RAIL, SHIP OR TRUCK; AFOREMENTIONED SERVICES ALSO IN THE CONTEXT OF THE MANAGEMENT OF CONTAINER TERMINALS, NAMELY, TRANSPORT OF GOODS, STORAGE OF GOODS, PACKAGING OF GOODS TO THE ORDER AND SPECIFICATION OF OTHERS, DELIVERY OF GOODS, STORAGE CONTAINER RENTAL, WAREHOUSE RENTAL (U.S. CLS. 100 AND 105).
KATHRYN COWARD, EXAMINING ATTORNEY

SN 85-207,661. UNISHIPPERS GLOBAL LOGISTICS, LLC, SALT LAKE CITY, UT. FILED 12-29-2010.



NO CLAIM IS MADE TO THE EXCLUSIVE RIGHT TO USE "FREIGHT MANAGER", APART FROM THE MARK AS SHOWN.

THE MARK CONSISTS OF THE WORDS "FREIGHT MANAGER" IN STYLIZED LETTERING WITH THE WORD "FREIGHT" POSITIONED AS A TRAILER ON THE BACK OF A TRUCK.

FOR PARCEL SHIPPING SERVICES; SHIPPING AND DELIVERY SERVICES, NAMELY, PICKUP, TRANSPORTATION, AND DELIVERY OF PACKAGES AND LETTERS BY VARIOUS MODES OF TRANSPORTATION (U.S. CLS. 100 AND 105).

FIRST USE 11-30-2010; IN COMMERCE 11-30-2010.
TINA L. SNAPP, EXAMINING ATTORNEY

CLASS 39—(Continued).

SN 85-375,606. DALLAS VALET SERVICE INC., DALLAS, TX. AND DEMACHKIE, DANNY, RICHARDSON, TX. FILED 7-19-2011.



NO CLAIM IS MADE TO THE EXCLUSIVE RIGHT TO USE "DALLAS VALET", APART FROM THE MARK AS SHOWN.

THE COLOR(S) BLACK, RED AND WHITE IS/ARE CLAIMED AS A FEATURE OF THE MARK.

THE MARK CONSISTS OF THE WORDS "DALLAS VALET" WITH "DALLAS" VERTICAL IN BLACK AND "VALET" IN RED, DIVIDED BY A BLACK TRIANGLE THAT CONNECTS WITH A BLACK LINE UNDER BOTH WORDS AND A WHITE RECTANGLE INSIDE THE BLACK LINE.

FOR VALET PARKING (U.S. CLS. 100 AND 105).
FIRST USE 6-1-1993; IN COMMERCE 6-1-1993.
FRANK LATTUCA, EXAMINING ATTORNEY

SN 85-435,031. CASCO BAY ISLAND TRANSIT DISTRICT, PORTLAND, ME. FILED 9-29-2011.

CASCO BAY LINES

THE MARK CONSISTS OF STANDARD CHARACTERS WITHOUT CLAIM TO ANY PARTICULAR FONT, STYLE, SIZE, OR COLOR.

NO CLAIM IS MADE TO THE EXCLUSIVE RIGHT TO USE "LINES", APART FROM THE MARK AS SHOWN.

SEC. 2(F).
FOR CHARTERING OF BOATS; TRANSPORT BY FERRY AND BOAT (U.S. CLS. 100 AND 105).
FIRST USE 10-24-1987; IN COMMERCE 10-24-1987.
ELLEN B. AWRICH, EXAMINING ATTORNEY

CLASS 39—(Continued).

SN 85-454,426. RAIL LOGIX GP, LLC, HOUSTON, TX. FILED 10-24-2011.

Rail Logix

THE MARK CONSISTS OF STANDARD CHARACTERS WITHOUT CLAIM TO ANY PARTICULAR FONT, STYLE, SIZE, OR COLOR.

NO CLAIM IS MADE TO THE EXCLUSIVE RIGHT TO USE "RAIL", APART FROM THE MARK AS SHOWN.

FOR RAILCAR STORAGE; ON-DEMAND SWITCHING, NAMELY, MOVING OF RAILCARS TO A LOCATION DESIGNATED BY A CUSTOMER SUCH AS FROM STORAGE INTO THE STAGING AREA OF THE RAIL YARD, TO THE INTERCHANGE, TO A TRANSLOADING AREA, OR VICE VERSA; RAILCAR INTERCHANGE SERVICES, NAMELY, COORDINATING WITH MAIN RAIL LINE CARRIERS TO MOVE RAILCARS OUT OF THE RAIL YARD AND ONTO THE MAIN RAIL LINE FOR TRANSPORTATION OUT OF THE RAIL YARD, AND VICE VERSA; AND, TRANSLOADING SERVICES, NAMELY, FREIGHT LOADING SERVICES (U.S. CLS. 100 AND 105).

FIRST USE 9-1-2011; IN COMMERCE 9-1-2011.
JOHN DWYER, EXAMINING ATTORNEY

CLASS 39—(Continued).

SN 85-512,174. INTERSTATE WORLDWIDE RELOCATION SERVICES, SPRINGFIELD, VA. FILED 1-9-2012.

TOP HAT

THE MARK CONSISTS OF STANDARD CHARACTERS WITHOUT CLAIM TO ANY PARTICULAR FONT, STYLE, SIZE, OR COLOR.

FOR MOVING, STORAGE, TRANSPORT AND SHIPPING OF GOODS (U.S. CLS. 100 AND 105).

FIRST USE 6-25-1967; IN COMMERCE 6-25-1967.
MICHAEL WEBSTER, EXAMINING ATTORNEY

SN 85-454,440. RAIL LOGIX GP, LLC, HOUSTON, TX. FILED 10-24-2011.

Keeping Industry on Track

THE MARK CONSISTS OF STANDARD CHARACTERS WITHOUT CLAIM TO ANY PARTICULAR FONT, STYLE, SIZE, OR COLOR.

FOR RAILCAR STORAGE; ON-DEMAND SWITCHING, NAMELY, MOVING OF RAILCARS TO A LOCATION DESIGNATED BY A CUSTOMER SUCH AS FROM STORAGE INTO THE STAGING AREA OF THE RAIL YARD, TO THE INTERCHANGE, TO A TRANSLOADING AREA, OR VICE VERSA; RAILCAR INTERCHANGE SERVICES, NAMELY, COORDINATING WITH MAIN RAIL LINE CARRIERS TO MOVE RAILCARS OUT OF THE RAIL YARD AND ONTO THE MAIN RAIL LINE FOR TRANSPORTATION OUT OF THE RAIL YARD, AND VICE VERSA; AND, TRANSLOADING SERVICES, NAMELY, FREIGHT LOADING SERVICES (U.S. CLS. 100 AND 105).

FIRST USE 9-1-2011; IN COMMERCE 9-1-2011.
JOHN DWYER, EXAMINING ATTORNEY

SN 85-512,856. THRIFTY PROPANE, INC., MEDINA, OH. FILED 1-10-2012.

Thrifty Propane

THE MARK CONSISTS OF STANDARD CHARACTERS WITHOUT CLAIM TO ANY PARTICULAR FONT, STYLE, SIZE, OR COLOR.

NO CLAIM IS MADE TO THE EXCLUSIVE RIGHT TO USE "PROPANE", APART FROM THE MARK AS SHOWN. FOR FUEL DELIVERY SERVICES FEATURING PROPANE (U.S. CLS. 100 AND 105).

FIRST USE 7-1-2003; IN COMMERCE 9-15-2005.
CURTIS FRENCH, EXAMINING ATTORNEY

CLASS 39—(Continued).

SN 85-519,576. PARKING AUTHORITY OF THE CITY OF ELIZABETH, NJ, ELIZABETH, NJ. FILED 1-18-2012.



THE COLOR(S) GREEN, YELLOW, WHITE, AND BLACK IS/ARE CLAIMED AS A FEATURE OF THE MARK.

THE MARK CONSISTS OF A YELLOW LETTER "E" ON A GREEN CIRCLE WITH 3 WHITE CARS PARKED ON THE HORIZONTAL SEGMENTS OF THE "E". THE CIRCLE APPEARS ON A BACKGROUND CONSISTING OF A BLACK HORIZONTAL BAND AT THE TOP, A WHITE HORIZONTAL BAND IN THE MIDDLE, AND A GREEN HORIZONTAL BAND AT THE BOTTOM.

FOR VEHICLE PARKING SERVICES RELATING TO THE AVAILABILITY OF ON-STREET AND OFF-STREET PARKING SPACES; PARKING LOT SERVICES; PARKING GARAGES SERVICES (U.S. CLS. 100 AND 105).

FIRST USE 1-1-2006; IN COMMERCE 1-1-2006.

APRIL HESIK, EXAMINING ATTORNEY

SN 85-520,510. BOSTON DUCK TOURS, BOSTON, MA. FILED 1-19-2012.

**Boston's Official
ChampionSHIP**

THE MARK CONSISTS OF STANDARD CHARACTERS WITHOUT CLAIM TO ANY PARTICULAR FONT, STYLE, SIZE, OR COLOR.

NO CLAIM IS MADE TO THE EXCLUSIVE RIGHT TO USE "BOSTON'S OFFICIAL", APART FROM THE MARK AS SHOWN.

FOR CONDUCTING SIGHTSEEING TOURS FOR OTHERS (U.S. CLS. 100 AND 105).

FIRST USE 1-18-2012; IN COMMERCE 1-18-2012.

LOURDES AYALA, EXAMINING ATTORNEY

CLASS 39—(Continued).

SN 85-522,251. THINK GREEN LIMOUSINE, AKA THINK GREEN LIMO, NAPERVILLE, IL. FILED 1-22-2012.

Think Green Limousine

THE MARK CONSISTS OF STANDARD CHARACTERS WITHOUT CLAIM TO ANY PARTICULAR FONT, STYLE, SIZE, OR COLOR.

NO CLAIM IS MADE TO THE EXCLUSIVE RIGHT TO USE "GREEN LIMOUSINE", APART FROM THE MARK AS SHOWN.

FOR LIMOUSINE SERVICES (U.S. CLS. 100 AND 105).

FIRST USE 3-5-2010; IN COMMERCE 4-19-2010.

WENDY JUN, EXAMINING ATTORNEY

SN 85-524,559. AMERICAN AIRLINES, INC., FORT WORTH, TX. FILED 1-25-2012.

APRENDI.COM

THE MARK CONSISTS OF STANDARD CHARACTERS WITHOUT CLAIM TO ANY PARTICULAR FONT, STYLE, SIZE, OR COLOR.

THE ENGLISH TRANSLATION OF "APRENDI" IS "I LEARNED".

FOR PROVIDING A WEBSITE FOR OTHERS FEATURING INFORMATION ABOUT TRAVEL AND INTERNATIONAL DESTINATIONS (U.S. CLS. 100 AND 105).

FIRST USE 9-21-2011; IN COMMERCE 9-21-2011.

DEBORAH LOBO, EXAMINING ATTORNEY

SN 85-527,428. SPIRIT CRUISES, LLC, CHICAGO, IL. FILED 1-27-2012.

FREEDOM ELITE

THE MARK CONSISTS OF STANDARD CHARACTERS WITHOUT CLAIM TO ANY PARTICULAR FONT, STYLE, SIZE, OR COLOR.

FOR CRUISE SHIP SERVICES; ARRANGING AND CONDUCTING SIGHTSEEING TOURS FOR OTHERS; YACHT AND BOAT CHARTER SERVICES; DAY CRUISE SERVICES FEATURING BRUNCH, LUNCH, DINNER AND RELATED ENTERTAINMENT (U.S. CLS. 100 AND 105).

JOSEPH PAPPAFOTIS, EXAMINING ATTORNEY

CLASS 39—(Continued).

SN 85-531,328. SAN DIEGO GAS & ELECTRIC COMPANY, SAN DIEGO, CA. FILED 2-1-2012.

SUNRATE

THE MARK CONSISTS OF STANDARD CHARACTERS WITHOUT CLAIM TO ANY PARTICULAR FONT, STYLE, SIZE, OR COLOR.
FOR UTILITY SERVICES, NAMELY, PROVIDING SOLAR POWER (U.S. CLS. 100 AND 105).
ANGELA DUONG, EXAMINING ATTORNEY

SN 85-531,362. SEABURY ASSET MANAGEMENT LLC, NEW YORK, NY. FILED 2-1-2012.

SALT

THE MARK CONSISTS OF STANDARD CHARACTERS WITHOUT CLAIM TO ANY PARTICULAR FONT, STYLE, SIZE, OR COLOR.
FOR LEASING OF AIRCRAFT (U.S. CLS. 100 AND 105).
SUSAN BILLHEIMER, EXAMINING ATTORNEY

SN 85-531,888. NTH DEGREE INNOVATIONS, INC., MILLTOWN, NJ. FILED 2-2-2012.

DRINK KING DISTRIBUTING

THE MARK CONSISTS OF STANDARD CHARACTERS WITHOUT CLAIM TO ANY PARTICULAR FONT, STYLE, SIZE, OR COLOR.
NO CLAIM IS MADE TO THE EXCLUSIVE RIGHT TO USE "DRINK" AND "DISTRIBUTING", APART FROM THE MARK AS SHOWN.
FOR DISTRIBUTION SERVICES, NAMELY, DELIVERY OF BEVERAGES AND DIETARY SUPPLEMENTS (U.S. CLS. 100 AND 105).
FIRST USE 1-31-2012; IN COMMERCE 1-31-2012.
MYRIAH HABEEB, EXAMINING ATTORNEY

CLASS 39—(Continued).

SN 85-532,476. GREEN COURTE PARTNERS, LLC, LAKE FOREST, IL. FILED 2-2-2012.

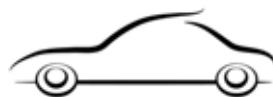

THE MARK CONSISTS OF THEY STYLIZED SILHOUETTE OF AN AUTOMOBILE.
FOR PARKING GARAGES SERVICES; PROVISION OF CAR PARKING FACILITIES; VEHICLE PARKING (U.S. CLS. 100 AND 105).
EMILY CARLSEN, EXAMINING ATTORNEY

SN 85-532,509. UTAH STORAGE ASSETS LLC, SAN DIEGO, CA. FILED 2-2-2012.

STOR'EM SELF STORAGE

THE MARK CONSISTS OF STANDARD CHARACTERS WITHOUT CLAIM TO ANY PARTICULAR FONT, STYLE, SIZE, OR COLOR.
NO CLAIM IS MADE TO THE EXCLUSIVE RIGHT TO USE "SELF STORAGE", APART FROM THE MARK AS SHOWN.
FOR PROVIDING SELF-STORAGE FACILITIES FOR OTHERS (U.S. CLS. 100 AND 105).
TARAH HARDY, EXAMINING ATTORNEY

SN 85-532,823. ABLE BODY MOVING AND DELIVERY LLC, BIRMINGHAM, AL. FILED 2-3-2012.

**The most efficient way
from point A to B**

THE MARK CONSISTS OF STANDARD CHARACTERS WITHOUT CLAIM TO ANY PARTICULAR FONT, STYLE, SIZE, OR COLOR.
FOR MOVING COMPANY SERVICES (U.S. CLS. 100 AND 105).
FIRST USE 7-1-2011; IN COMMERCE 7-1-2011.
SETH A. RAPPAPORT, EXAMINING ATTORNEY

CLASS 39—(Continued).

SN 85-533,054. INSOURCE MOVE MANAGEMENT, DETROIT, MI. FILED 2-3-2012.

InSource Move Management

THE MARK CONSISTS OF STANDARD CHARACTERS WITHOUT CLAIM TO ANY PARTICULAR FONT, STYLE, SIZE, OR COLOR.

NO CLAIM IS MADE TO THE EXCLUSIVE RIGHT TO USE "MOVE MANAGEMENT", APART FROM THE MARK AS SHOWN.

FOR TRANSPORT, PACKAGING, TRUCKING HAULING AND STORAGE OF GOODS, NAMELY, DOMESTIC AND INTERNATIONAL HOUSEHOLD GOODS AND COMMERCIAL FREIGHT; MOVING, STORAGE, AND TRANSPORTATION SERVICES BY TRUCK, RAIL, AIR AND BOAT, WAREHOUSING SERVICES, FREIGHT AND TRANSPORTATION BROKERAGE SERVICES AND FREIGHT FORWARDING SERVICES ALL FEATURING THE TRANSPORTATION OF GOODS AND PERSONAL EFFECTS FOR OTHERS, FOR GENERAL FREIGHT AND HOUSEHOLD GOODS; TRANSPORTATION OF GOODS BY TRUCK, AIR, RAIL AND BOAT; PACKING ARTICLES OTHER THAN HOUSEHOLD GOODS FOR TRANSPORTATION AND STORAGE; FREIGHT STATION SERVICES, NAMELY, CARGO HANDLING IN THE NATURE OF PICKUP, RECEIVING, CONSOLIDATION AND DISTRIBUTION THEREOF DOMESTICALLY AND INTERNATIONALLY; MOVE MANAGEMENT, NAMELY, TRANSPORTATION OF HOUSEHOLD GOODS AND COMMERCIAL PREMISES GOODS BY TRUCK, AIR, RAIL AND BOAT (U.S. CLS. 100 AND 105).

FIRST USE 2-18-2003; IN COMMERCE 2-18-2003.
KATHRYN COWARD, EXAMINING ATTORNEY

SN 85-533,060. HEALTH GLOBE, BOSTON, MA. FILED 2-3-2012.

HEALTHGLOBE

THE MARK CONSISTS OF STANDARD CHARACTERS WITHOUT CLAIM TO ANY PARTICULAR FONT, STYLE, SIZE, OR COLOR.

FOR MEDICAL TOURISM SERVICES, NAMELY, MAKING TRANSPORTATION RESERVATIONS AND BOOKINGS FOR TRAVEL TO ANOTHER COUNTRY IN ORDER TO OBTAIN HEALTH CARE (U.S. CLS. 100 AND 105).

FIRST USE 7-1-2010; IN COMMERCE 7-1-2010.
SETH A. RAPPAPORT, EXAMINING ATTORNEY

CLASS 39—(Continued).

SN 85-534,381. MUSTACHE RIDES, LLC, INDIANAPOLIS, IN. FILED 2-6-2012.

MUSTACHE RIDES

THE MARK CONSISTS OF STANDARD CHARACTERS WITHOUT CLAIM TO ANY PARTICULAR FONT, STYLE, SIZE, OR COLOR.

NO CLAIM IS MADE TO THE EXCLUSIVE RIGHT TO USE "RIDES", APART FROM THE MARK AS SHOWN.

FOR LIMOUSINE SERVICES (U.S. CLS. 100 AND 105).
DAVID COLLIER, EXAMINING ATTORNEY

SN 85-535,336. SUPERSHUTTLE INTERNATIONAL, INC., SCOTTSDALE, AZ. FILED 2-6-2012.



THE MARK CONSISTS OF AN IMAGE OF A VAN WITH WINGS WITH THE WORDS SUPERSHUTTLE ALONG THE SIDE OF THE VAN.

FOR TRANSPORTATION SERVICES, NAMELY, AIRPORT GROUND, CHARTER, AND DOOR-TO-DOOR TRANSPORTATION SERVICES OF PASSENGERS BY MOTOR VEHICLES (U.S. CLS. 100 AND 105).

MIDGE BUTLER, EXAMINING ATTORNEY

SN 85-536,534. HELP THY NEIGHBORS, CHARLOTTE, NC. FILED 2-7-2012.

HELP THY NEIGHBORS

THE MARK CONSISTS OF STANDARD CHARACTERS WITHOUT CLAIM TO ANY PARTICULAR FONT, STYLE, SIZE, OR COLOR.

FOR PROVIDING FREE OR LOW COST TRANSPORTATION FOR ELDERLY PERSONS, DISABLED PERSONS, AND PERSONS WITH HEALTH CONCERNS (U.S. CLS. 100 AND 105).

FIRST USE 2-6-2012; IN COMMERCE 2-6-2012.
ALYSSA STEEL, EXAMINING ATTORNEY

CLASS 39—(Continued).

SN 85-536,948. JUNK MAN LLC, HENDERSON, NV. FILED 2-8-2012.



THE MARK CONSISTS OF A TRUCK WITH THE STYLIZED TEXT "JUNKMAN".
FOR JUNK REMOVAL; JUNK, TRASH AND DEBRIS REMOVAL (U.S. CLS. 100 AND 105).
FIRST USE 12-10-2011; IN COMMERCE 1-9-2012.
DOMINICK J. SALEMI, EXAMINING ATTORNEY

SN 85-537,727. CONTIKI TOURS INTERNATIONAL LIMITED, ST. PETER PORT, GUERNSEY, FILED 2-8-2012.

THIS WAY TO AMAZING

THE MARK CONSISTS OF STANDARD CHARACTERS WITHOUT CLAIM TO ANY PARTICULAR FONT, STYLE, SIZE, OR COLOR.
FOR TRAVEL SERVICES, NAMELY, ORGANIZING, ARRANGING, AND OPERATING ESCORTED TOURS (U.S. CLS. 100 AND 105).
FIRST USE 10-0-2011; IN COMMERCE 10-0-2011.
ELI HELLMAN, EXAMINING ATTORNEY

SN 85-539,263. BIN IT LLC, HOBOKEN, NJ. FILED 2-10-2012.



THE MARK CONSISTS OF THE WORDS BIN IT STYLIZED WITH AN ARROW ON THE RIGHT FACING THE WORDS.
FOR RENTAL SERVICES, NAMELY, RENTAL OF PLASTIC STORAGE CONTAINERS, WARDROBE BINS AND MOVING DOLLIES (U.S. CLS. 100 AND 105).
FIRST USE 7-1-2011; IN COMMERCE 7-1-2011.
JOHN HWANG, EXAMINING ATTORNEY

CLASS 39—(Continued).

SN 85-539,267. BIN IT LLC, HOBOKEN, NJ. FILED 2-10-2012.

BIN-IT

THE MARK CONSISTS OF STANDARD CHARACTERS WITHOUT CLAIM TO ANY PARTICULAR FONT, STYLE, SIZE, OR COLOR.
FOR RENTAL SERVICES, NAMELY, RENTAL OF PLASTIC STORAGE CONTAINERS, WARDROBE BINS AND MOVING DOLLIES (U.S. CLS. 100 AND 105).
FIRST USE 7-1-2011; IN COMMERCE 7-1-2011.
JOHN HWANG, EXAMINING ATTORNEY

SN 85-540,294. KIJAGO LLC, WASHINGTON, DC. FILED 2-11-2012.



THE MARK CONSISTS OF A CIRCLE CONTAINING TWO VERTICAL LINES, EACH CROSSED BY A SHORT HORIZONTAL LINE AS IN THE LETTER "T", WITH THE STYLIZED WORDING "TRIPTUNER" APPEARING TO THE RIGHT OF THE CIRCLE.
FOR BOOKING OF TRAVEL TICKETS ; ON-LINE TRANSPORTATION RESERVATION AND TRAVEL TICKET RESERVATION SERVICES; ORGANISATION OF TRAVEL; PROVIDING AN ON-LINE SEARCHABLE COMPUTER DATABASE FEATURING INFORMATION ON TRAVEL; PROVIDING INFORMATION, NEWS AND COMMENTARY IN THE FIELD OF TRAVEL; TRAVEL BOOKING AGENCIES; TRAVEL GUIDE AND TRAVEL INFORMATION SERVICES; TRAVEL ROUTE PLANNING (U.S. CLS. 100 AND 105).
FIRST USE 4-8-2011; IN COMMERCE 4-8-2011.
CHRISIE B. KING, EXAMINING ATTORNEY

SN 85-548,693. VANGUARD TRADEMARK HOLDINGS USA LLC, ST. LOUIS, MO. FILED 2-21-2012.

PREMIER
SELECTION

THE MARK CONSISTS OF THE WORDS "PREMIER" OVER THE WORD "SELECTION" WITH AN INVERTED TRIANGLE OVER THE LETTER "M" OF THE WORD "PREMIER".
FOR VEHICLE RENTAL AND LEASING SERVICES, AND RESERVATION SERVICES FOR THE RENTAL AND LEASING OF VEHICLES (U.S. CLS. 100 AND 105).
TEJBIR SINGH, EXAMINING ATTORNEY

CLASS 40—MATERIAL TREATMENT

SN 79-099,071. ESSLOR INTERNATIONAL (COMPAGNIE GENERALE D'OPTIQUE), F-94220 CHARENTON LE PONT, FRANCE, FILED 5-6-2011.



PRIORITY DATE OF 11-9-2010 IS CLAIMED.
OWNER OF INTERNATIONAL REGISTRATION 1081858 DATED 5-6-2011, EXPIRES 5-6-2021.

NO CLAIM IS MADE TO THE EXCLUSIVE RIGHT TO USE "BLOCKING", APART FROM THE MARK AS SHOWN.
THE COLOR(S) GREEN, BLUE AND OFF-WHITE IS/ARE CLAIMED AS A FEATURE OF THE MARK.

THE WORDS "GREEN" AND "TECHNO" ARE IN GREEN; THE WORD "BLOCKING" IS IN OFF-WHITE AND APPEARS INSIDE A FRAME WITH A BLUE BACKGROUND.

FOR MACHINING, SIZING, CUTTING, GRINDING, EDGING, BEVELLING, FEATHER EDGING, EDGING WITH A GROOVE, CHAMFERING, DRILLING, FINISHING, SMOOTHING, POLISHING, FINE REWORKING AND STRIPPING OF SPECTACLE LENSES AND OPHTHALMIC LENSES; TREATMENT AND COATING OF SPECTACLE LENSES AND OPHTHALMIC LENSES; APPLICATION OF TEMPORARY ADHERENT TOP LAYERS AND COATINGS TO SPECTACLE LENSES AND OPHTHALMIC LENSES (U.S. CLS. 100, 103 AND 106).

ERNEST SHOSHO, EXAMINING ATTORNEY

SN 85-258,205. BETTER WORLD MATERIALS INTERNATIONAL, INC., SPANAWAY, WA. FILED 3-4-2011.

BETTER WORLD MATERIALS

THE MARK CONSISTS OF STANDARD CHARACTERS WITHOUT CLAIM TO ANY PARTICULAR FONT, STYLE, SIZE, OR COLOR.

NO CLAIM IS MADE TO THE EXCLUSIVE RIGHT TO USE "MATERIALS", APART FROM THE MARK AS SHOWN.

FOR RECYCLING (U.S. CLS. 100, 103 AND 106).
FIRST USE 6-16-2008; IN COMMERCE 6-16-2008.
KATHERINE M. DUBRAY, EXAMINING ATTORNEY

CLASS 40—(Continued).

SN 85-397,831. G & H DIVERSIFIED MANUFACTURING, LP, HOUSTON, TX. FILED 8-15-2011.

G&H

THE MARK CONSISTS OF STANDARD CHARACTERS WITHOUT CLAIM TO ANY PARTICULAR FONT, STYLE, SIZE, OR COLOR.

FOR TECHNICAL SERVICES IN THE FIELD OF FABRICATION, NAMELY, CUSTOM MANUFACTURING AND PROTOTYPE FABRICATION OF METAL PARTS FOR INDUSTRIAL AND HOUSEHOLD GOODS, REQUIRING MANUAL ROBOTIC WELDING, PRECISION MACHINING, CNC (COMPUTER NUMERICAL CONTROL) LASER CUTTING, TOOLING AND WIRE EDM (ELECTRICAL DISCHARGE MACHINING) AND/OR PRECISION SHEET METAL AND FABRICATION (U.S. CLS. 100, 103 AND 106).

FIRST USE 0-0-1958; IN COMMERCE 0-0-1958.
RICHARD WHITE, EXAMINING ATTORNEY

SN 85-403,914. MASONITE INTERNATIONAL CORPORATION, MISSISSAUGA, CANADA, FILED 8-22-2011.

MASONITE COORDINATES

THE MARK CONSISTS OF STANDARD CHARACTERS WITHOUT CLAIM TO ANY PARTICULAR FONT, STYLE, SIZE, OR COLOR.

OWNER OF U.S. REG. NOS. 3,114,552, 3,867,989 AND OTHERS.

NO CLAIM IS MADE TO THE EXCLUSIVE RIGHT TO USE "COORDINATES", APART FROM THE MARK AS SHOWN.

FOR MANUFACTURE OF DOORS TO THE ORDER AND SPECIFICATION OF OTHERS (U.S. CLS. 100, 103 AND 106).

FIRST USE 12-31-2009; IN COMMERCE 8-15-2011.
ELIZABETH KAJUBI, EXAMINING ATTORNEY

SN 85-410,310. G2 REVOLUTION, LLC, HUNTLEY, IL. FILED 8-30-2011.

SECOND LIFE

THE MARK CONSISTS OF STANDARD CHARACTERS WITHOUT CLAIM TO ANY PARTICULAR FONT, STYLE, SIZE, OR COLOR.

FOR MATERIAL TREATMENT SERVICES IN CONNECTION WITH RECYCLING; RECYCLING (U.S. CLS. 100, 103 AND 106).

FIRST USE 9-1-2010; IN COMMERCE 10-1-2010.
RAMONA ORTIGA, EXAMINING ATTORNEY

CLASS 40—(Continued).

SN 85-422,442. MAGGIE AUSTIN CAKE, LLC, DBA MAGGIE AUSTIN CAKE, TAKOMA PARK, MD. FILED 9-14-2011.



THE MARK CONSISTS OF A BIRD AND TWO FLOWERS ON A BRANCH ABOVE THE LETTER "M".
FOR CUSTOM CAKE DECORATING SERVICES (U.S. CLS. 100, 103 AND 106).
FIRST USE 6-1-2010; IN COMMERCE 7-1-2010.
NORA BUCHANAN WILL, EXAMINING ATTORNEY

SN 85-478,383. RAMSEY, ARLA J, DBA SPIRIT WATER DISTILLERY, BLUE LAKE, CA. FILED 11-21-2011.



NO CLAIM IS MADE TO THE EXCLUSIVE RIGHT TO USE "DISTILLERY", APART FROM THE MARK AS SHOWN.
THE COLOR(S) BLUE, BLACK AND GRAY IS/ARE CLAIMED AS A FEATURE OF THE MARK.
THE MARK CONSISTS OF THE FOLLOWING: THE WORDING "SPIRIT WATER DISTILLERY" WITH "SPIRIT" MOSTLY IN BLUE WITH LETTER "T" CONSISTING OF A FLAG DESIGN FADING FROM DARK BLUE AT THE TOP TO LIGHTER BLUE AND THEN GRAY AT THE BOTTOM, THE WORDING "WATER DISTILLERY" IS IN BLACK.
FOR SPIRITS DISTILLERY SERVICES (U.S. CLS. 100, 103 AND 106).
SUE LAWRENCE, EXAMINING ATTORNEY

CLASS 40—(Continued).

SN 85-498,126. LAMINATE TECHNOLOGIES, INC., TIFFIN, OH. FILED 12-17-2011.

LAMINATE TECHNOLOGIES

THE MARK CONSISTS OF STANDARD CHARACTERS WITHOUT CLAIM TO ANY PARTICULAR FONT, STYLE, SIZE, OR COLOR.
NO CLAIM IS MADE TO THE EXCLUSIVE RIGHT TO USE "LAMINATE", APART FROM THE MARK AS SHOWN. SEC. 2(F).
FOR MANUFACTURE OF LAMINATED WOOD PRODUCTS TO ORDER AND/OR SPECIFICATION OF OTHERS (U.S. CLS. 100, 103 AND 106).
FIRST USE 0-0-1985; IN COMMERCE 0-0-1985.
ROBERT STRUCK, EXAMINING ATTORNEY

SN 85-501,162. BAZZ HOUSTON, GARDEN GROVE, CA. FILED 12-21-2011.



OWNER OF U.S. REG. NO. 1,669,763.
THE COLOR(S) BLACK AND RED IS/ARE CLAIMED AS A FEATURE OF THE MARK.
THE MARK CONSISTS OF THE FOLLOWING: THE LETTERS "BH" IN RED, ENCLOSED IN A BLACK SINGLE LINE SQUARE ABOVE THE WORDING "BAZZ HOUSTON" IN BLACK. THE MARK APPEARS ON A TRANSPARENT BACKGROUND.
FOR CUSTOM MANUFACTURING OF COIL AND FLAT SPRINGS AND WIRE FORMS, METAL STAMPING, TOOLING AND ASSEMBLY (U.S. CLS. 100, 103 AND 106).
FIRST USE 1-1-1965; IN COMMERCE 1-1-1965.
COLLEEN KEARNEY, EXAMINING ATTORNEY

SN 85-511,139. GRAPHIC DIMENSIONS, INC., AUSTELL, GA. FILED 1-7-2012.

FLEXMATE

THE MARK CONSISTS OF STANDARD CHARACTERS WITHOUT CLAIM TO ANY PARTICULAR FONT, STYLE, SIZE, OR COLOR.
FOR SERVICES, NAMELY, CUSTOM IMPRINTING AND PRINTING OF FORMS FOR RESALE BY OTHERS, THE FORMS BEING COMPATIBLE FOR USE BY COMPUTER PROGRAMS (U.S. CLS. 100, 103 AND 106).
DAWN FELDMAN, EXAMINING ATTORNEY

CLASS 40—(Continued).

SN 85-532,202. CATHETER RESEARCH, INC., INDIANAPOLIS, IN. FILED 2-2-2012.



OWNER OF U.S. REG. NO. 1,692,754.
THE MARK CONSISTS OF THE LOWER CASE LETTERS "CRI", APPEARING AS THOUGH THE LETTERS WERE CREATED BY TUBING, WITH THE CENTER OF EACH LETTER AN EMPTY SPACE.

FOR CONTRACT MANUFACTURING IN THE FIELD OF MEDICAL DEVICES (U.S. CLS. 100, 103 AND 106).
FIRST USE 1-31-1995; IN COMMERCE 1-31-1995.
GEORGE LORENZO, EXAMINING ATTORNEY

SN 85-533,228. DYNAMIC DOMES, PARK CITY, UT. FILED 2-3-2012.

**QUALITY ISN'T
EXPENSIVE...IT'S PRICELESS!**

THE MARK CONSISTS OF STANDARD CHARACTERS WITHOUT CLAIM TO ANY PARTICULAR FONT, STYLE, SIZE, OR COLOR.

FOR CUSTOM MANUFACTURE OF DOME STICKERS AND STICKERS (U.S. CLS. 100, 103 AND 106).
MARC LEIPZIG, EXAMINING ATTORNEY

SN 85-534,819. MIDWEST TRUCK & AUTO PARTS, INC., CHICAGO, IL. FILED 2-6-2012.

SOURCE INTERNATIONAL

THE MARK CONSISTS OF STANDARD CHARACTERS WITHOUT CLAIM TO ANY PARTICULAR FONT, STYLE, SIZE, OR COLOR.

SEC. 2(F).
FOR CONTRACT MANUFACTURING OF PARTS, COMPONENTS AND ASSEMBLIES IN THE AGRICULTURE, AUTOMOTIVE, CONSTRUCTION AND MARINE EQUIPMENT FIELDS; CUSTOM FABRICATION AND PRODUCTION OF PARTS AND ASSEMBLIES IN THE AGRICULTURE, AUTOMOTIVE, CONSTRUCTION AND MARINE EQUIPMENT FIELDS; MANUFACTURING SERVICES FOR OTHERS IN THE AGRICULTURE, AUTOMOTIVE, CONSTRUCTION AND MARINE EQUIPMENT FIELDS (U.S. CLS. 100, 103 AND 106).
FIRST USE 0-0-1997; IN COMMERCE 0-0-1997.
BRIAN CALLAGHAN, EXAMINING ATTORNEY

CLASS 40—(Continued).

SN 85-535,574. FRIEDRICHSEN ENTERPRISES, INC., PERRY, IA. FILED 2-7-2012.



THE MARK CONSISTS OF THE WORDS CAKE ME I'M YOURS WITH "CAKE ME" APPEARING OVER "I'M YOURS" WITH AN EXCLAMATION POINT AFTER THE WORD "YOURS." AN IMAGE OF A TWO-TIERED CAKE APPEARS TO THE RIGHT OF THE MARK WITH A FLOWER-LIKE FIGURE OVER THE TOP-LAYER OF THE CAKE; A CURVED LINE APPEARS UNDER THE MARK RUNNING FROM THE LEFT OF THE BOTTOM-LAYER OF THE CAKE TO THE RIGHT OF THE WORD "YOURS!" WITH THE LINE SPLITTING INTO TWO CURLED ENDS, ONE CURLING UPWARD AND ONE CURLING DOWNWARD; THREE DOTS APPEARS WHERE THE LINE SPLITS INTO THE CURLED ENDS.

FOR CUSTOM CAKE DECORATING SERVICES (U.S. CLS. 100, 103 AND 106).
FIRST USE 9-15-2010; IN COMMERCE 9-15-2010.
LINDA MICKLEBURGH, EXAMINING ATTORNEY

SN 85-535,577. FRIEDRICHSEN ENTERPRISES, INC., PERRY, IA. FILED 2-7-2012.

Cake Me I'm Yours!

THE MARK CONSISTS OF STANDARD CHARACTERS WITHOUT CLAIM TO ANY PARTICULAR FONT, STYLE, SIZE, OR COLOR.

FOR CUSTOM CAKE DECORATING SERVICES (U.S. CLS. 100, 103 AND 106).
FIRST USE 9-15-2004; IN COMMERCE 9-15-2004.
LINDA MICKLEBURGH, EXAMINING ATTORNEY

CLASS 40—(Continued).

SN 85-535,901. CONTROLLED THERMAL TECHNOLOGY, PHOENIX, AZ. FILED 2-7-2012.

Nitridox

THE MARK CONSISTS OF STANDARD CHARACTERS WITHOUT CLAIM TO ANY PARTICULAR FONT, STYLE, SIZE, OR COLOR.

FOR METAL HEAT TREATING SERVICES BY MEANS OF FERRITIC NITROCARBURIZING; METAL TREATING; METAL TREATMENT; TREATMENT OF METAL (U.S. CLS. 100, 103 AND 106).

FIRST USE 6-1-2011; IN COMMERCE 6-1-2011.
KAPIL BHANOT, EXAMINING ATTORNEY

SN 85-536,306. KG CREATIVE DESIGN LTD., NEW YORK, NY. FILED 2-7-2012.



THE MARK CONSISTS OF SPECIAL MARK WITH THE LETTERS "K" AND "G" INFUSED TOGETHER WITH DOUBLE BLACK BORDERS.

FOR JEWELRY CASTING (U.S. CLS. 100, 103 AND 106).
FIRST USE 12-1-1987; IN COMMERCE 12-1-1987.
HELENE LIWINSKI, EXAMINING ATTORNEY

CLASS 40—(Continued).

SN 85-537,500. GIDDY UP INC, DENVER, CO. FILED 2-8-2012.



THE MARK CONSISTS OF A GIRL ON A REARING BRONC HORSE INSIDE OF TWO CIRCLES AND TWO STARS INSIDE OF THE FIRST CIRCLE, THE TEXT "GIDDY" AT THE TOP AND "UP" AT THE BOTTOM, BETWEEN THE CIRCLES.

FOR CUSTOMIZED PRINTING OF COMPANY NAMES AND LOGOS FOR PROMOTIONAL AND ADVERTISING PURPOSES ON THE GOODS OF OTHERS; EMBROIDERY SERVICES; SCREEN PRINTING (U.S. CLS. 100, 103 AND 106).

FIRST USE 10-1-2008; IN COMMERCE 10-1-2008.
JOHN E. MICHOS, EXAMINING ATTORNEY

SN 85-538,980. I.D.E. TECHNOLOGIES LTD., KADIMA, ISRAEL, FILED 2-10-2012.

IDE PROGREEN

THE MARK CONSISTS OF STANDARD CHARACTERS WITHOUT CLAIM TO ANY PARTICULAR FONT, STYLE, SIZE, OR COLOR.

OWNER OF ERP N CMNTY TM OFC REG. NO. 010255651, DATED 1-15-2012, EXPIRES 9-11-2021.

FOR WATER TREATMENT AND PURIFICATION; WATER TREATING; LEASING OF WATER PURIFICATION EQUIPMENT; WATER TREATMENT SERVICES; WATER DESALINATION SERVICES; RENTAL OF WATER PURIFYING APPARATUS; ENVIRONMENTAL REMEDIATION SERVICES, NAMELY, TREATMENT OF WATER; RENTAL OF WATER PURIFICATION EQUIPMENT; RENTAL OF WATER FILTRATION UNITS FOR COMMERCIAL USE; RENTAL OF WATER FILTERS; RENTAL OF WATER TREATMENT EQUIPMENT (U.S. CLS. 100, 103 AND 106).

CURTIS FRENCH, EXAMINING ATTORNEY

CLASS 40—(Continued).

SN 85-539,654. UNITED PRECIOUS METAL REFINING, INC., ALDEN, NY. FILED 2-10-2012.

VIP Pass

THE MARK CONSISTS OF STANDARD CHARACTERS WITHOUT CLAIM TO ANY PARTICULAR FONT, STYLE, SIZE, OR COLOR.

FOR EXPEDITED METAL REFINING SERVICES, NAMELY REFINING OF PRECIOUS METALS (U.S. CLS. 100, 103 AND 106).

LUCY ARANT, EXAMINING ATTORNEY

SN 85-539,667. UNITED PRECIOUS METAL REFINING, INC., ALDEN, NY. FILED 2-10-2012.

QUICK PASS

THE MARK CONSISTS OF STANDARD CHARACTERS WITHOUT CLAIM TO ANY PARTICULAR FONT, STYLE, SIZE, OR COLOR.

FOR EXPEDITED METAL REFINING SERVICES, NAMELY, REFINING OF PRECIOUS METALS (U.S. CLS. 100, 103 AND 106).

LUCY ARANT, EXAMINING ATTORNEY

SN 85-540,277. SHOOTDOTEEDIT LLC, SOLANA BEACH, CA. FILED 2-11-2012.



OWNER OF U.S. REG. NO. 4,041,696.
THE MARK CONSISTS OF THE WORDS "SHOOT" "DOT" AND "EDIT", WITH THE WORD "DOT" BEING FORMED WITHIN A DARKENED CIRCLE.

FOR PHOTOGRAPHIC PROCESSING; PHOTOGRAPHIC RETOUCHING (U.S. CLS. 100, 103 AND 106).
FIRST USE 1-0-2012; IN COMMERCE 1-0-2012.

JENNIFER MARTIN, EXAMINING ATTORNEY

CLASS 40—(Continued).

SN 85-547,913. APPLIED PROCESS, INC., LIVONIA, MI. FILED 2-21-2012.



THE MARK CONSISTS OF STYLIZED LOWERCASE "A" "P" WITH A FLAME IN THE CENTER OF THE "A".

FOR METAL HEAT TREATING SERVICES BY MEANS OF AUSTEMPERING, SALT BATH QUENCH, TO PRODUCE HARDENED METALS FOR USE IN MOTORIZED VEHICLES, TRUCKING, CONSTRUCTION, MINING, RAILWAY, SHIPPING, WIND TURBINES, WEAPONS, HEAVING EQUIPMENT, BRIDGES, AERONAUTICS, DRILLING POWER TOOLS, AND RIGGING (U.S. CLS. 100, 103 AND 106).

FIRST USE 0-0-2010; IN COMMERCE 0-0-2010.
ROBIN MITTLER, EXAMINING ATTORNEY

SN 85-558,694. RSI HOME PRODUCTS MANAGEMENT, INC., ANAHEIM, CA. FILED 3-2-2012.



OWNER OF U.S. REG. NOS. 1,610,592, 3,934,780 AND OTHERS.

THE MARK CONSISTS OF THE WORDS "RSI BETTER EVERY DAY" WITHIN A SQUARE.

FOR MANUFACTURING SERVICES FOR OTHERS IN THE FIELD OF CABINETS, VANITIES, FURNITURE MIRRORS, COUNTERTOPS, AND STORAGE ORGANIZERS AND ACCESSORIES (U.S. CLS. 100, 103 AND 106).

SEAN CROWLEY, EXAMINING ATTORNEY

CLASS 40—(Continued).

SN 85-558,699. RSI HOME PRODUCTS MANAGEMENT, INC., ANAHEIM, CA. FILED 3-2-2012.

RSI BETTER EVERY DAY

THE MARK CONSISTS OF STANDARD CHARACTERS WITHOUT CLAIM TO ANY PARTICULAR FONT, STYLE, SIZE, OR COLOR.

OWNER OF U.S. REG. NOS. 1,610,592, 3,934,780 AND OTHERS.

FOR MANUFACTURING SERVICES FOR OTHERS IN THE FIELD OF CABINETS, VANITIES, FURNITURE MIRRORS, COUNTERTOPS, AND STORAGE ORGANIZERS AND ACCESSORIES (U.S. CLS. 100, 103 AND 106).
SEAN CROWLEY, EXAMINING ATTORNEY

CLASS 41—EDUCATION AND ENTERTAINMENT

SN 76-683,740. GROUP KAITU, LLC, RICHMOND, VA. FILED 11-7-2007.

EROS SHEMALE ESCORTS

THE MARK CONSISTS OF STANDARD CHARACTERS WITHOUT CLAIM TO ANY PARTICULAR FONT, STYLE, SIZE, OR COLOR.

OWNER OF U.S. REG. NOS. 2,793,831, 3,134,894 AND OTHERS.

NO CLAIM IS MADE TO THE EXCLUSIVE RIGHT TO USE "SHEMALE ESCORTS", APART FROM THE MARK AS SHOWN.

FOR PROVIDING INFORMATION IN THE FIELD OF ADULT-THEMED ENTERTAINMENT VIA A GLOBAL COMPUTER NETWORK; PROVIDING ONLINE PUBLICATIONS, NAMELY, A MAGAZINE AND ARTICLES IN THE FIELD OF ADULT-THEMED ENTERTAINMENT VIA A GLOBAL COMPUTER NETWORK (U.S. CLS. 100, 101 AND 107).

FIRST USE 9-28-2007; IN COMMERCE 9-28-2007.
LEIGH LOWRY, EXAMINING ATTORNEY

SN 76-708,256. THE NEW HAMPSHIRE LOTTERY COMMISSION, CONCORD, NH. FILED 7-7-2011.

MONEY PUZZLE

THE MARK CONSISTS OF STANDARD CHARACTERS WITHOUT CLAIM TO ANY PARTICULAR FONT, STYLE, SIZE, OR COLOR.

NO CLAIM IS MADE TO THE EXCLUSIVE RIGHT TO USE "PUZZLE", APART FROM THE MARK AS SHOWN.

FOR LOTTERY GAME SERVICES (U.S. CLS. 100, 101 AND 107).

FIRST USE 12-31-2000; IN COMMERCE 12-31-2000.
CARYN GLASSER, EXAMINING ATTORNEY

CLASS 41—(Continued).

SN 76-708,921. CAMERON, TIMOTHY A., STONE MOUNTAIN, GA. AND GLENN, GARY W., STONE MOUNTAIN, GA. AND GATES, JIMMY E., STONE MOUNTAIN, GA. AND JENKINS, GARY E., STONE MOUNTAIN, GA. AND L. RASBORO, JOHNATHAN, STONE MOUNTAIN, GA. FILED 8-29-2011.

SILK

THE MARK CONSISTS OF STANDARD CHARACTERS WITHOUT CLAIM TO ANY PARTICULAR FONT, STYLE, SIZE, OR COLOR.

FOR ENTERTAINMENT SERVICES IN THE NATURE OF LIVE AND RECORDED MUSICAL AND DRAMATIC PERFORMANCES BY A GROUP (U.S. CLS. 100, 101 AND 107).

FIRST USE 11-11-1992; IN COMMERCE 11-11-1992.
SUZANNE BLANE, EXAMINING ATTORNEY

SN 76-708,985. WHIPPERHILL OUTDOORS, INC., LOCK HAVEN, PA. FILED 9-6-2011.

TRIPLE MAG

THE MARK CONSISTS OF STANDARD CHARACTERS WITHOUT CLAIM TO ANY PARTICULAR FONT, STYLE, SIZE, OR COLOR.

FOR EDUCATIONAL AND ENTERTAINMENT SERVICES, NAMELY, VIDEO PRODUCTION SERVICES FOR THE CREATION OF HUNTING VIDEOS FOR DISTRIBUTION ON TELEVISION OR THE INTERNET (U.S. CLS. 100, 101 AND 107).

ESTHER BELENKER, EXAMINING ATTORNEY

SN 76-710,255. SPORTSATIONALS, LLC, CHADDS FORD, PA. FILED 1-12-2012.

Sportsationals

THE MARK CONSISTS OF STANDARD CHARACTERS WITHOUT CLAIM TO ANY PARTICULAR FONT, STYLE, SIZE, OR COLOR.

FOR ENTERTAINMENT SERVICES, NAMELY, PROVIDING A WEBSITE FEATURING PRESENTATIONS IN THE FIELD OF EDUCATIONAL INFORMATION DIRECTED AT CHILDREN AND THEIR FAMILIES ABOUT LEARNING SKILLS, HEALTHFUL LIVING AND STAYING ACTIVE THROUGH INVOLVEMENT IN SPORTS (U.S. CLS. 100, 101 AND 107).

FIRST USE 11-28-2011; IN COMMERCE 11-28-2011.
KATINA MISTER, EXAMINING ATTORNEY

CLASS 41—(Continued).

SN 77-156,540. SIEVRIGHT, ANDREW, REDDING, CA. FILED 4-13-2007.

FOREVER YOUNG

THE MARK CONSISTS OF STANDARD CHARACTERS WITHOUT CLAIM TO ANY PARTICULAR FONT, STYLE, SIZE, OR COLOR.

FOR EDUCATIONAL SERVICES, NAMELY, TV AND INTERNET CLASSES AND SEMINARS ON HOW TO STAY YOUTHFUL AND YOUNG NO MATTER YOUR AGE (U.S. CLS. 100, 101 AND 107).

FRANK LATTUCA, EXAMINING ATTORNEY

SN 77-381,593. DISNEY ONLINE, BURBANK, CA. FILED 1-27-2008.

KABOOSE FAMILY NETWORK

THE MARK CONSISTS OF STANDARD CHARACTERS WITHOUT CLAIM TO ANY PARTICULAR FONT, STYLE, SIZE, OR COLOR.

PRIORITY CLAIMED UNDER SEC. 44(D) ON CANADA APPLICATION NO. 1379413, FILED 1-16-2008.

OWNER OF U.S. REG. NOS. 2,723,021, 3,078,674 AND 3,214,973.

NO CLAIM IS MADE TO THE EXCLUSIVE RIGHT TO USE "FAMILY NETWORK", APART FROM THE MARK AS SHOWN.

FOR PROVIDING INFORMATION DIRECTED TO CHILDREN, PARENTS, AND TEACHERS VIA A GLOBAL COMPUTER INFORMATION NETWORK IN THE FIELD OF ENTERTAINMENT; PROVIDING INFORMATION DIRECTED TO CHILDREN, PARENTS, AND TEACHERS VIA A GLOBAL COMPUTER INFORMATION NETWORK IN THE FIELD OF EDUCATION, NAMELY, PARENTING CONCERNING EDUCATION OF CHILDREN AND ART CLASSES (U.S. CLS. 100, 101 AND 107).

BRIDGETT SMITH, EXAMINING ATTORNEY

CLASS 41—(Continued).

SN 77-969,284. LOURDES REYES ROSAS, D.F., MEXICO, FILED 3-26-2010.

GELART FLORAL

THE MARK CONSISTS OF STANDARD CHARACTERS WITHOUT CLAIM TO ANY PARTICULAR FONT, STYLE, SIZE, OR COLOR.

NO CLAIM IS MADE TO THE EXCLUSIVE RIGHT TO USE "FLORAL", APART FROM THE MARK AS SHOWN.

FOR EDUCATIONAL SERVICES, NAMELY, CONDUCTING WORKSHOPS ON THE CREATION OF DECORATIVE GELATIN FOOD PRODUCTS, AND DISTRIBUTION OF TRAINING MATERIALS IN CONNECTION THEREWITH (U.S. CLS. 100, 101 AND 107).

FIRST USE 11-29-1997; IN COMMERCE 6-13-2003.

KATHERINE STOIDES, EXAMINING ATTORNEY

SN 79-098,824. ILC INTERNATIONAL LEGAL CONSULTANTS (SINGAPORE) PTE. LTD., SINGAPORE, FILED 4-8-2011.



PRIORITY DATE OF 12-16-2010 IS CLAIMED. OWNER OF INTERNATIONAL REGISTRATION 1081151 DATED 4-8-2011, EXPIRES 4-8-2021.

THE COLOR(S) BLACK, MAGENTA, RED, ORANGE, YELLOW AND WHITE IS/ARE CLAIMED AS A FEATURE OF THE MARK.

THE MARK CONSISTS OF THE STYLIZED WORD "BLUSH" IN MAGENTA LETTERS AND A CIRCULAR DESIGN WITH OVERLAPPING DIAGONAL LINES COMPRISING OF BANDS OF COLOR IN MAGENTA, RED, ORANGE, YELLOW AND WHITE, ALL ON A BLACK BACKGROUND.

FOR ENTERTAINMENT SERVICES, NAMELY, LIVE PERFORMANCES BY A MUSICAL GROUP (U.S. CLS. 100, 101 AND 107).

PATRICIA EVANKO, EXAMINING ATTORNEY

CLASS 41—(Continued).

SN 79-109,741. STUDIO PILATES INTERNATIONAL PTY LTD; AS TRUSTEE FOR; THE STUDIO PILATES IP TRUST, AUSTRALIA, FILED 12-16-2011.



OWNER OF INTERNATIONAL REGISTRATION 1108272 DATED 12-16-2011, EXPIRES 12-16-2021.

NO CLAIM IS MADE TO THE EXCLUSIVE RIGHT TO USE "STUDIO PILATES INTERNATIONAL", APART FROM THE MARK AS SHOWN.

THE MARK CONSISTS OF THE STYLIZED WORDING "STUDIO PILATES INTERNATIONAL" TO THE RIGHT OF A PARTIALLY SHADED CIRCLE CONTAINING THE LETTERS "SP".

FOR PROVIDING FITNESS AND EXERCISE FACILITIES; HEALTH CLUB SERVICES, NAMELY, PROVIDING EXERCISE INSTRUCTION, EDUCATION AND EQUIPMENT IN THE FIELD OF PHYSICAL EXERCISE (U.S. CLS. 100, 101 AND 107).

HEATHER THOMPSON, EXAMINING ATTORNEY

CLASS 41—(Continued).

SN 85-036,989. IMPOSSIBLE2POSSIBLE, INC., BELLFLOWER, CA. FILED 5-12-2010.



THE MARK CONSISTS OF THE STYLIZED WORDING "I2P" BELOW WHICH IS LOCATED THE STYLIZED WORDING "IMPOSSIBLE2POSSIBLE". ALL OF THE STYLIZED WORDING ARE CONTAINED WITHIN AN OUTLINED RECTANGLE WITH ROUNDED CORNERS.

FOR EDUCATIONAL AND ENTERTAINMENT SERVICES, NAMELY, PROVIDING EXPERIENTIAL LEARNING ACTIVITIES, NAMELY, CLASSES, SEMINARS AND WORKSHOPS FOR YOUTH IN THE FIELD OF GLOBAL SOCIAL AND ENVIRONMENTAL ACTION; EDUCATIONAL SERVICES, NAMELY, CONDUCTING CLASSES, SEMINARS, CONFERENCES, WORKSHOPS, RETREATS, CAMPS AND FIELD TRIPS IN THE FIELD OF GLOBAL SOCIAL AND ENVIRONMENTAL ACTION; EDUCATIONAL SERVICES, NAMELY, PROVIDING LIVE AND ON-LINE CLASSES, SEMINARS AND WORKSHOPS IN THE FIELD OF GLOBAL SOCIAL AND ENVIRONMENTAL ACTION; ORGANIZING ON-LINE EXHIBITIONS AND CONFERENCES IN THE FIELDS OF EDUCATION, CULTURE, SPORTS AND ENTERTAINMENT FOR NON-BUSINESS AND NON-COMMERCIAL PURPOSES; EDUCATIONAL SERVICES, NAMELY, CONDUCTING ON-LINE CLASSES AND WORKSHOPS IN THE FIELD OF CUSTOMIZED LEADERSHIP TRAINING AND RESEARCH AND WRITING EDUCATIONAL MATERIALS; PRODUCTION OF FILMS AND TELEVISION PROGRAMS; PROVIDING CURRENT EVENT NEWS AND INFORMATION VIA A GLOBAL COMPUTER NETWORK, NAMELY, CURRENT EVENT NEWS RELATING TO GLOBAL AND SOCIAL AND ENVIRONMENTAL ACTION UNDERTAKEN BY OTHERS; PROVIDING A WEBSITE FEATURING INFORMATION ON EXERCISE AND FITNESS; PROVIDING COURSES AND INFORMATION IN THE FIELD OF GLOBAL WATER RESOURCES AND WATER MANAGEMENT (U.S. CLS. 100, 101 AND 107).

FIRST USE 6-17-2008; IN COMMERCE 6-17-2008.
 NAPOLEON SHARMA, EXAMINING ATTORNEY

SN 85-079,764. BONNER, LISA, NEW YORK, NY. FILED 7-7-2010.

THE ADVENTURES OF A SINGLISTA

THE MARK CONSISTS OF STANDARD CHARACTERS WITHOUT CLAIM TO ANY PARTICULAR FONT, STYLE, SIZE, OR COLOR.

FOR PROVIDING AN ON-LINE MONTHLY COLUMN AND NON-DOWNLOADABLE ELECTRONIC PUBLICATIONS IN THE NATURE OF MAGAZINES, NEWSLETTERS, ARTICLES IN THE FIELDS OF TRAVEL, URBAN EVENTS, DATING AND RELATIONSHIP ADVICE (U.S. CLS. 100, 101 AND 107).

FIRST USE 7-6-2010; IN COMMERCE 7-6-2010.
 JAMES LOVELACE, EXAMINING ATTORNEY

CLASS 41—(Continued).

SN 85-102,385. SPIN GEEKS, LLC, WASHINGTON, UT. FILED 8-6-2010.



THE MARK CONSISTS OF THE WORDS "SPINGEEKS" IN BLOCK ITALICIZED DESIGN. OUTLINED WITH ABOVE THE "NGE" OF "SPINGEEKS" APPEARS A STYLIZED IMAGE OF A BICYCLIST RIDING A BICYCLE. THE RIDER OF THE BICYCLE APPEARS TO BE WEARING A CAPE, BLOWING BEHIND HIM AS IF IN A BREEZE. THE WHEELS OF THE BICYCLE CONTAIN TWO DOTS THAT MAKE THE IMAGE, WHEN TAKEN AS A WHOLE, TO LOOK LIKE EYEBALLS WITHIN A PAIR OF SPECTACLES. THERE IS A SMALL AREA OF WHITE BENEATH THE BICYCLIST'S TORSO. THE UPPER PORTION OF THE LETTER "G" APPEARS TO BE THE MOUTH OF THE IMAGE.

FOR ENTERTAINMENT SERVICES IN THE NATURE OF ORGANIZING BICYCLE RACING AND EXHIBITIONS (U.S. CLS. 100, 101 AND 107).

FIRST USE 1-1-2009; IN COMMERCE 1-1-2009.

LINDA MICKLEBURGH, EXAMINING ATTORNEY

SN 85-115,760. BNP MEDIA II, LLC, TROY, MI. FILED 8-25-2010.

SECURITY

THE MARK CONSISTS OF STANDARD CHARACTERS WITHOUT CLAIM TO ANY PARTICULAR FONT, STYLE, SIZE, OR COLOR.

OWNER OF U.S. REG. NOS. 1,602,233, 1,610,901 AND 2,099,200.

SEC. 2(F).

FOR PROVIDING ONLINE PUBLICATIONS IN THE NATURE OF ARTICLES, MAGAZINES, WHITE PAPERS, COLUMNS, AND NEWSLETTERS IN THE FIELD OF SAFETY AND SECURITY PRODUCTS AND SERVICES THAT ARE OF INTEREST TO THOSE IN THE SAFETY AND SECURITY PRODUCTS AND SERVICES INDUSTRY; PROVIDING ONLINE JOURNALS, NAMELY, BLOGS, FEATURING TOPICS OF INTEREST TO THOSE IN THE SAFETY AND SECURITY PRODUCTS AND SERVICES INDUSTRY (U.S. CLS. 100, 101 AND 107).

FIRST USE 1-25-1999; IN COMMERCE 1-25-1999.

MICHELLE DUBOIS, EXAMINING ATTORNEY

CLASS 41—(Continued).

SN 85-145,316. THE WELLSRING CONSORTIUM, BATAVIA, IL. FILED 10-5-2010.



NO CLAIM IS MADE TO THE EXCLUSIVE RIGHT TO USE "BEST PLATE", APART FROM THE MARK AS SHOWN.

THE COLOR(S) SILVER, ORANGE AND BLACK IS/ARE CLAIMED AS A FEATURE OF THE MARK.

THE MARK CONSISTS OF A SILVER COVERED DISH OR PLATTER; THE TOP IS RAISED ABOVE THE DISH, AND BETWEEN THESE ELEMENTS APPEAR THE WORDS "BEST PLATE" IN BLACK LETTERING; BEHIND THIS DESIGN IS AN ORANGE STARBURST.

FOR ENTERTAINMENT SERVICES IN THE NATURE OF AN ON-GOING REALITY BASED TELEVISION PROGRAM (U.S. CLS. 100, 101 AND 107).

HENRY S. ZAK, EXAMINING ATTORNEY

SN 85-165,164. OLSEN, CHRISTOPHER KAI, LA GRANGE PARK, IL. FILED 10-29-2010.

The Karl Dahl Show

THE MARK CONSISTS OF STANDARD CHARACTERS WITHOUT CLAIM TO ANY PARTICULAR FONT, STYLE, SIZE, OR COLOR.

NO CLAIM IS MADE TO THE EXCLUSIVE RIGHT TO USE "SHOW", APART FROM THE MARK AS SHOWN.

THE NAME(S), PORTRAIT(S), AND/OR SIGNATURE(S) SHOWN IN THE MARK DOES NOT IDENTIFY A PARTICULAR LIVING INDIVIDUAL.

FOR MOTION PICTURE FILMS IN THE FIELD OF COMEDY AND ENTERTAINMENT, NAMELY, THE PRODUCTION AND DISTRIBUTION THEREOF; TELEVISION, RADIO, AND INTERNET PROGRAMS IN THE FIELD OF COMEDY AND ENTERTAINMENT, NAMELY, THE PRODUCTION AND DISTRIBUTION THEREOF; DISTRIBUTION OF MOTION PICTURE FILMS; ELECTRONIC PUBLISHING SERVICES, NAMELY, PUBLICATION OF TEXTUAL AND GRAPHIC WORKS IN THE NATURE OF A SERIES OF COMIC AND STORY BOOKS, BOOKS, MAGAZINES, NEWSLETTERS AND ELECTRONIC AND DIGITAL MEDIA IN THE FIELD OF COMEDY AND ENTERTAINMENT, ALL OF THE FOREGOING DELIVERED DIGITALLY VIA A GLOBAL COMPUTER NETWORK (U.S. CLS. 100, 101 AND 107).

INGA ERVIN, EXAMINING ATTORNEY

CLASS 41—(Continued).

SN 85-165,173. OLSEN, CHRISTOPHER KAI, LA GRANGE PARK, IL. FILED 10-29-2010.

Ursula The Uber-Girl

THE MARK CONSISTS OF STANDARD CHARACTERS WITHOUT CLAIM TO ANY PARTICULAR FONT, STYLE, SIZE, OR COLOR.

THE NAME(S), PORTRAIT(S), AND/OR SIGNATURE(S) SHOWN IN THE MARK DOES NOT IDENTIFY A PARTICULAR LIVING INDIVIDUAL.

FOR MOTION PICTURE FILMS IN THE FIELD OF COMEDY AND ENTERTAINMENT, NAMELY, THE PRODUCTION AND DISTRIBUTION THEREOF; TELEVISION, RADIO, AND INTERNET PROGRAMS IN THE FIELD OF COMEDY AND ENTERTAINMENT, NAMELY, THE PRODUCTION AND DISTRIBUTION THEREOF; DISTRIBUTION OF MOTION PICTURE FILMS; ELECTRONIC PUBLISHING SERVICES, NAMELY, PUBLICATION OF TEXTUAL AND GRAPHIC WORKS IN THE NATURE OF A SERIES OF COMIC AND STORY BOOKS, BOOKS, MAGAZINES, NEWSLETTERS AND ELECTRONIC AND DIGITAL MEDIA IN THE FIELD OF COMEDY AND ENTERTAINMENT, ALL OF THE FOREGOING DELIVERED DIGITALLY VIA A GLOBAL COMPUTER NETWORK (U.S. CLS. 100, 101 AND 107).

INGA ERVIN, EXAMINING ATTORNEY

CLASS 41—(Continued).

SN 85-184,923. MEAN MUGZ, LLC, CHICAGO, IL. FILED 11-24-2010.



THE MARK CONSISTS OF THE WORDS "MEAN MUGZ" UNDER THE IMAGE OF A FACE.

FOR ENTERTAINMENT SERVICES, NAMELY, PROVIDING A WEBSITE FEATURING NON-DOWNLOADABLE FUNNY PICTURES, HUMOROUS NON-DOWNLOADABLE VIDEOS, NEWS ABOUT ENTERTAINMENT, SPORTS, CURRENT EVENTS, AND HUMOROUS EVENTS, AND FUNNY ARTICLES ABOUT ENTERTAINMENT, SPORTS, CURRENT EVENTS, AND HUMOROUS EVENTS, GAMES; ENTERTAINMENT SERVICES, NAMELY, CONDUCTING CONTESTS (U.S. CLS. 100, 101 AND 107).

DAVID TAYLOR, EXAMINING ATTORNEY

SN 85-171,224. UNIVERSITY OF SOUTH CAROLINA, COLUMBIA, SC. FILED 11-8-2010.

USC CONNECT

THE MARK CONSISTS OF STANDARD CHARACTERS WITHOUT CLAIM TO ANY PARTICULAR FONT, STYLE, SIZE, OR COLOR.

CONCURRENT REGISTRATION WITH REGISTRATION NO. 2319979

OWNER OF U.S. REG. NO. 2,407,529.

FOR EDUCATIONAL SERVICES, NAMELY, PROVIDING CLASSES, COURSES AND SEMINARS AT THE UNDERGRADUATE, POST-GRADUATE, ADULT EDUCATION AND PROFESSIONAL LEVELS THAT ARE INTEGRATED WITH OUTSIDE OF THE CLASSROOM EXPERIENCE (U.S. CLS. 100, 101 AND 107).

FIRST USE 1-9-2012; IN COMMERCE 1-9-2012.

MARK PILARO, EXAMINING ATTORNEY

SN 85-192,728. MARIA COOPER, JANIS, LAGUNA BEACH, CA. FILED 12-7-2010.

Gary Cooper

THE MARK CONSISTS OF STANDARD CHARACTERS WITHOUT CLAIM TO ANY PARTICULAR FONT, STYLE, SIZE, OR COLOR.

THE NAME(S), PORTRAIT(S), AND/OR SIGNATURE(S) SHOWN IN THE MARK DOES NOT IDENTIFY A PARTICULAR LIVING INDIVIDUAL.

FOR ENTERTAINMENT SERVICES, NAMELY, PROVIDING A WEB SITE FEATURING PHOTOGRAPHIC, VIDEO AND PROSE PRESENTATIONS FEATURING FILM-CLIPS, INFORMATION, PHOTOGRAPHS, BIOGRAPHIES, AND FILM CREDITS CONCERNING OR RELATED TO GARY COOPER AND HIS RECORDED ARTISTIC, DRAMATIC AND VISUAL ARTS PERFORMANCES AS AN ACTOR AND LIFE AS AN AMERICAN ENTERTAINER (U.S. CLS. 100, 101 AND 107).

FIRST USE 9-15-2011; IN COMMERCE 9-15-2011.

KELLY BOULTON, EXAMINING ATTORNEY

CLASS 41—(Continued).

SN 85-203,041. ROSEMARY DANIELL, DBA ZONA ROSA, LLC, SAVANNAH, GA. FILED 12-21-2010.



THE COLOR(S) PINK, BLACK, AND DARK PINK IS/ARE CLAIMED AS A FEATURE OF THE MARK.

THE MARK CONSISTS OF A DARK PINK LIP PRINT ON A PALE PINK BACKGROUND WITH BLACK CURSIVE LETTERS SPELLING OUT "ZONA ROSA".

THE ENGLISH TRANSLATION OF THE SPANISH WORDS "ZONA ROSA" IS "PINK ZONE".

FOR PERSONAL COACHING SERVICES IN THE FIELD OF WRITING (U.S. CLS. 100, 101 AND 107).

FIRST USE 0-0-1983; IN COMMERCE 0-0-1983.

ANN E. SAPPENFIELD, EXAMINING ATTORNEY

CLASS 41—(Continued).

SN 85-215,361. HOME BOX OFFICE, INC., NEW YORK, NY. FILED 1-11-2011.



OWNER OF U.S. REG. NOS. 1,349,993, 2,239,669 AND OTHERS.

THE MARK CONSISTS OF THE WORD "MAX" WITH THE LETTER "A" SLIGHTLY LARGER THAN THE LETTERS "M" AND "X".

FOR ENTERTAINMENT SERVICES IN THE NATURE OF PROVIDING ENTERTAINMENT PROGRAMMING AND CONTENT, NAMELY, ON-GOING TELEVISION PROGRAMS, AND RELATED CLIPS AND GRAPHICS AND INFORMATION RELATING TO TELEVISION PROGRAMMING AND CONTENT IN THE FIELDS OF COMEDY, DRAMA, ACTION, VARIETY, ADVENTURE, SPORTS, HEALTH, FITNESS, MUSICALS, CURRENT EVENTS AND ENTERTAINMENT NEWS, DOCUMENTARY AND ANIMATION, VIA TELEVISION, CABLE AND SATELLITE SYSTEMS, THE INTERNET, ELECTRONIC COMMUNICATIONS NETWORKS, COMPUTER NETWORKS AND WIRELESS COMMUNICATIONS NETWORKS (U.S. CLS. 100, 101 AND 107).

JENNIFER WILLISTON, EXAMINING ATTORNEY

SN 85-214,466. GREENSPUN MEDIA GROUP, LLC, HENDERSON, NV. FILED 1-10-2011.

VEGAS INC.

THE MARK CONSISTS OF STANDARD CHARACTERS WITHOUT CLAIM TO ANY PARTICULAR FONT, STYLE, SIZE, OR COLOR.

OWNER OF U.S. REG. NOS. 2,943,458, 3,724,212 AND OTHERS.

NO CLAIM IS MADE TO THE EXCLUSIVE RIGHT TO USE "VEGAS", APART FROM THE MARK AS SHOWN.

FOR PROVIDING NON-DOWNLOADABLE ONLINE PUBLICATIONS, NAMELY, MAGAZINES FOCUSING ON ECONOMICS, NAMELY, GAMING AND NON GAMING RESORTS, SUPPORT ORGANIZATIONS AND COMPANIES (U.S. CLS. 100, 101 AND 107).

DARRYL SPRUILL, EXAMINING ATTORNEY

SN 85-229,959. MATTEL, INC., EL SEGUNDO, CA. FILED 1-31-2011.

PRECOOL

THE MARK CONSISTS OF STANDARD CHARACTERS WITHOUT CLAIM TO ANY PARTICULAR FONT, STYLE, SIZE, OR COLOR.

FOR ENTERTAINMENT SERVICES, NAMELY, PROVIDING ONLINE COMPUTER GAMES AND ENTERTAINMENT INFORMATION VIA A WEBSITE (U.S. CLS. 100, 101 AND 107).

LIEF MARTIN, EXAMINING ATTORNEY

CLASS 41—(Continued).

SN 85-235,310. FRANCESCO DEL MARO, ROME, ITALY, FILED 2-7-2011.

HITWEEK

THE MARK CONSISTS OF STANDARD CHARACTERS WITHOUT CLAIM TO ANY PARTICULAR FONT, STYLE, SIZE, OR COLOR.

FOR ENTERTAINMENT SERVICES IN THE NATURE OF DEVELOPMENT, CREATION, PRODUCTION AND POST-PRODUCTION SERVICES OF MULTIMEDIA ENTERTAINMENT CONTENT; ENTERTAINMENT SERVICES IN THE NATURE OF PRESENTING LIVE MUSICAL PERFORMANCES (U.S. CLS. 100, 101 AND 107).

FIRST USE 1-1-2009; IN COMMERCE 4-1-2009.
STEVEN PEREZ, EXAMINING ATTORNEY

CLASS 41—(Continued).

ENTERTAINMENT INFORMATION VIA THE INTERNET; ENTERTAINMENT SERVICES, NAMELY, CONDUCTING PARTIES; ORGANIZING RELIGIOUS EVENTS, NAMELY, RELIGIOUS INSTRUCTION SERVICES, AND CULTURAL EVENTS; ORGANIZING EXHIBITIONS AND EVENTS FOR EDUCATIONAL, RELIGIOUS INSTRUCTION, CULTURAL, ARTS AND ENTERTAINMENT PURPOSES; ARRANGING AND CONDUCTING OF MUSIC CONCERTS; ENTERTAINMENT SERVICES, NAMELY, PRODUCTION OF LIVE MUSICAL CONCERTS; ENTERTAINMENT, NAMELY, LIVE VARIETY, DRAMA AND COMEDY PERFORMANCES FEATURING LIVE AND RECORDED MUSIC; ARRANGING AND CONDUCTING OF CONCERTS AND LIVE MUSIC EVENTS; ENTERTAINMENT SERVICES, NAMELY, CONDUCTING ONLINE CONTESTS AND SWEEPSTAKES SERVICES; ENTERTAINMENT, NAMELY, LIVE PERFORMANCES BY MUSICAL BANDS; PRESENTATION OF MUSICAL PERFORMANCE; PROVISION OF INFORMATION RELATING TO LIVE MUSICAL CONCERTS (U.S. CLS. 100, 101 AND 107).

DANNEAN HETZEL, EXAMINING ATTORNEY

SN 85-235,901. NEXTBOOK, INC., NEW YORK, NY. FILED 2-7-2011.

JEWICY

OWNER OF U.S. REG. NOS. 2,843,648, 2,907,226 AND 3,228,371.

THE MARK CONSISTS OF THE LETTERS "J", "E", "C", AND "Y" IN A STYLIZED FORMAT WITH THE HEBREW CHARACTER "SHIN" IN A STYLIZED FORMAT BETWEEN THE "JE", AND "CY".

FOR ON-LINE JOURNALS, NAMELY, BLOGS FEATURING INFORMATION IN THE FIELD OF RELIGIOUS, CULTURAL, ARTS AND EDUCATIONAL MATERIAL; ENTERTAINMENT SERVICES, NAMELY, PROVIDING A WEBSITE FEATURING AUDIO AND AUDIOVISUAL RECORDINGS FEATURING RELIGIOUS MATERIAL, CULTURAL MATERIAL, THE ARTS AND EDUCATIONAL MATERIAL; PROVIDING INFORMATION IN THE FIELDS OF RELIGIOUS INSTRUCTION, CULTURAL EVENTS, THE ARTS AND EDUCATION VIA THE INTERNET; PROVIDING NON-DOWNLOADABLE ELECTRONIC PUBLICATIONS IN THE NATURE OF ELECTRONIC MAGAZINES AND ONLINE MAGAZINES RELATING TO THE JEWISH CULTURE, MUSIC AND ENTERTAINMENT; ELECTRONIC PUBLICATION SERVICES, NAMELY, PUBLICATION OF ELECTRONIC MAGAZINES AND ONLINE MAGAZINES; PROVIDING A WEBSITE FEATURING ENTERTAINMENT INFORMATION ON MUSICAL ARTISTS, MUSICAL CONCERT TOURS, EVENTS AND DOWNLOADABLE AND STREAMING AUDIO AND AUDIOVISUAL MUSICAL CONTENT; PROVIDING EN-

SN 85-243,331. REMARK MEDIA, INC., ATLANTA, GA. FILED 2-16-2011.

DIME SPRING

THE MARK CONSISTS OF STANDARD CHARACTERS WITHOUT CLAIM TO ANY PARTICULAR FONT, STYLE, SIZE, OR COLOR.

FOR ON-LINE DIGITAL PUBLICATION OF ARTICLES, PHOTOGRAPHS, ILLUSTRATIONS, AND VIDEOS IN THE FIELD OF FINANCE (U.S. CLS. 100, 101 AND 107).

DEZMONA MIZELLE, EXAMINING ATTORNEY

CLASS 41—(Continued).

SN 85-251,142. WINGSPAN PICTURES, LLC, BURBANK, CA. FILED 2-24-2011.



NO CLAIM IS MADE TO THE EXCLUSIVE RIGHT TO USE "PICTURES", APART FROM THE MARK AS SHOWN.

THE MARK CONSISTS OF THE WORDING "WINGSPAN PICTURES" PRESENTED IN STYLIZED FONT. BETWEEN THESE TWO WORDS IS A DESIGN ELEMENT COMPRISED A SINGLE LINE CIRCLE WITH A STYLIZED "W" SUPERIMPOSED THEREON. EACH SIDE ELEMENT OF THE "W" IS COMPRISED OF A STYLIZED DEPICTION OF A WING.

FOR ANIMATION PRODUCTION SERVICES; ENTERTAINMENT AND EDUCATION SERVICES IN THE NATURE OF A SERIES OF SHORT SHOWS FEATURING ONLINE EDUCATIONAL CONTENT DISTRIBUTED TO MOBILE HANDSETS, WHICH MAY INCLUDE VIDEO, TEXT, PHOTOS, ILLUSTRATIONS OR HYPERTEXT; ENTERTAINMENT MEDIA PRODUCTION SERVICES FOR MOTION PICTURES, TELEVISION AND INTERNET; ENTERTAINMENT SERVICES, NAMELY, MULTIMEDIA PRODUCTION SERVICES; FILM AND VIDEO PRODUCTION; FILM AND VIDEO PRODUCTION CONSULTING SERVICES; FILM EDITING; FILM STUDIOS; MEDIA PRODUCTION SERVICES, NAMELY, VIDEO AND FILM PRODUCTION; MULTIMEDIA ENTERTAINMENT SERVICES IN THE NATURE OF DEVELOPMENT, PRODUCTION AND POST-PRODUCTION SERVICES IN THE FIELDS OF VIDEO AND FILMS; PRODUCTION OF HUMOROUS VIDEOS FOR THE INTERNET (U.S. CLS. 100, 101 AND 107).

FIRST USE 11-14-2008; IN COMMERCE 11-14-2008.
GRETCHEN ULRICH, EXAMINING ATTORNEY

SN 85-294,534. YOUNG, JEROME M, NEW YORK, NY. FILED 4-13-2011.

3Star

THE MARK CONSISTS OF STANDARD CHARACTERS WITHOUT CLAIM TO ANY PARTICULAR FONT, STYLE, SIZE, OR COLOR.

FOR ENTERTAINMENT SERVICES IN THE NATURE OF LIVE MUSICAL PERFORMANCES (U.S. CLS. 100, 101 AND 107).

FIRST USE 9-30-2005; IN COMMERCE 10-31-2005.
SEAN CROWLEY, EXAMINING ATTORNEY

CLASS 41—(Continued).

SN 85-303,890. SE ENTERTAINMENT, SHELDON, IA. FILED 4-25-2011.

STOVETOP PRODUCTIONS

THE MARK CONSISTS OF STANDARD CHARACTERS WITHOUT CLAIM TO ANY PARTICULAR FONT, STYLE, SIZE, OR COLOR.

NO CLAIM IS MADE TO THE EXCLUSIVE RIGHT TO USE "PRODUCTIONS", APART FROM THE MARK AS SHOWN.

FOR ENTERTAINMENT SERVICES, NAMELY, LIVE MUSICAL PERFORMANCES; DISC JOCKEY SERVICES (U.S. CLS. 100, 101 AND 107).

FIRST USE 1-1-2011; IN COMMERCE 1-1-2011.
KATHLEEN M. VANSTON, EXAMINING ATTORNEY

SN 85-305,418. KOOKEE MONSTERS, INC., SAN LORENZO, CA. FILED 4-26-2011.

KooKee Monsters

THE MARK CONSISTS OF STANDARD CHARACTERS WITHOUT CLAIM TO ANY PARTICULAR FONT, STYLE, SIZE, OR COLOR.

FOR ENTERTAINMENT SERVICES, NAMELY, PROVIDING ONLINE VIDEO GAMES (U.S. CLS. 100, 101 AND 107).

FIRST USE 1-7-2011; IN COMMERCE 4-1-2011.
BILL DAWE, EXAMINING ATTORNEY

SN 85-305,802. DAVID G. MAJOR ASSOCIATES, INC., ALEXANDRIA, VA. FILED 4-27-2011.

SPYPEDIA

THE MARK CONSISTS OF STANDARD CHARACTERS WITHOUT CLAIM TO ANY PARTICULAR FONT, STYLE, SIZE, OR COLOR.

FOR EDUCATIONAL AND TRAINING SERVICES, NAMELY, CONDUCTING EDUCATIONAL RESEARCH, PUBLISHING RESEARCH RESULTS IN THE FORM OF ELECTRONIC PUBLICATIONS, AND PROVIDING ONLINE EDUCATIONAL RESEARCH SERVICES IN THE FIELD OF COUNTERINTELLIGENCE (U.S. CLS. 100, 101 AND 107).

FIRST USE 5-25-2011; IN COMMERCE 5-25-2011.
TIMOTHY FINNEGAN, EXAMINING ATTORNEY

CLASS 41—(Continued).

SN 85-309,756. TEXAS CHEER, INC., DBA CHEER TEXAS, AMARILLO, TX. FILED 5-2-2011.

NO CLAIM IS MADE TO THE EXCLUSIVE RIGHT TO USE "CHEER", APART FROM THE MARK AS SHOWN.

THE MARK CONSISTS OF THE WORD "CHEER" IN STYLIZED BLOCK LETTERS WITH A 5-POINTED STAR SITUATED BENEATH AND PARTIALLY COVERING THE FIRST "E" IN THE WORD "CHEER" AND STYLIZED BLOCK LETTERS "TE" AND "AS" SITUATED TO THE LEFT AND RIGHT OF THE STAR, RESPECTIVELY.

SEC. 2(F) AS TO "CHEER TEXAS".

FOR INSTRUCTION IN THE FIELD OF CHEERLEADING, TUMBLING AND TRAMPOLINE (U.S. CLS. 100, 101 AND 107).

FIRST USE 8-0-2000; IN COMMERCE 8-0-2000.
ALICIA COLLINS, EXAMINING ATTORNEY

CLASS 41—(Continued).

SN 85-329,348. WOOFMEISTER, LLC, MAYWOOD, NJ. FILED 5-24-2011.

THE MARK CONSISTS OF STANDARD CHARACTERS WITHOUT CLAIM TO ANY PARTICULAR FONT, STYLE, SIZE, OR COLOR.

FOR PRODUCTION OF COOKING SHOWS; PRODUCTION OF COOKING SHOWS TEACHING HOW TO COOK FOR PETS; ORGANIZING EDUCATIONAL COOKING DEMONSTRATIONS; ORGANIZING EDUCATIONAL COOKING DEMONSTRATIONS TEACHING HOW TO COOK FOR PETS (U.S. CLS. 100, 101 AND 107).
KELLEY WELLS, EXAMINING ATTORNEY

SN 85-327,457. CJ 4DPLEX CO., LTD., SEOUL, REPUBLIC OF KOREA, FILED 5-23-2011.

THE MARK CONSISTS OF STANDARD CHARACTERS WITHOUT CLAIM TO ANY PARTICULAR FONT, STYLE, SIZE, OR COLOR.

PRIORITY CLAIMED UNDER SEC. 44(D) ON REPUBLIC OF KOREA APPLICATION NO. 41-2010-3068, FILED 11-30-2010, REG. NO. 0229083, DATED 3-26-2012, EXPIRES 3-26-2022.

FOR CINEMA THEATERS; CINEMA THEATERS PROVIDING MOVIE AUDIENCE EFFECTS SUCH AS WIND, SCENT, WATER SPRAY, MOTION, VIBRATION, SMOKE, BUBBLE, LASER OR FLASH; PRODUCTION OF RADIO AND TELEVISION PROGRAMS; PRESENTATION OF LIVE SHOW PERFORMANCES; PRESENTATION OF MUSICAL PERFORMANCE; IMPRESARIO SERVICES, NAMELY, ORGANIZATION OF LIVE SHOW PERFORMANCES IN THE FIELD OF MOVIES; ANIMATION PRODUCTION SERVICES; ENTERTAINMENT IN THE NATURE OF LIVE STAGE PERFORMANCES IN THE NATURE OF PLAYS AND CONCERTS; DISTRIBUTION OF MOTION PICTURE FILMS; ENTERTAINMENT SERVICES, NAMELY, PLANNING AND CONDUCTING A SERIES OF FILM FESTIVALS; FILM PRODUCTION; MOVIE STUDIOS; RENTAL OF CINE-FILMS; PUBLICATION OF PERIODICALS; NIGHT CLUBS; VIDEOTAPING; NEWS REPORTERS SERVICES; PROVIDING AMUSEMENT FACILITIES; ARRANGING FOR TICKET RESERVATIONS FOR MOVIES; ARRANGING FOR TICKET RESERVATIONS FOR SHOWS AND OTHER ENTERTAINMENT EVENTS; PROVISION OF ENTERTAINMENT INFORMATION AND DATA CONCERNING MOVIES (U.S. CLS. 100, 101 AND 107).
PATRICIA EVANKO, EXAMINING ATTORNEY

SN 85-330,936. REMARK MEDIA, INC., ATLANTA, GA. FILED 5-26-2011.

THE MARK CONSISTS OF STANDARD CHARACTERS WITHOUT CLAIM TO ANY PARTICULAR FONT, STYLE, SIZE, OR COLOR.

FOR DIGITAL VIDEO, AUDIO, AND MULTIMEDIA PUBLISHING SERVICES; ELECTRONIC PUBLISHING SERVICES, NAMELY, PUBLICATION OF TEXT AND GRAPHIC WORKS OF OTHERS ON-LINE FEATURING AUTOMOTIVE, COMMUNICATIONS, ENTERTAINMENT, FASHION, FINANCE, HEALTH, HOME, LAW, NEWS, PRODUCTS, SCIENCE, SPORTS, TECHNOLOGY AND TRAVEL; ON-LINE ELECTRONIC NEWSLETTERS DELIVERED BY E-MAIL IN THE FIELDS OF AUTOMOTIVE, COMMUNICATIONS, ENTERTAINMENT, FASHION, FINANCE, HEALTH, HOME, LAW, NEWS, PRODUCTS, SCIENCE, SPORTS, TECHNOLOGY AND TRAVEL; ON-LINE JOURNALS, NAMELY, BLOGS FEATURING CONTENT IN THE FIELDS OF AUTOMOTIVE, COMMUNICATIONS, ENTERTAINMENT, FASHION, FINANCE, HEALTH, HOME, LAW, NEWS, PRODUCTS, SCIENCE, SPORTS, TECHNOLOGY AND TRAVEL (U.S. CLS. 100, 101 AND 107).
DAVID COLLIER, EXAMINING ATTORNEY

CLASS 41—(Continued).

SN 85-336,956. WILLIAMS, DARRELL, DBA THELOOP21-COM, BEVERLY HILLS, CA. FILED 6-2-2011.

LOOP 21

THE MARK CONSISTS OF STANDARD CHARACTERS WITHOUT CLAIM TO ANY PARTICULAR FONT, STYLE, SIZE, OR COLOR.

FOR PROVIDING AN INTERNET WEBSITE FEATURING NEWS AND INFORMATION IN THE FIELD OF AFRICAN-AMERICAN FOCUSED EDUCATION, SPORTS, AND ENTERTAINMENT (U.S. CLS. 100, 101 AND 107).

FIRST USE 8-1-2008; IN COMMERCE 8-1-2008.
ANNE E. GUSTASON, EXAMINING ATTORNEY

SN 85-338,603. FILM SCHOOLED, LLC, CINCINNATI, OH. FILED 6-6-2011.

FILM SCHOOLED

THE MARK CONSISTS OF STANDARD CHARACTERS WITHOUT CLAIM TO ANY PARTICULAR FONT, STYLE, SIZE, OR COLOR.

NO CLAIM IS MADE TO THE EXCLUSIVE RIGHT TO USE "FILM", APART FROM THE MARK AS SHOWN.

FOR ENTERTAINMENT SERVICES, NAMELY, ARRANGING AND CONDUCTING OF COMPETITIONS FOR MOVIE MAKING, NAMELY, WRITING, PRODUCING, SCORING, DIRECTING, EDITING, SPECIAL EFFECTS, GRAPHICS, AND FILMING (U.S. CLS. 100, 101 AND 107).

FIRST USE 2-11-2011; IN COMMERCE 2-11-2011.
SEAN CROWLEY, EXAMINING ATTORNEY

CLASS 41—(Continued).

SN 85-342,680. TUTORS ON CAMPUS, LLC, MCLEAN, VA. FILED 6-9-2011.



NO CLAIM IS MADE TO THE EXCLUSIVE RIGHT TO USE "TUTORS", APART FROM THE MARK AS SHOWN.

THE MARK CONSISTS OF THE DESIGN OF AN OWL IN BLACK AND WHITE PERCHED ON A BANNER, WITH THE WORDING "TUTORS ON CAMPUS" WITHIN THE BANNER CONTAINING TWO STARS AND TWO LEAVES BELOW.

FOR EDUCATIONAL SERVICES, NAMELY, PROVIDING TUTORING SERVICES FOR UNDERGRADUATES IN A FULL RANGE OF COLLEGE SUBJECTS (U.S. CLS. 100, 101 AND 107).

KIMBERLY PERRY, EXAMINING ATTORNEY

SN 85-344,546. TEAM FAIRFAX 2013, FAIRFAX, VA. FILED 6-13-2011.



THE MARK CONSISTS OF THE HEAD OF AN EAGLE WHERE THE EYE IS DEPICTED BY A STAR.

FOR (BASED ON INTENT TO USE) EDUCATION AND ENTERTAINMENT SERVICES, NAMELY, PROVIDING RADIO, TELEVISION AND CABLE TELEVISION PROGRAMS FEATURING SPORTS, ATHLETES, FIREMAN, POLICEMEN, EMERGENCY SERVICE PROVIDERS AND PROFILES OF INDIVIDUALS AND UNITS OF EMERGENCY SERVICE PROVIDERS; ON-LINE COMPUTER SERVICES, NAMELY, PROVIDING INFORMATION IN THE FIELD OF ENTERTAINMENT ACTIVITIES BY MEANS OF A GLOBAL COMPUTER NETWORK, NAMELY, INFORMATION REGARDING SPORTS, ATHLETES, AND FIREMEN, POLICEMEN, EMERGENCY SERVICE PROVIDERS AND PROFILES OF INDIVIDUALS UNITS OF EMERGENCY SERVICE PROVIDERS INVOLVED IN ATHLETIC EVENTS AND ENTERTAINMENT ACTIVITIES; CONDUCTING ENTERTAINMENT EXHIBITIONS IN THE NATURE OF PARADES AND AWARDS CEREMONIES; (BASED ON USE IN COMMERCE) ORGANIZING SPORTS COMPETITIONS, ATHLETIC EVENTS AND GAMES (U.S. CLS. 100, 101 AND 107).

FIRST USE 2-28-2011; IN COMMERCE 2-28-2011.
JOSETTE BEVERLY, EXAMINING ATTORNEY

CLASS 41—(Continued).

SN 85-345,036. ACADEMY OF TELEVISION ARTS & SCIENCES FOUNDATION, NORTH HOLLYWOOD, CA. FILED 6-13-2011.



OWNER OF U.S. REG. NOS. 1,649,437, 2,755,461 AND 3,156,041.

NO CLAIM IS MADE TO THE EXCLUSIVE RIGHT TO USE "TELEVISION AWARDS", APART FROM THE MARK AS SHOWN.

THE MARK CONSISTS OF THE STYLIZED WORDING "COLLEGE TELEVISION AWARDS" OVER A GLOBE, AND A STYLIZED FIGURE OF A HUMAN HOLDING A GLOBE NEXT TO THE WORDING.

SEC. 2(F) AS TO "COLLEGE TELEVISION AWARDS".

FOR ENTERTAINMENT SERVICES, NAMELY, PLANNING, ORGANIZING, ARRANGING, MANAGING AND CONDUCTING COMPETITIONS IN THE FIELD OF TELEVISION, FILM, VIDEO FILM, AND DIGITAL FILM PRODUCTION; PROVIDING RECOGNITION BY THE WAY OF A SERIES OF AWARDS TO DEMONSTRATE EXCELLENCE IN THE FIELD OF TELEVISION, FILM, VIDEO FILM, AND DIGITAL FILM PRODUCTION (U.S. CLS. 100, 101 AND 107).

FIRST USE 4-9-2011, THE MARK WAS FIRST USED ANYWHERE IN A DIFFERENT FORM OTHER THAN THAT SOUGHT TO BE REGISTERED AT LEAST AS EARLY AS 03/19/2006; IN COMMERCE 4-9-2011, THE MARK WAS FIRST USED IN COMMERCE IN A DIFFERENT FORM OTHER THAN THAT SOUGHT TO BE REGISTERED AT LEAST AS EARLY AS 03/19/2006.

PAULA MAHONEY, EXAMINING ATTORNEY



SN 85-345,698. G2 LIFESTYLES LLC, LONG BEACH, CA. FILED 6-14-2011.

ROCK BOTTOM BODY

THE MARK CONSISTS OF STANDARD CHARACTERS WITHOUT CLAIM TO ANY PARTICULAR FONT, STYLE, SIZE, OR COLOR.

FOR PHYSICAL FITNESS TRAINING OF INDIVIDUALS AND GROUPS; PHYSICAL FITNESS TRAINING SERVICES (U.S. CLS. 100, 101 AND 107).

SANJEEV VOHRA, EXAMINING ATTORNEY

CLASS 41—(Continued).

SN 85-345,752. G2 LIFESTYLES LLC, LONG BEACH, CA. FILED 6-14-2011.



THE COLOR(S) WHITE AND ORANGE IS/ARE CLAIMED AS A FEATURE OF THE MARK.

THE MARK CONSISTS OF THE LOWERCASE WORD "BOTTOM" IN SOLID ORANGE SANDWICHED BETWEEN THE WORDS "ROCK" AND "BODY" IN SOLID WHITE WITH A PARTIAL HUMAN TORSO AND UPPER THIGH POSITIONED NEXT TO THE "Y" OF THE WORD "BODY" AND OUTLINED IN WHITE. THE COLOR GRAY SERVES AS BACKGROUND FOR THE MARK AND FORMS NO PART OF THE CLAIMED, STYLIZED DESIGN.

FOR PHYSICAL FITNESS TRAINING OF INDIVIDUALS AND GROUPS; PHYSICAL FITNESS TRAINING SERVICES (U.S. CLS. 100, 101 AND 107).

SANJEEV VOHRA, EXAMINING ATTORNEY



SN 85-347,775. FIRST BAPTIST CHURCH MILLINGTON, MILLINGTON, TN. FILED 6-16-2011.



THE COLOR(S) SILVER, BLACK, YELLOW, WHITE AND GRAY IS/ARE CLAIMED AS A FEATURE OF THE MARK.

THE MARK CONSISTS OF STYLIZED WORDING "MERGE" IN BOLD SILVER PRINT OUTLINED IN BLACK WITH A BLACK ROAD WITH YELLOW AND WHITE LINES AND A GRAY CURB LEADING TO THE WORD "MERGE" AND THE BLACK WORDS "WHERE CAMP AND MISSIONS MEET" ABOVE THE WORD "MERGE" WITH GRAY TIRE TRACKS, YELLOW ROAD LINES, AND GRAY PICTURES OF STUDENTS DOING SPORTS AND MISSIONS IN GRAY BEHIND THE WORD "MERGE", ALL ON A SILVER RECTANGULAR BACKGROUND.

FOR A CHRISTIAN BASED SUMMER CAMP FOR STUDENTS IN THE 6 - 12 GRADE COMBINING MISSION OPPORTUNITIES, RECREATION AND WORSHIP (U.S. CLS. 100, 101 AND 107).

FIRST USE 6-15-2011; IN COMMERCE 6-15-2011.

NICHOLAS COLEMAN, EXAMINING ATTORNEY

CLASS 41—(Continued).

SN 85-352,603. JAX PHOTOGRAPHY, CHESAPEAKE BEACH, MD. FILED 6-22-2011.



NO CLAIM IS MADE TO THE EXCLUSIVE RIGHT TO USE "PHOTOGRAPHY", APART FROM THE MARK AS SHOWN.

THE MARK CONSISTS OF THE WORDING "JAX PHOTOGRAPHY", USING SCRIPT LETTERS FOR THE WORD "JAX", AND UPPERCASE LETTERS WITH A STROKE ABOVE AND BELOW FOR THE WORD "PHOTOGRAPHY".

FOR WEDDING PHOTOGRAPHY SERVICES (U.S. CLS. 100, 101 AND 107).

FIRST USE 0-0-2000; IN COMMERCE 0-0-2000.
SARA BENJAMIN, EXAMINING ATTORNEY

SN 85-356,827. LAFFSTER, SANTA MONICA, CA. FILED 6-27-2011.

LAFFSTER

THE MARK CONSISTS OF STANDARD CHARACTERS WITHOUT CLAIM TO ANY PARTICULAR FONT, STYLE, SIZE, OR COLOR.

FOR ENTERTAINMENT SERVICES, NAMELY, PROVIDING A WEBSITE FEATURING COMEDY PERFORMANCES; ENTERTAINMENT SERVICES, NAMELY, PROVIDING INFORMATION IN THE FIELD OF COMEDY, AND COMMENTARY AND ARTICLES ABOUT COMEDY, ALL ON-LINE VIA A GLOBAL COMPUTER NETWORK; ENTERTAINMENT SERVICES, NAMELY, A MULTIMEDIA PROGRAM SERIES FEATURING SOCIAL NETWORKING DISTRIBUTED VIA VARIOUS PLATFORMS ACROSS MULTIPLE FORMS OF TRANSMISSION MEDIA; PROVIDING AN ON-LINE COMPUTER DATABASE IN THE FIELD OF COMEDY PERFORMANCES; ENTERTAINMENT SERVICES, NAMELY, THE PRODUCTION OF COMEDY SHOWS; ENTERTAINMENT SERVICES, NAMELY, WRITING COMEDY MATERIAL FOR OTHERS; PROVIDING IN-DEPTH ANALYSIS TO THE COMEDY INDUSTRY DETAILING ENTERTAINMENT TRENDS SURROUNDING COMEDIANS AND CONTENT BOTH NATIONWIDE AND REGIONALLY (U.S. CLS. 100, 101 AND 107).

MIDGE BUTLER, EXAMINING ATTORNEY

CLASS 41—(Continued).

SN 85-359,649. RICH, PRESTON D., BALTIMORE, MD. FILED 6-29-2011.



NO CLAIM IS MADE TO THE EXCLUSIVE RIGHT TO USE "RECORDS", APART FROM THE MARK AS SHOWN.

FOR ENTERTAINMENT SERVICES IN THE NATURE OF RECORDING, PRODUCTION AND POST-PRODUCTION SERVICES IN THE FIELD OF MUSIC (U.S. CLS. 100, 101 AND 107).

FIRST USE 3-1-2001; IN COMMERCE 3-1-2001.
HANNO RITTNER, EXAMINING ATTORNEY

SN 85-360,451. GC2 LLC, MEDFIELD, MA. FILED 6-30-2011.

UBFit

THE MARK CONSISTS OF STANDARD CHARACTERS WITHOUT CLAIM TO ANY PARTICULAR FONT, STYLE, SIZE, OR COLOR.

FOR INTERACTIVE ON-LINE WEB JOURNALS IN THE FIELD OF FITNESS (U.S. CLS. 100, 101 AND 107).

FIRST USE 2-11-2010; IN COMMERCE 2-11-2010.
STEVEN JACKSON, EXAMINING ATTORNEY

CLASS 41—(Continued).

SN 85-362,043. YES LIV CAN LLC, BROOKLYN, NY. FILED 7-1-2011.

YES LIV CAN

THE MARK CONSISTS OF STANDARD CHARACTERS WITHOUT CLAIM TO ANY PARTICULAR FONT, STYLE, SIZE, OR COLOR.

FOR RECORDING STUDIO SERVICES; ENTERTAINMENT, NAMELY, LIVE MUSIC CONCERTS AND PERFORMANCES; MULTIMEDIA ENTERTAINMENT SERVICES IN THE NATURE OF DEVELOPMENT, PRODUCTION AND POST-PRODUCTION SERVICES IN THE FIELDS OF MUSIC, VIDEO, VIDEO GAMES, FILMS AND OTHER AUDIOVISUAL WORKS; MULTIMEDIA ENTERTAINMENT SERVICES IN THE NATURE OF RECORDING, PRODUCTION AND POST-PRODUCTION SERVICES IN THE FIELDS OF MUSIC, VIDEO, VIDEO GAMES, FILMS AND OTHER AUDIOVISUAL WORKS; POST-PRODUCTION EDITING SERVICES IN THE FIELD OF MUSIC, VIDEO, VIDEO GAMES, FILM AND OTHER AUDIOVISUAL WORKS; PRODUCTION OF AUDIO RECORDING; PRODUCTION OF RADIO OR TELEVISION PROGRAMS; PROVIDING INFORMATION, NEWS AND COMMENTARY IN THE FIELD OF ENTERTAINMENT; PUBLISHING OF ELECTRONIC PUBLICATIONS; SPECIAL EVENT PLANNING FOR SOCIAL ENTERTAINMENT PURPOSES; PARTY PLANNING CONSULTING; PARTY PLANNING SERVICES; ENTERTAINMENT IN THE NATURE OF THEATER PRODUCTIONS; FILM, MUSIC, VIDEO AND AUDIOVISUAL WORKS PRODUCTION; ENTERTAINMENT SERVICES, NAMELY, PERSONAL APPEARANCES BY MUSICIANS, VOCALISTS, RECORDING ARTISTS, PERFORMANCE ARTISTS, ENTERTAINERS, ACTORS, ATHLETES, MODELS, COMEDIANS, CELEBRITIES, PRODUCERS, AND OTHER PERSONS OF NOTORIETY (U.S. CLS. 100, 101 AND 107).

MARK SPARACINO, EXAMINING ATTORNEY

CLASS 41—(Continued).

SN 85-364,913. LIU, ALEX BING AN, SINGAPORE, SINGAPORE, FILED 7-7-2011.



NO CLAIM IS MADE TO THE EXCLUSIVE RIGHT TO USE "INTERNATIONAL PAGEANT", APART FROM THE MARK AS SHOWN.

THE MARK CONSISTS OF THE WORDS "MISS TOURISM QUEEN INTERNATIONAL PAGEANT" POSITIONED UNDERNEATH A TIARA AND TO THE LEFT OF A STYLIZED GLOBE.

FOR ARRANGING OF BEAUTY CONTESTS; ENTERTAINMENT IN THE NATURE OF BEAUTY PAGEANTS; ARRANGING OF CONTESTS; ENTERTAINMENT, NAMELY, PRODUCTION OF TELEVISION SHOWS; FILM PRODUCTION (U.S. CLS. 100, 101 AND 107).

MICHAEL KEATING, EXAMINING ATTORNEY

SN 85-363,060. SPEECH IMPROVEMENT RESOURCES, LLC, JOHNS CREEK, GA. FILED 7-5-2011.

Immersion Listening

THE MARK CONSISTS OF STANDARD CHARACTERS WITHOUT CLAIM TO ANY PARTICULAR FONT, STYLE, SIZE, OR COLOR.

FOR PROFESSIONAL COACHING SERVICES IN THE FIELD OF BUSINESS COMMUNICATIONS (U.S. CLS. 100, 101 AND 107).

FIRST USE 4-0-2008; IN COMMERCE 4-0-2008.

REGINA DRUMMOND, EXAMINING ATTORNEY

SN 85-365,911. RITA ORA, NEW YORK, NY. FILED 7-7-2011.

RITA ORA

THE MARK CONSISTS OF STANDARD CHARACTERS WITHOUT CLAIM TO ANY PARTICULAR FONT, STYLE, SIZE, OR COLOR.

THE NAME(S), PORTRAIT(S), AND/OR SIGNATURE(S) SHOWN IN THE MARK IDENTIFIES "RITA ORA", WHOSE CONSENT(S) TO REGISTER IS MADE OF RECORD.

FOR ENTERTAINMENT SERVICES, NAMELY, LIVE MUSICAL PERFORMANCES BY A PERFORMER OR GROUP (U.S. CLS. 100, 101 AND 107).

KAREN K. BUSH, EXAMINING ATTORNEY

CLASS 41—(Continued).

SN 85-366,134. O'REILLY MEDIA, INC., SEBASTOPOL, CA. FILED 7-8-2011.

MAKER PRESS

THE MARK CONSISTS OF STANDARD CHARACTERS WITHOUT CLAIM TO ANY PARTICULAR FONT, STYLE, SIZE, OR COLOR.

NO CLAIM IS MADE TO THE EXCLUSIVE RIGHT TO USE "PRESS", APART FROM THE MARK AS SHOWN.

FOR PROVIDING A WEBSITE FEATURING NON-DOWNLOADABLE PUBLICATIONS IN THE NATURE OF INSTRUCTIONS AND PLANS FOR BUILDING OR ASSEMBLING TOYS, CONSUMER ELECTRONICS, HOUSEWARES AND GADGETS FROM KITS (U.S. CLS. 100, 101 AND 107).

JULIE GUTTADAURO, EXAMINING ATTORNEY

SN 85-367,130. NBCUNIVERSAL MEDIA, LLC, NEW YORK, NY. FILED 7-8-2011.



OWNER OF U.S. REG. NOS. 1,144,545, 1,637,487 AND OTHERS.

NO CLAIM IS MADE TO THE EXCLUSIVE RIGHT TO USE "SPORTS", APART FROM THE MARK AS SHOWN.

THE MARK CONSISTS OF THE WORDS "UNIVERSAL SPORTS" WITH THE NBC PEACOCK DESIGN USED AS THE DOT OF THE LETTER "I" SET AGAINST A PARTIAL CIRCLE BACKGROUND.

FOR ENTERTAINMENT SERVICES, NAMELY, PROVIDING ON-GOING PROGRAMMING IN THE FIELDS OF SPORTS, SPORTS NEWS AND ENTERTAINMENT VIA TELEVISION, CABLE TELEVISION, RADIO SYSTEMS AND WIRELESS COMMUNICATION NETWORKS; PROVIDING INFORMATION IN THE FIELD OF SPORTS, SPORTS NEWS AND ENTERTAINMENT VIA A GLOBAL COMPUTER NETWORK AND WIRELESS COMMUNICATION NETWORKS; ENTERTAINMENT SERVICES, NAMELY, PROVIDING NON-DOWNLOADABLE AUDIO, VISUAL AND AUDIO-VISUAL CONTENT FEATURING SPORTS, SPORTS NEWS AND ENTERTAINMENT VIA A GLOBAL COMPUTER NETWORK AND WIRELESS COMMUNICATION NETWORKS (U.S. CLS. 100, 101 AND 107).

FIRST USE 6-30-2008; IN COMMERCE 6-30-2008.
THOMAS MANOR, EXAMINING ATTORNEY

CLASS 41—(Continued).

SN 85-367,402. SOLETRON LLC, PARKLAND, FL. FILED 7-10-2011.

Soletron

THE MARK CONSISTS OF STANDARD CHARACTERS WITHOUT CLAIM TO ANY PARTICULAR FONT, STYLE, SIZE, OR COLOR.

FOR PROVIDING A WEBSITE FEATURING ON-LINE JOURNALS, NAMELY, BLOGS IN THE FIELDS OF SNEAKERS AND OTHER SPORTS AND URBAN APPAREL AND ACCESSORIES, LIFESTYLE ACTIVITIES, MUSIC, MOVIES, AND FASHION MODELS; PROVIDING A WEBSITE FEATURING NON-DOWNLOADABLE ELECTRONIC PUBLICATIONS IN THE NATURE OF WRITTEN ARTICLES IN THE FIELDS OF SNEAKERS AND OTHER SPORTS AND URBAN APPAREL AND ACCESSORIES, LIFESTYLE ACTIVITIES, MUSIC, MOVIES AND FASHION MODELS; PROVIDING A WEBSITE FEATURING NON-DOWNLOADABLE VIDEOS AND VIDEO INTERVIEWS IN THE FIELD OF ENTERTAINMENT, NAMELY, MUSIC, MOVIES, AND FASHION MODELING FOR ENTERTAINMENT PURPOSES (U.S. CLS. 100, 101 AND 107).

FIRST USE 3-16-2011; IN COMMERCE 3-16-2011.
SEAN CROWLEY, EXAMINING ATTORNEY

SN 85-368,480. MLM COMPLIANCE VT, LLC, IDAHO FALLS, ID. FILED 7-11-2011.



NO CLAIM IS MADE TO THE EXCLUSIVE RIGHT TO USE "MLM COMPLIANCE VIRTUAL TRAINING", APART FROM THE MARK AS SHOWN.

THE MARK CONSISTS OF THE STYLIZED WORDING "MLM COMPLIANCE VIRTUAL TRAINING" WITH A GRAPHIC SPIRAL COMPRISED OF FOUR ARMS CONSISTING OF TRIANGLES OF DECREASING SIZE IN CONTRASTING SHADES.

FOR INTERACTIVE ON-LINE TRAINING SERVICES IN THE FIELD OF DIRECT SELLING AND MULTI-LEVEL MARKETING LEGAL AND REGULATORY COMPLIANCE (U.S. CLS. 100, 101 AND 107).

FIRST USE 6-24-2011; IN COMMERCE 6-24-2011.
STEVEN PEREZ, EXAMINING ATTORNEY

CLASS 41—(Continued).

SN 85-371,013. KREWE OF LYRA, INC., MANDEVILLE, LA.
FILED 7-14-2011.

KREWE OF LYRA

THE MARK CONSISTS OF STANDARD CHARACTERS WITHOUT CLAIM TO ANY PARTICULAR FONT, STYLE, SIZE, OR COLOR.

FOR ENTERTAINMENT SERVICES, NAMELY, ORGANIZING AND CONDUCTING CARNIVAL PARADES AND BALLS (U.S. CLS. 100, 101 AND 107).

FIRST USE 2-5-2011; IN COMMERCE 2-5-2011.

AMY C. KEAN, EXAMINING ATTORNEY

CLASS 41—(Continued).

SN 85-377,316. UNIVERSAL HEALTH CARE GROUP, INC.,
ST. PETERSBURG, FL. FILED 7-21-2011.



THE MARK CONSISTS OF THE STYLIZED WORDING "VITA" ON TOP OF "LIFE" IN CAPITAL LETTERS WITH A STYLIZED HUMAN SILHOUETTE FIGURE FORMED BY GEOMETRIC SHAPES COMPRISING THE LETTER "I" FOR BOTH THE WORD "VITA" AND "LIFE".

FOR PHYSICAL FITNESS CONSULTATION PROVIDED TO BENEFIT MEMBERS ENROLLED IN A REPLACEMENT BENEFIT HEALTH PLAN (U.S. CLS. 100, 101 AND 107).

FIRST USE 8-0-2008; IN COMMERCE 8-0-2008.

DORITT L. CARROLL, EXAMINING ATTORNEY

SN 85-377,512. MYBLOCKNYC LLC, NEW YORK, NY.
FILED 7-21-2011.

STREET FILMMAKING

THE MARK CONSISTS OF STANDARD CHARACTERS WITHOUT CLAIM TO ANY PARTICULAR FONT, STYLE, SIZE, OR COLOR.

NO CLAIM IS MADE TO THE EXCLUSIVE RIGHT TO USE "FILMMAKING", APART FROM THE MARK AS SHOWN.

FOR FILM AND VIDEO PRODUCTION CONSULTING SERVICES; EDUCATION SERVICES, NAMELY, PROVIDING CLASSES, SEMINARS, TUTORIALS, WORKSHOPS, CAMPS, SCHOOL PROGRAMS, IN THE FIELD OF SCRIPT WRITING, FILMMAKING, FILM PRODUCTION, FILM EDITING, STORYTELLING, PHOTOGRAPHY, VISUAL AND AUDIO PERFORMANCES, PRODUCTION OF ENTERTAINMENT AND MULTI-MEDIA ART FILMS AND DISTRIBUTION OF COURSE MATERIAL IN CONNECTION THEREWITH; EDUCATION SERVICES, NAMELY, CONDUCTING PROGRAMS DESIGNED TO TRAIN TEACHERS TO USE FILMMAKING AS A METHOD OF ENGAGING STUDENTS IN LEARNING; RENTAL OF CAMERAS AND AUDIO-VISUAL EQUIPMENT; PROVIDING A WEBSITE FEATURING INFORMATION IN THE FIELD OF EDUCATION, SCRIPT WRITING, FILMMAKING, FILM PRODUCTION, FILM EDITING, STORYTELLING, PHOTOGRAPHY, VISUAL AND AUDIO PERFORMANCES, PRODUCTION OF ENTERTAINMENT AND MULTI-MEDIA ART FILMS (U.S. CLS. 100, 101 AND 107).

KIMBERLY PERRY, EXAMINING ATTORNEY

SN 85-376,914. TUPELO HONEY RAYCOM, LLC, NEW
YORK, NY. FILED 7-21-2011.

FOLLOW CHANNEL

THE MARK CONSISTS OF STANDARD CHARACTERS WITHOUT CLAIM TO ANY PARTICULAR FONT, STYLE, SIZE, OR COLOR.

NO CLAIM IS MADE TO THE EXCLUSIVE RIGHT TO USE "CHANNEL", APART FROM THE MARK AS SHOWN.

FOR ENTERTAINMENT SERVICES, NAMELY, PROVIDING DIGITAL MEDIA PLATFORMS FEATURING VIDEOS OF ATHLETES' AND CELEBRITIES' SOCIAL AND PROFESSIONAL LIVES; PRODUCTION AND DISTRIBUTION OF ENTERTAINMENT CONTENT, NAMELY, VIDEOS AND WEBSITES FEATURING ATHLETES' AND CELEBRITIES' SOCIAL AND PROFESSIONAL LIVES (U.S. CLS. 100, 101 AND 107).

ZACHARY BELLO, EXAMINING ATTORNEY

CLASS 41—(Continued).

SN 85-379,827. TECH COCKTAIL, LLC, ARLINGTON, VA.
FILED 7-25-2011.

Startup Mixology

THE MARK CONSISTS OF STANDARD CHARACTERS WITHOUT CLAIM TO ANY PARTICULAR FONT, STYLE, SIZE, OR COLOR.

NO CLAIM IS MADE TO THE EXCLUSIVE RIGHT TO USE "STARTUP", APART FROM THE MARK AS SHOWN, FOR EDUCATIONAL SERVICES, NAMELY, IN CONDUCTING CONFERENCES IN THE FIELD OF NEW BUSINESS VENTURES AND BUSINESS DEVELOPMENT (U.S. CLS. 100, 101 AND 107).

FIRST USE 8-1-2010; IN COMMERCE 8-1-2010.
JAMES A. RAUEN, EXAMINING ATTORNEY

SN 85-384,838. FITZGERALD, SHANNON, NEW YORK, NY.
FILED 7-29-2011.

THE ACCIDENTAL EXECUTIVE

THE MARK CONSISTS OF STANDARD CHARACTERS WITHOUT CLAIM TO ANY PARTICULAR FONT, STYLE, SIZE, OR COLOR.

NO CLAIM IS MADE TO THE EXCLUSIVE RIGHT TO USE "EXECUTIVE", APART FROM THE MARK AS SHOWN.

FOR ARRANGING AND CONDUCTING NIGHTCLUB PARTIES; ARRANGING AND CONDUCTING OF CONCERTS; ARRANGING, ORGANIZING, CONDUCTING, AND HOSTING SOCIAL ENTERTAINMENT EVENTS; CONDUCTING WORKSHOPS AND SEMINARS IN PERSONAL AWARENESS; CONDUCTING WORKSHOPS AND SEMINARS IN SELF AWARENESS; CONDUCTING WORKSHOPS AND SEMINARS IN CLOTHING, CLOTHING DESIGN, FASHION AND MUSIC; CUSTOM WRITING SERVICES; EDUCATIONAL AND ENTERTAINMENT SERVICES, NAMELY, PROVIDING MOTIVATIONAL AND EDUCATIONAL SPEAKERS; EDUCATIONAL AND ENTERTAINMENT SERVICES, NAMELY, PROVIDING MOTIVATIONAL AND EDUCATIONAL SPEAKERS IN THE FIELD OF SELF- AND PERSONAL IMPROVEMENT; ENTERTAINMENT IN THE NATURE OF ON-GOING TELEVISION PROGRAMS IN THE FIELD OF CLOTHING, CLOTHING DESIGN, FASHION AND MUSIC; ENTERTAINMENT IN THE NATURE OF TELEVISION NEWS SHOWS; ENTERTAINMENT SERVICES, NAMELY, WINE AND FOOD TASTINGS; ENTERTAINMENT SERVICES, NAMELY, WINE TASTINGS; FILM AND VIDEO PRODUCTION; FILM PRODUCTION; MEDIA PRODUCTION SERVICES, NAMELY, VIDEO AND FILM PRODUCTION; MOTION PICTURE FILM PRODUCTION; MOVIE STUDIOS; MULTIMEDIA ENTERTAINMENT SERVICES IN THE NATURE OF DEVELOPMENT, PRODUCTION AND POST-PRODUCTION SERVICES IN THE FIELDS OF VIDEO AND FILMS; MULTIMEDIA ENTERTAINMENT SERVICES IN THE NATURE OF RECORDING, PRODUC-

CLASS 41—(Continued).

TION AND POST-PRODUCTION SERVICES IN THE FIELDS OF MUSIC, VIDEO, AND FILMS; ON-LINE JOURNALS, NAMELY, BLOGS FEATURING CLOTHING, CLOTHING AND ARCHITECTURAL DESIGN, FASHION AND MUSIC; ORGANIZING CULTURAL AND ARTS EVENTS; PARTY PLANNING; PARTY PLANNING CONSULTATION; PHOTOGRAPHY; PHOTOGRAPHY SERVICES; POEM AND LYRIC WRITING; PRODUCTION OF FILMS; PRODUCTION OF TELEVISION PROGRAMS; PUBLISHING OF BOOKS, E-BOOKS, AUDIO BOOKS, MUSIC AND ILLUSTRATIONS; PUBLISHING OF WEB MAGAZINES; SCRIPT WRITING SERVICES; SONG WRITING SERVICES; WRITING OF ARTICLES FOR JOURNALS OTHER THAN FOR ADVERTISING OR PUBLICITY; WRITING OF ARTICLES FOR PERIODICALS OTHER THAN FOR ADVERTISING OR PUBLICITY; WRITING OF ARTICLES FOR PROFESSIONAL JOURNALS OTHER THAN FOR ADVERTISING OR PUBLICITY; WRITING OF TEXTS; WRITING OF TEXTS OTHER THAN PUBLICITY TEXTS (U.S. CLS. 100, 101 AND 107).

FIRST USE 6-25-2011; IN COMMERCE 6-25-2011.
MARC LEIPZIG, EXAMINING ATTORNEY

SN 85-388,659. FLORIDA ACADEMY OF PERFORMING ARTS, INC., LITHIA, FL. FILED 8-3-2011.



NO CLAIM IS MADE TO THE EXCLUSIVE RIGHT TO USE "FLORIDA ACADEMY OF PERFORMING ARTS", APART FROM THE MARK AS SHOWN.

THE MARK CONSISTS OF THE STYLIZED LETTERS "FAOPA", WITH THE "O" EMITTING RAYS IN THE MANNER OF A SUN. BELOW THESE LETTERS IS THE WORDING "THE FLORIDA ACADEMY OF PERFORMING ARTS" IN STYLIZED FORM.

FOR CONDUCTING WORKSHOPS AND SEMINARS IN THE FIELDS OF MUSIC, THEATRICALS, AND DANCE; DIRECTION OR PRESENTATION OF LIVE MUSIC, THEATRICALS, AND DANCE PERFORMANCES; EDUCATION SERVICES, NAMELY, PROVIDING LIVE AND ON-LINE CLASSES, CAMPS, LESSONS, SEMINARS, WORKSHOPS, INSTRUCTIONS, TUTORING AND MENTORING IN THE FIELDS OF MUSIC, THEATRICALS, AND DANCE; EDUCATIONAL SERVICES, NAMELY, CONDUCTING LIVE AND ON-LINE CLASSES, CAMPS, LESSONS, SEMINARS, WORKSHOPS, INSTRUCTIONS, TUTORING AND MENTORING IN THE FIELDS OF MUSIC, THEATRICALS, AND DANCE AND DISTRIBUTION OF PRINTED MATERIALS IN CONNECTION THEREWITH IN HARD COPY OR ELECTRONIC FORMAT ON THE SAME TOPICS; ENTERTAINMENT IN THE NATURE OF VISUAL AND AUDIO PERFORMANCES BY ACTORS, MUSICAL BANDS, ROCK GROUPS, ORCHESTRAS, AND DANCERS; ENTERTAINMENT SERVICES, NAMELY, LIVE PERFORMANCES IN THE FIELDS OF MUSIC, THEATRICALS, AND DANCE; ENTERTAINMENT SERVICES, NAMELY, PROVIDING A WEB SITE FEATURING PHOTOGRAPHIC, AUDIO, VIDEO AND PROSE PRESENTATIONS FEATURING PERFORMANCES IN THE FIELDS OF MUSIC, THEATRICALS, AND DANCE; ENTERTAINMENT, NAMELY, PRODUCTION OF LIVE PERFORMANCES IN THE

CLASS 41—(Continued).

FIELDS OF MUSIC, THEATRICALS, AND DANCE; INSTRUCTION IN THE FIELDS OF MUSIC, THEATRICALS AND DANCE; PLANNING ARRANGEMENT OF PERFORMANCES IN THE FIELDS OF MUSIC, THEATRICALS, AND DANCE; PRESENTATION OF PERFORMANCES IN THE FIELDS OF MUSIC, THEATRICALS, AND DANCE; PROVIDING A WEBSITE FEATURING INFORMATION IN THE FIELDS OF MUSIC, THEATRICALS, DANCE AND ENTERTAINMENT; PROVIDING A WEBSITE FOR PERSONS TO REGISTER FOR CLASSES FOR THE PURPOSE OF ENTERTAINMENT; PROVIDING CLASSES, CAMPS, LESSONS, SEMINARS, WORKSHOPS, INSTRUCTIONS, TUTORING AND MENTORING IN THE FIELDS OF MUSIC, THEATRICALS, AND DANCE; PROVIDING FACILITIES FOR PERFORMANCES IN THE FIELDS OF MUSIC, THEATRICALS, AND DANCE; TEACHING IN THE FIELDS OF MUSIC, THEATRICALS, AND DANCE; PROVIDING FACILITIES FOR LIVE PERFORMANCES IN THE FIELDS OF MUSIC, THEATRICALS, AND DANCE, NAMELY, THEATRES, STAGES, CENTERS, AND VENUES (U.S. CLS. 100, 101 AND 107).

FIRST USE 9-1-2009; IN COMMERCE 2-1-2010.
REBECCA EISINGER, EXAMINING ATTORNEY

SN 85-392,177. THE SAN DIEGO UNION-TRIBUNE, LLC, SAN DIEGO, CA. FILED 8-8-2011.

SAN DIEGO UNION-TRIBUNE

THE MARK CONSISTS OF STANDARD CHARACTERS WITHOUT CLAIM TO ANY PARTICULAR FONT, STYLE, SIZE, OR COLOR.

SEC. 2(F) AS TO "SAN DIEGO".

FOR ENTERTAINMENT SERVICES, NAMELY, PROVIDING A GENERAL INTEREST WEB SITE FEATURING BLOGS, NON-DOWNLOADABLE PUBLICATIONS IN THE NATURE OF NEWSPAPERS FEATURING NEWS AND INFORMATION IN THE FIELDS OF BUSINESS, HEALTH, DINING, BEAUTY, LIFESTYLES, POLITICS, ENTERTAINMENT, ART, SCIENCE, TECHNOLOGY, TRAVEL, SHOPPING, REAL ESTATE, ATTRACTIONS, EVENTS, AND COMMUNITIES, AND INFORMATION IN THE FIELD OF ENTERTAINMENT NEWS, ENTERTAINMENT ATTRACTIONS AND ENTERTAINMENT EVENTS; PROVIDING A WEB SITE FEATURING INFORMATION AND NEWS IN THE FIELD OF ART (U.S. CLS. 100, 101 AND 107).

FIRST USE 11-18-1995; IN COMMERCE 11-18-1995.
JAY BESCH, EXAMINING ATTORNEY

CLASS 41—(Continued).

SN 85-392,397. SAN DIEGO UNION-TRIBUNE, LLC, SAN DIEGO, CA. FILED 8-8-2011.

DISCOVERSD

THE MARK CONSISTS OF STANDARD CHARACTERS WITHOUT CLAIM TO ANY PARTICULAR FONT, STYLE, SIZE, OR COLOR.

FOR ENTERTAINMENT SERVICES, NAMELY, PROVIDING A GENERAL INTEREST WEB SITE FEATURING BLOGS, NON-DOWNLOADABLE PUBLICATIONS IN THE NATURE OF NEWSPAPERS FEATURING NEWS AND INFORMATION IN THE FIELDS OF BUSINESS, HEALTH, DINING, BEAUTY, LIFESTYLES, POLITICS, ENTERTAINMENT, ART, SCIENCE, TECHNOLOGY, TRAVEL, SHOPPING, REAL ESTATE, ATTRACTIONS, EVENTS, AND COMMUNITIES, AND INFORMATION IN THE FIELD OF ENTERTAINMENT NEWS, ENTERTAINMENT ATTRACTIONS AND ENTERTAINMENT EVENTS; PROVIDING A WEB SITE FEATURING INFORMATION AND NEWS IN THE FIELD OF ART (U.S. CLS. 100, 101 AND 107).

FIRST USE 2-28-2006; IN COMMERCE 2-28-2006.
JAY BESCH, EXAMINING ATTORNEY

SN 85-398,501. BRIANNA ARIELLE TOWNSEND, DBA STUDIO ARIELLE, WASHINGTON, DC. FILED 8-15-2011.

Studio Arielle

THE MARK CONSISTS OF STANDARD CHARACTERS WITHOUT CLAIM TO ANY PARTICULAR FONT, STYLE, SIZE, OR COLOR.

NO CLAIM IS MADE TO THE EXCLUSIVE RIGHT TO USE "STUDIO", APART FROM THE MARK AS SHOWN. FOR PHOTOGRAPHY SERVICES (U.S. CLS. 100, 101 AND 107).

FIRST USE 10-20-2010; IN COMMERCE 3-15-2011.
LINDA M. KING, EXAMINING ATTORNEY

CLASS 41—(Continued).

SN 85-398,618. BULLARD, CHRIS, DENTON, TX. FILED 8-16-2011.

CHRIS BULLARD

THE MARK CONSISTS OF STANDARD CHARACTERS WITHOUT CLAIM TO ANY PARTICULAR FONT, STYLE, SIZE, OR COLOR.

THE NAME(S), PORTRAIT(S), AND/OR SIGNATURE(S) SHOWN IN THE MARK IDENTIFIES "CHRIS BULLARD", WHOSE CONSENT(S) TO REGISTER IS MADE OF RECORD.

FOR ENTERTAINMENT RENDERED BY A MUSICAL ARTIST, NAMELY, ENTERTAINMENT IN THE NATURE OF VISUAL AND AUDIO PERFORMANCES BY A MUSICAL ACT; LIVE PERFORMANCES BY A MUSICAL ACT; MULTIMEDIA ENTERTAINMENT SERVICES IN THE NATURE OF RECORDING, PRODUCTION AND POST-PRODUCTION SERVICES IN THE FIELD OF MUSIC AND VIDEO; ENTERTAINMENT SERVICES BY A MUSICAL ARTIST, NAMELY, MUSIC COMPOSITION FOR OTHERS; ENTERTAINMENT SERVICES BY A MUSICAL ARTIST, NAMELY, PRODUCTION OF MUSICAL SOUND RECORDINGS; PROVIDING A WEBSITE FEATURING PHOTOGRAPHIC, VIDEO AND PROSE PRESENTATIONS FEATURING A SOLO MUSIC RECORDING ARTIST; PROVIDING A WEBSITE FEATURING NEWS AND ON-LINE REVIEWS OF A SOLO MUSIC RECORDING ARTIST (U.S. CLS. 100, 101 AND 107).

FIRST USE 8-1-2011; IN COMMERCE 8-1-2011.
KEVIN CORWIN, EXAMINING ATTORNEY

SN 85-400,574. HUMAN LOVES HUMAN, INC., NEW YORK, NY. FILED 8-17-2011.

YUMMY BOYZ

THE MARK CONSISTS OF STANDARD CHARACTERS WITHOUT CLAIM TO ANY PARTICULAR FONT, STYLE, SIZE, OR COLOR.

FOR PROVIDING A WEBSITE FEATURING MUSIC VIDEOS AND MUSIC; PROVIDING A WEBSITE FEATURING INFORMATION REGARDING ACTORS, MUSICAL ARTISTS, TELEVISION, MOVIES AND MUSIC; ENTERTAINMENT SERVICES IN THE NATURE OF ONGOING ENTERTAINMENT PROGRAMS IN THE FIELD OF COMEDY, DRAMA AND MUSIC FOR DISTRIBUTION VIA TELEVISION, CABLE, SATELLITE, AUDIO AND VIDEO MEDIA, COMPUTER DISCS AND ELECTRONIC MEANS, ALL OF THE PRECEDING INTENDED FOR GENERAL ADULT AUDIENCES (U.S. CLS. 100, 101 AND 107).

ALLISON SCHRODY, EXAMINING ATTORNEY

CLASS 41—(Continued).

SN 85-400,591. CABELA'S INCORPORATED, SIDNEY, NE. FILED 8-17-2011.



OWNER OF U.S. REG. NOS. 1,151,981, 3,072,246 AND OTHERS.

NO CLAIM IS MADE TO THE EXCLUSIVE RIGHT TO USE "TEAM CHAMPIONSHIP", APART FROM THE MARK AS SHOWN.

THE MARK CONSISTS OF THE WORDS "CABELA'S" IN STYLIZED FONT ABOVE "NTC" IN STYLIZED BLOCK LETTERS ABOVE THE WORDS "NATIONAL TEAM CHAMPIONSHIP" WITH A FISH DESIGN ABOVE THE WORD "CABELA'S".

SEC. 2(F) AS TO "NATIONAL TEAM CHAMPIONSHIP". FOR ENTERTAINMENT SERVICES, NAMELY, ORGANIZING AND CONDUCTING FISHING TOURNAMENTS (U.S. CLS. 100, 101 AND 107).

FIRST USE 12-15-2010; IN COMMERCE 12-15-2010.
ROBERT STRUCK, EXAMINING ATTORNEY

SN 85-403,025. TODD SEAN WHITE, DBA FOXY HAWAII CLOTHING CO., KAPAA, HI. FILED 8-20-2011.

Ultimate Foxy Championship

THE MARK CONSISTS OF STANDARD CHARACTERS WITHOUT CLAIM TO ANY PARTICULAR FONT, STYLE, SIZE, OR COLOR.

NO CLAIM IS MADE TO THE EXCLUSIVE RIGHT TO USE "ULTIMATE" AND "CHAMPIONSHIP", APART FROM THE MARK AS SHOWN.

FOR ENTERTAINMENT SERVICES, NAMELY, CONDUCTING CONTESTS (U.S. CLS. 100, 101 AND 107).

STEVEN JACKSON, EXAMINING ATTORNEY

CLASS 41—(Continued).

SN 85-411,845. CITY OF MIAMI BEACH, MIAMI BEACH, FL.
FILED 8-31-2011.

MIAMI BEACH

THE MARK CONSISTS OF THE STYLIZED WORDING, "MIAMI BEACH" IN WHICH "MIAMI" IS THINNER AND "BEACH" IS THICKER OR BOLDED.

SEC. 2(F).

FOR PROVIDING INFORMATION AND NEWS VIA A WEBSITE IN THE FIELD OF GOVERNMENT SERVICES, NAMELY, INFORMATION ABOUT ARTS, EDUCATION AND PARKS IN MIAMI BEACH (U.S. CLS. 100, 101 AND 107).

FIRST USE 8-1-2005; IN COMMERCE 8-1-2005.
ROBIN CHOSID, EXAMINING ATTORNEY

SN 85-413,187. REHABSTUDIO LIMITED, BELFAST,
NORTHERN IRELAND, FILED 9-1-2011.

HAND BUILT DIGITAL

THE MARK CONSISTS OF STANDARD CHARACTERS WITHOUT CLAIM TO ANY PARTICULAR FONT, STYLE, SIZE, OR COLOR.

NO CLAIM IS MADE TO THE EXCLUSIVE RIGHT TO USE "DIGITAL", APART FROM THE MARK AS SHOWN.

FOR MULTIMEDIA ENTERTAINMENT SERVICES IN THE NATURE OF DEVELOPMENT, PRODUCTION AND POST-PRODUCTION SERVICES IN THE FIELDS OF VIDEO AND FILMS (U.S. CLS. 100, 101 AND 107).

FIRST USE 4-6-2005; IN COMMERCE 5-8-2008.
SKYE YOUNG, EXAMINING ATTORNEY

SN 85-434,766. JOHN E. JONES, EAST HELENA, MT. AND
ORION THORNTON, EAST HELENA, MT. FILED 9-28-
2011.

Code Green

THE MARK CONSISTS OF STANDARD CHARACTERS WITHOUT CLAIM TO ANY PARTICULAR FONT, STYLE, SIZE, OR COLOR.

FOR EDUCATIONAL SERVICES, NAMELY, CONDUCTING SEMINARS, CLASSES, WORKSHOPS AND TRAINING TO FIRST RESPONDERS AND FIREFIGHTERS IN THE FIELD OF FIRES INVOLVING RENEWABLE ENERGY SYSTEMS AND DISTRIBUTION OF COURSE MATERIAL IN CONNECTION THEREWITH (U.S. CLS. 100, 101 AND 107).

FIRST USE 8-2-2011; IN COMMERCE 8-2-2011.
REBECCA SMITH, EXAMINING ATTORNEY

CLASS 41—(Continued).

SN 85-438,990. BELOTTI, DUANE J., MONTVILLE, NJ.
FILED 10-4-2011.



NO CLAIM IS MADE TO THE EXCLUSIVE RIGHT TO USE "ARENA", APART FROM THE MARK AS SHOWN.

THE MARK CONSISTS OF THE BOLD WORD "ARENA" IN AN ARC SHAPE AND PLACED ON TOP OF THE BOLD WORDS "RELIVE THE ROCK". THE GROUPING OF THESE WORDS TOGETHER CONNOTES A VISUAL REPRESENTATION OF AN ARENA STADIUM.

FOR ENTERTAINMENT SERVICES IN THE NATURE OF LIVE PERFORMANCES BY A MUSICAL BAND; ENTERTAINMENT SERVICES, NAMELY, PROVIDING A WEBSITE FEATURING NON-DOWNLOADABLE MUSICAL PERFORMANCES, MUSICAL VIDEOS, AND RELATED FILM CLIPS AND PHOTOGRAPHS IN THE FIELD OF MUSIC AND MUSICAL PERFORMANCES (U.S. CLS. 100, 101 AND 107).

FIRST USE 7-23-2010; IN COMMERCE 6-9-2011.
LINDA LAVACHE, EXAMINING ATTORNEY

CLASS 41—(Continued).

SN 85-440,163. ST. NORBERT COLLEGE, INC., DE PERE, WI. FILED 10-5-2011.

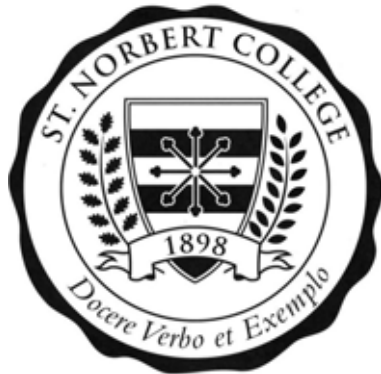
**CLASS 41—(Continued).**

SN 85-447,751. S.P.I.C. ENTERTAINMENT, LLC, MAITLAND, FL. FILED 10-14-2011.

SPICILICIOUS

OWNER OF U.S. REG. NOS. 2,997,410, 3,010,838 AND 3,010,839.

NO CLAIM IS MADE TO THE EXCLUSIVE RIGHT TO USE "COLLEGE" AND "1898", APART FROM THE MARK AS SHOWN.

THE MARK CONSISTS OF A SHIELD WITH HORIZONTAL BANDS AND AN EIGHT-ARMED CROSS OVERLAYING THE BANDS WITH A BRANCH AND LEAVES ON EACH SIDE OF THE SHIELD AND A BANNER ACROSS THE BOTTOM OF THE SHIELD CONTAINING "1898", ALL IN A CIRCLE, SURROUNDED BY ANOTHER CIRCULAR BAND CONTAINING "ST. NORBERT COLLEGE" AT THE TOP AND "DOCERE VERBO ET EXEMPLO" AT THE BOTTOM, ALL SURROUNDED BY A CIRCULAR BORDER CONTAINING SCALLOPED EDGES.

THE ENGLISH TRANSLATION OF "DOCERE VERBO ET EXEMPLO" IN THE MARK IS: "TO TEACH BY WORD AND EXAMPLE".

FOR EDUCATIONAL SERVICES, NAMELY, PROVIDING COURSES OF INSTRUCTION, CONDUCTING LECTURES, WORKSHOPS, SEMINARS AND CONFERENCES, ALL AT THE COLLEGE LEVEL, AND CONDUCTING EXTENSION COURSES AT THE COLLEGE OR HIGHER LEVEL AND COMMUNITY SERVICE WORKSHOPS AND LECTURE WORKSHOPS IN THE FIELDS OF HUMANITIES AND FINE ARTS, NATURAL SCIENCES, SOCIAL SCIENCES AND INTERNATIONAL STUDIES; ENTERTAINMENT IN THE NATURE OF HOCKEY, FOOTBALL, BASEBALL, BASKETBALL, SOCCER, VOLLEYBALL, SOFTBALL, TRACK, GOLF AND CROSS COUNTRY GAMES/MEETS, THEATER PRODUCTIONS, PUBLIC LECTURES IN THE FIELDS OF HUMANITIES AND FINE ARTS, NATURAL SCIENCES, SOCIAL SCIENCES AND INTERNATIONAL STUDIES, ART EXHIBITIONS, LIVE MUSIC CONCERTS, DANCE AND BALLET PERFORMANCES, AND MOTION PICTURE THEATER SERVICES (U.S. CLS. 100, 101 AND 107).

FIRST USE 9-1-2007; IN COMMERCE 9-1-2007.

DOMINICK J. SALEMI, EXAMINING ATTORNEY

THE MARK CONSISTS OF STANDARD CHARACTERS WITHOUT CLAIM TO ANY PARTICULAR FONT, STYLE, SIZE, OR COLOR.

FOR ENTERTAINMENT SERVICES, NAMELY, LIVE PERFORMANCES BY A MUSICAL GROUP OR DANCE GROUP; LIVE PERFORMANCES FEATURING PRE-RECORDED VOCAL AND INSTRUMENTAL PERFORMANCES VIEWED ON A BIG SCREEN; PROVIDING A CONTINUING COMEDY, MUSIC, DANCE AND VARIETY SHOWS BROADCAST OVER TELEVISION OR THE INTERNET; ENTERTAINMENT IN THE NATURE OF VISUAL AND AUDIO PERFORMANCES BY AMATEUR AND PROFESSIONAL ACTORS, MUSICIANS, DANCERS AND ARTISTS; NON-DOWNLOADABLE PRE-RECORDED AND LIVE AND VISUAL AND AUDIO PERFORMANCES BY AMATEUR AND PROFESSIONAL ACTORS, ARTISTS, MUSICIANS AND DANCERS; AND PROVIDING A WEBSITE FEATURING TEMPORARY USE OF ONLINE NON-DOWNLOADABLE AUDIO FILES, MUSICAL SOUND RECORDINGS, MULTIMEDIA FILES, VIDEO FILES, TEXT FILES, AUDIO MATERIAL AND VIDEO MATERIAL DELIVERED BY THE INTERNET, ALL FEATURING ENTERTAINMENT IN THE NATURE OF FICTIONAL AND NON-FICTIONAL MOTION PICTURES, MUSIC VIDEOS, ANIMATED CARTOONS, LIVE MUSIC CONCERTS, MUSICAL PERFORMANCES, THEATRICAL PERFORMANCES, DANCE PERFORMANCES, COMEDY SHOWS, CONTINUING MUSIC, COMEDY, AND VARIETY SHOWS (U.S. CLS. 100, 101 AND 107).

CHRISTINA SOBRAL, EXAMINING ATTORNEY

CLASS 41—(Continued).

SN 85-448,238. SALVATORE VACCARO, MAPLE, CANADA, FILED 10-14-2011.

SYMPHONIC SPIRIT

THE MARK CONSISTS OF STANDARD CHARACTERS WITHOUT CLAIM TO ANY PARTICULAR FONT, STYLE, SIZE, OR COLOR.

NO CLAIM IS MADE TO THE EXCLUSIVE RIGHT TO USE "SYMPHONIC", APART FROM THE MARK AS SHOWN.

FOR (BASED ON USE IN COMMERCE) ENTERTAINMENT INFORMATION SERVICES, NAMELY, PROVIDING INFORMATION AND NEWS RELEASES ABOUT A MUSICAL ARTIST; ENTERTAINMENT SERVICES, NAMELY, PROVIDING NON-DOWNLOADABLE PLAYBACK OF MUSIC VIA GLOBAL COMMUNICATIONS NETWORKS; MUSIC PRODUCTION SERVICES; MUSIC PUBLISHING SERVICES; MUSIC VIDEO PRODUCTION; PRODUCTION OF MUSICAL SOUND RECORDING; PRODUCTION OF MUSICAL VIDEOS; PRODUCTION OF SOUND AND MUSIC VIDEO RECORDINGS(BASED ON INTENT TO USE) ENTERTAINMENT IN THE NATURE OF VISUAL AND AUDIO PERFORMANCES, NAMELY, MUSICAL BAND, ROCK GROUP, GYMNASTIC, DANCE, AND BALLET PERFORMANCES; ENTERTAINMENT SERVICES BY A MUSICAL ARTIST AND PRODUCER, NAMELY, MUSICAL COMPOSITION FOR OTHERS AND PRODUCTION OF MUSICAL SOUND RECORDINGS; ENTERTAINMENT SERVICES IN THE NATURE OF LIVE MUSICAL PERFORMANCES; ENTERTAINMENT SERVICES, NAMELY, NON-DOWNLOADABLE RINGTONES, PRE-RECORDED MUSIC, AND GRAPHICS PRESENTED TO MOBILE COMMUNICATIONS DEVICES VIA A GLOBAL COMPUTER NETWORK AND WIRELESS NETWORKS; ENTERTAINMENT, NAMELY, LIVE PERFORMANCES BY A MUSICAL BAND; LIVE PERFORMANCES BY A MUSICAL GROUP; MUSIC COMPOSITION FOR OTHERS; MUSIC COMPOSITION SERVICES (U.S. CLS. 100, 101 AND 107).

FIRST USE 4-15-2010; IN COMMERCE 2-9-2011.
SUZANNE BLANE, EXAMINING ATTORNEY

SN 85-448,763. SMART ADVANTAGE, INC., HOLLYWOOD, FL. FILED 10-17-2011.

RELEVANT SELLING

THE MARK CONSISTS OF STANDARD CHARACTERS WITHOUT CLAIM TO ANY PARTICULAR FONT, STYLE, SIZE, OR COLOR.

NO CLAIM IS MADE TO THE EXCLUSIVE RIGHT TO USE "SELLING", APART FROM THE MARK AS SHOWN.

FOR EDUCATIONAL SERVICES, NAMELY, CONDUCTING SEMINARS, CONFERENCES AND WORKSHOPS IN THE FIELDS OF BUSINESS SALES AND DISTRIBUTION OF TRAINING MATERIALS IN CONNECTION THEREWITH (U.S. CLS. 100, 101 AND 107).

PAUL MORENO, EXAMINING ATTORNEY

CLASS 41—(Continued).

SN 85-450,101. KEVIN LANE TURNER, DALLAS, TX. FILED 10-18-2011.



THE COLOR(S) GRADIENT LIGHT BLUE TO DARK BLUE, PURPLE, GRADIENT GOLD TO PALE YELLOW IS/ ARE CLAIMED AS A FEATURE OF THE MARK.

THE MARK CONSISTS OF A DEEP BLUE GLOBE WITH A SUNBURST OFF-CENTER TOWARD THE UPPER-LEFT FROM THE GLOBE'S CENTER POINT WITH THE TEXT "TLS-T3" IN GOLD LETTERING TO THE LOWER-LEFT OF THE SUNBURST AND CENTERED IN THE MIDDLE OF THE GLOBE. ALONG THE OUTSIDE PERIMETER OF THE BLUE GLOBE AND SURROUNDING THE SUNBURST AND THE "TLS-T3" ARE THREE CURVED MOVING CLOCKWISE GOLD ARROWS WHOSE TAIL IS GOLD WITH THE HEAD OF EACH TRANSITIONING TO A PALE YELLOW. EACH ARROW CONTAINS A LABEL OF BLACK TEXT CENTERED WITHIN THE ARROW. THE FIRST LETTER OF EACH LABEL BEGINS AT THE BOTTOM OF THE ARROW HEAD AND CONTINUES THROUGH BODY OF THE ARROW TOWARD THE TAIL. THE FIRST ARROW IN THE UPPER LEFT OF AND INSIDE THE BLUE GLOBE CONTAINS THE WORD "TRAINING". THE SECOND ARROW IN THE BOTTOM TO BOTTOM LEFT AND INSIDE OF THE BLUE GLOBE CONTAINS THE WORD "TIME". THE THIRD ARROW ALONG THE RIGHT INNER SIDE OF THE BLUE GLOBE CONTAINS THE WORD "TOOLS".

FOR BUSINESS TRAINING; BUSINESS TRAINING CONSULTANCY SERVICES; BUSINESS TRAINING IN THE FIELD OF LEADERSHIP TRAINING AND HUMAN DEVELOPMENT; EDUCATIONAL SERVICES, NAMELY, CONDUCTING SEMINARS, WORKSHOPS, CONFERENCES IN THE FIELDS OF CHANGE MANAGEMENT, LEADERSHIP TRAINING, HUMAN DEVELOPMENT AND DISTRIBUTION OF TRAINING MATERIALS IN CONNECTION THEREWITH; EDUCATIONAL SERVICES, NAMELY, PROVIDING A LEARNING AND INNOVATION CENTER FEATURING FULLY CUSTOMIZED LEADERSHIP, MOTIVATIONAL, EDUCATIONAL, AND BRAINSTORMING TRAINING; INTERACTIVE ON-LINE TRAINING SERVICES IN THE FIELD OF CHANGE MANAGEMENT, LEADERSHIP TRAINING, HUMAN DEVELOPMENT; TEACHING AND TRAINING IN BUSINESS, INDUSTRY AND INFORMATION TECHNOLOGY; TEACHING, TRAINING, TUTORING AND COURSES OF INSTRUCTION AT THE UNDERGRADUATE, GRADUATE AND POST-GRADUATE LEVEL; TRAINING COURSES IN STRATEGIC PLANNING RELATING TO ADVERTISING, PROMOTION, MARKETING AND BUSINESS (U.S. CLS. 100, 101 AND 107).

FIRST USE 10-8-2010; IN COMMERCE 10-8-2010.
DORITT L. CARROLL, EXAMINING ATTORNEY

CLASS 41—(Continued).

SN 85-454,343. BOWMAN, RUSSEL, PLANO, TX. FILED 10-24-2011.

Self-Help Hangover

THE MARK CONSISTS OF STANDARD CHARACTERS WITHOUT CLAIM TO ANY PARTICULAR FONT, STYLE, SIZE, OR COLOR.

NO CLAIM IS MADE TO THE EXCLUSIVE RIGHT TO USE "SELF-HELP", APART FROM THE MARK AS SHOWN.

FOR EDUCATIONAL AND ENTERTAINMENT SERVICES, NAMELY, CONDUCTING CLASSES, SEMINARS, AND WORKSHOPS IN THE FIELD OF PERSONAL, CAREER, AND BUSINESS PLANNING AND DISTRIBUTION OF COURSE MATERIALS IN CONNECTION THEREWITH, AND EDUCATION CONSULTING RELATED THERETO (U.S. CLS. 100, 101 AND 107).

LUCY ARANT, EXAMINING ATTORNEY

SN 85-454,798. STREED, MICHAEL W., CORONA, CA. AND STREED, ELIZABETH ANN, CORONA, CA. FILED 10-24-2011.

SKETCHCOP

THE MARK CONSISTS OF STANDARD CHARACTERS WITHOUT CLAIM TO ANY PARTICULAR FONT, STYLE, SIZE, OR COLOR.

OWNER OF U.S. REG. NOS. 3,879,854 AND 4,070,827.

FOR ENTERTAINMENT SERVICES, NAMELY, AN ON-GOING TELEVISION SERIES IN THE FIELD OF CRIME, LAW ENFORCEMENT, CRIMINAL JUSTICE AND FORENSICS (U.S. CLS. 100, 101 AND 107).

DANIEL CAPSHAW, EXAMINING ATTORNEY

SN 85-455,745. JANELLE ELLIS, DALLAS, TX. FILED 10-25-2011.

FAIR PARK FILM FORUM

THE MARK CONSISTS OF STANDARD CHARACTERS WITHOUT CLAIM TO ANY PARTICULAR FONT, STYLE, SIZE, OR COLOR.

NO CLAIM IS MADE TO THE EXCLUSIVE RIGHT TO USE "FILM FORUM", APART FROM THE MARK AS SHOWN.

SEC. 2(F).

FOR ENTERTAINMENT SERVICES, NAMELY, PLANNING AND CONDUCTING A SERIES OF FILM FESTIVALS TO PROMOTE DIALOG RELATED TO WOMEN TOPICS (U.S. CLS. 100, 101 AND 107).

FIRST USE 10-11-2005; IN COMMERCE 10-11-2005.

PRISCILLA MILTON, EXAMINING ATTORNEY

CLASS 41—(Continued).

SN 85-459,211. INTERNATIONAL IVY L.L.C., SUMMIT, NJ. AND WONG, PUI WAN LILY, SUMMIT, NJ. FILED 10-28-2011.



THE STIPPLING IS A FEATURE OF THE MARK AND DOES NOT INDICATE COLOR.

THE COLOR(S) GREEN AND WHITE IS/ARE CLAIMED AS A FEATURE OF THE MARK.

THE MARK CONSISTS OF TWO WHITE, FLUTED COLUMNS WITH A WHITE MARBLE BASE ABOVE AND BELOW THE TWO COLUMNS; A GREEN IVY VINE IS ENCIRCLING EACH COLUMN; A GREEN GLOBE IS BEHIND THE COLUMNS.

FOR EDUCATION SERVICES, NAMELY, PROVIDING KINDERGARTEN THROUGH 12TH GRADE (K-12) CLASSROOM INSTRUCTION; EDUCATION SERVICES, NAMELY, PROVIDING LIVE AND ON-LINE INSTRUCTION, TUTORING, MENTORING, CLASSES, SEMINARS, WORKSHOPS AND ADVICE IN THE FIELD OF ENGLISH AS A SECOND OR FOREIGN LANGUAGE, TECHNOLOGY, SCIENCE, ARTS, SPORT, CREATIVITY, INNOVATION, BUSINESS, COLLEGE PREPARATION AND COGNITIVE TRAINING (U.S. CLS. 100, 101 AND 107).

FIRST USE 10-28-2011; IN COMMERCE 10-28-2011.

ERIN FALK, EXAMINING ATTORNEY

SN 85-460,140. KNUTSON, GAYLE M., DBA TUNDRA FILMS, INC., MARINE ON ST. CROIX, MN. FILED 10-31-2011.

TUNDRA FILMS

THE MARK CONSISTS OF STANDARD CHARACTERS WITHOUT CLAIM TO ANY PARTICULAR FONT, STYLE, SIZE, OR COLOR.

NO CLAIM IS MADE TO THE EXCLUSIVE RIGHT TO USE "FILMS", APART FROM THE MARK AS SHOWN.

FOR ENTERTAINMENT MEDIA PRODUCTION SERVICES FOR MOTION PICTURES, TELEVISION AND INTERNET (U.S. CLS. 100, 101 AND 107).

FIRST USE 6-1-1998; IN COMMERCE 6-1-1998.

SUSAN LESLIE DUBOIS, EXAMINING ATTORNEY

CLASS 41—(Continued).

SN 85-467,908. BIRMINGHAM, MCCANN D., NEW BRITAIN, CT. FILED 11-9-2011.

'SELFLESS... INC.

THE MARK CONSISTS OF STANDARD CHARACTERS WITHOUT CLAIM TO ANY PARTICULAR FONT, STYLE, SIZE, OR COLOR.

NO CLAIM IS MADE TO THE EXCLUSIVE RIGHT TO USE "INC", APART FROM THE MARK AS SHOWN.

FOR EDUCATIONAL SERVICES, NAMELY, ORGANIZING AND CONDUCTING EDUCATIONAL SEMINARS IN THE FIELD OF GENERAL AND SOCIAL STUDIES, INTRAMURAL ACTIVITIES AND SPORTS, AND SCHOOL TEAM SPORTS, TO PROVIDE POSITIVE SOCIAL AND MONETARY IMPACTS TO LOCALITIES IN BOTH EDUCATIONAL EXPERIENCES AND RESIDENTIAL EXPERIENCES (U.S. CLS. 100, 101 AND 107).
PAUL MORENO, EXAMINING ATTORNEY

SN 85-470,439. THE HEALTH CARE COMPLIANCE ASSOCIATION, DBA SOCIETY OF CORPORATE COMPLIANCE AND ETHICS, MINNEAPOLIS, MN. FILED 11-11-2011.

**COMPLIANCE & ETHICS
INSTITUTE**

THE MARK CONSISTS OF STANDARD CHARACTERS WITHOUT CLAIM TO ANY PARTICULAR FONT, STYLE, SIZE, OR COLOR.

NO CLAIM IS MADE TO THE EXCLUSIVE RIGHT TO USE "INSTITUTE", APART FROM THE MARK AS SHOWN.
SEC. 2(F).

FOR EDUCATIONAL SERVICES, NAMELY, CONDUCTING CONFERENCES IN THE FIELD OF COMPLIANCE AND ETHICS, AND DISTRIBUTING COURSE MATERIALS IN CONNECTION THEREWITH (U.S. CLS. 100, 101 AND 107).

FIRST USE 8-0-2005; IN COMMERCE 8-0-2005.
ZACHARY BELLO, EXAMINING ATTORNEY

CLASS 41—(Continued).

SN 85-472,971. JASON JANI, BRICK, NJ. FILED 11-15-2011.

SCE EVENT GROUP

THE MARK CONSISTS OF STANDARD CHARACTERS WITHOUT CLAIM TO ANY PARTICULAR FONT, STYLE, SIZE, OR COLOR.

NO CLAIM IS MADE TO THE EXCLUSIVE RIGHT TO USE "EVENT GROUP", APART FROM THE MARK AS SHOWN.

FOR ARRANGING AND CONDUCTING SPECIAL EVENTS FOR SOCIAL ENTERTAINMENT PURPOSES; ARRANGING, ORGANIZING, CONDUCTING AND HOSTING SOCIAL ENTERTAINMENT EVENTS (U.S. CLS. 100, 101 AND 107).

FIRST USE 9-1-2011; IN COMMERCE 11-7-2011.
GINA HAYES, EXAMINING ATTORNEY

SN 85-473,779. APPRECIATIVE STRATEGIES, LLC, MONTOURSVILLE, PA. FILED 11-16-2011.

Appreciative Strategies

THE MARK CONSISTS OF STANDARD CHARACTERS WITHOUT CLAIM TO ANY PARTICULAR FONT, STYLE, SIZE, OR COLOR.

SEC. 2(F).

FOR ARRANGEMENT OF TRAINING COURSES IN TEACHING INSTITUTES; BUSINESS TRAINING; BUSINESS TRAINING CONSULTANCY SERVICES; BUSINESS TRAINING IN THE FIELD OF STRATEGIC PLANNING; DEVELOPING TRAINING SYSTEMS AND LEARNING METHODOLOGIES FOR OTHERS; EDUCATION SERVICES, NAMELY, PROVIDING CAREER RE-TRAINING CONFERENCES, WORKSHOPS, SEMINARS IN THE FIELDS OF SOFT SKILL EMPLOYEE DEVELOPMENT; EDUCATION SERVICES, NAMELY, PROVIDING ONLINE COGNITIVE ASSESSMENTS AND TRAINING PROGRAMS THAT HELP IDENTIFY COGNITIVE STRENGTHS AND WEAKNESSES OF AN INDIVIDUAL; EDUCATION SERVICES, NAMELY, TRAINING EDUCATORS TO TEACH THROUGH SERVICE LEARNING AND CIVIC ENGAGEMENT AND PROVIDING CURRICULA IN CONNECTION THEREWITH; EDUCATIONAL SERVICES, NAMELY, CONDUCTING CONFERENCES, WORKSHOPS, SEMINARS IN THE FIELDS OF ORGANIZATION DEVELOPMENT, INNOVATION, STRATEGIC PLANNING, SALES AND DISTRIBUTION OF TRAINING MATERIALS IN CONNECTION THEREWITH; EDUCATIONAL SERVICES, NAMELY, CONDUCTING CONFERENCES, WORKSHOPS, SEMINARS IN THE FIELD OF LEADERSHIP, COMMUNICATIONS, GROUP DYNAMICS, CUSTOMER

CLASS 41—(Continued).

SERVICE, CONFLICT, TRAIN-THE-TRAINER AND DISTRIBUTION OF TRAINING MATERIAL IN CONNECTION THEREWITH; EDUCATIONAL SERVICES, NAMELY, OFFERING OF ASSESSMENTS AND SURVEYS IN THE FIELD OF EDUCATOR TRAINING AND PERFORMANCE FOR THE PURPOSE OF IMPROVING TEACHING PROCEDURES; EDUCATIONAL SERVICES, NAMELY, PROVIDING A LEARNING AND INNOVATION CENTER FEATURING FULLY CUSTOMIZED LEADERSHIP, MOTIVATIONAL, EDUCATIONAL, AND BRAINSTORMING TRAINING; EDUCATIONAL SERVICES, NAMELY, TEACHER TRAINING IN THE FIELD OF SOFT SKILLS DEVELOPMENT, COMMUNICATION, LISTENING, RELATIONSHIP AND TEAM-BUILDING, CONFLICT, BULLYING PROVIDED ON A REAL-TIME BASIS DURING CLASSROOM INSTRUCTION; TRAINING COURSES IN STRATEGIC PLANNING RELATING TO ADVERTISING, PROMOTION, MARKETING AND BUSINESS; TRAINING SERVICES IN THE FIELD OF SOFT SKILLS EMPLOYEE DEVELOPMENT (U.S. CLS. 100, 101 AND 107).

FIRST USE 1-0-2007; IN COMMERCE 1-0-2007.
KIM MONINGHOFF, EXAMINING ATTORNEY

CLASS 41—(Continued).

CIRCULAR BORDER SURROUNDS THE BIRD HEAD DESIGN; THE WORD "TORONTO" IN STYLIZED SOLID DARK UPPERCASE LETTERING APPEARS WITHIN THE CIRCULAR BORDER ABOVE THE BIRD HEAD DESIGN; THE WORDS "BLUE JAYS" IN STYLIZED LIGHT AND DARK UPPERCASE LETTERING APPEAR WITHIN THE CIRCULAR BORDER BELOW THE BIRD HEAD DESIGN; THE FOREGOING IS IN TURN SURROUNDED BY AN EXTERIOR CIRCULAR BORDER COMPRISED OF THIN DARK, LIGHT AND DARK STRIPES.

SEC. 2(F) AS TO "TORONTO".

FOR ENTERTAINMENT SERVICES, NAMELY, BASEBALL EXHIBITIONS, ORGANIZING AND CONDUCTING AN ARRAY OF ATHLETIC EVENTS RENDERED LIVE OR RECORDED FOR DISTRIBUTION THROUGH BROADCAST MEDIA; EDUCATIONAL SERVICES IN THE NATURE OF BASEBALL CAMPS, SEMINARS AND CLINICS; ORGANIZING AND CONDUCTING FANTASY SPORTS CONTESTS, SWEEPSTAKES, AND ON-LINE COMPETITIONS; PRODUCTION AND PROVISION OF ON-GOING TELEVISION, INTERNET AND RADIO PROGRAMS IN THE FIELD OF SPORTS; PROVIDING NEWS, INFORMATION, PODCASTS, WEB CASTS, ONLINE NEWSLETTERS, AND ONLINE JOURNALS, NAMELY, BLOGS, ALL OF THE FOREGOING IN THE FIELD OF SPORTS; ORGANIZING COMMUNITY SPORTING AND CULTURAL EVENTS; ENTERTAINMENT IN THE NATURE OF LIVE PERFORMANCES BY COSTUMED MASCOTS, CHEERLEADERS, AND DANCE GROUPS; FAN CLUBS; FESTIVALS FEATURING A VARIETY OF SPORTS AND ENTERTAINMENT ACTIVITIES; PROVIDING SPORTS FACILITIES; RENTAL OF STADIUM FACILITIES; PROVIDING FACILITIES FOR SPORTS TOURNAMENTS (U.S. CLS. 100, 101 AND 107).

GIANCARLO CASTRO, EXAMINING ATTORNEY

SN 85-477,862. ROGERS BLUE JAYS BASEBALL PARTNERSHIP, TORONTO, ONTARIO, CANADA, FILED 11-21-2011.

SN 85-478,436. PACIFIC BATTLESHIP CENTER, PLACENTIA, CA. FILED 11-21-2011.



OWNER OF U.S. REG. NOS. 1,258,241, 3,330,437 AND OTHERS.

THE MARK CONSISTS OF THE STYLIZED REPRESENTATION OF THE HEAD OF A BLUE JAY BIRD IN PROFILE SUPERIMPOSED ON A BASEBALL GRAPHIC WITH A STYLIZED REPRESENTATION OF A MAPLE LEAF SUPERIMPOSED ON THE RIGHT SIDE OF THE BIRD GRAPHIC (HEREINAFTER THE BIRD HEAD DESIGN); A LIGHT



NO CLAIM IS MADE TO THE EXCLUSIVE RIGHT TO USE "USS IOWA BB-61" AND "LOS ANGELES", APART FROM THE MARK AS SHOWN.

THE COLOR(S) BLACK, BLUE, WHITE, GOLD, TAN, GRAY AND LIGHT GRAY IS/ARE CLAIMED AS A FEATURE OF THE MARK.

THE MARK CONSISTS OF A BLACK RECTANGLE OUTLINED IN WHITE WITH "USS IOWA" IN WHITE, "BB-61" IN GRAY, THE BATTLESHIP IN GRAY AND LIGHT GRAY WITH BLACK SHADING, GOLD STARS ON A TAN BACKGROUND, A BLUE SKY WITH WHITE CLOUDS AND "LOS ANGELES" IN WHITE.

FOR MUSEUMS (U.S. CLS. 100, 101 AND 107).
FIRST USE 10-1-2011; IN COMMERCE 10-1-2011.
MICHELE SWAIN, EXAMINING ATTORNEY

CLASS 41—(Continued).

SN 85-479,432. GLYDASCOPE INC., CHATSWORTH, CA. FILED 11-22-2011.



THE STIPLING IS FOR SHADING PURPOSES ONLY.
THE MARK CONSISTS OF THE LETTER "G" IN LARGE TYPE FOLLOWED BY "LYDASCOPE" TO FORM THE WORD "GLYDASCOPE" WITH A STYLIZED DESIGN OF COMPASS POINTS COMPRISING THE CENTER OF THE LETTER "G". THE LETTERING "LYDASCOPE" IS LAID OVER A SLOPING FILM FRAME THAT REFLECTS THE IMAGE OF THE LETTERS.

FOR ENTERTAINMENT SERVICES IN THE NATURE OF DEVELOPMENT, CREATION, PRODUCTION AND POST-PRODUCTION SERVICES OF MULTIMEDIA ENTERTAINMENT CONTENT (U.S. CLS. 100, 101 AND 107).
FIRST USE 9-10-2011; IN COMMERCE 9-10-2011.
LAURA KOVALSKY, EXAMINING ATTORNEY

CLASS 41—(Continued).

SN 85-480,173. LANAE ST. JOHN, DBA THE MAMASUTRA, MILL VALLEY, CA. FILED 11-23-2011.

The MamaSutra

THE MARK CONSISTS OF STANDARD CHARACTERS WITHOUT CLAIM TO ANY PARTICULAR FONT, STYLE, SIZE, OR COLOR.

FOR LIFE COACHING, INCLUDING ONE-ON-ONE COUNSELING AND GROUP COACHING, IN THE FIELD OF SEXUAL HEALTH AND SEXUALITY; ONLINE JOURNALS, NAMELY, ONLINE BLOGS AND ARTICLES FEATURING TOPICS RELATED TO SEXUAL HEALTH AND SEXUALITY; EDUCATIONAL SERVICES IN THE FIELD OF SEXUAL HEALTH AND SEXUALITY, NAMELY, PROVIDING EDUCATIONAL SPEAKERS, SEMINARS, A CONTINUING EDUCATIONAL RADIO SHOW, EDUCATIONAL WEBINARS, WORKSHOPS, AND CLASSES, AND DISTRIBUTING COURSE MATERIALS, EDUCATIONAL MATERIALS, AND TRAINING MATERIALS IN CONNECTION THEREWITH (U.S. CLS. 100, 101 AND 107).

FIRST USE 8-1-2010; IN COMMERCE 8-1-2010.
RAMONA ORTIGA, EXAMINING ATTORNEY

SN 85-480,232. WISNER, SAMUEL ADAMS, NEW YORK, NY. FILED 11-23-2011.

SN 85-479,705. MATCHSTICK, LLC, BOONTON, NJ. FILED 11-23-2011.

BOOSTERSHOT

THE MARK CONSISTS OF STANDARD CHARACTERS WITHOUT CLAIM TO ANY PARTICULAR FONT, STYLE, SIZE, OR COLOR.

FOR EDUCATION SERVICES, NAMELY, CONDUCTING TRAINING AND WORKSHOPS ON MARKETING AND BUSINESS STRATEGY FOR LARGE AND SMALL MEDICAL DEVICE FIRMS, LIFE SCIENCE AND PHARMACEUTICAL INDUSTRIES (U.S. CLS. 100, 101 AND 107).

BARBARA RUTLAND, EXAMINING ATTORNEY

SAMMY ADAMS

THE MARK CONSISTS OF STANDARD CHARACTERS WITHOUT CLAIM TO ANY PARTICULAR FONT, STYLE, SIZE, OR COLOR.

THE NAME(S), PORTRAIT(S), AND/OR SIGNATURE(S) SHOWN IN THE MARK IDENTIFIES SAMUEL ADAMS WISNER, WHOSE CONSENT(S) TO REGISTER IS MADE OF RECORD.

FOR ENTERTAINMENT SERVICES BY A MUSICAL ARTIST IN THE NATURE OF LIVE MUSICAL PERFORMANCES (U.S. CLS. 100, 101 AND 107).

FIRST USE 10-7-2011, THE MARK WAS FIRST USED ANYWHERE IN A DIFFERENT FORM OTHER THAN THAT SOUGHT TO BE REGISTERED AT LEAST AS EARLY AS 09/00/2009; IN COMMERCE 10-7-2011, THE MARK WAS FIRST USED IN COMMERCE IN A DIFFERENT FORM OTHER THAN THAT SOUGHT TO BE REGISTERED AT LEAST AS EARLY AS 09/00/2009.

ANTHONY RINKER, EXAMINING ATTORNEY

CLASS 41—(Continued).

SN 85-483,407. FITNESS ANYWHERE LLC, SAN FRANCISCO, CA. FILED 11-30-2011.

TRX CORE

THE MARK CONSISTS OF STANDARD CHARACTERS WITHOUT CLAIM TO ANY PARTICULAR FONT, STYLE, SIZE, OR COLOR.

OWNER OF U.S. REG. NOS. 3,202,696, 4,018,159 AND OTHERS.

NO CLAIM IS MADE TO THE EXCLUSIVE RIGHT TO USE "CORE", APART FROM THE MARK AS SHOWN.

FOR PHYSICAL EDUCATION SERVICES; PHYSICAL FITNESS CONDITIONING CLASSES; PHYSICAL FITNESS CONSULTATION; PHYSICAL FITNESS INSTRUCTION; PHYSICAL FITNESS TRAINING OF INDIVIDUALS AND GROUPS; PHYSICAL FITNESS TRAINING SERVICES (U.S. CLS. 100, 101 AND 107).

MATTHEW PAPPAS, EXAMINING ATTORNEY

SN 85-483,531. MISS UNIVERSE L.P., LLLP, NEW YORK, NY. FILED 11-30-2011.

**MISS DISTRICT OF COLUMBIA
TEEN USA**

THE MARK CONSISTS OF STANDARD CHARACTERS WITHOUT CLAIM TO ANY PARTICULAR FONT, STYLE, SIZE, OR COLOR.

NO CLAIM IS MADE TO THE EXCLUSIVE RIGHT TO USE "DISTRICT OF COLUMBIA TEEN", APART FROM THE MARK AS SHOWN.

SEC. 2(F) AS TO "USA".

FOR ENTERTAINMENT SERVICES, NAMELY, BEAUTY PAGEANTS (U.S. CLS. 100, 101 AND 107).

FIRST USE 8-0-1983; IN COMMERCE 8-0-1983.

ZACHARY BELLO, EXAMINING ATTORNEY

SN 85-485,171. STORYKEEP, BROOKLYN, NY. FILED 12-1-2011.

STORYKEEP

THE MARK CONSISTS OF STANDARD CHARACTERS WITHOUT CLAIM TO ANY PARTICULAR FONT, STYLE, SIZE, OR COLOR.

FOR MULTIMEDIA PRODUCTION SERVICES FEATURING AUDIO, VIDEO, PHOTOGRAPHIC AND PROSE PRESENTATIONS IN THE NATURE OF PERSONALIZED STORIES OF INDIVIDUALS AND FAMILIES FOR THE PURPOSE OF PRESERVATION (U.S. CLS. 100, 101 AND 107).

FIRST USE 3-25-2011; IN COMMERCE 3-25-2011.

KHANH LE, EXAMINING ATTORNEY

CLASS 41—(Continued).

SN 85-491,270. KRESSEN, LILI V., WOODBRIDGE, CT. FILED 12-9-2011.

ALLIE'S DREAM

THE MARK CONSISTS OF STANDARD CHARACTERS WITHOUT CLAIM TO ANY PARTICULAR FONT, STYLE, SIZE, OR COLOR.

THE NAME(S), PORTRAIT(S), AND/OR SIGNATURE(S) SHOWN IN THE MARK IDENTIFIES ALLIE KRESSEN, WHOSE CONSENT(S) TO REGISTER IS MADE OF RECORD.

FOR CHARITABLE SERVICES, NAMELY, PROVIDING EDUCATIONAL, SOCIAL, RECREATIONAL AND VOCATIONAL SUPPORTS IN THE NATURE OF CLASSROOM LEARNING, WORKSHOP SEMINARS, AND INDIVIDUAL AND GROUP TRAINING SESSIONS FOR PROVIDING AND TEACHING LIFE SKILLS FOR YOUNG ADULTS WITH DEVELOPMENTAL DISABILITIES TO PROMOTE INTEGRATION WITH THE COMMUNITY (U.S. CLS. 100, 101 AND 107).

FIRST USE 12-0-2009; IN COMMERCE 12-0-2009.

DARRYL SPRUILL, EXAMINING ATTORNEY

SN 85-494,652. WOHLKE, LEANNE M, DBA EPIC YOGA, BRENTWOOD, TN. FILED 12-14-2011.



NO CLAIM IS MADE TO THE EXCLUSIVE RIGHT TO USE "YOGA", APART FROM THE MARK AS SHOWN.

THE MARK CONSISTS OF THE WORDS "EPIC YOGA" IN CENTURY GOTHIC FONT WITH A DESIGN ELEMENT IN BETWEEN THE WORDS, CONSISTING OF A SUN IMAGE WITH THREE SWIRLS IN THE MIDDLE. THE SUN'S RAYS LOOK LIKE FLAMES AND ARE IN A GRADIENT PATTERN. AROUND THE DESIGN ELEMENT IS A SERIES OF DOTS.

FOR YOGA INSTRUCTION (U.S. CLS. 100, 101 AND 107).

FIRST USE 4-20-2011; IN COMMERCE 4-20-2011.

CHARISMA HAMPTON, EXAMINING ATTORNEY

CLASS 41—(Continued).

SN 85-496,438. ULTIMATE TAZER BALL, CARLSBAD, CA. FILED 12-15-2011.

CLASS 41—(Continued).

SN 85-502,887. SLATER, ABRA, LOS GATOS, CA. FILED 12-23-2011.

UTB

THE MARK CONSISTS OF STANDARD CHARACTERS WITHOUT CLAIM TO ANY PARTICULAR FONT, STYLE, SIZE, OR COLOR.

FOR ENTERTAINMENT SERVICES, NAMELY, PROVISION OF RECREATIONAL AREAS IN THE NATURE OF PLAY AREAS; MULTI-USE RECREATIONAL SERVICES, NAMELY, FACILITIES FOR LIVE GAMES; ENTERTAINMENT SERVICES, NAMELY, AN AMUSEMENT CENTER FOR GAMES USING ELECTRIC CHARGED WEAPONRY (U.S. CLS. 100, 101 AND 107).
BERNICE MIDDLETON, EXAMINING ATTORNEY

SN 85-500,951. THE CIRCLE CENTER, INC., NASHVILLE, TN. FILED 12-21-2011.



NO CLAIM IS MADE TO THE EXCLUSIVE RIGHT TO USE "CENTER", APART FROM THE MARK AS SHOWN.

THE COLOR(S) ORANGE, BROWN, GREEN, BLUE AND BLACK IS/ARE CLAIMED AS A FEATURE OF THE MARK.

THE MARK CONSISTS OF TEXT AND GEOMETRIC FEATURES - FOUR (4) SEPARATE COLORED (ONE ORANGE, ONE BROWN, ONE BLUE, ONE GREEN) AND SHADED CIRCLES CONNECTED BY TWO (2) INTERSECTING BLACK LINES WITH THE WORDS "THE CIRCLE CENTER" IN BLACK OPTIMA REGULAR FONT ARCED OVER THE GEOMETRIC SHAPES AND A BLACK LINE ARCED UNDER THE GEOMETRIC SHAPES FORMING A GESTURAL OUTER CIRCLE AROUND THE GEOMETRIC SHAPES.

FOR CHARITABLE SERVICES, NAMELY, PROVIDING TRAINING IN THE FIELD OF GROUP FACILITATION AND COMMUNICATIONS TO INDIVIDUALS AND ORGANIZATIONS FOR THE PURPOSE OF BUILDING COMMUNITY, REDUCING CONFLICT, ENHANCING COMMUNICATIONS AND PROVIDING PERSONAL AND LEADERSHIP DEVELOPMENT (U.S. CLS. 100, 101 AND 107).

FIRST USE 10-1-2008; IN COMMERCE 10-1-2008.
MARIA-VICTORIA SUAREZ, EXAMINING ATTORNEY



NO CLAIM IS MADE TO THE EXCLUSIVE RIGHT TO USE "CHALLENGE", APART FROM THE MARK AS SHOWN.

THE STIPPLING IS FOR SHADING PURPOSES ONLY.
THE MARK CONSISTS OF A STYLIZED DESIGN WITH VARIOUS CURVED LINES SURROUNDED BY STARS AND STYLIZED FLAMES. AROUND THE LEFT SIDE OF THE FLAME DESIGN IS THE STYLIZED TEXT "SPIRIT OF THE FLAME". ALONG ONE CURVED LINE THROUGH THE CENTER OF THE DESIGN IS THE STYLIZED TEXT "CHALLENGE".

FOR ENTERTAINMENT IN THE NATURE OF COMPETITIONS IN THE FIELD OF GYMNASTICS; ORGANIZING, ARRANGING, AND CONDUCTING GYMNASTICS EVENTS (U.S. CLS. 100, 101 AND 107).

FIRST USE 2-28-2004; IN COMMERCE 3-0-2009.
MARILYN IZZI, EXAMINING ATTORNEY

CLASS 41—(Continued).

SN 85-503,507. ACTIVEWEAR BRANDS LLC, CHARLOTTE, NC. FILED 12-23-2011.

SWEAT.tv

THE MARK CONSISTS OF STANDARD CHARACTERS WITHOUT CLAIM TO ANY PARTICULAR FONT, STYLE, SIZE, OR COLOR.

FOR ENTERTAINMENT SERVICES, NAMELY, PROVIDING A WEB SITE FEATURING PHOTOGRAPHIC, VIDEO AND PROSE PRESENTATIONS FEATURING EXERCISE TRAINING ADVICE, FITNESS ADVICE, FITNESS TIPS, YOGA ADVICE AND YOGA TIPS; ON-LINE JOURNALS, NAMELY, BLOGS FEATURING HEALTH AND WELLNESS ADVICE, EXERCISE TRAINING ADVICE, FITNESS ADVICE, FITNESS TIPS, YOGA ADVICE AND YOGA TIPS; PRODUCTION AND DISTRIBUTION OF VIDEOS IN THE FIELD OF EXERCISE TRAINING AND ADVICE ON HEALTH AND WELLNESS; PROVIDING A WEBSITE FEATURING BLOGS AND NON-DOWNLOADABLE PUBLICATIONS IN THE NATURE OF ARTICLES IN THE FIELD(S) OF HEALTH AND WELLNESS ADVICE, EXERCISE TRAINING ADVICE, FITNESS ADVICE, FITNESS TIPS, YOGA ADVICE AND YOGA TIPS; PROVIDING A WEBSITE FEATURING INFORMATION ON EXERCISE AND FITNESS; PROVIDING A WEBSITE FEATURING ONLINE SPORTS TRAINING AND TRAINING ADVICE AND THE RECORDING OF TRAINING AND WORKOUTS; PROVIDING AN INTERACTIVE WEBSITE FEATURING INFORMATION AND LINKS RELATING TO FITNESS; PROVIDING ON-LINE MAGAZINES IN THE FIELD OF HEALTH AND WELLNESS ADVICE, EXERCISE TRAINING ADVICE, FITNESS ADVICE, FITNESS TIPS, YOGA ADVICE AND YOGA TIPS (U.S. CLS. 100, 101 AND 107).
TRACY CROSS, EXAMINING ATTORNEY

SN 85-504,911. BROUGHTON, BARRY A, OLEAN, NY. FILED 12-28-2011.

A.K.T. American Freestyle Karate

THE MARK CONSISTS OF STANDARD CHARACTERS WITHOUT CLAIM TO ANY PARTICULAR FONT, STYLE, SIZE, OR COLOR.

NO CLAIM IS MADE TO THE EXCLUSIVE RIGHT TO USE "AMERICAN FREESTYLE KARATE", APART FROM THE MARK AS SHOWN.

FOR EDUCATION SERVICES, NAMELY, PROVIDING LIVE AND ON-LINE CLASSES, SEMINARS AND WORKSHOPS IN THE FIELD OF FITNESS, EXERCISE, KARATE AND MARTIAL ARTS (U.S. CLS. 100, 101 AND 107).

FIRST USE 9-1-2007; IN COMMERCE 9-1-2008.
SUZANNE BLANE, EXAMINING ATTORNEY

CLASS 41—(Continued).

SN 85-508,068. CLEAR LAW INSTITUTE LLC, ARLINGTON, VA. FILED 1-3-2012.

CLEAR LAW INSTITUTE

THE MARK CONSISTS OF STANDARD CHARACTERS WITHOUT CLAIM TO ANY PARTICULAR FONT, STYLE, SIZE, OR COLOR.

NO CLAIM IS MADE TO THE EXCLUSIVE RIGHT TO USE "LAW INSTITUTE", APART FROM THE MARK AS SHOWN.

FOR EDUCATION SERVICES, NAMELY, PROVIDING TRAINING, CLASSES, SEMINARS, WORKSHOPS, WEBINARS, AND ONLINE COURSES IN THE FIELD OF CONDUCTING INVESTIGATIONS AND DETECTING DECEPTION, LAW, COMPLIANCE WITH LAWS AND REGULATIONS, HUMAN RESOURCES, AND BUSINESS ETHICS, AND DISTRIBUTION OF PRINTED MATERIALS IN CONNECTION THEREWITH IN HARD COPY OR ELECTRONIC FORMAT ON THE SAME TOPICS (U.S. CLS. 100, 101 AND 107).

FIRST USE 10-4-2011; IN COMMERCE 10-4-2011.
JENNIFER RICHARDSON, EXAMINING ATTORNEY

SN 85-508,912. OUR FILM FESTIVAL, INC., SAN FRANCISCO, CA. FILED 1-4-2012.

FANDOR

THE MARK CONSISTS OF STANDARD CHARACTERS WITHOUT CLAIM TO ANY PARTICULAR FONT, STYLE, SIZE, OR COLOR.

THE WORDING "FANDOR" HAS NO MEANING IN A FOREIGN LANGUAGE.

FOR ENTERTAINMENT SERVICES, NAMELY, THE PROVISION OF CONTINUING MOVIES, MOVIE CLIPS AND FILMS FEATURING COMEDY, DRAMA, ACTION, VARIETY, ADVENTURE, SPORTS, MUSICALS, CURRENT EVENTS AND ENTERTAINMENT NEWS, DOCUMENTARY AND ANIMATION, DELIVERED BY THE INTERNET, ELECTRONIC COMMUNICATIONS NETWORKS, COMPUTER NETWORKS AND WIRELESS COMMUNICATIONS NETWORKS; ENTERTAINMENT SERVICES, NAMELY, PROVIDING INFORMATION RELATING TO FILMS IN THE FIELDS OF COMEDY, DRAMA, ACTION, VARIETY, ADVENTURE, SPORTS, MUSICALS, CURRENT EVENTS AND ENTERTAINMENT NEWS, DOCUMENTARY AND ANIMATION, VIA THE INTERNET, ELECTRONIC COMMUNICATIONS NETWORKS, COMPUTER NETWORKS AND WIRELESS COMMUNICATIONS NETWORKS (U.S. CLS. 100, 101 AND 107).

FIRST USE 6-21-2010; IN COMMERCE 10-20-2010.
JANICE KIM, EXAMINING ATTORNEY

CLASS 41—(Continued).

SN 85-511,110. PETERSON, BROOKS R., SAINT PAUL, MN. FILED 1-7-2012.

ACROSS CULTURES

THE MARK CONSISTS OF STANDARD CHARACTERS WITHOUT CLAIM TO ANY PARTICULAR FONT, STYLE, SIZE, OR COLOR.

SEC. 2(F).
FOR EDUCATIONAL SERVICES, NAMELY, CONDUCTING WORKSHOPS IN THE FIELD OF MULTICULTURALISM FOR INDIVIDUALS AND GROUPS ENGAGED IN GLOBAL ACTIVITIES AND DISTRIBUTION OF TRAINING MATERIAL IN CONNECTION THEREWITH (U.S. CLS. 100, 101 AND 107).
FIRST USE 5-15-1989; IN COMMERCE 5-15-1989.
SUNG IN, EXAMINING ATTORNEY

SN 85-514,842. GROOP, KRISTIN B., GILBERT, AZ. FILED 1-12-2012.



NO CLAIM IS MADE TO THE EXCLUSIVE RIGHT TO USE "ESTHETIC ADVISOR" OR "LASER ACADEMY", APART FROM THE MARK AS SHOWN.

THE COLOR(S) BLUE AND BLACK IS/ARE CLAIMED AS A FEATURE OF THE MARK.

THE MARK CONSISTS OF THREE TOUCHING BLUE TRIANGLES TO THE LEFT OF THE STYLIZED WORDINGS "ESTHETICADVISOR" AND "LASER ACADEMY", OF WHICH "ESTHETIC" AND "LASER ACADEMY" ARE IN BLACK COLOR AND "ADVISOR" IS IN BLUE COLOR.

FOR CONTINUING EDUCATION SERVICES, NAMELY, PROVIDING LIVE AND ON-LINE CONTINUING PROFESSIONAL EDUCATION SEMINARS IN THE FIELD OF MEDICAL PROCEDURES, INCLUDING, LASER HAIR REMOVAL, ACNE REDUCTION, LASER TATTOO REMOVAL, SPIDER VEIN TREATMENTS, SKIN REJUVENATION, BOTULINUM TOXIN TREATMENTS, MICRODERMABRASION, INJECTABLE FILLER TREATMENTS, FACIALS, AND SKIN CARE; EDUCATIONAL SERVICES, NAMELY, PROVIDING CONTINUING PROFESSIONAL EDUCATION COURSES IN THE FIELD OF MEDICAL, COSMETIC AND AESTHETIC; PROVIDING CONTINUING MEDICAL EDUCATION COURSES; VOCATIONAL EDUCATION IN THE FIELD OF MEDICAL LASER SAFETY AND PROCEDURES (U.S. CLS. 100, 101 AND 107).

FIRST USE 11-5-2011; IN COMMERCE 1-3-2012.
DAWN HAN, EXAMINING ATTORNEY

CLASS 41—(Continued).

SN 85-514,920. DOMINGO, RAEMAR P, IRVINE, CA. FILED 1-12-2012.



THE MARK CONSISTS OF A STYLIZED NUMBER "8" NEXT TO THE SILHOUETTE OF A MAN WHOSE ARM IS SUPPORTING THE NUMBER "8" TO PREVENT IT FROM FALLING.

FOR PERSONAL FITNESS TRAINING SERVICES AND CONSULTANCY; PERSONAL FITNESS TRAINING SERVICES FEATURING AEROBIC AND ANAEROBIC ACTIVITIES COMBINED WITH RESISTANCE AND FLEXIBILITY TRAINING; PHYSICAL FITNESS STUDIO SERVICES, NAMELY, PROVIDING GROUP EXERCISE INSTRUCTION, EQUIPMENT, AND FACILITIES; PHYSICAL FITNESS TRAINING OF INDIVIDUALS AND GROUPS; PROVIDING A WEB SITE FEATURING INFORMATION ON EXERCISE AND FITNESS; PROVIDING A WEBSITE FEATURING INFORMATION ON EXERCISE AND FITNESS; PROVIDING AN ON-LINE COMPUTER DATABASE FEATURING INFORMATION REGARDING EXERCISE AND FITNESS; PROVIDING AN ON-LINE COMPUTER DATABASE FEATURING INFORMATION REGARDING EXERCISE AND FITNESS BEFORE AND AFTER PREGNANCY; PROVIDING ASSISTANCE, PERSONAL TRAINING AND PHYSICAL FITNESS CONSULTATION TO CORPORATE CLIENTS TO HELP THEIR EMPLOYEES MAKE PHYSICAL FITNESS, STRENGTH, CONDITIONING, AND EXERCISE ALTERATIONS IN THEIR DAILY LIVING; PROVIDING CLASSES, WORKSHOPS, SEMINARS AND CAMPS IN THE FIELDS OF FITNESS, EXERCISE, BOXING, KICK BOXING AND MIXED MARTIAL ARTS; PROVIDING PHYSICAL FITNESS AND EXERCISE SERVICE, NAMELY, INDOOR CYCLING AND YOGA INSTRUCTION (U.S. CLS. 100, 101 AND 107).

FIRST USE 12-16-2011; IN COMMERCE 12-16-2011.
ELIZABETH HUGHITT, EXAMINING ATTORNEY

SN 85-515,743. EXPERIENCE LEARNING COMMUNITY, SEATTLE, WA. FILED 1-13-2012.



THE MARK CONSISTS OF STANDARD CHARACTERS WITHOUT CLAIM TO ANY PARTICULAR FONT, STYLE, SIZE, OR COLOR.

OWNER OF U.S. REG. NOS. 2,522,869, 2,576,414 AND OTHERS.
FOR MUSEUM SERVICES (U.S. CLS. 100, 101 AND 107).

FIRST USE 6-23-2000; IN COMMERCE 6-23-2000.
MAUREEN DALL, EXAMINING ATTORNEY

CLASS 41—(Continued).

SN 85-516,759. NEAL KATZ, WHEELING, IL. FILED 1-14-2012.

UNITED DRAG RACING LEAGUE

THE MARK CONSISTS OF STANDARD CHARACTERS WITHOUT CLAIM TO ANY PARTICULAR FONT, STYLE, SIZE, OR COLOR.

NO CLAIM IS MADE TO THE EXCLUSIVE RIGHT TO USE "DRAG RACING LEAGUE", APART FROM THE MARK AS SHOWN.

FOR ENTERTAINMENT SERVICES, NAMELY, PERFORMING AND COMPETING IN MOTOR SPORTS EVENTS (U.S. CLS. 100, 101 AND 107).
MICHELE SWAIN, EXAMINING ATTORNEY

SN 85-517,492. BATTLE, KENDRICK, COLUMBUS, GA. FILED 1-16-2012.

IED Muzik

THE MARK CONSISTS OF STANDARD CHARACTERS WITHOUT CLAIM TO ANY PARTICULAR FONT, STYLE, SIZE, OR COLOR.

NO CLAIM IS MADE TO THE EXCLUSIVE RIGHT TO USE "MUSIC", APART FROM THE MARK AS SHOWN.

FOR ENTERTAINMENT SERVICES IN THE NATURE OF RECORDING, PRODUCTION AND POST-PRODUCTION SERVICES IN THE FIELD OF MUSIC (U.S. CLS. 100, 101 AND 107).
KAPIL BHANOT, EXAMINING ATTORNEY

CLASS 41—(Continued).

SN 85-517,626. BURGOS, STARLIN, BRONX, NY. FILED 1-17-2012.

EL PURITAN

THE MARK CONSISTS OF STANDARD CHARACTERS WITHOUT CLAIM TO ANY PARTICULAR FONT, STYLE, SIZE, OR COLOR.

FOR ENTERTAINMENT RENDERED BY A MUSICAL ARTIST, NAMELY, ENTERTAINMENT IN THE NATURE OF VISUAL AND AUDIO PERFORMANCES BY A MUSICAL ACT; LIVE PERFORMANCES BY A MUSICAL ACT; MULTIMEDIA ENTERTAINMENT SERVICES IN THE NATURE OF RECORDING, PRODUCTION AND POST-PRODUCTION SERVICES IN THE FIELD OF MUSIC AND VIDEO; ENTERTAINMENT SERVICES BY A MUSICAL ARTIST, NAMELY, MUSIC SONGWRITING, MUSIC RECORDING, MUSIC PRODUCTION, MUSIC PUBLISHING, MUSIC VIDEO RECORDING, PRODUCTION AND PUBLISHING, MUSICAL COMPOSITION AND PRODUCTION OF MUSICAL SOUND RECORDINGS; PROVIDING AN INTERNET WEBSITE PORTAL IN THE FIELD OF MUSIC (U.S. CLS. 100, 101 AND 107).

GENE MACIOL, EXAMINING ATTORNEY

SN 85-518,283. DS FOUNDATION, LLC, DBA DAWN SELA PHOTOGRAPHY, BEACON, NY. FILED 1-17-2012.

Beautiful Experience By
Dawn

THE MARK CONSISTS OF STANDARD CHARACTERS WITHOUT CLAIM TO ANY PARTICULAR FONT, STYLE, SIZE, OR COLOR.

FOR PHOTOGRAPHY SERVICES; PORTRAIT PHOTOGRAPHY (U.S. CLS. 100, 101 AND 107).
FIRST USE 1-17-2012; IN COMMERCE 1-17-2012.
ALEX KEAM, EXAMINING ATTORNEY

CLASS 41—(Continued).

SN 85-519,348. VALOR CAPITAL ASSET MANAGEMENT, LLC., THE HILLS, TX. FILED 1-18-2012.

Certified Technical Analyst CTA

THE MARK CONSISTS OF STANDARD CHARACTERS WITHOUT CLAIM TO ANY PARTICULAR FONT, STYLE, SIZE, OR COLOR.

NO CLAIM IS MADE TO THE EXCLUSIVE RIGHT TO USE "CERTIFIED TECHNICAL ANALYST", APART FROM THE MARK AS SHOWN.

FOR EDUCATION SERVICES, NAMELY, PROVIDING LIVE AND ON-LINE COURSES OF INSTRUCTION, WORKSHOPS, SEMINARS, AND CONFERENCES FOR PURPOSES OF CERTIFICATION IN THE FIELD OF FINANCIAL ANALYSIS AND TECHNICAL TRADING ANALYSIS, AND DISTRIBUTING COURSE MATERIALS IN CONNECTION THEREWITH (U.S. CLS. 100, 101 AND 107).

FIRST USE 10-3-2011; IN COMMERCE 10-3-2011.
JAMES GRIFFIN, EXAMINING ATTORNEY

SN 85-519,349. WEDDING STORY, LLC, ANNANDALE, VA. FILED 1-18-2012.

WEDDING STORY

THE MARK CONSISTS OF STANDARD CHARACTERS WITHOUT CLAIM TO ANY PARTICULAR FONT, STYLE, SIZE, OR COLOR.

NO CLAIM IS MADE TO THE EXCLUSIVE RIGHT TO USE "WEDDING", APART FROM THE MARK AS SHOWN.

FOR WEDDING PLANNING AND COORDINATION SERVICES (U.S. CLS. 100, 101 AND 107).

FIRST USE 1-15-2005; IN COMMERCE 1-15-2005.
JAMES GRIFFIN, EXAMINING ATTORNEY

SN 85-519,580. TAYLOR, JOSHUA, FOUNTAINVILLE, PA. FILED 1-18-2012.

Ride Republic

THE MARK CONSISTS OF STANDARD CHARACTERS WITHOUT CLAIM TO ANY PARTICULAR FONT, STYLE, SIZE, OR COLOR.

NO CLAIM IS MADE TO THE EXCLUSIVE RIGHT TO USE "RIDE", APART FROM THE MARK AS SHOWN.

FOR PROVIDING PHYSICAL FITNESS AND EXERCISE SERVICE, NAMELY, INDOOR CYCLING; PHYSICAL FITNESS INSTRUCTIONS IN THE FIELD OF INDOOR CYCLING; PROVIDING FITNESS AND EXERCISE FACILITIES FOR INDOOR CYCLING (U.S. CLS. 100, 101 AND 107).

COLLEEN DOMBROW, EXAMINING ATTORNEY

CLASS 41—(Continued).

SN 85-519,585. LUNDBLAD, KENT, SANTA ROSA, CA. FILED 1-18-2012.

The 72 Pins

THE MARK CONSISTS OF STANDARD CHARACTERS WITHOUT CLAIM TO ANY PARTICULAR FONT, STYLE, SIZE, OR COLOR.

FOR PROVIDING INFORMATION, NEWS AND COMMENTARY IN THE FIELD OF VIDEO GAMES; ON-LINE JOURNALS, NAMELY, BLOGS FEATURING THE SUBJECT OF VIDEO GAMES (U.S. CLS. 100, 101 AND 107).

FIRST USE 12-30-2010; IN COMMERCE 12-30-2010.
NAAKWAMA ANKRAH, EXAMINING ATTORNEY

SN 85-519,655. ACRO SPORTS INTERNATIONAL, INC., MESQUITE, TX. FILED 1-18-2012.



NO CLAIM IS MADE TO THE EXCLUSIVE RIGHT TO USE "GYMNASTICS", APART FROM THE MARK AS SHOWN.

THE COLOR(S) BLUE AND BLACK IS/ARE CLAIMED AS A FEATURE OF THE MARK.

THE MARK CONSISTS THREE BRILLIANT BLUE HORIZONTAL BARS ON EACH SIDE OF THE BLACK CAPITAL LETTERS "ASI", WITH "GYMNASTICS" IN BLACK PRINT UNDERNEATH, AND THE COLOR WHITE REPRESENTS BACKGROUND AND/OR TRANSPARENT AREAS AND IS NOT PART OF THE MARK.

FOR GYMNASTIC INSTRUCTION; PROVIDING GYMNASTIC FACILITIES (U.S. CLS. 100, 101 AND 107).

FIRST USE 5-1-1993; IN COMMERCE 5-1-1993.
GENE MACIOL, EXAMINING ATTORNEY

SN 85-519,761. TYLER, JULIE, LOS ANGELES, CA. FILED 1-19-2012.

GOLDEN GOOSE FILMS

THE MARK CONSISTS OF STANDARD CHARACTERS WITHOUT CLAIM TO ANY PARTICULAR FONT, STYLE, SIZE, OR COLOR.

NO CLAIM IS MADE TO THE EXCLUSIVE RIGHT TO USE "FILMS", APART FROM THE MARK AS SHOWN.

FOR ENTERTAINMENT SERVICES, NAMELY, PRODUCTION OF FILMS, RADIO AND TELEVISION PROGRAMS; ENTERTAINMENT SERVICES IN THE NATURE OF DEVELOPMENT, CREATION, PRODUCTION AND POST-PRODUCTION SERVICES OF MULTIMEDIA ENTERTAINMENT CONTENT (U.S. CLS. 100, 101 AND 107).

TASHIA BUNCH, EXAMINING ATTORNEY

CLASS 41—(Continued).

SN 85-520,000. FREAD, CHRISTOPHER, BOCA RATON, FL. FILED 1-19-2012.

COOK-A-STRATIONS

THE MARK CONSISTS OF STANDARD CHARACTERS WITHOUT CLAIM TO ANY PARTICULAR FONT, STYLE, SIZE, OR COLOR.

FOR PROVIDING EDUCATIONAL AND ENTERTAINING COOKING DEMONSTRATIONS AT TRADE SHOWS, GREEN MARKETS, WINE AND FOOD FESTIVALS AND PRIVATE EVENTS (U.S. CLS. 100, 101 AND 107).

FIRST USE 1-2-2012; IN COMMERCE 1-9-2012.
THEODORE MCBRIDE, EXAMINING ATTORNEY

SN 85-520,233. FIORINO, ANTHONY, SOMERS, NY. FILED 1-19-2012.

Hey Coach Tony

THE MARK CONSISTS OF STANDARD CHARACTERS WITHOUT CLAIM TO ANY PARTICULAR FONT, STYLE, SIZE, OR COLOR.

THE NAME "COACH TONY" IDENTIFIES THE PSEUDONYM OF ANTHONY FIORINO, A LIVING INDIVIDUAL WHOSE CONSENT IS OF RECORD.

FOR ENTERTAINMENT SERVICES, NAMELY, PROVIDING CONTINUING RADIO AND TELEVISION SHOWS IN THE FIELDS OF SPORTS, YOUTH SPORTS, PARENTING, AND SPORTS COACHING (U.S. CLS. 100, 101 AND 107).

JASON BLAIR, EXAMINING ATTORNEY

SN 85-520,381. THE TRUSTEES OF THE UNIVERSITY OF PENNSYLVANIA, PHILADELPHIA, PA. FILED 1-19-2012.

UPENN

THE MARK CONSISTS OF STANDARD CHARACTERS WITHOUT CLAIM TO ANY PARTICULAR FONT, STYLE, SIZE, OR COLOR.

OWNER OF U.S. REG. NOS. 1,773,208, 3,393,892 AND OTHERS.

FOR EDUCATIONAL SERVICES, NAMELY, PROVIDING COURSES OF INSTRUCTION AT THE UNDERGRADUATE, GRADUATE, AND POST GRADUATE LEVELS; EDUCATIONAL SERVICES, NAMELY, PROVIDING CONTINUING PROFESSIONAL EDUCATION COURSES IN THE FIELDS OF THE LIBERAL ARTS AND SCIENCES, NURSING, SOCIAL POLICY, BUSINESS, ENGLISH AND FOREIGN LANGUAGES (U.S. CLS. 100, 101 AND 107).

STEVEN PEREZ, EXAMINING ATTORNEY

CLASS 41—(Continued).

SN 85-520,397. THE TRUSTEES OF THE UNIVERSITY OF PENNSYLVANIA, PHILADELPHIA, PA. FILED 1-19-2012.

UPENN.EDU

THE MARK CONSISTS OF STANDARD CHARACTERS WITHOUT CLAIM TO ANY PARTICULAR FONT, STYLE, SIZE, OR COLOR.

OWNER OF U.S. REG. NOS. 1,773,208, 3,393,892 AND OTHERS.

FOR EDUCATIONAL SERVICES, NAMELY, PROVIDING COURSES OF INSTRUCTION AT THE UNDERGRADUATE, GRADUATE, AND POST GRADUATE LEVELS; EDUCATIONAL SERVICES, NAMELY, PROVIDING CONTINUING PROFESSIONAL EDUCATION COURSES IN THE FIELDS OF THE LIBERAL ARTS AND SCIENCES, NURSING, SOCIAL POLICY, BUSINESS, ENGLISH AND FOREIGN LANGUAGES (U.S. CLS. 100, 101 AND 107).

STEVEN PEREZ, EXAMINING ATTORNEY

SN 85-520,438. MAGNIFICAT HIGH SCHOOL, ROCKY RIVER, OH. FILED 1-19-2012.

SURROUND LEARNING

THE MARK CONSISTS OF STANDARD CHARACTERS WITHOUT CLAIM TO ANY PARTICULAR FONT, STYLE, SIZE, OR COLOR.

NO CLAIM IS MADE TO THE EXCLUSIVE RIGHT TO USE "LEARNING", APART FROM THE MARK AS SHOWN.

FOR EDUCATIONAL SERVICES, NAMELY, PROVIDING A LEARNING AND INNOVATION CENTER FEATURING FULLY CUSTOMIZED EDUCATIONAL TRAINING THROUGH SPACE PLANNING AND ARRANGEMENT OF INFORMATION TECHNOLOGY (U.S. CLS. 100, 101 AND 107).

FIRST USE 7-29-2010; IN COMMERCE 7-29-2010.

DAVID YONTEF, EXAMINING ATTORNEY

CLASS 41—(Continued).

SN 85-520,925. BEW, LLC, CAMP HILL, PA. FILED 1-20-2012.



NO CLAIM IS MADE TO THE EXCLUSIVE RIGHT TO USE "MICRO SCHOOL", APART FROM THE MARK AS SHOWN.

THE COLOR(S) BROWN AND GREEN IS/ARE CLAIMED AS A FEATURE OF THE MARK.

THE MARK CONSISTS OF BROWN "BE" OVER GREEN "W" WITH THE A GREEN "MICRO" AND BROWN "SCHOOL" UNDERNEATH TWO PARALLEL LINES, ONE GREEN AND THE OTHER LINE BROWN.

FOR EDUCATION SERVICES, NAMELY, PROVIDING ON-LINE INSTRUCTION IN THE FIELD OF MATH, READING, WRITING, SCIENCE, AND SOCIAL STUDIES (U.S. CLS. 100, 101 AND 107).

FIRST USE 4-13-2011; IN COMMERCE 4-13-2011.
TEJBIR SINGH, EXAMINING ATTORNEY

CLASS 41—(Continued).

SN 85-521,280. WESTERN GOVERNORS UNIVERSITY, SALT LAKE CITY, UT. FILED 1-20-2012.

WGU CALIFORNIA

THE MARK CONSISTS OF STANDARD CHARACTERS WITHOUT CLAIM TO ANY PARTICULAR FONT, STYLE, SIZE, OR COLOR.

OWNER OF U.S. REG. NOS. 2,374,880, 4,069,580 AND OTHERS.

NO CLAIM IS MADE TO THE EXCLUSIVE RIGHT TO USE "CALIFORNIA", APART FROM THE MARK AS SHOWN.

FOR CAREER COUNSELING, NAMELY, PROVIDING ADVICE CONCERNING EDUCATION OPTIONS TO PURSUE CAREER OPPORTUNITIES; EDUCATIONAL COUNSELING SERVICES TO ASSIST STUDENTS IN PLANNING AND PREPARING FOR FURTHER EDUCATION; EDUCATIONAL SERVICES, NAMELY, PROVIDING ONLINE INSTRUCTION IN THE FIELD OF EDUCATION, BUSINESS, INFORMATION TECHNOLOGY, NURSING, HEALTH AND HEALTH CARE; EDUCATIONAL TESTING SERVICES (U.S. CLS. 100, 101 AND 107).

TINA MAI, EXAMINING ATTORNEY

SN 85-521,121. CASEY, STEVEN, ATLANTA, GA. FILED 1-20-2012.

DEATH OF KINGS

THE MARK CONSISTS OF STANDARD CHARACTERS WITHOUT CLAIM TO ANY PARTICULAR FONT, STYLE, SIZE, OR COLOR.

FOR ENTERTAINMENT RENDERED BY A MUSICAL BAND, NAMELY, ENTERTAINMENT IN THE NATURE OF VISUAL AND AUDIO PERFORMANCES BY A MUSICAL ACT ; LIVE PERFORMANCES BY A MUSICAL ACT; MULTIMEDIA ENTERTAINMENT SERVICES IN THE NATURE OF RECORDING, PRODUCTION AND POST-PRODUCTION SERVICES IN THE FIELD OF MUSIC AND VIDEO; ENTERTAINMENT SERVICES BY A MUSICAL ARTIST, NAMELY, MUSIC SONGWRITING, RECORDING, PRODUCTION AND PUBLISHING, MUSIC VIDEO PRODUCTION, MUSIC COMPOSITION AND PRODUCTION OF MUSICAL SOUND RECORDINGS; PROVIDING AN INTERNET WEBSITE PORTAL IN THE FIELD OF MUSIC (U.S. CLS. 100, 101 AND 107).

FIRST USE 1-1-2008; IN COMMERCE 1-1-2008.
DAVID ELTON, EXAMINING ATTORNEY

SN 85-521,303. WESTERN GOVERNORS UNIVERSITY, SALT LAKE CITY, UT. FILED 1-20-2012.

WGU NEW YORK

THE MARK CONSISTS OF STANDARD CHARACTERS WITHOUT CLAIM TO ANY PARTICULAR FONT, STYLE, SIZE, OR COLOR.

OWNER OF U.S. REG. NOS. 2,374,880, 4,069,580 AND OTHERS.

NO CLAIM IS MADE TO THE EXCLUSIVE RIGHT TO USE "NEW YORK", APART FROM THE MARK AS SHOWN.

FOR CAREER COUNSELING, NAMELY, PROVIDING ADVICE CONCERNING EDUCATION OPTIONS TO PURSUE CAREER OPPORTUNITIES; EDUCATIONAL COUNSELING SERVICES TO ASSIST STUDENTS IN PLANNING AND PREPARING FOR FURTHER EDUCATION; EDUCATIONAL SERVICES, NAMELY, PROVIDING ONLINE INSTRUCTION IN THE FIELD OF EDUCATION, BUSINESS, INFORMATION TECHNOLOGY, NURSING, HEALTH AND HEALTH CARE; EDUCATIONAL TESTING SERVICES (U.S. CLS. 100, 101 AND 107).

TINA MAI, EXAMINING ATTORNEY

CLASS 41—(Continued).

SN 85-521,352. ONLINE HEALTHNOW, INC., TAMPA, FL.
FILED 1-20-2012.

CARE2LEARN

THE MARK CONSISTS OF STANDARD CHARACTERS WITHOUT CLAIM TO ANY PARTICULAR FONT, STYLE, SIZE, OR COLOR.

OWNER OF U.S. REG. NO. 2,990,811.

FOR EDUCATIONAL SERVICES, NAMELY, CONDUCTING ONLINE EDUCATION CLASSES, PROVIDING ONLINE ASSESSMENT CHECKLISTS, TRACKING PROGRAMS AND RELATED ASSESSMENT SERVICES, AND PROVIDING ONLINE TRAINING TOOLS IN THE NATURE OF PROVIDING THE ABILITY TO ASSIGN, TRACK, AND MANAGE TRAINING AND TO FACILITATE LIVE TRAINING, ALL IN THE FIELD OF HEALTH CARE FOR HEALTHCARE PROFESSIONALS AND CORPORATIONS (U.S. CLS. 100, 101 AND 107).

FIRST USE 6-30-2000; IN COMMERCE 6-30-2000.

TINA MAI, EXAMINING ATTORNEY

CLASS 41—(Continued).

SN 85-521,406. ARVIN, ROBERT F., CHATSWORTH, CA.
FILED 1-20-2012.

PolitiZoid

THE MARK CONSISTS OF STANDARD CHARACTERS WITHOUT CLAIM TO ANY PARTICULAR FONT, STYLE, SIZE, OR COLOR.

FOR ENTERTAINMENT SERVICES, NAMELY, PROVIDING A WEB SITE FEATURING ONLINE NON-DOWNLOADABLE AUDIO AND VIDEO RECORDINGS FEATURING POLITICAL SATIRE (U.S. CLS. 100, 101 AND 107).

FIRST USE 9-25-2009; IN COMMERCE 9-25-2009.

KRISTINA MORRIS, EXAMINING ATTORNEY

SN 85-521,353. WESTERN GOVERNORS UNIVERSITY, SALT LAKE CITY, UT. FILED 1-20-2012.

WGU OREGON

THE MARK CONSISTS OF STANDARD CHARACTERS WITHOUT CLAIM TO ANY PARTICULAR FONT, STYLE, SIZE, OR COLOR.

OWNER OF U.S. REG. NOS. 2,374,880, 4,069,580 AND OTHERS.

NO CLAIM IS MADE TO THE EXCLUSIVE RIGHT TO USE "OREGON", APART FROM THE MARK AS SHOWN.

FOR CAREER COUNSELING, NAMELY, PROVIDING ADVICE CONCERNING EDUCATION OPTIONS TO PURSUE CAREER OPPORTUNITIES; EDUCATIONAL COUNSELING SERVICES TO ASSIST STUDENTS IN PLANNING AND PREPARING FOR FURTHER EDUCATION; EDUCATIONAL SERVICES, NAMELY, PROVIDING ONLINE INSTRUCTION IN THE FIELD OF EDUCATION, BUSINESS, INFORMATION TECHNOLOGY, NURSING, HEALTH AND HEALTH CARE; EDUCATIONAL TESTING SERVICES (U.S. CLS. 100, 101 AND 107).

TINA MAI, EXAMINING ATTORNEY

SN 85-521,432. VALOR CAPITAL ASSET MANAGEMENT, LLC., THE HILLS, TEXAS 78738, TX. FILED 1-20-2012.

Chartered Technical Analyst CTA

THE MARK CONSISTS OF STANDARD CHARACTERS WITHOUT CLAIM TO ANY PARTICULAR FONT, STYLE, SIZE, OR COLOR.

NO CLAIM IS MADE TO THE EXCLUSIVE RIGHT TO USE "CHARTERED TECHNICAL ANALYST", APART FROM THE MARK AS SHOWN.

FOR EDUCATION SERVICES, NAMELY, PROVIDING LIVE AND ON-LINE COURSES OF INSTRUCTION, WORKSHOPS, SEMINARS, AND CONFERENCES FOR PURPOSES OF CERTIFICATION IN THE FIELD OF FINANCIAL ANALYSIS AND TECHNICAL TRADING ANALYSIS, AND DISTRIBUTING COURSE MATERIALS IN CONNECTION THEREWITH (U.S. CLS. 100, 101 AND 107).

FIRST USE 10-3-2011; IN COMMERCE 10-3-2011.

JAMES GRIFFIN, EXAMINING ATTORNEY

CLASS 41—(Continued).

SN 85-521,435. UNIVERSITY EMERGENCY MEDICINE FOUNDATION, PROVIDENCE, RI. FILED 1-20-2012.



THE COLOR(S) BLUE, GOLD, AND WHITE IS/ARE CLAIMED AS A FEATURE OF THE MARK.

THE MARK CONSISTS OF THE BLUE STYLIZED WORDING "BE" WITH A BLUE LINE EXTENDING FROM THE "E" FORMING AN EKG LINE THAT UNDERLINES THE WORDING "CLEAR", FORMS THE "A" IN "CLEAR", AND ENDS IN SOUND WAVES. THE LETTERS "C", "L", "E", AND "R" IN "CLEAR" ARE GOLD WITH A BLUE OUTLINE. THE ENTIRE MARK IS ON A WHITE BACKGROUND.

FOR MEDICAL MULTIDISCIPLINE STAFF COMMUNICATION TRAINING VIA MEDICAL SIMULATION WITH VIDEO DEBRIEFING FOR THE APPLICATION OF CREW RESOURCE MANAGEMENT (CRM) AND PATIENT SERVICE PRINCIPLES (U.S. CLS. 100, 101 AND 107).

FIRST USE 3-15-2011; IN COMMERCE 3-15-2011.
KRISTINA MORRIS, EXAMINING ATTORNEY

CLASS 41—(Continued).

SN 85-522,323. THE ROSE PROGRAM, LTD., NORWALK, OH. FILED 1-23-2012.

THE ROSE PROGRAM

THE MARK CONSISTS OF STANDARD CHARACTERS WITHOUT CLAIM TO ANY PARTICULAR FONT, STYLE, SIZE, OR COLOR.

NO CLAIM IS MADE TO THE EXCLUSIVE RIGHT TO USE "PROGRAM", APART FROM THE MARK AS SHOWN.

FOR WORKSHOPS AND SEMINARS IN THE FIELD OF SELF-AWARENESS TO HELP PEOPLE GAIN UNDERSTANDING AND BECOME MORE COMFORTABLE WITH, BETTER ORGANIZED WITH, AND ACCEPTING OF, THE NORMAL AGING PROCESS AND THE INEVITABLE END OF LIFE (U.S. CLS. 100, 101 AND 107).

JAMES LOVELACE, EXAMINING ATTORNEY

SN 85-522,330. KINFOLKS FOUNDATION, INC., JACKSONVILLE, FL. FILED 1-23-2012.

THE KINFOLKS SOUL FOOD FESTIVAL

THE MARK CONSISTS OF STANDARD CHARACTERS WITHOUT CLAIM TO ANY PARTICULAR FONT, STYLE, SIZE, OR COLOR.

NO CLAIM IS MADE TO THE EXCLUSIVE RIGHT TO USE "SOUL FOOD FESTIVAL", APART FROM THE MARK AS SHOWN.

FOR ORGANIZING COMMUNITY FESTIVALS FEATURING PRIMARILY MUSICAL ENTERTAINMENT AND COMEDY JAMS AND ALSO PROVIDING SOUL FOOD AND PLATFORMS OF INFORMATION FOR THE PUBLIC ON HEALTH AND WELLNESS, EDUCATION, HOUSING, FINANCING, BUSINESS AND WORKFORCE DEVELOPMENT (U.S. CLS. 100, 101 AND 107).

FIRST USE 6-0-2007; IN COMMERCE 6-0-2007.
KEVIN DINALLO, EXAMINING ATTORNEY

SN 85-521,557. JAMES, SHEILA, MINNEAPOLIS, MN. FILED 1-20-2012.



NO CLAIM IS MADE TO THE EXCLUSIVE RIGHT TO USE "SOLUTIONS", APART FROM THE MARK AS SHOWN.

THE MARK CONSISTS OF A LARGE LETTER "S" INSIDE OF A DIAMOND ABOVE THE WORDS "SHAPE UP SOLUTIONS". THE "S" IN THE WORDS "SHAPE" AND "SOLUTION" ARE INSIDE OF DIAMONDS.

FOR PROVIDING ASSISTANCE, PERSONAL TRAINING AND PHYSICAL FITNESS CONSULTATION TO INDIVIDUALS TO HELP THEM MAKE PHYSICAL FITNESS, STRENGTH, CONDITIONING, AND EXERCISE IMPROVEMENT IN THEIR DAILY LIVING (U.S. CLS. 100, 101 AND 107).

FIRST USE 1-1-2000; IN COMMERCE 1-1-2000.
LAURIE MAYES, EXAMINING ATTORNEY

SN 85-522,611. SCHOOL DISTRICT OF GRANTSBURG, GRANTSBURG, WI. FILED 1-23-2012.

IFORWARD

THE MARK CONSISTS OF STANDARD CHARACTERS WITHOUT CLAIM TO ANY PARTICULAR FONT, STYLE, SIZE, OR COLOR.

FOR EDUCATIONAL SERVICES, NAMELY, PROVIDING KINDERGARTEN THROUGH 12TH GRADE (K-12) AND COLLEGE ON-LINE TRAINING CLASSES AND PROGRAMS AND DISTRIBUTING COURSE MATERIALS AND CURRICULA IN CONNECTION THEREWITH (U.S. CLS. 100, 101 AND 107).

KATHRYN COWARD, EXAMINING ATTORNEY

CLASS 41—(Continued).

SN 85-522,662. TRUESSENCE LLC, WAYZATA, MN. FILED 1-23-2012.

HOLY SEXUALITY

THE MARK CONSISTS OF STANDARD CHARACTERS WITHOUT CLAIM TO ANY PARTICULAR FONT, STYLE, SIZE, OR COLOR.

NO CLAIM IS MADE TO THE EXCLUSIVE RIGHT TO USE "SEXUALITY", APART FROM THE MARK AS SHOWN.

FOR WORKSHOPS AND SEMINARS IN THE FIELD OF SPIRITUALITY AND SEXUALITY (U.S. CLS. 100, 101 AND 107).

FIRST USE 3-27-2009; IN COMMERCE 3-27-2009.
TINA L. SNAPP, EXAMINING ATTORNEY

CLASS 41—(Continued).

SN 85-523,642. ROUND STAR, INC., NEW YORK, NY. FILED 1-24-2012.



NO CLAIM IS MADE TO THE EXCLUSIVE RIGHT TO USE "INCORPORATED", APART FROM THE MARK AS SHOWN.

THE MARK CONSISTS OF FIVE STYLIZED BLADES ANGLED COUNTERCLOCKWISE TO FORM AN OUTLINE OF A STYLIZED STAR, FOLLOWED BY THE STYLIZED WORDS "ROUND STAR" SET ON TOP OF THE STYLIZED WORD "INCORPORATED".

FOR MULTIMEDIA ENTERTAINMENT SERVICES IN THE NATURE OF DEVELOPMENT, PRODUCTION AND POST-PRODUCTION SERVICES IN THE FIELDS OF VIDEO AND FILMS (U.S. CLS. 100, 101 AND 107).

JAY FLOWERS, EXAMINING ATTORNEY

SN 85-523,657. HENG DAI MEDIA, LLC, DBA MUSIC CITY ROOTS, LEBANON, TN. FILED 1-24-2012.

ROOTS RADIO

THE MARK CONSISTS OF STANDARD CHARACTERS WITHOUT CLAIM TO ANY PARTICULAR FONT, STYLE, SIZE, OR COLOR.

NO CLAIM IS MADE TO THE EXCLUSIVE RIGHT TO USE "RADIO", APART FROM THE MARK AS SHOWN.

FOR ENTERTAINMENT SERVICES, NAMELY, PROVIDING ON-GOING RADIO PROGRAMMING IN THE FIELD OF MUSIC (U.S. CLS. 100, 101 AND 107).

JAY FLOWERS, EXAMINING ATTORNEY

SN 85-523,343. PRICE, KATHERINE A, ARLINGTON, VA. FILED 1-23-2012.

ADHDC

THE MARK CONSISTS OF STANDARD CHARACTERS WITHOUT CLAIM TO ANY PARTICULAR FONT, STYLE, SIZE, OR COLOR.

FOR PERSONAL COACHING IN THE FIELD OF ATTENTION DEFICIT HYPERACTIVITY DISORDER ALSO KNOWN AS ADHD, FOR PARENTS OF KIDS WITH THE DISORDER; EDUCATIONAL CONSULTING SERVICES IN THE ACADEMIC FIELD SPECIFICALLY RELATED TO ATTENTION DEFICIT HYPERACTIVITY DISORDER ALSO KNOWN AS ADHD, FOR PARENTS OF KIDS WITH THE DISORDER; PROVIDING A WEBSITE FEATURING EDUCATIONAL AND MOTIVATIONAL NEWS AND INFORMATION IN THE FIELD OF ATTENTION DEFICIT HYPERACTIVITY DISORDER ALSO KNOWN AS ADHD, FOR PARENTS OF KIDS WITH THE DISORDER; AND CUSTOM WRITING SERVICES FOR OTHERS IN THE FIELD OF ATTENTION DEFICIT HYPERACTIVITY DISORDER ALSO KNOWN AS ADHD, FOR PARENTS OF KIDS WITH THE DISORDER (U.S. CLS. 100, 101 AND 107).

JOHN WILKE, EXAMINING ATTORNEY

SN 85-523,659. SOUTHERN CALIFORNIA PUBLIC RADIO, PASADENA, CA. FILED 1-24-2012.

DAILY CONNECT

THE MARK CONSISTS OF STANDARD CHARACTERS WITHOUT CLAIM TO ANY PARTICULAR FONT, STYLE, SIZE, OR COLOR.

NO CLAIM IS MADE TO THE EXCLUSIVE RIGHT TO USE "DAILY", APART FROM THE MARK AS SHOWN.

FOR PROVIDING ONLINE ELECTRONIC NEWSLETTERS DELIVERED BY EMAIL IN THE FIELD OF NEWS, CURRENT EVENTS AND TOPICS OF GENERAL INTEREST (U.S. CLS. 100, 101 AND 107).

FIRST USE 4-18-2011; IN COMMERCE 4-18-2011.

JAY FLOWERS, EXAMINING ATTORNEY

CLASS 41—(Continued).

SN 85-523,736. ASPHALT GREEN INC., NEW YORK, NY. FILED 1-24-2012.

SNOWMAN SHOWDOWN

THE MARK CONSISTS OF STANDARD CHARACTERS WITHOUT CLAIM TO ANY PARTICULAR FONT, STYLE, SIZE, OR COLOR.

NO CLAIM IS MADE TO THE EXCLUSIVE RIGHT TO USE "SNOWMAN", APART FROM THE MARK AS SHOWN.

FOR ORGANIZING, ARRANGING, AND CONDUCTING SNOWMAN BUILDING TO ENCOURAGE PHYSICAL ACTIVITY FOR FAMILIES (U.S. CLS. 100, 101 AND 107).

FIRST USE 12-16-2010; IN COMMERCE 12-16-2010.
KAPIL BHANOT, EXAMINING ATTORNEY

SN 85-524,145. BARCELONA ENTERPRISES, SHERMAN OAKS, CA. FILED 1-24-2012.

Indulge Los Angeles

THE MARK CONSISTS OF STANDARD CHARACTERS WITHOUT CLAIM TO ANY PARTICULAR FONT, STYLE, SIZE, OR COLOR.

NO CLAIM IS MADE TO THE EXCLUSIVE RIGHT TO USE "LOS ANGELES", APART FROM THE MARK AS SHOWN.

FOR ORGANIZING COMMUNITY FESTIVALS FEATURING PRIMARILY TASTINGS AND EXHIBITIONS FEATURING CHOCOLATE, PASTRY, WINE, SPIRITS AND BEER (U.S. CLS. 100, 101 AND 107).

FIRST USE 1-14-2009; IN COMMERCE 6-19-2009.
TINA BROWN, EXAMINING ATTORNEY

SN 85-524,273. GAMEFETCH, LLC, TRIANGLE, VA. FILED 1-24-2012.

Gamefetch

THE MARK CONSISTS OF STANDARD CHARACTERS WITHOUT CLAIM TO ANY PARTICULAR FONT, STYLE, SIZE, OR COLOR.

FOR PROVIDING ONLINE RENTALS OF VIDEO GAMES, DELIVERED TO RECIPIENTS VIA POSTAL MAIL (U.S. CLS. 100, 101 AND 107).

FIRST USE 2-17-2011; IN COMMERCE 4-13-2011.
MARILYN IZZI, EXAMINING ATTORNEY

CLASS 41—(Continued).

SN 85-524,275. CHEERS TO ART, LLC, CINCINNATI, OH. FILED 1-24-2012.



NO CLAIM IS MADE TO THE EXCLUSIVE RIGHT TO USE "PAINTING WINE GIFTS", APART FROM THE MARK AS SHOWN.

THE MARK CONSISTS OF THE STYLIZED TEXT "CHEERS" AT THE TOP, BELOW AND LEFT OF THAT IS AN ARTIST EASEL, WINE GLASS, AND SPLASH OF PAINT WITH THE STYLIZED TEXT "TO" ON IT, THE STYLIZED TEXT "ART!" TO THE RIGHT OF THE DESIGN, THE STYLIZED TEXT "ART AS ENTERTAINMENT" BELOW THAT, AND THE STYLIZED TEXT "PAINTING . WINE . GIFTS" BELOW THAT.

FOR ENTERTAINMENT SERVICES, IN THE NATURE OF ORGANIZING, ARRANGING, AND CONDUCTING ACRYLIC PAINTING CLASSES (U.S. CLS. 100, 101 AND 107).

FIRST USE 9-15-2010; IN COMMERCE 11-15-2010.
MARILYN IZZI, EXAMINING ATTORNEY

SN 85-524,569. MJR VETERINARY SERVICES LLC, DBA GRANDVIEW ANIMAL CLINIC, COLUMBUS, OH. FILED 1-25-2012.

ANIMAL CARE WITH DR. MIKE

THE MARK CONSISTS OF STANDARD CHARACTERS WITHOUT CLAIM TO ANY PARTICULAR FONT, STYLE, SIZE, OR COLOR.

NO CLAIM IS MADE TO THE EXCLUSIVE RIGHT TO USE "ANIMAL CARE", APART FROM THE MARK AS SHOWN.

THE NAME(S), PORTRAIT(S), AND/OR SIGNATURE(S) SHOWN IN THE MARK IDENTIFIES DR. MICHAEL REIDELBACH, A LIVING INDIVIDUAL, WHOSE CONSENT(S) TO REGISTER IS MADE OF RECORD.

FOR ENTERTAINMENT SERVICES, NAMELY, PROVIDING AN ON-GOING RADIO PROGRAM IN THE FIELD OF VETERINARY MEDICINE (U.S. CLS. 100, 101 AND 107).

JORDAN BAKER, EXAMINING ATTORNEY

CLASS 41—(Continued).

SN 85-524,676. HYKEN, SHEP, ST. LOUIS, MO. FILED 1-25-2012.

Shep Hyken

THE MARK CONSISTS OF STANDARD CHARACTERS WITHOUT CLAIM TO ANY PARTICULAR FONT, STYLE, SIZE, OR COLOR.

THE NAME "SHEP HYKEN" IDENTIFIES A LIVING INDIVIDUAL WHOSE CONSENT IS OF RECORD.

FOR EDUCATIONAL AND ENTERTAINMENT SERVICES, NAMELY, PROVIDING MOTIVATIONAL SPEAKER SERVICES IN THE FIELD OF CUSTOMER SERVICE; BUSINESS TRAINING CONSULTANCY SERVICES; BUSINESS TRAINING IN THE FIELD OF CUSTOMER SERVICE AND OTHER BUSINESS RELATED TOPICS; ENTERTAINMENT IN THE NATURE OF LIVE PERFORMANCES BY A MOTIVATIONAL SPEAKER; ENTERTAINMENT IN THE NATURE OF LIVE STAGE PERFORMANCES IN THE NATURE OF SPEECHES FOR HIRE IN THE FIELD OF CUSTOMER SERVICE AND OTHER BUSINESS TOPICS BY AN INDIVIDUAL; EDUCATIONAL AND ENTERTAINMENT SERVICES, NAMELY, PROVIDING MOTIVATIONAL SPEAKER SERVICES IN THE FIELD OF CUSTOMER SERVICE AND OTHER BUSINESS TOPICS (U.S. CLS. 100, 101 AND 107).

FIRST USE 9-0-1983; IN COMMERCE 9-0-1983.
SARA BENJAMIN, EXAMINING ATTORNEY

SN 85-525,277. MARVIN, WILLIAM R., DBA THE RESTAURANT DOCTOR, GIG HARBOR, WA. FILED S.R. 1-25-2012; AM. P.R. 5-3-2012.

The Restaurant Doctor

THE MARK CONSISTS OF STANDARD CHARACTERS WITHOUT CLAIM TO ANY PARTICULAR FONT, STYLE, SIZE, OR COLOR.

NO CLAIM IS MADE TO THE EXCLUSIVE RIGHT TO USE "RESTAURANT", APART FROM THE MARK AS SHOWN.

FOR EDUCATIONAL SERVICES, NAMELY, CONDUCTING SEMINARS AND LECTURES IN THE FIELD OF HOSPITALITY AND MANAGEMENT (U.S. CLS. 100, 101 AND 107).

FIRST USE 4-8-1991; IN COMMERCE 4-8-1991.
KAREN K. BUSH, EXAMINING ATTORNEY

CLASS 41—(Continued).

SN 85-525,375. ELDREDGE, EMILY JANE, DBA THE DRAWING OUT PROCESS, TUCSON, AZ. FILED 1-25-2012.

The Drawing Out Process

THE MARK CONSISTS OF STANDARD CHARACTERS WITHOUT CLAIM TO ANY PARTICULAR FONT, STYLE, SIZE, OR COLOR.

NO CLAIM IS MADE TO THE EXCLUSIVE RIGHT TO USE "PROCESS", APART FROM THE MARK AS SHOWN.

FOR EDUCATIONAL AND PERSONAL COACHING SERVICES, NAMELY, CONDUCTING SEMINARS, CONFERENCES, RETREATS, WORKSHOPS, AND PRIVATE INSTRUCTION IN THE FIELD OF EMOTIONAL WELLNESS (U.S. CLS. 100, 101 AND 107).

FIRST USE 5-6-2011; IN COMMERCE 7-1-2011.
DAVID MURRAY, EXAMINING ATTORNEY

SN 85-526,574. YOUNG, LAVONDA, ALVARADO, TX. FILED 1-26-2012.

Divine Blessings Academy

THE MARK CONSISTS OF STANDARD CHARACTERS WITHOUT CLAIM TO ANY PARTICULAR FONT, STYLE, SIZE, OR COLOR.

NO CLAIM IS MADE TO THE EXCLUSIVE RIGHT TO USE "ACADEMY", APART FROM THE MARK AS SHOWN.

FOR EDUCATION SERVICES, NAMELY, PROVIDING ONLINE AND CORRESPONDENCE EDUCATIONAL COURSES AND DEGREE PROGRAMS IN THE FIELD OF HOLISTIC HEALING AND SPIRITUAL HEALING WITH DIRECT INSTRUCTOR ASSISTANCE (U.S. CLS. 100, 101 AND 107).

FIRST USE 2-1-2010; IN COMMERCE 6-1-2010.
AISHA SALEM, EXAMINING ATTORNEY

SN 85-526,709. TONETTI-SPELLMAN, JENNIFER, VALHALLA, NY. FILED 1-27-2012.

THEN SHE SNAPPED

THE MARK CONSISTS OF STANDARD CHARACTERS WITHOUT CLAIM TO ANY PARTICULAR FONT, STYLE, SIZE, OR COLOR.

FOR PHOTOGRAPHY CONSULTING SERVICES, NAMELY, PROVIDING CLASSES AND INSTRUCTION IN THE FIELD OF PHOTOGRAPHY (U.S. CLS. 100, 101 AND 107).

FIRST USE 9-19-2011; IN COMMERCE 9-19-2011.
STEPHANIE ALI, EXAMINING ATTORNEY

CLASS 41—(Continued).

SN 85-527,073. HHK ENTERTAINMENT LLC, BEVERLY HILLS, CA. FILED 1-27-2012.

H2KZ

THE MARK CONSISTS OF STANDARD CHARACTERS WITHOUT CLAIM TO ANY PARTICULAR FONT, STYLE, SIZE, OR COLOR.

FOR EDUCATION SERVICES, NAMELY, PROVIDING CLASSES AND INSTRUCTION IN THE FIELD OF DANCE (U.S. CLS. 100, 101 AND 107).

FIRST USE 9-1-2005; IN COMMERCE 9-1-2005.
KIM MONINGHOFF, EXAMINING ATTORNEY

CLASS 41—(Continued).

SN 85-528,276. ARNEVET, INC., KENSINGTON, MD. FILED 1-30-2012.



THE MARK CONSISTS OF A STYLIZED LETTER "M" COMPOSED OF TWO LETTER "M'S", ONE OF WHICH IS ORIENTED UPSIDE DOWN AND CROSSING UNDER AND OVER THE OTHER LETTER "M". THE WORD "MUTMONIX" APPEARS BENEATH THE STYLIZED LETTER "M" IN STYLIZED FONT.

FOR ENTERTAINMENT SERVICES, NAMELY, PROVIDING A COMPUTER GAME ONLINE AND IN MOBILE WIRELESS FORM, IN THE NATURE OF AN INTERACTIVE TREASURE HUNT ADVENTURE GAME (U.S. CLS. 100, 101 AND 107).

JOHN GARTNER, EXAMINING ATTORNEY

SN 85-527,102. THE BALLROOM WAY, LOS ANGELES, CA. FILED 1-27-2012.



THE COLOR(S) RED, YELLOW, BLACK IS/ARE CLAIMED AS A FEATURE OF THE MARK.

THE MARK CONSISTS OF THE "ZUMBELI" IN BLACK, A WOMAN BELLY DANCER IN RED AND YELLOW, AND PARTIAL CIRCLE IN YELLOW WITH A RED BORDER.

FOR PERSONAL FITNESS TRAINING SERVICES FEATURING AEROBIC AND ANAEROBIC ACTIVITIES COMBINED WITH RESISTANCE AND FLEXIBILITY TRAINING (U.S. CLS. 100, 101 AND 107).

FIRST USE 1-15-2012; IN COMMERCE 1-15-2012.
DAVID C. REIHNER, EXAMINING ATTORNEY

SN 85-528,343. ADVENTURE GOLF DESIGN AND DEVELOPMENT, TRAVERSE CITY, MI. FILED 1-30-2012.

HOLLYWOOD DRIVE IN GOLF

FINAL DRAFT

THE MARK CONSISTS OF STANDARD CHARACTERS WITHOUT CLAIM TO ANY PARTICULAR FONT, STYLE, SIZE, OR COLOR.

FOR ENTERTAINMENT SERVICES, NAMELY, AN ON-GOING SERIES FEATURING AMATEUR AND PROFESSIONAL ATHLETES PROVIDED THROUGH CABLE TELEVISION AND WEBCASTS (U.S. CLS. 100, 101 AND 107).

APRIL ROACH, EXAMINING ATTORNEY

THE MARK CONSISTS OF STANDARD CHARACTERS WITHOUT CLAIM TO ANY PARTICULAR FONT, STYLE, SIZE, OR COLOR.

NO CLAIM IS MADE TO THE EXCLUSIVE RIGHT TO USE "GOLF", APART FROM THE MARK AS SHOWN.

FOR MINIATURE GOLF COURSE SERVICES (U.S. CLS. 100, 101 AND 107).

ARETHA SOMERVILLE, EXAMINING ATTORNEY

CLASS 41—(Continued).

SN 85-528,402. DEBORAH WILLIAMSON, KOHLER, WI. AND STACY DOCKINS, MIDLOTHIAN, TX. AND PHILIP URSO, NEWPORT, RI. FILED 1-30-2012.

LIVE LOVE TEACH

THE MARK CONSISTS OF STANDARD CHARACTERS WITHOUT CLAIM TO ANY PARTICULAR FONT, STYLE, SIZE, OR COLOR.

NO CLAIM IS MADE TO THE EXCLUSIVE RIGHT TO USE "TEACH", APART FROM THE MARK AS SHOWN.

FOR PROVIDING CLASSES, WORKSHOPS, SEMINARS, CAMPS, AND TRAINING OF YOGA TEACHERS FOR CERTIFICATION, ALL IN THE FIELDS OF FITNESS, EXERCISE AND YOGA (U.S. CLS. 100, 101 AND 107).

FIRST USE 7-1-2010; IN COMMERCE 2-1-2011.
AMY ALFIERI, EXAMINING ATTORNEY

SN 85-528,723. FIRST DESCENTS, DENVER, CO. FILED 1-30-2012.

OUT LIVING IT

THE MARK CONSISTS OF STANDARD CHARACTERS WITHOUT CLAIM TO ANY PARTICULAR FONT, STYLE, SIZE, OR COLOR.

FOR CHARITABLE SERVICES, NAMELY, PROVIDING MOTIVATIONAL EXTREME SPORTS CAMPS FOR YOUNG ADULTS WITH CANCER (U.S. CLS. 100, 101 AND 107).

FIRST USE 3-16-2012; IN COMMERCE 3-16-2012.
FONG HSU, EXAMINING ATTORNEY

SN 85-529,699. INTENDED HEALTH AND FITNESS, AUSTIN, TX. FILED 1-31-2012.

IDEAL METABOLISM - IDEAL WEIGHT

THE MARK CONSISTS OF STANDARD CHARACTERS WITHOUT CLAIM TO ANY PARTICULAR FONT, STYLE, SIZE, OR COLOR.

FOR PHYSICAL FITNESS TRAINING SERVICES (U.S. CLS. 100, 101 AND 107).

FIRST USE 2-23-2011; IN COMMERCE 2-23-2011.
DOMINICK J. SALEMI, EXAMINING ATTORNEY

CLASS 41—(Continued).

SN 85-530,311. DISNEY ENTERPRISES, INC., BURBANK, CA. FILED 1-31-2012.

MYMAGIC+

THE MARK CONSISTS OF STANDARD CHARACTERS WITHOUT CLAIM TO ANY PARTICULAR FONT, STYLE, SIZE, OR COLOR.

FOR PRODUCTION, PRESENTATION, DISTRIBUTION, AND RENTAL OF MOTION PICTURE FILMS; PRODUCTION, PRESENTATION, DISTRIBUTION, AND RENTAL OF TELEVISION AND RADIO PROGRAMS; PRODUCTION, PRESENTATION, AND RENTAL OF SOUND AND VISUAL RECORDINGS; PRODUCTION OF LIVE-ACTION AND ANIMATED ENTERTAINMENT SHOWS AND INTERACTIVE PROGRAMS FOR DISTRIBUTION VIA AUDIO AND VISUAL MEDIA, AND ELECTRONIC MEANS; PRODUCTION AND PROVISION OF ENTERTAINMENT NEWS AND ENTERTAINMENT INFORMATION VIA COMMUNICATION AND COMPUTER NETWORKS; PROVIDING ENTERTAINMENT SERVICES VIA A GLOBAL COMMUNICATION NETWORK IN THE NATURE OF ONLINE GAMES AND WEBSITES FEATURING A WIDE VARIETY OF GENERAL INTEREST ENTERTAINMENT INFORMATION RELATING TO MOTION PICTURE FILMS, TELEVISION SHOW PROGRAMS, MUSICAL VIDEOS, AMUSEMENT PARK AND THEME PARK SERVICES RELATED FILM CLIPS, PHOTOGRAPHS, AND OTHER MULTIMEDIA MATERIALS; AMUSEMENT PARK AND THEME PARK SERVICES; EDUCATIONAL AND ENTERTAINMENT SERVICES RENDERED IN OR RELATING TO THEME PARKS, NAMELY, LIVE STAGE SHOWS, LIVE AMUSEMENT PARK SHOWS, LIVE PERFORMANCES BY COSTUMED CHARACTERS, AND PRESENTATION OF LIVE THEATRICAL PERFORMANCES; PRESENTATION OF LIVE STAGE SHOWS; PRESENTATION OF LIVE SHOW PERFORMANCES; THEATER PRODUCTIONS (U.S. CLS. 100, 101 AND 107).

DORITT L. CARROLL, EXAMINING ATTORNEY

SN 85-530,440. OROPEZA, CHRISTIAN ALEXANDER, WASHINGTON, DC. FILED 1-31-2012.

WHERE THE GIRLS GO

THE MARK CONSISTS OF STANDARD CHARACTERS WITHOUT CLAIM TO ANY PARTICULAR FONT, STYLE, SIZE, OR COLOR.

FOR PROVIDING A WEBSITE FEATURING BLOGS AND NON-DOWNLOADABLE PUBLICATIONS IN THE NATURE OF ARTICLES IN THE FIELD OF LESBIAN EVENTS; SPECIAL EVENT PLANNING FOR SOCIAL ENTERTAINMENT PURPOSES (U.S. CLS. 100, 101 AND 107).

FIRST USE 7-1-2007; IN COMMERCE 7-1-2007.
LAURA KOVALSKY, EXAMINING ATTORNEY

CLASS 41—(Continued).

SN 85-530,553. HOWARD & O'BRIEN ASSOCIATES, INC., CLEVELAND, OH. FILED 2-1-2012.

Conversations with the Board

THE MARK CONSISTS OF STANDARD CHARACTERS WITHOUT CLAIM TO ANY PARTICULAR FONT, STYLE, SIZE, OR COLOR.

FOR CONDUCTING SPEAKING SERIES THAT HELPS PROMOTE FEMALE INCLUSION ON BOARDS OF DIRECTORS AND ADVISORY PANELS FOR PUBLICLY TRADED AND PRIVATE COMPANIES (U.S. CLS. 100, 101 AND 107).

FIRST USE 12-1-2004; IN COMMERCE 12-1-2004.
SHAVELL MCPHERSON, EXAMINING ATTORNEY

SN 85-530,726. NEXT LEVEL FITNESS, INC., EDEN PRAIRIE, MN. FILED 2-1-2012.

FIERCE FORCE

THE MARK CONSISTS OF STANDARD CHARACTERS WITHOUT CLAIM TO ANY PARTICULAR FONT, STYLE, SIZE, OR COLOR.

OWNER OF U.S. REG. NOS. 3,221,909, 3,650,881 AND OTHERS.

FOR PROVIDING PHYSICAL FITNESS CLASSES (U.S. CLS. 100, 101 AND 107).

FIRST USE 12-1-2011; IN COMMERCE 12-1-2011.
AMY ALFIERI, EXAMINING ATTORNEY

SN 85-530,780. LESLI JACOBS, NASHVILLE, TN. FILED 2-1-2012.

MICROEXERCISE

THE MARK CONSISTS OF STANDARD CHARACTERS WITHOUT CLAIM TO ANY PARTICULAR FONT, STYLE, SIZE, OR COLOR.

FOR ADVISORY, CONSULTATION AND COUNSELING SERVICES IN THE FIELD OF PHYSICAL AND MENTAL WELLNESS EDUCATION BY PROVIDING PERSONALIZED WELLNESS PLANS TO DIRECT AND ASSIST CLIENTS REGARDING MEDITATION, BREATHING, MINDFULNESS, VOLUNTEERISM, PHYSICAL EXERCISE, LEISURE AND OUTDOOR ACTIVITIES (U.S. CLS. 100, 101 AND 107).

BRIDGETT SMITH, EXAMINING ATTORNEY

CLASS 41—(Continued).

SN 85-530,788. LESLI JACOBS, NASHVILLE, TN. FILED 2-1-2012.

MICROHEALTH

THE MARK CONSISTS OF STANDARD CHARACTERS WITHOUT CLAIM TO ANY PARTICULAR FONT, STYLE, SIZE, OR COLOR.

FOR ADVISORY, CONSULTATION AND COUNSELING SERVICES IN THE FIELD OF PHYSICAL AND MENTAL WELLNESS EDUCATION BY PROVIDING PERSONALIZED WELLNESS PLANS TO DIRECT AND ASSIST CLIENTS REGARDING MEDITATION, BREATHING, MINDFULNESS, VOLUNTEERISM, PHYSICAL EXERCISE, LEISURE AND OUTDOOR ACTIVITIES (U.S. CLS. 100, 101 AND 107).

BRIDGETT SMITH, EXAMINING ATTORNEY

SN 85-530,835. DANCES FOR A VARIABLE POPULATION, INC., NEW YORK, NY. FILED 2-1-2012.

Variable Pop

THE MARK CONSISTS OF STANDARD CHARACTERS WITHOUT CLAIM TO ANY PARTICULAR FONT, STYLE, SIZE, OR COLOR.

FOR DANCE CLASSES AND WORKSHOPS FOR PERSONS OF ALL AGES AND ABILITIES (U.S. CLS. 100, 101 AND 107).

FIRST USE 9-30-2009; IN COMMERCE 9-30-2009.
FRED CARL, EXAMINING ATTORNEY

SN 85-530,844. IBEC LANGUAGE INSTITUTE, INC., NEW YORK, NY. FILED 2-1-2012.

IBEC

THE MARK CONSISTS OF STANDARD CHARACTERS WITHOUT CLAIM TO ANY PARTICULAR FONT, STYLE, SIZE, OR COLOR.

FOR LANGUAGE INSTRUCTION (U.S. CLS. 100, 101 AND 107).

FIRST USE 5-1-1994; IN COMMERCE 5-1-1994.
MARY CRAWFORD, EXAMINING ATTORNEY

CLASS 41—(Continued).

SN 85-531,001. SPATULA DAD, LLC, AUSTIN, TX. FILED 2-1-2012.

SPATULA MOM

THE MARK CONSISTS OF STANDARD CHARACTERS WITHOUT CLAIM TO ANY PARTICULAR FONT, STYLE, SIZE, OR COLOR.

FOR EDUCATIONAL SERVICES, NAMELY, PROVIDING COURSES OF INSTRUCTION IN THE FIELD OF COOKING (U.S. CLS. 100, 101 AND 107).

LESLIE RICHARDS, EXAMINING ATTORNEY

SN 85-531,089. SCHOOLS FOR CHILDREN, INC., ARLINGTON, MA. FILED 2-1-2012.

NATIONAL INSTITUTE FOR STUDENT CENTERED EDUCATION (NISCE)

THE MARK CONSISTS OF STANDARD CHARACTERS WITHOUT CLAIM TO ANY PARTICULAR FONT, STYLE, SIZE, OR COLOR.

NO CLAIM IS MADE TO THE EXCLUSIVE RIGHT TO USE "NATIONAL INSTITUTE FOR STUDENT CENTERED EDUCATION", APART FROM THE MARK AS SHOWN.

FOR EDUCATION SERVICES, NAMELY, PROVIDING LIVE, ONLINE AND WRITTEN TRAINING, SEMINARS AND DISTRIBUTION OF TRAINING MATERIALS IN CONNECTION THEREWITH, ALL IN THE FIELD OF STUDENT CENTERED EDUCATION (U.S. CLS. 100, 101 AND 107).

FIRST USE 0-0-2012; IN COMMERCE 0-0-2012.
FONG HSU, EXAMINING ATTORNEY

SN 85-531,097. SPATULA DAD, LLC, AUSTIN, TX. FILED 2-1-2012.

SPATULA DAD

THE MARK CONSISTS OF STANDARD CHARACTERS WITHOUT CLAIM TO ANY PARTICULAR FONT, STYLE, SIZE, OR COLOR.

FOR PROVIDING A WEB SITE FEATURING ON-LINE COURSES OF INSTRUCTION IN THE FIELD OF COOKING (U.S. CLS. 100, 101 AND 107).

FIRST USE 6-4-2010; IN COMMERCE 6-4-2010.
LESLIE RICHARDS, EXAMINING ATTORNEY

CLASS 41—(Continued).

SN 85-531,190. NLVBC, INC., MILWAUKEE, WI. FILED 2-1-2012.

NEXT LEVEL VOLLEYBALL CLUB

THE MARK CONSISTS OF STANDARD CHARACTERS WITHOUT CLAIM TO ANY PARTICULAR FONT, STYLE, SIZE, OR COLOR.

NO CLAIM IS MADE TO THE EXCLUSIVE RIGHT TO USE "VOLLEYBALL CLUB", APART FROM THE MARK AS SHOWN.

FOR AMATEUR YOUTH VOLLEYBALL SPORTS SERVICES, NAMELY, ORGANIZING AND PROVIDING YOUTH SPORTS ACTIVITIES; COACHING, INSTRUCTION AND TRAINING IN THE FIELD OF AMATEUR YOUTH VOLLEYBALL (U.S. CLS. 100, 101 AND 107).

FIRST USE 10-31-2003; IN COMMERCE 1-31-2004.
DAVID H. STINE, EXAMINING ATTORNEY

SN 85-531,267. NLVBC, INC., MILWAUKEE, WI. FILED 2-1-2012.



NO CLAIM IS MADE TO THE EXCLUSIVE RIGHT TO USE "VOLLEYBALL CLUB", APART FROM THE MARK AS SHOWN.

THE MARK CONSISTS OF THE WORDS "NEXT LEVEL VOLLEYBALL CLUB" WHERE THE LETTER "L" IN THE WORD "LEVEL" HAS BEEN REPLACED BY THE IMAGE OF VOLLEYBALL PLAYER IN MOTION, JUMPING TO SPIKE A VOLLEYBALL.

FOR AMATEUR YOUTH VOLLEYBALL SPORTS SERVICES, NAMELY, ORGANIZING AND PROVIDING YOUTH SPORTS ACTIVITIES; COACHING, INSTRUCTION AND TRAINING IN THE FIELD OF AMATEUR YOUTH VOLLEYBALL (U.S. CLS. 100, 101 AND 107).

FIRST USE 10-31-2003; IN COMMERCE 1-31-2004.
DAVID H. STINE, EXAMINING ATTORNEY

CLASS 41—(Continued).

SN 85-531,275. HUNTINGTON MARK, LLC, ORADELL, NJ. FILED 2-1-2012.



OWNER OF U.S. REG. NO. 1,425,199.
THE MARK CONSISTS OF THE STYLIZED DESIGN OF THREE TREE LEAVES.
FOR EDUCATIONAL SERVICES, NAMELY, PROVIDING TUTORING IN THE FIELDS OF READING, WRITING, STUDY SKILLS, MATH, PHONICS, SPELLING, VOCABULARY, PRE-ALGEBRA, ALGEBRA, GEOMETRY, TRIGONOMETRY, PRE-CALCULUS, CALCULUS, GENERAL SCIENCE, EARTH SCIENCE, BIOLOGY, CHEMISTRY, AND PHYSICS; CONDUCTING CLASSES, SEMINARS, WORKSHOPS, AND TUTORING IN THE FIELD OF PREPARATION FOR STANDARDIZED EXAMS (U.S. CLS. 100, 101 AND 107).
FIRST USE 4-8-1985; IN COMMERCE 4-8-1985.
SUSAN LESLIE DUBOIS, EXAMINING ATTORNEY

SN 85-531,330. NICOLEE MCMAHON, SAN DIEGO, CA. FILED 2-1-2012.

PRACTICE OF IMMEDIACY IN THE ARTS

THE MARK CONSISTS OF STANDARD CHARACTERS WITHOUT CLAIM TO ANY PARTICULAR FONT, STYLE, SIZE, OR COLOR.
FOR EDUCATIONAL SERVICES, NAMELY, PROVIDING ONLINE INSTRUCTION IN THE FIELD OF THE ARTS; WORKSHOPS AND SEMINARS IN THE FIELD OF THE ARTS (U.S. CLS. 100, 101 AND 107).
FIRST USE 0-0-1997; IN COMMERCE 0-0-1997.
ANGELA DUONG, EXAMINING ATTORNEY

CLASS 41—(Continued).

SN 85-531,651. AISHA FRANCIS, NORTH HOLLYWOOD, CA. FILED 2-1-2012.

Pump Camp

THE MARK CONSISTS OF STANDARD CHARACTERS WITHOUT CLAIM TO ANY PARTICULAR FONT, STYLE, SIZE, OR COLOR.
FOR EDUCATIONAL SERVICES, NAMELY, CONDUCTING CLASSES AND WORKSHOPS IN THE FIELD OF DANCE AND MOVEMENT (U.S. CLS. 100, 101 AND 107).
FIRST USE 1-1-2011; IN COMMERCE 1-1-2011.
CAROLYN CATALDO, EXAMINING ATTORNEY

SN 85-531,672. BEASON, MICHELLE DAWN, WALNUT CREEK, CA. FILED 2-2-2012.

Michelle's Gateways

THE MARK CONSISTS OF STANDARD CHARACTERS WITHOUT CLAIM TO ANY PARTICULAR FONT, STYLE, SIZE, OR COLOR.
FOR ENTERTAINMENT, NAMELY, PRODUCTION OF AN ADVENTURE TRAVEL TELEVISION SHOW; PRODUCTION AND DISTRIBUTION OF TELEVISION SHOWS AND MOVIES (U.S. CLS. 100, 101 AND 107).
FIRST USE 2-1-2012; IN COMMERCE 2-1-2012.
MICHELE SWAIN, EXAMINING ATTORNEY

CLASS 41—(Continued).

SN 85-531,686. NEFF, ANA, ASHLAND, OR. FILED 2-2-2012.

FULL ON

THE MARK CONSISTS OF STANDARD CHARACTERS WITHOUT CLAIM TO ANY PARTICULAR FONT, STYLE, SIZE, OR COLOR.

FOR EDUCATIONAL SERVICES, NAMELY, CONDUCTING WORKSHOPS AND SEMINARS IN THE FIELD OF BUSINESS, MOTIVATION, SELF-HELP AND PERSONAL EMPOWERMENT AND DISTRIBUTION OF COURSE MATERIAL IN CONNECTION THEREWITH; LIFE COACHING SERVICES IN THE FIELD OF MOTIVATION, SELF-HELP AND PERSONAL EMPOWERMENT; ON-LINE JOURNALS, NAMELY, BLOGS FEATURING INFORMATION IN THE FIELD OF BUSINESS, MOTIVATION, SELF-HELP AND PERSONAL EMPOWERMENT; PERSONAL COACHING SERVICES IN THE FIELD OF MOTIVATION, SELF-HELP AND PERSONAL EMPOWERMENT; PERSONAL COACHING SERVICES IN THE FIELD OF MOTIVATION, SELF-HELP AND PERSONAL EMPOWERMENT; PROVIDING ONLINE NEWSLETTERS IN THE FIELD OF BUSINESS, MOTIVATION, SELF-HELP AND PERSONAL EMPOWERMENT VIA E-MAIL (U.S. CLS. 100, 101 AND 107).

FIRST USE 6-1-2008; IN COMMERCE 8-8-2010.
BILL DAWE, EXAMINING ATTORNEY

SN 85-531,795. SCHOLASTIC INC., NEW YORK, NY. FILED 2-2-2012.

INFINITY RING

THE MARK CONSISTS OF STANDARD CHARACTERS WITHOUT CLAIM TO ANY PARTICULAR FONT, STYLE, SIZE, OR COLOR.

FOR ONLINE EDUCATIONAL AND ENTERTAINMENT SERVICES, NAMELY, PROVIDING A WEBSITE FEATURING INFORMATION ABOUT A SERIES OF FICTION BOOKS FOR CHILDREN, INTERACTIVE GAMES, INTERACTIVE BOOKS, INTERACTIVE DIGITAL CARD GAMES AND LEARNING ACTIVITIES, NAMELY, USING CLUES TO SOLVE MYSTERIES (U.S. CLS. 100, 101 AND 107).

NICHOLAS ALTREE, EXAMINING ATTORNEY

CLASS 41—(Continued).

SN 85-531,802. SCHOLASTIC INC., NEW YORK, NY. FILED 2-2-2012.



THE MARK CONSISTS OF THE WORD "INFINITY" IN STYLIZED LETTERING, BELOW WHICH IS THE WORD "RING" IN STYLIZED LETTERING SUPERIMPOSED OVER AN INFINITY SYMBOL.

FOR ONLINE EDUCATIONAL AND ENTERTAINMENT SERVICES, NAMELY, PROVIDING A WEBSITE FEATURING INFORMATION ABOUT A SERIES OF FICTION BOOKS FOR CHILDREN, INTERACTIVE GAMES, INTERACTIVE BOOKS, INTERACTIVE DIGITAL CARD GAMES AND LEARNING ACTIVITIES, NAMELY, USING CLUES TO SOLVE MYSTERIES (U.S. CLS. 100, 101 AND 107).

NICHOLAS ALTREE, EXAMINING ATTORNEY

SN 85-531,857. NEWCO RIDERS, LLC, NIWOT, CO. FILED 2-2-2012.

RoughRiders

THE MARK CONSISTS OF STANDARD CHARACTERS WITHOUT CLAIM TO ANY PARTICULAR FONT, STYLE, SIZE, OR COLOR.

FOR ENTERTAINMENT IN THE NATURE OF HOCKEY GAMES (U.S. CLS. 100, 101 AND 107).

FIRST USE 9-1-1999; IN COMMERCE 9-1-1999.
BERYL GARDNER, EXAMINING ATTORNEY

SN 85-531,879. PFEFFER, PATRICK, PANAMA CITY BEACH, FL. FILED 2-2-2012.

ON THE EDGE

THE MARK CONSISTS OF STANDARD CHARACTERS WITHOUT CLAIM TO ANY PARTICULAR FONT, STYLE, SIZE, OR COLOR.

FOR ENTERTAINMENT, NAMELY, A CONTINUING MUSIC SHOW BROADCAST OVER RADIO, SATELLITE, AND INTERNET (U.S. CLS. 100, 101 AND 107).

FIRST USE 8-1-1995; IN COMMERCE 8-1-1995.
ALEX KEAM, EXAMINING ATTORNEY

CLASS 41—(Continued).

SN 85-531,881. OM PRODUCTIONS LLC, CHICAGO, IL.
FILED 2-2-2012.

GAY FOR A DAY

THE MARK CONSISTS OF STANDARD CHARACTERS WITHOUT CLAIM TO ANY PARTICULAR FONT, STYLE, SIZE, OR COLOR.

FOR ENTERTAINMENT AND EDUCATIONAL SERVICES IN THE NATURE OF ON-GOING SHOWS FEATURING PERSONAL RELATIONSHIPS AND LIFESTYLES BROADCAST OVER TELEVISION, SATELLITE, THE INTERNET, AUDIO MEDIA, AND VIDEO MEDIA (U.S. CLS. 100, 101 AND 107).

AISHA CLARKE, EXAMINING ATTORNEY

SN 85-531,954. SCOTT'S PEEK'N PEAK, LLC, ERIE, PA.
FILED 1-30-2012.

PEEK'N PEAK

THE MARK CONSISTS OF STANDARD CHARACTERS WITHOUT CLAIM TO ANY PARTICULAR FONT, STYLE, SIZE, OR COLOR.

FOR GOLF COURSES; SKI RESORTS (U.S. CLS. 100, 101 AND 107).

FIRST USE 0-0-1964; IN COMMERCE 0-0-1964.

MATTHEW EINSTEIN, EXAMINING ATTORNEY

SN 85-531,965. TULSA ZOO MANAGEMENT, INC., TULSA, OK. FILED 2-2-2012.

WHAT WILL YOU SEA?

THE MARK CONSISTS OF STANDARD CHARACTERS WITHOUT CLAIM TO ANY PARTICULAR FONT, STYLE, SIZE, OR COLOR.

FOR ZOOS; EDUCATIONAL AND ENTERTAINMENT SERVICES, NAMELY, PROVIDING EXHIBITS, LIVE SHOWS, CLASSES, EVENTS, PROGRAMS, AND LECTURES IN THE FIELDS OF WILDLIFE AND WILDLIFE CONSERVATION (U.S. CLS. 100, 101 AND 107).

FIRST USE 2-6-2012; IN COMMERCE 2-6-2012.

JAY FLOWERS, EXAMINING ATTORNEY

CLASS 41—(Continued).

SN 85-532,174. BIDNIS HOLDINGS, INC., MARINA DEL REY, CA. FILED 2-2-2012.

Rob Thomas

THE MARK CONSISTS OF STANDARD CHARACTERS WITHOUT CLAIM TO ANY PARTICULAR FONT, STYLE, SIZE, OR COLOR.

THE NAME(S), PORTRAIT(S), AND/OR SIGNATURE(S) SHOWN IN THE MARK IDENTIFIES ROB THOMAS, WHOSE CONSENT(S) TO REGISTER IS MADE OF RECORD.

FOR ENTERTAINMENT SERVICES IN THE NATURE OF LIVE MUSICAL AND VOCAL PERFORMANCES BY A MUSICAL BAND (U.S. CLS. 100, 101 AND 107).

FIRST USE 2-1-2005; IN COMMERCE 4-1-2005.

HOWARD B. LEVINE, EXAMINING ATTORNEY

SN 85-532,364. EPPERSON, KELLY, LOVES PARK, IL. FILED 2-2-2012.



THE MARK CONSISTS OF THE STYLIZED WORD "JOY" WITH THE LETTER "O" AS A DESIGN OF A COLOR-WHEEL/PINWHEEL. UNDERNEATH IS THE STYLIZED TEXT "BEYOND YOUR DREAMS".

FOR PERSONAL COACHING SERVICES IN THE FIELD OF MIND, BODY, AND SPIRIT WELL-BEING (U.S. CLS. 100, 101 AND 107).

FIRST USE 1-1-2011; IN COMMERCE 1-1-2011.

JOHN DWYER, EXAMINING ATTORNEY

CLASS 41—(Continued).

SN 85-532,456. CEDEL ENTERTAINMENT PRODUCTION LLC, MIAMI, FL. FILED 2-2-2012.

Ruta 99

THE MARK CONSISTS OF STANDARD CHARACTERS WITHOUT CLAIM TO ANY PARTICULAR FONT, STYLE, SIZE, OR COLOR.

THE ENGLISH TRANSLATION OF RUTA IN THE MARK IS ROUTE.

FOR ENTERTAINMENT SERVICES, NAMELY, AN ON-GOING SERIES FEATURING SPANISH LANGUAGE NEWS AND PUBLIC AFFAIRS PROGRAMMING PROVIDED THROUGH BROADCAST TELEVISION, CABLE TELEVISION, SATELLITE TELEVISION AND THE INTERNET; ENTERTAINMENT SERVICES, NAMELY, PRODUCTION AND DISTRIBUTION OF ONGOING TELEVISION PROGRAMS IN THE FIELD OF SPANISH LANGUAGE NEWS AND PUBLIC AFFAIRS; ENTERTAINMENT, NAMELY, PRODUCTION OF SPANISH LANGUAGE NEWS AND PUBLIC AFFAIRS PROGRAMMING; PRODUCTION OF CABLE TELEVISION PROGRAMS; PRODUCTION OF TELEVISION PROGRAMS (U.S. CLS. 100, 101 AND 107).

SUSAN STIGLITZ, EXAMINING ATTORNEY

SN 85-532,473. CEDEL ENTERTAINMENT PRODUCTION LLC, MIAMI, FL. FILED 2-2-2012.

Lo Peor de Lo Peor

THE MARK CONSISTS OF STANDARD CHARACTERS WITHOUT CLAIM TO ANY PARTICULAR FONT, STYLE, SIZE, OR COLOR.

THE ENGLISH TRANSLATION OF "LO PEOR DE LO PEOR" IN THE MARK IS "THE WORST OF THE WORST".

FOR ENTERTAINMENT SERVICES, NAMELY, AN ON-GOING SERIES FEATURING SPANISH LANGUAGE INVESTIGATIVE NEWS AND PUBLIC AFFAIRS PROGRAMMING PROVIDED THROUGH BROADCAST TELEVISION, CABLE TELEVISION, SATELLITE TELEVISION AND THE INTERNET; ENTERTAINMENT SERVICES, NAMELY, PRODUCTION AND DISTRIBUTION OF ONGOING TELEVISION PROGRAMS IN THE FIELD OF SPANISH LANGUAGE INVESTIGATIVE NEWS AND PUBLIC AFFAIRS; ENTERTAINMENT, NAMELY, PRODUCTION OF SPANISH LANGUAGE INVESTIGATIVE NEWS AND PUBLIC AFFAIRS PROGRAMMING; PRODUCTION OF CABLE TELEVISION PROGRAMS; PRODUCTION OF TELEVISION PROGRAMS (U.S. CLS. 100, 101 AND 107).

SUSAN STIGLITZ, EXAMINING ATTORNEY

CLASS 41—(Continued).

SN 85-532,520. CEDEL ENTERTAINMENT PRODUCTION LLC, MIAMI, FL. FILED 2-2-2012.

99, Con Joe Ferrero

THE MARK CONSISTS OF STANDARD CHARACTERS WITHOUT CLAIM TO ANY PARTICULAR FONT, STYLE, SIZE, OR COLOR.

THE NAME(S), PORTRAIT(S), AND/OR SIGNATURE(S) SHOWN IN THE MARK IDENTIFIES "JOE FERRERO", WHOSE CONSENT(S) TO REGISTER IS MADE OF RECORD.

THE ENGLISH TRANSLATION OF "CON" IN THE MARK IS "WITH".

FOR ENTERTAINMENT SERVICES, NAMELY, AN ON-GOING SERIES FEATURING SPANISH LANGUAGE NEWS AND PUBLIC AFFAIRS PROGRAMMING PROVIDED THROUGH BROADCAST TELEVISION, CABLE TELEVISION, SATELLITE TELEVISION AND THE INTERNET; ENTERTAINMENT SERVICES, NAMELY, PRODUCTION AND DISTRIBUTION OF ONGOING TELEVISION PROGRAMS IN THE FIELD OF SPANISH LANGUAGE NEWS AND PUBLIC AFFAIRS; ENTERTAINMENT, NAMELY, PRODUCTION OF SPANISH LANGUAGE NEWS AND PUBLIC AFFAIRS TELEVISION PROGRAMS; PRODUCTION OF CABLE TELEVISION PROGRAMS; PRODUCTION OF TELEVISION PROGRAMS (U.S. CLS. 100, 101 AND 107).

SUSAN STIGLITZ, EXAMINING ATTORNEY

SN 85-532,567. CURA HOME CARE SERVICES, LLC, DBA NORTH VALLEY HOMEWATCH CAREGIVERS, PHOENIX, AZ. FILED 2-2-2012.

HEROES IN THE HOME

THE MARK CONSISTS OF STANDARD CHARACTERS WITHOUT CLAIM TO ANY PARTICULAR FONT, STYLE, SIZE, OR COLOR.

FOR AWARDS PROGRAM FOR INDIVIDUALS WHO HAVE MADE SIGNIFICANT CONTRIBUTIONS AS FAMILY CAREGIVERS (U.S. CLS. 100, 101 AND 107).

FIRST USE 6-6-2011; IN COMMERCE 6-6-2011.

ELISSA GARBER KON, EXAMINING ATTORNEY

CLASS 41—(Continued).

SN 85-532,577. CURA HOME CARE SERVICES, LLC, DBA NORTH VALLEY HOMEWATCH CAREGIVERS, PHOENIX, AZ. FILED 2-2-2012.

A COMMUNITY CELEBRATION OF CAREGIVING

THE MARK CONSISTS OF STANDARD CHARACTERS WITHOUT CLAIM TO ANY PARTICULAR FONT, STYLE, SIZE, OR COLOR.

FOR AWARDS PROGRAM FOR INDIVIDUALS WHO HAVE MADE SIGNIFICANT CONTRIBUTIONS AS FAMILY CAREGIVERS (U.S. CLS. 100, 101 AND 107).

FIRST USE 6-6-2011; IN COMMERCE 6-6-2011.
ELISSA GARBER KON, EXAMINING ATTORNEY

SN 85-532,595. WENRICH, GRAYDON VOIGT, POINT PLEASANT, NJ. AND PATERINI, JOHN ANTHONY, GLADSTONE, MO. AND GIDLEY, SAMUEL WAYNE, OMAHA, NE. AND BYRD, NICHOLAS ALEXANDER, CHARLOTTE, NC. FILED 2-2-2012.

THE LONELY BISCUITS

THE MARK CONSISTS OF STANDARD CHARACTERS WITHOUT CLAIM TO ANY PARTICULAR FONT, STYLE, SIZE, OR COLOR.

FOR ENTERTAINMENT, NAMELY, LIVE PERFORMANCES BY A MUSICAL BAND (U.S. CLS. 100, 101 AND 107).

RONALD MCMORROW, EXAMINING ATTORNEY

SN 85-532,859. KOURI, CARRIE ANN, ST. LOUIS, MO. FILED 2-3-2012.

CARRIE ANN

THE MARK CONSISTS OF STANDARD CHARACTERS WITHOUT CLAIM TO ANY PARTICULAR FONT, STYLE, SIZE, OR COLOR.

FOR PHOTOGRAPHY SERVICES (U.S. CLS. 100, 101 AND 107).

GENE MACIOL, EXAMINING ATTORNEY

CLASS 41—(Continued).

SN 85-532,901. PINK UP THE PACE, LLC, ST. AUGUSTINE, FL. FILED 2-3-2012.



THE MARK CONSISTS OF THE PHRASE "PINK UP THE PACE" WITH THE I IN PINK BEING A RIBBON.

FOR ATHLETIC AND SPORTS EVENT SERVICES, NAMELY, ARRANGING, ORGANIZING, OPERATING AND CONDUCTING MARATHON RACES (U.S. CLS. 100, 101 AND 107).

FIRST USE 8-26-2009; IN COMMERCE 8-26-2009.
MATTHEW KLINE, EXAMINING ATTORNEY

SN 85-532,994. WISH I MAY, SPRINGFIELD, MO. FILED 2-3-2012.

WISH I MAY

THE MARK CONSISTS OF STANDARD CHARACTERS WITHOUT CLAIM TO ANY PARTICULAR FONT, STYLE, SIZE, OR COLOR.

FOR CHARITABLE SERVICES, NAMELY, COLLABORATING WITH OTHER NOT FOR PROFIT ORGANIZATIONS TO PROVIDE PARENTS AND GUARDIANS OF UNDERPRIVILEGED CHILDREN WITH THE SUPPLIES THEY NEED TO GIVE THEIR CHILDREN BIRTHDAY CELEBRATIONS (U.S. CLS. 100, 101 AND 107).

FIRST USE 6-15-2011; IN COMMERCE 9-6-2011.
SALLY SHIH, EXAMINING ATTORNEY

SN 85-533,032. WISH I MAY, SPRINGFIELD, MO. FILED 2-3-2012.



THE MARK CONSISTS OF A CUPCAKE WITH ONE CANDLE ON TOP THAT HAS A STAR IN PLACE OF THE FLAME, AND THE WORD "WISH" TO THE LEFT OF THE CUPCAKE AND THE WORDS "I MAY" TO THE RIGHT OF THE CUPCAKE, WITH LINES ABOVE AND BELOW THE WORDS.

FOR CHARITABLE SERVICES, NAMELY, COLLABORATING WITH OTHER NOT FOR PROFIT ORGANIZATIONS TO PROVIDE PARENTS AND GUARDIANS OF UNDERPRIVILEGED CHILDREN WITH THE SUPPLIES THEY NEED TO GIVE THEIR CHILDREN BIRTHDAY CELEBRATIONS (U.S. CLS. 100, 101 AND 107).

FIRST USE 10-14-2011; IN COMMERCE 12-5-2011.
SALLY SHIH, EXAMINING ATTORNEY

CLASS 41—(Continued).

SN 85-533,068. KENNETH J MCCANTS, LINCOLN, NE. FILED 2-3-2012.

Twits and Giggles

THE MARK CONSISTS OF STANDARD CHARACTERS WITHOUT CLAIM TO ANY PARTICULAR FONT, STYLE, SIZE, OR COLOR.

FOR ENTERTAINMENT, NAMELY, A CONTINUING COMEDY SHOW BROADCAST OVER INTERNET (U.S. CLS. 100, 101 AND 107).

JUDITH HELFMAN, EXAMINING ATTORNEY

SN 85-533,279. CARNEY, DANA MARIE, DOWNERS GROVE, IL. FILED 2-3-2012.

METAYOGICS

THE MARK CONSISTS OF STANDARD CHARACTERS WITHOUT CLAIM TO ANY PARTICULAR FONT, STYLE, SIZE, OR COLOR.

FOR PROVIDING PHYSICAL FITNESS AND EXERCISE SERVICE, NAMELY, INDOOR CYCLING AND YOGA INSTRUCTION (U.S. CLS. 100, 101 AND 107).

FIRST USE 1-9-2012; IN COMMERCE 1-9-2012.

ANDREW LAWRENCE, EXAMINING ATTORNEY

SN 85-533,389. AMY CADY, LAGUNA NIGUEL, CA. FILED 2-3-2012.



THE COLOR(S) GREEN AND WHITE IS/ARE CLAIMED AS A FEATURE OF THE MARK.

THE MARK CONSISTS OF PERSON IN THE PILATES HUNDREDS POSITION WITH FOUR ITERATIONS OF LEG POSITIONS IN GREEN AND WHITE.

FOR PHYSICAL FITNESS STUDIO SERVICES, NAMELY, PROVIDING EXERCISE CLASSES, BODY SCULPTING CLASSES, AND GROUP FITNESS CLASSES; PRODUCTION OF DVDS, VIDEOTAPES AND TELEVISION PROGRAMS FEATURING FITNESS EXERCISES AND PILATES TECHNIQUES (U.S. CLS. 100, 101 AND 107).

FIRST USE 5-1-2009; IN COMMERCE 5-1-2009.

KEVON CHISOLM, EXAMINING ATTORNEY

CLASS 41—(Continued).

SN 85-533,449. THE CHALKBOARD PROJECT, LLC, LOS ANGELES, CA. FILED 2-3-2012.

THE CHALKBOARD

THE MARK CONSISTS OF STANDARD CHARACTERS WITHOUT CLAIM TO ANY PARTICULAR FONT, STYLE, SIZE, OR COLOR.

FOR PROVIDING A WEBSITE FEATURING BLOGS AND NON-DOWNLOADABLE PUBLICATIONS AND MEDIA IN THE NATURE OF ARTICLES, VIDEO, AND NEWSLETTERS IN THE FIELDS OF HEALTH, WELLNESS, FITNESS, LIFESTYLE, BEAUTY, NUTRITION, AND PHILANTHROPY (U.S. CLS. 100, 101 AND 107).

FIRST USE 1-16-2012; IN COMMERCE 1-16-2012.

MIDGE BUTLER, EXAMINING ATTORNEY

SN 85-533,504. DELTA SOCIETY, BELLEVUE, WA. FILED 2-3-2012.

PET PARTNERS

THE MARK CONSISTS OF STANDARD CHARACTERS WITHOUT CLAIM TO ANY PARTICULAR FONT, STYLE, SIZE, OR COLOR.

OWNER OF U.S. REG. NO. 1,710,593.

FOR EDUCATIONAL SERVICES, NAMELY CONDUCTING WORKSHOPS AND ONLINE TRAINING COURSES IN THE FIELD OF SERVICE DOGS AND THERAPY ANIMALS; EDUCATIONAL SERVICES RENDERED THROUGH THE MEDIUM OF AN ANNUAL LIVE AWARDS PROGRAM REGARDING THE USE AND ACCOMMODATION OF SERVICE DOGS AND THERAPY ANIMALS; PROVIDING ONLINE MAGAZINES IN THE FIELD OF SERVICE DOGS, THERAPY ANIMALS AND HUMAN HEALTH BENEFITS OF PETS; PROVIDING A WEBSITE FEATURING RESOURCES, NAMELY, A WEBSITE FEATURING PRIMARILY NON-DOWNLOADABLE PUBLICATIONS IN THE NATURE OF ARTICLES, STUDIES, RESEARCH REPORTS, DIRECTORIES, AND BIBLIOGRAPHIES IN THE FIELD OF SERVICE DOGS, THERAPY ANIMALS AND THE HUMAN HEALTH BENEFITS OF PETS (U.S. CLS. 100, 101 AND 107).

MICHAEL WIENER, EXAMINING ATTORNEY

CLASS 41—(Continued).

SN 85-533,509. DELTA SOCIETY, BELLEVUE, WA. FILED 2-3-2012.

TOUCHING LIVES, IMPROVING
HEALTH

THE MARK CONSISTS OF STANDARD CHARACTERS WITHOUT CLAIM TO ANY PARTICULAR FONT, STYLE, SIZE, OR COLOR.

FOR EDUCATIONAL SERVICES, NAMELY CONDUCTING WORKSHOPS AND ONLINE TRAINING COURSES IN THE FIELD OF SERVICE DOGS AND THERAPY ANIMALS; EDUCATIONAL SERVICES RENDERED THROUGH THE MEDIUM OF AN ANNUAL LIVE AWARDS PROGRAM REGARDING THE USE AND ACCOMMODATION OF SERVICE DOGS AND THERAPY ANIMALS; PROVIDING ONLINE MAGAZINES IN THE FIELD OF SERVICE DOGS, THERAPY ANIMALS AND HUMAN HEALTH BENEFITS OF PETS; PROVIDING A WEBSITE FEATURING RESOURCES, NAMELY, A WEBSITE FEATURING PRIMARILY NON-DOWNLOADABLE PUBLICATIONS IN THE NATURE OF ARTICLES, STUDIES, RESEARCH REPORTS, DIRECTORIES, AND BIBLIOGRAPHIES IN THE FIELD OF SERVICE DOGS, THERAPY ANIMALS AND THE HUMAN HEALTH BENEFITS OF PETS (U.S. CLS. 100, 101 AND 107).

MICHAEL WIENER, EXAMINING ATTORNEY

CLASS 41—(Continued).

SN 85-533,626. SCOREBROKER, LLC, IRVING, TX. FILED 2-3-2012.

ScoreBroker

THE MARK CONSISTS OF STANDARD CHARACTERS WITHOUT CLAIM TO ANY PARTICULAR FONT, STYLE, SIZE, OR COLOR.

FOR ENTERTAINMENT SERVICES IN THE NATURE OF FANTASY SPORTS LEAGUES (U.S. CLS. 100, 101 AND 107).

FIRST USE 1-1-2012; IN COMMERCE 1-1-2012.

TEJBIR SINGH, EXAMINING ATTORNEY

SN 85-533,641. PSC INCORPORATED, CASTLE ROCK, CO. FILED 2-3-2012.

ROCK AND STROLL

THE MARK CONSISTS OF STANDARD CHARACTERS WITHOUT CLAIM TO ANY PARTICULAR FONT, STYLE, SIZE, OR COLOR.

FOR ORGANIZING, ARRANGING, AND CONDUCTING RUNNING EVENTS (U.S. CLS. 100, 101 AND 107).

SANJEEV VOHRA, EXAMINING ATTORNEY

SN 85-533,614. SUSTAINING SPACES, LLC, EUREKA, MO. FILED 2-3-2012.

GREENTAIN

SN 85-533,710. EXPOZI, SANTA CLARA, CA. FILED 2-3-2012.

THE MARK CONSISTS OF STANDARD CHARACTERS WITHOUT CLAIM TO ANY PARTICULAR FONT, STYLE, SIZE, OR COLOR.

FOR EDUCATIONAL SERVICES, NAMELY, PROVIDING ONLINE INSTRUCTION IN THE FIELD OF REAL ESTATE, NAMELY, TEACHING CUSTOMERS TO MAKE HOMES MORE LIVABLE, MORE SUSTAINABLE AND MORE SELLABLE AND TEACHING CUSTOMERS TO EVALUATE HOME MAINTENANCE, HOME INSURANCE, HOME REMODELING AND HOME IMPROVEMENT (U.S. CLS. 100, 101 AND 107).

FIRST USE 10-21-2011; IN COMMERCE 11-16-2011.

MIDGE BUTLER, EXAMINING ATTORNEY

JUMP START YOUR FUTURE

THE MARK CONSISTS OF STANDARD CHARACTERS WITHOUT CLAIM TO ANY PARTICULAR FONT, STYLE, SIZE, OR COLOR.

FOR VOCATIONAL GUIDANCE (U.S. CLS. 100, 101 AND 107).

APRIL HESIK, EXAMINING ATTORNEY

CLASS 41—(Continued).

SN 85-533,845. WILSON, JASON, SAN FRANCISCO, CA. FILED 2-3-2012.

The Institution

THE MARK CONSISTS OF STANDARD CHARACTERS WITHOUT CLAIM TO ANY PARTICULAR FONT, STYLE, SIZE, OR COLOR.

FOR ENTERTAINMENT, NAMELY, LIVE PERFORMANCES BY A MUSICAL BAND (U.S. CLS. 100, 101 AND 107).

FIRST USE 1-1-2003; IN COMMERCE 1-1-2005.
BRIAN CALLAGHAN, EXAMINING ATTORNEY

SN 85-533,950. JOY2DANCE, SOMERSET, NJ. FILED 2-3-2012.



NO CLAIM IS MADE TO THE EXCLUSIVE RIGHT TO USE "DANCE", APART FROM THE MARK AS SHOWN.

THE MARK CONSISTS OF AN ABSTRACT BACKGROUND WITH THE SILHOUETTE OF A MAN DANCING WITH A WOMAN, AND WITH THE STYLIZED TEXT "JOY2DANCE".

FOR DANCE STUDIOS (U.S. CLS. 100, 101 AND 107).
FIRST USE 4-15-2011; IN COMMERCE 4-15-2011.
TEJBIR SINGH, EXAMINING ATTORNEY

SN 85-533,963. AMUSEMENT MANAGEMENT PARTNERS, LLC, JACKSONVILLE, FL. FILED 2-3-2012.

CELEBRATE THE WORD

THE MARK CONSISTS OF STANDARD CHARACTERS WITHOUT CLAIM TO ANY PARTICULAR FONT, STYLE, SIZE, OR COLOR.

FOR ARRANGING AND CONDUCTING FESTIVALS FEATURING CHRISTIAN MUSIC GROUPS (U.S. CLS. 100, 101 AND 107).

MICHELE SWAIN, EXAMINING ATTORNEY

CLASS 41—(Continued).

SN 85-534,006. GRACE, AMRITA, KULA, HI. FILED 2-4-2012.

RECLAIMING APHRODITE

THE MARK CONSISTS OF STANDARD CHARACTERS WITHOUT CLAIM TO ANY PARTICULAR FONT, STYLE, SIZE, OR COLOR.

FOR CONDUCTING WORKSHOPS AND SEMINARS THAT ASSIST WOMEN IN RECOVERING FROM SEXUAL ABUSE (U.S. CLS. 100, 101 AND 107).

FIRST USE 9-9-2009; IN COMMERCE 9-9-2009.
LUCY ARANT, EXAMINING ATTORNEY

SN 85-534,009. CYBERTEX, INC., AUSTIN, TX. FILED 2-4-2012.



THE MARK CONSISTS OF AN IMAGE OF A SOLID CIRCLE WITH THREE CURVED LINES COMING OUT FROM BEHIND ON THE LEFT SIDE PARTIALLY SURROUNDING IT, ENDING IN THE MIDDLE PART OF THE CIRCLE WITH TIPS LIKE FISH HOOKS AND THE UPPER RIGHT PORTION OF THE CIRCLE IS HIGHLIGHTED AS SHOWN IN THE MARK.

FOR VOCATIONAL EDUCATION IN THE FIELD OF HEALTHCARE, MEDICINE, INFORMATION TECHNOLOGY AND IT CONSULTING; COMPUTER EDUCATION TRAINING SERVICES; EDUCATION SERVICES IN THE NATURE OF COURSES AT THE UNIVERSITY LEVEL (U.S. CLS. 100, 101 AND 107).

FIRST USE 6-14-1999; IN COMMERCE 6-14-1999.
STEVEN PEREZ, EXAMINING ATTORNEY

CLASS 41—(Continued).

SN 85-534,149. GATHONI, CATHERINE, TORONTO, ONTARIO, CANADA, FILED 2-4-2012.

The Last Minute Student

THE MARK CONSISTS OF STANDARD CHARACTERS WITHOUT CLAIM TO ANY PARTICULAR FONT, STYLE, SIZE, OR COLOR.

NO CLAIM IS MADE TO THE EXCLUSIVE RIGHT TO USE "STUDENT", APART FROM THE MARK AS SHOWN, FOR EDUCATION SERVICES IN THE NATURE OF COURSES AT THE UNIVERSITY LEVEL (U.S. CLS. 100, 101 AND 107).

JACQUELINE A. LAVINE, EXAMINING ATTORNEY

CLASS 41—(Continued).

SN 85-534,324. VAN HORN, EARL P., SAFETY HARBOR, FL. FILED 2-5-2012.

MAKE A BOW BEFORE TYING THE KNOT

THE MARK CONSISTS OF STANDARD CHARACTERS WITHOUT CLAIM TO ANY PARTICULAR FONT, STYLE, SIZE, OR COLOR.

FOR PARTY AND WEDDING PLANNING, COORDINATION AND CONSULTATION SERVICES (U.S. CLS. 100, 101 AND 107).

FIRST USE 1-5-2012; IN COMMERCE 1-5-2012. LAKEISHA LEWIS, EXAMINING ATTORNEY

SN 85-534,207. MICHAEL R DELEON, DBA STEERED STRAIGHT, INC., MILLVILLE, NJ. FILED 2-5-2012.

Steered Straight, Inc.

THE MARK CONSISTS OF STANDARD CHARACTERS WITHOUT CLAIM TO ANY PARTICULAR FONT, STYLE, SIZE, OR COLOR.

NO CLAIM IS MADE TO THE EXCLUSIVE RIGHT TO USE "INC.", APART FROM THE MARK AS SHOWN.

FOR EDUCATIONAL SERVICES, NAMELY, CONDUCTING SEMINARS AND PRESENTATIONS IN THE FIELD OF GANGS, ALCOHOL, DRUGS AND BULLYING (U.S. CLS. 100, 101 AND 107).

FIRST USE 1-1-2000; IN COMMERCE 1-1-2000. LYNDSEY KUYKENDALL, EXAMINING ATTORNEY

SN 85-534,342. MARIA KERMATH, SANTA MONICA, CA. FILED 2-6-2012.

KOR180

THE MARK CONSISTS OF STANDARD CHARACTERS WITHOUT CLAIM TO ANY PARTICULAR FONT, STYLE, SIZE, OR COLOR.

FOR PHYSICAL FITNESS CONSULTATION; PROVIDING A WEB SITE FEATURING INFORMATION ON EXERCISE AND FITNESS; PROVIDING FITNESS AND EXERCISE FACILITIES (U.S. CLS. 100, 101 AND 107).

ANDREW LEASER, EXAMINING ATTORNEY

SN 85-534,285. MACMILLAN, JOSEPHINE BENNETT, BERKELEY, CA. FILED 2-5-2012.

FairyCamp

THE MARK CONSISTS OF STANDARD CHARACTERS WITHOUT CLAIM TO ANY PARTICULAR FONT, STYLE, SIZE, OR COLOR.

FOR PROVIDING EDUCATIONAL INFORMATION IN THE ACADEMIC FIELD OF ECOLOGICAL SUSTAINABILITY FOR THE PURPOSE OF ACADEMIC STUDY (U.S. CLS. 100, 101 AND 107).

FIRST USE 3-21-2004; IN COMMERCE 3-21-2004. DAWN FELDMAN, EXAMINING ATTORNEY

SN 85-534,401. SPR THERAPEUTICS, LLC, CLEVELAND, OH. FILED 2-6-2012.

NERVESPACE

THE MARK CONSISTS OF STANDARD CHARACTERS WITHOUT CLAIM TO ANY PARTICULAR FONT, STYLE, SIZE, OR COLOR.

FOR EDUCATIONAL SERVICES, NAMELY, CONDUCTING SEMINARS AND WORKSHOPS IN THE FIELD OF NEURAL STIMULATION AND DISTRIBUTION OF EDUCATIONAL MATERIALS IN CONNECTION THEREWITH (U.S. CLS. 100, 101 AND 107).

ALYSSA STEEL, EXAMINING ATTORNEY

CLASS 41—(Continued).

SN 85-534,422. ADVANCE MAGAZINE PUBLISHERS INC., NEW YORK, NY. FILED 2-6-2012.

CLASS 41—(Continued).

SN 85-534,643. SEVEN PEAKS PLACE, LC, PROVO, UT. FILED 2-6-2012.

LIVING BY NUMBERS

THE MARK CONSISTS OF STANDARD CHARACTERS WITHOUT CLAIM TO ANY PARTICULAR FONT, STYLE, SIZE, OR COLOR.

FOR EDUCATIONAL SERVICES, NAMELY, CONDUCTING CLASSES, SEMINARS, CONFERENCES AND WORKSHOPS IN THE FIELD OF HEALTH, SCIENCE, MEDICINE AND TECHNOLOGY (U.S. CLS. 100, 101 AND 107).

KRISTIN DAHLING, EXAMINING ATTORNEY

Seven Peaks

THE MARK CONSISTS OF STANDARD CHARACTERS WITHOUT CLAIM TO ANY PARTICULAR FONT, STYLE, SIZE, OR COLOR.

FOR ENTERTAINMENT IN THE NATURE OF A WATER PARK AND AMUSEMENT CENTER (U.S. CLS. 100, 101 AND 107).

FIRST USE 9-1-1999; IN COMMERCE 9-1-1999.

JESSICA FATHY, EXAMINING ATTORNEY

SN 85-534,444. SEREN MOTUS LLC, DBA BARREAMPED, FRANKLIN, TN. FILED 2-6-2012.

Shake To Change

THE MARK CONSISTS OF STANDARD CHARACTERS WITHOUT CLAIM TO ANY PARTICULAR FONT, STYLE, SIZE, OR COLOR.

FOR PHYSICAL FITNESS STUDIO SERVICES, NAMELY, PROVIDING EXERCISE CLASSES, BODY SCULPTING CLASSES, AND GROUP FITNESS CLASSES (U.S. CLS. 100, 101 AND 107).

FIRST USE 12-3-2011; IN COMMERCE 1-15-2012.

ANNE E. GUSTASON, EXAMINING ATTORNEY

SN 85-534,795. BIGSTUB, INC., THOUSAND OAKS, CA. FILED 2-6-2012.

SN 85-534,546. SOUTHEAST LINEMAN TRAINING CENTER, LLC, TRENTON, GA. FILED 2-6-2012.

**AT THE END OF THE DAY IT
COMES DOWN TO K-D-A
Knowledge.Discipline.Ability**

THE MARK CONSISTS OF STANDARD CHARACTERS WITHOUT CLAIM TO ANY PARTICULAR FONT, STYLE, SIZE, OR COLOR.

FOR VOCATIONAL EDUCATION IN THE FIELD OF LINEMAN APPRENTICE TRAINING (U.S. CLS. 100, 101 AND 107).

FIRST USE 4-18-2011; IN COMMERCE 4-18-2011.

BRIAN NEVILLE, EXAMINING ATTORNEY

THE COLOR(S) RED AND BLACK IS/ARE CLAIMED AS A FEATURE OF THE MARK.

THE MARK CONSISTS OF THE STYLIZED WORD "BIG" IN BLACK WITH THE DOT IN THE "I" BEING THE ARTISTIC RENDERING OF A STAR IN RED. THE WORD "BIG" IS FOLLOWED BY THE WORD "STUB" IN RED. THE "B" IN THE WORD "STUB" APPEARS INSIDE THE ARTISTIC RENDERING OF A TICKET IN BLACK.

FOR TICKET AGENCY SERVICES FOR ENTERTAINMENT EVENTS (U.S. CLS. 100, 101 AND 107).

FIRST USE 0-0-2006; IN COMMERCE 0-0-2006.

JAY FLOWERS, EXAMINING ATTORNEY

CLASS 41—(Continued).

SN 85-534,796. PROJECT BABY ENTERPRISES, FORMERLY MEDIA SPEEDWAY, LA JOLLA, CA. FILED 2-6-2012.



The logo for "ProjectBaby" features the word "Project" in a blue, sans-serif font and "Baby" in an orange, cursive font.

OWNER OF U.S. REG. NO. 3,456,365.
THE COLOR(S) BLUE AND ORANGE IS/ARE CLAIMED AS A FEATURE OF THE MARK.

THE MARK CONSISTS OF THE WORDS "PROJECT BABY" WITH THE FIRST WORD "PROJECT" IN THE COLOR BLUE AND THE SECOND WORD "BABY" IN THE COLOR ORANGE AND THE SECOND LETTER "A" FOR THE WORD "BABY" IS TILED TO THE RIGHT.

FOR ENTERTAINMENT IN THE NATURE OF AN ONGOING TELEVISION PROGRAM WHERE EACH EPISODE FOLLOWS REAL LIFE COUPLES AND COVERS ALL ASPECTS OF STARTING A FAMILY, NAMELY, NATURAL REPRODUCTION AND ALL FORMS OF ASSISTED REPRODUCTION; PROVIDING AN INTERNET WEB SITE THAT FEATURES AN ONGOING TELEVISION PROGRAM WHERE EACH EPISODE FOLLOWS REAL LIFE COUPLES AND COVERS ALL ASPECTS OF STARTING A FAMILY, NAMELY, NATURAL REPRODUCTION AND ALL FORMS OF ASSISTED REPRODUCTION, PODCASTS AND ONLINE JOURNALS, NAMELY, BLOGS ABOUT TRYING TO START A FAMILY (U.S. CLS. 100, 101 AND 107).

FIRST USE 12-4-2004; IN COMMERCE 6-14-2005.
JAY FLOWERS, EXAMINING ATTORNEY

SN 85-534,852. AYOUB, MICHELE, NEW CANAAN, CT. FILED 2-6-2012.

FITNESS FOR YOUR CAUSE

THE MARK CONSISTS OF STANDARD CHARACTERS WITHOUT CLAIM TO ANY PARTICULAR FONT, STYLE, SIZE, OR COLOR.

FOR HEALTH CLUB SERVICES, NAMELY, PROVIDING INSTRUCTION AND EQUIPMENT IN THE FIELD OF PHYSICAL EXERCISE; PERSONAL TRAINING PROVIDED IN CONNECTION WITH WEIGHT LOSS AND EXERCISE PROGRAMS; PHYSICAL FITNESS STUDIO SERVICES, NAMELY, PROVIDING EXERCISE CLASSES, BODY SCULPTING CLASSES, AND GROUP FITNESS CLASSES; PROVIDING A WEB SITE FEATURING INFORMATION ON EXERCISE AND FITNESS (U.S. CLS. 100, 101 AND 107).

KEVIN DINALLO, EXAMINING ATTORNEY

CLASS 41—(Continued).

SN 85-534,877. QUALITY OF LIFE, LLC, NEWARK, NJ. FILED 2-6-2012.

FINAL GENERATION

THE MARK CONSISTS OF STANDARD CHARACTERS WITHOUT CLAIM TO ANY PARTICULAR FONT, STYLE, SIZE, OR COLOR.

FOR ENTERTAINMENT IN THE NATURE OF VISUAL AND AUDIO PERFORMANCES BY A MUSICAL GROUP (U.S. CLS. 100, 101 AND 107).

THOMAS MANOR, EXAMINING ATTORNEY

SN 85-534,886. SEVEN PEAKS PLACE LC, PROVO, UT. FILED 2-6-2012.

Pass Of All Passes

THE MARK CONSISTS OF STANDARD CHARACTERS WITHOUT CLAIM TO ANY PARTICULAR FONT, STYLE, SIZE, OR COLOR.

FOR ENTERTAINMENT SERVICES, NAMELY, ARRANGING FOR TICKET RESERVATIONS FOR WATER PARKS AND AMUSEMENT CENTERS (U.S. CLS. 100, 101 AND 107).

FIRST USE 8-1-2010; IN COMMERCE 8-1-2010.
CHERYL CLAYTON, EXAMINING ATTORNEY

SN 85-534,914. SEVEN PEAKS PLACE LC, PROVO, UT. FILED 2-6-2012.

Trafalga

THE MARK CONSISTS OF STANDARD CHARACTERS WITHOUT CLAIM TO ANY PARTICULAR FONT, STYLE, SIZE, OR COLOR.

FOR ENTERTAINMENT SERVICES IN THE NATURE OF AN AMUSEMENT PARK ATTRACTION, NAMELY, A THEMED AREA (U.S. CLS. 100, 101 AND 107).

FIRST USE 5-1-1999; IN COMMERCE 5-1-1999.
CHERYL CLAYTON, EXAMINING ATTORNEY

CLASS 41—(Continued).

SN 85-535,000. LOYAL CHRISTIAN BENEFIT ASSOCIATION, AKA LCBA, ERIE, PA. FILED 2-6-2012.

Generosity Footprints

THE MARK CONSISTS OF STANDARD CHARACTERS WITHOUT CLAIM TO ANY PARTICULAR FONT, STYLE, SIZE, OR COLOR.

FOR PROVIDING RECOGNITION AND INCENTIVES BY THE WAY OF AWARDS AND CONTESTS TO DEMONSTRATE EXCELLENCE IN THE FIELD OF ORGANIZED NON-PROFIT SERVICE AND INDIVIDUAL VOLUNTEERISM (U.S. CLS. 100, 101 AND 107).

FIRST USE 8-15-2011; IN COMMERCE 1-1-2012.
LINDA E. BLOHM, EXAMINING ATTORNEY

CLASS 41—(Continued).

SN 85-535,049. RIVER LIGHT V, L.P., NEW YORK, NY. FILED 2-6-2012.

THE CAT'S MEOW

THE MARK CONSISTS OF STANDARD CHARACTERS WITHOUT CLAIM TO ANY PARTICULAR FONT, STYLE, SIZE, OR COLOR.

OWNER OF U.S. REG. NO. 4,042,226.
FOR ON-LINE JOURNALS, NAMELY, BLOGS FEATURING NEWS, INFORMATION, AND INTERVIEWS REGARDING POPULAR CULTURE, FASHION, AND CELEBRITIES (U.S. CLS. 100, 101 AND 107).

FIRST USE 8-16-2010; IN COMMERCE 8-16-2010.
MICHAEL GAAFAR, EXAMINING ATTORNEY

SN 85-535,008. PATERSON, LISA, STUDIO CITY, CA. FILED 2-6-2012.

MUSICFUEL

THE MARK CONSISTS OF STANDARD CHARACTERS WITHOUT CLAIM TO ANY PARTICULAR FONT, STYLE, SIZE, OR COLOR.

FOR PROVIDING A WEBSITE FEATURING ENTERTAINMENT INFORMATION; PROVIDING EDUCATIONAL MENTORING SERVICES AND PROGRAMS IN THE FIELD OF MUSIC FOR UNDERPRIVILEGED TEENS (U.S. CLS. 100, 101 AND 107).

FIRST USE 9-0-2011; IN COMMERCE 11-0-2011.
AMY HELLA, EXAMINING ATTORNEY

SN 85-535,055. BHASKARAN, SUNIL, CAPITOLA, CA. FILED 2-6-2012.

CAHAYA MIND

THE MARK CONSISTS OF STANDARD CHARACTERS WITHOUT CLAIM TO ANY PARTICULAR FONT, STYLE, SIZE, OR COLOR.

THE ENGLISH TRANSLATION OF "CAHAYA" IN THE MARK IS LIGHT OR GLOW OR GLEAM IN MALAY.

FOR EDUCATIONAL SERVICES, NAMELY, PROVIDING SEMINARS AND WORKSHOPS ON THE TOPIC OF BUSINESS STRATEGIES AND MARKETING (U.S. CLS. 100, 101 AND 107).

JENNIFER VASQUEZ, EXAMINING ATTORNEY

SN 85-535,019. SEVEN PEAKS PLACE LC, PROVO, UT. FILED 2-6-2012.

Gift Of All Gifts

THE MARK CONSISTS OF STANDARD CHARACTERS WITHOUT CLAIM TO ANY PARTICULAR FONT, STYLE, SIZE, OR COLOR.

FOR ENTERTAINMENT SERVICES, NAMELY, ARRANGING FOR TICKET RESERVATIONS FOR WATER PARKS AND AMUSEMENT CENTERS (U.S. CLS. 100, 101 AND 107).

FIRST USE 12-1-2010; IN COMMERCE 12-1-2010.
CHERYL CLAYTON, EXAMINING ATTORNEY

SN 85-535,107. FALCON, CHRISTOPHER, GLENVIEW, IL. FILED 2-6-2012.

SLAPFORCE

THE MARK CONSISTS OF STANDARD CHARACTERS WITHOUT CLAIM TO ANY PARTICULAR FONT, STYLE, SIZE, OR COLOR.

FOR PROVIDING A WEBSITE FEATURING ENTERTAINMENT INFORMATION (U.S. CLS. 100, 101 AND 107).

WILLIAM BRECKENFELD, EXAMINING ATTORNEY

CLASS 41—(Continued).

SN 85-535,125. FIFTH THIRD BANCORP, CINCINNATI, OH.
FILED 2-6-2012.

FIFTH THIRD BANK PRESENTS
PEOPLE OF COURAGE

THE MARK CONSISTS OF STANDARD CHARACTERS WITHOUT CLAIM TO ANY PARTICULAR FONT, STYLE, SIZE, OR COLOR.

FOR AWARD PROGRAM FOR INDIVIDUALS WHO HAVE MADE SIGNIFICANT CONTRIBUTIONS TO THE COMMUNITY (U.S. CLS. 100, 101 AND 107).

JENNIFER VASQUEZ, EXAMINING ATTORNEY

CLASS 41—(Continued).

SN 85-535,347. TROPICANA LAS VEGAS, INC., LAS VEGAS, NV. FILED 2-6-2012.

Swim. Play. Flirt.

THE MARK CONSISTS OF STANDARD CHARACTERS WITHOUT CLAIM TO ANY PARTICULAR FONT, STYLE, SIZE, OR COLOR.

FOR DANCE CLUB SERVICES; ENTERTAINMENT SERVICES, NAMELY, CONDUCTING PARTIES; NIGHT CLUBS (U.S. CLS. 100, 101 AND 107).

RENEE MCCRAY, EXAMINING ATTORNEY

SN 85-535,181. TOM VITORINO MANAGEMENT, INC, DBA THE RISING, GRANADA HILLS, CA. FILED 2-6-2012.

THE RISING

THE MARK CONSISTS OF STANDARD CHARACTERS WITHOUT CLAIM TO ANY PARTICULAR FONT, STYLE, SIZE, OR COLOR.

FOR ENTERTAINMENT IN THE NATURE OF VISUAL AND AUDIO PERFORMANCES, NAMELY, MUSICAL BAND, ROCK GROUP, GYMNASTIC, DANCE, AND BALLET PERFORMANCES (U.S. CLS. 100, 101 AND 107).

FIRST USE 9-3-2010; IN COMMERCE 9-3-2010.

JENNIFER VASQUEZ, EXAMINING ATTORNEY

SN 85-535,499. MONTY L. PERRIGO, HARTSBURG, MO. FILED 2-7-2012.

AMERICAN 88 MONSTER

THE MARK CONSISTS OF STANDARD CHARACTERS WITHOUT CLAIM TO ANY PARTICULAR FONT, STYLE, SIZE, OR COLOR.

NO CLAIM IS MADE TO THE EXCLUSIVE RIGHT TO USE "MONSTER", APART FROM THE MARK AS SHOWN. FOR ENTERTAINMENT SERVICES IN THE NATURE OF MONSTER TRUCK PERFORMANCES (U.S. CLS. 100, 101 AND 107).

COLLEEN MULCRONE, EXAMINING ATTORNEY

SN 85-535,288. EXPRESSION OF LIFE PC, BOULDER, CO. FILED 2-6-2012.

PINK TENT

THE MARK CONSISTS OF STANDARD CHARACTERS WITHOUT CLAIM TO ANY PARTICULAR FONT, STYLE, SIZE, OR COLOR.

FOR EDUCATIONAL SERVICES, NAMELY, CONDUCTING CLASSES, SEMINARS, CONFERENCES, WORKSHOPS, TELESEMINARS, WEBINARS, AND PODCASTS IN THE FIELD OF WOMEN'S HEALTH AND WELLNESS, WITH A FOCUS ON HERPES EDUCATION, AND DISTRIBUTION OF EDUCATIONAL MATERIALS IN CONNECTION THEREWITH; PRODUCTION OF DVDS AND CDS FEATURING WOMEN'S HEALTH AND WELLNESS; EDUCATION, NAMELY, A CONTINUING HEALTH SHOW BROADCAST OVER RADIO, WEBINARS AND TELECONFERENCES (U.S. CLS. 100, 101 AND 107).

LAKEISHA LEWIS, EXAMINING ATTORNEY

SN 85-535,561. NATIONAL RAILWAY HISTORICAL SOCIETY, PHILADELPHIA, PA. FILED 2-7-2012.

NRHS

THE MARK CONSISTS OF THE STYLIZED LETTERS "NRHS". THE HORIZONTAL LINES THROUGH THE LETTERS ARE A FEATURE OF THE MARK AND DO NOT INDICATE COLOR.

FOR EDUCATIONAL SERVICES, NAMELY, PROVIDING WORKSHOPS AND CULTURAL SEMINARS, ALL RELATING TO THE RAILROADING INDUSTRY AND ITS HISTORICAL EVOLUTION, AND ORGANIZING HISTORICAL RAILROAD EXHIBITIONS FOR ENTERTAINMENT IN INTERNATIONAL CLASS 41 (U.S. CLS. 100, 101 AND 107).

FIRST USE 6-21-2010; IN COMMERCE 6-21-2010.
PAM WILLIS, EXAMINING ATTORNEY

CLASS 41—(Continued).

SN 85-535,629. SEAMUS JAMES, LLC, CORAL SPRINGS, FL.
FILED 2-7-2012.

GYPSY MOONDANCE

THE MARK CONSISTS OF STANDARD CHARACTERS
WITHOUT CLAIM TO ANY PARTICULAR FONT, STYLE,
SIZE, OR COLOR.

FOR NIGHT CLUBS (U.S. CLS. 100, 101 AND 107).
KATHRYN COWARD, EXAMINING ATTORNEY

SN 85-535,641. BRAINSTORMS, INC., SANTE FE, NM.
FILED 2-7-2012.

GYMTOPIA

THE MARK CONSISTS OF STANDARD CHARACTERS
WITHOUT CLAIM TO ANY PARTICULAR FONT, STYLE,
SIZE, OR COLOR.

FOR CONDUCTING FITNESS CLASSES; CONSULTING
SERVICES IN THE FIELDS OF FITNESS AND
EXERCISE; COUNSELING SERVICES IN THE FIELD
OF PHYSICAL FITNESS; PERSONAL FITNESS TRAINING
SERVICES AND CONSULTANCY; PHYSICAL FITNESS
STUDIO SERVICES, NAMELY, PROVIDING
EXERCISE CLASSES, BODY SCULPTING CLASSES,
AND GROUP FITNESS CLASSES (U.S. CLS. 100, 101
AND 107).

REBECCA SMITH, EXAMINING ATTORNEY

SN 85-535,645. ROTENGO, LLC, SAN ANTONIO, TX. FILED
2-7-2012.

USRTA

THE MARK CONSISTS OF STANDARD CHARACTERS
WITHOUT CLAIM TO ANY PARTICULAR FONT, STYLE,
SIZE, OR COLOR.

FOR ENCOURAGING AMATEUR SPORTS AND PHYSICAL
EDUCATION BY ORGANIZING, SANCTIONING,
CONDUCTING, REGULATING AND GOVERNING
AMATEUR ATHLETIC PROGRAMS AND ACTIVITIES;
ORGANIZING, ARRANGING, AND CONDUCTING
ROTENGO AND/OR ROAD TENNIS EVENTS (U.S. CLS. 100,
101 AND 107).

JAY FLOWERS, EXAMINING ATTORNEY

CLASS 41—(Continued).

SN 85-535,659. EUREKA EQUITIES INC, GREAT NECK, NY.
FILED 2-7-2012.

Ask A Nerd

THE MARK CONSISTS OF STANDARD CHARACTERS
WITHOUT CLAIM TO ANY PARTICULAR FONT, STYLE,
SIZE, OR COLOR.

FOR EDUCATION SERVICES, NAMELY, PROVIDING
ONLINE TUTORING IN THE FIELD OF WRITING AND
EDITING (U.S. CLS. 100, 101 AND 107).

FIRST USE 9-1-2009; IN COMMERCE 9-1-2009.
KATHRYN COWARD, EXAMINING ATTORNEY

SN 85-535,698. LEFEVER & ASSOCIATES, LLC, NORFOLK,
VA. FILED 2-7-2012.

Now For Life

THE MARK CONSISTS OF STANDARD CHARACTERS
WITHOUT CLAIM TO ANY PARTICULAR FONT, STYLE,
SIZE, OR COLOR.

FOR EDUCATION SERVICES, NAMELY, PROVIDING
CLASSES, SEMINARS, TRAINING, AND CURRICULA
IN THE FIELDS OF MENTAL HEALTH AND FITNESS
TO ELITE WARRIORS, ATHLETES, AND TOP PROFESSIONALS
AND THE DISTRIBUTION OF EDUCATIONAL MATERIAL
IN CONNECTION THEREWITH (U.S. CLS. 100, 101
AND 107).

ASMAT KHAN, EXAMINING ATTORNEY

SN 85-535,837. ZITNICK, KARA J. JENSEN, BURNSVILLE,
MN. FILED 2-7-2012.

LaunchHER

THE MARK CONSISTS OF STANDARD CHARACTERS
WITHOUT CLAIM TO ANY PARTICULAR FONT, STYLE,
SIZE, OR COLOR.

FOR PROVIDING A WEBSITE FEATURING BLOGS
AND NON-DOWNLOADABLE PUBLICATIONS IN THE
NATURE OF ARTICLES IN THE FIELD(S) OF ENTREPRENEURSHIP,
MARKETING, INTELLECTUAL PROPERTY, AND WOMEN-OWNED
BUSINESSES (U.S. CLS. 100, 101 AND 107).

FIRST USE 1-1-2010; IN COMMERCE 1-1-2010.
VERNA BETH RIRIE, EXAMINING ATTORNEY

CLASS 41—(Continued).

SN 85-536,020. JUPITERBOUNCE.COM, JUPITER, FL. FILED 2-7-2012.

JupiterBounce

THE MARK CONSISTS OF STANDARD CHARACTERS WITHOUT CLAIM TO ANY PARTICULAR FONT, STYLE, SIZE, OR COLOR.

FOR RENTAL OF AMUSEMENT MACHINES AND APPARATUSES, NAMELY, BOUNCE HOUSES IN THE NATURE OF AN AIR INFLATED CUSHION IN AN AIR INFLATED STRUCTURE (U.S. CLS. 100, 101 AND 107).
FIRST USE 4-10-2006; IN COMMERCE 4-10-2006.
KIM MONINGHOFF, EXAMINING ATTORNEY

CLASS 41—(Continued).

SN 85-536,348. SOUTH DAKOTA BOARD OF REGENTS, PIERRE, SD. FILED 2-7-2012.



SN 85-536,160. SOUTH DAKOTA BOARD OF REGENTS, PIERRE, SD. FILED 2-7-2012.



THE MARK CONSISTS OF A CARICATURE OF A WOMAN'S HEAD.

FOR ENTERTAINMENT SERVICES, NAMELY, A COLLEGE HOMECOMING FESTIVAL FEATURING ENTERTAINMENT IN THE NATURE OF A FOOTBALL GAME, PICNIC, LIVE MUSICAL PERFORMANCE, AND PARADE (U.S. CLS. 100, 101 AND 107).

FIRST USE 0-0-1996; IN COMMERCE 0-0-1996.
INGA ERVIN, EXAMINING ATTORNEY

THE MARK CONSISTS OF A CARICATURE OF A MAN'S HEAD COMMONLY KNOWN AS A 'HOBO'.

FOR ENTERTAINMENT SERVICES, NAMELY, A COLLEGE HOMECOMING FESTIVAL FEATURING ENTERTAINMENT IN THE NATURE OF A FOOTBALL GAME, PICNIC, LIVE MUSICAL PERFORMANCE, AND PARADE (U.S. CLS. 100, 101 AND 107).

FIRST USE 0-0-1962; IN COMMERCE 0-0-1962.
INGA ERVIN, EXAMINING ATTORNEY

SN 85-536,355. REELPATH, PORTLAND, OR. FILED 2-7-2012.

ReelPath

SN 85-536,311. BRANDON SCOTT MCLEAN, RALEIGH, NC. FILED 2-7-2012.

YOUNG & NEW

THE MARK CONSISTS OF STANDARD CHARACTERS WITHOUT CLAIM TO ANY PARTICULAR FONT, STYLE, SIZE, OR COLOR.

FOR ENTERTAINMENT SERVICES, NAMELY LIVE PERFORMANCES BY A MUSICAL BAND (U.S. CLS. 100, 101 AND 107).

FIRST USE 2-2-2012; IN COMMERCE 2-2-2012.
MARK SPARACINO, EXAMINING ATTORNEY

THE MARK CONSISTS OF STANDARD CHARACTERS WITHOUT CLAIM TO ANY PARTICULAR FONT, STYLE, SIZE, OR COLOR.

FOR ENTERTAINMENT SERVICES, NAMELY, MULTIMEDIA PRODUCTION SERVICES; ENTERTAINMENT SERVICES, NAMELY, PRODUCTION OF SPECIAL EFFECTS INCLUDING MODEL-MAKING SERVICES, COMPUTER-GENERATED IMAGERY AND COMPUTER-GENERATED GRAPHICS FOR THE PRODUCTION OF MOTION PICTURES, VIDEOS, AND MOVIE TRAILERS; SPECIAL EFFECTS ANIMATION SERVICES FOR FILM AND VIDEO (U.S. CLS. 100, 101 AND 107).

TASHIA BUNCH, EXAMINING ATTORNEY

CLASS 41—(Continued).

SN 85-536,407. UGOL, CHAR, SCOTTSDALE, AZ. FILED 2-7-2012.

KidontheAteam

THE MARK CONSISTS OF STANDARD CHARACTERS WITHOUT CLAIM TO ANY PARTICULAR FONT, STYLE, SIZE, OR COLOR.

FOR PROVIDING ON-LINE PUBLICATIONS IN THE NATURE OF AN E-BOOK IN THE FIELD OF EDUCATIONAL AND INFORMATIONAL AUTISM MATERIALS (U.S. CLS. 100, 101 AND 107).

DAVID H. STINE, EXAMINING ATTORNEY

SN 85-536,408. BARON, IVANNA, AURORA, CO. AND BARON, GERMAINE, AURORA, CO. FILED 2-7-2012.

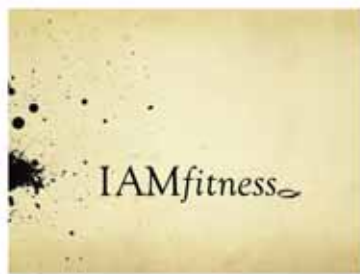

THE COLOR(S) RUSTIC BEIGE AND BLACK IS/ARE CLAIMED AS A FEATURE OF THE MARK.

THE MARK CONSISTS OF THE BLACK STYLIZED TEXT "IAMFITNESS" AGAINST A RECTANGLE-SHAPED RUSTIC BEIGE BACKGROUND. TO THE RIGHT OF THE TEXT IS A BLACK CHRISTIAN FISH SYMBOL. AT THE LEFT SIDE OF THE RECTANGLE IS A BLACK INK SPLATTER DESIGN.

FOR PERSONAL FITNESS TRAINING SERVICES AND CONSULTANCY (U.S. CLS. 100, 101 AND 107).

FIRST USE 4-19-2012; IN COMMERCE 4-19-2012.

ADA HAN, EXAMINING ATTORNEY

SN 85-536,424. A440 MINISTRIES, INC, NORCROSS, GA. FILED 2-7-2012.

tune your soul to an infinite frequency

THE MARK CONSISTS OF STANDARD CHARACTERS WITHOUT CLAIM TO ANY PARTICULAR FONT, STYLE, SIZE, OR COLOR.

FOR CHRISTIAN RELIGIOUS SERVICES, NAMELY, ENCOURAGING GATHERING TO PRAYER AND WORSHIP, COMMUNITY OUTREACH AND SPIRITUAL MENTORING (U.S. CLS. 100, 101 AND 107).

THEODORE MCBRIDE, EXAMINING ATTORNEY

CLASS 41—(Continued).

SN 85-536,426. BLANK, JESSICA, BROOKLYN, NY. FILED 2-7-2012.

BronyCon

THE MARK CONSISTS OF STANDARD CHARACTERS WITHOUT CLAIM TO ANY PARTICULAR FONT, STYLE, SIZE, OR COLOR.

FOR ARRANGING, ORGANIZING, CONDUCTING, AND HOSTING SOCIAL ENTERTAINMENT EVENTS (U.S. CLS. 100, 101 AND 107).

FIRST USE 6-3-2011; IN COMMERCE 6-25-2011.

SUNG IN, EXAMINING ATTORNEY

SN 85-536,430. STRAYHORN, MASON, CABOT, AR. AND HOWARD, SETH, CABOT, AR. AND BRATCHER, JUSTIN, CABOT, AZ. AND GRAVES, JOSH, CABOT, AR. FILED 2-7-2012.

Transcend

THE MARK CONSISTS OF STANDARD CHARACTERS WITHOUT CLAIM TO ANY PARTICULAR FONT, STYLE, SIZE, OR COLOR.

FOR ENTERTAINMENT, NAMELY, LIVE PERFORMANCES BY A MUSICAL BAND (U.S. CLS. 100, 101 AND 107).

FIRST USE 3-1-2011; IN COMMERCE 10-1-2011.

SUNG IN, EXAMINING ATTORNEY

SN 85-536,452. AGRI SERVICE, VISTA, CA. FILED 2-7-2012.

GROW YOUR PASSION

THE MARK CONSISTS OF STANDARD CHARACTERS WITHOUT CLAIM TO ANY PARTICULAR FONT, STYLE, SIZE, OR COLOR.

FOR EDUCATION SERVICES, NAMELY, PROVIDING CLASSES AND WORKSHOPS IN THE FIELD OF GARDENING (U.S. CLS. 100, 101 AND 107).

FIRST USE 12-1-2011; IN COMMERCE 1-4-2012.

SUNG IN, EXAMINING ATTORNEY

CLASS 41—(Continued).

SN 85-536,453. MARVELOUS MUSIC GROUP, SUNRISE, FL. FILED 2-7-2012.

TAG

THE MARK CONSISTS OF STANDARD CHARACTERS WITHOUT CLAIM TO ANY PARTICULAR FONT, STYLE, SIZE, OR COLOR.

FOR ENTERTAINMENT IN THE NATURE OF LIVE MUSICAL PERFORMANCES (U.S. CLS. 100, 101 AND 107).

FIRST USE 2-10-2010; IN COMMERCE 2-10-2010.
SUNG IN, EXAMINING ATTORNEY

SN 85-536,619. BASH, LLC, ARLINGTON, VA. FILED 2-8-2012.

BASH

THE MARK CONSISTS OF STANDARD CHARACTERS WITHOUT CLAIM TO ANY PARTICULAR FONT, STYLE, SIZE, OR COLOR.

FOR PARTY AND WEDDING PLANNING, COORDINATION AND CONSULTATION SERVICES; PROVIDING INFORMATION IN THE FIELD OF WEDDING PARTY PLANNING (U.S. CLS. 100, 101 AND 107).

FIRST USE 1-3-2008; IN COMMERCE 1-14-2008.
DORITT L. CARROLL, EXAMINING ATTORNEY

SN 85-536,756. DESROSIER, PAUL J., TUCSON, AZ. FILED 2-8-2012.

FitFlexRX

THE MARK CONSISTS OF STANDARD CHARACTERS WITHOUT CLAIM TO ANY PARTICULAR FONT, STYLE, SIZE, OR COLOR.

FOR PHYSICAL FITNESS CONDITIONING CLASSES; PHYSICAL FITNESS TRAINING SERVICES; PROVIDING FITNESS AND EXERCISE FACILITIES (U.S. CLS. 100, 101 AND 107).

NAKIA HENRY, EXAMINING ATTORNEY

CLASS 41—(Continued).

SN 85-536,780. RAPP, MARION, TEMPERANCE, MI. FILED 2-8-2012.

AZPECS

THE MARK CONSISTS OF STANDARD CHARACTERS WITHOUT CLAIM TO ANY PARTICULAR FONT, STYLE, SIZE, OR COLOR.

FOR PHOTOGRAPHY SERVICES (U.S. CLS. 100, 101 AND 107).

FIRST USE 2-8-2012; IN COMMERCE 2-8-2012.
ROSELLE HERRERA, EXAMINING ATTORNEY

SN 85-536,822. MINDFIELD PRODUCTIONS, INC., NEW YORK, NY. FILED 2-8-2012.



NO CLAIM IS MADE TO THE EXCLUSIVE RIGHT TO USE "CREATIVE PRODUCTIONS", APART FROM THE MARK AS SHOWN.

THE COLOR(S) BLUE AND WHITE IS/ARE CLAIMED AS A FEATURE OF THE MARK.

THE MARK CONSISTS OF BLUE CLOUD WITH "MINDFIELD" IN WHITE STYLIZED FONT. FROM THE "M" IS A THOUGHT CLOUD WITH "MF" IN BLUE STYLIZED LETTERS WITHIN IT. BELOW "MINDFIELD" IS A WHITE LINE WITH "CREATIVE PRODUCTIONS" IN WHITE STYLIZED LETTERS BELOW THE LINE.

FOR FILM AND VIDEO PRODUCTION; FILM AND VIDEO PRODUCTION CONSULTING SERVICES; FILM EDITING (U.S. CLS. 100, 101 AND 107).

FIRST USE 0-0-2011; IN COMMERCE 0-0-2011.
CARYN GLASSER, EXAMINING ATTORNEY

CLASS 41—(Continued).

SN 85-536,828. HUNTINGTON MARK, LLC, ORADELL, NJ. FILED 2-8-2012.

YOUR CHILD CAN LEARN

THE MARK CONSISTS OF STANDARD CHARACTERS WITHOUT CLAIM TO ANY PARTICULAR FONT, STYLE, SIZE, OR COLOR.

OWNER OF U.S. REG. NO. 3,103,102.

FOR EDUCATIONAL SERVICES, NAMELY, PROVIDING TUTORING IN THE FIELDS OF READING, WRITING, STUDY SKILLS, MATH, PHONICS, SPELLING, VOCABULARY, PRE-ALGEBRA, ALGEBRA, GEOMETRY, TRIGONOMETRY, PRE-CALCULUS, CALCULUS, GENERAL SCIENCE, EARTH SCIENCE, BIOLOGY, CHEMISTRY, AND PHYSICS; CONDUCTING CLASSES, SEMINARS, WORKSHOPS, AND TUTORING IN THE FIELD OF PREPARATION FOR STANDARDIZED EXAMS (U.S. CLS. 100, 101 AND 107).

FIRST USE 1-19-1995; IN COMMERCE 1-19-1995.

SUSAN LESLIE DUBOIS, EXAMINING ATTORNEY

SN 85-536,952. THE TOMKAT STUDIO, LLC, CHANDLER, AZ. FILED 2-8-2012.

the tomkat studio

THE MARK CONSISTS OF STANDARD CHARACTERS WITHOUT CLAIM TO ANY PARTICULAR FONT, STYLE, SIZE, OR COLOR.

FOR PROVIDING A WEB SITE THAT FEATURES INFORMAL INSTRUCTION ON SOCIAL ENTERTAINING, PARTY STYLING, AND PARTY PLANNING (U.S. CLS. 100, 101 AND 107).

FIRST USE 12-20-2008; IN COMMERCE 12-20-2008.

ANDREW LEASER, EXAMINING ATTORNEY

SN 85-537,014. CVOX GROUP LLC, MIAMI, FL. FILED 2-8-2012.

CVOX

THE MARK CONSISTS OF STANDARD CHARACTERS WITHOUT CLAIM TO ANY PARTICULAR FONT, STYLE, SIZE, OR COLOR.

FOR MEDIA PRODUCTION SERVICES, NAMELY, VIDEO AND FILM PRODUCTION; PRODUCTION OF RADIO OR TELEVISION PROGRAMS (U.S. CLS. 100, 101 AND 107).

FIRST USE 7-31-2007; IN COMMERCE 7-31-2007.

JAY BESCH, EXAMINING ATTORNEY

CLASS 41—(Continued).

SN 85-537,137. SOUTHERN ARKANSAS UNIVERSITY, MAGNOLIA, AR. FILED 2-8-2012.



THE MARK CONSISTS OF A RIDER ON A BUCKING MULE FRAMED BY A MULE SHOE.

FOR EDUCATIONAL SERVICES, NAMELY PROVIDING COURSES OF INSTRUCTION AT THE COLLEGE LEVEL, AND ENTERTAINMENT SERVICES, NAMELY ORGANIZING AND CONDUCTING COLLEGE LEVEL SPORTING EVENTS (U.S. CLS. 100, 101 AND 107).

FIRST USE 12-31-2004; IN COMMERCE 12-31-2004.

ROBIN CHOSID, EXAMINING ATTORNEY

SN 85-537,235. AZTECA INTERNATIONAL CORPORATION, GLENDALE, CA. FILED 2-8-2012.

CINE ESPECTACULAR DEL SABADO

THE MARK CONSISTS OF STANDARD CHARACTERS WITHOUT CLAIM TO ANY PARTICULAR FONT, STYLE, SIZE, OR COLOR.

OWNER OF U.S. REG. NO. 3,799,293.

NO CLAIM IS MADE TO THE EXCLUSIVE RIGHT TO USE "CINE AND SABADO", APART FROM THE MARK AS SHOWN.

THE ENGLISH TRANSLATION OF CINE ESPECTACULAR DEL SABADO IN THE MARK IS SATURDAY MOVIE SPECTACULAR.

FOR ENTERTAINMENT SERVICES, NAMELY, AN ON-GOING TELEVISION SERIES FEATURING COMEDY, ACTION AND DRAMATIC FILMS (U.S. CLS. 100, 101 AND 107).

PAM WILLIS, EXAMINING ATTORNEY

CLASS 41—(Continued).

SN 85-537,381. BRANDENBURG PROPERTIES, LLC, SAN JOSE, CA. FILED 2-8-2012.



THE MARK CONSISTS OF CONCENTRIC CIRCLES WITH A FLAG POLE IN CENTER WITH A FLAG AND THE LETTERS/NUMBER "USP3" UNDERNEATH THE CIRCLES.

FOR ENTERTAINMENT IN THE NATURE OF GOLF TOURNAMENTS; ORGANIZATION OF SPORTS COMPETITIONS; ORGANIZING COMMUNITY SPORTING AND CULTURAL EVENTS (U.S. CLS. 100, 101 AND 107).
JOHN KELLY, EXAMINING ATTORNEY

SN 85-537,387. METRAMATRIX, INC., LOUISVILLE, KY. FILED 2-8-2012.

MAGIC ON MAIN

THE MARK CONSISTS OF STANDARD CHARACTERS WITHOUT CLAIM TO ANY PARTICULAR FONT, STYLE, SIZE, OR COLOR.

FOR ENTERTAINMENT IN THE NATURE OF PROVIDING MAGIC SHOWS AND VENUES FOR MAGIC SHOWS; ENTERTAINMENT IN THE NATURE OF A NATIONAL MAGIC FESTIVAL (U.S. CLS. 100, 101 AND 107).

FIRST USE 11-14-2011; IN COMMERCE 11-14-2011.
DEIRDRE ROBERTSON, EXAMINING ATTORNEY

SN 85-537,393. WARM SPRINGS PRODUCTIONS, LLC, MISSOULA, MT. FILED 2-8-2012.

FATHERS OF INVENTION

THE MARK CONSISTS OF STANDARD CHARACTERS WITHOUT CLAIM TO ANY PARTICULAR FONT, STYLE, SIZE, OR COLOR.

FOR ENTERTAINMENT IN THE NATURE OF ONGOING TELEVISION PROGRAMS IN THE FIELD OF DOCUMENTARIES; ENTERTAINMENT SERVICES IN THE NATURE OF AN ON-GOING REALITY BASED TELEVISION PROGRAM (U.S. CLS. 100, 101 AND 107).
SARA BENJAMIN, EXAMINING ATTORNEY

CLASS 41—(Continued).

SN 85-537,576. SANTANA, ANGELIQUE, FORT LAUDERDALE, FL. FILED 2-8-2012.

Healing from the inside out

THE MARK CONSISTS OF STANDARD CHARACTERS WITHOUT CLAIM TO ANY PARTICULAR FONT, STYLE, SIZE, OR COLOR.

FOR PROFESSIONAL COACHING SERVICES IN THE FIELD OF HEALTH, NUTRITION, PERSONAL TRAINING (U.S. CLS. 100, 101 AND 107).

CHRISTOPHER LAW, EXAMINING ATTORNEY

SN 85-537,689. ANGEL LOPEZ, VALLEY STREAM, NY. FILED 2-8-2012.

Samurai Bugs

THE MARK CONSISTS OF STANDARD CHARACTERS WITHOUT CLAIM TO ANY PARTICULAR FONT, STYLE, SIZE, OR COLOR.

FOR ENTERTAINMENT IN THE NATURE OF ONGOING TELEVISION PROGRAMS IN THE FIELD OF A CARTOON; PROVIDING ONLINE NON-DOWNLOADABLE COMIC BOOKS AND GRAPHIC NOVELS (U.S. CLS. 100, 101 AND 107).

VIVIAN MICZNIK FIRST, EXAMINING ATTORNEY

SN 85-537,835. CALDWELL, JAY E. PARK RIDGE, NJ. FILED 2-9-2012.

TBR

THE MARK CONSISTS OF STANDARD CHARACTERS WITHOUT CLAIM TO ANY PARTICULAR FONT, STYLE, SIZE, OR COLOR.

FOR EDUCATIONAL SERVICES, NAMELY, CONDUCTING CLASSES, SEMINARS, CONFERENCES, AND WORKSHOPS IN THE FIELDS OF PASS RUSHING DEFENSIVE TECHNIQUES IN THE SPORT OF FOOTBALL AND DISTRIBUTION OF TRAINING MATERIALS IN CONNECTION THEREWITH (U.S. CLS. 100, 101 AND 107).

JOHN HWANG, EXAMINING ATTORNEY

CLASS 41—(Continued).

SN 85-537,848. CALDWELL, JAY E, PARK RIDGE, NJ. FILED 2-9-2012.

CLOCKPOINT

THE MARK CONSISTS OF STANDARD CHARACTERS WITHOUT CLAIM TO ANY PARTICULAR FONT, STYLE, SIZE, OR COLOR.

FOR EDUCATIONAL SERVICES, NAMELY, CONDUCTING CLASSES, SEMINARS, CONFERENCES, AND WORKSHOPS IN THE FIELDS OF HAIRCUTTING AND HAIR STYLING AND DISTRIBUTION OF TRAINING MATERIAL IN CONNECTION THEREWITH (U.S. CLS. 100, 101 AND 107).

JOHN HWANG, EXAMINING ATTORNEY

SN 85-537,966. THE DREAM COME TRUE, LLC, LAS VEGAS, NV. FILED 2-9-2012.

THE DREAM COME TRUE

THE MARK CONSISTS OF STANDARD CHARACTERS WITHOUT CLAIM TO ANY PARTICULAR FONT, STYLE, SIZE, OR COLOR.

FOR ENTERTAINMENT SERVICES FEATURING LIVE MUSICAL AND THEATRICAL PERFORMANCES (U.S. CLS. 100, 101 AND 107).

ELISSA GARBER KON, EXAMINING ATTORNEY

SN 85-537,970. SHARGRILLA, LLC, HILLSDALE, NJ. FILED 2-9-2012.

SHARGRILLA

THE MARK CONSISTS OF STANDARD CHARACTERS WITHOUT CLAIM TO ANY PARTICULAR FONT, STYLE, SIZE, OR COLOR.

FOR ENTERTAINMENT SERVICES AND INFORMATION SERVICES, NAMELY, PROVIDING A WEBSITE ON A VARIETY OF TOPICS CONCERNING MEN'S LIFESTYLE AND POPULAR CULTURE (U.S. CLS. 100, 101 AND 107).

INGA ERVIN, EXAMINING ATTORNEY

CLASS 41—(Continued).

SN 85-537,983. SHARGRILLA, LLC, HILLSDALE, NJ. FILED 2-9-2012.

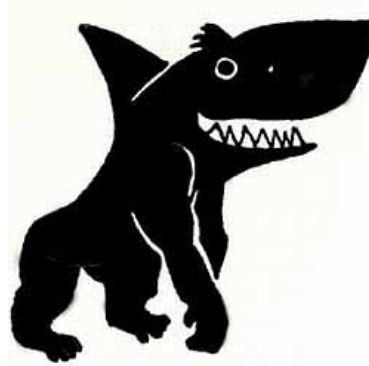

THE MARK CONSISTS OF A FANCIFUL HYBRID ANIMAL CONSISTING OF THE LOWER BODY OF A GORILLA AND THE UPPER BODY OF A SHARK.

FOR ENTERTAINMENT SERVICES AND INFORMATION SERVICES, NAMELY, PROVIDING A WEBSITE ON A VARIETY OF TOPICS CONCERNING MEN'S LIFESTYLE AND POPULAR CULTURE (U.S. CLS. 100, 101 AND 107).

INGA ERVIN, EXAMINING ATTORNEY

SN 85-538,031. KINLAW, ALEXANDER W., TERRA CEIA, FL. FILED 2-9-2012.

YESTERDAYZE

THE MARK CONSISTS OF STANDARD CHARACTERS WITHOUT CLAIM TO ANY PARTICULAR FONT, STYLE, SIZE, OR COLOR.

FOR ENTERTAINMENT IN THE NATURE OF A MUSICAL GROUP; ENTERTAINMENT SERVICES IN THE NATURE OF LIVE MUSICAL PERFORMANCES; ENTERTAINMENT, NAMELY, LIVE PERFORMANCES BY A MUSICAL BAND (U.S. CLS. 100, 101 AND 107).

FIRST USE 9-22-2007; IN COMMERCE 9-22-2007.

CHARLES L. JENKINS, EXAMINING ATTORNEY

CLASS 41—(Continued).

SN 85-538,196. ROGERS, TORI, KIHEI, HI. FILED 2-9-2012.

**HAWAIIAN ISLAND WEDDING
PLANNERS**

THE MARK CONSISTS OF STANDARD CHARACTERS WITHOUT CLAIM TO ANY PARTICULAR FONT, STYLE, SIZE, OR COLOR.

NO CLAIM IS MADE TO THE EXCLUSIVE RIGHT TO USE "WEDDING PLANNERS", APART FROM THE MARK AS SHOWN.

SEC. 2(F).

FOR PARTY AND WEDDING PLANNING AND COORDINATION SERVICES; PARTY AND WEDDING PLANNING CONSULTATION SERVICES; PARTY AND WEDDING PLANNING, COORDINATION AND CONSULTATION SERVICES; PROVIDING INFORMATION IN THE FIELD OF WEDDING PARTY PLANNING; PROVIDING INFORMATION REGARDING WEDDING PLANNING FOR WEDDING PARTIES; WEDDING PLANNING AND COORDINATION SERVICES (U.S. CLS. 100, 101 AND 107).

FIRST USE 5-1-1998; IN COMMERCE 5-1-1998.
KAREN K. BUSH, EXAMINING ATTORNEY

SN 85-538,206. COLLEGE OF WESTERN IDAHO, NAMPA, ID. FILED 2-9-2012.

ACHIEVE MORE

THE MARK CONSISTS OF STANDARD CHARACTERS WITHOUT CLAIM TO ANY PARTICULAR FONT, STYLE, SIZE, OR COLOR.

FOR EDUCATIONAL SERVICES, NAMELY, PROVIDING COURSES OF INSTRUCTION THROUGH CLASSES, SEMINARS AND WORKSHOPS AT THE COMMUNITY COLLEGE LEVEL (U.S. CLS. 100, 101 AND 107).

FIRST USE 8-20-2008; IN COMMERCE 8-20-2008.
CHRISTOPHER BUONGIORNO, EXAMINING ATTORNEY

SN 85-538,233. MAESTRO LLC, DBA MAESTRO ELEARNING, OSHTEMO, MI. FILED 2-9-2012.

MAESTRO

THE MARK CONSISTS OF STANDARD CHARACTERS WITHOUT CLAIM TO ANY PARTICULAR FONT, STYLE, SIZE, OR COLOR.

FOR BUSINESS TRAINING; DEVELOPING TRAINING SYSTEMS AND LEARNING METHODOLOGIES FOR OTHERS; INTERACTIVE ON-LINE TRAINING SERVICES IN THE FIELD OF MOBILE DEVICE APPLICATIONS AS REQUESTED BY CLIENTS (U.S. CLS. 100, 101 AND 107).

FIRST USE 4-1-2007; IN COMMERCE 4-1-2007.
SHANNON TWOHIG, EXAMINING ATTORNEY

CLASS 41—(Continued).

SN 85-538,235. ROGERS, TORI, KIHEI, HI. FILED 2-9-2012.



THE COLOR(S) BLACK, WHITE AND PINK IS/ARE CLAIMED AS A FEATURE OF THE MARK.

THE MARK CONSISTS OF THE STYLIZED LETTER "H" IN BLACK, NEXT TO A STYLIZED DESIGN OF A PINK FLOWER WITH A WHITE CENTER.

FOR PARTY AND WEDDING PLANNING AND COORDINATION SERVICES; PARTY AND WEDDING PLANNING CONSULTATION SERVICES; PARTY AND WEDDING PLANNING, COORDINATION AND CONSULTATION SERVICES; PROVIDING INFORMATION IN THE FIELD OF WEDDING PARTY PLANNING; PROVIDING INFORMATION REGARDING WEDDING PLANNING FOR WEDDING PARTIES; WEDDING PLANNING AND COORDINATION SERVICES (U.S. CLS. 100, 101 AND 107).

FIRST USE 1-0-2011; IN COMMERCE 1-0-2011.
KAREN K. BUSH, EXAMINING ATTORNEY

SN 85-538,236. COLLEGE OF WESTERN IDAHO, NAMPA, ID. FILED 2-9-2012.

CWI

THE MARK CONSISTS OF STANDARD CHARACTERS WITHOUT CLAIM TO ANY PARTICULAR FONT, STYLE, SIZE, OR COLOR.

FOR EDUCATIONAL SERVICES, NAMELY, PROVIDING COURSES OF INSTRUCTION THROUGH CLASSES, SEMINARS AND WORKSHOPS AT THE COMMUNITY COLLEGE LEVEL (U.S. CLS. 100, 101 AND 107).

FIRST USE 4-2-2008; IN COMMERCE 4-2-2008.
CHRISTOPHER BUONGIORNO, EXAMINING ATTORNEY

CLASS 41—(Continued).

SN 85-538,313. MICHAEL P. KNAPP SR., GRAND RAPIDS, MI. FILED 2-9-2012.

TEE FOR TWO

THE MARK CONSISTS OF STANDARD CHARACTERS WITHOUT CLAIM TO ANY PARTICULAR FONT, STYLE, SIZE, OR COLOR.

FOR ENTERTAINMENT, NAMELY, A CONTINUING ROMANTIC HUMOR SHOW FEATURING SITUATIONS INVOLVING GOLF BROADCAST OVER TELEVISION AND INTERNET (U.S. CLS. 100, 101 AND 107).

ANGELA M. MICHELI, EXAMINING ATTORNEY

SN 85-538,368. PATH MEDIA HOLDINGS, LLC, CHARLESTOWN, ST.KITTS-NEVIS, FILED 2-9-2012.

GGW

THE MARK CONSISTS OF STANDARD CHARACTERS WITHOUT CLAIM TO ANY PARTICULAR FONT, STYLE, SIZE, OR COLOR.

FOR ENTERTAINMENT SERVICES, NAMELY, PROVIDING A WEB SITE FEATURING ADULT ENTERTAINMENT, ADULT CONTENT VIDEOS, RELATED FILM CLIPS, PHOTOGRAPHS, AND OTHER MULTIMEDIA MATERIALS, FEATURING ADULT ENTERTAINMENT, WEBCASTS IN THE FIELD OF ADULT ENTERTAINMENT, EVENTS, NAMELY, PROMOTIONAL PARTIES FOR VARIOUS VENUES AND VENDORS (U.S. CLS. 100, 101 AND 107).

SUSAN LESLIE DUBOIS, EXAMINING ATTORNEY

SN 85-538,461. CHARLES E. DANIELS, LEBANON, TN. FILED 2-9-2012.

DIXIE QUICKIE

THE MARK CONSISTS OF STANDARD CHARACTERS WITHOUT CLAIM TO ANY PARTICULAR FONT, STYLE, SIZE, OR COLOR.

FOR EDUCATION AND ENTERTAINMENT SERVICES, NAMELY, AN ONGOING SERIES OF AUDIO SEGMENTS FEATURING MUSIC AND MUSIC COMMENTARY, ACCESSIBLE BY RADIO, SATELLITE AND THE INTERNET (U.S. CLS. 100, 101 AND 107).

SOPHIA S. KIM, EXAMINING ATTORNEY

CLASS 41—(Continued).

SN 85-538,559. OUR SOLDIERS SPEAK, INC., NEW YORK, NY. FILED 2-9-2012.

OUR SOLDIERS SPEAK

THE MARK CONSISTS OF STANDARD CHARACTERS WITHOUT CLAIM TO ANY PARTICULAR FONT, STYLE, SIZE, OR COLOR.

FOR EDUCATIONAL SERVICES, NAMELY, CONDUCTING SEMINARS, LECTURES AND WORKSHOPS FROM THE PERSPECTIVE OF ISRAELI COMBAT VETERANS FROM THE FRONT LINES OF ISRAELI BATTLEFIELDS TO PROVIDE THE PUBLIC WITH AN APOLITICAL VIEWPOINT OF CURRENT ISRAELI MILITARY STRUGGLES, REAL TIME BATTLEFIELD DILEMMAS AND THE DIFFERENCES BETWEEN MEDIA HEADLINES AND THE REALITIES OF COMBAT ZONES (U.S. CLS. 100, 101 AND 107).

FIRST USE 1-1-2009; IN COMMERCE 1-1-2009.
ELLEN B. AWRICH, EXAMINING ATTORNEY

SN 85-538,664. STACKIT, INC., SPOKANE, WA. FILED 2-9-2012.

STACKIT FITNESS

THE MARK CONSISTS OF STANDARD CHARACTERS WITHOUT CLAIM TO ANY PARTICULAR FONT, STYLE, SIZE, OR COLOR.

NO CLAIM IS MADE TO THE EXCLUSIVE RIGHT TO USE "FITNESS", APART FROM THE MARK AS SHOWN.

FOR PROVIDING GYMNASIUMS, FITNESS AND SPORTS FACILITIES, PROVIDING ASSISTANCE AND FITNESS EVALUATIONS, CONSULTATIONS AND PERSONAL TRAINING TO INDIVIDUALS TO HELP THEM TO MAKE HEALTH, WELLNESS, AND NUTRITIONAL CHANGES IN THEIR DAILY LIVING AND FITNESS ROUTINES TO IMPROVE THEIR HEALTH AND SPORTS PERFORMANCE (U.S. CLS. 100, 101 AND 107).

BRIDGETT SMITH, EXAMINING ATTORNEY

CLASS 41—(Continued).

SN 85-538,856. GLENNA C. BAILEY, CHANDLER, AZ. FILED 2-9-2012.

FUN AND FANCY FAIRY

THE MARK CONSISTS OF STANDARD CHARACTERS WITHOUT CLAIM TO ANY PARTICULAR FONT, STYLE, SIZE, OR COLOR.

FOR EDUCATIONAL AND ENTERTAINMENT SERVICES, NAMELY, PROVIDING ON-LINE INTERACTIVE CHILDREN'S STORIES; PROVIDING A WEBSITE FEATURING INFORMATION IN THE FIELDS OF EDUCATION AND ENTERTAINMENT FOR CHILDREN; PROVIDING INFORMATION RELATING TO EDUCATIONAL AND ENTERTAINMENT ACTIVITIES AND EVENTS FOR CHILDREN; PROVIDING ON-LINE RESOURCE GUIDES FOR RELATIVES CONCERNING CHILDREN IN THE FIELDS OF EDUCATION, RECREATION, AND ENTERTAINMENT (U.S. CLS. 100, 101 AND 107).

JESSICA A. POWERS, EXAMINING ATTORNEY

SN 85-538,903. DISNEY ENTERPRISES, INC., BURBANK, CA. FILED 2-9-2012.

DISNEY KUDOS

THE MARK CONSISTS OF STANDARD CHARACTERS WITHOUT CLAIM TO ANY PARTICULAR FONT, STYLE, SIZE, OR COLOR.

FOR THEME PARK SERVICES (U.S. CLS. 100, 101 AND 107).

GEOFFREY FOSDICK, EXAMINING ATTORNEY

SN 85-539,257. HEARTLAND YOUTH FOUNDATION, GRAIN VALLEY, MO. FILED 2-10-2012.

Heartland Showcase

THE MARK CONSISTS OF STANDARD CHARACTERS WITHOUT CLAIM TO ANY PARTICULAR FONT, STYLE, SIZE, OR COLOR.

NO CLAIM IS MADE TO THE EXCLUSIVE RIGHT TO USE "SHOWCASE", APART FROM THE MARK AS SHOWN. FOR ENTERTAINMENT IN THE NATURE OF SOFTBALL TOURNAMENTS (U.S. CLS. 100, 101 AND 107).

FIRST USE 6-0-2001; IN COMMERCE 6-0-2001.
FRANK LATTUCA, EXAMINING ATTORNEY

CLASS 41—(Continued).

SN 85-539,321. JONES, KENNETH, TRENTON, NJ. FILED 2-10-2012.



THE MARK CONSISTS OF THE LITERAL ELEMENT "FLYT NATION" WHEREIN THERE ARE TWO HANDS FORMING FLIGHT SYMBOL OVER WHICH THE WORDS "FLYT NATION" ARE WRITTEN.

FOR PRODUCTION OF SOUND RECORDINGS; SOUND RECORDING STUDIOS; EDITING OR RECORDING OF SOUNDS AND IMAGES; VIDEO RECORDING SERVICES (U.S. CLS. 100, 101 AND 107).

ANDREW LEASER, EXAMINING ATTORNEY

SN 85-539,332. THE GENERAL HOSPITAL CORPORATION, BOSTON, MA. FILED 2-10-2012.

PRIMARY CARE INSIGHT

THE MARK CONSISTS OF STANDARD CHARACTERS WITHOUT CLAIM TO ANY PARTICULAR FONT, STYLE, SIZE, OR COLOR.

NO CLAIM IS MADE TO THE EXCLUSIVE RIGHT TO USE "PRIMARY CARE", APART FROM THE MARK AS SHOWN.

FOR ON-LINE ELECTRONIC NEWSLETTERS DELIVERED BY E-MAIL IN THE FIELD OF PRIMARY HEALTH CARE; PROVIDING ON-LINE NEWSLETTERS IN THE FIELD OF PRIMARY HEALTH CARE; PROVIDING ON-LINE PUBLICATIONS IN THE NATURE OF ARTICLES AND REPORTS IN THE FIELD OF PRIMARY HEALTH CARE (U.S. CLS. 100, 101 AND 107).

FIRST USE 1-0-2012; IN COMMERCE 1-0-2012.
ANDREW LEASER, EXAMINING ATTORNEY

CLASS 41—(Continued).

SN 85-539,684. THE JOYCE HAWKINS COMPANY, LLC, ATLANTA, GA. FILED 2-10-2012.

TEAM BREEZY

THE MARK CONSISTS OF STANDARD CHARACTERS WITHOUT CLAIM TO ANY PARTICULAR FONT, STYLE, SIZE, OR COLOR.

FOR FAN CLUBS; PROVIDING A WEB SITE FEATURING FAN CLUB INFORMATION; PROVIDING A WEB SITE THAT FEATURES INFORMATION ON MUSIC, ENTERTAINMENT, TELEVISION, FILM, THE ARTS, FASHION, LIFESTYLES, CULTURE, TECHNOLOGY, EMERGING BRANDS, SOCIAL ISSUES AND POLITICS; RECORD PRODUCTION; MUSIC PRODUCTION; AUDIO RECORDING AND PRODUCTION; VIDEOTAPE PRODUCTION; MOTION PICTURE SONG PRODUCTION; PRODUCTION OF VIDEO DISCS FOR OTHERS; RECORDING STUDIOS; ENTERTAINMENT SERVICES, NAMELY, PRODUCING MUSICAL AUDIO AND VIDEO PROGRAMS; DISTRIBUTION OF MUSICAL AND AUDIO AND VIDEO PROGRAMS; MUSIC COMPOSITION AND TRANSCRIPTION FOR OTHERS; SONG WRITING SERVICES; MUSIC PUBLISHING SERVICES; ENTERTAINMENT IN THE NATURE OF LIVE PERFORMANCES BY A MUSICAL ARTIST, MUSICAL GROUP OR MUSICAL BAND; ENTERTAINMENT IN THE NATURE OF VISUAL AND AUDIO PERFORMANCES BY A MUSICAL ARTIST, MUSICAL GROUP AND MUSICAL BAND; ENTERTAINMENT, NAMELY, LIVE MUSIC CONCERTS; ENTERTAINMENT, NAMELY, PERSONAL APPEARANCES BY A MUSICIAN, MUSICAL GROUP, MUSICAL BAND, ENTERTAINER, ACTOR OR CELEBRITY; ENTERTAINMENT SERVICES, NAMELY, PROVIDING A WEB SITE FEATURING MUSICAL PERFORMANCES, MUSICAL VIDEOS, RELATED FILM CLIPS, AND PHOTOGRAPHS; ENTERTAINMENT SERVICES, NAMELY, PROVIDING PRERECORDED MUSIC, INFORMATION IN THE FIELD OF MUSIC, COMMENTARY AND ARTICLES ABOUT MUSIC, ALL ONLINE VIA A GLOBAL COMPUTER NETWORK; PRODUCTION OF TELEVISION AND RADIO PROGRAMS; RADIO ENTERTAINMENT PRODUCTION; MOTION PICTURE FILM PRODUCTION; ENTERTAINMENT IN THE NATURE OF ON-GOING TELEVISION, CABLE TELEVISION AND RADIO PROGRAMS FEATURING MUSIC, BEAUTY, FASHION, LIFESTYLES, CULTURE, TECHNOLOGY, EMERGING BRANDS, SOCIAL ISSUES, POLITICS, COMEDY, DRAMATIC ACTS, AND SPOKEN WORD; ENTERTAINMENT SERVICES, NAMELY, PROVIDING TELEVISION AND CABLE TELEVISION PROGRAMS FEATURING MUSIC, ENTERTAINMENT, FASHION, LIFESTYLES, CULTURE, TECHNOLOGY, EMERGING BRANDS, SOCIAL ISSUES, POLITICS, COMEDY, DRAMA, DRAMEDY, AND SPOKEN WORD; PROVIDING A VARIETY SHOW DISTRIBUTED OVER TELEVISION, CABLE TELEVISION, RADIO, SATELLITE, AUDIO AND VIDEO MEDIA; ENTERTAINMENT, NAMELY, A CONTINUING VARIETY AND MUSICAL SHOW BROADCAST OVER TELEVISION, SATELLITE, THE INTERNET, AUDIO AND VIDEO MEDIA; ENTERTAINMENT IN THE NATURE OF THEATER PRODUCTION; ENTERTAINMENT IN THE NATURE OF TRAVELING TOURS FEATURING MUSIC, DRAMA, AND SPOKEN WORD; ENTERTAINMENT SERVICES, NAMELY, PROVIDING AN ON-LINE COMPUTER GAME; PROVIDING A COMPUTER GAME THAT MAY BE ACCESSED NETWORK-WIDE BY NETWORK USERS (U.S. CLS. 100, 101 AND 107).

JILL PRATER, EXAMINING ATTORNEY

CLASS 41—(Continued).

SN 85-539,717. PICTOMETRY INTERNATIONAL CORP., ROCHESTER, NY. FILED 2-10-2012.



THE MARK CONSISTS OF THE LETTER "P" AND FOUR COLORED GEOMETRIC SHAPES. THE GEOMETRIC SHAPES ARE POSITIONED AROUND THE LEFT PORTION OF THE "P".

FOR DIGITAL IMAGING SERVICES; AERIAL IMAGERY SERVICES; EDUCATIONAL SERVICES, NAMELY, CONDUCTING CONFERENCES AND WORKSHOPS IN THE FIELD OF GEO-REFERENCED, ORTHOGONAL, AND OBLIQUE AERIAL IMAGING (U.S. CLS. 100, 101 AND 107).

FIRST USE 10-22-2011; IN COMMERCE 10-22-2011.
HENRY S. ZAK, EXAMINING ATTORNEY

SN 85-539,762. MAMA'S BLACK SHEEP, AKA LAURA J. CERULLI AND M. ASHLAND MILLER, BALTIMORE, MD. FILED 2-10-2012.

Mama's Black Sheep

THE MARK CONSISTS OF STANDARD CHARACTERS WITHOUT CLAIM TO ANY PARTICULAR FONT, STYLE, SIZE, OR COLOR.

FOR ENTERTAINMENT SERVICES IN THE NATURE OF LIVE MUSICAL PERFORMANCES (U.S. CLS. 100, 101 AND 107).

FIRST USE 10-24-2008; IN COMMERCE 10-24-2008.
REBECCA GILBERT, EXAMINING ATTORNEY

CLASS 41—(Continued).

SN 85-539,802. JACKSON FAMILY FARMS, LLC, SANTA ROSA, CA. FILED 2-10-2012.

HISTORY IN A GLASS

THE MARK CONSISTS OF STANDARD CHARACTERS WITHOUT CLAIM TO ANY PARTICULAR FONT, STYLE, SIZE, OR COLOR.

FOR ENTERTAINMENT SERVICES, NAMELY, WINE TASTINGS (U.S. CLS. 100, 101 AND 107).
FIRST USE 10-1-2009; IN COMMERCE 10-1-2009.
PAM WILLIS, EXAMINING ATTORNEY

CLASS 41—(Continued).

SN 85-540,046. HARRIS, MARK A., DBA RAW TALENT SPORTS, SHAKER HEIGHTS, OH. FILED 2-10-2012.

RAW TALENT

THE MARK CONSISTS OF STANDARD CHARACTERS WITHOUT CLAIM TO ANY PARTICULAR FONT, STYLE, SIZE, OR COLOR.

FOR ATHLETIC TRAINING SERVICES; SPORTS TRAINING SERVICES (U.S. CLS. 100, 101 AND 107).
KIM MONINGHOFF, EXAMINING ATTORNEY

SN 85-540,011. INTERNATIONAL UNIVERSITY OF NORTH AMERICA, INC., SANTA CLARA, CA. FILED 2-10-2012.

IUNA

THE MARK CONSISTS OF STANDARD CHARACTERS WITHOUT CLAIM TO ANY PARTICULAR FONT, STYLE, SIZE, OR COLOR.

FOR EDUCATION SERVICES, NAMELY, PROVIDING ON-LINE CLASSES IN THE FIELD OF BUSINESS AND MANAGEMENT, EDUCATION, HEALTHCARE ADMINISTRATION, AND INFORMATION TECHNOLOGY; EDUCATIONAL SERVICES, NAMELY, CONDUCTING DISTANCE LEARNING INSTRUCTION AT THE UNIVERSITY LEVEL; EDUCATIONAL SERVICES, NAMELY, CONDUCTING ONLINE MASTER'S DEGREE AND CONTINUING EDUCATION CLASSES IN THE FIELDS OF BUSINESS AND MANAGEMENT, EDUCATION, HEALTHCARE ADMINISTRATION, AND INFORMATION TECHNOLOGY AND DISTRIBUTION OF TRAINING MATERIALS IN CONNECTION THEREWITH (U.S. CLS. 100, 101 AND 107).

FIRST USE 1-23-2012; IN COMMERCE 1-23-2012.
APRIL ROACH, EXAMINING ATTORNEY

SN 85-540,086. BERNARD, A SEBASTIAN, NEW YORK, NY. FILED 2-10-2012.

Vital Movement

THE MARK CONSISTS OF STANDARD CHARACTERS WITHOUT CLAIM TO ANY PARTICULAR FONT, STYLE, SIZE, OR COLOR.

FOR PHYSICAL FITNESS INSTRUCTION AND CONSULTATION WORKSHOPS AND CLASSES WITH EMPHASIS ON THE INTEGRATION OF MENTAL AND PHYSICAL AWARENESS (U.S. CLS. 100, 101 AND 107).
FIRST USE 3-24-2001; IN COMMERCE 3-24-2001.
ZACHARY BELLO, EXAMINING ATTORNEY

SN 85-540,033. CANTRELL, LAURA, ISSAQUAH, WA. FILED 2-10-2012.

Schendo

THE MARK CONSISTS OF STANDARD CHARACTERS WITHOUT CLAIM TO ANY PARTICULAR FONT, STYLE, SIZE, OR COLOR.

FOR PHYSICAL FITNESS INSTRUCTION (U.S. CLS. 100, 101 AND 107).
LAURIE KAUFMAN, EXAMINING ATTORNEY

SN 85-540,099. DREAMMAKERS MEDIA, INC., BEVERLY HILLS, CA. FILED 2-10-2012.

UNDENIABLE

THE MARK CONSISTS OF STANDARD CHARACTERS WITHOUT CLAIM TO ANY PARTICULAR FONT, STYLE, SIZE, OR COLOR.

FOR ENTERTAINMENT INFORMATION; ENTERTAINMENT SERVICES IN THE NATURE OF AN ONGOING REALITY BASED TELEVISION PROGRAM; ENTERTAINMENT SERVICES, NAMELY, THE PROVISION OF CONTINUING PROGRAMS FEATURING CAREER ADVICE AND DEVELOPMENT DELIVERED BY THE INTERNET AND AT A PHYSICAL LOCATION (U.S. CLS. 100, 101 AND 107).
CHRISTINE MARTIN, EXAMINING ATTORNEY

CLASS 41—(Continued).

SN 85-540,102. DAN V. OLSON, HUNTINGTON BEACH, CA. FILED 2-10-2012.

BoomerFit

THE MARK CONSISTS OF STANDARD CHARACTERS WITHOUT CLAIM TO ANY PARTICULAR FONT, STYLE, SIZE, OR COLOR.

FOR PERSONAL FITNESS TRAINING SERVICES AND CONSULTANCY; PHYSICAL FITNESS CONSULTATION; PROVIDING ASSISTANCE, PERSONAL TRAINING AND PHYSICAL FITNESS CONSULTATION TO CORPORATE CLIENTS TO HELP THEIR EMPLOYEES MAKE PHYSICAL FITNESS, STRENGTH, CONDITIONING, AND EXERCISE ALTERATIONS IN THEIR DAILY LIVING; PROVIDING ASSISTANCE, PERSONAL TRAINING AND PHYSICAL FITNESS CONSULTATION TO INDIVIDUALS TO HELP THEM MAKE PHYSICAL FITNESS, STRENGTH, CONDITIONING, AND EXERCISE IMPROVEMENT IN THEIR DAILY LIVING (U.S. CLS. 100, 101 AND 107).

LINDA E. BLOHM, EXAMINING ATTORNEY

SN 85-540,199. GOLDBERG, JACKIE, AKA THE PINK LADY, WOODLAND HILLS, CA. FILED 2-11-2012.

Rockin' with the Ages

THE MARK CONSISTS OF STANDARD CHARACTERS WITHOUT CLAIM TO ANY PARTICULAR FONT, STYLE, SIZE, OR COLOR.

FOR ENTERTAINMENT IN THE NATURE OF VISUAL AND AUDIO PERFORMANCES, AND MUSICAL, VARIETY, NEWS AND COMEDY SHOWS; ENTERTAINMENT, NAMELY, LIVE MUSIC CONCERTS; ENTERTAINMENT, NAMELY, PRODUCTION OF MUSICAL SHOWS (U.S. CLS. 100, 101 AND 107).

FIRST USE 7-1-2009; IN COMMERCE 7-1-2009.
ASMAT KHAN, EXAMINING ATTORNEY

SN 85-540,336. SSP ENTERPRISES - AYS, L.L.C., GLENDALE, AZ. FILED 2-11-2012.

NYS

THE MARK CONSISTS OF STANDARD CHARACTERS WITHOUT CLAIM TO ANY PARTICULAR FONT, STYLE, SIZE, OR COLOR.

FOR AMATEUR YOUTH SPORTS SERVICES, NAMELY, ORGANIZING AND PROVIDING YOUTH SPORTS ACTIVITIES (U.S. CLS. 100, 101 AND 107).

FIRST USE 2-1-2010; IN COMMERCE 2-1-2010.
GRETTA YAO, EXAMINING ATTORNEY

CLASS 41—(Continued).

SN 85-540,340. SSP ENTERPRISES - AYS, L.L.C., GLENDALE, AZ. FILED 2-11-2012.



THE MARK CONSISTS OF THE LETTERS "NYS" IN OUTLINED BLOCK LETTER FORM.

FOR AMATEUR YOUTH SPORTS SERVICES, NAMELY, ORGANIZING AND PROVIDING YOUTH SPORTS ACTIVITIES (U.S. CLS. 100, 101 AND 107).

FIRST USE 2-1-2010; IN COMMERCE 2-1-2010.
GRETTA YAO, EXAMINING ATTORNEY

SN 85-540,468. JENSEN, TROY, LOS ANGELES, CA. FILED 2-12-2012.

BEAUTY OR BUST

THE MARK CONSISTS OF STANDARD CHARACTERS WITHOUT CLAIM TO ANY PARTICULAR FONT, STYLE, SIZE, OR COLOR.

FOR ENTERTAINMENT SERVICES, NAMELY, PROVIDING A WEB SITE FEATURING PHOTOGRAPHIC, AUDIO, VIDEO AND PROSE PRESENTATIONS FEATURING THE PRODUCTION AND DISTRIBUTION OF A "REALITY" TELEVISION SHOW AND MOVIE; PLANNING ARRANGEMENT OF SHOWING MOVIES, SHOWS, PLAYS OR DRAMATIC PERFORMANCES; DIRECTION OF MAKING MOTION PICTURES AND TELEVISION PROGRAMS; ENTERTAINMENT IN THE NATURE OF A SERIES OF AN ON-GOING "REALITY" TELEVISION PROGRAM FEATURING DRAMA, COMEDY AND COMPETITION BETWEEN MAKE-UP ARTISTS AND FASHION PHOTOGRAPHERS (U.S. CLS. 100, 101 AND 107).

ALICE BENMAMAN, EXAMINING ATTORNEY

CLASS 41—(Continued).

SN 85-540,824. WALLSTREETPILOT, CHAPEL HILL, NC. FILED 2-13-2012.

WallStreetPilot

THE MARK CONSISTS OF STANDARD CHARACTERS WITHOUT CLAIM TO ANY PARTICULAR FONT, STYLE, SIZE, OR COLOR.

FOR PROVIDING ON-LINE NEWSLETTERS IN THE FIELD OF STOCK MARKET CONDITIONS (U.S. CLS. 100, 101 AND 107).

JENNIFER VASQUEZ, EXAMINING ATTORNEY

SN 85-549,996. MAJOR LEAGUE LACROSSE LLC, BOSTON, MA. FILED 2-22-2012.

PHILADELPHIA BARRAGE

THE MARK CONSISTS OF STANDARD CHARACTERS WITHOUT CLAIM TO ANY PARTICULAR FONT, STYLE, SIZE, OR COLOR.

OWNER OF U.S. REG. NOS. 3,112,401, 3,159,591 AND OTHERS.

NO CLAIM IS MADE TO THE EXCLUSIVE RIGHT TO USE "PHILADELPHIA", APART FROM THE MARK AS SHOWN.

FOR ENTERTAINMENT IN THE NATURE OF LACROSSE GAMES, COMPETITIONS AND TOURNAMENTS; ENTERTAINMENT, NAMELY, PARTICIPATION IN LACROSSE GAMES AND COMPETITIONS; CONDUCTING ENTERTAINMENT EXHIBITIONS IN THE NATURE OF LACROSSE GAMES AND COMPETITIONS; ORGANIZING EXHIBITIONS FOR THE SPORT OF LACROSSE; PROVIDING FACILITIES FOR LACROSSE TOURNAMENTS; ARRANGING AND CONDUCTING ATHLETIC COMPETITIONS FOR THE SPORT OF LACROSSE; ENTERTAINMENT IN THE NATURE ON-GOING TELEVISION PROGRAMS IN THE FIELD OF SPORTING EVENTS FEATURING LACROSSE; ENTERTAINMENT, NAMELY, A CONTINUING SPORTS EVENT SHOW FEATURING LACROSSE DISTRIBUTED OVER TELEVISION, SATELLITE, AUDIO AND VIDEO MEDIA; ENTERTAINMENT SERVICES, NAMELY, PROVIDING A CONTINUING TELEVISION PROGRAM FEATURING SPORTING EVENTS FEATURING LACROSSE VIA A GLOBAL COMPUTER NETWORK; PROVIDING AN ON-LINE COMPUTER DATABASE IN THE FIELD OF LACROSSE; ENTERTAINMENT SERVICES, NAMELY, PROVIDING A WEB SITE FEATURING SPORTS INFORMATION PERTAINING TO LACROSSE GOODS AND SERVICES (U.S. CLS. 100, 101 AND 107).

ELLEN B. AWRICH, EXAMINING ATTORNEY

CLASS 41—(Continued).

SN 85-558,105. HANNA-BARBERA PRODUCTIONS, INC., BURBANK, CA. FILED 3-1-2012.

PENELOPE PITSTOP

THE MARK CONSISTS OF STANDARD CHARACTERS WITHOUT CLAIM TO ANY PARTICULAR FONT, STYLE, SIZE, OR COLOR.

FOR ENTERTAINMENT SERVICES IN THE NATURE OF LIVE-ACTION, COMEDY, DRAMA, ANIMATED, AND REALITY TELEVISION SERIES; PRODUCTION OF LIVE-ACTION, COMEDY, DRAMA, ANIMATED AND REALITY TELEVISION SERIES; DISTRIBUTION AND DISPLAY OF LIVE-ACTION, COMEDY, DRAMA AND ANIMATED MOTION PICTURE THEATRICAL FILMS; PRODUCTION OF LIVE-ACTION, COMEDY, DRAMA AND ANIMATED MOTION PICTURE THEATRICAL FILMS; THEATRICAL PERFORMANCES BOTH ANIMATED AND LIVE ACTION; INTERNET SERVICES PROVIDING INFORMATION VIA AN ELECTRONIC GLOBAL COMPUTER NETWORK IN THE FIELD OF ENTERTAINMENT RELATING SPECIFICALLY TO MOVIES, AND TELEVISION; PROVIDING NEWS ABOUT CURRENT EVENTS AND ENTERTAINMENT, AND INFORMATION RELATED TO EDUCATION AND CULTURAL EVENTS, VIA A GLOBAL COMPUTER NETWORK; AND PROVIDING INFORMATION FOR AND ACTUAL ENTERTAINMENT VIA AN ELECTRONIC GLOBAL COMMUNICATIONS NETWORK IN THE NATURE OF LIVE-ACTION, COMEDY, DRAMA AND ANIMATED PROGRAMS AND PRODUCTION OF LIVE-ACTION, COMEDY, DRAMA AND ANIMATED MOTION PICTURE FILMS FOR DISTRIBUTION VIA A GLOBAL COMPUTER NETWORK; MULTIMEDIA ENTERTAINMENT SERVICES IN THE NATURE OF RECORDING, PRODUCTION AND POST-PRODUCTION SERVICES IN THE FIELDS OF MUSIC, VIDEO AND FILMS; ANIMATION PRODUCTION SERVICES; AND SPECIAL EFFECT ANIMATION SERVICES FOR FILM AND VIDEO (U.S. CLS. 100, 101 AND 107).

PAM WILLIS, EXAMINING ATTORNEY

SN 85-559,267. KAMMER, CHRIS, MIDDLETON, WI. FILED 3-2-2012.

Get Out the Brush

THE MARK CONSISTS OF STANDARD CHARACTERS WITHOUT CLAIM TO ANY PARTICULAR FONT, STYLE, SIZE, OR COLOR.

FOR EDUCATIONAL SERVICES, NAMELY, TRAINING PEOPLE ON PROPER DENTAL CARE (U.S. CLS. 100, 101 AND 107).

KATHERINE CHANG, EXAMINING ATTORNEY

CLASS 41—(Continued).

SN 85-562,366. HARPER, WENDY, COLUMBIA, MD. FILED 3-7-2012.



NO CLAIM IS MADE TO THE EXCLUSIVE RIGHT TO USE "HEALING" AND "FOUR ELEMENTS SHAMANIC HEALING", APART FROM THE MARK AS SHOWN.

THE COLOR(S) GREEN, BLUE, WHITE AND INDIGO IS/ ARE CLAIMED AS A FEATURE OF THE MARK.

THE MARK CONSISTS OF A CIRCULAR FLOWER DESIGN WITH THE WORDING "HUNABKU" CENTERED BELOW IT AND THE WORD "HEALING" CENTERED BELOW THE WORD "HUNABKU" WHERE THE WORDS "HUNABKU" AND "HEALING" SHARE THE SAME LETTER "H". THE WORDING "HUNABKU HEALING" APPEARS IN BLUE FADING INTO INDIGO FROM TOP TO BOTTOM. THE WORDING "FOUR ELEMENTS SHAMANIC HEALING" APPEARS IN BLUE CENTERED BELOW THE LETTERS "HEALIN" IN THE WORDING "HEALING". THE CENTER OF THE FLOWER DESIGN CONTAINS A GREEN AND WHITE SWIRL AND DIAGONAL LINE DESIGN. THERE IS A BLUE BORDER AROUND THE CENTER CIRCLE. THERE ARE SIX ROWS OF WHITE PETALS WHICH ARE OUTLINED IN DIFFERENT COLORS EXTENDING OUTWARD FROM THE CENTER CIRCLE. THE FIRST ROW IS BLUE, THE SECOND IS LIGHT GREEN, THE THIRD ROW IS BLUE, THE FOURTH ROW IS INDIGO, THE FIFTH ROW IS BLUE AND SIXTH ROW IS GREEN.

FOR EDUCATION AND ENTERTAINMENT SERVICES, NAMELY, WORKSHOPS, CLASSES, AND SEMINARS IN THE FIELD OF HOLISTIC HEALING (U.S. CLS. 100, 101 AND 107).

FIRST USE 1-1-2012; IN COMMERCE 1-1-2012.

TINA BROWN, EXAMINING ATTORNEY

SN 85-562,777. CELGENE CORPORATION, SUMMIT, NJ. FILED 3-7-2012.

S.T.E.P.S.

OWNER OF U.S. REG. NO. 2,463,707.

THE MARK CONSISTS OF "S" PERIOD "T" PERIOD "E" PERIOD "P" PERIOD "S" PERIOD ALL IN ITALICS.

FOR EDUCATIONAL CLASSES AND PROGRAMS IN THE FIELD OF THALIDOMIDE AND SAFETY ISSUES PERTAINING TO THALIDOMIDE, AND DISTRIBUTION OF WRITTEN MATERIALS THEREWITH (U.S. CLS. 100, 101 AND 107).

FIRST USE 9-29-1998; IN COMMERCE 9-29-1998.

KELLY TRUSILO, EXAMINING ATTORNEY

CLASS 41—(Continued).

SN 85-564,920. WALLACE III, CLIFFORD, SOUTHFIELD, MI. FILED 3-9-2012.

PRO SPECS

THE MARK CONSISTS OF STANDARD CHARACTERS WITHOUT CLAIM TO ANY PARTICULAR FONT, STYLE, SIZE, OR COLOR.

FOR ENTERTAINMENT SERVICES, NAMELY, AN ON-GOING SERIES FEATURING AMATEUR AND PROFESSIONAL ATHLETES PROVIDED THROUGH CABLE TELEVISION AND WEBCASTS (U.S. CLS. 100, 101 AND 107).

APRIL ROACH, EXAMINING ATTORNEY

SN 85-566,178. SUMMIT ENTERTAINMENT, LLC, SANTA MONICA, CA. FILED 3-10-2012.

SUMMIT MUSIC PUBLISHING

THE MARK CONSISTS OF STANDARD CHARACTERS WITHOUT CLAIM TO ANY PARTICULAR FONT, STYLE, SIZE, OR COLOR.

OWNER OF U.S. REG. NOS. 2,097,423, 3,756,889 AND OTHERS.

NO CLAIM IS MADE TO THE EXCLUSIVE RIGHT TO USE "MUSIC PUBLISHING", APART FROM THE MARK AS SHOWN.

FOR MUSIC PUBLISHING SERVICES (U.S. CLS. 100, 101 AND 107).

FIRST USE 1-6-2009; IN COMMERCE 1-6-2009.

MAUREEN DALL, EXAMINING ATTORNEY

SN 85-570,592. GREENBRIER IA, INC., WHITE SULPHUR SPRING, WV. FILED 3-15-2012.

The Greenbrier Golf Academy

THE MARK CONSISTS OF STANDARD CHARACTERS WITHOUT CLAIM TO ANY PARTICULAR FONT, STYLE, SIZE, OR COLOR.

OWNER OF U.S. REG. NOS. 1,482,046, 1,633,507 AND OTHERS.

NO CLAIM IS MADE TO THE EXCLUSIVE RIGHT TO USE "GOLF ACADEMY", APART FROM THE MARK AS SHOWN.

FOR FITTING OF GOLF CLUBS TO INDIVIDUAL USERS; GOLF DRIVING RANGE SERVICES; GOLF FITNESS INSTRUCTION; GOLF INSTRUCTION; PROVIDING A WEBSITE FEATURING INFORMATION ON GOLF AND GOLF INSTRUCTION; PROVIDING GOLF FACILITIES (U.S. CLS. 100, 101 AND 107).

FIRST USE 3-1-2008; IN COMMERCE 3-1-2008.

MATTHEW MCDOWELL, EXAMINING ATTORNEY

CLASS 41—(Continued).

SN 85-571,313. SAIDI, AISHA, DBA WORD TECHNOLOGY, HIRAM, ME. FILED 3-16-2012.

Word Technology

THE MARK CONSISTS OF STANDARD CHARACTERS WITHOUT CLAIM TO ANY PARTICULAR FONT, STYLE, SIZE, OR COLOR.

FOR CUSTOM WRITING SERVICES (U.S. CLS. 100, 101 AND 107).

FIRST USE 7-5-2011; IN COMMERCE 8-8-2011.
DARRYL SPRULL, EXAMINING ATTORNEY

CLASS 41—(Continued).

SN 85-576,656. AMERICAN COUNCIL ON EDUCATION, WASHINGTON, DC. FILED 3-22-2012.

ACE FELLOWS
Program

OWNER OF U.S. REG. NOS. 2,484,476, 3,495,340 AND OTHERS.

NO CLAIM IS MADE TO THE EXCLUSIVE RIGHT TO USE "FELLOWS PROGRAM", APART FROM THE MARK AS SHOWN.

THE MARK CONSISTS OF THE WORDING "ACE FELLOWS PROGRAM", WITH A CURVING HORIZONTAL LINE BETWEEN "ACE FELLOWS" AND "PROGRAM".

FOR EDUCATIONAL SERVICES, NAMELY, CONDUCTING PROGRAMS IN THE FIELD OF PREPARING SENIOR LEADERS TO SERVE AMERICAN COLLEGES AND UNIVERSITIES (U.S. CLS. 100, 101 AND 107).

PRISCILLA MILTON, EXAMINING ATTORNEY

SN 85-576,931. RUCKUS MEDIA GROUP, INC., WILTON, CT. FILED 3-22-2012.

VIDREADER

THE MARK CONSISTS OF STANDARD CHARACTERS WITHOUT CLAIM TO ANY PARTICULAR FONT, STYLE, SIZE, OR COLOR.

FOR PUBLICATION OF ELECTRONIC BOOKS DISTRIBUTED TO MOBILE AND NON-MOBILE MEDIA DEVICES FEATURING VIDEO, TEXT, GAMES, AND ILLUSTRATIONS (U.S. CLS. 100, 101 AND 107).

SOPHIA S. KIM, EXAMINING ATTORNEY

SN 85-575,265. NEVER QUIT NEVER LLC, ATLANTIC BEACH, FL. FILED 3-21-2012.

TRIDENT

THE MARK CONSISTS OF STANDARD CHARACTERS WITHOUT CLAIM TO ANY PARTICULAR FONT, STYLE, SIZE, OR COLOR.

FOR AMATEUR YOUTH SPORTS SERVICES, NAMELY, ORGANIZING AND PROVIDING YOUTH SPORTS ACTIVITIES; ATHLETIC AND SPORTS EVENT SERVICES, NAMELY, ARRANGING, ORGANIZING, OPERATING AND CONDUCTING MARATHON RACES; ENTERTAINMENT IN THE NATURE OF SPORTING AND PHYSICAL FITNESS GAMES; ORGANISATION OF SPORTS COMPETITIONS; ORGANIZATION OF SPORTS COMPETITIONS; ORGANIZING COMMUNITY FESTIVALS FEATURING A VARIETY OF ACTIVITIES, NAMELY, SPORTING EVENTS, ART EXHIBITIONS, FLEA MARKETS, ETHNIC DANCES AND THE LIKE; ORGANIZING SPORTING EVENTS, NAMELY, TRIATHLONS; ORGANIZING SPORTING EVENTS, NAMELY, RUNNING, SWIMMING, WALKING, HIKING, PADDLING, BIKING, BICYCLING, PULL UPS, PUSH UPS, PULL UPS, LOW CRAWL; ORGANIZING, ARRANGING, AND CONDUCTING SPORTING EVENTS; PROVIDING A WEB SITE FEATURING SPORTING INFORMATION; PROVIDING A WEBSITE FEATURING INFORMATION RELATING TO THE SPORT OF RUNNING, SWIMMING, PADDLING, BICYCLING, WALKING, PUSH UPS, PULL UPS, SIT UPS, LOW CRAWLS (U.S. CLS. 100, 101 AND 107).

FIRST USE 4-29-2007; IN COMMERCE 4-30-2007.
GINA HAYES, EXAMINING ATTORNEY

SN 85-582,780. WESTERN PROFESSIONAL HOCKEY LEAGUE INC., GLENDALE, AZ. AND CENTRAL HOCKEY LEAGUE, INC., TULSA, OK. FILED 3-28-2012.

CHL2

THE MARK CONSISTS OF STANDARD CHARACTERS WITHOUT CLAIM TO ANY PARTICULAR FONT, STYLE, SIZE, OR COLOR.

FOR CONDUCTING ENTERTAINMENT EXHIBITIONS IN THE NATURE OF HOCKEY MATCHES; ENTERTAINMENT IN THE NATURE OF HOCKEY GAMES; ENTERTAINMENT SERVICES, NAMELY, ARRANGING AND CONDUCTING OF COMPETITIONS FOR HOCKEY (U.S. CLS. 100, 101 AND 107).

ELI HELLMAN, EXAMINING ATTORNEY

CLASS 41—(Continued).

SN 85-586,127. SOUTHERN CALIFORNIA PUBLIC RADIO, PASADENA, CA. FILED 4-2-2012.

BALANCE NOT BIAS

THE MARK CONSISTS OF STANDARD CHARACTERS WITHOUT CLAIM TO ANY PARTICULAR FONT, STYLE, SIZE, OR COLOR.

FOR PROVIDING ON-GOING RADIO SHOWS RELATING TO NEWS AND CURRENT EVENTS, BROADCAST OVER THE MEDIA OF RADIO AND VIA A GLOBAL COMPUTER NETWORK; PROVIDING ONLINE INFORMATION IN THE FIELDS OF NEWS AND CURRENT EVENTS (U.S. CLS. 100, 101 AND 107).

FIRST USE 1-0-2012; IN COMMERCE 1-0-2012.
JAY FLOWERS, EXAMINING ATTORNEY

SN 85-586,128. SOUTHERN CALIFORNIA PUBLIC RADIO, PASADENA, CA. FILED 4-2-2012.

IDEAS NOT IDEOLOGY

THE MARK CONSISTS OF STANDARD CHARACTERS WITHOUT CLAIM TO ANY PARTICULAR FONT, STYLE, SIZE, OR COLOR.

FOR PROVIDING ON-GOING RADIO SHOWS RELATING TO NEWS AND CURRENT EVENTS, BROADCAST OVER THE MEDIA OF RADIO AND VIA A GLOBAL COMPUTER NETWORK; PROVIDING ONLINE INFORMATION IN THE FIELDS OF NEWS AND CURRENT EVENTS (U.S. CLS. 100, 101 AND 107).

FIRST USE 1-0-2012; IN COMMERCE 1-0-2012.
JAY FLOWERS, EXAMINING ATTORNEY

SN 85-594,596. ADVISORS EXCEL, LLC, TOPEKA, KS. FILED 4-11-2012.

WORLD SERIES OF SALES

THE MARK CONSISTS OF STANDARD CHARACTERS WITHOUT CLAIM TO ANY PARTICULAR FONT, STYLE, SIZE, OR COLOR.

FOR TRAINING SERVICES IN THE FIELD OF INSURANCE FOR AGENTS (U.S. CLS. 100, 101 AND 107).

FIRST USE 7-1-2007; IN COMMERCE 7-1-2007.
KRISTINA MORRIS, EXAMINING ATTORNEY

CLASS 41—(Continued).

SN 85-595,616. AMERICAN EXPRESS MARKETING & DEVELOPMENT CORP., NEW YORK, NY. FILED 4-12-2012.

DEPARTURES BLACKBOOK TO GO

THE MARK CONSISTS OF STANDARD CHARACTERS WITHOUT CLAIM TO ANY PARTICULAR FONT, STYLE, SIZE, OR COLOR.

OWNER OF U.S. REG. NOS. 2,552,823, 3,728,250 AND OTHERS.

FOR PROVIDING ON-LINE MAGAZINES IN THE FIELD OF TRAVEL, FOOD, WINE, FASHION AND LIFESTYLE TOPICS (U.S. CLS. 100, 101 AND 107).

KIMBERLY FRYE, EXAMINING ATTORNEY

SN 85-976,493. BEYOND PILATES, LLC, DALLAS, TX. FILED 9-2-2011.



THE COLOR(S) TURQUOISE IS/ARE CLAIMED AS A FEATURE OF THE MARK.

THE MARK CONSISTS OF THE WORD "BEYOND" IN A TURQUOISE COLOR SUCH THAT THE LETTER "Y" IS UPSIDE DOWN AND THE LETTER "N" IS INVERTED.

FOR PROVIDING FITNESS AND EXERCISE STUDIO SERVICES, NAMELY, PILATES INSTRUCTION AND TRAINING; PHYSICAL FITNESS STUDIO SERVICES, NAMELY, PROVIDING GROUP EXERCISE INSTRUCTION, EQUIPMENT, AND FACILITIES; PROVIDING PHYSICAL FITNESS AND EXERCISE SERVICE, NAMELY, INDOOR CYCLING AND YOGA INSTRUCTION (U.S. CLS. 100, 101 AND 107).

FIRST USE 5-29-2010; IN COMMERCE 5-29-2010.
NORA BUCHANAN WILL, EXAMINING ATTORNEY

SN 85-976,529. LAYTON, MARK, LONG BEACH, CA. FILED 9-14-2010.



THE MARK CONSISTS OF STANDARD CHARACTERS WITHOUT CLAIM TO ANY PARTICULAR FONT, STYLE, SIZE, OR COLOR.

NO CLAIM IS MADE TO THE EXCLUSIVE RIGHT TO USE "AGILE", APART FROM THE MARK AS SHOWN.

FOR EDUCATION SERVICES, NAMELY, CONDUCTING TRAINING SEMINARS, WORKSHOPS AND CLASSES ALL IN THE FIELDS OF PROJECT MANAGEMENT, COMPUTER SOFTWARE DEVELOPMENT, AND PROJECT MANAGEMENT TRAINING (U.S. CLS. 100, 101 AND 107).

FIRST USE 1-5-2001; IN COMMERCE 1-7-2008.
BERYL GARDNER, EXAMINING ATTORNEY

CLASS 41—(Continued).

SN 85-976,810. WHERE'S IT @? MEDIA, LLC, ST. LOUIS, MO. FILED 8-2-2011.

WHERE'S IT @?

THE MARK CONSISTS OF STANDARD CHARACTERS WITHOUT CLAIM TO ANY PARTICULAR FONT, STYLE, SIZE, OR COLOR.

FOR BOOK PUBLISHING; PUBLICATION OF BOOKS AND OTHER PRINTED MATTER; ONLINE ELECTRONIC PUBLISHING OF BOOKS AND PERIODICALS; CHARITABLE SERVICES, NAMELY, PROVIDING BOOKS TO PEOPLE; CUSTOM WRITING SERVICES (U.S. CLS. 100, 101 AND 107).

FIRST USE 4-15-2010; IN COMMERCE 11-30-2010.
DAVID YONTEF, EXAMINING ATTORNEY

CLASS 42—SCIENTIFIC AND COMPUTER SERVICES

SN 77-931,114. DANCKER, SELLEW & DOUGLAS, INC., SOMERVILLE, NJ. FILED 2-9-2010.

PARAMOUNT FMS

THE MARK CONSISTS OF STANDARD CHARACTERS WITHOUT CLAIM TO ANY PARTICULAR FONT, STYLE, SIZE, OR COLOR.

FOR PLANNING AND LAYOUT DESIGN FOR THE INTERIOR SPACE OF OFFICES (U.S. CLS. 100 AND 101).
FIRST USE 1-20-2009; IN COMMERCE 3-1-2009.

ESTHER A. BORSUK, EXAMINING ATTORNEY

SN 77-931,127. DANCKER, SELLEW & DOUGLAS, INC., SOMERVILLE, NJ. FILED 2-9-2010.

PARAMOUNT FACILITY MANAGEMENT SOLUTIONS

THE MARK CONSISTS OF STANDARD CHARACTERS WITHOUT CLAIM TO ANY PARTICULAR FONT, STYLE, SIZE, OR COLOR.

NO CLAIM IS MADE TO THE EXCLUSIVE RIGHT TO USE "FACILITY MANAGEMENT SOLUTIONS", APART FROM THE MARK AS SHOWN.

FOR PLANNING AND LAYOUT DESIGN FOR THE INTERIOR SPACE OF OFFICES (U.S. CLS. 100 AND 101).
FIRST USE 1-20-2009; IN COMMERCE 3-1-2009.

ESTHER A. BORSUK, EXAMINING ATTORNEY

CLASS 42—(Continued).

SN 79-100,717. ALCATEL LUCENT, F-75007 PARIS, FRANCE, FILED 6-21-2011.

AT THE SPEED OF IDEAS

THE MARK CONSISTS OF STANDARD CHARACTERS WITHOUT CLAIM TO ANY PARTICULAR FONT, STYLE, SIZE, OR COLOR.

PRIORITY DATE OF 1-19-2011 IS CLAIMED.

OWNER OF INTERNATIONAL REGISTRATION 1085823 DATED 6-21-2011, EXPIRES 6-21-2021.

FOR ENGINEERING PROJECT STUDIES AND ENGINEERING SERVICES IN CONNECTION WITH TELECOMMUNICATIONS AND DATA PROCESSING; LEASING, DESIGN, INSTALLATION, UPDATING AND MAINTENANCE OF COMPUTER SOFTWARE; RENTAL OF DATA PROCESSING APPARATUS AND EQUIPMENT; DESIGN AND HOSTING OF INTERNET SITES (U.S. CLS. 100 AND 101).

LEIGH LOWRY, EXAMINING ATTORNEY

SN 79-101,599. EXPRIMM, F-78280 GUYANCOURT, FRANCE, FILED 7-11-2011.

HYPERVISION

OWNER OF INTERNATIONAL REGISTRATION 1088125 DATED 7-11-2011, EXPIRES 7-11-2021.

FOR TECHNICAL APPRAISALS AND DIAGNOSTICS PERFORMED BY TECHNICAL AND ENGINEERING SPECIALISTS IN ORDER TO DETERMINE, OPTIMIZE AND MONITOR OVER TIME THE ENERGY PERFORMANCE OF BUILDINGS; ENERGY CONSUMPTION FORECASTING SERVICES, NAMELY, EVALUATIONS, ESTIMATES AND RESEARCH IN THE FIELD OF THE ENERGY PERFORMANCE OF BUILDINGS PROVIDED BY ENGINEERS; ENGINEERING SERVICES IN CONNECTION WITH THE ENERGY PERFORMANCE OF BUILDINGS; TECHNICAL PROJECT STUDIES, NAMELY, TECHNICAL STUDIES IN THE FIELD OF ANALYZING AND ACCESSING THE ENERGY PERFORMANCE OF BUILDINGS; TECHNICAL INSPECTION SERVICES ENABLING CERTIFICATION AND EVALUATION IN CONNECTION WITH THE ENERGY PERFORMANCE OF BUILDINGS (U.S. CLS. 100 AND 101).

DAVID HOFFMAN, EXAMINING ATTORNEY

CLASS 42—(Continued).

SN 85-088,611. KUNYAR INSTITUTE, THE, WELLESLEY, MA. FILED S.R. 7-20-2010; AM. P.R. 3-30-2012.



NO CLAIM IS MADE TO THE EXCLUSIVE RIGHT TO USE "THE LIBRARY OF HEALTH", APART FROM THE MARK AS SHOWN.

THE MARK CONSISTS OF AN IMAGE OF A SHIELD WITH THE WORDING "THE LIBRARY OF HEALTH" CENTERED INSIDE THE SHIELD.

FOR PROVIDING A WEBSITE FEATURING INFORMATION ABOUT INVESTIGATIONAL MEDICAL DEVICES, DIAGNOSTIC TECHNOLOGY AND DRUGS; PROVIDING MEDICAL, AND SCIENTIFIC, AND BIOTECHNOLOGY RESEARCH INFORMATION IN THE FIELD OF PHARMACEUTICALS AND CLINICAL TRIALS; SOFTWARE AS A SERVICE (SAAS) SERVICES, NAMELY, HOSTING SOFTWARE FOR USE BY OTHERS FOR HEALTH OR HEALTH CARE RELATED DATABASE MANAGEMENT PROVIDED TO PATIENTS, DOCTORS, SCIENTISTS AND/OR THE GENERAL HEALTH CARE COMMUNITY (U.S. CLS. 100 AND 101).

FIRST USE 11-22-2011; IN COMMERCE 11-22-2011.
ANDREA K. NADELMAN, EXAMINING ATTORNEY

SN 85-199,059. BARNABAS FUND, INC., DBA BARNABAS AID, MCLEAN, VA. FILED 12-15-2010.

ISAAC PUBLISHING

THE MARK CONSISTS OF STANDARD CHARACTERS WITHOUT CLAIM TO ANY PARTICULAR FONT, STYLE, SIZE, OR COLOR.

NO CLAIM IS MADE TO THE EXCLUSIVE RIGHT TO USE "PUBLISHING", APART FROM THE MARK AS SHOWN.

FOR GRAPHIC DESIGN SERVICES; PROVIDING GRAPHIC AND MULTIMEDIA DESIGN SERVICES FOR THE PURPOSE OF PROMOTING THE GOODS AND SERVICES OF OTHERS; DESIGN AND CREATING WEB SITES FOR OTHERS; WEB SITE DESIGN (U.S. CLS. 100 AND 101).

FIRST USE 1-12-2007; IN COMMERCE 1-12-2007.
ROBIN CHOSID, EXAMINING ATTORNEY

CLASS 42—(Continued).

SN 85-236,673. MAXPOINT INTERACTIVE, INC., CARY, NC. FILED 2-8-2011.

MAXPOINT

THE MARK CONSISTS OF STANDARD CHARACTERS WITHOUT CLAIM TO ANY PARTICULAR FONT, STYLE, SIZE, OR COLOR.

FOR PROVIDING ONLINE NON-DOWNLOADABLE SOFTWARE FOR USE BY MEDIA BUYERS FOR USE IN IDENTIFYING TARGET AUDIENCES FOR ONLINE ADVERTISING CAMPAIGNS (U.S. CLS. 100 AND 101).

WENDY JUN, EXAMINING ATTORNEY

SN 85-256,540. THE GIRAFFE GROUP, ALEXANDRIA, VA. FILED 3-3-2011.



THE GIRAFFE GROUP LLC

NO CLAIM IS MADE TO THE EXCLUSIVE RIGHT TO USE "GROUP LLC", APART FROM THE MARK AS SHOWN.

THE MARK CONSISTS OF THE WORDING "THE GIRAFFE GROUP LLC" BELOW A TREE, A GIRAFFE STANDING BEHIND THE TREE, AND A HORIZONTAL LINE UNDER THE TREE AND THE GIRAFFE.

FOR IT CONSULTING SERVICES, CONSULTING SERVICES FOR BUSINESS-PROCESS AND WORKFLOW AUTOMATION, COMPUTER CONSULTING SERVICES IN THE FIELD OF INFORMATION TECHNOLOGY MANAGEMENT, CONSULTING SERVICES IN THE FIELD OF CLOUD COMPUTING, COMPUTER PROGRAMMING SERVICES (U.S. CLS. 100 AND 101).

FIRST USE 7-1-2001; IN COMMERCE 7-1-2001.
TINA MAI, EXAMINING ATTORNEY

CLASS 42—(Continued).

SN 85-267,147. JULINGTON CREEK PLANTATION PROPERTY OWNERS' ASSOCIATION, INC., ST JOHNS, FL. FILED 3-15-2011.



NO CLAIM IS MADE TO THE EXCLUSIVE RIGHT TO USE "JULINGTON CREEK", APART FROM THE MARK AS SHOWN.

THE MARK CONSISTS OF STYLIZED LETTERS "JC" IN A BOX BROKEN BY WAVY LINES WITH THE WORDS "JULINGTON CREEK PLANTATION" BELOW, AND A HORIZONTAL LINE APPEARING BELOW THE WORDING "JULINGTON CREEK", AND ABOVE "PLANTATION".

FOR ARCHITECTURAL CONSULTANCY, NAMELY, ARCHITECTURAL REVIEW AND APPROVAL SERVICES (U.S. CLS. 100 AND 101).

FIRST USE 1-1-2000; IN COMMERCE 1-1-2000.
ALAIN LAPTER, EXAMINING ATTORNEY

SN 85-271,442. QUICK-CHECK, INC., PENSACOLA, FL. FILED 3-19-2011.



THE COLOR(S) TAN, GREEN, BLUE-GREEN, WHITE, AND BLACK IS/ARE CLAIMED AS A FEATURE OF THE MARK.

THE MARK CONSISTS OF A CARTOON DOLLAR SIGN WITH EYES, ARMS, LEGS DEPICTED IN A RUNNING MOTION. THE COLORS TAN AND GREEN APPEAR ON THE BODY, GLOVES, AND SHOES OF THE CARTOON CHARACTER DOLLAR. THE COLOR BLUE-GREEN APPEARS ON THE SHADING OF THE CARTOON CHARACTER DOLLAR. THE COLOR BLACK APPEARS ON THE OUTLINE AND THE EYES ON THE CARTOON CHARACTER DOLLAR. THE COLOR WHITE APPEARS ON THE EYES.

FOR COMPUTER CONSULTATION; TECHNOLOGICAL CONSULTATION IN THE TECHNOLOGY FIELD OF COMPUTER SOFTWARE FOR AUTOMATED CLEARING HOUSE PAYMENT PROCESSING; CUSTOMIZED SOFTWARE DEVELOPMENT SERVICES IN THE FIELD OF PROCESSING FINANCIAL TRANSACTIONS (U.S. CLS. 100 AND 101).

FIRST USE 4-21-2005; IN COMMERCE 4-21-2005.
CIMMERIAN COLEMAN, EXAMINING ATTORNEY

CLASS 42—(Continued).

SN 85-304,838. BESANG INC., BEAVERTON, OR. FILED 4-26-2011.

BESANG

THE MARK CONSISTS OF STANDARD CHARACTERS WITHOUT CLAIM TO ANY PARTICULAR FONT, STYLE, SIZE, OR COLOR.

FOR TECHNICAL CONSULTING IN THE FIELD OF RESEARCH AND DEVELOPMENT OF SEMICONDUCTOR DEVICES (U.S. CLS. 100 AND 101).

DAWN FELDMAN, EXAMINING ATTORNEY

SN 85-324,327. WRITE ABOUT ME, QUEENS, NY. FILED 5-18-2011.



THE MARK CONSISTS OF A ROUND SMILEY FACE TO THE LEFT OF THE LETTERING "WRITE ABOUT ME", AND ALL OF THE AFOREMENTIONED ABOVE THE WORDING "REAL STORIES FOR REAL PEOPLE".

FOR COMPUTER SERVICES, NAMELY, CREATING AN ON-LINE COMMUNITY FOR REGISTERED USERS TO PARTICIPATE IN DISCUSSIONS, SHARE STORIES THEY HAVE WRITTEN, GET FEEDBACK FROM THEIR PEERS, FORM VIRTUAL COMMUNITIES, AND ENGAGE IN SOCIAL NETWORKING (U.S. CLS. 100 AND 101).

TRACY CROSS, EXAMINING ATTORNEY

SN 85-330,979. ION GEOPHYSICAL CORPORATION, HOUSTON, TX. FILED 5-26-2011.

ION GEOPHYSICAL

THE MARK CONSISTS OF STANDARD CHARACTERS WITHOUT CLAIM TO ANY PARTICULAR FONT, STYLE, SIZE, OR COLOR.

NO CLAIM IS MADE TO THE EXCLUSIVE RIGHT TO USE "GEOPHYSICAL", APART FROM THE MARK AS SHOWN.

FOR GEOPHYSICAL ENGINEERING AND CONSULTING SERVICES; DESIGN AND PLANNING OF SEISMIC SURVEYS; AND SCIENTIFIC STUDY AND RESEARCH IN THE FIELDS OF OIL AND GAS EXPLORATION AND PRODUCTION OF OIL AND GAS (U.S. CLS. 100 AND 101).

FIRST USE 9-21-2007; IN COMMERCE 5-25-2011.
DAVID C. REIHNER, EXAMINING ATTORNEY

CLASS 42—(Continued).

SN 85-332,083. LTS SOFTWARE, INC., VIRGINIA BEACH, VA. FILED 5-27-2011.

ESMART TAX

THE MARK CONSISTS OF STANDARD CHARACTERS WITHOUT CLAIM TO ANY PARTICULAR FONT, STYLE, SIZE, OR COLOR.

OWNER OF U.S. REG. NO. 2,526,313.

NO CLAIM IS MADE TO THE EXCLUSIVE RIGHT TO USE "TAX", APART FROM THE MARK AS SHOWN.

SEC. 2(F).

FOR NON-DOWNLOADABLE COMPUTER FIRMWARE AND SOFTWARE USED TO PREPARE AND ELECTRONICALLY FILE INDIVIDUAL INCOME TAX RETURNS, 1040S, TAX SCHEDULES AND OTHER RELATED TAX FORMS WITH THE IRS OR OTHER GOVERNMENT AGENCIES (U.S. CLS. 100 AND 101).

FIRST USE 6-0-1998; IN COMMERCE 10-0-1998.

RAUL CORDOVA, EXAMINING ATTORNEY

SN 85-334,412. NOVATEK INC., PROVO, UT. FILED 5-31-2011.



THE COLOR(S) GREY, RED, AND NAVY BLUE IS/ARE CLAIMED AS A FEATURE OF THE MARK.

THE MARK CONSISTS OF NAVY BLUE BACKGROUND FADING UPWARDS TO GREY WITH RED COGS SUPERIMPOSED THEREON, GREY STYLIZED LETTERS COMPRISING THE LETTER "I", A CALIPER FORMING THE LETTER "C", A COMPASS FORMING THE LETTER "A" AND A PROTRACTOR FORMING THE LETTER "D" SUPERIMPOSED THEREON.

FOR PROVIDING TEMPORARY USE OF WEB-BASED SOFTWARE APPLICATIONS FOR MOBILE PHONES, LAPTOPS, NOTEBOOKS, NOTEPADS, NAMELY, USER INTERFACING SOFTWARE APPLICATIONS FOR VIEWING AND MANIPULATING COMPUTER ASSISTED DESIGNS AND 3D MODELS (U.S. CLS. 100 AND 101).

KIMBERLY PERRY, EXAMINING ATTORNEY

CLASS 42—(Continued).

SN 85-343,344. DYNAFLOW, INC., JESSUP, MD. FILED 6-10-2011.

PHANTOMCLOUD

THE MARK CONSISTS OF THE WORDS "PHANTOM-CLOUD" STYLIZED. THE "P" IN "PHANTOM" IS CAPITALIZED WITH THE REST "HANTOM" IS STYLIZED IN SMALL CAPS. THE "C" IN "CLOUD" IS CAPITALIZED WITH THE REST "LOUD" IS STYLIZED IN SMALL CAPS. THERE IS NO SPACE BETWEEN THE TWO WORDS "PHANTOM" AND "CLOUD".

FOR SOFTWARE AS A SERVICE (SAAS) SERVICES FEATURING SOFTWARE FOR COMPUTATIONAL FLUID DYNAMICS OF THE INTERACTION OF BUBBLE CLOUDS AND NEARBY STRUCTURES (U.S. CLS. 100 AND 101).

FIRST USE 7-29-2005; IN COMMERCE 11-9-2007.

ANN E. SAPPENFIELD, EXAMINING ATTORNEY

SN 85-348,165. PHARMERICA CORPORATION, LOUISVILLE, KY. FILED 6-16-2011.

PHARMERICA RXFORECASTER

THE MARK CONSISTS OF STANDARD CHARACTERS WITHOUT CLAIM TO ANY PARTICULAR FONT, STYLE, SIZE, OR COLOR.

OWNER OF U.S. REG. NOS. 2,304,597 AND 3,139,556.

FOR PROVIDING TEMPORARY USE OF ONLINE NON-DOWNLOADABLE COMPUTER SOFTWARE FOR USE BY HEALTH CARE INSTITUTIONS TO MANAGE PATIENT MEDICATION TREATMENT, USAGE, AND COST, PLACE MEDICATION ORDERS, AND PROVIDE INFORMATION, REPORTS, ORDERS, AND RECORDS RELATED TO PATIENT MEDICATION VIA ONLINE, TELEPHONIC AND FACSIMILE ADDRESS (U.S. CLS. 100 AND 101).

SANI KHOURI, EXAMINING ATTORNEY

SN 85-352,808. C.O.O.L. LLC, DBA PIMP MY KICKS, BEDFORD HEIGHTS, OH. FILED 6-22-2011.

Pimp My Kicks

THE MARK CONSISTS OF STANDARD CHARACTERS WITHOUT CLAIM TO ANY PARTICULAR FONT, STYLE, SIZE, OR COLOR.

NO CLAIM IS MADE TO THE EXCLUSIVE RIGHT TO USE "KICKS", APART FROM THE MARK AS SHOWN.

FOR CUSTOM DESIGN OF SNEAKER AND SHIRTS BASED ON PERSONAL SELECTIONS MADE BY THE CUSTOMER (U.S. CLS. 100 AND 101).

FIRST USE 6-1-2004; IN COMMERCE 6-1-2004.

SEAN CROWLEY, EXAMINING ATTORNEY

CLASS 42—(Continued).

SN 85-360,050. FAROOQ, ANWAR M, MONTCLAIR, CA. FILED 6-29-2011.

THE ZERO POLLUTION SOLUTION

THE MARK CONSISTS OF STANDARD CHARACTERS WITHOUT CLAIM TO ANY PARTICULAR FONT, STYLE, SIZE, OR COLOR.

NO CLAIM IS MADE TO THE EXCLUSIVE RIGHT TO USE "POLLUTION SOLUTION", APART FROM THE MARK AS SHOWN.

FOR PROVIDING INFORMATION IN THE FIELD OF GREEN AND ENVIRONMENTALLY-FRIENDLY VEHICLE TRANSPORTATION AND TRAFFIC PLANNING SOLUTIONS AND INNOVATIONS (U.S. CLS. 100 AND 101).

FIRST USE 0-0-2009; IN COMMERCE 0-0-2009.
WILLIAM VERHOSEK, EXAMINING ATTORNEY

SN 85-360,672. ADKNOWLEDGE, INC., KANSAS CITY, MO. FILED 6-30-2011.

SOCIAL2WEB

THE MARK CONSISTS OF STANDARD CHARACTERS WITHOUT CLAIM TO ANY PARTICULAR FONT, STYLE, SIZE, OR COLOR.

FOR PROVIDING TEMPORARY USE OF ONLINE NON-DOWNLOADABLE COMPUTER PROGRAMS FOR EMBEDDING GAMES AND APPLICATIONS INTO ONLINE FRAMEWORKS FOR RUNNING ON STANDALONE WEB PAGES, PORTAL SITES, OR OTHER PUBLISHERS WEBSITES, AND CONSULTING SERVICES THEREFOR (U.S. CLS. 100 AND 101).

EDWARD NELSON, EXAMINING ATTORNEY

SN 85-361,411. KIZ TOYS, INC., ALPHARETTA, GA. FILED 7-1-2011.

MUCK

THE MARK CONSISTS OF STANDARD CHARACTERS WITHOUT CLAIM TO ANY PARTICULAR FONT, STYLE, SIZE, OR COLOR.

FOR APPLICATION SERVICE PROVIDER (ASP) FEATURING GAME SOFTWARE FOR USE IN AN ON-LINE VIRTUAL ENVIRONMENT FEATURING FICTIONAL CHARACTERS ENGAGING IN ADVENTURES, SPORTS, RACING, EDUCATIONAL AND OTHER GAMING ACTIVITIES (U.S. CLS. 100 AND 101).

KHANH LE, EXAMINING ATTORNEY

CLASS 42—(Continued).

SN 85-365,259. RAMBØLL GRUPPEN A/S, COPENHAGEN, DENMARK, FILED 7-7-2011.

RAMBOLL

THE MARK CONSISTS OF STANDARD CHARACTERS WITHOUT CLAIM TO ANY PARTICULAR FONT, STYLE, SIZE, OR COLOR.

FOR ENGINEERING AND TECHNICAL ENGINEERING CONSULTING SERVICES IN THE FIELD OF ENERGY (U.S. CLS. 100 AND 101).

DOMINIC FATHY, EXAMINING ATTORNEY

SN 85-366,135. DJ EVENT PLANNER, INC., MARSHALL, MN. FILED 7-8-2011.

DJ EVENT PLANNER

THE MARK CONSISTS OF STANDARD CHARACTERS WITHOUT CLAIM TO ANY PARTICULAR FONT, STYLE, SIZE, OR COLOR.

SEC. 2(F).
FOR NON-DOWNLOADABLE COMPUTER SOFTWARE FOR USE IN EVENT PLANNING AND EVENT MANAGEMENT (U.S. CLS. 100 AND 101).

FIRST USE 11-1-2000; IN COMMERCE 2-1-2001.
JULIE GUTTADAURO, EXAMINING ATTORNEY

SN 85-367,629. DIAMONDS AMONG RUBIES, LLC, WELLESLEY, MA. FILED 7-11-2011.

DIAMONDS AMONG RUBIES

THE MARK CONSISTS OF STANDARD CHARACTERS WITHOUT CLAIM TO ANY PARTICULAR FONT, STYLE, SIZE, OR COLOR.

FOR COMPUTER SERVICES, NAMELY, CREATING AN ON-LINE COMMUNITY FOR USERS TO PARTICIPATE IN DISCUSSIONS, EXCHANGE INFORMATION AND RECOMMENDATIONS, AND ENGAGE IN SOCIAL NETWORKING SERVICES IN THE FIELD OF MEDICINE (U.S. CLS. 100 AND 101).

JIM RINGLE, EXAMINING ATTORNEY

CLASS 42—(Continued).

SN 85-368,015. STERLING READINESS ROUNDS L.L.C., EUDORA, KS. FILED 7-11-2011.

PATIENT SATISFACTION REAL
TIME

THE MARK CONSISTS OF STANDARD CHARACTERS WITHOUT CLAIM TO ANY PARTICULAR FONT, STYLE, SIZE, OR COLOR.

NO CLAIM IS MADE TO THE EXCLUSIVE RIGHT TO USE "REAL TIME", APART FROM THE MARK AS SHOWN.

FOR NON-DOWNLOADABLE COMPUTER SOFTWARE FOR USE BY HOSPITALS TO IMPROVE PATIENT SAFETY AND QUALITY BY GATHERING QUALITY AND EXPERIENCE OBSERVATIONS, TRIGGERING SERVICE RECOVERY, AGGREGATING RESULTS, PROVIDING REMINDERS AND CHECKLISTS, AND PROVIDING IMPROVEMENT DASHBOARDS TO ENABLE A FOCUSED APPROACH TO IMPROVING PATIENT SAFETY (U.S. CLS. 100 AND 101).

FIRST USE 4-1-2011; IN COMMERCE 4-1-2011.
TEJBIR SINGH, EXAMINING ATTORNEY

CLASS 42—(Continued).

SN 85-370,347. YESPIX, LLC, WILMINGTON, DE. FILED 7-13-2011.

YesPix

THE MARK CONSISTS OF STANDARD CHARACTERS WITHOUT CLAIM TO ANY PARTICULAR FONT, STYLE, SIZE, OR COLOR.

FOR PROVIDING A WEB SITE THAT GIVE COMPUTER USERS AND MOBILE PHONE USERS THE ABILITY TO UPLOAD, EXCHANGE AND SHARE PHOTOS, VIDEOS AND VIDEO LOGS; PROVIDING ON-LINE, NON-DOWNLOADABLE SOFTWARE APPLICATIONS FOR MOBILE PHONES, PORTABLE MEDIA PLAYERS, AND HANDHELD COMPUTERS THAT PROVIDE USERS THE ABILITY TO UPLOAD, EXCHANGE AND SHARE PHOTOS, VIDEOS AND VIDEO LOGS (U.S. CLS. 100 AND 101).

FIRST USE 9-9-2010; IN COMMERCE 2-1-2011.
MARK SHINER, EXAMINING ATTORNEY

SN 85-371,253. EARTH CONSULTING GROUP, INC., MAR-
IETTA, GA. FILED 7-14-2011.

RSBA

THE MARK CONSISTS OF STANDARD CHARACTERS WITHOUT CLAIM TO ANY PARTICULAR FONT, STYLE, SIZE, OR COLOR.

FOR ENVIRONMENTAL EVALUATION SERVICES, NAMELY, EVALUATING THE EFFICIENCY OF GROUNDWATER REMEDIATION SYSTEMS THAT REMOVE CONTAMINANT MASS FROM GROUNDWATER (U.S. CLS. 100 AND 101).

FIRST USE 7-11-2011; IN COMMERCE 7-11-2011.
DAVID H. STINE, EXAMINING ATTORNEY

SN 85-371,256. EARTH CONSULTING GROUP, INC., MAR-
IETTA, GA. FILED 7-14-2011.



SN 85-370,104. LEININGER, ERIC J, NEW ORLEANS, LA.
FILED 7-13-2011.

THE MARK CONSISTS OF THE STYLIZED WORDING "HAPPYFUNPLANET" WITH A SEMI-CIRCLE DESIGN COMPRISED OF BLOCKS.

FOR PROVIDING A WEBSITE FEATURING ON-LINE NON-DOWNLOADABLE SOFTWARE THAT ENABLES USERS TO CREATE, SHARE AND EVALUATE EDUCATIONAL INFORMATION (U.S. CLS. 100 AND 101).

NATALIE POLZER, EXAMINING ATTORNEY

RICKER METHOD

THE MARK CONSISTS OF STANDARD CHARACTERS WITHOUT CLAIM TO ANY PARTICULAR FONT, STYLE, SIZE, OR COLOR.

NO CLAIM IS MADE TO THE EXCLUSIVE RIGHT TO USE "METHOD", APART FROM THE MARK AS SHOWN.

FOR ENVIRONMENTAL EVALUATION SERVICES, NAMELY, EVALUATING PLUME STABILITY AT REMEDIATION SITES (U.S. CLS. 100 AND 101).

DAVID H. STINE, EXAMINING ATTORNEY

CLASS 42—(Continued).

SN 85-371,343. EARTH CONSULTING GROUP, INC., MAR-
LETTA, GA. FILED 7-14-2011.

RICKER PLUME STABILITY METHOD

THE MARK CONSISTS OF STANDARD CHARACTERS
WITHOUT CLAIM TO ANY PARTICULAR FONT, STYLE,
SIZE, OR COLOR.

NO CLAIM IS MADE TO THE EXCLUSIVE RIGHT TO
USE "PLUME STABILITY METHOD", APART FROM THE
MARK AS SHOWN.

FOR ENVIRONMENTAL EVALUATION SERVICES,
NAMELY, EVALUATING PLUME STABILITY AT RE-
MEDIATION SITES (U.S. CLS. 100 AND 101).

DAVID H. STINE, EXAMINING ATTORNEY

SN 85-373,757. PROTEINSIMPLE, SANTA CLARA, CA.
FILED 7-18-2011.

PROTEINSIMPLE

THE MARK CONSISTS OF STANDARD CHARACTERS
WITHOUT CLAIM TO ANY PARTICULAR FONT, STYLE,
SIZE, OR COLOR.

FOR RESEARCH AND ANALYSIS SERVICES FOR
OTHERS IN THE IMMUNOASSAY, GENETICS, BIO-
MARKER DISCOVERY, AND PROTEIN ANALYSIS
FIELDS; TECHNICAL SUPPORT SERVICES, NAMELY,
TROUBLESHOOTING IN THE NATURE OF DIAGNOS-
ING COMPUTER SOFTWARE PROBLEMS (U.S. CLS. 100
AND 101).

RICHARD WHITE, EXAMINING ATTORNEY

SN 85-378,428. BIG PLAYAR INC., BEVERLY HILLS, CA.
FILED 7-22-2011.

BIG PLAYAR

THE MARK CONSISTS OF STANDARD CHARACTERS
WITHOUT CLAIM TO ANY PARTICULAR FONT, STYLE,
SIZE, OR COLOR.

FOR CREATION AND DEVELOPMENT OF AUGMEN-
TED REALITY GOODS AND SERVICES, NAMELY,
SOFTWARE DEVELOPMENT SERVICES FOR OTHERS;
DESIGN AND DEVELOPMENT OF COMPUTER GAME
SOFTWARE; COMPUTER PROGRAMMING SERVICES
FOR THE CREATION OF AUGMENTED REALITY
GOODS AND SERVICES (U.S. CLS. 100 AND 101).

FIRST USE 4-0-2011; IN COMMERCE 4-0-2011.

ALLISON SCHRODY, EXAMINING ATTORNEY

CLASS 42—(Continued).

SN 85-380,438. VIDI ENTERTAINMENT, INC., BOZEMAN,
MT. FILED 7-25-2011.



vidi entertainment inc

NO CLAIM IS MADE TO THE EXCLUSIVE RIGHT TO
USE "ENTERTAINMENT INC", APART FROM THE MARK
AS SHOWN.

THE COLOR(S) RED, GREEN, BLUE, AND GREY IS/ARE
CLAIMED AS A FEATURE OF THE MARK.

THE MARK CONSISTS OF THE GREY STYLIZED
WORDING "VIDI ENTERTAINMENT INC" AND STYLIZED
LETTER "V" IN THREE DIMENSIONS EMBEDDED WITH-
IN A THREE DIMENSIONAL CUBE WITH GREY STIP-
PLING BENEATH THE CUBE. THE TOP OF THE CUBE IS
RED WITH THE REMAINING SIDES IN GREY. THE LEFT
SIDE OF THE LETTER "V" IS GREEN WITH THE RIGHT
SIDE IN BLUE. THE COLOR WHITE REPRESENTS BACK-
GROUND, OUTLINING, SHADING AND/OR TRANSPAR-
ENT AREAS AND IS NOT PART OF THE MARK.

THE ENGLISH TRANSLATION OF "VIDI" IS "I SAW".
FOR PROVIDING A WEB SITE FEATURING TEM-
PORARY USE OF NON-DOWNLOADABLE SOFTWARE
ALLOWING WEB SITE USERS TO UPLOAD, POST AND
DISPLAY ONLINE VIDEOS FOR SHARING WITH
OTHERS FOR ENTERTAINMENT PURPOSES (U.S.
CLS. 100 AND 101).

FIRST USE 7-0-2010; IN COMMERCE 8-0-2010.

BRIAN PINO, EXAMINING ATTORNEY

SN 85-387,829. ACTIVE ENDPOINTS, INC., WALTHAM, MA.
FILED 8-3-2011.

CLOUD EXTEND

THE MARK CONSISTS OF STANDARD CHARACTERS
WITHOUT CLAIM TO ANY PARTICULAR FONT, STYLE,
SIZE, OR COLOR.

NO CLAIM IS MADE TO THE EXCLUSIVE RIGHT TO
USE "CLOUD", APART FROM THE MARK AS SHOWN.

FOR SOFTWARE AS A SERVICE (SAAS) SERVICES
OR HOSTED SERVICES OVER THE INTERNET FEAT-
URING SOFTWARE FOR SPECIFYING AND EXECUT-
ING A SCREENFLOW THAT IS EMBEDDED IN A WEB
APPLICATION OR EXTENDS THE FUNCTIONALITY
OF A WEB APPLICATION; SOFTWARE AS A SERVICE
(SAAS) SERVICES FEATURING SOFTWARE TO CUS-
TOMIZE AND AUGMENT SOFTWARE APPLICATIONS
BY ADDING QUESTION-ORIENTED SCREEN FLOWS
CONSTRUCTED WITH DIRECTED GRAPH STEPS, DI-
RECTING THE USER TO PERFORM ACTIONS OR
PROVIDE INPUT (U.S. CLS. 100 AND 101).

DAVID I, EXAMINING ATTORNEY

CLASS 42—(Continued).

SN 85-388,434. ALSTOM TECHNOLOGY LTD, BADEN, SWITZERLAND, FILED 8-3-2011.

LifeCycle

THE COLOR(S) BLUE IS/ARE CLAIMED AS A FEATURE OF THE MARK.

THE MARK CONSISTS OF THE LITERAL ELEMENT "LIFECYCLE" INCLUDES AN INITIAL LOWERCASE, LETTER "L" IN ITALIC TYPESET WITH THE REMAINING LETTERS IN LOWER CASE, REGULAR TYPESET, EXCEPT A REGULAR TYPESET, UPPER CASE "L" AND "C", ALL IN THE COLOR BLUE.

FOR TECHNICAL CONSULTATION IN THE FIELD OF POWER PLANT ENGINEERING, NAMELY, TESTING AND EVALUATION OF POWER PLANT EQUIPMENT TO IMPROVE PERFORMANCE AND EFFICIENCY OF SUCH EQUIPMENT (U.S. CLS. 100 AND 101).

HENRY S. ZAK, EXAMINING ATTORNEY

SN 85-397,766. BRISTOL-MYERS SQUIBB COMPANY, NEW YORK, NY. FILED 8-15-2011.



NO CLAIM IS MADE TO THE EXCLUSIVE RIGHT TO USE "FIND A STUDY", APART FROM THE MARK AS SHOWN.

THE MARK CONSISTS OF A SPEECH BALLOON WITH THE SILHOUETTES OF TWO PEOPLE IN A CIRCLE WITHIN THE SPEECH BALLOON SUPERIMPOSED OVER A MAP AND A RECTANGLE WITH THE WORDS "FIND A STUDY" AT THE BOTTOM.

FOR PROVIDING MEDICAL AND SCIENTIFIC RESEARCH INFORMATION IN THE FIELD OF PHARMACEUTICALS AND CLINICAL TRIALS (U.S. CLS. 100 AND 101).

BILL DAWE, EXAMINING ATTORNEY

CLASS 42—(Continued).

SN 85-412,539. CUMMINGS ENGINEERING CONSULTANTS, INCORPORATED, CHANDLER, AZ. FILED 9-1-2011.

TIPRNET

THE MARK CONSISTS OF STANDARD CHARACTERS WITHOUT CLAIM TO ANY PARTICULAR FONT, STYLE, SIZE, OR COLOR.

FOR COMPUTER HARDWARE AND SOFTWARE CONSULTING SERVICES; COMPUTER SERVICES, NAMELY, ACTING AS AN APPLICATION SERVICE PROVIDER IN THE FIELD OF INFORMATION MANAGEMENT TO HOST COMPUTER APPLICATION SOFTWARE FOR THE PURPOSE OF CRYPTOGRAPHIC SYSTEMS; COMPUTER SERVICES, NAMELY, REMOTE AND ON-SITE MANAGEMENT OF CRYPTOGRAPHIC SYSTEMS OF OTHERS; COMPUTER SOFTWARE DEVELOPMENT IN THE FIELD OF CRYPTOGRAPHIC SYSTEMS; COMPUTER SOFTWARE DEVELOPMENT, COMPUTER PROGRAMMING AND MAINTENANCE OF COMPUTER SOFTWARE FOR CRYPTOGRAPHIC SYSTEMS; CONSULTING SERVICES IN THE FIELD OF THE DESIGN OF CRYPTOGRAPHIC SYSTEMS; DESIGN AND DEVELOPMENT OF COMPUTER SOFTWARE FOR CRYPTOGRAPHIC SYSTEMS; DESIGN AND DEVELOPMENT OF SOFTWARE AND HARDWARE FOR CRYPTOGRAPHIC SYSTEMS; DESIGN FOR OTHERS IN THE FIELD OF CRYPTOGRAPHIC SYSTEMS; DESIGN, DEVELOPMENT, AND CONSULTING SERVICES RELATED THERETO IN THE FIELD OF CRYPTOGRAPHIC SYSTEMS; DESIGN, DEVELOPMENT, AND IMPLEMENTATION OF SOFTWARE FOR CRYPTOGRAPHIC SYSTEMS; INSTALLATION AND MAINTENANCE OF CRYPTOGRAPHIC SYSTEM SOFTWARE; INSTALLATION OF CRYPTOGRAPHIC SYSTEM SOFTWARE; INSTALLATION, MAINTENANCE AND REPAIR OF CRYPTOGRAPHIC SYSTEM SOFTWARE; MAINTENANCE OF COMPUTER SOFTWARE USED FOR CRYPTOGRAPHIC SYSTEMS; PLATFORM AS A SERVICE (PAAS) FEATURING COMPUTER SOFTWARE PLATFORMS FOR OPERATING AND MANAGING CRYPTOGRAPHIC SYSTEMS; PROVIDING ON-LINE NON-DOWNLOADABLE SOFTWARE FOR OPERATING AND MANAGING CRYPTOGRAPHIC SYSTEMS; PROVIDING TEMPORARY USE OF ON-LINE NON-DOWNLOADABLE SOFTWARE FOR OPERATING AND MANAGING CRYPTOGRAPHIC SYSTEMS; SOFTWARE AS A SERVICE (SAAS) SERVICES FEATURING SOFTWARE FOR OPERATING AND MANAGING CRYPTOGRAPHIC SYSTEMS; SOFTWARE DEVELOPMENT AND PRODUCT DEVELOPMENT CONSULTING IN THE FIELD OF CRYPTOGRAPHIC SYSTEMS; SOFTWARE DEVELOPMENT IN THE FIELD OF CRYPTOGRAPHIC SYSTEMS; TECHNOLOGY SPECIFICATION, NAMELY, ANALYZING TECHNOLOGY REQUIREMENTS AND DEVELOPING RECOMMENDATIONS FOR THE COMPUTER SOFTWARE AND SYSTEMS AND OTHER TECHNOLOGY NEEDED TO MEET THOSE REQUIREMENTS, IN THE FIELD OF CRYPTOGRAPHIC SYSTEMS (U.S. CLS. 100 AND 101).

FIRST USE 11-1-2010; IN COMMERCE 11-1-2010.

WARREN L. OLANDRIA, EXAMINING ATTORNEY

CLASS 42—(Continued).

SN 85-412,550. CUMMINGS ENGINEERING CONSULTANTS, INCORPORATED, CHANDLER, AZ. FILED 9-1-2011.



NO CLAIM IS MADE TO THE EXCLUSIVE RIGHT TO USE "SECUREMOBILE", APART FROM THE MARK AS SHOWN.

THE MARK CONSISTS OF THE WORDING "SECUREMOBILE" WITH THREE (3) CONCENTRIC CURVES EMITTING FROM THE DOT ABOVE THE "I" IN THE WORD "MOBILE"; THE WORDING "SECUREMOBILE" APPEARS ON A RECTANGULAR BACKGROUND WITH A PAD LOCK ATTACHED TO THE UPPER RIGHT CORNER OF THE RECTANGLE.

FOR COMPUTER HARDWARE AND SOFTWARE CONSULTING SERVICES; COMPUTER SERVICES, NAMELY, ACTING AS AN APPLICATION SERVICE PROVIDER IN THE FIELD OF INFORMATION MANAGEMENT TO HOST COMPUTER APPLICATION SOFTWARE FOR THE PURPOSE OF CRYPTOGRAPHIC SYSTEMS; COMPUTER SERVICES, NAMELY, REMOTE AND ON-SITE MANAGEMENT OF CRYPTOGRAPHIC SYSTEMS OF OTHERS; COMPUTER SOFTWARE DEVELOPMENT IN THE FIELD OF CRYPTOGRAPHIC SYSTEMS; COMPUTER SOFTWARE DEVELOPMENT, COMPUTER PROGRAMMING AND MAINTENANCE OF COMPUTER SOFTWARE FOR CRYPTOGRAPHIC SYSTEMS; CONSULTING SERVICES IN THE FIELD OF THE DESIGN OF CRYPTOGRAPHIC SYSTEMS; DESIGN AND DEVELOPMENT OF COMPUTER SOFTWARE FOR CRYPTOGRAPHIC SYSTEMS; DESIGN AND DEVELOPMENT OF SOFTWARE AND HARDWARE FOR CRYPTOGRAPHIC SYSTEMS; DESIGN FOR OTHERS IN THE FIELD OF CRYPTOGRAPHIC SYSTEMS; DESIGN, DEVELOPMENT, AND CONSULTING SERVICES RELATED THERETO IN THE FIELD OF CRYPTOGRAPHIC SYSTEMS; DESIGN, DEVELOPMENT, AND IMPLEMENTATION OF SOFTWARE FOR CRYPTOGRAPHIC SYSTEMS; INSTALLATION AND MAINTENANCE OF CRYPTOGRAPHIC SYSTEM SOFTWARE; INSTALLATION OF CRYPTOGRAPHIC SYSTEM SOFTWARE; INSTALLATION, MAINTENANCE AND REPAIR OF CRYPTOGRAPHIC SYSTEM SOFTWARE; MAINTENANCE OF COMPUTER SOFTWARE USED FOR CRYPTOGRAPHIC SYSTEMS; PLATFORM AS A SERVICE (PAAS) FEATURING COMPUTER SOFTWARE PLATFORMS FOR OPERATING AND MANAGING CRYPTOGRAPHIC SYSTEMS; PROVIDING ON-LINE NON-DOWNLOADABLE SOFTWARE FOR OPERATING AND MANAGING CRYPTOGRAPHIC SYSTEMS; PROVIDING TEMPORARY USE OF ON-LINE NON-DOWNLOADABLE SOFTWARE FOR OPERATING AND MANAGING CRYPTOGRAPHIC SYSTEMS; SOFTWARE AS A SERVICE (SAAS) SERVICES FEATURING SOFTWARE FOR OPERATING AND MANAGING CRYPTOGRAPHIC SYSTEMS; SOFTWARE DEVELOPMENT AND PRODUCT DEVELOPMENT CONSULTING IN THE FIELD OF CRYPTOGRAPHIC SYSTEMS; SOFTWARE DEVELOPMENT CONSULTING IN THE FIELD OF CRYPTOGRAPHIC SYSTEMS; SOFTWARE DEVELOPMENT IN THE FIELD OF CRYPTOGRAPHIC SYSTEMS; TECHNOLOGY SPECIFICATION, NAMELY, ANALYZING TECHNOLOGY REQUIREMENTS AND DEVELOPING RECOMMENDATIONS FOR THE COMPUTER SOFTWARE AND SYSTEMS AND OTHER TECHNOLOGY NEEDED TO MEET THOSE REQUIREMENTS, IN THE FIELD OF CRYPTOGRAPHIC SYSTEMS (U.S. CLS. 100 AND 101).

FIRST USE 9-1-2009; IN COMMERCE 9-29-2009.
WARREN L. OLANDRIA, EXAMINING ATTORNEY

CLASS 42—(Continued).

SN 85-427,882. MISHAAL AEROSPACE CORPORATION, MIAMI, FL. FILED 9-21-2011.



NO CLAIM IS MADE TO THE EXCLUSIVE RIGHT TO USE "AEROSPACE ENGINEERING CONSULTING", APART FROM THE MARK AS SHOWN.

THE MARK CONSISTS OF THE WORD "MISHAAL" IN ALL CAPITAL LETTERS ABOVE THE WORDS "AEROSPACE ENGINEERING CONSULTING" IN SMALLER, ALL CAPITAL LETTERS, WITH THE WORDS UNDERNEATH A PLANET AND STARS IMAGE, WITH A CIRCLE SEPARATED IN HALF BY A HORIZONTAL WAVY LINE THAT REPRESENTS A PLANET, AND WITH THREE PLUS SIGNS ABOVE AND TO THE RIGHT OF THE CIRCLE REPRESENTING STARS.

FOR TECHNICAL SERVICES, NAMELY, CONSULTING IN THE FIELD OF ENGINEERING FOR BUSINESSES IN THE AVIATION, AEROSPACE AND DEFENSE INDUSTRIES (U.S. CLS. 100 AND 101).

FIRST USE 7-10-2011; IN COMMERCE 9-19-2011.
JAMES LOVELACE, EXAMINING ATTORNEY

SN 85-430,226. NACSO NON-PROFIT BUSINESS LEAGUE, AKA NATIONAL ASSOCIATION OF CREDIT SERVICES ORGANIZATIONS, MCKINNEY, TX. FILED 9-23-2011.

**Be Part of the Solution,
Not Part of the Problem**

THE MARK CONSISTS OF STANDARD CHARACTERS WITHOUT CLAIM TO ANY PARTICULAR FONT, STYLE, SIZE, OR COLOR.

FOR ACCREDITATION SERVICES, NAMELY, DEVELOPING AND ADMINISTERING STANDARDS AND PROCEDURES FOR CERTIFYING PROFESSIONALS IN THE FIELD OF CREDIT SERVICES ORGANIZATIONS (U.S. CLS. 100 AND 101).

FIRST USE 9-8-2011; IN COMMERCE 9-8-2011.
MARK RADEMACHER, EXAMINING ATTORNEY

SN 85-430,560. INFOTEX INC., KOKOMO, IN. FILED 9-23-2011.



THE COLOR(S) BLUE AND BLACK IS/ARE CLAIMED AS A FEATURE OF THE MARK.

THE MARK CONSISTS OF THE WORD "INFOTEX" WITH THE LETTERS "I" AND "T" IN BLUE AND THE LETTERS "NFO" AND "EX" IN BLACK.

FOR COMPUTER SECURITY SERVICES, NAMELY, MANAGED SECURITY SERVICES AND COMPUTER SECURITY CONSULTING (U.S. CLS. 100 AND 101).

FIRST USE 8-18-2000; IN COMMERCE 8-18-2000.
LOURDES AYALA, EXAMINING ATTORNEY

CLASS 42—(Continued).

SN 85-431,131. NEO GROUP INC., QUINCY, MA. FILED 9-24-2011.

NeoBioLab

THE MARK CONSISTS OF STANDARD CHARACTERS WITHOUT CLAIM TO ANY PARTICULAR FONT, STYLE, SIZE, OR COLOR.

FOR BIOLOGICAL RESEARCH (U.S. CLS. 100 AND 101).

ANDREA HACK, EXAMINING ATTORNEY

CLASS 42—(Continued).

GRAPHIC SYSTEMS; PROVIDING ON-LINE NON-DOWNLOADABLE SOFTWARE FOR OPERATING AND MANAGING CRYPTOGRAPHIC SYSTEMS; PROVIDING TEMPORARY USE OF ON-LINE NON-DOWNLOADABLE SOFTWARE FOR OPERATING AND MANAGING CRYPTOGRAPHIC SYSTEMS; SOFTWARE AS A SERVICE (SAAS) SERVICES FEATURING SOFTWARE FOR OPERATING AND MANAGING CRYPTOGRAPHIC SYSTEMS; SOFTWARE DEVELOPMENT AND PRODUCT DEVELOPMENT CONSULTING IN THE FIELD OF CRYPTOGRAPHIC SYSTEMS; SOFTWARE DEVELOPMENT CONSULTING IN THE FIELD OF CRYPTOGRAPHIC SYSTEMS; SOFTWARE DEVELOPMENT IN THE FIELD OF CRYPTOGRAPHIC SYSTEMS; TECHNOLOGY SPECIFICATION, NAMELY, ANALYZING TECHNOLOGY REQUIREMENTS AND DEVELOPING RECOMMENDATIONS FOR THE COMPUTER SOFTWARE AND SYSTEMS AND OTHER TECHNOLOGY NEEDED TO MEET THOSE REQUIREMENTS, IN THE FIELD OF CRYPTOGRAPHIC SYSTEMS (U.S. CLS. 100 AND 101).

FIRST USE 8-4-2011; IN COMMERCE 8-5-2011.

WARREN L. OLANDRIA, EXAMINING ATTORNEY

SN 85-432,495. CUMMINGS ENGINEERING CONSULTANTS, INCORPORATED, CHANDLER, AZ. FILED 9-27-2011.

CryptoSleeve

THE MARK CONSISTS OF STANDARD CHARACTERS WITHOUT CLAIM TO ANY PARTICULAR FONT, STYLE, SIZE, OR COLOR.

FOR COMPUTER HARDWARE AND SOFTWARE CONSULTING SERVICES; COMPUTER SERVICES, NAMELY, ACTING AS AN APPLICATION SERVICE PROVIDER IN THE FIELD OF INFORMATION MANAGEMENT TO HOST COMPUTER APPLICATION SOFTWARE FOR THE PURPOSE OF CRYPTOGRAPHIC SYSTEMS; COMPUTER SERVICES, NAMELY, REMOTE AND ON-SITE MANAGEMENT OF CRYPTOGRAPHIC SYSTEMS OF OTHERS; COMPUTER SOFTWARE DEVELOPMENT IN THE FIELD OF CRYPTOGRAPHIC SYSTEMS; COMPUTER SOFTWARE DEVELOPMENT, COMPUTER PROGRAMMING AND MAINTENANCE OF COMPUTER SOFTWARE FOR CRYPTOGRAPHIC SYSTEMS; CONSULTING SERVICES IN THE FIELD OF THE DESIGN OF CRYPTOGRAPHIC SYSTEMS; DESIGN AND DEVELOPMENT OF COMPUTER SOFTWARE FOR CRYPTOGRAPHIC SYSTEMS; DESIGN AND DEVELOPMENT OF SOFTWARE AND HARDWARE FOR CRYPTOGRAPHIC SYSTEMS; DESIGN FOR OTHERS IN THE FIELD OF CRYPTOGRAPHIC SYSTEMS; DESIGN, DEVELOPMENT, AND CONSULTING SERVICES RELATED THERETO IN THE FIELD OF CRYPTOGRAPHIC SYSTEMS; DESIGN, DEVELOPMENT, AND IMPLEMENTATION OF SOFTWARE FOR CRYPTOGRAPHIC SYSTEMS; INSTALLATION AND MAINTENANCE OF CRYPTOGRAPHIC SYSTEM SOFTWARE; INSTALLATION OF CRYPTOGRAPHIC SYSTEM SOFTWARE; INSTALLATION, MAINTENANCE AND REPAIR OF CRYPTOGRAPHIC SYSTEM SOFTWARE; MAINTENANCE OF COMPUTER SOFTWARE USED FOR CRYPTOGRAPHIC SYSTEMS; PLATFORM AS A SERVICE (PAAS) FEATURING COMPUTER SOFTWARE PLATFORMS FOR OPERATING AND MANAGING CRYPTO-

SN 85-432,501. CUMMINGS ENGINEERING CONSULTANTS, INCORPORATED, CHANDLER, AZ. FILED 9-27-2011.

GeospatialTrust

THE MARK CONSISTS OF STANDARD CHARACTERS WITHOUT CLAIM TO ANY PARTICULAR FONT, STYLE, SIZE, OR COLOR.

FOR COMPUTER HARDWARE AND SOFTWARE CONSULTING SERVICES; COMPUTER SERVICES, NAMELY, ACTING AS AN APPLICATION SERVICE PROVIDER IN THE FIELD OF INFORMATION MANAGEMENT TO HOST COMPUTER APPLICATION SOFTWARE FOR THE PURPOSE OF CRYPTOGRAPHIC SYSTEMS; COMPUTER SERVICES, NAMELY, REMOTE AND ON-SITE MANAGEMENT OF CRYPTOGRAPHIC SYSTEMS OF OTHERS; COMPUTER SOFTWARE DEVELOPMENT IN THE FIELD OF CRYPTOGRAPHIC SYSTEMS; COMPUTER SOFTWARE DEVELOPMENT, COMPUTER PROGRAMMING AND MAINTENANCE OF COMPUTER SOFTWARE FOR CRYPTOGRAPHIC SYSTEMS; CONSULTING SERVICES IN THE FIELD OF THE DESIGN OF CRYPTOGRAPHIC SYSTEMS; DESIGN AND DEVELOPMENT OF COMPUTER SOFTWARE FOR CRYPTOGRAPHIC SYSTEMS; DESIGN AND DEVELOPMENT OF SOFTWARE AND HARDWARE FOR CRYPTOGRAPHIC SYSTEMS; DESIGN FOR OTHERS IN THE FIELD OF CRYPTOGRAPHIC SYSTEMS; DESIGN, DEVELOPMENT, AND CONSULTING SERVICES RELATED THERETO IN THE FIELD OF CRYPTOGRAPHIC SYSTEMS; DESIGN, DEVELOPMENT, AND IMPLEMENTATION OF SOFTWARE FOR CRYPTOGRAPHIC SYSTEMS; INSTALLATION AND MAINTENANCE OF CRYPTOGRAPHIC SYSTEM SOFTWARE; INSTALLATION OF CRYPTOGRAPHIC SYSTEM SOFTWARE; INSTALLATION, MAINTENANCE AND REPAIR OF CRYPTOGRAPHIC SYSTEM SOFTWARE; MAINTENANCE OF COMPUTER SOFTWARE USED FOR CRYPTOGRAPHIC SYSTEMS; PLATFORM AS A SERVICE (PAAS) FEATURING COMPUTER SOFTWARE PLATFORMS FOR OPERATING AND MANAGING CRYPTO-

CLASS 42—(Continued).

GRAPHIC SYSTEMS; PROVIDING ON-LINE NON-DOWNLOADABLE SOFTWARE FOR OPERATING AND MANAGING CRYPTOGRAPHIC SYSTEMS; PROVIDING TEMPORARY USE OF ON-LINE NON-DOWNLOADABLE SOFTWARE FOR OPERATING AND MANAGING CRYPTOGRAPHIC SYSTEMS; SOFTWARE AS A SERVICE (SAAS) SERVICES FEATURING SOFTWARE FOR OPERATING AND MANAGING CRYPTOGRAPHIC SYSTEMS; SOFTWARE DEVELOPMENT AND PRODUCT DEVELOPMENT CONSULTING IN THE FIELD OF CRYPTOGRAPHIC SYSTEMS; SOFTWARE DEVELOPMENT CONSULTING IN THE FIELD OF CRYPTOGRAPHIC SYSTEMS; SOFTWARE DEVELOPMENT IN THE FIELD OF CRYPTOGRAPHIC SYSTEMS; TECHNOLOGY SPECIFICATION, NAMELY, ANALYZING TECHNOLOGY REQUIREMENTS AND DEVELOPING RECOMMENDATIONS FOR THE COMPUTER SOFTWARE AND SYSTEMS AND OTHER TECHNOLOGY NEEDED TO MEET THOSE REQUIREMENTS, IN THE FIELD OF CRYPTOGRAPHIC SYSTEMS (U.S. CLS. 100 AND 101).

FIRST USE 8-1-2011; IN COMMERCE 8-1-2011.
WARREN L. OLANDRIA, EXAMINING ATTORNEY

CLASS 42—(Continued).

GRAPHIC SYSTEMS; PROVIDING ON-LINE NON-DOWNLOADABLE SOFTWARE FOR OPERATING AND MANAGING CRYPTOGRAPHIC SYSTEMS; PROVIDING TEMPORARY USE OF ON-LINE NON-DOWNLOADABLE SOFTWARE FOR OPERATING AND MANAGING CRYPTOGRAPHIC SYSTEMS; SOFTWARE AS A SERVICE (SAAS) SERVICES FEATURING SOFTWARE FOR OPERATING AND MANAGING CRYPTOGRAPHIC SYSTEMS; SOFTWARE DEVELOPMENT AND PRODUCT DEVELOPMENT CONSULTING IN THE FIELD OF CRYPTOGRAPHIC SYSTEMS; SOFTWARE DEVELOPMENT CONSULTING IN THE FIELD OF CRYPTOGRAPHIC SYSTEMS; SOFTWARE DEVELOPMENT IN THE FIELD OF CRYPTOGRAPHIC SYSTEMS; TECHNOLOGY SPECIFICATION, NAMELY, ANALYZING TECHNOLOGY REQUIREMENTS AND DEVELOPING RECOMMENDATIONS FOR THE COMPUTER SOFTWARE AND SYSTEMS AND OTHER TECHNOLOGY NEEDED TO MEET THOSE REQUIREMENTS, IN THE FIELD OF CRYPTOGRAPHIC SYSTEMS (U.S. CLS. 100 AND 101).

FIRST USE 8-1-2011; IN COMMERCE 8-1-2011.
WARREN L. OLANDRIA, EXAMINING ATTORNEY

SN 85-432,504. CUMMINGS ENGINEERING CONSULTANTS, INCORPORATED, CHANDLER, AZ. FILED 9-27-2011.

AgileTrust

THE MARK CONSISTS OF STANDARD CHARACTERS WITHOUT CLAIM TO ANY PARTICULAR FONT, STYLE, SIZE, OR COLOR.

FOR COMPUTER HARDWARE AND SOFTWARE CONSULTING SERVICES; COMPUTER SERVICES, NAMELY, ACTING AS AN APPLICATION SERVICE PROVIDER IN THE FIELD OF INFORMATION MANAGEMENT TO HOST COMPUTER APPLICATION SOFTWARE FOR THE PURPOSE OF CRYPTOGRAPHIC SYSTEMS; COMPUTER SERVICES, NAMELY, REMOTE AND ON-SITE MANAGEMENT OF CRYPTOGRAPHIC SYSTEMS OF OTHERS; COMPUTER SOFTWARE DEVELOPMENT IN THE FIELD OF CRYPTOGRAPHIC SYSTEMS; COMPUTER SOFTWARE DEVELOPMENT, COMPUTER PROGRAMMING AND MAINTENANCE OF COMPUTER SOFTWARE FOR CRYPTOGRAPHIC SYSTEMS; CONSULTING SERVICES IN THE FIELD OF THE DESIGN OF CRYPTOGRAPHIC SYSTEMS; DESIGN AND DEVELOPMENT OF COMPUTER SOFTWARE FOR CRYPTOGRAPHIC SYSTEMS; DESIGN FOR OTHERS IN THE FIELD OF CRYPTOGRAPHIC SYSTEMS; DESIGN, DEVELOPMENT, AND CONSULTING SERVICES RELATED THERETO IN THE FIELD OF CRYPTOGRAPHIC SYSTEMS; DESIGN, DEVELOPMENT, AND IMPLEMENTATION OF SOFTWARE FOR CRYPTOGRAPHIC SYSTEMS; INSTALLATION AND MAINTENANCE OF CRYPTOGRAPHIC SYSTEM SOFTWARE; INSTALLATION OF CRYPTOGRAPHIC SYSTEM SOFTWARE; INSTALLATION, MAINTENANCE AND REPAIR OF CRYPTOGRAPHIC SYSTEM SOFTWARE; MAINTENANCE OF COMPUTER SOFTWARE USED FOR CRYPTOGRAPHIC SYSTEMS; PLATFORM AS A SERVICE (PAAS) FEATURING COMPUTER SOFTWARE PLATFORMS FOR OPERATING AND MANAGING CRYPTO-

SN 85-435,932. VINTAGE SOFTWARE, LLC, JACKSON, MO. FILED 9-29-2011.

VINTAGE SOFTWARE

THE MARK CONSISTS OF STANDARD CHARACTERS WITHOUT CLAIM TO ANY PARTICULAR FONT, STYLE, SIZE, OR COLOR.

NO CLAIM IS MADE TO THE EXCLUSIVE RIGHT TO USE "SOFTWARE", APART FROM THE MARK AS SHOWN.

FOR COMPUTER PROGRAMMING SERVICES, NAMELY, CREATION OF MOBILE COMMUNICATION DEVICE APPLICATIONS; COMPUTER SOFTWARE DESIGN; COMPUTER SOFTWARE DEVELOPMENT; COMPUTER TECHNICAL SUPPORT SERVICES, NAMELY, 24/7 SERVICE DESK/HELP DESK SERVICES FOR IT INFRASTRUCTURE, OPERATING SYSTEMS, DATABASE SYSTEMS, AND WEB APPLICATIONS.; CONSULTANCY IN THE FIELD OF SOFTWARE DESIGN; CREATING, DESIGNING AND MAINTAINING WEB SITES; CUSTOMIZED SOFTWARE DEVELOPMENT SERVICES (U.S. CLS. 100 AND 101).

FIRST USE 2-28-2007; IN COMMERCE 2-28-2007.
GISELLE AGOSTO, EXAMINING ATTORNEY

CLASS 42—(Continued).

SN 85-440,840. CHATAND, INC., NEW YORK, NY. FILED 10-6-2011.

CHAT&

THE MARK CONSISTS OF STANDARD CHARACTERS WITHOUT CLAIM TO ANY PARTICULAR FONT, STYLE, SIZE, OR COLOR.

FOR PROVIDING TEMPORARY USE OF ONLINE, NON-DOWNLOADABLE COMPUTER SOFTWARE FOR WEB BROWSING AND INFORMATION SHARING IN THE FIELD OF SALES AND CONVERSION; PROVIDING TEMPORARY USE OF ONLINE, NON-DOWNLOADABLE COMPUTER SOFTWARE FOR WEB BROWSING AND INFORMATION SHARING IN THE FIELD OF COMMUNICATIONS; PROVIDING TEMPORARY USE OF ONLINE, NON-DOWNLOADABLE COMPUTER SOFTWARE FOR WEB BROWSING AND INFORMATION SHARING IN THE FIELD OF CO-BROWSING; PROVIDING ONLINE, NON-DOWNLOADABLE COMPUTER SOFTWARE FOR WEB BROWSING AND INFORMATION SHARING IN THE FIELD OF CUSTOMER SERVICE (U.S. CLS. 100 AND 101).

FIRST USE 6-0-2010; IN COMMERCE 1-0-2011.
BILL DAWE, EXAMINING ATTORNEY

SN 85-444,030. AMERICAN ASSOCIATION OF PHYSICIAN SPECIALISTS, INC., TAMPA, FL. FILED 10-11-2011.



OWNER OF U.S. REG. NO. 3,991,368.

NO CLAIM IS MADE TO THE EXCLUSIVE RIGHT TO USE "BOARD OF CERTIFICATION IN FAMILY MEDICINE OBSTETRICS ORGANIZED 2007" AND "THE PICTORIAL REPRESENTATION OF THE CADUCEUS SYMBOL", APART FROM THE MARK AS SHOWN.

THE COLOR(S) BLUE, GOLD AND WHITE IS/ARE CLAIMED AS A FEATURE OF THE MARK.

THE MARK CONSISTS OF AN OVAL WITH A BLUE AND GOLD BORDER; INSIDE THE BORDER IS A WHITE BAND WITH THE BLUE WORDS "BOARD OF CERTIFICATION IN FAMILY MEDICINE OBSTETRICS" BEGINNING IN THE LOWER LEFT OF THE BAND AND RUNNING UPWARDS AND AROUND THE BORDER AND ENDING IN THE

CLASS 42—(Continued).

LOWER RIGHT; AT THE BOTTOM CENTER OF THE BORDER, IN SMALLER FONTS ARE THE BLUE WORDS "ORGANIZED 2007"; THE CENTER OF THE OVAL IS BLUE AND IN ITS CENTER IS A GOLD STAFF WITH A SNAKE WRAPPED AROUND IT, SIMILAR TO A CADUCEUS; IN THE CENTER, TO THE LEFT OF THE STAFF, IN WHITE OUTLINE FORM, ARE A MAN AND A WOMAN FACING INWARD AND ON THE RIGHT OF THE STAFF, ALSO IN WHITE OUTLINE FORM, IS A WOMAN FACING INWARD WITH AN UNBORN BABY IN HER STOMACH.

FOR ACCREDITATION SERVICES, NAMELY, DEVELOPING AND ADMINISTERING STANDARDS AND PROCEDURES FOR CERTIFYING PROFESSIONALS IN THE FIELD OF FAMILY MEDICINE OBSTETRICS (U.S. CLS. 100 AND 101).

FIRST USE 12-13-2010; IN COMMERCE 12-13-2010.
AMY ALFIERI, EXAMINING ATTORNEY

SN 85-447,128. GDSX, LTD., ALLEN, TX. FILED 10-13-2011.

COMPLEAT Express

THE MARK CONSISTS OF STANDARD CHARACTERS WITHOUT CLAIM TO ANY PARTICULAR FONT, STYLE, SIZE, OR COLOR.

FOR PROVIDING A NON-DOWNLOADABLE PROPRIETARY SOFTWARE FOR AUTOMATING THE PROCESSING OF PASSENGER NAME RECORDS (PNRS) ON BEHALF OF TRAVEL AGENCIES, WHEREBY THE AGENCIES CAN SELECT FROM A MENU OF SCRIPTS TO RUN FROM A STANDARD LIST (U.S. CLS. 100 AND 101).

FIRST USE 3-31-2010; IN COMMERCE 3-31-2010.
LAURIE MAYES, EXAMINING ATTORNEY

SN 85-451,381. GDSX, LTD., ALLEN, TX. FILED 10-19-2011.

COMPLEAT Managed

THE MARK CONSISTS OF STANDARD CHARACTERS WITHOUT CLAIM TO ANY PARTICULAR FONT, STYLE, SIZE, OR COLOR.

NO CLAIM IS MADE TO THE EXCLUSIVE RIGHT TO USE "MANAGED", APART FROM THE MARK AS SHOWN.

FOR PROVIDING A NON-DOWNLOADABLE PROPRIETARY SOFTWARE FOR AUTOMATING THE PROCESSING OF PASSENGER NAME RECORDS (PNRS) ON BEHALF OF TRAVEL AGENCIES (U.S. CLS. 100 AND 101).

FIRST USE 6-30-2010; IN COMMERCE 6-30-2010.
LAURIE MAYES, EXAMINING ATTORNEY

CLASS 42—(Continued).

SN 85-452,091. FIRST DATA CORPORATION, GREENWOOD VILLAGE, CO. FILED 10-20-2011.

RAPID CONNECT

THE MARK CONSISTS OF STANDARD CHARACTERS WITHOUT CLAIM TO ANY PARTICULAR FONT, STYLE, SIZE, OR COLOR.

NO CLAIM IS MADE TO THE EXCLUSIVE RIGHT TO USE "CONNECT", APART FROM THE MARK AS SHOWN.

FOR COMPUTER SERVICES, NAMELY, PROVIDING AN INTERACTIVE WEB SITE FEATURING TECHNOLOGY THAT ALLOWS USERS TO CONNECT TO PAYMENT PROCESSING PLATFORMS (U.S. CLS. 100 AND 101).

MICHELE SWAIN, EXAMINING ATTORNEY

SN 85-454,131. AFAXYS, INC., CHARLESTON, SC. FILED 10-24-2011.

**AIIMS**
AFAXYS INTEGRATED INVENTORY MANAGEMENT SUPPORT

OWNER OF U.S. REG. NOS. 3,953,466 AND 4,090,908.
NO CLAIM IS MADE TO THE EXCLUSIVE RIGHT TO USE "INTEGRATED INVENTORY MANAGEMENT SUPPORT", APART FROM THE MARK AS SHOWN.

THE MARK CONSISTS OF THE ACRONYM "AIIMS" WHICH APPEARS ABOVE THE SMALLER WORDS "AFAXYS INTEGRATED INVENTORY MANAGEMENT SUPPORT", AND TO THE RIGHT OF AN ABSTRACT HUMAN FIGURE DESIGN ELEMENT WITH RAISED OUTSTRETCHED ARMS. THREE SHADED PILL-SHAPED OVALS APPEAR IN AN ARCH SHAPE ABOVE THE ABSTRACT HUMAN FIGURE'S RAISED OUTSTRETCHED ARMS.

FOR PROVIDING TEMPORARY USE OF INTERACTIVE ON-LINE NON-DOWNLOADABLE SOFTWARE FOR CUSTOMERS TO TRACK, PLAN, PREPARE, COMMUNICATE, AND ANALYZE PRODUCT UTILIZATION, INVENTORIES, FORECASTS, UNDERLYING DRIVERS, COSTS AND FORECASTING/INVENTORY MANAGEMENT PERFORMANCE IN THE FIELD OF PHARMACEUTICALS (U.S. CLS. 100 AND 101).

COLLEEN DOMBROW, EXAMINING ATTORNEY

CLASS 42—(Continued).

SN 85-455,969. GDSX, LTD., ALLEN, TX. FILED 10-25-2011.

**CETAS**

THE COLOR(S) ORANGE, BLUE, GREEN, GRAY AND BLACK IS/ARE CLAIMED AS A FEATURE OF THE MARK.

THE MARK CONSISTS OF A SQUARE IMAGE CONSISTING OF AN ORANGE CHECK MARK ATOP A BLUE CHECK MARK, BOTH OF WHICH ARE ATOP A GREEN CHECK MARK, WITH THE REMAINDER OF THE SQUARE BEING GRAY. THE WORD "CETAS" APPEARS IN BLACK LETTERS TO THE RIGHT OF THE AFOREMENTIONED SQUARE IMAGE.

FOR PROVIDING PROPRIETARY ONLINE NON-DOWNLOADABLE SOFTWARE FOR AUTOMATING PRE-TRIP APPROVAL FOR OTHERS TO ENFORCE COMPLIANCE WITH THEIR CORPORATE TRAVEL POLICIES IN THE FIELD OF CORPORATE TRAVEL MANAGEMENT (U.S. CLS. 100 AND 101).

FIRST USE 7-31-2011; IN COMMERCE 7-31-2011.

LAURIE MAYES, EXAMINING ATTORNEY

SN 85-457,302. BRYAN ANDERSON, CARMEL, IN. FILED 10-26-2011.

RIDING SHOTGUN

THE MARK CONSISTS OF STANDARD CHARACTERS WITHOUT CLAIM TO ANY PARTICULAR FONT, STYLE, SIZE, OR COLOR.

FOR TECHNOLOGY CONSULTATION IN THE AUTOMOTIVE INDUSTRY IN THE FIELD OF DATA PROCESSING (U.S. CLS. 100 AND 101).

PRISCILLA MILTON, EXAMINING ATTORNEY

CLASS 42—(Continued).

SN 85-459,572. EONIX CORPORATION, HENDERSON, NV. FILED 10-28-2011.

SERVERHUB

THE MARK CONSISTS OF STANDARD CHARACTERS WITHOUT CLAIM TO ANY PARTICULAR FONT, STYLE, SIZE, OR COLOR.

SEC. 2(F).

FOR COMPUTER CO-LOCATION SERVICES, NAMELY, PROVIDING FACILITIES FOR THE LOCATION OF COMPUTER SERVERS WITH THE EQUIPMENT OF OTHERS; COMPUTER SERVICES, NAMELY, INTERNET PROTOCOL ADDRESS MANAGEMENT; COMPUTER SERVICES, NAMELY, PROVIDING VIRTUAL AND NON VIRTUAL APPLICATION SERVERS, WEB SERVERS, FILE SERVERS, CO-LOCATION SERVERS, LOAD BALANCING SERVERS, REDUNDANCY SERVERS, MEDIA SERVERS AND DATABASE SERVERS OF VARIABLE CAPACITY TO THIRD PARTY COMPUTING AND DATA STORAGE FACILITIES; CREATING AND MAINTAINING INTERNET SITES FOR OTHERS; HOSTING INTERNET SITES FOR OTHERS; HOSTING WEBSITES ON THE INTERNET; MAINTENANCE OF SOFTWARE FOR INTERNET ACCESS; RENTAL OF WEB SERVERS; TECHNICAL CONSULTING SERVICES IN THE FIELDS OF DATACENTER ARCHITECTURE, PUBLIC AND PRIVATE CLOUD COMPUTING SOLUTIONS, AND EVALUATION AND IMPLEMENTATION OF INTERNET TECHNOLOGY AND SERVICES; TECHNOLOGY ADVICE PROVIDED TO INTERNET USERS BY MEANS OF A SUPPORT HOTLINE; WEB SITE HOSTING SERVICES (U.S. CLS. 100 AND 101).

FIRST USE 3-12-2002; IN COMMERCE 3-12-2002.

REBECCA SMITH, EXAMINING ATTORNEY

CLASS 42—(Continued).

SN 85-467,608. MICROSOFT CORPORATION, REDMOND, WA. FILED 11-8-2011.



OWNER OF U.S. REG. NOS. 1,626,863, 3,905,558 AND OTHERS.

THE MARK CONSISTS OF A BOX WITH A ROUNDED UPPER LEFT CORNER CONTAINING THE LETTERS "XL" AND AN IMAGE OF A SHEET OF PAPER.

FOR CLOUD COMPUTING FEATURING SOFTWARE FOR USE IN CREATING, ACCESSING AND EDITING ELECTRONIC SPREADSHEETS AND ACCESSING REMOTELY STORED DATA FOR SUCH APPLICATIONS; PROVIDING TEMPORARY USE OF ON-LINE NON-DOWNLOADABLE SOFTWARE AND APPLICATIONS FOR CREATING, ACCESSING AND EDITING ELECTRONIC SPREADSHEETS; PROVIDING TECHNICAL INFORMATION IN THE FIELD OF COMPUTER SOFTWARE AND CLOUD COMPUTING (U.S. CLS. 100 AND 101).

SETH A. RAPPAPORT, EXAMINING ATTORNEY

SN 85-461,569. THINKAGE, LLC, KINGSTON, NH. FILED 11-1-2011.

RANGL

THE MARK CONSISTS OF STANDARD CHARACTERS WITHOUT CLAIM TO ANY PARTICULAR FONT, STYLE, SIZE, OR COLOR.

FOR PROVIDING AN INTERACTIVE WEBSITE FEATURING ONLINE NON-DOWNLOADABLE SOFTWARE THAT ENABLES REGISTERED USERS TO CREATE AND MANAGE PROFILES, UPLOAD, DOWNLOAD, POST, DISPLAY, TAG, SHARE, DISTRIBUTE AND OTHERWISE PROVIDE AUDIO, VIDEO AND MULTIMEDIA CONTENT AND INFORMATION AND TO REVIEW, RATE, RANK AND COMMENT ON THE POSTINGS OF OTHER REGISTERED USERS FOR PURPOSES OF ENTERTAINMENT AND DISCUSSION (U.S. CLS. 100 AND 101).

LEIGH CAROLINE CASE, EXAMINING ATTORNEY

SN 85-467,625. MICROSOFT CORPORATION, REDMOND, WA. FILED 11-8-2011.

POWERPOINT

THE MARK CONSISTS OF STANDARD CHARACTERS WITHOUT CLAIM TO ANY PARTICULAR FONT, STYLE, SIZE, OR COLOR.

OWNER OF U.S. REG. NO. 1,475,795.

FOR CLOUD COMPUTING FEATURING SOFTWARE FOR USE IN CREATING, ACCESSING AND EDITING PRESENTATION GRAPHICS AND ACCESSING REMOTELY STORED DATA FOR SUCH APPLICATIONS; PROVIDING TEMPORARY USE OF ON-LINE NON-DOWNLOADABLE SOFTWARE AND APPLICATIONS FOR CREATING, ACCESSING AND EDITING PRESENTATION GRAPHICS; PROVIDING TECHNICAL INFORMATION IN THE FIELD OF COMPUTER SOFTWARE AND CLOUD COMPUTING (U.S. CLS. 100 AND 101).

SETH A. RAPPAPORT, EXAMINING ATTORNEY

CLASS 42—(Continued).

SN 85-468,974. ANNETTE BACK, NEW YORK, NY. FILED 11-9-2011.

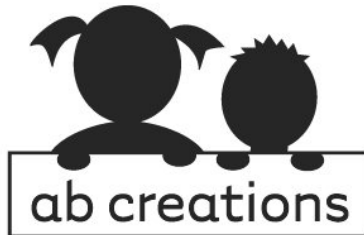

NO CLAIM IS MADE TO THE EXCLUSIVE RIGHT TO USE "CREATIONS", APART FROM THE MARK AS SHOWN.

THE MARK CONSISTS OF DRAWING OF A BOY AND A GIRL HOLDING UP A SIGN IN WHICH IT SAYS "AB CREATIONS".

FOR VISUAL DESIGN SERVICES FOR OTHERS IN DIGITAL FORMAT IN THE FIELD OF ARTWORK (U.S. CLS. 100 AND 101).

FIRST USE 9-22-2011; IN COMMERCE 9-22-2011.
LINDA ESTRADA, EXAMINING ATTORNEY

CLASS 42—(Continued).

SN 85-478,175. MINDSHARE NETWORKS, INC., EAGLE, ID. FILED 11-21-2011.



THE COLOR(S) BLACK, WHITE, GREEN, AND GRAY IS/ ARE CLAIMED AS A FEATURE OF THE MARK.

THE MARK CONSISTS OF A STYLIZED WHITE CLOUD WITH A BLACK OUTLINE. INSIDE THE CLOUD ARE THREE PARTIALLY SHADED SQUARES IN GREEN. THE WORD "SLIDEKLOWD" IS TO THE RIGHT OF THE DESIGN WITH THE PORTION OF THE MARK "SLIDE" IN GREEN AND THE PORTION OF THE MARK "KLOWD" IN GRAY.

FOR PLATFORM AS A SERVICE (PAAS) FEATURING COMPUTER SOFTWARE PLATFORMS FOR CONDUCTING CONFERENCES, SEMINARS, AND WORKSHOPS THROUGH PRESENTATIONS FOR BOTH PROFESSIONAL AND EDUCATIONAL CONTEXTS (U.S. CLS. 100 AND 101).

FIRST USE 8-15-2011; IN COMMERCE 9-15-2011.
JEFFREY LOOK, EXAMINING ATTORNEY

SN 85-469,528. ODIGIA, INC., WINSTON SALEM, NC. FILED 11-10-2011.



OWNER OF U.S. REG. NO. 4,075,487.
NO CLAIM IS MADE TO THE EXCLUSIVE RIGHT TO USE "ODIGIA", APART FROM THE MARK AS SHOWN.

THE MARK CONSISTS OF AN IMAGE OF TWO LARGE LEAVES AND TWO SMALL LEAVES WITH THE WORD "ODIGIA" TO THE RIGHT OF THE IMAGE.

THE ENGLISH TRANSLATION OF "ODIGIA" IN THE MARK IS "INSTRUCTION."

FOR PROVIDING A WEB-BASED SYSTEM AND ONLINE PORTAL FEATURING ONLINE NON-DOWNLOADABLE SOFTWARE THAT ENABLES USERS TO ACCESS TRAINING, EDUCATION AND TESTING MATERIALS CREATED TO CUSTOMER SPECIFICATION FOR COURSES OF INSTRUCTION PROVIDED IN WORKFORCE TRAINING AND DEVELOPMENT, K-12 EDUCATION, COLLEGE LEVEL INSTRUCTION, AND PERSONAL DEVELOPMENT (U.S. CLS. 100 AND 101).

FIRST USE 3-25-2010; IN COMMERCE 3-25-2010.
LINDA LAVACHE, EXAMINING ATTORNEY

SN 85-478,864. RIVER BEND CENTER, LLC, STAMFORD, CT. FILED 11-22-2011.

1-877-NON-STOP

THE MARK CONSISTS OF STANDARD CHARACTERS WITHOUT CLAIM TO ANY PARTICULAR FONT, STYLE, SIZE, OR COLOR.

FOR COMPUTER SERVICES, NAMELY, PROVIDING DATA CENTER SERVICES IN THE NATURE OF PROVIDING FACILITIES FOR THE LOCATION OF COMPUTER SERVERS WITH THE EQUIPMENT OF OTHERS; COMPUTER SERVICES, NAMELY, DATA RECOVERY AND DISASTER RECOVERY PLANNING; BUSINESS CONTINUITY SERVICES FOR OTHERS, NAMELY, RENTAL OF SPACE IN A COMPUTER CO-LOCATION FACILITY FOR CONTAINERIZED DATA CENTERS OF OTHERS, AND LEASING OF COMPUTER FACILITIES (U.S. CLS. 100 AND 101).

FIRST USE 0-0-2002; IN COMMERCE 11-17-2011.
JAY BESCH, EXAMINING ATTORNEY

CLASS 42—(Continued).

SN 85-484,249. VERIO INC., GREENWOOD VILLAGE, CO. FILED 11-30-2011.

cloud(n)

THE MARK CONSISTS OF STANDARD CHARACTERS WITHOUT CLAIM TO ANY PARTICULAR FONT, STYLE, SIZE, OR COLOR.

FOR COMPUTER SERVICES, NAMELY, CLOUD HOSTING PROVIDER SERVICES (U.S. CLS. 100 AND 101).

FIRST USE 3-29-2012; IN COMMERCE 3-29-2012.
NATALIE POLZER, EXAMINING ATTORNEY

CLASS 42—(Continued).

SN 85-486,785. ASSOCIATED PATHOLOGISTS, LLC, BRENTWOOD, TN. FILED 12-5-2011.

HPV CERVICA

THE MARK CONSISTS OF STANDARD CHARACTERS WITHOUT CLAIM TO ANY PARTICULAR FONT, STYLE, SIZE, OR COLOR.

NO CLAIM IS MADE TO THE EXCLUSIVE RIGHT TO USE "HPV", APART FROM THE MARK AS SHOWN.

THE WORDING "CERVICA" HAS NO MEANING IN A FOREIGN LANGUAGE.

FOR MEDICAL LABORATORY SERVICES IN THE FIELD OF DETECTION OF CERVICAL CANCER (U.S. CLS. 100 AND 101).

ANGELA M. MICHELI, EXAMINING ATTORNEY

SN 85-485,572. DOTQS, INC., CHICAGO, IL. FILED 12-2-2011.



THE MARK CONSISTS OF AN IMAGE OF THE STYLIZED WORD "DOTQS" TO THE RIGHT OF A STYLIZED IMAGE OF A BRIDGE.

FOR QUALITY MANAGEMENT SERVICES, NAMELY, QUALITY EVALUATION AND ANALYSIS, QUALITY ASSURANCE, AND QUALITY CONTROL, IN THE FIELD OF BRIDGE CONSTRUCTION, BUILDING CONSTRUCTION, STRUCTURAL STEEL ERECTION, STRUCTURAL STEEL FABRICATION, TELECOMMUNICATIONS, PHARMACEUTICALS, AND QUALITY MANAGEMENT SYSTEMS; TESTING, ANALYSIS, AND EVALUATION OF THE KNOWLEDGE, SKILLS AND ABILITIES OF OTHERS FOR THE PURPOSE OF CERTIFICATION AND RE-CERTIFICATION IN THE FIELD OF BRIDGE CONSTRUCTION, BUILDING CONSTRUCTION, STRUCTURAL STEEL ERECTION, STRUCTURAL STEEL FABRICATION, TELECOMMUNICATIONS, PHARMACEUTICALS, AND QUALITY MANAGEMENT SYSTEMS (U.S. CLS. 100 AND 101).

FIRST USE 6-1-2011; IN COMMERCE 6-1-2011.
MARLENE BELL, EXAMINING ATTORNEY

SN 85-494,880. FOREST LABORATORIES, INC., NEW YORK, NY. FILED 12-14-2011.

FOREST LABORATORIES
CLINICAL TRIAL REGISTRY

THE MARK CONSISTS OF STANDARD CHARACTERS WITHOUT CLAIM TO ANY PARTICULAR FONT, STYLE, SIZE, OR COLOR.

NO CLAIM IS MADE TO THE EXCLUSIVE RIGHT TO USE "CLINICAL TRIAL REGISTRY", APART FROM THE MARK AS SHOWN.

FOR INTERNET WEBSITE PROVIDING INFORMATION ON CLINICAL TRIALS FOR EXISTING AND PROSPECTIVE PHARMACEUTICAL PRODUCTS (U.S. CLS. 100 AND 101).

FIRST USE 2-8-2005; IN COMMERCE 2-8-2005.
MICHELE SWAIN, EXAMINING ATTORNEY

CLASS 42—(Continued).

SN 85-494,902. COALITION AMERICA HOLDING COMPANY, INC., ATLANTA, GA. FILED 12-14-2011.

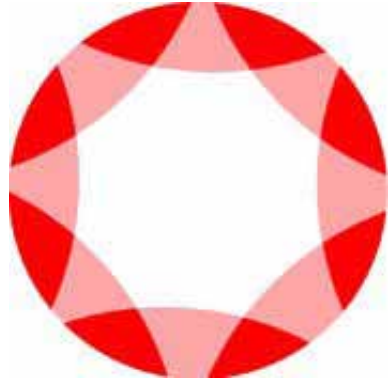

THE COLOR(S) RED, LIGHT RED, AND WHITE IS/ARE CLAIMED AS A FEATURE OF THE MARK.

THE MARK CONSISTS OF THE FOLLOWING: A CIRCLE WITH A PRISM DESIGN BORDER IN RED WITH DOTS THAT FILL IN THE LIGHTER SECTION IN THE COLOR LIGHT RED WITH A WHITE CENTER.

FOR DEVELOPMENT AND IMPLEMENTATION OF SOFTWARE, DATABASE AND TECHNOLOGY SOLUTIONS FOR THE PURPOSE OF PROVIDING SAVINGS ON MEDICAL, DENTAL AND WORKERS' COMPENSATION HEALTHCARE COSTS UTILIZING PROPRIETARY PROVIDER CONTRACTS, PPO NETWORKS, PROVIDER NEGOTIATIONS, AND DATA ANALYTICS TO ACHIEVE SAVINGS FOR NATIONAL CLIENT BASE (U.S. CLS. 100 AND 101).

ANNE E. GUSTASON, EXAMINING ATTORNEY

SN 85-494,911. COALITION AMERICA HOLDING COMPANY, INC., ATLANTA, GA. FILED 12-14-2011.



THE MARK CONSISTS OF THE WORD "STRATOSE" WITH THE "O" HAVING A PRISM DESIGN BORDER ABOVE THE WORDS "PEOPLE ANALYTICS RESULTS" WITH THE WORDS SEPARATED WITH DOTS.

FOR DEVELOPMENT AND IMPLEMENTATION OF SOFTWARE, DATABASE AND TECHNOLOGY SOLUTIONS FOR THE PURPOSE OF PROVIDING SAVINGS ON MEDICAL, DENTAL AND WORKERS' COMPENSATION HEALTHCARE COSTS UTILIZING PROPRIETARY PROVIDER CONTRACTS, PPO NETWORKS, PROVIDER NEGOTIATIONS, AND DATA ANALYTICS TO ACHIEVE SAVINGS FOR NATIONAL CLIENT BASE (U.S. CLS. 100 AND 101).

ANNE E. GUSTASON, EXAMINING ATTORNEY

CLASS 42—(Continued).

SN 85-503,435. MORPHLABS, INC., MANHATTAN BEACH, CA. FILED 12-23-2011.



THE MARK CONSISTS OF STANDARD CHARACTERS WITHOUT CLAIM TO ANY PARTICULAR FONT, STYLE, SIZE, OR COLOR.

FOR PROVIDING TEMPORARY USE OF ON-LINE NON-DOWNLOADABLE COMPUTER PROGRAMS FOR CLOUD COMPUTING MANAGEMENT (U.S. CLS. 100 AND 101).

FIRST USE 6-27-2011; IN COMMERCE 6-27-2011.
MATTHEW MCDOWELL, EXAMINING ATTORNEY

SN 85-507,638. KLEMESHEV, GENNADY, MOSCOW, RUSSIAN FED., FILED 1-3-2012.



THE MARK CONSISTS OF THE WORD "AGAVOO" IN STYLIZED FONT.

THE WORDING "AGAVOO" HAS NO MEANING IN A FOREIGN LANGUAGE.

FOR PROVIDING TEMPORARY USE OF ONLINE, NON-DOWNLOADABLE COMPUTER SOFTWARE THAT ALLOWS SUBSCRIBERS TO UTILIZE VOIP COMMUNICATION SERVICES IN THE NATURE OF VIDEO CHAT AND CONFERENCING, PHONE CALLS AND EXCHANGE OF ELECTRONIC DOCUMENTS (U.S. CLS. 100 AND 101).

FIRST USE 7-26-2011; IN COMMERCE 7-26-2011.
MARTHA FROMM, EXAMINING ATTORNEY

SN 85-509,175. DERIVED DESIGNS LLC, GERMANTOWN, WI. FILED 1-5-2012.



THE MARK CONSISTS OF STANDARD CHARACTERS WITHOUT CLAIM TO ANY PARTICULAR FONT, STYLE, SIZE, OR COLOR.

NO CLAIM IS MADE TO THE EXCLUSIVE RIGHT TO USE "DESIGNS", APART FROM THE MARK AS SHOWN.

FOR GRAPHIC DESIGN SERVICES; WEBSITE DESIGN, DEVELOPMENT, AND MAINTENANCE FOR OTHERS; COMPUTER SOFTWARE DESIGN FOR OTHERS (U.S. CLS. 100 AND 101).

FIRST USE 3-4-2011; IN COMMERCE 8-11-2011.
DANNEAN HETZEL, EXAMINING ATTORNEY

CLASS 42—(Continued).

SN 85-510,968. JEANE DOLE, DENVER, CO. FILED 1-6-2012.

DESIGN DETECTIVE

THE MARK CONSISTS OF STANDARD CHARACTERS WITHOUT CLAIM TO ANY PARTICULAR FONT, STYLE, SIZE, OR COLOR.

NO CLAIM IS MADE TO THE EXCLUSIVE RIGHT TO USE "DESIGN", APART FROM THE MARK AS SHOWN.

FOR INTERIOR DESIGN SERVICES (U.S. CLS. 100 AND 101).

FIRST USE 3-20-2011; IN COMMERCE 5-23-2011.
SOPHIA S. KIM, EXAMINING ATTORNEY

SN 85-512,465. CROTHALL SERVICES GROUP, WAYNE, PA. FILED 1-10-2012.

TEAMOPS

THE MARK CONSISTS OF STANDARD CHARACTERS WITHOUT CLAIM TO ANY PARTICULAR FONT, STYLE, SIZE, OR COLOR.

FOR PROVIDING ON-LINE, NON-DOWNLOADABLE SOFTWARE, NAMELY, SOFTWARE WHICH ALLOWS USERS TO INPUT AND OBTAIN INFORMATION RELATING TO EQUIPMENT INVENTORY, SCHEDULE MAINTENANCE WORK ORDERS, AND ACCESS CORRECTIVE AND PREVENTATIVE MAINTENANCE TRACKING DATA, ALL FOR USE IN CONNECTION WITH FACILITIES MANAGEMENT (U.S. CLS. 100 AND 101).

FIRST USE 9-1-2005; IN COMMERCE 11-16-2005.
JIM RINGLE, EXAMINING ATTORNEY

SN 85-513,395. ETERNA, LLC, EL PASO, TX. FILED 1-10-2012.

PET SORROWS

THE MARK CONSISTS OF STANDARD CHARACTERS WITHOUT CLAIM TO ANY PARTICULAR FONT, STYLE, SIZE, OR COLOR.

OWNER OF U.S. REG. NO. 3,844,518.

NO CLAIM IS MADE TO THE EXCLUSIVE RIGHT TO USE "PET", APART FROM THE MARK AS SHOWN.

FOR PROVIDING AN ONLINE WEBSITE FEATURING TEMPORARY USE OF NON-DOWNLOADABLE COMPUTER SOFTWARE FOR USE BY INDIVIDUALS TO FULFILL THE NEEDS THAT ARISE FROM THE DEATH OF A PET, NAMELY, PLANNING, SELECTING PROVIDERS, COMMUNICATING THE LOSS TO OTHERS, MEMORIALIZING AND FINDING PET GRIEF RESOURCES (U.S. CLS. 100 AND 101).

LINDA ESTRADA, EXAMINING ATTORNEY

CLASS 42—(Continued).

SN 85-514,473. KWANTI INC., MOUNTAIN VIEW, CA. FILED 1-11-2012.

Kwanti

THE MARK CONSISTS OF STANDARD CHARACTERS WITHOUT CLAIM TO ANY PARTICULAR FONT, STYLE, SIZE, OR COLOR.

THE ENGLISH TRANSLATION OF THE WORD "KWANTI" IN THE MARK IS "QUANTITATIVE".

FOR PROVIDING TEMPORARY USE OF A WEB-BASED SOFTWARE APPLICATION FOR USE IN MANAGEMENT OF FINANCIAL INVESTMENTS (U.S. CLS. 100 AND 101).

FIRST USE 11-1-2006; IN COMMERCE 7-16-2007.
LESLEY LAMOTHE, EXAMINING ATTORNEY

SN 85-517,462. IMEDMEDIA INC., RUSSELL, ON, CANADA, FILED S.R. 1-16-2012; AM. P.R. 4-25-2012.

IMEDTEACH

THE MARK CONSISTS OF STANDARD CHARACTERS WITHOUT CLAIM TO ANY PARTICULAR FONT, STYLE, SIZE, OR COLOR.

FOR SOFTWARE AS A SERVICES FEATURING SOFTWARE FOR SCHOOLS, MEDICAL DIVISIONS, HOSPITALS, INSTITUTIONS, AND GOVERNMENT AGENCIES TO CREATE CUSTOMIZED TEACHING AND TESTING MODULES FOR STUDENTS, STAFF AND PROFESSIONALS (U.S. CLS. 100 AND 101).

FIRST USE 6-1-2009; IN COMMERCE 6-1-2009.
KAREN K. BUSH, EXAMINING ATTORNEY

SN 85-518,228. GOTTLIEB, MICHAEL W., DBA MAXOÖN, NEW YORK, NY. FILED 1-17-2012.

MAXOÖN

THE COLOR(S) BLACK, ORANGE AND DARK ORANGE IS/ARE CLAIMED AS A FEATURE OF THE MARK.

THE MARK CONSISTS OF THE LETTERS "MAX" IN BLACK, "O" IN ORANGE TOUCHING A DARK ORANGE "Ö" WITH AN UMLAT, FOLLOWED BY THE LETTER "N" IN BLACK.

FOR GRAPHIC ARTS DESIGNING; GRAPHIC DESIGN SERVICES; INDUSTRIAL AND GRAPHIC ART DESIGN (U.S. CLS. 100 AND 101).

JORDAN BAKER, EXAMINING ATTORNEY

CLASS 42—(Continued).

SN 85-518,374. BE DIGITAL MEDIA SOLUTIONS, LLC, QUINCY, IL. FILED 1-17-2012.

COMMOTION

THE MARK CONSISTS OF STANDARD CHARACTERS WITHOUT CLAIM TO ANY PARTICULAR FONT, STYLE, SIZE, OR COLOR.

FOR APPLICATION SERVICE PROVIDER (ASP) FEATURING SOFTWARE FOR USE IN PROVIDING LIVE INTERACTIVE CHAT, LIVE LISTENER POLLING, LIVE PLAYLIST VOTING, ALBUM ART SYNCHRONIZATION, LIVE PLAYLISTS, INTERACTIVE MEDIA SERVICES, MOBILE MARKETING PLATFORMS AND CUSTOMIZED ELECTRONIC DISPLAYS IN THE FIELD OF RADIO PROGRAMME BROADCASTING; VENDOR-ON-PREMISE SERVICES, NAMELY, THE CUSTOMIZATION OF SOFTWARE APPLICATIONS FOR RADIO STATIONS THAT PROVIDE LIVE INTERACTIVE CHAT, LIVE LISTENER POLLING, LIVE PLAY LIST VOTING, ALBUM ART SYNCHRONIZATION, LIVE PLAYLISTS AND INTERACTIVE MEDIA SERVICES TO RADIO LISTENERS VIA MOBILE PHONES, TABLETS, COMPUTERS AND ELECTRONIC HANDHELD DEVICES (U.S. CLS. 100 AND 101).

FIRST USE 12-0-2011; IN COMMERCE 12-0-2011.
JULIE VEPPUMTHARA, EXAMINING ATTORNEY

SN 85-518,415. BE DIGITAL MEDIA SOLUTIONS, LLC, QUINCY, IL. FILED 1-17-2012.

CROWDCONTROL

THE MARK CONSISTS OF STANDARD CHARACTERS WITHOUT CLAIM TO ANY PARTICULAR FONT, STYLE, SIZE, OR COLOR.

FOR APPLICATION SERVICE PROVIDER (ASP) FEATURING SOFTWARE FOR USE IN PROVIDING LIVE INTERACTIVE CHAT, LIVE LISTENER POLLING, LIVE PLAYLIST VOTING, ALBUM ART SYNCHRONIZATION, LIVE PLAYLISTS, INTERACTIVE MEDIA SERVICES, MOBILE MARKETING PLATFORMS AND CUSTOMIZED ELECTRONIC DISPLAYS IN THE FIELD OF RADIO PROGRAMME BROADCASTING; VENDOR-ON-PREMISE SERVICES, NAMELY, THE CUSTOMIZATION OF SOFTWARE APPLICATIONS FOR RADIO STATIONS THAT PROVIDE LIVE INTERACTIVE CHAT, LIVE LISTENER POLLING, LIVE PLAY LIST VOTING, ALBUM ART SYNCHRONIZATION, LIVE PLAYLISTS AND INTERACTIVE MEDIA SERVICES TO RADIO LISTENERS VIA MOBILE PHONES, TABLETS, COMPUTERS AND ELECTRONIC HANDHELD DEVICES (U.S. CLS. 100 AND 101).

FIRST USE 12-0-2011; IN COMMERCE 12-0-2011.
JULIE VEPPUMTHARA, EXAMINING ATTORNEY

CLASS 42—(Continued).

SN 85-518,835. SUMMIT CONSULTING GROUP, INC., DBA SUMMIT GLOBAL TESTING, ANNAPOLIS, MD. FILED 1-18-2012.



NO CLAIM IS MADE TO THE EXCLUSIVE RIGHT TO USE "GLOBAL TESTING", APART FROM THE MARK AS SHOWN.

THE COLOR(S) YELLOW AND GREEN IS/ARE CLAIMED AS A FEATURE OF THE MARK.

THE MARK CONSISTS OF THREE STYLIZED MOUNTAINS OF DIFFERING SIZES WITH A TRIANGULAR GREEN MOUNTAIN APPEARING MOST PROMINENT AND IS POSITIONED IN BETWEEN TWO SMALLER YELLOW STYLIZED MOUNTAINS ON EITHER SIDE, COUPLED WITH THE WORDS "SUMMIT GLOBAL TESTING" IN GREEN WHEREIN EACH "M" OF "SUMMIT" IS MISSING PART OF THE LETTER IN ORDER TO CONJURE MOUNTAIN PEAK IMAGES.

FOR DESIGN, DEVELOPMENT AND IMPLEMENTATION OF SOFTWARE, HARDWARE AND TECHNOLOGY SOLUTIONS, AND CONSULTING SERVICES RELATED THERETO, IN THE FIELD OF COMPUTER-BASED EDUCATIONAL AND STANDARDIZED TESTING (U.S. CLS. 100 AND 101).

FIRST USE 12-15-2011; IN COMMERCE 12-15-2011.
THEODORE MCBRIDE, EXAMINING ATTORNEY

SN 85-519,386. STOCK-TRAK, INC., MONTREAL, QUEBEC, CANADA, FILED 1-18-2012.

HOWTHEMARKETWORKS.COM

THE MARK CONSISTS OF STANDARD CHARACTERS WITHOUT CLAIM TO ANY PARTICULAR FONT, STYLE, SIZE, OR COLOR.

FOR PROVIDING ON-LINE NON-DOWNLOADABLE SOFTWARE FEATURING AN INVESTMENT PORTFOLIO SIMULATOR (U.S. CLS. 100 AND 101).

FIRST USE 4-22-2004; IN COMMERCE 4-22-2004.
BRIDGETT SMITH, EXAMINING ATTORNEY

CLASS 42—(Continued).

SN 85-519,644. BE DIGITAL MEDIA SOLUTIONS, LLC, QUINCY, IL. FILED 1-18-2012.



THE MARK CONSISTS OF THE WORDS "CROWD" AND "CONTROL". THE LITERAL ELEMENTS OF THE MARK ARE BISECTED BY TWO HANDS JUXTAPOSED NEXT TO EACH OTHER WITH ONE HAND WITH ITS THUMB POINTED DOWN AND THE OTHER HAND WITH THE THUMB POINTED UP.

FOR APPLICATION SERVICE PROVIDER (ASP) FEATURING SOFTWARE FOR USE IN PROVIDING LIVE INTERACTIVE CHAT, LIVE LISTENER POLLING, LIVE PLAYLIST VOTING, ALBUM ART SYNCHRONIZATION, LIVE PLAYLISTS, INTERACTIVE MEDIA SERVICES, MOBILE MARKETING PLATFORMS AND CUSTOMIZED ELECTRONIC DISPLAYS IN THE FIELD OF RADIO PROGRAMME BROADCASTING; VENDOR-ON-PREMISE SERVICES, NAMELY, THE CUSTOMIZATION OF SOFTWARE APPLICATIONS FOR RADIO STATIONS THAT PROVIDE LIVE INTERACTIVE CHAT, LIVE LISTENER POLLING, LIVE PLAY LIST VOTING, ALBUM ART SYNCHRONIZATION, LIVE PLAYLISTS AND INTERACTIVE MEDIA SERVICES TO RADIO LISTENERS VIA MOBILE PHONES, TABLETS, COMPUTERS AND ELECTRONIC HANDHELD DEVICES (U.S. CLS. 100 AND 101).

FIRST USE 12-0-2011; IN COMMERCE 12-0-2011.
JULIE VEPPUMTHARA, EXAMINING ATTORNEY

CLASS 42—(Continued).

SN 85-519,664. STANLEY NTIENSE UMOH, DBA SHRYER SYSTEMS, ATLANTA, GA. FILED 1-18-2012.



THE COLOR(S) LIGHT-BLUE, WHITE, BLACK, AND GREEN IS/ARE CLAIMED AS A FEATURE OF THE MARK.

THE MARK CONSISTS OF A LIGHT BLUE STYLIZED CLOUD WITH HELICAL WHITE CUT TRIMMINGS SUSPENDED OVER AN ENTWINED SWIRL LIKE GREEN FOLIAGE OF A PLANT IN POSITION WITH A GREEN SYMMETRICAL TRUNK AND THE BLACK STYLIZED WORDING "SHRYER" APPEARING UNDERNEATH.

FOR DESIGN, DEVELOPMENT, AND CONSULTING SERVICES RELATED THERETO IN THE FIELD OF TANGIBLE NEGATIVE DYNAMIC SHOWER SYSTEMS COMPOSED OF AROMATIC PREPARATIONS AND RETICULATION IN PURPOSE OF DECONTAMINATION, CONSERVATION, AND PROPAGATION; DESIGN, DEVELOPMENT, AND CONSULTING SERVICES RELATED THERETO IN THE FIELD OF TANGIBLE EVAPORATING AROMATIC SHOWER BALLS FOR SPECIFIC MEDICAL CONDITIONS, DECONTAMINATION, OR RECREATIONAL MASSAGE THERAPY; DESIGN, DEVELOPMENT, AND CONSULTING SERVICES RELATED THERETO IN THE FIELD OF CUSTOM PIPING AND AUTOMATED VALVES FOR REGULATING THE FLOW OF GASES, LIQUIDS, OR ELECTRICITY (U.S. CLS. 100 AND 101).

GENE MACIOL, EXAMINING ATTORNEY

CLASS 42—(Continued).

SN 85-519,667. STYLESEAT, INC., SAN FRANCISCO, CA. FILED 1-18-2012.

STYLESEAT

THE MARK CONSISTS OF STANDARD CHARACTERS WITHOUT CLAIM TO ANY PARTICULAR FONT, STYLE, SIZE, OR COLOR.

FOR PROVIDING TEMPORARY USE OF ON-LINE NON-DOWNLOADABLE SOFTWARE AND APPLICATIONS FOR LISTING SERVICES, SEARCHING FOR SERVICE PROVIDERS, LOCATING SERVICE PROVIDERS, SCHEDULING OR BOOKING APPOINTMENTS, MANAGING CALENDARS, MANAGING SCHEDULES, MANAGING CLIENT SERVICES, POSTING AND VIEWING INFORMATION AND PHOTOS, POSTING REVIEWS OF BUSINESSES OR INDIVIDUALS BASED ON LOCATION AND/OR SERVICES, CREATING WEB PAGES, CREATING PROFILES, AND CREATING, TRACKING OR MANAGING ADVERTISING OR PROMOTIONAL CAMPAIGNS; PLATFORM AS A SERVICE (PAAS) FEATURING COMPUTER SOFTWARE PLATFORMS FOR USE IN MANAGING BUSINESS OPERATIONS TO ALIGN WITH BUSINESS OBJECTIVES (U.S. CLS. 100 AND 101).

FIRST USE 1-21-2010; IN COMMERCE 1-21-2010.
GENE MACIOL, EXAMINING ATTORNEY

CLASS 42—(Continued).

SN 85-521,233. CABA, STEVE, NEW YORK, NY. FILED 1-20-2012.



THE MARK CONSISTS OF A STYLIZED REPRESENTATION OF A PRAYING MANTIS.

FOR GRAPHIC DESIGN SERVICES (U.S. CLS. 100 AND 101).

FIRST USE 10-11-2011; IN COMMERCE 10-11-2011.
JEFFREY LOOK, EXAMINING ATTORNEY

SN 85-521,388. E-BUILDER, INC., PLANTATION, FL. FILED 1-20-2012.



THE COLOR(S) BLACK, WHITE, AND GOLD IS/ARE CLAIMED AS A FEATURE OF THE MARK.

THE MARK CONSISTS OF A STYLIZED "B" IN WHICH THE TOP AND BACK ARE IN BLACK WITH WHITE BANDS CORRESPONDING TO THE CIRCLES IN THE "B", AND THE FRONT FACE BEING IN GOLD.

FOR PROVIDING TEMPORARY USE OF A WEB-BASED, DATABASE-DRIVEN SOFTWARE APPLICATION FOR USE IN COMPUTER PROJECT MANAGEMENT, CAPITAL PROJECT MANAGEMENT, AND BUSINESS PROCESS MANAGEMENT, INCLUDING COST MANAGEMENT, CAPITAL PROJECT PLANNING, SCHEDULING MANAGEMENT, DOCUMENT MANAGEMENT, BID MANAGEMENT, TO CREATE AUTOMATE AND MANAGE PROCUREMENT, SUPPLY CHAIN, WORKFLOW AND ANY OTHER BUSINESS PROCESSES, INCLUDING ON-SITE AND 24/7 TECHNICAL SUPPORT CONSULTATION SERVICES THEREFOR; SOFTWARE AS A SERVICE SERVICES FEATURING SOFTWARE FOR USE IN BUSINESS PROCESS MANAGEMENT, COMPUTER PROJECT MANAGEMENT, AND CAPITAL PROJECT MANAGEMENT, INCLUDING ON-SITE AND 24/7 TECHNICAL SUPPORT CONSULTATION SERVICES THEREFOR; COMPUTER SERVICES, NAMELY, CONSULTATION SERVICES IN THE FIELD OF SOFTWARE AS A SERVICE FOR USE IN CONSTRUCTION PROJECT MANAGEMENT, INCLUDING ON-SITE AND 24/7 TECHNICAL SUPPORT CONSULTATION SERVICES THEREFOR (U.S. CLS. 100 AND 101).

FIRST USE 7-1-2000; IN COMMERCE 7-1-2000.
JUDITH HELFMAN, EXAMINING ATTORNEY

SN 85-520,166. EJURIS CORPORATION, CALGARY, ALBERTA, CANADA, FILED 1-19-2012.

EJURIS

THE MARK CONSISTS OF STANDARD CHARACTERS WITHOUT CLAIM TO ANY PARTICULAR FONT, STYLE, SIZE, OR COLOR.

THE WORDING "EJURIS" HAS NO MEANING IN A FOREIGN LANGUAGE.

FOR ON-LINE NETWORK SOFTWARE AS A SERVICE (SAAS) SERVICES VIA A WEBSITE FEATURING SOFTWARE THAT ENABLES USERS TO MANAGE DATA AND SHARE DATA IN THE LEGAL PROFESSION AND THAT PROVIDES ACCESS TO A DATABASE OF DOCUMENTS UPLOADED BY USERS OF THE WEBSITE (U.S. CLS. 100 AND 101).

BRIAN PINO, EXAMINING ATTORNEY

CLASS 42—(Continued).

SN 85-521,393. FRONTLINE TECHNOLOGIES, INC., EXTON, PA. FILED 1-20-2012.



THE MARK CONSISTS OF THE STYLIZED WORD "PRISMA" ALONG WITH FOUR SMALL TRIANGLES INCLUDING A SHAPE OF A DIAMOND FORMING AN ARROW SERVING AS THE DOT IN THE LETTER "I". THE ENGLISH TRANSLATION OF THE WORD "PRISMA" IN THE MARK IS "PRISM".

FOR SOFTWARE AS A SERVICE (SAAS) SERVICES FEATURING SOFTWARE FOR USE IN DATABASE MANAGEMENT FOR AUTOMATING TEACHER AND EMPLOYEE EVALUATIONS (U.S. CLS. 100 AND 101).
FIRST USE 1-3-2012; IN COMMERCE 1-16-2012.
JUDITH HELFMAN, EXAMINING ATTORNEY

SN 85-521,693. EXPERIMENTAL PATHOLOGY LABORATORIES, INC., STERLING, VA. FILED 1-20-2012.



OWNER OF U.S. REG. NOS. 1,640,058 AND 3,099,032.
THE MARK CONSISTS OF THE LETTERS "EPL" AND A MICROSCOPE LOGO.
FOR PATHOLOGY STUDY SERVICES (U.S. CLS. 100 AND 101).
FIRST USE 4-0-2004; IN COMMERCE 4-0-2004.
SUE LAWRENCE, EXAMINING ATTORNEY

SN 85-521,754. EXPERIMENTAL PATHOLOGY LABORATORIES, INC., STERLING, VA. FILED 1-20-2012.

EPL

THE MARK CONSISTS OF STANDARD CHARACTERS WITHOUT CLAIM TO ANY PARTICULAR FONT, STYLE, SIZE, OR COLOR.

OWNER OF U.S. REG. NO. 1,640,058.
FOR PATHOLOGY STUDY SERVICES (U.S. CLS. 100 AND 101).
FIRST USE 7-0-1971; IN COMMERCE 7-0-1973.
SUE LAWRENCE, EXAMINING ATTORNEY

CLASS 42—(Continued).

SN 85-521,755. STRONGROOM SOLUTIONS, INC., HOUSTON, TX. FILED 1-20-2012.

Strongroom

THE MARK CONSISTS OF STANDARD CHARACTERS WITHOUT CLAIM TO ANY PARTICULAR FONT, STYLE, SIZE, OR COLOR.

FOR SOFTWARE AS A SERVICE (SAAS) SERVICES FEATURING SOFTWARE FOR USE IN BILL PAYMENT APPLICATIONS (U.S. CLS. 100 AND 101).
FIRST USE 1-6-2004; IN COMMERCE 1-6-2004.
ROBERT C. CLARK JR., EXAMINING ATTORNEY

SN 85-522,146. EYEPREDICT LLC, AKA EYE-PREDICT LLC, LOS ANGELES, CA. FILED 1-21-2012.

EYEPREDICT

THE MARK CONSISTS OF STANDARD CHARACTERS WITHOUT CLAIM TO ANY PARTICULAR FONT, STYLE, SIZE, OR COLOR.

OWNER OF U.S. REG. NO. 3,515,466.
FOR APPLICATION SERVICE PROVIDER (ASP) FEATURING SOFTWARE FOR USE IN ENHANCING VISUAL ATTENTION AND DISPLAY EFFECTIVENESS, ASSESSING ATTENTION DEFICITS, AND IMPROVING PERFORMANCE IN ATTENTION-DEMANDING ACTIVITIES (U.S. CLS. 100 AND 101).
FIRST USE 11-6-2006; IN COMMERCE 11-6-2006.
TINA BROWN, EXAMINING ATTORNEY

SN 85-523,448. DAYMARK SOLUTIONS, INC., BURLINGTON, MA. FILED 1-24-2012.

LATITUDE

THE MARK CONSISTS OF STANDARD CHARACTERS WITHOUT CLAIM TO ANY PARTICULAR FONT, STYLE, SIZE, OR COLOR.

FOR COMPUTER SERVICES, NAMELY, CLOUD HOSTING PROVIDER SERVICES TO ENABLE DATA STORAGE; CONSULTING SERVICES IN THE FIELD OF CLOUD COMPUTING FOR THE PURPOSE OF DATA STORAGE (U.S. CLS. 100 AND 101).
IRA J. GOODSaid, EXAMINING ATTORNEY

CLASS 42—(Continued).

SN 85-523,449. DAYMARK SOLUTIONS, INC., BURLINGTON, MA. FILED 1-24-2012.

DAYMARK

THE MARK CONSISTS OF STANDARD CHARACTERS WITHOUT CLAIM TO ANY PARTICULAR FONT, STYLE, SIZE, OR COLOR.

OWNER OF U.S. REG. NO. 3,161,550.

FOR COMPUTER CONSULTATION SERVICES; DESIGN AND IMPLEMENTATION OF COMPUTER HARDWARE AND SOFTWARE, INTEGRATION OF COMPUTER SYSTEMS AND NETWORKS, AND COMPUTER PROJECT MANAGEMENT SERVICES, ALL FOR DATA BACKUP AND RECOVERY, DIGITAL DATA STORAGE, DISASTER RECOVERY AND DATA STORAGE; COMPUTER SERVICES, NAMELY, CLOUD HOSTING PROVIDER SERVICES TO ENABLE DATA STORAGE; CONSULTING SERVICES IN THE FIELD OF CLOUD COMPUTING FOR THE PURPOSE OF DATA STORAGE (U.S. CLS. 100 AND 101).

FIRST USE 8-15-2001; IN COMMERCE 9-15-2001.

IRA J. GOODSAD, EXAMINING ATTORNEY

CLASS 42—(Continued).

SN 85-524,190. CASTRO, CARLOS SEBASTIAN, MIAMI, FL. FILED 1-24-2012.

Gozuk

THE MARK CONSISTS OF STANDARD CHARACTERS WITHOUT CLAIM TO ANY PARTICULAR FONT, STYLE, SIZE, OR COLOR.

THE ENGLISH TRANSLATION OF "GOZUK" IS "THE EYE".

FOR PROVIDING ON-LINE NON-DOWNLOADABLE SOFTWARE FOR PROJECT MANAGEMENT AND COLLABORATION (U.S. CLS. 100 AND 101).

LEIGH CAROLINE CASE, EXAMINING ATTORNEY

SN 85-523,597. GIBBS & COX, INC., DBA G&C, NEW YORK, NY. FILED 1-24-2012.



NO CLAIM IS MADE TO THE EXCLUSIVE RIGHT TO USE "MARITIME SOLUTIONS", APART FROM THE MARK AS SHOWN.

THE COLOR(S) BLUE, BLACK, AND GREY IS/ARE CLAIMED AS A FEATURE OF THE MARK.

THE MARK CONSISTS OF THE WORDING "GIBBS & COX" IN BLACK ABOVE THE WORDS "MARITIME SOLUTIONS" IN GREY. TO THE LEFT OF THE WORDING IS A STYLIZED IMAGE OF SHIP'S BOW CONSISTING OF CURVED LINES, BANDS OR BARS AND OTHER LINES, BANDS OR BARS IN BLUE. THE MARK APPEARS ON A TRANSPARENT BACKGROUND.

FOR NAVAL ARCHITECTURAL DESIGN AND MARINE ENGINEERING SERVICES (U.S. CLS. 100 AND 101).

FIRST USE 1-15-2012; IN COMMERCE 1-19-2012.

CHRIS WELLS, EXAMINING ATTORNEY

SN 85-525,174. ANNLEO, INC., SPIRIT LAKE, IA. FILED 1-25-2012.

Annleo

THE MARK CONSISTS OF STANDARD CHARACTERS WITHOUT CLAIM TO ANY PARTICULAR FONT, STYLE, SIZE, OR COLOR.

THE NAME(S), PORTRAIT(S), AND/OR SIGNATURE(S) SHOWN IN THE MARK DOES NOT IDENTIFY A PARTICULAR LIVING INDIVIDUAL.

FOR PROVIDING USERS TEMPORARY USE OF ON-LINE NON-DOWNLOADABLE SOFTWARE FOR MANAGING INFORMATION IN THE FIELD OF HUMAN RESOURCES AND WORKFORCE MANAGEMENT (U.S. CLS. 100 AND 101).

H. M. FISHER, EXAMINING ATTORNEY

CLASS 42—(Continued).

SN 85-528,337. NUBIFER INC., SAN DIEGO, CA. FILED 1-30-2012.

 The logo for LENDINGCRM features the word "LENDING" in a light gray, sans-serif font, followed by "CRM" in a bold, orange, sans-serif font.

THE COLOR(S) GRAY AND ORANGE IS/ARE CLAIMED AS A FEATURE OF THE MARK.

THE MARK CONSISTS OF THE WORDING "LENDINGCRM" IN A STYLIZED FONT WHERE "LENDING" IS WRITTEN IN THE COLOR GRAY AND "CRM" IS WRITTEN IN THE COLOR ORANGE.

FOR APPLICATION SERVICE PROVIDER (ASP) FEATURING SOFTWARE FOR USE IN PROCESSING AND STORING DATA IN THE FIELD OF STUDENT LOANS; CLOUD COMPUTING FEATURING SOFTWARE FOR USE IN PROCESSING AND STORING DATA IN THE FIELD OF STUDENT LOANS; PROVIDING A WEBSITE FEATURING NON-DOWNLOADABLE SOFTWARE FOR PROCESSING AND STORING DATA IN THE FIELD OF STUDENT LOANS; SOFTWARE AS A SERVICE (SAAS) SERVICES FEATURING SOFTWARE FOR PROCESSING AND STORING DATA IN THE FIELD OF STUDENT LOANS (U.S. CLS. 100 AND 101).

FIRST USE 7-10-2009; IN COMMERCE 7-10-2009.
JANICE KIM, EXAMINING ATTORNEY

SN 85-528,633. INVENSAS CORPORATION, SAN JOSE, CA. FILED 1-30-2012.

FD

THE MARK CONSISTS OF STANDARD CHARACTERS WITHOUT CLAIM TO ANY PARTICULAR FONT, STYLE, SIZE, OR COLOR.

FOR COMPUTER HARDWARE AND SOFTWARE DESIGN SERVICES FOR OTHERS AND ENGINEERING SERVICES IN THE FIELDS OF COMPUTER HARDWARE AND SOFTWARE FOR OTHERS (U.S. CLS. 100 AND 101).

EDWARD NELSON, EXAMINING ATTORNEY

CLASS 42—(Continued).

SN 85-528,648. INVENSAS CORPORATION, SAN JOSE, CA. FILED 1-30-2012.

TFD

THE MARK CONSISTS OF STANDARD CHARACTERS WITHOUT CLAIM TO ANY PARTICULAR FONT, STYLE, SIZE, OR COLOR.

FOR COMPUTER HARDWARE AND SOFTWARE DESIGN SERVICES FOR OTHERS AND ENGINEERING SERVICES IN THE FIELDS OF COMPUTER HARDWARE AND SOFTWARE FOR OTHERS (U.S. CLS. 100 AND 101).

EDWARD NELSON, EXAMINING ATTORNEY

SN 85-529,232. INTERNATIONAL COUNCIL OF E-COMMERCE CONSULTANTS, AKA EC-COUNCIL, ALBUQUERQUE, NM. FILED 1-31-2012.



NO CLAIM IS MADE TO THE EXCLUSIVE RIGHT TO USE "CERTIFIED SECURITY ANALYST", APART FROM THE MARK AS SHOWN.

THE MARK CONSISTS OF THE WORDING "E" AND "CSA" ALL APPEARING IN LARGE BOLD LETTERING. THE "E" IS SEPARATED FROM THE "CSA" BY A VERTICAL LINE. THE WORDING, "E-COUNCIL", APPEARS BELOW THE "E" AND ON THE OTHER SIDE OF THE LINE "CERTIFIED SECURITY ANALYST" APPEARS BELOW THE "CSA".

SEC. 2(F).

FOR TESTING, ANALYSIS, AND EVALUATION OF THE KNOWLEDGE, SKILLS AND ABILITIES OF OTHERS FOR THE PURPOSE OF CERTIFICATION AND RE-CERTIFICATION IN THE FIELD OF INFORMATION TECHNOLOGY SECURITY EDUCATION (U.S. CLS. 100 AND 101).

FIRST USE 1-1-2005; IN COMMERCE 1-1-2005.

C. DIONNE CLYBURN, EXAMINING ATTORNEY

SN 85-529,340. INFOGRATE, INC., BRONXVILLE, NY. FILED 1-31-2012.

INFOGRATE

THE MARK CONSISTS OF STANDARD CHARACTERS WITHOUT CLAIM TO ANY PARTICULAR FONT, STYLE, SIZE, OR COLOR.

FOR DEVELOPING COMPUTER SOFTWARE; IT CONSULTING SERVICES (U.S. CLS. 100 AND 101).

FIRST USE 8-20-1996; IN COMMERCE 8-20-1996.

DAWN HAN, EXAMINING ATTORNEY

CLASS 42—(Continued).

SN 85-530,707. FLORIDALEA HOLDINGS, SAUCIER, MS.
FILED 2-1-2012.

NOTESTREAM

THE MARK CONSISTS OF STANDARD CHARACTERS WITHOUT CLAIM TO ANY PARTICULAR FONT, STYLE, SIZE, OR COLOR.

FOR SOFTWARE AS A SERVICE (SAAS) SERVICES FEATURING SOFTWARE FOR SHARING DOCUMENTS WITH PROFESSIONALS (U.S. CLS. 100 AND 101).

FIRST USE 7-21-2011; IN COMMERCE 7-21-2011.
INGA ERVIN, EXAMINING ATTORNEY

CLASS 42—(Continued).

SN 85-530,729. FLORIDALEA HOLDINGS, SAUCIER, MS.
FILED 2-1-2012.



THE COLOR(S) DARK BLUE, BLUE, LIGHT BLUE, PURPLE AND ORANGE IS/ARE CLAIMED AS A FEATURE OF THE MARK.

THE MARK CONSISTS OF THE STYLIZED TERMS "NOTESTREAMER" THE TERM "NOTE" IS IN BLUE, AND THE TERM "STREAMER" IS IN ORANGE. THE "S" IN "STREAMER" IS CAPITALIZED. NEXT TO THE TERMS IS A STYLIZED DESIGN OF A ROUNDED SQUARE THAT FADES FROM DARK BLUE AT THE BOTTOM TO BLUE AT THE TOP. WITHIN THE SQUARE IS A CURVED ARROW AND A LIGHT BLUE CLOUD. ABOVE THE TERMS IS AN EXTENDED LINE THAT FADES FROM PURPLE TO LIGHT BLUE AT THE END IS AN ARROW.

FOR SOFTWARE AS A SERVICE (SAAS) SERVICES FEATURING SOFTWARE FOR SHARING DOCUMENTS WITH PROFESSIONALS (U.S. CLS. 100 AND 101).

FIRST USE 7-21-2011; IN COMMERCE 7-21-2011.
INGA ERVIN, EXAMINING ATTORNEY

SN 85-530,831. UL LLC, NORTHBROOK, IL. FILED 2-1-2012.

SN 85-530,711. MUSICIAN AUDITION, LLC, SCOTTSDALE, AZ. FILED 2-1-2012.

ADVANTAGE

THE MARK CONSISTS OF STANDARD CHARACTERS WITHOUT CLAIM TO ANY PARTICULAR FONT, STYLE, SIZE, OR COLOR.

FOR TESTING, ANALYSIS AND EVALUATION OF THE GOODS OF OTHERS FOR THE PURPOSE OF CERTIFICATION (U.S. CLS. 100 AND 101).

FIRST USE 12-0-2011; IN COMMERCE 12-0-2011.
JAMES LOVELACE, EXAMINING ATTORNEY



SN 85-530,887. ALLSTATE INSURANCE COMPANY, NORTHBROOK, IL. FILED 2-1-2012.

WHAT'S YOUR STUFF WORTH?

THE MARK CONSISTS OF TWO MUSIC NOTES CONNECTED TOGETHER TO FORM THE LETTER "M." THE MUSIC NOTE ON THE RIGHT BEING LARGER THAN THE MUSIC NOTE ON THE LEFT TO GIVE THE IMPRESSION OF PERSPECTIVE.

FOR PROVIDING A WEBSITE THAT GIVES COMPUTER USERS THE ABILITY TO POST AND RETRIEVE CLASSIFIED LISTINGS, DATA, MESSAGES, IMAGES, MUSIC, VIDEO, AND INFORMATION RELATING TO MUSICIANS, MUSICAL COLLABORATIONS, AND MUSICAL EVENTS (U.S. CLS. 100 AND 101).

FIRST USE 10-24-2011; IN COMMERCE 10-24-2011.
CAROLINE WOOD, EXAMINING ATTORNEY

THE MARK CONSISTS OF STANDARD CHARACTERS WITHOUT CLAIM TO ANY PARTICULAR FONT, STYLE, SIZE, OR COLOR.

FOR PROVIDING TEMPORARY USE OF ON-LINE NON-DOWNLOADABLE SOFTWARE APPLICATION FOR ESTIMATING THE VALUE OF PERSONAL PROPERTY AND ILLUSTRATING THE VALUE OF RENTER'S INSURANCE IN THE FIELD OF INSURANCE (U.S. CLS. 100 AND 101).

FIRST USE 11-8-2011; IN COMMERCE 11-8-2011.
ZACHARY BELLO, EXAMINING ATTORNEY

CLASS 42—(Continued).

SN 85-531,295. KELLEY, JOHN, CLARKESVILLE, GA.
FILED 2-1-2012.

AgileRemote

THE MARK CONSISTS OF STANDARD CHARACTERS WITHOUT CLAIM TO ANY PARTICULAR FONT, STYLE, SIZE, OR COLOR.
FOR COMPUTER SOFTWARE DEVELOPMENT (U.S. CLS. 100 AND 101).
FIRST USE 4-10-2010; IN COMMERCE 8-4-2010.
ANDREA HACK, EXAMINING ATTORNEY

SN 85-531,438. APPMATRIX, INC., ROSEVILLE, CA. FILED 2-1-2012.

AppMatrix SmartMerchant

THE MARK CONSISTS OF STANDARD CHARACTERS WITHOUT CLAIM TO ANY PARTICULAR FONT, STYLE, SIZE, OR COLOR.
FOR COMPUTER SOFTWARE DEVELOPMENT IN THE FIELD OF MOBILE APPLICATIONS (U.S. CLS. 100 AND 101).
DAVID MURRAY, EXAMINING ATTORNEY

SN 85-531,459. ZIMMERMANN, RALPH, PASADENA, CA.
FILED 2-1-2012.

Simplepractice

THE MARK CONSISTS OF STANDARD CHARACTERS WITHOUT CLAIM TO ANY PARTICULAR FONT, STYLE, SIZE, OR COLOR.
FOR PROVIDING ON-LINE NON-DOWNLOADABLE SOFTWARE FOR PRACTICE MANAGEMENT AND COLLABORATION (U.S. CLS. 100 AND 101).
FIRST USE 1-18-2012; IN COMMERCE 1-18-2012.
CHERYL CLAYTON, EXAMINING ATTORNEY

CLASS 42—(Continued).

SN 85-531,512. CLOUDHARMONY INC., MONARCH BEACH, CA. FILED 2-1-2012.

CLOUDPROBE

THE MARK CONSISTS OF STANDARD CHARACTERS WITHOUT CLAIM TO ANY PARTICULAR FONT, STYLE, SIZE, OR COLOR.
FOR PROVIDING ON-LINE, NON-DOWNLOADABLE, INTERNET-BASED SOFTWARE APPLICATION FOR ALLOWING USERS TO MONITOR NETWORK PERFORMANCE AND AVAILABILITY OF CLOUD AND TRADITIONAL HOSTING SERVICES (U.S. CLS. 100 AND 101).
JULIE GUTTADAURO, EXAMINING ATTORNEY

SN 85-531,513. CLOUDHARMONY INC., MONARCH BEACH, CA. FILED 2-1-2012.

CLOUDBENCH

THE MARK CONSISTS OF STANDARD CHARACTERS WITHOUT CLAIM TO ANY PARTICULAR FONT, STYLE, SIZE, OR COLOR.
FOR PROVIDING ON-LINE, NON-DOWNLOADABLE, INTERNET-BASED SOFTWARE APPLICATION FOR ALLOWING USERS TO TEST THE PERFORMANCE OF CLOUD SERVICES BY RUNNING BENCHMARKS AGAINST THOSE SERVICES (U.S. CLS. 100 AND 101).
JULIE GUTTADAURO, EXAMINING ATTORNEY

SN 85-531,640. SYGENA LLC, NEWTON, NJ. FILED 2-1-2012.

SYGENA

THE MARK CONSISTS OF STANDARD CHARACTERS WITHOUT CLAIM TO ANY PARTICULAR FONT, STYLE, SIZE, OR COLOR.
FOR COMPUTER SERVICES, NAMELY, COMPUTER SYSTEM ADMINISTRATION FOR OTHERS; COMPUTER SERVICES, NAMELY, ON-SITE MANAGEMENT OF INFORMATION TECHNOLOGY (IT) SYSTEMS; COMPUTER SERVICES, NAMELY, REMOTE MANAGEMENT OF THE INFORMATION TECHNOLOGY (IT) SYSTEMS OF OTHERS; PROFESSIONAL COMPUTER SERVICES, NAMELY, NETWORK ANALYSIS, LAN/WAN DESIGN, WIRELESS ENGINEERING, VIRTUALIZATION AND COMPUTER PROJECT MANAGEMENT (U.S. CLS. 100 AND 101).
FIRST USE 1-31-2012; IN COMMERCE 1-31-2012.
MAH ROSENBERG, EXAMINING ATTORNEY

CLASS 42—(Continued).

SN 85-531,667. ESSOCIATE INC., DBA HANDBAKED, SAN FRANCISCO, CA. FILED 2-2-2012.

HANDBAKED

THE MARK CONSISTS OF STANDARD CHARACTERS WITHOUT CLAIM TO ANY PARTICULAR FONT, STYLE, SIZE, OR COLOR.

FOR COMPUTER SOFTWARE DEVELOPMENT IN THE FIELD OF MOBILE APPLICATIONS; PROGRAMMING OF MULTIMEDIA APPLICATIONS (U.S. CLS. 100 AND 101).

FIRST USE 10-26-2011; IN COMMERCE 12-7-2011.
KATHERINE STOIDES, EXAMINING ATTORNEY



SN 85-531,815. TARN HOLDING, INC, EMERALD HILLS, CA. FILED 2-2-2012.

MyUberSelf

THE MARK CONSISTS OF STANDARD CHARACTERS WITHOUT CLAIM TO ANY PARTICULAR FONT, STYLE, SIZE, OR COLOR.

FOR PROVIDING A WEB SITE FEATURING TECHNOLOGY THAT ENABLES USERS TO CREATE, BOOKMARK, ANNOTATE, AND PUBLICLY SHARE DATA (U.S. CLS. 100 AND 101).

BILL DAWE, EXAMINING ATTORNEY



SN 85-531,867. SITEMASON, INC., NASHVILLE, TN. FILED 2-2-2012.

SITEMASON

THE MARK CONSISTS OF STANDARD CHARACTERS WITHOUT CLAIM TO ANY PARTICULAR FONT, STYLE, SIZE, OR COLOR.

FOR APPLICATION SERVICE PROVIDER, NAMELY, PROVIDING, HOSTING, MANAGING, DEVELOPING AND MAINTAINING APPLICATIONS, SOFTWARE, WEBSITES AND DATABASES IN THE FIELDS OF ECOMMERCE, ONLINE PAYMENTS, ORDER QUEUING, WEBSITE DESIGN, DATA STORAGE, SHARED COMPUTING CAPACITY SCALING, MESSAGING SERVICES AND CALCULATION OF WEBSITE RANKING BASED ON USER TRAFFIC (U.S. CLS. 100 AND 101).

FIRST USE 1-1-2001; IN COMMERCE 1-1-2001.
AISHA CLARKE, EXAMINING ATTORNEY

CLASS 42—(Continued).

SN 85-531,884. RRG SERVICES, INC., SAN ANTONIO, TX. FILED 2-2-2012.

On-Point

THE MARK CONSISTS OF STANDARD CHARACTERS WITHOUT CLAIM TO ANY PARTICULAR FONT, STYLE, SIZE, OR COLOR.

FOR COMPUTER SERVICES, NAMELY, ON-SITE MANAGEMENT OF INFORMATION TECHNOLOGY (IT) SYSTEMS; COMPUTER SERVICES, NAMELY, REMOTE AND ON-SITE MANAGEMENT OF INFORMATION TECHNOLOGY (IT) SYSTEMS OF OTHERS; COMPUTER SERVICES, NAMELY, REMOTE MANAGEMENT OF THE INFORMATION TECHNOLOGY (IT) SYSTEMS OF OTHERS; COMPUTER SERVICES, NAMELY, REMOTE MANAGEMENT OF INFORMATION TECHNOLOGY (IT) SYSTEMS FOR OTHERS; PLANNING, DESIGN AND MANAGEMENT OF INFORMATION TECHNOLOGY SYSTEMS; REMOTE MONITORING AND MANAGEMENT; MANAGED SERVICES PROVIDER (U.S. CLS. 100 AND 101).

AISHA CLARKE, EXAMINING ATTORNEY



SN 85-531,885. SITEMASON, INC., NASHVILLE, TN. FILED 2-2-2012.

BUILD ON US

THE MARK CONSISTS OF STANDARD CHARACTERS WITHOUT CLAIM TO ANY PARTICULAR FONT, STYLE, SIZE, OR COLOR.

FOR APPLICATION SERVICE PROVIDER, NAMELY, PROVIDING, HOSTING, MANAGING, DEVELOPING AND MAINTAINING APPLICATIONS, SOFTWARE, WEBSITES AND DATABASES IN THE FIELDS OF ECOMMERCE, ONLINE PAYMENTS, ORDER QUEUING, WEBSITE DESIGN, DATA STORAGE, SHARED COMPUTING CAPACITY SCALING, MESSAGING SERVICES AND CALCULATION OF WEBSITE RANKING BASED ON USER TRAFFIC (U.S. CLS. 100 AND 101).

FIRST USE 1-9-2012; IN COMMERCE 1-9-2012.
AISHA CLARKE, EXAMINING ATTORNEY

CLASS 42—(Continued).

SN 85-531,934. INVOICE EXCHANGE, LLC, ORLANDO, FL.
FILED 2-2-2012.

VIEWPOST

THE MARK CONSISTS OF STANDARD CHARACTERS WITHOUT CLAIM TO ANY PARTICULAR FONT, STYLE, SIZE, OR COLOR.

FOR PROVIDING A WEBSITE FEATURING NON-DOWNLOADABLE SOFTWARE FOR ACCOUNTING FUNCTIONS, BILL PAYMENT, AND FACILITATING MANAGEMENT OF INVOICES, MANAGEMENT OF PAYABLES, AND THE INTEGRATION OF ENTERPRISE RESOURCE PLANNING (ERP) SYSTEMS (U.S. CLS. 100 AND 101).

LAURIE KAUFMAN, EXAMINING ATTORNEY

SN 85-532,170. AQUAVIT PHARMACEUTICALS, INC., DBA
AQUAVIT PHARMACEUTICALS, INC., NEW YORK, NY.
FILED 2-2-2012.

Science Personalized. Healthcare Modernized.

THE MARK CONSISTS OF STANDARD CHARACTERS WITHOUT CLAIM TO ANY PARTICULAR FONT, STYLE, SIZE, OR COLOR.

FOR RESEARCH AND DEVELOPMENT IN THE PHARMACEUTICAL AND BIOTECHNOLOGY FIELDS (U.S. CLS. 100 AND 101).

YAT SYE, LEE, EXAMINING ATTORNEY

SN 85-532,245. ROSSETTI ASSOCIATES INCORPORATED,
SOUTHFIELD, MI. FILED 2-2-2012.

DESIGNING EXPERIENCES. GENERATING VALUE.

THE MARK CONSISTS OF STANDARD CHARACTERS WITHOUT CLAIM TO ANY PARTICULAR FONT, STYLE, SIZE, OR COLOR.

FOR ARCHITECTURAL CONSULTANCY (U.S. CLS. 100 AND 101).

FIRST USE 11-4-2011; IN COMMERCE 11-4-2011.

TARAH HARDY, EXAMINING ATTORNEY

CLASS 42—(Continued).

SN 85-532,372. MITCHELL, JEFFREY R, DENVER, CO.
FILED 2-2-2012.

re:design

THE MARK CONSISTS OF STANDARD CHARACTERS WITHOUT CLAIM TO ANY PARTICULAR FONT, STYLE, SIZE, OR COLOR.

FOR GRAPHIC AND MULTIMEDIA DESIGN SERVICES FOR THE PURPOSE OF PROMOTING THE GOODS AND SERVICES OF OTHERS (U.S. CLS. 100 AND 101).

FIRST USE 10-1-2011; IN COMMERCE 10-1-2011.
JESSICA A. POWERS, EXAMINING ATTORNEY

SN 85-532,563. ASURE SOFTWARE, INC., AUSTIN, TX.
FILED 2-2-2012.

AsureForce

THE MARK CONSISTS OF STANDARD CHARACTERS WITHOUT CLAIM TO ANY PARTICULAR FONT, STYLE, SIZE, OR COLOR.

OWNER OF U.S. REG. NO. 3,568,332.

FOR SOFTWARE AS A SERVICE (SAAS) SERVICES FEATURING SOFTWARE FOR WORKFORCE MANAGEMENT, NAMELY, TIME AND ATTENDANCE, PAYROLL, LABOR MANAGEMENT, HUMAN RESOURCES AND ADMINISTRATION, AND PROJECT MANAGEMENT (U.S. CLS. 100 AND 101).

FIRST USE 1-23-2012; IN COMMERCE 1-23-2012.

MARC LEIPZIG, EXAMINING ATTORNEY

SN 85-532,569. ASURE SOFTWARE, INC., AUSTIN, TX.
FILED 2-2-2012.

AsureSpace

THE MARK CONSISTS OF STANDARD CHARACTERS WITHOUT CLAIM TO ANY PARTICULAR FONT, STYLE, SIZE, OR COLOR.

OWNER OF U.S. REG. NO. 3,568,332.

FOR SOFTWARE AS A SERVICE (SAAS) SERVICES FEATURING SOFTWARE FOR MANAGING OFFICE FACILITIES, MEETING ROOMS, PERSONNEL SCHEDULES, AND TECHNOLOGY ASSETS (U.S. CLS. 100 AND 101).

MARC LEIPZIG, EXAMINING ATTORNEY

CLASS 42—(Continued).

SN 85-532,714. PROJECT DIRECT, LLC, STATELINE, NV. FILED 2-2-2012.

workbuddy

THE MARK CONSISTS OF STANDARD CHARACTERS WITHOUT CLAIM TO ANY PARTICULAR FONT, STYLE, SIZE, OR COLOR.

FOR DESIGN, CREATION, HOSTING, MAINTENANCE OF WEBSITES FOR OTHERS; PLANNING, DESIGN, DEVELOPMENT, MAINTENANCE AND OPTIMIZATION OF ONLINE WEBSITES FOR THIRD PARTIES; PROVIDING A WEBSITE FEATURING INFORMATION IN THE FIELD OF INTERIOR DESIGN AND ARCHITECTURE FOR USE BY INTERIOR DESIGNERS AND ARCHITECTS; PROVIDING A WEBSITE FEATURING INFORMATION ABOUT GREEN ARCHITECTURE, INTERIOR DESIGN, SUSTAINABLE COMMUNITY PLANNING AND INFRASTRUCTURE DEVELOPMENT; PROVIDING AN INTERNET WEBSITE PORTAL OFFERING INFORMATION IN THE FIELD OF COMPUTER AIDED DESIGN; WEBSITE DESIGN AND DEVELOPMENT FOR OTHERS; GRAPHIC DESIGN SERVICES; COMPUTER GRAPHICS DESIGN SERVICES ; DIGITAL IMAGE CORRECTION SERVICES OF VIDEOS ; PROVIDING A WEB SITE FEATURING TECHNOLOGY THAT ENABLES INTERNET USERS TO SHARE DOCUMENTS, IMAGES AND VIDEOS; APPLICATION SERVICE PROVIDER, NAMELY, HOSTING, MANAGING, DEVELOPING, ANALYZING, AND MAINTAINING APPLICATIONS, SOFTWARE, AND WEB SITES, OF OTHERS IN THE FIELDS OF ADVERTISING AND MARKETING; VISUAL DESIGN SERVICES IN THE NATURE OF DESIGNING VISUAL ELEMENTS FOR ONLINE, BROADCAST, PRINT, OUTDOOR AND OTHER COMMUNICATION MEDIA; SOCIAL BOOKMARKING WEBSITE SERVICES, NAMELY, PROVIDING A WEBSITE FEATURING TECHNOLOGY THAT ENABLES USERS TO ORGANIZE, STORE, MANAGE, SHARE AND SEARCH FOR BOOKMARKS OF RESOURCES ONLINE; COMPUTER SERVICES, NAMELY, DESIGNING AND IMPLEMENTING WEBSITES, WEBPAGES, HOME PAGES, INTERNET SITES, SOCIAL MEDIA PAGES, BLOGS, AND VIDEO ARCHIVING FOR OTHERS; CREATING AND MAINTAINING INTERNET SITES FOR OTHERS; DESIGN, CREATION, HOSTING AND MAINTENANCE OF INTERNET SITES FOR THIRD PARTIES; DESIGNING AND DEVELOPING WEBPAGES ON THE INTERNET; DESIGNING INTERNET SITES FOR OTHERS; HOSTING INTERNET SITES FOR OTHERS; HOSTING OF DIGITAL CONTENT ON THE INTERNET; HOSTING WEBSITES ON THE INTERNET; INSTALLATION AND MAINTENANCE OF INTERNET ACCESS SOFTWARE; WEB PUBLISHING, NAMELY, CREATING A WEBSITE AND UPLOADING IT ONTO AN INTERNET SERVER; PROVIDING A WEB SITE FEATURING TECHNOLOGY THAT ENABLES INTERNET USERS TO SHARE DOCUMENTS, IMAGES AND VIDEOS; PROVIDING A WEB SITE FEATURING TECHNOLOGY THAT ENABLES INTERNET USERS TO CREATE, BOOKMARK, ANNOTATE, AND PUBLICLY SHARE DATA; MAINTENANCE OF SOFTWARE FOR INTERNET ACCESS (U.S. CLS. 100 AND 101).

FIRST USE 9-27-2011; IN COMMERCE 9-27-2011.

JILL C. ALT, EXAMINING ATTORNEY

CLASS 42—(Continued).

SN 85-532,758. UNITEDHEALTH GROUP INCORPORATED, MINNETONKA, MN. FILED 2-2-2012.

MYX

THE MARK CONSISTS OF STANDARD CHARACTERS WITHOUT CLAIM TO ANY PARTICULAR FONT, STYLE, SIZE, OR COLOR.

FOR APPLICATION SERVICE PROVIDER (ASP) FEATURING SOFTWARE TO ENABLE UPLOADING, POSTING, SHOWING, DISPLAYING, TAGGING, BLOGGING, SHARING OR OTHERWISE PROVIDING ELECTRONIC MEDIA OR INFORMATION OVER THE INTERNET OR OTHER COMMUNICATIONS NETWORK; COMPUTER SERVICES, NAMELY, HOSTING ONLINE WEB FACILITIES FOR OTHERS FOR ORGANIZING AND CONDUCTING ONLINE MEETINGS, GATHERINGS, AND INTERACTIVE DISCUSSIONS; COMPUTER SERVICES IN THE NATURE OF CUSTOMIZED WEB PAGES FEATURING USER-DEFINED INFORMATION, PERSONAL PROFILES AND INFORMATION; PROVIDING A WEB SITE OVER THE INTERNET OR ELECTRONIC COMMUNICATIONS NETWORKS THAT GIVES COMPUTER USERS THE ABILITY TO UPLOAD, POST, SHOW, DISPLAY AND TAG VIDEO CLIPS; PROVIDING ON-LINE COMPUTER DATABASES AND ON-LINE SEARCHABLE DATABASES IN THE FIELD OF FORMING AND CONNECTING WITH VIRTUAL COMMUNITIES IN THE MEDICAL AND HEALTHCARE FIELDS; CONSULTING SERVICES IN THE FIELD OF CLOUD COMPUTING; COMPUTER SERVICES, NAMELY, CLOUD HOSTING PROVIDER SERVICES; CLOUD COMPUTING FEATURING SOFTWARE FOR USE IN THE HEALTH CARE INDUSTRY; APPLICATION SERVICE PROVIDER (ASP), NAMELY, HOSTING COMPUTER SOFTWARE APPLICATIONS OF OTHERS (U.S. CLS. 100 AND 101).

MATTHEW EINSTEIN, EXAMINING ATTORNEY

SN 85-532,797. TEAPPLIX INC, PALO ALTO, CA. FILED 2-2-2012.

InventoryAdvisor

THE MARK CONSISTS OF STANDARD CHARACTERS WITHOUT CLAIM TO ANY PARTICULAR FONT, STYLE, SIZE, OR COLOR.

FOR PROVIDING ON-LINE NON-DOWNLOADABLE SOFTWARE FOR MANAGING E-COMMERCE CATALOG AND INVENTORY (U.S. CLS. 100 AND 101).

FIRST USE 2-2-2012; IN COMMERCE 2-2-2012.

HENRY S. ZAK, EXAMINING ATTORNEY

CLASS 42—(Continued).

SN 85-532,911. 2090185 ONTARIO INC., RICHMOND HILL, ONTARIO, CANADA, FILED 2-3-2012.

NOTEBRIDGE

THE MARK CONSISTS OF STANDARD CHARACTERS WITHOUT CLAIM TO ANY PARTICULAR FONT, STYLE, SIZE, OR COLOR.

FOR PROVIDING ON-LINE NON-DOWNLOADABLE SOFTWARE FOR COMMUNICATION MANAGEMENT IN THE FIELD OF CHILD-BASED BUSINESSES, CENTERS AND ORGANIZATIONS (U.S. CLS. 100 AND 101).
WILLIAM ROSSMAN, EXAMINING ATTORNEY

SN 85-533,025. FARM COUNTRY TRADER, INC., INWOOD, IA. FILED 2-3-2012.



THE MARK CONSISTS OF TWO "U" SHAPED FIGURES, EACH TERMINATING IN AN ARROW. ONE U IS ON TOP OF THE OTHER WITH THEIR INNER PORTIONS INTER-LOCKING.

FOR TEMPORARY USE OF NON-DOWNLOADABLE COMPUTER SOFTWARE FOR MANAGING INVENTORY VIA COMPUTER NETWORKS (U.S. CLS. 100 AND 101).

FIRST USE 0-0-1999; IN COMMERCE 0-0-1999.
ANDREA HACK, EXAMINING ATTORNEY

SN 85-533,178. TOUCH POINT ONE, LLC, INDIANAPOLIS, IN. FILED 2-3-2012.

ACUITY

THE MARK CONSISTS OF STANDARD CHARACTERS WITHOUT CLAIM TO ANY PARTICULAR FONT, STYLE, SIZE, OR COLOR.

FOR PROVIDING TEMPORARY USE OF ON-LINE NON-DOWNLOADABLE SOFTWARE FOR DATABASE DRIVEN DATA AGGREGATION, DATA MANAGEMENT, DATA ANALYSIS AND DATA VISUALIZATION, FOR USE BY CALL CENTERS AND SERVICE CENTERS IN ANALYZING FRONT-LINE OPERATIONS (U.S. CLS. 100 AND 101).

FIRST USE 11-30-2010; IN COMMERCE 11-30-2010.
JORDAN BAKER, EXAMINING ATTORNEY

CLASS 42—(Continued).

SN 85-533,248. UNDERSTAND.COM, LLC, RENO, NV. FILED 2-3-2012.

**Insanely Great Medical
Education**

THE MARK CONSISTS OF STANDARD CHARACTERS WITHOUT CLAIM TO ANY PARTICULAR FONT, STYLE, SIZE, OR COLOR.

NO CLAIM IS MADE TO THE EXCLUSIVE RIGHT TO USE "MEDICAL EDUCATION", APART FROM THE MARK AS SHOWN.

FOR DESIGN, DEVELOPMENT AND IMPLEMENTATION OF SOFTWARE; PROVIDING COMPUTER PROGRAMMING SERVICES TO CUSTOMERS THAT ENABLES THEM TO PROVIDE VIDEO AND AUDIO CONTENT ON THEIR WEB SITES; DESIGN AND DEVELOPMENT OF ON-LINE COMPUTER SOFTWARE SYSTEMS; COMPUTER SOFTWARE DEVELOPMENT, COMPUTER PROGRAMMING AND MAINTENANCE OF COMPUTER SOFTWARE IN THE FIELDS OF EDUCATION, EMPLOYEE TRAINING, MEDICINE, LEARNING MANAGEMENT, MEDICAL DEVICES AND HEALTHCARE; DEVELOPING CUSTOMIZED SOFTWARE IN THE FIELDS OF EDUCATION, EMPLOYEE TRAINING, MEDICINE, LEARNING MANAGEMENT, MEDICAL DEVICES AND HEALTHCARE FOR OTHERS; RESEARCH AND DEVELOPMENT AND CONSULTATION RELATED THERETO IN THE FIELD OF MEDIA DEVELOPMENT, NAMELY, THE GRAPHIC ENHANCEMENT OF MEDICAL AND LIFE SCIENCE TEACHING MATERIALS AND WEB-SITES AND CONSULTATION AND TECHNOLOGICAL RESEARCH IN THE FIELDS OF WEBSITE DESIGN AND WEBSITE DEVELOPMENT FOR OTHERS; ANIMATION DESIGN FOR OTHERS; COMPUTER GRAPHICS DESIGN SERVICES, NAMELY, CREATING OF 3D COMPUTER MODELS, ANIMATIONS, AND VIDEOS; COMPUTER GRAPHICS DESIGN SERVICES, NAMELY, CREATING OF 3D COMPUTER MODELS, ANIMATIONS, AND VIDEOS OF SURGICAL TECHNIQUES, DISEASES, MEDICAL CONDITIONS, AND MEDICAL PROCEDURES; CONSULTING SERVICES IN THE FIELD OF SOFTWARE AS A SERVICE (SAAS); CONSULTING SERVICES IN THE FIELD OF CLOUD COMPUTING; CONSULTING SERVICES IN THE FIELD OF PROVIDING ONLINE, NON-DOWNLOADABLE SOFTWARE AND APPLICATIONS (U.S. CLS. 100 AND 101).

TEJBIR SINGH, EXAMINING ATTORNEY

CLASS 42—(Continued).

SN 85-533,260. UNDERSTAND.COM, LLC, RENO, NV. FILED 2-3-2012.

Insanely Great Patient Education

THE MARK CONSISTS OF STANDARD CHARACTERS WITHOUT CLAIM TO ANY PARTICULAR FONT, STYLE, SIZE, OR COLOR.

NO CLAIM IS MADE TO THE EXCLUSIVE RIGHT TO USE "PATIENT EDUCATION", APART FROM THE MARK AS SHOWN.

FOR DESIGN, DEVELOPMENT AND IMPLEMENTATION OF SOFTWARE; PROVIDING COMPUTER PROGRAMMING SERVICES TO CUSTOMERS THAT ENABLES THEM TO PROVIDE VIDEO AND AUDIO CONTENT ON THEIR WEB SITES; DESIGN AND DEVELOPMENT OF ON-LINE COMPUTER SOFTWARE SYSTEMS; COMPUTER SOFTWARE DEVELOPMENT, COMPUTER PROGRAMMING AND MAINTENANCE OF COMPUTER SOFTWARE IN THE FIELDS OF EDUCATION, EMPLOYEE TRAINING, MEDICINE, LEARNING MANAGEMENT, MEDICAL DEVICES AND HEALTHCARE; DEVELOPING CUSTOMIZED SOFTWARE IN THE FIELDS OF EDUCATION, EMPLOYEE TRAINING, MEDICINE, LEARNING MANAGEMENT, MEDICAL DEVICES AND HEALTHCARE FOR OTHERS; RESEARCH AND DEVELOPMENT AND CONSULTATION RELATED THERETO IN THE FIELD OF MEDIA DEVELOPMENT, NAMELY, THE GRAPHIC ENHANCEMENT OF MEDICAL AND LIFE SCIENCE TEACHING MATERIALS AND WEB-SITES AND CONSULTATION AND TECHNOLOGICAL RESEARCH IN THE FIELDS OF WEBSITE DESIGN AND WEBSITE DEVELOPMENT FOR OTHERS; ANIMATION DESIGN FOR OTHERS; COMPUTER GRAPHICS DESIGN SERVICES, NAMELY, CREATING OF 3D COMPUTER MODELS, ANIMATIONS, AND VIDEOS; COMPUTER GRAPHICS DESIGN SERVICES, NAMELY, CREATING OF 3D COMPUTER MODELS, ANIMATIONS, AND VIDEOS OF SURGICAL TECHNIQUES, DISEASES, MEDICAL CONDITIONS, AND MEDICAL PROCEDURES; CONSULTING SERVICES IN THE FIELD OF SOFTWARE AS A SERVICE (SAAS); CONSULTING SERVICES IN THE FIELD OF CLOUD COMPUTING; CONSULTING SERVICES IN THE FIELD OF PROVIDING ONLINE, NON-DOWNLOADABLE SOFTWARE AND APPLICATIONS (U.S. CLS. 100 AND 101).

TEJBIR SINGH, EXAMINING ATTORNEY

CLASS 42—(Continued).

SN 85-533,386. SENECORE LLC, UPPER SADDLE RIVER, NJ. FILED 2-3-2012.

GoPrinter

THE MARK CONSISTS OF STANDARD CHARACTERS WITHOUT CLAIM TO ANY PARTICULAR FONT, STYLE, SIZE, OR COLOR.

FOR APPLICATION SERVICE PROVIDER (ASP) FEATURING SOFTWARE FOR USE IN CONNECTION WITH PREPARATION, STORAGE, AND COMMUNICATION OF ELECTRONIC DOCUMENTS TO FACILITATE PRINTING OF SAID DOCUMENTS ON PAPER OR OTHER MEDIA USING A CONVENTIONAL PRINTING DEVICE CONNECTED TO A COMPUTER OR NETWORK.; COMPUTER SOFTWARE DEVELOPMENT IN THE FIELD OF MOBILE APPLICATIONS (U.S. CLS. 100 AND 101).

FIRST USE 11-4-2011; IN COMMERCE 2-1-2012.

C. DIONNE CLYBURN, EXAMINING ATTORNEY

SN 85-533,578. FACEPLAY, INC., SINGER ISLAND, FL. FILED 2-3-2012.

Faceplay

THE MARK CONSISTS OF STANDARD CHARACTERS WITHOUT CLAIM TO ANY PARTICULAR FONT, STYLE, SIZE, OR COLOR.

FOR COMPUTER SERVICES, NAMELY, CREATING AN ON-LINE COMMUNITY FOR REGISTERED USERS TO IMPROVE AND SHOWCASE THEIR SKILLS, PARTICIPATE IN COMPETITIONS, GET FEEDBACK FROM THEIR PEERS, FORM VIRTUAL COMMUNITIES, PURCHASE AND EXCHANGE VIRTUAL GOODS AND SERVICES, ENGAGE IN SOCIAL NETWORKING AND IMPROVE THEIR TALENT; COMPUTER SERVICES, NAMELY, CREATING AN ON-LINE COMMUNITY FOR REGISTERED USERS TO PARTICIPATE IN DISCUSSIONS, GET FEEDBACK FROM THEIR PEERS, FORM VIRTUAL COMMUNITIES, AND ENGAGE IN SOCIAL NETWORKING; CREATING AN ON-LINE COMMUNITY FOR PLAYERS FOR THE PURPOSE OF CONNECTING PLAYERS, TEAMS AND LEAGUES AND ORGANIZING GAME ACTIVITIES; PROVIDING A WEB SITE ALLOWING WEB SITE USERS TO UPLOAD AND SHARE ON-LINE PICTURES, TEXT, USER-GENERATED VIDEOS, ESSAYS AND ARTICLES ON A WIDE VARIETY OF TOPICS AND SUBJECTS FOR ENTERTAINMENT PURPOSES (U.S. CLS. 100 AND 101).

NAKWAMA ANKRAH, EXAMINING ATTORNEY

CLASS 42—(Continued).

SN 85-533,701. MICROSTRAIN, INC., WILLISTON, VT.
FILED 2-3-2012.

MATHENGINE

THE MARK CONSISTS OF STANDARD CHARACTERS WITHOUT CLAIM TO ANY PARTICULAR FONT, STYLE, SIZE, OR COLOR.

FOR COMPUTER SERVICES, NAMELY, HOSTING AN INTERACTIVE WEB SITE THAT ALLOWS VISITORS TO ACCESS, CONSOLIDATE, MAINTAIN, MANAGE, PROCESS, SHARE, AND TRACK STATISTICAL INFORMATION; COMPUTER SERVICES, NAMELY, PROVIDING SEARCH PLATFORMS TO ALLOW USERS TO ACCESS, CONSOLIDATE, MAINTAIN, MANAGE, PROCESS, SHARE, AND TRACK STATISTICAL INFORMATION; PROVIDING A WEB-BASED DATA AGGREGATION SERVICE FEATURING TECHNOLOGY THAT ENABLES USERS TO REDUCE OPERATING COSTS AND IMPROVE OVERALL QUALITY, EFFICIENCY AND SAFETY OF A WIDE RANGE OF MACHINES, VEHICLES, THE ENVIRONMENT AND CIVIL STRUCTURES; PROVIDING A WEB-BASED SERVICE FEATURING TECHNOLOGY THAT ENABLES USERS TO VIEW, MANAGE, PROCESS AND STORE DATA FOR ANALYSIS, ALERTS, HISTORIC TRENDS, POST PROCESSING, TROUBLESHOOTING AND CONTROL OF SENSOR NETWORKS THAT ARE MONITORING THE CONDITION AND PERFORMANCE OF THE ENVIRONMENT, PLANTS, ANIMALS, STRUCTURES AND MACHINES; PROVIDING A WEB-BASED SERVICE FEATURING TECHNOLOGY THAT ENABLES USERS TO VIEW, MANAGE, PROCESS AND STORE DATA FROM WIRED AND WIRELESS SENSOR NETWORKS; PROVIDING USE OF A WEB-BASED INTEGRATED DEVELOPMENT ENVIRONMENT THAT ALLOWS USERS TO CREATE, EDIT, UPLOAD, SAVE, COMPILE, DEVELOP, DEBUG, SHARE, MONITOR, COLLABORATE, EXECUTE, AND SCHEDULE PROGRAMS AND APPLICATIONS FOR PERSONAL, INSTITUTIONAL, EDUCATIONAL, GOVERNMENT, MEDICAL, THERAPEUTIC AND INVESTIGATIVE USE AND USE IN COOPERATIVE AND SOCIAL NETWORKS ALL FOR ACCESSING, CONSOLIDATING, MAINTAINING, MANAGING, PROCESSING, SHARING, AND TRACKING INFORMATION AND DATA (U.S. CLS. 100 AND 101).

FIRST USE 6-6-2011; IN COMMERCE 6-6-2011.
MARK SHINER, EXAMINING ATTORNEY

SN 85-533,875. JUSTSERVICE.NET, LLC, CHICAGO, IL.
FILED 2-3-2012.

GuiGlue

THE MARK CONSISTS OF STANDARD CHARACTERS WITHOUT CLAIM TO ANY PARTICULAR FONT, STYLE, SIZE, OR COLOR.

FOR DESIGNING, CUSTOMIZING AND IMPLEMENTING GRAPHICAL USER INTERFACES FOR OTHERS THAT INTERFACE WITH A CLOUD-BASED DATA MANAGEMENT SYSTEM (U.S. CLS. 100 AND 101).

PATRICIA EVANKO, EXAMINING ATTORNEY

CLASS 42—(Continued).

SN 85-533,889. LIEBER, CHRISTOPHER, PEWAUKEE, WI.
FILED 2-3-2012.

Statwack

THE MARK CONSISTS OF STANDARD CHARACTERS WITHOUT CLAIM TO ANY PARTICULAR FONT, STYLE, SIZE, OR COLOR.

FOR PROVIDING A WEBSITE FEATURING TECHNOLOGY THAT ENABLES USERS TO CREATE PROFILES FOR ENTERING AND TRACKING THEIR STATISTICS AND RELATED INFORMATION FOR SPORTS, ACTIVITIES AND HOBBIES (U.S. CLS. 100 AND 101).

FIRST USE 1-12-2011; IN COMMERCE 1-12-2011.
KEVIN DINALLO, EXAMINING ATTORNEY

SN 85-534,227. ALPHAPLEX INC, COLORADO SPRINGS,
CO. FILED 2-5-2012.

ALPHAPLEX

THE MARK CONSISTS OF STANDARD CHARACTERS WITHOUT CLAIM TO ANY PARTICULAR FONT, STYLE, SIZE, OR COLOR.

OWNER OF U.S. REG. NO. 2,588,578.
FOR DESIGN OF HOME PAGES, COMPUTER SOFTWARE AND WEB SITES; DESIGN, CREATION, HOSTING, MAINTENANCE OF WEBSITES FOR OTHERS (U.S. CLS. 100 AND 101).

FIRST USE 2-1-1997; IN COMMERCE 7-1-1997.
MICHAEL ENGEL, EXAMINING ATTORNEY

SN 85-534,360. OMNISTRAT INCORPORATED, SOMERVILLE, MA. FILED 2-6-2012.

Stratstore

THE MARK CONSISTS OF STANDARD CHARACTERS WITHOUT CLAIM TO ANY PARTICULAR FONT, STYLE, SIZE, OR COLOR.

FOR SOFTWARE AS A SERVICE (SAAS) SERVICES FEATURING SOFTWARE FOR ORGANIZATIONAL STRATEGY, PLANNING AND EXECUTION (U.S. CLS. 100 AND 101).

FIRST USE 12-1-2011; IN COMMERCE 12-1-2011.
ANDREW LEASER, EXAMINING ATTORNEY

CLASS 42—(Continued).

SN 85-534,669. FELLOWS INK OF SETH PRESTON ERIC MARCUS, DALLAS, TX. FILED 2-6-2012.



THE MARK CONSISTS OF THE WORDING "FELLOWS INK" WITH A GLOBE WITH CONTINENTS SHOWING, WHICH IS USED AS THE DOT IN THE "I" OF "INK", WHICH IS USED AS THE LOWER LINE IN THE "F".

FOR ARCHITECTURAL DESIGN (U.S. CLS. 100 AND 101).

TAMARA FRAZIER, EXAMINING ATTORNEY

SN 85-534,759. EPREVENTIONS LLC, NEWPORT BEACH, CA. FILED 2-6-2012.

EPREVENTIONS

THE MARK CONSISTS OF STANDARD CHARACTERS WITHOUT CLAIM TO ANY PARTICULAR FONT, STYLE, SIZE, OR COLOR.

FOR PROVIDING TEMPORARY USE OF NON-DOWNLOADABLE SOFTWARE FOR ORGANIZING AND CONDUCTING ONLINE GATHERINGS AND INTERACTIVE DISCUSSIONS; PROVIDING A WEBSITE THAT GIVES USERS THE ABILITY TO ORGANIZE AND CONDUCT GATHERINGS AND INTERACTIVE DISCUSSIONS (U.S. CLS. 100 AND 101).

SUSAN LESLIE DUBOIS, EXAMINING ATTORNEY

SN 85-535,041. HOANG, TRAVIS THANG TOAN, SAN JOSE, CA. FILED 2-6-2012.

MyPetMasterpiece

THE MARK CONSISTS OF STANDARD CHARACTERS WITHOUT CLAIM TO ANY PARTICULAR FONT, STYLE, SIZE, OR COLOR.

FOR CONSULTING IN THE FIELD OF INFORMATION TECHNOLOGY (U.S. CLS. 100 AND 101).

MATTHEW PAPPAS, EXAMINING ATTORNEY

CLASS 42—(Continued).

SN 85-535,236. ITX CORP., PITTSFORD, NY. FILED 2-6-2012.

THE NEW HOW

THE MARK CONSISTS OF STANDARD CHARACTERS WITHOUT CLAIM TO ANY PARTICULAR FONT, STYLE, SIZE, OR COLOR.

FOR COMPUTER SERVICES, NAMELY, PROVIDING MOBILE TECHNOLOGY SOLUTIONS, NAMELY, COMPUTER SOFTWARE DESIGN FOR OTHERS; HOSTING OF DIGITAL CONTENT ON THE INTERNET; HOSTING OF SOFTWARE, WEBSITES, INTERNET WEB SOFTWARE APPLICATIONS, ELECTRONIC DATABASES, BUSINESS COMPUTER SOFTWARE APPLICATIONS AND OTHER COMPUTER APPLICATIONS ON THE INTERNET AND ON A VIRTUAL PRIVATE SERVER; RECOVERY OF COMPUTER DATA; COMPUTER SERVICES, NAMELY, MONITORING AND REPORTING ON THE PERFORMANCE, AVAILABILITY, AND ERRORS OF COMPUTER SOFTWARE, INTERNET WEB SOFTWARE APPLICATIONS, ELECTRONIC DATABASES, BUSINESS COMPUTER SOFTWARE APPLICATIONS, DIGITAL CONTENT AND THE WEB SITES OF OTHERS; COMPUTER VIRUS PROTECTION SERVICES; COMPUTER SERVICES, NAMELY, PROVIDING A WEB SITE FOR OTHERS IN THE FIELD OF HOSTING AND MANAGEMENT OF COMPUTER HARDWARE, COMPUTER OPERATING SYSTEMS, AND COMPUTER APPLICATION INFRASTRUCTURE, NAMELY, PROVIDING SECURE ACCESS TO INFORMATION AND CONTROLS TO MONITOR AND HELP OPTIMIZE THE PERFORMANCE OF COMPUTER HARDWARE AND SOFTWARE THAT SUPPORTS HOSTED COMPUTER SOFTWARE, INTERNET WEBSITES, INTERNET WEB SOFTWARE APPLICATIONS, ELECTRONIC DATABASES, DIGITAL CONTENT, AND BUSINESS COMPUTER SOFTWARE APPLICATIONS OF OTHERS THAT ARE ACCESSIBLE VIA THE INTERNET; COMPUTER PROGRAMMING; COMPUTER HARDWARE DEVELOPMENT; RENTAL OF COMPUTER SOFTWARE AND PROGRAMS; COMPUTER SYSTEMS INTEGRATION SERVICES; COMPUTER SYSTEMS ENGINEERING SERVICES; DATA ENCRYPTION SERVICES (U.S. CLS. 100 AND 101).

FIRST USE 0-0-2001; IN COMMERCE 0-0-2002.

LUCY ARANT, EXAMINING ATTORNEY

SN 85-535,665. AFRICA, OLIVER JUSTIN, ALTA LOMA, CA. FILED 2-7-2012.

Ruby Owl

THE MARK CONSISTS OF STANDARD CHARACTERS WITHOUT CLAIM TO ANY PARTICULAR FONT, STYLE, SIZE, OR COLOR.

FOR DESIGNING ELECTRONICS AND ELECTRONIC COMPONENTS IN THE NATURE OF COMPUTERS, VIDEO GAME SYSTEMS, HOME ENTERTAINMENT SYSTEMS, AND VARIOUS ELECTRONICS (U.S. CLS. 100 AND 101).

GRETTA YAO, EXAMINING ATTORNEY

CLASS 42—(Continued).

SN 85-535,726. RELATIVE RESCUE, LLC, SANTA FE, NM. FILED 2-7-2012.

RelativeRescue

THE MARK CONSISTS OF STANDARD CHARACTERS WITHOUT CLAIM TO ANY PARTICULAR FONT, STYLE, SIZE, OR COLOR.

FOR PROVIDING A SECURE, WEB-BASED SERVICE ENABLING INDIVIDUALS TO STORE AND TRANSMIT INFORMATION, INCLUDING FORENSIC TOOLS, TO ASSIST LAW ENFORCEMENT AND SEARCH PERSONNEL SHOULD A CHILD OR DEPENDENT ADULT BECOME A MISSING PERSON (U.S. CLS. 100 AND 101).
CHRISTINA SOBRAL, EXAMINING ATTORNEY

SN 85-535,909. WHO'S DOING, LLC, HOUSTON, TX. FILED 2-7-2012.

Who's Doing

THE MARK CONSISTS OF STANDARD CHARACTERS WITHOUT CLAIM TO ANY PARTICULAR FONT, STYLE, SIZE, OR COLOR.

FOR PROVIDING A WEB SITE FEATURING TECHNOLOGY THAT ENABLES USERS TO SHARE INFORMATION AND COMMUNICATE WITH OTHER USERS (U.S. CLS. 100 AND 101).

FIRST USE 1-24-2012; IN COMMERCE 1-24-2012.
JOHN WILKE, EXAMINING ATTORNEY

SN 85-535,959. CWILL CORP., WHITE MARSH, MD. FILED 2-7-2012.



THE MARK CONSISTS OF SIX CURVED BANDS, WHERE THREE CURVED BANDS WITH A COMMON CENTER CURVE TO THE RIGHT AND UP ABOVE THREE BANDS WITH A COMMON CENTER THAT CURVE TO THE LEFT AND DOWN FROM THE TOP THREE BANDS.

FOR PROVIDING A WEBSITE FEATURING NON-DOWNLOADABLE SOFTWARE FOR MANAGEMENT OF BUSINESS, CUSTOMER, AND PERSONAL RELATIONSHIPS (U.S. CLS. 100 AND 101).

ANDREW LEASER, EXAMINING ATTORNEY

CLASS 42—(Continued).

SN 85-536,107. AGADIA SYSTEMS INC, PARSIPPANY, NJ. FILED 2-7-2012.

PromptPA

THE MARK CONSISTS OF STANDARD CHARACTERS WITHOUT CLAIM TO ANY PARTICULAR FONT, STYLE, SIZE, OR COLOR.

FOR COMPUTER PROGRAMMING SERVICES, NAMELY, DESIGN, DEVELOPMENT AND IMPLEMENTATION OF SOFTWARE (U.S. CLS. 100 AND 101).
TINA MAI, EXAMINING ATTORNEY

SN 85-536,239. MONTROSE COMPLIANCE SERVICES, INC., SANTA CLARA, CA. FILED 2-7-2012.

EMC MADE SIMPLE

THE MARK CONSISTS OF STANDARD CHARACTERS WITHOUT CLAIM TO ANY PARTICULAR FONT, STYLE, SIZE, OR COLOR.

FOR CONSULTING IN THE FIELD OF ELECTRICAL ENGINEERING (U.S. CLS. 100 AND 101).

FIRST USE 2-6-2012; IN COMMERCE 2-6-2012.

VIVIAN MICZNIK FIRST, EXAMINING ATTORNEY

SN 85-536,349. TEKNON CORPORATION, DBA SYMMETRY SOFTWARE, SCOTTSDALE, AZ. FILED 2-7-2012.

THE RIGHT TAXES THE FIRST TIME

THE MARK CONSISTS OF STANDARD CHARACTERS WITHOUT CLAIM TO ANY PARTICULAR FONT, STYLE, SIZE, OR COLOR.

FOR PROVIDING TEMPORARY USE OF ONLINE, NON-DOWNLOADABLE SOFTWARE WHICH: DETERMINES ALL PAYROLL TAXES ASSOCIATED WITH A SPECIFIC ADDRESS OR ADDRESSES VIA THE INTERNET; ALLOWS THE USER TO MAKE PAYROLL-RELATED CALCULATIONS VIA THE INTERNET (U.S. CLS. 100 AND 101).

FIRST USE 5-27-2009; IN COMMERCE 5-27-2009.

EDWARD FENNESSY, EXAMINING ATTORNEY

CLASS 42—(Continued).

SN 85-536,370. CLEAR OFFER, LAS VEGAS, NV. FILED 2-7-2012.

CLEAR OFFER

THE MARK CONSISTS OF STANDARD CHARACTERS WITHOUT CLAIM TO ANY PARTICULAR FONT, STYLE, SIZE, OR COLOR.

FOR PROVIDING A SECURE ELECTRONIC ONLINE SYSTEM FEATURING TECHNOLOGY WHICH ALLOWS BUYERS AND SELLERS TO NEGOTIATE SALES PRICE AND TERMS OF BOTH REAL AND PERSONAL PROPERTY DIRECTLY (U.S. CLS. 100 AND 101).

FIRST USE 2-6-2012; IN COMMERCE 2-6-2012.
IRA J. GOODSAD, EXAMINING ATTORNEY

SN 85-536,523. ENGAGE BDR, INC., WEST HOLLYWOOD, CA. FILED 2-7-2012.



THE MARK CONSISTS OF THE WORD FIRST AND THE WORD IMPRESSION AT THE BOTTOM AND AN UPRIGHT RECTANGLE TO THE LEFT.

FOR HOSTING A SOFTWARE PLATFORM THAT ENABLES ADVERTISERS TO TARGET ONLINE AND MOBILE INVENTORY (U.S. CLS. 100 AND 101).

FIRST USE 12-1-2011; IN COMMERCE 12-1-2011.
NAKIA HENRY, EXAMINING ATTORNEY

SN 85-536,635. EXACTCOST, INC., MCLEAN, VA. FILED 2-8-2012.



THE MARK CONSISTS OF A CAPITALIZED LETTER "M" WITH A SUPERSCRIPED "2" AND A LOWER CASE LETTER "X" TO THE RIGHT OF THE CAPITALIZED LETTER "M".

FOR APPLICATION SERVICE PROVIDER (ASP) FEATURING SOFTWARE FOR USE DATA MANAGEMENT, ACTIVITY-BASED COST AND PERFORMANCE MANAGEMENT FOR USE IN THE HEALTHCARE FIELD, AND PROVIDING RELATED CONSULTING SERVICES (U.S. CLS. 100 AND 101).

JOSETTE BEVERLY, EXAMINING ATTORNEY

CLASS 42—(Continued).

SN 85-536,786. MERCHANTRY, INC., NEW YORK, NY. FILED 2-8-2012.

MERCHANTRY

THE MARK CONSISTS OF STANDARD CHARACTERS WITHOUT CLAIM TO ANY PARTICULAR FONT, STYLE, SIZE, OR COLOR.

FOR PROVIDING ON-LINE NON DOWNLOADABLE SOFTWARE FOR DATABASE MANAGEMENT AND INTEGRATION (U.S. CLS. 100 AND 101).

MAYUR VAGHANI, EXAMINING ATTORNEY

SN 85-536,974. CHRISTIAN CALVINO, MAR DEL PLATA, BS.AS., ARGENTINA, FILED 2-8-2012.

between

THE MARK CONSISTS OF STANDARD CHARACTERS WITHOUT CLAIM TO ANY PARTICULAR FONT, STYLE, SIZE, OR COLOR.

FOR COMPUTER WEBSITE DESIGN; CREATING AND DESIGNING WEB PAGES FOR OTHERS; CREATING, DESIGNING AND MAINTAINING WEB SITES; CREATION, DESIGN, DEVELOPMENT AND MAINTENANCE OF WEB SITES FOR THIRD PARTIES; DESIGN AND CREATING WEB SITES FOR OTHERS; DESIGN AND DEVELOPMENT OF GRAPHIC USER INTERFACE; DESIGN AND MAINTENANCE OF WEB SITES FOR OTHERS; DESIGN OF HOME PAGES AND WEB SITES; DESIGN OF INFORMATION GRAPHICS AND DATA VISUALIZATION MATERIALS; GRAPHIC DESIGN SERVICES FOR CREATING GRAPHIC ELEMENTS OF CORPORATE, SERVICE, AND PRODUCT LOGOS (U.S. CLS. 100 AND 101).

FIRST USE 10-24-2011; IN COMMERCE 10-24-2011.
BERNICE MIDDLETON, EXAMINING ATTORNEY

CLASS 42—(Continued).

SN 85-537,001. LOGICAL THINGS, INC., AUSTIN, TX. FILED 2-8-2012.



THE MARK CONSISTS OF THE WORDS "LOGICAL THINGS" WITH A STAR ABOVE THE WORDS.

FOR WEB SITE DESIGN SERVICES FOR OTHERS; GRAPHIC ART DESIGN SERVICES; WEB SITE DEVELOPMENT CONSULTING SERVICES; GRAPHIC DESIGN CONSULTING SERVICES; AND THE CREATION OF ANIMATED DESIGNS FOR OTHERS (U.S. CLS. 100 AND 101).

FIRST USE 1-1-2008; IN COMMERCE 1-1-2008.
ERNEST SHOSHO, EXAMINING ATTORNEY

SN 85-537,317. SETHY, SANAT, SAN RAMON, CA. FILED 2-8-2012.

TOCK

THE MARK CONSISTS OF STANDARD CHARACTERS WITHOUT CLAIM TO ANY PARTICULAR FONT, STYLE, SIZE, OR COLOR.

FOR APPLICATION SERVICE PROVIDER (ASP) FEATURING SOFTWARE IN THE FIELD OF TRACKING EMPLOYEE INFORMATION REGARDING ATTENDANCE, SICK LEAVE, VACATION AND PAYROLL (U.S. CLS. 100 AND 101).

ANDREA HACK, EXAMINING ATTORNEY

SN 85-537,492. NAFISI, JENNIFER, MISSION VIEJO, CA. FILED 2-8-2012.

MetricIntent

THE MARK CONSISTS OF STANDARD CHARACTERS WITHOUT CLAIM TO ANY PARTICULAR FONT, STYLE, SIZE, OR COLOR.

FOR COMPUTER PROGRAMMING; COMPUTER SERVICES, NAMELY, SEARCH ENGINE OPTIMIZATION; WEBSITE DESIGN AND DEVELOPMENT FOR OTHERS (U.S. CLS. 100 AND 101).

FIRST USE 4-16-2010; IN COMMERCE 1-1-2011.
JAY BESCH, EXAMINING ATTORNEY

CLASS 42—(Continued).

SN 85-537,870. LINKDEX LIMITED, LONDON, UNITED KINGDOM, FILED 2-9-2012.

SEIZE EVERY OPPORTUNITY

THE MARK CONSISTS OF STANDARD CHARACTERS WITHOUT CLAIM TO ANY PARTICULAR FONT, STYLE, SIZE, OR COLOR.

FOR COMPUTER SERVICES, NAMELY, SEARCH ENGINE OPTIMIZATION; CONSULTING SERVICES IN THE FIELD OF SEARCH ENGINE OPTIMIZATION (U.S. CLS. 100 AND 101).

FIRST USE 0-0-2011; IN COMMERCE 0-0-2011.
LUCY ARANT, EXAMINING ATTORNEY

SN 85-538,402. GRAMERCYONE TECHNOLOGY CORP., NEW YORK, NY. FILED 2-9-2012.



THE COLOR(S) BLACK, GRAY, BLUE, GREEN, ORANGE, PURPLE AND YELLOW IS/ARE CLAIMED AS A FEATURE OF THE MARK.

THE MARK CONSISTS OF THE STYLIZED WORD "GO" WITH "G" IN BLACK AND "O" IN GRAY WITH A STYLIZED NUMBER "1" VERTICALLY DISSECTING THE WORD THROUGH THE LETTER "O". THE TOP HALF OF THE NUMBER "1" IS FORMED BY CIRCLES IN BLUE, ORANGE AND GREEN AT THE TOP WITH A PURPLE AND YELLOW CIRCLE FORMING THE BOTTOM HALF OF THE NUMBER "1".

FOR PROVIDING ONLINE NON-DOWNLOADABLE SOFTWARE FOR USE IN SCHEDULING AND MANAGEMENT OF RESERVATIONS FOR CUSTOMERS, POINT-OF-SALE SOLUTIONS FOR FLOOR AND MANAGEMENT STAFF, INVENTORY MANAGEMENT, CUSTOMER RELATIONSHIP MANAGEMENT, SOCIAL MEDIA INTEGRATION, MANAGEMENT OF EMPLOYEES SCHEDULES, CREATING REPORTS, CREATING AND PROVIDING GIFT CERTIFICATES, COUPONS AND PROMOTIONAL SPECIALS, AND MANAGING DISCOUNT PROGRAMS (U.S. CLS. 100 AND 101).

FIRST USE 10-30-2010; IN COMMERCE 10-30-2010.
MICHAEL KEATING, EXAMINING ATTORNEY

CLASS 42—(Continued).

SN 85-538,722. THE BLAKE COMPANY, LLC, HONOLULU, HI. FILED 2-9-2012.

FitnessScheduler

THE MARK CONSISTS OF STANDARD CHARACTERS WITHOUT CLAIM TO ANY PARTICULAR FONT, STYLE, SIZE, OR COLOR.

FOR PROVIDING A WEB SITE FEATURING TECHNOLOGY THAT ENABLES USERS TO SCHEDULE TASKS AND APPOINTMENTS; SOFTWARE AS A SERVICE (SAAS) SERVICES FEATURING SOFTWARE FOR SCHEDULING TASKS AND APPOINTMENTS (U.S. CLS. 100 AND 101).

LINDA E. BLOHM, EXAMINING ATTORNEY



SN 85-538,979. ALASKA TEXTILES INCORPORATED, ANCHORAGE, AK. FILED 2-10-2012.

WEBSAM

THE MARK CONSISTS OF STANDARD CHARACTERS WITHOUT CLAIM TO ANY PARTICULAR FONT, STYLE, SIZE, OR COLOR.

FOR PROVIDING A WEBSITE FEATURING NON-DOWNLOADABLE SOFTWARE FOR CORPORATE APPAREL ADMINISTRATION AND REPORTING (U.S. CLS. 100 AND 101).

FIRST USE 10-10-2011; IN COMMERCE 10-10-2011.
CURTIS FRENCH, EXAMINING ATTORNEY



SN 85-539,118. PEGGEST INC., BALTIMORE, MD. FILED 2-10-2012.

Peggest

THE MARK CONSISTS OF STANDARD CHARACTERS WITHOUT CLAIM TO ANY PARTICULAR FONT, STYLE, SIZE, OR COLOR.

FOR PROVIDING A WEB SITE FEATURING TECHNOLOGY THAT ENABLES INTERNET USERS TO CREATE, BOOKMARK, ANNOTATE, AND PUBLICLY SHARE DATA (U.S. CLS. 100 AND 101).

DAVID H. STINE, EXAMINING ATTORNEY

CLASS 42—(Continued).

SN 85-539,486. PIC BUSINESS SYSTEMS, INC., SAN ANTONIO, TX. FILED 2-10-2012.

Open Your Browser to a New Way of Doing Business

THE MARK CONSISTS OF STANDARD CHARACTERS WITHOUT CLAIM TO ANY PARTICULAR FONT, STYLE, SIZE, OR COLOR.

FOR PROVIDING ONLINE NON-DOWNLOADABLE ENTERPRISE RESOURCE PLANNING SOFTWARE FOR MANUFACTURERS FOR INVENTORY CONTROL, ORDER ENTRY, ACCOUNTS RECEIVABLE AND PAYABLE, GENERAL LEDGER, AND PURCHASING (U.S. CLS. 100 AND 101).

FIRST USE 1-1-2005; IN COMMERCE 1-1-2005.
ALEX KEAM, EXAMINING ATTORNEY



SN 85-539,497. COMMERCE SIGNALS, INC., DAVIDSON, NC. FILED 2-10-2012.

COMMERCESIGNALS

THE MARK CONSISTS OF STANDARD CHARACTERS WITHOUT CLAIM TO ANY PARTICULAR FONT, STYLE, SIZE, OR COLOR.

FOR SOFTWARE DEVELOPMENT AND DESIGN FOR OTHERS IN THE FIELD OF ONLINE AND MOBILE ADVERTISING; SOFTWARE AS A SERVICE (SAAS) FEATURING SOFTWARE THAT ALLOWS RETAILERS TO ASSIST IN THE TARGETING AND EFFECTIVENESS OF ONLINE AND MOBILE ADVERTISEMENTS WHILE MAINTAINING CONTROL OF DATA TO ENSURE CONSUMER PRIVACY; PLATFORM AS A SERVICE (PAAS) FEATURING A SOFTWARE PLATFORM THAT ALLOWS TARGETING OF ONLINE AND MOBILE ADVERTISING BY TAGGING, ANALYZING, REPORTING, INTEGRATING, CONTROLLING, MANAGING AND SHARING A WIDE VARIETY OF DATA AND INFORMATION FROM VARIOUS SOURCES (U.S. CLS. 100 AND 101).

ANDREA HACK, EXAMINING ATTORNEY

CLASS 42—(Continued).

SN 85-539,829. MYSONGTOYOU, INC., PALO ALTO, CA.
FILED 2-10-2012.

PLAYVUU

THE MARK CONSISTS OF STANDARD CHARACTERS WITHOUT CLAIM TO ANY PARTICULAR FONT, STYLE, SIZE, OR COLOR.

FOR COMPUTER SERVICES, NAMELY, HOSTING ON-LINE WEB FACILITIES FOR OTHERS TO SHOW-CASE MULTIMEDIA PRODUCING INCLUDING VIDEO PRODUCING, PERFORMANCE, SONGWRITING AND MUSICAL TALENTS AND FOR FACILITATING AND CONDUCTING ONLINE CONNECTIONS, COLLABORATIONS, AND INTERACTIVE DISCUSSIONS ABOUT VIDEO PRODUCING, SONGWRITING AND MUSIC; APPLICATION SERVICE PROVIDER (ASP) FEATURING SOFTWARE FOR USE IN CREATING, EDITING, ACCESSING DIGITAL MULTIMEDIA CONTENT INCLUDING VIDEO AND AUDIO CONTENT AND THE SHARING THEREOF; APPLICATION SERVICE PROVIDER FEATURING SOFTWARE FOR CREATING AND SHARING MULTIMEDIA CONTENT INCLUDING AUDIO AND VIDEO CONTENT WITH SPECIAL EFFECTS; APPLICATION SERVICE PROVIDER FEATURING SOFTWARE FOR CREATING VIDEO AND MUSICAL TOOLS AND BEATS FOR USERS TO CREATE MUSIC AND/OR TO SHARE MUSIC WITH OTHERS; COMPUTER SERVICES, NAMELY, CREATING AN ON-LINE COMMUNITY FOR REGISTERED USERS TO DEVELOP AND COLLABORATE ON MAKING MUSIC AND TO SHARE CONTENT WITH OTHER REGISTERED USERS AND WITH OTHERS VIA LINKS TO THIRD-PARTY WEB SITES; HOSTING AN ON-LINE COMMUNITY WEB SITE FEATURING A PLACE WHERE USERS CAN COLLABORATE IN MAKING AND SHARING MEDIA INCLUDING VIDEO AND MUSIC; MOBILE APPLICATION PROVIDER FOR SHARING AND CREATION OF MULTIMEDIA CONTENT INCLUDING VIDEO AND AUDIO CONTENT (U.S. CLS. 100 AND 101).

DAVID MURRAY, EXAMINING ATTORNEY

SN 85-539,999. DO N REVIEW, LLC, ORMOND BEACH, FL.
FILED 2-10-2012.

Do-N-Review

THE MARK CONSISTS OF STANDARD CHARACTERS WITHOUT CLAIM TO ANY PARTICULAR FONT, STYLE, SIZE, OR COLOR.

FOR COMPUTER SERVICES, NAMELY, CREATING AN ON-LINE COMMUNITY FOR REGISTERED USERS TO PARTICIPATE IN DISCUSSIONS, GET FEEDBACK FROM THEIR PEERS, FORM VIRTUAL COMMUNITIES, AND ENGAGE IN SOCIAL NETWORKING (U.S. CLS. 100 AND 101).

KAREN K. BUSH, EXAMINING ATTORNEY

CLASS 42—(Continued).

SN 85-540,049. ISHAPEPOLICY, LLC, WALL TOWNSHIP, NJ.
FILED 2-10-2012.

iElect

THE MARK CONSISTS OF STANDARD CHARACTERS WITHOUT CLAIM TO ANY PARTICULAR FONT, STYLE, SIZE, OR COLOR.

FOR PROVIDING AN INTERACTIVE WEBSITE FEATURING TECHNOLOGY THAT ALLOWS USERS TO ANSWER A SERIES OF POLITICAL QUESTIONS WHICH IN TURN WILL BE COMPARED TO THE VIEWPOINTS FROM VARIOUS CANDIDATES RUNNING FOR THAT ELECTED OFFICE, THUS ALLOWING THE USERS TO SEE THEIR MATCH PERCENTAGE FROM HIGHEST TO LOWEST, AND BE ABLE TO REVIEW MORE INFORMATION AND ANSWERS ABOUT EACH CANDIDATE (U.S. CLS. 100 AND 101).

FIRST USE 2-10-2012; IN COMMERCE 2-10-2012.

TARAH HARDY, EXAMINING ATTORNEY

SN 85-540,202. PLUMROCKET INC, NEW YORK, NY. FILED
2-11-2012.

Plumrocket

THE MARK CONSISTS OF STANDARD CHARACTERS WITHOUT CLAIM TO ANY PARTICULAR FONT, STYLE, SIZE, OR COLOR.

FOR BUILDING AND MAINTAINING WEBSITES (U.S. CLS. 100 AND 101).

FIRST USE 5-26-2010; IN COMMERCE 5-26-2010.

ASMAT KHAN, EXAMINING ATTORNEY

CLASS 42—(Continued).

SN 85-540,567. DERYA UNUTMAZ, NEW YORK, NY. AND ORAL ALPAN, FAIRFAX, VA. FILED 2-12-2012.

Longenics

THE MARK CONSISTS OF STANDARD CHARACTERS WITHOUT CLAIM TO ANY PARTICULAR FONT, STYLE, SIZE, OR COLOR.

FOR CONSULTING SERVICES IN THE FIELDS OF BIOTECHNOLOGY, PHARMACEUTICAL RESEARCH AND DEVELOPMENT, LABORATORY TESTING, DIAGNOSTICS, AND PHARMACOGENETICS; DEVELOPMENT OF PHARMACEUTICAL PREPARATIONS AND MEDICINES; MEDICAL AND SCIENTIFIC RESEARCH IN THE FIELD OF CANCER TREATMENT AND DIAGNOSIS; MEDICAL RESEARCH SERVICES IN THE FIELD OF CANCER; PHARMACEUTICAL DRUG DEVELOPMENT SERVICES; PHARMACEUTICAL RESEARCH AND DEVELOPMENT; PHARMACEUTICAL RESEARCH SERVICES; PROVIDING LABORATORY RESEARCH SERVICES IN THE FIELD OF GENE EXPRESSION, NAMELY, CANCER BIOLOGY; PROVIDING MEDICAL AND SCIENTIFIC RESEARCH INFORMATION IN THE FIELD OF PHARMACEUTICALS AND CLINICAL TRIALS; PROVIDING MEDICAL AND SCIENTIFIC RESEARCH INFORMATION IN THE FIELDS OF PHARMACEUTICALS AND GENETICS; PROVIDING REAGENT SAMPLE TESTING AND DIAGNOSTIC SERVICES FOR OTHERS IN THE FIELDS OF SCIENCE AND RESEARCH RELATED THERETO; RESEARCH AND DEVELOPMENT IN THE PHARMACEUTICAL AND BIOTECHNOLOGY FIELDS; RESEARCH AND DEVELOPMENT OF PHARMACEUTICALS FOR THE TREATMENT OF AGE-RELATED DISEASES AND CANCER (U.S. CLS. 100 AND 101).

ESTHER A. BORSUK, EXAMINING ATTORNEY

SN 85-540,602. WHO'S DOING, LLC, HOUSTON, TX. FILED 2-13-2012.



THE MARK CONSISTS OF FIVE CIRCLES, THREE OF WHICH COMPRISE A TOP ROW AND TWO OF WHICH COMPRISE A BOTTOM ROW WHICH IS PARALLEL TO THE TOP ROW. THE TWO ROWS OF CIRCLES ARE OFFSET SLIGHTLY AS IF EACH CIRCLE WERE AT THE END OF EACH LINE IN THE LETTER "W". THERE IS AN ADDITIONAL SMALL CIRCLE IN THE CENTER OF EACH OF THE FIVE CIRCLES. THERE ARE TWO LINES PRESENT. ONE OF WHICH CONNECTS THE TOP RIGHT AND BOTTOM RIGHT CIRCLES. THE OTHER LINE CONNECTS THE TOP MIDDLE AND BOTTOM LEFT CIRCLES.

FOR PROVIDING A WEB SITE FEATURING TECHNOLOGY THAT ENABLES USERS TO SHARE INFORMATION AND COMMUNICATE WITH OTHER USERS (U.S. CLS. 100 AND 101).

FIRST USE 1-24-2012; IN COMMERCE 1-24-2012.

JOHN WILKE, EXAMINING ATTORNEY

CLASS 42—(Continued).

SN 85-558,050. EPIC SYSTEMS CORPORATION, VERONA, WI. FILED 3-1-2012.

EPIC

THE MARK CONSISTS OF STANDARD CHARACTERS WITHOUT CLAIM TO ANY PARTICULAR FONT, STYLE, SIZE, OR COLOR.

OWNER OF U.S. REG. NOS. 1,791,373, 2,601,981 AND OTHERS.

FOR DESIGN AND DEVELOPMENT OF COMPUTER SOFTWARE FOR USE IN THE HEALTHCARE FIELD; IMPLEMENTATION AND MAINTENANCE OF COMPUTER SOFTWARE FOR USE IN THE HEALTHCARE FIELD; TECHNICAL SUPPORT, NAMELY, TROUBLESHOOTING OF COMPUTER SOFTWARE PROBLEMS RELATIVE TO SOFTWARE USED BY HEALTHCARE ORGANIZATIONS; CONSULTING SERVICES ON THE SUBJECT OF DESIGN, IMPLEMENTATION, OPERATION, MAINTENANCE AND TROUBLESHOOTING OF COMPUTER SOFTWARE USED BY HEALTHCARE ORGANIZATIONS (U.S. CLS. 100 AND 101).

FIRST USE 2-1-1979; IN COMMERCE 6-1-1979.

DAVID TAYLOR, EXAMINING ATTORNEY

SN 85-564,275. HALLIBURTON ENERGY SERVICES, INC., CARROLLTON, TX. FILED 3-8-2012.

XAMINER

THE MARK CONSISTS OF STANDARD CHARACTERS WITHOUT CLAIM TO ANY PARTICULAR FONT, STYLE, SIZE, OR COLOR.

FOR OIL AND GAS WELL LOGGING SERVICES UTILIZING DOWNHOLE OPEN HOLE SENSORS (U.S. CLS. 100 AND 101).

Laurie Mayes, Examining Attorney

CLASS 42—(Continued).

SN 85-578,583. LEEMANN-PLUOT, PASCAL, MONTCLAIR, NJ. FILED 3-23-2012.



NO CLAIM IS MADE TO THE EXCLUSIVE RIGHT TO USE "QA", APART FROM THE MARK AS SHOWN.

THE MARK CONSISTS OF THE STYLIZED TEXT "QA" IN WHICH THE LETTER "Q" CONTAINS AN IMAGE OF THE EARTH. THE CROSSBAR OF THE LETTER "Q" FORMS THE FIRST SEGMENT OF A TICK MARK. THE SECOND SEGMENT OF THE TICK MARK FORMS THE FIRST SEGMENT OF THE LETTER "A".

FOR INTERNATIONAL CONSULTING SERVICES RELATED TO QUALITY ASSURANCE, QUALITY MANAGEMENT AND QUALITY CONTROL OF PRECLINICAL AND CLINICAL RESEARCH IN THE FIELD OF PHARMACEUTICALS, BIOTECHNOLOGY, MEDICAL ENGINEERING, AND MEDICAL PRODUCTS (U.S. CLS. 100 AND 101).

BRENDAN MCCAULEY, EXAMINING ATTORNEY

CLASS 42—(Continued).

SN 85-578,676. BRECKINRIDGE TAYLOR LLC, DALLAS, TX. FILED 3-23-2012.



THE MARK CONSISTS OF THE SHAPE OF A SOLID COLOR CAPITAL LETTER "B" CONTAINING THE SHAPE OF A CAPITAL LETTER "T" ANGLED AT APPROXIMATELY 45 DEGREES TO THE LEFT IN THE UPPER PORTION OF THE SOLID LETTER "B", WITH THE "T" SHOWN IN A LIGHT SHADED CONTRASTING COLOR OR SHOWN IN THE NEGATIVE AS THE ABSENCE OF THE DARK COLOR USED FOR THE "B" (IF USED ON A COLORED BACKGROUND).

FOR CONSULTING IN THE FIELD OF COMMERCIAL AND RESIDENTIAL INTERIOR DESIGN; DESIGN OF INTERIOR DECOR; DESIGN OF TEXTILES; FURNITURE DESIGN SERVICES; INTERIOR DESIGN SERVICES; INTERIOR DESIGN SERVICES INCLUDING SPACE PLANNING, FURNITURE SELECTION, MATERIAL AND SURFACE SELECTION; INTERIOR DESIGN SERVICES, NAMELY, DESIGN CUSTOM FURNITURE, RUGS, TEXTILES, HOME FURNISHING PRODUCTS AND ACCESSORIES; LANDSCAPE ARCHITECTURAL DESIGN (U.S. CLS. 100 AND 101).

FIRST USE 12-0-2010; IN COMMERCE 12-0-2010.
JOHN DALIER, EXAMINING ATTORNEY

SN 85-608,454. IO DATA CENTERS, LLC, PHOENIX, AZ. FILED 4-25-2012.

POWERED BY IO

THE MARK CONSISTS OF STANDARD CHARACTERS WITHOUT CLAIM TO ANY PARTICULAR FONT, STYLE, SIZE, OR COLOR.

OWNER OF U.S. REG. NOS. 3,827,956, 3,963,695 AND OTHERS.

FOR COMPUTER COLOCATION SERVICES, NAMELY, PROVIDING FACILITIES FOR THE LOCATION OF COMPUTER SERVERS WITH THE EQUIPMENT OF OTHERS (U.S. CLS. 100 AND 101).

DANIEL CAPSHAW, EXAMINING ATTORNEY

CLASS 43—HOTEL AND RESTAURANT SERVICES

SN 79-099,266. SUHAIL HASAN, UNITED KINGDOM, FILED 6-10-2011.

TINSELTOWN

THE MARK CONSISTS OF STANDARD CHARACTERS WITHOUT CLAIM TO ANY PARTICULAR FONT, STYLE, SIZE, OR COLOR.

OWNER OF INTERNATIONAL REGISTRATION 1082308 DATED 6-10-2011, EXPIRES 6-10-2021.

FOR SERVICES FOR PROVIDING FOOD AND DRINK; RESTAURANT, BAR AND CATERING SERVICES; CAFES; SNACK-BARS; TAKEAWAY RESTAURANT SERVICES; RESTAURANT, CAFES AND SNACK-BARS FEATURING HOME DELIVERY (U.S. CLS. 100 AND 101).

RON FAIRBANKS, EXAMINING ATTORNEY

CLASS 43—(Continued).

SN 85-234,370. WOODSPOON, INC., LOS ANGELES, CA. FILED 2-4-2011.

WoodSpoon

THE MARK CONSISTS OF STANDARD CHARACTERS WITHOUT CLAIM TO ANY PARTICULAR FONT, STYLE, SIZE, OR COLOR.

FOR RESTAURANT SERVICES FEATURING BRAZILIAN CUISINE, EXCLUDING BARBEQUE SAUCE AND FOODS PREPARED WITH BARBEQUE SAUCE; RESTAURANT SERVICES, INCLUDING SIT-DOWN SERVICE OF FOOD AND TAKE-OUT RESTAURANT SERVICES FEATURING BRAZILIAN CUISINE, EXCLUDING BARBEQUE SAUCE AND FOODS PREPARED WITH BARBEQUE SAUCE (U.S. CLS. 100 AND 101).

FIRST USE 11-26-2006; IN COMMERCE 11-26-2006.
ANDREA K. NADELMAN, EXAMINING ATTORNEY

SN 85-233,849. RANDY PEACHES, DBA DO YOURSELF A FLAVA, BOWIE, MD. FILED 2-3-2011.



THE COLOR(S) GREEN, ORANGE, BLACK, WHITE AND GRAY IS/ARE CLAIMED AS A FEATURE OF THE MARK.

THE MARK CONSISTS OF A PEACH CHEF WALKING WHILE HOLDING AN ELEGANT SERVING TRAY; THE BODY OF THE CHEF IS A PEACH IN ORANGE; THE NECKERCHIEF/SCARF IS A GREEN LEAF; ALL ELEMENTS IN THE CHEF DESIGN ARE OUTLINED IN BLACK; THE COLOR WHITE APPEARS IN THE DOME AND HANDLE OF THE SERVING TRAY AND THE CHEF HAT; THE BACKGROUND OF THE MARK IS TRANSPARENT; THE CHEF DESIGN APPEARS ABOVE THE WORDING "DO YOURSELF A FLAVA!!!" WHICH APPEARS IN GRAY; AND A SWOOPING ORANGE LINE APPEARS BELOW THE WORDING "DO YOURSELF A FLAVA!!!"

FOR RESTAURANT, BAR AND CATERING SERVICES (U.S. CLS. 100 AND 101).

FIRST USE 3-13-2010; IN COMMERCE 4-9-2010.
BILL DAWE, EXAMINING ATTORNEY

SN 85-242,878. FATHER FLANAGAN'S BOYS' HOME, BOYS TOWN, NE. FILED 2-15-2011.

BOYS TOWN INTEGRATED CONTINUUM OF CARE

THE MARK CONSISTS OF STANDARD CHARACTERS WITHOUT CLAIM TO ANY PARTICULAR FONT, STYLE, SIZE, OR COLOR.

OWNER OF U.S. REG. NOS. 1,334,772, 3,627,959 AND OTHERS.

NO CLAIM IS MADE TO THE EXCLUSIVE RIGHT TO USE "INTEGRATED CONTINUUM OF CARE", APART FROM THE MARK AS SHOWN.

FOR JUVENILE CUSTODIAL CARE SERVICES, NAMELY, PROVIDING EMERGENCY SHELTER SERVICES IN THE NATURE OF TEMPORARY HOUSING; PROVIDING TEMPORARY HOMES AND EMERGENCY SHELTERS FOR CHILDREN (U.S. CLS. 100 AND 101).

FIRST USE 5-1-2010; IN COMMERCE 5-1-2010.
ALEXANDER L. POWERS, EXAMINING ATTORNEY

CLASS 43—(Continued).

SN 85-262,546. SHANTINIKETAN INC, TAVARES, FL. FILED 3-9-2011.



THE NAME(S), PORTRAIT(S), AND/OR SIGNATURE(S) SHOWN IN THE MARK DOES NOT IDENTIFY A PARTICULAR LIVING INDIVIDUAL.

THE COLOR(S) GOLD IS/ARE CLAIMED AS A FEATURE OF THE MARK.

THE MARK CONSISTS OF THE WORDING "SHANTINIKETAN" REPRESENTED IN STYLIZED FONT AND IN THE COLOR GOLD.

THE ENGLISH TRANSLATION OF "SHANTINIKETAN" IN THE MARK IS "PEACE HOUSE".

SEC. 2(F).

FOR RETIREMENT HOMES (U.S. CLS. 100 AND 101).

FIRST USE 1-1-2008; IN COMMERCE 1-1-2008.

WARREN L. OLANDRIA, EXAMINING ATTORNEY

CLASS 43—(Continued).

SN 85-353,369. PURE CONCEPTS, LTD., HUMBLE, TX. FILED 6-22-2011.



NO CLAIM IS MADE TO THE EXCLUSIVE RIGHT TO USE "HEALTHY EATERY", APART FROM THE MARK AS SHOWN.

THE COLOR(S) GREEN, BROWN AND WHITE IS/ARE CLAIMED AS A FEATURE OF THE MARK.

THE MARK CONSISTS OF A DESIGN FEATURING LEAVES AND A FORK IN GREEN OUTLINED IN WHITE, AND BELOW IS THE WORDING "PURE" IN BROWN AND "HEALTHY EATERY" IN GREEN.

FOR RESTAURANT AND CAFE SERVICES; CATERING SERVICES; RESTAURANT SERVICES FEATURING SANDWICHES; RESTAURANT SERVICES FEATURING NATURAL, ORGANIC FOODS; SERVING OF FOOD AND DRINKS (U.S. CLS. 100 AND 101).

FIRST USE 9-7-2010; IN COMMERCE 9-7-2010.

AMY KELLY, EXAMINING ATTORNEY

SN 85-308,709. CLASSIC RESIDENCE MANAGEMENT LIMITED PARTNERSHIP, CHICAGO, IL. FILED 4-29-2011.

CLASSIC RESIDENCE

THE MARK CONSISTS OF STANDARD CHARACTERS WITHOUT CLAIM TO ANY PARTICULAR FONT, STYLE, SIZE, OR COLOR.

FOR PROVIDING ASSISTED LIVING FACILITIES (U.S. CLS. 100 AND 101).

FIRST USE 6-8-2010; IN COMMERCE 6-8-2010.

WARREN L. OLANDRIA, EXAMINING ATTORNEY

SN 85-367,673. BT CONCEPTS LLC, EDMOND, OK. FILED 7-11-2011.



OWNER OF U.S. REG. NO. 4,028,083.

NO CLAIM IS MADE TO THE EXCLUSIVE RIGHT TO USE "THE OKLAHOMA ORIGINAL", "BREWERY", AND "SINCE 1992", APART FROM THE MARK AS SHOWN.

THE MARK CONSISTS OF THE WORDS "THE OKLAHOMA ORIGINAL" ACROSS ON THE FIRST LINE IN ALL CAPITAL LETTERS, THE WORD "BRICKTOWN" ON THE SECOND LINE IN ALL CAPITAL LETTERS, THE WORD "BREWERY" ON A THIRD LINE IN ALL CAPITAL LETTERS, AND THE WORDS "SINCE 1992" IN ALL CAPITAL LETTERS ON THE FOURTH LINE WITH TWO LEAF DESIGNS ON EACH SIDE OF THE WORDS "SINCE 1992".

SEC. 2(F) AS TO "BRICKTOWN".

FOR BAR AND RESTAURANT SERVICES (U.S. CLS. 100 AND 101).

FIRST USE 6-6-2011; IN COMMERCE 6-6-2011.

DEBORAH LOBO, EXAMINING ATTORNEY

CLASS 43—(Continued).

SN 85-372,899. GENGHIS GRILL FRANCHISE CONCEPTS, LP, DALLAS, TX. FILED 7-15-2011.

KULINARY KALENDAR

THE MARK CONSISTS OF STANDARD CHARACTERS WITHOUT CLAIM TO ANY PARTICULAR FONT, STYLE, SIZE, OR COLOR.

NO CLAIM IS MADE TO THE EXCLUSIVE RIGHT TO USE "KULINARY", APART FROM THE MARK AS SHOWN. FOR RESTAURANT AND BAR SERVICES; CARRY-OUT RESTAURANT SERVICES; CATERING SERVICES; RESTAURANT SERVICES FEATURING HOME DELIVERY (U.S. CLS. 100 AND 101).

CHRISTINE COOPER, EXAMINING ATTORNEY

SN 85-377,890. A G CONSULTING, LLC, SAN JUAN CAPISTRANO, CA. FILED 7-21-2011.

SAPPHIRE CULINARY GROUP

THE MARK CONSISTS OF STANDARD CHARACTERS WITHOUT CLAIM TO ANY PARTICULAR FONT, STYLE, SIZE, OR COLOR.

OWNER OF U.S. REG. NO. 3,445,876.
NO CLAIM IS MADE TO THE EXCLUSIVE RIGHT TO USE "CULINARY GROUP", APART FROM THE MARK AS SHOWN.

FOR RESTAURANT AND BAR SERVICES; CATERING SERVICES; CATERING SERVICES FOR THE PROVISION OF FOOD AND BEVERAGES (U.S. CLS. 100 AND 101).

ALICE BENMAMAN, EXAMINING ATTORNEY

SN 85-377,895. A G CONSULTING, LLC, SAN JUAN CAPISTRANO, CA. FILED 7-21-2011.

SAPPHIRE CATERING

THE MARK CONSISTS OF STANDARD CHARACTERS WITHOUT CLAIM TO ANY PARTICULAR FONT, STYLE, SIZE, OR COLOR.

OWNER OF U.S. REG. NO. 3,445,876.
NO CLAIM IS MADE TO THE EXCLUSIVE RIGHT TO USE "CATERING", APART FROM THE MARK AS SHOWN. FOR CATERING SERVICES; CATERING SERVICES FOR THE PROVISION OF FOOD AND BEVERAGES (U.S. CLS. 100 AND 101).

ALICE BENMAMAN, EXAMINING ATTORNEY

CLASS 43—(Continued).

SN 85-378,504. FP HOLDINGS, L.P., LAS VEGAS, NV. FILED 7-22-2011.

SKY CASINO

THE MARK CONSISTS OF STANDARD CHARACTERS WITHOUT CLAIM TO ANY PARTICULAR FONT, STYLE, SIZE, OR COLOR.

OWNER OF U.S. REG. NOS. 3,114,586 AND 3,628,859.
NO CLAIM IS MADE TO THE EXCLUSIVE RIGHT TO USE "CASINO", APART FROM THE MARK AS SHOWN. FOR RESTAURANT AND COCKTAIL LOUNGE SERVICES (U.S. CLS. 100 AND 101).

GINA FINK, EXAMINING ATTORNEY

SN 85-386,948. ICRAVE LLC, NEW YORK, NY. FILED 8-2-2011.

MOOSHI

THE MARK CONSISTS OF STANDARD CHARACTERS WITHOUT CLAIM TO ANY PARTICULAR FONT, STYLE, SIZE, OR COLOR.

FOR RESTAURANT AND RESTAURANT SERVICES (U.S. CLS. 100 AND 101).

ZACHARY BELLO, EXAMINING ATTORNEY

SN 85-400,656. CHRIS TSAILAKIS, PHOENIX, AZ. FILED 8-17-2011.

MY BIG FAT GREEK

THE MARK CONSISTS OF STANDARD CHARACTERS WITHOUT CLAIM TO ANY PARTICULAR FONT, STYLE, SIZE, OR COLOR.

OWNER OF U.S. REG. NO. 3,202,521.
NO CLAIM IS MADE TO THE EXCLUSIVE RIGHT TO USE "GREEK", APART FROM THE MARK AS SHOWN. FOR RESTAURANT SERVICES (U.S. CLS. 100 AND 101).

FIRST USE 12-31-2002; IN COMMERCE 12-31-2002.
DAVID H. STINE, EXAMINING ATTORNEY

CLASS 43—(Continued).

SN 85-404,057. ROY YAMAGUCHI, HONOLULU, HI. FILED 8-22-2011.

CHEF ROY YAMAGUCHI

THE MARK CONSISTS OF STANDARD CHARACTERS WITHOUT CLAIM TO ANY PARTICULAR FONT, STYLE, SIZE, OR COLOR.

NO CLAIM IS MADE TO THE EXCLUSIVE RIGHT TO USE "CHEF", APART FROM THE MARK AS SHOWN.

THE NAME "ROY YAMAGUCHI" IDENTIFIES A LIVING INDIVIDUAL WHOSE CONSENT IS OF RECORD.

FOR RESTAURANT AND BAR SERVICES, NAMELY, PROVIDING OF FOOD AND BEVERAGES FOR CONSUMPTION ON AND OFF THE PREMISES (U.S. CLS. 100 AND 101).

ARETHA SOMERVILLE, EXAMINING ATTORNEY

SN 85-419,568. CUSANO, SAMUEL, ROCKY HILL, CT. AND CUSANO, COURTNEY J., ROCKY HILL, CT. FILED 9-10-2011.

SPORTSAURANT

THE MARK CONSISTS OF STANDARD CHARACTERS WITHOUT CLAIM TO ANY PARTICULAR FONT, STYLE, SIZE, OR COLOR.

FOR RESTAURANT AND BAR SERVICES (U.S. CLS. 100 AND 101).

RONALD MCMORROW, EXAMINING ATTORNEY

SN 85-431,544. TKR PLANNERS, INC., NEW YORK, NY. FILED 9-26-2011.

WASAN

THE MARK CONSISTS OF STANDARD CHARACTERS WITHOUT CLAIM TO ANY PARTICULAR FONT, STYLE, SIZE, OR COLOR.

THE WORDING "WASAN" HAS NO MEANING IN A FOREIGN LANGUAGE.

FOR RESTAURANT SERVICES (U.S. CLS. 100 AND 101).

FIRST USE 4-28-2010; IN COMMERCE 4-28-2010.

MICHAEL LITZAU, EXAMINING ATTORNEY

CLASS 43—(Continued).

SN 85-444,024. LE REVE VENTURES, LLC, HOUSTON, TX. FILED 10-11-2011.

VINO DOG

THE MARK CONSISTS OF STANDARD CHARACTERS WITHOUT CLAIM TO ANY PARTICULAR FONT, STYLE, SIZE, OR COLOR.

NO CLAIM IS MADE TO THE EXCLUSIVE RIGHT TO USE "VINO", APART FROM THE MARK AS SHOWN.

THE ENGLISH TRANSLATION OF THE WORD "VINO" IN THE MARK IS "WINE".

FOR RESTAURANT AND BAR SERVICES (U.S. CLS. 100 AND 101).

CHRISTOPHER LAW, EXAMINING ATTORNEY

SN 85-451,348. REBEL HOUSE 299 LLC, BOCA RATON, FL. FILED 10-19-2011.

REBEL HOUSE

THE MARK CONSISTS OF STANDARD CHARACTERS WITHOUT CLAIM TO ANY PARTICULAR FONT, STYLE, SIZE, OR COLOR.

NO CLAIM IS MADE TO THE EXCLUSIVE RIGHT TO USE "HOUSE", APART FROM THE MARK AS SHOWN.

FOR BAR AND RESTAURANT SERVICES (U.S. CLS. 100 AND 101).

KIMBERLY PERRY, EXAMINING ATTORNEY

SN 85-451,718. CRESTHILLS SUITES COMPANY, LLC, LIVERPOOL, NY. FILED 10-20-2011.

**CrestHill
SUITES**

NO CLAIM IS MADE TO THE EXCLUSIVE RIGHT TO USE "SUITES", APART FROM THE MARK AS SHOWN.

THE MARK CONSISTS OF THE LITERAL ELEMENT "CRESTHILL SUITES". THE APPLICANT IS NOT CLAIMING COLOR AS A FEATURE OF THE MARK. THE MARK CONSISTS OF RIGHT-ALIGNED WORDING WITH "CRESTHILL" UNDERLINED AND THE WORD "SUITES" BELOW.

FOR HOTEL ACCOMMODATION SERVICES; HOTEL SERVICES (U.S. CLS. 100 AND 101).

FIRST USE 3-17-2000; IN COMMERCE 3-17-2000.

EMILY CARLSEN, EXAMINING ATTORNEY

CLASS 43—(Continued).

SN 85-460,112. SPECTRUM RETIREMENT COMMUNITIES, LLC, DENVER, CO. FILED 10-31-2011.

THE PATH TO THE PRESENT

THE MARK CONSISTS OF STANDARD CHARACTERS WITHOUT CLAIM TO ANY PARTICULAR FONT, STYLE, SIZE, OR COLOR.

FOR RETIREMENT HOMES, NAMELY, PROVIDING ASSISTED LIVING FACILITIES AND CONGREGATE LIVING FACILITIES FOR SENIORS (U.S. CLS. 100 AND 101).

FIRST USE 9-1-2011; IN COMMERCE 9-1-2011.
MICHAEL WEBSTER, EXAMINING ATTORNEY

CLASS 43—(Continued).

SN 85-485,210. LEGEND PETROLEUM LLC., TA TANDOOR AND CURRY, WEST PALM BEACH, FL. FILED 12-1-2011.



NO CLAIM IS MADE TO THE EXCLUSIVE RIGHT TO USE "TANDOOR & CURRY" AND THE PICTORIAL REPRESENTATION OF A CURRY DISH, APART FROM THE MARK AS SHOWN.

THE COLOR(S) BROWN, TAN, SILVER, GREEN, RED AND WHITE IS/ARE CLAIMED AS A FEATURE OF THE MARK.

THE MARK CONSISTS OF A SIGN HANGING ON A SILVER ROD WITH TWO SILVER CHAINS ATTACHED, THE OVAL IS OUTLINED IN THE COLOR RED WITH A BROWN BACKGROUND IN THE CENTER APPEARS A PICTURE OF FOOD WITH RED SAUCE, WHITE ONIONS AND GREEN CILANTRO, THE PAN APPEARS IN THE COLOR TAN AND IS OUTLINED IN RED WITH TWO GREEN CILANTRO LEAVES BENEATH, THE WORDING, FOR RESTAURANT SERVICES (U.S. CLS. 100 AND 101).

FIRST USE 8-15-2011; IN COMMERCE 8-15-2011.
JAY FLOWERS, EXAMINING ATTORNEY

SN 85-486,559. SANJAY PATEL, DBA BOLLYWOOD BITES, VAN NUYS, CA. FILED 12-3-2011.



NO CLAIM IS MADE TO THE EXCLUSIVE RIGHT TO USE "BITES", APART FROM THE MARK AS SHOWN.

THE COLOR(S) GOLDEN, BLACK, GRAY, SAFFRON, WHITE, GREEN, ORANGE, RED IS/ARE CLAIMED AS A FEATURE OF THE MARK.

THE MARK CONSISTS OF BLACK CIRCLE WITH GOLDEN BOUNDARY; INSIDE IS BIG GRAY STAR CONTAINING A GOLDEN PLATE WITH A GOLDEN FORK, GOLDEN KNIFE, AND GOLDEN SPOON; OUTSIDE THE CIRCLE ARE SMALL STARS OF SAFFRON, WHITE, AND GREEN COLORS; AND "BOLLYWOOD BITES" WRITTEN AT THE BOTTOM IN 2D STYLE IN ORANGE COLOR WITH RED SHADE.

FOR CONTRACT FOOD SERVICES; FAST-FOOD RESTAURANT SERVICES; FOOD PREPARATION SERVICES; PROVIDING OF FOOD AND DRINK VIA A MOBILE TRUCK; RESTAURANT SERVICES, INCLUDING SIT-DOWN SERVICE OF FOOD AND TAKE-OUT RESTAURANT SERVICES (U.S. CLS. 100 AND 101).

FIRST USE 12-15-2010; IN COMMERCE 1-6-2011.
GINA HAYES, EXAMINING ATTORNEY

SN 85-465,501. SUSHI METSUYAN INC, AKA METSUYAN, JAMAICA ESTATES, NY. FILED 11-6-2011.

metsuyan

THE MARK CONSISTS OF STANDARD CHARACTERS WITHOUT CLAIM TO ANY PARTICULAR FONT, STYLE, SIZE, OR COLOR.

OWNER OF U.S. REG. NOS. 2,899,701 AND 2,914,518. THE ENGLISH TRANSLATION OF THE WORD "METSUYAN" IN THE MARK IS "FINE".

FOR RESTAURANT SERVICES; CATERING SERVICES; CONTRACT FOOD SERVICES; SUSHI RESTAURANTS (U.S. CLS. 100 AND 101).

FIRST USE 9-5-1995; IN COMMERCE 9-5-1995.
JILL PRATER, EXAMINING ATTORNEY

CLASS 43—(Continued).

SN 85-491,330. SWEETWATER GAP ENTERPRISES, LLC, BOULDER, CO. FILED 12-9-2011.



FOR RESTAURANT SERVICES RENDERED IN A DECOR OF ANTIQUE FURNITURE AND COLLECTIBLES THAT ARE OFFERED FOR SALE TO RESTAURANT PATRONS (U.S. CLS. 100 AND 101).
BRIAN NEVILLE, EXAMINING ATTORNEY

CLASS 43—(Continued).

SN 85-498,661. HEAVENLY SENT, INC., EVERETT, WA. FILED 12-19-2011.



NO CLAIM IS MADE TO THE EXCLUSIVE RIGHT TO USE "FRIED CHICKEN", APART FROM THE MARK AS SHOWN.

THE LIKENESS (OR, "PORTRAIT") IN THE MARK IDENTIFIES A LIVING INDIVIDUAL WHOSE CONSENT IS OF RECORD.

THE MARK CONSISTS OF THE WORDS "HEAVEN SENT FRIED CHICKEN" SUPERIMPOSED ON A CLOUD WITH RAYS OF SUNSHINE BEHIND IT ALL WITHIN A RECTANGULAR BORDER, SITUATED TO THE RIGHT AND ON TOP OF THE RECTANGLE IS A PICTURE OF APPLICANT'S FOUNDER, EZELL STEPHENS, WEARING A T-SHIRT BEARING THE WORDS "GOD IS GOOD ALL THE TIME", NECKLACES, GLASSES, AND A HAT.

FOR RESTAURANT SERVICES FEATURING FRIED CHICKEN (U.S. CLS. 100 AND 101).

NAKIA HENRY, EXAMINING ATTORNEY

SN 85-494,114. RIO GRANDE MEXICAN RESTAURANTS, INC., FORT COLLINS, CO. FILED 12-13-2011.



OWNER OF U.S. REG. NO. 2,088,601.
NO CLAIM IS MADE TO THE EXCLUSIVE RIGHT TO USE "MEXICAN RESTAURANT", APART FROM THE MARK AS SHOWN.

THE COLOR(S) GREEN, GOLD, AND BLACK IS/ARE CLAIMED AS A FEATURE OF THE MARK.

THE MARK CONSISTS OF THE WORDS "RIO GRANDE" IN GREEN LETTERING OUTLINED IN BLACK ABOVE THE WORDS "MEXICAN RESTAURANT" IN BLACK LETTERING ABOVE A BLACK AND GOLD FIVE-POINT STAR BETWEEN TWO BLACK LINES.

FOR BAR SERVICES; RESTAURANT SERVICES FEATURING MEXICAN FOOD (U.S. CLS. 100 AND 101).

FIRST USE 6-5-2008; IN COMMERCE 6-5-2008.
MICHAEL TANNER, EXAMINING ATTORNEY

SN 85-508,751. ON THE ROCKS RESTAURANT, LLC, ST. LOUIS, MO. FILED 1-4-2012.



THE COLOR(S) RED, BLACK IS/ARE CLAIMED AS A FEATURE OF THE MARK.

THE MARK CONSISTS OF A PARTIALLY OPEN RED CIRCLE WITH A RED ARTISTIC SWIPE INSIDE THE PARTIALLY OPEN CIRCLE, NEAR THE UPPER RIGHT OPENING OF THE CIRCLE. THE ENTIRE DESIGN HAS A BLACK BACKGROUND.

FOR RESTAURANT SERVICES; CARRY OUT RESTAURANT SERVICES; CATERING SERVICES; BAR SERVICES (U.S. CLS. 100 AND 101).

MARK SPARACINO, EXAMINING ATTORNEY

CLASS 43—(Continued).

SN 85-512,199. SCI RESTAURANT GROUP, INC., PORTLAND, OR. FILED 1-9-2012.

SLAPPY CAKES

THE MARK CONSISTS OF STANDARD CHARACTERS WITHOUT CLAIM TO ANY PARTICULAR FONT, STYLE, SIZE, OR COLOR.

FOR RESTAURANT SERVICES, NAMELY, A FULL SERVICE BREAKFAST RESTAURANT (U.S. CLS. 100 AND 101).

FIRST USE 10-0-2008; IN COMMERCE 10-0-2008.
DAVID MURRAY, EXAMINING ATTORNEY

SN 85-519,928. BUBBY'S IP HOLDINGS, INC., NEW YORK, NY. FILED 1-19-2012.

BUBBY'S

THE MARK CONSISTS OF STANDARD CHARACTERS WITHOUT CLAIM TO ANY PARTICULAR FONT, STYLE, SIZE, OR COLOR.

OWNER OF U.S. REG. NO. 1,802,422.
FOR RESTAURANT SERVICES (U.S. CLS. 100 AND 101).

FIRST USE 12-21-1990; IN COMMERCE 12-21-1990.
DOUGLAS LEE, EXAMINING ATTORNEY

SN 85-520,038. WILSON MANAGEMENT, LLC., SIOUX FALLS, SD. FILED 1-19-2012.



OWNER OF U.S. REG. NOS. 3,169,593 AND 3,169,595.
NO CLAIM IS MADE TO THE EXCLUSIVE RIGHT TO USE "BRAZILIAN GRILL", APART FROM THE MARK AS SHOWN.

THE MARK CONSISTS OF THE WORDS "CARNAVAL BRAZILIAN GRILL" WITH A FLAME EMANATING FROM THE LETTER "N" IN "CARNAVAL".

FOR BAR SERVICES; RESTAURANT SERVICES (U.S. CLS. 100 AND 101).
FIRST USE 0-0-2008; IN COMMERCE 0-0-2008.
MEGHAN REINHART, EXAMINING ATTORNEY

CLASS 43—(Continued).

SN 85-520,339. DENICAS, DUBLIN, CA. FILED 1-19-2012.



NO CLAIM IS MADE TO THE EXCLUSIVE RIGHT TO USE "REAL FOOD KITCHEN", APART FROM THE MARK AS SHOWN.

THE COLOR(S) LIGHT BLUE IS/ARE CLAIMED AS A FEATURE OF THE MARK.

THE MARK CONSISTS OF THE LIGHT BLUE STYLIZED WORDING "DENICA'S REAL FOOD KITCHEN" AND A STYLIZED LIGHT BLUE FORK, ROLLING PIN, AND SPOON VERTICALLY POSITIONED ON AN OVAL PLATE SHAPED BACKGROUND WITH IRREGULAR BORDERS AND SHADING. THE COLOR WHITE REPRESENTS BACKGROUND, OUTLINING, SHADING AND/OR TRANSPARENT AREAS AND IS NOT PART OF THE MARK.

FOR RESTAURANT AND CAFE SERVICES (U.S. CLS. 100 AND 101).
FIRST USE 12-27-2011; IN COMMERCE 12-27-2011.
BRIAN PINO, EXAMINING ATTORNEY

SN 85-521,897. RODOLFO VALENTIN PERALTA AREAS, MEXICO, D.F., MEXICO, FILED 1-20-2012.



NO CLAIM IS MADE TO THE EXCLUSIVE RIGHT TO USE "FONDA ARGENTINA DESDE 1993", APART FROM THE MARK AS SHOWN.

THE MARK CONSISTS OF A DESIGN ELEMENT INCLUDING THE OUTLINED SKETCH OF THE HEADSHOT OF A MALE WITH LONG HAIR WEARING A HEAD BAND AND A SIDE SWEEP BANG THAT COVERS HIS LEFT EYEBROW. BELOW THE HEADSHOT IS THE LITERAL ELEMENT "FONDA ARGENTINA DESDE 1993". THE

CLASS 43—(Continued).

WORDING "FONDA" APPEARS IMMEDIATELY BELOW THE DESIGN ELEMENT IN ALL CAPITAL LETTERS. IMMEDIATELY BELOW THIS IS THE WORDING "ARGENTINA" IN ALL CAPITAL LETTERS WITH THE BEGINNING LETTER A AND ENDING LETTER A APPEARING IN RAISED CAPITAL LETTERS. IMMEDIATELY BELOW THIS IS THE WORDING "DESDE 1993" IN ALL CAPITAL LETTERS WHICH APPEARS WITH A SPACE BETWEEN EACH INDIVIDUAL LETTER INSIDE AN OUTLINED BORDER FRAMING SUCH WORDING.

THE ENGLISH TRANSLATION OF "FONDA ARGENTINA DESDE 1993" IN THE MARK IS "RESTAURANT ARGENTINA SINCE 1993".

FOR BAR SERVICES; RESTAURANT SERVICES FEATURING ARGENTINE CUISINE (U.S. CLS. 100 AND 101).

FIRST USE 4-14-2011; IN COMMERCE 4-14-2011.
MATTHEW MCDOWELL, EXAMINING ATTORNEY

CLASS 43—(Continued).

YELLOW, STYLIZED FONT. THE BURGER ITSELF CONSISTS OF AN ORANGE BOTTOM BUN AND, AS YOU PROGRESS UPWARD, A YELLOW SLICE OF CHEESE, RED TOMATO SLICES, A BROWN PATTY, GREEN LETTUCE AND AN ORANGE TOP BUN WITH A SET OF EYES IN WHITE WITH BLACK AND BROWN PUPIL AND IRIS, A WHITE SMILE AND TWO ARMS IN ORANGE. THE RIGHTMOST ARM IS POSITIONED AT THE HIP OF THE BURGER AND THE OTHER IS RAISED AND FORMED INTO A "THUMBS-UP" SIGN.

FOR FAST-FOOD RESTAURANT SERVICES; RESTAURANT SERVICES FEATURING COLOMBIAN STYLE BURGERS, CHEESEBURGERS, HOT DOGS, CORNCAKES, QUESADILLAS, SALCHIPAPAS, CHORIZOS, BEEF AND CHICKEN SKEWERS AND EMPANADAS (U.S. CLS. 100 AND 101).

FIRST USE 9-25-2010; IN COMMERCE 9-25-2010.
B. PARADEWELAI, EXAMINING ATTORNEY

SN 85-524,283. TABLE HOST LLC, CHICAGO, IL. FILED 1-24-2012.

Table Host

THE MARK CONSISTS OF STANDARD CHARACTERS WITHOUT CLAIM TO ANY PARTICULAR FONT, STYLE, SIZE, OR COLOR.

FOR ONLINE RESERVATION SERVICES, NAMELY, PROVIDING A WEBSITE WHERE REGISTERED MEMBERS CAN MAKE RESTAURANT RESERVATIONS CHOOSING FROM A LIST OF PARTICIPATING VENDORS (U.S. CLS. 100 AND 101).

KIMBERLY FRYE, EXAMINING ATTORNEY

SN 85-524,753. JUNIOR COLOMBIAN BURGER, INC., ORLANDO, FL. FILED 1-25-2012.



NO CLAIM IS MADE TO THE EXCLUSIVE RIGHT TO USE "COLOMBIAN BURGER", APART FROM THE MARK AS SHOWN.

THE COLOR(S) RED, BLACK, YELLOW, ORANGE, GREEN, BROWN AND WHITE IS/ARE CLAIMED AS A FEATURE OF THE MARK.

THE MARK CONSISTS OF THE WORD "JUNIOR" IN BOLD RED LETTERS, OUTLINED IN BLACK, WITH THE IMAGE OF A HAMBURGER REPRESENTING THE "O." THE WORD "JUNIOR" IS POSITIONED ABOVE A BLACK OVAL CONTAINING THE WORDS "COLOMBIAN BURGER" WHICH ARE CAPITALIZED AND WRITTEN IN A

SN 85-525,197. PMK, LLC, NASHVILLE, TN. FILED 1-25-2012.

BURGER UP

THE MARK CONSISTS OF STANDARD CHARACTERS WITHOUT CLAIM TO ANY PARTICULAR FONT, STYLE, SIZE, OR COLOR.

OWNER OF U.S. REG. NO. 4,128,018.

NO CLAIM IS MADE TO THE EXCLUSIVE RIGHT TO USE "BURGER", APART FROM THE MARK AS SHOWN.

FOR RESTAURANT SERVICES (U.S. CLS. 100 AND 101).

FIRST USE 5-1-2010; IN COMMERCE 5-1-2010.
AMY ALFIERI, EXAMINING ATTORNEY

SN 85-529,579. JEFF RUBY CULINARY ENTERTAINMENT, INC., CINCINNATI, OH. FILED 1-31-2012.



THE NAME "JEFF RUBY" IDENTIFIES A LIVING INDIVIDUAL WHOSE CONSENT IS OF RECORD.

THE MARK CONSISTS OF AN OVAL-SHAPED DESIGN WITH THE WORDS "JEFF RUBY'S" IN CURSIVE WRITING ACROSS THE TOP.

FOR RESTAURANT SERVICES; BAR SERVICES (U.S. CLS. 100 AND 101).

ARETHA SOMERVILLE, EXAMINING ATTORNEY

CLASS 43—(Continued).

SN 85-529,797. A NEW WAY TO MAKE DOUGH, LLC, NASHVILLE, TN. FILED 1-31-2012.



NO CLAIM IS MADE TO THE EXCLUSIVE RIGHT TO USE "FIVE POINTS PIZZA", APART FROM THE MARK AS SHOWN.

THE MARK CONSISTS OF A TRIANGLE WITH THE POINT AT THE BOTTOM, INSIDE OF WHICH ARE THE FOLLOWING: A SMALL CURVED BAND PLACED ABOVE THE WORD "FIVE" IN CAPITAL LETTERS PLACED ABOVE THE WORD "POINTS" IN CAPITAL LETTERS PLACED ABOVE THE WORD "PIZZA" IN CAPITAL LETTERS WRITTEN INSIDE A LARGER BREAKOUT BOX THAT EXTENDS OUTSIDE THE TRIANGLE; THE BREAKOUT BOX SITS ABOVE A SMALL STAR PLACED JUST ABOVE THE POINT AT THE BOTTOM OF THE TRIANGLE.

FOR PIZZA PARLORS (U.S. CLS. 100 AND 101).
FIRST USE 8-13-2011; IN COMMERCE 8-13-2011.
WILLIAM VERHOSEK, EXAMINING ATTORNEY

SN 85-530,565. MINISTRY OF SOUND GROUP LIMITED, LONDON, UNITED KINGDOM, FILED 2-1-2012.



THE MARK CONSISTS OF THE TERM "HEDKANDI" FOLLOWED BY THE DESIGN OF A STYLIZED, SIX-POINTED STAR TO THE RIGHT. THE BOTTOM POINT OF THE STAR IS ELONGATED.

FOR BARS, RESTAURANTS AND HOTELS; PROVISION OF TEMPORARY ACCOMMODATION SERVICES AND CATERING SERVICES; MAKING RESERVATIONS AND BOOKINGS FOR RESTAURANTS AND TEMPORARY VACATION LODGING; SERVICES FOR PROVIDING FOOD AND DRINK (U.S. CLS. 100 AND 101).
LINDA MICKLEBURGH, EXAMINING ATTORNEY

CLASS 43—(Continued).

SN 85-531,107. ROSSLER, JON, FALLS CHURCH, VA. FILED 2-1-2012.

CORNED BEEF KING

THE MARK CONSISTS OF STANDARD CHARACTERS WITHOUT CLAIM TO ANY PARTICULAR FONT, STYLE, SIZE, OR COLOR.

NO CLAIM IS MADE TO THE EXCLUSIVE RIGHT TO USE "CORNED BEEF", APART FROM THE MARK AS SHOWN.

FOR RESTAURANT SERVICES (U.S. CLS. 100 AND 101).
JULIE VEPPUMTHARA, EXAMINING ATTORNEY

SN 85-531,226. AMERICAN BLUE RIBBON HOLDINGS, LLC, DENVER, CO. FILED 2-1-2012.



THE MARK CONSISTS OF THE LETTERS "VI" IN STYLIZED FONT.

FOR RESTAURANT SERVICES (U.S. CLS. 100 AND 101).

FIRST USE 1-1-2010; IN COMMERCE 1-1-2010.
BRIDGETT SMITH, EXAMINING ATTORNEY

SN 85-531,238. BABY BACK BLUES, INC., PLAINFIELD, IL. FILED 2-1-2012.

IT'S ALL GOOD COOKED ON WOOD

THE MARK CONSISTS OF STANDARD CHARACTERS WITHOUT CLAIM TO ANY PARTICULAR FONT, STYLE, SIZE, OR COLOR.

FOR RESTAURANT SERVICES (U.S. CLS. 100 AND 101).

FIRST USE 6-30-2007; IN COMMERCE 6-30-2007.
NAKIA HENRY, EXAMINING ATTORNEY

CLASS 43—(Continued).

SN 85-531,450. DUENDE LLC, OAKLAND, CA. FILED 2-1-2012.

Duende

THE MARK CONSISTS OF STANDARD CHARACTERS WITHOUT CLAIM TO ANY PARTICULAR FONT, STYLE, SIZE, OR COLOR.

FOR BAR SERVICES; RESTAURANT SERVICES (U.S. CLS. 100 AND 101).

COLLEEN DOMBROW, EXAMINING ATTORNEY

SN 85-531,642. LAKESIDE RESTAURANTS, INC., WATKINSVILLE, GA. FILED 2-1-2012.

SKOGIES

THE MARK CONSISTS OF STANDARD CHARACTERS WITHOUT CLAIM TO ANY PARTICULAR FONT, STYLE, SIZE, OR COLOR.

FOR RESTAURANT SERVICES; RESTAURANT SERVICES FEATURING FISH, CHICKEN, SEAFOOD, SANDWICHES, SIDE DISHES, SALADS; RESTAURANT SERVICES, INCLUDING SIT-DOWN SERVICE OF FOOD AND TAKE-OUT RESTAURANT SERVICES; RESTAURANT SERVICES, NAMELY, PROVIDING OF FOOD AND BEVERAGES FOR CONSUMPTION ON AND OFF THE PREMISES (U.S. CLS. 100 AND 101).

FIRST USE 7-31-2005; IN COMMERCE 7-31-2005.
CAROLYN CATALDO, EXAMINING ATTORNEY

SN 85-531,647. LAKESIDE RESTAURANTS, INC., WATKINSVILLE, GA. FILED 2-1-2012.



THE MARK CONSISTS OF A STYLISTIC RENDERING OF A FISH WITH THE STYLISTIC LITERAL ELEMENT

CLASS 43—(Continued).

"SKOGIES" INTEGRATED INTO THE STYLISTIC RENDERING OF THE FISH WITH THE LOWER PORTION OF THE FIRST "S" AND THE DESCENDING PORTION OF THE "G" FORMING PORTIONS OF THE BELLY OF THE STYLISTIC RENDERING OF THE FISH AND THE SECOND "S" FORMING THE TAIL OF THE STYLISTIC RENDERING OF THE FISH, THE STYLISTIC RENDERING OF THE FISH INCLUDING A FIN ON THE TOP AND VARIOUS SIZED BUBBLES OVER THE FRONT OF THE STYLISTIC RENDERING OF THE FISH.

FOR RESTAURANT SERVICES; RESTAURANT SERVICES FEATURING FISH, CHICKEN, SEAFOOD, SANDWICHES, SIDE DISHES, SALADS; RESTAURANT SERVICES, INCLUDING SIT-DOWN SERVICE OF FOOD AND TAKE-OUT RESTAURANT SERVICES; RESTAURANT SERVICES, NAMELY, PROVIDING OF FOOD AND BEVERAGES FOR CONSUMPTION ON AND OFF THE PREMISES (U.S. CLS. 100 AND 101).

FIRST USE 7-31-2005; IN COMMERCE 7-31-2005.
CAROLYN CATALDO, EXAMINING ATTORNEY

SN 85-531,664. BOKEBOWL LLC, PORTLAND, OR. FILED 2-2-2012.



FOR RESTAURANT SERVICES (U.S. CLS. 100 AND 101).

FIRST USE 3-30-2011; IN COMMERCE 3-30-2011.
KIM MONINGHOFF, EXAMINING ATTORNEY

SN 85-531,749. ACCOR NORTH AMERICA, INC., CARROLLTON, TX. FILED 2-2-2012.

SAVE MORE FOR WHAT YOU
TRAVEL FOR

THE MARK CONSISTS OF STANDARD CHARACTERS WITHOUT CLAIM TO ANY PARTICULAR FONT, STYLE, SIZE, OR COLOR.

FOR HOTEL SERVICES; MOTEL SERVICES (U.S. CLS. 100 AND 101).

DEZMONA MIZELLE, EXAMINING ATTORNEY

CLASS 43—(Continued).

SN 85-532,130. LAST IN CONCEPTS, LLC, BATON ROUGE, LA. FILED 2-2-2012.

LAST IN CONCEPTS

THE MARK CONSISTS OF STANDARD CHARACTERS WITHOUT CLAIM TO ANY PARTICULAR FONT, STYLE, SIZE, OR COLOR.

FOR RESTAURANT AND BAR SERVICES (U.S. CLS. 100 AND 101).

ALEX KEAM, EXAMINING ATTORNEY

SN 85-532,269. SOL MAYA CORPORATION, OLNEY, MD. FILED 2-2-2012.



THE MARK CONSISTS OF THE WORDS "VILLA MAYA" IN STYLIZED LETTERING WITH THE DESIGN OF A STYLIZED FORK ABOVE THE LETTERS "AYA", AND A HORIZONTAL BORDER ABOVE AND BELOW THE WORDS FORMED BY A SERIES OF INVERTED HALF-DIAMOND DESIGNS.

FOR RESTAURANT SERVICES (U.S. CLS. 100 AND 101).

FIRST USE 10-0-2010; IN COMMERCE 10-0-2010.
WILLIAM VERHOSEK, EXAMINING ATTORNEY

SN 85-532,326. PARK LANE HOTEL, INC., NEW YORK, NY. FILED 2-2-2012.

**THE HELMSLEY SANDCASTLE
HOTEL**

THE MARK CONSISTS OF STANDARD CHARACTERS WITHOUT CLAIM TO ANY PARTICULAR FONT, STYLE, SIZE, OR COLOR.

OWNER OF U.S. REG. NO. 3,665,513.
NO CLAIM IS MADE TO THE EXCLUSIVE RIGHT TO USE "HOTEL", APART FROM THE MARK AS SHOWN.

FOR HOTEL SERVICES (U.S. CLS. 100 AND 101).
FIRST USE 10-1-2002; IN COMMERCE 10-1-2002.
JOHN DWYER, EXAMINING ATTORNEY

CLASS 43—(Continued).

SN 85-532,360. PARK LANE HOTEL, INC., NEW YORK, NY. FILED 2-2-2012.



OWNER OF U.S. REG. NO. 3,665,513.
NO CLAIM IS MADE TO THE EXCLUSIVE RIGHT TO USE "HOTEL", APART FROM THE MARK AS SHOWN.

THE MARK CONSISTS OF THE WORDS "THE HELMSLEY SANDCASTLE" IN STYLIZED LETTERING BELOW A DESIGN OF A CASTLE AND ABOVE A HORIZONTAL LINE BELOW WHICH IS THE WORD "HOTEL" IN STYLIZED LETTERING.

FOR HOTEL SERVICES (U.S. CLS. 100 AND 101).
FIRST USE 10-1-2002; IN COMMERCE 10-1-2002.
JOHN DWYER, EXAMINING ATTORNEY

SN 85-532,669. RICKENBACKER'S BISTRO & RESTAURANT, LLC, OGDEN, UT. FILED 2-2-2012.

PERFECTION TO THE BONE

THE MARK CONSISTS OF STANDARD CHARACTERS WITHOUT CLAIM TO ANY PARTICULAR FONT, STYLE, SIZE, OR COLOR.

FOR RESTAURANT AND CATERING SERVICES; RESTAURANTS FEATURING HOME DELIVERY; TAKE-OUT RESTAURANT SERVICES (U.S. CLS. 100 AND 101).

SANJEEV VOHRA, EXAMINING ATTORNEY

SN 85-532,974. THE BOARDINGHOUSE, LLC, CHICAGO, IL. FILED 2-3-2012.

THE BOARDINGHOUSE

THE MARK CONSISTS OF STANDARD CHARACTERS WITHOUT CLAIM TO ANY PARTICULAR FONT, STYLE, SIZE, OR COLOR.

FOR BAR SERVICES; RESTAURANT SERVICES (U.S. CLS. 100 AND 101).
BARBARA BROWN, EXAMINING ATTORNEY

CLASS 43—(Continued).

SN 85-533,393. SIMPLY SOUTHERN RESTAURANT GROUP, INC., AUBURN, AL. FILED 2-3-2012.

**A Simple Concept, A Superb
Experience**

THE MARK CONSISTS OF STANDARD CHARACTERS WITHOUT CLAIM TO ANY PARTICULAR FONT, STYLE, SIZE, OR COLOR.

FOR RESTAURANT SERVICES (U.S. CLS. 100 AND 101).

FIRST USE 4-0-2011; IN COMMERCE 4-0-2011.
JENNIFER VASQUEZ, EXAMINING ATTORNEY

CLASS 43—(Continued).

SN 85-534,289. THE ORANGE COUNTY CENTER FOR LIVING PEACE FOUNDATION, BEVERLY HILLS, CA. FILED 2-5-2012.

GOOD HAPPENS

THE MARK CONSISTS OF STANDARD CHARACTERS WITHOUT CLAIM TO ANY PARTICULAR FONT, STYLE, SIZE, OR COLOR.

FOR PROVIDING COMMUNITY CENTERS FOR SOCIAL GATHERINGS AND MEETINGS (U.S. CLS. 100 AND 101).

FIRST USE 1-25-2009; IN COMMERCE 1-25-2009.
DAWN FELDMAN, EXAMINING ATTORNEY

SN 85-533,678. CAMPINE CATERING, LLC., SAN DIEGO, CA. FILED 2-3-2012.

Campine

THE MARK CONSISTS OF STANDARD CHARACTERS WITHOUT CLAIM TO ANY PARTICULAR FONT, STYLE, SIZE, OR COLOR.

FOR CATERING SERVICES (U.S. CLS. 100 AND 101).

FIRST USE 7-31-2011; IN COMMERCE 7-31-2011.
JILL C. ALT, EXAMINING ATTORNEY

SN 85-534,593. INTUITOTS EARLY CHILD CARE AND DEVELOPMENT, LLC, OWINGS MILLS, MD. FILED 2-6-2012.

INTUITOTS

THE MARK CONSISTS OF STANDARD CHARACTERS WITHOUT CLAIM TO ANY PARTICULAR FONT, STYLE, SIZE, OR COLOR.

FOR PROVIDING CHILD CARE CENTERS (U.S. CLS. 100 AND 101).

GEORGE LORENZO, EXAMINING ATTORNEY

SN 85-533,786. CHOW YUM, LLC, LOS ANGELES, CA. FILED 2-3-2012.

CHOW YUM

THE MARK CONSISTS OF STANDARD CHARACTERS WITHOUT CLAIM TO ANY PARTICULAR FONT, STYLE, SIZE, OR COLOR.

FOR RESTAURANT SERVICES (U.S. CLS. 100 AND 101).

CAROLYN CATALDO, EXAMINING ATTORNEY

SN 85-534,814. DOUBLE COMFORT, LLC, COLUMBUS, OH. FILED 2-6-2012.

DOUBLE COMFORT

THE MARK CONSISTS OF STANDARD CHARACTERS WITHOUT CLAIM TO ANY PARTICULAR FONT, STYLE, SIZE, OR COLOR.

FOR RESTAURANT SERVICES (U.S. CLS. 100 AND 101).

WILLIAM BRECKENFELD, EXAMINING ATTORNEY

CLASS 43—(Continued).

SN 85-534,850. ARNULFO VAZQUEZ ALMANZA, LAREDO, TX. AND MARIA ASCENCION VAZQUEZ, LAREDO, TX. FILED 2-6-2012.



THE COLOR(S) RED, YELLOW, GREEN, AND WHITE IS/ ARE CLAIMED AS A FEATURE OF THE MARK.

THE MARK CONSISTS OF THE LITERAL ELEMENT 5° (FIVE DEGREES) IS SET IN A ROUNDED, WHITE FONT IN THE CENTER OF A RED CIRCLE, WHICH IS SUPERIMPOSED OVER A LARGER, CONCENTRIC WHITE CIRCLE, WHICH IS SUPERIMPOSED OVER A LARGER, CONCENTRIC GREEN CIRCLE. THE GREEN CIRCLE IS LARGELY OBSCURED BY THE WHITE CIRCLE SUCH THAT IT IS EFFECTIVELY A BORDER FOR THE INTERIOR WHITE CIRCLE; THE WHITE CIRCLE IS LARGELY OBSCURED BY THE RED CIRCLE SUCH THAT IT IS EFFECTIVELY A BORDER FOR THE INTERIOR RED CIRCLE, WHICH IS AMPLY LARGE ENOUGH TO ACCOMMODATE THE PROMINENT WHITE LITERAL ELEMENT. TOGETHER, THE LITERAL ELEMENT AND THREE CONCENTRIC CIRCLES COMPRISE A POINT OF FOCUS IN THE DESIGN. THE POINT OF FOCUS IS SET IN THE CENTER OF A SUN DESIGN. THE SUN DESIGN IS YELLOW WITH SIXTEEN (16) STYLIZED "FLARES", EACH "FLARE" CONSISTING OF ONE VERTEX PROTRUDING FROM TWO CURVED LINES OF SIMILAR CONCAVITY. THE "FLARES" ALTERNATE IN CONCAVITY AND IN SIZE; THERE ARE TWO DIFFERENT LENGTHS OF "FLARE", THE SMALLER LENGTH BEING APPROXIMATELY TWO THIRDS AS LONG AS THE LONGER LENGTH. THE STYLIZED SUN DESIGN IS OUTLINED IN THE SAME SHADE OF GREEN AS THE OUTERMOST CIRCLE IN THE CIRCULAR POINT OF FOCUS.

FOR RESTAURANT SERVICES (U.S. CLS. 100 AND 101).

THOMAS MANOR, EXAMINING ATTORNEY

SN 85-534,892. ARNULFO VAZQUEZ ALMANZA, LAREDO, TX. FILED 2-6-2012.

El Quinto Sol

THE MARK CONSISTS OF STANDARD CHARACTERS WITHOUT CLAIM TO ANY PARTICULAR FONT, STYLE, SIZE, OR COLOR.

THE ENGLISH TRANSLATION OF "EL QUINTO SOL" IN THE MARK IS "THE FIFTH SUN".

FOR RESTAURANT SERVICES (U.S. CLS. 100 AND 101).

THOMAS MANOR, EXAMINING ATTORNEY

CLASS 43—(Continued).

SN 85-534,984. BA2, LLC, FORMERLY THE BIGFOOT LODGE, LLC, LOS ANGELES, CA. FILED 2-6-2012.

IDLE HOUR

THE MARK CONSISTS OF STANDARD CHARACTERS WITHOUT CLAIM TO ANY PARTICULAR FONT, STYLE, SIZE, OR COLOR.

FOR BAR SERVICES; COCKTAIL LOUNGE SERVICES (U.S. CLS. 100 AND 101).

KAREN K. BUSH, EXAMINING ATTORNEY

SN 85-535,105. DOUBLE COMFORT, LLC, COLUMBUS, OH. FILED 2-6-2012.

BUY A MEAL, GIVE A MEAL

THE MARK CONSISTS OF STANDARD CHARACTERS WITHOUT CLAIM TO ANY PARTICULAR FONT, STYLE, SIZE, OR COLOR.

FOR RESTAURANT SERVICES FEATURING A CHARITABLE PROGRAM FOR CUSTOMERS WHERE SELLER MAKES A COMMITMENT TO A CHARITABLE CONTRIBUTION OF FOOD OR AN EQUIVALENT MONETARY VALUE CORRESPONDING TO THE CUSTOMER PURCHASE (U.S. CLS. 100 AND 101).

WILLIAM BRECKENFELD, EXAMINING ATTORNEY

SN 85-535,282. FLINN, DAVID VALENTINO, WRIGHTWOOD, CA. FILED 2-6-2012.

Simplicitea

THE MARK CONSISTS OF THE STYLIZED TEXT "SIMPLICITEA" WITH A VINE UNDERLINING THE WORD. EACH LETTER "I" IS DOTTED WITH A SMALL LEAF.

FOR TEA ROOMS (U.S. CLS. 100 AND 101).

FIRST USE 1-1-2012; IN COMMERCE 1-1-2012.

NAKIA HENRY, EXAMINING ATTORNEY

CLASS 43—(Continued).

SN 85-535,355. TROPICANA LAS VEGAS, INC., LAS VEGAS, NV. FILED 2-6-2012.

Swim. Play. Flirt.

THE MARK CONSISTS OF STANDARD CHARACTERS WITHOUT CLAIM TO ANY PARTICULAR FONT, STYLE, SIZE, OR COLOR.
FOR BAR SERVICES; RESTAURANT SERVICES; TAVERN SERVICES (U.S. CLS. 100 AND 101).
RENEE MCCRAY, EXAMINING ATTORNEY

SN 85-535,392. LE PETIT IP, LLC, WEST HOLLYWOOD, CA. FILED 2-6-2012.

IT'S A PLEASURE... DOING PLEASURE WITH YOU

THE MARK CONSISTS OF STANDARD CHARACTERS WITHOUT CLAIM TO ANY PARTICULAR FONT, STYLE, SIZE, OR COLOR.
FOR HOTEL SERVICES (U.S. CLS. 100 AND 101).
FIRST USE 10-0-2009; IN COMMERCE 10-0-2009.
BARBARA GAYNOR, EXAMINING ATTORNEY

SN 85-535,563. DOCTOR'S ASSOCIATES INC., MILFORD, CT. FILED 2-7-2012.



OWNER OF U.S. REG. NOS. 1,174,608, 3,869,196 AND OTHERS.

NO CLAIM IS MADE TO THE EXCLUSIVE RIGHT TO USE "FRESH" AND "FOR KIDS", APART FROM THE MARK AS SHOWN.

THE MARK CONSISTS OF THE WORD "SUBWAY" WITH ARROWS EMANATING OUTWARDLY FROM THE BOTTOM OF THE "S" AND THE TOP OF THE "Y". IN THE UPPER PORTION OF AN OVAL CONTAINING THE WORDING "FRESH FIT" IN THE CENTER AND "FOR KIDS" AT THE LOWER RIGHT OF THE OVAL.

FOR RESTAURANT SERVICES (U.S. CLS. 100 AND 101).

FIRST USE 11-28-2006; IN COMMERCE 11-28-2006.
TARAH HARDY, EXAMINING ATTORNEY

CLASS 43—(Continued).

SN 85-535,583. CURTIS NYSMITH, LOS ANGELES, CA. FILED 2-7-2012.

SmithHouse

THE MARK CONSISTS OF STANDARD CHARACTERS WITHOUT CLAIM TO ANY PARTICULAR FONT, STYLE, SIZE, OR COLOR.

FOR RESTAURANT SERVICES (U.S. CLS. 100 AND 101).

PATRICIA EVANKO, EXAMINING ATTORNEY

SN 85-535,711. FOX RESTAURANT CONCEPTS LLC, SCOTTSDALE, AZ. FILED 2-7-2012.

TUTTA LA CASA

THE MARK CONSISTS OF STANDARD CHARACTERS WITHOUT CLAIM TO ANY PARTICULAR FONT, STYLE, SIZE, OR COLOR.

THE ENGLISH TRANSLATION OF "TUTTA LA CASA" IN THE MARK IS "THE WHOLE HOUSE".

FOR RESTAURANT SERVICES; BAR SERVICES; CATERING SERVICES; RESTAURANT RESERVATION SERVICES; PREPARATION OF FOOD AND BEVERAGES FOR OTHERS; COCKTAIL LOUNGE SERVICES; RESTAURANT CARRY OUT SERVICES; CAFE SERVICES; TAKE-OUT RESTAURANT SERVICES; RESTAURANTS FEATURING PRIVATE DINING ROOMS; PROVIDING DINING FACILITIES FOR SPECIAL EVENTS AND PRIVATE PARTIES; DINING SERVICES, NAMELY, PROVIDING INDOOR/OUTDOOR AND PRIVATE RESTAURANT SERVICES FEATURING FOOD AND DRINK; LUNCH AND DINNER RESTAURANT SERVICES; PROVISION OF FOOD AND DRINK IN RESTAURANTS; SIT-DOWN SERVICE OF FOOD AND TAKE-OUT RESTAURANT SERVICES; PROVIDING OF FOOD AND BEVERAGES FOR CONSUMPTION ON AND OFF THE PREMISES (U.S. CLS. 100 AND 101).

GRETTA YAO, EXAMINING ATTORNEY

SN 85-535,905. PUNTO DE VISTA LUXURY SERVICES LTDA., MIAMI, FL. FILED 2-7-2012.

PUNTO DE VISTA

THE MARK CONSISTS OF STANDARD CHARACTERS WITHOUT CLAIM TO ANY PARTICULAR FONT, STYLE, SIZE, OR COLOR.

THE ENGLISH TRANSLATION OF "PUNTO DE VISTA" IN THE MARK IS "POINT OF VIEW".

FOR PROVIDING TEMPORARY ACCOMMODATIONS AND LODGING IN THE NATURE OF A PRIVATE LUXURY VILLA (U.S. CLS. 100 AND 101).

FIRST USE 1-0-2010; IN COMMERCE 1-0-2010.

LAURIE KAUFMAN, EXAMINING ATTORNEY

CLASS 43—(Continued).

SN 85-536,007. ROBERT WHOLEY & CO., INC., PITTSBURGH, PA. FILED 2-7-2012.

WHOLEY

THE MARK CONSISTS OF STANDARD CHARACTERS WITHOUT CLAIM TO ANY PARTICULAR FONT, STYLE, SIZE, OR COLOR.
OWNER OF U.S. REG. NOS. 2,479,494 AND 2,492,163. SEC. 2(F).
FOR RESTAURANT SERVICES (U.S. CLS. 100 AND 101).
FIRST USE 0-0-1960; IN COMMERCE 0-0-1960.
BRIDGETT SMITH, EXAMINING ATTORNEY

CLASS 43—(Continued).

SN 85-536,975. A & P EQUITY GROUP, LLC, MESA, AZ. FILED 2-8-2012.

CABALLERO

THE MARK CONSISTS OF STANDARD CHARACTERS WITHOUT CLAIM TO ANY PARTICULAR FONT, STYLE, SIZE, OR COLOR.
FOR RESTAURANT SERVICES; TAKE-OUT RESTAURANT SERVICES (U.S. CLS. 100 AND 101).
FIRST USE 8-12-2009; IN COMMERCE 8-12-2009.
VIVIAN MICZNIK FIRST, EXAMINING ATTORNEY

SN 85-536,984. A & P EQUITY GROUP, LLC, MESA, AZ. FILED 2-8-2012.

SN 85-536,937. 4 HANDS BREWING COMPANY, LLC, SAINT LOUIS, MO. FILED 2-8-2012.

ALES WITHOUT BORDERS

THE MARK CONSISTS OF STANDARD CHARACTERS WITHOUT CLAIM TO ANY PARTICULAR FONT, STYLE, SIZE, OR COLOR.
FOR BAR SERVICES (U.S. CLS. 100 AND 101).
FIRST USE 11-11-2011; IN COMMERCE 11-11-2011.
MICHAEL WEBSTER, EXAMINING ATTORNEY

Caballero Grill

THE MARK CONSISTS OF STANDARD CHARACTERS WITHOUT CLAIM TO ANY PARTICULAR FONT, STYLE, SIZE, OR COLOR.
NO CLAIM IS MADE TO THE EXCLUSIVE RIGHT TO USE "GRILL", APART FROM THE MARK AS SHOWN.
FOR RESTAURANT SERVICES; TAKE-OUT RESTAURANT SERVICES (U.S. CLS. 100 AND 101).
FIRST USE 8-12-2009; IN COMMERCE 8-12-2009.
VIVIAN MICZNIK FIRST, EXAMINING ATTORNEY

SN 85-536,971. CUNEO HOSPITALITY LLC, SANTA YNEZ, CA. FILED 2-8-2012.

RANCH & REATA ROADHOUSE

THE MARK CONSISTS OF STANDARD CHARACTERS WITHOUT CLAIM TO ANY PARTICULAR FONT, STYLE, SIZE, OR COLOR.
NO CLAIM IS MADE TO THE EXCLUSIVE RIGHT TO USE "ROADHOUSE", APART FROM THE MARK AS SHOWN.
FOR RESTAURANT SERVICES (U.S. CLS. 100 AND 101).
BERNICE MIDDLETON, EXAMINING ATTORNEY

SN 85-537,327. MOLLY MOON'S HOMEMADE ICE CREAM LLC, SEATTLE, WA. FILED 2-8-2012.

MOLLY MOON'S HOMEMADE ICE CREAM

THE MARK CONSISTS OF STANDARD CHARACTERS WITHOUT CLAIM TO ANY PARTICULAR FONT, STYLE, SIZE, OR COLOR.
NO CLAIM IS MADE TO THE EXCLUSIVE RIGHT TO USE "HOMEMADE ICE CREAM", APART FROM THE MARK AS SHOWN.
FOR ICE CREAM PARLORS; ICE CREAM SHOP SERVICES IN THE NATURE OF A RESTAURANT (U.S. CLS. 100 AND 101).
FIRST USE 1-19-2008; IN COMMERCE 1-19-2008.
GRETCHEN ULRICH, EXAMINING ATTORNEY

CLASS 43—(Continued).

SN 85-537,881. POGS, LLC, COATESVILLE, PA. FILED 2-9-2012.

POGS

THE MARK CONSISTS OF STANDARD CHARACTERS WITHOUT CLAIM TO ANY PARTICULAR FONT, STYLE, SIZE, OR COLOR.

FOR RESTAURANT AND CATERING SERVICES (U.S. CLS. 100 AND 101).

JEFF DEFORD, EXAMINING ATTORNEY

SN 85-537,931. TRINITY GROUP, LLC, ALBUQUERQUE, NM. FILED 2-9-2012.

Fastino's

THE MARK CONSISTS OF STANDARD CHARACTERS WITHOUT CLAIM TO ANY PARTICULAR FONT, STYLE, SIZE, OR COLOR.

FOR RESTAURANT SERVICES (U.S. CLS. 100 AND 101).

FIRST USE 12-7-2009; IN COMMERCE 12-7-2009.

KEVON CHISOLM, EXAMINING ATTORNEY

SN 85-537,937. BRYANT, RAYSHAWN A, MIAMI, FL. AND LANG, KATELYN M, SYDNEY, AUSTRALIA, FILED 2-9-2012.

Reggaeton

THE MARK CONSISTS OF STANDARD CHARACTERS WITHOUT CLAIM TO ANY PARTICULAR FONT, STYLE, SIZE, OR COLOR.

FOR RESTAURANT AND CAFE SERVICES; RESTAURANT AND CATERING SERVICES; RESTAURANT SERVICES, NAMELY, PROVIDING OF FOOD AND BEVERAGES FOR CONSUMPTION ON AND OFF THE PREMISES (U.S. CLS. 100 AND 101).

EMILY CARLSEN, EXAMINING ATTORNEY

CLASS 43—(Continued).

SN 85-537,959. BRYANT, RAYSHAWN A, MIAMI BEACH, FL. AND LANG, KATELYN M, SYDNEY, AUSTRALIA, FILED 2-9-2012.

R-Music

THE MARK CONSISTS OF STANDARD CHARACTERS WITHOUT CLAIM TO ANY PARTICULAR FONT, STYLE, SIZE, OR COLOR.

FOR FAST-FOOD RESTAURANT SERVICES; MAKING RESERVATIONS AND BOOKINGS FOR RESTAURANTS AND MEALS; MOBILE RESTAURANT SERVICES; RESTAURANT AND CAFE SERVICES; RESTAURANT AND CATERING SERVICES; RESTAURANT RESERVATION SERVICES; RESTAURANT SERVICES, INCLUDING SIT-DOWN SERVICE OF FOOD AND TAKE-OUT RESTAURANT SERVICES; RESTAURANT SERVICES, NAMELY, PROVIDING OF FOOD AND BEVERAGES FOR CONSUMPTION ON AND OFF THE PREMISES; RESTAURANTS FEATURING HOME DELIVERY; SELF-SERVICE RESTAURANTS; TAKE-OUT RESTAURANT SERVICES (U.S. CLS. 100 AND 101).

EMILY CARLSEN, EXAMINING ATTORNEY

SN 85-538,383. PANAMA JACK INTERNATIONAL, INC., ORLANDO, FL. FILED 2-9-2012.



OWNER OF U.S. REG. NOS. 1,325,936, 1,354,253 AND OTHERS.

THE NAME(S), PORTRAIT(S), AND/OR SIGNATURE(S) SHOWN IN THE MARK DOES NOT IDENTIFY A PARTICULAR LIVING INDIVIDUAL.

THE MARK CONSISTS OF A STYLIZED DESIGN OF A MAN WITH A MONOCLE WEARING A PITH HELMET WITHIN AN OVAL DESIGN.

FOR RESTAURANT AND BAR SERVICES (U.S. CLS. 100 AND 101).

SUSAN LESLIE DUBOIS, EXAMINING ATTORNEY

CLASS 43—(Continued).

SN 85-538,737. JOE HART, MILWAUKEE, WI. FILED 2-9-2012.

CLUTCH

THE MARK CONSISTS OF STANDARD CHARACTERS WITHOUT CLAIM TO ANY PARTICULAR FONT, STYLE, SIZE, OR COLOR.

FOR RESTAURANT SERVICES, NAMELY PROVIDED IN A DECOR FEATURING ORIGINAL THREE DIMENSIONAL ARTWORK OF METAL STONE, WOOD, GLASS AND MARBLE, NAMELY PROVIDING BREAKFAST, LUNCH AND DINNER ENTREES AND FOOD AND BEVERAGES FOR CONSUMPTION ON AND OFF THE PREMISES (U.S. CLS. 100 AND 101).

CAROLINE WOOD, EXAMINING ATTORNEY

CLASS 43—(Continued).

SN 85-539,221. GOURMET KINEYA CO., LTD., OSAKA-SHI, OSAKA, JAPAN, FILED 2-10-2012.

SOJIBO

THE MARK CONSISTS OF STANDARD CHARACTERS WITHOUT CLAIM TO ANY PARTICULAR FONT, STYLE, SIZE, OR COLOR.

FOR RESTAURANT AND BAR SERVICES; FOOD PREPARATION SERVICES (U.S. CLS. 100 AND 101).

FRANK LATTUCA, EXAMINING ATTORNEY

SN 85-538,962. RICKENBACKER'S BISTRO & RESTAURANT, LLC, OGDEN, UT. FILED 2-10-2012.

WHAT NATURE PERFECTED ... WE PREPARE

THE MARK CONSISTS OF STANDARD CHARACTERS WITHOUT CLAIM TO ANY PARTICULAR FONT, STYLE, SIZE, OR COLOR.

FOR RESTAURANT AND CATERING SERVICES; RESTAURANTS FEATURING HOME DELIVERY; TAKE-OUT RESTAURANT SERVICES (U.S. CLS. 100 AND 101).

SANJEEV VOHRA, EXAMINING ATTORNEY

SN 85-539,225. SACK, SCOTT, SAN FRANCISCO, CA. FILED 2-10-2012.

FATCO

THE MARK CONSISTS OF STANDARD CHARACTERS WITHOUT CLAIM TO ANY PARTICULAR FONT, STYLE, SIZE, OR COLOR.

FOR RESTAURANT SERVICES (U.S. CLS. 100 AND 101).

FRANK LATTUCA, EXAMINING ATTORNEY

SN 85-538,963. RICKENBACKER'S BISTRO & RESTAURANT, LLC, OGDEN, UT. FILED 2-10-2012.

PURE N SIMPLE

THE MARK CONSISTS OF STANDARD CHARACTERS WITHOUT CLAIM TO ANY PARTICULAR FONT, STYLE, SIZE, OR COLOR.

FOR RESTAURANT AND CATERING SERVICES; RESTAURANTS FEATURING HOME DELIVERY; TAKE-OUT RESTAURANT SERVICES (U.S. CLS. 100 AND 101).

SANJEEV VOHRA, EXAMINING ATTORNEY

SN 85-539,247. GOURMET KINEYA CO., LTD., OSAKA-SHI, OSAKA, JAPAN, FILED 2-10-2012.



THE MARK CONSISTS OF NON-LATIN CHARACTERS. THE NON-LATIN CHARACTERS IN THE MARK TRANSLITERATE TO SOJIBO AND THIS HAS NO MEANING IN A FOREIGN LANGUAGE.

FOR RESTAURANT AND BAR SERVICES; FOOD PREPARATION SERVICES (U.S. CLS. 100 AND 101).

FRANK LATTUCA, EXAMINING ATTORNEY

CLASS 43—(Continued).

SN 85-539,949. COCA HOLDING INTL. CO., LTD., SURIYA-WONGSE, BANGRAK, THAILAND, FILED 2-10-2012.

mango tree

THE MARK CONSISTS OF THE WORDS MANGO TREE, STYLIZED.
FOR RESTAURANT SERVICES (U.S. CLS. 100 AND 101).

MICHAEL SOUDERS, EXAMINING ATTORNEY

SN 85-542,665. MODERN MEXICAN RESTAURANTS, INC. DBA RICHARD SANDOVAL RESTAURANTS, DENVER, CO. FILED 2-14-2012.

RAYMI

THE MARK CONSISTS OF STANDARD CHARACTERS WITHOUT CLAIM TO ANY PARTICULAR FONT, STYLE, SIZE, OR COLOR.
FOR BAR SERVICES; RESTAURANT SERVICES (U.S. CLS. 100 AND 101).

LINDSEY RUBIN, EXAMINING ATTORNEY

SN 85-590,811. PARACE, LLC, YORKTOWN HEIGHTS, NY. FILED 4-6-2012.

iPork

THE MARK CONSISTS OF STANDARD CHARACTERS WITHOUT CLAIM TO ANY PARTICULAR FONT, STYLE, SIZE, OR COLOR.

FOR RESTAURANT SERVICES, NAMELY, PROVIDING OF FOOD AND BEVERAGES FOR CONSUMPTION ON AND OFF THE PREMISES (U.S. CLS. 100 AND 101).

KRISTINA MORRIS, EXAMINING ATTORNEY

CLASS 44—MEDICAL, BEAUTY AND AGRICULTURAL SERVICES

SN 77-955,909. FOX, DEBORAH, EL CAJON, CA. FILED 3-10-2010.

MONOTHEIST PSYCHOLOGY OF
TRANSCENDENCE: THE WARRIOR
HEALER

THE MARK CONSISTS OF STANDARD CHARACTERS WITHOUT CLAIM TO ANY PARTICULAR FONT, STYLE, SIZE, OR COLOR.

NO CLAIM IS MADE TO THE EXCLUSIVE RIGHT TO USE "MONOTHEIST PSYCHOLOGY OF TRANSCENDENCE", APART FROM THE MARK AS SHOWN.

FOR CLINICAL MENTAL HEALTH COUNSELING SERVICES AND DISTRIBUTION OF COUNSELING MATERIALS IN CONNECTION THEREWITH, PSYCHOLOGICAL COUNSELING AND DISTRIBUTION OF COUNSELING MATERIALS IN CONNECTION THEREWITH (U.S. CLS. 100 AND 101).

KIM SAITO, EXAMINING ATTORNEY

SN 85-167,092. U.S. MEDICAL MANAGEMENT, LLC, FARMINGTON HILLS, MI. FILED 11-2-2010.

GRACE HOSPICE

THE MARK CONSISTS OF STANDARD CHARACTERS WITHOUT CLAIM TO ANY PARTICULAR FONT, STYLE, SIZE, OR COLOR.

NO CLAIM IS MADE TO THE EXCLUSIVE RIGHT TO USE "HOSPICE", APART FROM THE MARK AS SHOWN.

FOR HOSPICES (U.S. CLS. 100 AND 101).
FIRST USE 5-9-2005; IN COMMERCE 5-9-2005.

CHARLOTTE CORWIN, EXAMINING ATTORNEY

SN 85-186,842. SOUTH DENVER OB/GYN, LITTLETON, CO. FILED 11-30-2010.

SAVING SECOND BASE . . .
ONE BREAST AT A TIME

THE MARK CONSISTS OF STANDARD CHARACTERS WITHOUT CLAIM TO ANY PARTICULAR FONT, STYLE, SIZE, OR COLOR.

FOR MEDICAL SERVICES, NAMELY, BREAST CANCER PREVENTION AND AWARENESS, NAMELY, BREAST EXAMS (U.S. CLS. 100 AND 101).

FIRST USE 7-1-2010; IN COMMERCE 9-1-2010.

MATTHEW EINSTEIN, EXAMINING ATTORNEY

CLASS 44—(Continued).

SN 85-199,057. WHISTLING DUCK VINEYARDS, ROUND ROCK, TX. FILED S.R. 12-15-2010; AM. P.R. 4-2-2012.

Whistling Duck Vineyards

THE MARK CONSISTS OF STANDARD CHARACTERS WITHOUT CLAIM TO ANY PARTICULAR FONT, STYLE, SIZE, OR COLOR.

NO CLAIM IS MADE TO THE EXCLUSIVE RIGHT TO USE "VINEYARDS", APART FROM THE MARK AS SHOWN.

FOR VINEYARD AND WINERY SERVICES, NAMELY, THE CULTIVATION OF GRAPES FOR OTHERS. PROVIDE INFORMATION IN THE FIELD OF VINEYARD HORTICULTURE (U.S. CLS. 100 AND 101).

FIRST USE 3-1-2010; IN COMMERCE 3-1-2010.

ANN E. SAPPENFIELD, EXAMINING ATTORNEY

SN 85-212,903. HOSPITAL HOUSEKEEPING SYSTEMS, LLC, AUSTIN, TX. FILED 1-7-2011.

BEDWATCH

THE MARK CONSISTS OF STANDARD CHARACTERS WITHOUT CLAIM TO ANY PARTICULAR FONT, STYLE, SIZE, OR COLOR.

FOR HOSPITAL INFORMATION SERVICES, NAMELY, PROVIDING MEDICAL INFORMATION CONCERNING TREATMENT OF PATIENTS, AND HOSPITAL PATIENT CAPABILITIES; HOSPITAL INFORMATION SERVICES, NAMELY, PROVIDING MEDICAL INFORMATION CONCERNING TREATMENT OF PATIENTS; HOSPITAL INFORMATION SERVICES, NAMELY, PROVIDING MEDICAL INFORMATION CONCERNING HOSPITAL PATIENT CAPABILITIES; HOSPITAL INFORMATION SERVICES, NAMELY, HOSPITAL PATIENT OCCUPANCY INFORMATION, HOSPITAL PATIENT OCCUPANCY TRACKING, AND HOSPITAL PATIENT LOCATION INFORMATION; HOSPITAL INFORMATION SERVICES, NAMELY, HOSPITAL PATIENT OCCUPANCY INFORMATION; HOSPITAL INFORMATION SERVICES, NAMELY, HOSPITAL PATIENT OCCUPANCY TRACKING; HOSPITAL INFORMATION SERVICES, NAMELY, HOSPITAL PATIENT LOCATION INFORMATION (U.S. CLS. 100 AND 101).

CURTIS FRENCH, EXAMINING ATTORNEY

CLASS 44—(Continued).

SN 85-247,850. POSITIVE MARKETING CONCEPTS, LLC, VANCOUVER, WA. FILED 2-22-2011.



NO CLAIM IS MADE TO THE EXCLUSIVE RIGHT TO USE "HEALTH", APART FROM THE MARK AS SHOWN.

THE COLOR(S) BLUE, GREEN AND WHITE IS/ARE CLAIMED AS A FEATURE OF THE MARK.

THE MARK CONSISTS OF A BOX IN GREEN COLOR AND INSIDE THE BOX THERE IS AN IMAGE DEPICTING LETTER "V" AND BELOW WHICH THERE IS LETTER "H" BOTH CURVED IN WHITE COLOR. AT THE BOTTOM OF THE IMAGE THERE ARE WORDS "VITELA" WRITTEN IN BLUE COLOR AND THE WORD "HEALTH" IN GREEN COLOR AS SHOWN IN THE MARK.

THE ENGLISH TRANSLATION OF "VITELA" IN THE MARK IS "CALF".

FOR HEALTH ASSESSMENT SERVICES, NAMELY, PROVIDING METABOLIC ASSESSMENT PROFILES (MAP) TO CLIENTS OBTAINED BY USING A PORTABLE METABOLIC MEASUREMENT SYSTEM IN THE NATURE OF A UNIQUE, HEART -RATE BASED OVERVIEW OF THEIR OWN METABOLISM IN ORDER TO ASSIST IN REACHING WEIGHT LOSS, SPORTS PERFORMANCE, HEALTH, FITNESS, AND WELLNESS-RELATED GOALS; CONDUCTING MEDICAL PHYSICAL EVALUATIONS (U.S. CLS. 100 AND 101).

FIRST USE 1-15-2010; IN COMMERCE 4-1-2010.

MICHELE SWAIN, EXAMINING ATTORNEY

SN 85-281,505. PINCKNEY II M.D., JAMES S., DALLAS, TX. FILED 3-30-2011.



NO CLAIM IS MADE TO THE EXCLUSIVE RIGHT TO USE "PHYSICIAN SENIOR SERVICES" AND THE CADUCEUS SYMBOL, APART FROM THE MARK AS SHOWN.

THE MARK CONSISTS OF THE TERM "PHYSICIAN" IN STYLIZED LETTERING HAVING AN "I" THAT IS FORMED USING A DRAWING OF A CADUCEUS STAFF. DIRECTLY BENEATH THE TERM "PHYSICIAN" IS THE PHRASE "SENIOR SERVICES" IN SMALLER, STYLIZED LETTERING ALL CONTAINED WITHIN A RECTANGLE RUNNING HORIZONTAL AT THE BOTTOM OF THE MARK. THE TOP PORTION OF THE MARK CONSISTS OF A DRAWING OF A HOUSE'S ROOFTOP WITH A CHIMNEY PROTRUDING UP FROM THE RIGHT SLOPE OF THE ROOFTOP.

FOR MEDICAL SERVICES (U.S. CLS. 100 AND 101).

FIRST USE 6-0-2010; IN COMMERCE 6-0-2010.

CHRISTINE COOPER, EXAMINING ATTORNEY

CLASS 44—(Continued).

SN 85-348,221. STEVEN K. GREKIN, BLOOMFIELD HILLS, MI. FILED 6-16-2011.



NO CLAIM IS MADE TO THE EXCLUSIVE RIGHT TO USE "DERMATOLOGY CO.", APART FROM THE MARK AS SHOWN.

THE MARK CONSISTS OF THE WORDS "BEDSIDE DERMATOLOGY CO". WITH A SWOOSH UNDER THE WORDING, AND IN THE BACKGROUND IS A DROPLET WITH A REFLECTION ON IT AND BELOW THE DROPLET IS THE SHADOW OF THE DROPLET WHICH IS A CIRCLE WITH A CIRCLE IN THE MIDDLE.

FOR DERMATOLOGY SERVICES (U.S. CLS. 100 AND 101).

MARC LEIPZIG, EXAMINING ATTORNEY

CLASS 44—(Continued).

SN 85-361,056. FOXEN VINEYARD, INC., SANTA BARBARA, CA. FILED 6-30-2011.

FOXEN FARMING

THE MARK CONSISTS OF STANDARD CHARACTERS WITHOUT CLAIM TO ANY PARTICULAR FONT, STYLE, SIZE, OR COLOR.

OWNER OF U.S. REG. NO. 2,076,681.

NO CLAIM IS MADE TO THE EXCLUSIVE RIGHT TO USE "FARMING", APART FROM THE MARK AS SHOWN.

FOR CONTRACT FARMING FOR OTHERS; VINEYARD AND WINERY SERVICES, NAMELY, THE CULTIVATION OF GRAPES FOR OTHERS; VITICULTURE SERVICES, NAMELY, GRAPE GROWING AND CULTIVATION OF GRAPES FOR OTHERS; VITICULTURE SERVICES, NAMELY GRAPE GROWING AND CULTIVATION OF GRAPES TO THE SPECIFICATIONS OF OTHERS (U.S. CLS. 100 AND 101).

HANNO RITTNER, EXAMINING ATTORNEY

SN 85-356,535. TRANQUILITY SPA, SCARSDALE, NY. FILED 6-27-2011.

TRANQUILITY SPA

THE MARK CONSISTS OF STANDARD CHARACTERS WITHOUT CLAIM TO ANY PARTICULAR FONT, STYLE, SIZE, OR COLOR.

NO CLAIM IS MADE TO THE EXCLUSIVE RIGHT TO USE "SPA", APART FROM THE MARK AS SHOWN.

FOR HEALTH SPA SERVICES FOR HEALTH AND WELLNESS OF THE BODY AND SPIRIT, NAMELY, PROVIDING MASSAGE, FACIAL AND BODY TREATMENT SERVICES, COSMETIC BODY CARE SERVICES; HEALTH SPA SERVICES FOR HEALTH AND WELLNESS OF THE MIND, BODY AND SPIRIT OFFERED IN OR FROM A REMOTE, MOBILE OR TEMPORARY ON-SITE LOCATION; HEALTH SPA SERVICES, NAMELY, BODY WRAPS, MUD TREATMENTS, SEAWEED TREATMENTS, HYDROTHERAPY BATHS, AND BODY SCRUBS; HEALTH SPA SERVICES, NAMELY, COSMETIC BODY CARE SERVICES (U.S. CLS. 100 AND 101).

FIRST USE 7-28-2010; IN COMMERCE 7-28-2010.

JOHN E. MICHOS, EXAMINING ATTORNEY

SN 85-383,949. GENEROSA DINGAL, POMPANO BEACH, FL. FILED 7-28-2011.

GEN SPA

THE MARK CONSISTS OF STANDARD CHARACTERS WITHOUT CLAIM TO ANY PARTICULAR FONT, STYLE, SIZE, OR COLOR.

NO CLAIM IS MADE TO THE EXCLUSIVE RIGHT TO USE "SPA", APART FROM THE MARK AS SHOWN.

FOR EQUINE MASSAGE AND KINESTHESIOLOGY SERVICES; HEALTH SPA SERVICES FOR HEALTH AND WELLNESS OF THE BODY AND SPIRIT, NAMELY, PROVIDING MASSAGE, FACIAL AND BODY TREATMENT SERVICES, COSMETIC BODY CARE SERVICES; HEALTH SPA SERVICES, NAMELY, LASER TREATMENTS FOR ACNE, REJUVENATION, SCARS, TATTOO REMOVAL AND FOR FACIALS AND MASSAGE; INFORMATION RELATING TO MASSAGE; MASSAGE; MASSAGE AND THERAPEUTIC SHIATSU MASSAGE; MASSAGE THERAPY SERVICES; MASSAGES; SALON SERVICES, NAMELY, FACIALS, MANICURES AND MASSAGES THAT ARE PROVIDED IN A TRAILER OUTFITTED WITH CHAIR, TABLE AND SINK ACCESSORIES (U.S. CLS. 100 AND 101).

FIRST USE 5-25-2011; IN COMMERCE 5-26-2011.

STEVEN R. FINE, EXAMINING ATTORNEY

CLASS 44—(Continued).

SN 85-390,911. HOWELL, MARIO, CHANDLER, AZ. FILED 8-5-2011.



NO CLAIM IS MADE TO THE EXCLUSIVE RIGHT TO USE "AQUA", APART FROM THE MARK AS SHOWN. THE STIPPLING IS FOR SHADING PURPOSES ONLY. THE COLOR(S) AQUA BLUE, TEAL, AND WHITE IS/ARE CLAIMED AS A FEATURE OF THE MARK. THE MARK CONSISTS OF THE TEXT "AQUA" IN AQUA BLUE AND "BALL 'CISES" IN WHITE. THE WORDING APPEARS INSIDE A ROUND DESIGN MADE UP OF AQUA BLUE AND TEAL, THE TERM "AQUA" APPEARS AT THE TOP PORTION OF THE IMAGE, ABOVE A 'BELT', WHICH GOES AROUND THE IMAGE AND INCLUDES THE WORDING "BALL 'CISES". FOR PHYSICAL REHABILITATION (U.S. CLS. 100 AND 101). C. DIONNE CLYBURN, EXAMINING ATTORNEY

SN 85-400,164. SPECTRUM LABS, INC., TEMPE, AZ. FILED 8-17-2011.



NO CLAIM IS MADE TO THE EXCLUSIVE RIGHT TO USE "TECHNOLOGY", APART FROM THE MARK AS SHOWN. THE MARK CONSISTS OF THE STYLIZED LETTERS "BECSCREEN" WITH CIRCLES TO THE LEFT AND AN OVAL UNDERNEATH THE LETTERS "BECSCREEN" CONTAINING THE WORDS "UTILIZING INNOVOSCEPT TECHNOLOGY". FOR MEDICAL TESTING FOR DIAGNOSTIC OR TREATMENT PURPOSES FEATURING A DIAGNOSTIC ASSAY THAT IDENTIFIES NON PLANKTONIC STRAINS OF BACTERIA AND DETERMINES THE REGIMEN OF ANTIBIOTIC TO ELIMINATE THE BACTERIA (U.S. CLS. 100 AND 101). FIRST USE 5-19-2011; IN COMMERCE 5-19-2011. ANN E. SAPPENFIELD, EXAMINING ATTORNEY

CLASS 44—(Continued).

SN 85-407,971. UHS OF DELAWARE, INC., KING OF PRUSSIA, PA. FILED 8-26-2011.



OWNER OF U.S. REG. NOS. 3,504,010 AND 3,926,510. NO CLAIM IS MADE TO THE EXCLUSIVE RIGHT TO USE "MEDICAL CENTER REHAB SERVICES", APART FROM THE MARK AS SHOWN. THE MARK CONSISTS OF A HUMAN FIGURE IN A RUNNING POSITION SURROUNDED BY AN ARC ELEMENT THAT TAPERS AT EACH END. TO THE RIGHT OF THE DESIGN ARE THE WORDS "TEXOMA MEDICAL CENTER REHAB SERVICES". SEC. 2(F) AS TO "TEXOMA MEDICAL CENTER". FOR HEALTHCARE; MEDICAL SERVICES (U.S. CLS. 100 AND 101). MATTHEW KLINE, EXAMINING ATTORNEY

SN 85-407,976. UHS OF DELAWARE, INC., KING OF PRUSSIA, PA. FILED 8-26-2011.

THE VALVE INSTITUTE AT MANATEE MEMORIAL HOSPITAL

THE MARK CONSISTS OF STANDARD CHARACTERS WITHOUT CLAIM TO ANY PARTICULAR FONT, STYLE, SIZE, OR COLOR. OWNER OF U.S. REG. NOS. 3,802,075, 3,904,494 AND 3,998,725. NO CLAIM IS MADE TO THE EXCLUSIVE RIGHT TO USE "THE VALVE INSTITUTE AT" AND "HOSPITAL", APART FROM THE MARK AS SHOWN. SEC. 2(F) AS TO "MANATEE MEMORIAL HOSPITAL". FOR HEALTHCARE; MEDICAL SERVICES (U.S. CLS. 100 AND 101). MATTHEW KLINE, EXAMINING ATTORNEY

SN 85-419,227. SHREINER TREE CARE SPECIALISTS, INC., KING OF PRUSSIA, PA. FILED 9-9-2011.



NO CLAIM IS MADE TO THE EXCLUSIVE RIGHT TO USE "TREE CARE", APART FROM THE MARK AS SHOWN. THE COLOR(S) GREEN AND YELLOW IS/ARE CLAIMED AS A FEATURE OF THE MARK. THE MARK CONSISTS OF AN IMAGE OF A TREE

CLASS 44—(Continued).

WITHIN A SQUARE HAVING SEPARATE HALVES IN ALTERNATE COLORS. THE BACKGROUND OF THE LEFT SIDE OF THE SQUARE IS GREEN AND HALF OF THE TREE IS YELLOW. THE RIGHT SIDE OF THE SQUARE IS YELLOW AND BORDERED IN GREEN AND SHOWS THE RIGHT HALF OF THE TREE IN GREEN. NEXT TO THIS IMAGE ARE THE WORDS "SHREINER TREE CARE" IN GREEN. IN BETWEEN THE WORDS "SHREINER" AND "TREE CARE" ARE TWO HORIZONTAL LINES IN YELLOW AND GREEN.

FOR TREE CARE SERVICES, NAMELY, TREE SURGERY, ORNAMENTAL AND SAFETY PRUNING AND TRIMMING OF TREES AND SHRUBS, TREE FERTILIZATION AND TREE CARE MAINTENANCE FOR TREE PRESERVATION, DISEASE PREVENTION, DIAGNOSIS AND PROTECTIVE TREATMENT OF TREES AND SHRUBS, HAZARDOUS TREE EVALUATIONS TO DETERMINE WHETHER PRUNING IS REQUIRED, TREE REMOVALS AND STUMP GRINDING; LANDSCAPE PLANTINGS; PLANT HEALTH CARE SERVICES, NAMELY, INSPECTIONS AND MONITORING, TREE AND SHRUB FERTILIZATION, AND PEST CONTROL SERVICES FOR AGRICULTURAL PURPOSES, NAMELY, APPLYING INSECT AND DEER REPELLENT TREATMENTS, DISEASE MANAGEMENT AND INSECT AND DEER BROWSING CONTROL SERVICES; LANDSCAPE CARE OF GOLF FACILITIES, COMMERCIAL AND INSTITUTIONAL PROPERTIES (U.S. CLS. 100 AND 101).

FIRST USE 8-1-2011; IN COMMERCE 8-1-2011.
MICHELLE DUBOIS, EXAMINING ATTORNEY



SN 85-424,044. ST. DOMINIC JACKSON MEMORIAL HOSPITAL, JACKSON, MS. FILED 9-15-2011.

**Sanctuary Body Spa of St.
Dominic's**

THE MARK CONSISTS OF STANDARD CHARACTERS WITHOUT CLAIM TO ANY PARTICULAR FONT, STYLE, SIZE, OR COLOR.

NO CLAIM IS MADE TO THE EXCLUSIVE RIGHT TO USE "BODY SPA", APART FROM THE MARK AS SHOWN.

FOR HEALTH SPA SERVICES FOR HEALTH AND WELLNESS OF THE BODY AND SPIRIT (U.S. CLS. 100 AND 101).

FIRST USE 7-25-2011; IN COMMERCE 9-14-2011.
FRED CARL, EXAMINING ATTORNEY

CLASS 44—(Continued).

SN 85-427,512. SUNOVION PHARMACEUTICALS INC., MARLBOROUGH, MA. FILED 9-20-2011.

FOLLOW THE WINGS

THE MARK CONSISTS OF STANDARD CHARACTERS WITHOUT CLAIM TO ANY PARTICULAR FONT, STYLE, SIZE, OR COLOR.

FOR PROVIDING INFORMATION FOR CONSUMERS IN THE AREAS OF PHARMACEUTICAL SAFETY BY A WEBSITE; MEDICAL INFORMATION SERVICES, NAMELY, PROVIDING INFORMATION TO PATIENTS RELATING TO TREATMENT OF SLEEP DISORDERS; PHARMACEUTICAL ADVICE; ON-LINE INFORMATION SERVICES, NAMELY, A WEBSITE PROVIDING INFORMATION TO PATIENTS RELATING TO THE PREVENTION, DIAGNOSIS, AND TREATMENT OF SLEEP DISORDERS; PROVIDING MEDICAL INFORMATION RELATING TO ONGOING RESEARCH PROGRAMS AND STUDIES IN THE FIELD OF SLEEP DISORDERS; PROVIDING INFORMATION IN THE FIELD OF SLEEP DISORDERS VIA THE INTERNET (U.S. CLS. 100 AND 101).

FIRST USE 10-17-2011; IN COMMERCE 10-17-2011.
MICHAEL LITZAU, EXAMINING ATTORNEY



SN 85-428,818. HOURGLASS PERFORMANCE INSTITUTE, LLC, EASTPOINT, FL. FILED 9-21-2011.

**HOURGLASS PERFORMANCE
INSTITUTE**

THE MARK CONSISTS OF STANDARD CHARACTERS WITHOUT CLAIM TO ANY PARTICULAR FONT, STYLE, SIZE, OR COLOR.

NO CLAIM IS MADE TO THE EXCLUSIVE RIGHT TO USE "PERFORMANCE INSTITUTE", APART FROM THE MARK AS SHOWN.

FOR PSYCHOLOGICAL ASSESSMENT SERVICES IN THE FIELD OF PERFORMANCE WITH SPECIALIZATION IN SPORTS (U.S. CLS. 100 AND 101).

ALLISON SCHRODY, EXAMINING ATTORNEY

CLASS 44—(Continued).

SN 85-432,564. UHS OF DELAWARE, INC., KING OF PRUSSIA, PA. FILED 9-27-2011.



OWNER OF U.S. REG. NOS. 2,649,125, 3,059,851 AND OTHERS.

NO CLAIM IS MADE TO THE EXCLUSIVE RIGHT TO USE "BREAST CARE CENTER AT" AND "HOSPITAL", APART FROM THE MARK AS SHOWN.

THE MARK CONSISTS OF THE WORDS "BREAST CARE CENTER AT SUMMERLIN HOSPITAL", WITH A FLOWER DESIGN ABOVE THE WORD "BREAST".

SEC. 2(F) AS TO "SUMMERLIN HOSPITAL".
FOR HEALTHCARE; MEDICAL SERVICES (U.S. CLS. 100 AND 101).

FIRST USE 9-22-2011; IN COMMERCE 9-22-2011.
MATTHEW KLINE, EXAMINING ATTORNEY

CLASS 44—(Continued).

SN 85-450,900. AMERICAN ANIMAL HOSPITAL ASSOCIATION, LAKEWOOD, CO. FILED 10-19-2011.

TRENDS TODAY

THE MARK CONSISTS OF STANDARD CHARACTERS WITHOUT CLAIM TO ANY PARTICULAR FONT, STYLE, SIZE, OR COLOR.

OWNER OF U.S. REG. NO. 1,375,821.

NO CLAIM IS MADE TO THE EXCLUSIVE RIGHT TO USE "TRENDS", APART FROM THE MARK AS SHOWN.

FOR PROVIDING ON-LINE INFORMATION, NEWS AND COMMENTARY FEATURING INFORMATION OF INTEREST TO COMPANION ANIMAL VETERINARY PRACTICES; PROVIDING ON-LINE INFORMATION, NEWS AND COMMENTARY IN THE FIELD OF VETERINARY MEDICINE AND PRACTICE (U.S. CLS. 100 AND 101).

FIRST USE 2-27-2009; IN COMMERCE 2-27-2009.
JEFF DEFORD, EXAMINING ATTORNEY

SN 85-442,948. PROMEDICA HEALTH SYSTEM, INC., TOLEDO, OH. FILED 10-9-2011.

**PROMEDICA DEFIANCE
REGIONAL HOSPITAL**

THE MARK CONSISTS OF STANDARD CHARACTERS WITHOUT CLAIM TO ANY PARTICULAR FONT, STYLE, SIZE, OR COLOR.

OWNER OF U.S. REG. NOS. 3,150,664, 3,966,382 AND OTHERS.

NO CLAIM IS MADE TO THE EXCLUSIVE RIGHT TO USE "DEFIANCE REGIONAL HOSPITAL", APART FROM THE MARK AS SHOWN.

FOR HEALTH CARE SERVICES (U.S. CLS. 100 AND 101).
FIRST USE 6-24-2011; IN COMMERCE 6-24-2011.
MARILYN IZZI, EXAMINING ATTORNEY

SN 85-451,961. DR. O'SHEA, MD, MARLTON, NJ. FILED 10-20-2011.

**THE SPINE INSTITUTE OF
SOUTHERN NEW JERSEY**

THE MARK CONSISTS OF STANDARD CHARACTERS WITHOUT CLAIM TO ANY PARTICULAR FONT, STYLE, SIZE, OR COLOR.

NO CLAIM IS MADE TO THE EXCLUSIVE RIGHT TO USE "SPINE INSTITUTE", APART FROM THE MARK AS SHOWN.

SEC. 2(F).

FOR SPECIALIZED MEDICAL SERVICES, NAMELY, OPERATIVE AND NON-OPERATIVE ORTHOPEDIC AND NEUROSURGICAL SPINE CARE (U.S. CLS. 100 AND 101).

FIRST USE 1-1-2000; IN COMMERCE 1-1-2000.
DEZMONA MIZELLE, EXAMINING ATTORNEY

CLASS 44—(Continued).

SN 85-458,453. CAROLINA CANINES FOR SERVICE INC., AKA CAROLINA CANINES, WILMINGTON, NC. FILED 10-27-2011.

Carolina Canines

THE MARK CONSISTS OF STANDARD CHARACTERS WITHOUT CLAIM TO ANY PARTICULAR FONT, STYLE, SIZE, OR COLOR.

NO CLAIM IS MADE TO THE EXCLUSIVE RIGHT TO USE "CANINES", APART FROM THE MARK AS SHOWN. SEC. 2(F).

FOR CHARITABLE SERVICES, NAMELY, PROVIDING TRAINED SERVICE DOGS FOR DISABLED INDIVIDUALS (U.S. CLS. 100 AND 101).

FIRST USE 12-1-1996; IN COMMERCE 12-1-1996.
DEIRDRE ROBERTSON, EXAMINING ATTORNEY

CLASS 44—(Continued).

SN 85-483,175. NEURO PAIN CONSULTANTS, P.C., BLOOMFIELD HILLS, MI. FILED 11-29-2011.



NO CLAIM IS MADE TO THE EXCLUSIVE RIGHT TO USE "NEURO PAIN CONSULTANTS", APART FROM THE MARK AS SHOWN.

THE MARK CONSISTS OF THE SILHOUETTE OF MAN HOLDING A BANNER WITH BOTH HANDS AND THE WORDS "NEURO PAIN CONSULTANTS".

FOR HEALTH CARE, CONSISTING OF MULTI-DISCIPLINARY APPROACH IN THE DIAGNOSIS AND TREATMENT OF ACUTE AND CHRONIC PAIN AND SURGERY OF THE BRAIN, SPINE AND PERIPHERAL NERVES (U.S. CLS. 100 AND 101).

FIRST USE 2-28-2006; IN COMMERCE 2-28-2006.
GINA HAYES, EXAMINING ATTORNEY

SN 85-474,675. PHARMACY FRIEND, NEWPORT, RI. FILED 11-16-2011.

Pharmacy Friend

THE MARK CONSISTS OF STANDARD CHARACTERS WITHOUT CLAIM TO ANY PARTICULAR FONT, STYLE, SIZE, OR COLOR.

NO CLAIM IS MADE TO THE EXCLUSIVE RIGHT TO USE "PHARMACY", APART FROM THE MARK AS SHOWN.

FOR MEDICAL AND PHARMACEUTICAL CONSULTATION (U.S. CLS. 100 AND 101).

FIRST USE 10-25-2011; IN COMMERCE 11-1-2011.
SUZANNE BLANE, EXAMINING ATTORNEY

SN 85-483,179. NEURO PAIN CONSULTANTS, P.C., DBA CENTER FOR INTEGRATED THERAPY, BLOOMFIELD HILLS, MI. FILED 11-29-2011.

SN 85-483,163. NEURO PAIN CONSULTANTS, P.C., DBA PAIN CARE ASSOCIATES, BLOOMFIELD HILLS, MI. FILED 11-29-2011.



Pain Care Associates



Center for Integrated Therapy

NO CLAIM IS MADE TO THE EXCLUSIVE RIGHT TO USE "PAIN CARE ASSOCIATES", APART FROM THE MARK AS SHOWN.

THE MARK CONSISTS OF THE SILHOUETTE OF MAN HOLDING A BANNER WITH BOTH HANDS AND THE WORDS "PAIN CARE ASSOCIATES".

FOR HEALTH CARE, CONSISTING OF MULTI-DISCIPLINARY TEAM APPROACH TO ACUTE AND CHRONIC PAIN MANAGEMENT (U.S. CLS. 100 AND 101).

FIRST USE 2-28-2006; IN COMMERCE 2-28-2006.
GINA HAYES, EXAMINING ATTORNEY

NO CLAIM IS MADE TO THE EXCLUSIVE RIGHT TO USE "CENTER FOR INTEGRATED THERAPY", APART FROM THE MARK AS SHOWN.

THE MARK CONSISTS OF THE SILHOUETTE OF MAN HOLDING A BANNER WITH BOTH HANDS AND THE WORDS CENTER FOR INTEGRATED THERAPY.

FOR HEALTH CARE, CONSISTING OF BOTH TRADITIONAL AND NON-TRADITIONAL PHYSICAL AND OTHER THERAPY SERVICES (U.S. CLS. 100 AND 101).

FIRST USE 2-28-2006; IN COMMERCE 2-28-2006.
GINA HAYES, EXAMINING ATTORNEY

CLASS 44—(Continued).

SN 85-483,186. NEURO PAIN CONSULTANTS, P.C., DBA NEUROSURGICAL CONSULTANTS, BLOOMFIELD HILLS, MI. FILED 11-29-2011.



Neurosurgical Consultants

NO CLAIM IS MADE TO THE EXCLUSIVE RIGHT TO USE "NEUROSURGICAL CONSULTANTS", APART FROM THE MARK AS SHOWN.

THE MARK CONSISTS OF THE SILHOUETTE OF MAN HOLDING A BANNER WITH BOTH HANDS AND THE WORDS "NEUROSURGICAL CONSULTANTS".

FOR HEALTH CARE, CONSISTING OF SPECIALIZED SERVICES IN PAIN MANAGEMENT, NEUROSURGICAL AND PHYSICAL THERAPY (U.S. CLS. 100 AND 101).

FIRST USE 2-28-2006; IN COMMERCE 2-28-2006.
GINA HAYES, EXAMINING ATTORNEY

SN 85-484,374. BSK DEL PARTNERS, LLC, NEW YORK, NY. FILED 11-30-2011.

SALON AT THE DEL

THE MARK CONSISTS OF STANDARD CHARACTERS WITHOUT CLAIM TO ANY PARTICULAR FONT, STYLE, SIZE, OR COLOR.

OWNER OF U.S. REG. NOS. 3,316,529, 3,499,002 AND OTHERS.

FOR BEAUTY SALON SERVICES; DAY SPA SERVICES, NAMELY, NAIL CARE, MANICURES, PEDICURES AND NAIL ENHANCEMENTS; HAIR SALON SERVICES (U.S. CLS. 100 AND 101).

FIRST USE 12-21-2011; IN COMMERCE 12-21-2011.
SHAVELL MCPHERSON, EXAMINING ATTORNEY

CLASS 44—(Continued).

SN 85-492,379. EMPATHY THERAPY, INC., SACRAMENTO, CA. FILED 12-11-2011.



NO CLAIM IS MADE TO THE EXCLUSIVE RIGHT TO USE "THERAPY", APART FROM THE MARK AS SHOWN. THE MARK CONSISTS OF THE STYLIZED TEXT "EMPATHY THERAPY" NEXT TO AN ABSTRACT DESIGN OF TWO PEOPLE FACING EACH OTHER AND INTERCONNECTING WITH EACH OTHER.

FOR PSYCHIATRIC CONSULTATION; PSYCHIATRIC SERVICES (U.S. CLS. 100 AND 101).

FIRST USE 10-1-2011; IN COMMERCE 10-15-2011.
RENEE MCCRAY, EXAMINING ATTORNEY

SN 85-494,282. WILBUR-ELLIS COMPANY, SAN FRANCISCO, CA. FILED 12-13-2011.



OWNER OF U.S. REG. NO. 3,935,143. THE COLOR(S) BLACK AND GOLD IS/ARE CLAIMED AS A FEATURE OF THE MARK.

THE MARK CONSISTS OF THE STYLIZED WORDING "AGVERDICT KNOWLEDGE ACQUIRED, INTELLIGENCE APPLIED" AND DESIGN. THE WORDING "AGVERDICT" APPEARS ABOVE A BLACK HORIZONTAL LINE, WITH THE LETTERS "AG" IN GOLD AND THE LETTERS "VERDICT" IN BLACK WITH A BLACK LINE EXTENDING TO THE RIGHT FROM THE TOP OF THE "V". ABOVE THE WORD "AGVERDICT" APPEARS A DESIGN CONSISTING OF GOLD SQUARES ARRANGED IN A BINARY COMPUTER-LANGUAGE TYPE DISPLAY, IN AN AREA TWO SQUARES HIGH AND 27 SQUARES LONG, WITH THIRTEEN GOLD SQUARES IN THE UPPER LINE AND EIGHTEEN GOLD SQUARES IN THE LOWER LINE. UNDERNEATH THE WORD "AGVERDICT" AND THE HORIZONTAL LINE APPEARS THE WORDING "KNOWLEDGE ACQUIRED, INTELLIGENCE APPLIED" IN BLACK.

FOR ADVISORY AND CONSULTATION SERVICES IN THE FIELDS OF AGRONOMY, AGRICULTURE, AND HORTICULTURE; PROVIDING AN ON-LINE COMPUTER DATABASE FOR MANAGING INFORMATION IN THE FIELD OF AGRONOMIC SERVICES (U.S. CLS. 100 AND 101).

FIRST USE 12-13-2010; IN COMMERCE 12-13-2010.
JERI J. FICKES, EXAMINING ATTORNEY

CLASS 44—(Continued).

SN 85-496,527. THE GREEN AIR PROJECT, INC., WINTER PARK, FL. FILED 12-15-2011.

Green Air Project

THE MARK CONSISTS OF STANDARD CHARACTERS WITHOUT CLAIM TO ANY PARTICULAR FONT, STYLE, SIZE, OR COLOR.

NO CLAIM IS MADE TO THE EXCLUSIVE RIGHT TO USE "PROJECT", APART FROM THE MARK AS SHOWN.

FOR TREE PLANTING FOR CARBON OFFSETTING PURPOSES (U.S. CLS. 100 AND 101).

FIRST USE 6-1-2011; IN COMMERCE 6-1-2011.

AHSEN KHAN, EXAMINING ATTORNEY

CLASS 44—(Continued).

SN 85-519,301. PHILLIPS, AMY K., WALNUT CREEK, CA. FILED 1-18-2012.

Naturally Born

THE MARK CONSISTS OF STANDARD CHARACTERS WITHOUT CLAIM TO ANY PARTICULAR FONT, STYLE, SIZE, OR COLOR.

FOR PROVIDING A WEBSITE FEATURING INFORMATION ABOUT HEALTH AND WELLNESS, NAMELY, METHODS OF NATURAL CHILDBIRTHING AND BREASTFEEDING; PROVIDING ONLINE REVIEWS OF NATURAL CHILDBIRTH AND BREASTFEEDING SUPPORT PROVIDERS (U.S. CLS. 100 AND 101).

FIRST USE 12-1-2010; IN COMMERCE 12-1-2010.

KIMBERLY FRYE, EXAMINING ATTORNEY

SN 85-497,953. GRAND PRIX SMILES PA, ORLANDO, FL. FILED 12-16-2011.



SN 85-522,321. URGENT CARE MSO, LLC, MORGANTOWN, WV. FILED 1-23-2012.

GREAT CARE. FAST.

THE COLOR(S) BLACK, WHITE, RED, SILVER, AND GRAY IS/ARE CLAIMED AS A FEATURE OF THE MARK.

THE MARK CONSISTS OF A WHITE TOOTH WITH AN UNFURLED BLACK AND WHITE CHECKERED FLAG WITH RED AND WHITE RACING STRIPES IN THE BACKGROUND. THE WHOLE LOGO IS OUTLINED IN GRAY/SILVER THE WORD "SMILES" IS IN RED, IT IS LEANING FORWARD AND HAS WHITE LINES THROUGH THE TOP OF THE LETTERS TO PORTRAY SPEED. ON TOP OF THE WORD "SMILES" THERE IS THE STYLIZED TEXT "GRAND PRIX" IN BLACK WITH A SMALL UNFURLED BLACK AND WHITE CHECKERED FLAG AND A WHITE TOOTH.

FOR DENTIST SERVICES (U.S. CLS. 100 AND 101).

FLORENTINA BLANDU, EXAMINING ATTORNEY

THE MARK CONSISTS OF STANDARD CHARACTERS WITHOUT CLAIM TO ANY PARTICULAR FONT, STYLE, SIZE, OR COLOR.

OWNER OF U.S. REG. NO. 3,195,312.

SEC. 2(F).

FOR MEDICAL CLINICS SPECIALIZING IN URGENT MEDICAL CARE AND TREATMENT (U.S. CLS. 100 AND 101).

FIRST USE 12-1-2004; IN COMMERCE 12-1-2004.

JAMES LOVELACE, EXAMINING ATTORNEY

CLASS 44—(Continued).

SN 85-522,359. SOBERMD, LLC, MONROE, LA. FILED 1-23-2012.



THE COLOR(S) PURPLE, BLUE, LIGHT BLUE, AND BLACK IS/ARE CLAIMED AS A FEATURE OF THE MARK. THE MARK CONSISTS OF THE WORD "SOBERMD" IN THE COLOR BLACK; THREE QUARTER-MOON DESIGNS OF GRADUAL LESSER SIZE PLACED AT THE LEFT SIDE OF THE WORD "SOBERMD"; THE LARGEST QUARTER-MOON DESIGN IS PURPLE, THE MEDIUM QUARTER-MOON DESIGN IS BLUE, AND THE SMALLEST QUARTER-MOON DESIGN IS LIGHT BLUE. THE WHITE IN THE MARK REPRESENTS TRANSPARENCY OR BACKGROUND AND IS NOT CLAIMED AS A FEATURE OF THE MARK.

FOR PROVIDING A WEBSITE FEATURING HEALTH AND WELLNESS INFORMATION IN THE FIELDS OF ALCOHOLISM, ADDICTION, AND EATING DISORDERS; PROVIDING A WEBSITE FEATURING INFORMATION, NEWS, AND COMMENTARY IN THE FIELD OF ALCOHOLISM, ADDICTION, AND EATING DISORDERS (U.S. CLS. 100 AND 101).

FIRST USE 1-11-2010; IN COMMERCE 1-11-2010.
KIMBERLY FRYE, EXAMINING ATTORNEY

CLASS 44—(Continued).

SN 85-523,881. ALTAMED HEALTH SERVICES CORPORATION, LOS ANGELES, CA. FILED 1-24-2012.

STOMP

THE MARK CONSISTS OF STANDARD CHARACTERS WITHOUT CLAIM TO ANY PARTICULAR FONT, STYLE, SIZE, OR COLOR.

FOR MEDICAL SERVICES, NAMELY, DIETARY GUIDANCE AND WEIGHT MANAGEMENT SERVICES IN THE NATURE OF WEIGHT LOSS AND/OR WEIGHT MAINTENANCE PROGRAMS (U.S. CLS. 100 AND 101).

KATHLEEN M. VANSTON, EXAMINING ATTORNEY

SN 85-524,277. DEBORAH WILSON GARDEN SERVICES LLC, NANTUCKET, MA. FILED 1-24-2012.



DEBORAH
WILSON
Garden Services, LLC

NO CLAIM IS MADE TO THE EXCLUSIVE RIGHT TO USE "GARDEN SERVICES LLC", APART FROM THE MARK AS SHOWN.

THE NAME "DEBORAH WILSON" IDENTIFIES A LIVING INDIVIDUAL WHOSE CONSENT IS OF RECORD.

THE MARK CONSISTS OF A GARDEN TROWEL AND GARDEN FORK CROSSED OVER EACH OTHER, SURROUNDED BY A STYLIZED DESIGN, AND THE TEXT "DEBORAH WILSON GARDEN SERVICES, LLC" STACKED BELOW THE DESIGN.

FOR GARDEN DESIGN, INSTALLATION AND MAINTENANCE OF INTERIOR BOTANICAL DISPLAYS, STREETSCAPE CONTAINER PLANTINGS AND ROOFTOP GARDENS FOR OTHERS; LANDSCAPE DESIGN; LANDSCAPE GARDENING (U.S. CLS. 100 AND 101).

FIRST USE 3-1-2011; IN COMMERCE 3-1-2011.
GISELLE AGOSTO, EXAMINING ATTORNEY

SN 85-523,623. KANDOR DENTAL SPA & SALON LLC, OVIEDO, FL. FILED 1-24-2012.



THE MARK CONSISTS OF THE WORDS "KANDOR" IN STYLIZED LETTERING, WITH LETTER "K" APPEARING AS A FANCIFUL REPRESENTATION OF A HUMAN BEING.

FOR DENTIST SERVICES; HEALTH SPA SERVICES FOR HEALTH AND WELLNESS OF THE BODY AND SPIRIT, NAMELY, PROVIDING MASSAGE, FACIAL AND BODY TREATMENT SERVICES, COSMETIC BODY CARE SERVICES (U.S. CLS. 100 AND 101).

FIRST USE 6-21-2011; IN COMMERCE 6-21-2011.
JUDITH HELFMAN, EXAMINING ATTORNEY

CLASS 44—(Continued).

SN 85-524,444. GAYLE, MICHAEL CHARLES, CEDAR PARK, TX. FILED 1-24-2012.



NO CLAIM IS MADE TO THE EXCLUSIVE RIGHT TO USE "IPHYSICAL THERAPY", APART FROM THE MARK AS SHOWN.

THE COLOR(S) BLUE, ORANGE, YELLOW, AND BLACK IS/ARE CLAIMED AS A FEATURE OF THE MARK.

THE MARK CONSISTS OF A BLUE SWIRL SURROUNDING A SEPARATE YELLOW SWIRL. THE WORDS "IPHYSICAL THERAPY" IN ORANGE WITH BLACK OUTLINING START WITH THE LOWER CASE "I" LOCATED IN THE CENTER OF THE SWIRL AND THE BOTTOM OF LETTER "P" IS INSIDE THE SWIRL. THE REMAINING LETTERS "HYSICAL THERAPY" START FROM OUTSIDE OF THE SWIRL NEXT TO THE LETTER "P" AND EXTEND FROM LEFT TO RIGHT.

FOR HOME HEALTH CARE SERVICES, NAMELY, PHYSICAL THERAPY (U.S. CLS. 100 AND 101).

FIRST USE 5-10-2009; IN COMMERCE 8-20-2010.

KAREN K. BUSH, EXAMINING ATTORNEY

SN 85-526,642. BRENNAN, JAMES C., FARMINGTON, CT. FILED 1-26-2012.



THE COLOR(S) GREEN, BLACK, WHITE AND GRAY IS/ARE CLAIMED AS A FEATURE OF THE MARK.

THE MARK CONSISTS OF THE STYLIZED WORDING "JEKL" IN GREEN AND OUTLINED IN WHITE, BLACK AND GRAY. THE WORDING OVERLAYS THE OUTLINE OF AN INCOMPLETE BLACK OVAL.

FOR PROVIDING ASSISTANCE, FITNESS EVALUATION AND CONSULTATION TO INDIVIDUALS TO HELP THEM MAKE HEALTH, WELLNESS AND NUTRITIONAL CHANGES IN THEIR DAILY LIVING TO IMPROVE HEALTH (U.S. CLS. 100 AND 101).

FIRST USE 6-10-2007; IN COMMERCE 6-10-2007.

KATHERINE CONNOLLY, EXAMINING ATTORNEY

SN 85-530,520. MCMURRY, JEANNE D., DBA KONA DESTINATION, KAILUA KONA, HI. FILED 2-1-2012.

KONA TOUCH

THE MARK CONSISTS OF STANDARD CHARACTERS WITHOUT CLAIM TO ANY PARTICULAR FONT, STYLE, SIZE, OR COLOR.

NO CLAIM IS MADE TO THE EXCLUSIVE RIGHT TO USE "KONA", APART FROM THE MARK AS SHOWN.

FOR AROMATHERAPY SERVICES (U.S. CLS. 100 AND 101).

FIRST USE 1-30-2012; IN COMMERCE 1-31-2012.

LUCY ARANT, EXAMINING ATTORNEY

CLASS 44—(Continued).

SN 85-531,661. ALEXANDER-ABT, JONATHAN MAX, TA STEVENAGE ORTHODONTICS, STEVENAGE, UNITED KINGDOM, FILED 2-2-2012.

saturday smiles

THE MARK CONSISTS OF STANDARD CHARACTERS WITHOUT CLAIM TO ANY PARTICULAR FONT, STYLE, SIZE, OR COLOR.

FOR DENTAL SERVICES, NAMELY, PERFORMING RESTORATIVE AND COSMETIC PROCEDURES; ORTHODONTIC SERVICES (U.S. CLS. 100 AND 101).

JESSICA A. POWERS, EXAMINING ATTORNEY

SN 85-531,666. ALEXANDER-ABT, JONATHAN M, TA STEVENAGE ORTHODONTICS, STEVENAGE, UNITED KINGDOM, FILED 2-2-2012.

weekend smiles

THE MARK CONSISTS OF STANDARD CHARACTERS WITHOUT CLAIM TO ANY PARTICULAR FONT, STYLE, SIZE, OR COLOR.

FOR DENTAL SERVICES, NAMELY, PERFORMING RESTORATIVE AND COSMETIC PROCEDURES; ORTHODONTIC SERVICES (U.S. CLS. 100 AND 101).

KATHERINE STOIDES, EXAMINING ATTORNEY

SN 85-532,009. REEVES, SALLY H., MADBURY, NH. FILED 2-2-2012.

CHAMP Choosing Health and Making Progress

THE MARK CONSISTS OF STANDARD CHARACTERS WITHOUT CLAIM TO ANY PARTICULAR FONT, STYLE, SIZE, OR COLOR.

NO CLAIM IS MADE TO THE EXCLUSIVE RIGHT TO USE "HEALTH", APART FROM THE MARK AS SHOWN.

FOR PROVIDING ASSISTANCE, FITNESS EVALUATION AND CONSULTATION TO CORPORATE CLIENTS TO HELP THEIR EMPLOYEES MAKE HEALTH, WELLNESS AND NUTRITIONAL CHANGES IN THEIR DAILY LIVING TO IMPROVE HEALTH; PROVIDING ASSISTANCE, FITNESS EVALUATION AND CONSULTATION TO INDIVIDUALS TO HELP THEM MAKE HEALTH, WELLNESS AND NUTRITIONAL CHANGES IN THEIR DAILY LIVING TO IMPROVE HEALTH (U.S. CLS. 100 AND 101).

BARBARA RUTLAND, EXAMINING ATTORNEY

CLASS 44—(Continued).

SN 85-532,712. WARRIORS LIVE ON, INC., SAN DIEGO, CA. FILED 2-2-2012.

WARRIORS LIVE ON

THE MARK CONSISTS OF STANDARD CHARACTERS WITHOUT CLAIM TO ANY PARTICULAR FONT, STYLE, SIZE, OR COLOR.

FOR ART THERAPY; BODYWORK THERAPY SERVICES, NAMELY, STRUCTURAL INTEGRATION THERAPY AND MOVEMENT THERAPY; COGNITIVE THERAPY SERVICES; DANCE MOVEMENT THERAPY SERVICES; DREAM ANALYSIS THERAPY SERVICES; INSOMNIA THERAPY SERVICES; NUTRITIONAL THERAPY SERVICES; PHYSICAL THERAPY; PHYSICAL THERAPY IN THE NATURE OF MOVEMENT THERAPY; STRESS REDUCTION THERAPY; THERAPY FOR HUMANS WITH USE OF HORSES; VITAMIN THERAPY (U.S. CLS. 100 AND 101).
FIRST USE 12-1-2011; IN COMMERCE 1-1-2012.

JUDITH HELFMAN, EXAMINING ATTORNEY

SN 85-532,725. WARRIORS LIVE ON, INC., SAN DIEGO, CA. FILED 2-2-2012.



THE COLOR(S) BROWN, ORANGE, LIGHT ORANGE, YELLOW, WHITE IS/ARE CLAIMED AS A FEATURE OF THE MARK.

THE MARK CONSISTS OF A HALF SUNBURST WITH RAYS OF YELLOW, ORANGE AND LIGHT ORANGE DEPICTED AS EXTENDING FROM A WHITE HALF CIRCLE ABOVE THE WORDS "WARRIORS LIVE ON" IN BROWN ALL ON A WHITE BACKGROUND.

FOR ART THERAPY; BODYWORK THERAPY; DANCE MOVEMENT THERAPY SERVICES; DREAM ANALYSIS THERAPY SERVICES; INSOMNIA THERAPY SERVICES; MASSAGE THERAPY SERVICES; MENTAL HEALTH THERAPY SERVICES; MUSIC THERAPY FOR PHYSICAL, PSYCHOLOGICAL AND COGNITIVE PURPOSES; NUTRITIONAL THERAPY SERVICES; PHYSICAL THERAPY; PHYSICAL THERAPY IN THE NATURE OF MOVEMENT THERAPY; STRESS REDUCTION THERAPY; THERAPY FOR HUMANS WITH USE OF HORSES; VITAMIN THERAPY (U.S. CLS. 100 AND 101).
FIRST USE 12-1-2011; IN COMMERCE 1-9-2012.

JUDITH HELFMAN, EXAMINING ATTORNEY

CLASS 44—(Continued).

SN 85-532,806. SANCHEZ & ASSOCIATES, LLC, DBA FORGET THE SPA, GLOUCESTER, MA. FILED 2-2-2012.

Forget the Spa

THE MARK CONSISTS OF STANDARD CHARACTERS WITHOUT CLAIM TO ANY PARTICULAR FONT, STYLE, SIZE, OR COLOR.

FOR HEALTH SPA SERVICES FOR HEALTH AND WELLNESS OF THE BODY AND SPIRIT, NAMELY, PROVIDING MASSAGE, FACIAL AND BODY TREATMENT SERVICES, COSMETIC BODY CARE SERVICES (U.S. CLS. 100 AND 101).

FIRST USE 12-6-2011; IN COMMERCE 12-6-2011.
MARK SHINER, EXAMINING ATTORNEY

SN 85-533,007. KAUFMAN, STEPHEN, NEW YORK, NY. FILED 2-3-2012.

**Self-Revealization
Acceptance**

THE MARK CONSISTS OF STANDARD CHARACTERS WITHOUT CLAIM TO ANY PARTICULAR FONT, STYLE, SIZE, OR COLOR.

FOR CONSULTING IN THE FIELD OF HEALTH AND WELLNESS TO BRING ABOUT PERSONAL HAPPINESS (U.S. CLS. 100 AND 101).

FIRST USE 4-22-1993; IN COMMERCE 4-22-1993.
JEFFREY LOOK, EXAMINING ATTORNEY

SN 85-533,840. ADVANCED LITHO PRINTING & BINDERY, LAKE FOREST, CA. FILED 2-3-2012.

Beauty and The Ink

THE MARK CONSISTS OF STANDARD CHARACTERS WITHOUT CLAIM TO ANY PARTICULAR FONT, STYLE, SIZE, OR COLOR.

FOR BEAUTY SALONS; TATTOO STUDIOS (U.S. CLS. 100 AND 101).

FIRST USE 6-1-2010; IN COMMERCE 6-1-2010.
DEBORAH LOBO, EXAMINING ATTORNEY

CLASS 44—(Continued).

SN 85-534,014. ALEXANDER-ABT, JONATHAN M, TA STEVENAGE ORTHODONTICS, STEVENAGE, UNITED KINGDOM, FILED 2-4-2012.

smiles on saturdays

THE MARK CONSISTS OF STANDARD CHARACTERS WITHOUT CLAIM TO ANY PARTICULAR FONT, STYLE, SIZE, OR COLOR.

FOR DENTAL SERVICES, NAMELY, PERFORMING RESTORATIVE AND COSMETIC PROCEDURES; ORTHODONTIC SERVICES (U.S. CLS. 100 AND 101).
KATHERINE STOIDES, EXAMINING ATTORNEY

SN 85-534,055. ALANA HEALTHCARE, LLC, DICKSON, TN. FILED 2-4-2012.

CROM

THE MARK CONSISTS OF STANDARD CHARACTERS WITHOUT CLAIM TO ANY PARTICULAR FONT, STYLE, SIZE, OR COLOR.

FOR HEALTHCARE (U.S. CLS. 100 AND 101).
KAREN BRACEY, EXAMINING ATTORNEY

SN 85-534,189. ALEXANDER-ABT, JONATHAN M, TA STEVENAGE ORTHODONTICS, STEVENAGE, UNITED KINGDOM, FILED 2-5-2012.

saturday specialists

THE MARK CONSISTS OF STANDARD CHARACTERS WITHOUT CLAIM TO ANY PARTICULAR FONT, STYLE, SIZE, OR COLOR.

FOR DENTAL SERVICES, NAMELY, PERFORMING RESTORATIVE AND COSMETIC PROCEDURES; ORTHODONTIC SERVICES (U.S. CLS. 100 AND 101).
KATHERINE STOIDES, EXAMINING ATTORNEY

CLASS 44—(Continued).

SN 85-534,689. LUSH INVESTMENTS, INC., DBA ADVANCED SKIN FITNESS, DALLAS, TX. FILED 2-6-2012.

IREVIVAL

THE MARK CONSISTS OF STANDARD CHARACTERS WITHOUT CLAIM TO ANY PARTICULAR FONT, STYLE, SIZE, OR COLOR.

FOR MINIMALLY INVASIVE COSMETIC MEDICAL PROCEDURE COMBINING FRACTIONAL LASER RESURFACING AND THE INJECTION OF BLOOD-DERIVED GROWTH FACTORS INCLUDING PLATELET RICH FIBRIN MATRIX (U.S. CLS. 100 AND 101).

FIRST USE 1-27-2012; IN COMMERCE 1-27-2012.
JEFFREY LOOK, EXAMINING ATTORNEY

SN 85-534,718. LUSH INVESTMENTS, INC., DBA ADVANCED SKIN FITNESS, DALLAS, TX. FILED 2-6-2012.

NUSURFACE

THE MARK CONSISTS OF STANDARD CHARACTERS WITHOUT CLAIM TO ANY PARTICULAR FONT, STYLE, SIZE, OR COLOR.

FOR MINIMALLY INVASIVE COSMETIC MEDICAL PROCEDURE COMBINING FRACTIONAL LASER RESURFACING AND THE INJECTION OF BLOOD-DERIVED GROWTH FACTORS INCLUDING PLATELET RICH FIBRIN MATRIX (U.S. CLS. 100 AND 101).

FIRST USE 1-27-2012; IN COMMERCE 1-27-2012.
JEFFREY LOOK, EXAMINING ATTORNEY

SN 85-534,827. THE MEADOWS OF WICKENBURG, INC., WICKENBURG, AZ. FILED 2-6-2012.



THE
MEADOWS

OWNER OF U.S. REG. NOS. 2,013,513, 2,212,272 AND 2,981,057.

THE MARK CONSISTS OF THE WORDS "THE MEADOWS" UNDER A DESIGN OF A SUN WITH TWO WAVY LINES.

FOR MENTAL HEALTH AND SUBSTANCE ABUSE TREATMENT CENTER SERVICES (U.S. CLS. 100 AND 101).

FIRST USE 3-19-2012; IN COMMERCE 3-19-2012.
KATHRYN COWARD, EXAMINING ATTORNEY

CLASS 44—(Continued).

SN 85-536,111. ART4 NEW PARADIGM, LLC, LAKE FOREST PARK, WA. FILED 2-7-2012.

ART4 NEW PARADIGM LEADERS

THE MARK CONSISTS OF STANDARD CHARACTERS WITHOUT CLAIM TO ANY PARTICULAR FONT, STYLE, SIZE, OR COLOR.

FOR ART THERAPY; PROVIDING IN-PERSON ENERGY HEALING SERVICES; PROVIDING LONG-DISTANCE ENERGY HEALING SERVICES (U.S. CLS. 100 AND 101).

ELLEN PERKINS, EXAMINING ATTORNEY

SN 85-536,690. ALTAPOINT DATA SYSTEMS, LLC, MIDVALE, UT. FILED 2-8-2012.

zPatient

THE MARK CONSISTS OF STANDARD CHARACTERS WITHOUT CLAIM TO ANY PARTICULAR FONT, STYLE, SIZE, OR COLOR.

FOR MAINTAINING PATIENT MEDICAL RECORDS AND FILES (U.S. CLS. 100 AND 101).

FIRST USE 1-6-2010; IN COMMERCE 1-6-2010.

ASMAT KHAN, EXAMINING ATTORNEY

SN 85-536,737. SIMPLY STRONG, LTD., WINFIELD, IL. FILED 2-8-2012.

SIMPLY STRONG

THE MARK CONSISTS OF STANDARD CHARACTERS WITHOUT CLAIM TO ANY PARTICULAR FONT, STYLE, SIZE, OR COLOR.

FOR PROVIDING WELLNESS SERVICES, NAMELY, PERSONAL ASSESSMENTS, PERSONALIZED ROUTINES, MAINTENANCE SCHEDULES, AND COUNSELING (U.S. CLS. 100 AND 101).

KATHERINE M. DUBRAY, EXAMINING ATTORNEY

CLASS 44—(Continued).

SN 85-537,992. SHEKHINAH FOUNDATION, INC., AVEN- TURA, FL. FILED 2-9-2012.

SHEKHINAH

THE MARK CONSISTS OF STANDARD CHARACTERS WITHOUT CLAIM TO ANY PARTICULAR FONT, STYLE, SIZE, OR COLOR.

THE ENGLISH TRANSLATION OF SHEKHINAH IN THE MARK IS DWELLING OR PLACE WITH DIVINE/CREA- TIVE PRESENCE AND LIGHT.

FOR THERAPEUTIC SERVICES FOR INDIVIDUALS WITH COGNITIVE OR EMOTIONAL DISABILITIES IN A RESIDENTIAL COMMUNITY SETTING (U.S. CLS. 100 AND 101).

FIRST USE 11-30-2010; IN COMMERCE 11-30-2010.

LAKEISHA LEWIS, EXAMINING ATTORNEY

SN 85-537,996. SHEKHINAH FOUNDATION, INC., AVEN- TURA, FL. FILED 2-9-2012.



THE MARK CONSISTS OF A STYLIZED DRAWING OF A TREE CONTAINED WITHIN A CIRCULAR BORDER.

FOR THERAPEUTIC SERVICES FOR INDIVIDUALS WITH COGNITIVE OR EMOTIONAL DISABILITIES IN A RESIDENTIAL COMMUNITY SETTING (U.S. CLS. 100 AND 101).

FIRST USE 11-30-2010; IN COMMERCE 11-30-2010.

LAKEISHA LEWIS, EXAMINING ATTORNEY

CLASS 44—(Continued).

SN 85-538,171. ALEXANDER, JOYCE, SANTA CRUZ, CA. FILED 2-9-2012.

blikki

THE MARK CONSISTS OF STANDARD CHARACTERS WITHOUT CLAIM TO ANY PARTICULAR FONT, STYLE, SIZE, OR COLOR.

FOR PROVIDING A WEBSITE FEATURING INFORMATION ABOUT HEALTH, WELLNESS AND NUTRITION (U.S. CLS. 100 AND 101).

FIRST USE 1-17-2012; IN COMMERCE 1-24-2012.
SUNG IN, EXAMINING ATTORNEY

SN 85-538,626. DR. ADAM SCHEINER, TAMPA, FL. FILED 2-9-2012.

RESET

THE MARK CONSISTS OF STANDARD CHARACTERS WITHOUT CLAIM TO ANY PARTICULAR FONT, STYLE, SIZE, OR COLOR.

FOR COSMETIC AND PLASTIC SURGERY (U.S. CLS. 100 AND 101).

FIRST USE 12-31-2011; IN COMMERCE 12-31-2011.
MICHAEL GAAFAR, EXAMINING ATTORNEY

SN 85-539,149. WELLCO, ROYAL OAK, MI. FILED 2-10-2012.

WELLCO

THE MARK CONSISTS OF STANDARD CHARACTERS WITHOUT CLAIM TO ANY PARTICULAR FONT, STYLE, SIZE, OR COLOR.

FOR HEALTH CARE SERVICES, NAMELY, WELLNESS PROGRAMS (U.S. CLS. 100 AND 101).

FIRST USE 5-1-1996; IN COMMERCE 9-9-1997.
KEVON CHISOLM, EXAMINING ATTORNEY

CLASS 44—(Continued).

SN 85-539,660. GILSBAR, INC., COVINGTON, LA. FILED 2-10-2012.

PRIORITY 7

THE MARK CONSISTS OF STANDARD CHARACTERS WITHOUT CLAIM TO ANY PARTICULAR FONT, STYLE, SIZE, OR COLOR.

FOR CONSULTING IN THE FIELD OF HEALTH AND WELLNESS TO BRING ABOUT PERSONAL HAPPINESS; CONSULTING SERVICES IN THE FIELD OF MENTAL HEALTH AND WELLNESS; COUNSELING SERVICES IN THE FIELDS OF HEALTH, HERBALISM, AND LIFESTYLE WELLNESS; HEALTH CARE SERVICES, NAMELY, WELLNESS PROGRAMS; HEALTH SPA SERVICES FOR HEALTH AND WELLNESS OF THE BODY AND SPIRIT; WELLNESS AND HEALTH-RELATED CONSULTING SERVICES (U.S. CLS. 100 AND 101).

FIRST USE 5-0-2009; IN COMMERCE 5-0-2009.
ALLISON SCHRODY, EXAMINING ATTORNEY

SN 85-540,004. INSIDE OUT SALON, LOS ANGELES, CA. FILED 2-10-2012.

INNER BEAUTY IS SUSTAINABLE

THE MARK CONSISTS OF STANDARD CHARACTERS WITHOUT CLAIM TO ANY PARTICULAR FONT, STYLE, SIZE, OR COLOR.

FOR HAIR SALON SERVICES; HAIR STYLING; BEAUTY SALON SERVICES (U.S. CLS. 100 AND 101).

FIRST USE 4-15-2009; IN COMMERCE 6-10-2010.
YAT SYE, LEE, EXAMINING ATTORNEY

SN 85-540,400. VAHE' OHANESSIAN, TUJUNGA, CA. FILED 2-11-2012.

AIRIGATION

THE MARK CONSISTS OF STANDARD CHARACTERS WITHOUT CLAIM TO ANY PARTICULAR FONT, STYLE, SIZE, OR COLOR.

FOR COSMETIC DENTISTRY; DENTIST SERVICES; DENTISTRY; HEALTHCARE; MEDICAL SERVICES, NAMELY, TREATMENT OF BAD BREATH AND HALITOSIS (U.S. CLS. 100 AND 101).

FIRST USE 2-10-2012; IN COMMERCE 2-10-2012.
GEOFFREY FOSDICK, EXAMINING ATTORNEY

CLASS 44—(Continued).

SN 85-540,404. VAHE' OHANESSIAN, TUJUNGA, CA. FILED 2-12-2012.

TREAT YOUR BREATH TO FRESHNESS

THE MARK CONSISTS OF STANDARD CHARACTERS WITHOUT CLAIM TO ANY PARTICULAR FONT, STYLE, SIZE, OR COLOR.

FOR COSMETIC DENTISTRY; DENTIST SERVICES; DENTISTRY; HEALTHCARE; MEDICAL SERVICES, NAMELY, TREATMENT OF BAD BREATH AND HALITOSIS (U.S. CLS. 100 AND 101).

FIRST USE 2-10-2012; IN COMMERCE 2-10-2012.
GEOFFREY FOSDICK, EXAMINING ATTORNEY

SN 85-540,557. PRYOR, LANDON, ROCKFORD, IL. FILED 2-12-2012.

LOCKS & TOX

THE MARK CONSISTS OF STANDARD CHARACTERS WITHOUT CLAIM TO ANY PARTICULAR FONT, STYLE, SIZE, OR COLOR.

FOR PHYSICIAN SERVICES (U.S. CLS. 100 AND 101).
FIRST USE 12-1-2010; IN COMMERCE 12-1-2010.
NAAKWAMA ANKRAH, EXAMINING ATTORNEY

SN 85-566,829. CENTENE CORPORATION, ST. LOUIS, MO. FILED 3-12-2012.

FOCUS24

THE MARK CONSISTS OF STANDARD CHARACTERS WITHOUT CLAIM TO ANY PARTICULAR FONT, STYLE, SIZE, OR COLOR.

FOR BEHAVIORAL HEALTH SERVICES, NAMELY, A MANAGEMENT PROGRAM FOR CHILDREN IN FOSTER CARE (U.S. CLS. 100 AND 101).

JOHN E. MICHOS, EXAMINING ATTORNEY

CLASS 44—(Continued).

SN 85-600,494. TATTOO VANISH, INC., LAS VEGAS, NV. FILED 4-17-2012.

TATTOO VANISH

THE MARK CONSISTS OF STANDARD CHARACTERS WITHOUT CLAIM TO ANY PARTICULAR FONT, STYLE, SIZE, OR COLOR.

OWNER OF U.S. REG. NO. 3,806,058.

NO CLAIM IS MADE TO THE EXCLUSIVE RIGHT TO USE "TATTOO", APART FROM THE MARK AS SHOWN.

FOR TATTOO REMOVAL SERVICE UTILIZING A SPECIALLY FORMULATED SOLUTION (U.S. CLS. 100 AND 101).

FIRST USE 1-15-1993; IN COMMERCE 1-15-1993.

NAAKWAMA ANKRAH, EXAMINING ATTORNEY

CLASS 45—PERSONAL AND LEGAL SERVICES

SN 76-708,369. EDMUNDS, JULIE, DAVENPORT, IA. FILED 7-15-2011.

KIDDO BIRTHDAYS

THE MARK CONSISTS OF STANDARD CHARACTERS WITHOUT CLAIM TO ANY PARTICULAR FONT, STYLE, SIZE, OR COLOR.

NO CLAIM IS MADE TO THE EXCLUSIVE RIGHT TO USE "BIRTHDAYS", APART FROM THE MARK AS SHOWN.

FOR PERSONAL REMINDER SERVICES IS THE AREA OF UPCOMING BIRTHDAYS AND OTHER NOTEWORTHY EVENTS FOR FRIENDS, RELATIVES AND THEIR CHILDREN; PROVIDING A SELECTION OF ONLINE ELECTRONIC GREETING CARDS FOR BIRTHDAYS AND OTHER NOTEWORTHY EVENTS FOR FRIENDS, RELATIVES AND THEIR CHILDREN (U.S. CLS. 100 AND 101).

AMY ALFIERI, EXAMINING ATTORNEY

CLASS 45—(Continued).

SN 76-709,915. VERIFIED CREDENTIALS, INC., LAKEVILLE, MN. FILED 12-6-2011.

VERIFIED CREDENTIALS SCHOLAR

THE MARK CONSISTS OF STANDARD CHARACTERS WITHOUT CLAIM TO ANY PARTICULAR FONT, STYLE, SIZE, OR COLOR.

OWNER OF U.S. REG. NO. 2,904,545.

NO CLAIM IS MADE TO THE EXCLUSIVE RIGHT TO USE "SCHOLAR", APART FROM THE MARK AS SHOWN. SEC. 2(F) AS TO "VERIFIED CREDENTIALS".

FOR PROVIDING AN INTERACTIVE WEBSITE THAT FACILITATES THE COLLECTION, VERIFICATION AND MONITORING OF A PERSON'S BACKGROUND, CREDENTIALS AND PERSONAL INFORMATION; PERSONAL BACKGROUND SCREENING SERVICES; COLLECTING AND MONITORING THE CREDENTIALS AND PERSONAL INFORMATION OF STUDENTS AND POTENTIAL STUDENTS (U.S. CLS. 100 AND 101).

JOHN DALIER, EXAMINING ATTORNEY

SN 76-709,916. VERIFIED CREDENTIALS, INC., LAKEVILLE, MN. FILED 12-6-2011.

VERIFIED CREDENTIALS CONTRACTOR

THE MARK CONSISTS OF STANDARD CHARACTERS WITHOUT CLAIM TO ANY PARTICULAR FONT, STYLE, SIZE, OR COLOR.

OWNER OF U.S. REG. NO. 2,904,545.

NO CLAIM IS MADE TO THE EXCLUSIVE RIGHT TO USE "CONTRACTOR", APART FROM THE MARK AS SHOWN.

SEC. 2(F) AS TO "VERIFIED CREDENTIALS".

FOR PROVIDING AN INTERACTIVE WEBSITE THAT FACILITATES THE COLLECTION, VERIFICATION AND MONITORING OF A PERSON'S BACKGROUND, CREDENTIALS AND PERSONAL INFORMATION; PERSONAL BACKGROUND SCREENING SERVICES; COLLECTING AND MONITORING THE CREDENTIALS AND PERSONAL INFORMATION OF CONTRACTORS FOR THE PURPOSE OF DETERMINING ELIGIBILITY OF CONTRACTORS TO ENGAGE IN BUSINESS WITH OTHERS (U.S. CLS. 100 AND 101).

JOHN DALIER, EXAMINING ATTORNEY

SN 76-709,917. VERIFIED CREDENTIALS, INC., LAKEVILLE, MN. FILED 12-6-2011.

VERIFIED CREDENTIALS EMPLOYEE

THE MARK CONSISTS OF STANDARD CHARACTERS WITHOUT CLAIM TO ANY PARTICULAR FONT, STYLE, SIZE, OR COLOR.

OWNER OF U.S. REG. NO. 2,904,545.

NO CLAIM IS MADE TO THE EXCLUSIVE RIGHT TO USE "EMPLOYEE", APART FROM THE MARK AS SHOWN. SEC. 2(F) AS TO "VERIFIED CREDENTIALS".

FOR PROVIDING AN INTERACTIVE WEBSITE THAT FACILITATES THE VERIFICATION OF A PERSON'S BACKGROUND CREDENTIALS; EMPLOYMENT BACKGROUND SCREENING, NAMELY, BACKGROUND SCREENING OF CURRENT EMPLOYEES OF OTHERS; PRE-EMPLOYMENT BACKGROUND SCREENING (U.S. CLS. 100 AND 101).

JOHN DALIER, EXAMINING ATTORNEY

CLASS 45—(Continued).

SN 85-077,789. ATTRACTIVO LTD, SHOHAM, ISRAEL, FILED 7-4-2010.

Attractivo

THE MARK CONSISTS OF STANDARD CHARACTERS WITHOUT CLAIM TO ANY PARTICULAR FONT, STYLE, SIZE, OR COLOR.

OWNER OF ISRAEL REG. NO. 234639, DATED 5-2-2012, EXPIRES 1-3-2021.

THE ENGLISH TRANSLATION OF THE WORD "ATTRACTIVO" IN THE MARK IS "ATTRACTION".

FOR ON-LINE SOCIAL NETWORKING SERVICES (U.S. CLS. 100 AND 101).

ANNE E. GUSTASON, EXAMINING ATTORNEY

SN 85-154,515. BUTLER HESKETT PRODUCTIONS LLC, DBA WATER INTO WINE, LLC, DENVER, CO. FILED 10-17-2010.

Water Into Wine LLC

THE MARK CONSISTS OF STANDARD CHARACTERS WITHOUT CLAIM TO ANY PARTICULAR FONT, STYLE, SIZE, OR COLOR.

NO CLAIM IS MADE TO THE EXCLUSIVE RIGHT TO USE "LLC", APART FROM THE MARK AS SHOWN.

FOR PROVIDING INFORMATION RELATING TO DIVERSE HUMAN CULTURES, BELIEFS, AND LIFESTYLES (U.S. CLS. 100 AND 101).

FIRST USE 10-9-2010; IN COMMERCE 10-9-2010.

ELISSA GARBER KON, EXAMINING ATTORNEY

SN 85-300,189. DRRT LIMITED, DUBAI, UNITED ARAB EMIR., FILED 4-20-2011.

LEGAL ALPHA

THE MARK CONSISTS OF STANDARD CHARACTERS WITHOUT CLAIM TO ANY PARTICULAR FONT, STYLE, SIZE, OR COLOR.

NO CLAIM IS MADE TO THE EXCLUSIVE RIGHT TO USE "LEGAL", APART FROM THE MARK AS SHOWN.

FOR LEGAL SERVICES (U.S. CLS. 100 AND 101).

MARILYN IZZI, EXAMINING ATTORNEY

CLASS 45—(Continued).

SN 85-349,591. MANIC MANAGED MOM, LLC, PHOENIX, AZ. FILED 6-17-2011.

MANAGED MOMS.COM

THE MARK CONSISTS OF STANDARD CHARACTERS WITHOUT CLAIM TO ANY PARTICULAR FONT, STYLE, SIZE, OR COLOR.

NO CLAIM IS MADE TO THE EXCLUSIVE RIGHT TO USE "MANAGED", APART FROM THE MARK AS SHOWN.

FOR PROVIDING A WEBSITE FEATURING INFORMATION IN THE FIELD OF IDEAS FOR MANAGING DAILY LIFE, NAMELY, PERSONAL SCHEDULING AND ORGANIZATION OF DAILY TASKS, OBLIGATIONS AND DUTIES (U.S. CLS. 100 AND 101).

FIRST USE 3-1-2011; IN COMMERCE 3-1-2011.
BRENDAN REGAN, EXAMINING ATTORNEY

CLASS 45—(Continued).

SN 85-369,431. FLASHFOTO, INC., LOS GATOS, CA. FILED 7-12-2011.

**Your picture with anyone,
anything, anywhere**

THE MARK CONSISTS OF STANDARD CHARACTERS WITHOUT CLAIM TO ANY PARTICULAR FONT, STYLE, SIZE, OR COLOR.

FOR IMAGE MANIPULATION SERVICES, NAMELY, DIGITAL IMAGING SERVICES (U.S. CLS. 100 AND 101).
ALLISON SCHRODY, EXAMINING ATTORNEY

SN 85-369,059. BRAND TRADING COMPANY S.A., LUXEMBOURG, LUXEMBOURG, FILED 7-12-2011.

ANGELA

THE MARK CONSISTS OF STANDARD CHARACTERS WITHOUT CLAIM TO ANY PARTICULAR FONT, STYLE, SIZE, OR COLOR.

FOR PERSONAL AND SOCIAL SERVICES RENDERED BY OTHERS TO MEET THE NEEDS OF INDIVIDUALS, NAMELY, ONLINE SOCIAL NETWORKING SERVICES; HOROSCOPE CASTING; CLAIRVOYANT SERVICES, NAMELY, PSYCHIC READING SERVICES; CLAIRVOYANT SERVICES AT DISTANCE, NAMELY, PSYCHIC READING SERVICES (U.S. CLS. 100 AND 101).

ROBERT STRUCK, EXAMINING ATTORNEY

SN 85-372,400. FIESTA CATERING INTERNATIONAL, INC., THE VALLEY, ANGUILLA, FILED 7-15-2011.

XPRESS.COM

THE MARK CONSISTS OF STANDARD CHARACTERS WITHOUT CLAIM TO ANY PARTICULAR FONT, STYLE, SIZE, OR COLOR.

FOR DATING SERVICES (U.S. CLS. 100 AND 101).
KHANH LE, EXAMINING ATTORNEY

SN 85-369,165. BRAND TRADING COMPANY S.A., LUXEMBOURG, LUXEMBOURG, FILED 7-12-2011.

TUPAK

THE MARK CONSISTS OF STANDARD CHARACTERS WITHOUT CLAIM TO ANY PARTICULAR FONT, STYLE, SIZE, OR COLOR.

THE NAME(S), PORTRAIT(S), AND/OR SIGNATURE(S) SHOWN IN THE MARK DOES NOT IDENTIFY A PARTICULAR LIVING INDIVIDUAL.

FOR PERSONAL AND SOCIAL SERVICES RENDERED BY OTHERS TO MEET THE NEEDS OF INDIVIDUALS, NAMELY, ONLINE SOCIAL NETWORKING SERVICES; HOROSCOPE CASTING; CLAIRVOYANT SERVICES, NAMELY, PSYCHIC READING SERVICES; CLAIRVOYANT SERVICES AT DISTANCE, NAMELY, PSYCHIC READING SERVICES (U.S. CLS. 100 AND 101).

ROBERT STRUCK, EXAMINING ATTORNEY

SN 85-373,845. TERRA LAW LLP, SAN JOSE, CA. FILED 7-18-2011.

TERRA LAW

THE MARK CONSISTS OF STANDARD CHARACTERS WITHOUT CLAIM TO ANY PARTICULAR FONT, STYLE, SIZE, OR COLOR.

NO CLAIM IS MADE TO THE EXCLUSIVE RIGHT TO USE "LAW", APART FROM THE MARK AS SHOWN.
FOR LEGAL SERVICES (U.S. CLS. 100 AND 101).
FIRST USE 3-16-1999; IN COMMERCE 4-30-2000.
JAMES STEIN, EXAMINING ATTORNEY

CLASS 45—(Continued).

SN 85-392,740. FISCO, PASQUALE, NEW YORK, NY. FILED 8-8-2011.

Pasquale Fisco

THE MARK CONSISTS OF STANDARD CHARACTERS WITHOUT CLAIM TO ANY PARTICULAR FONT, STYLE, SIZE, OR COLOR.

THE NAME "PASQUALE FISCO" IDENTIFIES A LIVING INDIVIDUAL WHOSE CONSENT IS OF RECORD.

FOR SECURITY CONSULTANCY (U.S. CLS. 100 AND 101).

FIRST USE 5-13-1967; IN COMMERCE 5-13-1987.
COLLEEN DOMBROW, EXAMINING ATTORNEY

SN 85-404,670. NOBLE GRACE, ARLINGTON, TX. FILED 8-23-2011.



THE MARK CONSISTS OF THE STYLIZED TEXT "NOBLE GRACE" WITH A FLEUR DE LIS IS BEHIND THE WORDING "NOBLE GRACE" AND THE SYMBOL IS NOT REPLACING THE "O" IN NOBLE.

FOR REGULATORY COMPLIANCE CONSULTING FOR THE ENERGY INDUSTRY (U.S. CLS. 100 AND 101).

FIRST USE 10-18-2010; IN COMMERCE 10-18-2010.
STEPHANIE ALI, EXAMINING ATTORNEY

SN 85-429,557. ARIZONA CENTER FOR DISABILITY LAW, TUCSON, AZ. FILED 9-22-2011.



NO CLAIM IS MADE TO THE EXCLUSIVE RIGHT TO USE "ARIZONA CENTER FOR DISABILITY LAW", APART FROM THE MARK AS SHOWN.

THE COLOR(S) BLACK, WHITE, RED, YELLOW, BROWN AND GREEN/TEAL IS/ARE CLAIMED AS A FEATURE OF THE MARK.

THE MARK CONSISTS OF THE LETTERS "ACDL" IN BLOCK BLACK TEXT. BELOW THE LETTERS IS A GREEN/TEAL BANNER CONTAINING THE WORDS "ARIZONA CENTER FOR DISABILITY LAW" IN WHITE. TO THE LEFT OF BOTH THE LETTERS AND BANNER IS A STYLIZED DESIGN IN RED, GREEN/TEAL, YELLOW, BLACK AND BROWN WITH A SHAPE RESEMBLING A SUN.

FOR LEGAL SERVICES (U.S. CLS. 100 AND 101).
FIRST USE 4-1-2011; IN COMMERCE 4-1-2011.
ELI HELLMAN, EXAMINING ATTORNEY

CLASS 45—(Continued).

SN 85-449,372. HRABAL, ANTONIN, LAS VEGAS, NV. AND HIPPOCRATES UNIVERSITY, LAS VEGAS, NV. FILED 10-17-2011.

WE

THE MARK CONSISTS OF THE STYLIZED LETTERS "W" AND "E" DEPICTED IN A STRAIGHT ANGLE CONFIGURATION.

FOR RELIGIOUS AND SPIRITUAL SERVICES, NAMELY, PROVIDING GATHERINGS AND RETREATS TO DEVELOP AND ENHANCE THE SPIRITUAL LIVES OF INDIVIDUALS (U.S. CLS. 100 AND 101).

FIRST USE 5-1-2000; IN COMMERCE 5-1-2000.
BRIDGETT SMITH, EXAMINING ATTORNEY

SN 85-487,448. CAMARILLO HOSPICE CORPORATION, CAMARILLO, CA. FILED 12-6-2011.

CAMARILLO HOSPICE

THE MARK CONSISTS OF STANDARD CHARACTERS WITHOUT CLAIM TO ANY PARTICULAR FONT, STYLE, SIZE, OR COLOR.

NO CLAIM IS MADE TO THE EXCLUSIVE RIGHT TO USE "HOSPICE", APART FROM THE MARK AS SHOWN. SEC. 2(F).

FOR CHARITABLE OUTREACH SERVICES, NAMELY, PROVIDING COUNSELING SERVICES IN THE FIELD OF GRIEF AND BEREAVEMENT SUPPORT; PROVIDING NON-MEDICAL IN-HOME PERSONAL SERVICES FOR INDIVIDUALS INCLUDING CHECKING HOME CONDITION, SUPPLIES AND INDIVIDUAL WELL-BEING, SCHEDULING APPOINTMENTS, RUNNING ERRANDS, MAKING SAFETY CHECKS, AND PROVIDING ON-LINE INFORMATION RELATED TO THESE PERSONAL SERVICES (U.S. CLS. 100 AND 101).

FIRST USE 4-8-1979; IN COMMERCE 4-30-1979.
ZACHARY BELLO, EXAMINING ATTORNEY

CLASS 45—(Continued).

SN 85-501,335. OODA GROUP, LLC, ASHBURN, VA. FILED 12-21-2011.



NO CLAIM IS MADE TO THE EXCLUSIVE RIGHT TO USE "OODA", APART FROM THE MARK AS SHOWN.

THE COLOR(S) BLUE AND BLACK IS/ARE CLAIMED AS A FEATURE OF THE MARK.

THE MARK CONSISTS OF THE STYLIZED WORD "OODA" IN BLUE WITH A BLACK OUTLINE. THE FIRST "O" IN "OODA" IS FORMED BY FOUR ARROWS IN BLUE WITH A BLACK OUTLINE. THE SECOND "O" IS FORMED BY THE ARTISTIC RENDERING OF THE EARTH IN BLUE WITH A BLACK OUTLINE; THE OCEAN AREA IN THE GLOBE IS TRANSPARENT. THE COLOR WHITE IN THE MARK REPRESENTS BACKGROUND, OUTLINING, SHADING AND/OR TRANSPARENT AREAS AND IS NOT PART OF THE MARK.

FOR SECURITY SERVICES, NAMELY, THREAT SIMULATION VULNERABILITY ANALYSIS AND MITIGATION AND EMERGENCY AND CRISIS RESPONSE; PROVIDING SECURITY ASSESSMENTS TO BUSINESSES IN SELECTION OF BUSINESS LOCATIONS (U.S. CLS. 100 AND 101).

FIRST USE 0-0-2009; IN COMMERCE 0-0-2009.

HEATHER BIDDULPH, EXAMINING ATTORNEY

CLASS 45—(Continued).

SN 85-517,777. GHIRSCH, LLC, WILTON, CT. FILED 1-17-2012.

GO-TO COUNSEL

THE MARK CONSISTS OF STANDARD CHARACTERS WITHOUT CLAIM TO ANY PARTICULAR FONT, STYLE, SIZE, OR COLOR.

NO CLAIM IS MADE TO THE EXCLUSIVE RIGHT TO USE "COUNSEL", APART FROM THE MARK AS SHOWN.

FOR LEGAL SERVICES, NAMELY, PROVIDING CUSTOMIZED DOCUMENTATION, INFORMATION, COUNSELING, ADVICE AND CONSULTATION SERVICES IN ALL AREAS OF BUSINESS LAW (U.S. CLS. 100 AND 101).

ELI HELLMAN, EXAMINING ATTORNEY

SN 85-517,865. ANCESTRY.COM OPERATIONS INC., PROVO, UT. FILED 1-17-2012.

Genealogy Sleuth

THE MARK CONSISTS OF STANDARD CHARACTERS WITHOUT CLAIM TO ANY PARTICULAR FONT, STYLE, SIZE, OR COLOR.

NO CLAIM IS MADE TO THE EXCLUSIVE RIGHT TO USE "GENEALOGY", APART FROM THE MARK AS SHOWN.

FOR PROVISION OF GENEALOGICAL INFORMATION, NAMELY, PROVISION OF EDUCATIONAL, RESEARCH AND HISTORICAL TABLES OF GENEALOGICAL INFORMATION; PROVIDING GENEALOGICAL INFORMATION, NAMELY, FAMILY HISTORY INFORMATION SERVICES, NAMELY, RETRIEVING, RECORDING AND REVIEWING ANCESTRAL DATA VIA THE GLOBAL COMPUTER NETWORK; CONSULTANCY, INFORMATION AND ADVISORY SERVICES RELATING TO THE AFORESAID; AND PROVIDING AN ON-LINE COMPUTER DATABASE IN THE FIELD OF GENEALOGY INFORMATION AND FAMILY HISTORY INFORMATION; PROVIDING A WEBSITE FEATURING LINKS TO THIRD PARTY WEBSITES FEATURING SEARCH ENGINES, DATABASES, SOFTWARE TOOLS, DIRECTORIES, WEB SITES, AND HISTORICAL RECORDS IN THE FIELD OF GENEALOGICAL AND FAMILY HISTORY INFORMATION (U.S. CLS. 100 AND 101).

FIRST USE 1-16-2000; IN COMMERCE 1-16-2000.

LEIGH CAROLINE CASE, EXAMINING ATTORNEY

SN 85-503,422. COVERT, JAY, DBA URBAN OUTREACH, TROY, IL. FILED 12-23-2011.

URBAN OUTREACH

THE MARK CONSISTS OF STANDARD CHARACTERS WITHOUT CLAIM TO ANY PARTICULAR FONT, STYLE, SIZE, OR COLOR.

NO CLAIM IS MADE TO THE EXCLUSIVE RIGHT TO USE "OUTREACH", APART FROM THE MARK AS SHOWN.

SEC. 2(F).

FOR RELIGIOUS SERVICES, NAMELY, PROVIDING MINISTERIAL AND EVANGELICAL SERVICES (U.S. CLS. 100 AND 101).

FIRST USE 2-15-1995; IN COMMERCE 2-15-1995.

NAPOLEON SHARMA, EXAMINING ATTORNEY

CLASS 45—(Continued).

SN 85-517,939. BOWDITCH & DEWEY, LLP, WORCESTER, MA. FILED 1-17-2012.

BOWDITCH & DEWEY

THE MARK CONSISTS OF STANDARD CHARACTERS WITHOUT CLAIM TO ANY PARTICULAR FONT, STYLE, SIZE, OR COLOR.

FOR LEGAL SERVICES (U.S. CLS. 100 AND 101).
FIRST USE 10-1-1977; IN COMMERCE 10-1-1977.
MEGHAN REINHART, EXAMINING ATTORNEY

SN 85-520,031. HYMAN, STEPHANIE R., WILMINGTON, DE. FILED 1-19-2012.

**A&M Pet Sitting, The
Boarding Alternative LLC**

THE MARK CONSISTS OF STANDARD CHARACTERS WITHOUT CLAIM TO ANY PARTICULAR FONT, STYLE, SIZE, OR COLOR.

NO CLAIM IS MADE TO THE EXCLUSIVE RIGHT TO USE "PET SITTING THE BOARDING ALTERNATIVE LLC", APART FROM THE MARK AS SHOWN.

FOR PET SITTING (U.S. CLS. 100 AND 101).
FIRST USE 11-14-2011; IN COMMERCE 11-14-2011.
MEGHAN REINHART, EXAMINING ATTORNEY

SN 85-521,841. REVEREND EUNICE COLDMAN MINISTRIES LLC, ELMONT, NY. FILED 1-20-2012.



THE MARK CONSISTS OF A CIRCLE WITH FOUR BARS CROSSING IT HORIZONTALLY. THERE IS A STYLIZED FIGURE IN THE CENTER OF THE CIRCLE THAT LOOKS SEATED WITH AN EMBLEM ON THE FRONT THAT LOOKS LIKE A FOOTBALL GOALPOST. THE FIGURE IS TOUCHING A PLANT. THERE IS A ZIG ZAG LINE IN THE LOWER PORTION OF THE CIRCLE.

FOR MINISTERIAL SERVICES; SPIRITUAL COUNSELING SERVICES; SPIRITUAL SERVICES, NAMELY, PROVIDING GATHERINGS TO DEVELOP AND ENHANCE THE SPIRITUAL LIVES OF INDIVIDUALS AND CONDUCTING SPIRITUAL CEREMONIES IN THIS REGARD (U.S. CLS. 100 AND 101).

FIRST USE 1-4-2012; IN COMMERCE 1-4-2012.
ZHALEH DELANEY, EXAMINING ATTORNEY

CLASS 45—(Continued).

SN 85-521,964. GAIL'S GRAVITATIONAL FORCE, NEW YORK, NY. FILED 1-21-2012.

THE TRADEMARK TATTLER

THE MARK CONSISTS OF STANDARD CHARACTERS WITHOUT CLAIM TO ANY PARTICULAR FONT, STYLE, SIZE, OR COLOR.

NO CLAIM IS MADE TO THE EXCLUSIVE RIGHT TO USE "TRADEMARK", APART FROM THE MARK AS SHOWN.

FOR LEGAL SERVICES, NAMELY, CREATING NAMES AND SLOGANS AND FILING TRADEMARK APPLICATIONS (U.S. CLS. 100 AND 101).
AHSEN KHAN, EXAMINING ATTORNEY

SN 85-522,266. LUCKY BUDDY PETCARE, SACRAMENTO, CA. FILED 1-22-2012.



NO CLAIM IS MADE TO THE EXCLUSIVE RIGHT TO USE "PETCARE", APART FROM THE MARK AS SHOWN.

THE MARK CONSISTS OF A CLOVER SHAPE MADE UP OF CANINE NOSE SHAPES AND A STEM, THE STYLIZED WORDING "LUCKY BUDDY" WITH HORIZONTAL LINE ABOVE AND BELOW THE WORDING, AND THE STYLIZED WORDING "PETCARE".

FOR PET SITTING (U.S. CLS. 100 AND 101).
FIRST USE 1-20-2012; IN COMMERCE 1-20-2012.
JEAN IM, EXAMINING ATTORNEY

SN 85-523,813. NATIONAL ORGANIZATION FOR RARE DISORDERS, INC., DANBURY, CT. FILED 1-24-2012.

RareConnect

THE MARK CONSISTS OF STANDARD CHARACTERS WITHOUT CLAIM TO ANY PARTICULAR FONT, STYLE, SIZE, OR COLOR.

FOR ONLINE SOCIAL NETWORKING SERVICES IN THE AREA OF RARE DISEASES AND DISORDERS (U.S. CLS. 100 AND 101).

COLLEEN DOMBROW, EXAMINING ATTORNEY

CLASS 45—(Continued).

SN 85-524,296. GONZALEZ, JUAN CARLOS, WESTLAKE VILLAGE, CA. FILED 1-24-2012.

ENFOQUE

THE MARK CONSISTS OF STANDARD CHARACTERS WITHOUT CLAIM TO ANY PARTICULAR FONT, STYLE, SIZE, OR COLOR.

THE ENGLISH TRANSLATION OF THE WORD "ENFOQUE" IN THE MARK IS "FOCUS".

FOR LEGAL SERVICES (U.S. CLS. 100 AND 101).

FIRST USE 1-15-2012; IN COMMERCE 1-15-2012.

KATHERINE CONNOLLY, EXAMINING ATTORNEY

CLASS 45—(Continued).

SN 85-530,951. BRIAN KENNY, WILTON, CT. FILED 2-1-2012.

WEEBITS

THE MARK CONSISTS OF STANDARD CHARACTERS WITHOUT CLAIM TO ANY PARTICULAR FONT, STYLE, SIZE, OR COLOR.

FOR CARTOON CHARACTER LICENSING (U.S. CLS. 100 AND 101).

COLLEEN DOMBROW, EXAMINING ATTORNEY

SN 85-526,357. WINSTON & CASHATT, LAWYERS, A PROFESSIONAL SERVICE CORPORATION, AKA WINSTON & CASHATT; WINSTON & CASHATT, LAWYERS, SPOKANE, WA. FILED 1-26-2012.

**Winston & Cashatt,
Lawyers, A Professional
Service Corporation**

THE MARK CONSISTS OF STANDARD CHARACTERS WITHOUT CLAIM TO ANY PARTICULAR FONT, STYLE, SIZE, OR COLOR.

NO CLAIM IS MADE TO THE EXCLUSIVE RIGHT TO USE "LAWYERS, A PROFESSIONAL SERVICE CORPORATION", APART FROM THE MARK AS SHOWN.

FOR LEGAL SERVICES (U.S. CLS. 100 AND 101).

FIRST USE 9-20-1978; IN COMMERCE 9-20-1978.

KARANENDRA S. CHHINA, EXAMINING ATTORNEY

SN 85-531,116. ZENCOLOR CORPORATION, WILMINGTON, DE. FILED 2-1-2012.

Hue and Harmony

THE MARK CONSISTS OF STANDARD CHARACTERS WITHOUT CLAIM TO ANY PARTICULAR FONT, STYLE, SIZE, OR COLOR.

FOR COLOR ANALYSIS FOR WARDROBE AND FASHION SELECTION (U.S. CLS. 100 AND 101).

FIRST USE 1-10-2009; IN COMMERCE 1-10-2009.

FONG HSU, EXAMINING ATTORNEY

SN 85-529,341. PETS FOR PATRIOTS, INC., LONG BEACH, NY. FILED 1-31-2012.

PETS FOR PATRIOTS

THE MARK CONSISTS OF STANDARD CHARACTERS WITHOUT CLAIM TO ANY PARTICULAR FONT, STYLE, SIZE, OR COLOR.

NO CLAIM IS MADE TO THE EXCLUSIVE RIGHT TO USE "PETS", APART FROM THE MARK AS SHOWN.

FOR ADOPTIONS SERVICES OF DOMESTIC COMPANION ANIMALS (U.S. CLS. 100 AND 101).

FIRST USE 1-0-2010; IN COMMERCE 1-0-2010.

DAWN HAN, EXAMINING ATTORNEY

SN 85-531,393. OFFIT KURMAN, P.A., AKA OFFIT KURMAN, MAPLE LAWN, MD. FILED 2-1-2012.

**The sign on our door reads
"Attorneys At Law." But to
our clients, we're much
more.**

THE MARK CONSISTS OF STANDARD CHARACTERS WITHOUT CLAIM TO ANY PARTICULAR FONT, STYLE, SIZE, OR COLOR.

FOR LEGAL SERVICES (U.S. CLS. 100 AND 101).

FIRST USE 9-0-2005; IN COMMERCE 9-0-2005.

JEAN IM, EXAMINING ATTORNEY

CLASS 45—(Continued).

SN 85-531,618. LES ENTREPRISES PERPIGNAND CORP., DBA ANGRYSTUDENTS, MIAMI, FL. FILED 2-1-2012.

AngryStudents

THE MARK CONSISTS OF STANDARD CHARACTERS WITHOUT CLAIM TO ANY PARTICULAR FONT, STYLE, SIZE, OR COLOR.
FOR ON-LINE SOCIAL NETWORKING SERVICES (U.S. CLS. 100 AND 101).
FIRST USE 11-28-2011; IN COMMERCE 11-28-2011.
MATTHEW KLINE, EXAMINING ATTORNEY

SN 85-531,752. COUPLES FOR CHRIST, METROPOLITAN-WASHINGTON, D.C., INCORPORATED, GAITHERSBURG, MD. FILED 2-2-2012.

Parejas Para Cristo

THE MARK CONSISTS OF STANDARD CHARACTERS WITHOUT CLAIM TO ANY PARTICULAR FONT, STYLE, SIZE, OR COLOR.
THE ENGLISH TRANSLATION OF PAREJAS PARA CRISTO IN THE MARK IS COUPLES FOR CHRIST.
FOR RELIGIOUS AND SPIRITUAL SERVICES, NAMELY, PROVIDING GATHERINGS AND RETREATS TO DEVELOP AND ENHANCE THE SPIRITUAL LIVES OF INDIVIDUALS (U.S. CLS. 100 AND 101).
FIRST USE 1-21-2011; IN COMMERCE 1-21-2011.
MIDGE BUTLER, EXAMINING ATTORNEY

SN 85-531,960. WHITE, JOHNNA K., DBA PSYCHIC JOHNNA, BRADENTON, MA. FILED 2-2-2012.

Psychic Johnna

THE MARK CONSISTS OF STANDARD CHARACTERS WITHOUT CLAIM TO ANY PARTICULAR FONT, STYLE, SIZE, OR COLOR.
FOR PSYCHIC READING SERVICES; TAROT CARD READING SERVICES (U.S. CLS. 100 AND 101).
FIRST USE 1-1-2011; IN COMMERCE 11-1-2011.
JAY FLOWERS, EXAMINING ATTORNEY

CLASS 45—(Continued).

SN 85-531,968. HICKEY, ASHLEY, MIAMI, FL. FILED 2-2-2012.

Fresh Heirs

THE MARK CONSISTS OF STANDARD CHARACTERS WITHOUT CLAIM TO ANY PARTICULAR FONT, STYLE, SIZE, OR COLOR.
FOR FASHION CONSULTING SERVICES (U.S. CLS. 100 AND 101).
JAY FLOWERS, EXAMINING ATTORNEY

SN 85-531,993. HEBEL, INC., FAYETTEVILLE, GA. FILED 2-2-2012.

FORGIVING
FORWARD
Unleashing the Forgiveness Revolution

THE MARK CONSISTS OF THE STYLIZED TEXT "FORGIVING" ABOVE THE STYLIZED TEXT "FOR ARD" WITH A HORIZONTAL LINE TO THE LEFT OF THE TEXT AND A FAST FORWARD SYMBOL, TWO TRIANGLES, BETWEEN THE FIRST LETTER "R" AND THE LETTER "A". BELOW THIS TEXT IS THE STYLIZED TEXT "UNLEASHING THE FORGIVENESS REVOLUTION".
FOR CHRISTIAN MINISTRY SERVICES (U.S. CLS. 100 AND 101).
FIRST USE 5-0-2009; IN COMMERCE 2-21-2010.
GISELLE AGOSTO, EXAMINING ATTORNEY

SN 85-532,205. EE FOR LIFE, LLC, COLONIA, NJ. FILED 2-2-2012.

CHICKS WITH MAGNETUDE

THE MARK CONSISTS OF STANDARD CHARACTERS WITHOUT CLAIM TO ANY PARTICULAR FONT, STYLE, SIZE, OR COLOR.
OWNER OF U.S. REG. NO. 3,729,624.
FOR ON-LINE SOCIAL NETWORKING SERVICES (U.S. CLS. 100 AND 101).
SUSAN LESLIE DUBOIS, EXAMINING ATTORNEY

CLASS 45—(Continued).

SN 85-532,301. EKEHOLM AND ASSOCIATES, LLC, ALPHARETTA, GA. FILED 2-2-2012.

SCREENSAFE

THE MARK CONSISTS OF STANDARD CHARACTERS WITHOUT CLAIM TO ANY PARTICULAR FONT, STYLE, SIZE, OR COLOR.

OWNER OF U.S. REG. NO. 2,979,711.

FOR BACKGROUND INVESTIGATION AND RESEARCH SERVICES; BACKGROUND INVESTIGATION SERVICES; DETECTIVE INVESTIGATIONS; DMV RECORD INVESTIGATION SERVICES; EMPLOYEE MISCONDUCT INVESTIGATION SERVICES; INFIDELITY INVESTIGATION SERVICES IN THE FIELD OF PERSONAL RELATIONSHIPS; INVESTIGATION OF ASSETS, CREDIT REPORTS, FISCAL ASSESSMENTS, AND COLLECTION REPORTS FOR SECURITY OR AUTHENTICATION PURPOSES; INVESTIGATION OR SURVEILLANCE ON BACKGROUND PROFILES; INVESTIGATION SERVICES RELATED TO INSURANCE CLAIMS; ON-LINE IDENTITY RELIABILITY INVESTIGATION IN THE FIELD OF ON-LINE DATING AND CLAIMS MADE ABOUT AGE, GENDER; PERSONAL BACKGROUND INVESTIGATIONS; PRE-EMPLOYMENT BACKGROUND INVESTIGATION SERVICES; PRIVATE INVESTIGATION; PUBLIC RECORD INVESTIGATION SERVICES; WORKERS COMPENSATION FRAUD INVESTIGATION SERVICES (U.S. CLS. 100 AND 101).

FIRST USE 12-5-2003; IN COMMERCE 12-5-2003.
KIMBERLY PERRY, EXAMINING ATTORNEY

SN 85-532,419. JURISTAFF, INC., PHILADELPHIA, PA. FILED 2-2-2012.

JURISOLUTIONS

THE MARK CONSISTS OF STANDARD CHARACTERS WITHOUT CLAIM TO ANY PARTICULAR FONT, STYLE, SIZE, OR COLOR.

OWNER OF U.S. REG. NOS. 2,216,292 AND 3,480,451.
FOR LEGAL SERVICES (U.S. CLS. 100 AND 101).
JOHN DWYER, EXAMINING ATTORNEY

CLASS 45—(Continued).

SN 85-532,584. CARTER MARIO INJURY LAWYERS, P.C., MILFORD, CT. FILED 2-2-2012.

CARTER MARIO INJURY LAWYERS

THE MARK CONSISTS OF STANDARD CHARACTERS WITHOUT CLAIM TO ANY PARTICULAR FONT, STYLE, SIZE, OR COLOR.

NO CLAIM IS MADE TO THE EXCLUSIVE RIGHT TO USE "INJURY LAWYERS", APART FROM THE MARK AS SHOWN.

THE NAME(S), PORTRAIT(S), AND/OR SIGNATURE(S) SHOWN IN THE MARK IDENTIFIES CARTER MARIO, WHOSE CONSENT(S) TO REGISTER IS MADE OF RECORD.

FOR LEGAL SERVICES (U.S. CLS. 100 AND 101).
FIRST USE 6-1-2002; IN COMMERCE 6-1-2002.
RONALD MCMORROW, EXAMINING ATTORNEY

SN 85-532,612. MCDIVITT LAW FIRM, P.C., COLORADO SPRINGS, CO. FILED 2-2-2012.

MCDIVITT LAW FIRM

THE MARK CONSISTS OF STANDARD CHARACTERS WITHOUT CLAIM TO ANY PARTICULAR FONT, STYLE, SIZE, OR COLOR.

NO CLAIM IS MADE TO THE EXCLUSIVE RIGHT TO USE "LAW FIRM", APART FROM THE MARK AS SHOWN.

FOR LEGAL SERVICES (U.S. CLS. 100 AND 101).
FIRST USE 11-5-1993; IN COMMERCE 11-5-1993.
SUSAN STIGLITZ, EXAMINING ATTORNEY

SN 85-532,763. UNITEDHEALTH GROUP INCORPORATED, MINNETONKA, MN. FILED 2-2-2012.

MYX

THE MARK CONSISTS OF STANDARD CHARACTERS WITHOUT CLAIM TO ANY PARTICULAR FONT, STYLE, SIZE, OR COLOR.

FOR INTERNET BASED INTRODUCTION AND SOCIAL NETWORKING SERVICES FOR THE HEALTHCARE AND MEDICAL COMMUNITY; PROVIDING ON-LINE COMPUTER DATABASES AND ON-LINE SEARCHABLE DATABASES IN THE FIELD OF SOCIAL NETWORKING FOR THE HEALTHCARE AND MEDICAL COMMUNITY (U.S. CLS. 100 AND 101).

MATTHEW EINSTEIN, EXAMINING ATTORNEY

CLASS 45—(Continued).

SN 85-532,951. MCDIVITT LAW FIRM, P.C., COLORADO SPRINGS, CO. FILED 2-3-2012.

MCDIVITT MAKES A DIFFERENCE

THE MARK CONSISTS OF STANDARD CHARACTERS WITHOUT CLAIM TO ANY PARTICULAR FONT, STYLE, SIZE, OR COLOR.

FOR LEGAL SERVICES (U.S. CLS. 100 AND 101).
FIRST USE 1-21-2010; IN COMMERCE 1-21-2010.
SUSAN STIGLITZ, EXAMINING ATTORNEY

SN 85-533,176. KWINK, LLC, SCOTTSDALE, AZ. FILED 2-3-2012.



OWNER OF U.S. REG. NO. 4,026,500.
THE MARK CONSISTS OF THE WORD "KWINK" WITH A TILDE-SHAPED EYELID ABOVE THE WORD AND A CIRCULAR EYE FORMING THE DOT ON THE LETTER "I".
FOR COMPUTER DATING SERVICES (U.S. CLS. 100 AND 101).
FIRST USE 5-17-2011; IN COMMERCE 5-17-2011.
ANDREW LEASER, EXAMINING ATTORNEY

SN 85-533,395. BROCADIAN PLCC, DBA BROCADIAN LEGAL, ALEXANDRIA, VA. FILED 2-3-2012.

BROCADIAN LEGAL

THE MARK CONSISTS OF STANDARD CHARACTERS WITHOUT CLAIM TO ANY PARTICULAR FONT, STYLE, SIZE, OR COLOR.

OWNER OF U.S. REG. NOS. 3,726,627 AND 3,806,671.
NO CLAIM IS MADE TO THE EXCLUSIVE RIGHT TO USE "LEGAL", APART FROM THE MARK AS SHOWN.
FOR LEGAL SERVICES (U.S. CLS. 100 AND 101).
KEVON CHISOLM, EXAMINING ATTORNEY

CLASS 45—(Continued).

SN 85-533,492. PERFECT5 INC., CATHEDRAL CITY, CA. FILED 2-3-2012.

MYFLASHHOUSE

THE MARK CONSISTS OF STANDARD CHARACTERS WITHOUT CLAIM TO ANY PARTICULAR FONT, STYLE, SIZE, OR COLOR.

FOR ON-LINE SOCIAL NETWORKING SERVICES (U.S. CLS. 100 AND 101).
JOSETTE BEVERLY, EXAMINING ATTORNEY

SN 85-533,518. SHARELENDAR, INC., LAND O'LAKES, FL. FILED 2-3-2012.

SHARELENDAR

THE MARK CONSISTS OF STANDARD CHARACTERS WITHOUT CLAIM TO ANY PARTICULAR FONT, STYLE, SIZE, OR COLOR.

FOR ONLINE SOCIAL NETWORKING SERVICES PROVIDED THROUGH A COMMUNITY WEBSITE (U.S. CLS. 100 AND 101).
FIRST USE 5-23-2011; IN COMMERCE 5-23-2011.
FONG HSU, EXAMINING ATTORNEY

SN 85-534,307. CHRISTENSEN, MARCI N., DBA LOVE2SHINE4U, SCOTTSDALE, AZ. FILED 2-5-2012.

Love2shine4U

THE MARK CONSISTS OF STANDARD CHARACTERS WITHOUT CLAIM TO ANY PARTICULAR FONT, STYLE, SIZE, OR COLOR.

FOR CHRISTIAN MINISTRY SERVICES (U.S. CLS. 100 AND 101).
DAVID I, EXAMINING ATTORNEY

CLASS 45—(Continued).

SN 85-534,594. ATHLETICCONNECT, LLC, IRVING, TX. FILED 2-6-2012.

athletiConnect

THE MARK CONSISTS OF STANDARD CHARACTERS WITHOUT CLAIM TO ANY PARTICULAR FONT, STYLE, SIZE, OR COLOR.
FOR ON-LINE SOCIAL NETWORKING SERVICES (U.S. CLS. 100 AND 101).
FIRST USE 12-15-2011; IN COMMERCE 12-15-2011.
ANNE MADDEN, EXAMINING ATTORNEY

SN 85-535,523. CORRI FETMAN & ASSOCIATES, LTD., CHICAGO, IL. FILED 2-7-2012.

HOW CIVIL IS YOUR UNION?

THE MARK CONSISTS OF STANDARD CHARACTERS WITHOUT CLAIM TO ANY PARTICULAR FONT, STYLE, SIZE, OR COLOR.
FOR LEGAL SERVICES (U.S. CLS. 100 AND 101).
FIRST USE 11-3-2011; IN COMMERCE 11-3-2011.
JESSICA FATHY, EXAMINING ATTORNEY

SN 85-535,604. ENNIS, JENNIFER, RALEIGH, NC. FILED 2-7-2012.

JourneyMates

THE MARK CONSISTS OF THE WORDS, JOURNEY-MATES, AS ONE WORD, IN A EDWARDIANSCRIPT ITC FONT.
FOR RELIGIOUS AND SPIRITUAL SERVICES, NAMELY, PROVIDING GATHERINGS AND RETREATS TO DEVELOP AND ENHANCE THE SPIRITUAL LIVES OF INDIVIDUALS; SPIRITUAL COUNSELING (U.S. CLS. 100 AND 101).
FIRST USE 1-1-2006; IN COMMERCE 1-1-2006.
TOBY BULLOFF, EXAMINING ATTORNEY

CLASS 45—(Continued).

SN 85-535,658. IMMERSION PROJECT, FORT MYERS, FL. FILED 2-7-2012.

LOCALS KNOW

THE MARK CONSISTS OF STANDARD CHARACTERS WITHOUT CLAIM TO ANY PARTICULAR FONT, STYLE, SIZE, OR COLOR.
FOR PROVIDING AN ONLINE SOCIAL NETWORKING SERVICE FOR USERS TO CAPTURE AND SHARE STORIES THAT CAN BE COLLABORATIVELY ORGANIZED INTO GROUPS BASED ON SYSTEM OR USER DEFINED THEMES (U.S. CLS. 100 AND 101).
GRETTA YAO, EXAMINING ATTORNEY

SN 85-535,687. BLACKTOUCH... LLC, BROOKLYN, NY. FILED 2-7-2012.



THE MARK CONSISTS OF A STYLIZED CAPITAL "B".
FOR SECURITY GUARD SERVICES (U.S. CLS. 100 AND 101).
JULIE WATSON, EXAMINING ATTORNEY

SN 85-536,374. PEAR INNOVATIONS, LLC, AUSTIN, TX. FILED 2-7-2012.

PearHaven

THE MARK CONSISTS OF STANDARD CHARACTERS WITHOUT CLAIM TO ANY PARTICULAR FONT, STYLE, SIZE, OR COLOR.
FOR ON-LINE SOCIAL NETWORKING SERVICES (U.S. CLS. 100 AND 101).
FIRST USE 10-15-2011; IN COMMERCE 12-16-2011.
MARK T. MULLEN, EXAMINING ATTORNEY

CLASS 45—(Continued).

SN 85-536,416. PECK, RYON, LOS ANGELES, CA. FILED 2-7-2012.



THE MARK CONSISTS OF THE LETTERS "VQ", WITH GRASS GROWING OUT OF THE V AND THE A LEAF MAKING THE LETTER Q WITH A DROP OF WATER AT THE TIP OF THE LEAF. TO THE RIGHT OF THE DESIGN IS THE TEXT "VEGGIEQUARIAN CONSCIOUS FOOD FOR THE SOUL".

FOR ONLINE SOCIAL NETWORKING SERVICES IN THE FIELD OF HEALTH, NUTRITION, AND WELLNESS PROVIDED VIA A WEBSITE (U.S. CLS. 100 AND 101).

FIRST USE 7-13-2011; IN COMMERCE 7-13-2011.
GEOFFREY FOSDICK, EXAMINING ATTORNEY

SN 85-536,435. REMAIN AT HOME SENIOR CARE, ATHENS, GA. FILED 2-7-2012.

keeping the promise of
independence

THE MARK CONSISTS OF STANDARD CHARACTERS WITHOUT CLAIM TO ANY PARTICULAR FONT, STYLE, SIZE, OR COLOR.

FOR IN-HOME SUPPORT SERVICES TO SENIOR PERSONS, NAMELY, GERIATRIC CARE MANAGEMENT SERVICES IN THE NATURE OF THE COORDINATION OF NECESSARY SERVICES AND PERSONAL CARE FOR OLDER INDIVIDUALS; PERSONAL CARE ASSISTANCE OF ACTIVITIES OF DAILY LIVING, SUCH AS BATHING, GROOMING AND PERSONAL MOBILITY FOR MENTALLY OR PHYSICALLY CHALLENGED PEOPLE; PROVIDING NON-MEDICAL ASSISTED LIVING SERVICES FOR PERSONAL PURPOSES IN THE NATURE OF SCHEDULING APPOINTMENTS, ANSWERING THE TELEPHONE, CHECKING MESSAGES, MAIL SORTING, MAIL HANDLING, MAIL RECEIVING AND SECRETARIAL AND CLERICAL SERVICES; PROVIDING NON-MEDICAL IN-HOME PERSONAL SERVICES FOR INDIVIDUALS INCLUDING CHECKING HOME CONDITION, SUPPLIES AND INDIVIDUAL WELL-BEING, SCHEDULING APPOINTMENTS, RUNNING ERRANDS, MAKING SAFETY CHECKS, AND PROVIDING ON-LINE INFORMATION RELATED TO THESE PERSONAL SERVICES; PROVIDING NON-MEDICAL PERSONAL ASSISTANT SERVICES FOR OTHERS IN THE NATURE OF PLANNING, ORGANIZING, COORDINATING, ARRANGING AND ASSISTING INDIVIDUALS TO PERFORM DAILY TASKS (U.S. CLS. 100 AND 101).

KHANH LE, EXAMINING ATTORNEY

CLASS 45—(Continued).

SN 85-536,730. DC GOLF, COLORADO SPRINGS, CO. FILED 2-8-2012.

mygolfpad

THE MARK CONSISTS OF STANDARD CHARACTERS WITHOUT CLAIM TO ANY PARTICULAR FONT, STYLE, SIZE, OR COLOR.

FOR ONLINE SOCIAL NETWORKING SERVICES IN THE FIELD OF GOLF (U.S. CLS. 100 AND 101).
NAPOLEON SHARMA, EXAMINING ATTORNEY

SN 85-536,800. BLOCMATE, INC., CAMBRIDGE, MA. FILED 2-8-2012.

Blocmate

THE MARK CONSISTS OF STANDARD CHARACTERS WITHOUT CLAIM TO ANY PARTICULAR FONT, STYLE, SIZE, OR COLOR.

FOR INTERNET-BASED SOCIAL NETWORKING SERVICES; ON-LINE SOCIAL NETWORKING SERVICES (U.S. CLS. 100 AND 101).

FIRST USE 11-30-2010; IN COMMERCE 3-31-2011.
NAKIA HENRY, EXAMINING ATTORNEY

CLASS 45—(Continued).

SN 85-537,018. NTD PATENT & TRADEMARK AGENCY LIMITED, TSMHSATSUI E, KOWLOON, HONG KONG, FILED 2-8-2012.



NO CLAIM IS MADE TO THE EXCLUSIVE RIGHT TO USE "INTELLECTUAL PROPERTY", APART FROM THE MARK AS SHOWN.

THE MARK CONSISTS OF THE WORDS "NTD INTELLECTUAL PROPERTY" AND A STYLIZED DESIGN OF A LETTER "N"; IN THE MIDDLE OF THE LETTER "N" ALSO CONSIST OF CURVE LINES; THE LETTER "N" DESIGN IS PARTIALLY SHADED.

FOR INTELLECTUAL PROPERTY CONSULTATION; LEGAL CONSULTATION SERVICES; LEGAL SERVICES; LITIGATION CONSULTATION; LITIGATION SUPPORT SERVICES; PATENT AGENT SERVICES; PATENT AND INDUSTRIAL PROPERTY CONSULTATION; PROVIDING ASSISTANCE IN THE PROSECUTION OF TRADEMARK APPLICATIONS; PROVIDING INFORMATION RELATING TO LEGAL AFFAIRS; PROVIDING INFORMATION ABOUT INTELLECTUAL AND INDUSTRIAL PROPERTY RIGHTS; PROVIDING INFORMATION IN THE FIELD OF INTELLECTUAL PROPERTY; PROVIDING INFORMATION IN THE FIELD OF INTELLECTUAL PROPERTY LEGAL SERVICES; TRADEMARK WATCH SERVICES; ARBITRATION SERVICES; CONSULTING IN THE FIELD OF INTELLECTUAL PROPERTY LICENSING; COPYRIGHT MANAGEMENT CONSULTATION; DOMAIN NAME REGISTRATION SERVICES; INTELLECTUAL PROPERTY WATCH SERVICES; INVESTIGATION OR SURVEILLANCE ON BACKGROUND PROFILES; LEGAL DOCUMENT PREPARATION AND RESEARCH SERVICES FOR ATTORNEYS; LEGAL RESEARCH; LICENSING OF COMPUTER SOFTWARE (LEGAL SERVICES); LICENSING OF INTELLECTUAL PROPERTY (LEGAL SERVICES); ON-SITE LEGAL SERVICES; PARALEGAL SERVICES; PATENT LICENSING (LEGAL SERVICES); PERSONAL BACKGROUND INVESTIGATIONS; PROVIDING A WEB SITE FEATURING INFORMATION ABOUT PATENTS AND PATENT APPLICATIONS; PROVIDING AN ON-LINE INTERACTIVE DATABASE FEATURING LEGAL INFORMATION; PROVIDING ON-LINE INFORMATION AND NEWS IN THE FIELD OF LAW; PROVIDING ON-LINE INFORMATION IN THE FIELD OF INTELLECTUAL PROPERTY; PROVIDING ON-LINE INFORMATION IN THE FIELD OF INTELLECTUAL PROPERTY LEGAL SERVICES (U.S. CLS. 100 AND 101).
FIRST USE 6-26-1987; IN COMMERCE 9-8-1997.
SANDRA BUJA, EXAMINING ATTORNEY

CLASS 45—(Continued).

SN 85-537,539. SUDDENLY ORGANIZED LLC, SOUTHAMPTON, NJ. FILED 2-8-2012.

Suddenly Organized

THE MARK CONSISTS OF STANDARD CHARACTERS WITHOUT CLAIM TO ANY PARTICULAR FONT, STYLE, SIZE, OR COLOR.

FOR ORGANIZATIONAL SERVICES FOR HOME OR PERSONAL PURPOSES, NAMELY, ORGANIZING HOME AND LIVING SPACE (U.S. CLS. 100 AND 101).
FIRST USE 9-1-2011; IN COMMERCE 1-1-2012.
VIVIAN MICZNIK FIRST, EXAMINING ATTORNEY

SN 85-537,622. CLARENCE E. MCCLENDON MINISTRIES FULL HARVEST INTERNATIONAL CHURCH, FORMERLY HARVEST FIRE INCORPORATION, LOS ANGELES, CA. FILED 2-8-2012.



THE COLOR(S) BLACK, MUTED GOLD, PURPLE, VANILLA CREAM IS/ARE CLAIMED AS A FEATURE OF THE MARK.

THE MARK CONSISTS OF PURPLE LINES ENCIRCLING BLACK LINES THAT ENCIRCLE A STYLIZED SHIELD EMBOSSED WITH SLANTED MUTED GOLD AND VANILLA CREAM QUADRILATERALS WITH THE APPEARANCE OF RAYS OVERLAYED WITH PURPLE STYLIZED GEOMETRIC FIGURES FORMING FACING HANDS, THE PURPLE WORDS AND LETTERS "PRAYERFORCE", A PURPLE QUADRILATERAL WITH THE WORDS "A CALL TO ACTION" IN GOLD LETTERS, VANILLA CREAM QUADRILATERAL WITH A MUTED GOLD ARROWED-END CROSS, BARS AND LINES.

FOR CHRISTIAN MINISTRY SERVICES (U.S. CLS. 100 AND 101).

FIRST USE 4-26-2001; IN COMMERCE 4-26-2001.
DOUGLAS LEE, EXAMINING ATTORNEY

CLASS 45—(Continued).

SN 85-537,757. GOBA LLC, NASHVILLE, TN. FILED 2-8-2012.

LIFE IS BETTER WITH FRIENDS

THE MARK CONSISTS OF STANDARD CHARACTERS WITHOUT CLAIM TO ANY PARTICULAR FONT, STYLE, SIZE, OR COLOR.

FOR ON-LINE SOCIAL NETWORKING SERVICES (U.S. CLS. 100 AND 101).

FIRST USE 6-6-2011; IN COMMERCE 6-6-2011.

ERNEST SHOSHO, EXAMINING ATTORNEY

SN 85-537,855. BELLAMY, STEVE, SUMMERLAND, CA. FILED 2-9-2012.



THE COLOR(S) BLUE, RED, GRAY, YELLOW AND WHITE IS/ARE CLAIMED AS A FEATURE OF THE MARK.

THE MARK CONSISTS OF A STYLIZED RED LETTER "F", CASTING A GRAY SHADOW. TO THE RIGHT OF THE LETTER F, IS A BLUE STYLIZED DOG WITH WHITE AND BLUE EYE, A RED TONGUE, A RED COLLAR WITH A CIRCULAR YELLOW NAME TAG ATTACHED, CASTING A GRAY SHADOW. THERE ARE SMALL BLUE MARKS NEXT TO EITHER SIDE OF THE TAIL TO INDICATE THE TAIL IS WAGGING. TO THE RIGHT OF THE DOG, IS THE RED STYLIZED WORD "FUNVITE.COM". ABOVE THE SMALLER BLUE STYLIZED WORDS "THE FUN WAY TO SAY LET'S PLAY".

FOR ON-LINE SOCIAL NETWORKING SERVICES (U.S. CLS. 100 AND 101).

FIRST USE 1-1-2012; IN COMMERCE 1-1-2012.

KARANENDRA S. CHHINA, EXAMINING ATTORNEY

SN 85-537,913. SEGAL, NANCY LEE, COLUMBUS, OH. FILED 2-9-2012.

Phoetics

THE MARK CONSISTS OF STANDARD CHARACTERS WITHOUT CLAIM TO ANY PARTICULAR FONT, STYLE, SIZE, OR COLOR.

FOR SPIRITUAL COUNSELING (U.S. CLS. 100 AND 101).

FIRST USE 10-1-2009; IN COMMERCE 2-1-2010.

SIMON TENG, EXAMINING ATTORNEY

CLASS 45—(Continued).

SN 85-538,184. CORASH & HOLLENDER, P.C., STATEN ISLAND, NY. FILED 2-9-2012.



THE MARK CONSISTS OF A CONTOUR OF A FERRY BOAT WITH THE LITERAL ELEMENT "SILAWFIRM.COM" INSIDE OF THE MARK.

FOR ATTORNEY SERVICES; LEGAL CONSULTATION SERVICES; LEGAL SERVICES (U.S. CLS. 100 AND 101).

FIRST USE 0-0-1999; IN COMMERCE 0-0-1999.

NAKWAMA ANKRAH, EXAMINING ATTORNEY

SN 85-538,515. GLOBAL ALPHABET, INC., SUNNYVALE, CA. FILED 2-9-2012.

BIGCHURCH.COM

THE MARK CONSISTS OF STANDARD CHARACTERS WITHOUT CLAIM TO ANY PARTICULAR FONT, STYLE, SIZE, OR COLOR.

FOR COMPUTER DATING SERVICES; PROVIDING AN ON-LINE ELECTRONIC DATABASE ON GLOBAL COMPUTER NETWORKS IN THE FIELD OF INTERPERSONAL RELATIONSHIPS; ON-LINE SOCIAL NETWORKING SERVICES AND DATING SERVICES; PROVIDING AN ON-LINE COMPUTER DATABASE IN THE FIELDS OF SOCIAL NETWORKING, DATING AND RELATIONSHIPS (U.S. CLS. 100 AND 101).

FIRST USE 0-0-1996; IN COMMERCE 0-0-1996.

ANNE E. GUSTASON, EXAMINING ATTORNEY

SN 85-538,555. NICHEABLE, LLC, ARLINGTON, VA. FILED 2-9-2012.

POPT

THE MARK CONSISTS OF STANDARD CHARACTERS WITHOUT CLAIM TO ANY PARTICULAR FONT, STYLE, SIZE, OR COLOR.

FOR ONLINE SOCIAL NETWORKING SERVICES (U.S. CLS. 100 AND 101).

KAREN SEVERSON, EXAMINING ATTORNEY

CLASS 45—(Continued).

SN 85-538,729. URPOSSE INC., BOSTON, MA. FILED 2-9-2012.

urposse

THE MARK CONSISTS OF STANDARD CHARACTERS WITHOUT CLAIM TO ANY PARTICULAR FONT, STYLE, SIZE, OR COLOR.
FOR ON-LINE SOCIAL NETWORKING SERVICES (U.S. CLS. 100 AND 101).
CAROLINE WOOD, EXAMINING ATTORNEY

SN 85-538,752. DAVID W. STEWART, CARMEL, IN. FILED 2-9-2012.

STEWART & STEWART ATTORNEYS

THE MARK CONSISTS OF STANDARD CHARACTERS WITHOUT CLAIM TO ANY PARTICULAR FONT, STYLE, SIZE, OR COLOR.
NO CLAIM IS MADE TO THE EXCLUSIVE RIGHT TO USE "ATTORNEYS", APART FROM THE MARK AS SHOWN.
FOR LEGAL SERVICES (U.S. CLS. 100 AND 101).
FIRST USE 0-0-2000; IN COMMERCE 0-0-2000.
CURTIS FRENCH, EXAMINING ATTORNEY

SN 85-538,835. SURVIVAL, PREPAREDNESS, EMERGENCY KITS, LLC, TUCSON, AZ. FILED 2-9-2012.

PREPARE, SURVIVE, EMERGE!

THE MARK CONSISTS OF STANDARD CHARACTERS WITHOUT CLAIM TO ANY PARTICULAR FONT, STYLE, SIZE, OR COLOR.
FOR PROVIDING A WEBSITE FEATURING INFORMATION ON SURVIVAL SKILLS AND SURVIVAL PREPAREDNESS (U.S. CLS. 100 AND 101).
FIRST USE 1-26-2012; IN COMMERCE 1-26-2012.
JAMES A. RAUEN, EXAMINING ATTORNEY

CLASS 45—(Continued).

SN 85-538,902. MOMIN, RAZIN K, LAWRENCEVILLE, GA. FILED 2-9-2012.

INSTADATES

THE MARK CONSISTS OF STANDARD CHARACTERS WITHOUT CLAIM TO ANY PARTICULAR FONT, STYLE, SIZE, OR COLOR.
FOR COMPUTER DATING SERVICES; INTERNET BASED SOCIAL NETWORKING, INTRODUCTION, AND DATING SERVICES; VIDEO DATING SERVICES (U.S. CLS. 100 AND 101).
ALICIA COLLINS, EXAMINING ATTORNEY

SN 85-539,296. FELDMAN GALE, P.A., MIAMI, FL. FILED 2-10-2012.

YOUR DOCTOR IS BOARD CERTIFIED...IS YOUR LAWYER?

THE MARK CONSISTS OF STANDARD CHARACTERS WITHOUT CLAIM TO ANY PARTICULAR FONT, STYLE, SIZE, OR COLOR.
FOR LEGAL SERVICES; LEGAL SERVICES, NAMELY, INTELLECTUAL PROPERTY CONSULTING SERVICES IN THE FIELD OF IDENTIFICATION, STRATEGY, ANALYTICS, AND INVENTION; LEGAL SERVICES, NAMELY, PREPARATION OF APPLICATIONS FOR TRADEMARK REGISTRATION; LEGAL SERVICES, NAMELY, TRADEMARK MAINTENANCE SERVICES; LEGAL SERVICES, NAMELY, TRADEMARK SEARCHING AND CLEARANCE SERVICES; LITIGATION SERVICES; PROVIDING CUSTOMIZED LEGAL INFORMATION, COUNSELING, AND ADVICE, AND LITIGATION SERVICES IN THE FIELD OF PATENTS, TRADEMARKS, TRADE DRESS AND DOMAIN NAMES, COPYRIGHTS, TRADE SECRETS, COMPUTER/INTERNET LAW, E-COMMERCE, E-DISCOVERY, ENTERTAINMENT LAW, LITIGATION, CORPORATE TRANSACTIONAL, NON-COMPETITION AGREEMENTS (U.S. CLS. 100 AND 101).
DAVID C. REIHNER, EXAMINING ATTORNEY

SN 85-539,418. TOFU GIFTS, LLC, MONTE SERENO, CA. FILED 2-10-2012.

THINKING OF U

THE MARK CONSISTS OF STANDARD CHARACTERS WITHOUT CLAIM TO ANY PARTICULAR FONT, STYLE, SIZE, OR COLOR.
FOR ON-LINE SOCIAL NETWORKING SERVICES (U.S. CLS. 100 AND 101).
KATHERINE CHANG, EXAMINING ATTORNEY

CLASS 45—(Continued).

SN 85-539,690. JAMES YANG, ORANGE, CA. FILED 2-10-2012.

G11

THE MARK CONSISTS OF STANDARD CHARACTERS WITHOUT CLAIM TO ANY PARTICULAR FONT, STYLE, SIZE, OR COLOR.
FOR PROVIDING INFORMATION IN THE FIELD OF INTELLECTUAL PROPERTY (U.S. CLS. 100 AND 101).
MICHAEL SOUDERS, EXAMINING ATTORNEY

SN 85-539,900. DAVID W. STEWART, CARMEL, IN. FILED 2-10-2012.

GET STEWART

THE MARK CONSISTS OF STANDARD CHARACTERS WITHOUT CLAIM TO ANY PARTICULAR FONT, STYLE, SIZE, OR COLOR.
FOR LEGAL SERVICES (U.S. CLS. 100 AND 101).
FIRST USE 10-0-2007; IN COMMERCE 10-0-2007.
CURTIS FRENCH, EXAMINING ATTORNEY

SN 85-540,035. THREE SIXTY FIVE, LLC, MONTCLAIR, NJ. FILED 2-10-2012.

Active Happiness

THE MARK CONSISTS OF STANDARD CHARACTERS WITHOUT CLAIM TO ANY PARTICULAR FONT, STYLE, SIZE, OR COLOR.
FOR PROVIDING A WEB SITE FEATURING INFORMATION AND CONTENT IN THE FIELDS OF PERSONAL RELATIONSHIPS, PERSONAL GROWTH AND MOTIVATION, AND SELF-FULFILLMENT (U.S. CLS. 100 AND 101).
LAURIE KAUFMAN, EXAMINING ATTORNEY

CLASS 45—(Continued).

SN 85-540,141. ADLI LAW GROUP P.C., LOS ANGELES, CA. FILED 2-10-2012.

ANY DISPUTE, ANYWHERE IN THE WORLD

THE MARK CONSISTS OF STANDARD CHARACTERS WITHOUT CLAIM TO ANY PARTICULAR FONT, STYLE, SIZE, OR COLOR.
FOR LEGAL SERVICES (U.S. CLS. 100 AND 101).
FIRST USE 11-30-2011; IN COMMERCE 11-30-2011.
BRIDGETT SMITH, EXAMINING ATTORNEY

SN 85-541,516. RINCON MEDIA LLC, SANTA BARBARA, CA. FILED 2-13-2012.

CLUBCOUGARS

THE MARK CONSISTS OF STANDARD CHARACTERS WITHOUT CLAIM TO ANY PARTICULAR FONT, STYLE, SIZE, OR COLOR.
FOR COMPUTER DATING SERVICES; DATING SERVICES; DATING SERVICES, NAMELY, PROVIDING AN ON-LINE COMPUTER DATABASE FEATURING SINGLE PEOPLE INTERESTED IN MEETING OTHER SINGLE PEOPLE; INTERNET BASED SOCIAL NETWORKING, INTRODUCTION, AND DATING SERVICES (U.S. CLS. 100 AND 101).
JOSETTE BEVERLY, EXAMINING ATTORNEY

SN 85-553,081. FRANKIN, GUY, ENTRE DEUX, FRANCE. FILED 2-26-2012.



NO CLAIM IS MADE TO THE EXCLUSIVE RIGHT TO USE ".RE" AND "REAL ESTATE", APART FROM THE MARK AS SHOWN.

THE COLOR(S) RED AND BLACK IS/ARE CLAIMED AS A FEATURE OF THE MARK.

THE MARK CONSISTS OF THE WORDING ".RE" IN RED INSIDE A DESIGN OF A HOUSE IN BLACK. AN EQUAL SIGN APPEARS TO THE RIGHT OF THE HOUSE DESIGN IN BLACK. THE WORDING "REAL ESTATE" APPEARS TO THE RIGHT OF THE EQUAL SIGN. THE LETTER "R" IN "REAL" AND THE LETTER "E" IN "ESTATE" ARE IN RED WHILE THE REMAINDER OF THOSE TERMS ARE IN BLACK.

FOR DOMAIN NAME REGISTRATION SERVICES FEATURING THE REGISTRATION OF DOMAIN NAMES WITH THE GTLD THAT APPEARS IN THE MARK (U.S. CLS. 100 AND 101).

FIRST USE 2-13-2012; IN COMMERCE 2-13-2012.
SETH A. RAPPAPORT, EXAMINING ATTORNEY

SECTION 4.—PRIOR UNITED STATES CLASSIFICATION

APPLICATION IN ONE CLASS

COLLECTIVE MEMBERSHIP MARKS

CLASS 200—COLLECTIVE MEMBERSHIP
SN 76-710,169. IN MOCEAN GROUP, L.L.C., NEW YORK,
NY. FILED 1-3-2012.

SN 85-536,498. ASSOCIATED BODYWORK & MASSAGE
PROFESSIONALS, INC., GOLDEN, CO. FILED 2-7-2012.

S.O.S. FOUNDATION SUPPLIER ONE % FOR
SUSTAINABILITY

THE MARK CONSISTS OF STANDARD CHARACTERS
WITHOUT CLAIM TO ANY PARTICULAR FONT, STYLE,
SIZE, OR COLOR.

NO CLAIM IS MADE TO THE EXCLUSIVE RIGHT TO
USE "FOUNDATION" AND "ONE % FOR SUSTAINABIL-
ITY", APART FROM THE MARK AS SHOWN.

FOR INDICATING MEMBERSHIP IN AN ASSOCIA-
TION OF BUSINESSES THAT COMMIT TO DONATING
A PORTION OF THEIR ANNUAL NET REVENUES TO
CHARITABLE ENVIRONMENTAL ORGANIZATIONS IN
ORDER TO PROMOTE AND ENCOURAGE PRESERVA-
TION AND SAFEGUARDING OF THE ENVIRONMENT.
HAI-LY LAM, EXAMINING ATTORNEY

ASSOCIATED SKIN CARE
PROFESSIONALS

THE MARK CONSISTS OF STANDARD CHARACTERS
WITHOUT CLAIM TO ANY PARTICULAR FONT, STYLE,
SIZE, OR COLOR.

OWNER OF U.S. REG. NO. 3,429,977.

SEC. 2(F).
FOR INDICATING MEMBERSHIP IN AN ORGANIZA-
TION OF SKIN CARE PRACTITIONERS.

FIRST USE 1-0-2007; IN COMMERCE 1-0-2007.
ROBIN CHOSID, EXAMINING ATTORNEY

CERTIFICATION MARKS

CLASS A—GOODS

SN 85-489,599. CERTIFIED ONIONS, INC., NYSSA, OR.
FILED 12-7-2011.

SN 85-519,286. WALDEN, WILFORD, DENVER, CO. FILED
1-18-2012.



NO CLAIM IS MADE TO THE EXCLUSIVE RIGHT TO
USE "VISLA CLUB OF COLORADO", APART FROM THE
MARK AS SHOWN.

THE COLOR(S) RED, BLUE, GOLD AND WHITE IS/ARE
CLAIMED AS A FEATURE OF THE MARK.

THE MARK CONSISTS OF THE STYLIZED LETTERS, A
BLUE "V", NEXT TO A RED "C". INSIDE OF THE RED "C"
IS A GOLD IMAGE OF GRASSY TERRAIN. THERE IS THE
WHITE OUTLINE OF A DOG COVERING PART OF THE
LETTERS. BELOW THE DOG IS THE BLUE WORD "VIZSLA"
ABOVE THE BLUE WORDS "CLUB OF COLORADO". IN
SIDE OF THE RED "C" IS A GOLD IMAGE OF GRASSY
TERRAIN, WITH A WHITE BACKGROUND.

FOR INDICATING MEMBERSHIP IN A DOG CLUB.
FIRST USE 1-0-2009; IN COMMERCE 1-0-2009.
HENRY S. ZAK, EXAMINING ATTORNEY



NO CLAIM IS MADE TO THE EXCLUSIVE RIGHT TO
USE "CERTIFIED ONIONS, INC." AND "CHEMICAL RE-
SIDUE TESTED", APART FROM THE MARK AS SHOWN.

THE COLOR(S) WHITE, RED AND GREEN IS/ARE
CLAIMED AS A FEATURE OF THE MARK.

THE MARK CONSISTS OF A GREEN CIRCLE WITH THE
WORDING "CERTIFIED ONIONS INC. CHEMICAL RESI-
DUE TESTED", APPEARING IN THE COLOR WHITE, THE
CENTER OF THE CIRCLE CONTAINS A DESIGN WHICH
RESEMBLES AN ONION IN THE COLOR WHITE, AND A
LARGE RED CHECK MARK STARTS INSIDE THE CIRCLE
AND EXTENDS BEYOND THE CIRCLE BORDER.

THE CERTIFICATION MARK, AS USED BY AUTHO-
RIZED PERSONS, CERTIFIES ONIONS MARKETED FROM
THE IDAHO OR OREGON GROWING AREA ARE TESTED
BY THIRD PARTY FIELD AND FACILITIES TESTERS FOR
PESTICIDE RESIDUE AND THE PRESENCE OF UNDESIR-
ABLE PATHOGENS.

FOR ONIONS.
FIRST USE 8-31-2009; IN COMMERCE 8-31-2009.
JAY FLOWERS, EXAMINING ATTORNEY

SN 85-524,127. NATIONAL COUNCIL OF YOUNG ISRAEL,
NEW YORK, NY. FILED 1-24-2012.

SN 85-147,364. CLAIRE FOREST, ITHACA, NY. FILED 10-7-
2010.



NO CLAIM IS MADE TO THE EXCLUSIVE RIGHT TO USE "KOSHER DAIRY", APART FROM THE MARK AS SHOWN.

THE MARK CONSISTS OF THE WORD "KOSHER" AND "DAIRY" SEPARATED BY A LINE AND WITH THE "D" WITH A STAR IN IT ABOVE THE WORD "DAIRY".

THE CERTIFICATION MARK, AS USED BY AUTHORIZED PERSONS, CERTIFIES ALL PRODUCTS UNDER THE STAR "D KOSHER DAIRY" MARK ARE CERTIFIED "KOSHER DAIRY".

FOR KOSHER FOOD AND FOOD PRODUCTS.
FIRST USE 5-1-1997; IN COMMERCE 5-1-1997.
LINDSEY RUBIN, EXAMINING ATTORNEY

FAMILY DEVELOPMENT CREDENTIAL

THE MARK CONSISTS OF STANDARD CHARACTERS WITHOUT CLAIM TO ANY PARTICULAR FONT, STYLE, SIZE, OR COLOR.

NO CLAIM IS MADE TO THE EXCLUSIVE RIGHT TO USE "CREDENTIAL", APART FROM THE MARK AS SHOWN.

THE CERTIFICATION MARK, AS USED BY AUTHORIZED PERSONS, CERTIFIES THAT THE INDIVIDUALS RECEIVING SUCH CERTIFICATION HAVE COMPLETED THE REQUIRED TRAINING AND PROFESSIONAL EDUCATION REQUIREMENTS, AND HAVE PASSED THE REQUIRED EXAMINATION PERTAINING TO THE COACHING OF FAMILIES TO ACHIEVE INCREASED SELF-RELIANCE.

SEC. 2(F).

FOR COUNSELING IN THE FIELD OF STRENGTHENING FAMILIES AND FAMILY RELATIONSHIPS.

FIRST USE 9-17-1997; IN COMMERCE 9-17-1997.
DORITT L. CARROLL, EXAMINING ATTORNEY

CLASS B—SERVICES

SN 85-137,763. AMERICAN INSTITUTE OF CERTIFIED
PUBLIC ACCOUNTANTS, NEW YORK, NY. FILED 9-
24-2010.

SN 85-214,732. AMERICAN CULINARY FEDERATION,
AUGUSTINE, FL. FILED 1-11-2011.



OWNER OF U.S. REG. NOS. 2,493,206 AND 2,681,513.

NO CLAIM IS MADE TO THE EXCLUSIVE RIGHT TO USE "FOR SERVICE ORGANIZATIONS", APART FROM THE MARK AS SHOWN.

THE MARK CONSISTS OF TWO INTERTWINING LOOPS WITH A CIRCLE EMBEDDED IN THE MIDDLE OF THE TWO LOOPS. THE LETTERS "SOC" ARE SHOWN TO THE RIGHT OF THE TWO LOOPS WITH THE NUMBER "3" POSITIONED IN THE UPPER RIGHT HAND CORNER OF THE LETTER "C". THE TERMS "SYSTRUST FOR SERVICE ORGANIZATIONS" ARE DEPICTED UNDER THE LETTERS "SOC".

THE CERTIFICATION MARK, AS INTENDED TO BE USED BY AUTHORIZED PERSONS, IS INTENDED TO CERTIFY THAT THE INTERNAL CONTROLS OF THE SERVICE ORGANIZATIONS HAVE BEEN FOUND TO MEET THE PROFESSIONAL STANDARDS OF SECURITY, AVAILABILITY, PROCESSING INTEGRITY, CONFIDENTIALITY AND PRIVACY ESTABLISHED BY THE AMERICAN INSTITUTE OF CERTIFIED PUBLIC ACCOUNTANTS.

FOR SERVICES WITHIN THE ACCOUNTING PROFESSION.

BILL DAWE, EXAMINING ATTORNEY

CERTIFIED SOUS CHEF

THE MARK CONSISTS OF STANDARD CHARACTERS WITHOUT CLAIM TO ANY PARTICULAR FONT, STYLE, SIZE, OR COLOR.

OWNER OF U.S. REG. NOS. 3,575,642, 3,575,666 AND OTHERS.

NO CLAIM IS MADE TO THE EXCLUSIVE RIGHT TO USE "CERTIFIED", APART FROM THE MARK AS SHOWN.

THE CERTIFICATION MARK, AS USED BY AUTHORIZED PERSONS, CERTIFIES THAT THE PERSON USING THE MARK IS A PROFESSIONAL CHEF WHO HAS DEMONSTRATED ADVANCED KNOWLEDGE AND SKILLS PERTAINING TO PROFESSIONAL COOKING, NUTRITION, FOOD SAFETY, SANITATION, AND KITCHEN MANAGEMENT AS DETERMINED BY A TEST OF CULINARY SKILL AND KNOWLEDGE AUTHORIZED BY THE CERTIFIER. THE PROFESSIONAL SKILL AND KNOWLEDGE CAN BE DOCUMENTED BY BEING SUCCESSFULLY EMPLOYED FOR A MINIMUM OF FIVE YEARS AS AN ENTRY LEVEL CULINARIAN AND BY PASSING THE CERTIFICATION KNOWLEDGE AND SKILL PROFICIENCY TESTS ESTABLISHED BY THE CERTIFIER.

SEC. 2(F).

FOR COOKING SERVICES .

FIRST USE 0-0-1995; IN COMMERCE 0-0-1995.
DARRYL SPRUILL, EXAMINING ATTORNEY

SN 85-500,693. RESNA, ARLINGTON, VA. FILED 12-21-2011.

SN 85-538,044. CENTER FOR CREDENTIALING & EDUCATION, INC. (CCE), GREENSBORO, NC. FILED 2-9-2012.

ATP/SMS

THE MARK CONSISTS OF STANDARD CHARACTERS WITHOUT CLAIM TO ANY PARTICULAR FONT, STYLE, SIZE, OR COLOR.

OWNER OF U.S. REG. NO. 3,059,937.

THE CERTIFICATION MARK, AS USED BY AUTHORIZED PERSONS, CERTIFIES THAT THE AUTHORIZED PRACTITIONER HAS COMPLETED RECOGNIZED ACCEPTED LEVELS OF ADVANCED KNOWLEDGE AND SKILL IN THE SPECIALTY ASSISTIVE TECHNOLOGY FIELD OF SEATING AND MOBILITY NEEDS WITH THE GOAL OF ENSURING CONSUMER SAFEGUARDS AND INCREASED CONSUMER SATISFACTION.

FOR ANALYSIS, RECOMMENDATION, FITTING, AND TRAINING FOR THE PERSONAL MOBILITY AND SEATING NEEDS OF PERSONS WITH DISABILITIES IN ORDER TO IMPROVE INDEPENDENCE, HEALTH, FUNCTION, AND INVOLVEMENT IN LIFE ACTIVITIES.

FIRST USE 10-0-2010; IN COMMERCE 10-0-2010.
NELSON SNYDER, EXAMINING ATTORNEY

DCF

THE MARK CONSISTS OF STANDARD CHARACTERS WITHOUT CLAIM TO ANY PARTICULAR FONT, STYLE, SIZE, OR COLOR.

THE CERTIFICATION MARK, AS INTENDED TO BE USED BY AUTHORIZED PERSONS, IS INTENDED TO CERTIFY THAT AUTHORIZED PERSONS USING THE MARK HAVE SATISFIED CERTAIN MINIMUM EDUCATION AND CREDENTIALING REQUIREMENTS ESTABLISHED BY THE CERTIFIER, AND HAVE COMPLETED A TRAINING PROGRAM CONCERNING THE PROVISION OF QUALIFIED DISTANCE CAREER ADVICE SERVICES, APPROVED BY THE CERTIFIER.

FOR PROFESSIONAL CAREER DEVELOPMENT, PLANNING, AND ADVICE SERVICES THROUGH TECHNOLOGICAL AND ELECTRONIC MEANS, INCLUDING COMPUTERS, TELEPHONE, AND OTHER COMMUNICATION METHODS.

APRIL ROACH, EXAMINING ATTORNEY

SN 85-596,133. HUMAN RESOURCE CERTIFICATION INSTITUTE, ALEXANDRIA, VA. FILED 4-12-2012.

SN 85-538,022. CENTER FOR CREDENTIALING & EDUCATION, INC. (CCE), GREENSBORO, NC. FILED 2-9-2012.

HRBP

THE MARK CONSISTS OF STANDARD CHARACTERS WITHOUT CLAIM TO ANY PARTICULAR FONT, STYLE, SIZE, OR COLOR.

THE CERTIFICATION MARK, AS INTENDED TO BE USED BY AUTHORIZED PERSONS, IS INTENDED TO CERTIFY AUTHORIZED INDIVIDUALS COMPLETED THE NECESSARY EDUCATIONAL REQUIREMENTS TO BECOME CERTIFIED HUMAN RESOURCES PROFESSIONAL.

FOR HUMAN RESOURCE MANAGEMENT.
JAMES GRIFFIN, EXAMINING ATTORNEY

SN 85-596,143. HUMAN RESOURCE CERTIFICATION INSTITUTE, ALEXANDRIA, VA. FILED 4-12-2012.

DCC

THE MARK CONSISTS OF STANDARD CHARACTERS WITHOUT CLAIM TO ANY PARTICULAR FONT, STYLE, SIZE, OR COLOR.

THE CERTIFICATION MARK, AS INTENDED TO BE USED BY AUTHORIZED PERSONS, IS INTENDED TO CERTIFY THAT AUTHORIZED PERSONS USING THE MARK HAVE SATISFIED CERTAIN MINIMUM EDUCATION AND CREDENTIALING REQUIREMENTS ESTABLISHED BY THE CERTIFIER, AND HAVE COMPLETED A TRAINING PROGRAM CONCERNING THE PROVISION OF QUALIFIED DISTANCE COUNSELING SERVICES, APPROVED BY THE CERTIFIER.

FOR PROFESSIONAL MENTAL HEALTH COUNSELING SERVICES THROUGH TECHNOLOGICAL AND ELECTRONIC MEANS, INCLUDING COMPUTERS, TELEPHONE, AND OTHER COMMUNICATION METHODS.

APRIL ROACH, EXAMINING ATTORNEY

HRMP

THE MARK CONSISTS OF STANDARD CHARACTERS WITHOUT CLAIM TO ANY PARTICULAR FONT, STYLE, SIZE, OR COLOR.

THE CERTIFICATION MARK, AS INTENDED TO BE USED BY AUTHORIZED PERSONS, IS INTENDED TO CERTIFY AUTHORIZED INDIVIDUALS COMPLETED THE NECESSARY EDUCATIONAL REQUIREMENTS TO BECOME A CERTIFIED HUMAN RESOURCES PROFESSIONAL..
FOR HUMAN RESOURCE MANAGEMENT.

JAMES GRIFFIN, EXAMINING ATTORNEY

* * * * *

TRADEMARK REGISTRATIONS ISSUED

PRINCIPAL REGISTER

SECTION 1.— INTERNATIONAL CLASSIFICATION

The short titles associated below with the international class numbers are terms designed merely for quick identification and are not an official part of the international classification. The full names of international classes are given in section 6.1 of the trademark rules of practice.

The designation "U.S. Cl." appearing in this section refers to the U.S. class in effect prior to Sep. 1, 1973 rather than the international class which applies to applications filed on or after that date. For adoption of international classification see notice in the OFFICIAL GAZETTE of Jun. 26, 1973 (911 O.G. TM 210).

CLASS 1—CHEMICALS

- 4,162,820. **NISSIN (STANDARD CHARACTER)**. NISSIN CHEMICAL INDUSTRY CO. LTD., MULTIPLE CLASS, (INT. CLS. 1, 2, 17 AND 19), (U.S. CLS. 1, 5, 6, 10, 11, 12, 13, 16, 26, 33, 35, 46 AND 50). SN 79-088,181. PUB. 4-10-2012. FILED 9-15-2010.
- 4,162,832. **INSTANTDIP (STANDARD CHARACTER)**. EMS-PATENT AG, (U.S. CLS. 1, 5, 6, 10, 26 AND 46). SN 79-089,842. PUB. 4-10-2012. FILED 10-15-2010.
- 4,162,851. **VYDRO AND DESIGN**. HUNTSMAN INTERNATIONAL LLC, A DELAWARE CORPORATION, MULTIPLE CLASS, (INT. CLS. 1, 17 AND 19), (U.S. CLS. 1, 5, 6, 10, 12, 13, 26, 33, 35, 46 AND 50). SN 79-093,920. PUB. 4-10-2012. FILED 12-13-2010.
- 4,162,872. **CREMERCOR (STANDARD CHARACTER)**. CREMER OLEO GMBH & CO. KG, MULTIPLE CLASS, (INT. CLS. 1, 3 AND 5), (U.S. CLS. 1, 4, 5, 6, 10, 18, 26, 44, 46, 50, 51 AND 52). SN 79-096,829. PUB. 4-10-2012. FILED 2-3-2011.
- 4,162,899. **NOVALED (STANDARD CHARACTER)**. NOVALED AG, MULTIPLE CLASS, (INT. CLS. 1 AND 9), (U.S. CLS. 1, 5, 6, 10, 21, 23, 26, 36, 38 AND 46). SN 79-098,776. PUB. 4-10-2012. FILED 3-30-2011.
- 4,162,912. **TORAN 3 (STYLIZED)**, CHEMTEC S.R.L., MULTIPLE CLASS, (INT. CLS. 1 AND 2), (U.S. CLS. 1, 5, 6, 10, 11, 16, 26 AND 46). SN 79-099,196. PUB. 4-10-2012. FILED 4-8-2011.
- 4,162,944. **BERGACARE (STANDARD CHARACTER)**. BERG + SCHMIDT GMBH & CO. KG, MULTIPLE CLASS, (INT. CLS. 1 AND 4), (U.S. CLS. 1, 5, 6, 10, 15, 26 AND 46). SN 79-100,658. PUB. 4-10-2012. FILED 6-24-2011.
- 4,162,973. **BERGAZID (STANDARD CHARACTER)**. BERG + SCHMIDT GMBH & CO. KG, MULTIPLE CLASS, (INT. CLS. 1, 4 AND 29), (U.S. CLS. 1, 5, 6, 10, 15, 26 AND 46). SN 79-102,181. PUB. 4-10-2012. FILED 6-27-2011.
- 4,162,998. **DCM (STANDARD CHARACTER)**. DE CEUSTER MESTSTOFFEN, IN HET KORT GENAAMD D.C.M., NAAMLOZE VENNOOTSCHAP, MULTIPLE CLASS, (INT. CLS. 1, 5 AND 31), (U.S. CLS. 1, 5, 6, 10, 18, 26, 44, 46, 51 AND 52). SN 79-103,468. PUB. 4-10-2012. FILED 12-20-2010.
- 4,163,019. **FLORDIMEX (STYLIZED)**. CBW CHEMIE GMBH; BITTERFELD WOLFEN, (U.S. CLS. 1, 5, 6, 10, 26 AND 46). SN 79-104,670. PUB. 4-10-2012. FILED 7-27-2011.
- 4,163,023. **MOUSSINA (STANDARD CHARACTER)**. MITECH-IDEA SRL, MULTIPLE CLASS, (INT. CLS. 1, 3 AND 5), (U.S. CLS. 1, 4, 5, 6, 10, 18, 26, 44, 46, 50, 51 AND 52). SN 79-105,234. PUB. 4-10-2012. FILED 9-23-2011.
- 4,163,032. **CAPCHEM AND DESIGN**. SHENZHEN CAPCHEM TECHNOLOGY CO., LTD., (U.S. CLS. 1, 5, 6, 10, 26 AND 46). SN 79-106,112. PUB. 4-10-2012. FILED 9-15-2011.
- 4,163,044. **PROFAR (STANDARD CHARACTER)**. PETRONAS LUBRICANTS ITALY S.P.A., (U.S. CLS. 1, 5, 6, 10, 26 AND 46). SN 79-107,707. PUB. 4-10-2012. FILED 11-11-2011.
- 4,163,077. **ENVIA AND DESIGN**. ENVIA SYSTEMS, INC., MULTIPLE CLASS, (INT. CLS. 1 AND 9), (U.S. CLS. 1, 5, 6, 10, 21, 23, 26, 36, 38 AND 46). SN 85-102,148. PUB. 9-20-2011. FILED 8-6-2010.
- 4,163,096. **EPOXACAST (STANDARD CHARACTER)**. SMOOTH-ON, INC., (U.S. CLS. 1, 5, 6, 10, 26 AND 46). SN 85-121,084. PUB. 4-10-2012. FILED 9-1-2010.
- 4,163,107. **MISCELLANEOUS DESIGN**. LINCOLN GLOBAL, INC., (U.S. CLS. 1, 5, 6, 10, 26 AND 46). SN 85-141,458. PUB. 4-10-2012. FILED 9-29-2010.
- 4,163,130. **UP&C AND DESIGN**. ZHEJIANG ULTRAFINE POWDERS & CHEMICALS CO., LTD, (U.S. CLS. 1, 5, 6, 10, 26 AND 46). SN 85-160,930. PUB. 4-10-2012. FILED 10-26-2010.
- 4,163,142. **BETTER THAN EVER (STYLIZED)**. K-G SPRAY-PAK INC., MULTIPLE CLASS, (INT. CLS. 1, 2, 3, 4 AND 5), (U.S. CLS. 1, 4, 5, 6, 10, 11, 15, 16, 18, 26, 44, 46, 50, 51 AND 52). SN 85-167,903. PUB. 4-10-2012. FILED 11-3-2010.
- 4,163,158. **RUTLAND PLASTIC TECHNOLOGIES, INC. AND DESIGN**. RUTLAND PLASTIC TECHNOLOGIES, INC., MULTIPLE CLASS, (INT. CLS. 1 AND 2), (U.S. CLS. 1, 5, 6, 10, 11, 16, 26 AND 46). SN 85-186,167. PUB. 4-10-2012. FILED 11-29-2010.
- 4,163,168. **AMBERCUT (STANDARD CHARACTER)**. SAINT-GOBAIN CERAMICS & PLASTICS, INC., MULTIPLE CLASS, (INT. CLS. 1 AND 4), (U.S. CLS. 1, 5, 6, 10, 15, 26 AND 46). SN 85-204,823. PUB. 4-10-2012. FILED 12-23-2010.
- 4,163,174. **EPOXACOAT (STANDARD CHARACTER)**. SMOOTH-ON, INC., (U.S. CLS. 1, 5, 6, 10, 26 AND 46). SN 85-211,224. PUB. 1-3-2012. FILED 1-5-2011.
- 4,163,217. **FUSION PLUS AND DESIGN**. CONCRETE & PAVEMENT REPAIR, LLC, AKA CPR, LLC, (U.S. CLS. 1, 5, 6, 10, 26 AND 46). SN 85-260,604. PUB. 4-10-2012. FILED 3-8-2011.
- 4,163,271. **NINONI (STANDARD CHARACTER)**. CEDERBERG GMBH, MULTIPLE CLASS, (INT. CLS. 1, 5, 10 AND 44), (U.S. CLS. 1, 5, 6, 10, 18, 26, 39, 44, 46, 51, 52, 100 AND 101). SN 85-287,558. PUB. 4-10-2012. FILED 4-6-2011.
- 4,163,272. **BIOCHEMICA (STANDARD CHARACTER)**. HALL-STAR INNOVATIONS CORP., MULTIPLE CLASS, (INT. CLS. 1, 3, 4 AND 5), (U.S. CLS. 1, 4, 5, 6, 10, 15, 18, 26, 44, 46, 50, 51 AND 52). SN 85-287,634. PUB. 4-10-2012. FILED 4-6-2011.
- 4,163,404. **VIVEBLOOM (STANDARD CHARACTER)**. WATERSTONE VENTURES, LLP, (U.S. CLS. 1, 5, 6, 10, 26 AND 46). SN 85-310,799. PUB. 4-10-2012. FILED 5-3-2011.
- 4,163,565. **NUTRA FOOD INGREDIENTS (STANDARD CHARACTER)**. NUTRA FOOD INGREDIENTS, LLC, (U.S. CLS. 1, 5, 6, 10, 26 AND 46). SN 85-355,589. PUB. 4-10-2012. FILED 6-24-2011.
- 4,163,652. **ROCK RIVER (STANDARD CHARACTER)**. FASTENAL IP COMPANY, MULTIPLE CLASS, (INT. CLS. 1, 6, 8, 9 AND 17), (U.S. CLS. 1, 2, 5, 6, 10, 12, 13, 14, 21, 23, 25, 26, 28, 35, 36, 38, 44, 46 AND 50). SN 85-386,719. PUB. 4-10-2012. FILED 8-2-2011.
- 4,163,673. **CELU-LITE TECHNOLOGY (STANDARD CHARACTER)**. CELU-LITE, TA ZAGGORA, (U.S. CLS. 1, 5, 6, 10, 26 AND 46). SN 85-391,585. PUB. 4-10-2012. FILED 8-7-2011.
- 4,163,761. **COMPRESSORWORKS (STANDARD CHARACTER)**. COMPRESSORWORKS, INC., MULTIPLE CLASS, (INT. CLS. 1, 4 AND 11), (U.S. CLS. 1, 5, 6, 10, 13, 15, 21, 23, 26, 31, 34 AND 46). SN 85-418,492. PUB. 4-10-2012. FILED 9-9-2011.
- 4,163,822. **AKOSHINE (STANDARD CHARACTER)**. AKOTT EVOLUTION INC, (U.S. CLS. 1, 5, 6, 10, 26 AND 46). SN 85-

431,458. PUB. 4-10-2012. FILED 9-26-2011.

4,163,823. **ITALINE (STANDARD CHARACTER)**. AKOTT EVOLUTION INC, (U.S. CLS. 1, 5, 6, 10, 26 AND 46). SN 85-431,463. PUB. 4-10-2012. FILED 9-26-2011.

4,163,824. **AKOACTIVE (STANDARD CHARACTER)**. AKOTT EVOLUTION INC, (U.S. CLS. 1, 5, 6, 10, 26 AND 46). SN 85-431,464. PUB. 4-10-2012. FILED 9-26-2011.

4,163,842. **NESULINE (STANDARD CHARACTER)**. AKOTT EVOLUTION INC, (U.S. CLS. 1, 5, 6, 10, 26 AND 46). SN 85-433,899. PUB. 4-10-2012. FILED 9-28-2011.

4,163,898. **DURATRAN (STANDARD CHARACTER)**. SUNCOR ENERGY INC., (U.S. CLS. 1, 5, 6, 10, 26 AND 46). SN 85-440,691. PUB. 4-10-2012. FILED 10-6-2011.

4,163,916. **ESK (STANDARD CHARACTER)**. PURITAN MEDICAL PRODUCTS COMPANY LLC, (U.S. CLS. 1, 5, 6, 10, 26 AND 46). SN 85-442,407. PUB. 4-10-2012. FILED 10-7-2011.

4,163,925. **BEESAFE (STANDARD CHARACTER)**. NATURAL TECHNOLOGIES INC., (U.S. CLS. 1, 5, 6, 10, 26 AND 46). SN 85-443,584. PUB. 4-10-2012. FILED 10-10-2011.

4,163,943. **SANITRAP (STANDARD CHARACTER)**. AMERICAN BIOSYSTEMS, INC., (U.S. CLS. 1, 5, 6, 10, 26 AND 46). SN 85-445,817. PUB. 4-10-2012. FILED 10-12-2011.

4,163,987. **AUBEL (STANDARD CHARACTER)**. UYEMURA INTERNATIONAL CORPORATION, (U.S. CLS. 1, 5, 6, 10, 26 AND 46). SN 85-449,145. PUB. 4-10-2012. FILED 10-17-2011.

4,164,004. **STEROTEX (STANDARD CHARACTER)**. ABITEC CORPORATION, (U.S. CLS. 1, 5, 6, 10, 26 AND 46). SN 85-450,602. PUB. 4-10-2012. FILED 10-19-2011.

4,164,005. **ACCOMID (STANDARD CHARACTER)**. ABITEC CORPORATION, (U.S. CLS. 1, 5, 6, 10, 26 AND 46). SN 85-450,605. PUB. 4-10-2012. FILED 10-19-2011.

4,164,006. **ACCOMEEN (STANDARD CHARACTER)**. ABITEC CORPORATION, (U.S. CLS. 1, 5, 6, 10, 26 AND 46). SN 85-450,610. PUB. 4-10-2012. FILED 10-19-2011.

4,164,007. **ACCONON (STANDARD CHARACTER)**. ABITEC CORPORATION, (U.S. CLS. 1, 5, 6, 10, 26 AND 46). SN 85-450,614. PUB. 4-10-2012. FILED 10-19-2011.

4,164,008. **ACCOQUAT (STANDARD CHARACTER)**. ABITEC CORPORATION, (U.S. CLS. 1, 5, 6, 10, 26 AND 46). SN 85-450,618. PUB. 4-10-2012. FILED 10-19-2011.

4,164,018. **REACTION SNOW AND ICE MELTER AND DESIGN**. EARTH SERVICES & SUPPLY, LLC, (U.S. CLS. 1, 5, 6, 10, 26 AND 46). SN 85-450,984. PUB. 4-10-2012. FILED 10-19-2011.

4,164,061. **ENVIROMAX PLUS (STANDARD CHARACTER)**. PURITAN MEDICAL PRODUCTS COMPANY LLC, (U.S. CLS. 1, 5, 6, 10, 26 AND 46). SN 85-453,056. PUB. 4-10-2012. FILED 10-21-2011.

4,164,062. **ENVIROMAX (STANDARD CHARACTER)**. PURITAN MEDICAL PRODUCTS COMPANY LLC, (U.S. CLS. 1, 5, 6, 10, 26 AND 46). SN 85-453,060. PUB. 4-10-2012. FILED 10-21-2011.

4,164,221. **DURAMAX (STANDARD CHARACTER)**. M CHEMICAL COMPANY, INC., (U.S. CLS. 1, 5, 6, 10, 26 AND 46). SN 85-457,320. PUB. 4-10-2012. FILED 10-26-2011.

4,164,222. **DRYAMAX (STANDARD CHARACTER)**. M CHEMICAL COMPANY, INC., (U.S. CLS. 1, 5, 6, 10, 26 AND 46). SN 85-457,330. PUB. 4-10-2012. FILED 10-26-2011.

4,164,382. **THE WATER STOPS HERE (STANDARD CHARACTER)**. NEW IMAGE COATINGS, LLC, (U.S. CLS. 1, 5, 6, 10, 26 AND 46). SN 85-458,722. PUB. 4-10-2012. FILED 10-28-2011.

4,164,401. **POND CHAMPS (STANDARD CHARACTER)**. BLUEWATER CHEMGROUP, INC., (U.S. CLS. 1, 5, 6, 10, 26 AND 46). SN 85-458,908. PUB. 4-10-2012. FILED 10-28-2011.

4,164,409. **TNT (STANDARD CHARACTER)**. BLUEWATER CHEMGROUP, INC., (U.S. CLS. 1, 5, 6, 10, 26 AND 46). SN 85-458,994. PUB. 4-10-2012. FILED 10-28-2011.

4,164,447. **GOLDEN WEST BIOLOGICALS, INC. (STANDARD CHARACTER)**. GOLDEN WEST BIOLOGICALS, INC., (U.S. CLS. 1, 5, 6, 10, 26 AND 46). SN 85-459,434. PUB. 4-10-2012. FILED 10-28-2011.

4,164,450. **GWB AND DESIGN**. GOLDEN WEST BIOLOGICALS, INC., (U.S. CLS. 1, 5, 6, 10, 26 AND 46). SN 85-459,454. PUB. 4-10-2012. FILED 10-28-2011.

4,164,687. **BIOBUG (STANDARD CHARACTER)**. BETCO

CORPORATION, (U.S. CLS. 1, 5, 6, 10, 26 AND 46). SN 85-477,227. PUB. 4-10-2012. FILED 11-20-2011.

4,164,732. **BARAZAN (STANDARD CHARACTER)**. HALLIBURTON ENERGY SERVICES, INC., (U.S. CLS. 1, 5, 6, 10, 26 AND 46). SN 85-494,636. PUB. 4-10-2012. FILED 12-13-2011.

CLASS 2—PAINTS

4,162,820 (*See Class 1 for this trademark*).

4,162,912 (*See Class 1 for this trademark*).

4,162,945. **DAINÉ AND DESIGN**. DAÏNÉ D'ARENBERG, MULTIPLE CLASS, (INT. CLS. 2, 16, 20, 27 AND 42), (U.S. CLS. 2, 5, 6, 11, 13, 16, 19, 20, 22, 23, 25, 29, 32, 37, 38, 42, 50, 100 AND 101). SN 79-100,761. PUB. 4-10-2012. FILED 5-23-2011.

4,162,947. **KLEE PAUL KLEE (STYLIZED)**. ALEXANDER KLEE, MULTIPLE CLASS, (INT. CLS. 2, 3, 9, 14, 16, 18, 21, 24, 25, 27, 28, 35, 38, 41, 42, 43 AND 45), (U.S. CLS. 1, 2, 3, 4, 5, 6, 11, 13, 16, 19, 20, 21, 22, 23, 26, 27, 28, 29, 30, 33, 36, 37, 38, 39, 40, 41, 42, 50, 51, 52, 100, 101, 102, 104 AND 107). SN 79-100,913. PUB. 4-10-2012. FILED 6-29-2011.

4,163,039. **MUTOH (STYLIZED)**. MUTOH HOLDINGS CO., LTD., (U.S. CLS. 6, 11 AND 16). SN 79-106,919. PUB. 4-10-2012. FILED 9-20-2011.

4,163,142 (*See Class 1 for this trademark*).

4,163,158 (*See Class 1 for this trademark*).

4,163,250. **AMERI STRIPE (STANDARD CHARACTER)**. ALL AMERICAN PAINT CO., (U.S. CLS. 6, 11 AND 16). SN 85-275,523. PUB. 4-10-2012. FILED 3-24-2011.

4,163,631. **SUPERON (STANDARD CHARACTER)**. TIEWAY INTERNATIONAL INC., (U.S. CLS. 6, 11 AND 16). SN 85-381,897. PUB. 4-10-2012. FILED 7-27-2011.

4,163,747. **HEDRIX (STANDARD CHARACTER)**. MYPERFECTCOLOR LLC, (U.S. CLS. 6, 11 AND 16). SN 85-416,674. PUB. 4-10-2012. FILED 9-7-2011.

4,163,901. **MASTER'S TOUCH FINE ART STUDIO (STANDARD CHARACTER)**. HOBBY LOBBY STORES, INC., MULTIPLE CLASS, (INT. CLS. 2, 8 AND 16), (U.S. CLS. 2, 5, 6, 11, 16, 22, 23, 28, 29, 37, 38, 44 AND 50). SN 85-441,352. PUB. 4-10-2012. FILED 10-6-2011.

4,163,936. **PRE BIRD AND DESIGN**. PREBIRD COATING CO., LTD, (U.S. CLS. 6, 11 AND 16). SN 85-444,386. PUB. 4-10-2012. FILED 10-11-2011.

4,164,082. **BOAT GUARD (STANDARD CHARACTER)**. STAR BRITE DISTRIBUTING, INC., (U.S. CLS. 6, 11 AND 16). SN 85-453,570. PUB. 4-10-2012. FILED 10-21-2011.

4,164,397. **POND CHAMPS (STANDARD CHARACTER)**. BLUEWATER CHEMGROUP, INC., (U.S. CLS. 6, 11 AND 16). SN 85-458,880. PUB. 4-10-2012. FILED 10-28-2011.

4,164,768. **FIRE-GUARD (STANDARD CHARACTER)**. OSMOSE, INC., (U.S. CLS. 6, 11 AND 16). SN 85-519,481. PUB. 4-10-2012. FILED 1-18-2012.

CLASS 3—COSMETICS AND CLEANING PREPARATIONS

4,162,731. **SAY SHA:IN (STYLIZED)**. LG HOUSEHOLD & HEALTH CARE LTD., (U.S. CLS. 1, 4, 6, 50, 51 AND 52). SN 77-385,522. PUB. 4-10-2012. FILED 1-31-2008.

4,162,743. **THE ROOTS NATURELLE AND DESIGN**. CIDA CORP, (U.S. CLS. 1, 4, 6, 50, 51 AND 52). SN 77-609,430. PUB. 4-10-2012. FILED 11-6-2008.

4,162,748. **BOOGIE (STANDARD CHARACTER)**. LITTLE BUSY BODIES, INC., (U.S. CLS. 1, 4, 6, 50, 51 AND 52). SN 77-704,750. PUB. 4-10-2012. FILED 4-1-2009.

4,162,789. **SKIN+METRICS (STANDARD CHARACTER)**. STEINER RANCH DERMATOLOGY, (U.S. CLS. 1, 4, 6, 50, 51 AND 52). SN 77-964,790. PUB. 4-10-2012. FILED 3-22-2010.

4,162,804. **PLANTOCEUTICALS (STANDARD CHARACTER)**. DR. SPILLER BIOCOSMETIC GMBH, (U.S. CLS. 1, 4, 6, 50, 51 AND 52). SN 79-068,587. PUB. 4-10-2012. FILED 4-20-2009.

- 4,162,829. **NATURAL CREATIVITY CREATION NATURELLE DOGAL YARATICILIK EYÜP SABRI TUNCER EST 1923 AND DESIGN**. E.S.T. EYÜP SABRI TUNCER KOZMETİK SANAYİ ANONİM ŞİRKETİ, MULTIPLE CLASS, (INT. CLS. 3, 4, 5, 14, 21, 24, 25, 26, 29, 30, 32 AND 35), (U.S. CLS. 1, 2, 4, 6, 13, 15, 18, 22, 23, 27, 28, 29, 30, 33, 37, 39, 40, 42, 44, 45, 46, 48, 50, 51, 52, 100, 101 AND 102). SN 79-089,600. PUB. 8-16-2011. FILED 6-28-2010.
- 4,162,852. **MEIFUBAO AND DESIGN**. GUANGZHOU UNIASIA COSMETIC TECHNOLOGY CO.,LTD., (U.S. CLS. 1, 4, 6, 50, 51 AND 52). SN 79-094,173. PUB. 4-10-2012. FILED 2-8-2011.
- 4,162,861. **MAKE UP FOR LOVE (STANDARD CHARACTER)**. MAKE UP FOR EVER (SOCIÉTÉ ANONYME), (U.S. CLS. 1, 4, 6, 50, 51 AND 52). SN 79-095,610. PUB. 4-10-2012. FILED 3-11-2011.
- 4,162,864. **BIBES AND DESIGN**. BIBES AB, MULTIPLE CLASS, (INT. CLS. 3, 21 AND 24), (U.S. CLS. 1, 2, 4, 6, 13, 23, 29, 30, 33, 40, 42, 50, 51 AND 52). SN 79-096,103. PUB. 4-10-2012. FILED 3-14-2011.
- 4,162,866. **INVICTUS PACO RABANNE (STANDARD CHARACTER)**. PUIG FRANCE SOCIÉTÉ PAR ACTIONS SIMPLIFIÉE, (U.S. CLS. 1, 4, 6, 50, 51 AND 52). SN 79-096,464. PUB. 4-10-2012. FILED 4-15-2011.
- 4,162,872 (*See Class 1 for this trademark*).
- 4,162,875. **GOLD F&W PARIS AND DESIGN**. MARIE-HÉLÈNE PLANTIER ÉPOUSE GIRARD, (U.S. CLS. 1, 4, 6, 50, 51 AND 52). SN 79-097,260. PUB. 4-10-2012. FILED 3-24-2011.
- 4,162,900. **TEES WAY (STANDARD CHARACTER)**. IDEA BOX SA, MULTIPLE CLASS, (INT. CLS. 3, 18 AND 25), (U.S. CLS. 1, 2, 3, 4, 6, 22, 39, 41, 50, 51 AND 52). SN 79-098,908. PUB. 4-10-2012. FILED 5-10-2011.
- 4,162,901. **T-SHIRT WAY (STANDARD CHARACTER)**. IDEA BOX SA, MULTIPLE CLASS, (INT. CLS. 3, 18 AND 25), (U.S. CLS. 1, 2, 3, 4, 6, 22, 39, 41, 50, 51 AND 52). SN 79-098,909. PUB. 4-10-2012. FILED 5-10-2011.
- 4,162,930. **BIFIDERM (STANDARD CHARACTER)**. PROBIOTICAL SPA, MULTIPLE CLASS, (INT. CLS. 3 AND 5), (U.S. CLS. 1, 4, 6, 18, 44, 46, 50, 51 AND 52). SN 79-099,804. PUB. 4-10-2012. FILED 4-27-2011.
- 4,162,947 (*See Class 2 for this trademark*).
- 4,162,951. **SOLFINE FOLLIE AND DESIGN**. INTERNATIONAL TRADEMARKS S.A., (U.S. CLS. 1, 4, 6, 50, 51 AND 52). SN 79-101,028. PUB. 4-10-2012. FILED 6-30-2011.
- 4,162,959. **NYC NEW YORK COLOR EXCUSE MY FRENCH (STANDARD CHARACTER)**. COTY GERMANY GMBH, (U.S. CLS. 1, 4, 6, 50, 51 AND 52). SN 79-101,410. PUB. 4-10-2012. FILED 7-8-2011.
- 4,162,960. **REDEEM AND DESIGN**. JOHN DAHLGREN, (U.S. CLS. 1, 4, 6, 50, 51 AND 52). SN 79-101,455. PUB. 4-10-2012. FILED 3-31-2011.
- 4,162,965. **21 LE FOU (STYLIZED)**. GADO S.R.L., (U.S. CLS. 1, 4, 6, 50, 51 AND 52). SN 79-101,725. PUB. 4-10-2012. FILED 6-28-2011.
- 4,162,966. **14 LA TEMPÉRANCE (STYLIZED)**. GADO S.R.L., (U.S. CLS. 1, 4, 6, 50, 51 AND 52). SN 79-101,726. PUB. 4-10-2012. FILED 6-28-2011.
- 4,162,974. **NAILS UNIQUE OF JAPAN AND DESIGN**. KABUSHIKI KAISHA NAILS UNIQUE OF JAPAN (DOING BUSINESS AS NAILS UNIQUE OF JAPAN CO., LTD.), MULTIPLE CLASS, (INT. CLS. 3 AND 44), (U.S. CLS. 1, 4, 6, 50, 51, 52, 100 AND 101). SN 79-102,197. PUB. 4-10-2012. FILED 7-8-2011.
- 4,162,975. **ULTIMID NAILS UNIQUE AND DESIGN**. KABUSHIKI KAISHA NAILS UNIQUE OF JAPAN (DOING BUSINESS AS NAILS UNIQUE OF JAPAN CO., LTD.), MULTIPLE CLASS, (INT. CLS. 3 AND 44), (U.S. CLS. 1, 4, 6, 50, 51, 52, 100 AND 101). SN 79-102,198. PUB. 4-10-2012. FILED 7-8-2011.
- 4,163,009. **ATTIQUE (STANDARD CHARACTER)**. STRATEGEM, (U.S. CLS. 1, 4, 6, 50, 51 AND 52). SN 79-104,136. PUB. 4-10-2012. FILED 9-7-2011.
- 4,163,010. **MISCELLANEOUS DESIGN**. PARFUMERIE TIKI, (U.S. CLS. 1, 4, 6, 50, 51 AND 52). SN 79-104,140. PUB. 4-10-2012. FILED 9-2-2011.
- 4,163,020. **WINOA (STYLIZED)**. WINOA, MULTIPLE CLASS, (INT. CLS. 3, 7 AND 40), (U.S. CLS. 1, 4, 6, 13, 19, 21, 23, 31, 34, 35, 50, 51, 52, 100, 103 AND 106). SN 79-104,780. PUB. 4-10-2012. FILED 7-28-2011.
- 4,163,023 (*See Class 1 for this trademark*).
- 4,163,024. **MARVIS (STYLIZED)**. LUDOVICO MARTELLI S.R.L., (U.S. CLS. 1, 4, 6, 50, 51 AND 52). SN 79-105,326. PUB. 4-10-2012. FILED 5-6-2011.
- 4,163,028. **HELEN HARPER (STYLIZED)**. ONTEX BVBA, MULTIPLE CLASS, (INT. CLS. 3, 5, 10 AND 16), (U.S. CLS. 1, 2, 4, 5, 6, 18, 22, 23, 26, 29, 37, 38, 39, 44, 46, 50, 51 AND 52). SN 79-105,807. PUB. 4-10-2012. FILED 8-30-2011.
- 4,163,033. **URCCI (STYLIZED)**. SHANTOU LANACANE COEMETIC CO., LTD., (U.S. CLS. 1, 4, 6, 50, 51 AND 52). SN 79-106,201. PUB. 4-10-2012. FILED 11-2-2011.
- 4,163,052. **AIR LIGHT (STANDARD CHARACTER)**. AMOR-EPACIFIC CORPORATION, (U.S. CLS. 1, 4, 6, 50, 51 AND 52). SN 85-012,663. PUB. 4-10-2012. FILED 4-13-2010.
- 4,163,076. **VITALY ADVANCED FORMULA FORMULA AVANZADA AND DESIGN**. LABORATORIOS MK, S.A., (U.S. CLS. 1, 4, 6, 50, 51 AND 52). SN 85-100,964. PUB. 4-10-2012. FILED 8-5-2010.
- 4,163,142 (*See Class 1 for this trademark*).
- 4,163,170. **AMBERCLEAN (STANDARD CHARACTER)**. SAINT-GOBAIN CERAMICS & PLASTICS, INC., (U.S. CLS. 1, 4, 6, 50, 51 AND 52). SN 85-204,938. PUB. 4-10-2012. FILED 12-23-2010.
- 4,163,189. **LIP ELIXIRS (STANDARD CHARACTER)**. LIP ELIXIRS LLC, (U.S. CLS. 1, 4, 6, 50, 51 AND 52). SN 85-226,159. PUB. 4-10-2012. FILED 1-25-2011.
- 4,163,201. **STEPHAN'S AMERICAN MAN (STANDARD CHARACTER)**. THE STEPHAN CO., (U.S. CLS. 1, 4, 6, 50, 51 AND 52). SN 85-242,654. PUB. 4-10-2012. FILED 2-15-2011.
- 4,163,272 (*See Class 1 for this trademark*).
- 4,163,324. **RL EST. RALPH LAUREN 1987 AND DESIGN**. PRL USA HOLDINGS, INC., (U.S. CLS. 1, 4, 6, 50, 51 AND 52). SN 85-302,401. PUB. 4-10-2012. FILED 4-22-2011.
- 4,163,374. **ABDOLIFT (STANDARD CHARACTER)**. L'OREAL, (U.S. CLS. 1, 4, 6, 50, 51 AND 52). SN 85-308,128. PUB. 4-10-2012. FILED 4-29-2011.
- 4,163,386. **MISCELLANEOUS DESIGN**. M.P. MERCHANDISE LLC, MULTIPLE CLASS, (INT. CLS. 3 AND 25), (U.S. CLS. 1, 4, 6, 22, 39, 50, 51 AND 52). SN 85-309,398. PUB. 4-10-2012. FILED 5-2-2011.
- 4,163,389. **RARE EARTH (STANDARD CHARACTER)**. L'OREAL USA CREATIVE, INC., (U.S. CLS. 1, 4, 6, 50, 51 AND 52). SN 85-309,523. PUB. 4-10-2012. FILED 5-2-2011.
- 4,163,471. **TONICEA (STANDARD CHARACTER)**. PIERRE FABRE DERMO-COSMETIQUE, (U.S. CLS. 1, 4, 6, 50, 51 AND 52). SN 85-323,996. PUB. 4-10-2012. FILED 5-18-2011.
- 4,163,483. **CROWN LASHES (STANDARD CHARACTER)**. JB LINE, INC. DBA JB COSMETICS, (U.S. CLS. 1, 4, 6, 50, 51 AND 52). SN 85-330,113. PUB. 4-10-2012. FILED S.R. 5-25-2011; AM. P.R. 1-25-2012.
- 4,163,494. **MISCELLANEOUS DESIGN**. METHOD PRODUCTS, INC., (U.S. CLS. 1, 4, 6, 50, 51 AND 52). SN 85-335,350. PUB. 4-10-2012. FILED 6-1-2011.
- 4,163,517. **BEAUTIFUL DREAMS FROM THE AMAZON (STANDARD CHARACTER)**. MY LITTLE UNIVERSE LTD, (U.S. CLS. 1, 4, 6, 50, 51 AND 52). SN 85-343,864. PUB. 4-10-2012. FILED 6-11-2011.
- 4,163,575. **DAISY GEL (STANDARD CHARACTER)**. LOC DAC DUONG, DBA CALI BEAUTY SUPPLY #2, (U.S. CLS. 1, 4, 6, 50, 51 AND 52). SN 85-359,271. PUB. 1-3-2012. FILED 6-29-2011.
- 4,163,587. **SOLIANTE (STANDARD CHARACTER)**. PIERRE FABRE DERMO-COSMETIQUE, MULTIPLE CLASS, (INT. CLS. 3 AND 5), (U.S. CLS. 1, 4, 6, 18, 44, 46, 50, 51 AND 52). SN 85-365,481. PUB. 4-10-2012. FILED 7-7-2011.
- 4,163,588. **SILHOE (STANDARD CHARACTER)**. PIERRE FABRE DERMO-COSMETIQUE, MULTIPLE CLASS, (INT. CLS. 3 AND 5), (U.S. CLS. 1, 4, 6, 18, 44, 46, 50, 51 AND 52). SN 85-365,556. PUB. 4-10-2012. FILED 7-7-2011.
- 4,163,589. **SAVAR (STANDARD CHARACTER)**. INCLUSIV NATURALS LIMITED, MULTIPLE CLASS, (INT. CLS. 3, 5 AND 35), (U.S. CLS. 1, 4, 6, 18, 44, 46, 50, 51, 52, 100, 101 AND 102). SN 85-365,565. PUB. 4-10-2012. FILED 7-7-2011.
- 4,163,621. **IN PEACE (STANDARD CHARACTER)**. RUTH TYSON, (U.S. CLS. 1, 4, 6, 50, 51 AND 52). SN 85-377,939. PUB. 4-10-2012. FILED 7-21-2011.
- 4,163,752. **AWAKEN MY SENSES ORGANICS AND DESIGN**.

- AWAKEN MY SENSES INC., (U.S. CLS. 1, 4, 6, 50, 51 AND 52). SN 85-417,893. PUB. 4-10-2012. FILED 9-8-2011.
- 4,163,826. **AGE REVOLT AND DESIGN**. HEESEMANM, ELIZABETH, (U.S. CLS. 1, 4, 6, 50, 51 AND 52). SN 85-431,601. PUB. 3-6-2012. FILED 9-26-2011.
- 4,163,836. **NEMAT INTERNATIONAL AND DESIGN**. NEMAT INTERNATIONAL INC., (U.S. CLS. 1, 4, 6, 50, 51 AND 52). SN 85-433,384. PUB. 4-10-2012. FILED 9-27-2011.
- 4,163,868. **JADE EAST (STANDARD CHARACTER)**. KNIGHT DISTRIBUTING CO INC., DBA REGENCY COSMETICS, (U.S. CLS. 1, 4, 6, 50, 51 AND 52). SN 85-437,097. PUB. 4-10-2012. FILED 10-1-2011.
- 4,163,886. **MASSAGE FX (STANDARD CHARACTER)**. SCRIP, INC., (U.S. CLS. 1, 4, 6, 50, 51 AND 52). SN 85-438,878. PUB. 4-10-2012. FILED 10-4-2011.
- 4,163,894. **JOJOBA NATURALS AND DESIGN**. BURGOWNE, ADAM, (U.S. CLS. 1, 4, 6, 50, 51 AND 52). SN 85-440,306. PUB. 4-10-2012. FILED 10-5-2011.
- 4,163,959. **GIRL BOY HAIR CANDY AND DESIGN**. ARTURO TAVERNA INTERNATIONAL PTY. LTD., (U.S. CLS. 1, 4, 6, 50, 51 AND 52). SN 85-447,001. PUB. 4-10-2012. FILED 10-13-2011.
- 4,163,982. **TAN AID (STANDARD CHARACTER)**. SEGARRA, PAUL J., (U.S. CLS. 1, 4, 6, 50, 51 AND 52). SN 85-448,423. PUB. 4-10-2012. FILED 10-16-2011.
- 4,164,001. **NAUGHTY DESIRES (STYLIZED)**. GRIGGS, CHRISTOPHER R., (U.S. CLS. 1, 4, 6, 50, 51 AND 52). SN 85-450,371. PUB. 4-10-2012. FILED 10-18-2011.
- 4,164,080. **VIEW GUARD (STANDARD CHARACTER)**. STAR BRITE DISTRIBUTING, INC., (U.S. CLS. 1, 4, 6, 50, 51 AND 52). SN 85-453,537. PUB. 4-10-2012. FILED 10-21-2011.
- 4,164,146. **GIVE BACK BRANDS (STANDARD CHARACTER)**. GIVE BACK BRANDS FOUNDATION, (U.S. CLS. 1, 4, 6, 50, 51 AND 52). SN 85-455,453. PUB. 4-10-2012. FILED 10-25-2011.
- 4,164,157. **KERAPREMIUM (STYLIZED)**. KERATIN 4 U LLC, (U.S. CLS. 1, 4, 6, 50, 51 AND 52). SN 85-455,729. PUB. 4-10-2012. FILED 10-25-2011.
- 4,164,227. **FAMOUS DAVE'S (STANDARD CHARACTER)**. GOULD, DAVID, (U.S. CLS. 1, 4, 6, 50, 51 AND 52). SN 85-457,374. PUB. 4-10-2012. FILED 10-27-2011.
- 4,164,235. **SOFT & SHINY (STANDARD CHARACTER)**. IKORPE CHEMICALS LTD., (U.S. CLS. 1, 4, 6, 50, 51 AND 52). SN 85-457,475. PUB. 4-10-2012. FILED 10-27-2011.
- 4,164,278. **DRY LESS | LIVE MORE (STANDARD CHARACTER)**. KENRA PROFESSIONAL, LLC, (U.S. CLS. 1, 4, 6, 50, 51 AND 52). SN 85-457,857. PUB. 4-10-2012. FILED 10-27-2011.
- 4,164,368. **SHOW OFF (STANDARD CHARACTER)**. EATON OIL/AUTOMOTIVE CHEMICAL COMPANY, LLC, (U.S. CLS. 1, 4, 6, 50, 51 AND 52). SN 85-458,620. PUB. 4-10-2012. FILED 10-28-2011.
- 4,164,440. **BOOMER BOOST (STANDARD CHARACTER)**. BATTAGLIA, ANTHONY, (U.S. CLS. 1, 4, 6, 50, 51 AND 52). SN 85-459,396. PUB. 4-10-2012. FILED 10-28-2011.
- 4,164,458. **PURSUIT OF CLEANLINESS (STANDARD CHARACTER)**. MULTIFARIOUS PUBLICA GROUP, LLC, (U.S. CLS. 1, 4, 6, 50, 51 AND 52). SN 85-459,566. PUB. 4-10-2012. FILED 10-28-2011.
- 4,164,500. **SPA NIAGARA (STANDARD CHARACTER)**. SPA NIAGARA, LLC, MULTIPLE CLASS, (INT. CLS. 3 AND 44), (U.S. CLS. 1, 4, 6, 50, 51, 52, 100 AND 101). SN 85-460,033. PUB. 4-10-2012. FILED 10-31-2011.
- 4,164,564. **LEADERSHIP THROUGH INNOVATION (STANDARD CHARACTER)**. SUNSHINE MAKERS, INC., (U.S. CLS. 1, 4, 6, 50, 51 AND 52). SN 85-460,886. PUB. 4-10-2012. FILED 10-31-2011.
- 4,164,589. **AROMAPPEAL (STANDARD CHARACTER)**. PURITAN'S PRIDE, INC., (U.S. CLS. 1, 4, 6, 50, 51 AND 52). SN 85-461,418. PUB. 4-10-2012. FILED 11-1-2011.
- 4,164,604. **ELASTA QP AND DESIGN**. STRENGTH OF NATURE, LLC, (U.S. CLS. 1, 4, 6, 50, 51 AND 52). SN 85-463,303. PUB. 4-10-2012. FILED 11-3-2011.
- 4,164,605. **FLORAL FUSION (STANDARD CHARACTER)**. THE PROCTER & GAMBLE COMPANY, (U.S. CLS. 1, 4, 6, 50, 51 AND 52). SN 85-463,342. PUB. 4-10-2012. FILED 11-3-2011.
- 4,164,617. **DOLLICIOUS (STANDARD CHARACTER)**. ANTHONY COMELLA, (U.S. CLS. 1, 4, 6, 50, 51 AND 52). SN 85-465,065. PUB. 4-10-2012. FILED 11-4-2011.
- 4,164,669. **ROCK 77 (STANDARD CHARACTER)**. RETAIL ROYALTY COMPANY, (U.S. CLS. 1, 4, 6, 50, 51 AND 52). SN 85-473,242. PUB. 4-10-2012. FILED 11-15-2011.
- 4,164,680. **DAWN POWER CLEAN (STANDARD CHARACTER)**. THE PROCTER & GAMBLE COMPANY, (U.S. CLS. 1, 4, 6, 50, 51 AND 52). SN 85-476,208. PUB. 4-10-2012. FILED 11-18-2011.
- 4,164,695. **OH WHAT FUN IS PINK (STANDARD CHARACTER)**. VICTORIA'S SECRET STORES BRAND MANAGEMENT, INC., (U.S. CLS. 1, 4, 6, 50, 51 AND 52). SN 85-480,239. PUB. 4-10-2012. FILED 11-23-2011.
- 4,164,717. **FRESHLOCK (STANDARD CHARACTER)**. THE PROCTER & GAMBLE COMPANY, (U.S. CLS. 1, 4, 6, 50, 51 AND 52). SN 85-485,978. PUB. 4-10-2012. FILED 12-2-2011.
- 4,164,727. **LES EXCLUSIFS DE CHANEL (STANDARD CHARACTER)**. CHANEL, INC., (U.S. CLS. 1, 4, 6, 50, 51 AND 52). SN 85-489,292. PUB. 4-10-2012. FILED 12-7-2011.
- 4,164,734. **ONE TOOTHPASTE THAT DOES IT ALL (STANDARD CHARACTER)**. THE PROCTER & GAMBLE COMPANY, (U.S. CLS. 1, 4, 6, 50, 51 AND 52). SN 85-494,680. PUB. 4-10-2012. FILED 12-14-2011.
- 4,164,778. **IVYCLEANSE (STANDARD CHARACTER)**. PEAK BRANDS LLC, (U.S. CLS. 1, 4, 6, 50, 51 AND 52). SN 85-538,073. PUB. 4-10-2012. FILED 2-9-2012.

CLASS 4—LUBRICANTS AND FUELS

- 4,162,829 (*See Class 3 for this trademark*).
- 4,162,944 (*See Class 1 for this trademark*).
- 4,162,973 (*See Class 1 for this trademark*).
- 4,163,029. **BETTY BOSSI (STANDARD CHARACTER)**. BETTY BOSSI AG, MULTIPLE CLASS, (INT. CLS. 4, 8, 20, 21, 24, 35, 39 AND 42), (U.S. CLS. 1, 2, 6, 13, 15, 22, 23, 25, 28, 29, 30, 32, 33, 40, 42, 44, 50, 100, 101, 102 AND 105). SN 79-105,834. PUB. 4-10-2012. FILED 7-1-2011.
- 4,163,041. **ROKLUBE (STANDARD CHARACTER)**. PETRONAS LUBRICANTS ITALY S.P.A., (U.S. CLS. 1, 6 AND 15). SN 79-107,148. PUB. 4-10-2012. FILED 11-15-2011.
- 4,163,055. **ENCANA NATURAL GAS AND DESIGN**. ENCANA CORPORATION, MULTIPLE CLASS, (INT. CLS. 4, 7, 37, 39, 40 AND 42), (U.S. CLS. 1, 6, 13, 15, 19, 21, 23, 31, 34, 35, 100, 101, 103, 105 AND 106). SN 85-020,282. PUB. 2-21-2012. FILED 4-22-2010.
- 4,163,056. **ENCANA NATURAL GAS AND DESIGN**. ENCANA CORPORATION, MULTIPLE CLASS, (INT. CLS. 4, 7, 37, 39, 40 AND 42), (U.S. CLS. 1, 6, 13, 15, 19, 21, 23, 31, 34, 35, 100, 101, 103, 105 AND 106). SN 85-020,341. PUB. 2-21-2012. FILED 4-22-2010.
- 4,163,102. **HERSHEY'S COCOA AND DESIGN**. HERSHEY CHOCOLATE & CONFECTIONERY CORPORATION, (U.S. CLS. 1, 6 AND 15). SN 85-131,405. PUB. 4-10-2012. FILED 9-16-2010.
- 4,163,142 (*See Class 1 for this trademark*).
- 4,163,168 (*See Class 1 for this trademark*).
- 4,163,169. **AMBERLUBE (STANDARD CHARACTER)**. SAINT-GOBAIN CERAMICS & PLASTICS, INC., (U.S. CLS. 1, 6 AND 15). SN 85-204,911. PUB. 4-10-2012. FILED 12-23-2010.
- 4,163,244. **PENHALIGON'S MADURO LEAF (STANDARD CHARACTER)**. PENHALIGON'S LIMITED, (U.S. CLS. 1, 6 AND 15). SN 85-272,548. PUB. 4-10-2012. FILED 3-21-2011.
- 4,163,272 (*See Class 1 for this trademark*).
- 4,163,701. **NAJOOM MUSIC PRODUCTS, INC. AND DESIGN**. NAJOOM, DENNIS GEORGE, DBA NAJOOM MUSIC PRODUCTS, INC., MULTIPLE CLASS, (INT. CLS. 4 AND 15), (U.S. CLS. 1, 2, 6, 15, 21 AND 36). SN 85-403,705. PUB. 4-10-2012. FILED 8-22-2011.
- 4,163,761 (*See Class 1 for this trademark*).
- 4,164,063. **VECTON (STANDARD CHARACTER)**. CASTOL LIMITED, (U.S. CLS. 1, 6 AND 15). SN 85-453,065. PUB. 4-10-2012. FILED 10-21-2011.

CLASS 5—PHARMACEUTICALS

- 4,162,713. **VETASAN (STANDARD CHARACTER)**. KINETIC TECHNOLOGIES, LLC. (U.S. CLS. 6, 18, 44, 46, 51 AND 52). SN 76-708,752. PUB. 4-10-2012. FILED 8-15-2011.
- 4,162,816. **NUTRIO (STANDARD CHARACTER)**. X-TECHNOLOGY SWISS GMBH. MULTIPLE CLASS, (INT. CLS. 5 AND 32), (U.S. CLS. 6, 18, 44, 45, 46, 48, 51 AND 52). SN 79-086,609. PUB. 1-3-2012. FILED 7-9-2010.
- 4,162,826. **MISCELLANEOUS DESIGN**. SOLDAN HOLDING+ BONBONSPEZIALITÄTEN GMBH. MULTIPLE CLASS, (INT. CLS. 5 AND 30), (U.S. CLS. 6, 18, 44, 46, 51 AND 52). SN 79-088,848. PUB. 4-10-2012. FILED 9-1-2010.
- 4,162,829 (*See Class 3 for this trademark*).
- 4,162,865. **RELEVO (STANDARD CHARACTER)**. ABSORBEST AB. MULTIPLE CLASS, (INT. CLS. 5, 10 AND 16), (U.S. CLS. 2, 5, 6, 18, 22, 23, 26, 29, 37, 38, 39, 44, 46, 50, 51 AND 52). SN 79-096,309. PUB. 4-10-2012. FILED 3-31-2011.
- 4,162,872 (*See Class 1 for this trademark*).
- 4,162,878. **CILIXYL (STANDARD CHARACTER)**. RESDEVCO LTD., (U.S. CLS. 6, 18, 44, 46, 51 AND 52). SN 79-097,289. PUB. 4-10-2012. FILED 4-11-2011.
- 4,162,914. **DEFITELIO (STANDARD CHARACTER)**. GENTIUM SPA, (U.S. CLS. 6, 18, 44, 46, 51 AND 52). SN 79-099,301. PUB. 4-10-2012. FILED 5-16-2011.
- 4,162,916. **BR AND DESIGN**. THE RESEARCH FOUNDATION FOR MICROBIAL DISEASES OF OSAKA UNIVERSITY, (U.S. CLS. 6, 18, 44, 46, 51 AND 52). SN 79-099,327. PUB. 4-10-2012. FILED 4-4-2011.
- 4,162,930 (*See Class 3 for this trademark*).
- 4,162,949. **ANGELUS AQUATICUS (STANDARD CHARACTER)**. VODAX, A.S., MULTIPLE CLASS, (INT. CLS. 5 AND 32), (U.S. CLS. 6, 18, 44, 45, 46, 48, 51 AND 52). SN 79-100,960. PUB. 4-10-2012. FILED 6-1-2011.
- 4,162,978. **ACTISPRAY (STANDARD CHARACTER)**. PROTOPHARMA LIMITED, (U.S. CLS. 6, 18, 44, 46, 51 AND 52). SN 79-102,371. PUB. 4-10-2012. FILED 8-16-2011.
- 4,162,995. **BARTH-HAAS GROUP AND DESIGN**. JOH. BARTH & SOHN GMBH & CO. KG, MULTIPLE CLASS, (INT. CLS. 5, 30, 31, 32, 35, 36, 38, 41, 42 AND 44), (U.S. CLS. 1, 6, 18, 44, 45, 46, 48, 51, 52, 100, 101, 102, 104 AND 107). SN 79-103,157. PUB. 4-10-2012. FILED 6-20-2011.
- 4,162,998 (*See Class 1 for this trademark*).
- 4,163,006. **SO CALM (STANDARD CHARACTER)**. AB7 INDUSTRIES, MULTIPLE CLASS, (INT. CLS. 5, 10 AND 24), (U.S. CLS. 6, 18, 26, 39, 42, 44, 46, 50, 51 AND 52). SN 79-104,021. PUB. 4-10-2012. FILED 7-26-2011.
- 4,163,023 (*See Class 1 for this trademark*).
- 4,163,028 (*See Class 3 for this trademark*).
- 4,163,043. **AFFANIQ (STANDARD CHARACTER)**. H. LUNDBECK A/S, (U.S. CLS. 6, 18, 44, 46, 51 AND 52). SN 79-107,526. PUB. 4-10-2012. FILED 11-10-2011.
- 4,163,050. **OPTIFLAX (STANDARD CHARACTER)**. FORWARD FOODS LLC, (U.S. CLS. 6, 18, 44, 46, 51 AND 52). SN 85-010,193. PUB. 4-10-2012. FILED 4-9-2010.
- 4,163,079. **BESUNYEN (STANDARD CHARACTER)**. BEIJING OUTSELL HEALTH PRODUCT DEVELOPMENT CO., LTD. MULTIPLE CLASS, (INT. CLS. 5, 10, 29, 30, 32, 36, 40 AND 43), (U.S. CLS. 6, 18, 26, 39, 44, 45, 46, 48, 51, 52, 100, 101, 102, 103 AND 106). SN 85-103,796. PUB. 2-28-2012. FILED 8-10-2010.
- 4,163,080. **DAILY GENTLE CLEANSER (STANDARD CHARACTER)**. PRIMARY INVESTMENTS GROUP LIMITED, (U.S. CLS. 6, 18, 44, 46, 51 AND 52). SN 85-105,533. PUB. 4-10-2012. FILED 8-11-2010.
- 4,163,142 (*See Class 1 for this trademark*).
- 4,163,252. **FISH WITHOUT THE FISHIN' (STANDARD CHARACTER)**. MARLOW FOODS LIMITED, MULTIPLE CLASS, (INT. CLS. 5, 29 AND 30), (U.S. CLS. 6, 18, 44, 46, 51 AND 52). SN 85-276,976. PUB. 4-10-2012. FILED 3-25-2011.
- 4,163,265. **SB SUPER BANDZ AND DESIGN**. WOODE, JAMIE, (U.S. CLS. 6, 18, 44, 46, 51 AND 52). SN 85-285,879. PUB. 4-10-2012. FILED 4-4-2011.
- 4,163,271 (*See Class 1 for this trademark*).
- 4,163,272 (*See Class 1 for this trademark*).
- 4,163,297. **ANABOLIC FREAK (STANDARD CHARACTER)**. PHARMAFREAK HOLDINGS INC., (U.S. CLS. 6, 18, 44, 46, 51 AND 52). SN 85-294,341. PUB. 4-10-2012. FILED 4-13-2011.
- 4,163,308. **INTERNATIONAL NUTRITION (STANDARD CHARACTER)**. INTERNATIONAL NUTRITION, INC., MULTIPLE CLASS, (INT. CLS. 5 AND 31), (U.S. CLS. 1, 6, 18, 44, 46, 51 AND 52). SN 85-297,562. PUB. 4-10-2012. FILED 4-18-2011.
- 4,163,328. **LISTERINE (STYLIZED)**. JOHNSON & JOHNSON, (U.S. CLS. 6, 18, 44, 46, 51 AND 52). SN 85-303,301. PUB. 4-10-2012. FILED 4-25-2011.
- 4,163,447. **SMOOTHIE JUNCTION (STANDARD CHARACTER)**. SJGY, LLC. MULTIPLE CLASS, (INT. CLS. 5 AND 30), (U.S. CLS. 6, 18, 44, 46, 51 AND 52). SN 85-318,845. PUB. 4-10-2012. FILED 5-12-2011.
- 4,163,535. **MISCELLANEOUS DESIGN**. CONCORD INTERNATIONAL TRADING P/L, MULTIPLE CLASS, (INT. CLS. 5 AND 30), (U.S. CLS. 6, 18, 44, 46, 51 AND 52). SN 85-348,662. PUB. 4-10-2012. FILED 6-17-2011.
- 4,163,560. **EPLYS (STANDARD CHARACTER)**. BAYER AKTIENGESELLSCHAFT, (U.S. CLS. 6, 18, 44, 46, 51 AND 52). SN 85-355,246. PUB. 4-10-2012. FILED 6-24-2011.
- 4,163,561. **EFYPAT (STANDARD CHARACTER)**. BAYER AKTIENGESELLSCHAFT, (U.S. CLS. 6, 18, 44, 46, 51 AND 52). SN 85-355,262. PUB. 4-10-2012. FILED 6-24-2011.
- 4,163,587 (*See Class 3 for this trademark*).
- 4,163,588 (*See Class 3 for this trademark*).
- 4,163,589 (*See Class 3 for this trademark*).
- 4,163,617. **AMNEAL (STANDARD CHARACTER)**. AMNEAL PHARMACEUTICALS, LLC, (U.S. CLS. 6, 18, 44, 46, 51 AND 52). SN 85-376,933. PUB. 4-10-2012. FILED 7-21-2011.
- 4,163,693. **SIMPLY-T (STANDARD CHARACTER)**. BAYER AKTIENGESELLSCHAFT, MULTIPLE CLASS, (INT. CLS. 5 AND 10), (U.S. CLS. 6, 18, 26, 39, 44, 46, 51 AND 52). SN 85-400,945. PUB. 3-6-2012. FILED 8-18-2011.
- 4,163,749. **BANKABLEBODIES (STANDARD CHARACTER)**. BANKS, PATRICIA, (U.S. CLS. 6, 18, 44, 46, 51 AND 52). SN 85-417,177. PUB. 4-10-2012. FILED 9-7-2011.
- 4,163,778. **RAGEQUITRELIEF :(CAFFEINE FOR GAMERS (STYLIZED)**. ZANGAR ENTERPRISES, LLC, (U.S. CLS. 6, 18, 44, 46, 51 AND 52). SN 85-424,454. PUB. 4-10-2012. FILED 9-16-2011.
- 4,163,806. **BIOPHARMA SCIENTIFIC (STANDARD CHARACTER)**. BIOPHARMA SCIENTIFIC, LLC, (U.S. CLS. 6, 18, 44, 46, 51 AND 52). SN 85-428,528. PUB. 4-10-2012. FILED 9-21-2011.
- 4,163,816. **NUNATURALS HELPING TO KEEP YOU WELL! AND DESIGN**. NUNATURALS, INC., MULTIPLE CLASS, (INT. CLS. 5 AND 30), (U.S. CLS. 6, 18, 44, 46, 51 AND 52). SN 85-429,654. PUB. 4-10-2012. FILED 9-22-2011.
- 4,163,861. **HOT GIRL (STANDARD CHARACTER)**. SCHNELL, DONALD, MULTIPLE CLASS, (INT. CLS. 5 AND 41), (U.S. CLS. 6, 18, 44, 46, 51, 52, 100, 101 AND 107). SN 85-436,085. PUB. 4-10-2012. FILED 9-30-2011.
- 4,163,869. **A 250 (STANDARD CHARACTER)**. AMERICAN BIOSCIENCES, INC., (U.S. CLS. 6, 18, 44, 46, 51 AND 52). SN 85-437,183. PUB. 4-10-2012. FILED 10-1-2011.
- 4,163,877. **ORTHOPHIA (STANDARD CHARACTER)**. TOKUYAMA CORPORATION, (U.S. CLS. 6, 18, 44, 46, 51 AND 52). SN 85-438,057. PUB. 2-21-2012. FILED 10-3-2011.
- 4,163,930. **MISCELLANEOUS DESIGN**. YUNNAN HANDE BIO-TECH CO., LTD., (U.S. CLS. 6, 18, 44, 46, 51 AND 52). SN 85-443,925. PUB. 4-10-2012. FILED 10-11-2011.
- 4,163,932. **MISCELLANEOUS DESIGN**. ARENA PHARMACEUTICALS GMBH, (U.S. CLS. 6, 18, 44, 46, 51 AND 52). SN 85-444,185. PUB. 4-10-2012. FILED 10-11-2011.
- 4,163,933. **MISCELLANEOUS DESIGN**. ARENA PHARMACEUTICALS GMBH, (U.S. CLS. 6, 18, 44, 46, 51 AND 52). SN 85-444,191. PUB. 4-10-2012. FILED 10-11-2011.
- 4,164,050. **FUCUS PLUS (STANDARD CHARACTER)**. NORTH AMERICAN PHARMACAL, INC., (U.S. CLS. 6, 18, 44, 46, 51 AND 52). SN 85-452,584. PUB. 4-10-2012. FILED 10-20-2011.
- 4,164,075. **FEEL A BALANCE OF MIND & BODY (STANDARD CHARACTER)**. KOPPLA LTD., DBA KOPPLA NUTRIENTS, (U.S. CLS. 6, 18, 44, 46, 51 AND 52). SN 85-453,443. PUB. 4-10-2012. FILED 10-21-2011.
- 4,164,204. **FLEAS SUCK (STANDARD CHARACTER)**. FLEAVAC, LLC, (U.S. CLS. 6, 18, 44, 46, 51 AND 52). SN 85-456,831. PUB. 4-10-2012. FILED 10-26-2011.
- 4,164,206. **YULIN AND DESIGN**. GUANGXI YULIN PHARMACEUTICAL GROUP CO., LTD., (U.S. CLS. 6, 18, 44, 46, 51 AND 52). SN 85-456,926. PUB. 4-10-2012. FILED 10-26-

- 2011.
- 4,164,217. **ELEBRA (STANDARD CHARACTER)**. ELEBRA, LLC, (U.S. CLS. 6, 18, 44, 46, 51 AND 52). SN 85-457,263. PUB. 4-10-2012. FILED 10-26-2011.
- 4,164,353. **PRESTITOL (STANDARD CHARACTER)**. NATURAL WELLNESS, LLC, (U.S. CLS. 6, 18, 44, 46, 51 AND 52). SN 85-458,438. PUB. 4-10-2012. FILED 10-27-2011.
- 4,164,354. **MULTIMOR (STANDARD CHARACTER)**. NATURAL WELLNESS, LLC, (U.S. CLS. 6, 18, 44, 46, 51 AND 52). SN 85-458,441. PUB. 4-10-2012. FILED 10-27-2011.
- 4,164,375. **ALURA (STANDARD CHARACTER)**. NATURAL HEALTH TRENDS CORP., (U.S. CLS. 6, 18, 44, 46, 51 AND 52). SN 85-458,670. PUB. 4-10-2012. FILED 10-28-2011.
- 4,164,404. **ALGAE X (STANDARD CHARACTER)**. BLUEWATER CHEMGROUP, INC., (U.S. CLS. 6, 18, 44, 46, 51 AND 52). SN 85-458,936. PUB. 4-10-2012. FILED 10-28-2011.
- 4,164,407. **POND CHAMPS (STANDARD CHARACTER)**. BLUEWATER CHEMGROUP, INC., (U.S. CLS. 6, 18, 44, 46, 51 AND 52). SN 85-458,951. PUB. 4-10-2012. FILED 10-28-2011.
- 4,164,414. **GRENERA (STANDARD CHARACTER)**. GRENERA NUTRIENTS PVT LTD, (U.S. CLS. 6, 18, 44, 46, 51 AND 52). SN 85-459,033. PUB. 4-10-2012. FILED 10-28-2011.
- 4,164,434. **SPRAY YOUR WAY TO A HEALTHIER DAY! (STANDARD CHARACTER)**. NUTRAFUELS, (U.S. CLS. 6, 18, 44, 46, 51 AND 52). SN 85-459,275. PUB. 4-10-2012. FILED 10-28-2011.
- 4,164,544. **BULASTERONE (STANDARD CHARACTER)**. WHEAT, JARED R., (U.S. CLS. 6, 18, 44, 46, 51 AND 52). SN 85-460,637. PUB. 4-10-2012. FILED 10-31-2011.
- 4,164,629. **MEDICLEAR PLUS (STANDARD CHARACTER)**. THORNE RESEARCH, INC., (U.S. CLS. 6, 18, 44, 46, 51 AND 52). SN 85-467,498. PUB. 4-10-2012. FILED 11-8-2011.
- 4,164,630. **INCIVEK AND DESIGN**. VERTEX PHARMACEUTICALS INCORPORATED, (U.S. CLS. 6, 18, 44, 46, 51 AND 52). SN 85-467,598. PUB. 4-10-2012. FILED 11-8-2011.
- 4,164,654. **HOPGUARD (STANDARD CHARACTER)**. JOHN I. HAAS, INC., (U.S. CLS. 6, 18, 44, 46, 51 AND 52). SN 85-470,554. PUB. 4-10-2012. FILED 11-11-2011.
- 4,164,656. **AM - 300 (STANDARD CHARACTER)**. AMS HEALTH SCIENCES LLC, (U.S. CLS. 6, 18, 44, 46, 51 AND 52). SN 85-470,660. PUB. 4-10-2012. FILED 11-11-2011.
- 4,164,743. **FINEVIN (STANDARD CHARACTER)**. BAYER PHARMA AG, FORMERLY BAYER SCHERING PHARMA AG, (U.S. CLS. 6, 18, 44, 46, 51 AND 52). SN 85-501,002. PUB. 3-6-2012. FILED 12-21-2011.
- 4,164,760. **FUNCTION-ALA-TEA (STANDARD CHARACTER)**. ARLEN, MICHAEL W, (U.S. CLS. 6, 18, 44, 46, 51 AND 52). SN 85-511,172. PUB. 4-10-2012. FILED 1-7-2012.
- 4,164,761. **LONGEV-A-TEA (STANDARD CHARACTER)**. ARLEN, MICHAEL W, (U.S. CLS. 6, 18, 44, 46, 51 AND 52). SN 85-511,173. PUB. 4-10-2012. FILED 1-7-2012.
- 4,164,763. **PHENADRINE (STANDARD CHARACTER)**. WHEAT, JARED R., (U.S. CLS. 6, 18, 44, 46, 51 AND 52). SN 85-512,055. PUB. 4-10-2012. FILED 1-9-2012.
- 4,164,767. **TESTALENSIS (STANDARD CHARACTER)**. WHEAT, JARED R., (U.S. CLS. 6, 18, 44, 46, 51 AND 52). SN 85-518,329. PUB. 4-10-2012. FILED 1-17-2012.
- 4,164,773. **TURINAVOL (STANDARD CHARACTER)**. WHEAT, JARED R., (U.S. CLS. 6, 18, 44, 46, 51 AND 52). SN 85-524,094. PUB. 4-10-2012. FILED 1-24-2012.
- DEUTSCHE EDELSTAHLWERKE GMBH, (U.S. CLS. 2, 12, 13, 14, 23, 25 AND 50). SN 79-082,862. PUB. 2-15-2011. FILED 4-23-2010.
- 4,162,812. **SECURITAS (STANDARD CHARACTER)**. SECURITAS AB, MULTIPLE CLASS, (INT. CLS. 6, 9, 14, 35, 36, 37, 39, 41, 42 AND 45), (U.S. CLS. 2, 12, 13, 14, 21, 23, 25, 26, 27, 28, 36, 38, 50, 100, 101, 102, 103, 105, 106 AND 107). SN 79-084,027. PUB. 4-10-2012. FILED 4-19-2010.
- 4,162,819. **FRAME+ (STYLIZED)**. RAICO BAUTECHNIK GMBH, MULTIPLE CLASS, (INT. CLS. 6, 17, 19 AND 37), (U.S. CLS. 1, 2, 5, 12, 13, 14, 23, 25, 33, 35, 50, 100 AND 106). SN 79-087,943. PUB. 4-10-2012. FILED 9-7-2010.
- 4,162,868. **HSH (STANDARD CHARACTER)**. HSH SYSTEME FÜR PROZESS-IT GMBH, MULTIPLE CLASS, (INT. CLS. 6, 7, 9 AND 42), (U.S. CLS. 2, 12, 13, 14, 19, 21, 23, 25, 26, 31, 34, 35, 36, 38, 50, 100 AND 101). SN 79-096,686. PUB. 4-10-2012. FILED 1-28-2011.
- 4,162,873. **CYCLUS AND DESIGN**. SPIROPLEX GMBH, MULTIPLE CLASS, (INT. CLS. 6, 7, 9, 10 AND 20), (U.S. CLS. 2, 12, 13, 14, 19, 21, 22, 23, 25, 26, 31, 32, 34, 35, 36, 38, 39, 44 AND 50). SN 79-097,132. PUB. 4-10-2012. FILED 9-3-2010.
- 4,162,895. **DYNAPREX (STYLIZED)**. SUZUKI METAL INDUSTRY CO., LTD., (U.S. CLS. 2, 12, 13, 14, 23, 25 AND 50). SN 79-098,520. PUB. 4-10-2012. FILED 5-11-2011.
- 4,162,896. **RARFINE (STYLIZED)**. SUZUKI METAL INDUSTRY CO., LTD., (U.S. CLS. 2, 12, 13, 14, 23, 25 AND 50). SN 79-098,521. PUB. 4-10-2012. FILED 5-11-2011.
- 4,162,913. **AIRCRAFTING (STYLIZED)**. FOKKER TECHNOLOGY B.V., MULTIPLE CLASS, (INT. CLS. 6, 9, 12, 13, 19, 37, 39 AND 42), (U.S. CLS. 1, 2, 9, 12, 13, 14, 19, 21, 23, 25, 26, 31, 33, 35, 36, 38, 44, 50, 100, 101, 103, 105 AND 106). SN 79-099,246. PUB. 4-10-2012. FILED 3-8-2011.
- 4,162,943. **MISCELLANEOUS DESIGN**. PARKER HANNIFIN FRANCE SAS, MULTIPLE CLASS, (INT. CLS. 6, 11 AND 17), (U.S. CLS. 1, 2, 5, 12, 13, 14, 21, 23, 25, 31, 34, 35 AND 50). SN 79-100,513. PUB. 4-10-2012. FILED 3-14-2011.
- 4,162,956. **MISCELLANEOUS DESIGN**. YUHUAN DINGSHENG SANITARY & PLUMBING CO., LTD., MULTIPLE CLASS, (INT. CLS. 6 AND 11), (U.S. CLS. 2, 12, 13, 14, 21, 23, 25, 31, 34 AND 50). SN 79-101,342. PUB. 4-10-2012. FILED 4-11-2011.
- 4,162,957. **TASAN (STYLIZED)**. YUHUAN DINGSHENG SANITARY & PLUMBING CO., LTD., MULTIPLE CLASS, (INT. CLS. 6 AND 11), (U.S. CLS. 2, 12, 13, 14, 21, 23, 25, 31, 34 AND 50). SN 79-101,343. PUB. 4-10-2012. FILED 4-11-2011.
- 4,162,969. **LEVA (STANDARD CHARACTER)**. SITKA DEVELOPMENTS PTY LTD, (U.S. CLS. 2, 12, 13, 14, 23, 25 AND 50). SN 79-101,950. PUB. 4-10-2012. FILED 7-29-2011.
- 4,162,987. **PHENOFAB (STANDARD CHARACTER)**. KEYGENE N.V., MULTIPLE CLASS, (INT. CLS. 6, 9, 35 AND 42), (U.S. CLS. 2, 12, 13, 14, 21, 23, 25, 26, 36, 38, 50, 100, 101 AND 102). SN 79-102,787. PUB. 4-10-2012. FILED 6-30-2011.
- 4,163,008. **SOLISYSTEME (STANDARD CHARACTER)**. CASTEL JEAN-LOUIS, MULTIPLE CLASS, (INT. CLS. 6, 19, 22 AND 37), (U.S. CLS. 1, 2, 7, 12, 13, 14, 19, 22, 23, 25, 33, 42, 50, 100, 103 AND 106). SN 79-104,113. PUB. 4-10-2012. FILED 8-1-2011.
- 4,163,140. **HOLTEC INTERNATIONAL AND DESIGN**. HOLTEC INTERNATIONAL, MULTIPLE CLASS, (INT. CLS. 6, 11 AND 42), (U.S. CLS. 2, 12, 13, 14, 21, 23, 25, 31, 34, 50, 100 AND 101). SN 85-166,408. PUB. 4-10-2012. FILED 11-1-2010.
- 4,163,188. **GENUINE LISHI LOCKSMITH TOOLS AND DESIGN**. UAP LIMITED, (U.S. CLS. 2, 12, 13, 14, 23, 25 AND 50). SN 85-225,373. PUB. 4-10-2012. FILED 1-25-2011.
- 4,163,270. **CLICK BOND (STANDARD CHARACTER)**. CLICK BOND, INC., MULTIPLE CLASS, (INT. CLS. 6 AND 20), (U.S. CLS. 2, 12, 13, 14, 22, 23, 25, 32 AND 50). SN 85-286,930. PUB. 4-10-2012. FILED 4-5-2011.
- 4,163,507. **AP AND DESIGN**. THE GSI GROUP, LLC, MULTIPLE CLASS, (INT. CLS. 6, 7, 9, 11, 12 AND 21), (U.S. CLS. 2, 12, 13, 14, 19, 21, 23, 25, 26, 29, 30, 31, 33, 34, 35, 36, 38, 40, 44 AND 50). SN 85-339,098. PUB. 4-10-2012. FILED 6-6-2011.
- 4,163,526. **U.S. BOLT (STANDARD CHARACTER)**. U.S. BOLT MANUFACTURING, INC., MULTIPLE CLASS, (INT. CLS. 6 AND 42), (U.S. CLS. 2, 12, 13, 14, 23, 25, 50, 100 AND 101). SN 85-346,230. PUB. 4-10-2012. FILED 6-14-2011.
- 4,163,624. **TAMARA HENSICK DESIGNS THD AND DESIGN**. TAMARA HENSICK, MULTIPLE CLASS, (INT. CLS. 6

CLASS 6—METAL GOODS

- 4,162,721. **ULTRAHD (STANDARD CHARACTER)**. SEVILLE CLASSICS, INC., (U.S. CLS. 2, 12, 13, 14, 23, 25 AND 50). SN 76-709,509. PUB. 4-10-2012. FILED 10-25-2011.
- 4,162,738. **AD (STYLIZED)**. ASAH DENSO CO., LTD., MULTIPLE CLASS, (INT. CLS. 6, 7, 9, 11 AND 12), (U.S. CLS. 2, 12, 13, 14, 19, 21, 23, 25, 26, 31, 34, 35, 36, 38, 44 AND 50). SN 77-459,644. PUB. 4-10-2012. FILED 4-28-2008.
- 4,162,783. **CELLOCK (STANDARD CHARACTER)**. MUL-T-LOCK LTD., MULTIPLE CLASS, (INT. CLS. 6 AND 9), (U.S. CLS. 2, 12, 13, 14, 21, 23, 25, 26, 36, 38 AND 50). SN 77-953,731. PUB. 4-10-2012. FILED 3-8-2010.
- 4,162,811. **AERODUR (STANDARD CHARACTER)**.

- AND 14), (U.S. CLS. 2, 12, 13, 14, 23, 25, 27, 28 AND 50). SN 85-379,987. PUB. 4-10-2012. FILED 7-25-2011.
- 4,163,652 (*See Class 1 for this trademark*).
- 4,163,669. **DONGFANG AND DESIGN**. ORIENTAL INTERNATIONAL EQUIPMENT TRADING LIMITED, MULTIPLE CLASS, (INT. CLS. 6, 35 AND 39), (U.S. CLS. 2, 12, 13, 14, 23, 25, 50, 100, 101, 102 AND 105). SN 85-389,877. PUB. 4-10-2012. FILED 8-4-2011.
- 4,163,680. **UTILITYMAX (STANDARD CHARACTER)**. PV HARDWARE LLC, (U.S. CLS. 2, 12, 13, 14, 23, 25 AND 50). SN 85-395,306. PUB. 4-10-2012. FILED 8-11-2011.
- 4,163,731. **LADUR TYPE (STANDARD CHARACTER)**. MITEK HOLDINGS, INC., (U.S. CLS. 2, 12, 13, 14, 23, 25 AND 50). SN 85-413,407. PUB. 4-10-2012. FILED 9-1-2011.
- 4,163,938. **DYCONN AND DESIGN**. DYCONN, INC., MULTIPLE CLASS, (INT. CLS. 6 AND 9), (U.S. CLS. 2, 12, 13, 14, 21, 23, 25, 26, 36, 38 AND 50). SN 85-444,653. PUB. 4-10-2012. FILED 10-11-2011.
- 4,164,138. **TEMPER-LOC (STANDARD CHARACTER)**. TEMPER CORPORATION, (U.S. CLS. 2, 12, 13, 14, 23, 25 AND 50). SN 85-455,323. PUB. 4-10-2012. FILED 10-25-2011.
- 4,164,350. **CALBOND (STANDARD CHARACTER)**. CALPIPE INDUSTRIES, (U.S. CLS. 2, 12, 13, 14, 23, 25 AND 50). SN 85-458,381. PUB. 4-10-2012. FILED 10-27-2011.
- 4,164,422. **TINMAN TAILGATE TOOLCHEST (STANDARD CHARACTER)**. TINMAN TAILGATE TOOLCHEST CO, LLC, (U.S. CLS. 2, 12, 13, 14, 23, 25 AND 50). SN 85-459,146. PUB. 4-10-2012. FILED 10-28-2011.
- 4,164,482. **PETKEY (STANDARD CHARACTER)**. KLINKY, INC., (U.S. CLS. 2, 12, 13, 14, 23, 25 AND 50). SN 85-459,783. PUB. 4-10-2012. FILED 10-30-2011.
- 4,164,483. **HANDYKEY (STANDARD CHARACTER)**. KLINKY, INC., (U.S. CLS. 2, 12, 13, 14, 23, 25 AND 50). SN 85-459,784. PUB. 4-10-2012. FILED 10-30-2011.
- 4,164,484. **DRINKEY (STANDARD CHARACTER)**. KLINKY, INC., (U.S. CLS. 2, 12, 13, 14, 23, 25 AND 50). SN 85-459,785. PUB. 4-10-2012. FILED 10-30-2011.
- 4,164,685. **BLISSFIELD (STANDARD CHARACTER)**. BLISSFIELD MANUFACTURING CO., MULTIPLE CLASS, (INT. CLS. 6, 7, 11 AND 40), (U.S. CLS. 2, 12, 13, 14, 19, 21, 23, 25, 31, 34, 35, 50, 100, 103 AND 106). SN 85-477,173. PUB. 4-10-2012. FILED 11-19-2011.
- 4,164,686. **MISCELLANEOUS DESIGN**. BLISSFIELD MANUFACTURING CO., MULTIPLE CLASS, (INT. CLS. 6, 7, 11 AND 40), (U.S. CLS. 2, 12, 13, 14, 19, 21, 23, 25, 31, 34, 35, 50, 100, 103 AND 106). SN 85-477,188. PUB. 4-10-2012. FILED 11-19-2011.
-
- CLASS 7—MACHINERY**
- 4,162,701. **L-TEC (STANDARD CHARACTER)**. THE ESAB GROUP, INC., (U.S. CLS. 13, 19, 21, 23, 31, 34 AND 35). SN 76-707,278. PUB. 4-10-2012. FILED 4-14-2011.
- 4,162,729. **GO BUILD (STANDARD CHARACTER)**. POSITEC GROUP LIMITED, (U.S. CLS. 13, 19, 21, 23, 31, 34 AND 35). SN 77-305,914. PUB. 3-15-2011. FILED 10-17-2007.
- 4,162,738 (*See Class 6 for this trademark*).
- 4,162,747. **DENSO WAVE (STANDARD CHARACTER)**. DENSO CORPORATION, MULTIPLE CLASS, (INT. CLS. 7 AND 9), (U.S. CLS. 13, 19, 21, 23, 26, 31, 34, 35, 36 AND 38). SN 77-700,036. PUB. 4-26-2011. FILED 3-26-2009.
- 4,162,761. **LIVING ENVIRONMENT CARE AND DESIGN**. LG ELECTRONICS INC., MULTIPLE CLASS, (INT. CLS. 7, 9, 10, 11 AND 35), (U.S. CLS. 13, 19, 21, 23, 26, 31, 34, 35, 36, 38, 39, 44, 100, 101 AND 102). SN 77-814,325. PUB. 4-10-2012. FILED 8-27-2009.
- 4,162,762. **RESOURCE REDUCTION AND DESIGN**. LG ELECTRONICS INC., MULTIPLE CLASS, (INT. CLS. 7, 9, 10, 11 AND 35), (U.S. CLS. 13, 19, 21, 23, 26, 31, 34, 35, 36, 38, 39, 44, 100, 101 AND 102). SN 77-814,373. PUB. 4-10-2012. FILED 8-27-2009.
- 4,162,770. **TURN ON TOMORROW (STANDARD CHARACTER)**. SAMSUNG ELECTRONICS CO., LTD., MULTIPLE CLASS, (INT. CLS. 7, 9 AND 11), (U.S. CLS. 13, 19, 21, 23, 26, 31, 34, 35, 36 AND 38). SN 77-873,522. PUB. 3-20-2012. FILED 11-16-2009.
- 4,162,795. **400 SERIES (STANDARD CHARACTER)**. RBC BEARINGS INC., (U.S. CLS. 13, 19, 21, 23, 31, 34 AND 35). SN 78-745,159. PUB. 12-26-2006. FILED 11-2-2005.
- 4,162,813. **HAMMEL RECYCLINGTECHNIK AND DESIGN**. HAMMEL RECYCLINGTECHNIK GMBH, (U.S. CLS. 13, 19, 21, 23, 31, 34 AND 35). SN 79-084,624. PUB. 4-10-2012. FILED 4-7-2010.
- 4,162,836. **AL-VAC AND DESIGN**. AL MATERIEL A/S, (U.S. CLS. 13, 19, 21, 23, 31, 34 AND 35). SN 79-090,670. PUB. 4-10-2012. FILED 11-20-2010.
- 4,162,838. **GS AND DESIGN**. GRIBALDI & SALVIA S.P.A., (U.S. CLS. 13, 19, 21, 23, 31, 34 AND 35). SN 79-091,057. PUB. 4-10-2012. FILED 11-5-2010.
- 4,162,843. **SCHLEUNIGER AND DESIGN**. SCHLEUNIGER HOLDING AG, MULTIPLE CLASS, (INT. CLS. 7, 8, 9 AND 40), (U.S. CLS. 13, 19, 21, 23, 26, 28, 31, 34, 35, 36, 38, 44, 100, 103 AND 106). SN 79-091,831. PUB. 4-10-2012. FILED 11-2-2010.
- 4,162,853. **MISCELLANEOUS DESIGN**. GUANGZHOU AUTOMOBILE GROUP CO., LTD., MULTIPLE CLASS, (INT. CLS. 7, 12 AND 37), (U.S. CLS. 13, 19, 21, 23, 31, 34, 35, 44, 100, 103 AND 106). SN 79-094,370. PUB. 4-10-2012. FILED 11-12-2010.
- 4,162,857. **SITRAK AND DESIGN**. CHINA NATIONAL HEAVY DUTY TRUCK GROUP CO., LTD., MULTIPLE CLASS, (INT. CLS. 7 AND 37), (U.S. CLS. 13, 19, 21, 23, 31, 34, 35, 100, 103 AND 106). SN 79-095,220. PUB. 1-3-2012. FILED 12-30-2010.
- 4,162,862. **SITRAK (STYLIZED)**. CHINA NATIONAL HEAVY DUTY TRUCK GROUP CO., LTD., MULTIPLE CLASS, (INT. CLS. 7 AND 37), (U.S. CLS. 13, 19, 21, 23, 31, 34, 35, 100, 103 AND 106). SN 79-095,700. PUB. 1-3-2012. FILED 12-30-2010.
- 4,162,868 (*See Class 6 for this trademark*).
- 4,162,873 (*See Class 6 for this trademark*).
- 4,162,874. **NEW STANDARD AND DESIGN**. WILA B.V., MULTIPLE CLASS, (INT. CLS. 7, 37 AND 42), (U.S. CLS. 13, 19, 21, 23, 31, 34, 35, 100, 101, 103 AND 106). SN 79-097,196. PUB. 4-10-2012. FILED 3-25-2011.
- 4,162,904. **DCMS AND DESIGN**. CALEDONIAN INDUSTRIES LIMITED, MULTIPLE CLASS, (INT. CLS. 7 AND 40), (U.S. CLS. 13, 19, 21, 23, 31, 34, 35, 100, 103 AND 106). SN 79-098,989. PUB. 4-10-2012. FILED 8-24-2010.
- 4,162,933. **ENGINEERED SUSTAINABILITY F AND DESIGN**. FIVES, MULTIPLE CLASS, (INT. CLS. 7, 11 AND 37), (U.S. CLS. 13, 19, 21, 23, 31, 34, 35, 100, 103 AND 106). SN 79-099,931. PUB. 4-10-2012. FILED 4-4-2011.
- 4,162,938. **CG AND DESIGN**. STOPINC AKTIENGESELLSCHAFT, MULTIPLE CLASS, (INT. CLS. 7 AND 19), (U.S. CLS. 1, 12, 13, 19, 21, 23, 31, 33, 34, 35 AND 50). SN 79-100,202. PUB. 4-10-2012. FILED 3-22-2011.
- 4,162,940. **COMPACT AND DESIGN**. FONDAZIONE ISTITUTO ITALIANO DI TECNOLOGIA, MULTIPLE CLASS, (INT. CLS. 7 AND 9), (U.S. CLS. 13, 19, 21, 23, 26, 31, 34, 35, 36 AND 38). SN 79-100,226. PUB. 4-10-2012. FILED 4-5-2011.
- 4,162,967. **RIDDER (STANDARD CHARACTER)**. RIDDER BEHEER B.V., MULTIPLE CLASS, (INT. CLS. 7, 9 AND 37), (U.S. CLS. 13, 19, 21, 23, 26, 31, 34, 35, 36, 38, 100, 103 AND 106). SN 79-101,759. PUB. 4-10-2012. FILED 6-28-2011.
- 4,162,970. **DISPERIZER (STANDARD CHARACTER)**. SINTOKOGIO, LTD., (U.S. CLS. 13, 19, 21, 23, 31, 34 AND 35). SN 79-102,015. PUB. 4-10-2012. FILED 7-19-2011.
- 4,162,992. **EISENMANN (STANDARD CHARACTER)**. EISENMANN AG, MULTIPLE CLASS, (INT. CLS. 7 AND 11), (U.S. CLS. 13, 19, 21, 23, 31, 34 AND 35). SN 79-102,890. PUB. 4-10-2012. FILED 5-17-2011.
- 4,162,994. **EASY-FLOW (STANDARD CHARACTER)**. WINDMÖLLER & HÖLSCHER KG, MULTIPLE CLASS, (INT. CLS. 7 AND 9), (U.S. CLS. 13, 19, 21, 23, 26, 31, 34, 35, 36 AND 38). SN 79-102,964. PUB. 4-10-2012. FILED 8-23-2011.
- 4,163,020 (*See Class 3 for this trademark*).
- 4,163,031. **TAMAGAWA (STYLIZED)**. TAMAGAWA SEIKI CO., LTD., MULTIPLE CLASS, (INT. CLS. 7 AND 9), (U.S. CLS. 13, 19, 21, 23, 26, 31, 34, 35, 36 AND 38). SN 79-106,055. PUB. 4-10-2012. FILED 8-25-2011.
- 4,163,055 (*See Class 4 for this trademark*).
- 4,163,056 (*See Class 4 for this trademark*).

- 4,163,135. **KKL (STANDARD CHARACTER)**. STONE STEPS MANUFACTURING LLC, DBA SSM AND KKL, (U.S. CLS. 13, 19, 21, 23, 31, 34 AND 35). SN 85-163,961. PUB. 4-10-2012. FILED 10-28-2010.
- 4,163,200. **TERRATECH (STANDARD CHARACTER)**. TERRATECH MANUFACTURING, INC., (U.S. CLS. 13, 19, 21, 23, 31, 34 AND 35). SN 85-242,494. PUB. 4-10-2012. FILED 2-15-2011.
- 4,163,239. **340S (STANDARD CHARACTER)**. BETEILIGUNGEN SORG GMBH & CO. KG, MULTIPLE CLASS, (INT. CLS. 7, 9, 11 AND 19), (U.S. CLS. 1, 12, 13, 19, 21, 23, 26, 31, 33, 34, 35, 36, 38 AND 50). SN 85-272,117. PUB. 4-10-2012. FILED 3-21-2011.
- 4,163,240. **OXECON (STANDARD CHARACTER)**. BETEILIGUNGEN SORG GMBH & CO. KG, MULTIPLE CLASS, (INT. CLS. 7, 9, 11 AND 19), (U.S. CLS. 1, 12, 13, 19, 21, 23, 26, 31, 33, 34, 35, 36, 38 AND 50). SN 85-272,126. PUB. 4-10-2012. FILED 3-21-2011.
- 4,163,247. **T AND DESIGN**. WABTEC HOLDING CORP., MULTIPLE CLASS, (INT. CLS. 7 AND 37), (U.S. CLS. 13, 19, 21, 23, 31, 34, 35, 100, 103 AND 106). SN 85-273,535. PUB. 4-10-2012. FILED 3-22-2011.
- 4,163,286. **TEXTRONIC (STANDARD CHARACTER)**. TEXTRONIC INC, (U.S. CLS. 13, 19, 21, 23, 31, 34 AND 35). SN 85-291,246. PUB. 4-10-2012. FILED 4-10-2011.
- 4,163,298. **GRAPHITE (STANDARD CHARACTER)**. ORECK HOLDINGS, LLC, (U.S. CLS. 13, 19, 21, 23, 31, 34 AND 35). SN 85-294,395. PUB. 4-10-2012. FILED 4-13-2011.
- 4,163,366. **DIGIT (STANDARD CHARACTER)**. I.S.T. ITALIA SISTEMI TECNOLOGICI S.R.L., (U.S. CLS. 13, 19, 21, 23, 31, 34 AND 35). SN 85-307,478. PUB. 4-10-2012. FILED 4-28-2011.
- 4,163,439. **FEPDM (STANDARD CHARACTER)**. STAMFORD SCIENTIFIC INTERNATIONAL INC., DBA STAMFORD SCIENTIFIC INTERNATIONAL INC., (U.S. CLS. 13, 19, 21, 23, 31, 34 AND 35). SN 85-315,920. PUB. 4-10-2012. FILED 5-9-2011.
- 4,163,487. **MISCELLANEOUS DESIGN**. RHINO TOOL CO., (U.S. CLS. 13, 19, 21, 23, 31, 34 AND 35). SN 85-331,629. PUB. 4-10-2012. FILED 5-26-2011.
- 4,163,488. **RHINO (STANDARD CHARACTER)**. RHINO TOOL CO., (U.S. CLS. 13, 19, 21, 23, 31, 34 AND 35). SN 85-331,680. PUB. 4-10-2012. FILED 5-26-2011.
- 4,163,502. **FIBERMARK (STANDARD CHARACTER)**. EPILOG CORPORATION, (U.S. CLS. 13, 19, 21, 23, 31, 34 AND 35). SN 85-337,915. PUB. 4-10-2012. FILED 6-3-2011.
- 4,163,507 (*See Class 6 for this trademark*).
- 4,163,512. **TOPROL (STANDARD CHARACTER)**. TOP MACHINERY & EQUIPMENT (ZHENGZHOU) LTD., (U.S. CLS. 13, 19, 21, 23, 31, 34 AND 35). SN 85-340,738. PUB. 11-1-2011. FILED 6-8-2011.
- 4,163,602. **CGI GASKETS AN ISO 9001 COMPANY AND DESIGN**. CROWN GASKETS (INDIA), (U.S. CLS. 13, 19, 21, 23, 31, 34 AND 35). SN 85-370,974. PUB. 4-10-2012. FILED 7-14-2011.
- 4,163,748. **MANDREL 4X (STANDARD CHARACTER)**. M & Y TRADING, DBA HELBY IMPORT CO., (U.S. CLS. 13, 19, 21, 23, 31, 34 AND 35). SN 85-417,021. PUB. 4-10-2012. FILED 9-7-2011.
- 4,163,781. **CABLE MANAGEMENT WWW.CABLEMANAGEMENTUSA.COM ELECTRICAL WIRE CHOPPING AND DESIGN**. CABLE MANAGEMENT LLC, MULTIPLE CLASS, (INT. CLS. 7 AND 40), (U.S. CLS. 13, 19, 21, 23, 31, 34, 35, 100, 103 AND 106). SN 85-424,778. PUB. 4-10-2012. FILED 9-16-2011.
- 4,163,786. **WET REVOLUTION (STANDARD CHARACTER)**. EBARA CORPORATION, (U.S. CLS. 13, 19, 21, 23, 31, 34 AND 35). SN 85-426,110. PUB. 4-10-2012. FILED 9-19-2011.
- 4,163,908. **GISS (STANDARD CHARACTER)**. GUHRING OHG, (U.S. CLS. 13, 19, 21, 23, 31, 34 AND 35). SN 85-441,823. PUB. 4-10-2012. FILED 10-7-2011.
- 4,164,013. **MFP (STANDARD CHARACTER)**. MARTIN FLUID POWER COMPANY, (U.S. CLS. 13, 19, 21, 23, 31, 34 AND 35). SN 85-450,709. PUB. 4-10-2012. FILED 10-19-2011.
- 4,164,017. **MFP SEALS (STANDARD CHARACTER)**. MARTIN FLUID POWER COMPANY, (U.S. CLS. 13, 19, 21, 23, 31, 34 AND 35). SN 85-450,952. PUB. 4-10-2012. FILED 10-19-2011.
- 4,164,051. **TRAVELING TOWER (STANDARD CHARACTER)**. TRAVELING TOWER LLC, (U.S. CLS. 13, 19, 21, 23, 31, 34 AND 35). SN 85-452,598. PUB. 4-10-2012. FILED 10-20-2011.
- 4,164,098. **NYLO-LITH (STANDARD CHARACTER)**. ROTATION DYNAMICS CORPORATION, (U.S. CLS. 13, 19, 21, 23, 31, 34 AND 35). SN 85-454,247. PUB. 4-10-2012. FILED 10-24-2011.
- 4,164,099. **POLY-DAMP (STANDARD CHARACTER)**. ROTATION DYNAMICS CORPORATION, (U.S. CLS. 13, 19, 21, 23, 31, 34 AND 35). SN 85-454,267. PUB. 4-10-2012. FILED 10-24-2011.
- 4,164,122. **REVOLVER (STANDARD CHARACTER)**. GALE BANKS ENGINEERING, (U.S. CLS. 13, 19, 21, 23, 31, 34 AND 35). SN 85-454,813. PUB. 4-10-2012. FILED 10-24-2011.
- 4,164,130. **BMA SECURITY INTEGRITY BIOMASS MARKETING ASSOCIATES AND DESIGN**. BIOMASS MARKETING, LLC, (U.S. CLS. 13, 19, 21, 23, 31, 34 AND 35). SN 85-455,194. PUB. 4-10-2012. FILED 10-25-2011.
- 4,164,228. **PORKLIFT (STANDARD CHARACTER)**. PORKLIFT, INC., (U.S. CLS. 13, 19, 21, 23, 31, 34 AND 35). SN 85-457,382. PUB. 4-10-2012. FILED 10-27-2011.
- 4,164,275. **MASTERPACKER ECOPLUS (STANDARD CHARACTER)**. CVP SYSTEMS, INC., (U.S. CLS. 13, 19, 21, 23, 31, 34 AND 35). SN 85-457,817. PUB. 4-10-2012. FILED 10-27-2011.
- 4,164,277. **ECOPLUS (STANDARD CHARACTER)**. CVP SYSTEMS, INC., MULTIPLE CLASS, (INT. CLS. 7 AND 17), (U.S. CLS. 1, 5, 12, 13, 19, 21, 23, 31, 34, 35 AND 50). SN 85-457,849. PUB. 4-10-2012. FILED 10-27-2011.
- 4,164,301. **ECO+ (STANDARD CHARACTER)**. CVP SYSTEMS, INC., MULTIPLE CLASS, (INT. CLS. 7 AND 17), (U.S. CLS. 1, 5, 12, 13, 19, 21, 23, 31, 34, 35 AND 50). SN 85-457,986. PUB. 4-10-2012. FILED 10-27-2011.
- 4,164,495. **SMABOT AND DESIGN**. PROTREND CO., LTD., MULTIPLE CLASS, (INT. CLS. 7 AND 11), (U.S. CLS. 13, 19, 21, 23, 31, 34 AND 35). SN 85-459,957. PUB. 4-10-2012. FILED 10-31-2011.
- 4,164,648. **PISTON-PAC (STANDARD CHARACTER)**. MARTIN FLUID POWER COMPANY, (U.S. CLS. 13, 19, 21, 23, 31, 34 AND 35). SN 85-469,398. PUB. 4-10-2012. FILED 11-10-2011.
- 4,164,658. **SEANIC AND DESIGN**. MAKO DEEPWATER, INC., MULTIPLE CLASS, (INT. CLS. 7 AND 37), (U.S. CLS. 13, 19, 21, 23, 31, 34, 35, 100, 103 AND 106). SN 85-470,792. PUB. 4-10-2012. FILED 11-11-2011.
- 4,164,685 (*See Class 6 for this trademark*).
- 4,164,686 (*See Class 6 for this trademark*).

CLASS 8—HAND TOOLS

- 4,162,843 (*See Class 7 for this trademark*).
- 4,162,939. **OPERACE (STYLIZED)**. PB SWISS TOOLS GMBH, MULTIPLE CLASS, (INT. CLS. 8 AND 10), (U.S. CLS. 23, 26, 28, 39 AND 44). SN 79-100,225. PUB. 4-10-2012. FILED 4-13-2011.
- 4,162,996. **EXCELLENT EDGES AND DESIGN**. AUSTRALIAN BLADESMITHS PTY LTD, MULTIPLE CLASS, (INT. CLS. 8, 35 AND 39), (U.S. CLS. 23, 28, 44, 100, 101, 102 AND 105). SN 79-103,188. PUB. 4-10-2012. FILED 8-2-2011.
- 4,163,005. **YE AND DESIGN**. GUANGZHOU YUE YUAN TONG INTERNATIONAL INDUSTRY CO., LTD., MULTIPLE CLASS, (INT. CLS. 8 AND 21), (U.S. CLS. 2, 13, 23, 28, 29, 30, 33, 40, 44 AND 50). SN 79-103,994. PUB. 4-10-2012. FILED 9-27-2011.
- 4,163,029 (*See Class 4 for this trademark*).
- 4,163,238. **GENERATION GREEN BOTTLE CUTTER (STANDARD CHARACTER)**. DIAMOND TECH INTERNATIONAL, (U.S. CLS. 23, 28 AND 44). SN 85-271,629. PUB. 4-10-2012. FILED 3-20-2011.
- 4,163,467. **PAIL RIDER (STANDARD CHARACTER)**. GREEN, BOB, (U.S. CLS. 23, 28 AND 44). SN 85-323,189. PUB. 4-10-2012. FILED 5-17-2011.
- 4,163,484. **MISCELLANEOUS DESIGN**. APEX BRANDS, INC., (U.S. CLS. 23, 28 AND 44). SN 85-330,483. PUB. 4-10-2012. FILED 5-25-2011.
- 4,163,491. **PROLITHIUM SERIES (STANDARD CHARACTER)**. WAHL CLIPPER CORPORATION, (U.S. CLS. 23, 28 AND 44). SN 85-334,013. PUB. 4-10-2012. FILED 5-31-2011.

- 4,163,652 (*See Class 1 for this trademark*).
- 4,163,811. **ELARA (STANDARD CHARACTER)**. ELARA FOODSERVICE DISPOSABLES LLC, MULTIPLE CLASS, (INT. CLS. 8, 16, 21 AND 25), (U.S. CLS. 2, 5, 13, 22, 23, 28, 29, 30, 33, 37, 38, 39, 40, 44 AND 50). SN 85-429,064. PUB. 4-10-2012. FILED 9-22-2011.
- 4,163,844. **SHASER BIOSCIENCE (STANDARD CHARACTER)**. SHASER, INC., (U.S. CLS. 23, 28 AND 44). SN 85-434,103. PUB. 4-10-2012. FILED 9-28-2011.
- 4,163,901 (*See Class 2 for this trademark*).
- 4,164,266. **SELF CASA (STANDARD CHARACTER)**. J. & P. COATS, LIMITED, MULTIPLE CLASS, (INT. CLS. 8, 23 AND 26), (U.S. CLS. 23, 28, 37, 39, 40, 42, 43, 44 AND 50). SN 85-457,754. PUB. 4-10-2012. FILED 10-27-2011.
- 4,164,548. **CHANEL (STANDARD CHARACTER)**. CHANEL, INC., (U.S. CLS. 23, 28 AND 44). SN 85-460,678. PUB. 4-10-2012. FILED 10-31-2011.
-
- CLASS 9—ELECTRICAL AND SCIENTIFIC APPARATUS**
- 4,162,694. **AZD (STANDARD CHARACTER)**. AZURE DYNAMICS, INC., (U.S. CLS. 21, 23, 26, 36 AND 38). SN 76-697,990. PUB. 9-20-2011. FILED 6-22-2009.
- 4,162,699. **NEPHEW TOMMY (STANDARD CHARACTER)**. THE STEVE HARVEY RADIO NETWORK, INC., (U.S. CLS. 21, 23, 26, 36 AND 38). SN 76-705,919. PUB. 4-10-2012. FILED 1-6-2011.
- 4,162,708. **ACTION ALERT (STANDARD CHARACTER)**. KEYWARE, INC., (U.S. CLS. 21, 23, 26, 36 AND 38). SN 76-707,839. PUB. 4-10-2012. FILED 6-3-2011.
- 4,162,719. **VQUAD (STYLIZED)**. SWISSQUAL HOLDING AG, MULTIPLE CLASS, (INT. CLS. 9 AND 42), (U.S. CLS. 21, 23, 26, 36, 38, 100 AND 101). SN 76-709,476. PUB. 4-10-2012. FILED 7-6-2010.
- 4,162,726. **GAS AND DESIGN**. GROTTO S.P.A., MULTIPLE CLASS, (INT. CLS. 9, 16, 28, 35, 41, 42, 43 AND 45), (U.S. CLS. 2, 5, 21, 22, 23, 26, 29, 36, 37, 38, 50, 100, 101, 102 AND 107). SN 76-979,119. PUB. 9-27-2011. FILED 2-4-2003.
- 4,162,732. **LUCKY DEALER (STANDARD CHARACTER)**. DEQ SYSTEMES CORP., (U.S. CLS. 21, 23, 26, 36 AND 38). SN 77-387,148. PUB. 4-10-2012. FILED 2-2-2008.
- 4,162,735. **ZITRO SYSTEM (STANDARD CHARACTER)**. ZITRO IP S.A.R.L., MULTIPLE CLASS, (INT. CLS. 9, 28, 35, 38, 41 AND 42), (U.S. CLS. 21, 22, 23, 26, 36, 38, 50, 100, 101, 102, 104 AND 107). SN 77-457,755. PUB. 4-10-2012. FILED 4-25-2008.
- 4,162,736. **ZITRO GLOBAL AND DESIGN**. ZITRO IP S.A.R.L., MULTIPLE CLASS, (INT. CLS. 9, 28, 35, 38, 41 AND 42), (U.S. CLS. 21, 22, 23, 26, 36, 38, 50, 100, 101, 102, 104 AND 107). SN 77-457,764. PUB. 4-10-2012. FILED 4-25-2008.
- 4,162,737. **GLOBAL ZITRO AND DESIGN**. ZITRO IP S.A.R.L., MULTIPLE CLASS, (INT. CLS. 9, 28, 35, 38, 41 AND 42), (U.S. CLS. 21, 22, 23, 26, 36, 38, 50, 100, 101, 102, 104 AND 107). SN 77-457,776. PUB. 4-10-2012. FILED 4-25-2008.
- 4,162,738 (*See Class 6 for this trademark*).
- 4,162,747 (*See Class 7 for this trademark*).
- 4,162,753. **PSP GO (STANDARD CHARACTER)**. KABUSHIKI KAISHA SONY COMPUTER ENTERTAINMENT, TA SONY COMPUTER ENTERTAINMENT INC., MULTIPLE CLASS, (INT. CLS. 9, 16, 28, 35, 38, 41 AND 42), (U.S. CLS. 2, 5, 21, 22, 23, 26, 29, 36, 37, 38, 50, 100, 101, 102, 104 AND 107). SN 77-749,175. PUB. 4-10-2012. FILED 6-1-2009.
- 4,162,758. **ESSENTIAL SOUND PRODUCTS, INC. AND DESIGN**. ESSENTIAL SOUND PRODUCTS, INC., (U.S. CLS. 21, 23, 26, 36 AND 38). SN 77-759,567. PUB. 6-8-2010. FILED 6-15-2009.
- 4,162,761 (*See Class 7 for this trademark*).
- 4,162,762 (*See Class 7 for this trademark*).
- 4,162,766. **BLURB IQ AND DESIGN**. SPENCER, ANDREW MICHAEL, MULTIPLE CLASS, (INT. CLS. 9, 35 AND 42), (U.S. CLS. 21, 23, 26, 36, 38, 100, 101 AND 102). SN 77-840,524. PUB. 8-2-2011. FILED 10-2-2009.
- 4,162,770 (*See Class 7 for this trademark*).
- 4,162,783 (*See Class 6 for this trademark*).
- 4,162,784. **A-DECO (STANDARD CHARACTER)**. GALAXIA ELECTRONICS CO., LTD., (U.S. CLS. 21, 23, 26, 36 AND 38). SN 77-955,134. PUB. 4-10-2012. FILED 3-10-2010.
- 4,162,785. **STREAMWORK (STANDARD CHARACTER)**. SAP AG, MULTIPLE CLASS, (INT. CLS. 9, 16, 35, 38, 41 AND 42), (U.S. CLS. 2, 5, 21, 22, 23, 26, 29, 36, 37, 38, 50, 100, 101, 102, 104 AND 107). SN 77-957,702. PUB. 4-10-2012. FILED 3-12-2010.
- 4,162,799. **GOAL.COM (STANDARD CHARACTER)**. GOAL-COM (HOLDCO) S.A., MULTIPLE CLASS, (INT. CLS. 9, 25, 35 AND 41), (U.S. CLS. 21, 22, 23, 26, 36, 38, 39, 100, 101, 102 AND 107). SN 79-037,052. PUB. 4-10-2012. FILED 12-27-2006.
- 4,162,800. **OERLIKON AHEAD (STANDARD CHARACTER)**. RHEINMETALL AIR DEFENCE AG, MULTIPLE CLASS, (INT. CLS. 9 AND 13), (U.S. CLS. 2, 9, 21, 23, 26, 36 AND 38). SN 79-044,198. PUB. 4-10-2012. FILED 9-7-2007.
- 4,162,806. **ADEY (STANDARD CHARACTER)**. ADEY HOLDINGS (2008) LIMITED, MULTIPLE CLASS, (INT. CLS. 9, 11 AND 35), (U.S. CLS. 13, 21, 23, 26, 31, 34, 36, 38, 100, 101 AND 102). SN 79-075,585. PUB. 4-10-2012. FILED 10-29-2009.
- 4,162,812 (*See Class 6 for this trademark*).
- 4,162,814. **FRANZ (STANDARD CHARACTER)**. MYKITA STUDIO GMBH, (U.S. CLS. 21, 23, 26, 36 AND 38). SN 79-085,135. PUB. 4-10-2012. FILED 6-25-2010.
- 4,162,817. **NOKTON (STANDARD CHARACTER)**. VOIGTLÄNDER GMBH, (U.S. CLS. 21, 23, 26, 36 AND 38). SN 79-086,779. PUB. 4-10-2012. FILED 8-5-2010.
- 4,162,821. **CLESLINE (STANDARD CHARACTER)**. CLESTRA CLEANROOM (SOCIÉTÉ PAR ACTIONS SIMPLIFIÉE), MULTIPLE CLASS, (INT. CLS. 9 AND 11), (U.S. CLS. 13, 21, 23, 26, 31, 34, 36 AND 38). SN 79-088,203. PUB. 4-10-2012. FILED 8-13-2010.
- 4,162,825. **BAD PIGGIES (STANDARD CHARACTER)**. ROVIO ENTERTAINMENT LTD, MULTIPLE CLASS, (INT. CLS. 9, 16, 28 AND 41), (U.S. CLS. 2, 5, 21, 22, 23, 26, 29, 36, 37, 38, 50, 100, 101 AND 107). SN 79-088,847. PUB. 4-10-2012. FILED 9-10-2010.
- 4,162,827. **STROMAE (STYLIZED)**. MOSAERT SPRL, MULTIPLE CLASS, (INT. CLS. 9, 16, 25, 26, 35 AND 41), (U.S. CLS. 2, 5, 21, 22, 23, 26, 29, 36, 37, 38, 39, 40, 42, 50, 100, 101, 102 AND 107). SN 79-089,026. PUB. 4-10-2012. FILED 9-21-2010.
- 4,162,830. **CLOVER (STANDARD CHARACTER)**. KONINKLIJKE PHILIPS ELECTRONICS N.V., MULTIPLE CLASS, (INT. CLS. 9, 11, 35 AND 45), (U.S. CLS. 13, 21, 23, 26, 31, 34, 36, 38, 100, 101 AND 102). SN 79-089,748. PUB. 4-10-2012. FILED 9-24-2010.
- 4,162,831. **CD AND DESIGN**. CHRISTIAN DIOR COUTURE, MULTIPLE CLASS, (INT. CLS. 9, 14, 18 AND 25), (U.S. CLS. 1, 2, 3, 21, 22, 23, 26, 27, 28, 36, 38, 39, 41 AND 50). SN 79-089,824. PUB. 4-10-2012. FILED 8-11-2010.
- 4,162,835. **ANS (STANDARD CHARACTER)**. IPANEMA TECHNOLOGIES, MULTIPLE CLASS, (INT. CLS. 9 AND 38), (U.S. CLS. 21, 23, 26, 36, 38, 100, 101 AND 104). SN 79-090,405. PUB. 4-10-2012. FILED 10-22-2010.
- 4,162,843 (*See Class 7 for this trademark*).
- 4,162,844. **DRIMMI AND DESIGN**. OBSHESTVO S OGRANICHENNOY OTVETSTVENNOSTYU "DRIMMI", MULTIPLE CLASS, (INT. CLS. 9, 35, 38, 41 AND 42), (U.S. CLS. 21, 23, 26, 36, 38, 100, 101, 102, 104 AND 107). SN 79-091,869. PUB. 4-10-2012. FILED 8-11-2010.
- 4,162,845. **THERMOROYAL (STANDARD CHARACTER)**. HANS-JOACHIM WOLF, MULTIPLE CLASS, (INT. CLS. 9, 11, 12, 20, 21, 35 AND 39), (U.S. CLS. 2, 13, 19, 21, 22, 23, 25, 26, 29, 30, 31, 32, 33, 34, 35, 36, 38, 40, 44, 50, 100, 101, 102 AND 105). SN 79-092,116. PUB. 4-10-2012. FILED 10-5-2010.
- 4,162,846. **JEREMYVILLE (STANDARD CHARACTER)**. JEREMY PTY LTD, MULTIPLE CLASS, (INT. CLS. 9, 16, 18, 25, 27, 28 AND 35), (U.S. CLS. 1, 2, 3, 5, 19, 20, 21, 22, 23, 26, 29, 36, 37, 38, 39, 41, 42, 50, 100, 101 AND 102). SN 79-092,199. PUB. 1-3-2012. FILED 9-16-2010.
- 4,162,848. **SECUTRACE (STANDARD CHARACTER)**. LEONHARD KURZ STIFTUNG & CO. KG, MULTIPLE CLASS, (INT. CLS. 9, 16, 17, 39 AND 42), (U.S. CLS. 1, 2, 5, 12, 13, 21, 22, 23, 26, 29, 35, 36, 37, 38, 50, 100, 101 AND 105). SN 79-092,709. PUB. 4-10-2012. FILED 9-7-2010.
- 4,162,854. **YOZO AND DESIGN**. YOZOSOFT CO., LTD., (U.S. CLS. 21, 23, 26, 36 AND 38). SN 79-094,615. PUB. 4-10-2012. FILED 3-1-2011.

- 4,162,855. **MAXIMUM LIGHT DETECTION - MLD (STANDARD CHARACTER)**, DEGERENERGIE GMBH, (U.S. CLS. 21, 23, 26, 36 AND 38). SN 79-094,965. PUB. 4-10-2012. FILED 2-22-2011.
- 4,162,856. **TOPCM (STYLIZED)**, EC-LEASING CO., MULTIPLE CLASS, (INT. CLS. 9, 36, 38 AND 42), (U.S. CLS. 21, 23, 26, 36, 38, 100, 101, 102 AND 104). SN 79-095,142. PUB. 1-3-2012. FILED 2-3-2011.
- 4,162,867. **HOME SMART HOME (STANDARD CHARACTER)**, ZYXEL DEUTSCHLAND GMBH, MULTIPLE CLASS, (INT. CLS. 9, 38 AND 42), (U.S. CLS. 21, 23, 26, 36, 38, 100, 101 AND 104). SN 79-096,523. PUB. 1-3-2012. FILED 12-14-2010.
- 4,162,868 (*See Class 6 for this trademark*).
- 4,162,871. **AUDIO-3D.COM AND DESIGN**, MONSIEUR JEAN LUC HAURAI, AND MONSIEUR FRANCK ROSSET, MULTIPLE CLASS, (INT. CLS. 9, 10, 35, 38, 41 AND 42), (U.S. CLS. 21, 23, 26, 36, 38, 39, 44, 100, 101, 102, 104 AND 107). SN 79-096,817. PUB. 4-10-2012. FILED 11-23-2010.
- 4,162,873 (*See Class 6 for this trademark*).
- 4,162,879. **AUCTUS (STANDARD CHARACTER)**, FOSHAN NANHAI CHEVAN OPTICAL OPTICAL ELECTRONICS CO., LTD., (U.S. CLS. 21, 23, 26, 36 AND 38). SN 79-097,516. PUB. 4-10-2012. FILED 4-18-2011.
- 4,162,883. **SOUNDRAIL (STANDARD CHARACTER)**, FEONIC PLC, (U.S. CLS. 21, 23, 26, 36 AND 38). SN 79-097,705. PUB. 4-10-2012. FILED 4-28-2011.
- 4,162,885. **DBCLEAR (STANDARD CHARACTER)**, DEUTSCHE BANK AG, MULTIPLE CLASS, (INT. CLS. 9, 16, 35, 36 AND 42), (U.S. CLS. 2, 5, 21, 22, 23, 26, 29, 36, 37, 38, 50, 100, 101 AND 102). SN 79-097,770. PUB. 4-10-2012. FILED 2-11-2011.
- 4,162,889. **SOCIAL INK (STANDARD CHARACTER)**, YAPPA CORPORATION, (U.S. CLS. 21, 23, 26, 36 AND 38). SN 79-098,050. PUB. 4-10-2012. FILED 4-11-2011.
- 4,162,892. **AM (STYLIZED)**, AM EYEWEAR PTY LTD, MULTIPLE CLASS, (INT. CLS. 9 AND 25), (U.S. CLS. 21, 22, 23, 26, 36, 38 AND 39). SN 79-098,379. PUB. 4-10-2012. FILED 5-12-2011.
- 4,162,893. **HEW-KABEL (STANDARD CHARACTER)**, HEW-KABEL GMBH & CO. KG, (U.S. CLS. 21, 23, 26, 36 AND 38). SN 79-098,450. PUB. 4-10-2012. FILED 3-16-2011.
- 4,162,898. **SMAATO (STANDARD CHARACTER)**, SMAATO INC., MULTIPLE CLASS, (INT. CLS. 9, 38 AND 42), (U.S. CLS. 21, 23, 26, 36, 38, 100, 101 AND 104). SN 79-098,707. PUB. 4-10-2012. FILED 1-14-2011.
- 4,162,899 (*See Class 1 for this trademark*).
- 4,162,902. **MISCELLANEOUS DESIGN**, GELLER, WOLFGANG-PETER, MULTIPLE CLASS, (INT. CLS. 9 AND 18), (U.S. CLS. 1, 2, 3, 21, 22, 23, 26, 36, 38 AND 41). SN 79-098,978. PUB. 4-10-2012. FILED 5-23-2011.
- 4,162,908. **NIGHTBRITE (STANDARD CHARACTER)**, MELEXIS TESSENDERLO NV, MULTIPLE CLASS, (INT. CLS. 9, 41 AND 42), (U.S. CLS. 21, 23, 26, 36, 38, 100, 101 AND 107). SN 79-099,089. PUB. 4-10-2012. FILED 2-25-2011.
- 4,162,913 (*See Class 6 for this trademark*).
- 4,162,929. **SSS AND DESIGN**, SHINODA PLASMA CO., LTD., (U.S. CLS. 21, 23, 26, 36 AND 38). SN 79-099,772. PUB. 4-10-2012. FILED 6-27-2011.
- 4,162,935. **I* BOARD (STYLIZED)**, SCHWEIZER ELECTRONIC AG, MULTIPLE CLASS, (INT. CLS. 9, 35 AND 42), (U.S. CLS. 21, 23, 26, 36, 38, 100, 101 AND 102). SN 79-100,000. PUB. 4-10-2012. FILED 2-15-2011.
- 4,162,940 (*See Class 7 for this trademark*).
- 4,162,942. **ZODIAC AEROSPACE AND DESIGN**, ZODIAC AEROSPACE, MULTIPLE CLASS, (INT. CLS. 9, 11 AND 12), (U.S. CLS. 13, 19, 21, 23, 26, 31, 34, 35, 36, 38 AND 44). SN 79-100,324. PUB. 4-10-2012. FILED 2-7-2011.
- 4,162,946. **WAREHOUSE LONDON (STANDARD CHARACTER)**, WAREHOUSE FASHIONS LIMITED, MULTIPLE CLASS, (INT. CLS. 9, 14, 18, 25 AND 35), (U.S. CLS. 1, 2, 3, 21, 22, 23, 26, 27, 28, 36, 38, 39, 41, 50, 100, 101 AND 102). SN 79-100,838. PUB. 4-10-2012. FILED 4-16-2011.
- 4,162,947 (*See Class 2 for this trademark*).
- 4,162,955. **NOREVE (STYLIZED)**, MICHAËL MASSAT, MULTIPLE CLASS, (INT. CLS. 9, 14 AND 18), (U.S. CLS. 1, 2, 3, 21, 22, 23, 26, 27, 28, 36, 38, 41 AND 50). SN 79-101,282. PUB. 4-10-2012. FILED 5-30-2011.
- 4,162,967 (*See Class 7 for this trademark*).
- 4,162,985. **ERMET ZD HD (STANDARD CHARACTER)**, ERNI ELECTRONICS GMBH, MULTIPLE CLASS, (INT. CLS. 9 AND 17), (U.S. CLS. 1, 5, 12, 13, 21, 23, 26, 35, 36, 38 AND 50). SN 79-102,687. PUB. 4-10-2012. FILED 7-21-2011.
- 4,162,986. **ERMET ZDPLUS (STANDARD CHARACTER)**, ERNI ELECTRONICS GMBH, MULTIPLE CLASS, (INT. CLS. 9 AND 17), (U.S. CLS. 1, 5, 12, 13, 21, 23, 26, 35, 36, 38 AND 50). SN 79-102,688. PUB. 4-10-2012. FILED 7-21-2011.
- 4,162,987 (*See Class 6 for this trademark*).
- 4,162,993. **ESSE AND DESIGN**, OBHCHESTVO S OGRANICHENNOY OTVETSTVENNOSTYU "FONTINALIS", (U.S. CLS. 21, 23, 26, 36 AND 38). SN 79-102,930. PUB. 4-10-2012. FILED 7-27-2011.
- 4,162,994 (*See Class 7 for this trademark*).
- 4,162,999. **JOHCM (STANDARD CHARACTER)**, J O HAMBRO CAPITAL MANAGEMENT LIMITED, MULTIPLE CLASS, (INT. CLS. 9, 16, 35, 36 AND 41), (U.S. CLS. 2, 5, 21, 22, 23, 26, 29, 36, 37, 38, 50, 100, 101, 102 AND 107). SN 79-103,598. PUB. 4-10-2012. FILED 5-27-2011.
- 4,163,004. **SPILGAMES AND DESIGN**, SPIL GAMES INTANGIBLES B.V., MULTIPLE CLASS, (INT. CLS. 9, 35 AND 41), (U.S. CLS. 21, 23, 26, 36, 38, 100, 101, 102 AND 107). SN 79-103,835. PUB. 4-10-2012. FILED 3-15-2011.
- 4,163,007. **IN-MAP (STANDARD CHARACTER)**, JAN DE KESEL, MULTIPLE CLASS, (INT. CLS. 9, 35 AND 42), (U.S. CLS. 21, 23, 26, 36, 38, 100, 101 AND 102). SN 79-104,064. PUB. 4-10-2012. FILED 8-18-2011.
- 4,163,016. **BORRI AND DESIGN**, BORRI S.P.A., (U.S. CLS. 21, 23, 26, 36 AND 38). SN 79-104,481. PUB. 4-10-2012. FILED 4-27-2011.
- 4,163,025. **THE FOURTH HORSE (STANDARD CHARACTER)**, JAMES N O'CONNOR PTY LTD, MULTIPLE CLASS, (INT. CLS. 9, 28 AND 41), (U.S. CLS. 21, 22, 23, 26, 36, 38, 50, 100, 101 AND 107). SN 79-105,476. PUB. 4-10-2012. FILED 9-27-2011.
- 4,163,026. **OPEN WALLET AND DESIGN**, ACARDO TECHNOLOGIES AG, MULTIPLE CLASS, (INT. CLS. 9, 36, 38 AND 42), (U.S. CLS. 21, 23, 26, 36, 38, 100, 101, 102 AND 104). SN 79-105,617. PUB. 4-10-2012. FILED 6-10-2011.
- 4,163,031 (*See Class 7 for this trademark*).
- 4,163,035. **HATSUNE MIKU AND DESIGN**, CRYPTON FUTURE MEDIA INC., MULTIPLE CLASS, (INT. CLS. 9 AND 28), (U.S. CLS. 21, 22, 23, 26, 36, 38 AND 50). SN 79-106,369. PUB. 4-10-2012. FILED 7-25-2011.
- 4,163,040. **WINMAGINE (STANDARD CHARACTER)**, WINMAGINE, MULTIPLE CLASS, (INT. CLS. 9, 38 AND 42), (U.S. CLS. 21, 23, 26, 36, 38, 100, 101 AND 104). SN 79-107,026. PUB. 4-10-2012. FILED 5-13-2011.
- 4,163,053. **VERITRAX (STANDARD CHARACTER)**, CLARIANT AG, MULTIPLE CLASS, (INT. CLS. 9, 35 AND 42), (U.S. CLS. 21, 23, 26, 36, 38, 100, 101 AND 102). SN 85-013,796. PUB. 4-10-2012. FILED 4-14-2010.
- 4,163,057. **EXPRESS TELLER SERVICES NETWORK (STANDARD CHARACTER)**, EXPRESS TELLER SERVICES, INC., (U.S. CLS. 21, 23, 26, 36 AND 38). SN 85-025,230. PUB. 4-10-2012. FILED 4-28-2010.
- 4,163,058. **ALYENZ (STANDARD CHARACTER)**, JOKER AG/SA, MULTIPLE CLASS, (INT. CLS. 9, 16, 25 AND 28), (U.S. CLS. 2, 5, 21, 22, 23, 26, 29, 36, 37, 38, 39 AND 50). SN 85-029,655. PUB. 3-15-2011. FILED 5-4-2010.
- 4,163,059. **SCHEDONOMY (STANDARD CHARACTER)**, GESTION LOUIS-MARIELE INC., MULTIPLE CLASS, (INT. CLS. 9 AND 35), (U.S. CLS. 21, 23, 26, 36, 38, 100, 101 AND 102). SN 85-031,156. PUB. 4-10-2012. FILED 5-5-2010.
- 4,163,061. **RDA LIGHTING (STANDARD CHARACTER)**, RDA LIGHTING INC., MULTIPLE CLASS, (INT. CLS. 9, 11 AND 42), (U.S. CLS. 13, 21, 23, 26, 31, 34, 36, 38, 100 AND 101). SN 85-039,321. PUB. 4-10-2012. FILED 5-14-2010.
- 4,163,065. **WOMANITY (STANDARD CHARACTER)**, RENZO NI, ROBERTA, MULTIPLE CLASS, (INT. CLS. 9, 14, 16, 18 AND 25), (U.S. CLS. 1, 2, 3, 5, 21, 22, 23, 26, 27, 28, 29, 36, 37, 38, 39, 41 AND 50). SN 85-042,284. PUB. 6-14-2011. FILED 5-19-2010.
- 4,163,068. **MEDAPHOR (STANDARD CHARACTER)**, MEDAPHOR LIMITED, MULTIPLE CLASS, (INT. CLS. 9, 10, 16 AND 41), (U.S. CLS. 2, 5, 21, 22, 23, 26, 29, 36, 37, 38, 39, 44, 50, 100, 101 AND 107). SN 85-070,527. PUB. 4-10-2012. FILED

- 6-24-2010.
- 4,163,074. **I-SCOPE (STANDARD CHARACTER)**. MORITEX CORPORATION, (U.S. CLS. 21, 23, 26, 36 AND 38). SN 85-094,849. PUB. 4-10-2012. FILED 7-28-2010.
- 4,163,077 (*See Class 1 for this trademark*).
- 4,163,091. **AG AND DESIGN**. AUTO-GRAPHIC, INC., MULTIPLE CLASS, (INT. CLS. 9 AND 42), (U.S. CLS. 21, 23, 26, 36, 38, 100 AND 101). SN 85-117,895. PUB. 4-10-2012. FILED 8-27-2010.
- 4,163,093. **S AND DESIGN**. SHOPIFY INC., MULTIPLE CLASS, (INT. CLS. 9 AND 42), (U.S. CLS. 21, 23, 26, 36, 38, 100 AND 101). SN 85-120,175. PUB. 4-10-2012. FILED 8-31-2010.
- 4,163,106. **ID CREATION (STANDARD CHARACTER)**. SOGAL FRANCE, (U.S. CLS. 21, 23, 26, 36 AND 38). SN 85-136,602. PUB. 1-3-2012. FILED 9-23-2010.
- 4,163,119. **MICROEYE (STANDARD CHARACTER)**. PETER CHRISTIAN WOLDRICH, MULTIPLE CLASS, (INT. CLS. 9 AND 11), (U.S. CLS. 13, 21, 23, 26, 31, 34, 36 AND 38). SN 85-149,309. PUB. 4-10-2012. FILED 10-11-2010.
- 4,163,128. **SYNCJACK (STANDARD CHARACTER)**. ADVA AG OPTICAL NETWORKING, (U.S. CLS. 21, 23, 26, 36 AND 38). SN 85-158,503. PUB. 2-28-2012. FILED 10-21-2010.
- 4,163,131. **CITYXPRESS (STANDARD CHARACTER)**. CITYXPRESS LTD., MULTIPLE CLASS, (INT. CLS. 9, 35 AND 42), (U.S. CLS. 21, 23, 26, 36, 38, 100, 101 AND 102). SN 85-161,178. PUB. 4-10-2012. FILED 10-26-2010.
- 4,163,134. **MISCELLANEOUS DESIGN**. SCHLAFENDER HASE GMBH, MULTIPLE CLASS, (INT. CLS. 9, 16, 35 AND 42), (U.S. CLS. 2, 5, 21, 22, 23, 26, 29, 36, 37, 38, 50, 100, 101 AND 102). SN 85-162,701. PUB. 4-10-2012. FILED 10-27-2010.
- 4,163,138. **PRACTICE MAKES PERFECT (STANDARD CHARACTER)**. THE MCGRAW-HILL COMPANIES, INC., MULTIPLE CLASS, (INT. CLS. 9 AND 16), (U.S. CLS. 2, 5, 21, 22, 23, 26, 29, 36, 37, 38 AND 50). SN 85-164,894. PUB. 4-10-2012. FILED 10-29-2010.
- 4,163,176. **INNER CIRCLE (STANDARD CHARACTER)**. SEQUIN CORP., DBA INNERCIRCLE.COM, MULTIPLE CLASS, (INT. CLS. 9 AND 35), (U.S. CLS. 21, 23, 26, 36, 38, 100, 101 AND 102). SN 85-215,381. PUB. 9-20-2011. FILED 11-11-2011.
- 4,163,178. **W5 O4 AND DESIGN**. ZYNGA INC., MULTIPLE CLASS, (INT. CLS. 9 AND 41), (U.S. CLS. 21, 23, 26, 36, 38, 100, 101 AND 107). SN 85-216,489. PUB. 4-10-2012. FILED 1-13-2011.
- 4,163,184. **FX-SPORT (STANDARD CHARACTER)**. DUNCAN CHRISTOPHER WALSH, MULTIPLE CLASS, (INT. CLS. 9, 10 AND 14), (U.S. CLS. 2, 21, 23, 26, 27, 28, 36, 38, 39, 44 AND 50). SN 85-224,275. PUB. 4-10-2012. FILED 1-24-2011.
- 4,163,202. **HIPCHAT (STANDARD CHARACTER)**. HIPCHAT, INC., (U.S. CLS. 21, 23, 26, 36 AND 38). SN 85-242,953. PUB. 4-10-2012. FILED 2-15-2011.
- 4,163,205. **MISCELLANEOUS DESIGN**. FUJITSU LIMITED, MULTIPLE CLASS, (INT. CLS. 9, 35, 37, 38, 41, 42 AND 45), (U.S. CLS. 21, 23, 26, 36, 38, 100, 101, 102, 103, 104, 106 AND 107). SN 85-248,702. PUB. 4-10-2012. FILED 2-22-2011.
- 4,163,206. **SHAPING TOMORROW WITH YOU AND DESIGN**. FUJITSU LIMITED, MULTIPLE CLASS, (INT. CLS. 9, 35, 37, 38, 41, 42 AND 45), (U.S. CLS. 21, 23, 26, 36, 38, 100, 101, 102, 103, 104, 106 AND 107). SN 85-248,789. PUB. 4-10-2012. FILED 2-22-2011.
- 4,163,207. **MISCELLANEOUS DESIGN**. FUJITSU LIMITED, MULTIPLE CLASS, (INT. CLS. 9, 35, 37, 38, 41, 42 AND 45), (U.S. CLS. 21, 23, 26, 36, 38, 100, 101, 102, 103, 104, 106 AND 107). SN 85-248,836. PUB. 4-10-2012. FILED 2-22-2011.
- 4,163,223. **OVERDRIVE (STANDARD CHARACTER)**. OVERDRIVE, INC., MULTIPLE CLASS, (INT. CLS. 9, 41 AND 42), (U.S. CLS. 21, 23, 26, 36, 38, 100, 101 AND 107). SN 85-262,613. PUB. 4-10-2012. FILED 3-9-2011.
- 4,163,225. **MIVI (STANDARD CHARACTER)**. CAMPBELL, ROY LEONARD, MULTIPLE CLASS, (INT. CLS. 9 AND 41), (U.S. CLS. 21, 23, 26, 36, 38, 100, 101 AND 107). SN 85-263,313. PUB. 4-10-2012. FILED 3-10-2011.
- 4,163,226. **THE MORTGAGE OFFICE (STANDARD CHARACTER)**. APPLIED BUSINESS SOFTWARE, INC., (U.S. CLS. 21, 23, 26, 36 AND 38). SN 85-264,446. PUB. 4-10-2012. FILED 3-11-2011.
- 4,163,239 (*See Class 7 for this trademark*).
- 4,163,240 (*See Class 7 for this trademark*).
- 4,163,245. **SERVAID (STANDARD CHARACTER)**. ATLAS COPCO TOOLS AB, MULTIPLE CLASS, (INT. CLS. 9 AND 42), (U.S. CLS. 21, 23, 26, 36, 38, 100 AND 101). SN 85-272,805. PUB. 4-10-2012. FILED 3-21-2011.
- 4,163,253. **LASIKNEAR MULTIFOCAL (STANDARD CHARACTER)**. YOUNG'S VALLEY CONTAX, INC., (U.S. CLS. 21, 23, 26, 36 AND 38). SN 85-277,522. PUB. 4-10-2012. FILED 3-25-2011.
- 4,163,260. **IONGUARD (STANDARD CHARACTER)**. THERMO ELECTRON LED GMBH, (U.S. CLS. 21, 23, 26, 36 AND 38). SN 85-282,136. PUB. 4-10-2012. FILED 3-31-2011.
- 4,163,276. **OPTIBAY (STANDARD CHARACTER)**. RAMIREZ, ARNOLD, (U.S. CLS. 21, 23, 26, 36 AND 38). SN 85-289,045. PUB. 4-10-2012. FILED 4-7-2011.
- 4,163,278. **RAPIDFIRE (STANDARD CHARACTER)**. AGILENT TECHNOLOGIES, INC., (U.S. CLS. 21, 23, 26, 36 AND 38). SN 85-289,619. PUB. 4-10-2012. FILED 4-7-2011.
- 4,163,302. **KINETIC BY KURT (STANDARD CHARACTER)**. KURT MANUFACTURING COMPANY, INC., MULTIPLE CLASS, (INT. CLS. 9, 12, 27 AND 28), (U.S. CLS. 19, 20, 21, 22, 23, 26, 31, 35, 36, 37, 38, 42, 44 AND 50). SN 85-295,117. PUB. 4-10-2012. FILED 4-14-2011.
- 4,163,312. **MOBIQUITY (STANDARD CHARACTER)**. VERSATILE SYSTEMS, INC., (U.S. CLS. 21, 23, 26, 36 AND 38). SN 85-298,522. PUB. 4-10-2012. FILED 4-19-2011.
- 4,163,314. **JUMP ON! (STANDARD CHARACTER)**. T-MOBILE USA, INC., MULTIPLE CLASS, (INT. CLS. 9, 38 AND 42), (U.S. CLS. 21, 23, 26, 36, 38, 100, 101 AND 104). SN 85-298,924. PUB. 4-10-2012. FILED 4-19-2011.
- 4,163,327. **DIGITAL CEOS (STANDARD CHARACTER)**. MARKUS R DIERSBOCK, (U.S. CLS. 21, 23, 26, 36 AND 38). SN 85-302,935. PUB. 4-10-2012. FILED 4-23-2011.
- 4,163,333. **UNLEASHING TALENT (STANDARD CHARACTER)**. FRANKLIN COVEY CO., MULTIPLE CLASS, (INT. CLS. 9, 16 AND 41), (U.S. CLS. 2, 5, 21, 22, 23, 26, 29, 36, 37, 38, 50, 100, 101 AND 107). SN 85-303,517. PUB. 4-10-2012. FILED 4-25-2011.
- 4,163,358. **ADRS (STANDARD CHARACTER)**. 4 S TECHNOLOGIES, LLC, (U.S. CLS. 21, 23, 26, 36 AND 38). SN 85-306,822. PUB. 4-10-2012. FILED 4-28-2011.
- 4,163,359. **ASPS (STANDARD CHARACTER)**. 4 S TECHNOLOGIES, LLC, (U.S. CLS. 21, 23, 26, 36 AND 38). SN 85-306,827. PUB. 4-10-2012. FILED 4-28-2011.
- 4,163,360. **AARS (STANDARD CHARACTER)**. 4 S TECHNOLOGIES, LLC, (U.S. CLS. 21, 23, 26, 36 AND 38). SN 85-306,830. PUB. 4-10-2012. FILED 4-28-2011.
- 4,163,361. **GROUNDWIDGETS (STANDARD CHARACTER)**. ORISSA HOLDINGS, LLC, (U.S. CLS. 21, 23, 26, 36 AND 38). SN 85-306,946. PUB. 4-10-2012. FILED 4-28-2011.
- 4,163,371. **IMAL (STANDARD CHARACTER)**. PATH SOLUTIONS K.S.C., (U.S. CLS. 21, 23, 26, 36 AND 38). SN 85-307,910. PUB. 4-10-2012. FILED 4-28-2011.
- 4,163,396. **SEITO (STANDARD CHARACTER)**. SEITO SYSTEMS LIMITED, (U.S. CLS. 21, 23, 26, 36 AND 38). SN 85-310,372. PUB. 4-10-2012. FILED 5-2-2011.
- 4,163,402. **TVUPACK (STANDARD CHARACTER)**. TVU NETWORKS CORPORATION, (U.S. CLS. 21, 23, 26, 36 AND 38). SN 85-310,717. PUB. 4-10-2012. FILED 5-3-2011.
- 4,163,403. **THE WEDGE (STANDARD CHARACTER)**. WEDGEWORKS, LLC, (U.S. CLS. 21, 23, 26, 36 AND 38). SN 85-310,748. PUB. 4-10-2012. FILED 5-3-2011.
- 4,163,407. **MISCELLANEOUS DESIGN**. MISSISSIPPI STATE UNIVERSITY, MULTIPLE CLASS, (INT. CLS. 9 AND 42), (U.S. CLS. 21, 23, 26, 36, 38, 100 AND 101). SN 85-310,991. PUB. 4-10-2012. FILED 5-3-2011.
- 4,163,416. **COMALEX AND DESIGN**. HEARTLAND PAYMENT SYSTEMS, INC., (U.S. CLS. 21, 23, 26, 36 AND 38). SN 85-312,668. PUB. 4-10-2012. FILED 5-4-2011.
- 4,163,418. **A (STYLIZED)**. ACERBIS ITALIA SPA, MULTIPLE CLASS, (INT. CLS. 9, 11, 12, 18 AND 25), (U.S. CLS. 1, 2, 3, 13, 19, 21, 22, 23, 26, 31, 34, 35, 36, 38, 39, 41 AND 44). SN 85-313,359. PUB. 4-10-2012. FILED 5-5-2011.
- 4,163,432. **BRIDES WEDDING GENIUS (STANDARD CHARACTER)**. ADVANCE MAGAZINE PUBLISHERS INC., (U.S. CLS. 21, 23, 26, 36 AND 38). SN 85-314,575. PUB. 4-10-2012. FILED 5-6-2011.

- 4,163,437. **LIVE AND DESIGN**. CAO, JIANHUA, MULTIPLE CLASS, (INT. CLS. 9 AND 38), (U.S. CLS. 21, 23, 26, 36, 38, 100, 101 AND 104). SN 85-315,629. PUB. 4-10-2012. FILED 5-9-2011.
- 4,163,462. **LANPROTECT AND DESIGN**. AEP NETWORKS, INC., (U.S. CLS. 21, 23, 26, 36 AND 38). SN 85-322,484. PUB. 4-10-2012. FILED 5-17-2011.
- 4,163,463. **SERVICEPROTECT AND DESIGN**. AEP NETWORKS, INC., (U.S. CLS. 21, 23, 26, 36 AND 38). SN 85-322,487. PUB. 4-10-2012. FILED 5-17-2011.
- 4,163,464. **TONI & ASH (STYLIZED)**. TONI & ASH ENTERTAINMENT, LLC, (U.S. CLS. 21, 23, 26, 36 AND 38). SN 85-322,770. PUB. 4-10-2012. FILED 5-17-2011.
- 4,163,465. **TONI & ASH (STYLIZED)**. TONI & ASH ENTERTAINMENT, LLC, (U.S. CLS. 21, 23, 26, 36 AND 38). SN 85-322,776. PUB. 4-10-2012. FILED 5-17-2011.
- 4,163,507 (*See Class 6 for this trademark*).
- 4,163,519. **DERBY DAY DOLLARS (STANDARD CHARACTER)**. TOCCATA GAMING INTERNATIONAL, LLC, (U.S. CLS. 21, 23, 26, 36 AND 38). SN 85-344,588. PUB. 4-10-2012. FILED 6-13-2011.
- 4,163,522. **ACTIVTRAK (STANDARD CHARACTER)**. BIRCH GROVE SOFTWARE, INC., (U.S. CLS. 21, 23, 26, 36 AND 38). SN 85-345,013. PUB. 11-1-2011. FILED 6-13-2011.
- 4,163,545. **RUSH ASSOCIATED LABELS (STANDARD CHARACTER)**. RUSH ASSOCIATED LABELS, INC., (U.S. CLS. 21, 23, 26, 36 AND 38). SN 85-351,661. PUB. 4-10-2012. FILED 6-21-2011.
- 4,163,546. **RAL RUSH ASSOCIATED LABELS (STYLIZED)**. RUSH ASSOCIATED LABELS, INC., (U.S. CLS. 21, 23, 26, 36 AND 38). SN 85-351,686. PUB. 4-10-2012. FILED 6-21-2011.
- 4,163,549. **KINDERSCAN (STANDARD CHARACTER)**. CONTROLTEC, INC., (U.S. CLS. 21, 23, 26, 36 AND 38). SN 85-353,137. PUB. 4-10-2012. FILED 6-22-2011.
- 4,163,550. **G & F PRODUCTS AND DESIGN**. G & F PRODUCTS, INC., DBA G & F GLOVES, (U.S. CLS. 21, 23, 26, 36 AND 38). SN 85-353,199. PUB. 4-10-2012. FILED 6-22-2011.
- 4,163,554. **WE DELIVER POWER (STANDARD CHARACTER)**. SOUTHWIRE COMPANY, (U.S. CLS. 21, 23, 26, 36 AND 38). SN 85-354,239. PUB. 4-10-2012. FILED 6-23-2011.
- 4,163,563. **CORE FOCUS BY HATCH AND DESIGN**. HATCH, INC., (U.S. CLS. 21, 23, 26, 36 AND 38). SN 85-355,286. PUB. 11-1-2011. FILED 6-24-2011.
- 4,163,567. **OMATICS (STANDARD CHARACTER)**. ORISSA HOLDINGS, LLC, (U.S. CLS. 21, 23, 26, 36 AND 38). SN 85-355,887. PUB. 4-10-2012. FILED 6-24-2011.
- 4,163,577. **CHLORDIOXENSE (STANDARD CHARACTER)**. PALINTEST LIMITED, (U.S. CLS. 21, 23, 26, 36 AND 38). SN 85-360,308. PUB. 4-10-2012. FILED 6-30-2011.
- 4,163,581. **TPK AND DESIGN**. TPK TOUCH SOLUTIONS INC., MULTIPLE CLASS, (INT. CLS. 9 AND 42), (U.S. CLS. 21, 23, 26, 36, 38, 100 AND 101). SN 85-362,582. PUB. 4-10-2012. FILED 7-4-2011.
- 4,163,585. **QUICKCHARGE (STANDARD CHARACTER)**. M. M. HAYES COMPANY, INC., (U.S. CLS. 21, 23, 26, 36 AND 38). SN 85-365,300. PUB. 4-10-2012. FILED 7-7-2011.
- 4,163,593. **SCIENCE VOCABULARY ESSENTIALS (STANDARD CHARACTER)**. CREATIVE EDUCATION INSTITUTE, INC., MULTIPLE CLASS, (INT. CLS. 9 AND 16), (U.S. CLS. 2, 5, 21, 22, 23, 26, 29, 36, 37, 38 AND 50). SN 85-368,056. PUB. 4-10-2012. FILED 7-11-2011.
- 4,163,601. **ZOMBIE SMASH! (STANDARD CHARACTER)**. ZYNGA INC., MULTIPLE CLASS, (INT. CLS. 9 AND 41), (U.S. CLS. 21, 23, 26, 36, 38, 100, 101 AND 107). SN 85-370,785. PUB. 4-10-2012. FILED 7-13-2011.
- 4,163,608. **PICKAFIGHT (STANDARD CHARACTER)**. FIGHTERLINK, MULTIPLE CLASS, (INT. CLS. 9, 38 AND 41), (U.S. CLS. 21, 23, 26, 36, 38, 100, 101, 104 AND 107). SN 85-374,589. PUB. 4-10-2012. FILED 7-19-2011.
- 4,163,613. **INTELLIGENT HEATER TUBES (STANDARD CHARACTER)**. PETROLEUM ANALYZER COMPANY, L.P., (U.S. CLS. 21, 23, 26, 36 AND 38). SN 85-375,887. PUB. 4-10-2012. FILED 7-20-2011.
- 4,163,614. **WHITMAN CONTROLS EXCLUSIVE FACTORY SEAL AND DESIGN**. WHITMAN CONTROLS CORPORATION, (U.S. CLS. 21, 23, 26, 36 AND 38). SN 85-376,243. PUB. 4-10-2012. FILED 7-20-2011.
- 4,163,615. **WHITMAN CONTROLS CORPORATION (STANDARD CHARACTER)**. WHITMAN CONTROLS CORPORATION, (U.S. CLS. 21, 23, 26, 36 AND 38). SN 85-376,353. PUB. 4-10-2012. FILED 7-20-2011.
- 4,163,623. **THA STREET STRINGA AND DESIGN**. GINES, JACQUELINE M, AKA JACQUIE GINES, MULTIPLE CLASS, (INT. CLS. 9 AND 41), (U.S. CLS. 21, 23, 26, 36, 38, 100, 101 AND 107). SN 85-379,337. PUB. 4-10-2012. FILED 7-24-2011.
- 4,163,625. **ACR CONNECT AND DESIGN**. AMERICAN COLLEGE OF RADIOLOGY, (U.S. CLS. 21, 23, 26, 36 AND 38). SN 85-380,070. PUB. 4-10-2012. FILED 7-25-2011.
- 4,163,634. **K&C (STYLIZED)**. LIFUNG TRINITY MANAGEMENT (SINGAPORE) PTE. LTD., (U.S. CLS. 21, 23, 26, 36 AND 38). SN 85-382,142. PUB. 4-10-2012. FILED 7-27-2011.
- 4,163,635. **INTERNAV (STANDARD CHARACTER)**. NAVSYS CORPORATION, (U.S. CLS. 21, 23, 26, 36 AND 38). SN 85-382,293. PUB. 4-10-2012. FILED 7-27-2011.
- 4,163,639. **NO DRAWING-SENSORY MARK**. INTEL CORPORATION, (U.S. CLS. 21, 23, 26, 36 AND 38). SN 85-382,520. PUB. 4-10-2012. FILED 7-27-2011.
- 4,163,644. **RRHOT AND DESIGN**. RRRHOT LLC, (U.S. CLS. 21, 23, 26, 36 AND 38). SN 85-383,300. PUB. 4-10-2012. FILED 7-28-2011.
- 4,163,652 (*See Class 1 for this trademark*).
- 4,163,663. **ISO-ELASTIC (STANDARD CHARACTER)**. THE TIFFEN COMPANY, LLC, (U.S. CLS. 21, 23, 26, 36 AND 38). SN 85-389,561. PUB. 4-10-2012. FILED 8-4-2011.
- 4,163,664. **WEBSTORM (STANDARD CHARACTER)**. JET-BRAINS S.R.O., (U.S. CLS. 21, 23, 26, 36 AND 38). SN 85-389,732. PUB. 4-10-2012. FILED 8-4-2011.
- 4,163,665. **PYCHARM (STANDARD CHARACTER)**. JET-BRAINS S.R.O., (U.S. CLS. 21, 23, 26, 36 AND 38). SN 85-389,736. PUB. 4-10-2012. FILED 8-4-2011.
- 4,163,670. **COSMOS AND DESIGN**. OOI, WUI YUH, (U.S. CLS. 21, 23, 26, 36 AND 38). SN 85-390,937. PUB. 1-3-2012. FILED 8-5-2011.
- 4,163,671. **AY (STYLIZED)**. GOULART, PETER M, (U.S. CLS. 21, 23, 26, 36 AND 38). SN 85-391,197. PUB. 4-10-2012. FILED 8-5-2011.
- 4,163,675. **SERVANT KEEPER CHECK IN (STANDARD CHARACTER)**. SERVANT PC RESOURCES, INC., (U.S. CLS. 21, 23, 26, 36 AND 38). SN 85-392,187. PUB. 4-10-2012. FILED 8-8-2011.
- 4,163,688. **STARBUG (STANDARD CHARACTER)**. NEON RAIN INTERACTIVE, LLC, (U.S. CLS. 21, 23, 26, 36 AND 38). SN 85-398,063. PUB. 4-10-2012. FILED 8-15-2011.
- 4,163,691. **EKHO (STANDARD CHARACTER)**. EKHO BRAND AMERICAS, LLC, AKA EKHO HEART RATE MONITORS, MULTIPLE CLASS, (INT. CLS. 9 AND 10), (U.S. CLS. 21, 23, 26, 36, 38, 39 AND 44). SN 85-400,547. PUB. 4-10-2012. FILED 8-17-2011.
- 4,163,695. **MISCELLANEOUS DESIGN**. MULTIMEDIA GAMES, INC., MULTIPLE CLASS, (INT. CLS. 9 AND 41), (U.S. CLS. 21, 23, 26, 36, 38, 100, 101 AND 107). SN 85-402,277. PUB. 4-10-2012. FILED 8-19-2011.
- 4,163,703. **EAGLE INVESTMENT SYSTEMS (STANDARD CHARACTER)**. EAGLE INVESTMENT SYSTEMS CORP., (U.S. CLS. 21, 23, 26, 36 AND 38). SN 85-404,667. PUB. 4-10-2012. FILED 8-23-2011.
- 4,163,704. **EZ DEFENSE (STANDARD CHARACTER)**. MARTIAL ARTS MARKETING, INC., MULTIPLE CLASS, (INT. CLS. 9 AND 41), (U.S. CLS. 21, 23, 26, 36, 38, 100, 101 AND 107). SN 85-405,741. PUB. 4-10-2012. FILED 8-24-2011.
- 4,163,705. **GIGASTONE (STYLIZED)**. GIGASTONE CORPORATION, (U.S. CLS. 21, 23, 26, 36 AND 38). SN 85-405,947. PUB. 4-10-2012. FILED 8-24-2011.
- 4,163,721. **SEAMLESS DATA PUMP (STANDARD CHARACTER)**. SEAMLESS TECHNOLOGIES, INC., (U.S. CLS. 21, 23, 26, 36 AND 38). SN 85-411,179. PUB. 4-10-2012. FILED 8-30-2011.
- 4,163,724. **AUCTIONTRAC AND DESIGN**. ADESA, INC., (U.S. CLS. 21, 23, 26, 36 AND 38). SN 85-411,614. PUB. 4-10-2012. FILED 8-31-2011.
- 4,163,725. **EVENT EDGE (STANDARD CHARACTER)**. INDSPIRE LLC, DBA PERSOURCE, (U.S. CLS. 21, 23, 26, 36 AND 38). SN 85-411,682. PUB. 4-10-2012. FILED 8-31-2011.
- 4,163,728. **GOTOTAGS (STANDARD CHARACTER)**. WIRE-

- LESS SENSOR TECHNOLOGIES, INC., MULTIPLE CLASS, (INT. CLS. 9, 37 AND 42), (U.S. CLS. 21, 23, 26, 36, 38, 100, 101, 103 AND 106). SN 85-411,828. PUB. 4-10-2012. FILED 8-31-2011.
- 4,163,729. **EZDOCK (STANDARD CHARACTER)**. RTM INTERNATIONAL LLC, (U.S. CLS. 21, 23, 26, 36 AND 38). SN 85-412,872. PUB. 4-10-2012. FILED S.R. 9-1-2011; AM. P.R. 2-28-2012.
- 4,163,736. **KINGDEE (STYLIZED)**. KINGDEE SOFTWARE (CHINA) CO., LTD., (U.S. CLS. 21, 23, 26, 36 AND 38). SN 85-413,718. PUB. 4-10-2012. FILED 9-2-2011.
- 4,163,743. **PAINFUL PLEASURES (STANDARD CHARACTER)**. PAINFUL PLEASURES, INC., MULTIPLE CLASS, (INT. CLS. 9, 35, 38 AND 41), (U.S. CLS. 21, 23, 26, 36, 38, 100, 101, 102, 104 AND 107). SN 85-416,277. PUB. 4-10-2012. FILED 9-7-2011.
- 4,163,744. **MISCELLANEOUS DESIGN**. AMERICAN TEL-A-SYSTEMS, INC., AKA AMTELCO, MULTIPLE CLASS, (INT. CLS. 9 AND 38), (U.S. CLS. 21, 23, 26, 36, 38, 100, 101 AND 104). SN 85-416,393. PUB. 4-10-2012. FILED 9-7-2011.
- 4,163,764. **NASTY NESS (STANDARD CHARACTER)**. NESTOR OURANITSAS, AKA NASTY NESS, (U.S. CLS. 21, 23, 26, 36 AND 38). SN 85-419,289. PUB. 4-10-2012. FILED 9-9-2011.
- 4,163,791. **OPTIMEDIA (STANDARD CHARACTER)**. DATA-MAX-O'NEIL CORPORATION, (U.S. CLS. 21, 23, 26, 36 AND 38). SN 85-427,192. PUB. 4-10-2012. FILED 9-20-2011.
- 4,163,798. **FREELANCER PANEL AND DESIGN**. XYCHE WEB SOLUTIONS LLC, MULTIPLE CLASS, (INT. CLS. 9 AND 42), (U.S. CLS. 21, 23, 26, 36, 38, 100 AND 101). SN 85-427,740. PUB. 4-10-2012. FILED 9-21-2011.
- 4,163,801. **LUNAR RUNNER LAUNCH SETTINGS MEDALS EJECT AND DESIGN**. FLYING TIGER ENTERTAINMENT, INC., (U.S. CLS. 21, 23, 26, 36 AND 38). SN 85-428,161. PUB. 4-10-2012. FILED 9-21-2011.
- 4,163,817. **IR INFRARED RESOURCES AND DESIGN**. INFRARED RESOURCES, LLC, (U.S. CLS. 21, 23, 26, 36 AND 38). SN 85-430,635. PUB. 3-6-2012. FILED 9-23-2011.
- 4,163,819. **DURAVISION (STYLIZED)**. CARL ZEISS VISION GMBH, (U.S. CLS. 21, 23, 26, 36 AND 38). SN 85-430,885. PUB. 4-10-2012. FILED 9-23-2011.
- 4,163,825. **KETTLERCISE (STANDARD CHARACTER)**. KETTLEBELL SEMINARS LIMITED, MULTIPLE CLASS, (INT. CLS. 9, 16, 28 AND 41), (U.S. CLS. 2, 5, 21, 22, 23, 26, 29, 36, 37, 38, 50, 100, 101 AND 107). SN 85-431,494. PUB. 4-10-2012. FILED 9-26-2011.
- 4,163,830. **MIMORY (STANDARD CHARACTER)**. MIMOCO, INC., (U.S. CLS. 21, 23, 26, 36 AND 38). SN 85-432,687. PUB. 4-10-2012. FILED 9-27-2011.
- 4,163,832. **SLIM GAINER (STANDARD CHARACTER)**. DAIICHI DENPA KOGYO KABUSHIKI KAISHA, TA DAIICHI DENPA KOGYO CO., LTD., (U.S. CLS. 21, 23, 26, 36 AND 38). SN 85-433,181. PUB. 4-10-2012. FILED 9-27-2011.
- 4,163,856. **VOICEBO (STANDARD CHARACTER)**. FAST TRACK TECHNOLOGIES LIMITED, (U.S. CLS. 21, 23, 26, 36 AND 38). SN 85-435,379. PUB. 4-10-2012. FILED 9-29-2011.
- 4,163,860. **AUTOSPA (STANDARD CHARACTER)**. CHAR-DONNAY CORP., (U.S. CLS. 21, 23, 26, 36 AND 38). SN 85-435,967. PUB. 4-10-2012. FILED 9-30-2011.
- 4,163,878. **VISUAL TAKEOFF (STANDARD CHARACTER)**. COMPUT-ABILITY, INC., (U.S. CLS. 21, 23, 26, 36 AND 38). SN 85-438,220. PUB. 4-10-2012. FILED 10-3-2011.
- 4,163,888. **JONNY BEAR (STANDARD CHARACTER)**. GRAPSEED MEDIA LIMITED, MULTIPLE CLASS, (INT. CLS. 9 AND 16), (U.S. CLS. 2, 5, 21, 22, 23, 26, 29, 36, 37, 38 AND 50). SN 85-439,458. PUB. 4-10-2012. FILED 10-5-2011.
- 4,163,889. **ENTRY SERIES (STANDARD CHARACTER)**. JOHN MEZZALINGUA ASSOCIATES, INC. DBA PPC, (U.S. CLS. 21, 23, 26, 36 AND 38). SN 85-439,558. PUB. 4-10-2012. FILED 10-5-2011.
- 4,163,905. **COUPONMAT (STANDARD CHARACTER)**. COUPONMAT, LLC, MULTIPLE CLASS, (INT. CLS. 9, 35, 41 AND 42), (U.S. CLS. 21, 23, 26, 36, 38, 100, 101, 102 AND 107). SN 85-441,501. PUB. 4-10-2012. FILED 10-6-2011.
- 4,163,926. **FIVE STARS (STANDARD CHARACTER)**. FIVE STARS LOYALTY, INC., MULTIPLE CLASS, (INT. CLS. 9 AND 35), (U.S. CLS. 21, 23, 26, 36, 38, 100, 101 AND 102). SN 85-443,606. PUB. 4-10-2012. FILED 10-10-2011.
- 4,163,938 (*See Class 6 for this trademark*).
- 4,163,967. **SPIKE STIK (STANDARD CHARACTER)**. TRIPPE MANUFACTURING COMPANY, (U.S. CLS. 21, 23, 26, 36 AND 38). SN 85-447,739. PUB. 4-10-2012. FILED 10-14-2011.
- 4,163,991. **LITTLE MATH (STANDARD CHARACTER)**. BRILLKIDS, INC., (U.S. CLS. 21, 23, 26, 36 AND 38). SN 85-449,403. PUB. 4-10-2012. FILED 10-18-2011.
- 4,163,992. **BRILLKIDS (STANDARD CHARACTER)**. BRILLKIDS, INC., MULTIPLE CLASS, (INT. CLS. 9, 16 AND 41), (U.S. CLS. 2, 5, 21, 22, 23, 26, 29, 36, 37, 38, 50, 100, 101 AND 107). SN 85-449,413. PUB. 4-10-2012. FILED 10-18-2011.
- 4,164,009. **JESSE DEE (STANDARD CHARACTER)**. DEE, JESSE, (U.S. CLS. 21, 23, 26, 36 AND 38). SN 85-450,624. PUB. 4-10-2012. FILED 10-19-2011.
- 4,164,033. **REVISION RECORDS (STANDARD CHARACTER)**. SCOTT, JOSEPH, (U.S. CLS. 21, 23, 26, 36 AND 38). SN 85-451,784. PUB. 4-10-2012. FILED 10-20-2011.
- 4,164,034. **OREI AND DESIGN**. OREI LLC, AKA OREI, (U.S. CLS. 21, 23, 26, 36 AND 38). SN 85-451,804. PUB. 4-10-2012. FILED 10-20-2011.
- 4,164,039. **APTITUDE SOLUTIONS (STANDARD CHARACTER)**. LPS IP HOLDING COMPANY, LLC, MULTIPLE CLASS, (INT. CLS. 9 AND 42), (U.S. CLS. 21, 23, 26, 36, 38, 100 AND 101). SN 85-452,162. PUB. 4-10-2012. FILED 10-20-2011.
- 4,164,066. **EYE CLOUD (STANDARD CHARACTER)**. EYE-CLOUD LLC, (U.S. CLS. 21, 23, 26, 36 AND 38). SN 85-453,145. PUB. 4-10-2012. FILED 10-21-2011.
- 4,164,087. **TRUTH OR TRASH (STANDARD CHARACTER)**. IKAN MINISTRIES, (U.S. CLS. 21, 23, 26, 36 AND 38). SN 85-453,812. PUB. 4-10-2012. FILED 10-22-2011.
- 4,164,121. **O!CARE (STANDARD CHARACTER)**. OZAKI INTERNATIONAL CO., LTD., (U.S. CLS. 21, 23, 26, 36 AND 38). SN 85-454,808. PUB. 4-10-2012. FILED 10-24-2011.
- 4,164,125. **FRII (STANDARD CHARACTER)**. FRIISTYLE-COM, INC., (U.S. CLS. 21, 23, 26, 36 AND 38). SN 85-455,073. PUB. 4-10-2012. FILED 10-25-2011.
- 4,164,131. **PERIPOWER (STYLIZED)**. COMART CORPORATION, (U.S. CLS. 21, 23, 26, 36 AND 38). SN 85-455,206. PUB. 4-10-2012. FILED 10-25-2011.
- 4,164,144. **JACK TEAGARDEN (STANDARD CHARACTER)**. TEAGARDEN JOSEPH C, (U.S. CLS. 21, 23, 26, 36 AND 38). SN 85-455,413. PUB. 4-10-2012. FILED 10-25-2011.
- 4,164,150. **WANDL WIDE AREA NETWORK DESIGN LABORATORY AND DESIGN**. WANDL, INC., (U.S. CLS. 21, 23, 26, 36 AND 38). SN 85-455,645. PUB. 4-10-2012. FILED 10-25-2011.
- 4,164,158. **COPPER-TONE (STANDARD CHARACTER)**. SERGIO HAMERNIK, (U.S. CLS. 21, 23, 26, 36 AND 38). SN 85-455,737. PUB. 4-10-2012. FILED 10-25-2011.
- 4,164,171. **CORDIAL (STANDARD CHARACTER)**. MEAN, KIMLY, MULTIPLE CLASS, (INT. CLS. 9 AND 25), (U.S. CLS. 21, 22, 23, 26, 36, 38 AND 39). SN 85-455,984. PUB. 4-10-2012. FILED 10-25-2011.
- 4,164,179. **HOLLER (STANDARD CHARACTER)**. HOLLER, INC., (U.S. CLS. 21, 23, 26, 36 AND 38). SN 85-456,256. PUB. 4-10-2012. FILED 10-26-2011.
- 4,164,197. **SPICEBOARD (STANDARD CHARACTER)**. NO-VAQUEST LLC, (U.S. CLS. 21, 23, 26, 36 AND 38). SN 85-456,647. PUB. 4-10-2012. FILED 10-26-2011.
- 4,164,225. **BRAINSTORM BETTER (STANDARD CHARACTER)**. KUMAR, SRINIVAS, (U.S. CLS. 21, 23, 26, 36 AND 38). SN 85-457,361. PUB. 4-10-2012. FILED 10-27-2011.
- 4,164,233. **HOLDEM CONNECT (STANDARD CHARACTER)**. KITMAKER ENTERTAINMENT S.A., (U.S. CLS. 21, 23, 26, 36 AND 38). SN 85-457,454. PUB. 4-10-2012. FILED 10-27-2011.
- 4,164,236. **PETPROTEK AND DESIGN**. RELIANT ENTERPRISES, (U.S. CLS. 21, 23, 26, 36 AND 38). SN 85-457,480. PUB. 4-10-2012. FILED 10-27-2011.
- 4,164,253. **E Z (STANDARD CHARACTER)**. ARRIS, LLC, DBA SIGMA DESIGN INTERNATIONAL, (U.S. CLS. 21, 23, 26, 36 AND 38). SN 85-457,695. PUB. 4-10-2012. FILED 10-27-2011.
- 4,164,270. **EYO (STANDARD CHARACTER)**. TSB PLUS DEAL CORP, MULTIPLE CLASS, (INT. CLS. 9 AND 35), (U.S. CLS. 21, 23, 26, 36, 38, 100, 101 AND 102). SN 85-457,796.

- PUB. 4-10-2012. FILED 10-27-2011.
- 4,164,297. **C AND DESIGN. CONCRETE CMS, INC.**, (U.S. CLS. 21, 23, 26, 36 AND 38). SN 85-457,969. PUB. 4-10-2012. FILED 10-27-2011.
- 4,164,312. **BOOMGRIP (STANDARD CHARACTER)**. SMITH, MARK, (U.S. CLS. 21, 23, 26, 36 AND 38). SN 85-458,075. PUB. 4-10-2012. FILED 10-27-2011.
- 4,164,314. **HYPERCLASS (STANDARD CHARACTER)**. INTERNATIONAL BATTERY, INC., (U.S. CLS. 21, 23, 26, 36 AND 38). SN 85-458,121. PUB. 4-10-2012. FILED 10-27-2011.
- 4,164,316. **HYDROMAX (STANDARD CHARACTER)**. INTERNATIONAL BATTERY, INC., (U.S. CLS. 21, 23, 26, 36 AND 38). SN 85-458,137. PUB. 4-10-2012. FILED 10-27-2011.
- 4,164,359. **THE JOLT RACKET (STANDARD CHARACTER)**. TNT SALES & DISTRIBUTING LLC, (U.S. CLS. 21, 23, 26, 36 AND 38). SN 85-458,487. PUB. 4-10-2012. FILED 10-27-2011.
- 4,164,369. **CV5 (STANDARD CHARACTER)**. TECHNOLOGY CONCEPTS & DESIGN, INC., (U.S. CLS. 21, 23, 26, 36 AND 38). SN 85-458,622. PUB. 4-10-2012. FILED 10-28-2011.
- 4,164,371. **SAVING MOO (STANDARD CHARACTER)**. ESPAÑA ENTERTAINMENT, INC., (U.S. CLS. 21, 23, 26, 36 AND 38). SN 85-458,628. PUB. 4-10-2012. FILED 10-28-2011.
- 4,164,391. **ENFORCER (STANDARD CHARACTER)**. INNOVAR SYSTEMS LIMITED, (U.S. CLS. 21, 23, 26, 36 AND 38). SN 85-458,823. PUB. 4-10-2012. FILED 10-28-2011.
- 4,164,399. **REMOTEAR (STANDARD CHARACTER)**. OTOVATION, LLC, (U.S. CLS. 21, 23, 26, 36 AND 38). SN 85-458,888. PUB. 4-10-2012. FILED 10-28-2011.
- 4,164,417. **EI3CTRON (STANDARD CHARACTER)**. BIER DESIGNS INC, DBA EI3CTRON, (U.S. CLS. 21, 23, 26, 36 AND 38). SN 85-459,082. PUB. 4-10-2012. FILED 10-28-2011.
- 4,164,424. **CREATIVE MOBILE (STANDARD CHARACTER)**. CREATIVE MOBILE OÜ, MULTIPLE CLASS, (INT. CLS. 9 AND 42), (U.S. CLS. 21, 23, 26, 36, 38, 100 AND 101). SN 85-459,178. PUB. 4-10-2012. FILED 10-28-2011.
- 4,164,436. **WEBOP (STANDARD CHARACTER)**. JAZZ AT LINCOLN CENTER, INC., (U.S. CLS. 21, 23, 26, 36 AND 38). SN 85-459,294. PUB. 4-10-2012. FILED 10-28-2011.
- 4,164,445. **PEBBLE (STANDARD CHARACTER)**. EVOLIS, INC., (U.S. CLS. 21, 23, 26, 36 AND 38). SN 85-459,422. PUB. 4-10-2012. FILED 10-28-2011.
- 4,164,448. **THE ALTERNATES (STANDARD CHARACTER)**. CRAVEN, JAKE, MULTIPLE CLASS, (INT. CLS. 9 AND 41), (U.S. CLS. 21, 23, 26, 36, 38, 100, 101 AND 107). SN 85-459,442. PUB. 4-10-2012. FILED 10-28-2011.
- 4,164,456. **GEARTEX (STANDARD CHARACTER)**. HI TECH ELECTRONICS, (U.S. CLS. 21, 23, 26, 36 AND 38). SN 85-459,558. PUB. 4-10-2012. FILED 10-28-2011.
- 4,164,466. **BG (STANDARD CHARACTER)**. BLUE GEM SUNGLASSES, INC., (U.S. CLS. 21, 23, 26, 36 AND 38). SN 85-459,636. PUB. 4-10-2012. FILED 10-29-2011.
- 4,164,467. **FOLIobook (STANDARD CHARACTER)**. ROCKET GARDEN LABS LTD, (U.S. CLS. 21, 23, 26, 36 AND 38). SN 85-459,650. PUB. 4-10-2012. FILED 10-29-2011.
- 4,164,470. **LOST IN CUBE (STANDARD CHARACTER)**. WONDERSTAR GAMES INC, (U.S. CLS. 21, 23, 26, 36 AND 38). SN 85-459,684. PUB. 4-10-2012. FILED 10-29-2011.
- 4,164,477. **FANVISION AND DESIGN. KANGAROO MEDIA, INC.**, MULTIPLE CLASS, (INT. CLS. 9, 38 AND 41), (U.S. CLS. 21, 23, 26, 36, 38, 100, 101, 104 AND 107). SN 85-459,754. PUB. 4-10-2012. FILED 10-29-2011.
- 4,164,478. **WELCOME TO THE INSIDE (STANDARD CHARACTER)**. KANGAROO MEDIA, INC., MULTIPLE CLASS, (INT. CLS. 9, 38 AND 41), (U.S. CLS. 21, 23, 26, 36, 38, 100, 101, 104 AND 107). SN 85-459,756. PUB. 4-10-2012. FILED 10-29-2011.
- 4,164,486. **EASYCOMMERCE (STANDARD CHARACTER)**. K-RISE SYSTEMS, INC, (U.S. CLS. 21, 23, 26, 36 AND 38). SN 85-459,794. PUB. 4-10-2012. FILED 10-30-2011.
- 4,164,494. **MINDLESS BEHAVIOR (STANDARD CHARACTER)**. CONJUNCTION ENTERTAINMENT INC., MULTIPLE CLASS, (INT. CLS. 9, 16, 25, 26 AND 41), (U.S. CLS. 2, 5, 21, 22, 23, 26, 29, 36, 37, 38, 39, 40, 42, 50, 100, 101 AND 107). SN 85-459,924. PUB. 4-10-2012. FILED 10-31-2011.
- 4,164,510. **TALLEE (STANDARD CHARACTER)**. MEMY ISH SHALOM, (U.S. CLS. 21, 23, 26, 36 AND 38). SN 85-460,206. PUB. 4-10-2012. FILED 10-31-2011.
- 4,164,512. **PERFECT SPHERE (STANDARD CHARACTER)**. SHALOM, MEMY ISH, (U.S. CLS. 21, 23, 26, 36 AND 38). SN 85-460,231. PUB. 4-10-2012. FILED 10-31-2011.
- 4,164,525. **AIRMUX (STANDARD CHARACTER)**. RAD DATA COMMUNICATIONS LTD., (U.S. CLS. 21, 23, 26, 36 AND 38). SN 85-460,428. PUB. 4-10-2012. FILED 10-31-2011.
- 4,164,534. **FLEXTRA (STYLIZED)**. SV MICROWAVE, INC., (U.S. CLS. 21, 23, 26, 36 AND 38). SN 85-460,510. PUB. 4-10-2012. FILED 10-31-2011.
- 4,164,553. **MULBERRY (STANDARD CHARACTER)**. TOURA, LLC, DBA TOURA, (U.S. CLS. 21, 23, 26, 36 AND 38). SN 85-460,776. PUB. 4-10-2012. FILED 10-31-2011.
- 4,164,556. **OSLO (STANDARD CHARACTER)**. MONARCH MEDIA, INC., (U.S. CLS. 21, 23, 26, 36 AND 38). SN 85-460,811. PUB. 4-10-2012. FILED S.R. 10-31-2011; AM. P.R. 2-21-2012.
- 4,164,570. **PLUTO ATTACKS (STANDARD CHARACTER)**. CMI PRODUCTIONS LIMITED, (U.S. CLS. 21, 23, 26, 36 AND 38). SN 85-460,998. PUB. 4-10-2012. FILED 10-31-2011.
- 4,164,591. **IRIS EDUCATIONAL MEDIA (STANDARD CHARACTER)**. IRIS MEDIA INC., DBA IRIS EDUCATIONAL MEDIA, MULTIPLE CLASS, (INT. CLS. 9, 16, 35, 38, 41 AND 42), (U.S. CLS. 2, 5, 21, 22, 23, 26, 29, 36, 37, 38, 50, 100, 101, 102, 104 AND 107). SN 85-461,497. PUB. 4-10-2012. FILED 11-1-2011.
- 4,164,613. **MISCELLANEOUS DESIGN. GOOD NEWS PUBLISHERS**, (U.S. CLS. 21, 23, 26, 36 AND 38). SN 85-464,548. PUB. 4-10-2012. FILED 11-4-2011.
- 4,164,618. **BASALCASE AND DESIGN. BASAL, DERON, DBA BASAL ENTERPRISES**, (U.S. CLS. 21, 23, 26, 36 AND 38). SN 85-465,806. PUB. 4-10-2012. FILED 11-7-2011.
- 4,164,620. **WREXPert PRO (STANDARD CHARACTER)**. INJURY SCIENCES LLC, (U.S. CLS. 21, 23, 26, 36 AND 38). SN 85-465,939. PUB. 4-10-2012. FILED 11-7-2011.
- 4,164,632. **AEGIS HP54 (STANDARD CHARACTER)**. SHOWA BEST GLOVE, INC., (U.S. CLS. 21, 23, 26, 36 AND 38). SN 85-467,933. PUB. 4-10-2012. FILED 11-9-2011.
- 4,164,637. **GRAPeseed AND DESIGN. GRAPeseed MEDIA LTD.**, MULTIPLE CLASS, (INT. CLS. 9 AND 16), (U.S. CLS. 2, 5, 21, 22, 23, 26, 29, 36, 37, 38 AND 50). SN 85-468,280. PUB. 4-10-2012. FILED 11-9-2011.
- 4,164,638. **TANK (STANDARD CHARACTER)**. CASE-MATE, INC., (U.S. CLS. 21, 23, 26, 36 AND 38). SN 85-468,419. PUB. 4-10-2012. FILED 11-9-2011.
- 4,164,639. **O!MUSIC (STANDARD CHARACTER)**. OZAKI INTERNATIONAL CO., LTD., (U.S. CLS. 21, 23, 26, 36 AND 38). SN 85-468,487. PUB. 4-10-2012. FILED 11-9-2011.
- 4,164,668. **FLASH TECHNOLOGY (STANDARD CHARACTER)**. SPX CORPORATION, MULTIPLE CLASS, (INT. CLS. 9 AND 11), (U.S. CLS. 13, 21, 23, 26, 31, 34, 36 AND 38). SN 85-472,956. PUB. 4-10-2012. FILED 11-15-2011.
- 4,164,674. **DIGIT (STANDARD CHARACTER)**. CLEARVISION OPTICAL COMPANY, (U.S. CLS. 21, 23, 26, 36 AND 38). SN 85-474,430. PUB. 4-10-2012. FILED 11-16-2011.
- 4,164,697. **POWOW (STANDARD CHARACTER)**. OZAKI INTERNATIONAL CO., LTD., (U.S. CLS. 21, 23, 26, 36 AND 38). SN 85-480,401. PUB. 4-10-2012. FILED 11-23-2011.
- 4,164,712. **PURPOSEFUL DESIGN PUBLICATIONS AND DESIGN. ASSOCIATION OF CHRISTIAN SCHOOLS INTERNATIONAL**, MULTIPLE CLASS, (INT. CLS. 9, 16 AND 41), (U.S. CLS. 2, 5, 21, 22, 23, 26, 29, 36, 37, 38, 50, 100, 101 AND 107). SN 85-485,173. PUB. 4-10-2012. FILED 12-1-2011.
- 4,164,722. **AEGIS KVS4 (STANDARD CHARACTER)**. SHOWA BEST GLOVE, INC., (U.S. CLS. 21, 23, 26, 36 AND 38). SN 85-487,848. PUB. 4-10-2012. FILED 12-6-2011.
- 4,164,729. **YOUNG (STANDARD CHARACTER)**. R.M. YOUNG CO., (U.S. CLS. 21, 23, 26, 36 AND 38). SN 85-489,579. PUB. 4-10-2012. FILED 12-7-2011.
- 4,164,735. **MISCELLANEOUS DESIGN. AT&T INTELLECTUAL PROPERTY II, L.P.**, (U.S. CLS. 21, 23, 26, 36 AND 38). SN 85-494,721. PUB. 4-10-2012. FILED 12-14-2011.
- 4,164,745. **O! LEARN (STANDARD CHARACTER)**. OZAKI INTERNATIONAL CO., LTD., (U.S. CLS. 21, 23, 26, 36 AND 38). SN 85-505,123. PUB. 4-10-2012. FILED 12-28-2011.
- 4,164,746. **O!FUN (STANDARD CHARACTER)**. OZAKI INTERNATIONAL CO., LTD., MULTIPLE CLASS, (INT. CLS. 9 AND 10), (U.S. CLS. 21, 23, 26, 36, 38, 39 AND 44). SN 85-505,178. PUB. 4-10-2012. FILED 12-28-2011.

- 4,164,747. **O!FITNESS (STANDARD CHARACTER)**. OZAKI INTERNATIONAL CO., LTD., (U.S. CLS. 21, 23, 26, 36 AND 38). SN 85-505,212. PUB. 4-10-2012. FILED 12-28-2011.
- 4,164,748. **O!NAVI (STANDARD CHARACTER)**. OZAKI INTERNATIONAL CO., LTD., (U.S. CLS. 21, 23, 26, 36 AND 38). SN 85-505,220. PUB. 4-10-2012. FILED 12-28-2011.
- 4,164,749. **O!TOOL (STANDARD CHARACTER)**. OZAKI INTERNATIONAL CO., LTD., (U.S. CLS. 21, 23, 26, 36 AND 38). SN 85-505,235. PUB. 4-10-2012. FILED 12-28-2011.
- 4,164,759. **MY FOOD FIGHT! (STANDARD CHARACTER)**. CLOUD 9 PERFORMANCE SOLUTIONS, LLC, (U.S. CLS. 21, 23, 26, 36 AND 38). SN 85-510,909. PUB. 4-10-2012. FILED 1-6-2012.
- 4,164,762. **TIC TAC ROLL (STANDARD CHARACTER)**. VIL-LAROMAN, EMMANUEL E., DBA CERTIFIED COMPUTER SOLUTIONS A.K.A. COOL CARAT SOFTWARE, (U.S. CLS. 21, 23, 26, 36 AND 38). SN 85-511,864. PUB. 4-10-2012. FILED 1-9-2012.
- 4,164,770. **LUXE. INTERIORS + DESIGN (STANDARD CHARACTER)**. SANDOW MEDIA, LLC, (U.S. CLS. 21, 23, 26, 36 AND 38). SN 85-520,183. PUB. 4-10-2012. FILED 1-19-2012.
- 4,164,776. **M-PACK (STANDARD CHARACTER)**. OFS FITEL, LLC, (U.S. CLS. 21, 23, 26, 36 AND 38). SN 85-526,836. PUB. 4-10-2012. FILED 1-27-2012.

CLASS 10—MEDICAL APPARATUS

- 4,162,700. **MULTIPURPOSE BONE PLATE SYSTEM (STANDARD CHARACTER)**. BIOMEDTRIX, LLC, (U.S. CLS. 26, 39 AND 44). SN 76-706,906. PUB. 4-10-2012. FILED 3-21-2011.
- 4,162,761 (*See Class 7 for this trademark*).
- 4,162,762 (*See Class 7 for this trademark*).
- 4,162,786. **ALERT (STANDARD CHARACTER)**. ALCOHOL COUNTERMEASURE SYSTEMS (INTERNATIONAL) INC., (U.S. CLS. 26, 39 AND 44). SN 77-959,248. PUB. 12-7-2010. FILED 3-15-2010.
- 4,162,841. **NISO BIOMED AND DESIGN**. NISO BIOMED SRL, (U.S. CLS. 26, 39 AND 44). SN 79-091,395. PUB. 4-10-2012. FILED 10-7-2010.
- 4,162,863. **BODYWISE (STANDARD CHARACTER)**. COLOPLAST A/S, (U.S. CLS. 26, 39 AND 44). SN 79-095,877. PUB. 4-10-2012. FILED 2-18-2011.
- 4,162,865 (*See Class 5 for this trademark*).
- 4,162,871 (*See Class 9 for this trademark*).
- 4,162,873 (*See Class 6 for this trademark*).
- 4,162,880. **BONBONE AND DESIGN**. DAIYA INDUSTRY CO., LTD., (U.S. CLS. 26, 39 AND 44). SN 79-097,528. PUB. 4-10-2012. FILED 4-15-2011.
- 4,162,907. **LABYRINTH SYSTEM (STANDARD CHARACTER)**. ARTE CORPORATION, (U.S. CLS. 26, 39 AND 44). SN 79-099,086. PUB. 4-10-2012. FILED 6-7-2011.
- 4,162,919. **AXIGN (STANDARD CHARACTER)**. AXIGN PTY LTD AS TRUSTEE FOR AXIGN FOOTWEAR UNIT TRUST, AND AXIGN PTY LTD AS TRUSTEE FOR AXIGN FOOTWEAR UNIT TRUST, MULTIPLE CLASS, (INT. CLS. 10 AND 25), (U.S. CLS. 22, 26, 39 AND 44). SN 79-099,433. PUB. 4-10-2012. FILED 2-18-2011.
- 4,162,934. **MEDI-R (STYLIZED)**. RADIALL, (U.S. CLS. 26, 39 AND 44). SN 79-099,972. PUB. 4-10-2012. FILED 6-15-2011.
- 4,162,939 (*See Class 8 for this trademark*).
- 4,162,961. **DAMPFER (STANDARD CHARACTER)**. HALTER, VOLKER, AND KRETSCHMER, FELIX, MULTIPLE CLASS, (INT. CLS. 10, 11 AND 34), (U.S. CLS. 2, 8, 9, 13, 17, 21, 23, 26, 31, 34, 39 AND 44). SN 79-101,475. PUB. 4-10-2012. FILED 5-3-2011.
- 4,162,989. **SOLIDEA (STANDARD CHARACTER)**. CALZIFICIO PINELLI S.R.L., (U.S. CLS. 26, 39 AND 44). SN 79-102,849. PUB. 4-10-2012. FILED 11-15-2010.
- 4,163,006 (*See Class 5 for this trademark*).
- 4,163,013. **HM AND DESIGN**. MASLANKA, HERBERT, (U.S. CLS. 26, 39 AND 44). SN 79-104,306. PUB. 4-10-2012. FILED 8-9-2011.
- 4,163,027. **AMACE (STANDARD CHARACTER)**. MOBELIFE, NAAMLOZE VENNOOTSCHAP, MULTIPLE CLASS, (INT. CLS. 10, 40 AND 44), (U.S. CLS. 26, 39, 44, 100, 101, 103 AND 106). SN 79-105,774. PUB. 4-10-2012. FILED 9-20-2011.
- 4,163,028 (*See Class 3 for this trademark*).
- 4,163,068 (*See Class 9 for this trademark*).
- 4,163,079 (*See Class 5 for this trademark*).
- 4,163,161. **ACROBAT (STANDARD CHARACTER)**. ONDAL HOLDING GMBH, MULTIPLE CLASS, (INT. CLS. 10, 11, 37 AND 42), (U.S. CLS. 13, 21, 23, 26, 31, 34, 39, 44, 100, 101, 103 AND 106). SN 85-189,278. PUB. 4-10-2012. FILED 12-2-2010.
- 4,163,162. **ONDASCOPE (STANDARD CHARACTER)**. ONDAL HOLDING GMBH, MULTIPLE CLASS, (INT. CLS. 10, 11, 37 AND 42), (U.S. CLS. 13, 21, 23, 26, 31, 34, 39, 44, 100, 101, 103 AND 106). SN 85-189,305. PUB. 4-10-2012. FILED 12-2-2010.
- 4,163,184 (*See Class 9 for this trademark*).
- 4,163,210. **MULTI-GUIDE (STANDARD CHARACTER)**. STRYKER CORPORATION, (U.S. CLS. 26, 39 AND 44). SN 85-251,908. PUB. 4-10-2012. FILED 2-25-2011.
- 4,163,215. **CLIP AND DESIGN**. SPECMED, LLC, (U.S. CLS. 26, 39 AND 44). SN 85-258,736. PUB. 4-10-2012. FILED 3-4-2011.
- 4,163,263. **ZOLETIL (STANDARD CHARACTER)**. VIRBAC S.A., (U.S. CLS. 26, 39 AND 44). SN 85-285,117. PUB. 3-13-2012. FILED 4-4-2011.
- 4,163,271 (*See Class 1 for this trademark*).
- 4,163,287. **RADEX (STANDARD CHARACTER)**. ASCENSION ORTHOPEDICS, INC., (U.S. CLS. 26, 39 AND 44). SN 85-291,697. PUB. 4-10-2012. FILED 4-11-2011.
- 4,163,397. **ENCIRCLE (STANDARD CHARACTER)**. THE MERINO COMPANY PTY LTD, TA LEVANA TEXTILES, (U.S. CLS. 26, 39 AND 44). SN 85-310,382. PUB. 4-10-2012. FILED S.R. 5-2-2011; AM. P.R. 2-16-2012.
- 4,163,421. **CAIRE (STANDARD CHARACTER)**. CHART INC., (U.S. CLS. 26, 39 AND 44). SN 85-313,705. PUB. 4-10-2012. FILED 5-5-2011.
- 4,163,422. **CAIRE AND DESIGN**. CHART INC., (U.S. CLS. 26, 39 AND 44). SN 85-313,715. PUB. 4-10-2012. FILED 5-5-2011.
- 4,163,451. **TEMCARE SUPREME (STANDARD CHARACTER)**. TEMCARE MEDICAL DESIGN AND MANUFACTURING, INC., (U.S. CLS. 26, 39 AND 44). SN 85-319,464. PUB. 4-10-2012. FILED 5-12-2011.
- 4,163,452. **TEMCARE LUXE (STANDARD CHARACTER)**. TEMCARE MEDICAL DESIGN AND MANUFACTURING, INC., (U.S. CLS. 26, 39 AND 44). SN 85-319,494. PUB. 4-10-2012. FILED 5-12-2011.
- 4,163,672. **MONOSTERYL (STANDARD CHARACTER)**. MDT MICRO DIAMOND TECHNOLOGIES LTD, (U.S. CLS. 26, 39 AND 44). SN 85-391,571. PUB. 4-10-2012. FILED 8-7-2011.
- 4,163,681. **APEX DENTAL USA (STANDARD CHARACTER)**. DENTAL USA, (U.S. CLS. 26, 39 AND 44). SN 85-395,362. PUB. 4-10-2012. FILED 8-11-2011.
- 4,163,691 (*See Class 9 for this trademark*).
- 4,163,693 (*See Class 5 for this trademark*).
- 4,163,870. **DS2 PLATFORM AND DESIGN**. RAMIREZ, ROLANDO, (U.S. CLS. 26, 39 AND 44). SN 85-437,195. PUB. 4-10-2012. FILED 10-1-2011.
- 4,163,893. **BOSLEY LASERCOMB (STANDARD CHARACTER)**. BOSLEY, INC., (U.S. CLS. 26, 39 AND 44). SN 85-440,160. PUB. 4-10-2012. FILED 10-5-2011.
- 4,163,929. **COMTEK (STYLIZED)**. SHANDONG KANGTAI INDUSTRY CO., LTD., (U.S. CLS. 26, 39 AND 44). SN 85-443,905. PUB. 4-10-2012. FILED 10-11-2011.
- 4,164,046. **MIKE'S SPIKES (STANDARD CHARACTER)**. THE STOCKROOM, INC., (U.S. CLS. 26, 39 AND 44). SN 85-452,524. PUB. 4-10-2012. FILED 10-20-2011.
- 4,164,155. **THE HAND SHIELD (STANDARD CHARACTER)**. DINUNZIO, ROBERT, (U.S. CLS. 26, 39 AND 44). SN 85-455,717. PUB. 4-10-2012. FILED 10-25-2011.
- 4,164,200. **CHEWY CHARMS (STANDARD CHARACTER)**. SENSORY UNIVERSITY LLC, (U.S. CLS. 26, 39 AND 44). SN 85-456,754. PUB. 4-10-2012. FILED 10-26-2011.
- 4,164,254. **LOCORD (STANDARD CHARACTER)**. PROSTHETIC DESIGN, INC., (U.S. CLS. 26, 39 AND 44). SN 85-457,697. PUB. 4-10-2012. FILED 10-27-2011.
- 4,164,258. **MISTASSIST (STANDARD CHARACTER)**. AEROLUNG CORP, (U.S. CLS. 26, 39 AND 44). SN 85-457,720. PUB. 4-10-2012. FILED 10-27-2011.
- 4,164,286. **SNOREBEN (STANDARD CHARACTER)**. BENSON MEDICAL SERVICES PTY LTD, (U.S. CLS. 26, 39 AND 44).

- SN 85-457,900. PUB. 4-10-2012. FILED 10-27-2011.
 4,164,364. **TOEGRIP (STANDARD CHARACTER)**, SYNCHRO MEDICAL SARL, (U.S. CLS. 26, 39 AND 44). SN 85-458,588. PUB. 4-10-2012. FILED 10-28-2011.
 4,164,381. **CERAKET (STANDARD CHARACTER)**, HS TM, LLC, (U.S. CLS. 26, 39 AND 44). SN 85-458,715. PUB. 4-10-2012. FILED 10-28-2011.
 4,164,386. **SEX STASH (STANDARD CHARACTER)**, GLOW INDUSTRIES, INC., (U.S. CLS. 26, 39 AND 44). SN 85-458,783. PUB. 4-10-2012. FILED 10-28-2011.
 4,164,490. **SPA ICE (STANDARD CHARACTER)**, JANET E. BROWN, (U.S. CLS. 26, 39 AND 44). SN 85-459,875. PUB. 4-10-2012. FILED 10-30-2011.
 4,164,541. **ANIMARK (STANDARD CHARACTER)**, ANIMARK, INC., (U.S. CLS. 26, 39 AND 44). SN 85-460,579. PUB. 4-10-2012. FILED 10-31-2011.
 4,164,578. **ACTIJET (STANDARD CHARACTER)**, GEO-FROY, DAVID, (U.S. CLS. 26, 39 AND 44). SN 85-461,202. PUB. 4-10-2012. FILED 11-1-2011.
 4,164,626. **THERASTIM (STANDARD CHARACTER)**, PHOENIX MEDICAL DEVICES, LLC, (U.S. CLS. 26, 39 AND 44). SN 85-467,017. PUB. 4-10-2012. FILED 11-8-2011.
 4,164,746 (*See Class 9 for this trademark*).
 4,164,758. **RDH FREEDOM (STANDARD CHARACTER)**, DENTSPLY INTERNATIONAL INC., (U.S. CLS. 26, 39 AND 44). SN 85-510,707. PUB. 4-10-2012. FILED 1-6-2012.

CLASS 11—ENVIRONMENTAL CONTROL APPARATUS

- 4,162,711. **BRITELYT (STANDARD CHARACTER)**, BRITELYT, INC., (U.S. CLS. 13, 21, 23, 31 AND 34). SN 76-708,592. PUB. 4-10-2012. FILED 8-2-2011.
 4,162,738 (*See Class 6 for this trademark*).
 4,162,761 (*See Class 7 for this trademark*).
 4,162,762 (*See Class 7 for this trademark*).
 4,162,770 (*See Class 7 for this trademark*).
 4,162,777. **SLIM SPACEPLUS (STANDARD CHARACTER)**, LG ELECTRONICS INC., (U.S. CLS. 13, 21, 23, 31 AND 34). SN 77-936,869. PUB. 4-10-2012. FILED 2-16-2010.
 4,162,806 (*See Class 9 for this trademark*).
 4,162,821 (*See Class 9 for this trademark*).
 4,162,830 (*See Class 9 for this trademark*).
 4,162,845 (*See Class 9 for this trademark*).
 4,162,918. **CC (STYLIZED)**, CERASA S.P.A., MULTIPLE CLASS, (INT. CLS. 11, 20 AND 21), (U.S. CLS. 2, 13, 21, 22, 23, 25, 29, 30, 31, 32, 33, 34, 40 AND 50). SN 79-099,370. PUB. 4-10-2012. FILED 4-6-2011.
 4,162,924. **SURPRIGHT (STANDARD CHARACTER)**, GRUPO ANTOLIN-INGENIERIA, S.A., MULTIPLE CLASS, (INT. CLS. 11, 12 AND 42), (U.S. CLS. 13, 19, 21, 23, 31, 34, 35, 44, 100 AND 101). SN 79-099,473. PUB. 4-10-2012. FILED 5-4-2011.
 4,162,925. **PHENOM TECHNOLOGIES AND DESIGN**, JOHANNES ARTMAYR, (U.S. CLS. 13, 21, 23, 31 AND 34). SN 79-099,507. PUB. 4-10-2012. FILED 4-26-2011.
 4,162,933 (*See Class 7 for this trademark*).
 4,162,937. **KOALA TECHNOLOGY EVOLUTION AND DESIGN**, TECNOLOGICA S.A.S. DI VANELLA SIMONE & C., (U.S. CLS. 13, 21, 23, 31 AND 34). SN 79-100,183. PUB. 4-10-2012. FILED 5-18-2011.
 4,162,942 (*See Class 9 for this trademark*).
 4,162,943 (*See Class 6 for this trademark*).
 4,162,948. **SYLCOM (STANDARD CHARACTER)**, SYLCOM SRL, (U.S. CLS. 13, 21, 23, 31 AND 34). SN 79-100,922. PUB. 4-10-2012. FILED 7-13-2011.
 4,162,956 (*See Class 6 for this trademark*).
 4,162,957 (*See Class 6 for this trademark*).
 4,162,961 (*See Class 10 for this trademark*).
 4,162,992 (*See Class 7 for this trademark*).
 4,163,061 (*See Class 9 for this trademark*).
 4,163,119 (*See Class 9 for this trademark*).
 4,163,140 (*See Class 6 for this trademark*).
 4,163,161 (*See Class 10 for this trademark*).
 4,163,162 (*See Class 10 for this trademark*).
 4,163,165. **CMS (STANDARD CHARACTER)**, ENVIRONMEN-

- TAL CONTROL SYSTEMS, INC., DBA AQUASGROUP, (U.S. CLS. 13, 21, 23, 31 AND 34). SN 85-197,443. PUB. 4-10-2012. FILED 12-14-2010.
 4,163,239 (*See Class 7 for this trademark*).
 4,163,240 (*See Class 7 for this trademark*).
 4,163,258. **B AND DESIGN**, MDS GLOBAL HOLDING LTD., MULTIPLE CLASS, (INT. CLS. 11, 30 AND 32), (U.S. CLS. 13, 21, 23, 31, 34, 45, 46 AND 48). SN 85-281,517. PUB. 4-10-2012. FILED 3-30-2011.
 4,163,281. **ALDER NEWLED AND DESIGN**, ALDER OPTOMECHANICAL CORP., (U.S. CLS. 13, 21, 23, 31 AND 34). SN 85-290,264. PUB. 4-10-2012. FILED 4-8-2011.
 4,163,418 (*See Class 9 for this trademark*).
 4,163,444. **NH NICHOLAS HASLAM AND DESIGN**, NICHOLAS HASLAM LIMITED, MULTIPLE CLASS, (INT. CLS. 11, 18, 20, 21, 24, 27, 35 AND 42), (U.S. CLS. 1, 2, 3, 13, 19, 20, 21, 22, 23, 25, 29, 30, 31, 32, 33, 34, 37, 40, 41, 42, 50, 100, 101 AND 102). SN 85-317,944. PUB. 4-10-2012. FILED 5-11-2011.
 4,163,457. **TURTLESAFE AND DESIGN**, TURTLESAFE LLC, (U.S. CLS. 13, 21, 23, 31 AND 34). SN 85-321,424. PUB. 4-10-2012. FILED 5-16-2011.
 4,163,507 (*See Class 6 for this trademark*).
 4,163,582. **CES AND DESIGN**, CONSOLIDATED ENERGY SOLUTIONS INC., MULTIPLE CLASS, (INT. CLS. 11 AND 42), (U.S. CLS. 13, 21, 23, 31, 34, 100 AND 101). SN 85-362,613. PUB. 4-10-2012. FILED 7-4-2011.
 4,163,603. **HOLISPHERES (STANDARD CHARACTER)**, BALB, INC, MULTIPLE CLASS, (INT. CLS. 11, 20 AND 28), (U.S. CLS. 2, 13, 21, 22, 23, 25, 31, 32, 34, 38 AND 50). SN 85-371,029. PUB. 4-10-2012. FILED 7-14-2011.
 4,163,676. **ZIZA (STANDARD CHARACTER)**, ZIZA LIGHTING, INC., (U.S. CLS. 13, 21, 23, 31 AND 34). SN 85-392,210. PUB. 4-10-2012. FILED 8-8-2011.
 4,163,761 (*See Class 1 for this trademark*).
 4,163,834. **TUF-TITE (STANDARD CHARACTER)**, TUF-TITE, INC., MULTIPLE CLASS, (INT. CLS. 11 AND 19), (U.S. CLS. 1, 12, 13, 21, 23, 31, 33, 34 AND 50). SN 85-433,268. PUB. 4-10-2012. FILED 9-27-2011.
 4,163,846. **MISCELLANEOUS DESIGN**, TUF-TITE, INC., MULTIPLE CLASS, (INT. CLS. 11 AND 19), (U.S. CLS. 1, 12, 13, 21, 23, 31, 33, 34 AND 50). SN 85-434,222. PUB. 4-10-2012. FILED 9-28-2011.
 4,163,900. **PANORAMA WINDOW (STANDARD CHARACTER)**, ZOJIRUSHI AMERICA CORPORATION, (U.S. CLS. 13, 21, 23, 31 AND 34). SN 85-441,332. PUB. 4-10-2012. FILED 10-6-2011.
 4,163,917. **BRAZILIAN BUTT LIGHT (STANDARD CHARACTER)**, WELLS, GRANVILLE, (U.S. CLS. 13, 21, 23, 31 AND 34). SN 85-442,689. PUB. 4-10-2012. FILED 10-7-2011.
 4,164,124. **INTEGRILL (STANDARD CHARACTER)**, GRAND HALL ENTERPRISE CO., LTD., (U.S. CLS. 13, 21, 23, 31 AND 34). SN 85-455,072. PUB. 4-10-2012. FILED 10-25-2011.
 4,164,129. **WOMBAT (STANDARD CHARACTER)**, APRICUS SOLAR CO., LTD., (U.S. CLS. 13, 21, 23, 31 AND 34). SN 85-455,187. PUB. 4-10-2012. FILED 10-25-2011.
 4,164,321. **HIMALAYAN BREEZE AND DESIGN**, WBM INTERNATIONAL, LLC, (U.S. CLS. 13, 21, 23, 31 AND 34). SN 85-458,168. PUB. 4-10-2012. FILED 10-27-2011.
 4,164,419. **DUAL FLOOD PROTECTOR AND DESIGN**, MARTIN, PATRICK, (U.S. CLS. 13, 21, 23, 31 AND 34). SN 85-459,095. PUB. 4-10-2012. FILED 10-28-2011.
 4,164,473. **BOBBLE (STANDARD CHARACTER)**, MOVE COLLECTIVE LLC, (U.S. CLS. 13, 21, 23, 31 AND 34). SN 85-459,703. PUB. 4-10-2012. FILED 10-29-2011.
 4,164,495 (*See Class 7 for this trademark*).
 4,164,668 (*See Class 9 for this trademark*).
 4,164,685 (*See Class 6 for this trademark*).
 4,164,686 (*See Class 6 for this trademark*).

CLASS 12—VEHICLES

- 4,162,738 (*See Class 6 for this trademark*).
 4,162,774. **DEVICE (STANDARD CHARACTER)**, SEATTLE BIKE SUPPLY, INC., (U.S. CLS. 19, 21, 23, 31, 35 AND 44). SN 77-909,570. PUB. 4-10-2012. FILED 1-11-2010.
 4,162,845 (*See Class 9 for this trademark*).

4,162,853 (*See Class 7 for this trademark*).
 4,162,876. **BACIUZZI AND DESIGN**. UNITRON ENTERPRISES ZHUHAI CO., LTD., MULTIPLE CLASS, (INT. CLS. 12, 20, 25 AND 28), (U.S. CLS. 2, 13, 19, 21, 22, 23, 25, 31, 32, 35, 38, 39, 44 AND 50). SN 79-097,282. PUB. 4-10-2012. FILED 3-29-2010.
 4,162,903. **MISCELLANEOUS DESIGN**. TAOTAO GROUP CO., LTD., (U.S. CLS. 19, 21, 23, 31, 35 AND 44). SN 79-098,979. PUB. 4-10-2012. FILED 5-25-2011.
 4,162,905. **BELMAG AND DESIGN**. "BELMAG" JOINT-STOCK COMPANY, (U.S. CLS. 19, 21, 23, 31, 35 AND 44). SN 79-099,009. PUB. 4-10-2012. FILED 11-19-2010.
 4,162,913 (*See Class 6 for this trademark*).
 4,162,924 (*See Class 11 for this trademark*).
 4,162,942 (*See Class 9 for this trademark*).
 4,162,977. **F-DIESEL AND DESIGN**. FUJIKURA DIESEL CO., LTD., (U.S. CLS. 19, 21, 23, 31, 35 AND 44). SN 79-102,285. PUB. 4-10-2012. FILED 8-15-2011.
 4,162,981. **MISCELLANEOUS DESIGN**. ZHEJIANG SHUANGHUAN DRIVELINE CO., LTD., (U.S. CLS. 19, 21, 23, 31, 35 AND 44). SN 79-102,425. PUB. 4-10-2012. FILED 8-8-2011.
 4,162,983. **B'TWIN (STANDARD CHARACTER)**. DECATHLON SA, MULTIPLE CLASS, (INT. CLS. 12, 18 AND 28), (U.S. CLS. 1, 2, 3, 19, 21, 22, 23, 31, 35, 38, 41, 44 AND 50). SN 79-102,549. PUB. 4-10-2012. FILED 8-18-2011.
 4,162,997. **FRONTPRESS (STANDARD CHARACTER)**. FAUN UMWELTECHNIK GMBH & CO. KG, (U.S. CLS. 19, 21, 23, 31, 35 AND 44). SN 79-103,190. PUB. 4-10-2012. FILED 8-12-2011.
 4,163,036. **ITM SIT'N'GO AND DESIGN**. ITM BIKE COMPONENTS S.R.L., (U.S. CLS. 19, 21, 23, 31, 35 AND 44). SN 79-106,462. PUB. 4-10-2012. FILED 9-1-2011.
 4,163,038. **IBEG (STANDARD CHARACTER)**. PIETROWSKI, PETER, (U.S. CLS. 19, 21, 23, 31, 35 AND 44). SN 79-106,712. PUB. 4-10-2012. FILED 10-14-2011.
 4,163,081. **THE TWEED RUN (STANDARD CHARACTER)**. THE TWEED RUN, MULTIPLE CLASS, (INT. CLS. 12, 25 AND 41), (U.S. CLS. 19, 21, 22, 23, 31, 35, 39, 44, 100, 101 AND 107). SN 85-106,848. PUB. 4-10-2012. FILED 8-13-2010.
 4,163,172. **EXAFORM (STYLIZED)**. KIND SHOCK HI-TECH CO., LTD., (U.S. CLS. 19, 21, 23, 31, 35 AND 44). SN 85-208,624. PUB. 4-10-2012. FILED 12-31-2010.
 4,163,302 (*See Class 9 for this trademark*).
 4,163,338. **REPEL (STANDARD CHARACTER)**. ILLINOIS TOOL WORKS INC., (U.S. CLS. 19, 21, 23, 31, 35 AND 44). SN 85-304,349. PUB. 4-10-2012. FILED 4-25-2011.
 4,163,418 (*See Class 9 for this trademark*).
 4,163,507 (*See Class 6 for this trademark*).
 4,163,515. **COUNTY (STANDARD CHARACTER)**. COUNTY-TRAC LIMITED, (U.S. CLS. 19, 21, 23, 31, 35 AND 44). SN 85-342,966. PUB. 4-10-2012. FILED 6-10-2011.
 4,163,616. **STEG PEGZ (STANDARD CHARACTER)**. SMITH, STEPHEN, (U.S. CLS. 19, 21, 23, 31, 35 AND 44). SN 85-376,865. PUB. 4-10-2012. FILED 7-21-2011.
 4,163,968. **SCOOWL AND DESIGN**. PAUL YAFFE DESIGN, INC., (U.S. CLS. 19, 21, 23, 31, 35 AND 44). SN 85-447,856. PUB. 4-10-2012. FILED 10-14-2011.
 4,164,091. **GRADIENT (STYLIZED)**. TIEN HSIN INDUSTRIES CO., LTD., (U.S. CLS. 19, 21, 23, 31, 35 AND 44). SN 85-453,952. PUB. 4-10-2012. FILED 10-23-2011.
 4,164,106. **ALLSPORT (STANDARD CHARACTER)**. ROGUE RIVER SPORTS, INC., (U.S. CLS. 19, 21, 23, 31, 35 AND 44). SN 85-454,515. PUB. 4-10-2012. FILED 10-24-2011.
 4,164,108. **ULTRASPORT (STANDARD CHARACTER)**. ROGUE RIVER SPORTS, INC., (U.S. CLS. 19, 21, 23, 31, 35 AND 44). SN 85-454,543. PUB. 4-10-2012. FILED 10-24-2011.
 4,164,574. **RANGEBIKE (STANDARD CHARACTER)**. KEINAN, SHLOMO, (U.S. CLS. 19, 21, 23, 31, 35 AND 44). SN 85-461,093. PUB. 4-10-2012. FILED 11-1-2011.
 4,164,581. **HARDRACE (STANDARD CHARACTER)**. VELOCITYSHOP INC, (U.S. CLS. 19, 21, 23, 31, 35 AND 44). SN 85-461,249. PUB. 4-10-2012. FILED 11-1-2011.
 4,164,653. **MIRROR ARMOR AND DESIGN**. RIO STREAM PRODUCTS LLC, (U.S. CLS. 19, 21, 23, 31, 35 AND 44). SN 85-469,877. PUB. 4-10-2012. FILED 11-10-2011.
 4,164,716. **EVEELLE AND DESIGN**. EVEELLE, (U.S. CLS. 19, 21, 23, 31, 35 AND 44). SN 85-485,964. PUB. 4-10-2012. FILED 12-2-2011.

4,164,782. **BOWLUS ROAD CHIEF (STANDARD CHARACTER)**. OPEN THINK INC., (U.S. CLS. 19, 21, 23, 31, 35 AND 44). SN 85-976,752. PUB. 9-6-2011. FILED 4-21-2011.
 4,164,783. **BOWLUS (STANDARD CHARACTER)**. OPEN THINK INC., (U.S. CLS. 19, 21, 23, 31, 35 AND 44). SN 85-976,753. PUB. 8-30-2011. FILED 4-18-2011.

CLASS 13—FIREARMS

4,162,720. **SRM ARMS AND DESIGN**. SRM ARMS, INC, (U.S. CLS. 2 AND 9). SN 76-709,501. PUB. 4-10-2012. FILED 10-25-2011.
 4,162,800 (*See Class 9 for this trademark*).
 4,162,913 (*See Class 6 for this trademark*).
 4,163,268. **MAG PUG (STANDARD CHARACTER)**. CHARCO 2000, INC., AKA CHARTER ARMS, (U.S. CLS. 2 AND 9). SN 85-286,731. PUB. 11-1-2011. FILED 4-5-2011.
 4,163,492. **DUECK DEFENSE (STANDARD CHARACTER)**. BARRY W. DUECK, DBA DUECK DEFENSE, (U.S. CLS. 2 AND 9). SN 85-334,334. PUB. 4-10-2012. FILED 5-31-2011.
 4,163,508. **TRAJETECH (STANDARD CHARACTER)**. ONE SHOT, INC., (U.S. CLS. 2 AND 9). SN 85-339,120. PUB. 4-10-2012. FILED 6-6-2011.
 4,163,597. **LWRC INTERNATIONAL AND DESIGN**. LWRC INTERNATIONAL, LLC, (U.S. CLS. 2 AND 9). SN 85-369,149. PUB. 4-10-2012. FILED 7-12-2011.

CLASS 14—JEWELRY

4,162,805. **HANHART (STANDARD CHARACTER)**. A. HANHART GMBH & CO. KG, (U.S. CLS. 2, 27, 28 AND 50). SN 79-075,369. PUB. 4-10-2012. FILED 6-17-2009.
 4,162,812 (*See Class 6 for this trademark*).
 4,162,829 (*See Class 3 for this trademark*).
 4,162,831 (*See Class 9 for this trademark*).
 4,162,850. **PLANET LONDON (STANDARD CHARACTER)**. JACQUES VERT PLC, MULTIPLE CLASS, (INT. CLS. 14, 18, 25 AND 35), (U.S. CLS. 1, 2, 3, 22, 27, 28, 39, 41, 50, 100, 101 AND 102). SN 79-093,134. PUB. 4-10-2012. FILED 12-20-2010.
 4,162,910. **FIAT (STANDARD CHARACTER)**. FIAT GROUP MARKETING & CORPORATE COMMUNICATION S.P.A., MULTIPLE CLASS, (INT. CLS. 14, 25, 35 AND 37), (U.S. CLS. 2, 22, 27, 28, 39, 50, 100, 101, 102, 103 AND 106). SN 79-099,153. PUB. 4-10-2012. FILED 4-29-2011.
 4,162,946 (*See Class 9 for this trademark*).
 4,162,947 (*See Class 2 for this trademark*).
 4,162,955 (*See Class 9 for this trademark*).
 4,163,037. **OLD ENGLAND (STANDARD CHARACTER)**. AC-CURIST WATCHES LIMITED, (U.S. CLS. 2, 27, 28 AND 50). SN 79-106,631. PUB. 4-10-2012. FILED 11-12-2011.
 4,163,065 (*See Class 9 for this trademark*).
 4,163,184 (*See Class 9 for this trademark*).
 4,163,196. **CARLO GIOIELLIERE (STYLIZED)**. THE LITTLE DRINKS COMPANY LIMITED T/A RETAIL IN MOTION, MULTIPLE CLASS, (INT. CLS. 14 AND 25), (U.S. CLS. 2, 22, 27, 28, 39 AND 50). SN 85-237,858. PUB. 4-10-2012. FILED 2-9-2011.
 4,163,319. **G AND DESIGN**. CHANCEUSE PRODUCTIONS LLC, MULTIPLE CLASS, (INT. CLS. 14, 25 AND 33), (U.S. CLS. 2, 22, 27, 28, 39, 47, 49 AND 50). SN 85-300,253. PUB. 4-10-2012. FILED 4-20-2011.
 4,163,395. **I AM WHO ARE YOU (STANDARD CHARACTER)**. LILLY-HESTER, MICHELLE, (U.S. CLS. 2, 27, 28 AND 50). SN 85-310,363. PUB. 4-10-2012. FILED 5-2-2011.
 4,163,479. **GARGYLE (STANDARD CHARACTER)**. GARGYLE CORPORATION, DBA GARGYLE, (U.S. CLS. 2, 27, 28 AND 50). SN 85-326,323. PUB. 4-10-2012. FILED 5-20-2011.
 4,163,624 (*See Class 6 for this trademark*).
 4,163,667. **SWEET T (STANDARD CHARACTER)**. SWEET T 23, INC., (U.S. CLS. 2, 27, 28 AND 50). SN 85-389,793. PUB. 4-10-2012. FILED 8-4-2011.
 4,163,689. **GROOVY GARBAGE (STANDARD CHARACTER)**.

- SPENCER, RICHIE, AND SPENCER, JANE, MULTIPLE CLASS, (INT. CLS. 14 AND 18), (U.S. CLS. 1, 2, 3, 22, 27, 28, 41 AND 50). SN 85-399,847. PUB. 4-10-2012. FILED 8-17-2011.
- 4,163,715. **TERRYBERRY AND DESIGN**. TERRYBERRY, LLC, MULTIPLE CLASS, (INT. CLS. 14 AND 35), (U.S. CLS. 2, 27, 28, 50, 100, 101 AND 102). SN 85-409,328. PUB. 4-10-2012. FILED 8-29-2011.
- 4,163,717. **DONNI CHARM (STANDARD CHARACTER)**. DONNI CHARM, INC., MULTIPLE CLASS, (INT. CLS. 14 AND 25), (U.S. CLS. 2, 22, 27, 28, 39 AND 50). SN 85-410,017. PUB. 4-10-2012. FILED 8-29-2011.
- 4,163,815. **MIRACULOUS TEMPLAR DIAMOND (STANDARD CHARACTER)**. RAFAELI, DAVID, (U.S. CLS. 2, 27, 28 AND 50). SN 85-429,432. PUB. 4-10-2012. FILED 9-22-2011.
- 4,163,906. **NOURBEL (STANDARD CHARACTER)**. NOURBEL S.A., MULTIPLE CLASS, (INT. CLS. 14 AND 35), (U.S. CLS. 2, 27, 28, 50, 100, 101 AND 102). SN 85-441,658. PUB. 4-10-2012. FILED 10-7-2011.
- 4,164,107. **SADUSA (STANDARD CHARACTER)**. RICHLINE GROUP, INC., (U.S. CLS. 2, 27, 28 AND 50). SN 85-454,523. PUB. 4-10-2012. FILED 10-24-2011.
- 4,164,183. **TRAVELING PEACE PENDANT (STANDARD CHARACTER)**. ZTARF ARTS, LLC, (U.S. CLS. 2, 27, 28 AND 50). SN 85-456,281. PUB. 4-10-2012. FILED 10-26-2011.
- 4,164,243. **ABL (STYLIZED)**. ART BY LENNE, LLC, MULTIPLE CLASS, (INT. CLS. 14 AND 16), (U.S. CLS. 2, 5, 22, 23, 27, 28, 29, 37, 38 AND 50). SN 85-457,588. PUB. 4-10-2012. FILED 10-27-2011.
- 4,164,487. **KARMA CATCHERS (STANDARD CHARACTER)**. QUINN, MARIA VIRGINIA F, AKA GINNY QUINN, (U.S. CLS. 2, 27, 28 AND 50). SN 85-459,815. PUB. 4-10-2012. FILED 10-30-2011.
- 4,164,505. **10021 BY KARA (STANDARD CHARACTER)**. KARA ROSS NEW YORK, LLC, (U.S. CLS. 2, 27, 28 AND 50). SN 85-460,093. PUB. 4-10-2012. FILED 10-31-2011.
- 4,164,521. **RED DOOR CREATIONS (STANDARD CHARACTER)**. ANDREW BARNEY, (U.S. CLS. 2, 27, 28 AND 50). SN 85-460,364. PUB. 4-10-2012. FILED 10-31-2011.
- 4,164,539. **BRENT&JESS (STANDARD CHARACTER)**. BRENT A. WILLIAMS, AND JESSICA C. WILLIAMS, (U.S. CLS. 2, 27, 28 AND 50). SN 85-460,564. PUB. 4-10-2012. FILED 10-31-2011.
- 4,164,560. **ELECTRIC PICKS (STANDARD CHARACTER)**. MARY BARTON, (U.S. CLS. 2, 27, 28 AND 50). SN 85-460,867. PUB. 4-10-2012. FILED 10-31-2011.
- 4,164,688. **GABRIELLA SANTI (STANDARD CHARACTER)**. SAVVY CIE, INC., (U.S. CLS. 2, 27, 28 AND 50). SN 85-478,709. PUB. 4-10-2012. FILED 11-22-2011.
- 4,164,699. **MEMORY BAND (STANDARD CHARACTER)**. MILANO CONCEPTS LLC, (U.S. CLS. 2, 27, 28 AND 50). SN 85-481,998. PUB. 4-10-2012. FILED 11-28-2011.
- 4,164,737. **HENRI BENDEL AND DESIGN**. HENRI BENDEL, INC., MULTIPLE CLASS, (INT. CLS. 14 AND 18), (U.S. CLS. 1, 2, 3, 22, 27, 28, 41 AND 50). SN 85-495,052. PUB. 4-10-2012. FILED 12-14-2011.
- 4,164,766. **ROCAWEAR (STANDARD CHARACTER)**. STUDIO IP HOLDINGS LLC, (U.S. CLS. 2, 27, 28 AND 50). SN 85-517,408. PUB. 4-10-2012. FILED 1-16-2012.

CLASS 15—MUSICAL INSTRUMENTS

- 4,162,926. **SPUR (STANDARD CHARACTER)**. JOHN LESLIE ROOSE FRANCIS, (U.S. CLS. 2, 21 AND 36). SN 79-099,514. PUB. 4-10-2012. FILED 5-17-2011.
- 4,163,701 (*See Class 4 for this trademark*).
- 4,163,718. **GUITAR TECH (STANDARD CHARACTER)**. JOHN HORNBY SKEWES & CO LTD, (U.S. CLS. 2, 21 AND 36). SN 85-410,382. PUB. 4-10-2012. FILED 8-30-2011.
- 4,164,287. **JAMBOXX (STANDARD CHARACTER)**. MY MUSIC MACHINES, INC., (U.S. CLS. 2, 21 AND 36). SN 85-457,923. PUB. 4-10-2012. FILED 10-27-2011.

CLASS 16—PAPER GOODS AND PRINTED MATTER

- 4,162,707. **BROOKLYN ROASTED AND DESIGN**. GORILLA COFFEE, INC., MULTIPLE CLASS, (INT. CLS. 16, 21, 25 AND 30), (U.S. CLS. 2, 5, 13, 22, 23, 29, 30, 33, 37, 38, 39, 40, 46 AND 50). SN 76-707,803. PUB. 4-10-2012. FILED 5-31-2011.
- 4,162,709. **MISCELLANEOUS DESIGN**. GORILLA COFFEE, INC., MULTIPLE CLASS, (INT. CLS. 16, 21, 25 AND 30), (U.S. CLS. 2, 5, 13, 22, 23, 29, 30, 33, 37, 38, 39, 40, 46 AND 50). SN 76-707,876. PUB. 4-10-2012. FILED 6-6-2011.
- 4,162,722. **UUA (STANDARD CHARACTER)**. UNITARIAN UNIVERSALIST ASSOCIATION, MULTIPLE CLASS, (INT. CLS. 16 AND 35), (U.S. CLS. 2, 5, 22, 23, 29, 37, 38, 50, 100, 101 AND 102). SN 76-709,543. PUB. 4-10-2012. FILED 10-26-2011.
- 4,162,726 (*See Class 9 for this trademark*).
- 4,162,727. **GREENEARTH (STANDARD CHARACTER)**. KRUGER PRODUCTS L.P., (U.S. CLS. 2, 5, 22, 23, 29, 37, 38 AND 50). SN 77-143,502. PUB. 4-10-2012. FILED 3-29-2007.
- 4,162,753 (*See Class 9 for this trademark*).
- 4,162,765. **MILLIONAIRE'S READING CLUB (STANDARD CHARACTER)**. SPRINGBOARDS TO EDUCATION, INC., (U.S. CLS. 2, 5, 22, 23, 29, 37, 38 AND 50). SN 77-839,991. PUB. 1-3-2012. FILED 10-2-2009.
- 4,162,775. **PROVIDER APPRECIATION DAY (STANDARD CHARACTER)**. NATIONAL ASSOCIATION OF CHILD CARE RESOURCE & REFERRAL AGENCIES, MULTIPLE CLASS, (INT. CLS. 16, 35 AND 41), (U.S. CLS. 2, 5, 22, 23, 29, 37, 38, 50, 100, 101, 102 AND 107). SN 77-920,102. PUB. 4-10-2012. FILED 1-26-2010.
- 4,162,785 (*See Class 9 for this trademark*).
- 4,162,808. **PERFORMA BRIGHT (STANDARD CHARACTER)**. STORA ENSO OYJ, (U.S. CLS. 2, 5, 22, 23, 29, 37, 38 AND 50). SN 79-077,303. PUB. 4-10-2012. FILED 11-23-2009.
- 4,162,818. **MISCELLANEOUS DESIGN**. CARLO PAZOLINI TM GLOBAL SERVICE LIMITED, MULTIPLE CLASS, (INT. CLS. 16, 18 AND 25), (U.S. CLS. 1, 2, 3, 5, 22, 23, 29, 37, 38, 39, 41 AND 50). SN 79-087,505. PUB. 4-10-2012. FILED 8-30-2010.
- 4,162,825 (*See Class 9 for this trademark*).
- 4,162,827 (*See Class 9 for this trademark*).
- 4,162,837. **SKIN PEACE (STYLIZED)**. BAYER AKTIENGESELLSCHAFT, MULTIPLE CLASS, (INT. CLS. 16 AND 44), (U.S. CLS. 2, 5, 22, 23, 29, 37, 38, 50, 100 AND 101). SN 79-090,707. PUB. 11-1-2011. FILED 11-13-2010.
- 4,162,846 (*See Class 9 for this trademark*).
- 4,162,848 (*See Class 9 for this trademark*).
- 4,162,860. **SOLARIS (STANDARD CHARACTER)**. KOTKAMILLS OY, (U.S. CLS. 2, 5, 22, 23, 29, 37, 38 AND 50). SN 79-095,607. PUB. 4-10-2012. FILED 3-14-2011.
- 4,162,865 (*See Class 5 for this trademark*).
- 4,162,885 (*See Class 9 for this trademark*).
- 4,162,917. **MISCELLANEOUS DESIGN**. NANYANG TECHNOLOGICAL UNIVERSITY, MULTIPLE CLASS, (INT. CLS. 16 AND 36), (U.S. CLS. 2, 5, 22, 23, 29, 37, 38, 50, 100, 101 AND 102). SN 79-099,330. PUB. 4-10-2012. FILED 6-3-2011.
- 4,162,920. **IMAN (STYLIZED)**. NANYANG TECHNOLOGICAL UNIVERSITY, MULTIPLE CLASS, (INT. CLS. 16 AND 36), (U.S. CLS. 2, 5, 22, 23, 29, 37, 38, 50, 100, 101 AND 102). SN 79-099,435. PUB. 4-10-2012. FILED 5-6-2011.
- 4,162,921. **IGAVE THE GIFT OF GIVING AND DESIGN**. NANYANG TECHNOLOGICAL UNIVERSITY, MULTIPLE CLASS, (INT. CLS. 16 AND 36), (U.S. CLS. 2, 5, 22, 23, 29, 37, 38, 50, 100, 101 AND 102). SN 79-099,436. PUB. 4-10-2012. FILED 5-6-2011.
- 4,162,922. **IGAVE (STYLIZED)**. NANYANG TECHNOLOGICAL UNIVERSITY, MULTIPLE CLASS, (INT. CLS. 16 AND 36), (U.S. CLS. 2, 5, 22, 23, 29, 37, 38, 50, 100, 101 AND 102). SN 79-099,437. PUB. 4-10-2012. FILED 5-6-2011.
- 4,162,923. **IGAVE AND DESIGN**. NANYANG TECHNOLOGICAL UNIVERSITY, MULTIPLE CLASS, (INT. CLS. 16 AND 36), (U.S. CLS. 2, 5, 22, 23, 29, 37, 38, 50, 100, 101 AND 102). SN 79-099,438. PUB. 4-10-2012. FILED 5-6-2011.
- 4,162,945 (*See Class 2 for this trademark*).
- 4,162,947 (*See Class 2 for this trademark*).
- 4,162,979. **SIBARTH REAL ESTATE (STANDARD CHARACTER)**. SIBARTH REAL ESTATE, MULTIPLE CLASS, (INT.

- CLS. 16, 35 AND 36), (U.S. CLS. 2, 5, 22, 23, 29, 37, 38, 50, 100, 101 AND 102). SN 79-102,391. PUB. 4-10-2012. FILED 8-16-2011.
- 4,162,999 (*See Class 9 for this trademark*).
- 4,163,000. **H2O (STANDARD CHARACTER)**. WIEBE H. VAN DER MEER, (U.S. CLS. 2, 5, 22, 23, 29, 37, 38 AND 50). SN 79-103,682. PUB. 4-10-2012. FILED 8-31-2011.
- 4,163,028 (*See Class 3 for this trademark*).
- 4,163,058 (*See Class 9 for this trademark*).
- 4,163,065 (*See Class 9 for this trademark*).
- 4,163,068 (*See Class 9 for this trademark*).
- 4,163,075. **ZIPBOX THE RESEALABLE BOX AND DESIGN**. ZIPBOX LICENSE, LLC, (U.S. CLS. 2, 5, 22, 23, 29, 37, 38 AND 50). SN 85-098,283. PUB. 11-9-2010. FILED 8-2-2010.
- 4,163,082. **ZIPBOX THE RESEALABLE BOX AND DESIGN**. ZIPBOX LICENSE, LLC, (U.S. CLS. 2, 5, 22, 23, 29, 37, 38 AND 50). SN 85-109,582. PUB. 11-9-2010. FILED 8-17-2010.
- 4,163,083. **ZIPBOX THE RESEALABLE BOX AND DESIGN**. ZIPBOX LICENSE, LLC, (U.S. CLS. 2, 5, 22, 23, 29, 37, 38 AND 50). SN 85-109,595. PUB. 11-9-2010. FILED 8-17-2010.
- 4,163,090. **MEREDITH (STANDARD CHARACTER)**. MEREDITH COLLEGE, (U.S. CLS. 2, 5, 22, 23, 29, 37, 38 AND 50). SN 85-117,806. PUB. 4-10-2012. FILED 8-27-2010.
- 4,163,105. **BLU CIRCLE AND DESIGN**. KITARU INNOVATIONS INC., (U.S. CLS. 2, 5, 22, 23, 29, 37, 38 AND 50). SN 85-135,296. PUB. 4-10-2012. FILED 9-22-2010.
- 4,163,121. **THAT STEEZ (STANDARD CHARACTER)**. PIVA, SAMUEL, MULTIPLE CLASS, (INT. CLS. 16, 22 AND 25), (U.S. CLS. 1, 2, 5, 7, 19, 22, 23, 29, 37, 38, 39, 42 AND 50). SN 85-154,040. PUB. 4-10-2012. FILED 10-15-2010.
- 4,163,122. **I CAN READ! (STANDARD CHARACTER)**. HARPERCOLLINS PUBLISHERS L.L.C., (U.S. CLS. 2, 5, 22, 23, 29, 37, 38 AND 50). SN 85-155,988. PUB. 4-10-2012. FILED 10-19-2010.
- 4,163,123. **I CAN READ! AND DESIGN**. HARPERCOLLINS PUBLISHERS L.L.C., (U.S. CLS. 2, 5, 22, 23, 29, 37, 38 AND 50). SN 85-155,997. PUB. 4-10-2012. FILED 10-19-2010.
- 4,163,134 (*See Class 9 for this trademark*).
- 4,163,138 (*See Class 9 for this trademark*).
- 4,163,150. **IMPERIAL (STANDARD CHARACTER)**. BLUE MOUNTAIN WALLCOVERINGS CANADA INC., MULTIPLE CLASS, (INT. CLS. 16 AND 27), (U.S. CLS. 2, 5, 19, 20, 22, 23, 29, 37, 38, 42 AND 50). SN 85-175,569. PUB. 4-10-2012. FILED 11-12-2010.
- 4,163,152. **BLUE SEAL (STANDARD CHARACTER)**. KITARU INNOVATIONS INC., (U.S. CLS. 2, 5, 22, 23, 29, 37, 38 AND 50). SN 85-177,006. PUB. 4-10-2012. FILED 11-15-2010.
- 4,163,153. **BLACK SEAL (STANDARD CHARACTER)**. KITARU INNOVATIONS INC., (U.S. CLS. 2, 5, 22, 23, 29, 37, 38 AND 50). SN 85-177,624. PUB. 4-10-2012. FILED 11-16-2010.
- 4,163,163. **NUMBER CORNER (STANDARD CHARACTER)**. THE MATH LEARNING CENTER, MULTIPLE CLASS, (INT. CLS. 16 AND 28), (U.S. CLS. 2, 5, 22, 23, 29, 37, 38 AND 50). SN 85-191,643. PUB. 4-10-2012. FILED 12-6-2010.
- 4,163,204. **LATIN AND DESIGN**. LATIN STAR CORPORATION, (U.S. CLS. 2, 5, 22, 23, 29, 37, 38 AND 50). SN 85-248,465. PUB. 4-10-2012. FILED 2-22-2011.
- 4,163,228. **NATIONAL INSTITUTE OF MILITARY JUSTICE (STANDARD CHARACTER)**. NATIONAL INSTITUTE OF MILITARY JUSTICE, MULTIPLE CLASS, (INT. CLS. 16, 41 AND 45), (U.S. CLS. 2, 5, 22, 23, 29, 37, 38, 50, 100, 101 AND 107). SN 85-264,950. PUB. 4-10-2012. FILED 3-11-2011.
- 4,163,231. **NIMJ NATIONAL INSTITUTE OF MILITARY JUSTICE AND DESIGN**. NATIONAL INSTITUTE OF MILITARY JUSTICE, MULTIPLE CLASS, (INT. CLS. 16, 41 AND 45), (U.S. CLS. 2, 5, 22, 23, 29, 37, 38, 50, 100, 101 AND 107). SN 85-265,064. PUB. 4-10-2012. FILED 3-11-2011.
- 4,163,282. **SANLUIS RASSINI AND DESIGN**. SANLUIS CORPORACIÓN, S.A.B DE C.V., (U.S. CLS. 2, 5, 22, 23, 29, 37, 38 AND 50). SN 85-290,638. PUB. 4-10-2012. FILED 4-8-2011.
- 4,163,301. **BLUE RIBBON RECIPES (STANDARD CHARACTER)**. JUST A PINCH RECIPE CLUB, LLC, MULTIPLE CLASS, (INT. CLS. 16 AND 41), (U.S. CLS. 2, 5, 22, 23, 29, 37, 38, 50, 100, 101 AND 107). SN 85-295,090. PUB. 4-10-2012. FILED 4-14-2011.
- 4,163,333 (*See Class 9 for this trademark*).
- 4,163,364. **MISCELLANEOUS DESIGN**. REVERSE LOGISTICS GMBH, MULTIPLE CLASS, (INT. CLS. 16, 35, 38, 39, 40 AND 42), (U.S. CLS. 2, 5, 22, 23, 29, 37, 38, 50, 100, 101, 102, 103, 104, 105 AND 106). SN 85-307,313. PUB. 4-10-2012. FILED 4-28-2011.
- 4,163,424. **SPACESCAPES (STANDARD CHARACTER)**. HERRING, CECIL, (U.S. CLS. 2, 5, 22, 23, 29, 37, 38 AND 50). SN 85-313,965. PUB. 4-10-2012. FILED 5-6-2011.
- 4,163,456. **JOINT SUPERCHIEFS: ARMO, NAVO, MARINO, AIRFO (STANDARD CHARACTER)**. BELING, JOEL L, DBA SUPA CHARACTERS PTY LTD, MULTIPLE CLASS, (INT. CLS. 16, 25, 28 AND 41), (U.S. CLS. 2, 5, 22, 23, 29, 37, 38, 39, 50, 100, 101 AND 107). SN 85-321,417. PUB. 4-10-2012. FILED 5-16-2011.
- 4,163,481. **AMERICAN RIVER PACKAGEONE (STANDARD CHARACTER)**. KANDRIS, THOMAS P., DBA PACKAGEONE INC, (U.S. CLS. 2, 5, 22, 23, 29, 37, 38 AND 50). SN 85-328,720. PUB. 4-10-2012. FILED 5-24-2011.
- 4,163,509. **YESTERDAY'S BEST (STANDARD CHARACTER)**. KREITZER, JULIE L, (U.S. CLS. 2, 5, 22, 23, 29, 37, 38 AND 50). SN 85-339,280. PUB. 4-10-2012. FILED 6-6-2011.
- 4,163,513. **MELIA (STANDARD CHARACTER)**. DORPAN, S.L., MULTIPLE CLASS, (INT. CLS. 16 AND 43), (U.S. CLS. 2, 5, 22, 23, 29, 37, 38, 50, 100 AND 101). SN 85-341,344. PUB. 4-10-2012. FILED 6-8-2011.
- 4,163,525. **PREFERRED NEWS (STANDARD CHARACTER)**. PREFERRED GOVERNMENTAL INSURANCE TRUST, (U.S. CLS. 2, 5, 22, 23, 29, 37, 38 AND 50). SN 85-346,035. PUB. 4-10-2012. FILED 6-14-2011.
- 4,163,530. **DCWV AND DESIGN**. DCWV ACQUISITION CORPORATION, MULTIPLE CLASS, (INT. CLS. 16 AND 19), (U.S. CLS. 1, 2, 5, 12, 22, 23, 29, 33, 37, 38 AND 50). SN 85-346,736. PUB. 4-10-2012. FILED 6-15-2011.
- 4,163,593 (*See Class 9 for this trademark*).
- 4,163,594. **SHI SHI PUTTER (STANDARD CHARACTER)**. STARLIGHT CREATIONS LLC, MULTIPLE CLASS, (INT. CLS. 16, 35 AND 41), (U.S. CLS. 2, 5, 22, 23, 29, 37, 38, 50, 100, 101, 102 AND 107). SN 85-368,201. PUB. 4-10-2012. FILED 7-11-2011.
- 4,163,636. **COUPONPOP (STANDARD CHARACTER)**. VALASSIS COMMUNICATIONS, INC., (U.S. CLS. 2, 5, 22, 23, 29, 37, 38 AND 50). SN 85-382,472. PUB. 4-10-2012. FILED 7-27-2011.
- 4,163,637. **INFOPOP (STANDARD CHARACTER)**. VALASSIS COMMUNICATIONS, INC., (U.S. CLS. 2, 5, 22, 23, 29, 37, 38 AND 50). SN 85-382,480. PUB. 4-10-2012. FILED 7-27-2011.
- 4,163,660. **LADIES AUXILIARY VFW (STANDARD CHARACTER)**. VETERANS OF FOREIGN WARS OF THE UNITED STATES, (U.S. CLS. 2, 5, 22, 23, 29, 37, 38 AND 50). SN 85-388,009. PUB. 4-10-2012. FILED 8-3-2011.
- 4,163,679. **METAL MOUTH MEDIA (STANDARD CHARACTER)**. WATERMAN, PAMELA J., (U.S. CLS. 2, 5, 22, 23, 29, 37, 38 AND 50). SN 85-395,279. PUB. 4-10-2012. FILED 8-11-2011.
- 4,163,682. **TUFF-TAC (STANDARD CHARACTER)**. MERCHANT GENERAL CORPORATION, (U.S. CLS. 2, 5, 22, 23, 29, 37, 38 AND 50). SN 85-395,498. PUB. 4-10-2012. FILED 8-11-2011.
- 4,163,683. **ULTRA-TAC (STANDARD CHARACTER)**. MERCHANT GENERAL CORPORATION, (U.S. CLS. 2, 5, 22, 23, 29, 37, 38 AND 50). SN 85-395,653. PUB. 4-10-2012. FILED 8-11-2011.
- 4,163,709. **MPN (STANDARD CHARACTER)**. BABCOX MEDIA, INC., MULTIPLE CLASS, (INT. CLS. 16 AND 41), (U.S. CLS. 2, 5, 22, 23, 29, 37, 38, 50, 100, 101 AND 107). SN 85-408,107. PUB. 4-10-2012. FILED 8-26-2011.
- 4,163,741. **RDIO (STANDARD CHARACTER)**. RDIO, INC., MULTIPLE CLASS, (INT. CLS. 16 AND 35), (U.S. CLS. 2, 5, 22, 23, 29, 37, 38, 50, 100, 101 AND 102). SN 85-414,162. PUB. 4-10-2012. FILED 9-2-2011.
- 4,163,771. **SOURCE ESB (STANDARD CHARACTER)**. PENTON BUSINESS MEDIA, INC., MULTIPLE CLASS, (INT. CLS. 16 AND 35), (U.S. CLS. 2, 5, 22, 23, 29, 37, 38, 50, 100, 101 AND 102). SN 85-421,050. PUB. 4-10-2012. FILED 9-13-2011.
- 4,163,777. **CANDID CULTURE AND DESIGN**. CANDID CULTURE, INC., MULTIPLE CLASS, (INT. CLS. 16 AND 41), (U.S. CLS. 2, 5, 22, 23, 29, 37, 38, 50, 100, 101 AND 107). SN 85-423,898. PUB. 4-10-2012. FILED 9-15-2011.
- 4,163,802. **MEL KIPER (STANDARD CHARACTER)**. MEL

- KIPER ENTERPRISES, INC., (U.S. CLS. 2, 5, 22, 23, 29, 37, 38 AND 50). SN 85-428,206. PUB. 4-10-2012. FILED 9-21-2011.
- 4,163,811 (*See Class 8 for this trademark.*).
- 4,163,825 (*See Class 9 for this trademark.*).
- 4,163,888 (*See Class 9 for this trademark.*).
- 4,163,897. **TROPHY TAG (STANDARD CHARACTER)**. WORNARDT III, WALTER, WILLIAM, DBA TROPHY TAG, INC., (U.S. CLS. 2, 5, 22, 23, 29, 37, 38 AND 50). SN 85-440,650. PUB. 4-10-2012. FILED 10-6-2011.
- 4,163,901 (*See Class 2 for this trademark.*).
- 4,163,969. **2 DADS PUBLISHING (STANDARD CHARACTER)**. ZEMBY, ZACHARY, AND LIDEN, SERGIO PAUL, (U.S. CLS. 2, 5, 22, 23, 29, 37, 38 AND 50). SN 85-447,918. PUB. 4-10-2012. FILED 10-14-2011.
- 4,163,977. **IT'S ALL ABOUT SPARKY (STANDARD CHARACTER)**. MARIE LEFFINGWELL, (U.S. CLS. 2, 5, 22, 23, 29, 37, 38 AND 50). SN 85-448,329. PUB. 4-10-2012. FILED 10-15-2011.
- 4,163,984. **BORO AND DESIGN**. JKL PROJECTS INC., (U.S. CLS. 2, 5, 22, 23, 29, 37, 38 AND 50). SN 85-448,578. PUB. 4-10-2012. FILED 10-17-2011.
- 4,163,992 (*See Class 9 for this trademark.*).
- 4,163,999. **WOMENS CIRCLE AND DESIGN**. GIRLS CIRCLE ASSOCIATION, AKA ONE CIRCLE FOUNDATION, (U.S. CLS. 2, 5, 22, 23, 29, 37, 38 AND 50). SN 85-449,996. PUB. 4-10-2012. FILED 10-18-2011.
- 4,164,088. **TOILETBIBS (STANDARD CHARACTER)**. DAVID HAAG, (U.S. CLS. 2, 5, 22, 23, 29, 37, 38 AND 50). SN 85-453,823. PUB. 4-10-2012. FILED 10-22-2011.
- 4,164,104. **POINT...AIM...SHOOT (STANDARD CHARACTER)**. DAVID HAAG, (U.S. CLS. 2, 5, 22, 23, 29, 37, 38 AND 50). SN 85-454,399. PUB. 4-10-2012. FILED 10-24-2011.
- 4,164,193. **LAGUARDIA COMMUNITY COLLEGE AND DESIGN**. THE CITY UNIVERSITY OF NEW YORK THROUGH ITS COMMUNITY COLLEGE, LAGUARDIA COMMUNITY COLLEGE, MULTIPLE CLASS, (INT. CLS. 16, 21, 25 AND 41), (U.S. CLS. 2, 5, 13, 22, 23, 29, 30, 33, 37, 38, 39, 40, 50, 100, 101 AND 107). SN 85-456,547. PUB. 4-10-2012. FILED 10-26-2011.
- 4,164,195. **GESTALT PHOTOGRAPHS (STANDARD CHARACTER)**. GESTALT HOLDINGS, LP, (U.S. CLS. 2, 5, 22, 23, 29, 37, 38 AND 50). SN 85-456,635. PUB. 4-10-2012. FILED 10-26-2011.
- 4,164,205. **ROOSTER MAGAZINE (STANDARD CHARACTER)**. PREMIUM SOURCE, INC., (U.S. CLS. 2, 5, 22, 23, 29, 37, 38 AND 50). SN 85-456,869. PUB. 4-10-2012. FILED 10-26-2011.
- 4,164,242. **ASCO DAILY NEWS (STANDARD CHARACTER)**. AMERICAN SOCIETY OF CLINICAL ONCOLOGY, (U.S. CLS. 2, 5, 22, 23, 29, 37, 38 AND 50). SN 85-457,564. PUB. 4-10-2012. FILED 10-27-2011.
- 4,164,243 (*See Class 14 for this trademark.*).
- 4,164,248. **FEATHERHOUSE AND DESIGN**. PERRON, STEPHEN, AND PERRON, ANNE, AND PERRON, SEAN, (U.S. CLS. 2, 5, 22, 23, 29, 37, 38 AND 50). SN 85-457,637. PUB. 4-10-2012. FILED 10-27-2011.
- 4,164,259. **CLIC-MATIC (STANDARD CHARACTER)**. BIC CORPORATION, (U.S. CLS. 2, 5, 22, 23, 29, 37, 38 AND 50). SN 85-457,728. PUB. 4-10-2012. FILED 10-27-2011.
- 4,164,335. **LATINCORR (STANDARD CHARACTER)**. CARLOS PALACIOS, MULTIPLE CLASS, (INT. CLS. 16 AND 35), (U.S. CLS. 2, 5, 22, 23, 29, 37, 38, 50, 100, 101 AND 102). SN 85-458,255. PUB. 4-10-2012. FILED 10-27-2011.
- 4,164,355. **ZOMBIES VS CHEERLEADERS (STANDARD CHARACTER)**. FINITY PRODUCTIONS, (U.S. CLS. 2, 5, 22, 23, 29, 37, 38 AND 50). SN 85-458,449. PUB. 4-10-2012. FILED 10-27-2011.
- 4,164,362. **ESTRELLITA (STANDARD CHARACTER)**. ESTRELLITA, INC., (U.S. CLS. 2, 5, 22, 23, 29, 37, 38 AND 50). SN 85-458,526. PUB. 4-10-2012. FILED 10-28-2011.
- 4,164,411. **BOTTOM LINE PERSONAL (STANDARD CHARACTER)**. BOARDROOM INC., (U.S. CLS. 2, 5, 22, 23, 29, 37, 38 AND 50). SN 85-458,999. PUB. 4-10-2012. FILED 10-28-2011.
- 4,164,441. **CARE TO SHARE (STANDARD CHARACTER)**. STONEYBROOK PUBLISHING, INC., MULTIPLE CLASS, (INT. CLS. 16 AND 40), (U.S. CLS. 2, 5, 22, 23, 29, 37, 38, 50, 100, 103 AND 106). SN 85-459,404. PUB. 4-10-2012. FILED 10-28-2011.
- 4,164,443. **CARE TO SHARE (STYLIZED)**. STONEYBROOK PUBLISHING, INC., MULTIPLE CLASS, (INT. CLS. 16 AND 40), (U.S. CLS. 2, 5, 22, 23, 29, 37, 38, 50, 100, 103 AND 106). SN 85-459,410. PUB. 4-10-2012. FILED 10-28-2011.
- 4,164,454. **LOVE IS HELL (STANDARD CHARACTER)**. MATT GROENING PRODUCTIONS, INC., (U.S. CLS. 2, 5, 22, 23, 29, 37, 38 AND 50). SN 85-459,529. PUB. 4-10-2012. FILED 10-28-2011.
- 4,164,494 (*See Class 9 for this trademark.*).
- 4,164,498. **AVERAGE JOE (STANDARD CHARACTER)**. EFRON, MARVIN TANNER, (U.S. CLS. 2, 5, 22, 23, 29, 37, 38 AND 50). SN 85-460,002. PUB. 4-10-2012. FILED 10-31-2011.
- 4,164,584. **FRIENDLY ZOMBIES (STANDARD CHARACTER)**. TRALY (USA) INC., (U.S. CLS. 2, 5, 22, 23, 29, 37, 38 AND 50). SN 85-461,273. PUB. 4-10-2012. FILED 11-1-2011.
- 4,164,587. **ROAST MAGAZINE (STANDARD CHARACTER)**. JC PUBLISHING, INC., (U.S. CLS. 2, 5, 22, 23, 29, 37, 38 AND 50). SN 85-461,316. PUB. 4-10-2012. FILED 11-1-2011.
- 4,164,591 (*See Class 9 for this trademark.*).
- 4,164,637 (*See Class 9 for this trademark.*).
- 4,164,711. **PACIFIC BLUE (STANDARD CHARACTER)**. GEORGIA-PACIFIC CONSUMER PRODUCTS LP, (U.S. CLS. 2, 5, 22, 23, 29, 37, 38 AND 50). SN 85-485,024. PUB. 4-10-2012. FILED 12-1-2011.
- 4,164,712 (*See Class 9 for this trademark.*).
- 4,164,725. **METLIFE AUTO & HOME (STANDARD CHARACTER)**. METROPOLITAN LIFE INSURANCE COMPANY, (U.S. CLS. 2, 5, 22, 23, 29, 37, 38 AND 50). SN 85-488,703. PUB. 4-10-2012. FILED 12-6-2011.
- 4,164,742. **MISCELLANEOUS DESIGN**. MOHAWK FINE PAPERS INC., (U.S. CLS. 2, 5, 22, 23, 29, 37, 38 AND 50). SN 85-499,622. PUB. 4-10-2012. FILED 12-20-2011.
- 4,164,764. **SAFE-T-GARD (STANDARD CHARACTER)**. GEORGIA-PACIFIC CONSUMER PRODUCTS LP, MULTIPLE CLASS, (INT. CLS. 16 AND 21), (U.S. CLS. 2, 5, 13, 22, 23, 29, 30, 33, 37, 38, 40 AND 50). SN 85-513,030. PUB. 4-10-2012. FILED 1-10-2012.
- 4,164,781. **CAREER ADVICE CAREER CENTRAL I AND DESIGN**. COLLEGE CENTRAL NETWORK, INC., (U.S. CLS. 2, 5, 22, 23, 29, 37, 38 AND 50). SN 85-976,544. PUB. 12-13-2011. FILED 7-19-2011.

CLASS 17—RUBBER GOODS

- 4,162,819 (*See Class 6 for this trademark.*).
- 4,162,820 (*See Class 1 for this trademark.*).
- 4,162,833. **BLAUSTRALH (STANDARD CHARACTER)**. CON-TITECH AG, (U.S. CLS. 1, 5, 12, 13, 35 AND 50). SN 79-090,334. PUB. 4-10-2012. FILED 10-8-2010.
- 4,162,834. **ROTSTRAHL (STANDARD CHARACTER)**. CON-TITECH AG, (U.S. CLS. 1, 5, 12, 13, 35 AND 50). SN 79-090,335. PUB. 4-10-2012. FILED 10-8-2010.
- 4,162,848 (*See Class 9 for this trademark.*).
- 4,162,851 (*See Class 1 for this trademark.*).
- 4,162,943 (*See Class 6 for this trademark.*).
- 4,162,985 (*See Class 9 for this trademark.*).
- 4,162,986 (*See Class 9 for this trademark.*).
- 4,163,011. **CLRPYE (STANDARD CHARACTER)**. COVEME SPA, (U.S. CLS. 1, 5, 12, 13, 35 AND 50). SN 79-104,204. PUB. 4-10-2012. FILED 6-22-2011.
- 4,163,136. **OOMOO (STANDARD CHARACTER)**. SMOOTH-ON, INC., (U.S. CLS. 1, 5, 12, 13, 35 AND 50). SN 85-163,986. PUB. 4-10-2012. FILED 10-28-2010.
- 4,163,145. **ENVIROTUF (STANDARD CHARACTER)**. SPARTECH CORPORATION, (U.S. CLS. 1, 5, 12, 13, 35 AND 50). SN 85-170,111. PUB. 4-10-2012. FILED 11-5-2010.
- 4,163,315. **IDEX (STANDARD CHARACTER)**. IDEX CORPORATION, (U.S. CLS. 1, 5, 12, 13, 35 AND 50). SN 85-299,004. PUB. 4-10-2012. FILED 4-19-2011.
- 4,163,576. **DURA-GEL (STANDARD CHARACTER)**. PRESSURE MANAGEMENT GROUP, INC., DBA ALTERNA PRODUCTS, (U.S. CLS. 1, 5, 12, 13, 35 AND 50). SN 85-360,210. PUB. 4-10-2012. FILED 6-30-2011.
- 4,163,652 (*See Class 1 for this trademark.*).
- 4,164,120. **HI-FLEX EFILM (STANDARD CHARACTER)**. SEA-

SHELL TECHNOLOGY, LLC, (U.S. CLS. 1, 5, 12, 13, 35 AND 50). SN 85-454,771. PUB. 4-10-2012. FILED 10-24-2011.
4,164,277 (*See Class 7 for this trademark*).
4,164,301 (*See Class 7 for this trademark*).
4,164,698. **KNEADASEAL (STANDARD CHARACTER)**. POLY-MERIC SYSTEMS, INC., (U.S. CLS. 1, 5, 12, 13, 35 AND 50). SN 85-481,686. PUB. 4-10-2012. FILED 11-28-2011.

CLASS 18—LEATHER GOODS

4,162,772. **V VERSINO AND DESIGN**. CHAN, KWOK HUNG, MULTIPLE CLASS, (INT. CLS. 18 AND 25), (U.S. CLS. 1, 2, 3, 22, 39 AND 41). SN 77-904,129. PUB. 11-9-2010. FILED 1-4-2010.
4,162,792. **DITA (STANDARD CHARACTER)**. DITA, INC., MULTIPLE CLASS, (INT. CLS. 18 AND 25), (U.S. CLS. 1, 2, 3, 22, 39 AND 41). SN 78-507,802. PUB. 2-14-2006. FILED 10-28-2004.
4,162,818 (*See Class 16 for this trademark*).
4,162,831 (*See Class 9 for this trademark*).
4,162,840. **PRADA MILANO DAL 1913 AND DESIGN**. PRADA S.A., MULTIPLE CLASS, (INT. CLS. 18 AND 25), (U.S. CLS. 1, 2, 3, 22, 39 AND 41). SN 79-091,274. PUB. 4-10-2012. FILED 11-30-2010.
4,162,846 (*See Class 9 for this trademark*).
4,162,850 (*See Class 14 for this trademark*).
4,162,894. **DU PAREIL AU MÊME (STYLIZED)**. DU PAREIL AU MEME, MULTIPLE CLASS, (INT. CLS. 18, 24 AND 25), (U.S. CLS. 1, 2, 3, 22, 39, 41, 42 AND 50). SN 79-098,497. PUB. 4-10-2012. FILED 5-6-2011.
4,162,900 (*See Class 3 for this trademark*).
4,162,901 (*See Class 3 for this trademark*).
4,162,902 (*See Class 9 for this trademark*).
4,162,928. **DP..AM (STYLIZED)**. DU PAREIL AU MEME, MULTIPLE CLASS, (INT. CLS. 18, 24 AND 25), (U.S. CLS. 1, 2, 3, 22, 39, 41, 42 AND 50). SN 79-099,616. PUB. 4-10-2012. FILED 3-23-2011.
4,162,931. **MURDER INC. (STANDARD CHARACTER)**. TIMOTHY G.B. SIMMONS, MULTIPLE CLASS, (INT. CLS. 18, 25 AND 35), (U.S. CLS. 1, 2, 3, 22, 39, 41, 100, 101 AND 102). SN 79-099,905. PUB. 4-10-2012. FILED 4-18-2011.
4,162,932. **LE GESTE AND DESIGN**. SHANGHAI CONWOOD INTERNATIONAL CO., LTD., (U.S. CLS. 1, 2, 3, 22 AND 41). SN 79-099,917. PUB. 4-10-2012. FILED 6-28-2011.
4,162,946 (*See Class 9 for this trademark*).
4,162,947 (*See Class 2 for this trademark*).
4,162,955 (*See Class 9 for this trademark*).
4,162,983 (*See Class 12 for this trademark*).
4,163,012. **FITURAL (STANDARD CHARACTER)**. CHRISTOPH DECHLER, MULTIPLE CLASS, (INT. CLS. 18, 25, 29, 32 AND 41), (U.S. CLS. 1, 2, 3, 22, 39, 41, 45, 46, 48, 100, 101 AND 107). SN 79-104,242. PUB. 4-10-2012. FILED 5-19-2011.
4,163,015. **SNOOZIHEDZ (STANDARD CHARACTER)**. MAGMATIC LIMITED, MULTIPLE CLASS, (INT. CLS. 18, 20, 21, 24 AND 28), (U.S. CLS. 1, 2, 3, 13, 22, 23, 25, 29, 30, 32, 33, 38, 40, 41, 42 AND 50). SN 79-104,414. PUB. 4-10-2012. FILED 9-19-2011.
4,163,065 (*See Class 9 for this trademark*).
4,163,355. **BACK TO...BASICS (STANDARD CHARACTER)**. HORIZON GROUP USA, INC., MULTIPLE CLASS, (INT. CLS. 18 AND 25), (U.S. CLS. 1, 2, 3, 22, 39 AND 41). SN 85-306,492. PUB. 4-10-2012. FILED 4-27-2011.
4,163,418 (*See Class 9 for this trademark*).
4,163,444 (*See Class 11 for this trademark*).
4,163,580. **LEASH MATE (STANDARD CHARACTER)**. THE KYJEN COMPANY, INC., (U.S. CLS. 1, 2, 3, 22 AND 41). SN 85-362,545. PUB. 1-3-2012. FILED 7-3-2011.
4,163,604. **KORAL FIGHT CO. AND DESIGN**. KORAL BRASIL CONFECÇÃO LTDA ME, MULTIPLE CLASS, (INT. CLS. 18 AND 25), (U.S. CLS. 1, 2, 3, 22, 39 AND 41). SN 85-371,941. PUB. 1-3-2012. FILED 7-14-2011.
4,163,689 (*See Class 14 for this trademark*).
4,163,792. **TOREX (STANDARD CHARACTER)**. TORAY KABUSHIKI KAISHA (TORAY INDUSTRIES, INC.), MULTIPLE CLASS, (INT. CLS. 18, 22 AND 23), (U.S. CLS. 1, 2, 3, 7,

19, 22, 41, 42, 43 AND 50). SN 85-427,219. PUB. 3-6-2012. FILED 9-20-2011.
4,163,799. **I AND DESIGN**. INITIALS, (U.S. CLS. 1, 2, 3, 22 AND 41). SN 85-428,149. PUB. 4-10-2012. FILED 9-21-2011.
4,163,835. **MOLLY'S PAWS (STANDARD CHARACTER)**. SBARK CONSULTING, LLC, MULTIPLE CLASS, (INT. CLS. 18 AND 28), (U.S. CLS. 1, 2, 3, 22, 23, 38, 41 AND 50). SN 85-433,336. PUB. 4-10-2012. FILED 9-27-2011.
4,164,072. **H E BUDDY AND DESIGN**. HEB GROCERY COMPANY, LP, (U.S. CLS. 1, 2, 3, 22 AND 41). SN 85-453,386. PUB. 4-10-2012. FILED 10-21-2011.
4,164,188. **H-E-B AND DESIGN**. HEB GROCERY COMPANY, LP, (U.S. CLS. 1, 2, 3, 22 AND 41). SN 85-456,412. PUB. 4-10-2012. FILED 10-26-2011.
4,164,237. **DONNA KARAN NEW YORK (STANDARD CHARACTER)**. GABRIELLE STUDIO, INC., (U.S. CLS. 1, 2, 3, 22 AND 41). SN 85-457,505. PUB. 4-10-2012. FILED 10-27-2011.
4,164,452. **LAATHENA (STANDARD CHARACTER)**. LIU, YE RONG, (U.S. CLS. 1, 2, 3, 22 AND 41). SN 85-459,486. PUB. 4-10-2012. FILED 10-28-2011.
4,164,455. **MISCELLANEOUS DESIGN**. LIU, YE RONG, (U.S. CLS. 1, 2, 3, 22 AND 41). SN 85-459,538. PUB. 4-10-2012. FILED 10-28-2011.
4,164,608. **AEO (STANDARD CHARACTER)**. RETAIL ROYALTY COMPANY, (U.S. CLS. 1, 2, 3, 22 AND 41). SN 85-463,481. PUB. 4-10-2012. FILED 11-3-2011.
4,164,644. **PARAMOUNT PICTURES AND DESIGN**. PARAMOUNT PICTURES CORPORATION, (U.S. CLS. 1, 2, 3, 22 AND 41). SN 85-468,920. PUB. 4-10-2012. FILED 11-9-2011.
4,164,657. **HB AND DESIGN**. HENRI BENDEL, INC., (U.S. CLS. 1, 2, 3, 22 AND 41). SN 85-470,687. PUB. 4-10-2012. FILED 11-11-2011.
4,164,693. **SO SO HAPPY AND DESIGN**. SO SO HAPPY STUDIO, INC., MULTIPLE CLASS, (INT. CLS. 18, 25 AND 28), (U.S. CLS. 1, 2, 3, 22, 23, 38, 39, 41 AND 50). SN 85-479,515. PUB. 4-10-2012. FILED 11-22-2011.
4,164,737 (*See Class 14 for this trademark*).

CLASS 19—NON-METALLIC BUILDING MATERIALS

4,162,717. **DAC-ART (STANDARD CHARACTER)**. DIAL, JR., TED C., (U.S. CLS. 1, 12, 33 AND 50). SN 76-709,105. PUB. 4-10-2012. FILED 9-16-2011.
4,162,819 (*See Class 6 for this trademark*).
4,162,820 (*See Class 1 for this trademark*).
4,162,851 (*See Class 1 for this trademark*).
4,162,913 (*See Class 6 for this trademark*).
4,162,938 (*See Class 7 for this trademark*).
4,163,008 (*See Class 6 for this trademark*).
4,163,064. **HONEYSTONE (STANDARD CHARACTER)**. INNOVATION STONES LTD., (U.S. CLS. 1, 12, 33 AND 50). SN 85-041,317. PUB. 4-10-2012. FILED 5-18-2010.
4,163,192. **SCULPTSTONE (STANDARD CHARACTER)**. CHRISTOPHER F. O'HARE, INC, DBA PINEAPPLE GROVE DESIGNS, (U.S. CLS. 1, 12, 33 AND 50). SN 85-230,162. PUB. 4-10-2012. FILED 1-31-2011.
4,163,220. **CUSTOMSTONEWOOD (STANDARD CHARACTER)**. BENKOWSKI, DON V, (U.S. CLS. 1, 12, 33 AND 50). SN 85-261,980. PUB. 4-10-2012. FILED 3-9-2011.
4,163,239 (*See Class 7 for this trademark*).
4,163,240 (*See Class 7 for this trademark*).
4,163,340. **DURA SLAG (STANDARD CHARACTER)**. ASH GROVE CEMENT COMPANY, (U.S. CLS. 1, 12, 33 AND 50). SN 85-304,874. PUB. 4-10-2012. FILED 4-26-2011.
4,163,411. **ARCHIPHYTE AND DESIGN**. ARCHIPHYTE, LLC, MULTIPLE CLASS, (INT. CLS. 19 AND 37), (U.S. CLS. 1, 12, 33, 50, 100, 103 AND 106). SN 85-311,488. PUB. 4-10-2012. FILED 5-3-2011.
4,163,466. **CROSS OF A STORM (STANDARD CHARACTER)**. GUIDRY, II, HAROLD J., (U.S. CLS. 1, 12, 33 AND 50). SN 85-323,053. PUB. 4-10-2012. FILED 5-17-2011.
4,163,530 (*See Class 16 for this trademark*).
4,163,574. **KALOCER (STANDARD CHARACTER)**. KALENBORN INTERNATIONAL GMBH & CO. KG, MULTIPLE CLASS, (INT. CLS. 19, 37 AND 42), (U.S. CLS. 1, 12, 33, 50,

- 100, 101, 103 AND 106). SN 85-359,096. PUB. 4-10-2012. FILED 6-29-2011.
- 4,163,609. **E3 AND DESIGN**. C.A.B. ROOFING AND CONSTRUCTION, INC., DBA BEATTY'S BUILDERS, MULTIPLE CLASS, (INT. CLS. 19 AND 37), (U.S. CLS. 1, 12, 33, 50, 100, 103 AND 106). SN 85-374,810. PUB. 4-10-2012. FILED 7-19-2011.
- 4,163,638. **ADPOP (STANDARD CHARACTER)**. VALASSIS COMMUNICATIONS, INC., (U.S. CLS. 1, 12, 33 AND 50). SN 85-382,494. PUB. 4-10-2012. FILED 7-27-2011.
- 4,163,659. **FLOORPOP (STANDARD CHARACTER)**. VALASSIS COMMUNICATIONS, INC., (U.S. CLS. 1, 12, 33 AND 50). SN 85-387,871. PUB. 4-10-2012. FILED 8-3-2011.
- 4,163,735. **SLIMBRICK (STANDARD CHARACTER)**. MUTUAL MATERIALS COMPANY, (U.S. CLS. 1, 12, 33 AND 50). SN 85-413,570. PUB. 4-10-2012. FILED 9-1-2011.
- 4,163,814. **RAIN MOVER (STANDARD CHARACTER)**. DUFFY STEPHEN J, DBA ECO FILTER TECHNOLOGIES, (U.S. CLS. 1, 12, 33 AND 50). SN 85-429,314. PUB. 4-10-2012. FILED 9-22-2011.
- 4,163,834 (*See Class 11 for this trademark*).
- 4,163,846 (*See Class 11 for this trademark*).
- 4,163,948. **ENERGYCORE (STANDARD CHARACTER)**. MIKRON INDUSTRIES, INC., (U.S. CLS. 1, 12, 33 AND 50). SN 85-446,056. PUB. 4-10-2012. FILED 10-12-2011.
- 4,164,002. **PERGO XP (STANDARD CHARACTER)**. PERGO (EUROPE) AB, (U.S. CLS. 1, 12, 33 AND 50). SN 85-450,464. PUB. 4-10-2012. FILED 10-18-2011.
- 4,164,021. **HYPERION GLASS (STANDARD CHARACTER)**. HUNTER, CHIP, (U.S. CLS. 1, 12, 33 AND 50). SN 85-451,169. PUB. 4-10-2012. FILED 10-19-2011.
-
- CLASS 20—FURNITURE AND ARTICLES NOT OTHERWISE CLASSIFIED**
- 4,162,845 (*See Class 9 for this trademark*).
- 4,162,873 (*See Class 6 for this trademark*).
- 4,162,876 (*See Class 12 for this trademark*).
- 4,162,918 (*See Class 11 for this trademark*).
- 4,162,945 (*See Class 2 for this trademark*).
- 4,162,958. **POP CHANNEL AND DESIGN**. MAJRANI EUROPE S.R.L., MULTIPLE CLASS, (INT. CLS. 20 AND 35), (U.S. CLS. 2, 13, 22, 25, 32, 50, 100, 101 AND 102). SN 79-101,407. PUB. 4-10-2012. FILED 6-30-2011.
- 4,162,964. **CREAZIONI LA FANTASIA È MOBILE AND DESIGN**. SILIK SPA, MULTIPLE CLASS, (INT. CLS. 20 AND 24), (U.S. CLS. 2, 13, 22, 25, 32, 42 AND 50). SN 79-101,624. PUB. 4-10-2012. FILED 4-6-2011.
- 4,163,015 (*See Class 18 for this trademark*).
- 4,163,029 (*See Class 4 for this trademark*).
- 4,163,097. **PLATY (STANDARD CHARACTER)**. CASCADE DESIGNS, INC., MULTIPLE CLASS, (INT. CLS. 20 AND 21), (U.S. CLS. 2, 13, 22, 23, 25, 29, 30, 32, 33, 40 AND 50). SN 85-122,375. PUB. 4-10-2012. FILED 9-2-2010.
- 4,163,156. **FINAL FOOTPRINT ECO-CASKETS & NATURAL BURIALS AND DESIGN**. HILLHOUSE, JANE, DBA FINAL FOOTPRINT, "GREENING YOUR FINAL FOOTPRINT", (U.S. CLS. 2, 13, 22, 25, 32 AND 50). SN 85-179,253. PUB. 4-10-2012. FILED 11-17-2010.
- 4,163,241. **HAMMER (STANDARD CHARACTER)**. VOLT, LLC, (U.S. CLS. 2, 13, 22, 25, 32 AND 50). SN 85-272,208. PUB. 1-24-2012. FILED 3-21-2011.
- 4,163,243. **VG VERST GROUP LOGISTICS (STYLIZED)**. VERST GROUP LOGISTICS, INC., MULTIPLE CLASS, (INT. CLS. 20, 35 AND 39), (U.S. CLS. 2, 13, 22, 25, 32, 50, 100, 101, 102 AND 105). SN 85-272,427. PUB. 4-10-2012. FILED 3-21-2011.
- 4,163,270 (*See Class 6 for this trademark*).
- 4,163,294. **PARADISE BY FIBERBUILT AND DESIGN**. FIBERBUILT UMBRELLAS, (U.S. CLS. 2, 13, 22, 25, 32 AND 50). SN 85-293,622. PUB. 4-10-2012. FILED S.R. 4-13-2011; AM. P.R. 7-26-2011.
- 4,163,296. **THIRD COAST (STANDARD CHARACTER)**. BELL'S BREWERY, INC., MULTIPLE CLASS, (INT. CLS. 20, 25 AND 32), (U.S. CLS. 2, 13, 22, 25, 32, 39, 45, 46, 48 AND 50). SN 85-294,311. PUB. 4-10-2012. FILED 4-13-2011.
- 4,163,306. **SHEER MAGIC (STANDARD CHARACTER)**. 3 DAY BLINDS CORPORATION, MULTIPLE CLASS, (INT. CLS. 20 AND 24), (U.S. CLS. 2, 13, 22, 25, 32, 42 AND 50). SN 85-296,943. PUB. 4-10-2012. FILED 4-15-2011.
- 4,163,367. **WON'T GO FLAT (STANDARD CHARACTER)**. PACIFIC COAST FEATHER COMPANY, (U.S. CLS. 2, 13, 22, 25, 32 AND 50). SN 85-307,645. PUB. 4-10-2012. FILED 4-28-2011.
- 4,163,444 (*See Class 11 for this trademark*).
- 4,163,500. **CREEKVINE DESIGNS (STANDARD CHARACTER)**. FIFTHROOM MARKETS, INC., (U.S. CLS. 2, 13, 22, 25, 32 AND 50). SN 85-337,571. PUB. 4-10-2012. FILED 6-3-2011.
- 4,163,568. **ULTRAFLOW (STANDARD CHARACTER)**. PACIFIC COAST FEATHER COMPANY, (U.S. CLS. 2, 13, 22, 25, 32 AND 50). SN 85-355,977. PUB. 4-10-2012. FILED 6-24-2011.
- 4,163,603 (*See Class 11 for this trademark*).
- 4,163,700. **ULTRALITE (STANDARD CHARACTER)**. TELEFLEX INCORPORATED, (U.S. CLS. 2, 13, 22, 25, 32 AND 50). SN 85-403,512. PUB. 4-10-2012. FILED 8-22-2011.
- 4,163,891. **SMARTPANEL AND DESIGN**. AMERIWOOD INDUSTRIES, (U.S. CLS. 2, 13, 22, 25, 32 AND 50). SN 85-439,676. PUB. 4-10-2012. FILED 10-5-2011.
- 4,163,944. **ZZZ COLLECTION (STANDARD CHARACTER)**. MATTRESS DEALZZ, LLC, (U.S. CLS. 2, 13, 22, 25, 32 AND 50). SN 85-445,970. PUB. 4-10-2012. FILED 10-12-2011.
- 4,163,996. **CLING 'N GO (STANDARD CHARACTER)**. KRAMER, BRADLEY T., (U.S. CLS. 2, 13, 22, 25, 32 AND 50). SN 85-449,740. PUB. 4-10-2012. FILED 10-18-2011.
- 4,164,333. **SERENITY (STANDARD CHARACTER)**. FOUNDATIONS WORLDWIDE, INC., (U.S. CLS. 2, 13, 22, 25, 32 AND 50). SN 85-458,239. PUB. 4-10-2012. FILED 10-27-2011.
- 4,164,446. **RESTONIC AND DESIGN**. RESTONIC CORPORATION, (U.S. CLS. 2, 13, 22, 25, 32 AND 50). SN 85-459,423. PUB. 4-10-2012. FILED 10-28-2011.
- 4,164,453. **FIVE POINTS (STANDARD CHARACTER)**. WILLIAMS IMPORT COMPANY, INC., AND MAINLINE WORLD FURNITURE, INC., (U.S. CLS. 2, 13, 22, 25, 32 AND 50). SN 85-459,502. PUB. 4-10-2012. FILED 10-28-2011.
- 4,164,641. **DELINOW AND DESIGN**. NOWPAK, INC., (U.S. CLS. 2, 13, 22, 25, 32 AND 50). SN 85-468,752. PUB. 4-10-2012. FILED 11-9-2011.
- 4,164,642. **MICRONOW AND DESIGN**. NOWPAK, INC., (U.S. CLS. 2, 13, 22, 25, 32 AND 50). SN 85-468,759. PUB. 4-10-2012. FILED 11-9-2011.
- 4,164,690. **EVDREAM (STANDARD CHARACTER)**. PACIFIC COAST FEATHER COMPANY, (U.S. CLS. 2, 13, 22, 25, 32 AND 50). SN 85-478,793. PUB. 4-10-2012. FILED 11-22-2011.
- 4,164,755. **PILLOW-LOUNGER (STANDARD CHARACTER)**. SWEZEY, RICHARD, (U.S. CLS. 2, 13, 22, 25, 32 AND 50). SN 85-506,476. PUB. 4-10-2012. FILED 12-30-2011.
-
- CLASS 21—HOUSEWARES AND GLASS**
- 4,162,707 (*See Class 16 for this trademark*).
- 4,162,709 (*See Class 16 for this trademark*).
- 4,162,829 (*See Class 3 for this trademark*).
- 4,162,845 (*See Class 9 for this trademark*).
- 4,162,864 (*See Class 3 for this trademark*).
- 4,162,890. **STONE (STANDARD CHARACTER)**. WARIMEX WAREN-IMPORT-EXPORT-HANDELS GMBH, (U.S. CLS. 2, 13, 23, 29, 30, 33, 40 AND 50). SN 79-098,158. PUB. 1-3-2012. FILED 5-3-2011.
- 4,162,918 (*See Class 11 for this trademark*).
- 4,162,947 (*See Class 2 for this trademark*).
- 4,163,003. **MISCELLANEOUS DESIGN**. YONGKANG XINSHIDAI INDUSTRY CO., LTD., (U.S. CLS. 2, 13, 23, 29, 30, 33, 40 AND 50). SN 79-103,760. PUB. 4-10-2012. FILED 8-10-2011.
- 4,163,005 (*See Class 8 for this trademark*).
- 4,163,015 (*See Class 18 for this trademark*).
- 4,163,029 (*See Class 4 for this trademark*).
- 4,163,049. **MAX (STANDARD CHARACTER)**. RED SEA FISH PHARM LTD, (U.S. CLS. 2, 13, 23, 29, 30, 33, 40 AND 50). SN 85-004,818. PUB. 4-10-2012. FILED 4-2-2010.

4,163,097 (*See Class 20 for this trademark.*)
 4,163,112. **THE ROMANOV COLLECTION AND DESIGN.** AJKA CRYSTAL, LLC, (U.S. CLS. 2, 13, 23, 29, 30, 33, 40 AND 50). SN 85-143,437. PUB. 4-10-2012. FILED 10-1-2010.
 4,163,267. **SLIM-LINE (STANDARD CHARACTER).** C&A INTERNATIONAL, LLC, (U.S. CLS. 2, 13, 23, 29, 30, 33, 40 AND 50). SN 85-286,141. PUB. 4-10-2012. FILED 4-5-2011.
 4,163,444 (*See Class 11 for this trademark.*)
 4,163,499. **URBIO (STANDARD CHARACTER).** ALLER, JARED, (U.S. CLS. 2, 13, 23, 29, 30, 33, 40 AND 50). SN 85-337,061. PUB. 4-10-2012. FILED 6-3-2011.
 4,163,507 (*See Class 6 for this trademark.*)
 4,163,811 (*See Class 8 for this trademark.*)
 4,164,127. **INTERNATIONAL TABLEWARE INCORPORATED (STANDARD CHARACTER).** G.G. MARCK & ASSOCIATES, INC., (U.S. CLS. 2, 13, 23, 29, 30, 33, 40 AND 50). SN 85-455,134. PUB. 4-10-2012. FILED 10-25-2011.
 4,164,154. **STUFZ (STANDARD CHARACTER).** WESLEY CORPORATION, (U.S. CLS. 2, 13, 23, 29, 30, 33, 40 AND 50). SN 85-455,691. PUB. 4-10-2012. FILED 10-25-2011.
 4,164,193 (*See Class 16 for this trademark.*)
 4,164,370. **BUBBLE BOY (STANDARD CHARACTER).** WRIGHT, TIMOTHY A., DBA CHIP SHOT, LLC, (U.S. CLS. 2, 13, 23, 29, 30, 33, 40 AND 50). SN 85-458,625. PUB. 4-10-2012. FILED 10-28-2011.
 4,164,373. **BUBBLE GIRL (STANDARD CHARACTER).** WRIGHT, TIMOTHY A., DBA CHIP SHOT, LLC, (U.S. CLS. 2, 13, 23, 29, 30, 33, 40 AND 50). SN 85-458,636. PUB. 4-10-2012. FILED 10-28-2011.
 4,164,435. **2LIVING... (STANDARD CHARACTER).** HANGER HEADQUARTERS, (U.S. CLS. 2, 13, 23, 29, 30, 33, 40 AND 50). SN 85-459,280. PUB. 4-10-2012. FILED 10-28-2011.
 4,164,559. **SPEEDY WIPES (STANDARD CHARACTER).** WET MITT BRANDS, LLC, (U.S. CLS. 2, 13, 23, 29, 30, 33, 40 AND 50). SN 85-460,844. PUB. 4-10-2012. FILED 10-31-2011.
 4,164,625. **PURE BABY (STANDARD CHARACTER).** RADIUS CORPORATION, (U.S. CLS. 2, 13, 23, 29, 30, 33, 40 AND 50). SN 85-466,699. PUB. 4-10-2012. FILED 11-8-2011.
 4,164,643. **PARAMOUNT PICTURES AND DESIGN.** PARAMOUNT PICTURES CORPORATION, (U.S. CLS. 2, 13, 23, 29, 30, 33, 40 AND 50). SN 85-468,908. PUB. 4-10-2012. FILED 11-9-2011.
 4,164,696. **WELLINGTON HILL (STANDARD CHARACTER).** TARGET BRANDS, INC., (U.S. CLS. 2, 13, 23, 29, 30, 33, 40 AND 50). SN 85-480,255. PUB. 4-10-2012. FILED 11-23-2011.
 4,164,764 (*See Class 16 for this trademark.*)

CLASS 22—CORDAGE AND FIBERS

4,163,002. **SX AND DESIGN.** HANGZHOU SANXIN PAPER CO., LTD., (U.S. CLS. 1, 2, 7, 19, 22, 42 AND 50). SN 79-103,751. PUB. 4-10-2012. FILED 6-29-2011.
 4,163,008 (*See Class 6 for this trademark.*)
 4,163,087. **TETORON (STANDARD CHARACTER).** TORAY KABUSHIKI KAISHA, AKA TORAY INDUSTRIES, INC., AND TEIJIN KABUSHIKI KAISHA, AKA TEIJIN LIMITED, MULTIPLE CLASS, (INT. CLS. 22, 23 AND 24), (U.S. CLS. 1, 2, 7, 19, 22, 42, 43 AND 50). SN 85-113,787. PUB. 4-10-2012. FILED 8-23-2010.
 4,163,121 (*See Class 16 for this trademark.*)
 4,163,792 (*See Class 18 for this trademark.*)

CLASS 23—YARNS AND THREADS

4,163,087 (*See Class 22 for this trademark.*)
 4,163,792 (*See Class 18 for this trademark.*)
 4,163,810. **APPLEWOOD LANE ALPACAS (STANDARD CHARACTER).** APPLEWOOD LANE ALPACAS, LLC, (U.S. CL. 43). SN 85-429,030. PUB. 4-10-2012. FILED 9-22-2011.
 4,164,266 (*See Class 8 for this trademark.*)

CLASS 24—FABRICS

4,162,829 (*See Class 3 for this trademark.*)
 4,162,864 (*See Class 3 for this trademark.*)
 4,162,894 (*See Class 18 for this trademark.*)
 4,162,928 (*See Class 18 for this trademark.*)
 4,162,947 (*See Class 2 for this trademark.*)
 4,162,964 (*See Class 20 for this trademark.*)
 4,162,984. **HOSOO AND DESIGN.** HOSOO CO., LTD., (U.S. CLS. 42 AND 50). SN 79-102,684. PUB. 4-10-2012. FILED 8-11-2011.
 4,163,006 (*See Class 5 for this trademark.*)
 4,163,015 (*See Class 18 for this trademark.*)
 4,163,029 (*See Class 4 for this trademark.*)
 4,163,070. **TREKDRY FUNCTIONAL FABRIC QUICK DRYING + MOISTURE WICKING AND DESIGN.** TIONG LIONG INDUSTRIAL CO., LTD., MULTIPLE CLASS, (INT. CLS. 24 AND 25), (U.S. CLS. 22, 39, 42 AND 50). SN 85-077,305. PUB. 4-26-2011. FILED 7-2-2010.
 4,163,087 (*See Class 22 for this trademark.*)
 4,163,098. **SUBLIMAGIC (STANDARD CHARACTER).** THE DENALI COMPANIES LLC, (U.S. CLS. 42 AND 50). SN 85-123,906. PUB. 4-10-2012. FILED 9-7-2010.
 4,163,306 (*See Class 20 for this trademark.*)
 4,163,408. **EB EFFORTLESS BEDDING AND DESIGN.** EFFORTLESS BEDDING LLC, (U.S. CLS. 42 AND 50). SN 85-311,266. PUB. 4-10-2012. FILED 5-3-2011.
 4,163,444 (*See Class 11 for this trademark.*)
 4,163,648. **CLEVER GIRL INNOVATIONS AND DESIGN.** CLEVER GIRL INNOVATIONS, LLC, (U.S. CLS. 42 AND 50). SN 85-385,765. PUB. 4-10-2012. FILED S.R. 8-1-2011; AM. P.R. 12-28-2011.
 4,163,760. **MISCELLANEOUS DESIGN.** ZHEJIANG OVERBOUNDARY (GROUP) CO., LTD., (U.S. CLS. 42 AND 50). SN 85-418,353. PUB. 4-10-2012. FILED 9-9-2011.
 4,164,341. **MY LITTLE NIGHT OWL (STANDARD CHARACTER).** KATE ASPEN, INC., DBA BABY ASPEN, MULTIPLE CLASS, (INT. CLS. 24, 25 AND 28), (U.S. CLS. 22, 23, 38, 39, 42 AND 50). SN 85-458,300. PUB. 4-10-2012. FILED 10-27-2011.
 4,164,425. **TELO WRAP (STANDARD CHARACTER).** SHEHAB, ELAINE, (U.S. CLS. 42 AND 50). SN 85-459,189. PUB. 4-10-2012. FILED 10-28-2011.
 4,164,532. **GTA (STANDARD CHARACTER).** GLOBAL TEXTILE ALLIANCE, INC., (U.S. CLS. 42 AND 50). SN 85-460,486. PUB. 4-10-2012. FILED 10-31-2011.
 4,164,580. **MADE WITH HUGS (STANDARD CHARACTER).** IT'S GIRL STUFF, (U.S. CLS. 42 AND 50). SN 85-461,246. PUB. 4-10-2012. FILED 11-1-2011.
 4,164,661. **GREATEST SPORTSTOWN TOWEL (STANDARD CHARACTER).** LIFE IS SPORTS LLC, (U.S. CLS. 42 AND 50). SN 85-472,222. PUB. 4-10-2012. FILED 11-14-2011.
 4,164,676. **ENTRANT AND DESIGN.** TORAY KABUSHIKI KAISHA (TORAY INDUSTRIES, INC.), MULTIPLE CLASS, (INT. CLS. 24 AND 25), (U.S. CLS. 22, 39, 42 AND 50). SN 85-474,975. PUB. 3-6-2012. FILED 11-17-2011.

CLASS 25—CLOTHING

4,162,691. **NU NATIONS UNITY.** CHORNEY, JUDY LYNN, MULTIPLE CLASS, (INT. CLS. 25, 36, 41 AND 42), (U.S. CLS. 22, 39, 100, 101, 102 AND 107). SN 76-267,244. PUB. 4-10-2012. FILED 6-6-2001.
 4,162,707 (*See Class 16 for this trademark.*)
 4,162,709 (*See Class 16 for this trademark.*)
 4,162,725. **TOUGH DUCK (STANDARD CHARACTER).** WINNIPEG PANTS AND SPORTSWEAR MFG. LTD., (U.S. CLS. 22 AND 39). SN 76-709,577. PUB. 4-10-2012. FILED 10-31-2011.
 4,162,728. **WHOLESOME IS SEXY (STANDARD CHARACTER).** SWADE, CHERYL LYNN, (U.S. CLS. 22 AND 39). SN 77-176,001. PUB. 4-10-2012. FILED 5-8-2007.
 4,162,750. **WATERBABIES BIKINI (STANDARD CHARACTER).** WATERBABIES BIKINI, (U.S. CLS. 22 AND 39). SN 77-710,390. PUB. 4-10-2012. FILED S.R. 4-9-2009; AM. P.R. 2-8-2012.

- 4,162,751. **YOU'RE KILLING ME!! (STANDARD CHARACTER)**, ARGENTINO, WILLIAM, (U.S. CLS. 22 AND 39). SN 77-710,867. PUB. 4-10-2012. FILED 4-9-2009.
- 4,162,768. **MISCELLANEOUS DESIGN**. SKATE ONE CORP., MULTIPLE CLASS, (INT. CLS. 25 AND 28), (U.S. CLS. 22, 23, 38, 39 AND 50). SN 77-864,254. PUB. 4-6-2010. FILED 11-3-2009.
- 4,162,771. **INTIMIDATION CLOTHING (STANDARD CHARACTER)**, INTIMIDATION CLOTHING, LLC, (U.S. CLS. 22 AND 39). SN 77-900,590. PUB. 4-10-2012. FILED 12-23-2009.
- 4,162,772 (*See Class 18 for this trademark*).
- 4,162,773. **JERSEY ROYALTY (STANDARD CHARACTER)**. JARKEZIAN, HRATCH ROGER, (U.S. CLS. 22 AND 39). SN 77-907,418. PUB. 4-10-2012. FILED 1-7-2010.
- 4,162,780. **CAPESTORM (STANDARD CHARACTER)**. CAPESTORM OUTDOOR APPAREL (PTY) LTD., (U.S. CLS. 22 AND 39). SN 77-944,880. PUB. 4-10-2012. FILED 2-25-2010.
- 4,162,782. **HIGH COTTON TIES AND DESIGN**. HIGH COTTON TIES LLC, (U.S. CLS. 22 AND 39). SN 77-950,996. PUB. 7-12-2011. FILED 3-4-2010.
- 4,162,790. **DAHLGREN (STANDARD CHARACTER)**. DAHLGREN FOOTWEAR, INC., (U.S. CLS. 22 AND 39). SN 77-966,022. PUB. 4-10-2012. FILED 3-23-2010.
- 4,162,792 (*See Class 18 for this trademark*).
- 4,162,799 (*See Class 9 for this trademark*).
- 4,162,818 (*See Class 16 for this trademark*).
- 4,162,827 (*See Class 9 for this trademark*).
- 4,162,829 (*See Class 3 for this trademark*).
- 4,162,831 (*See Class 9 for this trademark*).
- 4,162,840 (*See Class 18 for this trademark*).
- 4,162,846 (*See Class 9 for this trademark*).
- 4,162,850 (*See Class 14 for this trademark*).
- 4,162,876 (*See Class 12 for this trademark*).
- 4,162,892 (*See Class 9 for this trademark*).
- 4,162,894 (*See Class 18 for this trademark*).
- 4,162,897. **HUMAN BOMB (STYLIZED)**. ILANN PEREZ, (U.S. CLS. 22 AND 39). SN 79-098,597. PUB. 4-10-2012. FILED 5-24-2011.
- 4,162,900 (*See Class 3 for this trademark*).
- 4,162,901 (*See Class 3 for this trademark*).
- 4,162,910 (*See Class 14 for this trademark*).
- 4,162,919 (*See Class 10 for this trademark*).
- 4,162,928 (*See Class 18 for this trademark*).
- 4,162,931 (*See Class 18 for this trademark*).
- 4,162,946 (*See Class 9 for this trademark*).
- 4,162,947 (*See Class 2 for this trademark*).
- 4,162,952. **ZÉMMERN (STYLIZED)**. NANTONG AUBADE ENTERPRISE CO.,LTD, (U.S. CLS. 22 AND 39). SN 79-101,100. PUB. 4-10-2012. FILED 7-5-2011.
- 4,162,962. **SUSSI (STYLIZED)**. FENG LI, (U.S. CLS. 22 AND 39). SN 79-101,535. PUB. 4-10-2012. FILED 8-10-2011.
- 4,162,972. **MAKA PU'U AND DESIGN**. ONESKY, INC., (U.S. CLS. 22 AND 39). SN 79-102,170. PUB. 4-10-2012. FILED 7-13-2011.
- 4,162,988. **SOLIDEA (STYLIZED)**. CALZIFICIO PINELLI SRL, (U.S. CLS. 22 AND 39). SN 79-102,841. PUB. 4-10-2012. FILED 11-15-2010.
- 4,163,012 (*See Class 18 for this trademark*).
- 4,163,021. **WANDA PANDA (STYLIZED)**. RAUL CAMPILLO RODRIGUEZ, (U.S. CLS. 22 AND 39). SN 79-104,900. PUB. 4-10-2012. FILED 9-19-2011.
- 4,163,022. **PARKRUN AND DESIGN**. PARKRUN LIMITED, MULTIPLE CLASS, (INT. CLS. 25, 35 AND 41), (U.S. CLS. 22, 39, 100, 101, 102 AND 107). SN 79-104,972. PUB. 4-10-2012. FILED 4-28-2011.
- 4,163,058 (*See Class 9 for this trademark*).
- 4,163,065 (*See Class 9 for this trademark*).
- 4,163,070 (*See Class 24 for this trademark*).
- 4,163,081 (*See Class 12 for this trademark*).
- 4,163,115. **TAHITIAN MOVE (STANDARD CHARACTER)**. LOANA CHIOCCHI, (U.S. CLS. 22 AND 39). SN 85-144,655. PUB. 9-13-2011. FILED 10-4-2010.
- 4,163,121 (*See Class 16 for this trademark*).
- 4,163,146. **SOLE OF SKATE (STANDARD CHARACTER)**. VANS, INC., (U.S. CLS. 22 AND 39). SN 85-170,209. PUB. 4-10-2012. FILED 11-5-2010.
- 4,163,154. **BREEZE (STANDARD CHARACTER)**. KATE LEXI DELLON, (U.S. CLS. 22 AND 39). SN 85-178,207. PUB. 4-5-2011. FILED 11-16-2010.
- 4,163,190. **CARBONSIX (STANDARD CHARACTER)**. WHITE, NIKIA S, (U.S. CLS. 22 AND 39). SN 85-228,236. PUB. 4-10-2012. FILED 1-27-2011.
- 4,163,196 (*See Class 14 for this trademark*).
- 4,163,219. **MISCELLANEOUS DESIGN**. COHEED AND CAMBRIA, (U.S. CLS. 22 AND 39). SN 85-261,557. PUB. 4-10-2012. FILED 3-8-2011.
- 4,163,227. **PIOLA AND DESIGN**. PIOLA, (U.S. CLS. 22 AND 39). SN 85-264,540. PUB. 4-10-2012. FILED 3-11-2011.
- 4,163,289. **TAAL AND DESIGN**. TAAL DANCEWEAR LLC, (U.S. CLS. 22 AND 39). SN 85-292,044. PUB. 4-10-2012. FILED 4-11-2011.
- 4,163,296 (*See Class 20 for this trademark*).
- 4,163,319 (*See Class 14 for this trademark*).
- 4,163,341. **ENVY NO ONE (STANDARD CHARACTER)**. INC INTERNATIONAL COMPANY, (U.S. CLS. 22 AND 39). SN 85-305,197. PUB. 4-10-2012. FILED 4-26-2011.
- 4,163,347. **BE COMFORTABLE BLONDO (STANDARD CHARACTER)**. 3074153 CANADA INC., (U.S. CLS. 22 AND 39). SN 85-305,939. PUB. 4-10-2012. FILED 4-27-2011.
- 4,163,348. **BE COMFORTABLE BLONDO AND DESIGN**. 3074153 CANADA INC., (U.S. CLS. 22 AND 39). SN 85-306,135. PUB. 4-10-2012. FILED 4-27-2011.
- 4,163,355 (*See Class 18 for this trademark*).
- 4,163,383. **KEE-TAH? (STANDARD CHARACTER)**. KEE-TAH ENTERTAINMENT, LLC LIMITED LIABILITY COMPANY, (U.S. CLS. 22 AND 39). SN 85-309,104. PUB. 4-10-2012. FILED 4-30-2011.
- 4,163,386 (*See Class 3 for this trademark*).
- 4,163,406. **CALIFORNIA DIRTY (STANDARD CHARACTER)**. SCOTT, RYAN A, (U.S. CLS. 22 AND 39). SN 85-310,948. PUB. 4-10-2012. FILED 5-3-2011.
- 4,163,418 (*See Class 9 for this trademark*).
- 4,163,423. **HAI DEN SURF (STANDARD CHARACTER)**. HAI DEN SURF, (U.S. CLS. 22 AND 39). SN 85-313,875. PUB. 4-10-2012. FILED 5-5-2011.
- 4,163,430. **MAXIME COSSOGUY DROWNING IN MY SLEEP (STANDARD CHARACTER)**. MAXIME COSSOGUY LLC, (U.S. CLS. 22 AND 39). SN 85-314,500. PUB. 4-10-2012. FILED 5-6-2011.
- 4,163,456 (*See Class 16 for this trademark*).
- 4,163,474. **ISAAC B. JEANS (STANDARD CHARACTER)**. BAROUKH, DIDIER, (U.S. CLS. 22 AND 39). SN 85-324,202. PUB. 4-10-2012. FILED 5-18-2011.
- 4,163,482. **PUREMENT CRAQUANTE (STANDARD CHARACTER)**. EVEDEN HUIT SAS, (U.S. CLS. 22 AND 39). SN 85-329,954. PUB. 4-10-2012. FILED 5-25-2011.
- 4,163,495. **NERD CODE (STANDARD CHARACTER)**. RUTHERFORD, FRED, MULTIPLE CLASS, (INT. CLS. 25 AND 45), (U.S. CLS. 22, 39, 100 AND 101). SN 85-336,028. PUB. 4-10-2012. FILED 6-2-2011.
- 4,163,520. **WE BE BUGGIN' (STANDARD CHARACTER)**. WASHINGTON, KENDALL J., (U.S. CLS. 22 AND 39). SN 85-344,600. PUB. 4-10-2012. FILED 6-13-2011.
- 4,163,536. **VIGYBU AND DESIGN**. EFFA, LOUIS, MULTIPLE CLASS, (INT. CLS. 25 AND 41), (U.S. CLS. 22, 39, 100, 101 AND 107). SN 85-348,789. PUB. 4-10-2012. FILED 6-17-2011.
- 4,163,557. **TRACY MCWILLIAMS (STANDARD CHARACTER)**. PURE POTENTIAL, LLC, (U.S. CLS. 22 AND 39). SN 85-354,586. PUB. 4-10-2012. FILED 6-23-2011.
- 4,163,604 (*See Class 18 for this trademark*).
- 4,163,630. **MOTIOND (STANDARD CHARACTER)**. FAIR HOME BUYERS, LLC, (U.S. CLS. 22 AND 39). SN 85-381,731. PUB. 4-10-2012. FILED 7-26-2011.
- 4,163,662. **MACNIFICENT (STANDARD CHARACTER)**. COURTNEY, MARTEL, (U.S. CLS. 22 AND 39). SN 85-388,881. PUB. 4-10-2012. FILED 8-3-2011.
- 4,163,687. **J JOYBOT (STYLIZED)**. JOYBOT LLC, (U.S. CLS. 22 AND 39). SN 85-397,361. PUB. 4-10-2012. FILED 8-13-2011.
- 4,163,717 (*See Class 14 for this trademark*).
- 4,163,722. **AGENTS OF A NEW DEMOCRACY AND. (STANDARD CHARACTER)**. FOITLE, CHRIS, AND MARGOL, CALE, (U.S. CLS. 22 AND 39). SN 85-411,210. PUB. 4-10-2012. FILED 8-30-2011.
- 4,163,742. **ELIMINATE AND DESIGN**. PHAM, THE, (U.S. CLS. 22 AND 39). SN 85-416,227. PUB. 4-10-2012. FILED 9-7-2011.
- 4,163,772. **POCKETS FULLA PILLZ (STANDARD CHARACTER)**

- TER**). POCKETS FULLA PILLZ, LLC, DBA POCKETS FULLA PILLZ, (U.S. CLS. 22 AND 39). SN 85-421,896. PUB. 4-10-2012. FILED 9-13-2011.
- 4,163,811 (*See Class 8 for this trademark*).
- 4,163,838. **MISCELLANEOUS DESIGN**. PHI DELTA THETA FRATERNITY, MULTIPLE CLASS, (INT. CLS. 25, 35, 36 AND 41), (U.S. CLS. 22, 39, 100, 101, 102 AND 107). SN 85-433,770. PUB. 4-10-2012. FILED 9-28-2011.
- 4,163,839. **BECOME THE GREATEST VERSION OF YOURSELF (STANDARD CHARACTER)**. PHI DELTA THETA FRATERNITY, MULTIPLE CLASS, (INT. CLS. 25, 35, 36 AND 41), (U.S. CLS. 22, 39, 100, 101, 102 AND 107). SN 85-433,775. PUB. 4-10-2012. FILED 9-28-2011.
- 4,163,845. **LA.HI (STANDARD CHARACTER)**. ROBERT GUEVARA, (U.S. CLS. 22 AND 39). SN 85-434,130. PUB. 4-10-2012. FILED 9-28-2011.
- 4,163,864. **DIANA E KELLY (STYLIZED)**. DIANA E. KELLY, INC, (U.S. CLS. 22 AND 39). SN 85-436,295. PUB. 4-10-2012. FILED S.R. 9-30-2011; AM. P.R. 1-23-2012.
- 4,163,881. **DUDALINA AND DESIGN**. DUDALINA S/A, (U.S. CLS. 22 AND 39). SN 85-438,457. PUB. 4-10-2012. FILED 10-4-2011.
- 4,163,882. **DUDALINA AND DESIGN**. DUDALINA S/A, (U.S. CLS. 22 AND 39). SN 85-438,480. PUB. 4-10-2012. FILED 10-4-2011.
- 4,163,892. **ANTONY VALLON (STYLIZED)**. HALABI, ANTONY, MULTIPLE CLASS, (INT. CLS. 25 AND 42), (U.S. CLS. 22, 39, 100 AND 101). SN 85-440,073. PUB. 4-10-2012. FILED 10-5-2011.
- 4,163,947. **ALPI COLLECTION (STANDARD CHARACTER)**. OLUKAI, INC., (U.S. CLS. 22 AND 39). SN 85-446,050. PUB. 4-10-2012. FILED 10-12-2011.
- 4,163,970. **SWETEEZ (STANDARD CHARACTER)**. COUNTS OF BARCELONA LLC, DBA SWETEEZ, (U.S. CLS. 22 AND 39). SN 85-447,973. PUB. 4-10-2012. FILED 10-14-2011.
- 4,163,980. **OTHERLIFE (STANDARD CHARACTER)**. CHRISTOPHER F. VAN MAARSEVEEN, DBA OTHERLIFE, (U.S. CLS. 22 AND 39). SN 85-448,368. PUB. 4-10-2012. FILED 10-15-2011.
- 4,164,102. **S SESSIMO (STYLIZED)**. MIN KIM, (U.S. CLS. 22 AND 39). SN 85-454,359. PUB. 4-10-2012. FILED 10-24-2011.
- 4,164,123. **PAMPLONA (STANDARD CHARACTER)**. STONE AGE EQUIPMENT, INC., (U.S. CLS. 22 AND 39). SN 85-455,061. PUB. 4-10-2012. FILED 10-25-2011.
- 4,164,126. **TALKING DONKEY EST. 2011 THE CHRISTIAN TEE SHOP AND DESIGN**. TANJO, HARYANTO, DBA TALKING DONKEY, (U.S. CLS. 22 AND 39). SN 85-455,074. PUB. 4-10-2012. FILED 10-25-2011.
- 4,164,140. **FIGHTIN UNCLE (STANDARD CHARACTER)**. FIGHTIN UNCLE LLC, (U.S. CLS. 22 AND 39). SN 85-455,347. PUB. 4-10-2012. FILED 10-25-2011.
- 4,164,141. **COOKIES BRAND AND DESIGN**. BRIAN STEVENS COLLECTION LLC, (U.S. CLS. 22 AND 39). SN 85-455,366. PUB. 4-10-2012. FILED 10-25-2011.
- 4,164,156. **BED STUY FLY (STANDARD CHARACTER)**. USENBOR, STEPHEN, (U.S. CLS. 22 AND 39). SN 85-455,725. PUB. 4-10-2012. FILED 10-25-2011.
- 4,164,166. **C CHASSÉ PERFORMANCE AND DESIGN**. ZOE MARKETING, INC., (U.S. CLS. 22 AND 39). SN 85-455,927. PUB. 4-10-2012. FILED 10-25-2011.
- 4,164,167. **C CHASSÉ AND DESIGN**. ZOE MARKETING, INC., (U.S. CLS. 22 AND 39). SN 85-455,942. PUB. 4-10-2012. FILED 10-25-2011.
- 4,164,171 (*See Class 9 for this trademark*).
- 4,164,193 (*See Class 16 for this trademark*).
- 4,164,213. **WITH & WESSEL (STANDARD CHARACTER)**. WITH & WESSEL LLC, (U.S. CLS. 22 AND 39). SN 85-457,215. PUB. 4-10-2012. FILED 10-26-2011.
- 4,164,215. **CONAMAXX (STANDARD CHARACTER)**. JUMAN INC., (U.S. CLS. 22 AND 39). SN 85-457,237. PUB. 4-10-2012. FILED 10-26-2011.
- 4,164,216. **W & W AND DESIGN**. WITH & WESSEL LLC, (U.S. CLS. 22 AND 39). SN 85-457,243. PUB. 4-10-2012. FILED 10-26-2011.
- 4,164,218. **SAXX (STANDARD CHARACTER)**. SAXX APPAREL LTD., (U.S. CLS. 22 AND 39). SN 85-457,275. PUB. 4-10-2012. FILED 10-26-2011.
- 4,164,219. **SAXX UNDERWEAR CO (STANDARD CHARACTER)**. SAXX APPAREL LTD., (U.S. CLS. 22 AND 39). SN 85-457,281. PUB. 4-10-2012. FILED 10-26-2011.
- 4,164,284. **BORGHESE (STANDARD CHARACTER)**. BORGHESE TRADEMARKS, INC., (U.S. CLS. 22 AND 39). SN 85-457,896. PUB. 4-10-2012. FILED 10-27-2011.
- 4,164,288. **FIN-ATIC AND DESIGN**. UWHARRIE APPAREL COMPANY, LLC, (U.S. CLS. 22 AND 39). SN 85-457,931. PUB. 4-10-2012. FILED 10-27-2011.
- 4,164,320. **BREATHE LATER (STANDARD CHARACTER)**. EGYED, PETER, (U.S. CLS. 22 AND 39). SN 85-458,164. PUB. 4-10-2012. FILED 10-27-2011.
- 4,164,325. **DAREZ... AND DESIGN**. DAREZ..., (U.S. CLS. 22 AND 39). SN 85-458,197. PUB. 4-10-2012. FILED 10-27-2011.
- 4,164,332. **RPD ROCK PAPER DENIM 1970 AND DESIGN**. MILLER III, DONALD CURTIS, (U.S. CLS. 22 AND 39). SN 85-458,227. PUB. 4-10-2012. FILED 10-27-2011.
- 4,164,337. **LEMON (STANDARD CHARACTER)**. ANEW LEGWEAR LLC, (U.S. CLS. 22 AND 39). SN 85-458,272. PUB. 4-10-2012. FILED 10-27-2011.
- 4,164,341 (*See Class 24 for this trademark*).
- 4,164,394. **LOVE YOU TO THE PALM AND MOON AND BACK (STANDARD CHARACTER)**. CAROLINA GIRLS PERSONALIZED, (U.S. CLS. 22 AND 39). SN 85-458,845. PUB. 4-10-2012. FILED 10-28-2011.
- 4,164,427. **(M)EAT LOCAL (STANDARD CHARACTER)**. FARMHAND FOODS, MULTIPLE CLASS, (INT. CLS. 25 AND 29), (U.S. CLS. 22, 39 AND 46). SN 85-459,214. PUB. 4-10-2012. FILED 10-28-2011.
- 4,164,437. **RHINOTUFF (STANDARD CHARACTER)**. RHINOTUFF, INC., (U.S. CLS. 22 AND 39). SN 85-459,317. PUB. 4-10-2012. FILED 10-28-2011.
- 4,164,451. **VESPERTINE (STANDARD CHARACTER)**. CANNER, SARAH, (U.S. CLS. 22 AND 39). SN 85-459,463. PUB. 4-10-2012. FILED 10-28-2011.
- 4,164,472. **FRESH IS BACK (STANDARD CHARACTER)**. BRENT, DOUG, (U.S. CLS. 22 AND 39). SN 85-459,695. PUB. 4-10-2012. FILED 10-29-2011.
- 4,164,494 (*See Class 9 for this trademark*).
- 4,164,502. **TITLE OF WORK (STANDARD CHARACTER)**. JONATHAN MEIZLER LLC, (U.S. CLS. 22 AND 39). SN 85-460,075. PUB. 4-10-2012. FILED 10-31-2011.
- 4,164,503. **PHOR PG PG GROATH AND DESIGN**. JONES JR., GREGORY BRIAN, (U.S. CLS. 22 AND 39). SN 85-460,081. PUB. 4-10-2012. FILED 10-31-2011.
- 4,164,538. **HIPSTAR KIDS AND DESIGN**. HIPSTAR LLC, (U.S. CLS. 22 AND 39). SN 85-460,557. PUB. 4-10-2012. FILED 10-31-2011.
- 4,164,547. **MOTHER DAUGHTER HEART (STANDARD CHARACTER)**. C-QUEST, INC., (U.S. CLS. 22 AND 39). SN 85-460,676. PUB. 4-10-2012. FILED 10-31-2011.
- 4,164,549. **GROOVEWEAR (STANDARD CHARACTER)**. CORBETT, ROBERT A., (U.S. CLS. 22 AND 39). SN 85-460,693. PUB. 4-10-2012. FILED 10-31-2011.
- 4,164,582. **FARIBA AND DESIGN**. FARIBA INC., (U.S. CLS. 22 AND 39). SN 85-461,262. PUB. 4-10-2012. FILED 11-1-2011.
- 4,164,585. **ELEXXI (STANDARD CHARACTER)**. PACIFIC CONTINENTAL TEXTILES, INC., (U.S. CLS. 22 AND 39). SN 85-461,304. PUB. 4-10-2012. FILED 11-1-2011.
- 4,164,603. **MISS B AND DESIGN**. BUSY BEES COLLECTION, INC., (U.S. CLS. 22 AND 39). SN 85-463,089. PUB. 4-10-2012. FILED 11-2-2011.
- 4,164,624. **STOP THE CHOP (STANDARD CHARACTER)**. CIUPO, LLC, (U.S. CLS. 22 AND 39). SN 85-466,574. PUB. 4-10-2012. FILED 11-7-2011.
- 4,164,631. **IT'S POOCH (STANDARD CHARACTER)**. JOY, KEVIN, (U.S. CLS. 22 AND 39). SN 85-467,611. PUB. 4-10-2012. FILED 11-8-2011.
- 4,164,633. **YES, I LOVE YOU. (STANDARD CHARACTER)**. GORECKI, TERESA, (U.S. CLS. 22 AND 39). SN 85-467,954. PUB. 4-10-2012. FILED 11-9-2011.
- 4,164,645. **PARAMOUNT PICTURES AND DESIGN**. PARAMOUNT PICTURES CORPORATION, (U.S. CLS. 22 AND 39). SN 85-468,927. PUB. 4-10-2012. FILED 11-9-2011.
- 4,164,676 (*See Class 24 for this trademark*).
- 4,164,683. **SON-R TECHNOLOGY AND DESIGN**. SR HOLDINGS, LLC, (U.S. CLS. 22 AND 39). SN 85-476,883. PUB. 4-10-2012. FILED 11-18-2011.
- 4,164,691. **KILLER LOOP (STANDARD CHARACTER)**. BEN-

COM SRL, (U.S. CLS. 22 AND 39). SN 85-479,295. PUB. 4-10-2012. FILED 11-22-2011.
 4,164,693 (*See Class 18 for this trademark*).
 4,164,724. **TP AND DESIGN**. NEW ERA CAP CO., INC., (U.S. CLS. 22 AND 39). SN 85-488,564. PUB. 4-10-2012. FILED 12-6-2011.
 4,164,775. **MODPOD (STANDARD CHARACTER)**. AETREX WORLDWIDE, INC., (U.S. CLS. 22 AND 39). SN 85-524,977. PUB. 4-10-2012. FILED 1-25-2012.
 4,164,780. **STAY-PUT (STANDARD CHARACTER)**. CHELSEA & SCOTT, LTD. (U.S. CLS. 22 AND 39). SN 85-976,265. PUB. 4-10-2012. FILED 5-25-2011.

CLASS 26—FANCY GOODS

4,162,764. **MODEL MODEL DREAMWEAVER (STANDARD CHARACTER)**. MODEL MODEL HAIR FASHION, INC., (U.S. CLS. 37, 39, 40, 42 AND 50). SN 77-827,888. PUB. 4-10-2012. FILED 9-16-2009.
 4,162,827 (*See Class 9 for this trademark*).
 4,162,829 (*See Class 3 for this trademark*).
 4,163,713. **FUTEX (STANDARD CHARACTER)**. CANDEN SCHULTZ, AND ROBERT SCHULTZ, MULTIPLE CLASS, (INT. CLS. 26 AND 40), (U.S. CLS. 37, 39, 40, 42, 50, 100, 103 AND 106). SN 85-408,836. PUB. 4-10-2012. FILED 8-26-2011.
 4,164,022. **MAG-IT (STANDARD CHARACTER)**. THE GLITZ COMPANY, LLC, (U.S. CLS. 37, 39, 40, 42 AND 50). SN 85-451,237. PUB. 4-10-2012. FILED 10-19-2011.
 4,164,113. **JS CHAMPION'S COLLECTION AND DESIGN**. MALLORCA MAGNETICS, INC., (U.S. CLS. 37, 39, 40, 42 AND 50). SN 85-454,639. PUB. 4-10-2012. FILED 10-24-2011.
 4,164,118. **REAL BUCKLES FOR REAL COWBOYS (STANDARD CHARACTER)**. MALLORCA MAGNETICS, INC., (U.S. CLS. 37, 39, 40, 42 AND 50). SN 85-454,739. PUB. 4-10-2012. FILED 10-24-2011.
 4,164,266 (*See Class 8 for this trademark*).
 4,164,415. **SMART TAPE (STANDARD CHARACTER)**. BRAZABRA CORPORATION, (U.S. CLS. 37, 39, 40, 42 AND 50). SN 85-459,046. PUB. 4-10-2012. FILED 10-28-2011.
 4,164,494 (*See Class 9 for this trademark*).
 4,164,651. **ROCK LEGEND COLLECTION (STANDARD CHARACTER)**. FARBBER, JASON, (U.S. CLS. 37, 39, 40, 42 AND 50). SN 85-469,856. PUB. 4-10-2012. FILED 11-10-2011.

CLASS 27—FLOOR COVERINGS

4,162,846 (*See Class 9 for this trademark*).
 4,162,891. **ERUTAN (STANDARD CHARACTER)**. BEST WOOL CARPETS BV, (U.S. CLS. 19, 20, 37, 42 AND 50). SN 79-098,359. PUB. 4-10-2012. FILED 3-18-2011.
 4,162,945 (*See Class 2 for this trademark*).
 4,162,947 (*See Class 2 for this trademark*).
 4,163,150 (*See Class 16 for this trademark*).
 4,163,302 (*See Class 9 for this trademark*).
 4,163,444 (*See Class 11 for this trademark*).

CLASS 28—TOYS AND SPORTING GOODS

4,162,696. **"THE WAKE-UP MAN" AND DESIGN**. WATTS, KENNETH E., (U.S. CLS. 22, 23, 38 AND 50). SN 76-704,706. PUB. 4-10-2012. FILED 9-21-2010.
 4,162,697. **FOOLIDENTS AND DESIGN**. WATTS, KENNETH E., (U.S. CLS. 22, 23, 38 AND 50). SN 76-704,707. PUB. 4-10-2012. FILED 9-21-2010.
 4,162,726 (*See Class 9 for this trademark*).
 4,162,735 (*See Class 9 for this trademark*).
 4,162,736 (*See Class 9 for this trademark*).
 4,162,737 (*See Class 9 for this trademark*).
 4,162,753 (*See Class 9 for this trademark*).
 4,162,768 (*See Class 25 for this trademark*).
 4,162,825 (*See Class 9 for this trademark*).

4,162,846 (*See Class 9 for this trademark*).
 4,162,876 (*See Class 12 for this trademark*).
 4,162,947 (*See Class 2 for this trademark*).
 4,162,954. **SURROUNDSAFE (STANDARD CHARACTER)**. TUBE PLASTICS LIMITED, (U.S. CLS. 22, 23, 38 AND 50). SN 79-101,211. PUB. 4-10-2012. FILED 4-13-2011.
 4,162,983 (*See Class 12 for this trademark*).
 4,163,015 (*See Class 18 for this trademark*).
 4,163,025 (*See Class 9 for this trademark*).
 4,163,035 (*See Class 9 for this trademark*).
 4,163,058 (*See Class 9 for this trademark*).
 4,163,067. **BOOMERANG (STANDARD CHARACTER)**. ALL FOR KIDZ, INC., (U.S. CLS. 22, 23, 38 AND 50). SN 85-053,647. PUB. 4-10-2012. FILED 6-3-2010.
 4,163,099. **FRANXAS (STANDARD CHARACTER)**. ANTONIO CORTES CAZARES, (U.S. CLS. 22, 23, 38 AND 50). SN 85-126,125. PUB. 4-10-2012. FILED 9-9-2010.
 4,163,163 (*See Class 16 for this trademark*).
 4,163,181. **BIGJIGS TOYS LTD AND DESIGN**. BIGJIGS TOYS LTD., (U.S. CLS. 22, 23, 38 AND 50). SN 85-219,051. PUB. 4-10-2012. FILED 1-17-2011.
 4,163,185. **MODELLO (STANDARD CHARACTER)**. PIERRE BELVEDERE GROUP INC., (U.S. CLS. 22, 23, 38 AND 50). SN 85-224,547. PUB. 4-10-2012. FILED 1-24-2011.
 4,163,292. **GET CREATIVE! (STANDARD CHARACTER)**. MANSON WESTERN CORPORATION, DBA WESTERN PSYCHOLOGICAL SERVICES, (U.S. CLS. 22, 23, 38 AND 50). SN 85-292,264. PUB. 4-10-2012. FILED 4-11-2011.
 4,163,302 (*See Class 9 for this trademark*).
 4,163,317. **HOCKEY TOWER (STANDARD CHARACTER)**. GRIT INC., (U.S. CLS. 22, 23, 38 AND 50). SN 85-299,520. PUB. 4-10-2012. FILED 4-20-2011.
 4,163,456 (*See Class 16 for this trademark*).
 4,163,514. **PHOTO FINISH RACEWAY (STANDARD CHARACTER)**. MATTEL, INC., (U.S. CLS. 22, 23, 38 AND 50). SN 85-341,426. PUB. 4-10-2012. FILED 6-8-2011.
 4,163,569. **Z ZOK SURF AND DESIGN**. YOUNG, JENNIFER B, AND GREENBAUM, ROBERT S, (U.S. CLS. 22, 23, 38 AND 50). SN 85-356,353. PUB. 4-10-2012. FILED S.R. 6-25-2011; AM. P.R. 12-23-2011.
 4,163,603 (*See Class 11 for this trademark*).
 4,163,712. **P AND DESIGN**. PEN PAL GIRLS INC., (U.S. CLS. 22, 23, 38 AND 50). SN 85-408,533. PUB. 4-10-2012. FILED 8-26-2011.
 4,163,745. **EXTREME ENGINEERING (STANDARD CHARACTER)**. THRILLWORKS, INC., MULTIPLE CLASS, (INT. CLS. 28 AND 35), (U.S. CLS. 22, 23, 38, 50, 100, 101 AND 102). SN 85-416,584. PUB. 4-10-2012. FILED 9-7-2011.
 4,163,751. **XFIXX (STANDARD CHARACTER)**. BRIDGESTONE SPORTS CO., LTD., (U.S. CLS. 22, 23, 38 AND 50). SN 85-417,561. PUB. 4-10-2012. FILED 9-8-2011.
 4,163,787. **E EXTREME ENGINEERING (STYLIZED)**. THRILLWORKS, INC., MULTIPLE CLASS, (INT. CLS. 28 AND 35), (U.S. CLS. 22, 23, 38, 50, 100, 101 AND 102). SN 85-426,182. PUB. 4-10-2012. FILED 9-19-2011.
 4,163,825 (*See Class 9 for this trademark*).
 4,163,835 (*See Class 18 for this trademark*).
 4,163,837. **BLUE DEMON JR. (STANDARD CHARACTER)**. RABADAN-URUETA, LUIS ROBERTO, (U.S. CLS. 22, 23, 38 AND 50). SN 85-433,614. PUB. 4-10-2012. FILED 9-28-2011.
 4,163,843. **DYNA KITE (STANDARD CHARACTER)**. OWENS, MARY ANN, (U.S. CLS. 22, 23, 38 AND 50). SN 85-434,034. PUB. 4-10-2012. FILED 9-28-2011.
 4,163,858. **SUNSOUT INC AND DESIGN**. SUNSOUT, INC., (U.S. CLS. 22, 23, 38 AND 50). SN 85-435,852. PUB. 4-10-2012. FILED 9-29-2011.
 4,163,875. **THE CARRY ALONG CLUB (STANDARD CHARACTER)**. FLOWERS, INC., (U.S. CLS. 22, 23, 38 AND 50). SN 85-437,978. PUB. 4-10-2012. FILED 10-3-2011.
 4,163,876. **THE CARRY ALONG CLUB AND DESIGN**. FLOWERS, INC., (U.S. CLS. 22, 23, 38 AND 50). SN 85-438,005. PUB. 4-10-2012. FILED 10-3-2011.
 4,163,927. **GROW-A-HEAD (STANDARD CHARACTER)**. SOURCING INTERNATIONAL LLC, DBA SOURCING INTERNATIONAL LLC, (U.S. CLS. 22, 23, 38 AND 50). SN 85-443,818. PUB. 4-10-2012. FILED 10-10-2011.
 4,163,956. **AUTO-ZIP (STANDARD CHARACTER)**. THRILLWORKS, INC., (U.S. CLS. 22, 23, 38 AND 50). SN 85-446,927.

- PUB. 4-10-2012. FILED 10-13-2011.
- 4,163,963. **ECOGUARD (STANDARD CHARACTER)**, PROMATS ATHLETICS, LLC, (U.S. CLS. 22, 23, 38 AND 50). SN 85-447,498. PUB. 4-10-2012. FILED 10-14-2011.
- 4,164,041. **TOWER (STANDARD CHARACTER)**, TOWER PADDLE BOARDS, INC., (U.S. CLS. 22, 23, 38 AND 50). SN 85-452,310. PUB. 4-10-2012. FILED 10-20-2011.
- 4,164,045. **MISCELLANEOUS DESIGN**, TOWER PADDLE BOARDS, INC., (U.S. CLS. 22, 23, 38 AND 50). SN 85-452,442. PUB. 4-10-2012. FILED 10-20-2011.
- 4,164,096. **WINPORT PLAYGROUNDS (STANDARD CHARACTER)**, AURORA INTERNATIONAL, LLC, (U.S. CLS. 22, 23, 38 AND 50). SN 85-454,221. PUB. 4-10-2012. FILED 10-24-2011.
- 4,164,341 (*See Class 24 for this trademark*).
- 4,164,366. **JESSE'S TOY BOX (STANDARD CHARACTER)**, JESSE'S TOY BOX, LLC, (U.S. CLS. 22, 23, 38 AND 50). SN 85-458,612. PUB. 4-10-2012. FILED 10-28-2011.
- 4,164,420. **CAMX AND DESIGN**, CAMX OUTDOORS, INC., (U.S. CLS. 22, 23, 38 AND 50). SN 85-459,108. PUB. 4-10-2012. FILED 10-28-2011.
- 4,164,550. **H&H LURE COMPANY (STANDARD CHARACTER)**, HUMPHREYS' H & H LURE COMPANY, INC, (U.S. CLS. 22, 23, 38 AND 50). SN 85-460,704. PUB. 4-10-2012. FILED 10-31-2011.
- 4,164,568. **MOUSE BALLS (STANDARD CHARACTER)**, PET-SPORT USA, INC., (U.S. CLS. 22, 23, 38 AND 50). SN 85-460,933. PUB. 4-10-2012. FILED 10-31-2011.
- 4,164,664. **ORRA (STANDARD CHARACTER)**, ABU AB, (U.S. CLS. 22, 23, 38 AND 50). SN 85-472,449. PUB. 4-10-2012. FILED 11-14-2011.
- 4,164,665. **KALEX (STANDARD CHARACTER)**, ABU AB, (U.S. CLS. 22, 23, 38 AND 50). SN 85-472,450. PUB. 4-10-2012. FILED 11-14-2011.
- 4,164,673. **AMERICAN HERO (STANDARD CHARACTER)**, KOKAI, STEPHEN J., (U.S. CLS. 22, 23, 38 AND 50). SN 85-473,896. PUB. 4-10-2012. FILED 11-16-2011.
- 4,164,693 (*See Class 18 for this trademark*).
- 4,164,710. **D AND DESIGN**, DEFENDER MOUTHGUARD LABORATORIES, LLC, MULTIPLE CLASS, (INT. CLS. 28 AND 40), (U.S. CLS. 22, 23, 38, 50, 100, 103 AND 106). SN 85-484,879. PUB. 4-10-2012. FILED 12-1-2011.
- 4,164,718. **ORTHOMOTION (STANDARD CHARACTER)**, DEFENDER MOUTHGUARD LABORATORIES, LLC, MULTIPLE CLASS, (INT. CLS. 28 AND 40), (U.S. CLS. 22, 23, 38, 50, 100, 103 AND 106). SN 85-486,266. PUB. 4-10-2012. FILED 12-2-2011.
- 4,164,771. **ZILLION (STANDARD CHARACTER)**, GLOBERIDE, INC., (U.S. CLS. 22, 23, 38 AND 50). SN 85-522,531. PUB. 4-10-2012. FILED 1-23-2012.
- 4,162,976. **TEYS AUSTRALIA AND DESIGN**, TEYS AUSTRALIA PTY LTD, (U.S. CL. 46). SN 79-102,267. PUB. 4-10-2012. FILED 7-27-2011.
- 4,163,001. **WYKE FARMS (STANDARD CHARACTER)**, WYKE FARMS LTD, (U.S. CL. 46). SN 79-103,728. PUB. 4-10-2012. FILED 9-14-2011.
- 4,163,012 (*See Class 18 for this trademark*).
- 4,163,046. **MARKET DISTRICT (STANDARD CHARACTER)**, PHOENIX INTANGIBLES HOLDING COMPANY, (U.S. CL. 46). SN 85-003,089. PUB. 4-10-2012. FILED 3-31-2010.
- 4,163,079 (*See Class 5 for this trademark*).
- 4,163,120. **LOVE YOUR INSIDES (STANDARD CHARACTER)**, YAKULT U.S.A. INC., (U.S. CL. 46). SN 85-151,001. PUB. 4-10-2012. FILED 10-12-2010.
- 4,163,141. **GO GO'S AND DESIGN**, GEORGIOS SAMIOS, DBA SAMIOS FOODS, (U.S. CL. 46). SN 85-167,164. PUB. 4-10-2012. FILED 11-2-2010.
- 4,163,144. **QUIÉRETE POR DENTRO (STANDARD CHARACTER)**, YAKULT U.S.A. INC., (U.S. CL. 46). SN 85-168,918. PUB. 4-10-2012. FILED 11-4-2010.
- 4,163,183. **BA-TAMPTE (STANDARD CHARACTER)**, BA-TAMPTE PICKLE PRODUCTS, INC., (U.S. CL. 46). SN 85-221,901. PUB. 4-10-2012. FILED 1-20-2011.
- 4,163,208. **E. WALDO WARD & SON (STANDARD CHARACTER)**, E. WALDO WARD & SON, INC., MULTIPLE CLASS, (INT. CLS. 29 AND 30), (U.S. CL. 46). SN 85-251,671. PUB. 4-10-2012. FILED 2-25-2011.
- 4,163,252 (*See Class 5 for this trademark*).
- 4,163,369. **PINKS HOT DOGS AND DESIGN**, PINK'S HOT DOGS, INC., MULTIPLE CLASS, (INT. CLS. 29 AND 43), (U.S. CLS. 46, 100 AND 101). SN 85-307,740. PUB. 4-10-2012. FILED 4-28-2011.
- 4,163,446. **BUCKLEY FARMS (STANDARD CHARACTER)**, TOPCO ASSOCIATES, LLC, (U.S. CL. 46). SN 85-318,513. PUB. 4-10-2012. FILED 5-11-2011.
- 4,163,493. **MISCELLANEOUS DESIGN**, CJ CHEILJEDANG CORPORATION, MULTIPLE CLASS, (INT. CLS. 29 AND 30), (U.S. CL. 46). SN 85-334,940. PUB. 4-10-2012. FILED 6-1-2011.
- 4,163,523. **SINCE 1929 DREYMILLER AND KRAY INC. HAMPSHIRE ILLINOIS 60140 847-683-2271 AND DESIGN**, DREYMILLER AND KRAY, INC., (U.S. CL. 46). SN 85-345,596. PUB. 4-10-2012. FILED 6-14-2011.
- 4,163,541. **GREAT DOGS (STANDARD CHARACTER)**, SF INVESTMENTS, INC., (U.S. CL. 46). SN 85-350,314. PUB. 4-10-2012. FILED 6-20-2011.
- 4,163,612. **SINCE 1985 GOLDEN TENDERS THE ORIGINAL & STILL THE BEST AND DESIGN**, GOLDEN FRANCHISING CORPORATION, AKA GOLDEN CHICK, (U.S. CL. 46). SN 85-375,361. PUB. 4-10-2012. FILED 7-19-2011.
- 4,163,620. **JERK'N PICKLE (STANDARD CHARACTER)**, JERK'NPICKLE, (U.S. CL. 46). SN 85-377,308. PUB. 4-10-2012. FILED 7-21-2011.
- 4,163,626. **MUSTERNAZE (STANDARD CHARACTER)**, SCHEXNAYDER, VILMORE J, (U.S. CL. 46). SN 85-380,189. PUB. 4-10-2012. FILED 7-25-2011.
- 4,163,763. **SEA SELECT (STANDARD CHARACTER)**, GOLDEN ISLES MARKETING ASSOCIATES, LLC, FORMERLY GOLDEN ISLES PRODUCTS GROUP, LLC, (U.S. CL. 46). SN 85-419,037. PUB. 4-10-2012. FILED 9-9-2011.
- 4,163,768. **KUSINA NI MARIA AND DESIGN**, RAMAR INTERNATIONAL CORPORATION, MULTIPLE CLASS, (INT. CLS. 29 AND 30), (U.S. CL. 46). SN 85-420,285. PUB. 4-10-2012. FILED 9-12-2011.
- 4,163,884. **TRUFFLE QUEEN (STANDARD CHARACTER)**, LA BUONA TAVOLA USA INC., MULTIPLE CLASS, (INT. CLS. 29 AND 30), (U.S. CL. 46). SN 85-438,644. PUB. 4-10-2012. FILED 10-4-2011.
- 4,163,919. **AMPHORA AND DESIGN**, AMPHORA INTERNATIONAL, INC, MULTIPLE CLASS, (INT. CLS. 29 AND 30), (U.S. CL. 46). SN 85-442,986. PUB. 4-10-2012. FILED 10-10-2011.
- 4,163,972. **MAGNA FRIES (STANDARD CHARACTER)**, QSL INTELLECTUAL PROPERTIES CORP., (U.S. CL. 46). SN 85-448,098. PUB. 4-10-2012. FILED 10-14-2011.
- 4,164,073. **RED HAT RANCH (STANDARD CHARACTER)**, FLANDERS PROVISION COMPANY, LLC, (U.S. CL. 46). SN 85-453,398. PUB. 4-10-2012. FILED 10-21-2011.

CLASS 29—MEATS AND PROCESSED FOODS

- 4,162,740. **DIVINE NATURALS (STANDARD CHARACTER)**, HAN, PAUL, (U.S. CL. 46). SN 77-548,946. PUB. 4-10-2012. FILED 8-17-2008.
- 4,162,742. **DIVINE NATURALS AND DESIGN**, HAN, PAUL, (U.S. CL. 46). SN 77-583,508. PUB. 4-10-2012. FILED 10-1-2008.
- 4,162,744. **NATRILICIOUS! (STANDARD CHARACTER)**, JSK FOODS INC., (U.S. CL. 46). SN 77-629,806. PUB. 4-10-2012. FILED 12-9-2008.
- 4,162,823. **PASTAROTTI ITALIAN PASTA & RISOTTI AND DESIGN**, ANTAAR&S S.P.A., MULTIPLE CLASS, (INT. CLS. 29 AND 30), (U.S. CL. 46). SN 79-088,452. PUB. 4-10-2012. FILED 9-15-2010.
- 4,162,829 (*See Class 3 for this trademark*).
- 4,162,886. **LOSANGE (STANDARD CHARACTER)**, PETROSIAN SA, MULTIPLE CLASS, (INT. CLS. 29, 30 AND 33), (U.S. CLS. 46, 47 AND 49). SN 79-097,776. PUB. 4-10-2012. FILED 1-26-2011.
- 4,162,936. **N 1929 NAMET DOYULMAZ LEZZET AND DESIGN**, NAMET GIDA SANAYI VE TICARET ANONIM SIRKETI, (U.S. CL. 46). SN 79-100,101. PUB. 4-10-2012. FILED 1-19-2011.
- 4,162,973 (*See Class 1 for this trademark*).

- 4,164,176. **DOUG'S NUTS (STANDARD CHARACTER)**. HAPPY NIBBLES LLC, (U.S. CL. 46). SN 85-456,052. PUB. 4-10-2012. FILED 10-25-2011.
- 4,164,427 (*See Class 25 for this trademark*).
- 4,164,566. **CRAVERY KITCHEN (STANDARD CHARACTER)**. EFP ARTISAN PRODUCTS LLC, MULTIPLE CLASS, (INT. CLS. 29 AND 30), (U.S. CL. 46). SN 85-460,892. PUB. 4-10-2012. FILED 10-31-2011.
- 4,164,606. **MISCELLANEOUS DESIGN**. SETTON INTERNATIONAL FOODS, INC., (U.S. CL. 46). SN 85-463,392. PUB. 4-10-2012. FILED 11-3-2011.
- 4,164,627. **CELIFIBR (STANDARD CHARACTER)**. SUKUL, RAJ, (U.S. CL. 46). SN 85-467,099. PUB. 4-10-2012. FILED 11-8-2011.
- 4,164,751. **YOPLAIT (STANDARD CHARACTER)**. YOPLAIT MARQUES, (U.S. CL. 46). SN 85-505,885. PUB. 4-10-2012. FILED 12-29-2011.
-
- CLASS 30—STAPLE FOODS**
- 4,162,707 (*See Class 16 for this trademark*).
- 4,162,709 (*See Class 16 for this trademark*).
- 4,162,712. **WINE SENSITIVE (STANDARD CHARACTER)**. ANJEL GUNNARSHAUG, (U.S. CL. 46). SN 76-708,738. PUB. 4-10-2012. FILED 8-15-2011.
- 4,162,741. **DR.YOUCOLLECTION (STANDARD CHARACTER)**. ORION CORPORATION, (U.S. CL. 46). SN 77-550,450. PUB. 4-10-2012. FILED 8-19-2008.
- 4,162,823 (*See Class 29 for this trademark*).
- 4,162,824. **INANIGIRI AND DESIGN**. KATO MASAYOSHI, MULTIPLE CLASS, (INT. CLS. 30 AND 35), (U.S. CLS. 46, 100, 101 AND 102). SN 79-088,756. PUB. 4-10-2012. FILED 7-22-2010.
- 4,162,826 (*See Class 5 for this trademark*).
- 4,162,829 (*See Class 3 for this trademark*).
- 4,162,886 (*See Class 29 for this trademark*).
- 4,162,971. **RICCIONEPIADINA AND DESIGN**. REJCA SRL, MULTIPLE CLASS, (INT. CLS. 30 AND 43), (U.S. CLS. 46, 100 AND 101). SN 79-102,130. PUB. 4-10-2012. FILED 6-30-2011.
- 4,162,980. **LINDT AND DESIGN**. CHOCOLADENFABRIK LINDT & SPRÜNGLI AG, (U.S. CL. 46). SN 79-102,424. PUB. 4-10-2012. FILED 8-5-2011.
- 4,162,990. **DIONE (STANDARD CHARACTER)**. AKCINE BENDROVE "KLAIPEDOS PIENAS", (U.S. CL. 46). SN 79-102,857. PUB. 4-10-2012. FILED 6-14-2011.
- 4,162,991. **DIONE PREMIUM ICECREAM ANNO 1950 AND DESIGN**. AKCINE BENDROVE "KLAIPEDOS PIENAS", (U.S. CL. 46). SN 79-102,860. PUB. 4-10-2012. FILED 6-21-2011.
- 4,162,995 (*See Class 5 for this trademark*).
- 4,163,017. **VEGAS NIGHT AND DESIGN**. MELDRUM PHILIPS AUSTRALIA PTY LTD, MULTIPLE CLASS, (INT. CLS. 30 AND 32), (U.S. CLS. 45, 46 AND 48). SN 79-104,514. PUB. 4-10-2012. FILED 9-27-2011.
- 4,163,079 (*See Class 5 for this trademark*).
- 4,163,208 (*See Class 29 for this trademark*).
- 4,163,221. **ORIGINAL RED (STANDARD CHARACTER)**. AMERICAN LICORICE CO., (U.S. CL. 46). SN 85-262,080. PUB. 4-10-2012. FILED 3-9-2011.
- 4,163,252 (*See Class 5 for this trademark*).
- 4,163,258 (*See Class 11 for this trademark*).
- 4,163,321. **GEAUX YO FROZEN YOGURT ON THE GO AND DESIGN**. GEAUX YO, LLC., (U.S. CL. 46). SN 85-300,591. PUB. 4-10-2012. FILED 4-20-2011.
- 4,163,336. **AFC FRANCHISE CORP. (STANDARD CHARACTER)**. ADVANCED FRESH CONCEPTS FRANCHISE CORPORATION, (U.S. CL. 46). SN 85-304,128. PUB. 4-10-2012. FILED 4-25-2011.
- 4,163,381. **PHIL'S RIBS #1 AND DESIGN**. PHIL'S BBQ, INC., (U.S. CL. 46). SN 85-308,903. PUB. 4-10-2012. FILED 4-29-2011.
- 4,163,393. **THE ORIGINAL INCREDIBALL (STANDARD CHARACTER)**. SWAIN CREATIONS, INC., DBA JER'S CHOCOLATES, (U.S. CL. 46). SN 85-309,773. PUB. 4-10-2012. FILED 5-2-2011.
- 4,163,394. **ORIGINAL INCREDIBAR (STANDARD CHARACTER)**. SWAIN CREATIONS, INC., DBA JER'S CHOCOLATES, (U.S. CL. 46). SN 85-309,797. PUB. 4-10-2012. FILED 5-2-2011.
- 4,163,447 (*See Class 5 for this trademark*).
- 4,163,453. **LUCKY CAKE (STANDARD CHARACTER)**. BLACK DIAMOND GAMING LLC., (U.S. CL. 46). SN 85-320,035. PUB. 4-10-2012. FILED 5-13-2011.
- 4,163,475. **DIRT ON A CAKE (STANDARD CHARACTER)**. DIRT ON A CAKE, LLC, (U.S. CL. 46). SN 85-324,333. PUB. 4-10-2012. FILED 5-18-2011.
- 4,163,477. **SO NICE YOU CAN SMELL IT! UMM, I WANT SOME NOW! (STANDARD CHARACTER)**. ECLIPSE JAMAICAN FOODS, INC., (U.S. CL. 46). SN 85-324,845. PUB. 4-10-2012. FILED 5-19-2011.
- 4,163,493 (*See Class 29 for this trademark*).
- 4,163,498. **HEALTHY LIVING MAIDA FREE AND DESIGN**. BRAR NATURAL FLOUR MILLING INC., (U.S. CL. 46). SN 85-336,797. PUB. 4-10-2012. FILED 6-2-2011.
- 4,163,535 (*See Class 5 for this trademark*).
- 4,163,543. **FROSTING ON TOP "SWEET TREATS" AND DESIGN**. TRISLER, TRISLER M., (U.S. CL. 46). SN 85-351,054. PUB. 4-10-2012. FILED 6-20-2011.
- 4,163,555. **COLBY'S KETTLE CORN (STANDARD CHARACTER)**. DIVECHA, COLBY, (U.S. CL. 46). SN 85-354,369. PUB. 4-10-2012. FILED 6-23-2011.
- 4,163,768 (*See Class 29 for this trademark*).
- 4,163,816 (*See Class 5 for this trademark*).
- 4,163,821. **PRETZEL PERFECTION AND DESIGN**. PRETZEL PERFECTION, LLC, DBA PRETZEL PERFECTION, (U.S. CL. 46). SN 85-431,417. PUB. 4-10-2012. FILED 9-25-2011.
- 4,163,884 (*See Class 29 for this trademark*).
- 4,163,903. **SANTA LUCIA ESTATE COFFEE (STANDARD CHARACTER)**. JAL COFFEE, LLC, DBA SANTA LUCIA ESTATE COFFEE, (U.S. CL. 46). SN 85-441,495. PUB. 4-10-2012. FILED 10-6-2011.
- 4,163,909. **FLOATEMS (STANDARD CHARACTER)**. PETE'S GOURMET CONFECTIONS, INC., DBA PETE'S GOURMET CONFECTIONS, (U.S. CL. 46). SN 85-441,830. PUB. 4-10-2012. FILED S.R. 10-7-2011; AM. P.R. 2-28-2012.
- 4,163,919 (*See Class 29 for this trademark*).
- 4,164,027. **MINI MURPH (STANDARD CHARACTER)**. PAPA MURPHY'S INTERNATIONAL, LLC, (U.S. CL. 46). SN 85-451,478. PUB. 4-10-2012. FILED 10-19-2011.
- 4,164,074. **TUMBLEWOOD TEAS (STANDARD CHARACTER)**. TUMBLEWOOD TEAS, LLC, (U.S. CL. 46). SN 85-453,430. PUB. 4-10-2012. FILED 10-21-2011.
- 4,164,079. **ROTAGILLA (STANDARD CHARACTER)**. MUNNINGS, MICHAEL F., (U.S. CL. 46). SN 85-453,534. PUB. 4-10-2012. FILED 10-21-2011.
- 4,164,094. **EL CEIBO (STANDARD CHARACTER)**. CENTRAL REGIONAL AGROPECUARIA INDUSTRIA DE COOPERATIVAS "EL CEIBO" LTDA., (U.S. CL. 46). SN 85-454,158. PUB. 4-10-2012. FILED 10-24-2011.
- 4,164,173. **WOMAN'S MOTHER TO BE (STANDARD CHARACTER)**. GOLDEN TEMPLE OF OREGON, LLC, (U.S. CL. 46). SN 85-456,006. PUB. 4-10-2012. FILED 10-25-2011.
- 4,164,203. **ART EATABLES (STANDARD CHARACTER)**. ART EATABLES, LLC, (U.S. CL. 46). SN 85-456,822. PUB. 4-10-2012. FILED 10-26-2011.
- 4,164,229. **CASA DEL TORO AND DESIGN**. THE H. T. HACKNEY CO., (U.S. CL. 46). SN 85-457,418. PUB. 4-10-2012. FILED 10-27-2011.
- 4,164,256. **NAIA (STANDARD CHARACTER)**. GMSX LLC, MULTIPLE CLASS, (INT. CLS. 30 AND 43), (U.S. CLS. 46, 100 AND 101). SN 85-457,713. PUB. 4-10-2012. FILED 10-27-2011.
- 4,164,282. **HONEST TO GOODNESS FLAVOR (STANDARD CHARACTER)**. GOLDING FARMS FOODS, INC., (U.S. CL. 46). SN 85-457,893. PUB. 4-10-2012. FILED 10-27-2011.
- 4,164,308. **ART EATABLES AND DESIGN**. ART EATABLES, LLC, (U.S. CL. 46). SN 85-458,035. PUB. 4-10-2012. FILED 10-27-2011.
- 4,164,378. **JETZEE (STANDARD CHARACTER)**. JET'S AMERICA, INC., (U.S. CL. 46). SN 85-458,712. PUB. 4-10-2012. FILED 10-28-2011.
- 4,164,400. **MISCELLANEOUS DESIGN**. MCKEE FOODS KINGMAN, INC., (U.S. CL. 46). SN 85-458,893. PUB. 4-10-

2012. FILED 10-28-2011.
- 4,164,402. **FALL TREE CAKES (STANDARD CHARACTER)**. MCKEE FOODS KINGMAN, INC., (U.S. CL. 46). SN 85-458,913. PUB. 4-10-2012. FILED 10-28-2011.
- 4,164,410. **KINGS' CHOICE (STYLIZED)**. CHIA KHIM LEE FOOD INDUSTRIES PTE LTD, (U.S. CL. 46). SN 85-458,995. PUB. 4-10-2012. FILED 10-28-2011.
- 4,164,423. **MARACAS ICE POPS AND DESIGN**. MARACAS LLC, (U.S. CL. 46). SN 85-459,161. PUB. 4-10-2012. FILED 10-28-2011.
- 4,164,426. **MARACAS ICE CREAM AND DESIGN**. MARACAS LLC, (U.S. CL. 46). SN 85-459,198. PUB. 4-10-2012. FILED 10-28-2011.
- 4,164,431. **MISCELLANEOUS DESIGN**. DANIELE DOMINICK, MULTIPLE CLASS, (INT. CLS. 30 AND 43), (U.S. CLS. 46, 100 AND 101). SN 85-459,248. PUB. 4-10-2012. FILED 10-28-2011.
- 4,164,459. **CRANBERRY BARN KITCHENS (STANDARD CHARACTER)**. CRANBERRY BARN KITCHENS, LLC, (U.S. CL. 46). SN 85-459,569. PUB. 4-10-2012. FILED 10-28-2011.
- 4,164,499. **PASTATO (STANDARD CHARACTER)**. RAJ SUKUL, (U.S. CL. 46). SN 85-460,006. PUB. 4-10-2012. FILED 10-31-2011.
- 4,164,566 (*See Class 29 for this trademark*).
- 4,164,607. **VERO ELOTES (STANDARD CHARACTER)**. GRUPO BIMBO, S.A. B. DE C.V., (U.S. CL. 46). SN 85-463,443. PUB. 4-10-2012. FILED 11-3-2011.
- 4,164,621. **PLEASANT POPS (STANDARD CHARACTER)**. PLEASANT POPS, LLC, (U.S. CL. 46). SN 85-466,151. PUB. 4-10-2012. FILED 11-7-2011.
- 4,164,671. **MISCELLANEOUS DESIGN**. BETHANY'S BEST, LLC, (U.S. CL. 46). SN 85-473,725. PUB. 4-10-2012. FILED 11-16-2011.
- 4,164,721. **HOOD FOUNTAIN (STANDARD CHARACTER)**. HP HOOD LLC, (U.S. CL. 46). SN 85-487,165. PUB. 4-10-2012. FILED 12-5-2011.
- 4,164,723. **SMÄHLBURGER (STANDARD CHARACTER)**. WAHLBURGERS I, LLC, (U.S. CL. 46). SN 85-488,065. PUB. 4-10-2012. FILED 12-6-2011.

CLASS 31—NATURAL AGRICULTURAL PRODUCTS

- 4,162,995 (*See Class 5 for this trademark*).
- 4,162,998 (*See Class 1 for this trademark*).
- 4,163,030. **FAIRYTALE FLOWERS AND DESIGN**. GARTNER-IET PKM A/S, MULTIPLE CLASS, (INT. CLS. 31 AND 44), (U.S. CLS. 1, 46, 100 AND 101). SN 79-105,873. PUB. 4-10-2012. FILED 1-18-2011.
- 4,163,095. **SUMMER SHOWCASE (STANDARD CHARACTER)**. LONGFIELD GARDENS LLC, (U.S. CLS. 1 AND 46). SN 85-120,857. PUB. 4-10-2012. FILED 9-1-2010.
- 4,163,101. **CUTIES (STYLIZED)**. PARAMOUNT CITRUS PACKING COMPANY LLC, AND SUN PACIFIC SHIPPERS, L.P., (U.S. CLS. 1 AND 46). SN 85-128,506. PUB. 4-10-2012. FILED 9-13-2010.
- 4,163,203. **PANDIA SEEDS (STANDARD CHARACTER)**. PANDIA SEEDS, INC., MULTIPLE CLASS, (INT. CLS. 31, 35 AND 42), (U.S. CLS. 1, 46, 100, 101 AND 102). SN 85-246,960. PUB. 4-10-2012. FILED 2-19-2011.
- 4,163,308 (*See Class 5 for this trademark*).
- 4,163,313. **MR. BONE (STANDARD CHARACTER)**. RUSH DIRECT, INC., (U.S. CLS. 1 AND 46). SN 85-298,821. PUB. 4-10-2012. FILED 4-19-2011.
- 4,163,352. **FRESHPET DOG JOY TREATS (STANDARD CHARACTER)**. PROFESSOR CONNOR'S, INC., DBA FRESHPET, (U.S. CLS. 1 AND 46). SN 85-306,337. PUB. 4-10-2012. FILED 4-27-2011.
- 4,163,353. **DOGNACTION (STANDARD CHARACTER)**. PROFESSOR CONNOR'S, INC., DBA FRESHPET, (U.S. CLS. 1 AND 46). SN 85-306,353. PUB. 4-10-2012. FILED 4-27-2011.
- 4,163,399. **WONDERLICIOUS (STANDARD CHARACTER)**. ALLYSON AMES COMPANY, INC., (U.S. CLS. 1 AND 46). SN 85-310,507. PUB. 4-10-2012. FILED 5-3-2011.
- 4,163,578. **NUTRITION THROUGH INNOVATION (STAN-**

- DARD CHARACTER)**. ZEIGLER BROS., INC., (U.S. CLS. 1 AND 46). SN 85-360,889. PUB. 4-10-2012. FILED 6-30-2011.
- 4,164,044. **SUN PATIENS AND DESIGN**. SAKATA SEED CORPORATION, (U.S. CLS. 1 AND 46). SN 85-452,436. PUB. 4-10-2012. FILED 10-20-2011.

CLASS 32—LIGHT BEVERAGES

- 4,162,787. **MINHAS CREEK (STANDARD CHARACTER)**. MOUNTAIN CREST SRL, (U.S. CLS. 45, 46 AND 48). SN 77-959,364. PUB. 4-10-2012. FILED 3-15-2010.
- 4,162,788. **MINHAS 75 (STANDARD CHARACTER)**. MOUNTAIN CREST SRL, (U.S. CLS. 45, 46 AND 48). SN 77-959,397. PUB. 4-10-2012. FILED 3-15-2010.
- 4,162,815. **LAV SVETLO PIVO 1892 LAGER BEER AND DESIGN**. "CARLSBERG SRBIJA" D.O.O., (U.S. CLS. 45, 46 AND 48). SN 79-086,199. PUB. 4-10-2012. FILED 6-29-2010.
- 4,162,816 (*See Class 5 for this trademark*).
- 4,162,829 (*See Class 3 for this trademark*).
- 4,162,839. **CANNABIA AND DESIGN**. CARMEN DUPETIT, (U.S. CLS. 45, 46 AND 48). SN 79-091,084. PUB. 4-10-2012. FILED 10-23-2010.
- 4,162,869. **OGGU (STANDARD CHARACTER)**. ORGANIC BEVERAGES GROUP B.V., (U.S. CLS. 45, 46 AND 48). SN 79-096,782. PUB. 4-10-2012. FILED 3-28-2011.
- 4,162,888. **0.0% AND DESIGN**. BAVARIA N.V., (U.S. CLS. 45, 46 AND 48). SN 79-098,025. PUB. 4-10-2012. FILED 4-18-2011.
- 4,162,949 (*See Class 5 for this trademark*).
- 4,162,968. **CHAMPION OF THE PLAYGROUND (STANDARD CHARACTER)**. ROBINSONS SOFT DRINKS LIMITED, MULTIPLE CLASS, (INT. CLS. 32 AND 41), (U.S. CLS. 45, 46, 48, 100, 101 AND 107). SN 79-101,854. PUB. 4-10-2012. FILED 5-27-2011.
- 4,162,995 (*See Class 5 for this trademark*).
- 4,163,012 (*See Class 18 for this trademark*).
- 4,163,017 (*See Class 30 for this trademark*).
- 4,163,079 (*See Class 5 for this trademark*).
- 4,163,251. **BULLY BLING (STANDARD CHARACTER)**. BULLY BLING ENERGY, LLC, (U.S. CLS. 45, 46 AND 48). SN 85-276,366. PUB. 4-10-2012. FILED 3-24-2011.
- 4,163,258 (*See Class 11 for this trademark*).
- 4,163,296 (*See Class 20 for this trademark*).
- 4,163,813. **CONTROVERSIALE (STANDARD CHARACTER)**. SHORT'S BREWING COMPANY, (U.S. CLS. 45, 46 AND 48). SN 85-429,159. PUB. 4-10-2012. FILED 9-22-2011.
- 4,163,847. **AZUL (STANDARD CHARACTER)**. MIRA INTERNATIONAL FOODS, INC., (U.S. CLS. 45, 46 AND 48). SN 85-434,455. PUB. 4-10-2012. FILED 9-28-2011.
- 4,163,945. **BIG K (STANDARD CHARACTER)**. THE KROGER CO. OF MICHIGAN, (U.S. CLS. 45, 46 AND 48). SN 85-445,990. PUB. 4-10-2012. FILED 10-12-2011.
- 4,163,974. **ALMOND SUN (STANDARD CHARACTER)**. TESTA, ROBERT, (U.S. CLS. 45, 46 AND 48). SN 85-448,104. PUB. 4-10-2012. FILED 10-14-2011.
- 4,163,983. **HEALING NONI (STANDARD CHARACTER)**. HEALING NONI CO., LLC, (U.S. CLS. 45, 46 AND 48). SN 85-448,572. PUB. 4-10-2012. FILED 10-17-2011.
- 4,164,111. **HEADLESS HORSEMAN PUMPKIN ALE (STANDARD CHARACTER)**. FOUR HORSEMEN BREWING COMPANY, INC., (U.S. CLS. 45, 46 AND 48). SN 85-454,631. PUB. 4-10-2012. FILED 10-24-2011.
- 4,164,234. **DOGFISH HEAD (STANDARD CHARACTER)**. DOGFISH HEAD MARKETING, LLC, (U.S. CLS. 45, 46 AND 48). SN 85-457,455. PUB. 4-10-2012. FILED 10-27-2011.
- 4,164,311. **MISCELLANEOUS DESIGN**. MARK ANTHONY INTERNATIONAL SRL, MULTIPLE CLASS, (INT. CLS. 32 AND 33), (U.S. CLS. 45, 46, 47, 48 AND 49). SN 85-458,063. PUB. 4-10-2012. FILED 10-27-2011.
- 4,164,334. **PARADISE IN A BOTTLE (STANDARD CHARACTER)**. SANDWICH ISLES TRADING CO., INC., (U.S. CLS. 45, 46 AND 48). SN 85-458,243. PUB. 4-10-2012. FILED 10-27-2011.
- 4,164,358. **ON THE TRACKS BREWERY AND DESIGN**. ON-THE-TRACKS BREWERY LLC, (U.S. CLS. 45, 46 AND 48). SN 85-458,473. PUB. 4-10-2012. FILED 10-27-2011.
- 4,164,518. **VERYFINE (STANDARD CHARACTER)**. VERY-

- FINE PRODUCTS, INC., (U.S. CLS. 45, 46 AND 48). SN 85-460,328. PUB. 4-10-2012. FILED 10-31-2011.
- 4,164,649. **BELMA (STANDARD CHARACTER)**. PUTER-BAUGH FARMS PARTNERSHIP, (U.S. CLS. 45, 46 AND 48). SN 85-469,440. PUB. 4-10-2012. FILED 11-10-2011.
- 4,164,650. **SPECIAL OPS I.P.A. AND DESIGN**. WARNER & WORTH, INC., DBA THE CANNON BREWPUB, (U.S. CLS. 45, 46 AND 48). SN 85-469,834. PUB. 4-10-2012. FILED 11-10-2011.
- 4,164,689. **SHALLOW GRAVE (STANDARD CHARACTER)**. HERETIC BREWING COMPANY, (U.S. CLS. 45, 46 AND 48). SN 85-478,718. PUB. 4-10-2012. FILED 11-22-2011.
- 4,164,740. **REFRESHE (STYLIZED)**. SAFEWAY INC., (U.S. CLS. 45, 46 AND 48). SN 85-497,449. PUB. 4-10-2012. FILED 12-16-2011.
- 4,164,741. **MISCELLANEOUS DESIGN**. SAFEWAY INC., (U.S. CLS. 45, 46 AND 48). SN 85-497,541. PUB. 4-10-2012. FILED 12-16-2011.
- 4,164,744. **SHINER BOCK BEER (STANDARD CHARACTER)**. SPOETZL BREWERY, INC., (U.S. CLS. 45, 46 AND 48). SN 85-501,958. PUB. 4-10-2012. FILED 12-22-2011.
- 4,164,774. **ROLLING HILLS FARM (STANDARD CHARACTER)**. HP HOOD LLC, (U.S. CLS. 45, 46 AND 48). SN 85-524,792. PUB. 4-10-2012. FILED 1-25-2012.

CLASS 33—WINES AND SPIRITS

- 4,162,801. **ARCO IRIS (STANDARD CHARACTER)**. BODEGAS FARIÑA, S.L., (U.S. CLS. 47 AND 49). SN 79-046,597. PUB. 4-10-2012. FILED 7-11-2007.
- 4,162,807. **PURE GREEN (STANDARD CHARACTER)**. RENBJER & MAGNUSSON AB, (U.S. CLS. 47 AND 49). SN 79-077,271. PUB. 4-10-2012. FILED 11-25-2009.
- 4,162,847. **A .K .3 LEGENDA ARMENI AND DESIGN**. ARARAT COGNAC FACTORY "A.K.Z." LLC, (U.S. CLS. 47 AND 49). SN 79-092,422. PUB. 4-10-2012. FILED 11-18-2010.
- 4,162,886 (*See Class 29 for this trademark*).
- 4,162,915. **MISCELLANEOUS DESIGN**. BAYADERA MANAGEMENT LIMITED, (U.S. CLS. 47 AND 49). SN 79-099,308. PUB. 4-10-2012. FILED 6-14-2011.
- 4,162,927. **THE GREAT BRITISH SPIRIT SINCE 1761 (STANDARD CHARACTER)**. QUINTESSENTIAL BRANDS S.A., (U.S. CLS. 47 AND 49). SN 79-099,568. PUB. 4-10-2012. FILED 3-25-2011.
- 4,162,982. **D DREAMER FRESH & FRUITY AND DESIGN**. GLOBAL WINE HOUSE OÚ, (U.S. CLS. 47 AND 49). SN 79-102,449. PUB. 4-10-2012. FILED 8-11-2011.
- 4,163,034. **ROMANICO (STANDARD CHARACTER)**. VIÑEDOS DE PAGANOS, S.L., (U.S. CLS. 47 AND 49). SN 79-106,210. PUB. 4-10-2012. FILED 11-10-2011.
- 4,163,155. **AMEDEE I (STANDARD CHARACTER)**. MAISON A.E. DOR, (U.S. CLS. 47 AND 49). SN 85-178,600. PUB. 4-10-2012. FILED 11-17-2010.
- 4,163,186. **MACKINLAY'S (STANDARD CHARACTER)**. WHYTE AND MACKAY LIMITED, (U.S. CLS. 47 AND 49). SN 85-224,685. PUB. 1-3-2012. FILED 1-24-2011.
- 4,163,319 (*See Class 14 for this trademark*).
- 4,163,322. **SCHMERLING'S (STANDARD CHARACTER)**. SCHMERLING AG, (U.S. CLS. 47 AND 49). SN 85-300,943. PUB. 4-10-2012. FILED 4-21-2011.
- 4,163,480. **REEL RED (STANDARD CHARACTER)**. PALM BAY INTERNATIONAL, INC., (U.S. CLS. 47 AND 49). SN 85-327,462. PUB. 4-10-2012. FILED 5-23-2011.
- 4,163,606. **ANIS LAS CADENAS DE FINISIMO PALADAR AND DESIGN**. HIJOS DE PABLO ESPARZA - BODEGAS NAVARRAS, S.A., (U.S. CLS. 47 AND 49). SN 85-374,420. PUB. 1-10-2012. FILED 7-18-2011.
- 4,163,618. **CHOCOLATE BAR 100% YUM (STANDARD CHARACTER)**. SAN ANTONIO WINERY, INC., (U.S. CLS. 47 AND 49). SN 85-377,178. PUB. 4-10-2012. FILED 7-21-2011.
- 4,163,656. **OLD KENTUCKY BARREL SELECT PRODUCT OF KENTUCKY AND DESIGN**. FRANK-LIN DISTILLERS PRODUCTS, LTD., (U.S. CLS. 47 AND 49). SN 85-387,028. PUB. 4-10-2012. FILED 8-2-2011.

- 4,163,978. **QUITA PENAS (STANDARD CHARACTER)**. RODRIGUEZ MORENO, LEONARDO, (U.S. CLS. 47 AND 49). SN 85-448,342. PUB. 4-10-2012. FILED 10-15-2011.
- 4,164,060. **GREASE MONKEY DISTILLERY (STANDARD CHARACTER)**. DISTILLED SPIRITS EPICENTER, LLC, MULTIPLE CLASS, (INT. CLS. 33 AND 42), (U.S. CLS. 47, 49, 100 AND 101). SN 85-453,035. PUB. 4-10-2012. FILED 10-21-2011.
- 4,164,177. **Y. ROUSSEAU AND DESIGN**. D'ARTAGNAN WINES CORPORATION, DBA Y ROUSSEAU WINES, (U.S. CLS. 47 AND 49). SN 85-456,146. PUB. 4-10-2012. FILED 10-25-2011.
- 4,164,187. **ODESSA AND DESIGN**. WEST SPIRIT GROUP, (U.S. CLS. 47 AND 49). SN 85-456,357. PUB. 4-10-2012. FILED 10-26-2011.
- 4,164,189. **THE CHOSEN AND DESIGN**. ELIAZ BINYAMINA (18-18) LTD., (U.S. CLS. 47 AND 49). SN 85-456,421. PUB. 4-10-2012. FILED 10-26-2011.
- 4,164,232. **DOGFISH HEAD (STANDARD CHARACTER)**. DOGFISH HEAD MARKETING, LLC, (U.S. CLS. 47 AND 49). SN 85-457,453. PUB. 4-10-2012. FILED 10-27-2011.
- 4,164,311 (*See Class 32 for this trademark*).
- 4,164,338. **OLDOS (STANDARD CHARACTER)**. EXPORTADORA DOS REALES, S. DE R.L. DE C.V., (U.S. CLS. 47 AND 49). SN 85-458,274. PUB. 4-10-2012. FILED 10-27-2011.
- 4,164,555. **RIDGE MONTE BELLO AND DESIGN**. RIDGE VINEYARDS, INC., (U.S. CLS. 47 AND 49). SN 85-460,801. PUB. 4-10-2012. FILED 10-31-2011.
- 4,164,660. **NINETEENTH VODKA (STANDARD CHARACTER)**. NINETEENTH SPIRITS, INC., (U.S. CLS. 47 AND 49). SN 85-471,670. PUB. 4-10-2012. FILED 11-14-2011.
- 4,164,677. **ANDEAN VINEYARDS (STANDARD CHARACTER)**. GRUPO PEÑAFLORES S.A., (U.S. CLS. 47 AND 49). SN 85-475,550. PUB. 4-10-2012. FILED 11-17-2011.
- 4,164,705. **YOGEV (STANDARD CHARACTER)**. ELIAZ BINYAMINA (18-18) LTD., (U.S. CLS. 47 AND 49). SN 85-483,292. PUB. 4-10-2012. FILED 11-30-2011.
- 4,164,706. **MISCELLANEOUS DESIGN**. ELIAZ BINYAMINA (18-18) LTD., (U.S. CLS. 47 AND 49). SN 85-483,298. PUB. 4-10-2012. FILED 11-30-2011.
- 4,164,713. **SABERTOOTH (STANDARD CHARACTER)**. SABERTOOTH MOTORCYCLES, LLC, (U.S. CLS. 47 AND 49). SN 85-485,435. PUB. 4-10-2012. FILED 12-1-2011.
- 4,164,714. **KAI (STANDARD CHARACTER)**. KAI VODKA LLC, (U.S. CLS. 47 AND 49). SN 85-485,450. PUB. 4-10-2012. FILED 12-1-2011.

CLASS 34—SMOKERS' ARTICLES

- 4,162,718. **LA FAMOSA NUNCIADA NORIEGA AND DESIGN**. WATSON, JOHN R SR., (U.S. CLS. 2, 8, 9 AND 17). SN 76-709,449. PUB. 4-10-2012. FILED 10-18-2011.
- 4,162,961 (*See Class 10 for this trademark*).
- 4,163,110. **VAPESAFE THE SMOKE-FREE REVOLUTION (STANDARD CHARACTER)**. LITTLE CIGARS, INC., DBA VAPESAFE, (U.S. CLS. 2, 8, 9 AND 17). SN 85-141,599. PUB. 4-10-2012. FILED 9-30-2010.
- 4,163,431. **MISCELLANEOUS DESIGN**. SWEDISH MATCH NORTH EUROPE AB, (U.S. CLS. 2, 8, 9 AND 17). SN 85-314,572. PUB. 4-10-2012. FILED 5-6-2011.
- 4,163,538. **VAPOR4LIFE (STANDARD CHARACTER)**. VAPOR 4 LIFE, INC., (U.S. CLS. 2, 8, 9 AND 17). SN 85-349,243. PUB. 11-8-2011. FILED 6-17-2011.
- 4,164,016. **VAPORBLUNT AND DESIGN**. CCW MOBIL TECHNOLOGIES INC., (U.S. CLS. 2, 8, 9 AND 17). SN 85-450,799. PUB. 4-10-2012. FILED 10-19-2011.
- 4,164,049. **ROSALONES (STANDARD CHARACTER)**. JOYA DE NICARAGUA, (U.S. CLS. 2, 8, 9 AND 17). SN 85-452,578. PUB. 4-10-2012. FILED 10-20-2011.
- 4,164,119. **NEW YORK NATURALS (STANDARD CHARACTER)**. ONQ WORLDWIDE, INC., (U.S. CLS. 2, 8, 9 AND 17). SN 85-454,750. PUB. 4-10-2012. FILED 10-24-2011.
- 4,164,377. **RAVE (STANDARD CHARACTER)**. LIGNUM-2, INC., (U.S. CLS. 2, 8, 9 AND 17). SN 85-458,695. PUB. 4-10-2012. FILED 10-28-2011.
- 4,164,619. **CIRRUS (STANDARD CHARACTER)**. LEAD BY

SALES, (U.S. CLS. 2, 8, 9 AND 17). SN 85-465,879. PUB. 4-10-2012. FILED 11-7-2011.

SERVICE MARKS

CLASS 35—ADVERTISING AND BUSINESS

- 4,162,695. **DENSO WAVE (STANDARD CHARACTER)**. DENSO CORPORATION, MULTIPLE CLASS, (INT. CLS. 35, 37 AND 42), (U.S. CLS. 100, 101, 102, 103 AND 106). SN 76-699,575. PUB. 4-10-2012. FILED 9-23-2009.
- 4,162,702. **R AND DESIGN**. SOLOMON FRIEDMAN ADVERTISING LIMITED LIABILITY COMPANY, (U.S. CLS. 100, 101 AND 102). SN 76-707,355. PUB. 4-10-2012. FILED 4-22-2011.
- 4,162,703. **R REAL INTEGRATED (STYLIZED)**. SOLOMON FRIEDMAN ADVERTISING LIMITED LIABILITY COMPANY, (U.S. CLS. 100, 101 AND 102). SN 76-707,356. PUB. 4-10-2012. FILED 4-22-2011.
- 4,162,704. **REAL INTEGRATED (STANDARD CHARACTER)**. SOLOMON FRIEDMAN ADVERTISING LIMITED LIABILITY COMPANY, (U.S. CLS. 100, 101 AND 102). SN 76-707,357. PUB. 4-10-2012. FILED 4-22-2011.
- 4,162,705. **MAXIMIZING DOMAIN VALUE (STANDARD CHARACTER)**. MARCHESI, MICHAEL A., (U.S. CLS. 100, 101 AND 102). SN 76-707,505. PUB. 4-10-2012. FILED 5-4-2011.
- 4,162,722 (*See Class 16 for this trademark*).
- 4,162,726 (*See Class 9 for this trademark*).
- 4,162,733. **USS AND DESIGN**. UNITED SHIPPING SOLUTIONS, (U.S. CLS. 100, 101 AND 102). SN 77-406,740. PUB. 7-22-2008. FILED 2-26-2008.
- 4,162,734. **FOOTED PLANET (STANDARD CHARACTER)**. CLOTHING GATEWAY CORPORATION, (U.S. CLS. 100, 101 AND 102). SN 77-452,443. PUB. 4-10-2012. FILED 4-18-2008.
- 4,162,735 (*See Class 9 for this trademark*).
- 4,162,736 (*See Class 9 for this trademark*).
- 4,162,737 (*See Class 9 for this trademark*).
- 4,162,745. **WHATWOMENNEED (STANDARD CHARACTER)**. FLEMING, NICHOLAS JOHN, AKA NICK FLEMING, MULTIPLE CLASS, (INT. CLS. 35, 38 AND 41), (U.S. CLS. 100, 101, 102, 104 AND 107). SN 77-655,068. PUB. 4-10-2012. FILED S.R. 1-23-2009; AM. P.R. 8-18-2010.
- 4,162,752. **EMERSON CLIMATE TECHNOLOGIES AUTHORIZED FULL-LINE WHOLESALE AND DESIGN**. EMERSON ELECTRIC CO., (U.S. CLS. 100, 101 AND 102). SN 77-742,921. PUB. 4-10-2012. FILED 5-22-2009.
- 4,162,753 (*See Class 9 for this trademark*).
- 4,162,761 (*See Class 7 for this trademark*).
- 4,162,762 (*See Class 7 for this trademark*).
- 4,162,766 (*See Class 9 for this trademark*).
- 4,162,775 (*See Class 16 for this trademark*).
- 4,162,785 (*See Class 9 for this trademark*).
- 4,162,791. **INSTANT REWARDS (STANDARD CHARACTER)**. BIG Y FOODS, INC., (U.S. CLS. 100, 101 AND 102). SN 77-969,444. PUB. 4-10-2012. FILED 3-26-2010.
- 4,162,797. **TERRA TOYS (STANDARD CHARACTER)**. EDWARDS, CHARLES, AND ALLSUP, ROMALDA, (U.S. CLS. 100, 101 AND 102). SN 78-881,271. PUB. 4-10-2012. FILED 5-11-2006.
- 4,162,799 (*See Class 9 for this trademark*).
- 4,162,806 (*See Class 9 for this trademark*).
- 4,162,809. **MEDIATRIUM (STANDARD CHARACTER)**. MEDIATRIUM, MULTIPLE CLASS, (INT. CLS. 35, 38 AND 41), (U.S. CLS. 100, 101, 102, 104 AND 107). SN 79-081,332. PUB. 4-10-2012. FILED 2-17-2010.
- 4,162,810. **PLAVID (STANDARD CHARACTER)**. MOSAI-COON S.P.A., MULTIPLE CLASS, (INT. CLS. 35, 38, 41 AND 42), (U.S. CLS. 100, 101, 102, 104 AND 107). SN 79-082,485. PUB. 4-10-2012. FILED 2-23-2010.
- 4,162,812 (*See Class 6 for this trademark*).
- 4,162,824 (*See Class 30 for this trademark*).
- 4,162,827 (*See Class 9 for this trademark*).
- 4,162,828. **SIGNING POWER (STYLIZED)**. SIGNOM OY, MULTIPLE CLASS, (INT. CLS. 35, 42 AND 45), (U.S. CLS. 100, 101 AND 102). SN 79-089,268. PUB. 4-10-2012. FILED 10-8-2010.
- 4,162,829 (*See Class 3 for this trademark*).
- 4,162,830 (*See Class 9 for this trademark*).
- 4,162,842. **DCA (STYLIZED)**. DCA DESIGN INTERNATIONAL LTD, MULTIPLE CLASS, (INT. CLS. 35 AND 42), (U.S. CLS. 100, 101 AND 102). SN 79-091,708. PUB. 4-10-2012. FILED 8-4-2010.
- 4,162,844 (*See Class 9 for this trademark*).
- 4,162,845 (*See Class 9 for this trademark*).
- 4,162,846 (*See Class 9 for this trademark*).
- 4,162,850 (*See Class 14 for this trademark*).
- 4,162,870. **ACABIZ AND DESIGN**. ACABIZ S.R.L., MULTIPLE CLASS, (INT. CLS. 35 AND 42), (U.S. CLS. 100, 101 AND 102). SN 79-096,786. PUB. 4-10-2012. FILED 4-12-2011.
- 4,162,871 (*See Class 9 for this trademark*).
- 4,162,881. **J. SAFRA (STANDARD CHARACTER)**. J. SAFRA IP HOLDING CO., SOCIÉTÉ DE DROIT LUXEMBOURGEOIS, (U.S. CLS. 100, 101 AND 102). SN 79-097,532. PUB. 4-10-2012. FILED 5-5-2011.
- 4,162,885 (*See Class 9 for this trademark*).
- 4,162,906. **TRADITION IN MOTION (STYLIZED)**. TABIO CORPORATION, (U.S. CLS. 100, 101 AND 102). SN 79-099,051. PUB. 4-10-2012. FILED 5-11-2011.
- 4,162,910 (*See Class 14 for this trademark*).
- 4,162,931 (*See Class 18 for this trademark*).
- 4,162,935 (*See Class 9 for this trademark*).
- 4,162,941. **CLINTEC (STANDARD CHARACTER)**. CLINTEC INTERNATIONAL LIMITED, MULTIPLE CLASS, (INT. CLS. 35, 41, 42 AND 45), (U.S. CLS. 100, 101, 102 AND 107). SN 79-100,249. PUB. 4-10-2012. FILED 3-8-2011.
- 4,162,946 (*See Class 9 for this trademark*).
- 4,162,947 (*See Class 2 for this trademark*).
- 4,162,958 (*See Class 20 for this trademark*).
- 4,162,979 (*See Class 16 for this trademark*).
- 4,162,987 (*See Class 6 for this trademark*).
- 4,162,995 (*See Class 5 for this trademark*).
- 4,162,996 (*See Class 8 for this trademark*).
- 4,162,999 (*See Class 9 for this trademark*).
- 4,163,004 (*See Class 9 for this trademark*).
- 4,163,007 (*See Class 9 for this trademark*).
- 4,163,022 (*See Class 25 for this trademark*).
- 4,163,029 (*See Class 4 for this trademark*).
- 4,163,042. **MEINTO (STANDARD CHARACTER)**. MIINTO APS, MULTIPLE CLASS, (INT. CLS. 35 AND 45), (U.S. CLS. 100, 101 AND 102). SN 79-107,296. PUB. 4-10-2012. FILED 9-12-2011.
- 4,163,048. **PROFESSIONAL GOLFERS' ASSOCIATION OF AMERICA PGA 1916 PGA VILLAGE VERANO AND DESIGN**. PROFESSIONAL GOLFERS' ASSOCIATION OF AMERICA, THE, (U.S. CLS. 100, 101 AND 102). SN 85-004,219. PUB. 9-20-2011. FILED 4-1-2010.
- 4,163,053 (*See Class 9 for this trademark*).
- 4,163,059 (*See Class 9 for this trademark*).
- 4,163,063. **TRANSCONTINENTAL AND DESIGN**. TRANSCONTINENTAL INC., (U.S. CLS. 100, 101 AND 102). SN 85-040,272. PUB. 4-10-2012. FILED 5-17-2010.
- 4,163,066. **TAYLOR SEARCH PARTNERS (STANDARD CHARACTER)**. TAYLOR SEARCH PARTNERS, LLC, (U.S. CLS. 100, 101 AND 102). SN 85-045,330. PUB. 4-10-2012. FILED 5-21-2010.
- 4,163,078. **GET MOUNTED WWW.PRORODEOHORSES.COM AND DESIGN**. PRORODEOHORSES.COM, (U.S. CLS. 100, 101 AND 102). SN 85-103,525. PUB. 4-10-2012. FILED 8-9-2010.
- 4,163,094. **A SHOP IN MINUTES, A BUSINESS FOR LIFE (STANDARD CHARACTER)**. SHOPIFY INC., MULTIPLE CLASS, (INT. CLS. 35 AND 42), (U.S. CLS. 100, 101 AND 102). SN 85-120,777. PUB. 4-10-2012. FILED 9-1-2010.
- 4,163,111. **BIG TIME AUDIO INC. (STANDARD CHARACTER)**. FEHRMAN, KATHRYN, (U.S. CLS. 100, 101 AND 102). SN 85-142,732. PUB. 4-10-2012. FILED 10-1-2010.
- 4,163,125. **BELLA (STANDARD CHARACTER)**. COLOR IMAGE APPAREL, INC., (U.S. CLS. 100, 101 AND 102). SN 85-156,401. PUB. 4-10-2012. FILED 10-19-2010.
- 4,163,127. **PUTMEBACKTOGETHER (STANDARD CHARAC-**

- TER**. NURSETOGETHER LLC, MULTIPLE CLASS, (INT. CLS. 35 AND 44), (U.S. CLS. 100, 101 AND 102). SN 85-158,279. PUB. 4-10-2012. FILED 10-21-2010.
- 4,163,131 (*See Class 9 for this trademark*).
- 4,163,133. **NEW YORK BATTERY AND ENERGY STORAGE TECHNOLOGY CONSORTIUM NY BES + AND DESIGN**. NEW YORK BATTERY AND ENERGY STORAGE TECHNOLOGY CONSORTIUM, INC., MULTIPLE CLASS, (INT. CLS. 35, 41 AND 42), (U.S. CLS. 100, 101, 102 AND 107). SN 85-162,113. PUB. 4-10-2012. FILED 10-27-2010.
- 4,163,134 (*See Class 9 for this trademark*).
- 4,163,148. **REDEFINWELLNESS (STANDARD CHARACTER)**. ARC TECHNOLOGIES, LLC, MULTIPLE CLASS, (INT. CLS. 35, 36, 41, 44 AND 45), (U.S. CLS. 100, 101, 102 AND 107). SN 85-171,172. PUB. 4-10-2012. FILED 11-8-2010.
- 4,163,159. **NEXT GENERATION OF TOUGH TOOLS (STANDARD CHARACTER)**. LF, LLC, (U.S. CLS. 100, 101 AND 102). SN 85-186,447. PUB. 4-10-2012. FILED 11-29-2010.
- 4,163,160. **CHANGO (STANDARD CHARACTER)**. CHANGO INC., (U.S. CLS. 100, 101 AND 102). SN 85-188,244. PUB. 4-10-2012. FILED 12-1-2010.
- 4,163,166. **FPDUGAN (STYLIZED)**. FPDUGAN, LLC, (U.S. CLS. 100, 101 AND 102). SN 85-200,187. PUB. 4-10-2012. FILED 12-17-2010.
- 4,163,176 (*See Class 9 for this trademark*).
- 4,163,187. **FOX MOTORS (STANDARD CHARACTER)**. FMG HOLDINGS, LLC, MULTIPLE CLASS, (INT. CLS. 35 AND 37), (U.S. CLS. 100, 101, 102, 103 AND 106). SN 85-225,107. PUB. 4-10-2012. FILED 1-25-2011.
- 4,163,191. **AWARENESS IN A BOX (STANDARD CHARACTER)**. MICHAEL SIEGEL, MULTIPLE CLASS, (INT. CLS. 35 AND 41), (U.S. CLS. 100, 101, 102 AND 107). SN 85-228,596. PUB. 4-10-2012. FILED 1-28-2011.
- 4,163,194. **ORCID (STANDARD CHARACTER)**. ORCID, INC., MULTIPLE CLASS, (INT. CLS. 35 AND 42), (U.S. CLS. 100, 101 AND 102). SN 85-235,555. PUB. 4-10-2012. FILED 2-7-2011.
- 4,163,195. **DASH (STANDARD CHARACTER)**. MEDIA DESIGN GROUP, LLC, (U.S. CLS. 100, 101 AND 102). SN 85-235,627. PUB. 4-10-2012. FILED 2-7-2011.
- 4,163,199. **MIKO GROUP, INC. AND DESIGN**. MIKO GROUP, INC., (U.S. CLS. 100, 101 AND 102). SN 85-242,326. PUB. 4-10-2012. FILED 2-15-2011.
- 4,163,203 (*See Class 31 for this trademark*).
- 4,163,205 (*See Class 9 for this trademark*).
- 4,163,206 (*See Class 9 for this trademark*).
- 4,163,207 (*See Class 9 for this trademark*).
- 4,163,212. **CONNECTING THE FRONT LINE TO THE BOTTOM LINE (STANDARD CHARACTER)**. RLG INTERNATIONAL, INC., (U.S. CLS. 100, 101 AND 102). SN 85-256,658. PUB. 4-10-2012. FILED 3-3-2011.
- 4,163,213. **TMP (STANDARD CHARACTER)**. RLG INTERNATIONAL, INC., (U.S. CLS. 100, 101 AND 102). SN 85-256,807. PUB. 4-10-2012. FILED 3-3-2011.
- 4,163,222. **CHILD S.H.A.R.E SUPPORT . HOPE . ADVOCACY . RESOURCES . ENCOURAGEMENT (STANDARD CHARACTER)**. CHILD S.H.A.R.E. PROGRAM, INC., MULTIPLE CLASS, (INT. CLS. 35 AND 41), (U.S. CLS. 100, 101, 102 AND 107). SN 85-262,543. PUB. 4-10-2012. FILED 3-9-2011.
- 4,163,237. **AMO ASSET MANAGEMENT OUTSOURCING, INC. (STYLIZED)**. ASSET MANAGEMENT OUTSOURCING, INC., MULTIPLE CLASS, (INT. CLS. 35 AND 36), (U.S. CLS. 100, 101 AND 102). SN 85-270,782. PUB. 4-10-2012. FILED 3-18-2011.
- 4,163,243 (*See Class 20 for this trademark*).
- 4,163,246. **7TH PLAYER AWARD (STANDARD CHARACTER)**. NEW ENGLAND SPORTS NETWORK, LP, MULTIPLE CLASS, (INT. CLS. 35 AND 41), (U.S. CLS. 100, 101, 102 AND 107). SN 85-273,475. PUB. 4-10-2012. FILED 3-22-2011.
- 4,163,255. **GAMERTELL (STANDARD CHARACTER)**. GADGETELL, LLC, MULTIPLE CLASS, (INT. CLS. 35, 41 AND 42), (U.S. CLS. 100, 101, 102 AND 107). SN 85-278,945. PUB. 4-10-2012. FILED 3-28-2011.
- 4,163,275. **CHOICES YOGURT BAR (STANDARD CHARACTER)**. COHEN, STACY J., (U.S. CLS. 100, 101 AND 102). SN 85-288,831. PUB. 4-10-2012. FILED 4-7-2011.
- 4,163,279. **JET AVIATION AND DESIGN**. JET AVIATION INTERNATIONAL, INC., MULTIPLE CLASS, (INT. CLS. 35, 36, 37, 39 AND 42), (U.S. CLS. 100, 101, 102, 103, 105 AND 106). SN 85-289,659. PUB. 4-10-2012. FILED 4-7-2011.
- 4,163,280. **MISCELLANEOUS DESIGN**. JET AVIATION INTERNATIONAL, INC., MULTIPLE CLASS, (INT. CLS. 35, 36, 37, 39 AND 42), (U.S. CLS. 100, 101, 102, 103, 105 AND 106). SN 85-289,664. PUB. 4-10-2012. FILED 4-7-2011.
- 4,163,293. **KKP BUSINESS SOLUTIONS AND DESIGN**. I.C.E.D. MANAGEMENT, INC., (U.S. CLS. 100, 101 AND 102). SN 85-292,958. PUB. 4-10-2012. FILED 4-12-2011.
- 4,163,295. **ADVANCED WARNING AND CONTAINMENT (STANDARD CHARACTER)**. INVENTIV MEDICAL MANAGEMENT LLC, (U.S. CLS. 100, 101 AND 102). SN 85-294,194. PUB. 4-10-2012. FILED 4-13-2011.
- 4,163,300. **THE INITIAL BABY.COM AND DESIGN**. THE INITIAL BABY, LLC, (U.S. CLS. 100, 101 AND 102). SN 85-295,015. PUB. 4-10-2012. FILED 4-14-2011.
- 4,163,304. **BLUESHIFT RESEARCH (STANDARD CHARACTER)**. BLUESHIFT RESEARCH LLC, (U.S. CLS. 100, 101 AND 102). SN 85-295,508. PUB. 4-10-2012. FILED 4-14-2011.
- 4,163,318. **MY AREAS BEST .COM (STANDARD CHARACTER)**. FESSLER, MARTIN, (U.S. CLS. 100, 101 AND 102). SN 85-299,992. PUB. 4-10-2012. FILED 4-20-2011.
- 4,163,320. **WHO'S IN YOUR CIRCLE? (STANDARD CHARACTER)**. 360 PUBLIC RELATIONS LLC, MULTIPLE CLASS, (INT. CLS. 35 AND 45), (U.S. CLS. 100, 101 AND 102). SN 85-300,254. PUB. 4-10-2012. FILED 4-20-2011.
- 4,163,323. **KINGPIN TATTOO SUPPLY AND DESIGN**. KINGPIN TATTOO SUPPLY, INC., FORMERLY KINGPIN BRAND TATTOO NEEDLES, INC., (U.S. CLS. 100, 101 AND 102). SN 85-301,232. PUB. 4-10-2012. FILED 4-21-2011.
- 4,163,325. **MANAGERENTHOUSES.COM AND DESIGN**. MANAGERENTHOUSES.COM, INC., MULTIPLE CLASS, (INT. CLS. 35 AND 36), (U.S. CLS. 100, 101 AND 102). SN 85-302,872. PUB. 4-10-2012. FILED 4-23-2011.
- 4,163,329. **CURBSIDE (STANDARD CHARACTER)**. CURBSIDE HOSPITALITY, INC., MULTIPLE CLASS, (INT. CLS. 35, 39 AND 45), (U.S. CLS. 100, 101, 102 AND 105). SN 85-303,302. PUB. 4-10-2012. FILED 4-25-2011.
- 4,163,330. **CURBSIDE HOSPITALITY AND DESIGN**. CURBSIDE HOSPITALITY, INC., MULTIPLE CLASS, (INT. CLS. 35, 39 AND 45), (U.S. CLS. 100, 101, 102 AND 105). SN 85-303,306. PUB. 4-10-2012. FILED 4-25-2011.
- 4,163,331. **CURBSIDE HOSPITALITY (STANDARD CHARACTER)**. CURBSIDE HOSPITALITY, INC., MULTIPLE CLASS, (INT. CLS. 35, 39 AND 45), (U.S. CLS. 100, 101, 102 AND 105). SN 85-303,308. PUB. 4-10-2012. FILED 4-25-2011.
- 4,163,337. **COASTAL LUXURY MANAGEMENT (STANDARD CHARACTER)**. COASTAL LUXURY MANAGEMENT, LLC, MULTIPLE CLASS, (INT. CLS. 35 AND 41), (U.S. CLS. 100, 101, 102 AND 107). SN 85-304,244. PUB. 4-10-2012. FILED 4-25-2011.
- 4,163,342. **THE UNFINISHED MISSION (STANDARD CHARACTER)**. UNFINISHED MISSION, LLC, THE, (U.S. CLS. 100, 101 AND 102). SN 85-305,200. PUB. 4-10-2012. FILED 4-26-2011.
- 4,163,343. **KIDS STORE AND DESIGN**. MONTGOMERY WARD, INC., (U.S. CLS. 100, 101 AND 102). SN 85-305,270. PUB. 4-10-2012. FILED 4-26-2011.
- 4,163,363. **TAX TERMINAL (STANDARD CHARACTER)**. RAPIDOTAX FINANCIAL CENTER, MULTIPLE CLASS, (INT. CLS. 35 AND 36), (U.S. CLS. 100, 101 AND 102). SN 85-307,259. PUB. 4-10-2012. FILED 4-28-2011.
- 4,163,364 (*See Class 16 for this trademark*).
- 4,163,372. **SAFE HOMES SAFE PARTIES (STANDARD CHARACTER)**. INFORMED FAMILIES, (U.S. CLS. 100, 101 AND 102). SN 85-307,954. PUB. 4-10-2012. FILED 4-29-2011.
- 4,163,373. **2ND ACT LOCAL MARKETING (STANDARD CHARACTER)**. STEWART, GREGORY, (U.S. CLS. 100, 101 AND 102). SN 85-307,964. PUB. 4-10-2012. FILED 4-29-2011.
- 4,163,378. **JOHNSON LAMBERT & CO. (STANDARD CHARACTER)**. JOHNSON LAMBERT & CO. LLP, MULTIPLE CLASS, (INT. CLS. 35 AND 41), (U.S. CLS. 100, 101, 102 AND 107). SN 85-308,473. PUB. 4-10-2012. FILED 4-29-2011.
- 4,163,379. **J L AND DESIGN**. JOHNSON LAMBERT & CO. LLP, MULTIPLE CLASS, (INT. CLS. 35 AND 41), (U.S. CLS. 100, 101, 102 AND 107). SN 85-308,519. PUB. 4-10-2012. FILED 4-29-2011.

- 4,163,387. **RENEW ADVANTAGE AND DESIGN**. RENEW ADVANTAGE LLC, MULTIPLE CLASS, (INT. CLS. 35 AND 44), (U.S. CLS. 100, 101 AND 102). SN 85-309,425. PUB. 4-10-2012. FILED 5-2-2011.
- 4,163,388. **RENEW ADVANTAGE (STANDARD CHARACTER)**. RENEW ADVANTAGE LLC, MULTIPLE CLASS, (INT. CLS. 35 AND 44), (U.S. CLS. 100, 101 AND 102). SN 85-309,426. PUB. 4-10-2012. FILED 5-2-2011.
- 4,163,410. **KBR (STANDARD CHARACTER)**. KELLOGG BROWN & ROOT LLC, MULTIPLE CLASS, (INT. CLS. 35, 36, 37, 40 AND 42), (U.S. CLS. 100, 101, 102, 103 AND 106). SN 85-311,297. PUB. 4-10-2012. FILED 5-3-2011.
- 4,163,414. **CIGDM (STANDARD CHARACTER)**. LACKEY, RON J., (U.S. CLS. 100, 101 AND 102). SN 85-312,412. PUB. 4-10-2012. FILED 5-4-2011.
- 4,163,415. **SWEET PICKLES (STANDARD CHARACTER)**. HORN, SUSAN, (U.S. CLS. 100, 101 AND 102). SN 85-312,557. PUB. 4-10-2012. FILED 5-4-2011.
- 4,163,425. **LEVRIDGE (STANDARD CHARACTER)**. LEVRIDGE RESOURCES, LLC, (U.S. CLS. 100, 101 AND 102). SN 85-314,007. PUB. 4-10-2012. FILED 5-6-2011.
- 4,163,426. **ONE HUNDRED SKIES (STANDARD CHARACTER)**. ONE HUNDRED SKIES LLC, MULTIPLE CLASS, (INT. CLS. 35 AND 41), (U.S. CLS. 100, 101, 102 AND 107). SN 85-314,233. PUB. 4-10-2012. FILED 5-6-2011.
- 4,163,438. **GIVE IT TO THE MANAGER (STANDARD CHARACTER)**. STORAGE PROPERTY PROTECTION LLC, (U.S. CLS. 100, 101 AND 102). SN 85-315,822. PUB. 4-10-2012. FILED 5-9-2011.
- 4,163,442. **MOSAIC MANAGED MARKETS (STANDARD CHARACTER)**. DRAFTFCB, INC., (U.S. CLS. 100, 101 AND 102). SN 85-317,732. PUB. 4-10-2012. FILED 5-11-2011.
- 4,163,443. **9 CLOUDS AND DESIGN**. 9 CLOUDS, INC., MULTIPLE CLASS, (INT. CLS. 35 AND 41), (U.S. CLS. 100, 101, 102 AND 107). SN 85-317,850. PUB. 4-10-2012. FILED 5-11-2011.
- 4,163,444 (*See Class 11 for this trademark*).
- 4,163,455. **CLUB 19 AND DESIGN**. PAR EMPRIZES, INC, DBA CLUB 19 GOLF & TRAVEL CLUB, (U.S. CLS. 100, 101 AND 102). SN 85-320,713. PUB. 4-10-2012. FILED 5-13-2011.
- 4,163,458. **CUP TO CUP RECYCLED AND DESIGN**. INTERNATIONAL PAPER COMPANY, (U.S. CLS. 100, 101 AND 102). SN 85-321,743. PUB. 4-10-2012. FILED 5-16-2011.
- 4,163,468. **BEST FLEETS TO DRIVE FOR (STANDARD CHARACTER)**. CRANIAL EXPANSION LEARNING SOLUTIONS INC., MULTIPLE CLASS, (INT. CLS. 35 AND 41), (U.S. CLS. 100, 101, 102 AND 107). SN 85-323,534. PUB. 4-10-2012. FILED 5-18-2011.
- 4,163,469. **BEST FLEETS TO DRIVE FOR AND DESIGN**. CRANIAL EXPANSION LEARNING SOLUTIONS INC., MULTIPLE CLASS, (INT. CLS. 35 AND 41), (U.S. CLS. 100, 101, 102 AND 107). SN 85-323,545. PUB. 4-10-2012. FILED 5-18-2011.
- 4,163,473. **INNOVATION CABINETRY AND DESIGN**. H.F.Z. CORPORATION, (U.S. CLS. 100, 101 AND 102). SN 85-324,058. PUB. 4-10-2012. FILED 5-18-2011.
- 4,163,476. **POWERSTANCE (STANDARD CHARACTER)**. POWERGROUP INTERNATIONAL, LLC, (U.S. CLS. 100, 101 AND 102). SN 85-324,441. PUB. 4-10-2012. FILED 5-18-2011.
- 4,163,486. **TRISTAR PAYMENTS (STANDARD CHARACTER)**. SIMON, DAVID, MULTIPLE CLASS, (INT. CLS. 35 AND 36), (U.S. CLS. 100, 101 AND 102). SN 85-331,158. PUB. 4-10-2012. FILED 5-26-2011.
- 4,163,496. **VACATION BLVD (STANDARD CHARACTER)**. VACATION BLVD, LLC, MULTIPLE CLASS, (INT. CLS. 35 AND 41), (U.S. CLS. 100, 101, 102 AND 107). SN 85-336,722. PUB. 4-10-2012. FILED 6-2-2011.
- 4,163,503. **UB AND DESIGN**. URBANBOUND, LLC, (U.S. CLS. 100, 101 AND 102). SN 85-338,444. PUB. 4-10-2012. FILED 6-6-2011.
- 4,163,504. **UB URBANBOUND AND DESIGN**. URBANBOUND, LLC, (U.S. CLS. 100, 101 AND 102). SN 85-338,451. PUB. 4-10-2012. FILED 6-6-2011.
- 4,163,506. **LUX : PREMIER (STANDARD CHARACTER)**. LUX PREMIER - LUX PUBLICATIONS, LLC, (U.S. CLS. 100, 101 AND 102). SN 85-338,588. PUB. 4-10-2012. FILED 6-6-2011.
- 4,163,511. **S BOBSYOURUNCLE. (STYLIZED)**. BOB'S YOUR UNCLE, INC., (U.S. CLS. 100, 101 AND 102). SN 85-340,686. PUB. 4-10-2012. FILED 6-8-2011.
- 4,163,516. **CKLASS (STANDARD CHARACTER)**. MUÑOZ WATANABE, ENRIQUE GUILLERMO, (U.S. CLS. 100, 101 AND 102). SN 85-343,817. PUB. 4-10-2012. FILED 6-10-2011.
- 4,163,518. **MY LITTLE UNIVERSE (STANDARD CHARACTER)**. MY LITTLE UNIVERSE LTD, (U.S. CLS. 100, 101 AND 102). SN 85-343,878. PUB. 4-10-2012. FILED 6-11-2011.
- 4,163,521. **YOUR BUSINESS, YOUR LIFE (STANDARD CHARACTER)**. THE GUARDIAN LIFE INSURANCE COMPANY OF AMERICA, MULTIPLE CLASS, (INT. CLS. 35 AND 36), (U.S. CLS. 100, 101 AND 102). SN 85-344,633. PUB. 4-10-2012. FILED 6-13-2011.
- 4,163,527. **THE BLUEBERRY TREE (STANDARD CHARACTER)**. HORN, SUSAN, (U.S. CLS. 100, 101 AND 102). SN 85-346,428. PUB. 4-10-2012. FILED 6-15-2011.
- 4,163,528. **BUILD YOUR FUTURE. BUILD AMERICA (STANDARD CHARACTER)**. NATIONAL CENTER FOR CONSTRUCTION EDUCATION AND RESEARCH, (U.S. CLS. 100, 101 AND 102). SN 85-346,549. PUB. 4-10-2012. FILED 6-15-2011.
- 4,163,529. **BUILD YOUR FUTURE: GO PRO IN CONSTRUCTION. (STANDARD CHARACTER)**. NATIONAL CENTER FOR CONSTRUCTION EDUCATION AND RESEARCH, (U.S. CLS. 100, 101 AND 102). SN 85-346,650. PUB. 4-10-2012. FILED 6-15-2011.
- 4,163,537. **MODIS (STANDARD CHARACTER)**. ADECCO SA, MULTIPLE CLASS, (INT. CLS. 35, 41 AND 42), (U.S. CLS. 100, 101, 102 AND 107). SN 85-348,991. PUB. 4-10-2012. FILED 6-17-2011.
- 4,163,552. **LOCALKETCH (STANDARD CHARACTER)**. LOCAL KETCH, LLC, (U.S. CLS. 100, 101 AND 102). SN 85-353,627. PUB. 4-10-2012. FILED 6-22-2011.
- 4,163,556. **RESOURCE WEST (STANDARD CHARACTER)**. RESOURCE WEST, INC., MULTIPLE CLASS, (INT. CLS. 35, 40 AND 42), (U.S. CLS. 100, 101, 102, 103 AND 106). SN 85-354,564. PUB. 4-10-2012. FILED 6-23-2011.
- 4,163,558. **TRACY MCWILLIAMS (STANDARD CHARACTER)**. PURE POTENTIAL, LLC, (U.S. CLS. 100, 101 AND 102). SN 85-354,610. PUB. 4-10-2012. FILED 6-23-2011.
- 4,163,562. **MISCELLANEOUS DESIGN**. PURE POTENTIAL, LLC, (U.S. CLS. 100, 101 AND 102). SN 85-355,273. PUB. 4-10-2012. FILED 6-24-2011.
- 4,163,572. **RELIASOURCE (STANDARD CHARACTER)**. RELIASOURCE, INC., MULTIPLE CLASS, (INT. CLS. 35, 38, 39, 40, 42 AND 45), (U.S. CLS. 100, 101, 102, 103, 104, 105 AND 106). SN 85-359,080. PUB. 4-10-2012. FILED 6-29-2011.
- 4,163,573. **RELIASOURCE (STYLIZED)**. RELIASOURCE, INC., MULTIPLE CLASS, (INT. CLS. 35, 38, 39, 40, 42 AND 45), (U.S. CLS. 100, 101, 102, 103, 104, 105 AND 106). SN 85-359,083. PUB. 4-10-2012. FILED 6-29-2011.
- 4,163,579. **UNCF NATIONAL ALUMNI COUNCIL A MIND IS A TERRIBLE THING TO WASTE AND DESIGN**. UNITED NEGRO COLLEGE FUND, INC., MULTIPLE CLASS, (INT. CLS. 35 AND 36), (U.S. CLS. 100, 101 AND 102). SN 85-361,876. PUB. 4-10-2012. FILED 7-1-2011.
- 4,163,583. **VOCAL BRANDING (STANDARD CHARACTER)**. MARKS, ROBERT, MULTIPLE CLASS, (INT. CLS. 35 AND 38), (U.S. CLS. 100, 101, 102 AND 104). SN 85-364,740. PUB. 4-10-2012. FILED 7-6-2011.
- 4,163,584. **COMEDY THAT ROCKS (STANDARD CHARACTER)**. SYNTHIA GODFREY, (U.S. CLS. 100, 101 AND 102). SN 85-364,847. PUB. 4-10-2012. FILED 7-7-2011.
- 4,163,586. **ARTISIN (STANDARD CHARACTER)**. ARTISIN L.L.C., (U.S. CLS. 100, 101 AND 102). SN 85-365,409. PUB. 4-10-2012. FILED 7-7-2011.
- 4,163,589 (*See Class 3 for this trademark*).
- 4,163,590. **ADVERTISER INTELLIGENCE REPORTS (STANDARD CHARACTER)**. PEARL, KEN, (U.S. CLS. 100, 101 AND 102). SN 85-367,072. PUB. 4-10-2012. FILED 7-8-2011.
- 4,163,591. **PANDA CONCEPTS (STANDARD CHARACTER)**. PANDA CONCEPTS LLC, (U.S. CLS. 100, 101 AND 102). SN 85-367,264. PUB. 4-10-2012. FILED 7-9-2011.
- 4,163,592. **PC PANDA CONCEPTS AND DESIGN**. PANDA CONCEPTS LLC, (U.S. CLS. 100, 101 AND 102). SN 85-367,269. PUB. 4-10-2012. FILED 7-9-2011.
- 4,163,594 (*See Class 16 for this trademark*).

- 4,163,596. **MSI MACHINERY TOOLING & SUPPLY AND DESIGN**. MACHINERY TOOLING & SUPPLY, LLC, MULTIPLE CLASS, (INT. CLS. 35 AND 39), (U.S. CLS. 100, 101, 102 AND 105). SN 85-368,975. PUB. 4-10-2012. FILED 7-12-2011.
- 4,163,599. **PROACCESS (STANDARD CHARACTER)**. PIONEER HI-BRED INTERNATIONAL, INC., (U.S. CLS. 100, 101 AND 102). SN 85-369,471. PUB. 4-10-2012. FILED 7-12-2011.
- 4,163,605. **MARICELA SANCHEZ ART (STANDARD CHARACTER)**. MARICELA SANCHEZ ART, (U.S. CLS. 100, 101 AND 102). SN 85-373,498. PUB. 4-10-2012. FILED 7-18-2011.
- 4,163,607. **THE HOOK UP (STANDARD CHARACTER)**. RA SUSHI HOLDING CORP., (U.S. CLS. 100, 101 AND 102). SN 85-374,460. PUB. 4-10-2012. FILED 7-18-2011.
- 4,163,622. **M AND DESIGN**. MCKINNEY & SILVER LLC, (U.S. CLS. 100, 101 AND 102). SN 85-378,396. PUB. 4-10-2012. FILED 7-22-2011.
- 4,163,628. **RUSHSTAR WIRELESS THE NATION'S LEADING PREPAID WIRELESS DISTRIBUTOR AND DESIGN**. RUSH STAR WIRELESS, INC., DBA RUSHSTAR WIRELESS, (U.S. CLS. 100, 101 AND 102). SN 85-381,193. PUB. 4-10-2012. FILED 7-26-2011.
- 4,163,641. **CLICKEDIN (STANDARD CHARACTER)**. TIME WARNER CABLE INC., (U.S. CLS. 100, 101 AND 102). SN 85-383,225. PUB. 4-10-2012. FILED 7-28-2011.
- 4,163,647. **COSTA (STANDARD CHARACTER)**. CROSS OPTICAL GROUP, INC., (U.S. CLS. 100, 101 AND 102). SN 85-385,703. PUB. 4-10-2012. FILED 8-1-2011.
- 4,163,649. **NS AND DESIGN**. NEXTSPACE COWORKING & INNOVATION, INC., MULTIPLE CLASS, (INT. CLS. 35, 36 AND 42), (U.S. CLS. 100, 101 AND 102). SN 85-385,947. PUB. 4-10-2012. FILED 8-1-2011.
- 4,163,658. **OCTOPUS CREATIVE (STANDARD CHARACTER)**. OCTOPUS CREATIVE, LLC, MULTIPLE CLASS, (INT. CLS. 35 AND 42), (U.S. CLS. 100, 101 AND 102). SN 85-387,660. PUB. 4-10-2012. FILED 8-2-2011.
- 4,163,661. **NECCP, NEW ENGLAND CENTER FOR CHRONIC PAIN, BECAUSE EVERYONE DESERVES A PAIN FREE LIFE (STYLIZED)**. RIVERSIDE MEDICAL, LLC, (U.S. CLS. 100, 101 AND 102). SN 85-388,540. PUB. 4-10-2012. FILED 8-3-2011.
- 4,163,669 (*See Class 6 for this trademark*).
- 4,163,674. **HARMONIZED COMMUNITY (STANDARD CHARACTER)**. WESTON SOLUTIONS (IPR), INC., MULTIPLE CLASS, (INT. CLS. 35, 37 AND 42), (U.S. CLS. 100, 101, 102, 103 AND 106). SN 85-391,808. PUB. 4-10-2012. FILED 8-8-2011.
- 4,163,685. **MISCELLANEOUS DESIGN**. GERONIMO'S, LTD., (U.S. CLS. 100, 101 AND 102). SN 85-396,363. PUB. 4-10-2012. FILED 8-12-2011.
- 4,163,690. **NU LOOK FURNITURE AND DESIGN**. ANDRE BROWN, DBA NU LOOK FURNITURE, INC., (U.S. CLS. 100, 101 AND 102). SN 85-400,037. PUB. 4-10-2012. FILED 8-17-2011.
- 4,163,694. **360 RECOGNITION (STANDARD CHARACTER)**. TERRYBERRY, LLC, (U.S. CLS. 100, 101 AND 102). SN 85-402,155. PUB. 4-10-2012. FILED 8-19-2011.
- 4,163,702. **LONE SURVIVOR FOUNDATION AND DESIGN**. LONE SURVIVOR FOUNDATION, (U.S. CLS. 100, 101 AND 102). SN 85-404,201. PUB. 4-10-2012. FILED 8-22-2011.
- 4,163,706. **GIVE A WOW (STANDARD CHARACTER)**. TERRYBERRY, LLC, (U.S. CLS. 100, 101 AND 102). SN 85-406,859. PUB. 4-10-2012. FILED 8-25-2011.
- 4,163,707. **BE RECOGNIZED (STANDARD CHARACTER)**. TERRYBERRY, LLC, (U.S. CLS. 100, 101 AND 102). SN 85-406,961. PUB. 4-10-2012. FILED 8-25-2011.
- 4,163,711. **MOBI (STANDARD CHARACTER)**. MOBI WIRELESS MANAGEMENT, LLC, MULTIPLE CLASS, (INT. CLS. 35 AND 42), (U.S. CLS. 100, 101 AND 102). SN 85-408,509. PUB. 4-10-2012. FILED 8-26-2011.
- 4,163,714. **THE DISTRICT OF COLUMBIA MIX (STANDARD CHARACTER)**. THE DC MIX ENTERTAINMENT GROUP, (U.S. CLS. 100, 101 AND 102). SN 85-409,148. PUB. 4-10-2012. FILED 8-28-2011.
- 4,163,715 (*See Class 14 for this trademark*).
- 4,163,719. **WE BRING ART TO LIFE (STANDARD CHARACTER)**. NEW ERA PUBLISHING, INC., (U.S. CLS. 100, 101 AND 102). SN 85-410,429. PUB. 4-10-2012. FILED 8-30-2011.
- 4,163,720. **SILVERSTONE GROUP S AND DESIGN**. SILVERSTONE GROUP, INCORPORATED, (U.S. CLS. 100, 101 AND 102). SN 85-410,752. PUB. 2-28-2012. FILED 8-30-2011.
- 4,163,726. **NINE LIVES MEDIA INC. (STANDARD CHARACTER)**. PENTON MEDIA, INC., MULTIPLE CLASS, (INT. CLS. 35 AND 41), (U.S. CLS. 100, 101, 102 AND 107). SN 85-411,803. PUB. 4-10-2012. FILED 8-31-2011.
- 4,163,733. **SHARESPOST (STANDARD CHARACTER)**. SHARESPOST, INC, MULTIPLE CLASS, (INT. CLS. 35, 36 AND 42), (U.S. CLS. 100, 101 AND 102). SN 85-413,423. PUB. 4-10-2012. FILED 9-1-2011.
- 4,163,734. **MISCELLANEOUS DESIGN**. PROTINGENT, INC., DBA PROTINGENT STAFFING, (U.S. CLS. 100, 101 AND 102). SN 85-413,502. PUB. 4-10-2012. FILED 9-1-2011.
- 4,163,737. **KINGDEE (STYLIZED)**. KINGDEE SOFTWARE (CHINA) CO., LTD., (U.S. CLS. 100, 101 AND 102). SN 85-413,729. PUB. 4-10-2012. FILED 9-2-2011.
- 4,163,741 (*See Class 16 for this trademark*).
- 4,163,743 (*See Class 9 for this trademark*).
- 4,163,745 (*See Class 28 for this trademark*).
- 4,163,746. **ENERGY NEUTRAL AND DESIGN**. ENERGY NEUTRAL LLC, (U.S. CLS. 100, 101 AND 102). SN 85-416,640. PUB. 4-10-2012. FILED 9-7-2011.
- 4,163,758. **PRE-FIXE (STANDARD CHARACTER)**. PRE-FIXE LLC, MULTIPLE CLASS, (INT. CLS. 35 AND 42), (U.S. CLS. 100, 101 AND 102). SN 85-418,025. PUB. 4-10-2012. FILED 9-8-2011.
- 4,163,771 (*See Class 16 for this trademark*).
- 4,163,776. **FOOD(S) UNLIMITED AND DESIGN**. VARKEY, JOSE PUTHIAKUNNEL, DBA FOOD(S) UNLIMITED, (U.S. CLS. 100, 101 AND 102). SN 85-423,026. PUB. 4-10-2012. FILED S.R. 9-14-2011; AM. P.R. 3-6-2012.
- 4,163,780. **CUBAN COUNCIL (STANDARD CHARACTER)**. BEETLEFARM, LLC, DBA CUBAN COUNCIL, MULTIPLE CLASS, (INT. CLS. 35 AND 42), (U.S. CLS. 100, 101 AND 102). SN 85-424,768. PUB. 4-10-2012. FILED 9-16-2011.
- 4,163,787 (*See Class 28 for this trademark*).
- 4,163,788. **UNITED WOMEN OF AMERICA (STANDARD CHARACTER)**. BRYANT-MCNEIL, RASHEEDA, (U.S. CLS. 100, 101 AND 102). SN 85-426,370. PUB. 4-10-2012. FILED 9-19-2011.
- 4,163,789. **AMERICAN DEFENDERS MOTORCYCLE CLUB AND DESIGN**. NEIL A WHITWORTH JR., (U.S. CLS. 100, 101 AND 102). SN 85-426,880. PUB. 4-10-2012. FILED 9-20-2011.
- 4,163,796. **CASHMERE SUITCASE (STANDARD CHARACTER)**. CASHMERE SUITCASE LLC, (U.S. CLS. 100, 101 AND 102). SN 85-427,611. PUB. 4-10-2012. FILED 9-20-2011.
- 4,163,818. **BLUE PANDA I N T E R A C T I V E AND DESIGN**. JEFFREY FLEISCHMAN, MULTIPLE CLASS, (INT. CLS. 35 AND 42), (U.S. CLS. 100, 101 AND 102). SN 85-430,638. PUB. 4-10-2012. FILED 9-23-2011.
- 4,163,820. **CARRIE'S TOUCH (STANDARD CHARACTER)**. DENYSE, TAMMIE, (U.S. CLS. 100, 101 AND 102). SN 85-430,983. PUB. 4-10-2012. FILED 9-23-2011.
- 4,163,838 (*See Class 25 for this trademark*).
- 4,163,839 (*See Class 25 for this trademark*).
- 4,163,849. **SUNDANCE DENTAL CARE (STANDARD CHARACTER)**. SUNDANCE DENTAL PARTNERS, LLC, (U.S. CLS. 100, 101 AND 102). SN 85-434,854. PUB. 4-10-2012. FILED 9-28-2011.
- 4,163,850. **SUNDANCE DENTAL CARE AND DESIGN**. SUNDANCE DENTAL PARTNERS, LLC, (U.S. CLS. 100, 101 AND 102). SN 85-434,859. PUB. 4-10-2012. FILED 9-28-2011.
- 4,163,851. **GLOBAL INTELLISYSTEMS (STANDARD CHARACTER)**. GLOBAL INTELLISYSTEMS LLC, (U.S. CLS. 100, 101 AND 102). SN 85-434,861. PUB. 4-10-2012. FILED 9-28-2011.
- 4,163,865. **EAT SHOP GIVE (STANDARD CHARACTER)**. EAT SHOP GIVE, LLC, (U.S. CLS. 100, 101 AND 102). SN 85-436,396. PUB. 4-10-2012. FILED 9-30-2011.
- 4,163,866. **INTERNATIONAL PET AND ANIMAL TRANSPORTATION ASSOCIATION (STANDARD CHARACTER)**. INTERNATIONAL PET AND ANIMAL TRANSPORTATION ASSOCIATION, (U.S. CLS. 100, 101 AND 102). SN 85-436,602. PUB. 4-10-2012. FILED 9-30-2011.
- 4,163,873. **TELUCA ROOTS IN HAIR COLOR AND DESIGN**.

- TELUCA, INC., (U.S. CLS. 100, 101 AND 102). SN 85-437,590. PUB. 4-10-2012. FILED 10-3-2011.
- 4,163,874. **PUTTING THE WORLD TO WORK (STANDARD CHARACTER)**. LOOSEMONKIES.COM LLC, (U.S. CLS. 100, 101 AND 102). SN 85-437,798. PUB. 4-10-2012. FILED 10-3-2011.
- 4,163,879. **SOLAURO (STANDARD CHARACTER)**. SOLAURO INDUSTRIES INC., MULTIPLE CLASS, (INT. CLS. 35, 37 AND 42), (U.S. CLS. 100, 101, 102, 103 AND 106). SN 85-438,310. PUB. 4-10-2012. FILED 10-4-2011.
- 4,163,880. **DUDALINA AND DESIGN**. DUDALINA S/A, (U.S. CLS. 100, 101 AND 102). SN 85-438,402. PUB. 4-10-2012. FILED 10-4-2011.
- 4,163,883. **DUDALINA AND DESIGN**. DUDALINA S/A, (U.S. CLS. 100, 101 AND 102). SN 85-438,492. PUB. 4-10-2012. FILED 10-4-2011.
- 4,163,890. **GCDAA GOLF CAR DEALERS ASSOCIATION OF AMERICA (STANDARD CHARACTER)**. GOLF CAR DEALERS ASSOCIATION OF AMERICA, LLC, (U.S. CLS. 100, 101 AND 102). SN 85-439,560. PUB. 4-10-2012. FILED 10-5-2011.
- 4,163,895. **LIQUID (STANDARD CHARACTER)**. LIQUID AGENCY, INC., (U.S. CLS. 100, 101 AND 102). SN 85-440,362. PUB. 4-10-2012. FILED 10-5-2011.
- 4,163,902. **EUG AND DESIGN**. EPICOR USERS GROUP, MULTIPLE CLASS, (INT. CLS. 35, 38 AND 41), (U.S. CLS. 100, 101, 102, 104 AND 107). SN 85-441,374. PUB. 4-10-2012. FILED 10-6-2011.
- 4,163,905 (*See Class 9 for this trademark*).
- 4,163,906 (*See Class 14 for this trademark*).
- 4,163,912. **GSSI (STANDARD CHARACTER)**. GLOBAL SAFETY SOURCES INCORPORATED, MULTIPLE CLASS, (INT. CLS. 35, 41 AND 45), (U.S. CLS. 100, 101, 102 AND 107). SN 85-441,890. PUB. 4-10-2012. FILED 10-7-2011.
- 4,163,913. **GSSI SAFETY (STANDARD CHARACTER)**. GLOBAL SAFETY SOURCES INCORPORATED, MULTIPLE CLASS, (INT. CLS. 35, 41 AND 45), (U.S. CLS. 100, 101, 102 AND 107). SN 85-441,918. PUB. 4-10-2012. FILED 10-7-2011.
- 4,163,915. **ENERGYSHERLOCK (STANDARD CHARACTER)**. VERIGREEN ENERGY & LIGHT SOLUTIONS LLC, (U.S. CLS. 100, 101 AND 102). SN 85-442,100. PUB. 4-10-2012. FILED 10-7-2011.
- 4,163,918. **ICA (STANDARD CHARACTER)**. DAL BELLO, PETER T., (U.S. CLS. 100, 101 AND 102). SN 85-442,974. PUB. 4-10-2012. FILED 10-9-2011.
- 4,163,921. **NEW EPIC MEDIA (STANDARD CHARACTER)**. EPIC MEDIA GROUP, LLC, MULTIPLE CLASS, (INT. CLS. 35 AND 42), (U.S. CLS. 100, 101 AND 102). SN 85-443,049. PUB. 4-10-2012. FILED 10-10-2011.
- 4,163,922. **ESG (STANDARD CHARACTER)**. ESG OPERATIONS, INC., MULTIPLE CLASS, (INT. CLS. 35, 36, 37, 40, 42 AND 45), (U.S. CLS. 100, 101, 102, 103 AND 106). SN 85-443,221. PUB. 4-10-2012. FILED 10-10-2011.
- 4,163,924. **CAR SOURCE (STANDARD CHARACTER)**. COLLINS AUTO GROUP, LLC, (U.S. CLS. 100, 101 AND 102). SN 85-443,506. PUB. 4-10-2012. FILED 10-10-2011.
- 4,163,926 (*See Class 9 for this trademark*).
- 4,163,934. **HOME OF THE LOW PRICE GUARANTEE OR IT'S FREE! (STANDARD CHARACTER)**. BESTWAY, INC., (U.S. CLS. 100, 101 AND 102). SN 85-444,201. PUB. 4-10-2012. FILED 10-11-2011.
- 4,163,950. **MUSIC DOING GOOD (STANDARD CHARACTER)**. MUSIC DOING GOOD, INC., (U.S. CLS. 100, 101 AND 102). SN 85-446,212. PUB. 4-10-2012. FILED 10-13-2011.
- 4,163,955. **SPHERE ACCESS AND DESIGN**. TASTE OF THE WORLD LLC, (U.S. CLS. 100, 101 AND 102). SN 85-446,879. PUB. 4-10-2012. FILED 10-13-2011.
- 4,163,961. **GSSI SAFETY AND DESIGN**. GLOBAL SAFETY SOURCES INCORPORATED, MULTIPLE CLASS, (INT. CLS. 35, 41 AND 45), (U.S. CLS. 100, 101, 102 AND 107). SN 85-447,400. PUB. 4-10-2012. FILED 10-14-2011.
- 4,163,965. **HANNAH STORM (STANDARD CHARACTER)**. HANNAH STORM FOUNDATION INC., MULTIPLE CLASS, (INT. CLS. 35 AND 36), (U.S. CLS. 100, 101 AND 102). SN 85-447,683. PUB. 4-10-2012. FILED 10-14-2011.
- 4,163,966. **AFTERLIKE MARKETING (STANDARD CHARACTER)**. SULLIVAN, DANIEL, (U.S. CLS. 100, 101 AND 102). SN 85-447,695. PUB. 4-10-2012. FILED 10-14-2011.
- 4,163,979. **THE BIOME COACH (STANDARD CHARACTER)**. JKLM CONSULTING, LLC, (U.S. CLS. 100, 101 AND 102). SN 85-448,346. PUB. 4-10-2012. FILED 10-15-2011.
- 4,163,985. **POSTER PROTECT (STANDARD CHARACTER)**. CALIFORNIA CHAMBER OF COMMERCE, (U.S. CLS. 100, 101 AND 102). SN 85-448,711. PUB. 4-10-2012. FILED 10-17-2011.
- 4,163,986. **VENTUREBOX (STANDARD CHARACTER)**. VENTUREBOX, INC., (U.S. CLS. 100, 101 AND 102). SN 85-448,964. PUB. 4-10-2012. FILED 10-17-2011.
- 4,163,993. **APPAPPEAL (STANDARD CHARACTER)**. COMCOASTER, MULTIPLE CLASS, (INT. CLS. 35 AND 42), (U.S. CLS. 100, 101 AND 102). SN 85-449,467. PUB. 4-10-2012. FILED 10-18-2011.
- 4,163,998. **RIVERMARK (STANDARD CHARACTER)**. RIVERMARK, LLC, MULTIPLE CLASS, (INT. CLS. 35 AND 42), (U.S. CLS. 100, 101 AND 102). SN 85-449,779. PUB. 4-10-2012. FILED 10-18-2011.
- 4,164,000. **WORLD FAMOUS ZANE'S CYCLES Z AND DESIGN**. ZANE'S INCORPORATED, DBA WORLD FAMOUS ZANE'S CYCLES, (U.S. CLS. 100, 101 AND 102). SN 85-450,049. PUB. 4-10-2012. FILED 10-18-2011.
- 4,164,014. **CAR FACTOR (STANDARD CHARACTER)**. TEAM VELOCITY MARKETING, LLC, (U.S. CLS. 100, 101 AND 102). SN 85-450,727. PUB. 4-10-2012. FILED 10-19-2011.
- 4,164,015. **SOUTH COUNTY HYDROPONICS AND DESIGN**. SOUTH COUNTY HYDROPONICS & ORGANICS, INC., (U.S. CLS. 100, 101 AND 102). SN 85-450,728. PUB. 4-10-2012. FILED 10-19-2011.
- 4,164,019. **RAMIREZ LIQUOR AND DESIGN**. PYRAMID INC., (U.S. CLS. 100, 101 AND 102). SN 85-451,036. PUB. 4-10-2012. FILED 10-19-2011.
- 4,164,026. **VELTI (STANDARD CHARACTER)**. VELTI PLC, MULTIPLE CLASS, (INT. CLS. 35 AND 42), (U.S. CLS. 100, 101 AND 102). SN 85-451,461. PUB. 4-10-2012. FILED 10-19-2011.
- 4,164,028. **TRUCKS TRUCKS AND MORE (STANDARD CHARACTER)**. NORTHWEST MOTORSPORT, INC., (U.S. CLS. 100, 101 AND 102). SN 85-451,519. PUB. 4-10-2012. FILED 10-19-2011.
- 4,164,030. **PROBATE FINDER ONDEMAND AND DESIGN**. DECEASED CREDIT MANAGEMENT, LLC, (U.S. CLS. 100, 101 AND 102). SN 85-451,655. PUB. 4-10-2012. FILED 10-20-2011.
- 4,164,035. **COFFEE RETRIEVER (STANDARD CHARACTER)**. ARAMATIC COFFEE SYSTEM OF THE HUDSON VALLEY, INC., (U.S. CLS. 100, 101 AND 102). SN 85-451,923. PUB. 4-10-2012. FILED 10-20-2011.
- 4,164,036. **VOLUNTEENS.COM (STANDARD CHARACTER)**. VOLUNTEENS.COM, L.L.C., (U.S. CLS. 100, 101 AND 102). SN 85-451,939. PUB. 4-10-2012. FILED 10-20-2011.
- 4,164,038. **OTTO ARCHITECTURE AND DESIGN (STANDARD CHARACTER)**. JEAN LIN, DBA OTTO ARCHITECTURE AND DESIGN, (U.S. CLS. 100, 101 AND 102). SN 85-452,151. PUB. 4-10-2012. FILED 10-20-2011.
- 4,164,047. **COFFEE RETRIEVER AND DESIGN**. ARAMATIC COFFEE SYSTEM OF THE HUDSON VALLEY, INC., (U.S. CLS. 100, 101 AND 102). SN 85-452,537. PUB. 4-10-2012. FILED 10-20-2011.
- 4,164,048. **FETCHING THE BEST DEALS ON COFFEE (STANDARD CHARACTER)**. ARAMATIC COFFEE SYSTEM OF THE HUDSON VALLEY, INC., (U.S. CLS. 100, 101 AND 102). SN 85-452,539. PUB. 4-10-2012. FILED 10-20-2011.
- 4,164,052. **NEWSIGMA AND DESIGN**. MADERE, CHARLES STANTON, (U.S. CLS. 100, 101 AND 102). SN 85-452,727. PUB. 4-10-2012. FILED 10-21-2011.
- 4,164,053. **GAME READY SCOUT DAY (STANDARD CHARACTER)**. GAME READY SCOUT DAY, INC., (U.S. CLS. 100, 101 AND 102). SN 85-452,838. PUB. 4-10-2012. FILED 10-21-2011.
- 4,164,059. **NINU (STYLIZED)**. KHAZANIE, NIRDHAR, (U.S. CLS. 100, 101 AND 102). SN 85-453,021. PUB. 4-10-2012. FILED 10-21-2011.
- 4,164,065. **THE FISH STORE AND DESIGN**. BAFIST, INC., DBA THE FISH STORE, MULTIPLE CLASS, (INT. CLS. 35 AND 43), (U.S. CLS. 100, 101 AND 102). SN 85-453,096. PUB. 4-10-2012. FILED 10-21-2011.
- 4,164,069. **YOGASTAGE (STANDARD CHARACTER)**. YOGA-

- STAGE, LLC, (U.S. CLS. 100, 101 AND 102). SN 85-453,326. PUB. 4-10-2012. FILED 10-21-2011.
- 4,164,070. **YPK (STANDARD CHARACTER)**. YOGASTAGE, LLC, (U.S. CLS. 100, 101 AND 102). SN 85-453,330. PUB. 4-10-2012. FILED 10-21-2011.
- 4,164,071. **NAMASTE Y'ALL (STANDARD CHARACTER)**. YOGASTAGE, LLC, (U.S. CLS. 100, 101 AND 102). SN 85-453,359. PUB. 4-10-2012. FILED 10-21-2011.
- 4,164,078. **MOGOARTS MARKETING (STANDARD CHARACTER)**. MOGO MARKETING & MEDIA, INC., (U.S. CLS. 100, 101 AND 102). SN 85-453,519. PUB. 4-10-2012. FILED 10-21-2011.
- 4,164,084. **BARTENDERS 411 AND DESIGN**. BARTENDERS411, INC., (U.S. CLS. 100, 101 AND 102). SN 85-453,688. PUB. 4-10-2012. FILED 10-21-2011.
- 4,164,092. **CARDINAL STAFFING SERVICES AND DESIGN**. CARDINAL SERVICES, INC., (U.S. CLS. 100, 101 AND 102). SN 85-454,096. PUB. 4-10-2012. FILED 10-24-2011.
- 4,164,093. **EQUITY INFORMATION TECHNOLOGY AND DESIGN**. EQUITY STAFFING GROUP INCORPORATED, (U.S. CLS. 100, 101 AND 102). SN 85-454,152. PUB. 4-10-2012. FILED 10-24-2011.
- 4,164,095. **EQUITY STAFFING GROUP AND DESIGN**. EQUITY STAFFING GROUP INCORPORATED, (U.S. CLS. 100, 101 AND 102). SN 85-454,207. PUB. 4-10-2012. FILED 10-24-2011.
- 4,164,100. **MIC: MEET INTERACT CONNECT (STANDARD CHARACTER)**. SYRACUSE AREA MUSIC AWARDS, INC., MULTIPLE CLASS, (INT. CLS. 35 AND 41), (U.S. CLS. 100, 101, 102 AND 107). SN 85-454,269. PUB. 4-10-2012. FILED 10-24-2011.
- 4,164,103. **SESSIMO (STYLIZED)**. MIN KIM, (U.S. CLS. 100, 101 AND 102). SN 85-454,397. PUB. 4-10-2012. FILED 10-24-2011.
- 4,164,112. **G AND DESIGN**. GIBBS CONTRACTING INC., MULTIPLE CLASS, (INT. CLS. 35 AND 39), (U.S. CLS. 100, 101, 102 AND 105). SN 85-454,634. PUB. 4-10-2012. FILED 10-24-2011.
- 4,164,132. **THE AR GROUP, LLP (STANDARD CHARACTER)**. THE AR GROUP, LLP, MULTIPLE CLASS, (INT. CLS. 35 AND 45), (U.S. CLS. 100, 101 AND 102). SN 85-455,218. PUB. 4-10-2012. FILED 10-25-2011.
- 4,164,133. **CATCHPOINT PARTNERS (STANDARD CHARACTER)**. CATCHPOINT PARTNERS LLC, DBA CATCHPOINT PARTNERS LLC, (U.S. CLS. 100, 101 AND 102). SN 85-455,235. PUB. 4-10-2012. FILED 10-25-2011.
- 4,164,134. **SOCIALPOWER (STANDARD CHARACTER)**. SOCIAL POWER LLC, (U.S. CLS. 100, 101 AND 102). SN 85-455,238. PUB. 4-10-2012. FILED 10-25-2011.
- 4,164,135. **THE POWER OF THE PEOPLE (STANDARD CHARACTER)**. SOCIAL POWER LLC, (U.S. CLS. 100, 101 AND 102). SN 85-455,260. PUB. 4-10-2012. FILED 10-25-2011.
- 4,164,136. **M MURPHY CONSULTING MAKING THE COMPLEX COMPREHENSIBLE AND DESIGN**. DENISE MURPHY, (U.S. CLS. 100, 101 AND 102). SN 85-455,270. PUB. 4-10-2012. FILED 10-25-2011.
- 4,164,143. **SUPERMERCADOS MORELOS GROCERY MEAT MARKET BAKERY TACOS AND DESIGN**. SUPERMERCADOS MORELOS, LLC, (U.S. CLS. 100, 101 AND 102). SN 85-455,399. PUB. 4-10-2012. FILED 10-25-2011.
- 4,164,145. **WORKING IN WITNESS FOR CHRIST (STANDARD CHARACTER)**. YOUNG CATHOLIC PROFESSIONALS, (U.S. CLS. 100, 101 AND 102). SN 85-455,415. PUB. 4-10-2012. FILED 10-25-2011.
- 4,164,147. **ALEXANDRIA CHAMBER OF COMMERCE AND DESIGN**. ALEXANDRIA CHAMBER OF COMMERCE, (U.S. CLS. 100, 101 AND 102). SN 85-455,478. PUB. 4-10-2012. FILED 10-25-2011.
- 4,164,160. **VALUE CHAIN PLUS (STANDARD CHARACTER)**. INSPIRAGE, LLC, MULTIPLE CLASS, (INT. CLS. 35 AND 42), (U.S. CLS. 100, 101 AND 102). SN 85-455,779. PUB. 4-10-2012. FILED 10-25-2011.
- 4,164,168. **SHOP TO BE GREEN WWW.SHOPTOBEGREEN.COM AND DESIGN**. SHOP TO BE GREEN, LLC, (U.S. CLS. 100, 101 AND 102). SN 85-455,966. PUB. 4-10-2012. FILED 10-25-2011.
- 4,164,192. **TRANSMISSIONHUB (STANDARD CHARACTER)**. CYBERTECH, INC., DBA ENERGY CENTRAL, (U.S. CLS. 100, 101 AND 102). SN 85-456,518. PUB. 4-10-2012. FILED 10-26-2011.
- 4,164,201. **HECARGO AND DESIGN**. STACEY, PAUL E., (U.S. CLS. 100, 101 AND 102). SN 85-456,781. PUB. 4-10-2012. FILED 10-26-2011.
- 4,164,210. **AVEUS (STANDARD CHARACTER)**. AVEUS, LLC, MULTIPLE CLASS, (INT. CLS. 35 AND 41), (U.S. CLS. 100, 101, 102 AND 107). SN 85-457,043. PUB. 4-10-2012. FILED 10-26-2011.
- 4,164,212. **SONS OF SOLOMON MOTORCYCLE CLUB AND DESIGN**. SONS OF SOLOMON MOTORCYCLE CLUB, INC., (U.S. CLS. 100, 101 AND 102). SN 85-457,143. PUB. 4-10-2012. FILED 10-26-2011.
- 4,164,220. **AGREEANCE (STANDARD CHARACTER)**. AGREEANCE LLC, (U.S. CLS. 100, 101 AND 102). SN 85-457,299. PUB. 4-10-2012. FILED 10-26-2011.
- 4,164,223. **PLUMPEACHY (STANDARD CHARACTER)**. CONSOLIDATED MERCHANTS GROUP, INC., (U.S. CLS. 100, 101 AND 102). SN 85-457,346. PUB. 4-10-2012. FILED 10-27-2011.
- 4,164,224. **GET JUICED! NOT SQUEEZED. (STANDARD CHARACTER)**. CONSOLIDATED MERCHANTS GROUP, INC., (U.S. CLS. 100, 101 AND 102). SN 85-457,348. PUB. 4-10-2012. FILED 10-27-2011.
- 4,164,230. **AG INSIGHT (STANDARD CHARACTER)**. BECK AG, INC., (U.S. CLS. 100, 101 AND 102). SN 85-457,419. PUB. 4-10-2012. FILED 10-27-2011.
- 4,164,239. **WE ANTICIPATE THE SOLUTIONS THAT SHAPE YOUR FUTURE (STANDARD CHARACTER)**. PCT FEDERAL SERVICES, LLC, (U.S. CLS. 100, 101 AND 102). SN 85-457,540. PUB. 4-10-2012. FILED 10-27-2011.
- 4,164,240. **AMERICAN GOLD EXCHANGE (STANDARD CHARACTER)**. AMERICAN GOLD EXCHANGE, INC., (U.S. CLS. 100, 101 AND 102). SN 85-457,551. PUB. 4-10-2012. FILED 10-27-2011.
- 4,164,245. **CARDINALPATH (STANDARD CHARACTER)**. CARDINAL PATH HOLDING COMPANY, (U.S. CLS. 100, 101 AND 102). SN 85-457,603. PUB. 4-10-2012. FILED 10-27-2011.
- 4,164,250. **CLEANSTEPS CARBON OFFSETS MAKE YOUR OWN FOOTPRINT (STANDARD CHARACTER)**. WASHINGTON GAS ENERGY SERVICES, INC., (U.S. CLS. 100, 101 AND 102). SN 85-457,657. PUB. 4-10-2012. FILED 10-27-2011.
- 4,164,251. **CLEANSTEPS WINDPOWER MAKE YOUR OWN FOOTPRINT (STANDARD CHARACTER)**. WASHINGTON GAS ENERGY SERVICES, INC., (U.S. CLS. 100, 101 AND 102). SN 85-457,670. PUB. 4-10-2012. FILED 10-27-2011.
- 4,164,252. **IT'S TIME TO CARE FOR THE CAREGIVERS (STANDARD CHARACTER)**. PSS WORLD MEDICAL, INC., (U.S. CLS. 100, 101 AND 102). SN 85-457,693. PUB. 4-10-2012. FILED 10-27-2011.
- 4,164,255. **CARDINALPATH AND DESIGN**. CARDINAL PATH HOLDING COMPANY, (U.S. CLS. 100, 101 AND 102). SN 85-457,709. PUB. 4-10-2012. FILED 10-27-2011.
- 4,164,260. **ALUMNI NEVER RETIRE (STANDARD CHARACTER)**. PROFESSIONAL BASKETBALL ALUMNI ASSOCIATION MARKETING, INC., (U.S. CLS. 100, 101 AND 102). SN 85-457,730. PUB. 4-10-2012. FILED 10-27-2011.
- 4,164,261. **G (STYLIZED)**. CHANTAL GUILLON DI DONATO, (U.S. CLS. 100, 101 AND 102). SN 85-457,731. PUB. 4-10-2012. FILED 10-27-2011.
- 4,164,262. **CMC COMETALS (STANDARD CHARACTER)**. COMMERCIAL METALS COMPANY, (U.S. CLS. 100, 101 AND 102). SN 85-457,738. PUB. 4-10-2012. FILED 10-27-2011.
- 4,164,264. **SEETHISHOMENOW (STANDARD CHARACTER)**. HAL SMITH MARKETING GROUP LLC, (U.S. CLS. 100, 101 AND 102). SN 85-457,742. PUB. 4-10-2012. FILED 10-27-2011.
- 4,164,267. **MOONTOAST (STANDARD CHARACTER)**. MOONTOAST, LLC, MULTIPLE CLASS, (INT. CLS. 35 AND 42), (U.S. CLS. 100, 101 AND 102). SN 85-457,770. PUB. 4-10-2012. FILED 10-27-2011.
- 4,164,269. **FCP (STANDARD CHARACTER)**. FCPGROTON, LLC, (U.S. CLS. 100, 101 AND 102). SN 85-457,788. PUB. 4-10-2012. FILED 10-27-2011.
- 4,164,270 (*See Class 9 for this trademark*).
- 4,164,271. **RCC WESTERN WEAR (STANDARD CHARACTER)**

- TER). RCC WESTERN STORES, INC., (U.S. CLS. 100, 101 AND 102). SN 85-457,801. PUB. 4-10-2012. FILED 10-27-2011.
- 4,164,292. **BIDX BE ICED DIAMOND EXCHANGE AND DESIGN**. TOP HAT, INC., (U.S. CLS. 100, 101 AND 102). SN 85-457,955. PUB. 4-10-2012. FILED 10-27-2011.
- 4,164,293. **RELATIONSHOP (STANDARD CHARACTER)**. GO THINK LLC, (U.S. CLS. 100, 101 AND 102). SN 85-457,959. PUB. 4-10-2012. FILED 10-27-2011.
- 4,164,294. **IMPULSIVE GROUP A LIFESTYLE HOSPITALITY COMPANY AND DESIGN**. IMPULSIVE ENTERPRISES LTD., (U.S. CLS. 100, 101 AND 102). SN 85-457,962. PUB. 4-10-2012. FILED 10-27-2011.
- 4,164,302. **RESUNATE (STANDARD CHARACTER)**. CAREER-IMP, INC., MULTIPLE CLASS, (INT. CLS. 35 AND 42), (U.S. CLS. 100, 101 AND 102). SN 85-457,989. PUB. 4-10-2012. FILED 10-27-2011.
- 4,164,306. **BANNED CHARISMA (STANDARD CHARACTER)**. CLAUSEN, CAMERON N, (U.S. CLS. 100, 101 AND 102). SN 85-458,022. PUB. 4-10-2012. FILED 10-27-2011.
- 4,164,315. **MISCELLANEOUS DESIGN**. PORPLEMONTAGE ENTERPRISES, LLC, (U.S. CLS. 100, 101 AND 102). SN 85-458,135. PUB. 4-10-2012. FILED 10-27-2011.
- 4,164,318. **HEART + MIND STRATEGIES (STANDARD CHARACTER)**. HEART + MIND STRATEGIES, (U.S. CLS. 100, 101 AND 102). SN 85-458,141. PUB. 4-10-2012. FILED 10-27-2011.
- 4,164,335 (*See Class 16 for this trademark*).
- 4,164,339. **PIXEL THEORY (STANDARD CHARACTER)**. PIXEL THEORY INC, DBA PIXEL THEORY, MULTIPLE CLASS, (INT. CLS. 35 AND 42), (U.S. CLS. 100, 101 AND 102). SN 85-458,276. PUB. 4-10-2012. FILED 10-27-2011.
- 4,164,343. **DYNAMIC SOCIAL COMMERCE (STANDARD CHARACTER)**. EXPRESS MOBILE, INC., (U.S. CLS. 100, 101 AND 102). SN 85-458,317. PUB. 4-10-2012. FILED 10-27-2011.
- 4,164,348. **REBELLIOUS AT HEART (STANDARD CHARACTER)**. REBELLIOUS AT HEART INC., (U.S. CLS. 100, 101 AND 102). SN 85-458,379. PUB. 4-10-2012. FILED 10-27-2011.
- 4,164,361. **THE POWER TO CHOOSE WISELY (STANDARD CHARACTER)**. POWER EQUIPMENT DIRECT, INC., (U.S. CLS. 100, 101 AND 102). SN 85-458,510. PUB. 4-10-2012. FILED 10-27-2011.
- 4,164,376. **WHATSOEVER THINGS ARE LOVELY! (STANDARD CHARACTER)**. CRISP, CONSTANCE, (U.S. CLS. 100, 101 AND 102). SN 85-458,684. PUB. 4-10-2012. FILED 10-28-2011.
- 4,164,379. **EVED (STANDARD CHARACTER)**. EVED LLC, (U.S. CLS. 100, 101 AND 102). SN 85-458,713. PUB. 4-10-2012. FILED 10-28-2011.
- 4,164,380. **PHARMACUMEN (STANDARD CHARACTER)**. PHARMACUMEN CONSULTING INC., (U.S. CLS. 100, 101 AND 102). SN 85-458,714. PUB. 4-10-2012. FILED 10-28-2011.
- 4,164,383. **NOT JUST OTHER MUSIC WEBPAGE (STANDARD CHARACTER)**. RODRIGUEZ, JOSUE, (U.S. CLS. 100, 101 AND 102). SN 85-458,740. PUB. 4-10-2012. FILED 10-28-2011.
- 4,164,384. **TIER10 MARKETING (STANDARD CHARACTER)**. TIER10 MARKETING, LLC, (U.S. CLS. 100, 101 AND 102). SN 85-458,756. PUB. 4-10-2012. FILED 10-28-2011.
- 4,164,385. **GET4IT (STYLIZED)**. NORTHERN CUSTOM DEVELOPMENT AND INTEGRATION, (U.S. CLS. 100, 101 AND 102). SN 85-458,776. PUB. 4-10-2012. FILED 10-28-2011.
- 4,164,389. **LIGHT, BRIGHT AND POLITE (STANDARD CHARACTER)**. OCHS, JOSHUA, (U.S. CLS. 100, 101 AND 102). SN 85-458,807. PUB. 4-10-2012. FILED 10-28-2011.
- 4,164,392. **MONKEY N MIDDLE (STANDARD CHARACTER)**. MONKEY N MIDDLE, INC., (U.S. CLS. 100, 101 AND 102). SN 85-458,824. PUB. 4-10-2012. FILED 10-28-2011.
- 4,164,393. **MONKEY N MIDDLE.COM AND DESIGN**. MONKEY N MIDDLE, INC., (U.S. CLS. 100, 101 AND 102). SN 85-458,844. PUB. 4-10-2012. FILED 10-28-2011.
- 4,164,412. **THE SKILLERY (STANDARD CHARACTER)**. THE SKILLERY, LLC, (U.S. CLS. 100, 101 AND 102). SN 85-459,004. PUB. 4-10-2012. FILED 10-28-2011.
- 4,164,413. **MLCI (STANDARD CHARACTER)**. CAMPION BARROW AND ASSOCIATES OF ILLINOIS, INC, (U.S. CLS. 100, 101 AND 102). SN 85-459,019. PUB. 4-10-2012. FILED 10-28-2011.
- 4,164,418. **WHERE CULTURE AND CAPABILITIES MEET (STANDARD CHARACTER)**. SECURIAN FINANCIAL GROUP, INC., (U.S. CLS. 100, 101 AND 102). SN 85-459,084. PUB. 4-10-2012. FILED 10-28-2011.
- 4,164,442. **NOVA FOR PPM (STANDARD CHARACTER)**. KALYPSO LP, (U.S. CLS. 100, 101 AND 102). SN 85-459,405. PUB. 4-10-2012. FILED 10-28-2011.
- 4,164,464. **YOUR CPA FIRM ON THE CLOUD (STANDARD CHARACTER)**. JANKOVIC LLC, (U.S. CLS. 100, 101 AND 102). SN 85-459,599. PUB. 4-10-2012. FILED 10-28-2011.
- 4,164,465. **THE BIKINI FOX AND DESIGN**. BELL, CHELSEA L, (U.S. CLS. 100, 101 AND 102). SN 85-459,618. PUB. 4-10-2012. FILED 10-29-2011.
- 4,164,474. **HONEYMOON PIXIE AND DESIGN**. HONEYMOON PIXIE, LLC, DBA HONEYMOONPIXIE.COM, (U.S. CLS. 100, 101 AND 102). SN 85-459,730. PUB. 4-10-2012. FILED 10-29-2011.
- 4,164,489. **MYRECRUITING (STANDARD CHARACTER)**. MCINTYRE & YOUNGBLOOD RECRUITING, LLC, (U.S. CLS. 100, 101 AND 102). SN 85-459,852. PUB. 4-10-2012. FILED 10-30-2011.
- 4,164,491. **YOUFLIX (STANDARD CHARACTER)**. DOAN, THAI CHAU, (U.S. CLS. 100, 101 AND 102). SN 85-459,900. PUB. 4-10-2012. FILED 10-30-2011.
- 4,164,492. **ARCASUN (STANDARD CHARACTER)**. ARCASUN LLC, (U.S. CLS. 100, 101 AND 102). SN 85-459,908. PUB. 4-10-2012. FILED 10-30-2011.
- 4,164,493. **WATTAGE (STANDARD CHARACTER)**. WATSON CAMERON LLC, DBA WATCAM, (U.S. CLS. 100, 101 AND 102). SN 85-459,913. PUB. 4-10-2012. FILED 10-30-2011.
- 4,164,496. **BEYOND GUIDANCE. RESULTS. (STANDARD CHARACTER)**. J.J.B. HILLIARD, W.L. LYONS, LLC, DBA HILLIARD LYONS, MULTIPLE CLASS, (INT. CLS. 35 AND 36), (U.S. CLS. 100, 101 AND 102). SN 85-459,961. PUB. 4-10-2012. FILED 10-31-2011.
- 4,164,507. **ASPN (STANDARD CHARACTER)**. ASPN PHARMACIES, LLC, (U.S. CLS. 100, 101 AND 102). SN 85-460,129. PUB. 4-10-2012. FILED 10-31-2011.
- 4,164,509. **PHUNRAISER AND DESIGN**. BLUE SPYDER MOBILE MEDIA, DBA PHUNRAISER, (U.S. CLS. 100, 101 AND 102). SN 85-460,187. PUB. 4-10-2012. FILED 10-31-2011.
- 4,164,522. **LIGHTBULBU (STANDARD CHARACTER)**. LEVECK LIGHTING PRODUCTS, INC., (U.S. CLS. 100, 101 AND 102). SN 85-460,374. PUB. 4-10-2012. FILED 10-31-2011.
- 4,164,526. **DROPTHOUGHT (STANDARD CHARACTER)**. DROPTHOUGHT, INC., (U.S. CLS. 100, 101 AND 102). SN 85-460,429. PUB. 4-10-2012. FILED 10-31-2011.
- 4,164,530. **SURPRISES BY MAIL.COM AND DESIGN**. SURPRISES BY MAIL, LTD, (U.S. CLS. 100, 101 AND 102). SN 85-460,466. PUB. 4-10-2012. FILED 10-31-2011.
- 4,164,533. **CAR-MERCIAL (STANDARD CHARACTER)**. AUTOMOTIVE WEBMERCIALS, LLC, (U.S. CLS. 100, 101 AND 102). SN 85-460,492. PUB. 4-10-2012. FILED 10-31-2011.
- 4,164,537. **CAR-MERCIAL AND DESIGN**. AUTOMOTIVE WEBMERCIALS, LLC, (U.S. CLS. 100, 101 AND 102). SN 85-460,544. PUB. 4-10-2012. FILED 10-31-2011.
- 4,164,551. **FATDUX (STANDARD CHARACTER)**. THE FATDUX GROUP APS, (U.S. CLS. 100, 101 AND 102). SN 85-460,724. PUB. 4-10-2012. FILED 10-31-2011.
- 4,164,552. **VSW SEARCH (STANDARD CHARACTER)**. VERTICAL SEARCH WORKS, INC., (U.S. CLS. 100, 101 AND 102). SN 85-460,759. PUB. 4-10-2012. FILED 10-31-2011.
- 4,164,557. **INMUSIC (STANDARD CHARACTER)**. INMUSIC, LLC, (U.S. CLS. 100, 101 AND 102). SN 85-460,819. PUB. 4-10-2012. FILED 10-31-2011.
- 4,164,562. **ASK FOR ARIZONA AND DESIGN**. HENSLEY & COMPANY, (U.S. CLS. 100, 101 AND 102). SN 85-460,877. PUB. 4-10-2012. FILED 10-31-2011.
- 4,164,586. **NEW WORLD AVIATION (STANDARD CHARACTER)**. NEW WORLD AVIATION, INC, MULTIPLE CLASS, (INT. CLS. 35, 37, 39 AND 45), (U.S. CLS. 100, 101, 102, 103, 105 AND 106). SN 85-461,314. PUB. 4-10-2012. FILED 11-1-2011.
- 4,164,588. **ABSOLUTE MICHIGAN (STANDARD CHARACTER)**. MCFARLANE, ANDREW L, (U.S. CLS. 100, 101 AND 102). SN 85-461,409. PUB. 4-10-2012. FILED 11-1-2011.
- 4,164,591 (*See Class 9 for this trademark*).

- 4,164,592. **JUST BE COOL**. (STANDARD CHARACTER). MCNEILL, GAVIN. (U.S. CLS. 100, 101 AND 102). SN 85-461,584. PUB. 4-10-2012. FILED 11-1-2011.
- 4,164,593. **BRAIN SURGERY** (STANDARD CHARACTER). THE BRAIN SURGERY GROUP, INC., (U.S. CLS. 100, 101 AND 102). SN 85-461,636. PUB. 4-10-2012. FILED 11-1-2011.
- 4,164,594. **WATCH ALLURE** (STANDARD CHARACTER). RAJIC, SAMIR. (U.S. CLS. 100, 101 AND 102). SN 85-461,791. PUB. 4-10-2012. FILED 11-1-2011.
- 4,164,595. **NAME AND DESIGN**. NATIONAL ASSOCIATION OF MINIATURE ENTHUSIASTS, (U.S. CLS. 100, 101 AND 102). SN 85-461,825. PUB. 4-10-2012. FILED 11-1-2011.
- 4,164,600. **PLYMOUTH ROCK ENERGY** (STANDARD CHARACTER). PLYMOUTH ROCK ENERGY, MULTIPLE CLASS, (INT. CLS. 35 AND 36), (U.S. CLS. 100, 101 AND 102). SN 85-462,608. PUB. 4-10-2012. FILED 11-2-2011.
- 4,164,601. **M AND DESIGN**. MASTER'S TRANSPORTATION, INC., MULTIPLE CLASS, (INT. CLS. 35, 37 AND 39), (U.S. CLS. 100, 101, 102, 103, 105 AND 106). SN 85-462,753. PUB. 4-10-2012. FILED 11-2-2011.
- 4,164,602. **AGE** (STANDARD CHARACTER). AMERICAN GOLD EXCHANGE, INC., (U.S. CLS. 100, 101 AND 102). SN 85-462,809. PUB. 4-10-2012. FILED 11-2-2011.
- 4,164,610. **LASH IMPRESSIONS WEARELASHIOUS.COM AND DESIGN**. GONZALES, MARY NINA. (U.S. CLS. 100, 101 AND 102). SN 85-463,960. PUB. 4-10-2012. FILED 11-3-2011.
- 4,164,623. **OUT-&OUT MARKETING** (STANDARD CHARACTER). DIMALANTA, ERNIE, MULTIPLE CLASS, (INT. CLS. 35 AND 41), (U.S. CLS. 100, 101, 102 AND 107). SN 85-466,503. PUB. 4-10-2012. FILED 11-7-2011.
- 4,164,634. **IGR WWW.INSTA-GATOR-RACING.COM AND DESIGN**. INSTA-GATOR CHOPPERS, LLC, MULTIPLE CLASS, (INT. CLS. 35 AND 37), (U.S. CLS. 100, 101, 102, 103 AND 106). SN 85-468,083. PUB. 4-10-2012. FILED 11-9-2011.
- 4,164,635. **AG INSIGHT JOIN THE CONVERSATION AND DESIGN**. BECK AG, INC., (U.S. CLS. 100, 101 AND 102). SN 85-468,239. PUB. 4-10-2012. FILED 11-9-2011.
- 4,164,636. **BECK AG JOIN THE CONVERSATION AND DESIGN**. BECK AG, INC., (U.S. CLS. 100, 101 AND 102). SN 85-468,253. PUB. 4-10-2012. FILED 11-9-2011.
- 4,164,646. **BRANDING STRATEGY INSIDER** (STANDARD CHARACTER). BLAKE PROJECT, INC., THE, (U.S. CLS. 100, 101 AND 102). SN 85-468,951. PUB. 4-10-2012. FILED 11-9-2011.
- 4,164,655. **MOGO MARKETING + MEDIA INC** (STANDARD CHARACTER). MOGO MARKETING AND MEDIA, INC., (U.S. CLS. 100, 101 AND 102). SN 85-470,621. PUB. 4-10-2012. FILED 11-11-2011.
- 4,164,662. **WHIMSY WHIMS** (STANDARD CHARACTER). ANN MARIE ZORZI, (U.S. CLS. 100, 101 AND 102). SN 85-472,253. PUB. 4-10-2012. FILED 11-14-2011.
- 4,164,663. **COUPONCRAZE.COM** (STANDARD CHARACTER). FLASHVIC, INC., (U.S. CLS. 100, 101 AND 102). SN 85-472,380. PUB. 4-10-2012. FILED 11-14-2011.
- 4,164,666. **COUPONCRAZE** (STANDARD CHARACTER). FLASHVIC, INC., (U.S. CLS. 100, 101 AND 102). SN 85-472,571. PUB. 4-10-2012. FILED 11-15-2011.
- 4,164,667. **TIMELY AND ACCURATE EVERY TIME** (STANDARD CHARACTER). CONSERVICE, LLC, MULTIPLE CLASS, (INT. CLS. 35 AND 39), (U.S. CLS. 100, 101, 102 AND 105). SN 85-472,809. PUB. 4-10-2012. FILED 11-15-2011.
- 4,164,708. **READY INDIAN COUNTRY PREPARE. PLAN. STAY INFORMED. AND DESIGN**. U.S. DEPARTMENT OF HOMELAND SECURITY, MULTIPLE CLASS, (INT. CLS. 35 AND 45), (U.S. CLS. 100, 101 AND 102). SN 85-483,624. PUB. 4-10-2012. FILED 11-30-2011.
- 4,164,709. **"...FINDING SOLUTIONS FOR FAMILIES, ESPECIALLY BUSY MOMS."** (STANDARD CHARACTER). KATHY IRELAND WORLDWIDE, (U.S. CLS. 100, 101 AND 102). SN 85-484,285. PUB. 4-10-2012. FILED 11-30-2011.
- 4,164,728. **KROGER** (STANDARD CHARACTER). THE KROGER CO. OF MICHIGAN, (U.S. CLS. 100, 101 AND 102). SN 85-489,540. PUB. 4-10-2012. FILED 12-7-2011.
- 4,164,730. **SANTA HAS ELVES. YOU HAVE TARGET.** (STANDARD CHARACTER). TARGET BRANDS, INC., (U.S. CLS. 100, 101 AND 102). SN 85-491,765. PUB. 4-10-2012. FILED 12-9-2011.
- 4,164,736. **MAMMOGRAM A FRIEND** (STANDARD CHARACTER). THE CARLE FOUNDATION, (U.S. CLS. 100, 101 AND 102). SN 85-495,009. PUB. 4-10-2012. FILED 12-14-2011.
- 4,164,750. **AMA** (STANDARD CHARACTER). AMERICAN MEDICAL ASSOCIATION, (U.S. CLS. 100, 101 AND 102). SN 85-505,647. PUB. 4-10-2012. FILED 12-29-2011.
- 4,164,753. **RCC WESTERN STORES AND DESIGN**. RCC WESTERN STORES, INC., (U.S. CLS. 100, 101 AND 102). SN 85-506,201. PUB. 4-10-2012. FILED 12-30-2011.
- 4,164,754. **KEEPING YOU AHEAD OF TECHNOLOGY** (STANDARD CHARACTER). KEY CODE MEDIA, INC., DBA KEY CODE MEDIA, INC., (U.S. CLS. 100, 101 AND 102). SN 85-506,359. PUB. 4-10-2012. FILED 12-30-2011.
- 4,164,757. **CITIBANK DEALS ABOUT TOWN** (STYLIZED). CITIGROUP INC., (U.S. CLS. 100, 101 AND 102). SN 85-510,327. PUB. 4-10-2012. FILED 1-6-2012.

CLASS 36—INSURANCE AND FINANCIAL

- 4,162,690. **DIMEXPRESS**. THE DIME SAVINGS BANK OF NEW YORK, FSB, (U.S. CLS. 100, 101 AND 102). SN 75-573,472. PUB. 4-10-2012. FILED 10-19-1998.
- 4,162,691 (*See Class 25 for this trademark.*)
- 4,162,756. **MOBILE MONEY FASTTRACK** (STANDARD CHARACTER). FISERV, INC., (U.S. CLS. 100, 101 AND 102). SN 77-751,786. PUB. 4-10-2012. FILED 6-4-2009.
- 4,162,757. **TWO RIVER COMMUNITY BANK** (STANDARD CHARACTER). TWO RIVER COMMUNITY BANK, (U.S. CLS. 100, 101 AND 102). SN 77-757,142. PUB. 7-6-2010. FILED 6-11-2009.
- 4,162,778. **TWO RIVER COMMUNITY BANK AND DESIGN**. TWO RIVER COMMUNITY BANK, (U.S. CLS. 100, 101 AND 102). SN 77-937,680. PUB. 7-27-2010. FILED 2-17-2010.
- 4,162,781. **BLACK COFFEE GALLERY ART AND COFFEE MADE BY ARTISTS AND DESIGN**. CAFE NEGRO GALLERY, S. DE R.L. DE C.V., (U.S. CLS. 100, 101 AND 102). SN 77-949,667. PUB. 4-10-2012. FILED 3-3-2010.
- 4,162,793. **WASHINGTON TRUST** (STANDARD CHARACTER). THE WASHINGTON TRUST COMPANY, (U.S. CLS. 100, 101 AND 102). SN 78-579,574. PUB. 7-24-2007. FILED 3-3-2005.
- 4,162,794. **WASHINGTON TRUST INVESTORS** (STANDARD CHARACTER). WASHINGTON TRUST COMPANY, (U.S. CLS. 100, 101 AND 102). SN 78-731,770. PUB. 7-17-2007. FILED 10-12-2005.
- 4,162,796. **DUNDEE FINANCIAL PLACE** (STANDARD CHARACTER). DUNDEE CORPORATION, (U.S. CLS. 100, 101 AND 102). SN 78-766,980. PUB. 4-10-2012. FILED 12-5-2005.
- 4,162,802. **CITIC** (STYLIZED). CITIC GROUP, (U.S. CLS. 100, 101 AND 102). SN 79-055,787. PUB. 3-3-2009. FILED 3-11-2008.
- 4,162,812 (*See Class 6 for this trademark.*)
- 4,162,856 (*See Class 9 for this trademark.*)
- 4,162,877. **VONLIFE** (STANDARD CHARACTER). HOLZHAUSEN PTY LTD AS TRUSTEE FOR VONLIFE TRUST, (U.S. CLS. 100, 101 AND 102). SN 79-097,286. PUB. 4-10-2012. FILED 4-1-2011.
- 4,162,885 (*See Class 9 for this trademark.*)
- 4,162,917 (*See Class 16 for this trademark.*)
- 4,162,920 (*See Class 16 for this trademark.*)
- 4,162,921 (*See Class 16 for this trademark.*)
- 4,162,922 (*See Class 16 for this trademark.*)
- 4,162,923 (*See Class 16 for this trademark.*)
- 4,162,979 (*See Class 16 for this trademark.*)
- 4,162,995 (*See Class 5 for this trademark.*)
- 4,162,999 (*See Class 9 for this trademark.*)
- 4,163,014. **XPAD AND DESIGN**. X-TRADE BROKERS DOM MAKLESKI S.A., (U.S. CLS. 100, 101 AND 102). SN 79-104,339. PUB. 4-10-2012. FILED 8-9-2011.
- 4,163,018. **X XSTATION AND DESIGN**. X-TRADE BROKERS DOM MAKLESKI S.A., (U.S. CLS. 100, 101 AND 102). SN 79-104,565. PUB. 4-10-2012. FILED 8-9-2011.
- 4,163,026 (*See Class 9 for this trademark.*)
- 4,163,054. **ONEENERGY RENEWABLES** (STANDARD CHARACTER). ONEENERGY, INC., DBA ONEENERGY RENEWABLES, MULTIPLE CLASS, (INT. CLS. 36 AND 40),

- (U.S. CLS. 100, 101, 102, 103 AND 106). SN 85-017,924. PUB. 4-5-2011. FILED 4-20-2010.
- 4,163,069. **ZBI VENTURES (STANDARD CHARACTER)**, ZIFF BROTHERS INVESTMENTS, L.L.C., (U.S. CLS. 100, 101 AND 102). SN 85-075,893. PUB. 4-10-2012. FILED 7-1-2010.
- 4,163,071. **ZBI VENTURES AND DESIGN**, ZIFF BROTHERS INVESTMENTS, L.L.C., (U.S. CLS. 100, 101 AND 102). SN 85-078,760. PUB. 4-10-2012. FILED 7-6-2010.
- 4,163,079 (*See Class 5 for this trademark*).
- 4,163,085. **EXOTIX AND DESIGN**, EXOTIX LIMITED, (U.S. CLS. 100, 101 AND 102). SN 85-111,091. PUB. 2-14-2012. FILED 8-19-2010.
- 4,163,086. **EXOTIX (STANDARD CHARACTER)**, EXOTIX LIMITED, (U.S. CLS. 100, 101 AND 102). SN 85-111,326. PUB. 2-14-2012. FILED 8-19-2010.
- 4,163,108. **AVC ARMOR (STANDARD CHARACTER)**, APPLIED VISUAL COMMUNICATIONS INC., MULTIPLE CLASS, (INT. CLS. 36, 37 AND 42), (U.S. CLS. 100, 101, 102, 103 AND 106). SN 85-141,535. PUB. 4-10-2012. FILED 9-29-2010.
- 4,163,109. **3YW (STANDARD CHARACTER)**, APPLIED VISUAL COMMUNICATIONS INC., (U.S. CLS. 100, 101 AND 102). SN 85-141,537. PUB. 4-10-2012. FILED 9-29-2010.
- 4,163,139. **INSURE MY PARTS (STANDARD CHARACTER)**, GIRARD, RENE, E., (U.S. CLS. 100, 101 AND 102). SN 85-165,692. PUB. 3-29-2011. FILED 10-31-2010.
- 4,163,148 (*See Class 35 for this trademark*).
- 4,163,151. **JAGADGURU KRIPALUJI YOG (STANDARD CHARACTER)**, JAGADGURU KRIPALUJI YOG, MULTIPLE CLASS, (INT. CLS. 36, 41 AND 45), (U.S. CLS. 100, 101, 102 AND 107). SN 85-175,587. PUB. 4-10-2012. FILED 11-12-2010.
- 4,163,173. **SOCIAL COINS (STANDARD CHARACTER)**, VISIONSYNC, INC., (U.S. CLS. 100, 101 AND 102). SN 85-208,762. PUB. 4-10-2012. FILED 1-1-2011.
- 4,163,229. **LEXINGTON PARTNERS AND DESIGN**, LEXINGTON PARTNERS ADVISORS L.P., FORMERLY LEXINGTON PARTNERS ADVISORS L.P., (U.S. CLS. 100, 101 AND 102). SN 85-264,987. PUB. 4-10-2012. FILED 3-11-2011.
- 4,163,230. **LEXINGTON PARTNERS (STANDARD CHARACTER)**, LEXINGTON PARTNERS ADVISORS L.P., FORMERLY LEXINGTON PARTNERS ADVISORS L.P., (U.S. CLS. 100, 101 AND 102). SN 85-265,011. PUB. 4-10-2012. FILED 3-11-2011.
- 4,163,237 (*See Class 35 for this trademark*).
- 4,163,254. **PINGAN AND DESIGN**, PING AN INSURANCE (GROUP) COMPANY OF CHINA, LTD., (U.S. CLS. 100, 101 AND 102). SN 85-278,747. PUB. 1-24-2012. FILED 3-28-2011.
- 4,163,262. **WHAT IF YOU COULD CHANGE THE WORLD? (STANDARD CHARACTER)**, GIVE CLEAN WATER INC., (U.S. CLS. 100, 101 AND 102). SN 85-284,298. PUB. 4-10-2012. FILED 4-1-2011.
- 4,163,273. **HEALTH INSURANCE OPTIONS LLC AND DESIGN**, HEALTH INSURANCE OPTIONS LLC, (U.S. CLS. 100, 101 AND 102). SN 85-288,596. PUB. 4-10-2012. FILED 4-7-2011.
- 4,163,279 (*See Class 35 for this trademark*).
- 4,163,280 (*See Class 35 for this trademark*).
- 4,163,288. **DORALBANKDIRECT (STYLIZED)**, DORAL FINANCIAL CORPORATION, (U.S. CLS. 100, 101 AND 102). SN 85-291,814. PUB. 4-10-2012. FILED 4-11-2011.
- 4,163,325 (*See Class 35 for this trademark*).
- 4,163,345. **I'M WITH THE BAND (STANDARD CHARACTER)**, MALIN, AMY, FORMERLY BALSAM, AMY, (U.S. CLS. 100, 101 AND 102). SN 85-305,541. PUB. 4-10-2012. FILED 4-27-2011.
- 4,163,356. **THE PREFERRED EDGE (STANDARD CHARACTER)**, PREFERRED GOVERNMENTAL INSURANCE TRUST, (U.S. CLS. 100, 101 AND 102). SN 85-306,619. PUB. 4-10-2012. FILED 4-27-2011.
- 4,163,357. **PREFERRED GOVERNMENTAL INSURANCE TRUST PGIT AND DESIGN**, PREFERRED GOVERNMENTAL INSURANCE TRUST, (U.S. CLS. 100, 101 AND 102). SN 85-306,638. PUB. 4-10-2012. FILED 4-27-2011.
- 4,163,362. **AMA INSURANCE AGENCY (STANDARD CHARACTER)**, AMA INSURANCE AGENCY, INC., (U.S. CLS. 100, 101 AND 102). SN 85-307,103. PUB. 4-10-2012. FILED 4-28-2011.
- 4,163,363 (*See Class 35 for this trademark*).
- 4,163,384. **KITCHELL (STANDARD CHARACTER)**, KITCHELL CORPORATION, MULTIPLE CLASS, (INT. CLS. 36, 37, 39 AND 42), (U.S. CLS. 100, 101, 102, 103, 105 AND 106). SN 85-309,215. PUB. 4-10-2012. FILED 4-30-2011.
- 4,163,385. **KITCHELL AND DESIGN**, KITCHELL CORPORATION, MULTIPLE CLASS, (INT. CLS. 36, 37, 39 AND 42), (U.S. CLS. 100, 101, 102, 103, 105 AND 106). SN 85-309,220. PUB. 4-10-2012. FILED 4-30-2011.
- 4,163,391. **THE TAX-EXEMPT FUND OF MARYLAND (STANDARD CHARACTER)**, TRUSTEES, THE AMERICAN FUNDS TAX-EXEMPT SERIES I, (U.S. CLS. 100, 101 AND 102). SN 85-309,588. PUB. 4-10-2012. FILED 5-2-2011.
- 4,163,392. **THE TAX-EXEMPT FUND OF VIRGINIA (STANDARD CHARACTER)**, TRUSTEES, THE AMERICAN FUNDS TAX-EXEMPT SERIES I, (U.S. CLS. 100, 101 AND 102). SN 85-309,607. PUB. 4-10-2012. FILED 5-2-2011.
- 4,163,409. **KBR VENTURES (STANDARD CHARACTER)**, KELLOGG BROWN & ROOT LLC, (U.S. CLS. 100, 101 AND 102). SN 85-311,290. PUB. 4-10-2012. FILED 5-3-2011.
- 4,163,410 (*See Class 35 for this trademark*).
- 4,163,412. **PHYSICIANS FINANCIAL PARTNERS AND DESIGN**, AMA INSURANCE AGENCY, INC., (U.S. CLS. 100, 101 AND 102). SN 85-312,071. PUB. 4-10-2012. FILED 5-4-2011.
- 4,163,433. **MATCH THE PROMISE FOUNDATION AND DESIGN**, TEXAS PREPAID HIGHER EDUCATION TUITION BOARD, (U.S. CLS. 100, 101 AND 102). SN 85-314,657. PUB. 4-10-2012. FILED 5-6-2011.
- 4,163,445. **MISCELLANEOUS DESIGN**, DUSTY FEET, INC., (U.S. CLS. 100, 101 AND 102). SN 85-318,101. PUB. 11-8-2011. FILED 5-11-2011.
- 4,163,485. **HOUSTON ZOMBIE WALK AND DESIGN**, THE HOUSTON/BAYOU CITY ZOMBIE WALK, (U.S. CLS. 100, 101 AND 102). SN 85-330,849. PUB. 4-10-2012. FILED 5-26-2011.
- 4,163,486 (*See Class 35 for this trademark*).
- 4,163,521 (*See Class 35 for this trademark*).
- 4,163,532. **MILL CREEK CAPITAL ADVISORS (STANDARD CHARACTER)**, MILL CREEK CAPITAL ADVISORS, LLC, (U.S. CLS. 100, 101 AND 102). SN 85-347,196. PUB. 4-10-2012. FILED 6-15-2011.
- 4,163,539. **RESCUE, REHAB, RETRAIN, REHOME. (STANDARD CHARACTER)**, GENTLE GIANTS DRAFT HORSE RESCUE SOCIETY, LTD., AKA GENTLE GIANTS, MULTIPLE CLASS, (INT. CLS. 36 AND 45), (U.S. CLS. 100, 101 AND 102). SN 85-349,394. PUB. 4-10-2012. FILED 6-17-2011.
- 4,163,579 (*See Class 35 for this trademark*).
- 4,163,627. **RUSHSTAR WIRELESS WIRELESS DELIVERED FAST & SIMPLE AND DESIGN**, RUSH STAR WIRELESS, INC., DBA RUSHSTAR WIRELESS, (U.S. CLS. 100, 101 AND 102). SN 85-381,155. PUB. 4-10-2012. FILED 7-26-2011.
- 4,163,642. **MISCELLANEOUS DESIGN**, VIRGINIA COOK REALTORS, (U.S. CLS. 100, 101 AND 102). SN 85-383,241. PUB. 4-10-2012. FILED 7-28-2011.
- 4,163,649 (*See Class 35 for this trademark*).
- 4,163,686. **BAAM (STANDARD CHARACTER)**, BLACKSTONE ALTERNATIVE ASSET MANAGEMENT L.P., (U.S. CLS. 100, 101 AND 102). SN 85-396,811. PUB. 4-10-2012. FILED 8-12-2011.
- 4,163,692. **ALLSUP MEDICARE COORDINATION SERVICES (STANDARD CHARACTER)**, ALLSUP, INC., (U.S. CLS. 100, 101 AND 102). SN 85-400,558. PUB. 4-10-2012. FILED 8-17-2011.
- 4,163,723. **HORIZON KINETICS (STANDARD CHARACTER)**, HORIZON KINETICS LLC, (U.S. CLS. 100, 101 AND 102). SN 85-411,386. PUB. 4-10-2012. FILED 8-31-2011.
- 4,163,733 (*See Class 35 for this trademark*).
- 4,163,755. **YORK TRADITIONS (STANDARD CHARACTER)**, YORK TRADITIONS BANK, (U.S. CLS. 100, 101 AND 102). SN 85-417,942. PUB. 4-10-2012. FILED 9-8-2011.
- 4,163,756. **SUMRIDGE PARTNERS (STANDARD CHARACTER)**, SUMRIDGE PARTNERS, LLC, (U.S. CLS. 100, 101 AND 102). SN 85-418,004. PUB. 4-10-2012. FILED 9-8-2011.
- 4,163,757. **WEALTH MANAGEMENT FIXED INCOME - EVEN THE ODDS (STANDARD CHARACTER)**, SUMRIDGE PARTNERS, LLC, (U.S. CLS. 100, 101 AND 102). SN 85-418,018. PUB. 4-10-2012. FILED 9-8-2011.

- 4,163,773. **SUPER FAN SPORTS FUNDRAISING SF2 AND DESIGN**. SUPER FAN SPORTS FUNDRAISING, LLC., (U.S. CLS. 100, 101 AND 102). SN 85-422,069. PUB. 4-10-2012. FILED 9-14-2011.
- 4,163,785. **SUMRIDGE PARTNERS AND DESIGN**. SUMRIDGE PARTNERS, LLC, (U.S. CLS. 100, 101 AND 102). SN 85-426,056. PUB. 4-10-2012. FILED 9-19-2011.
- 4,163,793. **PENTUCKET BANK ON TRACK TOGETHER SINCE 1891 AND DESIGN**. PENTUCKET BANK, (U.S. CLS. 100, 101 AND 102). SN 85-427,304. PUB. 4-10-2012. FILED 9-20-2011.
- 4,163,838 (*See Class 25 for this trademark*).
- 4,163,839 (*See Class 25 for this trademark*).
- 4,163,848. **GAY IT FORWARD (STANDARD CHARACTER)**. SKYFISH MEDIA LLC, DBA UNICORN BOOTY, (U.S. CLS. 100, 101 AND 102). SN 85-434,695. PUB. 4-10-2012. FILED 9-28-2011.
- 4,163,885. **LMP AND DESIGN**. LEGION OF YOUNG POLISH WOMEN, (U.S. CLS. 100, 101 AND 102). SN 85-438,824. PUB. 4-10-2012. FILED 10-4-2011.
- 4,163,907. **CU PROMISE (STANDARD CHARACTER)**. CUSO MORTGAGE CORP., (U.S. CLS. 100, 101 AND 102). SN 85-441,778. PUB. 4-10-2012. FILED 10-7-2011.
- 4,163,910. **CU PROMISE HOME LOANS FOR MAINE AND DESIGN**. CUSO MORTGAGE CORP., (U.S. CLS. 100, 101 AND 102). SN 85-441,839. PUB. 4-10-2012. FILED 10-7-2011.
- 4,163,922 (*See Class 35 for this trademark*).
- 4,163,923. **CUSTOMER SERVICE IS OUR POLICY (STYLIZED)**. MOSS INSURANCE AGENCY, INC., DBA PIONEER BUSINESS INSURANCE AGENCY, (U.S. CLS. 100, 101 AND 102). SN 85-443,351. PUB. 4-10-2012. FILED 10-10-2011.
- 4,163,931. **S.T.A.R. CLUB (STANDARD CHARACTER)**. REDSTONE FEDERAL CREDIT UNION, (U.S. CLS. 100, 101 AND 102). SN 85-443,995. PUB. 4-10-2012. FILED 10-11-2011.
- 4,163,939. **THE FPFC MARKET REPORT (STANDARD CHARACTER)**. FRESH PRODUCE & FLORAL COUNCIL, (U.S. CLS. 100, 101 AND 102). SN 85-444,823. PUB. 4-10-2012. FILED 10-11-2011.
- 4,163,942. **RESEARCH. RANKINGS. RESULTS. (STANDARD CHARACTER)**. THEINSURANCEADVISOR.COM, INC., (U.S. CLS. 100, 101 AND 102). SN 85-445,701. PUB. 4-10-2012. FILED 10-12-2011.
- 4,163,953. **CLOTHES FOR CURES (STANDARD CHARACTER)**. PROPER, MARK D., (U.S. CLS. 100, 101 AND 102). SN 85-446,506. PUB. 4-10-2012. FILED 10-13-2011.
- 4,163,965 (*See Class 35 for this trademark*).
- 4,163,975. **TAHOE LUXURY PROPERTIES AND DESIGN**. TAHOE LUXURY PROPERTIES, INC., (U.S. CLS. 100, 101 AND 102). SN 85-448,146. PUB. 4-10-2012. FILED 10-14-2011.
- 4,163,990. **LOAN ASSURE (STANDARD CHARACTER)**. PRIMAVERA FINANCIAL, INC., (U.S. CLS. 100, 101 AND 102). SN 85-449,337. PUB. 4-10-2012. FILED 10-17-2011.
- 4,164,003. **MISCELLANEOUS DESIGN**. NATIONAL CONDO & APARTMENT INSURANCE GROUP, LLC, (U.S. CLS. 100, 101 AND 102). SN 85-450,475. PUB. 4-10-2012. FILED 10-18-2011.
- 4,164,020. **GROVE ARCADE (STANDARD CHARACTER)**. GROVE ARCADE RESTORATION, LLC, (U.S. CLS. 100, 101 AND 102). SN 85-451,096. PUB. 4-10-2012. FILED 10-19-2011.
- 4,164,031. **INVESTED FOR FIFTY YEARS 50 SINCE 1960 AND DESIGN**. THE TRUSTEES OF THE WASHINGTON REAL ESTATE INVESTMENT TRUST, (U.S. CLS. 100, 101 AND 102). SN 85-451,702. PUB. 4-10-2012. FILED 10-20-2011.
- 4,164,032. **INVESTED FOR FIFTY YEARS 50 SINCE 1960 CELEBRATING 50 YEARS AND DESIGN**. THE TRUSTEES OF THE WASHINGTON REAL ESTATE INVESTMENT TRUST, (U.S. CLS. 100, 101 AND 102). SN 85-451,704. PUB. 4-10-2012. FILED 10-20-2011.
- 4,164,043. **NATIONAL CAPITAL AND DESIGN**. NATIONAL CAPITAL GROUP, LLC, (U.S. CLS. 100, 101 AND 102). SN 85-452,381. PUB. 4-10-2012. FILED 10-20-2011.
- 4,164,058. **NISA INVESTMENT ADVISORS, L.L.C. (STANDARD CHARACTER)**. NISA INVESTMENT ADVISORS, L.L.C., (U.S. CLS. 100, 101 AND 102). SN 85-453,020. PUB. 4-10-2012. FILED 10-21-2011.
- 4,164,159. **WHITEWOLF CAPITAL LLC AND DESIGN**. AZAR, ELIE P., (U.S. CLS. 100, 101 AND 102). SN 85-455,776. PUB. 4-10-2012. FILED 10-25-2011.
- 4,164,182. **GIVE TO WIN AND DESIGN**. GIVE TO WIN, INC., (U.S. CLS. 100, 101 AND 102). SN 85-456,275. PUB. 4-10-2012. FILED 10-26-2011.
- 4,164,184. **G AND DESIGN**. GIVE TO WIN, INC., (U.S. CLS. 100, 101 AND 102). SN 85-456,285. PUB. 4-10-2012. FILED 10-26-2011.
- 4,164,202. **CAREONE DEBT RELIEF SERVICES (STANDARD CHARACTER)**. 3C INCORPORATED, (U.S. CLS. 100, 101 AND 102). SN 85-456,793. PUB. 4-10-2012. FILED 10-26-2011.
- 4,164,283. **R REAL PROPERTY MANAGEMENT AND DESIGN**. REAL PROPERTY MANAGEMENT, INC., (U.S. CLS. 100, 101 AND 102). SN 85-457,895. PUB. 4-10-2012. FILED 10-27-2011.
- 4,164,296. **READING CO-OPERATIVE BANK (STANDARD CHARACTER)**. READING CO-OPERATIVE BANK, (U.S. CLS. 100, 101 AND 102). SN 85-457,966. PUB. 4-10-2012. FILED 10-27-2011.
- 4,164,300. **ASKELLIMAN (STANDARD CHARACTER)**. DOUGLAS ELLIMAN REALTY, LLC, (U.S. CLS. 100, 101 AND 102). SN 85-457,974. PUB. 4-10-2012. FILED 10-27-2011.
- 4,164,319. **WINE4PAWS AND DESIGN**. TOMASETTI, SARAH, (U.S. CLS. 100, 101 AND 102). SN 85-458,146. PUB. 4-10-2012. FILED 10-27-2011.
- 4,164,329. **MEDICAL SELECT AND DESIGN**. THE BENEFIT PLANNING GROUP, INC., (U.S. CLS. 100, 101 AND 102). SN 85-458,214. PUB. 4-10-2012. FILED 10-27-2011.
- 4,164,360. **LET'S KICK SOME RISK (STANDARD CHARACTER)**. SPORTS INSURANCE SPECIALISTS, LLC, DBA SIS, (U.S. CLS. 100, 101 AND 102). SN 85-458,492. PUB. 4-10-2012. FILED 10-27-2011.
- 4,164,367. **GID AND DESIGN**. GID INVESTMENT ADVISERS CORPORATION, MULTIPLE CLASS, (INT. CLS. 36 AND 37), (U.S. CLS. 100, 101, 102, 103 AND 106). SN 85-458,619. PUB. 4-10-2012. FILED 10-28-2011.
- 4,164,374. **FROM COTTAGES TO CASTLES, FROM BEACHFRONT TO RIVERFRONT, FROM GOLF COURSE LIVING TO ISLAND HOPPING (STANDARD CHARACTER)**. HARVEY & ASSOCIATES IN PARADISE P.A., DBA HARVEY & ASSOCIATES, (U.S. CLS. 100, 101 AND 102). SN 85-458,642. PUB. 4-10-2012. FILED 10-28-2011.
- 4,164,398. **TERAEXCHANGE (STANDARD CHARACTER)**. SPRING TRADING, INC., (U.S. CLS. 100, 101 AND 102). SN 85-458,882. PUB. 4-10-2012. FILED 10-28-2011.
- 4,164,430. **EQUITYSTATION (STANDARD CHARACTER)**. VFINANCE, INC., (U.S. CLS. 100, 101 AND 102). SN 85-459,246. PUB. 4-10-2012. FILED 10-28-2011.
- 4,164,439. **GO BUSINESS, GO. (STANDARD CHARACTER)**. MISSOURI BANK AND TRUST COMPANY OF KANSAS CITY, (U.S. CLS. 100, 101 AND 102). SN 85-459,395. PUB. 4-10-2012. FILED 10-28-2011.
- 4,164,479. **PROJECT PAZ AND DESIGN**. PROJECT PAZ, INC., (U.S. CLS. 100, 101 AND 102). SN 85-459,760. PUB. 4-10-2012. FILED 10-29-2011.
- 4,164,480. **MISCELLANEOUS DESIGN**. PROJECT PAZ, INC., (U.S. CLS. 100, 101 AND 102). SN 85-459,761. PUB. 4-10-2012. FILED 10-29-2011.
- 4,164,485. **LET THE COMPOUNDING BEGIN! (STANDARD CHARACTER)**. COASTWISE CAPITAL GROUP, LLC, (U.S. CLS. 100, 101 AND 102). SN 85-459,790. PUB. 4-10-2012. FILED 10-30-2011.
- 4,164,496 (*See Class 35 for this trademark*).
- 4,164,497. **PASADERA CAPITAL (STANDARD CHARACTER)**. PASADERA CAPITAL, LLC, DBA PASADERA CAPITAL, (U.S. CLS. 100, 101 AND 102). SN 85-459,984. PUB. 4-10-2012. FILED 10-31-2011.
- 4,164,504. **M MAXIM (STYLIZED)**. MAXIM LLC, (U.S. CLS. 100, 101 AND 102). SN 85-460,084. PUB. 4-10-2012. FILED 10-31-2011.
- 4,164,508. **HVF (STANDARD CHARACTER)**. HURON VALLEY FINANCIAL, INC., (U.S. CLS. 100, 101 AND 102). SN 85-460,162. PUB. 4-10-2012. FILED 10-31-2011.
- 4,164,516. **LOANS FOR THE BUSINESS OF LIFE (STANDARD CHARACTER)**. HURON VALLEY FINANCIAL, INC., (U.S. CLS. 100, 101 AND 102). SN 85-460,264. PUB. 4-10-2012. FILED 10-31-2011.
- 4,164,527. **BAUPOST (STANDARD CHARACTER)**. THE BAU-

- POST GROUP, L.L.C., (U.S. CLS. 100, 101 AND 102). SN 85-460,433. PUB. 4-10-2012. FILED 10-31-2011.
- 4,164,529. **SAGES & SEEKERS (STANDARD CHARACTER)**. SAGES & SEEKERS, INCORPORATED, MULTIPLE CLASS, (INT. CLS. 36 AND 41), (U.S. CLS. 100, 101, 102 AND 107). SN 85-460,465. PUB. 4-10-2012. FILED 10-31-2011.
- 4,164,540. **HOT PINK LUNCHEON (STANDARD CHARACTER)**. THE BREAST CANCER RESEARCH FOUNDATION, (U.S. CLS. 100, 101 AND 102). SN 85-460,573. PUB. 4-10-2012. FILED 10-31-2011.
- 4,164,567. **GROWING VOICES (STANDARD CHARACTER)**. GROWING VOICES, INC., (U.S. CLS. 100, 101 AND 102). SN 85-460,907. PUB. 4-10-2012. FILED 10-31-2011.
- 4,164,577. **IDEAL HOME LOANS (STANDARD CHARACTER)**. IDEAL HOME LOANS, LLC, (U.S. CLS. 100, 101 AND 102). SN 85-461,137. PUB. 4-10-2012. FILED 11-1-2011.
- 4,164,579. **DEFINING ALTERNATIVES (STANDARD CHARACTER)**. HATTERAS INVESTMENT PARTNERS, LLC, (U.S. CLS. 100, 101 AND 102). SN 85-461,229. PUB. 4-10-2012. FILED 11-1-2011.
- 4,164,596. **IMATTER PROGRAM (STANDARD CHARACTER)**. FIRST RELIANCE BANK, (U.S. CLS. 100, 101 AND 102). SN 85-461,966. PUB. 4-10-2012. FILED 11-1-2011.
- 4,164,597. **IMATTER PROGRAM (STYLIZED)**. FIRST RELIANCE BANK, (U.S. CLS. 100, 101 AND 102). SN 85-461,982. PUB. 4-10-2012. FILED 11-1-2011.
- 4,164,600 (*See Class 35 for this trademark*).
- 4,164,614. **CURENC SAN SF AND DESIGN**. CITY AND COUNTY OF SAN FRANCISCO, (U.S. CLS. 100, 101 AND 102). SN 85-464,729. PUB. 4-10-2012. FILED 11-4-2011.
- 4,164,615. **EVERBANK WEALTH MANAGEMENT (STANDARD CHARACTER)**. EVERBANK, (U.S. CLS. 100, 101 AND 102). SN 85-464,893. PUB. 4-10-2012. FILED 11-4-2011.
- 4,164,616. **LED BY YOU. GUIDED BY EXPERIENCE. (STANDARD CHARACTER)**. EVERBANK, (U.S. CLS. 100, 101 AND 102). SN 85-464,912. PUB. 4-10-2012. FILED 11-4-2011.
- 4,164,647. **STEWART ENTERPRISES (STANDARD CHARACTER)**. STEWART ENTERPRISES, INC., MULTIPLE CLASS, (INT. CLS. 36, 40 AND 45), (U.S. CLS. 100, 101, 102, 103 AND 106). SN 85-469,114. PUB. 4-10-2012. FILED 11-10-2011.
- 4,164,670. **BBCN (STANDARD CHARACTER)**. BBCN BANCORP, INC., (U.S. CLS. 100, 101 AND 102). SN 85-473,561. PUB. 4-10-2012. FILED 11-15-2011.
- 4,164,678. **ALL-AMERICAN BOOSTERS AND DESIGN**. ALL-AMERICAN PUBLISHING, LLC, (U.S. CLS. 100, 101 AND 102). SN 85-475,973. PUB. 4-10-2012. FILED 11-17-2011.
- 4,164,681. **WEST OF FIVE (STANDARD CHARACTER)**. TRILOGY INVESTMENT GROUP LLC, MULTIPLE CLASS, (INT. CLS. 36 AND 37), (U.S. CLS. 100, 101, 102, 103 AND 106). SN 85-476,426. PUB. 4-10-2012. FILED 11-18-2011.
- 4,164,682. **SETTING THE INDUSTRY STANDARD FOR PLAN LANGUAGE (STANDARD CHARACTER)**. THE PHIA GROUP, LLC, (U.S. CLS. 100, 101 AND 102). SN 85-476,525. PUB. 4-10-2012. FILED 11-18-2011.
- 4,164,700. **BBCN AND DESIGN**. BBCN BANCORP, INC., (U.S. CLS. 100, 101 AND 102). SN 85-482,168. PUB. 4-10-2012. FILED 11-29-2011.
- 4,164,701. **MISCELLANEOUS DESIGN**. BBCN BANCORP, INC., (U.S. CLS. 100, 101 AND 102). SN 85-482,173. PUB. 4-10-2012. FILED 11-29-2011.
- 4,164,703. **CALIFORNIA STATE RAILROAD MUSEUM FOUNDATION AND DESIGN**. CALIFORNIA STATE RAILROAD MUSEUM FOUNDATION, (U.S. CLS. 100, 101 AND 102). SN 85-483,007. PUB. 4-10-2012. FILED 11-29-2011.
- 4,164,704. **BBCN BANK (STANDARD CHARACTER)**. BBCN BANCORP, INC., (U.S. CLS. 100, 101 AND 102). SN 85-483,208. PUB. 4-10-2012. FILED 11-30-2011.
- 4,164,739. **BOWLING FOR THE BATTLE (STANDARD CHARACTER)**. RELENTLESS AGAINST CANCER, INC., (U.S. CLS. 100, 101 AND 102). SN 85-496,853. PUB. 4-10-2012. FILED 12-15-2011.

CLASS 37—CONSTRUCTION AND REPAIR

- 4,162,695 (*See Class 35 for this trademark*).
- 4,162,746. **THE GREEN GRASS PROJECT (STANDARD CHARACTER)**. MASTRONARDI PRODUCE LTD., (U.S. CLS. 100, 103 AND 106). SN 77-673,164. PUB. 4-10-2012. FILED 2-18-2009.
- 4,162,769. **ALTA EQUIPMENT COMPANY (STANDARD CHARACTER)**. ALTA EQUIPMENT COMPANY, INC., (U.S. CLS. 100, 103 AND 106). SN 77-864,483. PUB. 3-6-2012. FILED 11-4-2009.
- 4,162,812 (*See Class 6 for this trademark*).
- 4,162,819 (*See Class 6 for this trademark*).
- 4,162,822. **PRECAST FOUNTAIN (STANDARD CHARACTER)**. ELEMATIC GROUP OY, (U.S. CLS. 100, 103 AND 106). SN 79-088,217. PUB. 4-10-2012. FILED 9-15-2010.
- 4,162,853 (*See Class 7 for this trademark*).
- 4,162,857 (*See Class 7 for this trademark*).
- 4,162,862 (*See Class 7 for this trademark*).
- 4,162,874 (*See Class 7 for this trademark*).
- 4,162,909. **LM WIND POWER (STANDARD CHARACTER)**. LM WIND POWER A/S, MULTIPLE CLASS, (INT. CLS. 37, 40 AND 42), (U.S. CLS. 100, 101, 103 AND 106). SN 79-099,119. PUB. 4-10-2012. FILED 2-23-2011.
- 4,162,910 (*See Class 14 for this trademark*).
- 4,162,913 (*See Class 6 for this trademark*).
- 4,162,933 (*See Class 7 for this trademark*).
- 4,162,967 (*See Class 7 for this trademark*).
- 4,163,008 (*See Class 6 for this trademark*).
- 4,163,055 (*See Class 4 for this trademark*).
- 4,163,056 (*See Class 4 for this trademark*).
- 4,163,088. **TRITON DOOR SYSTEMS, INC. COMMERCIAL AND INDUSTRIAL DOOR SERVICE AND DESIGN**. TRITON DOOR SYSTEMS, INC., (U.S. CLS. 100, 103 AND 106). SN 85-114,281. PUB. 4-10-2012. FILED 8-24-2010.
- 4,163,108 (*See Class 36 for this trademark*).
- 4,163,124. **UIP GENERAL CONTRACTING INC. (STANDARD CHARACTER)**. UIP GENERAL CONTRACTING, INC., (U.S. CLS. 100, 103 AND 106). SN 85-156,235. PUB. 4-10-2012. FILED 10-19-2010.
- 4,163,161 (*See Class 10 for this trademark*).
- 4,163,162 (*See Class 10 for this trademark*).
- 4,163,187 (*See Class 35 for this trademark*).
- 4,163,205 (*See Class 9 for this trademark*).
- 4,163,206 (*See Class 9 for this trademark*).
- 4,163,207 (*See Class 9 for this trademark*).
- 4,163,211. **TECH 24 AND DESIGN**. FOODSERVICE TECHNOLOGIES, INC., AKA TECH-24, (U.S. CLS. 100, 103 AND 106). SN 85-255,783. PUB. 4-10-2012. FILED 3-2-2011.
- 4,163,214. **SUMMIT (STANDARD CHARACTER)**. SUMMIT ELECTRIC SUPPLY COMPANY, INC., (U.S. CLS. 100, 103 AND 106). SN 85-257,255. PUB. 4-10-2012. FILED 3-3-2011.
- 4,163,247 (*See Class 7 for this trademark*).
- 4,163,259. **NADER'S PEST RAIDERS AN ARROW EXTERMINATORS COMPANY SATISFACTION GUARANTEED AND DESIGN**. ARROW EXTERMINATORS, INC., (U.S. CLS. 100, 103 AND 106). SN 85-282,109. PUB. 4-10-2012. FILED 3-31-2011.
- 4,163,264. **SERVICE EXCELLENCE, IT'S IN OUR DNA (STANDARD CHARACTER)**. CONVERGINT TECHNOLOGIES LLC, (U.S. CLS. 100, 103 AND 106). SN 85-285,594. PUB. 4-10-2012. FILED 4-4-2011.
- 4,163,279 (*See Class 35 for this trademark*).
- 4,163,280 (*See Class 35 for this trademark*).
- 4,163,305. **THE PAINTED SOLE (STANDARD CHARACTER)**. NAGY-BURNS, GINA K., MULTIPLE CLASS, (INT. CLS. 37 AND 42), (U.S. CLS. 100, 101, 103 AND 106). SN 85-296,201. PUB. 4-10-2012. FILED 4-15-2011.
- 4,163,335. **A AVANT DATACOMM . SOLUTIONS AND DESIGN**. AVANT DATACOMM SOLUTIONS, INC., MULTIPLE CLASS, (INT. CLS. 37 AND 42), (U.S. CLS. 100, 101, 103 AND 106). SN 85-303,581. PUB. 4-10-2012. FILED 4-25-2011.
- 4,163,346. **PATCH + PAINT AND DESIGN**. PATCH AND PAINT, INC., (U.S. CLS. 100, 103 AND 106). SN 85-305,801. PUB. 4-10-2012. FILED 4-27-2011.
- 4,163,384 (*See Class 36 for this trademark*).
- 4,163,385 (*See Class 36 for this trademark*).
- 4,163,400. **SILVER STREET DEVELOPMENT (STANDARD CHARACTER)**. THE SILVER STREET GROUP, LLC, (U.S.

CLS. 100, 103 AND 106). SN 85-310,696. PUB. 4-10-2012. FILED 5-3-2011.

4,163,401. **A SILVER STREET COMMUNITY (STANDARD CHARACTER)**. THE SILVER STREET GROUP, LLC, (U.S. CLS. 100, 103 AND 106). SN 85-310,712. PUB. 4-10-2012. FILED 5-3-2011.

4,163,410 (*See Class 35 for this trademark*).

4,163,411 (*See Class 19 for this trademark*).

4,163,460. **THE GYM DOCTOR (STANDARD CHARACTER)**. MULLINS, MICHAEL PATRICK, DBA THE GYM DOCTOR, (U.S. CLS. 100, 103 AND 106). SN 85-322,146. PUB. 4-10-2012. FILED 5-16-2011.

4,163,510. **AUDIO & BEYOND (STANDARD CHARACTER)**. IN HOME TECH SOLUTIONS INC., (U.S. CLS. 100, 103 AND 106). SN 85-339,770. PUB. 4-10-2012. FILED 6-7-2011.

4,163,574 (*See Class 19 for this trademark*).

4,163,609 (*See Class 19 for this trademark*).

4,163,674 (*See Class 35 for this trademark*).

4,163,696. **COASTAL STATES CONTRACTORS AND DESIGN**. COASTAL STATES CONTRACTORS, INC., (U.S. CLS. 100, 103 AND 106). SN 85-402,970. PUB. 4-10-2012. FILED 8-20-2011.

4,163,728 (*See Class 9 for this trademark*).

4,163,779. **DIPOC (STANDARD CHARACTER)**. DIPOC INTERNATIONAL, (U.S. CLS. 100, 103 AND 106). SN 85-424,547. PUB. 4-10-2012. FILED 9-16-2011.

4,163,790. **MASSMAN CONSTRUCTION CO. (STANDARD CHARACTER)**. MASSMAN CONSTRUCTION CO., MULTIPLE CLASS, (INT. CLS. 37, 39 AND 42), (U.S. CLS. 100, 101, 103, 105 AND 106). SN 85-426,917. PUB. 4-10-2012. FILED 9-20-2011.

4,163,808. **ONE EARTH RECYCLING AND DESIGN**. ONE EARTH RECYCLING, INC., (U.S. CLS. 100, 103 AND 106). SN 85-428,746. PUB. 4-10-2012. FILED 9-21-2011.

4,163,840. **CALIBRATIONONE (STANDARD CHARACTER)**. USA SCIENTIFIC, INC., MULTIPLE CLASS, (INT. CLS. 37 AND 42), (U.S. CLS. 100, 101, 103 AND 106). SN 85-433,799. PUB. 4-10-2012. FILED 9-28-2011.

4,163,857. **M AND DESIGN**. OMEGA MORGAN, INC., MULTIPLE CLASS, (INT. CLS. 37 AND 39), (U.S. CLS. 100, 103, 105 AND 106). SN 85-435,656. PUB. 4-10-2012. FILED 9-29-2011.

4,163,879 (*See Class 35 for this trademark*).

4,163,922 (*See Class 35 for this trademark*).

4,163,928. **MACCO RESTORATION AND REMODELING AND DESIGN**. MACCO LLC, (U.S. CLS. 100, 103 AND 106). SN 85-443,844. PUB. 4-10-2012. FILED 10-10-2011.

4,163,946. **MR. GREEN JEANS APPLIANCE REPAIR AND DESIGN**. GRANT, TECORA, J, DBA MR. GREEN JEANS APPLIANCE REPAIR, (U.S. CLS. 100, 103 AND 106). SN 85-446,048. PUB. 4-10-2012. FILED 10-12-2011.

4,163,957. **LEL ENVIRONMENTAL, LTD. AND DESIGN**. LEL ENVIRONMENTAL, LTD., (U.S. CLS. 100, 103 AND 106). SN 85-446,952. PUB. 4-10-2012. FILED 10-13-2011.

4,164,010. **THE BULKHEAD GUYS BARRACUDA SERVICES, INC AND DESIGN**. BARRACUDA SERVICES, (U.S. CLS. 100, 103 AND 106). SN 85-450,653. PUB. 4-10-2012. FILED 10-19-2011.

4,164,115. **ZONE HOME SOLUTIONS (STANDARD CHARACTER)**. ZONE HOME SOLUTIONS, LLC, (U.S. CLS. 100, 103 AND 106). SN 85-454,705. PUB. 4-10-2012. FILED 10-24-2011.

4,164,244. **BUILT FROM THE IDEA UP (STANDARD CHARACTER)**. PN II, INC., (U.S. CLS. 100, 103 AND 106). SN 85-457,595. PUB. 4-10-2012. FILED 10-27-2011.

4,164,304. **IMPULSIVE GROUP A LIFESTYLE HOSPITALITY COMPANY AND DESIGN**. IMPULSIVE ENTERPRISES LTD., (U.S. CLS. 100, 103 AND 106). SN 85-458,005. PUB. 4-10-2012. FILED 10-27-2011.

4,164,367 (*See Class 36 for this trademark*).

4,164,395. **GOSNAY'S MOBILE CONTAINER REPAIR (STANDARD CHARACTER)**. GOSNAY, RICHARD, (U.S. CLS. 100, 103 AND 106). SN 85-458,867. PUB. 4-10-2012. FILED 10-28-2011.

4,164,569. **WELL BUILT, UNDER BUDGET (STANDARD CHARACTER)**. KIMBALL PROPERTIES LLC, (U.S. CLS. 100, 103 AND 106). SN 85-460,959. PUB. 4-10-2012. FILED 10-31-2011.

4,164,586 (*See Class 35 for this trademark*).

4,164,601 (*See Class 35 for this trademark*).

4,164,634 (*See Class 35 for this trademark*).

4,164,658 (*See Class 7 for this trademark*).

4,164,681 (*See Class 36 for this trademark*).

4,164,719. **SABERTOOTH (STANDARD CHARACTER)**. SABERTOOTH MOTORCYCLES, LLC, (U.S. CLS. 100, 103 AND 106). SN 85-486,669. PUB. 4-10-2012. FILED 12-4-2011.

CLASS 38—COMMUNICATION

4,162,735 (*See Class 9 for this trademark*).

4,162,736 (*See Class 9 for this trademark*).

4,162,737 (*See Class 9 for this trademark*).

4,162,745 (*See Class 35 for this trademark*).

4,162,753 (*See Class 9 for this trademark*).

4,162,785 (*See Class 9 for this trademark*).

4,162,809 (*See Class 35 for this trademark*).

4,162,810 (*See Class 35 for this trademark*).

4,162,835 (*See Class 9 for this trademark*).

4,162,844 (*See Class 9 for this trademark*).

4,162,856 (*See Class 9 for this trademark*).

4,162,858. **TRAXON (STANDARD CHARACTER)**. GLOBAL LOGISTICS SYSTEM WORLDWIDE COMPANY FOR DEVELOPMENT OF FREIGHT INFORMATION NETWORKS GMBH, MULTIPLE CLASS, (INT. CLS. 38 AND 42), (U.S. CLS. 100, 101 AND 104). SN 79-095,409. PUB. 4-10-2012. FILED 2-22-2011.

4,162,867 (*See Class 9 for this trademark*).

4,162,871 (*See Class 9 for this trademark*).

4,162,898 (*See Class 9 for this trademark*).

4,162,947 (*See Class 2 for this trademark*).

4,162,963. **SPORT 24 AND DESIGN**. IMG MEDIA LIMITED, MULTIPLE CLASS, (INT. CLS. 38, 41 AND 45), (U.S. CLS. 100, 101, 104 AND 107). SN 79-101,575. PUB. 4-10-2012. FILED 3-7-2011.

4,162,995 (*See Class 5 for this trademark*).

4,163,026 (*See Class 9 for this trademark*).

4,163,040 (*See Class 9 for this trademark*).

4,163,062. **THE TRAVELING WAITRESS (STANDARD CHARACTER)**. KROES, TARA, MULTIPLE CLASS, (INT. CLS. 38 AND 39), (U.S. CLS. 100, 101, 104 AND 105). SN 85-039,981. PUB. 4-10-2012. FILED 5-17-2010.

4,163,177. **EARTHLINK B U S I N E S S AND DESIGN**. EARTHLINK, INC., (U.S. CLS. 100, 101 AND 104). SN 85-215,741. PUB. 4-10-2012. FILED 1-12-2011.

4,163,205 (*See Class 9 for this trademark*).

4,163,206 (*See Class 9 for this trademark*).

4,163,207 (*See Class 9 for this trademark*).

4,163,248. **EARTHLINK CARRIER (STANDARD CHARACTER)**. EARTHLINK, INC., (U.S. CLS. 100, 101 AND 104). SN 85-274,268. PUB. 4-10-2012. FILED 3-23-2011.

4,163,314 (*See Class 9 for this trademark*).

4,163,364 (*See Class 16 for this trademark*).

4,163,365. **FISHIDY (STANDARD CHARACTER)**. OUTDOOR INSITE, LLC, MULTIPLE CLASS, (INT. CLS. 38, 42 AND 45), (U.S. CLS. 100, 101 AND 104). SN 85-307,352. PUB. 4-10-2012. FILED 4-28-2011.

4,163,405. **FXECOSYSTEM (STANDARD CHARACTER)**. FXECOSYSTEM, INC., (U.S. CLS. 100, 101 AND 104). SN 85-310,828. PUB. 4-10-2012. FILED 5-3-2011.

4,163,428. **HTTV HOMECASTING (STANDARD CHARACTER)**. HOMETOWNE TELEVISION, INC., (U.S. CLS. 100, 101 AND 104). SN 85-314,255. PUB. 4-10-2012. FILED 5-6-2011.

4,163,437 (*See Class 9 for this trademark*).

4,163,572 (*See Class 35 for this trademark*).

4,163,573 (*See Class 35 for this trademark*).

4,163,583 (*See Class 35 for this trademark*).

4,163,608 (*See Class 9 for this trademark*).

4,163,738. **KINGDEE (STYLIZED)**. KINGDEE SOFTWARE (CHINA) CO., LTD., (U.S. CLS. 100, 101 AND 104). SN 85-413,743. PUB. 4-10-2012. FILED 9-2-2011.

4,163,743 (*See Class 9 for this trademark*).

4,163,744 (*See Class 9 for this trademark*).

4,163,871. **V AND DESIGN**. SOMOSTV, LLC, (U.S. CLS. 100,

- 101 AND 104), SN 85-437,458. PUB. 4-10-2012. FILED 10-3-2011.
- 4,163,902 (*See Class 35 for this trademark*).
- 4,163,989. **PEAK 4G AND DESIGN**. ROCKY MOUNTAIN BROADBAND, (U.S. CLS. 100, 101 AND 104). SN 85-449,287. PUB. 4-10-2012. FILED 10-17-2011.
- 4,164,064. **MISCELLANEOUS DESIGN**. WEST ANGELES CHURCH OF GOD IN CHRIST, INC., MULTIPLE CLASS, (INT. CLS. 38 AND 45), (U.S. CLS. 100, 101 AND 104). SN 85-453,085. PUB. 4-10-2012. FILED 10-21-2011.
- 4,164,191. **ELITE PERFORMANCE NETWORK (STANDARD CHARACTER)**. DISPRESIVE MEDICAL, LLC, (U.S. CLS. 100, 101 AND 104). SN 85-456,469. PUB. 4-10-2012. FILED 10-26-2011.
- 4,164,198. **SIGN NOTHING. GET EVERYTHING. (STANDARD CHARACTER)**. T-MOBILE USA, INC., (U.S. CLS. 100, 101 AND 104). SN 85-456,667. PUB. 4-10-2012. FILED 10-26-2011.
- 4,164,336. **CASANOVA CREW (STANDARD CHARACTER)**. SANCHEZ, JARED, (U.S. CLS. 100, 101 AND 104). SN 85-458,260. PUB. 4-10-2012. FILED 10-27-2011.
- 4,164,477 (*See Class 9 for this trademark*).
- 4,164,478 (*See Class 9 for this trademark*).
- 4,164,511. **WOTWENTWRONG (STANDARD CHARACTER)**. FRUITION CONSULTING GROUP PTY. LTD., MULTIPLE CLASS, (INT. CLS. 38 AND 45), (U.S. CLS. 100, 101 AND 104). SN 85-460,222. PUB. 4-10-2012. FILED 10-31-2011.
- 4,164,546. **SPEED CENTER (STANDARD CHARACTER)**. SPEED CHANNEL, INC., (U.S. CLS. 100, 101 AND 104). SN 85-460,650. PUB. 4-10-2012. FILED 10-31-2011.
- 4,164,591 (*See Class 9 for this trademark*).

CLASS 39—TRANSPORTATION AND STORAGE

- 4,162,692. **MAC'S (STYLIZED)**. SHERMAN V. ALLEN, INC., (U.S. CLS. 100 AND 105). SN 76-572,850. PUB. 4-21-2009. FILED 1-30-2004.
- 4,162,779. **GFL LOGISTICS (STANDARD CHARACTER)**. STERLING PACKERS LIMITED, (U.S. CLS. 100 AND 105). SN 77-941,413. PUB. 9-27-2011. FILED 2-22-2010.
- 4,162,812 (*See Class 6 for this trademark*).
- 4,162,845 (*See Class 9 for this trademark*).
- 4,162,848 (*See Class 9 for this trademark*).
- 4,162,882. **KAZANTIP (STANDARD CHARACTER)**. SERGEJ LITVINOWSKIY, MULTIPLE CLASS, (INT. CLS. 39, 41 AND 43), (U.S. CLS. 100, 101, 105 AND 107). SN 79-097,627. PUB. 4-10-2012. FILED 9-14-2010.
- 4,162,913 (*See Class 6 for this trademark*).
- 4,162,996 (*See Class 8 for this trademark*).
- 4,163,029 (*See Class 4 for this trademark*).
- 4,163,055 (*See Class 4 for this trademark*).
- 4,163,056 (*See Class 4 for this trademark*).
- 4,163,062 (*See Class 38 for this trademark*).
- 4,163,104. **OTR AND DESIGN**. F.B.T. ENTERPRISES, INC., (U.S. CLS. 100 AND 105). SN 85-134,509. PUB. 4-10-2012. FILED 9-21-2010.
- 4,163,116. **ORCAS POWER & LIGHT CO-OP SERVING THE SAN JUANS SINCE 1937 AND DESIGN**. ORCAS POWER AND LIGHT COOPERATIVE, (U.S. CLS. 100 AND 105). SN 85-145,322. PUB. 4-10-2012. FILED 10-5-2010.
- 4,163,132. **LIDESTRI SPIRITS (STANDARD CHARACTER)**. LIDESTRI FOODS, INC., MULTIPLE CLASS, (INT. CLS. 39 AND 40), (U.S. CLS. 100, 103, 105 AND 106). SN 85-162,072. PUB. 4-10-2012. FILED 10-27-2010.
- 4,163,243 (*See Class 20 for this trademark*).
- 4,163,279 (*See Class 35 for this trademark*).
- 4,163,280 (*See Class 35 for this trademark*).
- 4,163,329 (*See Class 35 for this trademark*).
- 4,163,330 (*See Class 35 for this trademark*).
- 4,163,331 (*See Class 35 for this trademark*).
- 4,163,332. **PROFESSIONALLY TRAINED STUDENT-ATHLETE MOVERS (STANDARD CHARACTER)**. MEATHEAD MOVERS, INC., (U.S. CLS. 100 AND 105). SN 85-303,512. PUB. 4-10-2012. FILED 4-25-2011.
- 4,163,334. **YOUR PET PROTECTED (STANDARD CHARACTER)**. PETHUB, INC., (U.S. CLS. 100 AND 105). SN 85-303,530. PUB. 4-10-2012. FILED 4-25-2011.
- 4,163,364 (*See Class 16 for this trademark*).
- 4,163,380. **BEACH FINDER (STANDARD CHARACTER)**. COMM GROUP, INC., MULTIPLE CLASS, (INT. CLS. 39, 42 AND 43), (U.S. CLS. 100, 101 AND 105). SN 85-308,724. PUB. 4-10-2012. FILED 4-29-2011.
- 4,163,384 (*See Class 36 for this trademark*).
- 4,163,385 (*See Class 36 for this trademark*).
- 4,163,398. **FARRELL LINES AND DESIGN**. FARRELL LINES INCORPORATED, (U.S. CLS. 100 AND 105). SN 85-310,389. PUB. 4-10-2012. FILED 5-2-2011.
- 4,163,417. **1-800-PET-TAXI AND DESIGN**. 1-800-PET-TAXI, LLC, (U.S. CLS. 100 AND 105). SN 85-313,228. PUB. 4-10-2012. FILED 5-5-2011.
- 4,163,420. **INNOVATIVE PEOPLE REDEFINING PRINT (STANDARD CHARACTER)**. QUAD/GRAPHICS, INC., (U.S. CLS. 100 AND 105). SN 85-313,557. PUB. 4-10-2012. FILED 5-5-2011.
- 4,163,566. **PAWTOOTIE FOR PETS ON-THE-GO AND DESIGN**. RAMM TECHNOLOGIES, INC., (U.S. CLS. 100 AND 105). SN 85-355,865. PUB. 4-10-2012. FILED 6-24-2011.
- 4,163,572 (*See Class 35 for this trademark*).
- 4,163,573 (*See Class 35 for this trademark*).
- 4,163,596 (*See Class 35 for this trademark*).
- 4,163,650. **MANISTEE RIVER SALMON AND DESIGN**. NORTH SHORE ADVENTURES, LLC, DBA MANISTEE RIVER SALMON GUIDE SERVICE, (U.S. CLS. 100 AND 105). SN 85-386,026. PUB. 4-10-2012. FILED 8-1-2011.
- 4,163,669 (*See Class 6 for this trademark*).
- 4,163,684. **LADY JOY (STANDARD CHARACTER)**. DJ YACHT ENTERPRISES, LLC, (U.S. CLS. 100 AND 105). SN 85-396,229. PUB. 4-10-2012. FILED 8-12-2011.
- 4,163,790 (*See Class 37 for this trademark*).
- 4,163,795. **LOU LA VIE (STANDARD CHARACTER)**. SAFE HARBOR HOLDING II, LLC, MULTIPLE CLASS, (INT. CLS. 39 AND 41), (U.S. CLS. 100, 101, 105 AND 107). SN 85-427,534. PUB. 4-10-2012. FILED 9-20-2011.
- 4,163,809. **STAY UP. SLEEP MORE. (STANDARD CHARACTER)**. EDGEWEBHOSTING, INC., MULTIPLE CLASS, (INT. CLS. 39 AND 42), (U.S. CLS. 100, 101 AND 105). SN 85-428,800. PUB. 4-10-2012. FILED 9-21-2011.
- 4,163,857 (*See Class 37 for this trademark*).
- 4,163,887. **ALWAYS GREEN RECYCLING AND DESIGN**. ROBERTS, CLIFF, (U.S. CLS. 100 AND 105). SN 85-438,903. PUB. 4-10-2012. FILED 10-4-2011.
- 4,163,937. **METROLINA CRATING (STANDARD CHARACTER)**. PEARCE & ASSOCIATES, INC., DBA METROLINA CRATING, (U.S. CLS. 100 AND 105). SN 85-444,477. PUB. 4-10-2012. FILED 10-11-2011.
- 4,163,981. **SECRETS OF PARIS (STANDARD CHARACTER)**. FLEUR DE LIRE, (U.S. CLS. 100 AND 105). SN 85-448,407. PUB. 4-10-2012. FILED 10-16-2011.
- 4,164,112 (*See Class 35 for this trademark*).
- 4,164,148. **SMARTPACK (STANDARD CHARACTER)**. BELTWAY MOVERS ASSOCIATES, INC., (U.S. CLS. 100 AND 105). SN 85-455,525. PUB. 4-10-2012. FILED 10-25-2011.
- 4,164,186. **SHIP NEW ENGLAND AND DESIGN**. SHIP NEW ENGLAND, INC, (U.S. CLS. 100 AND 105). SN 85-456,335. PUB. 4-10-2012. FILED 10-26-2011.
- 4,164,194. **SWEETWATER TRAVEL COMPANY AND DESIGN**. SWEETWATER TRAVEL COMPANY, (U.S. CLS. 100 AND 105). SN 85-456,580. PUB. 4-10-2012. FILED 10-26-2011.
- 4,164,309. **IMPULSIVE GROUP A LIFESTYLE HOSPITALITY COMPANY AND DESIGN**. IMPULSIVE ENTERPRISES LTD., (U.S. CLS. 100 AND 105). SN 85-458,043. PUB. 4-10-2012. FILED 10-27-2011.
- 4,164,531. **CAPTAIN DOUG'S (STANDARD CHARACTER)**. EVERGLADES AIRBOAT RESORTS, LLC, (U.S. CLS. 100 AND 105). SN 85-460,470. PUB. 4-10-2012. FILED 10-31-2011.
- 4,164,586 (*See Class 35 for this trademark*).
- 4,164,601 (*See Class 35 for this trademark*).
- 4,164,667 (*See Class 35 for this trademark*).
- 4,164,720. **SABERTOOTH (STANDARD CHARACTER)**. SABERTOOTH MOTORCYCLES, LLC, (U.S. CLS. 100 AND 105). SN 85-486,676. PUB. 4-10-2012. FILED 12-4-2011.
- 4,164,777. **TRAVERSE CITY BASS AND DESIGN**. NORTH SHORE ADVENTURES, LLC, DBA TRAVERSE CITY

BASS, (U.S. CLS. 100 AND 105), SN 85-537,197. PUB. 4-10-2012. FILED 2-8-2012.

CLASS 40—MATERIAL TREATMENT

4,162,724. **SHENANDOAH MILLS AND DESIGN**. SHENANDOAH MILLS, INC., (U.S. CLS. 100, 103 AND 106). SN 76-709,560. PUB. 4-10-2012. FILED 10-27-2011.

4,162,763. **AMERICAN HYDRO (STANDARD CHARACTER)**. ASH EQUIPMENT CO., INC., (U.S. CLS. 100, 103 AND 106). SN 77-822,360. PUB. 11-1-2011. FILED 9-9-2009.

4,162,767. **AEROSION (STANDARD CHARACTER)**. COMMUNITION SYSTEMS INC., (U.S. CLS. 100, 103 AND 106). SN 77-841,276. PUB. 9-20-2011. FILED 10-5-2009.

4,162,803. **LEMTRONICS (STANDARD CHARACTER)**. LEMTRONICS SDN. BHD, MULTIPLE CLASS, (INT. CLS. 40 AND 42), (U.S. CLS. 100, 101, 103 AND 106). SN 79-067,374. PUB. 1-12-2010. FILED 2-25-2009.

4,162,843 (*See Class 7 for this trademark*).

4,162,904 (*See Class 7 for this trademark*).

4,162,909 (*See Class 37 for this trademark*).

4,163,020 (*See Class 3 for this trademark*).

4,163,027 (*See Class 10 for this trademark*).

4,163,054 (*See Class 36 for this trademark*).

4,163,055 (*See Class 4 for this trademark*).

4,163,056 (*See Class 4 for this trademark*).

4,163,079 (*See Class 5 for this trademark*).

4,163,132 (*See Class 39 for this trademark*).

4,163,216. **APEX AND DESIGN**. NAVON, SAAR, MULTIPLE CLASS, (INT. CLS. 40 AND 42), (U.S. CLS. 100, 101, 103 AND 106). SN 85-259,817. PUB. 4-10-2012. FILED 3-7-2011.

4,163,235. **TREEHOUSE AND DESIGN**. TREEHOUSE CALIFORNIA ALMONDS, LLC, (U.S. CLS. 100, 103 AND 106). SN 85-267,804. PUB. 4-10-2012. FILED 3-15-2011.

4,163,236. **CROOKED COTTON DESIGN, INC. CUSTOM APPAREL, EMBROIDERY & DIGITAL DESIGNS AND DESIGN**. CROOKED COTTON DESIGN, INC., (U.S. CLS. 100, 103 AND 106). SN 85-267,933. PUB. 4-10-2012. FILED 3-15-2011.

4,163,364 (*See Class 16 for this trademark*).

4,163,410 (*See Class 35 for this trademark*).

4,163,556 (*See Class 35 for this trademark*).

4,163,572 (*See Class 35 for this trademark*).

4,163,573 (*See Class 35 for this trademark*).

4,163,632. **CARBO-AUSTEMPERED (STANDARD CHARACTER)**. APPLIED PROCESS, INC., (U.S. CLS. 100, 103 AND 106). SN 85-382,091. PUB. 4-10-2012. FILED 7-27-2011.

4,163,633. **CARBO-AUSTEMPERING (STANDARD CHARACTER)**. APPLIED PROCESS, INC., (U.S. CLS. 100, 103 AND 106). SN 85-382,109. PUB. 4-10-2012. FILED 7-27-2011.

4,163,677. **TROPITRONICS (STANDARD CHARACTER)**. GHP PRODUCTS, LLC, (U.S. CLS. 100, 103 AND 106). SN 85-392,685. PUB. 4-10-2012. FILED 8-8-2011.

4,163,713 (*See Class 26 for this trademark*).

4,163,762. **PETROCLEAN (STANDARD CHARACTER)**. ENSOLVE BIOSYSTEMS, INC., (U.S. CLS. 100, 103 AND 106). SN 85-418,851. PUB. 4-10-2012. FILED 9-9-2011.

4,163,781 (*See Class 7 for this trademark*).

4,163,922 (*See Class 35 for this trademark*).

4,164,055. **YOU KNOW YOU WANNA (STANDARD CHARACTER)**. CHARLES J. MATTINGLY, (U.S. CLS. 100, 103 AND 106). SN 85-452,941. PUB. 4-10-2012. FILED 10-21-2011.

4,164,056. **BBC AND DESIGN**. CHARLES J. MATTINGLY, (U.S. CLS. 100, 103 AND 106). SN 85-452,943. PUB. 4-10-2012. FILED 10-21-2011.

4,164,153. **THE ART OF RING MAKING (STANDARD CHARACTER)**. KNOX JEWELERS LLC, (U.S. CLS. 100, 103 AND 106). SN 85-455,688. PUB. 4-10-2012. FILED 10-25-2011.

4,164,441 (*See Class 16 for this trademark*).

4,164,443 (*See Class 16 for this trademark*).

4,164,647 (*See Class 36 for this trademark*).

4,164,685 (*See Class 6 for this trademark*).

4,164,686 (*See Class 6 for this trademark*).

4,164,710 (*See Class 28 for this trademark*).

4,164,718 (*See Class 28 for this trademark*).

CLASS 41—EDUCATION AND ENTERTAINMENT

4,162,691 (*See Class 25 for this trademark*).

4,162,710. **KIDS GARDENING HELPING YOUNG MINDS GROW AND DESIGN**. NATIONAL GARDENING ASSOCIATION, INC., (U.S. CLS. 100, 101 AND 107). SN 76-708,536. PUB. 4-10-2012. FILED 7-29-2011.

4,162,723. **THE QUEST TO LAVA MOUNTAIN (STANDARD CHARACTER)**. THE COOPER INSTITUTE, (U.S. CLS. 100, 101 AND 107). SN 76-709,549. PUB. 4-10-2012. FILED 10-26-2011.

4,162,726 (*See Class 9 for this trademark*).

4,162,730. **MAGENTA (STANDARD CHARACTER)**. MAGENTA STUDIO PHOTO INC., (U.S. CLS. 100, 101 AND 107). SN 77-368,930. PUB. 4-10-2012. FILED 1-10-2008.

4,162,735 (*See Class 9 for this trademark*).

4,162,736 (*See Class 9 for this trademark*).

4,162,737 (*See Class 9 for this trademark*).

4,162,745 (*See Class 35 for this trademark*).

4,162,753 (*See Class 9 for this trademark*).

4,162,775 (*See Class 16 for this trademark*).

4,162,785 (*See Class 9 for this trademark*).

4,162,798. **KNETICS OPTIMIZING FITNESS ENERGY & PERFORMANCE TRAINING AND DESIGN**. NIAMANIA, INC., (U.S. CLS. 100, 101 AND 107). SN 78-909,302. PUB. 4-10-2012. FILED 6-15-2006.

4,162,799 (*See Class 9 for this trademark*).

4,162,809 (*See Class 35 for this trademark*).

4,162,810 (*See Class 35 for this trademark*).

4,162,812 (*See Class 6 for this trademark*).

4,162,825 (*See Class 9 for this trademark*).

4,162,827 (*See Class 9 for this trademark*).

4,162,844 (*See Class 9 for this trademark*).

4,162,859. **LA FINICE (STANDARD CHARACTER)**. LARA DE DONNO, MULTIPLE CLASS, (INT. CLS. 41 AND 44), (U.S. CLS. 100, 101 AND 107). SN 79-095,510. PUB. 4-10-2012. FILED 3-11-2011.

4,162,871 (*See Class 9 for this trademark*).

4,162,882 (*See Class 39 for this trademark*).

4,162,884. **PULSCIPLINE (STANDARD CHARACTER)**. FISCHER JACQUES, (U.S. CLS. 100, 101 AND 107). SN 79-097,757. PUB. 4-10-2012. FILED 4-14-2011.

4,162,887. **PULSESTRATEGY (STANDARD CHARACTER)**. FISCHER JACQUES, (U.S. CLS. 100, 101 AND 107). SN 79-097,820. PUB. 4-10-2012. FILED 4-14-2011.

4,162,908 (*See Class 9 for this trademark*).

4,162,941 (*See Class 35 for this trademark*).

4,162,947 (*See Class 2 for this trademark*).

4,162,953. **SUPERMARKET (STANDARD CHARACTER)**. SANDRO BOHNENBLUST, (U.S. CLS. 100, 101 AND 107). SN 79-101,196. PUB. 4-10-2012. FILED 7-7-2011.

4,162,963 (*See Class 38 for this trademark*).

4,162,968 (*See Class 32 for this trademark*).

4,162,995 (*See Class 5 for this trademark*).

4,162,999 (*See Class 9 for this trademark*).

4,163,004 (*See Class 9 for this trademark*).

4,163,012 (*See Class 18 for this trademark*).

4,163,022 (*See Class 25 for this trademark*).

4,163,025 (*See Class 9 for this trademark*).

4,163,045. **ISHOWCASE (STANDARD CHARACTER)**. JOURNEY 360 ENTERTAINMENT, LLC, DBA ISHOWCASE, (U.S. CLS. 100, 101 AND 107). SN 85-001,702. PUB. 4-10-2012. FILED 3-30-2010.

4,163,047. **KIDSSTREET (STANDARD CHARACTER)**. KIDS-STREET, LLC, (U.S. CLS. 100, 101 AND 107). SN 85-003,912. PUB. 4-10-2012. FILED 4-1-2010.

4,163,051. **SIMPACT (STANDARD CHARACTER)**. SIMPACT STRATEGY GROUP INC., (U.S. CLS. 100, 101 AND 107). SN 85-011,983. PUB. 4-10-2012. FILED 4-12-2010.

4,163,068 (*See Class 9 for this trademark*).

4,163,072. **PHOENIX PICK (STANDARD CHARACTER)**. ARC MANOR LLC, (U.S. CLS. 100, 101 AND 107). SN 85-079,050. PUB. 4-10-2012. FILED 7-7-2010.

4,163,081 (*See Class 12 for this trademark*).

4,163,084. **13D MOVIES YOU CAN TOUCH AND DESIGN**. AMARADIDIS, THEODOROS, (U.S. CLS. 100, 101 AND 107). SN 85-110,904. PUB. 4-10-2012. FILED 8-19-2010.

4,163,092. **MISCELLANEOUS DESIGN**. CREATIVE DESIGN

- FZ, LLC, MULTIPLE CLASS, (INT. CLS. 41 AND 43), (U.S. CLS. 100, 101 AND 107). SN 85-119,133. PUB. 4-10-2012. FILED 8-30-2010.
- 4,163,100. **BINGO HALL .COM AND DESIGN**. GUILFORD INTERNATIONAL GROUP LIMITED, (U.S. CLS. 100, 101 AND 107). SN 85-128,148. PUB. 4-10-2012. FILED 9-13-2010.
- 4,163,103. **DC CUPCAKES (STANDARD CHARACTER)**. DISCOVERY COMMUNICATIONS, LLC, (U.S. CLS. 100, 101 AND 107). SN 85-133,899. PUB. 4-10-2012. FILED 9-20-2010.
- 4,163,113. **LITTLE SPROUTS (STANDARD CHARACTER)**. WAYNDAN ENTERPRISES, (U.S. CLS. 100, 101 AND 107). SN 85-144,148. PUB. 1-3-2012. FILED 10-4-2010.
- 4,163,114. **AGRICULTURAL MEDIA SUMMIT AND DESIGN**. AGRICULTURAL MEDIA SUMMIT, LLC, (U.S. CLS. 100, 101 AND 107). SN 85-144,150. PUB. 4-10-2012. FILED 10-4-2010.
- 4,163,117. **THE MISSING PIECE THEATRE AND DESIGN**. MCLAUGHLIN, PATRICK R, AND MCGRANN, COLLEEN R, (U.S. CLS. 100, 101 AND 107). SN 85-148,007. PUB. 4-10-2012. FILED 10-8-2010.
- 4,163,118. **DIZZY DEAN BASEBALL INC. AND DESIGN**. DIZZY DEAN BASEBALL, INC., (U.S. CLS. 100, 101 AND 107). SN 85-148,267. PUB. 4-10-2012. FILED 10-8-2010.
- 4,163,129. **STYLEOGRAPHY (STANDARD CHARACTER)**. PYRAMID PRODUCTIONS I INC., (U.S. CLS. 100, 101 AND 107). SN 85-160,337. PUB. 4-10-2012. FILED 10-25-2010.
- 4,163,133 (*See Class 35 for this trademark*).
- 4,163,143. **PROMISE PLACES (STANDARD CHARACTER)**. AMERICA'S PROMISE -THE ALLIANCE FOR YOUTH, INC., (U.S. CLS. 100, 101 AND 107). SN 85-168,012. PUB. 4-10-2012. FILED 11-3-2010.
- 4,163,147. **I CAN READ! AND DESIGN**. HARPERCOLLINS PUBLISHERS L.L.C., (U.S. CLS. 100, 101 AND 107). SN 85-170,252. PUB. 4-10-2012. FILED 11-5-2010.
- 4,163,148 (*See Class 35 for this trademark*).
- 4,163,151 (*See Class 36 for this trademark*).
- 4,163,157. **DR. MOMMY (STANDARD CHARACTER)**. DR. CHRISTINA T. SCHLACHTER, PHD, DBA LSSLI, (U.S. CLS. 100, 101 AND 107). SN 85-182,608. PUB. 4-10-2012. FILED 11-22-2010.
- 4,163,167. **BAJA BEACH CLUB (STANDARD CHARACTER)**. SPATZ ENTERTAINMENT MANAGEMENT, LLC, MULTIPLE CLASS, (INT. CLS. 41 AND 43), (U.S. CLS. 100, 101 AND 107). SN 85-203,143. PUB. 4-10-2012. FILED 12-21-2010.
- 4,163,171. **MISCELLANEOUS DESIGN**. ANANDA CHURCH OF SELF-REALIZATION OF NEVADA COUNTY, MULTIPLE CLASS, (INT. CLS. 41 AND 45), (U.S. CLS. 100, 101 AND 107). SN 85-205,101. PUB. 4-10-2012. FILED 12-23-2010.
- 4,163,175. **PALM BEACH JEWISH FILM FESTIVAL AND DESIGN**. JEWISH COMMUNITY CENTER OF THE GREATER PALM BEACHES, INC., (U.S. CLS. 100, 101 AND 107). SN 85-212,235. PUB. 4-10-2012. FILED 1-6-2011.
- 4,163,178 (*See Class 9 for this trademark*).
- 4,163,191 (*See Class 35 for this trademark*).
- 4,163,198. **CIVIL RIGHTS GAME (STANDARD CHARACTER)**. OFFICE OF THE COMMISSIONER OF BASEBALL, (U.S. CLS. 100, 101 AND 107). SN 85-240,568. PUB. 4-10-2012. FILED 2-11-2011.
- 4,163,205 (*See Class 9 for this trademark*).
- 4,163,206 (*See Class 9 for this trademark*).
- 4,163,207 (*See Class 9 for this trademark*).
- 4,163,222 (*See Class 35 for this trademark*).
- 4,163,223 (*See Class 9 for this trademark*).
- 4,163,224. **STAR KIDS MUSIKTOWN AND DESIGN**. PERLA S. MCDONALD SANCHEZ, DBA STAR KIDS MUSIKTOWN, (U.S. CLS. 100, 101 AND 107). SN 85-262,658. PUB. 4-10-2012. FILED 3-9-2011.
- 4,163,225 (*See Class 9 for this trademark*).
- 4,163,228 (*See Class 16 for this trademark*).
- 4,163,231 (*See Class 16 for this trademark*).
- 4,163,232. **FIGHTER4HIRE (STANDARD CHARACTER)**. BURKEY, DARYLE W, AND BURKEY, MELANIE F, (U.S. CLS. 100, 101 AND 107). SN 85-265,479. PUB. 4-10-2012. FILED 3-12-2011.
- 4,163,234. **DIGITAL LIBRARY RESERVE (STANDARD CHARACTER)**. OVERDRIVE, INC., MULTIPLE CLASS, (INT. CLS. 41 AND 42), (U.S. CLS. 100, 101 AND 107). SN 85-266,537. PUB. 4-10-2012. FILED 3-14-2011.
- 4,163,246 (*See Class 35 for this trademark*).
- 4,163,255 (*See Class 35 for this trademark*).
- 4,163,257. **ORFEO MUSIC FESTIVAL (STANDARD CHARACTER)**. ORFEO MUSIC FESTIVAL, (U.S. CLS. 100, 101 AND 107). SN 85-279,925. PUB. 4-10-2012. FILED 3-29-2011.
- 4,163,283. **ARE YOU LINKED? (STANDARD CHARACTER)**. LINX DATING LLC, (U.S. CLS. 100, 101 AND 107). SN 85-290,844. PUB. 4-10-2012. FILED 4-8-2011.
- 4,163,284. **LINX DATING (STANDARD CHARACTER)**. LINX DATING LLC, (U.S. CLS. 100, 101 AND 107). SN 85-291,009. PUB. 4-10-2012. FILED 4-9-2011.
- 4,163,285. **LINK & DRINK (STANDARD CHARACTER)**. LINX DATING LLC, (U.S. CLS. 100, 101 AND 107). SN 85-291,013. PUB. 4-10-2012. FILED 4-9-2011.
- 4,163,290. **HUNTER ANGLER GARDENER COOK (STANDARD CHARACTER)**. SHAW, HANK, (U.S. CLS. 100, 101 AND 107). SN 85-292,087. PUB. 4-10-2012. FILED 4-11-2011.
- 4,163,291. **PONZOÑA MUSICAL AND DESIGN**. JUAREZ MATA , GUSTAVO, (U.S. CLS. 100, 101 AND 107). SN 85-292,150. PUB. 4-10-2012. FILED 4-11-2011.
- 4,163,299. **NEXTAGE PERFORMANCE INSTITUTE (STANDARD CHARACTER)**. NEXTAGE REALTY INTERNATIONAL, LLC, (U.S. CLS. 100, 101 AND 107). SN 85-294,798. PUB. 4-10-2012. FILED 4-14-2011.
- 4,163,301 (*See Class 16 for this trademark*).
- 4,163,307. **BALLOON UTOPIA (STANDARD CHARACTER)**. MASORI, SANDI, MULTIPLE CLASS, (INT. CLS. 41 AND 42), (U.S. CLS. 100, 101 AND 107). SN 85-297,333. PUB. 4-10-2012. FILED 4-18-2011.
- 4,163,309. **THE POWER OF THE PENNY (STANDARD CHARACTER)**. REDMOND, ELAINA, DBA SPENCER PUBLISHING, (U.S. CLS. 100, 101 AND 107). SN 85-297,620. PUB. 4-10-2012. FILED 4-18-2011.
- 4,163,310. **WORLD STAR CANDY (STANDARD CHARACTER)**. WORLDSTAR LLC, FORMERLY WORLD STAR HIP HOP INC., (U.S. CLS. 100, 101 AND 107). SN 85-297,652. PUB. 4-10-2012. FILED 4-18-2011.
- 4,163,311. **THE MASTER TEACHER (STANDARD CHARACTER)**. DEBRUYN HOLDINGS, INC., (U.S. CLS. 100, 101 AND 107). SN 85-297,823. PUB. 4-10-2012. FILED 4-18-2011.
- 4,163,316. **FRATERNITY MEN (STANDARD CHARACTER)**. ICONNEWMEDIA, INC., (U.S. CLS. 100, 101 AND 107). SN 85-299,120. PUB. 3-6-2012. FILED 4-19-2011.
- 4,163,333 (*See Class 9 for this trademark*).
- 4,163,337 (*See Class 35 for this trademark*).
- 4,163,339. **FASCIAL MANIPULATION SAPIENS POTENS EST MANUS AND DESIGN**. STECCO, LUIGI, MULTIPLE CLASS, (INT. CLS. 41 AND 44), (U.S. CLS. 100, 101 AND 107). SN 85-304,718. PUB. 4-10-2012. FILED 4-26-2011.
- 4,163,344. **SUMMITTREK EXECUTIVE BOARD (STANDARD CHARACTER)**. SUMMIT LIFE STRATEGIES, LLC, (U.S. CLS. 100, 101 AND 107). SN 85-305,442. PUB. 4-10-2012. FILED 4-26-2011.
- 4,163,350. **APRENDELO AND DESIGN**. E-THINGS SOLUCIONES, S.L., (U.S. CLS. 100, 101 AND 107). SN 85-306,297. PUB. 4-10-2012. FILED 4-27-2011.
- 4,163,351. **EQUEST THERAPEUTIC HORSEMANSHIP HUMANS. HORSES. HOPE. AND DESIGN**. EQUEST, (U.S. CLS. 100, 101 AND 107). SN 85-306,330. PUB. 4-10-2012. FILED 4-27-2011.
- 4,163,368. **SANTA CRUZ YOGA (STANDARD CHARACTER)**. STEPHENS, MARK E., DBA SANTA CRUZ YOGA, (U.S. CLS. 100, 101 AND 107). SN 85-307,705. PUB. 4-10-2012. FILED 4-28-2011.
- 4,163,375. **FUN CPE (STANDARD CHARACTER)**. WEAVER, CAROLYN C., DBA FUNCPE, (U.S. CLS. 100, 101 AND 107). SN 85-308,343. PUB. 4-10-2012. FILED 4-29-2011.
- 4,163,376. **MISCELLANEOUS DESIGN**. BB ENDEAVORS LLC, MULTIPLE CLASS, (INT. CLS. 41 AND 44), (U.S. CLS. 100, 101 AND 107). SN 85-308,376. PUB. 4-10-2012. FILED 4-29-2011.
- 4,163,378 (*See Class 35 for this trademark*).
- 4,163,379 (*See Class 35 for this trademark*).
- 4,163,413. **GGAR GREATER GREENVILLE ASSOCIATION OF REALTORS AND DESIGN**. THE GREATER GREENVILLE ASSOCIATION OF REALTORS, INC., (U.S. CLS. 100, 101 AND 107). SN 85-312,299. PUB. 4-10-2012. FILED 5-4-2011.

- 4,163,426 (*See Class 35 for this trademark*).
- 4,163,434. **K O CARTEL (STANDARD CHARACTER)**. GARRISON, MARTIN ANDREW, (U.S. CLS. 100, 101 AND 107). SN 85-314,719. PUB. 4-10-2012. FILED 5-6-2011.
- 4,163,435. **PAINTBOXTV (STANDARD CHARACTER)**. SUTTON STUDIOS & GALLERY, (U.S. CLS. 100, 101 AND 107). SN 85-315,243. PUB. 4-10-2012. FILED 5-8-2011.
- 4,163,436. **GO FOR LANGUAGES (STANDARD CHARACTER)**. GO FOR LANGUAGES US LLC, DBA GO FOR LANGUAGES, (U.S. CLS. 100, 101 AND 107). SN 85-315,307. PUB. 4-10-2012. FILED 5-9-2011.
- 4,163,443 (*See Class 35 for this trademark*).
- 4,163,449. **MUNSON TOWNSHIP BERKSHIRE HILLS COUNTRY CLUB AND DESIGN**. MUNSON REALTY CO., INC., (U.S. CLS. 100, 101 AND 107). SN 85-319,308. PUB. 4-10-2012. FILED 5-12-2011.
- 4,163,454. **ATTITUDE MEDIA (STANDARD CHARACTER)**. GROOM VENTURES, LLC, (U.S. CLS. 100, 101 AND 107). SN 85-320,552. PUB. 4-10-2012. FILED 5-13-2011.
- 4,163,456 (*See Class 16 for this trademark*).
- 4,163,459. **LEADERSHIP ACADEMY IN CHARACTER EDUCATION (STANDARD CHARACTER)**. THE CURATORS OF THE UNIVERSITY OF MISSOURI, (U.S. CLS. 100, 101 AND 107). SN 85-322,013. PUB. 4-10-2012. FILED 5-16-2011.
- 4,163,461. **CHIC AND STYLISH INSPIRATION FOR THE BUSY CITY BRIDE (STANDARD CHARACTER)**. MERCI NEW YORK, LLC, (U.S. CLS. 100, 101 AND 107). SN 85-322,254. PUB. 4-10-2012. FILED 5-16-2011.
- 4,163,468 (*See Class 35 for this trademark*).
- 4,163,469 (*See Class 35 for this trademark*).
- 4,163,470. **WHIP IT 180 (STANDARD CHARACTER)**. WELLMARK, INC., (U.S. CLS. 100, 101 AND 107). SN 85-323,866. PUB. 4-10-2012. FILED 5-18-2011.
- 4,163,472. **CINCO DE MILER AND DESIGN**. RUNNING AWAY ENTERPRISES, LLC, (U.S. CLS. 100, 101 AND 107). SN 85-324,053. PUB. 4-10-2012. FILED 5-18-2011.
- 4,163,489. **MY BEATPORT (STANDARD CHARACTER)**. BEATPORT, LLC, (U.S. CLS. 100, 101 AND 107). SN 85-332,533. PUB. 1-3-2012. FILED 5-27-2011.
- 4,163,496 (*See Class 35 for this trademark*).
- 4,163,501. **GONEWARK (STANDARD CHARACTER)**. RENAISSANCE NEWARK FOUNDATION, INC., (U.S. CLS. 100, 101 AND 107). SN 85-337,610. PUB. 4-10-2012. FILED 6-3-2011.
- 4,163,533. **GOLF STEADY (STANDARD CHARACTER)**. CAMPBELL, RAYMOND F, (U.S. CLS. 100, 101 AND 107). SN 85-348,116. PUB. 4-10-2012. FILED S.R. 6-16-2011; AM. P.R. 9-27-2011.
- 4,163,536 (*See Class 25 for this trademark*).
- 4,163,537 (*See Class 35 for this trademark*).
- 4,163,544. **TAKEOUT COMEDY (STANDARD CHARACTER)**. TAKEOUT ENTERTAINMENT LIMITED, (U.S. CLS. 100, 101 AND 107). SN 85-351,395. PUB. 2-7-2012. FILED 6-21-2011.
- 4,163,548. **FLY FISHING 101 (STANDARD CHARACTER)**. THE ORVIS COMPANY, INC., (U.S. CLS. 100, 101 AND 107). SN 85-353,107. PUB. 4-10-2012. FILED 6-22-2011.
- 4,163,559. **TRACY MCWILLIAMS (STANDARD CHARACTER)**. PURE POTENTIAL, LLC, (U.S. CLS. 100, 101 AND 107). SN 85-354,638. PUB. 4-10-2012. FILED 6-23-2011.
- 4,163,564. **MISCELLANEOUS DESIGN**. PURE POTENTIAL, LLC, (U.S. CLS. 100, 101 AND 107). SN 85-355,398. PUB. 4-10-2012. FILED 6-24-2011.
- 4,163,571. **PAMPER YOUR PARTNER (STANDARD CHARACTER)**. PYP, LLC., (U.S. CLS. 100, 101 AND 107). SN 85-358,545. PUB. 4-10-2012. FILED 6-28-2011.
- 4,163,594 (*See Class 16 for this trademark*).
- 4,163,600. **IDENTITY (STANDARD CHARACTER)**. NEVADA PROPERTY 1 LLC, MULTIPLE CLASS, (INT. CLS. 41 AND 43), (U.S. CLS. 100, 101 AND 107). SN 85-369,677. PUB. 4-10-2012. FILED 7-12-2011.
- 4,163,601 (*See Class 9 for this trademark*).
- 4,163,608 (*See Class 9 for this trademark*).
- 4,163,623 (*See Class 9 for this trademark*).
- 4,163,629. **EXPERIENCE THE DIFFERENCE (STYLIZED)**. EPISCOPAL SCHOOL OF JACKSONVILLE, INC., (U.S. CLS. 100, 101 AND 107). SN 85-381,681. PUB. 4-10-2012. FILED 7-26-2011.
- 4,163,640. **SPARK3000 (STANDARD CHARACTER)**. ACHIEVE3000, INC., (U.S. CLS. 100, 101 AND 107). SN 85-382,661. PUB. 4-10-2012. FILED 7-27-2011.
- 4,163,654. **CRAVING COCKTAILS? (STANDARD CHARACTER)**. PERLMAN, STACEY C., AND ALTSHTUL, SARA BETH, (U.S. CLS. 100, 101 AND 107). SN 85-386,914. PUB. 4-10-2012. FILED 8-2-2011.
- 4,163,666. **LINE GENIE (STANDARD CHARACTER)**. LINE GENIE LLC, (U.S. CLS. 100, 101 AND 107). SN 85-389,788. PUB. 4-10-2012. FILED 8-4-2011.
- 4,163,668. **NEVER WAIT IN LINE AGAIN (STANDARD CHARACTER)**. LINE GENIE LLC, (U.S. CLS. 100, 101 AND 107). SN 85-389,854. PUB. 4-10-2012. FILED 8-4-2011.
- 4,163,678. **WILL2SWEAT (STANDARD CHARACTER)**. WILL2SWEAT, INC., (U.S. CLS. 100, 101 AND 107). SN 85-393,874. PUB. 4-10-2012. FILED 8-9-2011.
- 4,163,695 (*See Class 9 for this trademark*).
- 4,163,704 (*See Class 9 for this trademark*).
- 4,163,709 (*See Class 16 for this trademark*).
- 4,163,726 (*See Class 35 for this trademark*).
- 4,163,727. **TALKIN' CLOUD (STANDARD CHARACTER)**. PENTON MEDIA, INC., MULTIPLE CLASS, (INT. CLS. 41 AND 42), (U.S. CLS. 100, 101 AND 107). SN 85-411,808. PUB. 4-10-2012. FILED 8-31-2011.
- 4,163,732. **IRONY POINT AND DESIGN**. DANIEL POWELL, (U.S. CLS. 100, 101 AND 107). SN 85-413,410. PUB. 4-10-2012. FILED 9-1-2011.
- 4,163,740. **BRANCHING OUT (STANDARD CHARACTER)**. THE OMAHA HOME FOR BOYS, MULTIPLE CLASS, (INT. CLS. 41 AND 43), (U.S. CLS. 100, 101 AND 107). SN 85-414,130. PUB. 4-10-2012. FILED 9-2-2011.
- 4,163,743 (*See Class 9 for this trademark*).
- 4,163,750. **MOJOBOTH (STANDARD CHARACTER)**. MOJO ENTERTAINMENT, LLC, (U.S. CLS. 100, 101 AND 107). SN 85-417,408. PUB. 4-10-2012. FILED 9-8-2011.
- 4,163,753. **C1 TRUCK DRIVER TRAINING (STANDARD CHARACTER)**. C1 TRUCK DRIVER TRAINING, LLC, (U.S. CLS. 100, 101 AND 107). SN 85-417,915. PUB. 4-10-2012. FILED 9-8-2011.
- 4,163,754. **C1 TRUCK DRIVER TRAINING AND DESIGN**. C1 TRUCK DRIVER TRAINING, LLC, (U.S. CLS. 100, 101 AND 107). SN 85-417,934. PUB. 4-10-2012. FILED 9-8-2011.
- 4,163,759. **NEEDCASH GET YOUR MONEY FAST AND DESIGN**. ACQUISITION MEDIA, LLC, (U.S. CLS. 100, 101 AND 107). SN 85-418,145. PUB. 4-10-2012. FILED S.R. 9-8-2011; AM. P.R. 1-17-2012.
- 4,163,766. **WINE DINE DESIGN (STANDARD CHARACTER)**. LAURA JEANNE DESIGN, LLC, MULTIPLE CLASS, (INT. CLS. 41 AND 42), (U.S. CLS. 100, 101 AND 107). SN 85-419,895. PUB. 4-10-2012. FILED 9-12-2011.
- 4,163,767. **MERRITT ATHLETIC CLUBS AND DESIGN**. MERRITT ATHLETIC CLUBS, LLC, (U.S. CLS. 100, 101 AND 107). SN 85-420,060. PUB. 4-10-2012. FILED 9-12-2011.
- 4,163,774. **TEENZART (STANDARD CHARACTER)**. KIDZART TEXAS, LLC, (U.S. CLS. 100, 101 AND 107). SN 85-422,480. PUB. 4-10-2012. FILED 9-14-2011.
- 4,163,777 (*See Class 16 for this trademark*).
- 4,163,795 (*See Class 39 for this trademark*).
- 4,163,797. **GRANFONDO + AND DESIGN**. SPCGE S.A.R.L., (U.S. CLS. 100, 101 AND 107). SN 85-427,683. PUB. 4-10-2012. FILED 9-20-2011.
- 4,163,800. **MISCELLANEOUS DESIGN**. COZZINI, ADAM, (U.S. CLS. 100, 101 AND 107). SN 85-428,159. PUB. 4-10-2012. FILED 9-21-2011.
- 4,163,803. **THE SALVATION ARMY (STANDARD CHARACTER)**. THE SALVATION ARMY NATIONAL CORPORATION, MULTIPLE CLASS, (INT. CLS. 41, 43 AND 45), (U.S. CLS. 100, 101 AND 107). SN 85-428,211. PUB. 4-10-2012. FILED 9-21-2011.
- 4,163,804. **IHEA INTERNATIONAL HUNTER EDUCATION ASSOCIATION HUNTING INCIDENT INVESTIGATION ACADEMY AND DESIGN**. INTERNATIONAL HUNTER EDUCATION ASSOCIATION, (U.S. CLS. 100, 101 AND 107). SN 85-428,277. PUB. 4-10-2012. FILED 9-21-2011.
- 4,163,805. **DANIELLE STEEL (STANDARD CHARACTER)**. DANIELLE STEEL, (U.S. CLS. 100, 101 AND 107). SN 85-428,301. PUB. 4-10-2012. FILED 9-21-2011.
- 4,163,825 (*See Class 9 for this trademark*).

- 4,163,827. **STAGED INCIDENT AND DESIGN**. STAGED INCIDENT, L.L.C., (U.S. CLS. 100, 101 AND 107). SN 85-431,966. PUB. 4-10-2012. FILED 9-26-2011.
- 4,163,829. **MIMOZINE (STANDARD CHARACTER)**. MIMO-CO, INC., (U.S. CLS. 100, 101 AND 107). SN 85-432,668. PUB. 4-10-2012. FILED 9-27-2011.
- 4,163,831. **WINE IN HEELS AND DESIGN**. MAWA MCQUEEN, DBA WINE IN HEELS LLC, (U.S. CLS. 100, 101 AND 107). SN 85-433,139. PUB. 4-10-2012. FILED 9-27-2011.
- 4,163,838 (*See Class 25 for this trademark*).
- 4,163,839 (*See Class 25 for this trademark*).
- 4,163,854. **MAKEIT4REEL AND DESIGN**. MINDFIELD PRODUCTIONS, INC., (U.S. CLS. 100, 101 AND 107). SN 85-434,989. PUB. 4-10-2012. FILED 9-29-2011.
- 4,163,861 (*See Class 5 for this trademark*).
- 4,163,867. **FORTUNE SAN LO POKER AND DESIGN**. SHUFFLE MASTER, INC., (U.S. CLS. 100, 101 AND 107). SN 85-436,897. PUB. 4-10-2012. FILED 9-30-2011.
- 4,163,902 (*See Class 35 for this trademark*).
- 4,163,904. **DANCING AROUND THE WORLD FOR WORLD PEACE (STANDARD CHARACTER)**. HERRERA, ORLANDO A., AND GOLDMEER, CONSTANCE, AND THE WORLD PEACE PROGRAM, LLC, (U.S. CLS. 100, 101 AND 107). SN 85-441,496. PUB. 4-10-2012. FILED 10-6-2011.
- 4,163,905 (*See Class 9 for this trademark*).
- 4,163,911. **CAMP MARIPOSA WHERE KIDS TRANSFORM AND DESIGN**. THE MOYER FOUNDATION, MULTIPLE CLASS, (INT. CLS. 41 AND 44), (U.S. CLS. 100, 101 AND 107). SN 85-441,882. PUB. 4-10-2012. FILED 10-7-2011.
- 4,163,912 (*See Class 35 for this trademark*).
- 4,163,913 (*See Class 35 for this trademark*).
- 4,163,940. **D.J. PROPHET (STANDARD CHARACTER)**. CARTIER, IAN SHANE, AKA D.J. PROPHET, (U.S. CLS. 100, 101 AND 107). SN 85-444,980. PUB. 4-10-2012. FILED 10-11-2011.
- 4,163,941. **DIRTCANDY AND DESIGN**. COHEN, AMANDA, MULTIPLE CLASS, (INT. CLS. 41 AND 43), (U.S. CLS. 100, 101 AND 107). SN 85-445,451. PUB. 4-10-2012. FILED 10-12-2011.
- 4,163,949. **PEERPARTY (STANDARD CHARACTER)**. LOWER, MICHAEL SEAN, DBA PEERPARTY, (U.S. CLS. 100, 101 AND 107). SN 85-446,185. PUB. 4-10-2012. FILED 10-13-2011.
- 4,163,954. **THE WAR ROOM (STANDARD CHARACTER)**. CURRENT MEDIA, LLC, (U.S. CLS. 100, 101 AND 107). SN 85-446,747. PUB. 4-10-2012. FILED 10-13-2011.
- 4,163,958. **MOONSHINERS REUNION (STANDARD CHARACTER)**. DEBBIE RHODES BARNWELL, (U.S. CLS. 100, 101 AND 107). SN 85-446,989. PUB. 4-10-2012. FILED 10-13-2011.
- 4,163,960. **PLUM HOLLOW (STANDARD CHARACTER)**. DEBBIE RHODES BARNWELL, (U.S. CLS. 100, 101 AND 107). SN 85-447,011. PUB. 4-10-2012. FILED 10-13-2011.
- 4,163,961 (*See Class 35 for this trademark*).
- 4,163,964. **PUBLIC WORKS PROJECT MANAGEMENT BOOTCAMP (STANDARD CHARACTER)**. PSMJ RESOURCES, INC., (U.S. CLS. 100, 101 AND 107). SN 85-447,678. PUB. 4-10-2012. FILED 10-14-2011.
- 4,163,971. **CATTLEMEN'S DAYS (STANDARD CHARACTER)**. CATTLEMEN'S DAYS, INC., (U.S. CLS. 100, 101 AND 107). SN 85-448,070. PUB. 4-10-2012. FILED 10-14-2011.
- 4,163,976. **GO PINK (STANDARD CHARACTER)**. DYNAMIC VISION INTERNATIONAL, INC., (U.S. CLS. 100, 101 AND 107). SN 85-448,323. PUB. 4-10-2012. FILED 10-15-2011.
- 4,163,992 (*See Class 9 for this trademark*).
- 4,163,995. **RED PIGGY PRESS (STANDARD CHARACTER)**. RED PIGGY PRESS, LLC, (U.S. CLS. 100, 101 AND 107). SN 85-449,736. PUB. 4-10-2012. FILED 10-18-2011.
- 4,164,011. **THE WHERESVILLE PROJECT (STANDARD CHARACTER)**. THE WHERESVILLE PROJECT PARTNERSHIP, (U.S. CLS. 100, 101 AND 107). SN 85-450,654. PUB. 4-10-2012. FILED 10-19-2011.
- 4,164,012. **THE FRANCES XAVIER WARDE SCHOOL (STANDARD CHARACTER)**. THE FRANCES XAVIER WARDE SCHOOL NFP, (U.S. CLS. 100, 101 AND 107). SN 85-450,663. PUB. 4-10-2012. FILED 10-19-2011.
- 4,164,023. **ASKDEB?RAH AND DESIGN**. COMMUNITY TECHKNOWLEDGE, INC., (U.S. CLS. 100, 101 AND 107). SN 85-451,256. PUB. 4-10-2012. FILED 10-19-2011.
- 4,164,025. **STRAY CATS (STANDARD CHARACTER)**. BLAST OFF, INC., (U.S. CLS. 100, 101 AND 107). SN 85-451,302. PUB. 4-10-2012. FILED 10-19-2011.
- 4,164,029. **GOOD INDIAN GIRL (STANDARD CHARACTER)**. GOOD GIRL LLC, (U.S. CLS. 100, 101 AND 107). SN 85-451,640. PUB. 4-10-2012. FILED 10-20-2011.
- 4,164,085. **EX FIDE FORTIS 1869 DILLARD UNIVERSITY AND DESIGN**. DILLARD UNIVERSITY, (U.S. CLS. 100, 101 AND 107). SN 85-453,733. PUB. 4-10-2012. FILED 10-21-2011.
- 4,164,086. **EX FIDE FORTIS 1869 DILLARD UNIVERSITY AND DESIGN**. DILLARD UNIVERSITY, (U.S. CLS. 100, 101 AND 107). SN 85-453,741. PUB. 4-10-2012. FILED 10-21-2011.
- 4,164,089. **DILLARD UNIVERSITY LOUISIANA EX FIDE FORTIS AND DESIGN**. DILLARD UNIVERSITY, (U.S. CLS. 100, 101 AND 107). SN 85-453,865. PUB. 4-10-2012. FILED 10-22-2011.
- 4,164,090. **LISTENING IMPACT BETTER LISTENING. STRONGER RESULTS. AND DESIGN**. EXPANDING THOUGHT, INC., (U.S. CLS. 100, 101 AND 107). SN 85-453,874. PUB. 4-10-2012. FILED 10-22-2011.
- 4,164,097. **TREASURE ME PHOTOGRAPHY (STANDARD CHARACTER)**. MARTHA WESTERGAARD, DBA TREASURE ME PHOTOGRAPHY, (U.S. CLS. 100, 101 AND 107). SN 85-454,236. PUB. 4-10-2012. FILED 10-24-2011.
- 4,164,100 (*See Class 35 for this trademark*).
- 4,164,101. **LEADERSHIPTRACTION (STANDARD CHARACTER)**. GOTTAGETTACOACH!, INC., (U.S. CLS. 100, 101 AND 107). SN 85-454,304. PUB. 4-10-2012. FILED 10-24-2011.
- 4,164,110. **SUSTAINABLE AGING (STANDARD CHARACTER)**. SUSTAINABLE AGING LLP, DBA SUSTAINABLE AGING, (U.S. CLS. 100, 101 AND 107). SN 85-454,580. PUB. 4-10-2012. FILED 10-24-2011.
- 4,164,137. **P AND DESIGN**. PITT COMMUNITY COLLEGE, (U.S. CLS. 100, 101 AND 107). SN 85-455,294. PUB. 4-10-2012. FILED 10-25-2011.
- 4,164,139. **THE SHINY DARKS (STANDARD CHARACTER)**. CARRELL, QUENTON, (U.S. CLS. 100, 101 AND 107). SN 85-455,326. PUB. 4-10-2012. FILED 10-25-2011.
- 4,164,142. **TRIPLE SPIRAL PRODUCTIONS (STANDARD CHARACTER)**. DUNSTON, MICHELANTONY, (U.S. CLS. 100, 101 AND 107). SN 85-455,382. PUB. 4-10-2012. FILED 10-25-2011.
- 4,164,149. **IABTP (STANDARD CHARACTER)**. BODYMIND INSTITUTE - IBSR LLC, (U.S. CLS. 100, 101 AND 107). SN 85-455,564. PUB. 4-10-2012. FILED 10-25-2011.
- 4,164,152. **TRAIN DIFFERENT (STANDARD CHARACTER)**. U GYM, LLC, (U.S. CLS. 100, 101 AND 107). SN 85-455,669. PUB. 4-10-2012. FILED 10-25-2011.
- 4,164,165. **PRECISION PATH LEARNING PLATFORM (STANDARD CHARACTER)**. CYPHERPATH LLC, (U.S. CLS. 100, 101 AND 107). SN 85-455,895. PUB. 4-10-2012. FILED 10-25-2011.
- 4,164,172. **MBA CATALYST (STANDARD CHARACTER)**. MEJIA, JESSE A., DBA MBA CATALYST, (U.S. CLS. 100, 101 AND 107). SN 85-455,999. PUB. 4-10-2012. FILED 10-25-2011.
- 4,164,178. **HYDRATOLOGY (STANDARD CHARACTER)**. ROSENTHAL, SUSAN, (U.S. CLS. 100, 101 AND 107). SN 85-456,180. PUB. 4-10-2012. FILED 10-26-2011.
- 4,164,185. **LIGHT BEINGS (STANDARD CHARACTER)**. LIVING WORLD ENTERTAINMENT, (U.S. CLS. 100, 101 AND 107). SN 85-456,319. PUB. 4-10-2012. FILED 10-26-2011.
- 4,164,193 (*See Class 16 for this trademark*).
- 4,164,196. **EAT GOOD ENT (STANDARD CHARACTER)**. LEWIS, KHARI, (U.S. CLS. 100, 101 AND 107). SN 85-456,640. PUB. 4-10-2012. FILED 10-26-2011.
- 4,164,210 (*See Class 35 for this trademark*).
- 4,164,231. **GLITTERATI (STANDARD CHARACTER)**. GLITTERATI INCORPORATED, (U.S. CLS. 100, 101 AND 107). SN 85-457,429. PUB. 4-10-2012. FILED 10-27-2011.
- 4,164,238. **JIU-JITSUPEDIA AND DESIGN**. APPERSON, SEAN, (U.S. CLS. 100, 101 AND 107). SN 85-457,518. PUB. 4-10-2012. FILED 10-27-2011.
- 4,164,246. **NAPADREAMIN WINE PARTIES AND DESIGN**. DMK ENTERPRISES LLC, (U.S. CLS. 100, 101 AND 107). SN 85-457,614. PUB. 4-10-2012. FILED 10-27-2011.
- 4,164,257. **CHANGE IS GOOD (STANDARD CHARACTER)**.

- ADELPHI UNIVERSITY, (U.S. CLS. 100, 101 AND 107). SN 85-457,719. PUB. 4-10-2012. FILED 10-27-2011.
- 4,164,263. **DON'T FEAR SUCCESS (STANDARD CHARACTER)**. ADELPHI UNIVERSITY, (U.S. CLS. 100, 101 AND 107). SN 85-457,740. PUB. 4-10-2012. FILED 10-27-2011.
- 4,164,265. **AIM HIGH (STANDARD CHARACTER)**. ADELPHI UNIVERSITY, (U.S. CLS. 100, 101 AND 107). SN 85-457,749. PUB. 4-10-2012. FILED 10-27-2011.
- 4,164,285. **OKC MOA OKLAHOMA CITY MUSEUM OF ART (STYLIZED)**. OKLAHOMA CITY MUSEUM OF ART, INC., (U.S. CLS. 100, 101 AND 107). SN 85-457,897. PUB. 4-10-2012. FILED 10-27-2011.
- 4,164,289. **STRONG IS BEAUTIFUL (STANDARD CHARACTER)**. GOLD MEDAL GYMNASTICS ACADEMY, L.L.C., (U.S. CLS. 100, 101 AND 107). SN 85-457,949. PUB. 4-10-2012. FILED 10-27-2011.
- 4,164,290. **OKCMOA (STANDARD CHARACTER)**. OKLAHOMA CITY MUSEUM OF ART, INC., (U.S. CLS. 100, 101 AND 107). SN 85-457,950. PUB. 4-10-2012. FILED 10-27-2011.
- 4,164,291. **PHLEARN (STANDARD CHARACTER)**. AARON NACE, (U.S. CLS. 100, 101 AND 107). SN 85-457,952. PUB. 4-10-2012. FILED 10-27-2011.
- 4,164,299. **THE LIFE AND TIMES OF SOLAR PEOPLE (STANDARD CHARACTER)**. SUNGEVITY, (U.S. CLS. 100, 101 AND 107). SN 85-457,973. PUB. 4-10-2012. FILED 10-27-2011.
- 4,164,305. **MATHTYME (STANDARD CHARACTER)**. PAMELA SMITH D/B/A MATHTYME, (U.S. CLS. 100, 101 AND 107). SN 85-458,009. PUB. 4-10-2012. FILED 10-27-2011.
- 4,164,310. **SUSAN ROANE (STANDARD CHARACTER)**. SUSAN ROANE, (U.S. CLS. 100, 101 AND 107). SN 85-458,050. PUB. 4-10-2012. FILED 10-27-2011.
- 4,164,357. **MUSIC COMPASS (STANDARD CHARACTER)**. MUSIC COMPASS LLC, (U.S. CLS. 100, 101 AND 107). SN 85-458,465. PUB. 4-10-2012. FILED 10-27-2011.
- 4,164,365. **BEHOLD THE LAMB (STANDARD CHARACTER)**. HARBOUR-SHORES BAPTIST CHURCH INC., (U.S. CLS. 100, 101 AND 107). SN 85-458,610. PUB. 4-10-2012. FILED 10-28-2011.
- 4,164,403. **S (STYLIZED)**. MCCOMMAS, JEFFREY, (U.S. CLS. 100, 101 AND 107). SN 85-458,920. PUB. 4-10-2012. FILED 10-28-2011.
- 4,164,406. **WRITING THE STORIES WE NEED TO WRITE (STANDARD CHARACTER)**. KATE HOPPER, LLC, (U.S. CLS. 100, 101 AND 107). SN 85-458,949. PUB. 4-10-2012. FILED 10-28-2011.
- 4,164,428. **NEURODANCE (STANDARD CHARACTER)**. WENDY J. CANNING, (U.S. CLS. 100, 101 AND 107). SN 85-459,222. PUB. 4-10-2012. FILED 10-28-2011.
- 4,164,432. **KIDREALM AND DESIGN**. THOMPSON, ROBERT, (U.S. CLS. 100, 101 AND 107). SN 85-459,250. PUB. 4-10-2012. FILED 10-28-2011.
- 4,164,444. **THE CRIBLINE (STANDARD CHARACTER)**. THE CRIBLINE, LLC, (U.S. CLS. 100, 101 AND 107). SN 85-459,412. PUB. 4-10-2012. FILED 10-28-2011.
- 4,164,448 (*See Class 9 for this trademark*).
- 4,164,460. **STELLAR CATERPILLAR (STANDARD CHARACTER)**. ESHELMAN, DONNA, (U.S. CLS. 100, 101 AND 107). SN 85-459,573. PUB. 4-10-2012. FILED 10-28-2011.
- 4,164,461. **THE MIDTOWN MEN (STANDARD CHARACTER)**. SPENCER, ROBERT J., AND REICHARD, DANIEL, AND LONGORIA, MICHAEL, AND HOFF, CHRISTIAN, (U.S. CLS. 100, 101 AND 107). SN 85-459,580. PUB. 4-10-2012. FILED 10-28-2011.
- 4,164,462. **WOBEON (STANDARD CHARACTER)**. AUSTIN FUSION MUSIC LLC, (U.S. CLS. 100, 101 AND 107). SN 85-459,586. PUB. 4-10-2012. FILED 10-28-2011.
- 4,164,463. **WO BE ON AND DESIGN**. AUSTIN FUSION MUSIC LLC, (U.S. CLS. 100, 101 AND 107). SN 85-459,592. PUB. 4-10-2012. FILED 10-28-2011.
- 4,164,469. **MISCELLANEOUS DESIGN**. BARBELLE, INC., (U.S. CLS. 100, 101 AND 107). SN 85-459,677. PUB. 4-10-2012. FILED 10-29-2011.
- 4,164,471. **WITHOUT A METHOD, IT'S JUST A GAMBLE (STANDARD CHARACTER)**. GAME DAY PICKS LLC, (U.S. CLS. 100, 101 AND 107). SN 85-459,687. PUB. 4-10-2012. FILED 10-29-2011.
- 4,164,476. **PROJECT BANDALOOP (STANDARD CHARACTER)**. PROJECT BANDALOOP, (U.S. CLS. 100, 101 AND 107). SN 85-459,735. PUB. 4-10-2012. FILED 10-29-2011.
- 4,164,477 (*See Class 9 for this trademark*).
- 4,164,478 (*See Class 9 for this trademark*).
- 4,164,481. **ELEVAGE EVENTS (STANDARD CHARACTER)**. ELEVAGE EVENTS, INC., (U.S. CLS. 100, 101 AND 107). SN 85-459,769. PUB. 4-10-2012. FILED 10-29-2011.
- 4,164,494 (*See Class 9 for this trademark*).
- 4,164,514. **ENERQI (STANDARD CHARACTER)**. MCDONALD, KAREN L, (U.S. CLS. 100, 101 AND 107). SN 85-460,246. PUB. 4-10-2012. FILED 10-31-2011.
- 4,164,523. **THE MOUNT AND DESIGN**. MOUNT SAINT MARY'S UNIVERSITY, INC., (U.S. CLS. 100, 101 AND 107). SN 85-460,392. PUB. 4-10-2012. FILED 10-31-2011.
- 4,164,524. **THE MOUNT (STANDARD CHARACTER)**. MOUNT SAINT MARY'S UNIVERSITY, INC., (U.S. CLS. 100, 101 AND 107). SN 85-460,412. PUB. 4-10-2012. FILED 10-31-2011.
- 4,164,529 (*See Class 36 for this trademark*).
- 4,164,543. **SOLITUDE HOUSE MUSEUM (STANDARD CHARACTER)**. UNION FORGE HERITAGE ASSOCIATION, (U.S. CLS. 100, 101 AND 107). SN 85-460,615. PUB. 4-10-2012. FILED 10-31-2011.
- 4,164,545. **SPEED CENTER (STANDARD CHARACTER)**. SPEED CHANNEL, INC., (U.S. CLS. 100, 101 AND 107). SN 85-460,647. PUB. 4-10-2012. FILED 10-31-2011.
- 4,164,554. **VOODOO BROWN (STANDARD CHARACTER)**. SOLVNT, LLC, (U.S. CLS. 100, 101 AND 107). SN 85-460,785. PUB. 4-10-2012. FILED 10-31-2011.
- 4,164,561. **ALPHASEARCH (STANDARD CHARACTER)**. OPTILINGUA US, INC, DBA ALPHATRAD, MULTIPLE CLASS, (INT. CLS. 41 AND 42), (U.S. CLS. 100, 101 AND 107). SN 85-460,870. PUB. 4-10-2012. FILED 10-31-2011.
- 4,164,563. **EM THE GEM (STANDARD CHARACTER)**. SCOTT, EMILY, (U.S. CLS. 100, 101 AND 107). SN 85-460,885. PUB. 4-10-2012. FILED 10-31-2011.
- 4,164,571. **THE SMALL PRESS THAT THINKS BIG (STANDARD CHARACTER)**. VANTAGE PRESS, INC., (U.S. CLS. 100, 101 AND 107). SN 85-461,001. PUB. 4-10-2012. FILED 10-31-2011.
- 4,164,572. **PUBLISH FOR REAL (STANDARD CHARACTER)**. VANTAGE PRESS, INC., (U.S. CLS. 100, 101 AND 107). SN 85-461,019. PUB. 4-10-2012. FILED 11-1-2011.
- 4,164,573. **OPERATION OPERA (STANDARD CHARACTER)**. VIRGINIA OPERA ASSOCIATION, INC., (U.S. CLS. 100, 101 AND 107). SN 85-461,068. PUB. 4-10-2012. FILED 11-1-2011.
- 4,164,591 (*See Class 9 for this trademark*).
- 4,164,611. **YOUR FAVORITE MARTIAN (STANDARD CHARACTER)**. RAY WILLIAM JOHNSON, AND MAKER STUDIOS, INC., (U.S. CLS. 100, 101 AND 107). SN 85-464,317. PUB. 4-10-2012. FILED 11-4-2011.
- 4,164,623 (*See Class 35 for this trademark*).
- 4,164,652. **ENCORE DATA ACADEMY (STANDARD CHARACTER)**. ENCORE HEALTH RESOURCES, LLC, (U.S. CLS. 100, 101 AND 107). SN 85-469,861. PUB. 4-10-2012. FILED 11-10-2011.
- 4,164,672. **GRAPSEED ENGLISH FOR CHILDREN AND DESIGN**. GRAPSEED MEDIA LTD., (U.S. CLS. 100, 101 AND 107). SN 85-473,825. PUB. 4-10-2012. FILED 11-16-2011.
- 4,164,694. **THE FAKESPEAREAN ACTING COMPANY (STANDARD CHARACTER)**. THOMPSON, ROBERT, (U.S. CLS. 100, 101 AND 107). SN 85-480,088. PUB. 4-10-2012. FILED 11-23-2011.
- 4,164,702. **MISCELLANEOUS DESIGN**. SOLVNT, LLC, (U.S. CLS. 100, 101 AND 107). SN 85-482,758. PUB. 4-10-2012. FILED 11-29-2011.
- 4,164,707. **BIG CHAMPIONSHIP AND DESIGN**. THE BIG TEN CONFERENCE, INC., (U.S. CLS. 100, 101 AND 107). SN 85-483,344. PUB. 4-10-2012. FILED 11-30-2011.
- 4,164,712 (*See Class 9 for this trademark*).
- 4,164,731. **NIGHT FEVER (STANDARD CHARACTER)**. DGMB CASINO, LLC, DBA RESORTS CASINO HOTEL, (U.S. CLS. 100, 101 AND 107). SN 85-492,157. PUB. 4-10-2012. FILED 12-9-2011.
- 4,164,733. **THE STANDARD METHOD FOR MASTERING THE STANDARDS (STANDARD CHARACTER)**. FUNEDUCATION.COM, INC., AKA FUNEDUCATION, INC., (U.S.

- CLS. 100, 101 AND 107). SN 85-494,645. PUB. 4-10-2012. FILED 12-14-2011.
- 4,164,752. **MYTHINKINGLAB (STANDARD CHARACTER)**. PEARSON EDUCATION, INC., (U.S. CLS. 100, 101 AND 107). SN 85-506,196. PUB. 4-10-2012. FILED 12-30-2011.
- 4,164,765. **NEW YEAR'S AT THE NEEDLE (STANDARD CHARACTER)**. SPACE NEEDLE LLC, (U.S. CLS. 100, 101 AND 107). SN 85-514,856. PUB. 4-10-2012. FILED 1-12-2012.
- 4,164,772. **TRIPLE D JAMZ AND DESIGN**. JACKSON, FREDDIE, DBA TRIPLE D JAMZ, (U.S. CLS. 100, 101 AND 107). SN 85-523,291. PUB. 4-10-2012. FILED S.R. 1-23-2012; AM. P.R. 2-16-2012.
-
- CLASS 42—SCIENTIFIC AND COMPUTER SERVICES**
- 4,162,691 (*See Class 25 for this trademark*).
- 4,162,693. **MAGNA STEYR (STANDARD CHARACTER)**. MAGNA INTERNATIONAL INC., (U.S. CLS. 100 AND 101). SN 76-670,307. PUB. 4-10-2012. FILED 12-14-2006.
- 4,162,695 (*See Class 35 for this trademark*).
- 4,162,698. **BMP BIOMEDICAL POLYMERS, INC. AND DESIGN**. BIOMEDICAL POLYMERS, INC., (U.S. CLS. 100 AND 101). SN 76-705,764. PUB. 4-10-2012. FILED 12-23-2010.
- 4,162,706. **CAP (STANDARD CHARACTER)**. INDUSTRIAL INFORMATION RESOURCES, INC., (U.S. CLS. 100 AND 101). SN 76-707,683. PUB. 4-10-2012. FILED 5-20-2011.
- 4,162,716. **PIONEER (STANDARD CHARACTER)**. PIONEER DRILLING COMPANY, (U.S. CLS. 100 AND 101). SN 76-709,079. PUB. 4-10-2012. FILED 9-15-2011.
- 4,162,719 (*See Class 9 for this trademark*).
- 4,162,726 (*See Class 9 for this trademark*).
- 4,162,735 (*See Class 9 for this trademark*).
- 4,162,736 (*See Class 9 for this trademark*).
- 4,162,737 (*See Class 9 for this trademark*).
- 4,162,753 (*See Class 9 for this trademark*).
- 4,162,759. **EYE PATH (STANDARD CHARACTER)**. ACCU-WEATHER, INC., (U.S. CLS. 100 AND 101). SN 77-759,699. PUB. 4-10-2012. FILED 6-15-2009.
- 4,162,760. **FISSION (STANDARD CHARACTER)**. 360 PROFESSIONAL SERVICES GROUP, (U.S. CLS. 100 AND 101). SN 77-766,555. PUB. 4-10-2012. FILED 6-23-2009.
- 4,162,766 (*See Class 9 for this trademark*).
- 4,162,785 (*See Class 9 for this trademark*).
- 4,162,803 (*See Class 40 for this trademark*).
- 4,162,810 (*See Class 35 for this trademark*).
- 4,162,812 (*See Class 6 for this trademark*).
- 4,162,828 (*See Class 35 for this trademark*).
- 4,162,842 (*See Class 35 for this trademark*).
- 4,162,844 (*See Class 9 for this trademark*).
- 4,162,848 (*See Class 9 for this trademark*).
- 4,162,849. **DAG DIALOGUE ADVISORY GROUP (STYLIZED)**. STICHTING DIALOGUE ADVISORY GROUP, MULTIPLE CLASS, (INT. CLS. 42 AND 45), (U.S. CLS. 100 AND 101). SN 79-092,981. PUB. 4-10-2012. FILED 12-10-2010.
- 4,162,856 (*See Class 9 for this trademark*).
- 4,162,858 (*See Class 38 for this trademark*).
- 4,162,867 (*See Class 9 for this trademark*).
- 4,162,868 (*See Class 6 for this trademark*).
- 4,162,870 (*See Class 35 for this trademark*).
- 4,162,871 (*See Class 9 for this trademark*).
- 4,162,874 (*See Class 7 for this trademark*).
- 4,162,885 (*See Class 9 for this trademark*).
- 4,162,898 (*See Class 9 for this trademark*).
- 4,162,908 (*See Class 9 for this trademark*).
- 4,162,909 (*See Class 37 for this trademark*).
- 4,162,911. **KERATINOSENS (STANDARD CHARACTER)**. GIVAUDAN SA, (U.S. CLS. 100 AND 101). SN 79-099,183. PUB. 4-10-2012. FILED 4-29-2011.
- 4,162,913 (*See Class 6 for this trademark*).
- 4,162,924 (*See Class 11 for this trademark*).
- 4,162,935 (*See Class 9 for this trademark*).
- 4,162,941 (*See Class 35 for this trademark*).
- 4,162,945 (*See Class 2 for this trademark*).
- 4,162,947 (*See Class 2 for this trademark*).
- 4,162,950. **ECOCERT AND DESIGN**. ECOCERT, (U.S. CLS. 100 AND 101). SN 79-101,018. PUB. 4-10-2012. FILED 4-26-2011.
- 4,162,987 (*See Class 6 for this trademark*).
- 4,162,995 (*See Class 5 for this trademark*).
- 4,163,007 (*See Class 9 for this trademark*).
- 4,163,026 (*See Class 9 for this trademark*).
- 4,163,029 (*See Class 4 for this trademark*).
- 4,163,040 (*See Class 9 for this trademark*).
- 4,163,053 (*See Class 9 for this trademark*).
- 4,163,055 (*See Class 4 for this trademark*).
- 4,163,056 (*See Class 4 for this trademark*).
- 4,163,060. **VIVVVA (STANDARD CHARACTER)**. VIVVVA-COM INC., (U.S. CLS. 100 AND 101). SN 85-033,384. PUB. 4-10-2012. FILED 5-7-2010.
- 4,163,061 (*See Class 9 for this trademark*).
- 4,163,089. **WEGOLOOK (STANDARD CHARACTER)**. WEGOLOOK, LLC, (U.S. CLS. 100 AND 101). SN 85-116,288. PUB. 4-10-2012. FILED 8-26-2010.
- 4,163,091 (*See Class 9 for this trademark*).
- 4,163,093 (*See Class 9 for this trademark*).
- 4,163,094 (*See Class 35 for this trademark*).
- 4,163,108 (*See Class 36 for this trademark*).
- 4,163,131 (*See Class 9 for this trademark*).
- 4,163,133 (*See Class 35 for this trademark*).
- 4,163,134 (*See Class 9 for this trademark*).
- 4,163,140 (*See Class 6 for this trademark*).
- 4,163,149. **REGSOURCE (STANDARD CHARACTER)**. REGSOURCE INC, (U.S. CLS. 100 AND 101). SN 85-172,092. PUB. 4-10-2012. FILED 11-9-2010.
- 4,163,161 (*See Class 10 for this trademark*).
- 4,163,162 (*See Class 10 for this trademark*).
- 4,163,164. **TEACHING TOOLS IN PLANT BIOLOGY IDEAS TO GROW ON AND DESIGN**. AMERICAN SOCIETY OF PLANT BIOLOGISTS, (U.S. CLS. 100 AND 101). SN 85-197,204. PUB. 4-10-2012. FILED 12-14-2010.
- 4,163,194 (*See Class 35 for this trademark*).
- 4,163,203 (*See Class 31 for this trademark*).
- 4,163,205 (*See Class 9 for this trademark*).
- 4,163,206 (*See Class 9 for this trademark*).
- 4,163,207 (*See Class 9 for this trademark*).
- 4,163,209. **I AM BILINGUE (STANDARD CHARACTER)**. MURPHY, BRENT P., (U.S. CLS. 100 AND 101). SN 85-251,789. PUB. 4-10-2012. FILED 2-25-2011.
- 4,163,216 (*See Class 40 for this trademark*).
- 4,163,218. **ENVIROSCOPE (STANDARD CHARACTER)**. LAYFIELD GROUP LIMITED, (U.S. CLS. 100 AND 101). SN 85-261,111. PUB. 4-10-2012. FILED 3-8-2011.
- 4,163,223 (*See Class 9 for this trademark*).
- 4,163,233. **GROWSAFE BEEF (STANDARD CHARACTER)**. GROWSAFE SYSTEMS LTD., (U.S. CLS. 100 AND 101). SN 85-265,902. PUB. 4-10-2012. FILED 3-14-2011.
- 4,163,234 (*See Class 41 for this trademark*).
- 4,163,245 (*See Class 9 for this trademark*).
- 4,163,249. **EARTHLINK CARRIER (STANDARD CHARACTER)**. EARTHLINK, INC., (U.S. CLS. 100 AND 101). SN 85-274,275. PUB. 4-10-2012. FILED 3-23-2011.
- 4,163,255 (*See Class 35 for this trademark*).
- 4,163,261. **AND I WIN (STANDARD CHARACTER)**. TIM KIGHT, DBA AND I WIN, LLC, AND CAREY KIGHT, DBA AND I WIN, LLC, AND DAVE MILLER, DBA AND I WIN, LLC, AND T. BRIAN KIGHT, DBA AND I WIN, LLC, (U.S. CLS. 100 AND 101). SN 85-283,494. PUB. 4-10-2012. FILED 4-1-2011.
- 4,163,266. **GRIP I.T. (STANDARD CHARACTER)**. GRIP I.T. SOLUTIONS, INC., (U.S. CLS. 100 AND 101). SN 85-286,093. PUB. 4-10-2012. FILED 4-5-2011.
- 4,163,269. **AIW (STANDARD CHARACTER)**. TIM KIGHT, DBA AND I WIN, LLC, AND CAREY KIGHT, DBA AND I WIN, LLC, AND DAVE MILLER, DBA AND I WIN, LLC, AND T. BRIAN KIGHT, DBA AND I WIN, LLC, (U.S. CLS. 100 AND 101). SN 85-286,769. PUB. 4-10-2012. FILED 4-5-2011.
- 4,163,277. **REVENUE GENERATING. MEASURABLE. GUARANTEED. (STANDARD CHARACTER)**. PROFITSTREAMS LLC, (U.S. CLS. 100 AND 101). SN 85-289,236. PUB. 4-10-2012. FILED 4-7-2011.
- 4,163,279 (*See Class 35 for this trademark*).
- 4,163,280 (*See Class 35 for this trademark*).
- 4,163,303. **CURTAIN CALL AND DESIGN**. BEVERLY L.

- HAWKINSON, DBA CURTAIN CALL, (U.S. CLS. 100 AND 101). SN 85-295,414. PUB. 1-3-2012. FILED 4-14-2011.
- 4,163,305 (*See Class 37 for this trademark.*).
- 4,163,307 (*See Class 41 for this trademark.*).
- 4,163,314 (*See Class 9 for this trademark.*).
- 4,163,326. **SILICONTH (STANDARD CHARACTER)**. LOUIE, RYAN K., (U.S. CLS. 100 AND 101). SN 85-302,899. PUB. 4-10-2012. FILED 4-23-2011.
- 4,163,335 (*See Class 37 for this trademark.*).
- 4,163,349. **BEN FRANKLIN ESOTERIC LABS (STANDARD CHARACTER)**. DE LA CRUZ, MICHAEL, (U.S. CLS. 100 AND 101). SN 85-306,224. PUB. 4-10-2012. FILED 4-27-2011.
- 4,163,354. **ALBANY KID (STANDARD CHARACTER)**. SANDFLY MEDIA, LLC, (U.S. CLS. 100 AND 101). SN 85-306,421. PUB. 4-10-2012. FILED 4-27-2011.
- 4,163,364 (*See Class 16 for this trademark.*).
- 4,163,365 (*See Class 38 for this trademark.*).
- 4,163,370. **FOREST GIANT (STANDARD CHARACTER)**. FOREST GIANT, INC., (U.S. CLS. 100 AND 101). SN 85-307,749. PUB. 4-10-2012. FILED 4-28-2011.
- 4,163,377. **GRIP I.T. SOLUTIONS AND DESIGN**. GRIP I.T. SOLUTIONS, INC., (U.S. CLS. 100 AND 101). SN 85-308,410. PUB. 4-10-2012. FILED 4-29-2011.
- 4,163,380 (*See Class 39 for this trademark.*).
- 4,163,384 (*See Class 36 for this trademark.*).
- 4,163,385 (*See Class 36 for this trademark.*).
- 4,163,407 (*See Class 9 for this trademark.*).
- 4,163,410 (*See Class 35 for this trademark.*).
- 4,163,419. **PLANENOISE AND DESIGN**. GROTELL CONSULTING, INC., (U.S. CLS. 100 AND 101). SN 85-313,370. PUB. 4-10-2012. FILED 5-5-2011.
- 4,163,429. **DISTRIBUTED STORE (STANDARD CHARACTER)**. MOONTOAST, LLC, (U.S. CLS. 100 AND 101). SN 85-314,288. PUB. 4-10-2012. FILED 5-6-2011.
- 4,163,440. **IDEATTACK (STANDARD CHARACTER)**. THOMAS, DAN, AND VARNICA, NATASHA, (U.S. CLS. 100 AND 101). SN 85-317,637. PUB. 4-10-2012. FILED 5-11-2011.
- 4,163,444 (*See Class 11 for this trademark.*).
- 4,163,448. **TEAR-A-BYTE (STANDARD CHARACTER)**. LISEF, LLC, DBA TECHR2, (U.S. CLS. 100 AND 101). SN 85-318,983. PUB. 4-10-2012. FILED 5-12-2011.
- 4,163,450. **WITTLE MEMORY (STANDARD CHARACTER)**. OLSON VENTURES, LLC, (U.S. CLS. 100 AND 101). SN 85-319,357. PUB. 4-10-2012. FILED 5-12-2011.
- 4,163,478. **FANCY AUTO TECHNOLOGY THAT KEEPS YOU MOVING. AND DESIGN**. FANCY AUTO, INC., (U.S. CLS. 100 AND 101). SN 85-325,508. PUB. 4-10-2012. FILED 5-19-2011.
- 4,163,497. **SOLECTOR (STANDARD CHARACTER)**. ALCOA INC., (U.S. CLS. 100 AND 101). SN 85-336,729. PUB. 4-10-2012. FILED 6-2-2011.
- 4,163,524. **SMALL DEMONS (STANDARD CHARACTER)**. SMALL DEMONS, INC., (U.S. CLS. 100 AND 101). SN 85-345,639. PUB. 4-10-2012. FILED 6-14-2011.
- 4,163,526 (*See Class 6 for this trademark.*).
- 4,163,531. **PAYBOOK (STANDARD CHARACTER)**. MY PAYBOOK, LLC, (U.S. CLS. 100 AND 101). SN 85-347,109. PUB. 4-10-2012. FILED 6-15-2011.
- 4,163,534. **GABISTA (STANDARD CHARACTER)**. EXM SERVICES INTERNATIONAL PTY LTD, (U.S. CLS. 100 AND 101). SN 85-348,645. PUB. 4-10-2012. FILED 6-17-2011.
- 4,163,537 (*See Class 35 for this trademark.*).
- 4,163,556 (*See Class 35 for this trademark.*).
- 4,163,570. **PETBYTES.ORG THE SOCIAL NETWORKING WEBSITE FOR ALL ANIMAL LOVERS AND DESIGN**. PET BYTES, LLC, (U.S. CLS. 100 AND 101). SN 85-357,848. PUB. 4-10-2012. FILED 6-28-2011.
- 4,163,572 (*See Class 35 for this trademark.*).
- 4,163,573 (*See Class 35 for this trademark.*).
- 4,163,574 (*See Class 19 for this trademark.*).
- 4,163,581 (*See Class 9 for this trademark.*).
- 4,163,582 (*See Class 11 for this trademark.*).
- 4,163,610. **NO PAPER. NO CONNECTION. NO PROBLEM. (STANDARD CHARACTER)**. ZERION SOFTWARE, INC., (U.S. CLS. 100 AND 101). SN 85-375,189. PUB. 4-10-2012. FILED 7-19-2011.
- 4,163,611. **THE SMART ENTERPRISE (STANDARD CHARACTER)**. ZERION SOFTWARE, INC., (U.S. CLS. 100 AND 101). SN 85-375,310. PUB. 4-10-2012. FILED 7-19-2011.
- 4,163,619. **FULLCONTACT (STANDARD CHARACTER)**. FULLCONTACT, INC., (U.S. CLS. 100 AND 101). SN 85-377,196. PUB. 4-10-2012. FILED 7-21-2011.
- 4,163,643. **WEBPHAGE (STANDARD CHARACTER)**. DYAX CORP., (U.S. CLS. 100 AND 101). SN 85-383,275. PUB. 4-10-2012. FILED 7-28-2011.
- 4,163,645. **D2 INTERIEURS (STANDARD CHARACTER)**. D2INTERIEURS, LLC, (U.S. CLS. 100 AND 101). SN 85-383,762. PUB. 4-10-2012. FILED 7-28-2011.
- 4,163,649 (*See Class 35 for this trademark.*).
- 4,163,658 (*See Class 35 for this trademark.*).
- 4,163,674 (*See Class 35 for this trademark.*).
- 4,163,708. **SHIFAMED (STANDARD CHARACTER)**. SHIFAMED, LLC, (U.S. CLS. 100 AND 101). SN 85-407,167. PUB. 4-10-2012. FILED 8-25-2011.
- 4,163,711 (*See Class 35 for this trademark.*).
- 4,163,716. **CLOUD OUTSIDE THE BOX. (STANDARD CHARACTER)**. ENTREDA, INC., (U.S. CLS. 100 AND 101). SN 85-409,462. PUB. 4-10-2012. FILED 8-29-2011.
- 4,163,727 (*See Class 41 for this trademark.*).
- 4,163,728 (*See Class 9 for this trademark.*).
- 4,163,733 (*See Class 35 for this trademark.*).
- 4,163,758 (*See Class 35 for this trademark.*).
- 4,163,766 (*See Class 41 for this trademark.*).
- 4,163,770. **KINGDEE (STYLIZED)**. KINGDEE SOFTWARE (CHINA) CO., LTD., (U.S. CLS. 100 AND 101). SN 85-420,976. PUB. 4-10-2012. FILED 9-13-2011.
- 4,163,780 (*See Class 35 for this trademark.*).
- 4,163,784. **SLIC-8 (STANDARD CHARACTER)**. SELMAN AND ASSOCIATES, LTD., (U.S. CLS. 100 AND 101). SN 85-425,700. PUB. 4-10-2012. FILED 9-19-2011.
- 4,163,790 (*See Class 37 for this trademark.*).
- 4,163,798 (*See Class 9 for this trademark.*).
- 4,163,809 (*See Class 39 for this trademark.*).
- 4,163,812. **CERTIFIED COLLECTIBLES GROUP (STANDARD CHARACTER)**. CERTIFIED COLLECTIBLES GROUP, (U.S. CLS. 100 AND 101). SN 85-429,139. PUB. 4-10-2012. FILED 9-22-2011.
- 4,163,818 (*See Class 35 for this trademark.*).
- 4,163,833. **GALERA THERAPEUTICS (STANDARD CHARACTER)**. GALERA THERAPEUTICS LLC, (U.S. CLS. 100 AND 101). SN 85-433,191. PUB. 4-10-2012. FILED 9-27-2011.
- 4,163,840 (*See Class 37 for this trademark.*).
- 4,163,862. **INOXCVA AND DESIGN**. CRYOGENIC VESSEL ALTERNATIVES, INC., (U.S. CLS. 100 AND 101). SN 85-436,177. PUB. 4-10-2012. FILED 9-30-2011.
- 4,163,863. **INOXCVA (STANDARD CHARACTER)**. CRYOGENIC VESSEL ALTERNATIVES, INC., (U.S. CLS. 100 AND 101). SN 85-436,193. PUB. 4-10-2012. FILED 9-30-2011.
- 4,163,872. **GRIT DESIGN (STANDARD CHARACTER)**. GRIT DESIGN LLC, (U.S. CLS. 100 AND 101). SN 85-437,585. PUB. 4-10-2012. FILED 10-3-2011.
- 4,163,879 (*See Class 35 for this trademark.*).
- 4,163,892 (*See Class 25 for this trademark.*).
- 4,163,905 (*See Class 9 for this trademark.*).
- 4,163,920. **QUICKCUE AND DESIGN**. QUICKCUE, LLC, (U.S. CLS. 100 AND 101). SN 85-443,040. PUB. 4-10-2012. FILED 10-10-2011.
- 4,163,921 (*See Class 35 for this trademark.*).
- 4,163,922 (*See Class 35 for this trademark.*).
- 4,163,952. **DINERMAGIC (STANDARD CHARACTER)**. WONG, PATRICK, (U.S. CLS. 100 AND 101). SN 85-446,487. PUB. 4-10-2012. FILED 10-13-2011.
- 4,163,993 (*See Class 35 for this trademark.*).
- 4,163,998 (*See Class 35 for this trademark.*).
- 4,164,026 (*See Class 35 for this trademark.*).
- 4,164,039 (*See Class 9 for this trademark.*).
- 4,164,040. **INTELLIGENT SYSTEM SOLUTIONS (STANDARD CHARACTER)**. ARMSTRONG GLOBAL HOLDINGS, INC., (U.S. CLS. 100 AND 101). SN 85-452,254. PUB. 4-10-2012. FILED 10-20-2011.
- 4,164,054. **DAVID MICHAEL (STANDARD CHARACTER)**. DAVID MICHAEL & CO., INC., (U.S. CLS. 100 AND 101). SN 85-452,910. PUB. 4-10-2012. FILED 10-21-2011.
- 4,164,057. **THE BEVERAGE MECHANICS (STANDARD CHARACTER)**. DISTILLED SPIRITS EPICENTER, LLC, (U.S. CLS. 100 AND 101). SN 85-453,014. PUB. 4-10-2012.

- FILED 10-21-2011.
 4,164,060 (*See Class 33 for this trademark*).
 4,164,067. **STAFFREADY AND DESIGN**. MAPLEWOOD SOFTWARE, INC., (U.S. CLS. 100 AND 101). SN 85-453,209. PUB. 4-10-2012. FILED 10-21-2011.
 4,164,077. **SKILLSETREADY AND DESIGN**. MAPLEWOOD SOFTWARE, INC., (U.S. CLS. 100 AND 101). SN 85-453,492. PUB. 4-10-2012. FILED 10-21-2011.
 4,164,081. **SCHEDULEREADY AND DESIGN**. MAPLEWOOD SOFTWARE, INC., (U.S. CLS. 100 AND 101). SN 85-453,538. PUB. 4-10-2012. FILED 10-21-2011.
 4,164,083. **INSPECTIONREADY AND DESIGN**. MAPLEWOOD SOFTWARE, INC., (U.S. CLS. 100 AND 101). SN 85-453,578. PUB. 4-10-2012. FILED 10-21-2011.
 4,164,117. **TRIBLOOM (STANDARD CHARACTER)**. M SQUARED ENTERPRISES, INC., DBA TRIBLOOM, INC., (U.S. CLS. 100 AND 101). SN 85-454,726. PUB. 4-10-2012. FILED 10-24-2011.
 4,164,160 (*See Class 35 for this trademark*).
 4,164,190. **CAS PRODUCTION & MARKETING (STANDARD CHARACTER)**. CAS PRODUCTION, INC., (U.S. CLS. 100 AND 101). SN 85-456,464. PUB. 4-10-2012. FILED 10-26-2011.
 4,164,199. **TIRESIAS TECHNOLOGIES AND DESIGN**. TIRESIAS TECHNOLOGIES, INC., (U.S. CLS. 100 AND 101). SN 85-456,680. PUB. 4-10-2012. FILED 10-26-2011.
 4,164,208. **HEALTHSTAR MY SPEAKER RESOURCE (STANDARD CHARACTER)**. HEALTHSTAR COMMUNICATIONS, (U.S. CLS. 100 AND 101). SN 85-456,998. PUB. 4-10-2012. FILED 10-26-2011.
 4,164,211. **HEALTHSTAR MYEVENTRESOURCE (STANDARD CHARACTER)**. HEALTHSTAR COMMUNICATIONS, (U.S. CLS. 100 AND 101). SN 85-457,055. PUB. 4-10-2012. FILED 10-26-2011.
 4,164,214. **BALLAST SAVER AND DESIGN**. GEORGETOWN RAIL EQUIPMENT COMPANY, (U.S. CLS. 100 AND 101). SN 85-457,233. PUB. 4-10-2012. FILED 10-26-2011.
 4,164,241. **LITTLEWOMAN DESIGN AND DESIGN**. LITTLE WOMAN DESIGN LLC, (U.S. CLS. 100 AND 101). SN 85-457,555. PUB. 4-10-2012. FILED 10-27-2011.
 4,164,249. **EPIC (STANDARD CHARACTER)**. CARGO AIRPORT SERVICES USA, LLC, (U.S. CLS. 100 AND 101). SN 85-457,638. PUB. 4-10-2012. FILED 10-27-2011.
 4,164,267 (*See Class 35 for this trademark*).
 4,164,268. **EPIC AND DESIGN**. CARGO AIRPORT SERVICES USA, LLC, (U.S. CLS. 100 AND 101). SN 85-457,783. PUB. 4-10-2012. FILED 10-27-2011.
 4,164,272. **V-SEPT (STANDARD CHARACTER)**. ADP DEALER SERVICES, INC., (U.S. CLS. 100 AND 101). SN 85-457,807. PUB. 4-10-2012. FILED 10-27-2011.
 4,164,276. **SONOSMILE (STANDARD CHARACTER)**. MULTI DIMENSIONAL IMAGING, LLC, DBA SONOSMILE, (U.S. CLS. 100 AND 101). SN 85-457,826. PUB. 4-10-2012. FILED 10-27-2011.
 4,164,295. **RELATIONSHOP (STANDARD CHARACTER)**. GO THINK LLC, (U.S. CLS. 100 AND 101). SN 85-457,963. PUB. 4-10-2012. FILED 10-27-2011.
 4,164,302 (*See Class 35 for this trademark*).
 4,164,303. **RECOVERYPOINT (STANDARD CHARACTER)**. RECOVERY POINT SYSTEMS, INC., (U.S. CLS. 100 AND 101). SN 85-457,995. PUB. 4-10-2012. FILED 10-27-2011.
 4,164,307. **SPRINGFIN (STANDARD CHARACTER)**. SPRINGFIN, LLC, (U.S. CLS. 100 AND 101). SN 85-458,024. PUB. 4-10-2012. FILED 10-27-2011.
 4,164,313. **MISCELLANEOUS DESIGN**. RECOVERY POINT SYSTEMS, INC., (U.S. CLS. 100 AND 101). SN 85-458,110. PUB. 4-10-2012. FILED 10-27-2011.
 4,164,324. **EASYGOALS (STANDARD CHARACTER)**. OPDETOP, INC., (U.S. CLS. 100 AND 101). SN 85-458,191. PUB. 4-10-2012. FILED 10-27-2011.
 4,164,326. **MONTY GRAPHICS (STANDARD CHARACTER)**. MONTLACK, CARA, (U.S. CLS. 100 AND 101). SN 85-458,203. PUB. 4-10-2012. FILED 10-27-2011.
 4,164,328. **BRING YOUR LIFE...TO LIFE! (STANDARD CHARACTER)**. OPDETOP, INC., (U.S. CLS. 100 AND 101). SN 85-458,211. PUB. 4-10-2012. FILED 10-27-2011.
 4,164,330. **HOSTGO (STANDARD CHARACTER)**. FRITSCHNET, INC., DBA HOSTGO.COM, (U.S. CLS. 100 AND 101). SN 85-458,219. PUB. 4-10-2012. FILED 10-27-2011.
 4,164,331. **HPDI (STANDARD CHARACTER)**. DRILLING INFO, INC., (U.S. CLS. 100 AND 101). SN 85-458,220. PUB. 4-10-2012. FILED 10-27-2011.
 4,164,339 (*See Class 35 for this trademark*).
 4,164,340. **OPEN TO EXPLORE (STANDARD CHARACTER)**. DRILLING INFO, INC., (U.S. CLS. 100 AND 101). SN 85-458,277. PUB. 4-10-2012. FILED 10-27-2011.
 4,164,342. **INSIGHT (STANDARD CHARACTER)**. CHAMPION COLLEGE SERVICES, INC., (U.S. CLS. 100 AND 101). SN 85-458,303. PUB. 4-10-2012. FILED 10-27-2011.
 4,164,344. **PINNACLE (STANDARD CHARACTER)**. CHAMPION COLLEGE SERVICES, INC., (U.S. CLS. 100 AND 101). SN 85-458,320. PUB. 4-10-2012. FILED 10-27-2011.
 4,164,346. **DELIVER (STANDARD CHARACTER)**. CHAMPION COLLEGE SERVICES, INC., (U.S. CLS. 100 AND 101). SN 85-458,340. PUB. 4-10-2012. FILED 10-27-2011.
 4,164,347. **PIONEER (STANDARD CHARACTER)**. CHAMPION COLLEGE SERVICES, INC., (U.S. CLS. 100 AND 101). SN 85-458,349. PUB. 4-10-2012. FILED 10-27-2011.
 4,164,349. **ADVANTAGE (STANDARD CHARACTER)**. CHAMPION COLLEGE SERVICES, INC., (U.S. CLS. 100 AND 101). SN 85-458,380. PUB. 4-10-2012. FILED 10-27-2011.
 4,164,352. **CHOICE (STANDARD CHARACTER)**. CHAMPION COLLEGE SERVICES, INC., (U.S. CLS. 100 AND 101). SN 85-458,407. PUB. 4-10-2012. FILED 10-27-2011.
 4,164,363. **WAVEFAX (STANDARD CHARACTER)**. WAVEFAX TECHNOLOGIES CO.,LTD., (U.S. CLS. 100 AND 101). SN 85-458,577. PUB. 4-10-2012. FILED 10-28-2011.
 4,164,387. **YOUCONTROL (STANDARD CHARACTER)**. JUNKNELIS, MATTHEW JUSTIN, (U.S. CLS. 100 AND 101). SN 85-458,792. PUB. 4-10-2012. FILED 10-28-2011.
 4,164,421. **AZWORDPIC (STYLIZED)**. INFINIT SOFTWARE SOLUTIONS, INC., (U.S. CLS. 100 AND 101). SN 85-459,129. PUB. 4-10-2012. FILED 10-28-2011.
 4,164,424 (*See Class 9 for this trademark*).
 4,164,449. **FUSE ANALYTICS AND DESIGN**. FUSE ANALYTICS, INC., (U.S. CLS. 100 AND 101). SN 85-459,451. PUB. 4-10-2012. FILED 10-28-2011.
 4,164,468. **ZOOKEEPER (STANDARD CHARACTER)**. ZOOKEEPER INDUSTRIES, LLC, (U.S. CLS. 100 AND 101). SN 85-459,674. PUB. 4-10-2012. FILED 10-29-2011.
 4,164,475. **THE BEST SMARTPHONE DEVELOPMENT COMPANY, PERIOD! (STANDARD CHARACTER)**. WALLDORFGROUP LLC, (U.S. CLS. 100 AND 101). SN 85-459,734. PUB. 4-10-2012. FILED 10-29-2011.
 4,164,501. **BREAKING PARADIGMS BY EMBRACING TECHNOLOGY (STANDARD CHARACTER)**. R2 CONSTRUCTION SERVICES, INC., (U.S. CLS. 100 AND 101). SN 85-460,060. PUB. 4-10-2012. FILED 10-31-2011.
 4,164,506. **EIM ELEMENT (STANDARD CHARACTER)**. EXCELLENCE IN MOTIVATION, INC., DBA EXCELLENCE IN MOTIVATION, (U.S. CLS. 100 AND 101). SN 85-460,101. PUB. 4-10-2012. FILED S.R. 10-31-2011; AM. P.R. 2-24-2012.
 4,164,513. **M-PACT (STANDARD CHARACTER)**. MORRIS EXPORT CRATING COMPANY, (U.S. CLS. 100 AND 101). SN 85-460,233. PUB. 4-10-2012. FILED 10-31-2011.
 4,164,561 (*See Class 41 for this trademark*).
 4,164,575. **LUNGFISH DESIGN AND DESIGN**. MICHAEL ANTHONY MAHARAJH, (U.S. CLS. 100 AND 101). SN 85-461,111. PUB. 4-10-2012. FILED 11-1-2011.
 4,164,590. **MOBILEPRM TRANSFORMING PATIENT RELATIONSHIPS AND DESIGN**. SWINGLEY, PAMELA, L, DBA MOBILE PRM, (U.S. CLS. 100 AND 101). SN 85-461,481. PUB. 4-10-2012. FILED 11-1-2011.
 4,164,591 (*See Class 9 for this trademark*).
 4,164,598. **FALSTAFF (STANDARD CHARACTER)**. PIKE, DAVID R, (U.S. CLS. 100 AND 101). SN 85-461,986. PUB. 4-10-2012. FILED 11-1-2011.
 4,164,609. **DIBELSNET (STANDARD CHARACTER)**. DYNAMIC MEASUREMENT GROUP, INC., (U.S. CLS. 100 AND 101). SN 85-463,933. PUB. 4-10-2012. FILED 11-3-2011.
 4,164,622. **HEALTHSTAR MYEVENTRESOURCE (STANDARD CHARACTER)**. HEALTHSTAR COMMUNICATIONS, (U.S. CLS. 100 AND 101). SN 85-466,377. PUB. 4-10-2012. FILED 11-7-2011.
 4,164,659. **EXPLORED ALL SEVEN (STANDARD CHARACTER)**. MCDONOUGH, DAVID, (U.S. CLS. 100 AND 101). SN 85-471,265. PUB. 4-10-2012. FILED 11-13-2011.

- 4,164,692. **DIDESKTOP (STANDARD CHARACTER)**. DRILLING INFO, INC., (U.S. CLS. 100 AND 101). SN 85-479,456. PUB. 4-10-2012. FILED 11-22-2011.
- 4,164,779. **CRYSTAL CG (STANDARD CHARACTER)**. CRYSTAL COMPUTER GRAPHICS LIMITED, (U.S. CLS. 100 AND 101). SN 85-976,244. PUB. 4-10-2012. FILED 4-11-2011.

CLASS 43—HOTEL AND RESTAURANT SERVICES

- 4,162,714. **BEERFEAST (STANDARD CHARACTER)**. EIGHT-O-MANAGEMENT, INC., (U.S. CLS. 100 AND 101). SN 76-709,008. PUB. 4-10-2012. FILED 9-7-2011.
- 4,162,726 (*See Class 9 for this trademark*).
- 4,162,739. **ABUNDANT LIFE (STANDARD CHARACTER)**. LUTHERAN SENIORLIFE, MULTIPLE CLASS, (INT. CLS. 43 AND 44), (U.S. CLS. 100 AND 101). SN 77-481,023. PUB. 4-6-2010. FILED 5-22-2008.
- 4,162,749. **COUPLES SECRET RENDEZVOUS (STANDARD CHARACTER)**. E.A. ISSA & BROS. LTD., (U.S. CLS. 100 AND 101). SN 77-709,470. PUB. 8-11-2009. FILED 4-8-2009.
- 4,162,882 (*See Class 39 for this trademark*).
- 4,162,947 (*See Class 2 for this trademark*).
- 4,162,971 (*See Class 30 for this trademark*).
- 4,163,079 (*See Class 5 for this trademark*).
- 4,163,092 (*See Class 41 for this trademark*).
- 4,163,137. **THE LAST FRONTIER...JUST AROUND THE CORNER. (STANDARD CHARACTER)**. COPPER WEST, INC., (U.S. CLS. 100 AND 101). SN 85-164,431. PUB. 4-10-2012. FILED 10-29-2010.
- 4,163,167 (*See Class 41 for this trademark*).
- 4,163,369 (*See Class 29 for this trademark*).
- 4,163,380 (*See Class 39 for this trademark*).
- 4,163,382. **PHIL'S RIBS #1 AND DESIGN**. PHIL'S BBQ, INC., (U.S. CLS. 100 AND 101). SN 85-308,922. PUB. 4-10-2012. FILED 4-29-2011.
- 4,163,390. **ONE CHILD ONE BLANKET (STANDARD CHARACTER)**. JOHNSON & JOHNSON, (U.S. CLS. 100 AND 101). SN 85-309,578. PUB. 4-10-2012. FILED 5-2-2011.
- 4,163,490. **BBQUEUE CAM (STANDARD CHARACTER)**. PHIL'S BBQ, INC., (U.S. CLS. 100 AND 101). SN 85-333,364. PUB. 4-10-2012. FILED 5-30-2011.
- 4,163,505. **LANDLUBBER'S RAW BAR & GRILL AND DESIGN**. HORSETRAIL, INC., (U.S. CLS. 100 AND 101). SN 85-338,467. PUB. 4-10-2012. FILED 6-6-2011.
- 4,163,513 (*See Class 16 for this trademark*).
- 4,163,547. **FEBRUANY (STANDARD CHARACTER)**. DOCTOR'S ASSOCIATES INC., (U.S. CLS. 100 AND 101). SN 85-352,590. PUB. 4-10-2012. FILED 6-22-2011.
- 4,163,551. **SONNY'S REAL PIT BAR-B-Q OFFICIAL PIT-MASTER AND DESIGN**. SONNY'S FRANCHISE COMPANY, (U.S. CLS. 100 AND 101). SN 85-353,342. PUB. 4-10-2012. FILED 6-22-2011.
- 4,163,600 (*See Class 41 for this trademark*).
- 4,163,646. **F AND DESIGN**. CHEN, SHI YONG, DBA FUSHIMI, AND CHEN, DANIEL, DBA FUSHIMI, AND LIN, XIAN, DBA FUSHIMI, (U.S. CLS. 100 AND 101). SN 85-385,450. PUB. 4-10-2012. FILED 7-30-2011.
- 4,163,653. **CP BURGER AND DESIGN**. CP BURGER, LLC, (U.S. CLS. 100 AND 101). SN 85-386,778. PUB. 4-10-2012. FILED 8-2-2011.
- 4,163,655. **THE ULTIMATE KABOBERY (STANDARD CHARACTER)**. PREMIER FOOD CONCEPTS LLC, (U.S. CLS. 100 AND 101). SN 85-386,960. PUB. 4-10-2012. FILED 8-2-2011.
- 4,163,657. **CP AND DESIGN**. CP BURGER, LLC, (U.S. CLS. 100 AND 101). SN 85-387,316. PUB. 4-10-2012. FILED 8-2-2011.
- 4,163,697. **PACIFIC CLINICS ADVANCING BEHAVIORAL HEALTHCARE AND DESIGN**. PACIFIC CLINICS, (U.S. CLS. 100 AND 101). SN 85-403,041. PUB. 4-10-2012. FILED 8-20-2011.
- 4,163,740 (*See Class 41 for this trademark*).
- 4,163,769. **THE FEZ AND DESIGN**. MONTE, ERIC, AND BIGOS, DONNA, (U.S. CLS. 100 AND 101). SN 85-420,841. PUB. 4-10-2012. FILED 9-12-2011.
- 4,163,775. **MY MAMA'S PIZZA & PASTA "NOBODY FEEDS YOU LIKE MAMA" AND DESIGN**. NIGHT FURY, INC., (U.S. CLS. 100 AND 101). SN 85-422,857. PUB. 4-10-2012. FILED 9-14-2011.
- 4,163,783. **CHAPEL HILL DAY CARE CENTER AND DESIGN**. CHAPEL HILL DAY CARE CENTER, (U.S. CLS. 100 AND 101). SN 85-424,961. PUB. 4-10-2012. FILED 9-16-2011.
- 4,163,794. **SAGRANTINO AND DESIGN**. PERNAZZA-CAMARENA, ALESSANDRO, (U.S. CLS. 100 AND 101). SN 85-427,452. PUB. 4-10-2012. FILED 9-20-2011.
- 4,163,803 (*See Class 41 for this trademark*).
- 4,163,841. **PITA HOUSE RESTAURANT AND DESIGN**. PITA HOUSE, INC., (U.S. CLS. 100 AND 101). SN 85-433,873. PUB. 4-10-2012. FILED 9-28-2011.
- 4,163,941 (*See Class 41 for this trademark*).
- 4,163,962. **WELCOME TO DELICIOUS (STANDARD CHARACTER)**. CULVER ENTERPRISES, INC., (U.S. CLS. 100 AND 101). SN 85-447,469. PUB. 4-10-2012. FILED 10-14-2011.
- 4,164,065 (*See Class 35 for this trademark*).
- 4,164,105. **JAX FISH HOUSE & OYSTER BAR (STANDARD CHARACTER)**. EMPIRE CRABHOUSE, LLC, (U.S. CLS. 100 AND 101). SN 85-454,402. PUB. 4-10-2012. FILED 10-24-2011.
- 4,164,109. **GYROMANIA (STANDARD CHARACTER)**. IOANNIS LAZARIDIS, (U.S. CLS. 100 AND 101). SN 85-454,558. PUB. 4-10-2012. FILED 10-24-2011.
- 4,164,151. **MILK RUN DONUT CAFE AND DESIGN**. MILK RUN LLC, AKA MILK RUN DONUT CAFE, (U.S. CLS. 100 AND 101). SN 85-455,657. PUB. 4-10-2012. FILED 10-25-2011.
- 4,164,169. **KNOSH'S AND DESIGN**. KNOSH ENTERPRISES, LLC, (U.S. CLS. 100 AND 101). SN 85-455,968. PUB. 4-10-2012. FILED 10-25-2011.
- 4,164,207. **VEGAN BLACK METAL CHEF (STANDARD CHARACTER)**. MANOWITZ, BRIAN, (U.S. CLS. 100 AND 101). SN 85-456,936. PUB. 4-10-2012. FILED 10-26-2011.
- 4,164,226. **PLACEMENT NAVIGATION (STANDARD CHARACTER)**. LISA DOYLE, (U.S. CLS. 100 AND 101). SN 85-457,370. PUB. 4-10-2012. FILED 10-27-2011.
- 4,164,256 (*See Class 30 for this trademark*).
- 4,164,279. **PEACH STREET CAFE (STANDARD CHARACTER)**. PEACH STREET CAFE, INC., (U.S. CLS. 100 AND 101). SN 85-457,879. PUB. 4-10-2012. FILED 10-27-2011.
- 4,164,322. **MAGICAL ELEGANCE ON THE MEXICAN RIVERA (STANDARD CHARACTER)**. TIDES HOTELS, L.L.C., (U.S. CLS. 100 AND 101). SN 85-458,171. PUB. 4-10-2012. FILED 10-27-2011.
- 4,164,323. **CHIC BY THE SHORE (STANDARD CHARACTER)**. TIDES HOTELS, L.L.C., (U.S. CLS. 100 AND 101). SN 85-458,175. PUB. 4-10-2012. FILED 10-27-2011.
- 4,164,327. **IMPULSIVE GROUP A LIFESTYLE HOSPITALITY COMPANY AND DESIGN**. IMPULSIVE ENTERPRISES LTD., (U.S. CLS. 100 AND 101). SN 85-458,206. PUB. 4-10-2012. FILED 10-27-2011.
- 4,164,351. **THE WHOLE BOWL (STANDARD CHARACTER)**. THE WHOLE BOWL, INC., (U.S. CLS. 100 AND 101). SN 85-458,387. PUB. 4-10-2012. FILED 10-27-2011.
- 4,164,396. **RED FACE JACK'S (STANDARD CHARACTER)**. RED FACE JACK'S, INC., (U.S. CLS. 100 AND 101). SN 85-458,874. PUB. 4-10-2012. FILED 10-28-2011.
- 4,164,429. **READ, REST, REFLECT (STANDARD CHARACTER)**. HOSPITALITY 3, LLC, (U.S. CLS. 100 AND 101). SN 85-459,226. PUB. 4-10-2012. FILED 10-28-2011.
- 4,164,431 (*See Class 30 for this trademark*).
- 4,164,433. **STUDYHOTELS.COM (STANDARD CHARACTER)**. HOSPITALITY 3, LLC, (U.S. CLS. 100 AND 101). SN 85-459,262. PUB. 4-10-2012. FILED 10-28-2011.
- 4,164,457. **RADIANT SENIOR LIVING (STANDARD CHARACTER)**. RADIANT SENIOR LIVING, INC., (U.S. CLS. 100 AND 101). SN 85-459,559. PUB. 4-10-2012. FILED 10-28-2011.
- 4,164,517. **SHISHKABAR (STANDARD CHARACTER)**. WINN, MICHAEL, (U.S. CLS. 100 AND 101). SN 85-460,326. PUB. 4-10-2012. FILED 10-31-2011.
- 4,164,520. **LIVE HERE, FOR THE BEST OF YOUR LIFE! (STANDARD CHARACTER)**. ABBEY PARK, L.L.C., (U.S. CLS. 100 AND 101). SN 85-460,352. PUB. 4-10-2012. FILED 10-31-2011.
- 4,164,583. **JOSE PEPPER'S AND DESIGN**. NORTHSTAR RESTAURANTS, INC., (U.S. CLS. 100 AND 101). SN 85-461,268. PUB. 4-10-2012. FILED 11-1-2011.
- 4,164,628. **BOLDBITE AND DESIGN**. CAPITOL EATS, INC., (U.S. CLS. 100 AND 101). SN 85-467,130. PUB. 4-10-2012.

- FILED 11-8-2011.
 4,164,675. **FOODONI GRILL "THE DIFFERENCE IN TASTE" AND DESIGN.** PANOS SERETIS, DBA FOODONI GRILL, (U.S. CLS. 100 AND 101). SN 85-474,547. PUB. 4-10-2012. FILED 11-16-2011.
 4,164,684. **LUCALI (STANDARD CHARACTER).** SANTA ELENA HOLDINGS LTD., (U.S. CLS. 100 AND 101). SN 85-477,000. PUB. 4-10-2012. FILED 11-18-2011.
 4,164,715. **SABERTOOTH (STANDARD CHARACTER).** SABERTOOTH MOTORCYCLES, LLC, (U.S. CLS. 100 AND 101). SN 85-485,452. PUB. 4-10-2012. FILED 12-1-2011.
 4,164,769. **SEASONS 52 FRESH GRILL (STANDARD CHARACTER).** DARDEN CONCEPTS, INC., (U.S. CLS. 100 AND 101). SN 85-520,142. PUB. 4-10-2012. FILED 1-19-2012.

CLASS 44—MEDICAL, BEAUTY AND AGRICULTURAL SERVICES

- 4,162,715. **MISCELLANEOUS DESIGN.** TEXAS HEALTH RESOURCES, (U.S. CLS. 100 AND 101). SN 76-709,073. PUB. 4-10-2012. FILED 9-15-2011.
 4,162,739 (*See Class 43 for this trademark.*)
 4,162,754. **SIGNATURE HEALTHCARE CARE REDEFINED S (STYLIZED).** SIGNATURE HEALTHCARE, LLC, (U.S. CLS. 100 AND 101). SN 77-750,203. PUB. 10-18-2011. FILED 6-2-2009.
 4,162,755. **SIGNATURE HEALTHCARE (STYLIZED).** SIGNATURE HEALTHCARE, LLC, (U.S. CLS. 100 AND 101). SN 77-751,350. PUB. 10-19-2010. FILED 6-3-2009.
 4,162,776. **SCISSOR CANDY AND DESIGN.** BERARDI, JOSEPH, (U.S. CLS. 100 AND 101). SN 77-927,138. PUB. 6-22-2010. FILED 2-3-2010.
 4,162,837 (*See Class 16 for this trademark.*)
 4,162,859 (*See Class 41 for this trademark.*)
 4,162,974 (*See Class 3 for this trademark.*)
 4,162,975 (*See Class 3 for this trademark.*)
 4,162,995 (*See Class 5 for this trademark.*)
 4,163,027 (*See Class 10 for this trademark.*)
 4,163,030 (*See Class 31 for this trademark.*)
 4,163,126. **ST. LUKE'S E CARE CONNECTION AND DESIGN.** ST. LUKE'S EPISCOPAL HEALTH SYSTEM, (U.S. CLS. 100 AND 101). SN 85-157,766. PUB. 10-4-2011. FILED 10-21-2010.
 4,163,127 (*See Class 35 for this trademark.*)
 4,163,148 (*See Class 35 for this trademark.*)
 4,163,242. **SKIN: HEALTH, SAFETY, BEAUTY. (STANDARD CHARACTER).** WEST COUNTY DERMATOLOGY, INC., (U.S. CLS. 100 AND 101). SN 85-272,304. PUB. 4-10-2012. FILED 3-21-2011.
 4,163,256. **SADDLEBACK MEMORIAL (STANDARD CHARACTER).** MEMORIAL HEALTH SERVICES, (U.S. CLS. 100 AND 101). SN 85-279,177. PUB. 4-10-2012. FILED 3-28-2011.
 4,163,271 (*See Class 1 for this trademark.*)
 4,163,339 (*See Class 41 for this trademark.*)
 4,163,376 (*See Class 41 for this trademark.*)
 4,163,387 (*See Class 35 for this trademark.*)
 4,163,388 (*See Class 35 for this trademark.*)
 4,163,441. **CENTER FOR COMPASSIONATE CARE WEST HOSPICE EL PASO AND DESIGN.** HOSPICE OF EL PASO, INC., (U.S. CLS. 100 AND 101). SN 85-317,688. PUB. 4-10-2012. FILED 5-11-2011.
 4,163,542. **SIGNATURE HEALTHCARE (STANDARD CHARACTER).** SIGNATURE HEALTHCARE, LLC, (U.S. CLS. 100 AND 101). SN 85-350,518. PUB. 1-24-2012. FILED 6-20-2011.
 4,163,553. **MY EYES MY STORY (STYLIZED).** NOVARTIS AG, (U.S. CLS. 100 AND 101). SN 85-354,227. PUB. 4-10-2012. FILED 6-23-2011.
 4,163,598. **FUNCTIONAL HEALTHCARE SOLUTIONS NEUROSCIENCE BIOCHEMISTRY NUTRITION MOVEMENT AND DESIGN.** FUNCTIONAL HEALTHCARE SOLUTIONS, PC, (U.S. CLS. 100 AND 101). SN 85-369,433. PUB. 4-10-2012. FILED 7-12-2011.
 4,163,651. **RUBS MASSAGE STUDIO AND DESIGN.** TAYLOR, SHELENE, (U.S. CLS. 100 AND 101). SN 85-386,565. PUB. 4-10-2012. FILED 8-2-2011.
 4,163,698. **PACIFIC CLINICS ADVANCING BEHAVIORAL HEALTHCARE AND DESIGN.** PACIFIC CLINICS, (U.S. CLS. 100 AND 101). SN 85-403,042. PUB. 4-10-2012. FILED 8-20-2011.
 4,163,699. **PACIFIC CLINICS ADVANCING BEHAVIORAL HEALTHCARE AND DESIGN.** PACIFIC CLINICS, (U.S. CLS. 100 AND 101). SN 85-403,046. PUB. 4-10-2012. FILED 8-20-2011.
 4,163,730. **WE ARE PODIATRIC PATHOLOGY (STANDARD CHARACTER).** BAKOTIC PATHOLOGY ASSOCIATES, LLC, (U.S. CLS. 100 AND 101). SN 85-413,353. PUB. 4-10-2012. FILED 9-1-2011.
 4,163,739. **BAKO AND DESIGN.** BAKOTIC PATHOLOGY ASSOCIATES, LLC, (U.S. CLS. 100 AND 101). SN 85-414,016. PUB. 4-10-2012. FILED 9-2-2011.
 4,163,782. **EXECUTIVE MED-CLUB OF TAMPA AND DESIGN.** BIEN, STEPHANIE, (U.S. CLS. 100 AND 101). SN 85-424,885. PUB. 4-10-2012. FILED 9-16-2011.
 4,163,828. **MOON MOUNTAIN TREE FARMS AND DESIGN.** MOON VALLEY NURSERY, LLC, (U.S. CLS. 100 AND 101). SN 85-432,618. PUB. 4-10-2012. FILED 9-27-2011.
 4,163,852. **SUNDANCE DENTAL KIDS (STANDARD CHARACTER).** SUNDANCE DENTAL PARTNERS, LLC, (U.S. CLS. 100 AND 101). SN 85-434,864. PUB. 4-10-2012. FILED 9-28-2011.
 4,163,853. **SUNDANCE DENTAL KIDS AND DESIGN.** SUNDANCE DENTAL PARTNERS, LLC, (U.S. CLS. 100 AND 101). SN 85-434,867. PUB. 4-10-2012. FILED 9-29-2011.
 4,163,855. **PRIMA WEIGHT LOSS (STANDARD CHARACTER).** RAO, CHETHANA V., (U.S. CLS. 100 AND 101). SN 85-435,237. PUB. 4-10-2012. FILED 9-29-2011.
 4,163,911 (*See Class 41 for this trademark.*)
 4,163,914. **SEA TURTLE INC. SOUTH PADRE ISLAND, TX. AND DESIGN.** SEA TURTLE, INCORPORATED, (U.S. CLS. 100 AND 101). SN 85-441,982. PUB. 4-10-2012. FILED 10-7-2011.
 4,163,951. **LAKE MURRAY DENTISTRY BRADLEY H. YOUNG, D.M.D. AND DESIGN.** LAKE MURRAY DENTISTRY, LLC, (U.S. CLS. 100 AND 101). SN 85-446,369. PUB. 4-10-2012. FILED 10-13-2011.
 4,163,988. **MISCELLANEOUS DESIGN.** NORTHWEST HEALTHCARE CORPORATION, (U.S. CLS. 100 AND 101). SN 85-449,208. PUB. 4-10-2012. FILED 10-17-2011.
 4,163,994. **DRIVEADVISE (STANDARD CHARACTER).** BETH ISRAEL DEACONESS MEDICAL CENTER, INC., (U.S. CLS. 100 AND 101). SN 85-449,653. PUB. 4-10-2012. FILED 10-18-2011.
 4,163,997. **ORGANIC BRONZE BAR (STANDARD CHARACTER).** ORGANIC BRONZE BAR, LLC, (U.S. CLS. 100 AND 101). SN 85-449,773. PUB. 4-10-2012. FILED 10-18-2011.
 4,164,024. **TALBOT HOSPICE FOUNDATION AND DESIGN.** TALBOT HOSPICE FOUNDATION, INC., MULTIPLE CLASS, (INT. CLS. 44 AND 45), (U.S. CLS. 100 AND 101). SN 85-451,257. PUB. 4-10-2012. FILED 10-19-2011.
 4,164,042. **CUT THE CORD (STANDARD CHARACTER).** TRIWEST HEALTHCARE ALLIANCE CORP., (U.S. CLS. 100 AND 101). SN 85-452,350. PUB. 4-10-2012. FILED 10-20-2011.
 4,164,076. **GREAT BOCA SMILES (STANDARD CHARACTER).** DR. ALAN Z MARKOWITZ, DMD PA, (U.S. CLS. 100 AND 101). SN 85-453,486. PUB. 4-10-2012. FILED 10-21-2011.
 4,164,114. **MILITARY HELPLINE MILITARYHELPLINE.ORG AND DESIGN.** THE OREGON PARTNERSHIP, INC., (U.S. CLS. 100 AND 101). SN 85-454,695. PUB. 4-10-2012. FILED 10-24-2011.
 4,164,116. **MISCELLANEOUS DESIGN.** SERRA, BRENDON, (U.S. CLS. 100 AND 101). SN 85-454,721. PUB. 4-10-2012. FILED 10-24-2011.
 4,164,128. **ZENJOYCE (STANDARD CHARACTER).** GLAXO GROUP LIMITED, (U.S. CLS. 100 AND 101). SN 85-455,178. PUB. 4-10-2012. FILED 10-25-2011.
 4,164,164. **THE HEART INSTITUTE AT PALM BEACH GARDENS MEDICAL CENTER. AND DESIGN.** PALM BEACH GARDENS COMMUNITY HOSPITAL, INC., (U.S. CLS. 100 AND 101). SN 85-455,844. PUB. 4-10-2012. FILED 10-25-2011.
 4,164,174. **BANFIELD PET HOSPITAL (STANDARD CHARACTER).** MEDICAL MANAGEMENT INTERNATIONAL, INC., (U.S. CLS. 100 AND 101). SN 85-456,018. PUB. 4-10-2012. FILED 10-25-2011.

- 4,164,209. **TALL PINES CARE AND REHAB AND DESIGN.** TALL PINES CARE AND REHAB, INC., (U.S. CLS. 100 AND 101). SN 85-457,019. PUB. 4-10-2012. FILED 10-26-2011.
- 4,164,280. **COLD-SUBFASCIAL (STANDARD CHARACTER).** MAERCKES, RIAN A., (U.S. CLS. 100 AND 101). SN 85-457,880. PUB. 4-10-2012. FILED 10-27-2011.
- 4,164,298. **MDWEIGHTWORX (STANDARD CHARACTER).** ANDRY HEALTH AND WELLNESS, LLC, (U.S. CLS. 100 AND 101). SN 85-457,970. PUB. 4-10-2012. FILED 10-27-2011.
- 4,164,317. **ARTISTRY CONCEPTS AND DESIGN.** ARTISTRY CONCEPTS, LLC, DBA ARTISTRY CONCEPTS, (U.S. CLS. 100 AND 101). SN 85-458,139. PUB. 4-10-2012. FILED 10-27-2011.
- 4,164,345. **IMAGE HOUSE, INC. (STANDARD CHARACTER).** IMAGE HOUSE, INC., (U.S. CLS. 100 AND 101). SN 85-458,331. PUB. 4-10-2012. FILED 10-27-2011.
- 4,164,372. **BRINGING LOVING CARE TO HEALTH CARE (STANDARD CHARACTER).** MOUNTAIN STATES HEALTH ALLIANCE, (U.S. CLS. 100 AND 101). SN 85-458,632. PUB. 4-10-2012. FILED 10-28-2011.
- 4,164,390. **SHUG-A-BUG KIDS SPA (STANDARD CHARACTER).** SHUG-A-BUG KIDS SPA LLC, (U.S. CLS. 100 AND 101). SN 85-458,819. PUB. 4-10-2012. FILED 10-28-2011.
- 4,164,488. **RDMP G (STYLIZED).** REGULATION DIRECTIVE MEDICAL PHYSICS, LLC, (U.S. CLS. 100 AND 101). SN 85-459,818. PUB. 4-10-2012. FILED 10-30-2011.
- 4,164,500 (*See Class 3 for this trademark.*).
- 4,164,515. **ORTHOMARYLAND (STANDARD CHARACTER).** ORTHOPAEDIC SPECIALTY CENTER, (U.S. CLS. 100 AND 101). SN 85-460,255. PUB. 4-10-2012. FILED 10-31-2011.
- 4,164,519. **LUXE GLOW (STANDARD CHARACTER).** AKIYO HENNA INC., (U.S. CLS. 100 AND 101). SN 85-460,329. PUB. 4-10-2012. FILED 10-31-2011.
- 4,164,542. **THE MICRO-MINI LIFT (STANDARD CHARACTER).** GODIN, MICHAEL, (U.S. CLS. 100 AND 101). SN 85-460,605. PUB. 4-10-2012. FILED 10-31-2011.
- 4,164,558. **FULLY ALIVE (STANDARD CHARACTER).** DR. ROBERT S. IVKER, D.O., P.C., (U.S. CLS. 100 AND 101). SN 85-460,825. PUB. 4-10-2012. FILED 10-31-2011.
- 4,164,576. **G R E G O T T AND DESIGN.** GREG OTT'S CENTER FOR PHYSICAL THERAPY & SPORTS PERFORMANCE, LLC, (U.S. CLS. 100 AND 101). SN 85-461,123. PUB. 4-10-2012. FILED 11-1-2011.
- 4,164,640. **THE RIGHT PLAN (STANDARD CHARACTER).** THE RIGHT PLAN, LLC, (U.S. CLS. 100 AND 101). SN 85-468,534. PUB. 4-10-2012. FILED 11-9-2011.
- 4,164,726. **VICTORY IN PINK (STANDARD CHARACTER).** ST VINCENT'S HEALTH SYSTEM INC, (U.S. CLS. 100 AND 101). SN 85-489,283. PUB. 4-10-2012. FILED 12-7-2011.
- 4,164,738. **THE CORE INSTITUTE CENTER FOR ORTHOPEDICRESEARCH AND EDUCATION AND DESIGN.** THE CENTER FOR ORTHOPEDIC AND RESEARCH EXCELLENCE, INC., (U.S. CLS. 100 AND 101). SN 85-496,373. PUB. 4-10-2012. FILED 12-15-2011.
- DBA MACSIMUM PUBLISHING LLC, (U.S. CLS. 100 AND 101). SN 85-232,312. PUB. 4-10-2012. FILED 2-2-2011.
- 4,163,197. **STAN (STANDARD CHARACTER).** THE EXCHANGE CLUB CENTER FOR THE PREVENTION OF CHILD ABUSE OF NORTH MISSISSIPPI, INCORPORATED, (U.S. CLS. 100 AND 101). SN 85-238,511. PUB. 4-10-2012. FILED 2-10-2011.
- 4,163,205 (*See Class 9 for this trademark.*).
- 4,163,206 (*See Class 9 for this trademark.*).
- 4,163,207 (*See Class 9 for this trademark.*).
- 4,163,228 (*See Class 16 for this trademark.*).
- 4,163,231 (*See Class 16 for this trademark.*).
- 4,163,274. **VERITAS (STANDARD CHARACTER).** VLG HOLDINGS, LLC, (U.S. CLS. 100 AND 101). SN 85-288,746. PUB. 4-10-2012. FILED 4-7-2011.
- 4,163,320 (*See Class 35 for this trademark.*).
- 4,163,329 (*See Class 35 for this trademark.*).
- 4,163,330 (*See Class 35 for this trademark.*).
- 4,163,331 (*See Class 35 for this trademark.*).
- 4,163,365 (*See Class 38 for this trademark.*).
- 4,163,427. **THE BUBBLEBUDS BUBBLELEE BUBBLELAA AND DESIGN.** DIANA MALERBA, (U.S. CLS. 100 AND 101). SN 85-314,248. PUB. 4-10-2012. FILED 5-6-2011.
- 4,163,495 (*See Class 25 for this trademark.*).
- 4,163,539 (*See Class 36 for this trademark.*).
- 4,163,540. **E-INTROS.COM (STANDARD CHARACTER).** FESTFARE, INC, (U.S. CLS. 100 AND 101). SN 85-349,934. PUB. 11-8-2011. FILED 6-19-2011.
- 4,163,572 (*See Class 35 for this trademark.*).
- 4,163,573 (*See Class 35 for this trademark.*).
- 4,163,595. **BEGIN HEALING (STANDARD CHARACTER).** LEGACY CHAPELS, L.L.C., (U.S. CLS. 100 AND 101). SN 85-368,940. PUB. 4-10-2012. FILED 7-12-2011.
- 4,163,710. **CLOTHES THE DEAL AND DESIGN.** CLOTHES THE DEAL, (U.S. CLS. 100 AND 101). SN 85-408,251. PUB. 4-10-2012. FILED 8-26-2011.
- 4,163,765. **MVR FLEET MANAGER (STANDARD CHARACTER).** DATA RESEARCH NETWORK, INC., DBA HIRESAFE, (U.S. CLS. 100 AND 101). SN 85-419,576. PUB. 4-10-2012. FILED 9-10-2011.
- 4,163,803 (*See Class 41 for this trademark.*).
- 4,163,807. **SVLG (STANDARD CHARACTER).** SILICON VALLEY LAW GROUP, AKA SVLG, (U.S. CLS. 100 AND 101). SN 85-428,618. PUB. 4-10-2012. FILED 9-21-2011.
- 4,163,859. **CMMINTS AND DESIGN.** CMMINTS, (U.S. CLS. 100 AND 101). SN 85-435,962. PUB. 4-10-2012. FILED 9-30-2011.
- 4,163,896. **THEMEWORK (STANDARD CHARACTER).** ERICA MEADE COUNSELING LLC, (U.S. CLS. 100 AND 101). SN 85-440,528. PUB. 4-10-2012. FILED 10-6-2011.
- 4,163,899. **KEEP THE FAITH (STANDARD CHARACTER).** KEEP THE FAITH FOUNDATION, INC., DBA KEEP THE FAITH, AND DAVID SAMS INDUSTRIES, INC., AKA TV FIRST, (U.S. CLS. 100 AND 101). SN 85-441,325. PUB. 4-10-2012. FILED 10-6-2011.
- 4,163,912 (*See Class 35 for this trademark.*).
- 4,163,913 (*See Class 35 for this trademark.*).
- 4,163,922 (*See Class 35 for this trademark.*).
- 4,163,935. **CHAI SOCIAL (STANDARD CHARACTER).** JESSICA MORENO, (U.S. CLS. 100 AND 101). SN 85-444,369. PUB. 4-10-2012. FILED 10-11-2011.
- 4,163,961 (*See Class 35 for this trademark.*).
- 4,163,973. **PROSPER LAW (STANDARD CHARACTER).** PROSPER LAW GROUP, LLP, (U.S. CLS. 100 AND 101). SN 85-448,099. PUB. 4-10-2012. FILED 10-14-2011.
- 4,164,024 (*See Class 44 for this trademark.*).
- 4,164,037. **COLLEGE APP ATTACK ATTACK YOUR COLLEGE APPLICATIONS WITH CONFIDENCE GO APE ON YOUR APPS! AND DESIGN.** MATHY, FRANCINE, (U.S. CLS. 100 AND 101). SN 85-452,146. PUB. 4-10-2012. FILED 10-20-2011.
- 4,164,064 (*See Class 38 for this trademark.*).
- 4,164,068. **COMMITDBA (STANDARD CHARACTER).** THE ROSS GROUP INC., (U.S. CLS. 100 AND 101). SN 85-453,211. PUB. 4-10-2012. FILED 10-21-2011.
- 4,164,132 (*See Class 35 for this trademark.*).
- 4,164,161. **HIV INNOCENCE GROUP (STANDARD CHARACTER).** OFFICE OF MEDICAL & SCIENTIFIC JUSTICE,

CLASS 45—PERSONAL AND LEGAL SERVICES

- 4,162,726 (*See Class 9 for this trademark.*).
- 4,162,812 (*See Class 6 for this trademark.*).
- 4,162,828 (*See Class 35 for this trademark.*).
- 4,162,830 (*See Class 9 for this trademark.*).
- 4,162,849 (*See Class 42 for this trademark.*).
- 4,162,941 (*See Class 35 for this trademark.*).
- 4,162,947 (*See Class 2 for this trademark.*).
- 4,162,963 (*See Class 38 for this trademark.*).
- 4,163,042 (*See Class 35 for this trademark.*).
- 4,163,148 (*See Class 35 for this trademark.*).
- 4,163,151 (*See Class 36 for this trademark.*).
- 4,163,171 (*See Class 41 for this trademark.*).
- 4,163,182. **STARKID (STANDARD CHARACTER).** ORI AYONMIKE, (U.S. CLS. 100 AND 101). SN 85-221,737. PUB. 4-10-2012. FILED 1-20-2011.
- 4,163,193. **SO YOU'RE SOBER; WHAT'S NEXT? CREATING A PERSONAL ACTION PLAN FOR LIFE BEYOND SOBRIETY.** (STANDARD CHARACTER). BRIAN MCALISTER,

- INC., (U.S. CLS. 100 AND 101). SN 85-455,820. PUB. 4-10-2012. FILED 10-25-2011.
- 4,164,162. **BECAUSE INTEGRITY IS WORTH DEFENDING (STANDARD CHARACTER)**. OFFICE OF MEDICAL & SCIENTIFIC JUSTICE, INC., (U.S. CLS. 100 AND 101). SN 85-455,832. PUB. 4-10-2012. FILED 10-25-2011.
- 4,164,163. **OMSJ (STANDARD CHARACTER)**. OFFICE OF MEDICAL & SCIENTIFIC JUSTICE, INC., (U.S. CLS. 100 AND 101). SN 85-455,837. PUB. 4-10-2012. FILED 10-25-2011.
- 4,164,170. **F A FRAUD AVENGERS (STYLIZED)**. FOUNDATION FOR FRAUD ABATEMENT & ACTIVISM, (U.S. CLS. 100 AND 101). SN 85-455,980. PUB. 4-10-2012. FILED 10-25-2011.
- 4,164,175. **EB READY TO WEAR AND DESIGN**. BRIGGEMAN, ELIZABETH, (U.S. CLS. 100 AND 101). SN 85-456,020. PUB. 4-10-2012. FILED 10-25-2011.
- 4,164,247. **POOPDECK (STANDARD CHARACTER)**. OUTCAST MARINE, INC., (U.S. CLS. 100 AND 101). SN 85-457,625. PUB. 4-10-2012. FILED 10-27-2011.
- 4,164,273. **MISCELLANEOUS DESIGN**. SNAPTRACS, INC., (U.S. CLS. 100 AND 101). SN 85-457,811. PUB. 4-10-2012. FILED 10-27-2011.
- 4,164,274. **TAGG (STANDARD CHARACTER)**. SNAPTRACS, INC., (U.S. CLS. 100 AND 101). SN 85-457,812. PUB. 4-10-2012. FILED 10-27-2011.
- 4,164,281. **LEVINS TAX LAW AND DESIGN**. LEVINS TAX LAW, LLC, (U.S. CLS. 100 AND 101). SN 85-457,888. PUB. 4-10-2012. FILED 10-27-2011.
- 4,164,356. **OFFIT KURMAN (STANDARD CHARACTER)**. OFFIT KURMAN, P.A., AKA OFFIT KURMAN, (U.S. CLS. 100 AND 101). SN 85-458,462. PUB. 4-10-2012. FILED 10-27-2011.
- 4,164,388. **ZWILLGEN (STANDARD CHARACTER)**. ZWILLGEN PLLC, FORMERLY ZWILLINGER GENESTKI LLP, (U.S. CLS. 100 AND 101). SN 85-458,805. PUB. 4-10-2012. FILED 10-28-2011.
- 4,164,405. **ZG AND DESIGN**. ZWILLGEN PLLC, FORMERLY ZWILLINGER GENESTKI LLP, (U.S. CLS. 100 AND 101). SN 85-458,948. PUB. 4-10-2012. FILED 10-28-2011.
- 4,164,408. **IMALIVE AND DESIGN**. IMALIVE LLC, (U.S. CLS. 100 AND 101). SN 85-458,962. PUB. 4-10-2012. FILED 10-28-2011.
- 4,164,416. **CHR (STANDARD CHARACTER)**. CHAPEL HILL REPORTING, LLC, (U.S. CLS. 100 AND 101). SN 85-459,052. PUB. 4-10-2012. FILED 10-28-2011.
- 4,164,438. **LAWSHIELD (STANDARD CHARACTER)**. WALKER, RICE & WISDOM, P.C., (U.S. CLS. 100 AND 101). SN 85-459,349. PUB. 4-10-2012. FILED 10-28-2011.
- 4,164,511 (*See Class 38 for this trademark*).
- 4,164,528. **THE MEDIATION PLACE (STANDARD CHARACTER)**. MEDIATION INTERNATIONAL LLC, (U.S. CLS. 100 AND 101). SN 85-460,446. PUB. 4-10-2012. FILED 10-31-2011.
- 4,164,535. **STUDIOVEENA.COM (STANDARD CHARACTER)**. BRAND, CHRISTOPHER, (U.S. CLS. 100 AND 101). SN 85-460,533. PUB. 4-10-2012. FILED 10-31-2011.
- 4,164,536. **LOVETT'S LOVIN' PET & HOME CARE (STANDARD CHARACTER)**. LOVETT, MELANIE J., (U.S. CLS. 100 AND 101). SN 85-460,540. PUB. 4-10-2012. FILED 10-31-2011.
- 4,164,565. **PAMPER ME GODLY (STANDARD CHARACTER)**. FAMILY OF FAITH FOUNDATION INC., (U.S. CLS. 100 AND 101). SN 85-460,890. PUB. 4-10-2012. FILED 10-31-2011.
- 4,164,586 (*See Class 35 for this trademark*).
- 4,164,599. **THE TEACHER'S LAWYER (STANDARD CHARACTER)**. THE LAW OFFICE OF B. A. THOMAS, LLC, (U.S. CLS. 100 AND 101). SN 85-461,987. PUB. 4-10-2012. FILED 11-1-2011.
- 4,164,612. **MISCELLANEOUS DESIGN**. GOOD NEWS PUBLISHERS, (U.S. CLS. 100 AND 101). SN 85-464,497. PUB. 4-10-2012. FILED 11-4-2011.
- 4,164,647 (*See Class 36 for this trademark*).
- 4,164,679. **MISCELLANEOUS DESIGN**. FAMILY OF FAITH FOUNDATION INC., (U.S. CLS. 100 AND 101). SN 85-476,123. PUB. 4-10-2012. FILED 11-18-2011.
- 4,164,708 (*See Class 35 for this trademark*).
- 4,164,756. **UNCOMMONLY SMART LAW (STANDARD CHARACTER)**. THE AR GROUP, LLP, DBA THE AR GROUP, (U.S. CLS. 100 AND 101). SN 85-506,966. PUB. 4-10-2012. FILED 12-31-2011.

* * * * *

SECTION 2.—PRIOR UNITED STATES CLASSIFICATION

CERTIFICATION MARKS

CLASS B—SERVICES

4,163,073. **CRSP (STANDARD CHARACTER)**. AMERICAN BANKERS ASSOCIATION, SN 85-087,371. PUB. 4-10-2012. FILED 7-19-2010.

4,163,179. **R.T.(BS)(ARRT) (STANDARD CHARACTER)**. AMERICAN REGISTRY OF RADIOLOGIC TECHNOLOGISTS, THE, SN 85-217,937. PUB. 4-10-2012. FILED 1-14-2011.

4,163,180. **R.T.(M)(ARRT) (STANDARD CHARACTER)**.

AMERICAN REGISTRY OF RADIOLOGIC TECHNOLOGISTS, THE, SN 85-218,206. PUB. 4-10-2012. FILED 1-14-2011.

4,164,180. **AV PREEMINENT (STANDARD CHARACTER)**. REED ELSEVIER PROPERTIES INC., SN 85-456,268. PUB. 4-10-2012. FILED 10-26-2011.

4,164,181. **BV DISTINGUISHED (STANDARD CHARACTER)**. REED ELSEVIER PROPERTIES INC., SN 85-456,270. PUB. 4-10-2012. FILED 10-26-2011.

* * * * *

TRADEMARK REGISTRATIONS ISSUED UNDER SECTION 1(d)

The following marks have registered on the Principal Register pursuant to the intent-to-use provisions of Section 1(d) of the Trademark Act of 1946, as amended.

SECTION 1.— INTERNATIONAL CLASSIFICATION

The short titles associated below with the international class numbers are terms designed merely for quick identification and are not an official part of the international classification. The full names of international classes are given in section 6.1 of the trademark rules of practice.

The designation "U.S. Cl." appearing in this section refers to the U.S. class in effect prior to Sep. 1, 1973 rather than the international class which applies to applications filed on or after that date. For adoption of international classification see notice in the OFFICIAL GAZETTE of Jun. 26, 1973 (911 O.G. TM 210).

Application in more than one class

4,164,789. GPPR, LLC., LOS ANGELES, CA. SN 76-701,768.
PUB. 2-1-2011, FILED 2-23-2010.

4,164,790. OGUDO, PETER, CULVER CITY, CA. SN 76-
701,933. PUB. 8-9-2011, FILED 3-5-2010.

**G.P.P.R. Gentleman,
Philosopher, Pervert & Rebel**

**ADAM LOOPHOLE PRESENTS ROT
APPAREL**

THE MARK CONSISTS OF STANDARD CHARACTERS
WITHOUT CLAIM TO ANY PARTICULAR FONT, STYLE,
SIZE, OR COLOR.

CLASS 9—ELECTRICAL AND SCIENTIFIC APPARATUS

FOR SUNGLASSES, HEADPHONES (U.S. CLS. 21, 23,
26, 36 AND 38).
FIRST USE 8-10-2010; IN COMMERCE 8-10-2010.

CLASS 14—JEWELRY

FOR WATCHES, NECKLACES, BRACELETS, PEN-
DANTS (U.S. CLS. 2, 27, 28 AND 50).
FIRST USE 10-1-2010; IN COMMERCE 10-1-2010.

CLASS 18—LEATHER GOODS

FOR BAGS, NAMELY, HAND BAGS, SHOULDER
BAGS, BACKPACKS, DUFFEL BAGS, BRIEF CASES
(U.S. CLS. 1, 2, 3, 22 AND 41).
FIRST USE 11-20-2010; IN COMMERCE 11-20-2010.

CLASS 25—CLOTHING

FOR COATS, JACKETS, CASUAL FOOTWEAR, DRESS
FOOTWEAR, ATHLETIC AND SPORTS FOOTWEAR,
SANDALS AND BEACH FOOTWEAR, SHIRTS, T
SHIRTS, BLOUSES, PANTS, JEANS, SWEAT SUITS,
SHORTS, SWIMWEAR, SOCKS, HOSIERY, RAINWEAR,
VESTS, SCARVES, HATS, HEADBANDS (U.S. CLS. 22
AND 39).
FIRST USE 8-15-2010; IN COMMERCE 8-15-2010.

THE MARK CONSISTS OF STANDARD CHARACTERS
WITHOUT CLAIM TO ANY PARTICULAR FONT, STYLE,
SIZE, OR COLOR.

NO CLAIM IS MADE TO THE EXCLUSIVE RIGHT TO
USE "APPAREL", APART FROM THE MARK AS SHOWN.
"ADAM LOOPHOLE" DOES NOT IDENTIFY A LIVING
INDIVIDUAL.

CLASS 18—LEATHER GOODS

FOR HANDBAGS, BACK PACKS, PURSES, WALLETS,
TOTE BAGS, TRAVEL BAGS, CARRY-ON BAGS (U.S.
CLS. 1, 2, 3, 22 AND 41).
FIRST USE 8-28-2008; IN COMMERCE 8-28-2008.

CLASS 25—CLOTHING

FOR CLOTHING, NAMELY, T-SHIRTS, VESTS,
SLACKS, HOODED SWEATSHIRTS, JACKETS, HATS,
FOOTWEAR, SHOES, SNEAKERS, SANDALS, CA-
PRICES, SOCKS, SLIPPERS, JEANS, UNDERGAR-
MENTS, BLOUSES, DRESSES, BLAZERS, SUITS, PANT
SUITS, SHIRTS, HOODED SWEATSHIRTS, COATS,
PANTS, BELTS (U.S. CLS. 22 AND 39).
FIRST USE 8-28-2008; IN COMMERCE 8-28-2008.

4,164,792. SHARP KABUSHIKI KAISHA, TA SHARP CORPORATION, OSAKA, JAPAN. SN 76-703,772. PUB. 5-10-2011, FILED 7-12-2010.

4,164,810. AVRIL LAVIGNE MUSIC & ENTERTAINMENT LLC, LOS ANGELES, CA. SN 77-394,683. PUB. 1-13-2009, FILED 2-12-2008.

RemoteFleet

CLASS 35—ADVERTISING AND BUSINESS

FOR PROVIDING BILLING INFORMATION IN THE NATURE OF PROVIDING ACCURATE USAGE BILL FOR MULTIFUNCTION PRINTERS COMBINED WITH COPYING MACHINES, FACSIMILES AND SCANNERS (U.S. CLS. 100, 101 AND 102).

FIRST USE 11-30-2009; IN COMMERCE 11-30-2009.

CLASS 42—SCIENTIFIC AND COMPUTER SERVICES

FOR MONITORING THROUGH COMPUTER NETWORKS FOR MULTIFUNCTION PRINTERS COMBINED WITH COPYING MACHINES, FACSIMILES AND SCANNERS, NAMELY, MONITORING SERVICE WHICH READS THE METERS FROM MULTIFUNCTION PRINTERS COMBINED WITH COPYING MACHINES, FACSIMILES AND SCANNERS (U.S. CLS. 100 AND 101).

FIRST USE 11-30-2009; IN COMMERCE 11-30-2009.

ABBEY DAWN BY AVRIL LAVIGNE

THE MARK CONSISTS OF STANDARD CHARACTERS WITHOUT CLAIM TO ANY PARTICULAR FONT, STYLE, SIZE, OR COLOR.

OWNER OF U.S. REG. NOS. 2,716,514, 2,805,492, AND OTHERS.

THE NAME SHOWN IN THE MARK IDENTIFIES "AVRIL LAVIGNE", WHOSE CONSENT TO REGISTER IS OF RECORD.

4,164,809. INVERSIONES TRIUNVIRATO S.A., SANTIAGO, CHILE. SN 77-278,981. PUB. 8-12-2008, FILED 9-13-2007.

COLLOKY

THE MARK CONSISTS OF STANDARD CHARACTERS WITHOUT CLAIM TO ANY PARTICULAR FONT, STYLE, SIZE, OR COLOR.

OWNER OF U.S. REG. NO. 2,029,136.

THE WORD "COLLOKY" HAS NO MEANING IN A FOREIGN LANGUAGE.

CLASS 18—LEATHER GOODS

FOR BAGS, NAMELY, HANDBAGS AND PURSUES (U.S. CLS. 1, 2, 3, 22 AND 41).

FIRST USE 12-15-2010; IN COMMERCE 12-15-2010.

CLASS 25—CLOTHING

FOR SWEATERS, HEADWEAR, NAMELY, CAPS; FOOTWEAR, NAMELY, SHOES AND BOOTS; DRESSES, SWIMSUITS; JACKETS; FOOTWEAR, NAMELY, BEACH FOOTWEAR, CASUAL FOOTWEAR; SWEAT PANTS; COATS (U.S. CLS. 22 AND 39).

FIRST USE 12-15-2010; IN COMMERCE 12-15-2010.

CLASS 3—COSMETICS AND CLEANING PREPARATIONS

FOR BATH AND BODY PRODUCTS, NAMELY, BATH SOAPS, BODY LOTIONS, BODY MILKS; NON-MEDICATED SKIN CARE PREPARATIONS; HAIR CARE PREPARATIONS; PERFUMERY; DEODORANTS FOR PERSONAL USE (U.S. CLS. 1, 4, 6, 50, 51 AND 52).

FIRST USE 0-0-2000; IN COMMERCE 0-0-2008.

CLASS 12—VEHICLES

FOR BABY CARRIAGES; ACCESSORIES FOR BABY CARRIAGES, NAMELY, COVERS AND CANOPIES; CHILDREN'S SAFETY SEATS FOR CARS; BABY SEATS ATTACHED TO BICYCLES (U.S. CLS. 19, 21, 23, 31, 35 AND 44).

FIRST USE 0-0-2006; IN COMMERCE 0-0-2008.

4,164,816. ELX FUTURES, L.P., NEW YORK, NY. SN 77-412,710. PUB. 1-27-2009, FILED 3-4-2008.

ELX

CLASS 35—ADVERTISING AND BUSINESS

FOR BUSINESS CONSULTATION SERVICES IN THE FIELD OF RETAIL SALES; RETAIL STORE SERVICES OFFERED THROUGH RETAIL STORES, CATALOG, MAIL ORDER AND ONLINE FEATURING A WIDE VARIETY OF CONSUMER GOODS OF OTHERS (U.S. CLS. 100, 101 AND 102).

FIRST USE 0-0-1990; IN COMMERCE 0-0-2008.

THE MARK CONSISTS OF STANDARD CHARACTERS WITHOUT CLAIM TO ANY PARTICULAR FONT, STYLE, SIZE, OR COLOR.

CLASS 36—INSURANCE AND FINANCIAL

FOR FINANCIAL SERVICES, NAMELY, PROVIDING FINANCIAL INFORMATION CONCERNING INVESTMENT SECURITIES, FINANCIAL INSTRUMENTS AND FUTURES CONTRACTS; FINANCIAL EXCHANGE; FUTURES EXCHANGE SERVICES, NAMELY, FINANCIAL TRADE EXECUTION, CONFIRMATION AND SETTLEMENT SERVICES IN THE FIELDS OF INVESTMENT SECURITIES, FINANCIAL INSTRUMENTS AND FUTURES CONTRACTS; INVESTMENT FUNDS TRANSFER AND TRANSACTION SERVICES; INVESTMENT BROKERAGE; FUTURES EXCHANGE SERVICES, NAMELY, TRANSACTING AND TRADING OF FINANCIAL INSTRUMENTS IN THE FIELDS OF INVESTMENT SECURITIES, FINANCIAL INSTRUMENTS AND FUTURES CONTRACTS; ORGANIZATION OF ELECTRONIC FUTURES EXCHANGE, NAMELY, PROVIDING AN ELECTRONIC MARKETPLACE FOR TRADING OF FINANCIAL INSTRUMENTS IN THE FIELDS OF INVESTMENT SECURITIES, FINANCIAL INSTRUMENTS AND FUTURES CONTRACTS; FINANCIAL INVESTMENT IN THE FIELD OF INVESTMENT SECURITIES, FINANCIAL INSTRUMENTS AND FUTURES CONTRACTS; FINANCIAL SERVICES IN THE NATURE OF AN INVESTMENT SECURITY; SECURITIES BROKERAGE; TRADING FINANCIAL INSTRUMENTS FOR OTHERS IN THE FIELDS OF INVESTMENT SECURITIES, FINANCIAL INSTRUMENTS AND FUTURES CONTRACTS; FUTURES EXCHANGE SERVICES, NAMELY, SETTLEMENT OF FINANCIAL AND SECURITIES TRANSACTIONS IN THE FIELDS OF INVESTMENT SECURITIES, FINANCIAL INSTRUMENTS AND FUTURES CONTRACTS; FINANCIAL CLEARING HOUSE SERVICES; PROVIDING AN ON-LINE COMPUTER DATABASE FEATURING FINANCIAL INFORMATION IN THE FIELD OF INVESTMENT SECURITIES, FINANCIAL INSTRUMENTS AND FUTURES CONTRACTS; PROVIDING A WEBSITE FEATURING FINANCIAL INFORMATION IN THE FIELD OF INVESTMENT SECURITIES, FINANCIAL INSTRUMENTS AND FUTURES CONTRACTS (U.S. CLS. 100, 101 AND 102).
FIRST USE 4-23-2012; IN COMMERCE 4-23-2012.

CLASS 42—SCIENTIFIC AND COMPUTER SERVICES

FOR DESIGN AND DEVELOPMENT OF COMPUTER HARDWARE AND SOFTWARE; INSTALLATION, MAINTENANCE AND UPDATING SERVICES FOR COMPUTER SOFTWARE; CONSULTANCY RELATING TO COMPUTER HARDWARE AND SOFTWARE; CONSULTING SERVICES IN THE FIELD OF DESIGN, SELECTION, IMPLEMENTATION AND USE OF COMPUTER HARDWARE AND SOFTWARE SYSTEMS FOR OTHERS; CUSTOMIZATION OF COMPUTER HARDWARE AND SOFTWARE; PROVIDING ON-LINE NON-DOWNLOADABLE SOFTWARE FOR ACCESSING FINANCIAL INFORMATION AND TRADING OF FINANCIAL INSTRUMENTS, INVESTMENT SECURITIES, FUTURES CONTRACTS; TECHNICAL SUPPORT SERVICES, NAMELY, CONSULTANCY IN THE FIELD OF COMPUTER HARDWARE AND SOFTWARE PROBLEMS (U.S. CLS. 100 AND 101).
FIRST USE 4-23-2012; IN COMMERCE 4-23-2012.

4,164,818. PARLU, INC., SAN FRANCISCO, CA. SN 77-452,436. PUB. 5-19-2009, FILED 4-18-2008.

PARLU

THE MARK CONSISTS OF STANDARD CHARACTERS WITHOUT CLAIM TO ANY PARTICULAR FONT, STYLE, SIZE, OR COLOR.

CLASS 42—SCIENTIFIC AND COMPUTER SERVICES

FOR COMPUTER SERVICES, NAMELY, HOSTING ONLINE WEB FACILITIES FOR OTHERS FOR ORGANIZING AND CONDUCTING ONLINE MEETINGS, GATHERINGS, AND INTERACTIVE DISCUSSIONS; COMPUTER SERVICES IN THE NATURE OF CUSTOMIZED WEB PAGES FEATURING USER-DEFINED INFORMATION, PERSONAL PROFILES AND INFORMATION; APPLICATION SERVICE PROVIDER FEATURING SOFTWARE TO ENABLE UPLOADING, POSTING, SHOWING, DISPLAYING, TAGGING, BLOGGING, SHARING OR OTHERWISE PROVIDING ELECTRONIC MEDIA OR INFORMATION OVER THE INTERNET OR OTHER COMMUNICATIONS NETWORK; PROVIDING TEMPORARY USE OF NON-DOWNLOADABLE SOFTWARE APPLICATIONS FOR NETWORKING ON SHARED INTERESTS OR CONCERNS; EXTRACTION AND RETRIEVAL OF INFORMATION AND DATA MINING BY MEANS OF GLOBAL COMPUTER NETWORK; CREATING INDICES OF INFORMATION, WEB SITES AND OTHER INFORMATION SOURCES IN CONNECTION WITH GLOBAL COMPUTER NETWORKS; PROVIDING INFORMATION ON COMPUTER TECHNOLOGY FROM SEARCHABLE INDICES AND DATABASES OF INFORMATION, INCLUDING TEXT, ELECTRONIC DOCUMENTS, DATABASES, GRAPHICS AND AUDIO VISUAL INFORMATION, BY MEANS OF GLOBAL COMPUTER NETWORK; COMPUTER SERVICES, NAMELY, MONITORING, ANALYZING AND REPORTING ON INTERNET TRAFFIC CONTROL AND CONTENT CONTROL OF THE WEBSITES AND WEBSITE BLOGS OF OTHERS; PROVIDING INFORMATION IN THE FIELDS OF WEATHER AND COMPUTER TECHNOLOGY VIA THE INTERNET; PROVIDING INFORMATION IN THE FIELDS OF SCIENCE AND TECHNOLOGY VIA THE INTERNET (U.S. CLS. 100 AND 101).
FIRST USE 6-26-2011; IN COMMERCE 6-26-2011.

CLASS 45—PERSONAL AND LEGAL SERVICES

FOR INTERNET BASED ON-LINE SOCIAL INTRODUCTION AND SOCIAL NETWORKING SERVICES (U.S. CLS. 100 AND 101).
FIRST USE 6-26-2011; IN COMMERCE 6-26-2011.

4,164,822. FIO CORPORATION, TORONTO, CANADA. SN 77-470,636. PUB. 2-24-2009, FILED 5-9-2008.

FIO

THE MARK CONSISTS OF STANDARD CHARACTERS WITHOUT CLAIM TO ANY PARTICULAR FONT, STYLE, SIZE, OR COLOR.

CLASS 10—MEDICAL APPARATUS

FOR MEDICAL INSTRUMENTS FOR DIAGNOSTIC EXAMINATION, NAMELY, PATHOGEN AND HOST EXPRESSION FACTORS DETECTION APPARATUSES; MEDICAL INSTRUMENTS FOR USE IN GENERAL EXAMINATION, NAMELY, INSTRUMENTS USED FOR DIAGNOSING HOST EXPRESSION FACTORS AND INSTRUMENTS, SWABS, SYRINGES AND CUVETTES USED FOR THE COLLECTION OF BIOLOGICAL FLUIDS, SUCH AS BLOOD AND TISSUE SAMPLES (U.S. CLS. 26, 39 AND 44).
FIRST USE 6-5-2011; IN COMMERCE 6-5-2011.

CLASS 35—ADVERTISING AND BUSINESS

FOR ELECTRONIC DATA COLLECTION AND DATA SUBMISSION SERVICES FOR BUSINESS PURPOSES IN THE FIELDS OF MEDICINE AND HEALTHCARE (U.S. CLS. 100, 101 AND 102).

FIRST USE 6-5-2011; IN COMMERCE 6-5-2011.

CLASS 39—TRANSPORTATION AND STORAGE

FOR ELECTRONIC STORAGE OF MEDICAL DIAGNOSTIC DATA FOR OTHERS (U.S. CLS. 100 AND 105).

FIRST USE 6-5-2011; IN COMMERCE 6-5-2011.

CLASS 42—SCIENTIFIC AND COMPUTER SERVICES

FOR COMPILING DATA FOR RESEARCH PURPOSES IN THE FIELD OF MEDICAL SCIENCE (U.S. CLS. 100 AND 101).

FIRST USE 6-5-2011; IN COMMERCE 6-5-2011.

CLASS 44—MEDICAL, BEAUTY AND AGRICULTURAL SERVICES

FOR PROVIDING MEDICAL INFORMATION, ADVICE AND DATA FOR HEALTHCARE PURPOSES (U.S. CLS. 100 AND 101).

FIRST USE 6-5-2011; IN COMMERCE 6-5-2011.

4,164,823. IN2WIT, LLC, KINGSPORT, TN. SN 77-502,463. PUB. 6-1-2010, FILED 6-18-2008.

in2Wit

THE MARK CONSISTS OF STANDARD CHARACTERS WITHOUT CLAIM TO ANY PARTICULAR FONT, STYLE, SIZE, OR COLOR.

CLASS 9—ELECTRICAL AND SCIENTIFIC APPARATUS

FOR DIGITAL MEDIA, NAMELY, CDS, DVDS, DOWNLOADABLE AUDIO FILES, DOWNLOADABLE TEXT AND GRAPHIC FILES, AND PRE-RECORDED VIDEOS FEATURING FICTION AND NON-FICTION BOOKS, PERFORMANCES AND PROMOTIONAL INFORMATION (U.S. CLS. 21, 23, 26, 36 AND 38).

FIRST USE 2-1-2008; IN COMMERCE 4-2-2008.

CLASS 16—PAPER GOODS AND PRINTED MATTER

FOR CALENDARS AND DIARIES; CARDS BEARING UNIVERSAL GREETINGS; CHILDREN'S BOOKS; GIFT CARDS; GREETING CARDS; NOTE CARDS; NOVELS; POSTERS; TYPEFACE; PRINTED BOOKS FEATURING ART (U.S. CLS. 2, 5, 22, 23, 29, 37, 38 AND 50).

FIRST USE 2-1-2008; IN COMMERCE 6-8-2010.

CLASS 35—ADVERTISING AND BUSINESS

FOR CREATIVE MARKETING DESIGN SERVICES; DESIGN OF ADVERTISING MATERIALS FOR OTHERS (U.S. CLS. 100, 101 AND 102).

FIRST USE 2-1-2008; IN COMMERCE 4-2-2008.

CLASS 41—EDUCATION AND ENTERTAINMENT

FOR BOOK AND REVIEW PUBLISHING; MULTIMEDIA PUBLISHING OF BOOKS, MAGAZINES, JOURNALS, SOFTWARE, GAMES, MUSIC, AND ELECTRONIC PUBLICATIONS (U.S. CLS. 100, 101 AND 107).

FIRST USE 2-1-2008; IN COMMERCE 4-2-2008.

CLASS 42—SCIENTIFIC AND COMPUTER SERVICES

FOR CREATING, DESIGNING AND MAINTAINING WEB SITES; CREATION AND MAINTENANCE OF WEB SITES FOR OTHERS; DESIGN AND DEVELOPMENT OF MULTIMEDIA PRODUCTS (U.S. CLS. 100 AND 101).

FIRST USE 2-1-2008; IN COMMERCE 5-16-2008.

4,164,837. TRIMACO, LLC, DURHAM, NC. SN 77-566,876. PUB. 7-21-2009, FILED 9-10-2008.



OWNER OF U.S. REG. NO. 3,238,423.
THE MARK CONSISTS OF TREE SHAPE FORMED WITH VARIOUS LINES.

CLASS 16—PAPER GOODS AND PRINTED MATTER

FOR MASKING PAPER FOR CONTRACTORS (U.S. CLS. 2, 5, 22, 23, 29, 37, 38 AND 50).

FIRST USE 9-30-2011; IN COMMERCE 9-30-2011.

CLASS 17—RUBBER GOODS

FOR BIODEGRADABLE PLASTIC SHEETING FOR USE AS DROP CLOTHS (U.S. CLS. 1, 5, 12, 13, 35 AND 50).

FIRST USE 4-30-2011; IN COMMERCE 4-30-2011.

4,164,838. MSCRIPTS, LLC, SAN FRANCISCO, CA. SN 77-570,497. PUB. 3-17-2009, FILED 9-15-2008.

MSCRIPTS

THE MARK CONSISTS OF STANDARD CHARACTERS WITHOUT CLAIM TO ANY PARTICULAR FONT, STYLE, SIZE, OR COLOR.

CLASS 9—ELECTRICAL AND SCIENTIFIC APPARATUS

FOR COMPUTER SOFTWARE AND DOWNLOADABLE COMPUTER SOFTWARE ALLOWING FOR THE MANAGEMENT, ADMINISTRATION AND PURCHASE OF PRESCRIPTION PHARMACEUTICALS, AND OTHER HEALTH CARE RELATED GOODS AND SERVICES, OVER A GLOBAL COMMUNICATIONS NETWORK, AND MOBILE AND WIRELESS COMMUNICATIONS NETWORKS (U.S. CLS. 21, 23, 26, 36 AND 38).

FIRST USE 7-29-2010; IN COMMERCE 7-29-2010.

CLASS 35—ADVERTISING AND BUSINESS

FOR ADVERTISING SERVICES, NAMELY, PROMOTING AND MARKETING THE GOODS AND SERVICES OF OTHERS THROUGH GLOBAL COMMUNICATIONS NETWORKS AND MOBILE AND WIRELESS TELEPHONE COMMUNICATION NETWORKS (U.S. CLS. 100, 101 AND 102).

FIRST USE 8-6-2009; IN COMMERCE 8-6-2009.

CLASS 42—SCIENTIFIC AND COMPUTER SERVICES

FOR PROVIDING TEMPORARY USE OF NON-DOWNLOADABLE SOFTWARE ALLOWING FOR THE MANAGEMENT, ADMINISTRATION AND PURCHASE OF PRESCRIPTION PHARMACEUTICALS, AND OTHER HEALTH CARE RELATED GOODS AND SERVICES, OVER A GLOBAL COMMUNICATIONS NETWORK AND MOBILE AND WIRELESS COMMUNICATION NETWORKS; COMPUTER CONSULTING SERVICES FOR COMPUTER SOFTWARE AND HARDWARE AND MOBILE AND WIRELESS NETWORKS; COMPUTER SOFTWARE AND COMPUTER HARDWARE TECHNICAL SUPPORT SERVICES; COMPUTER SERVICES, NAMELY, IMPLEMENTING COMPUTER SOFTWARE SYSTEMS FOR OTHERS; CUSTOMIZED SOFTWARE DEVELOPMENT, IMPLEMENTATION AND INSTALLATION; APPLICATION SERVICE PROVIDER, NAMELY, DEVELOPING, HOSTING, MANAGING, REPORTING AND MAINTAINING SOFTWARE, WEB SITES AND DATABASES OF OTHERS, MOBILE INFORMATION ACCESS, AND REMOTE DATA MANAGEMENT FOR WIRELESS DELIVERY OF CONTENT TO MOBILE ELECTRONIC DEVICES, HANDHELD COMPUTERS AND LAPTOPS, IN THE FIELDS OF PRESCRIPTION PHARMACEUTICALS AND HEALTH CARE GOODS AND SERVICES (U.S. CLS. 100 AND 101).

FIRST USE 7-29-2010; IN COMMERCE 7-29-2010.

4,164,853. MONTGOMERY WARD, INC., MONROE, WI. SN 77-594,172. PUB. 1-20-2009, FILED 10-16-2008.

MONKEY WARDS

THE MARK CONSISTS OF STANDARD CHARACTERS WITHOUT CLAIM TO ANY PARTICULAR FONT, STYLE, SIZE, OR COLOR.

OWNER OF U.S. REG. NOS. 1,170,705, 2,210,957, AND OTHERS.

CLASS 25—CLOTHING

FOR SHIRTS (U.S. CLS. 22 AND 39).
FIRST USE 4-10-2012; IN COMMERCE 4-10-2012.

CLASS 35—ADVERTISING AND BUSINESS

FOR ELECTRONIC CATALOG SERVICES FEATURING GENERAL MERCHANDISE AND CLOTHING, CHILDRENS' CLOTHING; MAIL ORDER CATALOG SERVICES FEATURING GENERAL MERCHANDISE AND CLOTHING, CHILDRENS' CLOTHING (U.S. CLS. 100, 101 AND 102).

FIRST USE 4-10-2012; IN COMMERCE 4-10-2012.

4,164,857. MARTHA STEWART LIVING OMNIMEDIA, INC., NEW YORK, NY. SN 77-624,534. PUB. 7-21-2009, FILED 12-2-2008.

**MARTHA STEWART COLLECTION
ALLERGY WISE**

THE MARK CONSISTS OF STANDARD CHARACTERS WITHOUT CLAIM TO ANY PARTICULAR FONT, STYLE, SIZE, OR COLOR.

OWNER OF U.S. REG. NOS. 2,182,768, 2,186,450, AND OTHERS.

NO CLAIM IS MADE TO THE EXCLUSIVE RIGHT TO USE "COLLECTION" OR "ALLERGY", APART FROM THE MARK AS SHOWN.

THE NAME(S), PORTRAIT(S), AND/OR SIGNATURE(S) SHOWN IN THE MARK IDENTIFIES "MARTHA STEWART", WHOSE CONSENT(S) TO REGISTER IS MADE OF RECORD.

CLASS 20—FURNITURE AND ARTICLES NOT OTHERWISE CLASSIFIED

FOR BED PILLOWS, BATH PILLOWS, PILLOWS, FIBER BEDS, MATTRESSES, FOAM BED MATTRESSES (U.S. CLS. 2, 13, 22, 25, 32 AND 50).

FIRST USE 1-0-2009; IN COMMERCE 1-0-2009.

CLASS 24—FABRICS

FOR COMFORTERS, COMFORTER PROTECTORS, NAMELY, COMFORTER COVERS, BED SPREADS, QUILTS, BED BLANKETS, AFGHANS, PILLOW PROTECTORS, NAMELY, PILLOW COVERS, PILLOW CASES, PILLOW SHAMS, MATTRESS PADS, BED PADS, FIBER BED PROTECTORS, NAMELY, BED PADS, BED SHEETS, BED LINEN, BED COVERS (U.S. CLS. 42 AND 50).

FIRST USE 1-0-2009; IN COMMERCE 1-0-2009.

4,164,861. SIENNA SINCLAIRE, LLC, SANTA MONICA, CA. SN 77-652,889. PUB. 9-13-2011, FILED 1-20-2009.

**THE WORKING GIRL: A MODERN
DAY COURTESAN**

THE MARK CONSISTS OF STANDARD CHARACTERS WITHOUT CLAIM TO ANY PARTICULAR FONT, STYLE, SIZE, OR COLOR.

CLASS 41—EDUCATION AND ENTERTAINMENT

FOR ENTERTAINMENT SERVICES, NAMELY, PROVIDING A WEB SITE FEATURING ADULT-THEMED PHOTOGRAPHS, VIDEOS, STORIES, AND ARTICLES; PROVIDING ADVICE AND INFORMATION REGARDING ADULT ENTERTAINMENT BUSINESS; EDUCATION SERVICES, NAMELY, PROVIDING CLASSES IN THE FIELD OF ADULT ENTERTAINMENT AND PROVIDING INFORMATION IN THE FIELD OF SEX EDUCATION (U.S. CLS. 100, 101 AND 107).

FIRST USE 1-1-2012; IN COMMERCE 1-1-2012.

CLASS 45—PERSONAL AND LEGAL SERVICES

FOR PROVIDING ADVICE AND INFORMATION IN THE FIELD OF PERSONAL RELATIONSHIPS, NAMELY, SEX AND RELATIONSHIPS (U.S. CLS. 100 AND 101).

FIRST USE 1-1-2012; IN COMMERCE 1-1-2012.

4,164,865. NORTHERN PACIFIC RESOURCES, LLC, MINNEAPOLIS, MN. SN 77-670,004. PUB. 8-31-2010, FILED 2-13-2009.



NO CLAIM IS MADE TO THE EXCLUSIVE RIGHT TO USE "RESOURCES", APART FROM THE MARK AS SHOWN.

THE MARK CONSISTS OF A CIRCLE SURROUNDING THE TERMS "NORTHERN PACIFIC RESOURCES" WHICH ARE WRAPPED AROUND A YIN AND YANG SYMBOL.

CLASS 40—MATERIAL TREATMENT

FOR PRODUCTION OF OIL AND GAS (U.S. CLS. 100, 103 AND 106).

FIRST USE 9-30-2005; IN COMMERCE 9-30-2005.

CLASS 42—SCIENTIFIC AND COMPUTER SERVICES

FOR EXPLORATION OF OIL AND GAS (U.S. CLS. 100 AND 101).

FIRST USE 9-30-2005; IN COMMERCE 9-30-2005.

4,164,873. QS WHOLESALE, INC., HUNTINGTON BEACH, CA. SN 77-703,510. PUB. 7-28-2009, FILED 3-31-2009.

QUIKSILVER

THE MARK CONSISTS OF STANDARD CHARACTERS WITHOUT CLAIM TO ANY PARTICULAR FONT, STYLE, SIZE, OR COLOR.

OWNER OF U.S. REG. NOS. 2,827,658, 3,389,708, AND OTHERS.

CLASS 21—HOUSEWARES AND GLASS

FOR WASTE BASKETS (U.S. CLS. 2, 13, 23, 29, 30, 33, 40 AND 50).

FIRST USE 3-31-2009; IN COMMERCE 3-31-2009.

CLASS 24—FABRICS

FOR DUVETS, QUILTS; BED SHEETS, PILLOWCASES, TOWELS, SHOWER CURTAINS (U.S. CLS. 42 AND 50).

FIRST USE 6-30-1999; IN COMMERCE 6-30-1999.

4,164,886. WANG, SHEN, CHANGXING, CHINA. SN 77-764,704. PUB. 5-18-2010, FILED 6-21-2009.

VICTORCX NEW YORK

THE MARK CONSISTS OF STANDARD CHARACTERS WITHOUT CLAIM TO ANY PARTICULAR FONT, STYLE, SIZE, OR COLOR.

NO CLAIM IS MADE TO THE EXCLUSIVE RIGHT TO USE "NEW YORK", APART FROM THE MARK AS SHOWN.

CLASS 18—LEATHER GOODS

FOR ACCESSORIES, NAMELY, BRIEFCASES, BRIEFCASE-TYPE PORTFOLIOS, ATTACHE CASE, TRAVEL BAGS, LUGGAGE, COSMETIC CASES SOLD EMPTY, DUFFEL BAGS, HANDBAGS, WALLETS AND KEY CASES (U.S. CLS. 1, 2, 3, 22 AND 41).

FIRST USE 1-1-2011; IN COMMERCE 1-1-2011.

CLASS 25—CLOTHING

FOR CLOTHING, NAMELY, DRESSES, SHIRTS, PANTS, SKIRTS, SWEATERS, JACKETS, SHOES AND FOOTWEAR, BELTS, SCARVES, HATS, GLOVES, SOCKS, TIES, NECKTIES (U.S. CLS. 22 AND 39).

FIRST USE 1-1-2011; IN COMMERCE 1-1-2011.

4,164,887. VOTERZOOMUSA, INC., SPRING, TX. SN 77-767,690. PUB. 11-10-2009, FILED 6-24-2009.

VOTERZOOM

THE MARK CONSISTS OF STANDARD CHARACTERS WITHOUT CLAIM TO ANY PARTICULAR FONT, STYLE,

SIZE, OR COLOR.

CLASS 16—PAPER GOODS AND PRINTED MATTER

FOR BUMPER STICKERS; PAMPHLETS IN THE FIELD OF POLITICAL CAMPAIGNS; PENS (U.S. CLS. 2, 5, 22, 23, 29, 37, 38 AND 50).

FIRST USE 4-24-2012; IN COMMERCE 4-24-2012.

CLASS 25—CLOTHING

FOR SHORT-SLEEVED OR LONG-SLEEVED T-SHIRTS; T-SHIRTS (U.S. CLS. 22 AND 39).

FIRST USE 4-24-2012; IN COMMERCE 4-24-2012.

CLASS 35—ADVERTISING AND BUSINESS

FOR ARRANGING OF SUBSCRIPTIONS FOR THE PUBLICATIONS OF OTHERS; ARRANGING SUBSCRIPTIONS OF THE ONLINE PUBLICATIONS OF OTHERS; ARRANGING SUBSCRIPTIONS TO TELECOMMUNICATION SERVICES; INFORMATION ABOUT POLITICAL ELECTIONS; PROVIDING AN INTERNET WEBSITE FEATURING NEWS AND INFORMATION IN THE FIELD OF NATIONAL AND INTERNATIONAL POLITICS; PROVIDING AN ON-LINE SEARCHABLE DATABASE FOR POLITICAL CAMPAIGNS WHICH ALLOW USERS TO COLLECT AND ANALYZE POLITICAL INFORMATION ELECTRONICALLY; PROVIDING INFORMATION REGARDING POLITICAL ISSUES, KNOWING HOW TO VOTE AND KNOWING HOW TO REGISTER TO VOTE (U.S. CLS. 100, 101 AND 102).

FIRST USE 4-24-2012; IN COMMERCE 4-24-2012.

4,164,889. DINER, MELISSA, BEVERLY HILLS, CA. AND PAGE, BRETT A., BEVERLY HILLS, CA. SN 77-776,832. PUB. 12-15-2009, FILED 7-8-2009.



THE MARK CONSISTS OF THE WORDING "THE GENERAL STORE" IN STYLIZED FONT.

CLASS 14—JEWELRY

FOR JEWELRY, NAMELY, NECKLACES, RINGS, BRACELETS, AND EARRINGS (U.S. CLS. 2, 27, 28 AND 50).

FIRST USE 8-18-2010; IN COMMERCE 7-1-2011.

CLASS 18—LEATHER GOODS

FOR LEATHER AND IMITATIONS OF LEATHER, AND GOODS MADE OF THESE MATERIALS, NAMELY, HANDBAGS, TRAVELING BAGS, AND PURSES (U.S. CLS. 1, 2, 3, 22 AND 41).

FIRST USE 8-18-2010; IN COMMERCE 7-1-2011.

CLASS 25—CLOTHING

FOR WOMEN'S CLOTHING, NAMELY, SHIRTS, BLOUSES, PANTS, SKIRTS, DRESSES, SHORTS, JACKETS, COATS, SWEATERS, SWEATSHIRTS, VESTS, UNDERGARMENTS AND BELTS; MEN'S CLOTHING, NAMELY, SHIRTS, PANTS, SHORTS, VESTS, SWEATERS, SWEATSHIRTS, JACKETS, COATS, UNDERGARMENTS AND BELTS; FOOTWEAR, NAMELY, SHOES, AND SANDALS; ACCESSORIES, NAMELY, HEADBANDS, SCARVES, AND HATS (U.S. CLS. 22 AND 39).

FIRST USE 8-8-2010; IN COMMERCE 7-1-2011.

4,164,891. BEACHBODY, LLC, SANTA MONICA, CA. SN 77-779,407. PUB. 10-13-2009, FILED 7-13-2009.

ULTIMATE RESET

THE MARK CONSISTS OF STANDARD CHARACTERS WITHOUT CLAIM TO ANY PARTICULAR FONT, STYLE, SIZE, OR COLOR.

CLASS 5—PHARMACEUTICALS

FOR MEAL REPLACEMENT BARS, MEAL REPLACEMENT AND DIETARY SUPPLEMENT DRINKS, POWDERED NUTRITIONAL SUPPLEMENT DRINK MIX, NUTRITIONAL AND DIETARY SUPPLEMENTS (U.S. CLS. 6, 18, 44, 46, 51 AND 52).

FIRST USE 4-12-2012; IN COMMERCE 4-12-2012.

CLASS 9—ELECTRICAL AND SCIENTIFIC APPARATUS

FOR PRE-RECORDED VIDEO CASSETTES, CDS AND DVDS FEATURING EXERCISE, FITNESS AND DIETARY INFORMATION AND INSTRUCTION, AND RELATED WRITTEN INSTRUCTIONAL MATERIALS SOLD TOGETHER WITH EACH OF THE FOREGOING (U.S. CLS. 21, 23, 26, 36 AND 38).

FIRST USE 4-12-2012; IN COMMERCE 4-12-2012.

4,164,893. BELLE MUD & SALT LTD., ARAD, ISRAEL. SN 77-786,564. PUB. 9-14-2010, FILED 7-22-2009.

SEA OF SPA

THE MARK CONSISTS OF STANDARD CHARACTERS WITHOUT CLAIM TO ANY PARTICULAR FONT, STYLE, SIZE, OR COLOR.

NO CLAIM IS MADE TO THE EXCLUSIVE RIGHT TO USE "SPA", APART FROM THE MARK AS SHOWN.

CLASS 3—COSMETICS AND CLEANING PREPARATIONS

FOR MINERAL BATH SALTS AND MUD BODY MASKS NOT FOR MEDICAL PURPOSES, MUD SKIN MASKS NOT FOR MEDICAL PURPOSES, COSMETIC MUD MASKS NOT FOR MEDICAL PURPOSES, BODY BUTTER, NON-MEDICATED SKIN CARE CREAM, NAMELY, AROMATHERAPY BODY PEELS, BODY CREAM, ALOE VERA BODY CREAMS, ALOE VERA FACE CREAMS, ALOE VERA CREAM FOR COSMETIC PURPOSES, COSMETIC CREAMS AND LOTIONS, MOISTURIZING CREAM FOR THE FACE AND BALD PATE, SHAMPOO, SOAP, LIQUID BATH SOAPS, LIQUID SOAPS FOR HANDS, FACE AND BODY, SHOWER GEL, TOOTHPASTE, BODY DEODORANT, BODY SPRAY USED AS A PERSONAL DEODORANT AND AS FRAGRANCE, DEODORANT FOR PERSONAL USE, DEODORANTS FOR BODY CARE, FOOT DEODORANT SPRAY, PERFUMES, AFTER SHAVE BALM NOT FOR MEDICAL PURPOSES, BODY SPRAYS, NAMELY, SEA WATER FROM THE DEAD SEA IN ATOMIZED CONTAINERS USED TO PRODUCE A COOLING EFFECT; ALL BEING PRODUCED FROM OR ENRICHED WITH MINERALS FROM THE DEAD SEA (U.S. CLS. 1, 4, 6, 50, 51 AND 52).

FIRST USE 1-30-2005; IN COMMERCE 1-30-2005.

CLASS 35—ADVERTISING AND BUSINESS

FOR ON LINE ADVERTISING ON A COMPUTER NETWORK; ON-LINE RETAIL STORE SERVICES FEATURING COSMETICS, BODY CARE PRODUCTS, SOAPS, PERFUMERY, ESSENTIAL OILS, HAIR LOTIONS, IDENTIFIERS, DEODORANTS; DIRECT MAIL ADVERTISING (U.S. CLS. 100, 101 AND 102).

FIRST USE 1-30-2011; IN COMMERCE 1-30-2011.

4,164,898. WILLIAMS, MARQUES E, DALLAS, TX. SN 77-800,337. PUB. 8-3-2010, FILED 8-9-2009.

JC
JORDAN CORDORI

THE MARK CONSISTS OF STANDARD CHARACTERS WITHOUT CLAIM TO ANY PARTICULAR FONT, STYLE, SIZE, OR COLOR.

THE NAME(S), PORTRAIT(S), AND/OR SIGNATURE(S) SHOWN IN THE MARK DOES NOT IDENTIFY A PARTICULAR LIVING INDIVIDUAL.

CLASS 3—COSMETICS AND CLEANING PREPARATIONS

FOR PERFUMES, COLOGNES, EAU DE PERFUMS, EAU DE TOILETTES, TOILET WATERS AND ESSENTIAL OILS FOR PERSONAL USE; SACHETS; TOILETRIES, NAMELY, PERFUME TOILET SOAPS, BODY LOTIONS AND CREAMS, BODY SHAMPOOS, HAIR SHAMPOOS AND HAIR DRESSING LOTIONS AND GELS, BATH GELS, BATH OILS, MILK BATHS, BATH SALTS, BATH BUBBLES, BODY POWDERS AND TALCUM POWDER, LIQUID BATH SOAPS FOR SOFTENING THE SKIN, SKIN AND BODY DEODORANTS AND ANTI-PERSPIRANTS; AND NAIL ENAMELS (U.S. CLS. 1, 4, 6, 50, 51 AND 52).

FIRST USE 1-18-2012; IN COMMERCE 1-18-2012.

CLASS 4—LUBRICANTS AND FUELS

FOR CANDLES (U.S. CLS. 1, 6 AND 15).
FIRST USE 9-20-2011; IN COMMERCE 9-20-2011.

4,164,904. KRAUSZ, ASHER, BROOKLYN, NY. SN 77-808,033. PUB. 1-19-2010, FILED 8-19-2009.

2B COZY

THE MARK CONSISTS OF STANDARD CHARACTERS WITHOUT CLAIM TO ANY PARTICULAR FONT, STYLE, SIZE, OR COLOR.

CLASS 10—MEDICAL APPARATUS

FOR SOCKS FOR DIABETICS (U.S. CLS. 26, 39 AND 44).

FIRST USE 0-0-2010; IN COMMERCE 0-0-2010.

CLASS 25—CLOTHING

FOR ANKLE SOCKS; ANKLETS; ATHLETIC APPAREL, NAMELY, SHIRTS, PANTS, JACKETS, FOOTWEAR, HATS AND CAPS, ATHLETIC UNIFORMS; BEACH FOOTWEAR; FLIP FLOPS; FOOTWEAR FOR MEN AND WOMEN; FOOTWEAR NOT FOR SPORTS; MEN'S DRESS SOCKS; MEN'S SOCKS; SOCKS; SOCKS AND STOCKINGS; THERMAL SOCKS; WOOLLEN SOCKS (U.S. CLS. 22 AND 39).

FIRST USE 0-0-2010; IN COMMERCE 0-0-2010.

4,164,906. DAO INC., ARCADIA, CA. SN 77-813,424. PUB. 1-19-2010, FILED 8-26-2009.

Define An Original

THE MARK CONSISTS OF STANDARD CHARACTERS WITHOUT CLAIM TO ANY PARTICULAR FONT, STYLE, SIZE, OR COLOR.

CLASS 14—JEWELRY

FOR CHARMS (U.S. CLS. 2, 27, 28 AND 50).
FIRST USE 3-27-2009; IN COMMERCE 10-29-2009.

CLASS 18—LEATHER GOODS

FOR CLUTCH PURSES (U.S. CLS. 1, 2, 3, 22 AND 41).
FIRST USE 3-27-2009; IN COMMERCE 10-29-2009.

CLASS 25—CLOTHING

FOR ATHLETIC APPAREL, NAMELY, SHIRTS, PANTS, JACKETS, FOOTWEAR, HATS AND CAPS, ATHLETIC UNIFORMS (U.S. CLS. 22 AND 39).
FIRST USE 3-27-2009; IN COMMERCE 10-29-2009.

4,164,911. GROTENHUIS, ERIC, FOLSOM, CA. SN 77-823,018. PUB. 2-2-2010, FILED 9-9-2009.

4,164,914. CORDELIA LIGHTING INC., RANCHO DOMINGUEZ, CA. SN 77-824,596. PUB. 2-16-2010, FILED 9-11-2009.

Touchwerk

THE MARK CONSISTS OF STANDARD CHARACTERS WITHOUT CLAIM TO ANY PARTICULAR FONT, STYLE, SIZE, OR COLOR.

CLASS 9—ELECTRICAL AND SCIENTIFIC APPARATUS

FOR COMPUTER MONITORS (U.S. CLS. 21, 23, 26, 36 AND 38).
FIRST USE 1-3-2010; IN COMMERCE 4-1-2012.

CLASS 20—FURNITURE AND ARTICLES NOT OTHERWISE CLASSIFIED

FOR OFFICE FURNITURE (U.S. CLS. 2, 13, 22, 25, 32 AND 50).
FIRST USE 1-3-2010; IN COMMERCE 4-1-2012.

4,164,912. REVENUEWIRE INC., VICTORIA, BC, CANADA. SN 77-823,068. PUB. 2-9-2010, FILED 9-9-2009.



THE MARK CONSISTS OF THE WORD "REVENUEWIRE" WITH A CIRCLE DESIGN APPEARING TO THE LEFT OF THE WORDING AND ENCLOSING A SMALLER CIRCLE WITH A "W" SHAPE IN THE CENTER.

CLASS 35—ADVERTISING AND BUSINESS

FOR PROVIDING ADVERTISING THROUGH AN INTERNET-BASED NETWORK OF AFFILIATED PUBLISHERS; MARKETING SERVICES, NAMELY, PROVIDING MARKETING ADVICE TO AFFILIATED PUBLISHERS (U.S. CLS. 100, 101 AND 102).
FIRST USE 7-31-2007; IN COMMERCE 7-31-2007.

CLASS 38—COMMUNICATION

FOR PROVIDING COMMUNICATION SERVICES, NAMELY, ELECTRONIC TRANSMISSION OF DATA AND DOCUMENTS AMONG USERS OF COMPUTERS VIA AN ELECTRONIC COMMUNICATIONS NETWORK (U.S. CLS. 100, 101 AND 104).
FIRST USE 7-31-2007; IN COMMERCE 7-31-2007.

ENVIROLITE

THE MARK CONSISTS OF STANDARD CHARACTERS WITHOUT CLAIM TO ANY PARTICULAR FONT, STYLE, SIZE, OR COLOR.

CLASS 9—ELECTRICAL AND SCIENTIFIC APPARATUS

FOR MOTION SENSITIVE SECURITY LIGHTING ACTIVATED BY MOTION DETECTORS (U.S. CLS. 21, 23, 26, 36 AND 38).
FIRST USE 3-0-2012; IN COMMERCE 3-0-2012.

CLASS 11—ENVIRONMENTAL CONTROL APPARATUS

FOR LIGHTING FIXTURES, NAMELY, CEILING LIGHT FIXTURES, CHANDELIER LIGHT FIXTURES, WALL LIGHT FIXTURES, BATHROOM LIGHT FIXTURES, SPOT LIGHTING FIXTURES, RECESSED LIGHT FIXTURES, TRACK LIGHTING FIXTURES, SCOFF LIGHTING FIXTURES, HANGING LAMP FIXTURES; LAMPS, NAMELY, TABLE LAMPS, FLOOR LAMPS, ELECTRIC LANTERNS, OUTDOOR SECURITY LIGHTING FOR BUILDINGS, SHOP LIGHTS, NAMELY, INDOOR HANGING LIGHTING PANELS; CEILING FANS; SOLAR LIGHT FIXTURES, NAMELY, INDOOR AND OUTDOOR SOLAR POWERED LIGHTING UNITS AND FIXTURES; LIGHT BULBS (U.S. CLS. 13, 21, 23, 31 AND 34).
FIRST USE 3-0-2012; IN COMMERCE 3-0-2012.

4,164,920. TUSKY, BARBARA, OCHTRUP, FED REP GERMANY. SN 77-830,690. PUB. 8-2-2011, FILED 9-21-2009.



PRIORITY CLAIMED UNDER SEC. 44(D) ON ERPN CMNTY TM OFC APPLICATION NO. 008528432, FILED 9-4-2009, REG. NO. 008528432, DATED 3-1-2010, EXPIRES 9-4-2019.

THE MARK CONSISTS OF A HOUSE WITH AN EGG SUPERIMPOSED THEREON, ALL ABOVE THE WORDS "GUT SPRINGENHEIDE", SURROUNDED BY A THIN LINE OUTLINE.

THE ENGLISH TRANSLATION OF "GUT SPRINGENHEIDE" IN THE MARK IS THE SPRINGENHEIDE ESTATE WHERE THE WORD "SPRINGENHEIDE" MEANS HEATHER OF THE SPRING FAMILY.

CLASS 20—FURNITURE AND ARTICLES NOT OTHERWISE CLASSIFIED

FOR (BASED ON USE IN COMMERCE) NATURAL-COLORED OR ARTIFICIAL COLORED EGG SHELLS FOR ORNAMENTAL USE AND FOR USE AS PACKAGING FOR EDIBLE GOODS OR DRINKS (U.S. CLS. 2, 13, 22, 25, 32 AND 50).

FIRST USE 7-8-2007; IN COMMERCE 7-8-2007.

CLASS 21—HOUSEWARES AND GLASS

FOR (BASED ON USE IN COMMERCE) EGG SHELLS USED AS SERVING DISHES AND PLATTERS (U.S. CLS. 2, 13, 23, 29, 30, 33, 40 AND 50).

FIRST USE 7-8-2007; IN COMMERCE 7-8-2007.

CLASS 29—MEATS AND PROCESSED FOODS

FOR (BASED ON USE IN COMMERCE) RAW AND COOKED POULTRY EGGS; COLORED OR DECORATED COOKED EGGS; YOLK AND WHITE OF EGGS FOR NUTRITION PURPOSES; SCRAMBLED EGG COMPOUNDS; FROZEN AND READY-TO-EAT EGG DISHES; COOKED AND PEELED EGGS PLACED IN SAUCES; EGG SALADS; INGREDIENTS FOR MAKING EGG DISHES, NAMELY, BACON, HAM, MINCED MEAT AND CHEESE; CANNED MEAT AND EGG DISHES; MEAT AND EGG DISHES IN FROZEN FORM; OMELETS, CREPES, TAMAGOYAKI, ATSUYAKI CONSISTING ESSENTIALLY OF EGG COMPOUNDS; FRITTATAS; SNACK FOODS, NAMELY, POTATO BASED SNACK FOODS AND VEGETABLE BASED SNACK FOODS (U.S. CL. 46).

FIRST USE 7-8-2007; IN COMMERCE 7-8-2007.

CLASS 30—STAPLE FOODS

FOR (BASED ON 44(E)) BREAD; PASTRIES AND CONFECTIONARY IN THE NATURE OF FANCY CAKES; CLAFOUTIS, NAMELY, EGG BASED DESSERTS; SALT; MUSTARD; SAUCES NOT INCLUDING SALAD DRESSINGS; MAYONNAISE AND REMOULADE; ICE CREAM; CHOCOLATE AND CHOCOLATE CONFECTIONARY; MOUSSE OF CHOCOLATE; NOUGAT AND NOUGAT CONFECTIONARY; SUGAR CONFECTIONARY; MARZIPAN; PERSIPAN; SNACK FOODS, NAMELY, CRISP BREAD, PRETZELS AND CRACKERS; OPEN-FACED SANDWICHES; PIES, TORTILLAS AND PANCAKES CONSISTING ESSENTIALLY OF EGG COMPOUNDS; DESSERTS, NAMELY, DESSERT PUDDINGS AND ICE CREAM DESSERTS; SUGAR CONFECTIONARY, DESSERT PUDDINGS, CHOCOLATE CONFECTIONARY, CHOCOLATE MOUSSE AND NOUGAT, ALL FILLED INTO NATURAL EMPTY EGG-SHAPED SHELLS; SALAD DRESSING (U.S. CL. 46).

CLASS 11—ENVIRONMENTAL CONTROL APPARATUS

FOR ELECTRIC LIGHTING FIXTURES (U.S. CLS. 13, 21, 23, 31 AND 34).

FIRST USE 2-0-2012; IN COMMERCE 2-0-2012.

CLASS 14—JEWELRY

FOR CLOCKS (U.S. CLS. 2, 27, 28 AND 50).

FIRST USE 2-0-2012; IN COMMERCE 2-0-2012.

CLASS 16—PAPER GOODS AND PRINTED MATTER

FOR WALL DECOR, NAMELY, FRAMED ART PRINTS (U.S. CLS. 2, 5, 22, 23, 29, 37, 38 AND 50).

FIRST USE 2-0-2012; IN COMMERCE 2-0-2012.

CLASS 20—FURNITURE AND ARTICLES NOT OTHERWISE CLASSIFIED

FOR FURNITURE, NAMELY, CHESTS AND CABINETS, BARS, BAR SETS COMPRISING BAR FURNITURE, BAR STOOLS, BED FRAMES, BENCHES, BOOKCASES, BUNK BEDS, CHAIRS, CHAISE LOUNGES, COAT RACKS, COFFEE TABLES, COMPUTER DESKS, CONSOLE TABLES, SOFA BEDS, DAY BEDS, DESKS, DRESSERS AND CHESTS OF DRAWERS, END TABLES, ENTERTAINMENT CENTERS, FILING CABINETS, FUTON FRAMES, GAME TABLE SEATING, ROCKING CHAIRS, BED HEADBOARDS, HOME THEATER SEATING, JEWELRY ARMOIRES, LIVING ROOM SETS COMPRISING LIVING ROOM FURNITURE, LOVESEATS, OTTOMANS, PUB AND BAR TABLES, PUB AND BAR SETS COMPRISING PUB AND BAR FURNITURE, RECLINERS, SECTIONALS, SOFAS, TABLES, TELEVISION STANDS, BATHROOM VANITIES (U.S. CLS. 2, 13, 22, 25, 32 AND 50).

FIRST USE 2-0-2012; IN COMMERCE 2-0-2012.

CLASS 24—FABRICS

FOR WALL DECOR, NAMELY, TEXTILE WALL HANGINGS (U.S. CLS. 42 AND 50).

FIRST USE 2-0-2012; IN COMMERCE 2-0-2012.

CLASS 27—FLOOR COVERINGS

FOR RUGS (U.S. CLS. 19, 20, 37, 42 AND 50).

FIRST USE 2-0-2012; IN COMMERCE 2-0-2012.

CLASS 28—TOYS AND SPORTING GOODS

FOR GAMING TABLES (U.S. CLS. 22, 23, 38 AND 50).

FIRST USE 2-0-2012; IN COMMERCE 2-0-2012.

4,164,924. WAYFAIR LLC, BOSTON, MA. SN 77-837,524. PUB. 2-9-2010, FILED 9-29-2009.

4,164,933. TF ENTERTAINMENT CORP., NEW YORK, NY. SN 77-854,215. PUB. 2-15-2011, FILED 10-21-2009.

HOKKU DESIGNS

THE MARK CONSISTS OF STANDARD CHARACTERS WITHOUT CLAIM TO ANY PARTICULAR FONT, STYLE, SIZE, OR COLOR.

NO CLAIM IS MADE TO THE EXCLUSIVE RIGHT TO USE "DESIGNS", APART FROM THE MARK AS SHOWN.

THOM FILICIA
 Home Collection

NO CLAIM IS MADE TO THE EXCLUSIVE RIGHT TO USE "HOME COLLECTION", APART FROM THE MARK AS SHOWN.

THE NAME(S), PORTRAIT(S), AND/OR SIGNATURE(S) SHOWN IN THE MARK IDENTIFIES "THOM FILICIA", WHOSE CONSENT(S) TO REGISTER IS MADE OF RE-

CORD.

THE MARK CONSISTS OF TWO PERPENDICULAR RECTANGLES AND TWO SQUARES ABOVE THE WORDING "THOM FILICIA HOME COLLECTION".

CLASS 20—FURNITURE AND ARTICLES NOT OTHERWISE CLASSIFIED

FOR FURNITURE (U.S. CLS. 2, 13, 22, 25, 32 AND 50).
FIRST USE 10-17-2009; IN COMMERCE 10-17-2009.

CLASS 27—FLOOR COVERINGS

FOR CARPETS AND RUGS (U.S. CLS. 19, 20, 37, 42 AND 50).
FIRST USE 4-0-2009; IN COMMERCE 4-0-2009.

4,164,939. LDM YORKTON CORP., YORKTON, SASK, CANADA. SN 77-871,370. PUB. 10-19-2010, FILED 11-12-2009.

LDM FOODS

THE MARK CONSISTS OF STANDARD CHARACTERS WITHOUT CLAIM TO ANY PARTICULAR FONT, STYLE, SIZE, OR COLOR.

NO CLAIM IS MADE TO THE EXCLUSIVE RIGHT TO USE "FOODS", APART FROM THE MARK AS SHOWN.

CLASS 29—MEATS AND PROCESSED FOODS

FOR CANOLA OIL AND CANOLA MEAL, SOLD IN BULK (U.S. CL. 46).
FIRST USE 12-1-2011; IN COMMERCE 12-1-2011.

CLASS 35—ADVERTISING AND BUSINESS

FOR WHOLESALE DISTRIBUTORSHIPS FEATURING CANOLA (U.S. CLS. 100, 101 AND 102).
FIRST USE 12-1-2011; IN COMMERCE 12-1-2011.

4,164,944. RIVERA, JULIO, NORTH BERGEN, NJ. SN 77-876,232. PUB. 11-1-2011, FILED 11-19-2009.



NO CLAIM IS MADE TO THE EXCLUSIVE RIGHT TO USE "PREMIUM" AND THE MAP OF ECUADOR, APART

FROM THE MARK AS SHOWN.

THE COLOR(S) YELLOW, BLUE, RED, GOLD, BLACK AND WHITE IS/ARE CLAIMED AS A FEATURE OF THE MARK.

THE MARK CONSISTS OF A SQUARE DESIGN OF GEOMETRIC SHAPES IN GOLD, RED, BLUE, WHITE AND BLACK, THE WORDING "ECUAFOOD" IN WHITE LETTERING WITHIN A RED BANNER WITH WHITE LINING AND BLACK SHADOWING AT THE LOWER EXTERIOR PORTION OF THE BANNER, BELOW THE WORDING "PREMIUM" IN BLACK LETTERING WITHIN A GOLD BANNER WITH BLACK SHADOWING AT THE LOWER EXTERIOR PORTION OF THE BANNER, ABOVE THE ECUADORIAN FLAG IN THE COLORS OF YELLOW, BLUE AND RED OVER WHICH IS DEPICTED A MAP OF ECUADOR OUTLINED IN BLACK WITH THE NAMES OF CITIES IN BLACK AND RIVERS IN BLUE. THE WHITE BACKGROUND ABOVE THE RED BANNER AND ECUADORIAN FLAG REPRESENTS A CLEAR BACKGROUND.

CLASS 29—MEATS AND PROCESSED FOODS

FOR FOOD ADDITIVES IN THE NATURE OF FAT ACIDS MADE FROM MEAT, FISH, FRUITS, VEGETABLES, EGGS, MILK AND EDIBLE OILS AND FATS; FOOD PACKAGE COMBINATIONS CONSISTING PRIMARILY OF CHEESE, MEAT AND/OR PROCESSED FRUIT; FRIED POTATOES; MEAT, FISH, FRUIT AND VEGETABLE PRESERVES; MEAT, FISH, POULTRY AND GAME; MEAT, FISH, POULTRY AND GAME PRESERVES; MEAT, FRUIT AND VEGETABLE JELLIES, JAMS; POTATO PANCAKES; PRE-PACKAGED DINNERS CONSISTING PRIMARILY OF MEAT, SEAFOOD OR POULTRY SERVED WITH PASTA, RICE OR VEGETABLES; PREPARED FOOD KITS COMPOSED OF MEAT, POULTRY, FISH, SEAFOOD, AND/OR VEGETABLES AND ALSO INCLUDING SAUCES OR SEASONINGS, READY FOR COOKING AND ASSEMBLY AS A MEAL (U.S. CL. 46).

FIRST USE 12-1-2008; IN COMMERCE 12-1-2008.

CLASS 30—STAPLE FOODS

FOR DOUGH-ENROBED FOODS CONSISTING OF A DOUGH-BASED WRAPPER WITH FILLINGS CONSISTING PRIMARILY OF MEATS, POULTRY, FISH, FRUITS AND VEGETABLES AND CHEESE (U.S. CL. 46).
FIRST USE 12-1-2008; IN COMMERCE 12-1-2008.

4,164,947. HALLA CLIMATE CONTROL CORPORATION, DAEJEON, REPUBLIC OF KOREA. SN 77-884,732. PUB. 3-8-2011, FILED 12-2-2009.

HALLA CLIMATE CONTROL CORP.

THE MARK CONSISTS OF STANDARD CHARACTERS WITHOUT CLAIM TO ANY PARTICULAR FONT, STYLE, SIZE, OR COLOR.

NO CLAIM IS MADE TO THE EXCLUSIVE RIGHT TO USE "CLIMATE CONTROL CORP.", APART FROM THE MARK AS SHOWN.

CLASS 7—MACHINERY

FOR COMPRESSORS FOR REFRIGERATORS; GAS COMPRESSORS; AIR COMPRESSORS; ELECTRIC COMPRESSORS; MACHINES, NAMELY, BELLOWS; CENTRIFUGAL BLOWERS; AXIAL FLOW BLOWERS FOR VEHICLES; TURBO BLOWERS FOR VEHICLES; ROTARY BLOWERS FOR VEHICLES; RADIATORS FOR VEHICLES; COMPRESSORS FOR AIR CONDITIONERS FOR VEHICLES; CLUTCHES FOR AIR CONDITIONER COMPRESSORS; RECIPROCATION COMPRESSORS FOR AIR CONDITIONERS; ROTARY COMPRESSORS FOR AIR CONDITIONERS; VEHICLE ENGINE PARTS, NAMELY, OIL COOLERS AND INTERCOOLERS (U.S. CLS. 13, 19, 21, 23, 31, 34 AND 35).

FIRST USE 7-30-2008; IN COMMERCE 12-2-2009.

CLASS 9—ELECTRICAL AND SCIENTIFIC APPARATUS

FOR TEMPERATURE CONTROLLERS FOR AIR CONDITIONERS FOR VEHICLES (U.S. CLS. 21, 23, 26, 36 AND 38).

FIRST USE 7-30-2008; IN COMMERCE 12-2-2009.

CLASS 11—ENVIRONMENTAL CONTROL APPARATUS

FOR AIR CONDITIONERS; AUTOMOTIVE VENTILATORS; HEATING RADIATORS; GAS COOLERS FOR VEHICLES; EVAPORATIVE AIR COOLERS; REFRIGERATORS; AIR PURIFYING APPARATUS; REFRIGERANT CONDENSORS FOR AIR CONDITIONERS FOR VEHICLES; PARTS FOR HEATING SYSTEMS, NAMELY, HEATER CORES FOR VEHICLES; EVAPORATORS FOR AIR CONDITIONERS; HEAT ACCUMULATORS; COOLING FANS FOR VEHICLES; AIR FILTERS FOR AIR CONDITIONERS; AIR PURIFIERS; AUTOMOTIVE HEATERS; AUTOMOTIVE DEFROSTERS (U.S. CLS. 13, 21, 23, 31 AND 34).

FIRST USE 7-30-2008; IN COMMERCE 12-2-2009.

CLASS 12—VEHICLES

FOR AUTOMOBILE BUMPER, VEHICLE HORN, COOLING MODULE, HEAD LAMP AND CARRIER FOR SAME, ALL SOLD AS A UNIT FOR THE FRONT END MODULE OF LAND VEHICLES; LAND VEHICLE PARTS, NAMELY, AUTOMOBILE BUMPERS, COCKPITS, AND DOOR PANELS FOR LAND VEHICLES; SHROUDS FOR COOLING FANS FOR VEHICLES (U.S. CLS. 19, 21, 23, 31, 35 AND 44).

FIRST USE 7-30-2008; IN COMMERCE 12-2-2009.

4,164,950. WHOLESOME GOODNESS LLC, LONG GROVE, IL. SN 77-886,421. PUB. 12-21-2010, FILED 12-4-2009.

WHOLESOME GOODNESS

THE MARK CONSISTS OF STANDARD CHARACTERS WITHOUT CLAIM TO ANY PARTICULAR FONT, STYLE, SIZE, OR COLOR.

NO CLAIM IS MADE TO THE EXCLUSIVE RIGHT TO USE "WHOLESOME", APART FROM THE MARK AS SHOWN.

CLASS 29—MEATS AND PROCESSED FOODS

FOR BEEF; CANNED FRUITS; CANNED FRUITS AND VEGETABLES; CANNED OR BOTTLED FRUITS; CANNED OR BOTTLED VEGETABLES; CANNED TOMATOES; CANNED VEGETABLES; DEHYDRATED FRUIT SNACKS; DRIED FRUITS; FROZEN FRUITS; FROZEN VEGETABLES; INSTANT POTATOES; POTATO CHIPS; POTATO-BASED SNACK FOODS; POULTRY; SNACK MIX CONSISTING OF DEHYDRATED FRUIT AND PROCESSED NUTS; SNACK MIX CONSISTING OF PRIMARILY OF PROCESSED NUTS AND SALTED SQUASH SEEDS AND ALSO INCLUDING TOASTED CORN; SNACK MIX CONSISTING OF WASABI PEAS, PROCESSED NUTS, DEHYDRATED FRUIT AND/OR RAISINS; SNACK MIX CONSISTING PRIMARILY OF DEHYDRATED FRUITS, PROCESSED NUTS AND ALSO INCLUDING SESAME STICKS; SNACK MIX CONSISTING PRIMARILY OF PROCESSED FRUITS, PROCESSED NUTS AND/OR RAISINS; SOUPS; YOGURT; YOGURT DRINKS; CHOCOLATE MILK; CONDENSED MILK; EVAPORATED MILK; GOAT MILK; MILK; POWDERED MILK; RICE MILK FOR USE AS A MILK SUBSTITUTE; PROTEIN-BASED NUTRIENT DENSE SNACK BARS; DEHYDRATED FRUIT BASED FRUIT BARS; SOY-BASED FOOD BEVERAGE USED AS A MILK SUBSTITUTE; PREPARED ENTREES CONSISTING PRIMARILY OF MEAT, POULTRY OR VEGETABLES; PREPARED MEALS CONSISTING PRIMARILY OF MEAT, POULTRY OR VEGETABLES; FROZEN PRE-PACKAGED ENTREES CONSISTING PRIMARILY OF CHICKEN, BEEF, PORK OR SEAFOOD; CHEESES; AND YOGURT-BASED BEVERAGES (U.S. CL. 46).

FIRST USE 1-0-2012; IN COMMERCE 1-0-2012.

CLASS 30—STAPLE FOODS

FOR TEA-BASED BEVERAGES; KETCHUP; MACARONI AND CHEESE; MUSTARD; PASTA; PASTA SAUCE; PIZZA; POPPED POPCORN; PRETZELS; RELISH; SALAD DRESSINGS; TOMATO SAUCE; BAKING POWDER; BARBEQUE SAUCE; COFFEE-BASED BEVERAGES; BREAD AND BUNS; BREAD AND PASTRY; BREAD CRUMBS; BROWN SUGAR; BRUSCHETTA-TOPPED BREAD; CAFFEINE-FREE COFFEE; CELERY SALT; CHILI SAUCE; CHOCOLATE SAUCE; COCOA; PREPARED COCOA, COCOA POWDER; COCOA BASED BEVERAGES; COFFEE; COFFEE BASED BEVERAGES; COFFEE BEANS; COFFEE PODS; CRYSTAL SUGAR; ENRICHED RICE; FLAVORED ICES; FROZEN CONFECTIONS; FROZEN CONFECTIONS, NAMELY, FREEZER POPS; FROZEN YOGURT CONFECTIONS; GARLIC BREAD; GRANULATED SUGAR; GROUND COFFEE BEANS; HONEY AND TREACLE; ICE CREAM; ICE CREAM DRINKS; ICE CREAMS; ICE-CREAM CAKES; INSTANT COFFEE; ITALIAN ICE; MAPLE SYRUP; MINERAL SALT FOR HUMAN CONSUMPTION; NATURAL BROWN SUGAR; ONION SALT; PANCAKE SYRUP; PASTRIES; PITA BREAD; POWDERED SUGAR; PUFFED RICE; RICE; RICE CAKES; RICE PUDDING; ROASTED COFFEE BEANS; ROLLS; SALAD SAUCES; SALT; SAUCE MIXES; SOY SAUCE; STEAK SAUCE; STUFFING MIXES CONTAINING BREAD; SUGAR; SUGAR SUBSTITUTES; SUGAR WAFERS; TABLE SALT; TABLE SYRUP; TAPIOCA; TARTAR SAUCE; VINEGAR; WHITE SUGAR; WHOLEMEAL BREAD; WHOLEMEAL RICE; WINE VINEGAR; WORCESTERSHIRE SAUCE; YEAST; CANDY, NAMELY, SUGAR REDUCED AND SUGAR FREE CANDIES; FROZEN PRE-PACKAGED ENTREES CONSISTING PRIMARILY OF PASTA OR RICE; YOGURT BASED SALAD DRESSINGS (U.S. CL. 46).

FIRST USE 1-0-2012; IN COMMERCE 1-0-2012.

CLASS 31—NATURAL AGRICULTURAL PRODUCTS

FOR FRESH CULINARY HERBS; FRESH FRUIT AND VEGETABLES; UNPROCESSED CEREAL SEEDS; UNPROCESSED EDIBLE SEEDS (U.S. CLS. 1 AND 46).

FIRST USE 1-0-2012; IN COMMERCE 1-0-2012.

CLASS 32—LIGHT BEVERAGES

FOR ENERGY DRINKS; FRUIT DRINKS; FRUIT JUICES; AERATED MINERAL WATERS; AERATED WATER; BOTTLED DRINKING WATER; DRINKING WATER WITH VITAMINS; MINERAL WATER; NON-ALCOHOLIC BEER; SODA WATER; SPARKLING WATER; SPRING WATER; STILL WATER; SYRUPS FOR MAKING BEVERAGES; DRINKING WATER WITH ADDED FIBER (U.S. CLS. 45, 46 AND 48).

FIRST USE 1-0-2012; IN COMMERCE 1-0-2012.

4,164,951. PETRUS BRASIL ACESSORIOS DA MODA LTDA., 01023-050 SÃO PAULO-SP, BRAZIL. SN 77-889,231. PUB. 2-1-2011, FILED 12-9-2009.



THE COLOR(S) FUCHSIA, WHITE, YELLOW, LIGHT PINK AND BURGUNDY IS/ARE CLAIMED AS A FEATURE OF THE MARK.

THE MARK CONSISTS OF THE WORD "JUST" IN WHITE, OUTLINED IN BURGUNDY AND WHITE, THE NUMERAL "4" IN YELLOW, OUTLINED IN BURGUNDY AND WHITE, AND THE WORD "PRINCESS" IN LIGHT PINK, OUTLINED IN BURGUNDY AND WHITE, THE "JUST 4" IS POSITIONED OVER THE WORD "PRINCESS" WHICH IS IN PINK OUTLINED IN BURGUNDY AND WHITE, THE "J" IN "JUST" BEING LOOPED THROUGH THE "P" IN PRINCESS, AND THE DOT IN THE "I" IN "PRINCESS" IS REPLACED BY A YELLOW CROWN OUTLINED IN BURGUNDY AND WHITE, ALL SET AGAINST A FUCHSIA BACKGROUND.

CLASS 9—ELECTRICAL AND SCIENTIFIC APPARATUS

FOR EYEGLASSES, EYEGLASS FRAMES, SPECTACLE GLASSES, EYEGLASS CHAINS, EYEGLASS CORDS, SPECTACLE CASES, EYEGLASS CASES (U.S. CLS. 21, 23, 26, 36 AND 38).

FIRST USE 3-1-2011; IN COMMERCE 3-1-2011.

CLASS 14—JEWELRY

FOR RINGS BEING JEWELRY, JEWELRY, EARRINGS, KEY RINGS OF PRECIOUS METAL, WATCHES, WRISTWATCHES, BROOCHES BEING JEWELRY, JEWELRY, NAMELY, ANKLETS (U.S. CLS. 2, 27, 28 AND 50).

FIRST USE 3-1-2011; IN COMMERCE 3-1-2011.

CLASS 16—PAPER GOODS AND PRINTED MATTER

FOR ELECTRIC AND MECHANICAL PENCIL SHARPENERS, DRAWING PADS, PEN CASES, PEN NIBS, DRAWING PENS, PEN CLIPS, STAPLES FOR OFFICE USE, DRAWING COMPASSES, DRAWING KIT COMPRISED OF PENCILS, PENS AND PAINTS, LOOSE-LEAF BINDERS, PENCIL HOLDERS, PENCILS, SCHOOL SUPPLIES, NAMELY, STATIONERY, ADHESIVES FOR STATIONERY USE, NAMELY, FOR USE WITH STICKER ALBUMS, AGENDAS, NOTEBOOKS, INK STAMPS, DIARIES AND PAPER LABELS (U.S. CLS. 2, 5, 22, 23, 29, 37, 38 AND 50).

FIRST USE 3-1-2011; IN COMMERCE 3-1-2011.

CLASS 18—LEATHER GOODS

FOR PURSES, BAGS, NAMELY, SHOULDER BAGS; SUITCASES, BACKPACKS, SCHOOL SATCHELS (U.S. CLS. 1, 2, 3, 22 AND 41).

FIRST USE 3-1-2011; IN COMMERCE 3-1-2011.

CLASS 28—TOYS AND SPORTING GOODS

FOR GAMES, NAMELY, ACTION SKILL GAMES; TOYS, NAMELY, DISC TOSS TOYS, TOY VEHICLES, TOY PISTOLS, TOY MASKS, TOY BUILDING BLOCKS; PLUSH TOYS, GAMES FOR ENTERTAINMENT, AMUSEMENT AND DISTRACTION, NAMELY, BOARD GAMES, BUILDING GAMES, CHESS GAMES, PARLOR GAMES; CHILDREN'S PLAY COSMETICS, NAMELY, A COSMETIC KIT WITH REAL COSMETICS FOR PLAYING (U.S. CLS. 22, 23, 38 AND 50).

FIRST USE 3-1-2011; IN COMMERCE 3-1-2011.

4,164,952. INTERTEK TESTING SERVICES NA INC., OAK BROOK, IL. SN 77-890,214. PUB. 11-2-2010, FILED 12-10-2009.

iComply

THE MARK CONSISTS OF STANDARD CHARACTERS WITHOUT CLAIM TO ANY PARTICULAR FONT, STYLE, SIZE, OR COLOR.

CLASS 42—SCIENTIFIC AND COMPUTER SERVICES

FOR CONSUMER PRODUCT SAFETY TESTING; CONSUMER PRODUCT SAFETY TESTING CONSULTATION (U.S. CLS. 100 AND 101).

FIRST USE 1-10-2011; IN COMMERCE 1-10-2011.

CLASS 45—PERSONAL AND LEGAL SERVICES

FOR CONSUMER PRODUCT SAFETY CONSULTATION (U.S. CLS. 100 AND 101).

FIRST USE 1-10-2011; IN COMMERCE 1-10-2011.

4,164,954. TALENT MONDIAL LTEE, QUATRE-BORNES, MAURITIUS. SN 77-895,124. PUB. 8-10-2010, FILED 12-16-2009.

S.I.L.K.

THE MARK CONSISTS OF STANDARD CHARACTERS WITHOUT CLAIM TO ANY PARTICULAR FONT, STYLE, SIZE, OR COLOR.

CLASS 35—ADVERTISING AND BUSINESS

FOR WORKFORCE MANAGEMENT AND CONSULTING, NAMELY, HUMAN RESOURCES CONSULTATION AND MANAGEMENT; CONSULTING SERVICES IN THE FIELD OF HUMAN RESOURCES DEVELOPMENT, NAMELY, FOR THE PROMOTION OF EMPLOYEE RETENTION, CAREER GROWTH, AND INCREASED PRODUCTIVITY FOR EMPLOYEES AND EMPLOYERS (U.S. CLS. 100, 101 AND 102).

FIRST USE 11-4-2011; IN COMMERCE 11-4-2011.

CLASS 41—EDUCATION AND ENTERTAINMENT

FOR WORKFORCE COACHING AND TRAINING, AND EDUCATIONAL SERVICES, NAMELY, ON-SITE AND ON-LINE WORKSHOPS, SEMINARS, PRESENTATIONS, AND CONFERENCES AND COURSE MATERIAL DISTRIBUTED THEREWITH, NAMELY, PRE-RECORDED VIDEO AND AUDIO PROGRAMS – ALL OF THE FOREGOING IN THE FIELD OF HUMAN RESOURCES DEVELOPMENT FOR THE PROMOTION OF EMPLOYEE RETENTION, CAREER GROWTH, AND INCREASED PRODUCTIVITY FOR EMPLOYEES AND EMPLOYERS (U.S. CLS. 100, 101 AND 107).

FIRST USE 11-4-2011; IN COMMERCE 11-4-2011.

4,164,955. LIQUID DIGITAL MEDIA, LLC, AMARILLO, TX. SN 77-896,717. PUB. 8-9-2011, FILED 12-18-2009.



THE MARK CONSISTS OF A CIRCULAR SWIRL PATTERN.

CLASS 9—ELECTRICAL AND SCIENTIFIC APPARATUS

FOR AUDIO AND AUDIOVISUAL RECORDINGS FEATURING MUSIC (U.S. CLS. 21, 23, 26, 36 AND 38).

FIRST USE 5-11-2010; IN COMMERCE 5-11-2010.

CLASS 41—EDUCATION AND ENTERTAINMENT

FOR ENTERTAINMENT SERVICES, NAMELY, RECORD LABEL SERVICES IN THE NATURE OF RECORDING, PRODUCTION, POST-PRODUCTION IN THE FIELD OF MUSIC (U.S. CLS. 100, 101 AND 107).

FIRST USE 8-0-2009; IN COMMERCE 8-0-2009.

4,164,957. KCI LICENSING, INC., SAN ANTONIO, TX. SN 77-898,811. PUB. 11-9-2010, FILED 12-22-2009.

V.A.C. VERAFLO CLEANSE

THE MARK CONSISTS OF STANDARD CHARACTERS WITHOUT CLAIM TO ANY PARTICULAR FONT, STYLE, SIZE, OR COLOR.

OWNER OF U.S. REG. NOS. 1,982,349, 2,792,362, AND OTHERS.

NO CLAIM IS MADE TO THE EXCLUSIVE RIGHT TO USE "CLEANSE", APART FROM THE MARK AS SHOWN.

CLASS 5—PHARMACEUTICALS

FOR WOUND DRESSINGS FOR NEGATIVE PRESSURE TISSUE TREATMENT (U.S. CLS. 6, 18, 44, 46, 51 AND 52).

FIRST USE 11-1-2011; IN COMMERCE 11-1-2011.

CLASS 10—MEDICAL APPARATUS

FOR WOUND DRESSING DEVICES, NAMELY, WOUND DRAINAGE APPARATUS AND WOUND SUCTION APPARATUS FOR USE WITH NEGATIVE PRESSURE WOUND TREATMENT (U.S. CLS. 26, 39 AND 44).

FIRST USE 11-1-2011; IN COMMERCE 11-1-2011.

4,164,963. GHOSTSTAR LLC, LAS VEGAS, NV. SN 77-906,382. PUB. 1-18-2011, FILED 1-6-2010.

GHOSTSTAR

THE MARK CONSISTS OF STANDARD CHARACTERS WITHOUT CLAIM TO ANY PARTICULAR FONT, STYLE, SIZE, OR COLOR.

CLASS 9—ELECTRICAL AND SCIENTIFIC APPARATUS

FOR DUST MASKS; DUST PROTECTIVE GOGGLES AND MASKS; PROTECTION MASKS; PROTECTIVE FACE MASKS NOT FOR MEDICAL PURPOSES; RESPIRATORY MASK FILTERS; PROTECTIVE FACE MASKS FOR GENERAL USE BY MOTORCYCLISTS, NOT FOR MEDICAL OR SPORTS PURPOSES (U.S. CLS. 21, 23, 26, 36 AND 38).

FIRST USE 2-15-2012; IN COMMERCE 2-15-2012.

CLASS 28—TOYS AND SPORTING GOODS

FOR FACE MASKS FOR MOTOCROSS SPORT RACING (U.S. CLS. 22, 23, 38 AND 50).
FIRST USE 2-15-2012; IN COMMERCE 2-15-2012.

4,164,964. ONE CLICK MOTORS, LLC, COLUMBIA, MD. SN 77-908,657. PUB. 5-25-2010, FILED 1-11-2010.

ONE CLICK MOTORS

THE MARK CONSISTS OF STANDARD CHARACTERS WITHOUT CLAIM TO ANY PARTICULAR FONT, STYLE, SIZE, OR COLOR.

NO CLAIM IS MADE TO THE EXCLUSIVE RIGHT TO USE "MOTORS", APART FROM THE MARK AS SHOWN.

CLASS 35—ADVERTISING AND BUSINESS

FOR ONLINE RETAIL STORE SERVICES IN THE FIELD OF AUTOMOBILES; ONLINE AUTOMOBILE AUCTIONEERING SERVICES; PROVIDING AN ONLINE DIRECTORY OF INFORMATION SERVICES FEATURING INFORMATION REGARDING THE PURCHASE OF AUTOMOBILES; PROVIDING INFORMATION IN THE FIELD OF AUTOMOBILE PURCHASING VIA A GLOBAL COMPUTER NETWORK; AND PROVIDING AN ONLINE COMPUTER DATABASE CONTAINING INFORMATION ABOUT AUTOMOBILE PURCHASING (U.S. CLS. 100, 101 AND 102).

FIRST USE 4-26-2012; IN COMMERCE 4-26-2012.

CLASS 36—INSURANCE AND FINANCIAL

FOR ONLINE FINANCIAL VALUATION OF AUTOMOBILES AND FACILITATION OF AUTOMOBILE FINANCING (U.S. CLS. 100, 101 AND 102).

FIRST USE 4-26-2012; IN COMMERCE 4-26-2012.

CLASS 42—SCIENTIFIC AND COMPUTER SERVICES

FOR COMPUTER SERVICES, NAMELY, PROVIDING SEARCH ENGINES FOR OBTAINING AUTOMOBILE PURCHASE DATA ON A GLOBAL COMPUTER NETWORK (U.S. CLS. 100 AND 101).

FIRST USE 4-26-2012; IN COMMERCE 4-26-2012.

4,164,967. ST ANDREWS LINKS, LTD., FIFE, UNITED KINGDOM. SN 77-912,923. PUB. 1-11-2011, FILED 1-15-2010.

ST ANDREWS

THE MARK CONSISTS OF STANDARD CHARACTERS WITHOUT CLAIM TO ANY PARTICULAR FONT, STYLE, SIZE, OR COLOR.

OWNER OF U.S. REG. NOS. 3,571,702, 3,594,357, AND OTHERS.
SEC. 2(F).

CLASS 9—ELECTRICAL AND SCIENTIFIC APPARATUS

FOR PRERECORDED CDS AND CD-ROMS RELATING TO GOLF; COMPUTER GAMES SOFTWARE; COMPUTER SOFTWARE FOR USE IN OPERATING GOLF SIMULATORS (U.S. CLS. 21, 23, 26, 36 AND 38).
FIRST USE 10-27-2002; IN COMMERCE 10-27-2002.

CLASS 28—TOYS AND SPORTING GOODS

FOR ELECTRONIC GOLF TRAINING SIMULATORS (U.S. CLS. 22, 23, 38 AND 50).
FIRST USE 6-4-2007; IN COMMERCE 6-4-2007.

4,164,975. THE ELECTORAL BRAND COMPANY LIMITED, CHRISTCHURCH, NEW ZEALAND. SN 77-938,614. PUB. 2-15-2011, FILED 2-18-2010.

**SAXXON**

1765

OWNER OF U.S. REG. NO. 3,081,723.

NO CLAIM IS MADE TO THE EXCLUSIVE RIGHT TO USE "1765" AND "SAXXON", APART FROM THE MARK AS SHOWN.

THE MARK CONSISTS OF THE NUMBERS "1765" BELOW A DRAGON IN A SHIELD DEVICE, AND THE WORD "SAXXON" TO THE RIGHT OF THE SHIELD.

CLASS 24—FABRICS

FOR TEXTILE MATERIALS, NAMELY, FABRICS FOR TEXTILE USE, WOVEN AND KNITTED TEXTILE FABRICS, WOOLEN FABRICS, CLOTHING FABRICS, NAMELY, TEXTILE FABRICS, AND ALL OF THE FOREGOING MADE IN WHOLE OR IN SUBSTANTIAL PART OF SAXON WOOL (U.S. CLS. 42 AND 50).

FIRST USE 12-31-2005; IN COMMERCE 12-31-2005.

CLASS 25—CLOTHING

FOR ARTICLES OF CLOTHING, NAMELY, SUITS, PANTS, JACKETS, COATS, AND ALL OF THE FOREGOING MADE IN WHOLE OR IN SUBSTANTIAL PART OF SAXON WOOL (U.S. CLS. 22 AND 39).

FIRST USE 12-31-2005; IN COMMERCE 12-31-2005.

4,164,978. KOGANEI CORPORATION, TOKYO, JAPAN. SN 77-945,743. PUB. 10-4-2011, FILED 2-26-2010.

KOGANEI

THE MARK CONSISTS OF STANDARD CHARACTERS WITHOUT CLAIM TO ANY PARTICULAR FONT, STYLE, SIZE, OR COLOR.

OWNER OF U.S. REG. NO. 1,677,354.
SEC. 2(F).

CLASS 6—METAL GOODS

FOR PIPE JOINTS MADE OF METAL; METAL PIPING AND METAL TUBE PARTS FOR PNEUMATIC USES, NAMELY, TUBE FITTINGS AND JOINTS, STOP FITTINGS AND JOINTS, ROTARY TUBE JOINTS, CONNECTOR BANDS FOR CONNECTORS AND MULTIPLE JOINTS, FREE METAL HOLDERS FOR VACUUM PADS FOR FREELY ADJUSTING ANGULAR ORIENTATION OF VACUUM PADS (U.S. CLS. 2, 12, 13, 14, 23, 25 AND 50).

FIRST USE 3-31-1981; IN COMMERCE 3-31-1981.

CLASS 7—MACHINERY

FOR AIR CONDENSERS; METALWORKING BLADES FOR LATHES; SPECIALLY ADAPTED REPLACEMENT AIR FILTER CARTRIDGES FOR FILTERING AIR FOR MECHANICAL PURPOSES; SPECIALLY ADAPTED REPLACEMENT MIST-FILTER CARTRIDGES FOR FILTERING MIST FOR MECHANICAL PURPOSES; CHECK VALVES AS MACHINE COMPONENTS; COMPRESSED AIR ENGINES FOR COMPRESSED AIR MACHINES; COMPRESSED AIR MACHINES; COMPRESSED AIR PUMPS; COMPRESSORS FOR MACHINES; HYDRAULIC AND PNEUMATIC CONTROL MECHANISMS FOR MACHINES, ENGINES AND MOTORS; HYDRAULIC CONTROLS FOR MACHINES, MOTORS AND ENGINES; PNEUMATIC CONTROLS FOR MACHINES, MOTORS AND ENGINES; MACHINE PARTS, NAMELY, CYLINDERS; PUMP DIAPHRAGMS; AIR FILTERS FOR USE IN CONNECTION WITH VALVES BEING PARTS OF MACHINE; OIL FILTERS FOR USE IN CONNECTION WITH VALVES BEING PARTS OF MACHINE; DUST FILTERS FOR USE IN CONNECTION WITH VALVES BEING PARTS OF MACHINE; LUBRICATING PUMPS; LUBRICATION MACHINES; PRESSURE REGULATORS AS PARTS OF MACHINES; PRESSURE VALVES AS PARTS OF MACHINES; PUMPS FOR MACHINES; PUMPS AS PARTS OF MACHINES, ENGINE OR MOTORS; VACUUM PUMPS; CHEMICAL LIQUID PUMPS FOR MACHINES; PRESSURE REDUCERS AS PARTS OF MACHINES; PRESSURE-REDUCING VALVES AS BEING PARTS OF MACHINES; REGULATORS AS BEING PARTS OF MACHINES; INDUSTRIAL ROBOTS; WATER SCALE INDUSTRIAL REMOVER MACHINE FOR DESCALING AND REMOVING IONIZED SILICA FROM WATER; OIL SEPARATORS; SHOCK ABSORBER PLUNGERS AS PARTS OF MACHINES; VALVES AS MACHINE COMPONENTS; DRAIN VALVES AS BEING PARTS OF MACHINES; FLUID PRESSURE CYLINDERS AS BEING PARTS OF MACHINES; PNEUMATIC CYLINDERS AS BEING PARTS OF MACHINES; HYDRAULIC CYLINDERS AS BEING PARTS OF MACHINES; ELECTRIC MOTOR DRIVEN CYLINDERS AS BEING PARTS OF MACHINES; AIR CYLINDERS AS BEING PARTS OF A SERIES OF MACHINES FOR ASSEMBLING ELECTRONIC COMPONENTS, NAMELY, SEMICONDUCTOR CHIPS; HYDRAULIC OSCILLATING ACTUATOR AND PNEUMATIC OSCILLATING ACTUATOR; SEMICONDUCTOR MANUFACTURING MACHINES FEATURING COATING AND DISCHARGING OF GLUE, INKS, AND PAINT FOR MANUFACTURING SEMICONDUCTORS; SOLENOID OPERATED VALVES FOR PNEUMATIC ACTUATOR; LINEAR ACTUATORS, VACUUM SWITCHING VALVES BEING PARTS OF MACHINES; VACUUM GENERATOR PUMPS AS BEING PARTS OF MACHINES; SHAFT COUPLINGS FOR CYLINDERS FOR MACHINES; SHOCK ABSORBERS FOR MACHINES; AIR COMPRESSORS; PNEUMATIC PRESSURE CONTROL VALVES AS MACHINE COMPONENTS; PNEUMATIC AIR FILTERS FOR MECHANICAL PURPOSES; PNEUMATIC LUBRICATION MACHINES; PNEUMATIC MIST SEPARATORS AS BEING PARTS OF MACHINES; FLUID SPEED CONTROL VALVES AS PARTS OF MACHINES, THROTTLE VALVES AS PARTS OF MACHINES, PRESSURE REDUCING VALVES AND PRESSURE CONTROL VALVES AS PARTS OF MACHINES; COMPRESSED AIR EJECTOR MACHINES; ROBOTIC ARMS FOR INDUSTRIAL PURPOSES (U.S. CLS. 13, 19, 21, 23, 31, 34 AND 35).

FIRST USE 3-31-1981; IN COMMERCE 3-31-1981.

CLASS 9—ELECTRICAL AND SCIENTIFIC APPARATUS

FOR ELECTRIC COILS; ELECTROMAGNETIC COILS; HOLDERS FOR ELECTRIC COILS; MULTIMEDIA SOFTWARE RECORDED ON CD-ROM FEATURING PRODUCT CATALOGS ABOUT PNEUMATIC MACHINE PARTS; ELECTRIC CONNECTIONS; CONNECTIONS FOR ELECTRIC LINES; ELECTRIC CONNECTORS; ELECTRIC CONTROL PANELS; STATIC ELECTRICITY DETECTORS; AIR ANALYSIS CONSTANT MONITOR APPARATUS FOR CLEANLINESS OF THE AIR; ION GENERATING APPARATUS FOR ELIMINATING STATIC ELECTRICITY FOR INDUSTRIAL PURPOSES AND NOT FOR THE TREATMENT OF AIR; MAGNETIC SENSOR; PRESSURE SENSOR FOR SEMICONDUCTOR TYPE; MULTI-CHANNEL PRESSURE SENSOR CONTROLLERS; ELECTROSTATIC VOLTAGE MEASURING APPARATUS; OZONISERS; PRESSURE GAUGES; PRESSURE INDICATORS; PRESSURE MEASURING INSTRUMENTS FOR USE IN CONNECTION WITH PNEUMATIC OR HYDRAULIC ACTUATORS BEING PARTS OF MACHINES; SOLENOID VALVES; TRANSMITTERS OF ELECTRONIC SIGNALS; ELECTRONIC PROXIMITY SWITCHES; SOLENOID VALVES; ELECTROSTATIC ELIMINATOR FOR INDUSTRIAL PURPOSES; ELECTRIC ACTUATORS (U.S. CLS. 21, 23, 26, 36 AND 38).

FIRST USE 3-31-1981; IN COMMERCE 3-31-1981.

CLASS 11—ENVIRONMENTAL CONTROL APPARATUS

FOR IONIZATION APPARATUS FOR THE TREATMENT OF AIR; DRYERS FOR THE REMOVAL OF SOLID, LIQUID AND VAPOR CONTAMINANTS FROM COMPRESSED AIR; AIR DEHUMIDIFICATION DEVICES; AIR FILTERS AS BEING PARTS OF HOUSEHOLD OR INDUSTRIAL INSTALLATIONS FILTERING MOISTURE AND DUST IN COMPRESSED AIR; PURIFICATION INSTALLATIONS FOR SEWAGE; WATER SOFTENING APPARATUS; WATER PURIFICATION INSTALLATIONS; WATER PURIFYING APPARATUS AND MACHINES (U.S. CLS. 13, 21, 23, 31 AND 34).

FIRST USE 3-31-1981; IN COMMERCE 3-31-1981.

CLASS 17—RUBBER GOODS

FOR FLEXIBLE COMPRESSED AIR PIPE FITTINGS, NOT OF METAL; FLEXIBLE TUBES, NOT OF METAL FOR PLUMBING PURPOSES; NON-METAL PIPE MUFFS FOR USE WITH PLUMBING PIPES; PIPE GASKETS; JOINT PACKING FOR PLUMBING PIPES; JUNCTIONS NOT OF METAL FOR PLUMBING PIPES; NON-METAL PIPE JOINTS FOR PNEUMATIC PIPE LAYING FOR PLUMBING PURPOSES; NON-METAL TUBES FOR PNEUMATIC PIPE LAYING FOR PLUMBING PURPOSES; NON-METAL FLEXIBLE PLUMBING PIPES MADE OF SYNTHETIC RESIN; FLEXIBLE PLUMBING PIPES MADE OF PLASTIC; NON-METAL PIPE JOINTS (U.S. CLS. 1, 5, 12, 13, 35 AND 50).

FIRST USE 3-31-1981; IN COMMERCE 3-31-1981.

4,164,983. NEXON KOREA CORPORATION, SEOUL, DEM REP OF KOREA. SN 77-950,050. PUB. 7-27-2010, FILED 3-3-2010.

VINDICTUS

THE MARK CONSISTS OF STANDARD CHARACTERS WITHOUT CLAIM TO ANY PARTICULAR FONT, STYLE, SIZE, OR COLOR.

CLASS 9—ELECTRICAL AND SCIENTIFIC APPARATUS

FOR COMPUTER SOFTWARE PROGRAMS FOR THE INTEGRATION OF TEXT, AUDIO, GRAPHICS, STILL IMAGES AND MOVING PICTURES INTO AN INTERACTIVE DELIVERY FOR MULTIMEDIA APPLICATIONS; COMPUTER GAME DVDS AND CDS; COMPUTER PROGRAMS FOR VIDEO GAMES; AND COMPUTER PROGRAMS FEATURING POSITIONABLE GAME PIECE FIGURES FOR USE IN THE FIELD OF COMPUTER GAMES, VIDEO AND COMPUTER GAME PROGRAMS (U.S. CLS. 21, 23, 26, 36 AND 38).

FIRST USE 10-4-2011; IN COMMERCE 10-4-2011.

CLASS 41—EDUCATION AND ENTERTAINMENT

FOR ENTERTAINMENT SERVICES, NAMELY, PROVIDING ON-LINE COMPUTER GAMES; PRODUCTION OF VIDEO AND COMPUTER GAME SOFTWARE; PROVIDING COMPUTER GAMES THAT MAY BE ACCESSED NETWORK-WIDE BY NETWORK USERS; AND PROVIDING INFORMATION ON-LINE RELATING TO COMPUTER GAMES AND COMPUTER ENHANCEMENTS FOR GAMES (U.S. CLS. 100, 101 AND 107).

FIRST USE 10-4-2011; IN COMMERCE 10-4-2011.

CLASS 36—INSURANCE AND FINANCIAL

FOR BUSINESS LIQUIDATION; BUSINESS LIQUIDATION, NAMELY, ASSET DISPOSITION AND REDEPLOYMENT SERVICES FOR INVENTORY, MACHINERY, EQUIPMENT, INTELLECTUAL PROPERTY, ACCOUNTS RECEIVABLE, AND REAL ESTATE IN THE MANUFACTURING, DISTRIBUTION, CONSUMER PRODUCTS AND RETAIL SECTORS; BUSINESS VALUATION; FINANCIAL APPRAISAL SERVICES FOR INVENTORY, MACHINERY, EQUIPMENT, INTELLECTUAL PROPERTY, ACCOUNTS RECEIVABLE AND REAL ESTATE IN THE MANUFACTURING, DISTRIBUTION, CONSUMER PRODUCTS AND RETAIL SECTORS; REAL ESTATE ADVISORY AND CONSULTING SERVICES; FINANCING SERVICES, NAMELY, COMMERCIAL LENDING AND EQUITY INVESTMENT IN THE MANUFACTURING, DISTRIBUTION, CONSUMER PRODUCTS AND RETAIL SECTORS (U.S. CLS. 100, 101 AND 102).

FIRST USE 5-7-2012; IN COMMERCE 5-7-2012.

4,164,991. AUTOMATED SECURITIES CLEARANCE LLC, JERSEY CITY, NJ. SN 77-957,703. PUB. 8-16-2011, FILED 3-12-2010.

4,164,990. GORDON BROTHERS GROUP, LLC, BOSTON, MA. SN 77-957,494. PUB. 8-10-2010, FILED 3-12-2010.

GBG

THE MARK CONSISTS OF STANDARD CHARACTERS WITHOUT CLAIM TO ANY PARTICULAR FONT, STYLE, SIZE, OR COLOR.

OWNER OF U.S. REG. NO. 3,099,657.

CLASS 35—ADVERTISING AND BUSINESS

FOR BUSINESS MANAGEMENT AND CONSULTING IN THE FIELDS OF MANUFACTURING, DISTRIBUTION, CONSUMER PRODUCTS AND RETAILING; BUSINESS CONSULTATION IN THE FIELD OF RESTRUCTURING AND TROUBLESHOOTING; BUSINESS PLANNING SERVICES; CONDUCTING MACHINERY, EQUIPMENT AND REAL ESTATE AUCTION SALES; LEASE NEGOTIATION, LEASE TERMINATION, LEASE MANAGEMENT AND LEASE RESTRUCTURING FOR OTHERS IN THE MANUFACTURING, DISTRIBUTION, CONSUMER PRODUCTS AND RETAIL SECTORS (U.S. CLS. 100, 101 AND 102).

FIRST USE 5-7-2012; IN COMMERCE 5-7-2012.

VALDI

THE MARK CONSISTS OF STANDARD CHARACTERS WITHOUT CLAIM TO ANY PARTICULAR FONT, STYLE, SIZE, OR COLOR.

THE WORDING "VALDI" HAS NO MEANING IN A FOREIGN LANGUAGE.

CLASS 9—ELECTRICAL AND SCIENTIFIC APPARATUS

FOR COMPUTER SOFTWARE USED FOR PROCESSING AND EXECUTING ORDERS FOR THE PURCHASE AND SALE OF FINANCIAL SECURITIES (U.S. CLS. 21, 23, 26, 36 AND 38).

FIRST USE 4-15-2010; IN COMMERCE 4-15-2010.

CLASS 42—SCIENTIFIC AND COMPUTER SERVICES

FOR APPLICATION SERVICE PROVIDER FEATURING SOFTWARE USED FOR PROCESSING AND EXECUTING ORDERS FOR THE PURCHASE AND SALE OF FINANCIAL SECURITIES (U.S. CLS. 100 AND 101).

FIRST USE 4-15-2010; IN COMMERCE 4-15-2010.

4,164,995. ESTORA PRODUCTS COMPANY, LLC, CHIPPEWA FALLS, IN. SN 77-961,882. PUB. 10-4-2011, FILED 3-18-2010.

ESTORA

THE MARK CONSISTS OF STANDARD CHARACTERS WITHOUT CLAIM TO ANY PARTICULAR FONT, STYLE, SIZE, OR COLOR.

CLASS 11—ENVIRONMENTAL CONTROL APPARATUS

FOR FAUCETS; SHOWER HEADS AND PARTS AND FITTINGS THEREFOR (U.S. CLS. 13, 21, 23, 31 AND 34).
FIRST USE 6-1-2010; IN COMMERCE 6-1-2010.

CLASS 21—HOUSEWARES AND GLASS

FOR TOWEL BARS; TOWEL RINGS; HOLDERS FOR TOILET PAPER (U.S. CLS. 2, 13, 23, 29, 30, 33, 40 AND 50).
FIRST USE 6-1-2010; IN COMMERCE 6-1-2010.

4,165,006. THE CRIMSON CUP, INC., COLUMBUS, OH. SN 77-981,884. PUB. 8-24-2010, FILED 10-12-2009.

LEAVE YOU FEELING ENERGIZED

THE MARK CONSISTS OF STANDARD CHARACTERS WITHOUT CLAIM TO ANY PARTICULAR FONT, STYLE, SIZE, OR COLOR.

CLASS 30—STAPLE FOODS

FOR COFFEE (U.S. CL. 46).
FIRST USE 1-31-2010; IN COMMERCE 1-31-2010.

CLASS 35—ADVERTISING AND BUSINESS

FOR WHOLESALE ORDERING AND DISTRIBUTORSHIP SERVICES IN THE FIELD OF COFFEE BEANS; MARKETING CONSULTING IN THE FIELD OF COFFEE BEANS, COFFEE GROUNDS AND BREWED COFFEE; RETAIL STORE SERVICES IN THE FIELD OF COFFEE BEANS AND COFFEE GROUNDS (U.S. CLS. 100, 101 AND 102).
FIRST USE 1-31-2010; IN COMMERCE 1-31-2010.

4,165,007. ACTIENT PHARMACEUTICALS LLC, DEERFIELD, IL. SN 77-983,129. PUB. 10-13-2009, FILED 3-5-2009.

ACTIENT

THE MARK CONSISTS OF STANDARD CHARACTERS WITHOUT CLAIM TO ANY PARTICULAR FONT, STYLE, SIZE, OR COLOR.

CLASS 35—ADVERTISING AND BUSINESS

FOR PROVIDING ADVERTISING, MARKETING AND PROMOTIONAL SERVICES FOR THE PHARMACEUTICAL AND MEDICAL PRODUCTS OF OTHERS; MARKETING SERVICES RELATED TO PHARMACEUTICAL RESEARCH AND DEVELOPMENT (U.S. CLS. 100, 101 AND 102).
FIRST USE 7-0-2010; IN COMMERCE 7-0-2010.

CLASS 42—SCIENTIFIC AND COMPUTER SERVICES

FOR DEVELOPMENT OF PHARMACEUTICAL PREPARATIONS AND MEDICINES; PHARMACEUTICAL RESEARCH AND DEVELOPMENT AND RELATED SERVICES, NAMELY, PHARMACEUTICAL DRUG DEVELOPMENT SERVICES (U.S. CLS. 100 AND 101).
FIRST USE 7-0-2010; IN COMMERCE 7-0-2010.

4,165,010. GRASSHOPPER HOUSE, LLC, MALIBU, CA. SN 77-983,140. PUB. 7-20-2010, FILED 3-23-2010.

MAKE THIS MOMENT COUNT!

THE MARK CONSISTS OF STANDARD CHARACTERS WITHOUT CLAIM TO ANY PARTICULAR FONT, STYLE, SIZE, OR COLOR.

CLASS 44—MEDICAL, BEAUTY AND AGRICULTURAL SERVICES

FOR TREATMENT, AND REHABILITATION SERVICES FOR PERSONS SUFFERING FROM SUBSTANCE ABUSE AND DEPENDENCIES, INCLUDING FROM DRUGS AND ALCOHOL; PSYCHOLOGICAL COUNSELING FOR PERSONS SUFFERING FROM SUBSTANCE ABUSE AND DEPENDENCIES, INCLUDING FROM DRUGS AND ALCOHOL; COUNSELING SERVICES IN THE FIELD OF MENTAL HEALTH (U.S. CLS. 100 AND 101).
FIRST USE 2-23-2012; IN COMMERCE 2-23-2012.

CLASS 45—PERSONAL AND LEGAL SERVICES

FOR SPIRITUAL COUNSELING (U.S. CLS. 100 AND 101).
FIRST USE 2-23-2012; IN COMMERCE 2-23-2012.

4,165,012. SHAUN WHITE ENTERPRISES, INC., CARLSBAD, CA. SN 77-983,149. PUB. 12-21-2010, FILED 1-12-2010.



THE MARK CONSISTS OF A STYLIZED LETTER "W".

CLASS 24—FABRICS

FOR BEDDING, NAMELY, SHEETS, COMFORTERS, PILLOW CASES, DUVETS (U.S. CLS. 42 AND 50).
FIRST USE 12-31-2011; IN COMMERCE 12-31-2011.

CLASS 25—CLOTHING

FOR CLOTHING AND ATHLETIC WEAR, NAMELY, SHIRTS, T-SHIRTS, PANTS, SHORTS, SWEATSHIRTS, SWEATPANTS, AND HOODED SWEAT SHIRTS; FOOTWEAR; HEADWEAR, NAMELY, HATS, CAPS, HEADBANDS; BATHING SUITS; JACKETS; BELTS; HALLOWEEN COSTUMES (U.S. CLS. 22 AND 39).

FIRST USE 8-31-2008; IN COMMERCE 8-31-2008.

4,165,015. RAY ENTERPRISES OF CHESAPEAKE WALK, INC., ANNAPOLIS, MD. SN 77-983,174. PUB. 2-8-2011, FILED 1-22-2010.



OWNER OF U.S. REG. NOS. 3,043,120, 3,210,507, AND OTHERS.

NO CLAIM IS MADE TO THE EXCLUSIVE RIGHT TO USE "THE ORIGINAL", APART FROM THE MARK AS SHOWN.

THE MARK CONSISTS OF THE WORDING "HOBO THE ORIGINAL". THE WORDING "THE ORIGINAL" IS BELOW THE TERM "HOBO".

SEC. 2(F) AS TO "HOBO".

THE 2(F) IN PART CLAIM IS RESTRICTED TO CLASS(ES) 018

CLASS 9—ELECTRICAL AND SCIENTIFIC APPARATUS

FOR EYEWEAR; SUNGLASSES; EYEGLASSES; SUNGLASS CASES; EYEGLASS CASES; SUNGLASS AND EYEGLASS CHAINS; SUNGLASS FRAMES; EYEGLASS FRAMES; EYEWEAR ACCESSORIES, NAMELY, STRAPS, NECK CORDS AND HEAD STRAPS WHICH RESTRAIN EYEWEAR FROM MOVEMENT ON A WEARER (U.S. CLS. 21, 23, 26, 36 AND 38).

FIRST USE 12-11-2011; IN COMMERCE 12-11-2011.

CLASS 18—LEATHER GOODS

FOR BACKPACKS; BOOK BAGS; TRAVEL BAGS; WALLETS; LEATHER KEY CHAINS; BRIEFCASES; BRIEFCASE TYPE PORTFOLIOS; DOCUMENT CASES; OVERNIGHT CASES; ALL PURPOSE SPORTS BAGS; CREDIT CARD CASES; JEWELRY ROLLS FOR TRAVEL USED TO ORGANIZE AND PROTECT JEWELRY NOT OF PRECIOUS METALS (U.S. CLS. 1, 2, 3, 22 AND 41).

FIRST USE 12-11-2011; IN COMMERCE 12-11-2011.

4,165,017. NORMAN DOIDGE, M.D., TORONTO, ONTARIO, CANADA. SN 77-983,200. PUB. 8-31-2010, FILED 8-11-2009.

**THE BRAIN THAT CHANGES
ITSELF**

THE MARK CONSISTS OF STANDARD CHARACTERS WITHOUT CLAIM TO ANY PARTICULAR FONT, STYLE, SIZE, OR COLOR.

CLASS 9—ELECTRICAL AND SCIENTIFIC APPARATUS

FOR SOUND AND AUDIOVISUAL RECORDINGS ON THE SUBJECTS OF THE HUMAN BRAIN, BRAIN SCIENCE AND NEUROPLASTICITY (U.S. CLS. 21, 23, 26, 36 AND 38).

FIRST USE 6-8-2008; IN COMMERCE 6-8-2008.

CLASS 41—EDUCATION AND ENTERTAINMENT

FOR EDUCATIONAL SERVICES, NAMELY, ONLINE AND LIVE SEMINARS AND LECTURES ON THE SUBJECTS OF THE HUMAN BRAIN, BRAIN SCIENCE AND NEUROPLASTICITY (U.S. CLS. 100, 101 AND 107).

FIRST USE 11-16-2008; IN COMMERCE 11-16-2008.

CLASS 42—SCIENTIFIC AND COMPUTER SERVICES

FOR PROVIDING A WEBSITE WITH SCIENTIFIC INFORMATION ON THE SUBJECTS OF THE HUMAN BRAIN, BRAIN SCIENCE AND NEUROPLASTICITY (U.S. CLS. 100 AND 101).

FIRST USE 4-29-2007; IN COMMERCE 4-29-2007.

4,165,018. THE TRUTH - 34, INC., SAN FRANCISCO, CA. SN 78-127,650. PUB. 4-15-2008, FILED 5-9-2002.

THE TRUTH

CLASS 14—JEWELRY

FOR JEWELRY (U.S. CLS. 2, 27, 28 AND 50).

FIRST USE 1-31-2010; IN COMMERCE 1-31-2010.

CLASS 25—CLOTHING

FOR SPORTS RELATED CLOTHING, NAMELY, CAPS, TOPS, T-SHIRTS, HEADWEAR, SHIRTS (U.S. CLS. 22 AND 39).

FIRST USE 5-31-2009; IN COMMERCE 5-31-2009.

CLASS 35—ADVERTISING AND BUSINESS

FOR PROMOTING BY AN ATHLETE THE SALE OF GOODS AND SERVICES OF OTHERS THROUGH THE ISSUANCE OF PRODUCT ENDORSEMENTS; ASSOCIATION SERVICES, NAMELY, PROMOTING BY AN ATHLETE OF INTERESTS OF YOUTH ORGANIZATIONS; PROMOTING BUSINESS AND TOURISM IN THE BOSTON, MASSACHUSETTS AREA; PROMOTING BY AN ATHLETE SPORTS COMPETITIONS AND/OR OTHER EVENTS; ; PROMOTING BY AN ATHLETE THE GOODS AND SERVICES OF OTHERS THROUGH PROMOTIONAL CONTESTS (U.S. CLS. 100, 101 AND 102).

FIRST USE 5-24-2002; IN COMMERCE 5-24-2002.

CLASS 36—INSURANCE AND FINANCIAL

FOR CHARITABLE FUNDRAISING FOR A FOUNDATION OF AN ATHLETE (U.S. CLS. 100, 101 AND 102).

FIRST USE 5-24-2002; IN COMMERCE 5-24-2002.

4,165,021. CLASSICAL COMMUNICATIONS LIMITED, OXFORDSHIRE, OX29 4SZ, UNITED KINGDOM. SN 78-648,070. PUB. 2-15-2011, FILED 6-10-2005.

The Gift
of Music

CLASS 9—ELECTRICAL AND SCIENTIFIC APPARATUS

FOR COMPACT DISCS, AUDIO CASSETTE TAPES, PHONOGRAPH RECORDS, AND COMPUTER DISKS, ALL FEATURING MUSIC; MOUSE PADS FOR USE WITH COMPUTER APPARATUS; METRONOMES; SOUND RECORDINGS FEATURING MUSIC; COMPUTER PROGRAMS AND SOFTWARE FOR RECORDING OR REPRODUCING MUSIC; PUBLICATIONS RECORDED ON MAGNETIC MEDIA, NAMELY, MAGAZINES FEATURING CLASSICAL MUSIC; DOWNLOADABLE MP3 FILES AND MP3 RECORDINGS FEATURING MUSIC; SOFTWARE FOR USE IN ELECTRONIC STORAGE OF MUSIC; EXPOSED CINEMATOGRAPHIC FILMS (U.S. CLS. 21, 23, 26, 36 AND 38).

FIRST USE 1-0-2003; IN COMMERCE 1-0-2003.

CLASS 41—EDUCATION AND ENTERTAINMENT

FOR ENTERTAINMENT SERVICES, NAMELY, LIVE MUSICAL PERFORMANCES, PROVIDING ONLINE, NON-DOWNLOADABLE MUSICAL SOUND RECORDINGS, PROVIDING ONLINE, NON-DOWNLOADABLE MUSICAL VIDEO RECORDINGS AND INFORMATION IN THE FIELD OF MUSIC, PROVIDING ONLINE, NON-DOWNLOADABLE MUSIC RECORDINGS, PROVIDING ONLINE, NON-DOWNLOADABLE MUSIC PERFORMANCES AND PROVIDING INFORMATION ABOUT A MUSICAL ARTIST, NAMELY, INFORMATION ABOUT THE TOURS OF MUSICAL ARTISTS PROVIDED VIA THE INTERNET; AUDIO RECORDING AND PRODUCTION SERVICES; MUSIC PUBLISHING SERVICES; ORGANIZING COMMUNITY CULTURAL EVENTS; PUBLISHING OF ELECTRONIC PUBLICATIONS; EDUCATIONAL SERVICES, NAMELY, CONDUCTING ONLINE EXHIBITIONS AND DISPLAYS AND INTERACTIVE EXHIBITS IN THE FIELD OF MUSIC; PRODUCTION, AND RENTAL OF EXPOSED CINEMATOGRAPHIC FILMS (U.S. CLS. 100, 101 AND 107).

FIRST USE 1-0-2003; IN COMMERCE 1-0-2003.

4,165,022. THE ONE CAMPAIGN, WASHINGTON, DC. SN 78-666,768. PUB. 3-4-2008, FILED 7-8-2005.

(RED)

THE MARK CONSISTS OF STANDARD CHARACTERS WITHOUT CLAIM TO ANY PARTICULAR FONT, STYLE, SIZE, OR COLOR.

CLASS 16—PAPER GOODS AND PRINTED MATTER

FOR PRINTED MATERIALS, NAMELY, BOOKLETS IN THE FIELDS OF AIDS IN AFRICA AND OTHER HUMANITARIAN RELIEF EFFORTS; POSTERS; POSTCARDS; MEMO PAPER (U.S. CLS. 2, 5, 22, 23, 29, 37, 38 AND 50).

FIRST USE 0-0-2007; IN COMMERCE 0-0-2007.

CLASS 35—ADVERTISING AND BUSINESS

FOR PROMOTING THE GOODS AND SERVICES OF OTHERS THROUGH THE USE OF ADVERTISING AND MARKETING CAMPAIGNS FOR THE PURPOSE OF PROMOTING AWARENESS IN THE FIELDS OF AIDS IN AFRICA AND OTHER HUMANITARIAN RELIEF EFFORTS; PROMOTING PUBLIC AWARENESS OF THE NEED TO FIGHT AIDS IN AFRICA AND OTHER HUMANITARIAN RELIEF EFFORTS; PROVIDING A WEBSITE PROMOTING AWARENESS ABOUT AIDS IN AFRICA AND OTHER HUMANITARIAN RELIEF EFFORTS; OTHER SERVICES FOR CHARITABLE PURPOSES, NAMELY, PROMOTING THE GOODS AND SERVICES OF OTHERS THROUGH THE USE OF ADVERTISING AND MARKETING CAMPAIGNS FOR THE PURPOSE OF PROMOTING AWARENESS ABOUT AIDS IN AFRICA AND OTHER HUMANITARIAN RELIEF EFFORTS IN THE NATURE OF COORDINATION OF THE PROCUREMENT AND DISTRIBUTION OF FOOD DONATIONS FROM MANUFACTURERS, WHOLESALERS, RETAILERS, AND GOVERNMENT AGENCIES TO ORGANIZATIONS PROVIDING FREE FOOD TO NEEDY PEOPLE (U.S. CLS. 100, 101 AND 102).

FIRST USE 1-0-2006; IN COMMERCE 1-0-2006.

4,165,025. TRUE VALUE COMPANY, CHICAGO, IL. SN 78-914,113. PUB. 2-10-2009, FILED 6-22-2006.

GRAND RENTAL STATION PARTY PLUS

THE MARK CONSISTS OF STANDARD CHARACTERS WITHOUT CLAIM TO ANY PARTICULAR FONT, STYLE, SIZE, OR COLOR.

OWNER OF U.S. REG. NOS. 1,339,534, 3,088,997, AND OTHERS.

NO CLAIM IS MADE TO THE EXCLUSIVE RIGHT TO USE "RENTAL" AND "PARTY", APART FROM THE MARK AS SHOWN.

CLASS 35—ADVERTISING AND BUSINESS

FOR RETAIL STORE SERVICES FEATURING PARTY EQUIPMENT AND SUPPLIES, PARTY BOXES, ICE SCULPTURES AND LIGHTED TRAY DISPLAYS (U.S. CLS. 100, 101 AND 102).

FIRST USE 0-0-2006; IN COMMERCE 0-0-2006.

CLASS 37—CONSTRUCTION AND REPAIR

FOR RENTAL OF CONSTRUCTION EQUIPMENT FOR PARTIES; RENTAL OF PAINTING EQUIPMENT FOR PARTIES; RENTAL OF FLOOR CLEANING MACHINES FOR PARTIES; RENTAL OF HAND AND POWER TOOLS FOR PARTIES (U.S. CLS. 100, 103 AND 106).

FIRST USE 0-0-2006; IN COMMERCE 0-0-2006.

CLASS 39—TRANSPORTATION AND STORAGE

FOR RENTAL OF MOVING EQUIPMENT AND SUPPLIES FOR PARTIES, NAMELY, MOVING PADS, BLANKETS, PALLET JACKS, DOLLIES, BOXES, AND HAND TRUCKS (U.S. CLS. 100 AND 105).

FIRST USE 0-0-2006; IN COMMERCE 0-0-2006.

CLASS 41—EDUCATION AND ENTERTAINMENT

FOR RENTAL OF EVENT SCENERY, NAMELY, WEDDING ARCHES AND CANDELABRAS; RENTAL OF PORTABLE SUPPORT STRUCTURES FOR DANCE AND OTHER EXERCISES; RENTAL OF PARTY EQUIPMENT AND SUPPLIES, NAMELY, BOUNCE HOUSES (U.S. CLS. 100, 101 AND 107).

FIRST USE 0-0-2006; IN COMMERCE 0-0-2006.

CLASS 43—HOTEL AND RESTAURANT SERVICES

FOR RENTAL OF BARBECUE GRILLS; RENTAL OF COTTON CANDY MACHINES; RENTAL OF TENTS AND CANOPIES; RENTAL OF FURNITURE; RENTAL OF FOLDING CHAIRS AND TABLES; AND RENTAL OF FOOD SERVICE EQUIPMENT (U.S. CLS. 100 AND 101).

FIRST USE 0-0-2006; IN COMMERCE 0-0-2006.

CLASS 44—MEDICAL, BEAUTY AND AGRICULTURAL SERVICES

FOR RENTAL OF LAWN AND GARDENING EQUIPMENT AND TOOLS FOR PARTIES (U.S. CLS. 100 AND 101).

FIRST USE 0-0-2006; IN COMMERCE 0-0-2006.

4,165,026. WORTHEN, MICHELLE I., PHOENIX, AZ. SN 78-943,700. PUB. 8-5-2008, FILED 8-3-2006.



M. I. WORTH

THE NAME IN THE MARK DOES NOT IDENTIFY A LIVING INDIVIDUAL.

CLASS 9—ELECTRICAL AND SCIENTIFIC APPARATUS

FOR PRE-RECORDED COMPACT DISCS AND SOUND RECORDINGS FEATURING MUSIC AND COMPUTER SOFTWARE FOR PROCESSING DIGITAL MUSIC FILES; COMPUTER SOFTWARE FOR MUSIC COMPOSITION AND ELECTRONIC PUBLICATIONS, NAMELY, BOOKS ON THE SUBJECT OF GAMING SOFTWARE RECORDED ON COMPUTER MEDIA (U.S. CLS. 21, 23, 26, 36 AND 38).

FIRST USE 8-0-2009; IN COMMERCE 8-0-2009.

CLASS 16—PAPER GOODS AND PRINTED MATTER

FOR SERIES OF FICTION BOOKS AND A SERIES OF NON-FICTION BOOKS ON THE SUBJECTS OF MUSIC, ARTISTS AND BIOGRAPHIES; GENERAL FEATURE MAGAZINES; NEWSPAPERS (U.S. CLS. 2, 5, 22, 23, 29, 37, 38 AND 50).

FIRST USE 8-0-2009; IN COMMERCE 8-0-2009.

4,165,031. GROUP PMX LLC, PORT WASHINGTON, NY. SN 85-003,685. PUB. 9-6-2011, FILED 3-31-2010.

GROUP PMX

THE MARK CONSISTS OF STANDARD CHARACTERS WITHOUT CLAIM TO ANY PARTICULAR FONT, STYLE, SIZE, OR COLOR.

OWNER OF U.S. REG. NO. 3,578,044.

NO CLAIM IS MADE TO THE EXCLUSIVE RIGHT TO USE "GROUP", APART FROM THE MARK AS SHOWN.

CLASS 35—ADVERTISING AND BUSINESS

FOR CONSTRUCTION SCHEDULING SERVICES (U.S. CLS. 100, 101 AND 102).

FIRST USE 4-30-2010; IN COMMERCE 4-30-2010.

CLASS 37—CONSTRUCTION AND REPAIR

FOR CONSTRUCTION CONSULTING SERVICES; CONSTRUCTION MANAGEMENT; CONSTRUCTION PROJECT MANAGEMENT SERVICES; CONSTRUCTION PLANNING SERVICES AND CONSTRUCTION PROGRAM MANAGEMENT SERVICES (U.S. CLS. 100, 103 AND 106).

FIRST USE 4-30-2010; IN COMMERCE 4-30-2010.

4,165,034. AEROFFICIENT, LLC, WINNETKA, IL. SN 85-005,143. PUB. 8-30-2011, FILED 4-2-2010.

AEROFFICIENT

THE MARK CONSISTS OF STANDARD CHARACTERS WITHOUT CLAIM TO ANY PARTICULAR FONT, STYLE, SIZE, OR COLOR.

CLASS 12—VEHICLES

FOR STRUCTURES, NAMELY, FAIRINGS AND BODY COWLINGS USED ON AND ATTACHED TO TRACTOR TRAILER TRUCK TRAILERS TO REDUCE AERODYNAMIC DRAG AND IMPROVE FUEL ECONOMY (U.S. CLS. 19, 21, 23, 31, 35 AND 44).

FIRST USE 9-27-2011; IN COMMERCE 9-27-2011.

CLASS 36—INSURANCE AND FINANCIAL

FOR LEASING FINANCIAL SERVICES IN THE FIELD OF HEAVY VEHICLE FUEL ECONOMY PRODUCTS AND PROCEDURES (U.S. CLS. 100, 101 AND 102).

FIRST USE 9-27-2011; IN COMMERCE 9-27-2011.

4,165,048. SPECIAL OLYMPICS, INC., WASHINGTON, DC. SN 85-015,029. PUB. 9-7-2010, FILED 4-15-2010.

EKS+

THE MARK CONSISTS OF STANDARD CHARACTERS WITHOUT CLAIM TO ANY PARTICULAR FONT, STYLE, SIZE, OR COLOR.

CLASS 35—ADVERTISING AND BUSINESS

FOR CHARITABLE SERVICES, NAMELY, ORGANIZING AND CONDUCTING VOLUNTEER PROGRAMS AND COMMUNITY SERVICE PROJECTS; PROMOTING PUBLIC AWARENESS OF ATHLETIC COMPETITIONS FOR ATHLETES WITH INTELLECTUAL AND OTHER DISABILITIES; PROMOTING PUBLIC AWARENESS ABOUT PEOPLE WITH INTELLECTUAL AND OTHER DISABILITIES; PROMOTING, SPONSORING AND ADMINISTERING AMATEUR ATHLETIC PROGRAMS AND ACTIVITIES; RECRUITING VOLUNTEERS AND ATHLETES TO PARTICIPATE IN ATHLETIC COMPETITIONS, CEREMONIAL ACTIVITIES AND FESTIVITIES THAT CELEBRATE PEOPLE WITH INTELLECTUAL AND OTHER DISABILITIES; SPONSORING ATHLETIC COMPETITIONS, CEREMONIAL ACTIVITIES, AND FESTIVITIES FOR ATHLETES WITH INTELLECTUAL AND OTHER DISABILITIES (U.S. CLS. 100, 101 AND 102).

FIRST USE 1-27-2010; IN COMMERCE 1-27-2010.

CLASS 41—EDUCATION AND ENTERTAINMENT

FOR ARRANGING AND CONDUCTING ATHLETIC COMPETITIONS; ORGANIZING ATHLETIC COMPETITIONS, CEREMONIAL ACTIVITIES, AND FESTIVITIES TO PROMOTE ATHLETES WITH INTELLECTUAL AND OTHER DISABILITIES; EDUCATIONAL SERVICES, NAMELY, OFFERING TRAINING PROGRAMS DESIGNED TO MOTIVATE YOUTH VOLUNTEERS TO INITIATE AND LEAD PROJECTS DESIGNED TO FOSTER RESPECT, DIGNITY, AND ADVOCACY FOR PEOPLE WITH INTELLECTUAL AND OTHER DISABILITIES; ENTERTAINMENT SERVICES, NAMELY, ONLINE PUBLIC AWARENESS RALLIES FEATURING LIVE STAGE PERFORMANCES AND SPEAKERS; ENTERTAINMENT SERVICES, NAMELY, PUBLIC AWARENESS RALLIES FEATURING LIVE STAGE PERFORMANCES AND SPEAKERS (U.S. CLS. 100, 101 AND 107).

FIRST USE 9-25-2010; IN COMMERCE 9-25-2010.

4,165,053. THE HOLLAND, INC., VANCOUVER, WA. SN 85-019,849. PUB. 9-21-2010, FILED 4-21-2010.



OWNER OF U.S. REG. NOS. 922,942, 2,389,112, AND OTHERS.

THE MARK CONSISTS OF THE WORD "BURGerville" LOCATED WITHIN AN ARCH, WITH A DOWNWARD FACING POINT AT THE BOTTOM CENTER.

CLASS 29—MEATS AND PROCESSED FOODS

FOR CHICKEN, FRENCH FRIED POTATOES, HASH BROWN POTATOES, FISH AND CHIPS, PREPARED VEGETABLE SALADS, COLESLAW, PROCESSED EGGS, BACON, HAM, SAUSAGE, VEGETARIAN SAUSAGE, MILK, AND CREAM CHEESE, ALL FOR CONSUMPTION ON OR OFF THE PREMISES (U.S. CL. 46).

FIRST USE 2-0-2009; IN COMMERCE 2-0-2009.

CLASS 30—STAPLE FOODS

FOR SANDWICHES, HAMBURGER AND CHEESE-BURGER SANDWICHES, FISH SANDWICHES, VEGGIE BURGER SANDWICHES, TURKEY BURGER SANDWICHES, TURKEY CLUB SANDWICHES, EGG SANDWICHES, BISCUITS, BAGELS, FRENCH TOAST, MILKSHAKES, FROZEN YOGURT, COOKIES, COFFEE, HOT CHOCOLATE, AND TEA, ALL FOR CONSUMPTION ON OR OFF THE PREMISES (U.S. CL. 46).

FIRST USE 2-0-2009; IN COMMERCE 2-0-2009.

CLASS 32—LIGHT BEVERAGES

FOR BEVERAGES, NAMELY, SOFT DRINKS, FRUIT FLAVORED DRINKS, SMOOTHIES, AND ORANGE JUICE, ALL FOR CONSUMPTION ON OR OFF THE PREMISES (U.S. CLS. 45, 46 AND 48).

FIRST USE 2-0-2009; IN COMMERCE 2-0-2009.

CLASS 43—HOTEL AND RESTAURANT SERVICES

FOR RESTAURANT SERVICES (U.S. CLS. 100 AND 101).

FIRST USE 2-0-2009; IN COMMERCE 2-0-2009.

4,165,054. ZT WEALTH, INC., PEARLAND, TX. SN 85-021,644. PUB. 9-13-2011, FILED 4-23-2010.

ZT WEALTH

THE MARK CONSISTS OF STANDARD CHARACTERS WITHOUT CLAIM TO ANY PARTICULAR FONT, STYLE, SIZE, OR COLOR.

NO CLAIM IS MADE TO THE EXCLUSIVE RIGHT TO USE "WEALTH", APART FROM THE MARK AS SHOWN.

CLASS 35—ADVERTISING AND BUSINESS

FOR CONSULTING IN THE FIELDS OF HEALTH-CARE OPERATIONS MANAGEMENT AND HOSPITAL OPERATIONS MANAGEMENT IN THE NATURE OF MEDICAL PRACTICE MANAGEMENT SERVICES FOR OTHERS, BUSINESS MANAGEMENT CONSULTING SERVICES; PROCUREMENT, NAMELY, PURCHASING MEDICAL EQUIPMENT FOR OTHERS (U.S. CLS. 100, 101 AND 102).

FIRST USE 1-1-2010; IN COMMERCE 1-1-2010.

CLASS 36—INSURANCE AND FINANCIAL

FOR INSURANCE AGENCY SERVICES; BROKERAGE SERVICES AND RELATED CONSULTING PERTAINING TO THE PROCUREMENT, BUYING, SELLING OF STOCKS, BONDS AND MUTUAL FUNDS; INVESTMENT CONSULTING SERVICES AND FUND INVESTMENT SERVICES IN THE NATURE OF PRIVATE INVESTMENT OFFERINGS; FINANCIAL RETIREMENT AND INVESTMENT PLANNING; INVESTMENT ACCOUNT PLANNING; ESTATE PLANNING; FINANCING SERVICES; REAL ESTATE INVESTMENT SERVICES; REAL ESTATE FINANCING SERVICES; REAL ESTATE MANAGEMENT SERVICES, NAMELY, RENTAL, LEASING AND MANAGEMENT OF COMMERCIAL PROPERTY, OFFICES AND OFFICE SPACE; PROPERTY MANAGEMENT OF COMMERCIAL OFFICE BUILDINGS AND MEDICAL FACILITIES; MORTGAGE SERVICES, NAMELY, MORTGAGE PLANNING AND MORTGAGE PLANNING CONSULTING SERVICES; INVESTMENT BANKING SERVICES (U.S. CLS. 100, 101 AND 102).

FIRST USE 1-1-2010; IN COMMERCE 1-1-2010.

4,165,059. AFFINION PUBLISHING, LLC, LAS VEGAS, NV.
SN 85-024,449. PUB. 3-29-2011, FILED 4-27-2010.

MobileSure

THE MARK CONSISTS OF STANDARD CHARACTERS WITHOUT CLAIM TO ANY PARTICULAR FONT, STYLE, SIZE, OR COLOR.

CLASS 36—INSURANCE AND FINANCIAL

FOR PROVIDING PROTECTION FOR MOBILE PHONES, NAMELY, PROVIDING EXTENDED WARRANTIES ON MOBILE PHONES AND REPLACEMENT OF MOBILE PHONES DAMAGED UNINTENTIONALLY BY THE USER IN ACCORDANCE WITH NORMAL DAILY USAGE; PROVIDING EXTENDED WARRANTIES ON MOBILE PHONES AGAINST DAMAGE AND THEFT (U.S. CLS. 100, 101 AND 102).

FIRST USE 10-0-2010; IN COMMERCE 10-0-2010.

CLASS 38—COMMUNICATION

FOR RENTAL OF MOBILE TELEPHONES; RENTAL OF CELL PHONES; TRANSMISSION, RECEPTION AND PROCESSING OF EMERGENCY SIGNALS; MESSAGE FORWARDING SERVICES (U.S. CLS. 100, 101 AND 104).

FIRST USE 10-0-2010; IN COMMERCE 10-0-2010.

CLASS 42—SCIENTIFIC AND COMPUTER SERVICES

FOR RECOVERY OF DATA FROM MOBILE PHONES (U.S. CLS. 100 AND 101).

FIRST USE 10-0-2010; IN COMMERCE 10-0-2010.

CLASS 45—PERSONAL AND LEGAL SERVICES

FOR MONITORING TELEPHONE CALLS FROM SUBSCRIBERS AND NOTIFYING EMERGENCY FACILITIES; PERSONAL CONCIERGE SERVICES FOR OTHERS COMPRISING MAKING REQUESTED PERSONAL ARRANGEMENTS AND RESERVATIONS, RUNNING ERRANDS AND PROVIDING CUSTOMER SPECIFIC INFORMATION TO MEET INDIVIDUAL NEEDS (U.S. CLS. 100 AND 101).

FIRST USE 10-0-2010; IN COMMERCE 10-0-2010.

4,165,063. TIME WARNER CABLE INC., NEW YORK, NY.
SN 85-031,803. PUB. 9-21-2010, FILED 5-6-2010.

USURF

THE MARK CONSISTS OF STANDARD CHARACTERS WITHOUT CLAIM TO ANY PARTICULAR FONT, STYLE, SIZE, OR COLOR.

CLASS 38—COMMUNICATION

FOR CABLE TELEVISION BROADCASTING; INTERACTIVE TELEVISION TRANSMISSION SERVICES; BROADBAND COMMUNICATIONS SERVICES, NAMELY, CABLE TELEVISION TRANSMISSION SERVICES, TRANSMISSION OF INTERACTIVE TELEVISION PROGRAMS AND TRANSMISSION OF HIGH-DEFINITION TELEVISION PROGRAMS (U.S. CLS. 100, 101 AND 104).

FIRST USE 2-1-2012; IN COMMERCE 2-1-2012.

CLASS 41—EDUCATION AND ENTERTAINMENT

FOR PRODUCTION OF TELEVISION PROGRAMS; TELEVISION PROGRAMMING SERVICES; ENTERTAINMENT SERVICES IN THE NATURE OF A CABLE TELEVISION CHANNEL SPECIALIZING IN NEWS, SPORTS AND INFORMATION ON TOPICS OF GENERAL INTEREST DELIVERED BY THE INTERNET AND BROADCAST OVER TELEVISION; PROVIDING AN INTERNET WEBSITE FEATURING NEWS, SPORTS AND INFORMATION ON TOPICS OF GENERAL INTEREST (U.S. CLS. 100, 101 AND 107).

FIRST USE 2-1-2012; IN COMMERCE 2-1-2012.

4,165,066. SMARTPOOL, INCORPORATED, LAKEWOOD, NJ. SN 85-033,869. PUB. 5-24-2011, FILED 5-10-2010.



THE MARK CONSISTS OF THE WORDING "EZ FUN" WITH THE LETTER "E" APPEARING AS THREE STYLIZED WAVY HORIZONTAL LINES.

CLASS 9—ELECTRICAL AND SCIENTIFIC APPARATUS

FOR GOGGLES FOR SWIMMERS; DIVING SNORKELS; MASKS FOR SNORKELING; BREATHING APPARATUS FOR UNDERWATER SWIMMING; FLOAT SUITS FOR SWIMMING, SPECIFICALLY, WATER-PROOF SURVIVAL SUITS FOR THE PREVENTION OF DROWNING; FLOATATION PRODUCTS FOR SWIMMING, NAMELY, SWIM FLOATS AND LIFE VESTS FOR SAFETY PURPOSES; SAFETY APPARATUS, NAMELY, INFLATABLE FLOTATION LIFESAVER DEVICE (U.S. CLS. 21, 23, 26, 36 AND 38).

FIRST USE 9-1-2011; IN COMMERCE 9-1-2011.

CLASS 28—TOYS AND SPORTING GOODS

FOR INFLATABLE POOL TOYS; BEACH BALLS; FLOATING INFLATABLE PLAYTHINGS, NAMELY, SPORTS BALLS, BEACH BALLS; FLOATS AND INFLATABLE TOYS FOR PLAY PURPOSES, NAMELY, FOAM FLOATS, SWIM FLOATS FOR RECREATIONAL PURPOSES; INFLATABLE BALLS FOR SPORTS; INFLATABLE FLOAT MATTRESSES FOR RECREATIONAL USE; TOY WATER GUNS; FLIPPERS FOR SWIMMING; PLAYING ARTICLES FOR SWIMMING POOLS; NAMELY, NETS FOR BALL GAMES, NET BALLS; SWIMMING FLOATS FOR RECREATIONAL USE IN SWIMMING AREAS; FLOATABLE SEATS FOR RECREATIONAL USE IN SWIMMING POOLS; FLOATING INFLATABLE SEATS FOR RECREATIONAL USE IN SWIMMING AREAS (U.S. CLS. 22, 23, 38 AND 50).
FIRST USE 9-1-2011; IN COMMERCE 9-1-2011.

4,165,069. THUNDER PERFORMANCE GROUP, INC., DBA THUNDER RACING, BATON ROUGE, LA. SN 85-036,452. PUB. 4-26-2011, FILED 5-12-2010.

THUNDER Racing

THE MARK CONSISTS OF STANDARD CHARACTERS WITHOUT CLAIM TO ANY PARTICULAR FONT, STYLE, SIZE, OR COLOR.

NO CLAIM IS MADE TO THE EXCLUSIVE RIGHT TO USE "RACING", APART FROM THE MARK AS SHOWN.

CLASS 37—CONSTRUCTION AND REPAIR

FOR AUTOMOTIVE CONVERSION SERVICES, NAMELY, INSTALLING SPECIALTY AUTOMOTIVE EQUIPMENT; AUTOMOTIVE MAINTENANCE AND REPAIR; AUTOMOTIVE MAINTENANCE SERVICES, NAMELY, AUTOMOTIVE UPGRADING; AUTOMOTIVE UPGRADE SERVICES, NAMELY, SUPERCHARGING, TURBOCHARGING AND PERFORMANCE UPGRADES OF AUTOMOBILES; PROVIDING AN INTERNET WEBSITE THAT FEATURES INFORMATION ABOUT AUTOMOTIVE MAINTENANCE AND REPAIR SERVICE; PROVIDING AN ONLINE COMPUTER DATABASE FEATURING TECHNICAL INFORMATION ABOUT AUTOMOTIVE PARTS AND ACCESSORIES AND THEIR INSTALLATION AND MAINTENANCE (U.S. CLS. 100, 103 AND 106).
FIRST USE 10-1-1995; IN COMMERCE 10-1-1995.

4,165,068. SHOATS, REGINALD, HONOLULU, HI. SN 85-035,704. PUB. 4-19-2011, FILED 5-11-2010.

GIGGLES & GAGGLES

CLASS 39—TRANSPORTATION AND STORAGE

FOR DISTRIBUTION SERVICES, NAMELY, DELIVERY OF AUTOMOTIVE PARTS (U.S. CLS. 100 AND 105).
FIRST USE 1-1-1995; IN COMMERCE 1-1-1995.

THE MARK CONSISTS OF STANDARD CHARACTERS WITHOUT CLAIM TO ANY PARTICULAR FONT, STYLE, SIZE, OR COLOR.

CLASS 9—ELECTRICAL AND SCIENTIFIC APPARATUS

FOR ELECTRICAL AND SCIENTIFIC APPARATUS, NAMELY, PRE-RECORDED, VIDEO AND AUDIO DISCS, CD ROMS, COMPACT DISCS, DIGITAL VERSATILE DISCS, MUSICAL VIDEO RECORDINGS, MUSICAL SOUND RECORDINGS AND FEATURING MUSIC, ANIMATED CARTOONS, LIVE-ACTION PERFORMANCES AND LIVE ACTION PERFORMANCES BY COSTUMED CHARACTERS ALL IN THE FIELDS OF SCIENCE FICTION, MYSTERY, FAIRY TALES, COMEDY AND DRAMA; DECORATIVE REFRIGERATOR MAGNET (U.S. CLS. 21, 23, 26, 36 AND 38).
FIRST USE 1-1-2011; IN COMMERCE 10-13-2011.

4,165,084. WHOLESOME GOODNESS LLC, LONG GROVE, IL. SN 85-053,139. PUB. 5-10-2011, FILED 6-2-2010.

**CLASS 16—PAPER GOODS AND PRINTED MATTER**

FOR DECALS; STICKERS; POSTERS (U.S. CLS. 2, 5, 22, 23, 29, 37, 38 AND 50).
FIRST USE 1-1-2011; IN COMMERCE 10-13-2011.

NO CLAIM IS MADE TO THE EXCLUSIVE RIGHT TO USE "DELICIOUS", APART FROM THE MARK AS SHOWN.

THE MARK CONSISTS OF THE WORDS "SIMPLE, NATURALLY DELICIOUS" IN A CIRCLE LOCATED AROUND A HEART WITH A LEAF ON THE RIGHT SIDE OF THE HEART.

CLASS 28—TOYS AND SPORTING GOODS

FOR PLUSH TOYS, STUFF TOYS, PUPPETS (U.S. CLS. 22, 23, 38 AND 50).
FIRST USE 1-1-2011; IN COMMERCE 10-13-2011.

CLASS 29—MEATS AND PROCESSED FOODS

FOR BEEF; CANNED FRUITS; CANNED FRUITS AND VEGETABLES; CANNED OR BOTTLED FRUITS; CANNED OR BOTTLED VEGETABLES; CANNED TOMATOES; CANNED VEGETABLES; DEHYDRATED FRUIT SNACKS; DRIED FRUITS; FROZEN FRUITS; FROZEN VEGETABLES; INSTANT POTATOES; POTATO CHIPS; POTATO-BASED SNACK FOODS; POULTRY; SNACK MIX CONSISTING OF DEHYDRATED FRUIT AND PROCESSED NUTS; SNACK MIX CONSISTING OF PRIMARILY OF PROCESSED NUTS AND SALTED SQUASH SEEDS AND ALSO INCLUDING TOASTED CORN; SNACK MIX CONSISTING OF WASABI PEAS, PROCESSED NUTS, DEHYDRATED FRUIT AND/OR RAISINS; SNACK MIX CONSISTING PRIMARILY OF DEHYDRATED FRUITS, PROCESSED NUTS AND ALSO INCLUDING SESAME STICKS; SNACK MIX CONSISTING PRIMARILY OF PROCESSED FRUITS, PROCESSED NUTS AND/OR RAISINS; SOUPS; YOGURT; YOGURT DRINKS; CHOCOLATE MILK; CONDENSED MILK; EVAPORATED MILK; GOAT MILK; MILK; POWDERED MILK; RICE MILK FOR USE AS A MILK SUBSTITUTE; PROTEIN BASED, NUTRIENT-DENSE SNACK BARS; DEHYDRATED FRUIT BASED FRUIT BARS; SOY-BASED FOOD BEVERAGE USED AS A MILK SUBSTITUTE; PREPARED ENTREES CONSISTING PRIMARILY OF MEAT, POULTRY OR VEGETABLES; PREPARED MEALS CONSISTING PRIMARILY OF MEAT, POULTRY OR VEGETABLES; FROZEN PRE-PACKAGED ENTREES CONSISTING PRIMARILY OF CHICKEN, BEEF, PORK, OR SEAFOOD; MEAT EXTENDERS CONSISTING PRIMARILY OF VEGETABLES, GRAINS OR SOY; CHEESES; AND YOGURT-BASED BEVERAGES (U.S. CL. 46).

FIRST USE 1-0-2012; IN COMMERCE 1-0-2012.

CLASS 30—STAPLE FOODS

FOR BEVERAGES MADE OF TEA; KETCHUP; MACARONI AND CHEESE; MUSTARD; PASTA; PASTA SAUCE; PIZZA; POPCORN; PRETZELS; READY-TO-EAT CEREALS; RELISH; SALAD DRESSINGS; TOMATO SAUCE; BAKING POWDER; BARBECUE SAUCE; BEVERAGES MADE OF COFFEE; BREAD AND BUNS; BREAD AND PASTRY; BREAD CRUMBS; BROWN SUGAR; BRUSCHETTA-TOPPED BREAD; CAFFEINE-FREE COFFEE; CELERY SALT; CEREAL-BASED SNACK FOODS; CHILI SAUCE; CHOCOLATE SAUCE; COCOA; PREPARED COCOA AND COCOA BASED BEVERAGES; COCOA POWDER; COCOA BASED BEVERAGES; COFFEE; COFFEE BASED BEVERAGES; COFFEE BEANS; COFFEE PODS; CRYSTAL SUGAR; ENRICHED RICE; FLAVORED ICES; FROZEN CONFECTIONS; FROZEN CONFECTIONS, NAMELY, FREEZER POPS; FROZEN YOGURT CONFECTIONS; GARLIC BREAD; GRANULATED SUGAR; GROUND COFFEE BEANS; HONEY AND TREACLE; ICE CREAM; ICE CREAM DRINKS; ICE CREAMS; ICE-CREAM CAKES; INSTANT COFFEE; ITALIAN ICE; MAPLE SYRUP; MINERAL SALT FOR HUMAN CONSUMPTION; NATURAL BROWN SUGAR; ONION SALT; PANCAKE SYRUP; PASTRIES; PITA BREAD; POWDERED SUGAR; PUFFED RICE; RICE; RICE CAKES; RICE PUDDING; RICE-BASED SNACK FOODS; ROASTED COFFEE BEANS; ROLLS; SALAD SAUCES; SALT; SAUCE MIXES; SOY SAUCE; STEAK SAUCE; STUFFING MIXES CONTAINING BREAD; SUGAR; SUGAR SUBSTITUTES; SUGAR WAFERS; TABLE SALT; TABLE SYRUP; TAPIOCA; TARTAR SAUCE; TOASTER PASTRIES; VINEGAR; WHITE SUGAR; WHOLEMEAL BREAD; WHOLEMEAL RICE; WINE VINEGAR; WORCESTERSHIRE SAUCE; YEAST; AND OATMEAL, REGULAR AND INSTANT; SALAD DRESSINGS CONTAINING YOGURT; FROZEN PRE-PACKAGED ENTREES CONSISTING PRIMARILY OF PASTA OR RICE; GRANOLA-BASED SNACK BARS; GRANOLA-BASED SNACKS; CANDY, NAMELY, SUGAR REDUCED AND SUGAR FREE CANDIES; GUMMY CANDIES; CEREAL BASED ENERGY BARS (U.S. CL. 46).

FIRST USE 1-0-2012; IN COMMERCE 1-0-2012.

CLASS 31—NATURAL AGRICULTURAL PRODUCTS

FOR FRESH CULINARY HERBS; FRESH FRUIT AND VEGETABLES; UNPROCESSED CEREAL SEEDS; UNPROCESSED EDIBLE SEEDS (U.S. CLS. 1 AND 46).
FIRST USE 1-0-2012; IN COMMERCE 1-0-2012.

CLASS 32—LIGHT BEVERAGES

FOR ENERGY DRINKS; FRUIT DRINKS; FRUIT JUICES; AERATED MINERAL WATERS; AERATED WATER; BOTTLED DRINKING WATER; DRINKING WATER WITH VITAMINS; MINERAL WATER; NON-ALCOHOLIC BEER; SODA WATER; SPARKLING WATER; SPRING WATER; STILL WATER; SYRUPS FOR MAKING BEVERAGES; DRINKING WATER WITH ADDED FIBER (U.S. CLS. 45, 46 AND 48).
FIRST USE 1-0-2012; IN COMMERCE 1-0-2012.

4,165,092. CHESAPEAKE HOSPITAL AUTHORITY, NORTH CHESAPEAKE, VA. SN 85-073,506. PUB. 11-30-2010, FILED 6-29-2010.

A SERIOUSLY UPLIFTING EXPERIENCE

THE MARK CONSISTS OF STANDARD CHARACTERS WITHOUT CLAIM TO ANY PARTICULAR FONT, STYLE, SIZE, OR COLOR.

CLASS 25—CLOTHING

FOR (BASED ON USE IN COMMERCE) CLOTHING, NAMELY, T-SHIRTS, BRAS, BRASSIERES, FLIP FLOPS, SCARVES, TIES, HATS, BOXER SHORTS (U.S. CLS. 22 AND 39).
FIRST USE 6-30-2008; IN COMMERCE 6-30-2008.

CLASS 36—INSURANCE AND FINANCIAL

FOR CHARITABLE FUNDRAISING SERVICES BY MEANS OF ORGANIZING AND CONDUCTING SPECIAL EVENTS FEATURING DISPLAYS AND EXHIBITIONS OF CREATIVELY DECORATED BRASSIERES (U.S. CLS. 100, 101 AND 102).
FIRST USE 9-1-2008; IN COMMERCE 9-1-2008.

4,165,094. STRATEGIC STORAGE HOLDINGS, LLC, LADERA RANCH, CA. SN 85-076,756. PUB. 6-7-2011, FILED 7-2-2010.

SMARTSTOP... THE SMARTER WAY TO STORE!

THE MARK CONSISTS OF STANDARD CHARACTERS WITHOUT CLAIM TO ANY PARTICULAR FONT, STYLE, SIZE, OR COLOR.

CLASS 35—ADVERTISING AND BUSINESS

FOR PROVIDING RETAIL STORE SERVICES FEATURING STORAGE SUPPLIES, NAMELY, BOXES, SHIPPING BLANKETS AND PADS, AND INSULATION MATERIALS (U.S. CLS. 100, 101 AND 102).
FIRST USE 11-16-2009; IN COMMERCE 12-21-2009.

CLASS 39—TRANSPORTATION AND STORAGE

FOR STORAGE OF GOODS; STORAGE OF VEHICLES, NAMELY, STORAGE OF CARS, RECREATIONAL VEHICLES, BOATS; AND AIRCRAFT OF OTHERS; STORAGE OF FILES AND DOCUMENTS OF OTHERS; PHYSICAL STORAGE OF ELECTRONICALLY-STORED DATA OR DOCUMENTS; STORAGE OF PERSONAL PROPERTY OF OTHERS; PROVIDING SELF-STORAGE FACILITIES FOR OTHERS; PROVIDING RENTAL STORAGE SPACES FOR OTHERS; WAREHOUSING SERVICES FOR GOODS OF OTHERS; PROVIDING PICKUP, DELIVERY AND STORAGE OF GOODS OF OTHERS (U.S. CLS. 100 AND 105).

FIRST USE 11-16-2009; IN COMMERCE 12-21-2009.

CLASS 37—CONSTRUCTION AND REPAIR

FOR LEASING AND RENTAL OF WIRELINE TOOLS FOR USE IN OIL AND GAS WELLS; OIL AND GAS WELL DRILLING SERVICES IN THE NATURE OF OPERATING WIRELINE TOOLS IN OIL AND GAS WELLS FOR OTHERS (U.S. CLS. 100, 103 AND 106).

FIRST USE 3-27-2012; IN COMMERCE 3-27-2012.

CLASS 41—EDUCATION AND ENTERTAINMENT

FOR TRAINING RELATING TO THE OPERATION AND MAINTENANCE OF WIRELINE TOOLS FOR OIL AND GAS WELLS (U.S. CLS. 100, 101 AND 107).

FIRST USE 3-27-2012; IN COMMERCE 3-27-2012.

4,165,098. MULTI PACKAGING SOLUTIONS, INC., LANSING, MI. SN 85-081,024. PUB. 5-10-2011, FILED 7-9-2010.

BLOOMIQ

THE MARK CONSISTS OF STANDARD CHARACTERS WITHOUT CLAIM TO ANY PARTICULAR FONT, STYLE, SIZE, OR COLOR.

CLASS 16—PAPER GOODS AND PRINTED MATTER

FOR EDUCATIONAL AND REFERENCE MATERIALS, NAMELY, FLORAL DESIGN GUIDES AND BOOKS, FLORAL WEDDING DESIGN GUIDES AND BOOKS, PROM AND HOMECOMING FLORAL GUIDES AND BOOKS, FLORAL FAN DECKS, NAMELY, HORTICULTURAL SAMPLE BOOKS, SYMPATHY FLORAL DESIGN GUIDES AND BOOKS, AND FLORAL DESIGN GUIDES AND BOOKS (U.S. CLS. 2, 5, 22, 23, 29, 37, 38 AND 50).

FIRST USE 7-31-2010; IN COMMERCE 7-31-2010.

CLASS 44—MEDICAL, BEAUTY AND AGRICULTURAL SERVICES

FOR COMPUTERIZED ONLINE INFORMATION SERVICES IN THE FIELD OF PLANT AND FLORAL DESIGN (U.S. CLS. 100 AND 101).

FIRST USE 7-31-2010; IN COMMERCE 7-31-2010.

4,165,099. IMPACT SELECTOR, INC., HEATH, TX. SN 85-082,213. PUB. 1-3-2012, FILED 7-12-2010.

EFFICIENT TOOLS = EFFICIENT OPERATIONS

NO CLAIM IS MADE TO THE EXCLUSIVE RIGHT TO USE "TOOLS", APART FROM THE MARK AS SHOWN.

4,165,100. GUIDEPOSTS A CHURCH CORPORATION, DANBURY, CT. SN 85-083,317. PUB. 5-10-2011, FILED 7-13-2010.

HOPE SPRINGS

THE MARK CONSISTS OF STANDARD CHARACTERS WITHOUT CLAIM TO ANY PARTICULAR FONT, STYLE, SIZE, OR COLOR.

CLASS 35—ADVERTISING AND BUSINESS

FOR ARRANGING AND CONDUCTING SPECIAL EVENTS FOR PROMOTIONAL OR ADVERTISING PURPOSES; ARRANGING AND CONDUCTING BUSINESS CONFERENCES AND CONVENTIONS FOR CONSUMERS (U.S. CLS. 100, 101 AND 102).

FIRST USE 9-9-2011; IN COMMERCE 9-9-2011.

CLASS 45—PERSONAL AND LEGAL SERVICES

FOR PROVIDING A WEBSITE FEATURING INFORMATION ABOUT RELIGION, NAMELY, FAITH AND SCRIPTURE BASED INFORMATION (U.S. CLS. 100 AND 101).

FIRST USE 9-9-2011; IN COMMERCE 9-9-2011.

4,165,101. PRINSCO, INC., WILLMAR, MN. SN 85-083,663. PUB. 12-14-2010, FILED 7-13-2010.

GOLDPRO

THE MARK CONSISTS OF STANDARD CHARACTERS WITHOUT CLAIM TO ANY PARTICULAR FONT, STYLE, SIZE, OR COLOR.

CLASS 17—RUBBER GOODS

FOR FLEXIBLE CORRUGATED PIPE, NOT OF METAL (U.S. CLS. 1, 5, 12, 13, 35 AND 50).

FIRST USE 9-1-2011; IN COMMERCE 9-1-2011.

CLASS 19—NON-METALLIC BUILDING MATERIALS

FOR RIGID CORRUGATED PIPE, NOT OF METAL (U.S. CLS. 1, 12, 33 AND 50).
FIRST USE 9-1-2011; IN COMMERCE 9-1-2011.

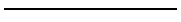

4,165,104. JOHN B. SANFILIPPO & SON, INC., ELGIN, IL. SN 85-085,576. PUB. 10-26-2010, FILED 7-15-2010.



THE MARK CONSISTS OF A CAPITAL LETTER "A" WITH THE TOP AND MIDDLE CONNECTING PORTIONS BEING DIVIDED BY WHITE SPACE AND PLACED OVER THE LETTERS "A R M A", WHICH LETTERS ARE FRAGMENTED AND OUTLINED IN BLACK WITH ONLY THAT PORTION OF THE LETTER "M" THAT IS SLANTED TO THE LEFT BEING SOLID, AND ALL PLACED OVER THE WORDS "ENERGY SNX".

THE ENGLISH TRANSLATION OF THE WORD "ARMA" IN THE MARK IS "WEAPON".

CLASS 18—LEATHER GOODS

FOR TOTE BAGS, LUGGAGE AND BACKPACKS (U.S. CLS. 1, 2, 3, 22 AND 41).
FIRST USE 2-0-2010; IN COMMERCE 7-15-2010.

CLASS 25—CLOTHING

FOR CLOTHING, NAMELY, SHIRTS, HATS, PANTS, BOXER BRIEFS, BOXER SHORTS AND FOOTWEAR (U.S. CLS. 22 AND 39).
FIRST USE 2-0-2010; IN COMMERCE 4-16-2010.

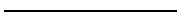

4,165,105. JOHN B. SANFILIPPO & SON, INC., ELGIN, IL. SN 85-085,581. PUB. 10-26-2010, FILED 7-15-2010.



THE MARK CONSISTS OF STANDARD CHARACTERS WITHOUT CLAIM TO ANY PARTICULAR FONT, STYLE, SIZE, OR COLOR.

THE ENGLISH TRANSLATION OF THE WORD "ARMA" IN THE MARK IS "WEAPON".

CLASS 18—LEATHER GOODS

FOR TOTE BAGS, LUGGAGE AND BACKPACKS (U.S. CLS. 1, 2, 3, 22 AND 41).
FIRST USE 2-0-2010; IN COMMERCE 7-15-2010.

CLASS 25—CLOTHING

FOR CLOTHING, NAMELY, SHIRTS, HATS, PANTS, BOXER BRIEFS, BOXER SHORTS AND FOOTWEAR (U.S. CLS. 22 AND 39).
FIRST USE 2-0-2010; IN COMMERCE 4-16-2010.

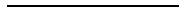

4,165,111. PHARMAOUEST INDUSTRIES, MINIAC MORVAN, FRANCE. SN 85-090,856. PUB. 7-26-2011, FILED 7-22-2010.

PHARMAOUEST INDUSTRIES

THE MARK CONSISTS OF STANDARD CHARACTERS WITHOUT CLAIM TO ANY PARTICULAR FONT, STYLE, SIZE, OR COLOR.

NO CLAIM IS MADE TO THE EXCLUSIVE RIGHT TO USE "INDUSTRIES", APART FROM THE MARK AS SHOWN.

CLASS 5—PHARMACEUTICALS

FOR PHARMACEUTICAL PREPARATIONS FOR THE TREATMENT OF BEDSORES AND THE BEDRIDDEN; SANITARY PREPARATIONS FOR MEDICAL PURPOSES; MEDICAL PLASTERS; MATERIALS FOR DRESSINGS, NAMELY, GAUZE; ADHESIVE TAPES FOR MEDICAL PURPOSES; MAGNETIC ANTI-RHEUMATISM RINGS FOR MEDICAL PURPOSES; CORN PADS FOR THE FEET; BANDAGES FOR DRESSINGS; HYGIENIC BANDAGES; MAGNETIC ANTI-RHEUMATISM BRACELETS FOR MEDICAL PURPOSES; BELTS FOR SANITARY NAPKINS AND TOWELS; MEDICATED COMPRESSES; SANITARY NAPKINS FOR INCONTINENCE; SANITARY DIAPERS FOR INCONTINENCE; PLASTERS FOR MEDICAL PURPOSES; SANITARY PANTY LINERS (U.S. CLS. 6, 18, 44, 46, 51 AND 52).
FIRST USE 12-31-1981; IN COMMERCE 12-31-2006.

CLASS 10—MEDICAL APPARATUS

FOR MEDICAL APPARATUS AND INSTRUMENTS, NAMELY, ORTHOPAEDIC ARTICLES IN THE NATURE OF ORTHOPEDIC BRACES, SPLINTS AND CERVICAL COLLARS; DRAW-SHEETS FOR SICK BEDS, SURGICAL SPLINTS; SURGICAL IMMOBILIZATION SPLINTS; ELASTIC BANDAGES; IMMOBILIZATION BANDAGES; PLASTER SUPPORT BANDAGES FOR ORTHOPAEDIC PURPOSES; ELASTIC STOCKINGS FOR SURGICAL PURPOSES; BASINS FOR MEDICAL PURPOSES; BED PANS; URINALS FOR MEDICAL PURPOSES; SPITTOONS FOR MEDICAL PURPOSES; BOTTLES FOR MEDICAL PURPOSES, NAMELY, INTRAVENOUS FEEDING BOTTLES; AMBULANCE STRETCHERS; WHEELED STRETCHERS; CRUTCHES; BELTS FOR MEDICAL PURPOSES; ORTHOPAEDIC BELTS; MEDICAL PATIENT TREATMENT CHAIRS, NAMELY, COM-MODE CHAIRS FOR MEDICAL PATIENTS; SCISSORS AND CLIPPERS FOR SURGERY; DROPPERS FOR MEDICAL PURPOSES SOLD EMPTY; ABDOMINAL CORSETS; PADS FOR PREVENTING PRESSURE SORES ON PATIENT BODIES; ANTI-DECUBITUS EQUIPMENT FOR MEDICAL PURPOSES, NAMELY, HEEL PIECES, ELBOW PIECES, ANKLE PROTECTION, FEET WARMER; THERAPEUTIC CUSHIONS FOR MEDICAL PURPOSES, THERAPEUTIC FOAM AND LATEX CUSHIONS FOR MEDICAL PURPOSES; CERVICAL PILLOWS FOR MEDICAL USE; CUTLERY, NAMELY, SURGICAL SHEARS; CORN KNIVES, NAMELY, KNIVES FOR CUTTING HUMAN TISSUE; BODY SUPPORT EQUIPMENT FOR MEDICAL PURPOSES, NAMELY, WRIST STRAPS, ANKLE STRAPS, BED STRAPS, PELVIC STRAPS, VENTRAL BELTS, BELTS WITH SELF GRIP FASTENER, SAFETY HARNESSSES, WHEEL CHAIR HARNESSSES, ARMSLINGS, ARM SPLINTS; ELECTRIC BLANKETS FOR MEDICAL PURPOSES; INVALIDS' HOISTS; SURGICAL DRAPES; MEDICAL PATIENT TREATMENT CHAIRS IN THE NATURE OF ARMCHAIRS FOR MEDICAL PURPOSES; GLOVES FOR MEDICAL PURPOSES; ORTHOPAEDIC KNEE BANDAGES; INHALERS SOLD EMPTY; THERAPEUTIC BEDS, SPECIALLY MADE FOR MEDICAL PURPOSES; THERAPEUTIC MATTRESSES, FOR MEDICAL PURPOSES; THERAPEUTIC MATTRESSES FOR MEDICAL PURPOSES MADE/ COMPOSED OF AIR, FOAM, GEL OR WATER; THERAPEUTIC BABY MATTRESSES FOR MEDICAL PURPOSES; PILLOWS FOR MEDICAL PURPOSES; CLOTHING, NAMELY, SCRUB TOPS AND BOTTOMS ESPECIALLY FOR OPERATING ROOMS; TOILET SEAT RAISERS FOR MEDICAL PURPOSES; BATH SEAT RAISERS FOR MEDICAL PURPOSES; THERAPEUTIC SEATS FOR MEDICAL PURPOSES; THERAPEUTIC SHOWER AND BATH SEATS FOR MEDICAL PURPOSES; NON-MEDICATED COMPRESSES (U.S. CLS. 26, 39 AND 44).

FIRST USE 12-31-1981; IN COMMERCE 12-31-2006.

4,165,114. LIFELOCK, INC., TEMPE, AZ. SN 85-095,370. PUB. 1-18-2011, FILED 7-28-2010.

**RELENTLESSLY PROTECTING
YOUR IDENTITY**

THE MARK CONSISTS OF STANDARD CHARACTERS WITHOUT CLAIM TO ANY PARTICULAR FONT, STYLE, SIZE, OR COLOR.

OWNER OF U.S. REG. NOS. 3,604,652 AND 3,780,480.

CLASS 36—INSURANCE AND FINANCIAL

FOR PROVIDING CREDIT REPORTING DATA MAINTAINED BY OTHERS; CREDIT RISK MANAGEMENT AND CONSULTATION SERVICES IN THE FIELD OF IDENTITY THEFT, NAMELY, ASSISTANCE WITH RESTORING AND ANALYZING CREDIT DAMAGED BY IDENTITY THEFT; PROVIDING ADVICE AND CONSULTATION IN THE FIELD OF CREDIT REPORTS AND CREDIT SCORES IN THE CONTEXT OF IDENTITY THEFT; FRAUD RESOLUTION ASSISTANCE, NAMELY, ASSISTANCE WITH RESTORING CREDIT DAMAGED BY IDENTITY THEFT; AND PROVIDING REIMBURSEMENT OF COSTS ASSOCIATED WITH IDENTITY THEFT (U.S. CLS. 100, 101 AND 102).

FIRST USE 6-0-2010; IN COMMERCE 6-0-2010.

CLASS 45—PERSONAL AND LEGAL SERVICES

FOR FRAUD DETECTION AND PREVENTION SERVICES IN THE NATURE OF ARRANGING SECURE AUTHENTICATION OF PERSONAL DATA IN REQUESTS TO OPEN BANKING, CREDIT, CREDIT CARD, INSURANCE, LOAN, AND OTHER FINANCIAL ACCOUNTS; FRAUD AND IDENTITY THEFT PROTECTION SERVICES; MONITORING THE INTERNET, PUBLIC RECORDS, CREDIT REPORTS, PRIVATE AND PUBLIC ELECTRONIC DATABASES, AND UNREGULATED GLOBAL COMPUTER NETWORKS TO FACILITATE THE DETECTION AND PREVENTION OF IDENTITY THEFT AND FRAUD; PROVIDING A SECURE INTERACTIVE WEBSITE CONCERNING NOTIFICATIONS OF POTENTIAL FRAUD AND POTENTIAL IDENTITY THEFT; RESOLUTION ASSISTANCE, NAMELY, PROVIDING ADVICE AND CONSULTATION IN THE FIELD OF DATA THEFT AND IDENTITY THEFT; CONSULTATION IN THE FIELD OF DATA THEFT AND IDENTITY THEFT; AND TRACKING, MONITORING, AND REPORTING REGARDING CONSUMER CREDIT REPORTS AND CHANGES THERETO FOR PURPOSES OF PROTECTING AGAINST DATA THEFT, IDENTITY THEFT AND FRAUD (U.S. CLS. 100 AND 101).

FIRST USE 6-0-2010; IN COMMERCE 6-0-2010.

4,165,117. ROBBINS RESEARCH INTERNATIONAL, INC., ESCONDIDO, CA. SN 85-097,328. PUB. 7-19-2011, FILED 7-30-2010.

**BREAKTHROUGH WITH TONY
ROBBINS**

THE MARK CONSISTS OF STANDARD CHARACTERS WITHOUT CLAIM TO ANY PARTICULAR FONT, STYLE, SIZE, OR COLOR.

OWNER OF U.S. REG. NOS. 1,852,682 AND 3,229,561.

THE NAME(S), PORTRAIT(S), AND/OR SIGNATURE(S) SHOWN IN THE MARK IDENTIFIES "TONY ROBBINS", WHOSE CONSENT(S) TO REGISTER IS MADE OF RECORD.

CLASS 9—ELECTRICAL AND SCIENTIFIC APPARATUS

FOR AUDIO AND VIDEO RECORDINGS IN THE FIELD OF PERSONAL IMPROVEMENT (U.S. CLS. 21, 23, 26, 36 AND 38).

FIRST USE 0-0-2010; IN COMMERCE 0-0-2010.

CLASS 41—EDUCATION AND ENTERTAINMENT

FOR EDUCATIONAL AND ENTERTAINMENT SERVICES, NAMELY, PROGRAMS ABOUT PERSONAL IMPROVEMENT ACCESSIBLE BY RADIO, TELEVISION, SATELLITE, AUDIO, VIDEO AND COMPUTER NETWORKS; EDUCATIONAL AND ENTERTAINMENT SERVICES, NAMELY, THE PRESENTATION OF SEMINARS, WORKSHOPS, PANEL DISCUSSIONS AND ONGOING TELEVISION AND RADIO SHOWS ALL IN THE FIELD OF PERSONAL IMPROVEMENT; EDUCATIONAL SERVICES, NAMELY, CONDUCTING CLASSES AND SEMINARS IN THE FIELD OF PERSONAL IMPROVEMENT (U.S. CLS. 100, 101 AND 107).

FIRST USE 0-0-2010; IN COMMERCE 0-0-2010.

CLASS 45—PERSONAL AND LEGAL SERVICES

FOR PROVIDING A WEBSITE FEATURING INFORMATION IN THE FIELD OF PERSONAL IMPROVEMENT (U.S. CLS. 100 AND 101).

FIRST USE 0-0-2010; IN COMMERCE 0-0-2010.

4,165,123. ACI WORLDWIDE CORP., ELKHORN, NE. SN 85-103,255. PUB. 1-18-2011, FILED 8-9-2010.



OWNER OF U.S. REG. NO. 2,420,572.
NO CLAIM IS MADE TO THE EXCLUSIVE RIGHT TO USE "PAYMENT SYSTEMS", APART FROM THE MARK AS SHOWN.

THE MARK CONSISTS OF THE CAPITAL LETTERS "ACI" WITH THE "A" STYLIZED WITHOUT A CENTER BAR AND A BREAK AT THE TOP BETWEEN THE TWO LEGS. THE WORDS "PAYMENT SYSTEMS" IN LOWER CASE LETTERS ARE BELOW THE LETTERS "ACI".

CLASS 42—SCIENTIFIC AND COMPUTER SERVICES

FOR APPLICATION SERVICE PROVIDER FEATURING SOFTWARE FOR USE IN ENABLING ORGANIZATIONS TO INITIATE, MANAGE, SECURE AND OPERATE ELECTRONIC PAYMENTS ACROSS MULTIPLE CHANNELS; DESIGN, DEVELOPMENT, INSTALLATION AND MAINTENANCE OF SOFTWARE FOR USE IN ENABLING ORGANIZATIONS TO INITIATE, MANAGE, SECURE AND OPERATE ELECTRONIC PAYMENTS ACROSS MULTIPLE CHANNELS (U.S. CLS. 100 AND 101).

FIRST USE 9-15-2010; IN COMMERCE 9-15-2010.

CLASS 45—PERSONAL AND LEGAL SERVICES

FOR LICENSING OF COMPUTER SOFTWARE PROGRAMS THAT ENABLE ORGANIZATIONS TO INITIATE, MANAGE, SECURE AND OPERATE ELECTRONIC PAYMENTS ACROSS MULTIPLE CHANNELS (U.S. CLS. 100 AND 101).

FIRST USE 9-15-2010; IN COMMERCE 9-15-2010.

4,165,125. EVAPCO, INC., TANEYTOWN, MD. SN 85-103,830. PUB. 1-10-2012, FILED 8-10-2010.



OWNER OF U.S. REG. NOS. 1,118,707, 1,222,502, AND 1,853,302.

THE MARK CONSISTS OF THE WORD "EVAPCO" ON A PENTAGONAL SHIELD, WITH A STYLIZED LEAF AT THE BOTTOM OF THE SHIELD BENEATH THE "C" AND "O".

CLASS 1—CHEMICALS

FOR WATER TREATMENT CHEMICALS FOR USE IN CONJUNCTION WITH REFRIGERATION AND COOLING EQUIPMENT (U.S. CLS. 1, 5, 6, 10, 26 AND 46).

FIRST USE 3-29-2011; IN COMMERCE 7-31-2011.

CLASS 11—ENVIRONMENTAL CONTROL APPARATUS

FOR REFRIGERATION AND COOLING EQUIPMENT, REPLACEMENT PARTS AND RELATED EQUIPMENT, NAMELY, COOLING TOWERS, EVAPORATIVE CONDENSERS, CLOSED CIRCUIT EVAPORATIVE COOLERS, EVAPORATORS, ROOFTOP AIR UNITS, CENTRIFUGAL FAN UNITS, COOLING UNITS FOR INDUSTRIAL PURPOSES, NAMELY, THERMAL ENERGY UNITS THAT MAKE AND STORE ICE USED FOR COOLING PURPOSES, AND NON-CHEMICAL WATER TREATMENT SYSTEMS COMPRISED OF SOME OR ALL OF THE FOLLOWING ELEMENTS: CHAMBER, ELECTRICAL PULSE TRANSFORMER PANEL, SHIELDED CABLE AND/OR MOTORIZED BALL VALVE, CONDUCTIVITY CONTROLLER WITH TOROIDAL CONDUCTIVITY SENSOR, PH SENSOR, FLOW SWITCH, PVC PH/CONDUCTIVITY SENSOR CHAMBER, Y-STRAINER, ISOLATION VALVES, AND INTERCONNECTING PIPING AND FITTINGS, ALL FOR USE IN CONNECTION WITH EVAPORATIVE COOLING SYSTEMS, NAMELY, COOLING TOWERS, CLOSED CIRCUIT COOLERS AND EVAPORATIVE CONDENSERS (U.S. CLS. 13, 21, 23, 31 AND 34).

FIRST USE 3-29-2011; IN COMMERCE 3-29-2011.

4,165,127. FOX ENTERPRISES, INC., FORT MYERS, FL. SN 85-107,277. PUB. 2-15-2011, FILED 8-13-2010.



OWNER OF U.S. REG. NOS. 2,261,901, 2,437,896, AND OTHERS.

THE COLOR(S) ORANGE, BLACK, WHITE, BLUE, YELLOW, BROWN AND GRAY IS/ARE CLAIMED AS A FEATURE OF THE MARK.

THE MARK CONSISTS OF THE WORDING "FOX" IN WHITE AND A ORANGE, WHITE, GRAY AND BLACK FOX WEARING A BLACK JACKET WITH A SMALL WHITE DESIGN OF A HEAD OF A FOX, HOLDING A BLUE, WHITE, BROWN, YELLOW AND BLACK GUITAR WITH A SMALL WHITE DESIGN OF A HEAD OF A FOX AND THE WORD "FOX" WEARING BLACK SUNGLASSES. THE WORD "FOX" AND THE HEAD OF THE FOX BOTH IN BLACK, APPEARS ON THE HEAD STOCK OF THE GUITAR.

4,165,128. FOX ENTERPRISES, INC., FORT MYERS, FL. SN 85-107,291. PUB. 2-15-2011, FILED 8-13-2010.



CLASS 9—ELECTRICAL AND SCIENTIFIC APPARATUS

FOR ACTIVE ELECTRONIC COMPONENTS AND PASSIVE ELECTRONIC COMPONENTS, NAMELY, QUARTZ CRYSTALS, MICROPROCESSOR CRYSTALS, CRYSTAL FILTERS, PHASED LOCKED LOOPS, FREQUENCY TRANSLATORS, FREQUENCY GENERATING DEVICES AND FREQUENCY CONTROLLING DEVICES; CRYSTAL CLOCK OSCILLATORS; OSCILLATORS; TEMPERATURE COMPENSATED CRYSTAL OSCILLATORS; VOLTAGE CONTROLLED CRYSTAL OSCILLATORS; OVEN CONTROLLED CRYSTAL OSCILLATORS; CERAMIC RESONATORS; VOLTAGE CONTROLLED OSCILLATORS; APPLICATION SPECIFIC INTEGRATED CIRCUITS; INTEGRATED CIRCUITS; PROGRAMMABLE INTEGRATED CIRCUITS; INTEGRATED CIRCUIT MODULES; BAW (BULK ACOUSTIC WAVE) RESONATORS; BAW OSCILLATORS; SAW (SURFACE ACOUSTIC WAVE) RESONATORS; SAW OSCILLATORS; AND SOFTWARE FOR RUNNING, PROGRAMMING AND CONTROLLING ALL OF THE FOREGOING (U.S. CLS. 21, 23, 26, 36 AND 38).

FIRST USE 4-12-2011; IN COMMERCE 4-12-2011.

CLASS 40—MATERIAL TREATMENT

FOR CUSTOM MANUFACTURE OF ACTIVE ELECTRONIC COMPONENTS AND PASSIVE ELECTRONIC COMPONENTS, NAMELY, QUARTZ CRYSTALS, MICROPROCESSOR CRYSTALS, CRYSTAL FILTERS, PHASED LOCKED LOOPS, FREQUENCY TRANSLATORS, FREQUENCY GENERATING DEVICES, FREQUENCY CONTROLLING DEVICES; CUSTOM MANUFACTURE OF CRYSTAL CLOCK OSCILLATORS, OSCILLATORS, TEMPERATURE COMPENSATED CRYSTAL OSCILLATORS, VOLTAGE CONTROLLED CRYSTAL OSCILLATORS, OVEN CONTROLLED CRYSTAL OSCILLATORS, CERAMIC RESONATORS, VOLTAGE CONTROLLED OSCILLATORS, BAW (BULK ACOUSTIC WAVE) RESONATORS, BAW OSCILLATORS, SAW (SURFACE ACOUSTIC WAVE) RESONATORS, SAW OSCILLATORS, APPLICATION SPECIFIC INTEGRATED CIRCUITS, INTEGRATED CIRCUITS, PROGRAMMABLE INTEGRATED CIRCUITS, INTEGRATED CIRCUIT MODULES; PROVIDING CUSTOM MANUFACTURE INFORMATION ON ALL OF THE FOREGOING VIA A GLOBAL COMPUTER INFORMATION NETWORK (U.S. CLS. 100, 103 AND 106).

FIRST USE 4-12-2011; IN COMMERCE 4-12-2011.

OWNER OF U.S. REG. NOS. 2,261,901, 2,437,896, AND OTHERS.

THE COLOR(S) ORANGE, BLACK, WHITE, DARK BLUE, LIGHT BLUE, YELLOW, BROWN AND GRAY IS/ARE CLAIMED AS A FEATURE OF THE MARK.

THE MARK CONSISTS OF THE FOLLOWING: THE WORDING "FOX" IN WHITE AND A ORANGE, WHITE, GRAY AND BLACK FOX WEARING A BLACK JACKET WITH A SMALL WHITE DESIGN OF A HEAD OF A FOX, HOLDING A BLUE, WHITE, BROWN, YELLOW AND BLACK GUITAR WITH A SMALL WHITE DESIGN OF A HEAD OF A FOX AND THE WORD "FOX" WEARING BLACK SUNGLASSES STANDING ON LIGHT BLUE, WHITE AND BLACK MINERAL FORMATIONS WITH A LIGHT BLUE BACKGROUND. THE WORD "FOX" AND HEAD OF THE FOX BOTH IN BLACK APPEARS ON THE HEAD STOCK OF THE GUITAR.

CLASS 9—ELECTRICAL AND SCIENTIFIC APPARATUS

FOR ACTIVE ELECTRONIC COMPONENTS AND PASSIVE ELECTRONIC COMPONENTS, NAMELY, QUARTZ CRYSTALS, MICROPROCESSOR CRYSTALS, CRYSTAL FILTERS, PHASED LOCKED LOOPS, FREQUENCY TRANSLATORS, FREQUENCY GENERATING DEVICES AND FREQUENCY CONTROLLING DEVICES; CRYSTAL CLOCK OSCILLATORS; OSCILLATORS; TEMPERATURE COMPENSATED CRYSTAL OSCILLATORS; VOLTAGE CONTROLLED CRYSTAL OSCILLATORS; OVEN CONTROLLED CRYSTAL OSCILLATORS; CERAMIC RESONATORS; VOLTAGE CONTROLLED OSCILLATORS; APPLICATION SPECIFIC INTEGRATED CIRCUITS; INTEGRATED CIRCUITS; PROGRAMMABLE INTEGRATED CIRCUITS; INTEGRATED CIRCUIT MODULES; BAW (BULK ACOUSTIC WAVE) RESONATORS; BAW OSCILLATORS; SAW (SURFACE ACOUSTIC WAVE) RESONATORS; SAW OSCILLATORS; AND SOFTWARE FOR RUNNING, PROGRAMMING AND CONTROLLING ALL OF THE FOREGOING (U.S. CLS. 21, 23, 26, 36 AND 38).

FIRST USE 4-12-2011; IN COMMERCE 4-12-2011.

CLASS 40—MATERIAL TREATMENT

FOR CUSTOM MANUFACTURE OF ACTIVE ELECTRONIC COMPONENTS AND PASSIVE ELECTRONIC COMPONENTS, NAMELY, QUARTZ CRYSTALS, MICROPROCESSOR CRYSTALS, CRYSTAL FILTERS, PHASED LOCKED LOOPS, FREQUENCY TRANSLATORS, FREQUENCY GENERATING DEVICES, FREQUENCY CONTROLLING DEVICES; CUSTOM MANUFACTURE OF CRYSTAL CLOCK OSCILLATORS, OSCILLATORS, TEMPERATURE COMPENSATED CRYSTAL OSCILLATORS, VOLTAGE CONTROLLED CRYSTAL OSCILLATORS, OVEN CONTROLLED CRYSTAL OSCILLATORS, CERAMIC RESONATORS, VOLTAGE CONTROLLED OSCILLATORS, BAW (BULK ACOUSTIC WAVE) RESONATORS, BAW OSCILLATORS, SAW (SURFACE ACOUSTIC WAVE) RESONATORS, SAW OSCILLATORS, APPLICATION SPECIFIC INTEGRATED CIRCUITS, INTEGRATED CIRCUITS, PROGRAMMABLE INTEGRATED CIRCUITS, INTEGRATED CIRCUIT MODULES; PROVIDING CUSTOM MANUFACTURE INFORMATION ON ALL OF THE FOREGOING VIA A GLOBAL COMPUTER INFORMATION NETWORK (U.S. CLS. 100, 103 AND 106).
FIRST USE 4-12-2011; IN COMMERCE 4-12-2011.

4,165,132. THE TJX COMPANIES, INC., FRAMINGHAM, MA. SN 85-107,961. PUB. 1-11-2011, FILED 8-16-2010.



OWNER OF U.S. REG. NOS. 2,117,444, 3,497,249, AND OTHERS.

NO CLAIM IS MADE TO THE EXCLUSIVE RIGHT TO USE "UNIVERSITY", APART FROM THE MARK AS SHOWN.

THE MARK CONSISTS OF "TJX UNIVERSITY", WITH THE "T" IN "TJX" OVERLAPPING A DESIGN OF A GLOBE OF THE WORLD.

CLASS 16—PAPER GOODS AND PRINTED MATTER

FOR PRINTED PUBLICATIONS, NAMELY, NEWSLETTERS, BROCHURES AND CALENDARS FEATURING INTERNAL INFORMATION TO EMPLOYEES REGARDING EMPLOYEE RESOURCES, BENEFITS AND PROGRAMS (U.S. CLS. 2, 5, 22, 23, 29, 37, 38 AND 50).

FIRST USE 2-1-2011; IN COMMERCE 2-1-2011.

CLASS 41—EDUCATION AND ENTERTAINMENT

FOR EDUCATIONAL SERVICES, NAMELY, CONDUCTING SEMINARS, WORKSHOPS, CLASSES, CONFERENCES AND SYMPOSIUMS IN THE FIELD OF LEADERSHIP DEVELOPMENT, HUMAN RESOURCES, CUSTOMER SERVICE, CUSTOMER AND EMPLOYEE SATISFACTION AND LOYALTY, EMPLOYEE RECRUITMENT, AND EMPLOYEE ORIENTATION, TRAINING AND DEVELOPMENT, AND DISTRIBUTION OF MATERIALS IN CONNECTION THEREWITH; EDUCATIONAL SERVICES RELATING TO EMPLOYMENT, NAMELY, PROVIDING COMMUNICATIONS VIA ONLINE AND ELECTRONIC PUBLICATIONS IN THE NATURE OF BOOKLETS, BROCHURES, TRAINING MATERIALS, FLYERS, HANDOUTS, NEWSLETTERS, CALENDARS, QUICK REFERENCE GUIDES TO EMPLOYEES REGARDING EMPLOYEE RESOURCES, BENEFITS AND PROGRAMS (U.S. CLS. 100, 101 AND 107).
FIRST USE 2-1-2011; IN COMMERCE 2-1-2011.

4,165,129. AMELIA'S DREAM, INC, NEW YORK, NY. SN 85-107,493. PUB. 1-25-2011, FILED 8-13-2010.

Parents With Angst

THE MARK CONSISTS OF STANDARD CHARACTERS WITHOUT CLAIM TO ANY PARTICULAR FONT, STYLE, SIZE, OR COLOR.

NO CLAIM IS MADE TO THE EXCLUSIVE RIGHT TO USE "PARENTS" FOR CLASS 9 & 41, APART FROM THE MARK AS SHOWN.

CLASS 9—ELECTRICAL AND SCIENTIFIC APPARATUS

FOR DIGITAL MATERIALS, NAMELY, CDS AND DVDS FEATURING MUSIC AND MUSICAL PERFORMANCES; DOWNLOADABLE MP3 FILES AND MP3 RECORDINGS FEATURING MUSIC (U.S. CLS. 21, 23, 26, 36 AND 38).

FIRST USE 5-22-2010; IN COMMERCE 11-13-2010.

CLASS 25—CLOTHING

FOR FLEECE PULLOVERS; FLEECE TOPS; HOODED SWEAT SHIRTS; JACKETS; PANTS; POLO SHIRTS; SHIRTS; SHOES; SHORTS; SOCKS; SWEAT PANTS; SWEATERS; T-SHIRTS (U.S. CLS. 22 AND 39).

FIRST USE 5-22-2010; IN COMMERCE 11-13-2010.

CLASS 41—EDUCATION AND ENTERTAINMENT

FOR ENTERTAINMENT SERVICES IN THE NATURE OF RECORDING, PRODUCTION AND POST-PRODUCTION SERVICES IN THE FIELDS OF MUSIC; ENTERTAINMENT, NAMELY, LIVE PERFORMANCES BY A MUSICAL BAND (U.S. CLS. 100, 101 AND 107).

FIRST USE 5-22-2010; IN COMMERCE 11-13-2010.

4,165,135. YOUNGMAN, JOEY, LOS ANGELES, CA. SN 85-108,515. PUB. 1-31-2012, FILED 8-16-2010.

WOLFGANG GARTNER

THE MARK CONSISTS OF STANDARD CHARACTERS WITHOUT CLAIM TO ANY PARTICULAR FONT, STYLE, SIZE, OR COLOR.

THE NAME "WOLFGANG GARTNER" IDENTIFIES A LIVING INDIVIDUAL WHOSE CONSENT IS OF RECORD.

CLASS 9—ELECTRICAL AND SCIENTIFIC APPARATUS

FOR PRERECORDED DIGITAL VERSATILE DISCS AND COMPACT DISCS FEATURING MUSICAL PERFORMANCES, MUSIC VIDEOS, MUSIC, DRAMATIC AND THEATRICAL PERFORMANCES; DOWNLOADABLE RING TONES FEATURING MUSIC AND VOICE MESSAGES; DOWNLOADABLE AUDIOVISUAL MULTIMEDIA FILES CONTAINING MUSICAL PERFORMANCES, MUSIC VIDEOS, MUSIC, DRAMATIC AND THEATRICAL PERFORMANCES (U.S. CLS. 21, 23, 26, 36 AND 38).

FIRST USE 12-31-2008; IN COMMERCE 12-31-2008.

CLASS 25—CLOTHING

FOR CLOTHING, NAMELY, SHIRTS, T-SHIRTS (U.S. CLS. 22 AND 39).

FIRST USE 12-31-2010; IN COMMERCE 12-31-2010.

CLASS 41—EDUCATION AND ENTERTAINMENT

FOR MUSIC PRODUCTION SERVICES; ENTERTAINMENT SERVICES, NAMELY, CONDUCTING LIVE MUSICAL PERFORMANCES; MUSIC VIDEO PRODUCTION SERVICES; ENTERTAINMENT SERVICES, NAMELY, PERSONAL APPEARANCES BY A CELEBRITY; SONG WRITING SERVICES FOR OTHERS; PROVIDING A WEBSITE FEATURING ENTERTAINMENT INFORMATION ABOUT MUSIC AND CELEBRITIES (U.S. CLS. 100, 101 AND 107).

FIRST USE 12-31-2008; IN COMMERCE 12-31-2008.

4,165,141. ASCENA RETAIL GROUP, INC., SUFFERN, NY. SN 85-110,081. PUB. 8-23-2011, FILED 8-18-2010.

ASCENA

THE MARK CONSISTS OF STANDARD CHARACTERS WITHOUT CLAIM TO ANY PARTICULAR FONT, STYLE, SIZE, OR COLOR.

THE ENGLISH TRANSLATION OF "ASCENA" IN THE MARK IS UPWARDS.

CLASS 35—ADVERTISING AND BUSINESS

FOR CONDUCTING SHAREHOLDER AND INVESTOR RELATIONS, NAMELY, PROVIDING SHAREHOLDER RECORD KEEPING AND CORPORATE BUSINESS INFORMATION AND ANALYSES (U.S. CLS. 100, 101 AND 102).

FIRST USE 1-1-2011; IN COMMERCE 1-1-2011.

CLASS 36—INSURANCE AND FINANCIAL

FOR ADMINISTRATION OF BENEFIT PLANS AND WELFARE BENEFIT PLANS CONCERNING INSURANCE AND FINANCE, PROVIDED TO EMPLOYEES AND EMPLOYEES OF AFFILIATES AND SUBSIDIARIES; FINANCIAL ADMINISTRATION OF RETIREMENT PLANS PROVIDED TO EMPLOYEES AND EMPLOYEES OF AFFILIATES AND SUBSIDIARIES, INCLUDING STOCK OPTION PLANS, RESTRICTED STOCK PLANS, 401K RETIREMENT PLAN, EMPLOYEE STOCK PURCHASE PLAN (U.S. CLS. 100, 101 AND 102).

FIRST USE 1-1-2011; IN COMMERCE 1-1-2011.

4,165,142. ASCENA RETAIL GROUP, INC., SUFFERN, NY. SN 85-110,093. PUB. 8-23-2011, FILED 8-18-2010.

ASCENA RETAIL GROUP

THE MARK CONSISTS OF STANDARD CHARACTERS WITHOUT CLAIM TO ANY PARTICULAR FONT, STYLE, SIZE, OR COLOR.

NO CLAIM IS MADE TO THE EXCLUSIVE RIGHT TO USE "RETAIL GROUP", APART FROM THE MARK AS SHOWN.

THE ENGLISH TRANSLATION OF "ASCENA" IN THE MARK IS UPWARDS.

CLASS 35—ADVERTISING AND BUSINESS

FOR CONDUCTING SHAREHOLDER AND INVESTOR RELATIONS, NAMELY, PROVIDING SHAREHOLDER RECORD KEEPING AND CORPORATE BUSINESS INFORMATION AND ANALYSES (U.S. CLS. 100, 101 AND 102).

FIRST USE 1-1-2011; IN COMMERCE 1-1-2011.

CLASS 36—INSURANCE AND FINANCIAL

FOR ADMINISTRATION OF BENEFIT PLANS AND WELFARE BENEFIT PLANS CONCERNING INSURANCE AND FINANCE, PROVIDED TO EMPLOYEES AND EMPLOYEES OF AFFILIATES AND SUBSIDIARIES; FINANCIAL ADMINISTRATION OF RETIREMENT PLANS PROVIDED TO EMPLOYEES AND EMPLOYEES OF AFFILIATES AND SUBSIDIARIES, INCLUDING STOCK OPTION PLANS, RESTRICTED STOCK PLANS, 401K RETIREMENT PLAN, EMPLOYEE STOCK PURCHASE PLAN (U.S. CLS. 100, 101 AND 102).

FIRST USE 1-1-2011; IN COMMERCE 1-1-2011.

4,165,148. APEXIGEN, INC., BURLINGAME, CA. SN 85-114,062. PUB. 3-8-2011, FILED 8-23-2010.

APEXIGEN

THE MARK CONSISTS OF STANDARD CHARACTERS WITHOUT CLAIM TO ANY PARTICULAR FONT, STYLE, SIZE, OR COLOR.

CLASS 42—SCIENTIFIC AND COMPUTER SERVICES

FOR CONSULTING SERVICES IN THE FIELD OF PHARMACEUTICALS, NAMELY, PHARMACEUTICAL RESEARCH; RESEARCH AND DEVELOPMENT OF PRODUCTS IN THE FIELD OF PHARMACEUTICALS AND THERAPEUTICS (U.S. CLS. 100 AND 101).

FIRST USE 12-3-2010; IN COMMERCE 12-3-2010.

CLASS 45—PERSONAL AND LEGAL SERVICES

FOR LICENSING OF INTELLECTUAL PROPERTY IN THE FIELDS OF THERAPEUTICS AND PHARMACEUTICALS (U.S. CLS. 100 AND 101).

FIRST USE 12-3-2010; IN COMMERCE 12-3-2010.

4,165,149. SANDERS, ROBIN RENEE, ALEXANDRIA, VA. SN 85-114,275. PUB. 2-1-2011, FILED 8-24-2010.

FEEEDS

THE MARK CONSISTS OF STANDARD CHARACTERS WITHOUT CLAIM TO ANY PARTICULAR FONT, STYLE, SIZE, OR COLOR.

CLASS 9—ELECTRICAL AND SCIENTIFIC APPARATUS

FOR DOWNLOADABLE ELECTRONIC PUBLICATIONS IN THE NATURE OF ELECTRONIC BOOKS AND ELECTRONIC ARTICLES IN THE FIELD OF FOOD SECURITY, EDUCATION, ENVIRONMENT-ENERGY, ECONOMICS, DEMOCRACY, AND SELF-HELP (U.S. CLS. 21, 23, 26, 36 AND 38).

FIRST USE 11-3-2011; IN COMMERCE 11-3-2011.

CLASS 16—PAPER GOODS AND PRINTED MATTER

FOR PUBLICATIONS, NAMELY, NON-FICTION BOOKS, PAMPHLETS, AND WRITTEN ARTICLES IN THE FIELDS OF FOOD SECURITY, EDUCATION, ENVIRONMENT-ENERGY, ECONOMICS, DEMOCRACY, AND SELF-HELP (U.S. CLS. 2, 5, 22, 23, 29, 37, 38 AND 50).

FIRST USE 11-3-2011; IN COMMERCE 11-3-2011.

4,165,153. BANEY, DAVID, CHICAGO, IL. SN 85-116,256. PUB. 11-29-2011, FILED 8-26-2010.

55 QUESTIONS

THE MARK CONSISTS OF STANDARD CHARACTERS WITHOUT CLAIM TO ANY PARTICULAR FONT, STYLE, SIZE, OR COLOR.

CLASS 35—ADVERTISING AND BUSINESS

FOR BUSINESS CONSULTING SERVICES, NAMELY, PROVIDING, DIRECTLY AND THROUGH BUSINESS-TO-BUSINESS PEER ADVISORY GROUPS MANAGEMENT, SALES, MARKETING, STRATEGIC PLANNING AND OPERATIONAL ADVICE TO BUSINESS OWNERS, THEIR DIRECTORS, AND EXECUTIVE MANAGEMENT TEAMS; PROVIDING BUSINESS INFORMATION RELATING TO QUARTERLY PLANNING AND MANAGEMENT OPERATIONS; AND DEVELOPING AND CONDUCTING SALES ASSESSMENT PROGRAMS RELATING TO THE HIRING OF SALES PERSONNEL AND EVALUATING EXISTING SALES FORCES (U.S. CLS. 100, 101 AND 102).

FIRST USE 12-10-2010; IN COMMERCE 12-10-2010.

CLASS 36—INSURANCE AND FINANCIAL

FOR CONSULTING SERVICES, NAMELY, PROVIDING FINANCIAL INFORMATION TO BUSINESSES (U.S. CLS. 100, 101 AND 102).

FIRST USE 12-10-2010; IN COMMERCE 12-10-2010.

4,165,166. ENTONE, INC., CUPERTINO, CA. SN 85-119,083. PUB. 5-3-2011, FILED 8-30-2010.

FUSIONTV

THE MARK CONSISTS OF STANDARD CHARACTERS WITHOUT CLAIM TO ANY PARTICULAR FONT, STYLE, SIZE, OR COLOR.

CLASS 9—ELECTRICAL AND SCIENTIFIC APPARATUS

FOR COMPUTER HARDWARE AND SOFTWARE FOR THE INTEGRATION OF TEXT, AUDIO, GRAPHICS, STILL IMAGES AND MOVING PICTURES INTO AN INTERACTIVE DELIVERY FOR MULTIMEDIA APPLICATIONS OVER DIGITAL BROADBAND NETWORKS FOR INTEGRATION WITH BROADCAST TELEVISION CHANNELS (U.S. CLS. 21, 23, 26, 36 AND 38).

FIRST USE 11-1-2010; IN COMMERCE 11-1-2010.

CLASS 38—COMMUNICATION

FOR PROVIDING TELECOMMUNICATIONS CONNECTIVITY SERVICES FOR THE TRANSFER OF MULTIMEDIA WORKS OVER DIGITAL BROADBAND NETWORKS FOR INTEGRATION WITH BROADCAST TELEVISION CHANNELS (U.S. CLS. 100, 101 AND 104).

FIRST USE 11-1-2010; IN COMMERCE 11-1-2010.

4,165,178. SEBRANEK, INC., BURLINGTON, WI. SN 85-121,881. PUB. 8-23-2011, FILED 9-2-2010.

THOUGHTFUL LEARNING

THE MARK CONSISTS OF STANDARD CHARACTERS WITHOUT CLAIM TO ANY PARTICULAR FONT, STYLE, SIZE, OR COLOR.

NO CLAIM IS MADE TO THE EXCLUSIVE RIGHT TO USE "LEARNING", APART FROM THE MARK AS SHOWN.

CLASS 9—ELECTRICAL AND SCIENTIFIC APPARATUS

FOR AUDIO BOOKS IN THE FIELD OF K-12 EDUCATION (U.S. CLS. 21, 23, 26, 36 AND 38).

FIRST USE 10-0-2011; IN COMMERCE 10-0-2011.

CLASS 16—PAPER GOODS AND PRINTED MATTER

FOR EDUCATIONAL PUBLICATIONS, NAMELY, BOOKS, WORKBOOKS, HAND-OUTS AND TEACHER GUIDES IN THE FIELDS OF K-12 EDUCATION (U.S. CLS. 2, 5, 22, 23, 29, 37, 38 AND 50).

FIRST USE 10-0-2011; IN COMMERCE 10-0-2011.

CLASS 41—EDUCATION AND ENTERTAINMENT

FOR PROVIDING AN EDUCATIONAL WEBSITE IN THE FIELD OF K-12 EDUCATION (U.S. CLS. 100, 101 AND 107).

FIRST USE 10-0-2011; IN COMMERCE 10-0-2011.

4,165,184. TATE, INCORPORATED, ALEXANDRIA, VA. SN 85-124,098. PUB. 3-8-2011, FILED 9-7-2010.



OWNER OF U.S. REG. NOS. 2,951,012, 3,817,065, AND OTHERS.

NO CLAIM IS MADE TO THE EXCLUSIVE RIGHT TO USE "GLOBAL", APART FROM THE MARK AS SHOWN.

THE MARK CONSISTS OF THE WORDS "TATE GLOBAL" BESIDES FOUR DIAGONAL STRIPES INSIDE A RECTANGLE.

CLASS 41—EDUCATION AND ENTERTAINMENT

FOR PROVIDING TRAINING FOR HIGH RISK OPERATIONS IN THE FIELDS OF SURVIVAL, EVASION, RESISTANCE AND ESCAPE; PERSONNEL RECOVERY TRAINING (U.S. CLS. 100, 101 AND 107).

FIRST USE 3-11-2011; IN COMMERCE 3-11-2011.

CLASS 42—SCIENTIFIC AND COMPUTER SERVICES

FOR TECHNICAL CONSULTATION AND RESEARCH IN THE FIELDS OF INFORMATION TECHNOLOGY, MILITARY TECHNOLOGIES, DEFENSE TECHNOLOGIES, DIGITAL VIDEO TECHNOLOGY, DIGITAL MAPPING TECHNOLOGY, RECONNAISSANCE TECHNOLOGY, INNOVATIVE ENGINEERING TECHNOLOGY AND BIOSCIENTIFIC APPLICATIONS (U.S. CLS. 100 AND 101).

FIRST USE 3-11-2011; IN COMMERCE 3-11-2011.

4,165,191. SA, SHUANG, RICHMOND, BC, CANADA. SN 85-125,878. PUB. 8-16-2011, FILED 9-9-2010.

GREENROOF

THE MARK CONSISTS OF STANDARD CHARACTERS WITHOUT CLAIM TO ANY PARTICULAR FONT, STYLE, SIZE, OR COLOR.

CLASS 7—MACHINERY

FOR AGRICULTURAL MACHINE AND ATTACHMENTS THEREFOR, NAMELY, LAWN AND GARDEN TILLING MACHINES; POWER OPERATED LAWN AND GARDEN TOOLS, NAMELY, CULTIVATORS, CHIPPERS, SHREDDERS, STRING TRIMMERS, EDGERS; GRASS MOWER, LAWNMOWERS; ELECTRIC LAWNMOWERS; ELECTRIC KNIVES, NAMELY, MOWER KNIVES; ELECTRIC CHAFF-CUTTERS; ELECTRIC LAWN TRIMMERS; SNOW PLOWS; DC GENERATORS, POWER OPERATED LAWN AND GARDEN TOOLS, NAMELY, CULTIVATORS, SHREDDERS, CHIPPERS, SPADES, WEEDERS, SHOVELS AND PRUNERS (U.S. CLS. 13, 19, 21, 23, 31, 34 AND 35).

FIRST USE 8-19-2010; IN COMMERCE 8-19-2010.

CLASS 19—NON-METALLIC BUILDING MATERIALS

FOR NON-METAL RAILS AND NON-METAL GUARD RAILS; NON-METAL STRUCTURES FOR MOUNTING SOLAR PANELS (U.S. CLS. 1, 12, 33 AND 50).

FIRST USE 9-13-2011; IN COMMERCE 9-13-2011.

4,165,199. KINGDOM GENERATION, LLC, PLAINFIELD, NJ. SN 85-127,161. PUB. 8-30-2011, FILED 9-10-2010.

KINGDOM GENERATION

THE MARK CONSISTS OF STANDARD CHARACTERS WITHOUT CLAIM TO ANY PARTICULAR FONT, STYLE, SIZE, OR COLOR.

CLASS 3—COSMETICS AND CLEANING PREPARATIONS

FOR ANOINTING OILS IN THE NATURE OF AROMATIC OILS AND BODY OILS, BODY LOTION, AND BODY SOAPS (U.S. CLS. 1, 4, 6, 50, 51 AND 52).

FIRST USE 6-0-2009; IN COMMERCE 6-0-2009.

CLASS 4—LUBRICANTS AND FUELS

FOR PARTY FAVORS, NAMELY, CANDLES (U.S. CLS. 1, 6 AND 15).

FIRST USE 10-1-2011; IN COMMERCE 10-1-2011.

CLASS 9—ELECTRICAL AND SCIENTIFIC APPARATUS

FOR MUSIC DVDS (U.S. CLS. 21, 23, 26, 36 AND 38).

FIRST USE 10-1-2011; IN COMMERCE 10-1-2011.

CLASS 16—PAPER GOODS AND PRINTED MATTER

FOR RELIGIOUS BOOKS AND PARTY FAVORS, NAMELY, BOOKMARKS (U.S. CLS. 2, 5, 22, 23, 29, 37, 38 AND 50).

FIRST USE 10-1-2011; IN COMMERCE 10-1-2011.

CLASS 30—STAPLE FOODS

FOR COFFEE AND TEAS (U.S. CL. 46).

FIRST USE 10-1-2011; IN COMMERCE 10-1-2011.

4,165,200. KINGDOM GENERATION, LLC, PLAINFIELD, NJ. SN 85-127,196. PUB. 8-30-2011, FILED 9-10-2010.

SPIRITUAL CARE

THE MARK CONSISTS OF STANDARD CHARACTERS WITHOUT CLAIM TO ANY PARTICULAR FONT, STYLE, SIZE, OR COLOR.

CLASS 3—COSMETICS AND CLEANING PREPARATIONS

FOR ANOINTING OILS IN THE NATURE OF AROMATIC OILS AND BODY OILS. BODY LOTION, AND BODY SOAPS (U.S. CLS. 1, 4, 6, 50, 51 AND 52).
FIRST USE 6-0-2009; IN COMMERCE 6-0-2009.

CLASS 4—LUBRICANTS AND FUELS

FOR PARTY FAVORS, NAMELY, CANDLES (U.S. CLS. 1, 6 AND 15).
FIRST USE 10-1-2011; IN COMMERCE 10-1-2011.

CLASS 9—ELECTRICAL AND SCIENTIFIC APPARATUS

FOR MUSIC DVDS (U.S. CLS. 21, 23, 26, 36 AND 38).
FIRST USE 10-1-2011; IN COMMERCE 10-1-2011.

CLASS 16—PAPER GOODS AND PRINTED MATTER

FOR RELIGIOUS BOOKS AND PARTY FAVORS, NAMELY, BOOKMARKS (U.S. CLS. 2, 5, 22, 23, 29, 37, 38 AND 50).
FIRST USE 10-1-2011; IN COMMERCE 10-1-2011.

CLASS 30—STAPLE FOODS

FOR TEAS (U.S. CL. 46).
FIRST USE 10-1-2011; IN COMMERCE 10-1-2011.

4,165,204. THOMASVILLE HOME FURNISHINGS, INC., THOMASVILLE, NC. SN 85-129,949. PUB. 8-23-2011, FILED 9-15-2010.

THOMASVILLE

THE MARK CONSISTS OF STANDARD CHARACTERS WITHOUT CLAIM TO ANY PARTICULAR FONT, STYLE, SIZE, OR COLOR.

OWNER OF U.S. REG. NOS. 1,151,730, 3,141,739, AND OTHERS.
SEC. 2(F).

CLASS 2—PAINTS

FOR WOOD PRESERVING OILS AND/OR OILS FOR USE AS PROTECTIVE COATINGS FOR WOOD (U.S. CLS. 6, 11 AND 16).
FIRST USE 11-0-2010; IN COMMERCE 11-0-2010.

CLASS 3—COSMETICS AND CLEANING PREPARATIONS

FOR WOOD CARE POLISHES, CREAMS, AND CLEANERS (U.S. CLS. 1, 4, 6, 50, 51 AND 52).
FIRST USE 11-0-2010; IN COMMERCE 11-0-2010.

CLASS 19—NON-METALLIC BUILDING MATERIALS

FOR NON-METAL SHUTTERS (U.S. CLS. 1, 12, 33 AND 50).
FIRST USE 2-0-2011; IN COMMERCE 2-0-2011.

4,165,205. THOMASVILLE HOME FURNISHINGS, INC., THOMASVILLE, NC. SN 85-129,968. PUB. 8-23-2011, FILED 9-15-2010.

Thomasville

OWNER OF U.S. REG. NOS. 1,151,730, 3,141,739, AND OTHERS.

THE MARK CONSISTS OF THE WORD "THOMASVILLE" WRITTEN IN A STYLIZED FORMAT.
SEC. 2(F).

CLASS 2—PAINTS

FOR WOOD PRESERVING OILS AND/OR OILS FOR USE AS PROTECTIVE COATINGS FOR WOOD (U.S. CLS. 6, 11 AND 16).
FIRST USE 11-0-2010; IN COMMERCE 11-0-2010.

CLASS 3—COSMETICS AND CLEANING PREPARATIONS

FOR WOOD CARE POLISHES, CREAMS, AND CLEANERS (U.S. CLS. 1, 4, 6, 50, 51 AND 52).
FIRST USE 11-0-2010; IN COMMERCE 11-0-2010.

CLASS 19—NON-METALLIC BUILDING MATERIALS

FOR NON-METAL SHUTTERS (U.S. CLS. 1, 12, 33 AND 50).
FIRST USE 2-0-2011; IN COMMERCE 2-0-2011.

4,165,206. NAN YANG FABRIC CO., LTD, AMPHOR KHOAYOI, THAILAND. SN 85-130,152. PUB. 8-16-2011, FILED 9-15-2010.



THE MARK CONSISTS OF THE WORD "TECHNICORE" IN STYLIZED LETTERS AND ABOVE THE "I" IS A CIRCLE CONTAINING TWO LOWER CASE LETTERS "E" INVERTED AND OVERLAPPING EACH OTHER.

CLASS 24—FABRICS

FOR KNITTED FABRIC; NATURAL FIBER BASE FABRICS; SEMI-NATURAL FIBER BASE FABRICS; SYNTHETIC BASE FABRICS; FABRIC FOR MANUFACTURE OF CLOTHING; KNITTED FABRIC USED TO MAKE CLOTHES (U.S. CLS. 42 AND 50).

FIRST USE 7-31-2011; IN COMMERCE 7-31-2011.

CLASS 25—CLOTHING

FOR SPORTSWEAR CLOTHING, NAMELY, SPORT SHIRTS, DRESSES AND COORDINATED JOGGING SUITS; JACKETS; PANTS; T-SHIRTS; T-SHIRTS WITH COLLARS AND/OR CUFFS; UNDERCLOTHING (U.S. CLS. 22 AND 39).

FIRST USE 7-31-2011; IN COMMERCE 7-31-2011.

4,165,208. STERLING PUBLISHING CO., INC., NEW YORK, NY. SN 85-130,406. PUB. 3-8-2011, FILED 9-15-2010.

SPLINTER

THE MARK CONSISTS OF STANDARD CHARACTERS WITHOUT CLAIM TO ANY PARTICULAR FONT, STYLE, SIZE, OR COLOR.

CLASS 9—ELECTRICAL AND SCIENTIFIC APPARATUS

FOR ELECTRONIC PUBLICATIONS, NAMELY, BOOKS AND PAMPHLETS FEATURING WORKS OF FICTION, BIOGRAPHICAL STORIES, AND POETRY FOR USE PRIMARILY BY TEENS AND YOUNG ADULTS (U.S. CLS. 21, 23, 26, 36 AND 38).

FIRST USE 1-31-2011; IN COMMERCE 1-31-2011.

CLASS 16—PAPER GOODS AND PRINTED MATTER

FOR PRINTED MATTER, NAMELY, BOOKS AND PAMPHLETS FEATURING WORKS OF FICTION, BIOGRAPHICAL STORIES, AND POETRY FOR USE PRIMARILY BY TEENS AND YOUNG ADULTS (U.S. CLS. 2, 5, 22, 23, 29, 37, 38 AND 50).

FIRST USE 1-31-2011; IN COMMERCE 1-31-2011.

CLASS 41—EDUCATION AND ENTERTAINMENT

FOR BOOK PUBLISHING SERVICES; ONLINE ELECTRONIC PUBLISHING OF BOOKS (U.S. CLS. 100, 101 AND 107).

FIRST USE 1-31-2011; IN COMMERCE 1-31-2011.

4,165,213. ALLIANCE DATA SYSTEMS CORPORATION, PLANO, TX. SN 85-131,885. PUB. 3-22-2011, FILED 9-17-2010.

MYCARDEXTRAS

THE MARK CONSISTS OF STANDARD CHARACTERS WITHOUT CLAIM TO ANY PARTICULAR FONT, STYLE, SIZE, OR COLOR.

CLASS 35—ADVERTISING AND BUSINESS

FOR ARRANGING AND CONDUCTING INCENTIVE REWARD PROGRAMS TO PROMOTE THE SALE OF VARIOUS GOODS AND SERVICES; CUSTOMER LOYALTY SERVICES AND CUSTOMER CLUB SERVICES, FOR COMMERCIAL, PROMOTIONAL AND/OR ADVERTISING PURPOSES; PROVIDING A WEBSITE FEATURING COMMERCIAL INFORMATION ABOUT SHOPPING INCENTIVES AND REWARDS (U.S. CLS. 100, 101 AND 102).

FIRST USE 1-1-2011; IN COMMERCE 1-1-2011.

CLASS 36—INSURANCE AND FINANCIAL

FOR CREDIT AND DEBIT CARD SERVICES; PROVIDING CASH AND OTHER REBATES FOR CREDIT CARD USE AS PART OF A CUSTOMER LOYALTY PROGRAM; PROVIDING REBATES AT PARTICIPATING ESTABLISHMENTS OF OTHERS THROUGH USE OF A MEMBERSHIP CARD; ON-LINE POSTING OF REWARDS, NAMELY, ELECTRONIC TRANSFER OF MONEY REWARDED AS A SHOPPING INCENTIVE (U.S. CLS. 100, 101 AND 102).

FIRST USE 1-1-2011; IN COMMERCE 1-1-2011.

4,165,214. ALLIANCE DATA SYSTEMS CORPORATION, PLANO, TX. SN 85-131,892. PUB. 3-22-2011, FILED 9-17-2010.

MYCARDEXTRAS.COM

THE MARK CONSISTS OF STANDARD CHARACTERS WITHOUT CLAIM TO ANY PARTICULAR FONT, STYLE, SIZE, OR COLOR.

CLASS 35—ADVERTISING AND BUSINESS

FOR ARRANGING AND CONDUCTING INCENTIVE REWARD PROGRAMS TO PROMOTE THE SALE OF VARIOUS GOODS AND SERVICES; CUSTOMER LOYALTY SERVICES AND CUSTOMER CLUB SERVICES, FOR COMMERCIAL, PROMOTIONAL AND/OR ADVERTISING PURPOSES; PROVIDING A WEBSITE FEATURING COMMERCIAL INFORMATION ABOUT SHOPPING INCENTIVES AND REWARDS (U.S. CLS. 100, 101 AND 102).

FIRST USE 1-1-2011; IN COMMERCE 1-1-2011.

CLASS 36—INSURANCE AND FINANCIAL

FOR CREDIT AND DEBIT CARD SERVICES; PROVIDING CASH AND OTHER REBATES FOR CREDIT CARD USE AS PART OF A CUSTOMER LOYALTY PROGRAM; PROVIDING REBATES AT PARTICIPATING ESTABLISHMENTS OF OTHERS THROUGH USE OF A MEMBERSHIP CARD; ON-LINE POSTING OF REWARDS, NAMELY, ELECTRONIC TRANSFER OF MONEY REWARDED AS A SHOPPING INCENTIVE (U.S. CLS. 100, 101 AND 102).

FIRST USE 1-1-2011; IN COMMERCE 1-1-2011.

4,165,216. EUGENE GEER III, ANDREW, CHARLESTON, SC. SN 85-133,976. PUB. 3-8-2011, FILED 9-20-2010.

OKRAVILLE

THE MARK CONSISTS OF STANDARD CHARACTERS WITHOUT CLAIM TO ANY PARTICULAR FONT, STYLE, SIZE, OR COLOR.

CLASS 3—COSMETICS AND CLEANING PREPARATIONS

FOR AFTERSHAVE PREPARATIONS; LIP BALM; LOTIONS FOR FACE AND BODY CARE; SUN TAN LOTION (U.S. CLS. 1, 4, 6, 50, 51 AND 52).

FIRST USE 10-20-2011; IN COMMERCE 10-20-2011.

CLASS 30—STAPLE FOODS

FOR HOT SAUCE; RELISH (U.S. CL. 46).
FIRST USE 10-20-2011; IN COMMERCE 10-20-2011.

CLASS 31—NATURAL AGRICULTURAL PRODUCTS

FOR FRESH VEGETABLES (U.S. CLS. 1 AND 46).
FIRST USE 10-20-2011; IN COMMERCE 10-20-2011.

4,165,222. NATIONAL AIR FILTRATION ASSOCIATION, VIRGINIA BEACH, VA. SN 85-134,572. PUB. 8-23-2011, FILED 9-21-2010.



OWNER OF U.S. REG. NOS. 1,379,798, 3,701,093, AND

3,930,802.

THE MARK CONSISTS OF THREE AIR FILTERS WITH AIR FLOWING THROUGH THEM THEN THE WORDS "NAFA NATIONAL AIR FILTRATION ASSOCIATION".

SEC. 2(F) AS TO "NATIONAL AIR FILTRATION ASSOCIATION".

CLASS 35—ADVERTISING AND BUSINESS

FOR BUSINESS SERVICES, NAMELY, FORMULATION OF BEST PRACTICES IN THE FIELD OF AIR FILTRATION (U.S. CLS. 100, 101 AND 102).

FIRST USE 12-1-2010; IN COMMERCE 12-1-2010.

CLASS 41—EDUCATION AND ENTERTAINMENT

FOR EDUCATIONAL SERVICES, NAMELY, CONDUCTING CLASSES, SEMINARS, FORUMS AND WORKSHOPS ON TECHNICAL STANDARDS, PERFORMANCE STANDARDS, GOVERNMENT REGULATIONS, AND PRODUCTS IN THE FIELD OF AIR FILTRATION (U.S. CLS. 100, 101 AND 107).

FIRST USE 10-31-2011; IN COMMERCE 10-31-2011.

CLASS 42—SCIENTIFIC AND COMPUTER SERVICES

FOR TESTING, ANALYSIS AND EVALUATION OF AIR FILTRATION PRODUCTS OF OTHERS FOR THE PURPOSE OF CERTIFICATION; ACCREDITATION SERVICES, NAMELY, DEVELOPING AND ADMINISTERING STANDARDS AND PROCEDURES FOR CERTIFYING PROFESSIONALS IN THE FIELD OF AIR FILTRATION; TESTING ANALYSIS AND EVALUATION OF THE LABORATORIES OF OTHERS IN THE FIELD OF AIR FILTRATION FOR THE PURPOSE OF CERTIFICATION (U.S. CLS. 100 AND 101).

FIRST USE 3-31-2012; IN COMMERCE 3-31-2012.

4,165,224. ANVIL KNITWEAR, INC., NEW YORK, NY. SN 85-135,301. PUB. 8-16-2011, FILED 9-22-2010.

SHIRT SCAN

THE MARK CONSISTS OF STANDARD CHARACTERS WITHOUT CLAIM TO ANY PARTICULAR FONT, STYLE, SIZE, OR COLOR.

NO CLAIM IS MADE TO THE EXCLUSIVE RIGHT TO USE "SHIRT", APART FROM THE MARK AS SHOWN.

CLASS 35—ADVERTISING AND BUSINESS

FOR PROVIDING INFORMATION IN THE FIELD OF SUPPLY CHAIN MANAGEMENT FOR CLOTHING VIA THE INTERNET; PROVIDING INFORMATION IN THE FIELD OF SUPPLY CHAIN MANAGEMENT FOR T-SHIRTS AND ORGANIC CLOTHING (U.S. CLS. 100, 101 AND 102).

FIRST USE 2-17-2011; IN COMMERCE 2-17-2011.

CLASS 40—MATERIAL TREATMENT

FOR PROVIDING INFORMATION IN THE FIELD OF MANUFACTURING OF CLOTHING AND CLOTHING RAW MATERIALS VIA THE INTERNET (U.S. CLS. 100, 103 AND 106).

FIRST USE 2-17-2011; IN COMMERCE 2-17-2011.

4,165,235. COIN LAUNDRY ASSOCIATION, DOWNERS GROVE, IL. SN 85-140,892. PUB. 8-30-2011, FILED 9-29-2010.

PLANET LAUNDRY

THE MARK CONSISTS OF STANDARD CHARACTERS WITHOUT CLAIM TO ANY PARTICULAR FONT, STYLE, SIZE, OR COLOR.

OWNER OF U.S. REG. NOS. 3,684,021 AND 3,874,227.

NO CLAIM IS MADE TO THE EXCLUSIVE RIGHT TO USE "LAUNDRY", APART FROM THE MARK AS SHOWN.

CLASS 16—PAPER GOODS AND PRINTED MATTER

FOR PUBLICATIONS IN THE FIELD OF THE LAUNDRY INDUSTRY, NAMELY, HAND-OUTS, POCKET GUIDES, AND BOOKS (U.S. CLS. 2, 5, 22, 23, 29, 37, 38 AND 50).

FIRST USE 7-1-2009; IN COMMERCE 6-1-2009.

CLASS 35—ADVERTISING AND BUSINESS

FOR EXHIBITION SERVICES, NAMELY, ORGANIZATION OF EXHIBITIONS FOR COMMERCIAL, PROMOTIONAL AND ADVERTISING PURPOSES IN THE FIELD OF THE LAUNDRY INDUSTRY; TRADE SHOW SERVICES, NAMELY, ARRANGING AND CONDUCTING TRADE SHOWS IN THE FIELD OF THE LAUNDRY INDUSTRY (U.S. CLS. 100, 101 AND 102).

FIRST USE 4-1-2009; IN COMMERCE 6-1-2009.

CLASS 41—EDUCATION AND ENTERTAINMENT

FOR EDUCATIONAL SERVICES, NAMELY, PROVIDING CLASSES, SEMINARS AND WORKSHOPS IN THE FIELD OF THE LAUNDRY INDUSTRY (U.S. CLS. 100, 101 AND 107).

FIRST USE 4-1-2009; IN COMMERCE 6-1-2009.

4,165,241. PROX13 PRODUCTIONS STUDIO LLC, HONOLULU, UT. SN 85-143,146. PUB. 3-22-2011, FILED 10-1-2010.

END OF AN EMPIRE

THE MARK CONSISTS OF STANDARD CHARACTERS WITHOUT CLAIM TO ANY PARTICULAR FONT, STYLE, SIZE, OR COLOR.

CLASS 9—ELECTRICAL AND SCIENTIFIC APPARATUS

FOR MOTION PICTURE FILMS FEATURING COMEDY, DRAMA, ACTION, ADVENTURE, AND ANIMATION, AND DIGITAL VERSATILE AND OTHER DISCS FEATURING MUSIC, COMEDY, DRAMA, ACTION, ADVENTURE, AND ANIMATION; GAME SOFTWARE ON CD ROM; VIDEO AND COMPUTER GAME PROGRAMS; VIDEO GAME CARTRIDGES AND CASSETTES; ELECTRONIC HAND-HELD GAME UNIT FOR USE WITH EXTERNAL DISPLAY SCREEN OR MONITOR (U.S. CLS. 21, 23, 26, 36 AND 38).

FIRST USE 5-17-2012; IN COMMERCE 5-17-2012.

CLASS 14—JEWELRY

FOR CLOCKS; WATCHES; JEWELRY, NAMELY, BRACELETS, BROOCHES, EARRINGS, LAPEL PINS, NECKLACES, ORNAMENTAL PINS, PENDANTS, AND RINGS (U.S. CLS. 2, 27, 28 AND 50).

FIRST USE 5-17-2012; IN COMMERCE 5-17-2012.

CLASS 25—CLOTHING

FOR CLOTHING FOR MEN, WOMEN, AND CHILDREN, NAMELY, SHIRTS, T-SHIRTS, SWEATSHIRTS, TROUSERS, PANTS, SHORTS, TANK TOPS, RAINWEAR, SKIRTS, BLOUSES, DRESSES, SWEATERS, JACKETS, COATS, RAINCOATS, TIES, ROBES, HATS, CAPS, SUNVISORS, BELTS, SCARVES, SLEEPWEAR, PAJAMAS, LINGERIE, UNDERWEAR, SHOES, SNEAKERS, SANDALS, AND MASQUERADE AND HALLOWEEN COSTUMES AND MASKS SOLD IN CONNECTION THEREWITH (U.S. CLS. 22 AND 39).

FIRST USE 5-17-2012; IN COMMERCE 5-17-2012.

CLASS 28—TOYS AND SPORTING GOODS

FOR TOYS AND SPORTING GOODS INCLUDING GAMES AND PLAYTHINGS, NAMELY, ACTION FIGURES AND ACCESSORIES THEREFOR, PLUSH TOYS, TOY VEHICLES, DOLLS, ELECTRONIC HAND-HELD GAME UNIT OTHER THAN THOSE ADAPTED FOR USE WITH AN EXTERNAL DISPLAY SCREEN OR MONITOR, GAME EQUIPMENT SOLD AS A UNIT FOR PLAYING A BOARD GAME, A CARD GAME, A MANIPULATIVE GAME, A PARLOR GAME, AND AN ACTION TYPE TARGET GAME, JIGSAW AND MANIPULATIVE PUZZLES (U.S. CLS. 22, 23, 38 AND 50).

FIRST USE 5-17-2012; IN COMMERCE 5-17-2012.

4,165,245. STERLING PUBLISHING CO., INC., NEW YORK, NY. SN 85-143,497. PUB. 4-5-2011, FILED 10-1-2010.

SPLINTER

THE MARK CONSISTS OF THE TERM "SPLINTER" WITH THE IMAGE OF A SPLINTER RUNNING THROUGH THE LETTERS.

CLASS 9—ELECTRICAL AND SCIENTIFIC APPARATUS

FOR ELECTRONIC DOWNLOADABLE PUBLICATIONS, NAMELY, BOOKS AND PAMPHLETS FEATURING WORKS OF FICTION, BIOGRAPHICAL STORIES, AND POETRY FOR USE PRIMARILY BY TEENS AND YOUNG ADULTS (U.S. CLS. 21, 23, 26, 36 AND 38).

FIRST USE 1-31-2011; IN COMMERCE 1-31-2011.

CLASS 16—PAPER GOODS AND PRINTED MATTER

FOR PRINTED MATTER, NAMELY, BOOKS AND PAMPHLETS FEATURING WORKS OF FICTION, BIOGRAPHICAL STORIES, AND POETRY FOR USE PRIMARILY BY TEENS AND YOUNG ADULTS (U.S. CLS. 2, 5, 22, 23, 29, 37, 38 AND 50).

FIRST USE 1-31-2011; IN COMMERCE 1-31-2011.

CLASS 41—EDUCATION AND ENTERTAINMENT

FOR BOOK PUBLISHING SERVICES; ONLINE ELECTRONIC PUBLISHING OF BOOKS (U.S. CLS. 100, 101 AND 107).

FIRST USE 1-31-2011; IN COMMERCE 1-31-2011.

4,165,246. PROX13 PRODUCTIONS STUDIO LLC, HONOLULU, HI. SN 85-143,584. PUB. 3-22-2011, FILED 10-1-2010.



THE MARK CONSISTS OF THE PHRASE "END OF AN EMPIRE" PLACED BETWEEN TWO OPPOSING LINES, AND CHARACTERS OF A FICTIONAL LANGUAGE PLACED BETWEEN THE LINES AND ABOVE AND BELOW THE PHRASE.

CLASS 9—ELECTRICAL AND SCIENTIFIC APPARATUS

FOR MOTION PICTURE FILMS FEATURING COMEDY, DRAMA, ACTION, ADVENTURE, AND ANIMATION, AND DIGITAL VERSATILE AND OTHER DISCS FEATURING MUSIC, COMEDY, DRAMA, ACTION, ADVENTURE, AND ANIMATION; GAME SOFTWARE ON CD ROM; VIDEO AND COMPUTER GAME PROGRAMS; VIDEO GAME CARTRIDGES AND CASSETTES; ELECTRONIC HAND-HELD GAME UNIT FOR USE WITH EXTERNAL DISPLAY SCREEN OR MONITOR (U.S. CLS. 21, 23, 26, 36 AND 38).

FIRST USE 5-17-2012; IN COMMERCE 5-17-2012.

CLASS 14—JEWELRY

FOR CLOCKS; WATCHES; JEWELRY, NAMELY, BRACELETS, BROOCHES, EARRINGS, LAPEL PINS, NECKLACES, ORNAMENTAL PINS, PENDANTS, AND RINGS (U.S. CLS. 2, 27, 28 AND 50).

FIRST USE 5-17-2012; IN COMMERCE 5-17-2012.

CLASS 25—CLOTHING

FOR CLOTHING FOR MEN, WOMEN, AND CHILDREN, NAMELY, SHIRTS, T-SHIRTS, SWEATSHIRTS, TROUSERS, PANTS, SHORTS, TANK TOPS, RAINWEAR, SKIRTS, BLOUSES, DRESSES, SWEATERS, JACKETS, COATS, RAINCOATS, TIES, ROBES, HATS, CAPS, SUNVISORS, BELTS, SCARVES, SLEEPWEAR, PAJAMAS, LINGERIE, UNDERWEAR, SHOES, SNEAKERS, SANDALS, AND MASQUERADE AND HALLOWEEN COSTUMES AND MASKS SOLD IN CONNECTION THEREWITH (U.S. CLS. 22 AND 39).

FIRST USE 5-17-2012; IN COMMERCE 5-17-2012.

CLASS 28—TOYS AND SPORTING GOODS

FOR TOYS AND SPORTING GOODS INCLUDING GAMES AND PLAYTHINGS, NAMELY, ACTION FIGURES AND ACCESSORIES THEREFOR, PLUSH TOYS, TOY VEHICLES, DOLLS, ELECTRONIC HAND-HELD GAME UNIT OTHER THAN THOSE ADAPTED FOR USE WITH AN EXTERNAL DISPLAY SCREEN OR MONITOR, GAME EQUIPMENT SOLD AS A UNIT FOR PLAYING A BOARD GAME, A CARD GAME, A MANIPULATIVE GAME, A PARLOR GAME, AND AN ACTION TYPE TARGET GAME, JIGSAW AND MANIPULATIVE PUZZLES (U.S. CLS. 22, 23, 38 AND 50).

FIRST USE 5-17-2012; IN COMMERCE 5-17-2012.

4,165,248. BWF TEXTIL GMBH & CO. KG, OFFINGEN, FED REP GERMANY. SN 85-145,448. PUB. 8-23-2011, FILED 10-5-2010.

BWF ENVIROTEC

THE MARK CONSISTS OF STANDARD CHARACTERS WITHOUT CLAIM TO ANY PARTICULAR FONT, STYLE, SIZE, OR COLOR.

CLASS 7—MACHINERY

FOR MACHINE PARTS, NAMELY, INDUSTRIAL DUST COLLECTION BAGS, DUST COLLECTOR BAG CAGES, LIQUID FILTER CLOTHS, BELTS AND DUST COLLECTOR BAG CARTRIDGES; AND REPLACEMENT PARTS AND FITTINGS FOR THE FOREGOING GOODS (U.S. CLS. 13, 19, 21, 23, 31, 34 AND 35).

FIRST USE 6-17-2011; IN COMMERCE 6-17-2011.

CLASS 41—EDUCATION AND ENTERTAINMENT

FOR EDUCATIONAL SERVICES, NAMELY, PROVIDING HEALTH AND SAFETY TRAINING IN THE INSTALLATION, OPERATION AND TROUBLESHOOTING OF INDUSTRIAL DUST COLLECTION BAGS (U.S. CLS. 100, 101 AND 107).

FIRST USE 6-17-2011; IN COMMERCE 6-17-2011.

CLASS 42—SCIENTIFIC AND COMPUTER SERVICES

FOR INSPECTION OF INDUSTRIAL DUST COLLECTION BAGS AND MACHINERY USED IN CONNECTION THEREWITH (U.S. CLS. 100 AND 101).

FIRST USE 6-17-2011; IN COMMERCE 6-17-2011.

4,165,255. WEBMD LLC, NEW YORK, NY. SN 85-147,940. PUB. 6-14-2011, FILED 10-7-2010.

READY! SET! MOVE!

THE MARK CONSISTS OF STANDARD CHARACTERS WITHOUT CLAIM TO ANY PARTICULAR FONT, STYLE, SIZE, OR COLOR.

CLASS 41—EDUCATION AND ENTERTAINMENT

FOR ENTERTAINMENT SERVICES, NAMELY, PROVIDING ONLINE HEALTH INCENTIVE AWARD PROGRAM DESIGNED TO REWARD PROGRAM PARTICIPANTS WHO EXERCISE IN ORDER TO MOTIVATE PARTICIPANTS TO ACHIEVE FITNESS GOALS (U.S. CLS. 100, 101 AND 107).

FIRST USE 9-26-2011; IN COMMERCE 9-26-2011.

CLASS 42—SCIENTIFIC AND COMPUTER SERVICES

FOR COMPUTER SERVICES, NAMELY, CREATING AN ONLINE WELLNESS COMMUNITY AND HOSTING AN ONLINE COMMUNITY WEBSITE RELATED TO WELLNESS FOR REGISTERED USERS TO PARTICIPATE IN FITNESS COMPETITIONS, FORM VIRTUAL COMMUNITIES, ENGAGE IN SOCIAL NETWORKING, CUSTOMIZE PERSONAL AND TEAM FITNESS PROFILES, ACCESS STATISTICS AND REAL TIME STANDINGS, COMPLETE FITNESS ASSESSMENTS AND EVALUATIONS AND REVIEW FITNESS INFORMATION (U.S. CLS. 100 AND 101).

FIRST USE 9-26-2011; IN COMMERCE 9-26-2011.

4,165,268. RSI HOME PRODUCTS MANAGEMENT, INC., ANAHEIM, CA. SN 85-152,689. PUB. 8-23-2011, FILED 10-14-2010.

CONTINENTAL CABINETS

THE MARK CONSISTS OF STANDARD CHARACTERS WITHOUT CLAIM TO ANY PARTICULAR FONT, STYLE, SIZE, OR COLOR.

OWNER OF U.S. REG. NO. 1,664,930.

NO CLAIM IS MADE TO THE EXCLUSIVE RIGHT TO USE "CABINETS", APART FROM THE MARK AS SHOWN.

CLASS 11—ENVIRONMENTAL CONTROL APPARATUS

FOR SINKS; BATHROOM VANITY TOPS AND SINK BOWL UNITS (U.S. CLS. 13, 21, 23, 31 AND 34).

FIRST USE 6-0-1987; IN COMMERCE 6-0-1987.

CLASS 20—FURNITURE AND ARTICLES NOT OTHERWISE CLASSIFIED

FOR CABINETS, INCLUDING KITCHEN CABINETS, CLOSET CABINETS, BATHROOM CABINETS, MEDICINE CABINETS, MIRRORED CABINETS, GARAGE CABINETS, AND STORAGE CABINETS; BATHROOM VANITIES; FURNITURE MIRRORS; FURNITURE PARTS; STORAGE AND ORGANIZATION SYSTEMS COMPRISING SHELVES, DRAWERS, CUPBOARDS, BASKETS AND CLOTHES RODS, SOLD AS A UNIT; STORAGE ACCESSORIES, NAMELY, NON-METAL FIXTURES COMPRISING SUPPORT ARMS FOR HANGING GENERAL HOUSEHOLD GOODS, NAMELY, BARS FOR HANGING CLOTHES, CLOTHES RODS, STORAGE RACKS AND SLIDING CLOTHES RAILS; CLOTHES HANGERS, STORAGE RACKS, SHOE RACKS, BELT RACKS AND TIE RACKS; GARAGE STORAGE RACKS FOR GENERAL USE AND GARAGE SHELVING; WORK BENCHES; WALL-MOUNTED TOOL RACKS (U.S. CLS. 2, 13, 22, 25, 32 AND 50).

FIRST USE 6-0-1987; IN COMMERCE 6-0-1987.

4,165,269. RSI HOME PRODUCTS MANAGEMENT, INC., ANAHEIM, CA. SN 85-152,696. PUB. 8-23-2011, FILED 10-14-2010.

**CONTINENTAL
CABINETS** 

OWNER OF U.S. REG. NO. 1,664,930.

NO CLAIM IS MADE TO THE EXCLUSIVE RIGHT TO USE "CABINETS", APART FROM THE MARK AS SHOWN.

THE MARK CONSISTS OF THE WORDS "CONTINENTAL CABINETS" AND WAVY LINES RESEMBLING A FLAG.

CLASS 11—ENVIRONMENTAL CONTROL APPARATUS

FOR SINKS; BATHROOM VANITY TOPS AND SINK BOWL UNITS (U.S. CLS. 13, 21, 23, 31 AND 34).

FIRST USE 6-0-1987; IN COMMERCE 6-0-1987.

CLASS 20—FURNITURE AND ARTICLES NOT OTHERWISE CLASSIFIED

FOR CABINETS, INCLUDING KITCHEN CABINETS, CLOSET CABINETS, BATHROOM CABINETS, MEDICINE CABINETS, MIRRORED CABINETS, GARAGE CABINETS, AND STORAGE CABINETS; BATHROOM VANITIES; FURNITURE MIRRORS; FURNITURE PARTS; STORAGE AND ORGANIZATION SYSTEMS COMPRISING SHELVES, DRAWERS, CUPBOARDS, BASKETS AND CLOTHES RODS, SOLD AS A UNIT; STORAGE ACCESSORIES, NAMELY, NON-METAL FIXTURES COMPRISING SUPPORT ARMS FOR HANGING GENERAL HOUSEHOLD GOODS, NAMELY, BARS FOR HANGING CLOTHES, CLOTHES RODS, STORAGE RACKS AND SLIDING CLOTHES RAILS; CLOTHES HANGERS, STORAGE RACKS, SHOE RACKS, BELT RACKS AND TIE RACKS; GARAGE STORAGE RACKS FOR GENERAL USE AND GARAGE SHELVING; WORK BENCHES; WALL-MOUNTED TOOL RACKS (U.S. CLS. 2, 13, 22, 25, 32 AND 50).

FIRST USE 6-0-1987; IN COMMERCE 6-0-1987.

4,165,272. BRISTOL-MYERS SQUIBB COMPANY, NEW YORK, NY. SN 85-155,051. PUB. 8-16-2011, FILED 10-18-2010.

Together  *Diabetes*

NO CLAIM IS MADE TO THE EXCLUSIVE RIGHT TO USE "DIABETES", APART FROM THE MARK AS SHOWN.

THE MARK CONSISTS OF THE WORDS "TOGETHER ON DIABETES", A MAP OF THE UNITED STATES AND A SUNBURST DESIGN CONTAINED IN THE LETTER "O".

CLASS 16—PAPER GOODS AND PRINTED MATTER

FOR PRINTED MATERIALS, NAMELY, BOOKLETS, BROCHURES, PAMPHLETS AND NEWSLETTERS REGARDING DIABETES (U.S. CLS. 2, 5, 22, 23, 29, 37, 38 AND 50).

FIRST USE 11-30-2010; IN COMMERCE 11-30-2010.

CLASS 41—EDUCATION AND ENTERTAINMENT

FOR EDUCATIONAL SERVICES, NAMELY, CONDUCTING CLASSES, SEMINARS, CONFERENCES AND WORKSHOPS REGARDING DIABETES (U.S. CLS. 100, 101 AND 107).

FIRST USE 11-30-2010; IN COMMERCE 11-30-2010.

4,165,281. NSF INTERNATIONAL, ANN ARBOR, MI. SN 85-158,863. PUB. 8-2-2011, FILED 10-22-2010.



OWNER OF U.S. REG. NOS. 1,139,117, 2,727,760, AND OTHERS.

THE COLOR(S) BLUE, WHITE AND GOLD IS/ARE CLAIMED AS A FEATURE OF THE MARK.

THE MARK CONSISTS OF THE LETTERS "NSF" IN WHITE INSIDE A BLUE CIRCLE, PRECEDING THE LETTERS "DBA" IN GOLD IN STYLIZED LETTERING.

CLASS 41—EDUCATION AND ENTERTAINMENT

FOR EDUCATIONAL AND TRAINING SERVICES, NAMELY, CONDUCTING AND PROVIDING IN-HOUSE TRAINING COURSES, RESIDENTIAL COURSES, AND RESIDENTIAL TRAINING COURSES IN THE FIELD OF PHARMACEUTICAL AND MEDICAL DEVICE DEVELOPMENT (U.S. CLS. 100, 101 AND 107).

FIRST USE 12-0-2010; IN COMMERCE 3-1-2011.

CLASS 42—SCIENTIFIC AND COMPUTER SERVICES

FOR PHARMACEUTICAL RESEARCH CONSULTANCY SERVICES; RESEARCH CONSULTANCY SERVICES FOR THE PHARMACEUTICAL INDUSTRY AND MEDICAL DEVICES DEVELOPMENT INDUSTRY; CONSULTANCY CONCERNING DESIGN AND DEVELOPMENT OF MEDICAL DEVICES; WATER SYSTEM QUALIFICATION AND VALIDATION CONSULTANCY, NAMELY, WATER QUALITY CONTROL SERVICES; TECHNICAL CONSULTING IN THE FIELD OF DESIGN AND DEVELOPMENT OF MEDICAL DEVICES; QUALITY MANAGEMENT SERVICES, NAMELY, QUALITY EVALUATION AND ANALYSIS, QUALITY ASSURANCE, AND QUALITY CONTROL IN THE FIELD OF PHARMACEUTICAL AND MEDICAL DEVICE DEVELOPMENT (U.S. CLS. 100 AND 101).

FIRST USE 12-0-2010; IN COMMERCE 3-1-2011.

CLASS 45—PERSONAL AND LEGAL SERVICES

FOR CONSULTING SERVICES RELATING TO REGULATORY COMPLIANCE IN THE PHARMACEUTICAL AND MEDICAL DEVICES INDUSTRY; CONSULTING SERVICES RELATING TO COMPLIANCE WITH INTERNATIONAL AND FEDERAL REGULATIONS CONCERNING THE PHARMACEUTICAL INDUSTRY AND THE MEDICAL DEVICES INDUSTRIES; CONSULTING IN THE FIELD OF MEDICAL EQUIPMENT REGULATORY COMPLIANCE; CONSULTANCY CONCERNING MEETING OF REGULATORY REQUIREMENTS IN THE FIELD OF PHARMACEUTICAL AND MEDICAL DEVICE DEVELOPMENT; REGULATORY COMPLIANCE CONSULTING IN THE FIELD OF NON-TOXIC MATERIALS USED IN THE MANUFACTURE OF COMPUTERS AND STERILIZING EQUIPMENT FOR THE MEDICAL INDUSTRY; REGULATORY COMPLIANCE CONSULTANCY IN THE FIELD OF PHARMACEUTICALS AND MEDICAL DEVICES DEVELOPMENT; CONSULTANCY CONCERNING REGULATORY COMPLIANCE OF DESIGNS OF NEW AND UPGRADED PHARMACEUTICAL AND MEDICAL DEVICE MANUFACTURING FACILITIES; CONSULTANCY CONCERNING PREPARATIONS FOR REGULATORY COMPLIANCE INSPECTIONS OF PHARMACEUTICAL AND MEDICAL DEVICE MANUFACTURING FACILITIES; CONSULTANCY CONCERNING PREPARATIONS TO RESPONSES TO SPECIAL REQUESTS FROM REGULATORY AUTHORITIES FOR REGULATORY COMPLIANCE IN THE FIELD OF PHARMACEUTICAL AND MEDICAL DEVICE DEVELOPMENT; CONSULTANCY CONCERNING REGULATORY COMPLIANCE IN THE FIELD OF MANUFACTURING PHARMACEUTICALS AND MEDICAL DEVICES (U.S. CLS. 100 AND 101).

FIRST USE 12-0-2010; IN COMMERCE 3-1-2011.

4,165,286. PAULIST EVANGELIZATION MINISTRIES, WASHINGTON, DC. SN 85-161,596. PUB. 1-3-2012, FILED 10-26-2010.



NO CLAIM IS MADE TO THE EXCLUSIVE RIGHT TO USE "EUCHARIST", APART FROM THE MARK AS SHOWN.

THE MARK CONSISTS OF A CHALICE AND HOST DESIGN ELEMENT WITH THE PHRASE "LIVING THE EUCHARIST" IN SCRIPT APPEARING TO THE LEFT OF THE DESIGN ELEMENT.

CLASS 9—ELECTRICAL AND SCIENTIFIC APPARATUS

FOR DVDS IN THE FIELD OF RELIGION (U.S. CLS. 21, 23, 26, 36 AND 38).

FIRST USE 8-31-2011; IN COMMERCE 8-31-2011.

CLASS 16—PAPER GOODS AND PRINTED MATTER

FOR JOURNALS, BOOKLETS, GUIDES, PRAYER CARDS, BROCHURES, POSTERS AND MANUALS ALL IN THE FIELD OF RELIGION (U.S. CLS. 2, 5, 22, 23, 29, 37, 38 AND 50).

FIRST USE 8-31-2011; IN COMMERCE 8-31-2011.

CLASS 41—EDUCATION AND ENTERTAINMENT

FOR EDUCATIONAL SERVICES, NAMELY, WORKSHOPS AND SEMINARS IN THE FIELD OF RELIGION (U.S. CLS. 100, 101 AND 107).

FIRST USE 6-30-2011; IN COMMERCE 6-30-2011.

4,165,287. THE ECHO SYSTEM CORP., NEW YORK, NY. SN 85-161,708. PUB. 4-12-2011, FILED 10-26-2010.

THE ECHO SYSTEM

THE MARK CONSISTS OF STANDARD CHARACTERS WITHOUT CLAIM TO ANY PARTICULAR FONT, STYLE, SIZE, OR COLOR.

NO CLAIM IS MADE TO THE EXCLUSIVE RIGHT TO USE "SYSTEM", APART FROM THE MARK AS SHOWN.

CLASS 35—ADVERTISING AND BUSINESS

FOR PROMOTING THE GOODS AND SERVICES OF OTHERS BY PROVIDING A WEBSITE FEATURING A SELF-SERVICE BUSINESS E-COMMERCE PLATFORM ENABLING CONSUMERS AND MARKETERS TO PROMOTE GOODS AND SERVICES THROUGH THE USE OF DISCOUNT INFORMATION, COUPONS, REBATES, PRODUCT REVIEWS AND LINKS TO RETAIL WEBSITES (U.S. CLS. 100, 101 AND 102).

FIRST USE 9-30-2010; IN COMMERCE 9-30-2010.

CLASS 42—SCIENTIFIC AND COMPUTER SERVICES

FOR SOFTWARE APPLICATION SERVICE PROVIDER FEATURING SOFTWARE FOR USE IN ENABLING MARKETERS AND CONSUMERS TO PROMOTE GOODS AND SERVICES OVER THE INTERNET, OR OTHER COMMUNICATIONS NETWORK, THROUGH A SELF-SERVICE, SOCIAL COMMERCE PLATFORM FEATURING DISCOUNT INFORMATION, COUPONS, REBATES, PRODUCT REVIEWS AND LINKS TO RETAIL WEBSITES (U.S. CLS. 100 AND 101).

FIRST USE 9-30-2010; IN COMMERCE 9-30-2010.

4,165,292. PSC, LLC, HOUSTON, TX. SN 85-163,287. PUB. 4-19-2011, FILED 10-28-2010.

PROVIDING TOMORROW'S SOLUTIONS TODAY

THE MARK CONSISTS OF STANDARD CHARACTERS WITHOUT CLAIM TO ANY PARTICULAR FONT, STYLE, SIZE, OR COLOR.

CLASS 37—CONSTRUCTION AND REPAIR

FOR ENVIRONMENTAL REMEDIATION SERVICES, NAMELY, COLLECTING AND DISPOSING OF INDUSTRIAL BY-PRODUCT STREAMS, AND WASTE DISPOSAL FOR OTHERS (U.S. CLS. 100, 103 AND 106).

FIRST USE 1-20-2011; IN COMMERCE 1-20-2011.

CLASS 40—MATERIAL TREATMENT

FOR RECYCLING OF WASTES AND INDUSTRIAL TOXIC WASTE DISPOSAL; WASTE MANAGEMENT AND WASTE TREATMENT SERVICES IN THE FIELDS OF CHEMICAL CLEANING, OIL TANK CLEANING, HEALTHCARE AND PHARMACEUTICAL, RETAIL ENVIRONMENTAL, AND HOUSEHOLD HAZARDOUS WASTE SERVICES (U.S. CLS. 100, 103 AND 106).

FIRST USE 1-20-2011; IN COMMERCE 1-20-2011.

4,165,325. ANTEA USA, INC., SHOREVIEW, MN. SN 85-179,788. PUB. 8-23-2011, FILED 11-18-2010.



THE COLOR(S) SHADES OF TEAL (BLUE-GREEN) IS/ ARE CLAIMED AS A FEATURE OF THE MARK.

THE MARK CONSISTS OF THREE CIRCULAR SHAPES EACH IN DIFFERENT SIZES AND DIFFERENT SHADES OF TEAL ONE IS SOLID THE OTHER TWO ARE RINGS.

CLASS 35—ADVERTISING AND BUSINESS

FOR ADVERTISING AND BUSINESS MANAGEMENT CONSULTING; COMMERCIAL BUSINESS MANAGEMENT; BUSINESS ADMINISTRATION AND OFFICE FUNCTIONS; MARKET RESEARCH; MARKET ANALYSIS; BUSINESS CONSULTING IN THE FIELD OF ENVIRONMENTAL MANAGEMENT, NAMELY, ADVISING BUSINESSES ON ISSUES OF ENVIRONMENTAL IMPACT, CONSERVATION, PRESERVATION AND PROTECTION, AND ECONOMIC ANALYSIS FOR BUSINESS PURPOSES (U.S. CLS. 100, 101 AND 102).

FIRST USE 1-5-2011; IN COMMERCE 1-5-2011.

CLASS 40—MATERIAL TREATMENT

FOR ENVIRONMENTAL REMEDIATION SERVICES, NAMELY, SOIL, WASTE AND/OR WATER TREATMENT SERVICES; HAZARDOUS WASTE MANAGEMENT; TREATMENT OF WASTE MATERIALS IN SOLID AND LIQUID FORMS; TREATMENT OF SOIL, SAND AND MATERIALS RESEMBLING SOIL; TREATMENT OF MATERIALS, NAMELY, EFFECTING SOIL INJECTIONS IN ORDER TO MAKE THE SOIL WATER RESISTANT OR TO HARDEN THE SOIL CONSTRUCTIVELY; ENVIRONMENTAL REMEDIATION SERVICES BY AN INJECTION COMPANY SPECIALIZED IN SOIL INJECTION TECHNIQUES, NAMELY, HORIZONTAL SOIL INJECTIONS, CONSTRUCTIVE SOIL INJECTIONS, GROUTED AND DAMMING INJECTIONS, INJECTIONS OF PROPERTY WITH DAMP LEAKAGES, BELOW GROUND LEVEL; TREATMENT OF MATERIALS FOR THE PURPOSE OF SOIL SANITATION AND SOIL DECONTAMINATION; ENVIRONMENTAL REMEDIATION CONSULTING SERVICES IN THE FIELD OF SOIL, AIR, WASTE AND WATER TREATMENT; SERVICES IN THE FIELD OF PROCESSING AND TREATMENT OF STEEL; PROCESSING, TREATMENT AND RECYCLING OF MINERAL AND ORGANIC SUBSTANCES, OF MATERIALS AND WASTE MATERIALS INTO SOLID OR LIQUID FERTILIZERS AND MIXTURES; OVERSIGHT MANAGEMENT OF HAZARDOUS AND NON-HAZARDOUS WASTES (U.S. CLS. 100, 103 AND 106).

FIRST USE 1-5-2011; IN COMMERCE 1-5-2011.

CLASS 41—EDUCATION AND ENTERTAINMENT

FOR DEVELOPMENT OF HEALTH AND SAFETY TRAINING PROGRAMS FOR OTHERS (U.S. CLS. 100, 101 AND 107).

FIRST USE 1-5-2011; IN COMMERCE 1-5-2011.

CLASS 42—SCIENTIFIC AND COMPUTER SERVICES

FOR CONSULTING SERVICES IN THE FIELD OF ENVIRONMENTAL ASSESSMENT AND PLANNING; ENGINEERING AND SURVEYOR SERVICES FOR BUILDING AND PROPERTY CONDITION ASSESSMENT; COMPUTER PROGRAMMING FOR ELECTRONIC DATA PROCESSING; DRAWING UP EXPERT REPORTS BY ENGINEERS AND LABORATORY TECHNICIANS; TECHNICAL CONSULTATION IN THE FIELD OF ENVIRONMENTAL ENGINEERING; SOIL ANALYSIS; PHOTOGRAMMETRY; PHOTOGRAMMETRIC MAP PRODUCTION; CONDUCTING AERIAL SURVEYS; PROVIDING INFORMATION IN THE FIELD OF GEOGRAPHY, NAMELY, IDENTIFICATION, ANALYSIS, AND INTERPRETATION OF THE DISTRIBUTION AND ARRANGEMENT OF LANDFORMS AND OTHER FEATURES OF THE EARTH'S SURFACE; SERVICES OF CHEMISTS, ENGINEERS, GEOGRAPHERS, NAMELY, MAPPING AND CARTOGRAPHY, ARCHITECTS AND LAND SURVEYORS; CONSULTING SERVICES RELATING TO HAZARDOUS MATERIALS MANAGEMENT; EVALUATION AND TESTING OF REAL ESTATE FOR THE PRESENCE OF HAZARDOUS MATERIAL; EVALUATING AND TESTING THE ENVIRONMENTAL QUALITIES AND IMPACT OF CONSUMER PRODUCTS FOR OTHERS; CONSULTING IN THE FIELD OF FACILITY WATER STEWARDSHIP, WATER MANAGEMENT AND IMPLEMENTATION OF WATER CONSERVATION PRACTICES; CONSULTING ON SOURCE WATER PROTECTION PROGRAMS; THIRD PARTY CERTIFICATION AUDITS, NAMELY, TESTING, ANALYSIS AND EVALUATION OF THIRD PARTY SERVICES FOR THE PURPOSE OF CERTIFICATION; ENVIRONMENTAL CONSULTING SERVICES, NAMELY, TECHNICAL CONSULTATION IN THE FIELD OF ENVIRONMENTAL ENGINEERING; ENVIRONMENTAL EVALUATION AND DUE DILIGENCE REVIEW FOR THE PRESENCE OF HAZARDOUS MATERIAL PRIOR TO PURCHASE AND SALE OF REAL ESTATE; DESIGN OF PETROLEUM HANDLING FACILITIES, AQUIFER RESTORATION SYSTEMS AND MINE DEWATERING SYSTEMS; DRAWING UP TECHNICAL EXPERT REPORTS IN THE FIELD OF SOIL SANITATION AND TREATMENT (U.S. CLS. 100 AND 101).

FIRST USE 1-5-2011; IN COMMERCE 1-5-2011.

CLASS 45—PERSONAL AND LEGAL SERVICES

FOR LOCAL REGIONAL AND GLOBAL REGULATORY COMPLIANCE CONSULTING IN THE FIELD OF ENVIRONMENTAL, HEALTH AND SAFETY; CONDUCTING ENVIRONMENTAL, HEALTH AND SAFETY COMPLIANCE AUDITS; AUDITING OF OCCUPATIONAL HEALTH AND SAFETY PROGRAMS; TECHNICAL CONSULTATION IN THE FIELD OF OCCUPATIONAL HEALTH AND SAFETY; ENVIRONMENTAL REGULATION COMPLIANCE CONSULTING, NAMELY, REVIEWING STANDARDS AND PRACTICES TO ASSURE COMPLIANCE WITH ENVIRONMENTAL AND OSHA LAWS AND REGULATIONS; PERMITTING, NAMELY, OBTAINING ENVIRONMENTAL, DESIGN, ZONING AND OTHER GOVERNMENTAL PERMITS FOR DEVELOPMENT PROJECTS (U.S. CLS. 100 AND 101).

FIRST USE 1-5-2011; IN COMMERCE 1-5-2011.

4,165,326. THE BUFFALO CITY CEMETERY, INC., BUFFALO, NY. SN 85-181,335. PUB. 8-30-2011, FILED 11-19-2010.



NO CLAIM IS MADE TO THE EXCLUSIVE RIGHT TO USE "CEMETERY", APART FROM THE MARK AS SHOWN.

THE MARK CONSISTS OF STYLIZED TREES BEARING LEAVES PLACED ON BOTH SIDES OF A PATHWAY EXTENDING FROM THE FOREGROUND INTO THE BACKGROUND, ALL PLACED ABOVE THE WORDS "LAKESIDE" AND "CEMETERY", WITH A HORIZONTAL LINE ON BOTH SIDES OF THE WORD "CEMETERY", AND ALL PLACED ABOVE THE SLOGAN "BEAUTIFUL. PEACEFUL. AFFORDABLE."

CLASS 44—MEDICAL, BEAUTY AND AGRICULTURAL SERVICES

FOR CEMETERY SERVICES, NAMELY, CEMETERY PLOT BEAUTIFICATION, MAINTENANCE, AND PERPETUAL CARE SERVICES FOR CEMETERY PLOTS, GRAVES, MAUSOLEUMS, CRYPTS AND NICHES (U.S. CLS. 100 AND 101).

FIRST USE 10-0-2011; IN COMMERCE 10-0-2011.

CLASS 45—PERSONAL AND LEGAL SERVICES

FOR CEMETERY SERVICES, NAMELY, PROVIDING GRAVE, PLOT, CRYPT AND NICHE CEMETERY SPACES; PROVIDING SERVICES CONSISTING OF INTERMENTS, BURIALS AND ENTOMBMENTS (U.S. CLS. 100 AND 101).

FIRST USE 9-0-2010; IN COMMERCE 9-0-2010.

4,165,327. SPICY SENSE INC, AKA SPICY SENSE INC, LOS ANGELES, CA. SN 85-181,725. PUB. 8-23-2011, FILED 11-19-2010.



THE COLOR(S) BROWN AND BLUE IS/ARE CLAIMED AS A FEATURE OF THE MARK.

THE MARK CONSISTS OF THE BLUE WORDS "MR. CHEF" WITH A BLUE CHEF'S HAT EMERGING FROM THE LETTER "C", WITH A BROWN LINE THROUGH THE MIDDLE AND EMERGING FROM THE SIDES OF THE HAT.

CLASS 29—MEATS AND PROCESSED FOODS

FOR CANNED FOOD, NAMELY, CANNED FRUITS AND CANNED VEGETABLES (U.S. CL. 46).
FIRST USE 3-1-2010; IN COMMERCE 3-1-2010.

CLASS 30—STAPLE FOODS

FOR RICE (U.S. CL. 46).
FIRST USE 3-1-2010; IN COMMERCE 3-1-2010.

4,165,328. EDGENET, INC., WAUKESHA, WI. SN 85-182,320.
PUB. 11-8-2011, FILED 11-22-2010.

EZEEDATA

THE MARK CONSISTS OF STANDARD CHARACTERS WITHOUT CLAIM TO ANY PARTICULAR FONT, STYLE, SIZE, OR COLOR.

CLASS 35—ADVERTISING AND BUSINESS

FOR COLLECTING RAW DATA RELATING TO THE PRODUCTS AND THE GOODS AND SERVICES OF OTHERS; COMPILING, CLASSIFYING AND ORGANIZING COLLECTED RAW DATA RELATING THE PRODUCTS AND THE GOODS AND SERVICES OF OTHERS IN ORDER TO CREATE ENRICHED DATA (U.S. CLS. 100, 101 AND 102).
FIRST USE 10-11-2010; IN COMMERCE 10-11-2010.

CLASS 45—PERSONAL AND LEGAL SERVICES

FOR LICENSING OF ENRICHED DATA ABOUT THE PRODUCTS AND GOODS AND SERVICES OF OTHERS TO THIRD PARTIES (U.S. CLS. 100 AND 101).
FIRST USE 9-2-2011; IN COMMERCE 9-2-2011.

4,165,329. EDGENET, INC., WAUKESHA, WI. SN 85-182,504.
PUB. 11-8-2011, FILED 11-22-2010.



THE MARK CONSISTS OF A STYLIZED LOWERCASE "E".

CLASS 35—ADVERTISING AND BUSINESS

FOR COLLECTING RAW DATA RELATING TO THE PRODUCTS AND THE GOODS AND SERVICES OF OTHERS; COMPILING, CLASSIFYING AND ORGANIZING COLLECTED RAW DATA RELATING THE PRODUCTS AND THE GOODS AND SERVICES OF OTHERS IN ORDER TO CREATE ENRICHED DATA (U.S. CLS. 100, 101 AND 102).
FIRST USE 10-11-2010; IN COMMERCE 10-11-2010.

CLASS 45—PERSONAL AND LEGAL SERVICES

FOR LICENSING OF ENRICHED DATA ABOUT THE PRODUCTS AND GOODS AND SERVICES OF OTHERS TO THIRD PARTIES (U.S. CLS. 100 AND 101).
FIRST USE 9-2-2011; IN COMMERCE 9-2-2011.

4,165,331. LOOKLAB INC., NEW YORK, NY. SN 85-183,240.
PUB. 10-4-2011, FILED 11-23-2010.

LOOKLAB

THE MARK CONSISTS OF STANDARD CHARACTERS WITHOUT CLAIM TO ANY PARTICULAR FONT, STYLE, SIZE, OR COLOR.

CLASS 35—ADVERTISING AND BUSINESS

FOR RETAIL STORE SERVICES FEATURING CLOTHING AND FASHION ACCESSORIES (U.S. CLS. 100, 101 AND 102).
FIRST USE 10-13-2011; IN COMMERCE 10-13-2011.

CLASS 42—SCIENTIFIC AND COMPUTER SERVICES

FOR CLOTHING AND FASHION DESIGN CONSULTING SERVICES; PROVIDING SEARCH ENGINES FOR THE INTERNET IN THE FIELDS OF CLOTHING AND FASHION; COMPUTER SERVICES, NAMELY, CREATING AN ONLINE COMMUNITY FOR USERS TO PARTICIPATE IN DISCUSSIONS, GET FEEDBACK AND FASHION SHOPPING SUGGESTIONS FROM INDUSTRY PROFESSIONALS AND THEIR PEERS, FORM VIRTUAL COMMUNITIES, AND ENGAGE IN SOCIAL NETWORKING FEATURING SOCIAL MEDIA PHOTOS, IMAGES, VIDEOS AND TOPICS OF FASHION AND GENERAL INTEREST TO SUCH USERS; PROVIDING TEMPORARY USE OF NONDOWNLOADABLE SOFTWARE FOR AGGREGATING AND INTEGRATING INFORMATION, IMAGES AND CONTENT FROM SOCIAL NETWORKS, PUBLICLY AVAILABLE SOURCES AND PERSONAL WEBSITES AND COMMUNICATIONS TO PROVIDE AND ENABLE USERS TO INTERACT WITH INFORMATION AND CONTENT ON TOPICS OF FASHION AND GENERAL INTEREST; PROVIDING TEMPORARY USE OF NONDOWNLOADABLE COMPUTER SOFTWARE THAT ENABLES USERS OF COMPUTERS AND MOBILE DEVICES TO ACCESS, AGGREGATE, ORGANIZE AND INTERACT WITH CONTENT, INFORMATION AND IMAGES FROM SOCIAL MEDIA WEBSITES, PUBLICLY AVAILABLE SOURCES, AND PERSONAL WEBSITES AND COMMUNICATIONS, AND PROVIDES DATA, INFORMATION AND UPDATES ON TOPICS OF FASHION AND GENERAL INTEREST TO MEMBERS OF AN ON-LINE COMMUNITY (U.S. CLS. 100 AND 101).
FIRST USE 10-13-2011; IN COMMERCE 10-13-2011.

CLASS 45—PERSONAL AND LEGAL SERVICES

FOR CLOTHING AND FASHION TREND CONSULTING SERVICES (U.S. CLS. 100 AND 101).
FIRST USE 10-13-2011; IN COMMERCE 10-13-2011.

4,165,346. NALCO COMPANY, NAPERVILLE, IL. SN 85-191,027. PUB. 1-10-2012, FILED 12-6-2010.

Water Intelligence Network

THE MARK CONSISTS OF STANDARD CHARACTERS WITHOUT CLAIM TO ANY PARTICULAR FONT, STYLE, SIZE, OR COLOR.

NO CLAIM IS MADE TO THE EXCLUSIVE RIGHT TO USE "WATER" AND "NETWORK", APART FROM THE MARK AS SHOWN.

CLASS 9—ELECTRICAL AND SCIENTIFIC APPARATUS

FOR REMOTE MONITORING EQUIPMENT IN THE NATURE OF ELECTRONIC APPARATUS FOR THE REMOTE CONTROL OF INDUSTRIAL OPERATIONS USED FOR PORTABLE DI EXCHANGE TANKS AND RO UNITS THAT SENDS INFORMATION TO AN ON-LINE DATA REPOSITORY FOR WATER SYSTEMS (U.S. CLS. 21, 23, 26, 36 AND 38).

FIRST USE 5-16-2011; IN COMMERCE 5-16-2011.

CLASS 42—SCIENTIFIC AND COMPUTER SERVICES

FOR REMOTE MONITORING SERVICE FOR WATER SYSTEMS APPARATUS, NAMELY, PORTABLE DI EXCHANGE TANKS AND RO UNITS (U.S. CLS. 100 AND 101).

FIRST USE 3-15-2011; IN COMMERCE 3-15-2011.

4,165,351. TERROR OF THE UNDERSTOOD RECORDS, LLC, NEW YORK, NY. SN 85-196,038. PUB. 4-26-2011, FILED 12-12-2010.

THE BLACK SOFT

THE MARK CONSISTS OF STANDARD CHARACTERS WITHOUT CLAIM TO ANY PARTICULAR FONT, STYLE, SIZE, OR COLOR.

CLASS 9—ELECTRICAL AND SCIENTIFIC APPARATUS

FOR AUDIO AND VIDEO RECORDINGS FEATURING MUSIC AND ARTISTIC PERFORMANCES; DIGITAL MUSIC DOWNLOADABLE FROM THE INTERNET; DOWNLOADABLE MUSICAL SOUND RECORDINGS; MUSICAL VIDEO RECORDINGS; SERIES OF MUSICAL SOUND RECORDINGS (U.S. CLS. 21, 23, 26, 36 AND 38).

FIRST USE 2-8-2011; IN COMMERCE 2-8-2011.

CLASS 41—EDUCATION AND ENTERTAINMENT

FOR ENTERTAINMENT IN THE NATURE OF VISUAL AND AUDIO PERFORMANCES BY A MUSICAL GROUP; ENTERTAINMENT SERVICES IN THE NATURE OF LIVE MUSICAL PERFORMANCES; ENTERTAINMENT SERVICES, NAMELY, PROVIDING A WEB SITE FEATURING NON-DOWNLOADABLE MUSICAL PERFORMANCES, MUSICAL VIDEOS, RELATED FILM CLIPS, PHOTOGRAPHS, AND OTHER MULTIMEDIA MATERIALS FEATURING MUSIC; ENTERTAINMENT SERVICES, NAMELY, PROVIDING NON-DOWNLOADABLE PLAYBACK OF MUSIC VIA GLOBAL COMMUNICATIONS NETWORKS (U.S. CLS. 100, 101 AND 107).

FIRST USE 2-8-2011; IN COMMERCE 2-8-2011.

4,165,354. WALGREEN CO., DEERFIELD, IL. SN 85-196,564. PUB. 8-30-2011, FILED 12-13-2010.

GOOD & DELISH

THE MARK CONSISTS OF STANDARD CHARACTERS WITHOUT CLAIM TO ANY PARTICULAR FONT, STYLE, SIZE, OR COLOR.

CLASS 29—MEATS AND PROCESSED FOODS

FOR YOGURTS; MEAT, FISH AND POULTRY; FRUIT, GARDEN AND VEGETABLE SALADS; DIPS; HUMMUS; POTATO SALAD; SOUPS (U.S. CL. 46).

FIRST USE 9-1-2010; IN COMMERCE 9-1-2010.

CLASS 30—STAPLE FOODS

FOR MACARONI AND CHEESE; PASTA; SANDWICHES; BROWNIES; SNACK CAKES; PACKAGED MEAL MIXES CONSISTING PRIMARILY OF PASTA OR RICE; PREPARED MEALS CONSISTING PRIMARILY OF PASTA OR RICE; OATMEAL (U.S. CL. 46).

FIRST USE 7-26-2010; IN COMMERCE 7-26-2010.

CLASS 31—NATURAL AGRICULTURAL PRODUCTS

FOR FRESH FRUITS AND VEGETABLES (U.S. CLS. 1 AND 46).

FIRST USE 9-10-2010; IN COMMERCE 9-1-2010.

4,165,355. WALGREEN CO., DEERFIELD, IL. SN 85-196,581. PUB. 8-30-2011, FILED 12-13-2010.



THE COLOR(S) RED, BLACK AND WHITE IS/ARE CLAIMED AS A FEATURE OF THE MARK.

THE MARK CONSISTS OF THE WORDING "DELISH" IN BLACK VERTICALLY SEPARATED BY RED CIRCLE WITH WHITE BORDER, CONTAINING THE WORDING "GOOD &" IN WHITE POSITIONED ABOVE AN AMPERSAND

CLASS 29—MEATS AND PROCESSED FOODS

FOR YOGURTS; MEAT, FISH AND POULTRY; FRUIT, GARDEN AND VEGETABLE SALADS; DIPS; HUMMUS; POTATO SALAD; SOUPS (U.S. CL. 46). FIRST USE 9-1-2010; IN COMMERCE 9-1-2010.

CLASS 30—STAPLE FOODS

FOR MACARONI AND CHEESE; PASTA; SANDWICHES; BROWNIES; SNACK CAKES; PACKAGED MEAL MIXES CONSISTING PRIMARILY OF PASTA OR RICE; PREPARED MEALS CONSISTING PRIMARILY OF PASTA OR RICE; OATMEAL (U.S. CL. 46). FIRST USE 7-26-2010; IN COMMERCE 7-26-2010.

CLASS 31—NATURAL AGRICULTURAL PRODUCTS

FOR FRESH FRUITS AND VEGETABLES (U.S. CLS. 1 AND 46). FIRST USE 9-1-2010; IN COMMERCE 9-1-2010.

4,165,357. OLCOTT, CARTER, MORRISTOWN, NJ. SN 85-198,785. PUB. 8-23-2011, FILED 12-15-2010.

9394

THE MARK CONSISTS OF STANDARD CHARACTERS WITHOUT CLAIM TO ANY PARTICULAR FONT, STYLE, SIZE, OR COLOR.

CLASS 25—CLOTHING

FOR APPAREL, NAMELY, ATHLETIC WEAR IN THE NATURE OF SHIRTS AND HOODED SWEATSHIRTS; BELTS; CLOTHING ACCESSORIES, NAMELY, HATS AND BANDANAS (U.S. CLS. 22 AND 39). FIRST USE 9-30-2011; IN COMMERCE 9-30-2011.

CLASS 26—FANCY GOODS

FOR BELT BUCKLES (U.S. CLS. 37, 39, 40, 42 AND 50). FIRST USE 9-30-2011; IN COMMERCE 9-30-2011.

4,165,361. OLCOTT, CARTER, MORRISTOWN, NJ. SN 85-200,760. PUB. 8-23-2011, FILED 12-17-2010.



THE MARK CONSISTS OF A STYLIZED SKULL OUTLINE WITH THE NUMBER "9394" APPEARING IN PLACE OF THE SKULL'S MOUTH.

CLASS 25—CLOTHING

FOR APPAREL, NAMELY, ATHLETIC WEAR IN THE NATURE OF SHIRTS AND HOODED SWEATSHIRTS; BELTS; CLOTHING ACCESSORIES, NAMELY, HATS AND BANDANAS (U.S. CLS. 22 AND 39). FIRST USE 9-30-2011; IN COMMERCE 9-30-2011.

CLASS 26—FANCY GOODS

FOR BELT BUCKLES (U.S. CLS. 37, 39, 40, 42 AND 50). FIRST USE 9-30-2011; IN COMMERCE 9-30-2011.

4,165,369. TASTI D-LITE LLC, FRANKLIN, TN. SN 85-203,877. PUB. 5-10-2011, FILED 12-22-2010.

start a Tasti habit.

THE MARK CONSISTS OF STANDARD CHARACTERS WITHOUT CLAIM TO ANY PARTICULAR FONT, STYLE, SIZE, OR COLOR.

OWNER OF U.S. REG. NOS. 1,525,999, 3,301,896, AND OTHERS.

CLASS 30—STAPLE FOODS

FOR FROZEN CONFECTIONS AND DESSERTS FOR CONSUMPTION ON OR OFF THE PREMISES (U.S. CL. 46). FIRST USE 1-0-2011; IN COMMERCE 1-0-2011.

CLASS 32—LIGHT BEVERAGES

FOR SMOOTHIES (U.S. CLS. 45, 46 AND 48). FIRST USE 1-0-2011; IN COMMERCE 1-0-2011.

CLASS 35—ADVERTISING AND BUSINESS

FOR RETAIL FROZEN CONFECTIONERY AND DESERT STORE SERVICES (U.S. CLS. 100, 101 AND 102).
FIRST USE 1-0-2011; IN COMMERCE 1-0-2011.

4,165,378. WARRIORS GROUP, LLC, FREDERICKSBURG, VA. SN 85-208,176. PUB. 8-16-2011, FILED 12-30-2010.

4,165,372. SAWLUZ CORPORATION, BOCA RATON, FL. SN 85-206,639. PUB. 6-14-2011, FILED 12-28-2010.

Sawluz

THE MARK CONSISTS OF STANDARD CHARACTERS WITHOUT CLAIM TO ANY PARTICULAR FONT, STYLE, SIZE, OR COLOR.

THE WORDING "SAWLUZ" HAS NO MEANING IN A FOREIGN LANGUAGE.

CLASS 38—COMMUNICATION

FOR ELECTRONIC DATA INTERCHANGE (EDI) SERVICES; PEER-TO-PEER NETWORK COMPUTER SERVICES, NAMELY, ELECTRONIC TRANSMISSION OF AUDIO, VIDEO AND OTHER DATA AND DOCUMENTS AMONG COMPUTERS (U.S. CLS. 100, 101 AND 104).

FIRST USE 1-2-1993; IN COMMERCE 11-12-2009.

CLASS 42—SCIENTIFIC AND COMPUTER SERVICES

FOR COMPUTER SERVICE, NAMELY, ACTING AS AN APPLICATION SERVICE PROVIDER IN THE FIELD OF INFORMATION MANAGEMENT TO HOST COMPUTER APPLICATION SOFTWARE FOR THE PURPOSE OF TRANSMITTING AND EXCHANGING DATA AMONG COMPANIES.; COMPUTER SERVICE, NAMELY, ACTING AS AN APPLICATION SERVICE PROVIDER IN THE FIELD OF KNOWLEDGE MANAGEMENT TO HOST COMPUTER APPLICATION SOFTWARE FOR SEARCHING AND RETRIEVING INFORMATION FROM DATABASES AND COMPUTER NETWORKS; COMPUTER SERVICE, NAMELY, ACTING AS AN APPLICATION SERVICE PROVIDER IN THE FIELD OF KNOWLEDGE MANAGEMENT TO HOST COMPUTER APPLICATION SOFTWARE FOR THE COLLECTION, EDITING, ORGANIZING, MODIFYING, BOOK MARKING, TRANSMISSION, STORAGE AND SHARING OF DATA AND INFORMATION; COMPUTER SERVICES, NAMELY, COMPUTER SYSTEM ADMINISTRATION FOR OTHERS; COMPUTER SERVICES, NAMELY, PROVIDING A WEB-BASED SYSTEM AND ONLINE PORTAL FOR CUSTOMERS TO REMOTELY MANAGE, ADMINISTER, MODIFY AND CONTROL THEIR END USER COMPUTER DEVICES, DATA AND SOFTWARE APPLICATIONS; COMPUTER SERVICES, NAMELY, PROVIDING AN INTERACTIVE WEB SITE THAT ALLOWS USERS TO COLLECT, STORE, MANAGE, DELIVER AND SHOWCASE ELECTRONIC AND PAPER-BASED CONTENT; COMPUTER SERVICES, NAMELY, REMOTE AND ON-SITE MANAGEMENT OF THE INFORMATION TECHNOLOGY (IT) CLOUD COMPUTING SYSTEMS OF OTHERS; COMPUTER SERVICES, NAMELY, REMOTE AND ON-SITE MANAGEMENT OF THE INFORMATION TECHNOLOGY (IT) SYSTEMS OF OTHERS; COMPUTER SERVICES, NAMELY, REMOTE MANAGEMENT OF COMPUTER APPLICATIONS FOR OTHERS; PROFESSIONAL COMPUTER SERVICES, NAMELY, NETWORK ANALYSIS, LAN/WAN DESIGN, WIRELESS ENGINEERING, VIRTUALIZATION AND COMPUTER PROJECT MANAGEMENT (U.S. CLS. 100 AND 101).

FIRST USE 1-2-1993; IN COMMERCE 11-12-2009.



THE COLOR(S) RED AND BLACK IS/ARE CLAIMED AS A FEATURE OF THE MARK.

THE MARK CONSISTS OF THE WORDS "WARRIORS-GUIDE" IN BLACK, BELOW TWO PARALLEL HORIZONTAL SWATHS OF RED PAINT LINES.

CLASS 16—PAPER GOODS AND PRINTED MATTER

FOR BOOKS, NAMELY, BOOKS RELATED TO LEADERSHIP DEVELOPMENT IN THE FIELD OF BUSINESS MANAGEMENT (U.S. CLS. 2, 5, 22, 23, 29, 37, 38 AND 50).
FIRST USE 5-1-2010; IN COMMERCE 5-1-2010.

CLASS 35—ADVERTISING AND BUSINESS

FOR CONSULTING SERVICES, NAMELY, CONSULTING IN THE FIELD OF BUSINESS DEVELOPMENT AND MANAGEMENT (U.S. CLS. 100, 101 AND 102).
FIRST USE 5-1-2010; IN COMMERCE 5-1-2010.

4,165,387. ALFRED BENESCH & COMPANY, CHICAGO, IL. SN 85-210,157. PUB. 12-20-2011, FILED 1-4-2011.



NO CLAIM IS MADE TO THE EXCLUSIVE RIGHT TO USE "ENGINEERS" AND "SCIENTISTS" AND "PLANNERS", APART FROM THE MARK AS SHOWN.

THE MARK CONSISTS OF THE WORD "BENESCH" TO THE RIGHT OF A STYLIZED DESIGN OF A GLOBE WITH TWO ARCS OVERLAYING IT, AND ABOVE THE WORDS AND DOTS "ENGINEERS · SCIENTISTS · PLANNERS".

CLASS 35—ADVERTISING AND BUSINESS

FOR CONSULTING IN THE FIELD OF VALUE ENGINEERING, NAMELY, COST ANALYSIS AND MANAGEMENT (U.S. CLS. 100, 101 AND 102).

FIRST USE 10-0-2010; IN COMMERCE 10-0-2010.

CLASS 42—SCIENTIFIC AND COMPUTER SERVICES

FOR ENGINEERING SERVICES, ENGINEERING SERVICES IN THE FIELD OF ENVIRONMENTAL COMPLIANCE, ENVIRONMENTAL SERVICES, NAMELY, TECHNICAL CONSULTATION IN THE FIELD OF ENVIRONMENTAL SCIENCE, ENGINEERING SERVICES AND DESIGN FOR OTHERS IN THE FIELD OF ENVIRONMENTAL SCIENCE; CONSULTING IN THE FIELDS OF ENGINEERING, CIVIL ENGINEERING, STRUCTURAL ENGINEERING, ENVIRONMENTAL ENGINEERING, BUILDING ENGINEERING, ARCHITECTURE, LAND USE PLANNING, SURVEYING, LANDSCAPE ARCHITECTURAL DESIGN, ENVIRONMENTAL SCIENCES, WATER QUALITY CONTROL, HYDRAULIC ENGINEERING, HYDROLOGIC ENGINEERING, TRAFFIC AND TRANSPORTATION ENGINEERING; GEOTECHNICAL SERVICES, NAMELY, CONSULTING IN THE FIELDS OF GEOTECHNICAL ENGINEERING AND OF SOILS AND CONSTRUCTION MATERIALS ENGINEERING; SCIENTIFIC CONSULTING IN THE FIELD OF HAZARDOUS MATERIALS MANAGEMENT; TECHNICAL CONSULTING IN THE FIELD OF GEOLOGY AND HYDROGEOLOGY; CONSULTING IN THE FIELD OF MATERIALS SAMPLING AND TESTING (U.S. CLS. 100 AND 101).

FIRST USE 10-0-2010; IN COMMERCE 10-0-2010.

4,165,388. KALOGIANNI, ALEXANDER, HUNTINGTON, NY. SN 85-210,793. PUB. 5-3-2011, FILED 1-5-2011.

AutoKinesis

THE MARK CONSISTS OF STANDARD CHARACTERS WITHOUT CLAIM TO ANY PARTICULAR FONT, STYLE, SIZE, OR COLOR.

CLASS 9—ELECTRICAL AND SCIENTIFIC APPARATUS

FOR ELECTRONIC PUBLICATIONS, NAMELY, MAGAZINE FEATURING AUTOMOTIVE NEWS AND CULTURE RECORDED ON COMPUTER MEDIA (U.S. CLS. 21, 23, 26, 36 AND 38).

FIRST USE 1-1-2008; IN COMMERCE 1-1-2008.

CLASS 41—EDUCATION AND ENTERTAINMENT

FOR PROVIDING ON-LINE MAGAZINES IN THE FIELD OF AUTOMOTIVE NEWS AND CULTURE (U.S. CLS. 100, 101 AND 107).

FIRST USE 1-1-2008; IN COMMERCE 1-1-2008.

4,165,392. PENSHURST TRADING INC., STAMFORD, CT. SN 85-213,431. PUB. 8-30-2011, FILED 1-8-2011.

JULISKA

THE MARK CONSISTS OF STANDARD CHARACTERS WITHOUT CLAIM TO ANY PARTICULAR FONT, STYLE, SIZE, OR COLOR.

OWNER OF U.S. REG. NO. 3,019,690.

CLASS 4—LUBRICANTS AND FUELS

FOR CANDLES (U.S. CLS. 1, 6 AND 15).
FIRST USE 6-0-2011; IN COMMERCE 6-0-2011.

CLASS 8—HAND TOOLS

FOR FLATWARE, NAMELY, FORKS, KNIVES, AND SPOONS; SPREADERS IN THE NATURE OF A SMALL KNIFE FOR BUTTER (U.S. CLS. 23, 28 AND 44).
FIRST USE 11-0-2003; IN COMMERCE 11-0-2003.

CLASS 11—ENVIRONMENTAL CONTROL APPARATUS

FOR LIGHTING FIXTURES, NAMELY, TABLE LAMPS, LAMP SHADES AND LAMP FINIALS (U.S. CLS. 13, 21, 23, 31 AND 34).
FIRST USE 10-0-2004; IN COMMERCE 10-0-2004.

CLASS 24—FABRICS

FOR TABLE LINENS, NAMELY, PLACE MATS, NAPKINS (U.S. CLS. 42 AND 50).
FIRST USE 4-0-2005; IN COMMERCE 4-0-2005.

4,165,396. BAYLOR HEALTH CARE SYSTEM, DALLAS, TX. SN 85-216,243. PUB. 8-9-2011, FILED 1-12-2011.

TOTAL RECREATION

THE MARK CONSISTS OF STANDARD CHARACTERS WITHOUT CLAIM TO ANY PARTICULAR FONT, STYLE, SIZE, OR COLOR.

NO CLAIM IS MADE TO THE EXCLUSIVE RIGHT TO USE "RECREATION", APART FROM THE MARK AS SHOWN.

CLASS 41—EDUCATION AND ENTERTAINMENT

FOR EDUCATIONAL SERVICES, NAMELY, TEACHER TRAINING IN THE FIELD OF COACHING PROVIDED ON A REAL-TIME BASIS DURING CLASSROOM INSTRUCTION; ENCOURAGING AMATEUR SPORTS AND PHYSICAL EDUCATION BY ORGANIZING, SANCTIONING, CONDUCTING, REGULATING AND GOVERNING AMATEUR SPORT AND LEISURE PROGRAMS AND ACTIVITIES; COMMUNITY OUTREACH SERVICES PROVIDED TO CHILDREN, TEENS, ADULTS AND SENIORS, NAMELY, PROVIDING INFORMATION, NEWS AND COMMENTARY IN THE FIELD OF PHYSICAL ACTIVITY AND LEISURE ACTIVITIES (U.S. CLS. 100, 101 AND 107).

FIRST USE 8-0-2011; IN COMMERCE 8-0-2011.

CLASS 44—MEDICAL, BEAUTY AND AGRICULTURAL SERVICES

FOR PROVIDING INFORMATION, NEWS AND COMMENTARY IN THE FIELD OF HEALTH AND WELLNESS (U.S. CLS. 100 AND 101).

FIRST USE 8-0-2011; IN COMMERCE 8-0-2011.

4,165,407. BAYLOR HEALTH CARE SYSTEM, DALLAS, TX. SN 85-220,887. PUB. 8-9-2011, FILED 1-19-2011.

MY HEALTH. YOUR
WELL-BEING. OUR COMMUNITY.

THE MARK CONSISTS OF STANDARD CHARACTERS WITHOUT CLAIM TO ANY PARTICULAR FONT, STYLE, SIZE, OR COLOR.

CLASS 41—EDUCATION AND ENTERTAINMENT

FOR EDUCATIONAL SERVICES, NAMELY, TEACHER TRAINING IN THE FIELD OF COACHING PROVIDED ON A REAL-TIME BASIS DURING CLASSROOM INSTRUCTION; ENCOURAGING AMATEUR SPORTS AND PHYSICAL EDUCATION BY ORGANIZING, SANCTIONING, CONDUCTING, REGULATING AND GOVERNING AMATEUR SPORT AND LEISURE PROGRAMS AND ACTIVITIES; COMMUNITY OUT-REACH SERVICES PROVIDED TO CHILDREN, TEENS, ADULTS AND SENIORS, NAMELY, PROVIDING INFORMATION, NEWS AND COMMENTARY IN THE FIELD OF PHYSICAL ACTIVITY AND LEISURE ACTIVITIES (U.S. CLS. 100, 101 AND 107).

FIRST USE 11-30-2009; IN COMMERCE 11-30-2009.

CLASS 44—MEDICAL, BEAUTY AND AGRICULTURAL SERVICES

FOR PROVIDING INFORMATION, NEWS AND COMMENTARY IN THE FIELD OF HEALTH AND WELLNESS (U.S. CLS. 100 AND 101).

FIRST USE 11-30-2009; IN COMMERCE 11-30-2009.

4,165,420. LESLIE D. CIBOROWSKI, DBA TRAINSMART-GLOBAL, INC., INVERNESS, IL. SN 85-229,404. PUB. 7-12-2011, FILED 1-29-2011.

TRAINSMARTGLOBAL

THE MARK CONSISTS OF STANDARD CHARACTERS WITHOUT CLAIM TO ANY PARTICULAR FONT, STYLE, SIZE, OR COLOR.

CLASS 16—PAPER GOODS AND PRINTED MATTER

FOR EDUCATIONAL PUBLICATIONS, NAMELY, PRINTED TRAINING MATERIALS IN THE FIELD OF BUSINESS (U.S. CLS. 2, 5, 22, 23, 29, 37, 38 AND 50).

FIRST USE 2-1-2011; IN COMMERCE 2-1-2011.

CLASS 41—EDUCATION AND ENTERTAINMENT

FOR BUSINESS EDUCATION AND TRAINING SERVICES, NAMELY, DEVELOPING, AND FACILITATING CUSTOMIZED IN-COMPANY LEADERSHIP AND EXECUTIVE DEVELOPMENT PROGRAMS, PROVIDING EXECUTIVE COACHING SERVICES, AND PROVIDING PUBLIC AND IN-COMPANY KEYNOTE PRESENTATIONS TO BUSINESS LEADERS (U.S. CLS. 100, 101 AND 107).

FIRST USE 2-1-2011; IN COMMERCE 2-1-2011.

4,165,437. ROSWELL PARK CANCER INSTITUTE CORPORATION, BUFFALO, NY. SN 85-242,868. PUB. 8-23-2011, FILED 2-15-2011.

Support for **Life**
THE CANCER SURVIVORS PROGRAM AT ROSWELL PARK

OWNER OF U.S. REG. NOS. 2,286,574, 3,775,222, AND OTHERS.

NO CLAIM IS MADE TO THE EXCLUSIVE RIGHT TO USE "CANCER SURVIVORS PROGRAM", APART FROM THE MARK AS SHOWN.

THE MARK CONSISTS OF THE WORDS "SUPPORT FOR LIFE" WITH THE WORDS "SUPPORT FOR" ABOVE A LINE AND THE LINE RUNNING INTO THE WORD "LIFE" AND UNDERNEATH ARE THE WORDS "THE CANCER SURVIVORS PROGRAM OF ROSWELL PARK".

CLASS 35—ADVERTISING AND BUSINESS

FOR PROMOTING PUBLIC AWARENESS AS TO THE CAUSES, TREATMENT AND PREVENTION OF ADULT AND PEDIATRIC CANCER (U.S. CLS. 100, 101 AND 102).

FIRST USE 11-30-2011; IN COMMERCE 11-30-2011.

CLASS 41—EDUCATION AND ENTERTAINMENT

FOR EDUCATIONAL SERVICES, NAMELY, WORKSHOPS AND SEMINARS ABOUT THE CAUSES AND TREATMENTS OF ADULT AND PEDIATRIC CANCER, PSYCHOSOCIAL ASPECTS OF THE EFFECTS OF ADULT AND PEDIATRIC CANCER IN SELF OR LOVED ONES AND DISTRIBUTION OF EDUCATIONAL AND COURSE MATERIALS IN CONNECTION THEREWITH (U.S. CLS. 100, 101 AND 107).

FIRST USE 11-30-2011; IN COMMERCE 11-30-2011.

4,165,438. FUSION LOGISTICS, INC., MIAMI, FL. SN 85-243,039. PUB. 7-19-2011, FILED 2-15-2011.

FUSION LOGISTICS

THE MARK CONSISTS OF STANDARD CHARACTERS WITHOUT CLAIM TO ANY PARTICULAR FONT, STYLE, SIZE, OR COLOR.

NO CLAIM IS MADE TO THE EXCLUSIVE RIGHT TO USE "LOGISTICS", APART FROM THE MARK AS SHOWN.

CLASS 35—ADVERTISING AND BUSINESS

FOR THIRD PARTY LOGISTICS SERVICES, NAMELY, ARRANGING THE TRANSPORTATION OF GOODS FOR OTHERS; BUSINESS MANAGEMENT SERVICES, NAMELY, MANAGING LOGISTICS, REVERSE LOGISTICS, SUPPLY CHAIN SERVICES, SUPPLY CHAIN VISIBILITY AND SYNCHRONIZATION, SUPPLY AND DEMAND FORECASTING AND PRODUCT DISTRIBUTION PROCESSES FOR OTHERS; BUSINESS CONSULTING SERVICES RELATING TO LOGISTICS, REVERSE LOGISTICS, SUPPLY CHAIN, AND PRODUCTION SYSTEMS AND DISTRIBUTION SOLUTIONS (U.S. CLS. 100, 101 AND 102).

FIRST USE 9-0-2011; IN COMMERCE 9-0-2011.

CLASS 39—TRANSPORTATION AND STORAGE

FOR BROKERAGE SERVICES, NAMELY, BROKERING AIR FREIGHT SHIPPING SERVICES, CARGO SHIP TRANSPORT SERVICES, AND PARCEL SHIPPING SERVICES (U.S. CLS. 100 AND 105).

FIRST USE 9-0-2011; IN COMMERCE 9-0-2011.

4,165,445. W.W. GRAINGER, INC., LAKE FOREST, IL. SN 85-245,423. PUB. 6-28-2011, FILED 2-17-2011.

WHAT EVERY WATER LAB NEEDS!

THE MARK CONSISTS OF STANDARD CHARACTERS WITHOUT CLAIM TO ANY PARTICULAR FONT, STYLE, SIZE, OR COLOR.

OWNER OF U.S. REG. NO. 2,895,948.

CLASS 16—PAPER GOODS AND PRINTED MATTER

FOR CATALOGS IN THE FIELD OF EQUIPMENT AND SUPPLIES FOR FORESTRY, SURVEYING AND MAPPING, HORTICULTURE, SCIENCE AND LABORATORY, CIVIL/LANDSCAPE ENGINEERING, WEATHER AND TEMPERATURE, WILDLIFE MANAGEMENT, SAFETY, ENVIRONMENTAL STUDIES AND EDUCATION, AND FOR PERSONAL, ENVIRONMENTAL AND LABORATORY SAFETY (U.S. CLS. 2, 5, 22, 23, 29, 37, 38 AND 50).

FIRST USE 0-0-2006; IN COMMERCE 0-0-2006.

4,165,444. W.W. GRAINGER, INC., LAKE FOREST, IL. SN 85-245,418. PUB. 6-28-2011, FILED 2-17-2011.

WHAT EVERY FOOD LAB NEEDS!

THE MARK CONSISTS OF STANDARD CHARACTERS WITHOUT CLAIM TO ANY PARTICULAR FONT, STYLE, SIZE, OR COLOR.

OWNER OF U.S. REG. NO. 2,895,948.

CLASS 16—PAPER GOODS AND PRINTED MATTER

FOR CATALOGS IN THE FIELD OF EQUIPMENT AND SUPPLIES FOR FORESTRY, SURVEYING AND MAPPING, HORTICULTURE, SCIENCE AND LABORATORY, CIVIL/LANDSCAPE ENGINEERING, WEATHER AND TEMPERATURE, WILDLIFE MANAGEMENT, SAFETY, ENVIRONMENTAL STUDIES AND EDUCATION, AND FOR PERSONAL, ENVIRONMENTAL AND LABORATORY SAFETY (U.S. CLS. 2, 5, 22, 23, 29, 37, 38 AND 50).

FIRST USE 0-0-2006; IN COMMERCE 0-0-2006.

CLASS 35—ADVERTISING AND BUSINESS

FOR DISTRIBUTORSHIP SERVICES AND MAIL ORDER CATALOG SERVICES IN THE FIELD OF EQUIPMENT AND SUPPLIES FOR FORESTRY, SURVEYING AND MAPPING, HORTICULTURE, SCIENCE AND LABORATORY, CIVIL/LANDSCAPE ENGINEERING, WEATHER AND TEMPERATURE, WILDLIFE MANAGEMENT, SAFETY, ENVIRONMENTAL STUDIES AND EDUCATION, AND FOR PERSONAL, ENVIRONMENTAL AND LABORATORY SAFETY (U.S. CLS. 100, 101 AND 102).

FIRST USE 0-0-2006; IN COMMERCE 0-0-2006.

CLASS 35—ADVERTISING AND BUSINESS

FOR DISTRIBUTORSHIP SERVICES AND MAIL ORDER CATALOG SERVICES IN THE FIELD OF EQUIPMENT AND SUPPLIES FOR FORESTRY, SURVEYING AND MAPPING, HORTICULTURE, SCIENCE AND LABORATORY, CIVIL/LANDSCAPE ENGINEERING, WEATHER AND TEMPERATURE, WILDLIFE MANAGEMENT, SAFETY, ENVIRONMENTAL STUDIES AND EDUCATION, AND FOR PERSONAL, ENVIRONMENTAL AND LABORATORY SAFETY (U.S. CLS. 100, 101 AND 102).

FIRST USE 0-0-2006; IN COMMERCE 0-0-2006.

4,165,446. COALESCENCE, LLC, COLUMBUS, OH. SN 85-246,505. PUB. 8-16-2011, FILED 2-18-2011.

COALESCENCE

THE MARK CONSISTS OF STANDARD CHARACTERS WITHOUT CLAIM TO ANY PARTICULAR FONT, STYLE, SIZE, OR COLOR.

CLASS 29—MEATS AND PROCESSED FOODS

FOR FROZEN ENTREES CONSISTING PRIMARILY OF FISH, POULTRY OR VEGETABLES; PREPARED ENTREES CONSISTING PRIMARILY OF FISH, POULTRY OR VEGETABLES; PACKAGED ENTREES CONSISTING PRIMARILY OF FISH, POULTRY OR VEGETABLES; APPETIZERS, NAMELY, BREADED AND FRIED JALAPENO PEPPERS; BEVERAGES CONSISTING PRINCIPALLY OF MILK; BOUILLON; BOUILLON CONCENTRATES; BROTH; CHEESE POWDER; DIP MIXES; DIPS; DRIED BEANS; DRIED LENTILS; DRIED MILK POWDER; DRIED SOYBEANS; DRIED VEGETABLES; DRINKABLE SOUPS; DRINKING YOGURTS; EDIBLE OIL; EDIBLE OILS; EDIBLE OILS AND EDIBLE FATS; EXTRACTS FOR SOUPS; EXTRACTS OF MEAT; EXTRACTS OF POULTRY; FOOD ADDITIVES IN THE NATURE OF FAT ACIDS MADE FROM MEAT, FISH, FRUITS, VEGETABLES, EGGS, MILK AND EDIBLE

OILS AND FATS; FOOD ADDITIVES, NAMELY, NATURAL FOOD EXTRACTS DERIVED FROM FISH, FISH OIL, FISH PROTEIN, ALGAE, SEAWEED, FISH OR SHARK CARTILAGE, OR SEASHELLS NOT FOR MEDICINAL PURPOSES AND FOR HUMAN CONSUMPTION; FOOD GLAZING PREPARATIONS COMPRISED PRIMARILY OF FRUIT AND/OR FRUIT PECTIN FOR USE IN COOKING AND BAKING; FOOD PACKAGE COMBINATIONS CONSISTING PRIMARILY OF CHEESE, MEAT AND/OR PROCESSED FRUIT; FORMED TEXTURED VEGETABLE PROTEIN TO BE USED AS AN EXTENDER OR MEAT SUBSTITUTE; FORMED TEXTURED VEGETABLE PROTEIN FOR USE AS A MEAT EXTENDER OR MEAT SUBSTITUTE; FROZEN, FROSTED, PRESERVED, PROCESSED, DRIED, COOKED OR CRYSTALLIZED FRUIT AND VEGETABLES EXTRACTS FOR USE IN PREPARED MEALS OR FOOD; FRUIT-BASED FOOD BEVERAGE; FRUIT-BASED ORGANIC FOOD BARS; FRUIT-BASED ORGANIC FOOD BARS, ALSO CONTAINING GRAIN, VEGETABLES, SEEDS AND CHOCOLATE; GLAZED FRUITS; GUACAMOLE; HOT CHILI PEPPER PUREE; MARINATED MEAT; MARINATED SEAFOOD; MARINATED FISH; MARINATED POULTRY; MARINATED VEGETABLES; MASHED POTATOES; MEAT AND MEAT EXTRACTS; MEAT EXTRACT; MEAT EXTRACTS; MEAT JUICES; MEAT PASTE, MEAT SUBSTITUTES; MILK PROTEIN; MILK PROTEINS; MILK-BASED BEVERAGE CONTAINING COFFEE; MILK-BASED BEVERAGES CONTAINING MILK CONCENTRATES, VEGETABLE OIL AND ADDED NUTRIENTS; MILK-BASED BEVERAGES WITH CHOCOLATE; MILK-BASED ENERGY DRINKS; MIXES FOR MAKING BROTHS; MIXES FOR MAKING SOUP; NON-ALCOHOLIC FRUIT EXTRACTS FOR USE AS INGREDIENTS OF NUTRITIONAL SUPPLEMENTS AND VITAMINS; NON-FAT, LOW-CARBOHYDRATE, HIGH-PROTEIN DAIRY-BASED MIX FOR MAKING NON-DESSERT FOODS, NAMELY, PROCESSED FRUIT-AND NUT-BASED FOOD BARS, SNACK BARS, FRUIT-BASED SNACK FOOD, PROTEIN-BASED NUTRIENT-DENSE SNACK FOODS; MULTIGRAIN-BASED SNACK FOODS, NON-MEDICATED INGREDIENTS OR ADDITIVES FOR USE IN FOOD, NAMELY, EXTRACTS OF FRUIT OR VEGETABLES AND ESSENCES OF FRUIT OR VEGETABLES; NON-MEDICATED INGREDIENTS OR ADDITIVES FOR USE AS INGREDIENTS IN NUTRITIONAL SUPPLEMENTS, NAMELY, EXTRACTS OF FRUIT OR VEGETABLES AND ESSENCES OF FRUIT OR VEGETABLES AND JUICES OF FRUIT AND VEGETABLES; OIL, NAMELY, EDIBLE OIL; POTATO CHIPS; POTATO CRISPS; POTATO CRISPS AND CHIPS; POTATO FRIES; POTATO FRITTERS; POTATO PANCAKES; POTATO-BASED SNACK FOODS; POULTRY; POULTRY, NAMELY, CHICKEN OR TURKEY; POWDERED MILK FOR FOOD PURPOSES; POWDERED OILS AND FATS; PREPARATIONS FOR MAKING BOUILLON; PREPARATIONS FOR MAKING BROTHS; PREPARATIONS FOR MAKING SOUPS; PREPARATIONS FOR MAKING SOUP; PREPARED ENTREES CONSISTING PRIMARILY OF VEGETABLES, SOUPS, FRUIT SALADS AND VEGETABLE SALADS; PREPARED FOOD KITS COMPOSED OF MEAT, POULTRY, FISH, SEAFOOD, AND/OR VEGETABLES AND ALSO INCLUDING SAUCES OR SEASONINGS, READY FOR COOKING AND ASSEMBLY AS A MEAL; PRESERVED FRUIT AND VEGETABLES; PRESERVED FRUITS AND VEGETABLES; PRESERVED MEATS AND SAUSAGES; PRESERVED VEGETABLES; PRESERVED, DRIED AND COOKED VEGETABLES, PRESERVED, DRIED, COOKED AND GRILLED VEGETABLES; PROCESSED OILS AND FATS; PROCESSED POTATOES; PROCESSED SOY BEANS; PROCESSED SWEET POTATOES; PROCESSED VEGETABLES AND FRUITS; PROCESSED VEGETABLES; PROCESSED VEGETABLES, NAMELY, COOKED CUCUMBER, MUSHROOMS, BELLFLOWER ROOT, SPINACH, SOYBEAN SPROUTS AND BRACKEN FERN STEMS USED IN BIBIMBAP DISHES; PROCESSED YAMS; PROTEIN FOR USE AS A FOOD ADDITIVE; PROTEIN FOR USE AS A FOOD FILLER; PROTEIN POWDERS FOR HUMAN CONSUMPTION FOR USE AS A FOOD ADDITIVE; PROTEINS BEING FOODSTUFFS FOR HUMAN CONSUMPTION; PRUNES; REFRIED BEANS; REFRIGERATED FOOD PACKAGE COMBINATIONS CONSISTING PRIMARILY OF MEAT, CHEESE OR PROCESSED VEGETABLES FOR PURPOSES OF CREATING A SANDWICH; SAUSAGES; SEAFOODS BOILED DOWN IN SOY SAUCE (TSUKUDANI); SEASONED MEAT; SEASONED SEAFOOD; SEASONED FISH; SEASONED POULTRY;

SEASONED VEGETABLES; SOUP MIXES; SOUP PASTES; SOUPS; SOUPS AND PREPARATIONS FOR MAKING SOUPS; SOY BURGER PATTIES; SOY PROTEIN FOR USE AS A FOOD ADDITIVE; SOY-BASED FOOD BARS; SOY-BASED FOOD BARS ALSO CONTAINING GRAIN, DRIED FRUITS, AND CHOCOLATE; SOY-BASED FOOD BEVERAGE USED AS A MILK SUBSTITUTE; SOY-BASED SNACK FOODS; STOCK; STOCK CUBES; TEXTURED VEGETABLE PROTEIN FOR USE AS A MEAT EXTENDER; TEXTURED VEGETABLE PROTEIN BITS HAVING A BACON FLAVOR; TEXTURED WHEY PROTEIN; TOFU BURGER PATTIES; TOFU-BASED SNACKS; TOMATO EXTRACTS; TOMATO PASTE; TOMATO PRESERVES; TOMATO PUREE; TURKEY BURGER PATTIES; UNFORMED TEXTURED VEGETABLE PROTEIN FOR USE AS A MEAT EXTENDER; VEGETABLE PASTE; VEGETABLE PROTEIN BITS HAVING A BACON FLAVOR; VEGETABLE PUREE; VEGETABLES, NAMELY, FROZEN COOKED VEGETABLES, VEGETABLE-BASED FOOD BEVERAGES; VEGETABLE-BASED MEAT SUBSTITUTES; VEGETABLE-BASED SNACK FOODS; VEGETARIAN SAUSAGES; VEGGIE BURGER PATTIES; WHEY; YOGURT-BASED BEVERAGES (U.S. CL. 46).

FIRST USE 4-10-2012; IN COMMERCE 4-10-2012.

CLASS 30—STAPLE FOODS

FOR FROZEN ENTREES CONSISTING PRIMARILY OF PASTA OR RICE; PREPARED ENTREES CONSISTING PRIMARILY OF PASTA OR RICE; AND PACKAGED ENTREES CONSISTING PRIMARILY OF PASTA OR RICE; ARTICHOKE SAUCE; ASIAN NOODLES; BAKERY DESSERTS; BAKERY PRODUCTS, NAMELY, SWEET BAKERY GOODS; BAKING POWDER; BAKING SODA; BARBECUE DRY RUB; BARBECUE SAUCE; BEAN-STARCH NOODLES (HARUSAME, UNCOOKED); BEIGNELS; BEVERAGES MADE OF COFFEE; BEVERAGES MADE OF TEA; BEVERAGES WITH A CHOCOLATE BASE; BEVERAGES WITH A COFFEE BASE; BEVERAGES WITH A TEA BASE; BREAD; BREAD AND BUNS; BREAD AND PASTRY; BREAD BASES; BREAD CRUMB; BREAD CRUMBS; BREAD MIXES; BRINE FOR COOKING; CAKE DOUGHS; CAKE MIXES; CAKE MIXES, NAMELY, CAKE BASES; CATSUP; CEREAL-BASED SNACK FOODS; CHEESE FLAVORED PUFFED CORN SNACKS; CHEESE FLAVORED SNACKS, NAMELY, CHEESE CURLS; CHEESE FLAVORED SNACKS, NAMELY, PUFFED CHEESE BALLS; CHEESE-FLAVORED CORN SNACKS; CHEESE SAUCE; CHICKEN WING SAUCE; CHILI PASTE FOR USE AS A SEASONING; CHILI POWDERS; CHILI SAUCE; CHILI SEASONING; CHIMICHURRI SAUCE; CHINESE NOODLES; CHOCOLATE; CHOCOLATE AND CHOCOLATES; CHOCOLATE-COVERED POTATO CHIPS; CHOCOLATE FOOD BEVERAGES NOT BEING DAIRY-BASED OR VEGETABLE BASED; CHOCOLATE MOUSSE; CHOCOLATE PASTES; CHOCOLATE POWDER; CHOCOLATE SAUCE; CHOCOLATE TOPPING; CHOCOLATES AND CHOCOLATE BASED READY TO EAT CANDIES AND SNACKS; COATINGS FOR FOOD MADE OF BREADING; COCOA; COCOA BEVERAGES WITH MILK; COCOA EXTRACTS FOR HUMAN CONSUMPTION; COCOA MIXES; COCOA POWDER; COCOA SPREADS; COCOA-BASED BEVERAGES; COCOA-BASED CONDIMENTS AND SEASONINGS FOR FOOD AND DRINK; COCOA-BASED INGREDIENT IN CONFECTIONERY PRODUCTS; COCONUT SUGAR; COFFEE; COFFEE; COFFEE AND ARTIFICIAL COFFEE; COFFEE AND COFFEE SUBSTITUTES; COFFEE AND TEA; COFFEE BASED BEVERAGES; COFFEE CAPSULES CONTAINING COFFEE FOR BREWING; COFFEE ESSENCES; COFFEE EXTRACTS; COFFEE EXTRACTS FOR USE AS SUBSTITUTES FOR COFFEE; COFFEE FLAVORED SYRUP USED IN MAKING FOOD BEVERAGES; COFFEE-BASED BEVERAGES; COMBINATION MEALS CONSISTING PRIMARILY OF PASTA OR RICE-BASED ENTREES AND SOUP OR SALAD FOR CONSUMPTION ON OR OFF THE PREMISES; CONDIMENT, NAMELY, PEPPER SAUCE; COOKIE MIXES; CONFECTIONERIES, NAMELY, SNACK FOODS, NAMELY, CHOCOLATE; CORN-BASED SNACK FOODS; CURRY POWDER; DIPPING SAUCES; DOUGH; DOUGH-ENROBED FOODS CONSISTING OF A DOUGH-BASED WRAPPER WITH FILLINGS CONSISTING PRIMARILY OF MEATS, POULTRY, FISH, FRUITS AND VEGETABLES AND CHEESE; DOUGH-ENROBED FOODS CONSISTING OF A DOUGH-BASED WRAPPER WITH FILLINGS CON-

SISTING PRIMARILY OF PASTA AND RICE; DRIED CHILI PEPPERS; DRIED PASTA; DRIED PIECES OF WHEAT GLUTEN (FU, UNCOOKED); DRIED SUGARED CAKES OF RICE FLOUR (RAKUGAN); DRY SEASONING MIXES FOR GRAVY, SPAGHETTI, STEWS, AND SLOPPY JOE; DRY SPICE RUB FOR MEATS AND FISH; EDIBLE FLOUR; EDIBLE SPICES, EDIBLE TURMERIC; ESPRESSO; ESPRESSO DRINKS; FISH SAUCE; FLAVOR ENHANCERS USED IN FOOD AND BEVERAGE PRODUCTS; FLAVORING SYRUP; FLAVORINGS; FLAVORINGS FOR BEVERAGES; FLAVORINGS FOR BEVERAGES, OTHER THAN ESSENTIAL OILS; FLAVORINGS, OTHER THAN ESSENTIAL OILS, FOR CAKES; FLAVOURED VINEGAR; FLAVOURINGS; FLAVOURINGS AND SEASONINGS; FLAVOURINGS FOR BUTTER; FLAVOURINGS FOR CAKES OTHER THAN ESSENTIAL OILS; FLAVOURINGS FOR CHEESES; FLAVOURINGS FOR FOODS; FLAVOURINGS FOR SOUPS; FLAVOURINGS OF ALMOND; FLAVOURINGS OF LEMONS; FLAVOURINGS OF TEA; FLAVOURINGS, OTHER THAN ESSENTIAL OILS, FOR CAKES; FOOD ADDITIVES FOR NON-NUTRITIONAL PURPOSES FOR USE AS A FLAVORING; FOOD CONDIMENT CONSISTING PRIMARILY OF KETCHUP AND SALSA; FOOD FLAVORINGS; FOOD FLAVOURINGS; FOOD SEASONINGS; FRESH PASTA; FRESH PIZZA; FROZEN APPETIZERS CONSISTING PRIMARILY OF CORNMEAL; FROZEN DOUGH FOR USE AS PIZZA, BREAD OR OTHER BREAD-TYPE PRODUCTS; FROZEN FLAVOURED WATERS; FROZEN SOY-BASED DESSERTS; FRUIT SAUCES EXCLUDING CRANBERRY SAUCE AND APPLESAUCE; GARDEN HERBS PRESERVED; GARLIC PASTE FOR USE AS A SEASONING; GRAIN-BASED BEVERAGES; GRAIN-BASED FOOD BARS ALSO CONTAINING SOY, DRIED FRUITS, AND CHOCOLATE; GRAIN-BASED FOOD BEVERAGES; GRAIN-BASED SNACK FOODS; GRANOLA SNACKS; GRANOLA-BASED SNACK BARS; GRAVIES, GRAVY; GRAVY MIXES; HERB TEA; HERBAL FOOD BEVERAGES; HERBAL INFUSIONS; HERBAL TEA; HOT CHILI PEPPER SAUCE; HOT SAUCE; INSTANT CHINESE NOODLES; MACARONI AND CHEESE; MARINADE MIXES; MARINADES; MEAT CURES; MEAT GRAVIES; MICROWAVE POPCORN; MILK SHAKES; MIX FOR MAKING COMBINED NOODLE AND SAUCE DISH; MIXES FOR BAKERY GOODS; MIXES FOR BAKER GOODS CONTAINING CORNMEAL; MIXES FOR MAKING BAKING BATTERS; MIXES FOR MAKING BATTERS FOR FRIED FOODS; MIXES FOR MAKING BREADING; MIXES IN THE NATURE OF CONCENTRATES, SYRUPS OR POWDERS USED IN THE PREPARATION OF TEA BASED BEVERAGES; MIXTURES OF COFFEE AND CHICORY; MUFFIN MIXES; NOODLES AND SAUCE MIXES COMBINED IN UNITARY PACKAGES; NOODLES AND SEASONING MIXES COMBINED IN UNITARY PACKAGES; NOODLES, SAUCE, AND PROCESSED VEGETABLES COMBINED IN UNITARY PACKAGES; NOODLES SAUCE, AND SEASONING TOPPINGS COMBINED IN UNITARY PACKAGES; NOODLES, SAUCE, DEHYDRATED VEGETABLES, AND TOPPING COMBINED IN UNITARY PACKAGES; NOODLES, SEASONINGS, EDIBLE OIL, AND FLAVORINGS COMBINED IN UNITARY PACKAGES; NOODLES, SEASONINGS, EDIBLE OIL, AND DEHYDRATED VEGETABLES COMBINED IN UNITARY PACKAGES; ORGANIC CURRY SAUCES; PACKAGED MEAL KITS CONSISTING PRIMARILY OF PASTA OR RICE; PACKAGED MEAL MIXES CONSISTING PRIMARILY OF PASTA OR RICE; PANCAKES; PASTA; PASTA AND NOODLES; PASTA FOR SOUPS; PASTA SALAD; PASTA SAUCE; PICANTE SAUCE; PICO DE GALLO SAUCE; PIZZA; PIZZA CRUST; PIZZA CRUST MIXES; PIZZA DOUGH; PIZZA SAUCE; POPCORN; POPPED POPCORN; POTATO FLOUR; PREPARED COCOA AND COCOA-BASED BEVERAGES; PREPARED COFFEE AND COFFEE-BASED BEVERAGES; PROCESSED CACAO; PROCESSED CEREALS; PROCESSED CEREAL-BASED FOOD TO BE USED AS A BREAKFAST FOOD, SNACK FOOD OR INGREDIENT FOR MAKING OTHER FOODS; PROCESSED GARLIC FOR USE AS SEASONING; PROCESSED GINSENG USED AS AN HERB, SPICE OR FLAVORING; PROCESSED HERBS; PROCESSED OATS; PROCESSED POPCORN; PROCESSED UNPOPPED POPCORN; READY TO EAT, CEREAL DERIVED FOOD BARS; READY-MADE SAUCES; READY-TO-EAT CEREALS; RICE NOODLES; SALAD DRESSING; SALAD DRESSINGS; SALAD SAUCES; SAUCE MIXES; SAUCES; SAUCES FOR BARBECUED MEAT; SCENTED WATER FOR FLAVORING BEVERAGES; SEASONED COATING FOR MEAT, FISH,

POULTRY; SEASONED COATING MIXTURES FOR FOOD; SEASONED RICE CAKES WITH FISH, MEAT, CHICKEN AND VEGETABLE TOPPINGS; SEASONING MIXES; SEASONING MIXES FOR SOUPS; SEASONING PASTES; SEASONINGS; SEASONINGS AND FLAVORINGS FOR DOG FOODS AND CATTLE FEED; SAVORY SEASONINGS FOR FOOD PRODUCTS, NAMELY, MEAT, MEAT ANALOGS, SNACKS, SALAD DRESSINGS, SAUCES, RUBS, MARINADES, GLAZES, SIDE DISHES, ENTREES, SOUPS, BAKERY, EXTRUDED SNACKS, BEVERAGES, NAMELY, ENERGY DRINKS, SPECIALTY DRINKS, COFFEE, TEA, AND SMOOTHIES; SHAKES; SLOPPY JOE SAUCE; SOY BEAN PASTE; SOY BURGER SANDWICHES; SOY SAUCE; SPAGHETTI; SPAGHETTI AND MEATBALLS; SPAGHETTI SAUCE; SPICE BLENDS; SPICE RUBS; SPICES; SPICES AND ICE; SPRING ROLLS; STARCH FOR USE IN MANUFACTURING FOOD; STARCH SYRUP; STARCH-BASED BINDING AGENTS FOR ICE CREAM; STARCH-BASED CANDIES (AME); STARCH-BASED THICKENERS FOR WHIPPED CREAM; STEAK SAUCE; TACO SEASONING; TARTAR SAUCE; TEA; TEA BAGS; TEA EXTRACTS; TEA FOR INFUSIONS; TEA-BASED BEVERAGES; TEA-BASED BEVERAGES WITH FRUIT FLAVORING; TERIYAKI SAUCE; TOMATO SAUCE; TORTILLA CHIPS; TORTILLA SHELLS; TURKEY BURGER SANDWICHES; TURMERIC; UDON NOODLES; UNLEAVENED BREAD IN THIN SHEETS; UNPOPPED POPCORN; UNROASTED COFFEE; VANILLA; VANILLA BEANS, VANILLA FLAVORINGS; VEGETABLES CONCENTRATES USED FOR SEASONING; VEGGIE BURGER SANDWICHES; WORCESTERSHIRE SAUCE; YEAST; YEAST EXTRACTS; YEAST EXTRACTS FOR FOOD; YEAST EXTRACTS FOR HUMAN CONSUMPTION; YEAST POWDER; YEAST, BAKING POWDER; YEAST, BAKING POWDER AND FLAVOURINGS (U.S. CL. 46).

FIRST USE 4-10-2012; IN COMMERCE 4-10-2012.

CLASS 40—MATERIAL TREATMENT

FOR PROVIDING TECHNICAL INFORMATION IN THE FIELD OF FOOD PROCESSING (U.S. CLS. 100, 103 AND 106).

FIRST USE 4-6-2012; IN COMMERCE 4-6-2012.

4,165,451. PRIACTA, INC., POWHATAN, VA. SN 85-249,741.
PUB. 7-19-2011, FILED 2-23-2011.



THE COLOR(S) BLUE AND GRAY IS/ARE CLAIMED AS A FEATURE OF THE MARK.

THE MARK CONSISTS OF A DIALOGUE BOX WITH A GRAY OUTLINE AND WHICH CONTAINS TWO GRAY CHECK MARKS AND TWO GRAY LINES. A PORTION OF A BLUE DIALOGUE BOX APPEARS ABOVE AND TO THE LEFT OF THE GRAY ONE, GIVING THE APPEARANCE OF THE GRAY ONE LAYING ON TOP OF THE BLUE ONE.

CLASS 9—ELECTRICAL AND SCIENTIFIC APPARATUS

FOR COMPUTER SOFTWARE FOR TASK AND PROJECT ASSIGNMENT, TRACKING; COMPUTER SOFTWARE FOR TASK AND APPOINTMENT SCHEDULING; COMPUTER SOFTWARE FOR DELEGATION OF TASKS AND PROJECTS; COMPUTER SOFTWARE FOR USE IN ENGAGING IN SOCIAL NETWORKING (U.S. CLS. 21, 23, 26, 36 AND 38).

FIRST USE 0-0-2011; IN COMMERCE 0-0-2011.

CLASS 42—SCIENTIFIC AND COMPUTER SERVICES

FOR SOFTWARE AS A SERVICE (SAAS) SERVICES FEATURING SOFTWARE FOR TASK AND PROJECT ASSIGNMENT, TRACKING, COORDINATION, AND FOLLOW-UP; SOFTWARE AS A SERVICE (SAAS) SERVICES FEATURING SOFTWARE FOR TASK AND APPOINTMENT SCHEDULING; SOFTWARE AS A SERVICE (SAAS) SERVICES FEATURING SOFTWARE FOR WORKFLOW COLLABORATION; SOFTWARE AS A SERVICE (SAAS) SERVICES FEATURING SOFTWARE FOR WORK PERFORMANCE MONITORING; SOFTWARE AS A SERVICE; SOFTWARE AS A SERVICE (SAAS) SERVICES FEATURING SOFTWARE FOR DELEGATION OF TASKS AND PROJECTS; SOFTWARE AS A SERVICE (SAAS) SERVICES FEATURING SOFTWARE FOR CREATING AND DISTRIBUTING MEETING AGENDAS; AND SOFTWARE AS A SERVICE (SAAS) SERVICES FEATURING SOFTWARE FOR USE IN ENGAGING IN SOCIAL NETWORKING (U.S. CLS. 100 AND 101).

FIRST USE 0-0-2011; IN COMMERCE 0-0-2011.

4,165,466. APOTHECARY PRODUCTS, INC., BURNSVILLE, MN. SN 85-255,848. PUB. 7-19-2011, FILED 3-2-2011.

Get the Most from Your
Medication

THE MARK CONSISTS OF STANDARD CHARACTERS WITHOUT CLAIM TO ANY PARTICULAR FONT, STYLE, SIZE, OR COLOR.

CLASS 35—ADVERTISING AND BUSINESS

FOR ONLINE RETAIL AND WHOLESALE STORE AND MAIL ORDER CATALOG SERVICES FEATURING PHARMACEUTICAL AND PHARMACEUTICAL RELATED PRODUCTS (U.S. CLS. 100, 101 AND 102).

FIRST USE 9-1-2011; IN COMMERCE 9-1-2011.

CLASS 44—MEDICAL, BEAUTY AND AGRICULTURAL SERVICES

FOR PROVIDING AN INFORMATIONAL WEBSITE FEATURING MEDICAL, HEALTH AND PHARMACEUTICAL INFORMATION (U.S. CLS. 100 AND 101).

FIRST USE 7-0-2010; IN COMMERCE 12-10-2010.

4,165,456. RETAIL CONCEPTS, INC., HOUSTON, TX. SN 85-252,530. PUB. 8-16-2011, FILED 2-26-2011.

4,165,475. ART PORTER MUSIC EDUCATION INC, LITTLE ROCK, AR. SN 85-259,694. PUB. 10-25-2011, FILED 3-7-2011.

B360

ART PORTER

THE MARK CONSISTS OF STANDARD CHARACTERS WITHOUT CLAIM TO ANY PARTICULAR FONT, STYLE, SIZE, OR COLOR.

OWNER OF U.S. REG. NOS. 2,584,844 AND 3,955,806.

CLASS 9—ELECTRICAL AND SCIENTIFIC APPARATUS

FOR PROTECTIVE HELMETS AND GOGGLES FOR SPORTS (U.S. CLS. 21, 23, 26, 36 AND 38).

FIRST USE 11-30-2011; IN COMMERCE 11-30-2011.

CLASS 18—LEATHER GOODS

FOR LUGGAGE AND BAGS FOR SPORTS (U.S. CLS. 1, 2, 3, 22 AND 41).

FIRST USE 11-30-2011; IN COMMERCE 11-30-2011.

THE MARK CONSISTS OF STANDARD CHARACTERS WITHOUT CLAIM TO ANY PARTICULAR FONT, STYLE, SIZE, OR COLOR.

THE NAME "ART PORTER" DOES NOT IDENTIFY A LIVING INDIVIDUAL.

CLASS 36—INSURANCE AND FINANCIAL

FOR CHARITABLE FUNDRAISING TO RAISE MONEY TO PROVIDE EDUCATIONAL SCHOLARSHIPS FOR MUSICIANS AND TO FUND MUSIC EDUCATION FOR MUSICALLY TALENTED STUDENTS (U.S. CLS. 100, 101 AND 102).

FIRST USE 6-1-1994; IN COMMERCE 6-1-1994.

CLASS 41—EDUCATION AND ENTERTAINMENT

FOR MUSIC EDUCATION SERVICES, NAMELY, CONDUCTING WORKSHOPS AND SEMINARS IN THE FIELD OF MUSIC FOR MUSICALLY TALENTED STUDENTS (U.S. CLS. 100, 101 AND 107).

FIRST USE 6-1-1994; IN COMMERCE 6-1-1994.

4,165,476. MUSICCAS LLC, SAN JOSE, CA. SN 85-259,789. PUB. 8-30-2011, FILED 3-7-2011.

4,165,484. NEXT ISSUE MEDIA, LLC, NEW YORK, NY. SN 85-261,869. PUB. 7-19-2011, FILED 3-9-2011.

MUSICCAS

THE MARK CONSISTS OF STANDARD CHARACTERS WITHOUT CLAIM TO ANY PARTICULAR FONT, STYLE, SIZE, OR COLOR.

CLASS 38—COMMUNICATION

FOR PROVIDING A WEB AND INTERNET BASED SERVICE THAT FACILITATES ELECTRONIC TRANSMISSION OF COMMUNICATIONS BETWEEN APPLICANTS AND SCHOOLS REGARDING ENROLLMENT APPLICATIONS (U.S. CLS. 100, 101 AND 104).
FIRST USE 4-6-2012; IN COMMERCE 4-6-2012.

CLASS 42—SCIENTIFIC AND COMPUTER SERVICES

FOR PROVIDING A WEB AND INTERNET BASED SERVICE THAT ENABLES USERS TO MANAGE, TRANSMIT, PROCESS AND TRACK APPLICATIONS, INCLUDING AUDITION MATERIALS, TO MUSIC SCHOOLS, COLLEGES AND GRADUATE SCHOOLS (U.S. CLS. 100 AND 101).
FIRST USE 4-6-2012; IN COMMERCE 4-6-2012.

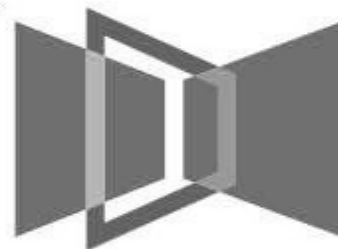

THE MARK CONSISTS OF A TRAPEZOID LINED UP PARALLEL TO ANOTHER TRAPEZOID WITH A TRAPEZOID OUTLINE OVERLAPPING THEM BOTH IN A PARALLEL FASHION.

CLASS 35—ADVERTISING AND BUSINESS

FOR ADVERTISING AND PUBLICITY SERVICES, NAMELY, PROMOTING THE GOODS, SERVICES, BRAND IDENTITY AND COMMERCIAL INFORMATION AND NEWS OF THIRD PARTIES THROUGH PRINT, AUDIO, VIDEO, DIGITAL AND ON-LINE MEDIA; ADVERTISING AND MARKETING SERVICES PROVIDED BY MEANS OF INDIRECT METHODS OF MARKETING COMMUNICATIONS, NAMELY, SOCIAL MEDIA, SEARCH ENGINE MARKETING, INQUIRY MARKETING, INTERNET MARKETING, MOBILE MARKETING, BLOGGING AND OTHER FORMS OF PASSIVE, SHARABLE OR VIRAL COMMUNICATIONS CHANNELS; ADVERTISING AND BUSINESS SERVICES, NAMELY, PROVIDING AN ONLINE WEBSITE WHERE ADVERTISERS, MARKETERS, AND CONTENT PROVIDERS CAN INTERACT WITH USERS FOR ADVERTISING AND PROMOTING KNOWLEDGE, PRODUCTS, AND SERVICES ON BEHALF OF THEMSELVES AND OTHERS; PROVIDING ADVERTISING SERVICES TO DISTRIBUTE ADVERTISEMENTS FOR DISPLAY ON THE INTERNET, NAMELY, IN WEBSITES, SOCIAL CONVERSATIONS OVER THE INTERNET, E-MAILS, MICROBLOGS, BLOGS, ELECTRONIC MESSAGES, INSTANT MESSAGES, TEXT MESSAGES, MULTIMEDIA MESSAGES, SOCIAL NETWORKS, STATUS UPDATES, FORUMS, ELECTRONIC BULLETIN BOARDS (U.S. CLS. 100, 101 AND 102).
FIRST USE 5-0-2011; IN COMMERCE 5-0-2011.

4,165,483. BIOLYST, LLC, MINNEAPOLIS, MN. SN 85-261,800. PUB. 7-26-2011, FILED 3-9-2011.

REALIEF

THE MARK CONSISTS OF STANDARD CHARACTERS WITHOUT CLAIM TO ANY PARTICULAR FONT, STYLE, SIZE, OR COLOR.

CLASS 10—MEDICAL APPARATUS

FOR LASERS FOR MEDICAL USE (U.S. CLS. 26, 39 AND 44).
FIRST USE 6-0-2011; IN COMMERCE 6-0-2011.

CLASS 35—ADVERTISING AND BUSINESS

FOR FRANCHISING, NAMELY, CONSULTATION AND ASSISTANCE IN BUSINESS MANAGEMENT, ORGANIZATION AND PROMOTION (U.S. CLS. 100, 101 AND 102).
FIRST USE 5-0-2011; IN COMMERCE 5-0-2011.

CLASS 44—MEDICAL, BEAUTY AND AGRICULTURAL SERVICES

FOR MEDICAL SERVICES, NAMELY, TREATMENT OF PAIN AND CIRCULATORY ISSUES AND CARE OF WOUNDS (U.S. CLS. 100 AND 101).
FIRST USE 11-0-2011; IN COMMERCE 11-0-2011.

CLASS 38—COMMUNICATION

FOR BROADCASTING SERVICES, NAMELY, TRANSMISSION OF ADVERTISING PROGRAMS AND MEDIA ADVERTISING COMMUNICATIONS VIA DIGITAL COMMUNICATIONS NETWORKS (U.S. CLS. 100, 101 AND 104).
FIRST USE 4-4-2012; IN COMMERCE 4-4-2012.

CLASS 41—EDUCATION AND ENTERTAINMENT

FOR DIGITAL VIDEO, AUDIO, AND MULTIMEDIA PUBLISHING SERVICES (U.S. CLS. 100, 101 AND 107).
FIRST USE 5-0-2011; IN COMMERCE 5-0-2011.

4,165,493. B 2 SQUARED, LLC, SAN JOSE, CA. SN 85-264,982.
PUB. 7-26-2011, FILED 3-11-2011.

Yalla

THE MARK CONSISTS OF STANDARD CHARACTERS WITHOUT CLAIM TO ANY PARTICULAR FONT, STYLE, SIZE, OR COLOR.

THE ENGLISH TRANSLATION OF "YALLA" IN THE MARK IS "HURRY UP".

CLASS 9—ELECTRICAL AND SCIENTIFIC APPARATUS

FOR COMPUTER GAME SOFTWARE; INTERACTIVE VIDEO GAME PROGRAMS; DOWNLOADABLE ELECTRONIC GAME PROGRAMS AND COMPUTER SOFTWARE FOR SOCIAL NETWORKING THAT MAY BE ACCESSED VIA THE INTERNET, COMPUTERS AND WIRELESS DEVICES; COMPUTER SOFTWARE TO ENABLE THE POSTING, SHOWING DISPLAYING AND SHARING OF INFORMATION IN THE FIELDS OF ELECTRONIC GAMING AND ENTERTAINMENT AND GENERAL INTEREST VIA THE INTERNET WITH THIRD PARTIES (U.S. CLS. 21, 23, 26, 36 AND 38).
FIRST USE 10-26-2011; IN COMMERCE 11-11-2011.

CLASS 41—EDUCATION AND ENTERTAINMENT

FOR ENTERTAINMENT SERVICES, NAMELY, PROVIDING ONLINE COMPUTER AND ELECTRONIC GAMES; ENTERTAINMENT SERVICES, NAMELY, PROVIDING AN INTERNET WEBSITE PORTAL IN THE FIELD OF COMPUTER GAMES AND GAMING; ENTERTAINMENT SERVICES, NAMELY, PROVIDING VIRTUAL ENVIRONMENTS IN WHICH USERS CAN INTERACT THROUGH GAMES FOR RECREATIONAL, LEISURE OR ENTERTAINMENT PURPOSES (U.S. CLS. 100, 101 AND 107).
FIRST USE 10-26-2011; IN COMMERCE 11-11-2011.

4,165,499. BEECH-NUT NUTRITION CORPORATION, AMSTERDAM, NY. SN 85-266,254. PUB. 7-26-2011, FILED 3-14-2011.

STAGE 4

THE MARK CONSISTS OF STANDARD CHARACTERS WITHOUT CLAIM TO ANY PARTICULAR FONT, STYLE, SIZE, OR COLOR.

OWNER OF U.S. REG. NOS. 1,756,410, 1,756,412, AND OTHERS.

CLASS 29—MEATS AND PROCESSED FOODS

FOR FRUIT-BASED SNACK FOODS; FRUIT AND YOGURT-BASED SNACK FOODS; GRAIN-BASED SNACK FOODS; MICROWAVEABLE MEALS IN A TRAY, CONSISTING PRIMARILY OF MEAT, POULTRY AND/OR VEGETABLES; PREPARED REHEATABLE MEALS CONSISTING PRIMARILY OF MEAT, POULTRY AND/OR VEGETABLES; FRUIT COMPOTES (U.S. CL. 46).
FIRST USE 4-1-2011; IN COMMERCE 4-1-2011.

CLASS 30—STAPLE FOODS

FOR CANDY; CHEESE-BASED SNACK FOODS, NAMELY, PUFFED CHEESE BALLS; COOKIES; PREPARED REHEATABLE MEALS CONSISTING PRIMARILY OF PASTA AND/OR CHEESE; RICE-BASED PUDDING DESSERT (U.S. CL. 46).
FIRST USE 3-0-2009; IN COMMERCE 3-0-2009.

4,165,506. A&E TELEVISION NETWORKS, LLC, NEW YORK, NY. SN 85-267,842. PUB. 8-2-2011, FILED 3-15-2011.

10 THINGS YOU DON'T KNOW ABOUT

THE MARK CONSISTS OF STANDARD CHARACTERS WITHOUT CLAIM TO ANY PARTICULAR FONT, STYLE, SIZE, OR COLOR.

CLASS 9—ELECTRICAL AND SCIENTIFIC APPARATUS

FOR MULTIMEDIA GOODS, NAMELY, PRE-RECORDED DIGITAL VIDEO DISCS AND DVD SUBJECTS OF GENERAL HUMAN INTEREST; DIGITAL MEDIA, NAMELY, DOWNLOADABLE AUDIO AND VIDEO FILES FEATURING SUBJECTS OF GENERAL HUMAN INTEREST; DOWNLOADABLE ON-LINE DISCUSSION BOARDS AND WEBCASTS FEATURING SUBJECTS OF GENERAL HUMAN INTEREST (U.S. CLS. 21, 23, 26, 36 AND 38).
FIRST USE 2-27-2012; IN COMMERCE 2-27-2012.

CLASS 41—EDUCATION AND ENTERTAINMENT

FOR ENTERTAINMENT SERVICES, NAMELY, A MULTIMEDIA PROGRAM SERIES FEATURING SUBJECTS OF GENERAL HUMAN INTEREST DISTRIBUTED VIA VARIOUS PLATFORMS ACROSS MULTIPLE FORMS OF TRANSMISSION MEDIA; ENTERTAINMENT SERVICES, NAMELY, AN ONGOING TELEVISION PROGRAM FEATURING SUBJECTS OF GENERAL HUMAN INTEREST; PROVIDING A WEBSITE FEATURING FACTS ABOUT ORDINARY OBJECTS AND MATERIALS (U.S. CLS. 100, 101 AND 107).
FIRST USE 2-27-2012; IN COMMERCE 2-27-2012.

4,165,507. SERIOUS CIVICS, LLC, HINTON, IA. SN 85-268,116. PUB. 8-16-2011, FILED 3-16-2011.

Serious Civics

THE MARK CONSISTS OF STANDARD CHARACTERS WITHOUT CLAIM TO ANY PARTICULAR FONT, STYLE, SIZE, OR COLOR.

NO CLAIM IS MADE TO THE EXCLUSIVE RIGHT TO USE "CIVICS", APART FROM THE MARK AS SHOWN.

CLASS 16—PAPER GOODS AND PRINTED MATTER

FOR PRINTED EDUCATIONAL MATERIALS IN THE FIELDS OF UNITED STATES CITIZENSHIP, THE CONSTITUTION, HISTORY, GOVERNMENT AND PHILOSOPHY (U.S. CLS. 2, 5, 22, 23, 29, 37, 38 AND 50).

FIRST USE 6-21-2011; IN COMMERCE 6-21-2011.

CLASS 41—EDUCATION AND ENTERTAINMENT

FOR EDUCATIONAL SERVICES, NAMELY, PROVIDING IN PERSON AND ONLINE LECTURES AND SEMINARS IN THE FIELDS OF UNITED STATES CITIZENSHIP, THE CONSTITUTION, HISTORY, GOVERNMENT AND PHILOSOPHY, AND PRINTABLE MATERIALS DISTRIBUTED THEREWITH (U.S. CLS. 100, 101 AND 107).

FIRST USE 9-2-2010; IN COMMERCE 9-2-2010.

4,165,509. APPTERA, INC., SUNNYVALE, CA. SN 85-268,338. PUB. 8-2-2011, FILED 3-16-2011.

POPTUIT

THE MARK CONSISTS OF STANDARD CHARACTERS WITHOUT CLAIM TO ANY PARTICULAR FONT, STYLE, SIZE, OR COLOR.

CLASS 9—ELECTRICAL AND SCIENTIFIC APPARATUS

FOR DOWNLOADABLE SOFTWARE IN THE NATURE OF A MOBILE APPLICATION FOR ENHANCING COMMUNICATIONS BETWEEN INDIVIDUALS AND BETWEEN CONSUMERS AND BUSINESSES INCLUDING, BUT NOT LIMITED TO, LEVERAGING VOICE AND DATA CHANNELS SIMULTANEOUSLY (U.S. CLS. 21, 23, 26, 36 AND 38).

FIRST USE 8-2-2011; IN COMMERCE 8-2-2011.

CLASS 35—ADVERTISING AND BUSINESS

FOR ADVERTISING AND MARKETING SERVICES PROVIDED BY MEANS OF DIRECT AND INDIRECT METHODS OF MARKETING COMMUNICATIONS, NAMELY, SOCIAL MEDIA, SEARCH ENGINE MARKETING, INQUIRY MARKETING, INTERNET MARKETING, MOBILE MARKETING, GEOGRAPHIC LOCATION BASED MARKETING, BLOGGING AND OTHER FORMS OF PASSIVE, SHARABLE OR VIRAL COMMUNICATIONS CHANNELS (U.S. CLS. 100, 101 AND 102).

FIRST USE 8-2-2011; IN COMMERCE 8-2-2011.

CLASS 38—COMMUNICATION

FOR WIRELESS ELECTRONIC TRANSMISSION SIMULTANEOUSLY OF VOICE SIGNALS, DATA, FACSIMILES, IMAGES AND INFORMATION (U.S. CLS. 100, 101 AND 104).

FIRST USE 8-2-2011; IN COMMERCE 8-2-2011.

CLASS 42—SCIENTIFIC AND COMPUTER SERVICES

FOR CLOUD COMPUTING FEATURING SOFTWARE FOR USE IN ENHANCING COMMUNICATIONS BETWEEN INDIVIDUALS AND BETWEEN CONSUMERS AND BUSINESSES INCLUDING, BUT NOT LIMITED TO, LEVERAGING VOICE AND DATA CHANNELS SIMULTANEOUSLY; SOFTWARE DEVELOPMENT AND PRODUCT DEVELOPMENT IN THE FIELD OF ENHANCING COMMUNICATIONS BETWEEN INDIVIDUALS AND BETWEEN CONSUMERS AND BUSINESSES INCLUDING, BUT NOT LIMITED TO, LEVERAGING VOICE AND DATA CHANNELS SIMULTANEOUSLY (U.S. CLS. 100 AND 101).

FIRST USE 8-2-2011; IN COMMERCE 8-2-2011.

4,165,540. WESLEY WOODS SENIOR LIVING, INC., ATLANTA, GA. SN 85-275,172. PUB. 9-20-2011, FILED 3-23-2011.

leaders in senior living

THE MARK CONSISTS OF STANDARD CHARACTERS WITHOUT CLAIM TO ANY PARTICULAR FONT, STYLE, SIZE, OR COLOR.

NO CLAIM IS MADE TO THE EXCLUSIVE RIGHT TO USE "SENIOR LIVING", APART FROM THE MARK AS SHOWN.

CLASS 35—ADVERTISING AND BUSINESS

FOR MANAGEMENT AND BUSINESS CONSULTING SERVICES IN THE FIELD OF RESIDENTIAL RETIREMENT COMMUNITIES FOR THE ELDERLY (U.S. CLS. 100, 101 AND 102).

FIRST USE 3-19-2012; IN COMMERCE 3-19-2012.

CLASS 43—HOTEL AND RESTAURANT SERVICES

FOR PROVIDING ASSISTED LIVING FACILITIES; RETIREMENT HOMES (U.S. CLS. 100 AND 101).

FIRST USE 3-19-2012; IN COMMERCE 3-19-2012.

CLASS 44—MEDICAL, BEAUTY AND AGRICULTURAL SERVICES

FOR CONVALESCENT HOMES; NURSING HOMES; PROVIDING LONG-TERM CARE FACILITIES (U.S. CLS. 100 AND 101).

FIRST USE 3-19-2012; IN COMMERCE 3-19-2012.

4,165,560. WPX ENERGY, INC., TULSA, OK. SN 85-277,383. PUB. 8-23-2011, FILED 3-25-2011.

WPX ENERGY

THE MARK CONSISTS OF STANDARD CHARACTERS WITHOUT CLAIM TO ANY PARTICULAR FONT, STYLE, SIZE, OR COLOR.

NO CLAIM IS MADE TO THE EXCLUSIVE RIGHT TO

USE "ENERGY", APART FROM THE MARK AS SHOWN.

4,165,580. SITV, INC., GLENDALE, CA. SN 85-281,498. PUB. 8-30-2011, FILED 3-30-2011.

CLASS 40—MATERIAL TREATMENT

FOR GAS PRODUCTION SERVICES; OIL PRODUCTION SERVICES (U.S. CLS. 100, 103 AND 106). FIRST USE 1-1-2012; IN COMMERCE 1-1-2012.

CLASS 42—SCIENTIFIC AND COMPUTER SERVICES

FOR EXPLORATION AND SEARCHING OF OIL AND GAS (U.S. CLS. 100 AND 101). FIRST USE 1-1-2012; IN COMMERCE 1-1-2012.

America's Nu Voice

THE MARK CONSISTS OF STANDARD CHARACTERS WITHOUT CLAIM TO ANY PARTICULAR FONT, STYLE, SIZE, OR COLOR.

NO CLAIM IS MADE TO THE EXCLUSIVE RIGHT TO USE "AMERICA'S", APART FROM THE MARK AS SHOWN.

CLASS 38—COMMUNICATION

FOR BROADCASTING PROGRAMS VIA A GLOBAL COMPUTER NETWORK; CABLE TELEVISION BROADCASTING; COMMUNICATION SERVICES, NAMELY, TRANSMISSION OF VOICE, AUDIO, VISUAL IMAGES AND DATA BY TELECOMMUNICATIONS NETWORKS, WIRELESS COMMUNICATION NETWORKS, THE INTERNET, INFORMATION SERVICES NETWORKS AND DATA NETWORKS; MOBILE MEDIA SERVICES IN THE NATURE OF ELECTRONIC TRANSMISSION OF ENTERTAINMENT MEDIA CONTENT; SATELLITE TELEVISION BROADCASTING; TELEVISION BROADCASTING; VIDEO TRANSMISSION OVER DIGITAL NETWORKS (U.S. CLS. 100, 101 AND 104). FIRST USE 7-4-2011; IN COMMERCE 7-4-2011.

4,165,572. TRUECAR, INC., SANTA MONICA, CA. SN 85-279,842. PUB. 8-9-2011, FILED 3-29-2011.

KNOW THE REAL PRICE

THE MARK CONSISTS OF STANDARD CHARACTERS WITHOUT CLAIM TO ANY PARTICULAR FONT, STYLE, SIZE, OR COLOR.

CLASS 35—ADVERTISING AND BUSINESS

FOR PROVIDING MOTORIZED VEHICLE PURCHASE ADVISORY AND CONSULTING SERVICES; PROVIDING MOTORIZED VEHICLE VALUE ADVISORY AND PRICE EVALUATION SERVICES; PROVIDING INFORMATION VIA A GLOBAL COMPUTER NETWORK IN CONNECTION WITH THE PRICE, VALUE AND SPECIFICATIONS OF MOTORIZED VEHICLES; STATISTICAL ANALYSIS OF NATIONAL AND REGIONAL MOTORIZED VEHICLE PRICE DATA; PROVIDING MOTORIZED VEHICLE PRICE REPORTS THAT INCLUDE DEALER COST, FACTORY INVOICE PRICE, AVERAGE PRICE, STICKER PRICE, MSRP, AND A STATISTICAL ANALYSIS OF PRICE FOR A PARTICULAR VEHICLE BASED ON ACTUAL PURCHASE DATA; MARKETING AND ADVERTISING SERVICES FOR SELLERS OF NEW AND USED MOTORIZED VEHICLES, MOTORIZED VEHICLE PARTS AND ACCESSORIES, AND MOTORIZED VEHICLE REPAIR, CUSTOMIZATION AND RESTORATION SERVICES (U.S. CLS. 100, 101 AND 102). FIRST USE 4-15-2011; IN COMMERCE 4-15-2011.

CLASS 41—EDUCATION AND ENTERTAINMENT

FOR ENTERTAINMENT IN THE NATURE OF ONGOING TELEVISION PROGRAMS IN THE FIELD OF MUSIC, ENTERTAINMENT, NEWS, REALITY AND GENERAL INTEREST TOPICS; ENTERTAINMENT SERVICES, NAMELY, PROVIDING A WEB SITE FEATURING PHOTOGRAPHIC, AUDIO, VIDEO AND PROSE PRESENTATIONS FEATURING MUSIC, ENTERTAINMENT, NEWS, REALITY AND GENERAL INTEREST TOPICS; ENTERTAINMENT SERVICES, NAMELY, THE PROVISION OF CONTINUING PROGRAMS, SEGMENTS AND SHOWS FEATURING MUSIC, ENTERTAINMENT, NEWS, REALITY AND GENERAL INTEREST TOPICS DELIVERED BY CABLE AND SATELLITE TELEVISION, ONLINE AND WIRELESS NETWORKS; PROVIDING INFORMATION, NEWS AND COMMENTARY IN THE FIELD OF ENTERTAINMENT (U.S. CLS. 100, 101 AND 107). FIRST USE 7-4-2011; IN COMMERCE 7-4-2011.

4,165,582. WD-40 COMPANY, SAN DIEGO, CA. SN 85-281,789. PUB. 2-7-2012, FILED 3-30-2011.

3-IN-ONE PROFESSIONAL

THE MARK CONSISTS OF STANDARD CHARACTERS WITHOUT CLAIM TO ANY PARTICULAR FONT, STYLE, SIZE, OR COLOR.

OWNER OF U.S. REG. NOS. 61,545, 1,100,509, AND OTHERS.

NO CLAIM IS MADE TO THE EXCLUSIVE RIGHT TO USE "PROFESSIONAL", APART FROM THE MARK AS SHOWN.

SEC. 2(F).

CLASS 42—SCIENTIFIC AND COMPUTER SERVICES

FOR PROVIDING A WEB SITE FEATURING TEMPORARY USE OF NON-DOWNLOADABLE SOFTWARE ALLOWING WEB SITE USERS TO SEARCH FOR, RESEARCH, PURCHASE AND SELL MOTORIZED VEHICLES (U.S. CLS. 100 AND 101). FIRST USE 4-15-2011; IN COMMERCE 4-15-2011.

CLASS 2—PAINTS

FOR RUST PREVENTION AND CORROSION CONTROL PREPARATIONS IN THE NATURE OF A COATING (U.S. CLS. 6, 11 AND 16).
FIRST USE 1-31-2003; IN COMMERCE 1-31-2003.

CLASS 3—COSMETICS AND CLEANING PREPARATIONS

FOR CLEANING PREPARATION FOR USE ON METAL SURFACES; CONTACT CLEANERS FOR REMOVAL OF RUST ON METALS (U.S. CLS. 1, 4, 6, 50, 51 AND 52).
FIRST USE 1-31-2003; IN COMMERCE 1-31-2003.

CLASS 4—LUBRICANTS AND FUELS

FOR ALL PURPOSE PENETRATING AND LUBRICATING OIL (U.S. CLS. 1, 6 AND 15).
FIRST USE 1-31-2003; IN COMMERCE 1-31-2003.

4,165,584. JOHNSON & JOHNSON, NEW BRUNSWICK, NJ. SN 85-281,962. PUB. 8-30-2011, FILED 3-31-2011.

DTIME

THE MARK CONSISTS OF STANDARD CHARACTERS WITHOUT CLAIM TO ANY PARTICULAR FONT, STYLE, SIZE, OR COLOR.

CLASS 9—ELECTRICAL AND SCIENTIFIC APPARATUS

FOR VIDEO RECORDINGS FEATURING INFORMATION ON DIABETES (U.S. CLS. 21, 23, 26, 36 AND 38).
FIRST USE 6-29-2011; IN COMMERCE 6-29-2011.

CLASS 44—MEDICAL, BEAUTY AND AGRICULTURAL SERVICES

FOR PROVIDING INFORMATION RELATED TO DIABETES (U.S. CLS. 100 AND 101).
FIRST USE 6-29-2011; IN COMMERCE 6-29-2011.

4,165,587. GLT FOODS, LLC, DBA FRIENDS FOODS, IRVINE, CA. SN 85-282,905. PUB. 9-6-2011, FILED 3-31-2011.

GOFIT

THE MARK CONSISTS OF STANDARD CHARACTERS WITHOUT CLAIM TO ANY PARTICULAR FONT, STYLE, SIZE, OR COLOR.

CLASS 29—MEATS AND PROCESSED FOODS

FOR VEGGIE BURGER PATTIES, VEGETABLE-BASED MEAT SUBSTITUTES (U.S. CL. 46).
FIRST USE 3-0-2011; IN COMMERCE 3-0-2011.

CLASS 30—STAPLE FOODS

FOR VEGGIE BURGER SANDWICHES (U.S. CL. 46).
FIRST USE 3-0-2011; IN COMMERCE 3-0-2011.

4,165,603. SPANFELLER MEDIA GROUP, INC., NEW YORK, NY. SN 85-284,701. PUB. 8-30-2011, FILED 4-3-2011.



NO CLAIM IS MADE TO THE EXCLUSIVE RIGHT TO USE "MEAL" AND "FOOD & DRINK", APART FROM THE MARK AS SHOWN.

THE MARK CONSISTS OF THE WORDS "THE DAILY MEAL" WITH THE WORDS "ALL THINGS FOOD & DRINK" UNDERNEATH THEM, ALL OF THE FOREGOING TO THE RIGHT OF AN ILLUSTRATION OF A PLATE WITH A FORK AND KNIFE ON IT.

CLASS 35—ADVERTISING AND BUSINESS

FOR ADVERTISING AND BUSINESS SERVICES, NAMELY, PROVIDING AN ONLINE WEBSITE WHERE ADVERTISERS, MARKETERS, AND CONTENT PROVIDERS CAN INTERACT WITH USERS FOR ADVERTISING, BRANDING, AND PROMOTING KNOWLEDGE, PRODUCTS AND SERVICES, ON BEHALF OF THEMSELVES AND OTHERS, AND FOR EVALUATING AND RATING THE SAME, ALL THE FOREGOING RELEVANT TO FOOD-RELATED TOPICS; PROVIDING A WEBSITE FOR CONNECTING SELLERS WITH BUYERS IN THE FIELD OF FOOD AND FOOD-RELATED PRODUCTS AND SERVICES (U.S. CLS. 100, 101 AND 102).
FIRST USE 10-15-2010; IN COMMERCE 10-15-2010.

CLASS 41—EDUCATION AND ENTERTAINMENT

FOR ON-LINE JOURNALS, NAMELY, BLOGS FEATURING FOOD, WINE AND RESTAURANTS AND OTHER FOOD-RELATED TOPICS (U.S. CLS. 100, 101 AND 107).
FIRST USE 1-24-2012; IN COMMERCE 1-24-2012.

CLASS 43—HOTEL AND RESTAURANT SERVICES

FOR PROVIDING A WEBSITE FEATURING NEWS AND INFORMATION IN THE FIELD OF FOOD AND WINE IN THE FORM OF RESTAURANT MEALS; PROVIDING A WEBSITE FEATURING INFORMATION ABOUT FOOD AND WINE PAIRING; PROVIDING A WEBSITE FEATURING INFORMATION ABOUT RESTAURANTS; PROVIDING AN INTERACTIVE WEBSITE IN THE FIELD OF RECIPES (U.S. CLS. 100 AND 101).
FIRST USE 10-15-2010; IN COMMERCE 10-15-2010.

4,165,615. AERO PNEUDRAULICS, INC., TORRANCE, CA. SN 85-286,955. PUB. 8-9-2011, FILED 4-5-2011.

AEROWORX

THE MARK CONSISTS OF STANDARD CHARACTERS WITHOUT CLAIM TO ANY PARTICULAR FONT, STYLE,

SIZE, OR COLOR.

CLASS 6—METAL GOODS

FOR HIGH PERFORMANCE AIRCRAFT PARTS, NAMELY, METAL HOSES, METAL HOSE ENDS, METAL HOSE FITTINGS, METAL ADAPTOR FITTINGS, METAL GASKETS, AND METAL PIPE FITTINGS (U.S. CLS. 2, 12, 13, 14, 23, 25 AND 50).
FIRST USE 8-2-2011; IN COMMERCE 8-2-2011.

CLASS 35—ADVERTISING AND BUSINESS

FOR RETAIL STORE SERVICES FEATURING AIRCRAFT PARTS (U.S. CLS. 100, 101 AND 102).
FIRST USE 8-2-2011; IN COMMERCE 8-2-2011.

CLASS 37—CONSTRUCTION AND REPAIR

FOR AIRCRAFT REPAIR AND MAINTENANCE; AND REBUILDING OF AIRCRAFT PARTS (U.S. CLS. 100, 103 AND 106).
FIRST USE 8-2-2011; IN COMMERCE 8-2-2011.

4,165,618. TRAKLOK CORPORATION, KNOXVILLE, TN. SN 85-287,710. PUB. 9-27-2011, FILED 4-6-2011.

YARD DOG

THE MARK CONSISTS OF STANDARD CHARACTERS WITHOUT CLAIM TO ANY PARTICULAR FONT, STYLE, SIZE, OR COLOR.

CLASS 9—ELECTRICAL AND SCIENTIFIC APPARATUS

FOR ELECTRONIC LOCK ASSEMBLIES COMPRISING A TRANSMISSION MEANS FOR MONITORING, LOCATING, TRACKING, AND SECURING STORAGE CONTAINERS (U.S. CLS. 21, 23, 26, 36 AND 38).
FIRST USE 4-12-2012; IN COMMERCE 4-12-2012.

CLASS 35—ADVERTISING AND BUSINESS

FOR MONITORING OF STORAGE CONTAINERS, NAMELY, PROVIDING TRACKING SERVICES AND INFORMATION REGARDING THE STATUS OF ELECTRONIC ASSEMBLIES FOR STORAGE CONTAINERS (U.S. CLS. 100, 101 AND 102).
FIRST USE 4-12-2012; IN COMMERCE 4-12-2012.

4,165,619. AFFINITY HEALTH SYSTEM, MENASHA, WI. SN 85-287,793. PUB. 9-6-2011, FILED 4-6-2011.

@AFFINITY

THE MARK CONSISTS OF STANDARD CHARACTERS WITHOUT CLAIM TO ANY PARTICULAR FONT, STYLE, SIZE, OR COLOR.

CLASS 16—PAPER GOODS AND PRINTED MATTER

FOR PROVIDING PRINTED INSTRUCTIONAL AND EDUCATIONAL MATERIALS FOR PATIENTS AND THE PUBLIC RELATING TO HEALTH AND WELLNESS, THE ENVIRONMENT, DIET AND NUTRITION (U.S. CLS. 2, 5, 22, 23, 29, 37, 38 AND 50).
FIRST USE 7-18-2011; IN COMMERCE 7-18-2011.

CLASS 41—EDUCATION AND ENTERTAINMENT

FOR PROVIDING ONLINE INSTRUCTIONAL AND EDUCATIONAL MATERIALS FOR PATIENTS AND THE PUBLIC RELATING TO HEALTH AND WELLNESS, THE ENVIRONMENT, DIET AND NUTRITION (U.S. CLS. 100, 101 AND 107).
FIRST USE 7-18-2011; IN COMMERCE 7-18-2011.

4,165,620. G100 INC., DBA G100, ASPEN, CO. SN 85-287,963. PUB. 8-30-2011, FILED 4-6-2011.

G100

THE MARK CONSISTS OF STANDARD CHARACTERS WITHOUT CLAIM TO ANY PARTICULAR FONT, STYLE, SIZE, OR COLOR.

OWNER OF U.S. REG. NO. 2,882,372.

CLASS 35—ADVERTISING AND BUSINESS

FOR BUSINESS NETWORKING SERVICES (U.S. CLS. 100, 101 AND 102).
FIRST USE 0-0-2002; IN COMMERCE 0-0-2002.

CLASS 41—EDUCATION AND ENTERTAINMENT

FOR ARRANGING AND CONDUCTING EDUCATIONAL MEETINGS FOR EXECUTIVES AND BUSINESS LEADERS TO SHARE IDEAS AND GAIN INSIGHTS ABOUT LEADERSHIP, MANAGEMENT, AND GLOBAL BUSINESS; BUSINESS EDUCATION AND TRAINING SERVICES; NAMELY, DEVELOPING AND FACILITATING EDUCATIONAL DISCUSSIONS ON ISSUES FACING CORPORATE LEADERSHIP AND PROVIDING BUSINESS EDUCATION PROGRAMS AND EDUCATIONAL KEYNOTE PRESENTATIONS TO CORPORATE EXECUTIVES; ARRANGING OF SEMINARS; MENTORING IN THE FIELD OF CORPORATE LEADERSHIP AND MANAGEMENT (U.S. CLS. 100, 101 AND 107).
FIRST USE 0-0-2002; IN COMMERCE 0-0-2002.

4,165,659. NATIONAL OVARIAN CANCER COALITION, INC., PLEASANTAN, CA. SN 85-298,245. PUB. 8-16-2011, FILED 4-18-2011.

BREAK THE SILENCE ON OVARIAN CANCER

THE MARK CONSISTS OF STANDARD CHARACTERS WITHOUT CLAIM TO ANY PARTICULAR FONT, STYLE, SIZE, OR COLOR.

CLASS 35—ADVERTISING AND BUSINESS

FOR ASSOCIATION SERVICES, NAMELY, PROMOTING THE INTERESTS OF THOSE WITH OVARIAN CANCER (U.S. CLS. 100, 101 AND 102).

FIRST USE 6-0-2011; IN COMMERCE 6-0-2011.

CLASS 44—MEDICAL, BEAUTY AND AGRICULTURAL SERVICES

FOR PROVIDING MEDICAL INFORMATION REGARDING OVARIAN CANCER TREATMENT AND THE DETECTION AND MANAGEMENT OF RELATED SYMPTOMS IN ORDER TO IMPROVE THE SURVIVAL RATE AND QUALITY OF LIFE FOR WOMEN WITH OVARIAN CANCER (U.S. CLS. 100 AND 101).

FIRST USE 6-0-2011; IN COMMERCE 6-0-2011.

CLASS 45—PERSONAL AND LEGAL SERVICES

FOR PROVIDING INFORMATION ABOUT HOW TO DEAL WITH AND PROCESS PERSONAL EMOTIONS RELATED TO OVARIAN CANCER TREATMENT IN ORDER TO IMPROVE THE SURVIVAL RATE AND QUALITY OF LIFE FOR WOMEN WITH OVARIAN CANCER (U.S. CLS. 100 AND 101).

FIRST USE 6-0-2011; IN COMMERCE 6-0-2011.

4,165,665. JMI SPORTSWEAR PTE. LTD., SINGAPORE, SINGAPORE. SN 85-299,798. PUB. 11-22-2011, FILED 4-20-2011.



THE MARK CONSISTS OF THE WORD "ONTIP" NEXT TO A SWIRL WITH A HORIZONTAL LINE LOCATED AT AND CROSSING THE CENTER OF THE SWIRL.

CLASS 9—ELECTRICAL AND SCIENTIFIC APPARATUS

FOR GLOVES SPECIALLY ADAPTED TO BE USED WITH TOUCH-SENSITIVE DEVICES, NAMELY, TOUCH PADS, TOUCH PANELS AND COMPUTER TOUCH SCREENS; COMPUTER STYLUSES FOR INTERACTING WITH TOUCH-SENSITIVE DEVICES; DEVICES FOR INTERACTING WITH TOUCH-SENSITIVE DEVICES, NAMELY, INSTRUMENTS TO FACILITATE OPERATING THE DEVICES IN THE NATURE OF A STYLUS-TYPE DEVICE THAT IS ATTACHED TO THE HAND FOR USE IN CONJUNCTION WITH PERSONAL DIGITAL ASSISTANTS, SMARTPHONES AND HANDHELD COMPUTERS (U.S. CLS. 21, 23, 26, 36 AND 38).

FIRST USE 7-25-2011; IN COMMERCE 7-25-2011.

CLASS 25—CLOTHING

FOR CLOTHING, NAMELY, GLOVES INCORPORATING TOUCH-SENSITIVE TECHNOLOGY (U.S. CLS. 22 AND 39).

FIRST USE 7-25-2011; IN COMMERCE 7-25-2011.

4,165,666. JMI SPORTSWEAR PTE. LTD., SINGAPORE, SINGAPORE. SN 85-299,842. PUB. 11-15-2011, FILED 4-20-2011.

ONTIP

THE MARK CONSISTS OF STANDARD CHARACTERS WITHOUT CLAIM TO ANY PARTICULAR FONT, STYLE, SIZE, OR COLOR.

CLASS 9—ELECTRICAL AND SCIENTIFIC APPARATUS

FOR GLOVES SPECIALLY ADAPTED TO BE USED WITH TOUCH-SENSITIVE DEVICES, NAMELY, TOUCH PADS, TOUCH PANELS AND COMPUTER TOUCH SCREENS; COMPUTER STYLUSES FOR INTERACTING WITH TOUCH-SENSITIVE DEVICES; DEVICES FOR INTERACTING WITH TOUCH-SENSITIVE DEVICES, NAMELY, INSTRUMENTS TO FACILITATE OPERATING THE DEVICES IN THE NATURE OF A STYLUS-TYPE DEVICE THAT IS ATTACHED TO THE HAND FOR USE IN CONJUNCTION WITH PERSONAL DIGITAL ASSISTANTS, SMARTPHONES AND HANDHELD COMPUTERS (U.S. CLS. 21, 23, 26, 36 AND 38).

FIRST USE 7-25-2011; IN COMMERCE 7-25-2011.

CLASS 25—CLOTHING

FOR CLOTHING, NAMELY, GLOVES INCORPORATING TOUCH-SENSITIVE TECHNOLOGY (U.S. CLS. 22 AND 39).

FIRST USE 7-25-2011; IN COMMERCE 7-25-2011.

4,165,669. PHOENIX PRODUCTS COMPANY, TERRYVILLE, CT. SN 85-300,722. PUB. 9-6-2011, FILED 4-21-2011.



THE MARK CONSISTS OF THE WORD "PURACIL" UNDERLINED IN A STYLIZED MANNER WITH A CIRCLE LAYERED OVER THE LETTERS "PUR".

CLASS 1—CHEMICALS

FOR CHEMICALS FOR SWIMMING POOLS AND SPAS, NAMELY, CLARIFIERS, PEROXIDE SHOCKS, CHELATING AGENTS, CHLORINE AND BROMINE REMOVERS, AND PH BALANCERS, AND STABILIZERS; ENZYMES FOR USE IN SWIMMING POOLS AND SPAS (U.S. CLS. 1, 5, 6, 10, 26 AND 46).

FIRST USE 5-17-2011; IN COMMERCE 5-17-2011.

CLASS 5—PHARMACEUTICALS

FOR SANITIZERS AND ALGAEICIDES FOR USE IN SWIMMING POOLS AND SPAS (U.S. CLS. 6, 18, 44, 46, 51 AND 52).

FIRST USE 5-17-2011; IN COMMERCE 5-17-2011.

4,165,693. BROWN, WESLEY B., LOS ANGELES, CA. SN 85-310,330. PUB. 9-20-2011, FILED 5-2-2011.

eyedee

THE MARK CONSISTS OF STANDARD CHARACTERS WITHOUT CLAIM TO ANY PARTICULAR FONT, STYLE, SIZE, OR COLOR.

CLASS 9—ELECTRICAL AND SCIENTIFIC APPARATUS

FOR COMPUTER APPLICATION SOFTWARE FOR MOBILE PHONES, NAMELY, SOFTWARE FOR TAKING AND SUBMITTING PHOTOGRAPHS TO A PARTICULAR WEBSITE, AND FOR VIEWING PHOTOGRAPHS SUBMITTED BY OTHER USERS TO THE SAME WEBSITE (U.S. CLS. 21, 23, 26, 36 AND 38).
FIRST USE 8-25-2011; IN COMMERCE 8-25-2011.

CLASS 41—EDUCATION AND ENTERTAINMENT

FOR ENTERTAINMENT SERVICES, NAMELY, PROVIDING A WEB SITE FEATURING NON-DOWNLOADABLE MUSICAL PERFORMANCES, MUSICAL VIDEOS, RELATED FILM CLIPS, PHOTOGRAPHS, AND OTHER MULTIMEDIA MATERIALS FEATURING PHOTOGRAPHS TAKEN BY MOBILE PHONE USERS FOR ENTERTAINMENT AND INFORMATIONAL PURPOSES (U.S. CLS. 100, 101 AND 107).
FIRST USE 8-25-2011; IN COMMERCE 8-25-2011.

4,165,696. LESHER, ROBERT MICHAEL, CORONA DEL MAR, CA. SN 85-311,160. PUB. 8-23-2011, FILED 5-3-2011.

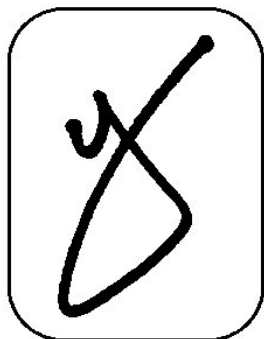

THE MARK CONSISTS OF A HAND DESIGNED "Y" INSIDE A SQUARE BOX WITH A PINLINE AROUND OUTSIDE OF BOX.

CLASS 35—ADVERTISING AND BUSINESS

FOR ON-LINE BUSINESS NETWORKING SERVICES; ON-LINE RETAIL STORE SERVICES FEATURING A WIDE VARIETY OF CONSUMER GOODS OF OTHERS (U.S. CLS. 100, 101 AND 102).
FIRST USE 4-22-2011; IN COMMERCE 4-22-2011.

CLASS 45—PERSONAL AND LEGAL SERVICES

FOR ON-LINE SOCIAL NETWORKING SERVICES (U.S. CLS. 100 AND 101).
FIRST USE 4-22-2011; IN COMMERCE 4-22-2011.

4,165,720. NEBRASKA FURNITURE MART, INC, OMAHA, NE. SN 85-325,311. PUB. 11-8-2011, FILED 5-19-2011.

BERKSHIRE

THE MARK CONSISTS OF STANDARD CHARACTERS WITHOUT CLAIM TO ANY PARTICULAR FONT, STYLE, SIZE, OR COLOR.

CLASS 6—METAL GOODS

FOR METAL AUDIO, VIDEO AND COMPUTER WALL AND CEILING MOUNTS (U.S. CLS. 2, 12, 13, 14, 23, 25 AND 50).
FIRST USE 8-31-2011; IN COMMERCE 8-31-2011.

CLASS 9—ELECTRICAL AND SCIENTIFIC APPARATUS

FOR HOME THEATER SYSTEMS COMPRISING OF DVD PLAYERS, PORTABLE DVD PLAYERS, AUDIO AMPLIFIERS, AUDIO SPEAKERS AND PROJECTOR SCREENS; PORTABLE LISTENING DEVICES; PLASMA TELEVISIONS, PORTABLE TELEVISIONS, ELECTRONIC EQUIPMENT, NAMELY, CABLES USED IN CONNECTION WITH COMPUTERS, COMPUTER PERIPHERAL DEVICES, TELEVISIONS; AUDIO-VIDEO EQUIPMENT, NAMELY, AUDIO AMPLIFIERS, AUDIO-RECEIVERS, VIDEO-RECEIVERS AND PROJECTOR SCREENS; CLOSED-CIRCUIT TV EQUIPMENT, NAMELY, CAMERAS, SWITCHERS, MONITORS, MICRAPHONES, AND RECORDERS; TELECOMMUNICATION EQUIPMENT, NAMELY, AUTOMATIC SWITCHING APPARATUS, TELECOMMUNICATIONS TRANSMITTERS, TELEPHONES; AUDIO-VIDEO RECEIVERS (U.S. CLS. 21, 23, 26, 36 AND 38).
FIRST USE 8-31-2011; IN COMMERCE 8-31-2011.

4,165,729. JCES MANAGEMENT LLC, NEW YORK, NY. SN 85-330,682. PUB. 11-22-2011, FILED 5-26-2011.

KING & GROVE

THE MARK CONSISTS OF STANDARD CHARACTERS WITHOUT CLAIM TO ANY PARTICULAR FONT, STYLE, SIZE, OR COLOR.

CLASS 41—EDUCATION AND ENTERTAINMENT

FOR NIGHT CLUBS (U.S. CLS. 100, 101 AND 107).
FIRST USE 5-26-2011; IN COMMERCE 5-26-2011.

CLASS 43—HOTEL AND RESTAURANT SERVICES

FOR HOTEL, RESTAURANT, BAR, AND CATERING SERVICES (U.S. CLS. 100 AND 101).
FIRST USE 5-13-2011; IN COMMERCE 5-13-2011.

4,165,733. MARK ANTHONY INTERNATIONAL SRL, ST. MICHAEL, BARBADOS. SN 85-331,546. PUB. 9-13-2011, FILED 5-26-2011.

CLASS 42—SCIENTIFIC AND COMPUTER SERVICES

FOR APPLICATION SERVICE PROVIDER (ASP) SERVICES FEATURING COMPUTER SOFTWARE FOR TRANSMISSION OF VOICE, DATA, GRAPHICS, IMAGES, AUDIO AND VIDEO BY MEANS OF TELECOMMUNICATIONS NETWORKS, WIRELESS COMMUNICATION NETWORKS, AND THE INTERNET; INFORMATION RELATING TO COMPUTER HARDWARE OR SOFTWARE PROVIDED ON-LINE FROM A GLOBAL COMPUTER NETWORK OR THE INTERNET (U.S. CLS. 100 AND 101).

FIRST USE 10-10-2011; IN COMMERCE 10-10-2011.

HARD. AND THEN SOME.

THE MARK CONSISTS OF STANDARD CHARACTERS WITHOUT CLAIM TO ANY PARTICULAR FONT, STYLE, SIZE, OR COLOR.

NO CLAIM IS MADE TO THE EXCLUSIVE RIGHT TO USE "HARD", APART FROM THE MARK AS SHOWN.

CLASS 32—LIGHT BEVERAGES

FOR FLAVORED BREWED MALT-BASED ALCOHOLIC BEVERAGES IN THE NATURE OF BEER (U.S. CLS. 45, 46 AND 48).

FIRST USE 1-22-2009; IN COMMERCE 1-22-2009.

CLASS 33—WINES AND SPIRITS

FOR ALCOHOLIC FLAVORED MALT COOLERS (U.S. CLS. 47 AND 49).

FIRST USE 1-22-2009; IN COMMERCE 1-22-2009.

4,165,739. TIBCO SOFTWARE INC., PALO ALTO, CA. SN 85-337,969. PUB. 10-25-2011, FILED 6-3-2011.

TIBCAST

THE MARK CONSISTS OF STANDARD CHARACTERS WITHOUT CLAIM TO ANY PARTICULAR FONT, STYLE, SIZE, OR COLOR.

OWNER OF U.S. REG. NOS. 1,659,536, 2,770,804, AND OTHERS.

CLASS 38—COMMUNICATION

FOR COMMUNICATION AND TELECOMMUNICATION SERVICES, NAMELY, TRANSMISSION OF VOICE, DATA, GRAPHICS, IMAGES, AUDIO AND VIDEO BY MEANS OF TELECOMMUNICATIONS NETWORKS, WIRELESS COMMUNICATION NETWORKS, AND THE INTERNET (U.S. CLS. 100, 101 AND 104).

FIRST USE 10-10-2011; IN COMMERCE 10-10-2011.

4,165,744. LIGHT OF HEALING HOPE FOUNDATION, WASHINGTON, DC. SN 85-338,938. PUB. 11-1-2011, FILED 6-6-2011.

LIGHT OF HEALING HOPE FOUNDATION

THE MARK CONSISTS OF STANDARD CHARACTERS WITHOUT CLAIM TO ANY PARTICULAR FONT, STYLE, SIZE, OR COLOR.

NO CLAIM IS MADE TO THE EXCLUSIVE RIGHT TO USE "FOUNDATION", APART FROM THE MARK AS SHOWN.

CLASS 9—ELECTRICAL AND SCIENTIFIC APPARATUS

FOR COMPACT DISKS CONTAINING MUSIC AND THE SPOKEN WORD IN THE FORM OF POETRY; AUDIO AND VIDEO RECORDINGS CONTAINING ARTISTIC PERFORMANCES (U.S. CLS. 21, 23, 26, 36 AND 38).

FIRST USE 8-10-2011; IN COMMERCE 8-10-2011.

CLASS 16—PAPER GOODS AND PRINTED MATTER

FOR STATIONERY, NOTECARDS, BOOKMARKS, PENS, BLANK JOURNALS; KITS COMPRISED PRIMARILY OF STATIONERY, NOTECARDS, BOOKMARKS, PENS OR BLANK JOURNALS (U.S. CLS. 2, 5, 22, 23, 29, 37, 38 AND 50).

FIRST USE 8-10-2011; IN COMMERCE 8-10-2011.

CLASS 41—EDUCATION AND ENTERTAINMENT

FOR CONDUCTING WORKSHOPS ON THE SUBJECT OF HEALTH AND HEALING THROUGH POETRY; MOTION PICTURE PRODUCTION; CHARITABLE SERVICES, NAMELY, PROVIDING BOOKS AND WRITING MATERIALS TO MEDICAL PATIENTS (U.S. CLS. 100, 101 AND 107).

FIRST USE 8-10-2011; IN COMMERCE 8-10-2011.

4,165,745. WASTE MANAGEMENT, INC., HOUSTON, TX. SN 85-339,661. PUB. 2-28-2012, FILED 6-7-2011.

M2Z

THE MARK CONSISTS OF STANDARD CHARACTERS WITHOUT CLAIM TO ANY PARTICULAR FONT, STYLE, SIZE, OR COLOR.

OWNER OF U.S. REG. NOS. 3,779,499 AND 3,908,303.

CLASS 9—ELECTRICAL AND SCIENTIFIC APPARATUS

FOR MAGNETS; DIGITAL AUDIO RECORDERS; DIGITAL VIDEO RECORDERS; PERSONAL COMPUTERS; MEMORY CARDS; ROLLING COMPUTER CASES; COMPUTER SHOULDER BAGS; DVDS FEATURING INFORMATION ABOUT WASTE MANAGEMENT SAFETY AND HEALTH RULES; SAFETY TRAINING MATERIALS; USB HARDWARE; USB CABLES; USB HUBS (U.S. CLS. 21, 23, 26, 36 AND 38).

FIRST USE 10-10-2006; IN COMMERCE 10-10-2006.

CLASS 16—PAPER GOODS AND PRINTED MATTER

FOR STATIONERY; PRINTED BROCHURES, GUIDES, CHARTS, POSTERS, FORMS AND MAGAZINES AND PAMPHLETS, NAMELY, IN THE FIELD OF SAFETY AND HEALTH; RING BINDERS; PAPER BAGS FOR PACKAGING MERCHANDISE OR GIFTS; PLASTIC BAGS FOR PACKAGING MERCHANDISE OR GIFTS; PADFOLIOS; CALENDARS; PERSONAL ORGANIZERS; BUMPER STICKERS; GREETING CARDS; PRINTED EDUCATIONAL MATERIALS IN THE FIELD OF SAFETY AND HEALTH AWARENESS IN THE WASTE AND TRASH FIELDS; ADHESIVE NOTEPADS; NOTE CARDS; LUNCH BAGS (U.S. CLS. 2, 5, 22, 23, 29, 37, 38 AND 50).

FIRST USE 3-4-2004; IN COMMERCE 3-4-2004.

CLASS 18—LEATHER GOODS

FOR ALL PURPOSE CARRYING BAGS; DUFFEL BAGS; BACK PACKS; LUGGAGE; LUGGAGE TAGS; UMBRELLAS; GOLF UMBRELLAS; CLOTH SHOPPING BAGS (U.S. CLS. 1, 2, 3, 22 AND 41).

FIRST USE 2-22-2005; IN COMMERCE 2-22-2005.

4,165,753. CMERIT USA, INC., CHINO, CA. SN 85-343,973. PUB. 11-1-2011, FILED 6-11-2011.

EVOS

THE MARK CONSISTS OF STANDARD CHARACTERS WITHOUT CLAIM TO ANY PARTICULAR FONT, STYLE, SIZE, OR COLOR.

CLASS 18—LEATHER GOODS

FOR ALL-PURPOSE CARRYING BAGS, ATHLETIC BAGS, BRIEFCASES AND ATTACHE CASES, BACK-PACKS WITH ROLLING WHEELS, CARRY-ALL BAGS, CARRY-ON BAGS, CLUTCH PURSES, FLIGHT BAGS, GARMENT BAGS FOR TRAVEL, HANDBAGS, LUGGAGE AND TRUNKS, OVERNIGHT BAGS, OVERNIGHT SUITCASES, TOTE BAGS, SUITCASES, WHEELED DUFFLE BAGS, WHEELED TOTE BAGS, WHEELED BAGS (U.S. CLS. 1, 2, 3, 22 AND 41).

FIRST USE 1-1-2012; IN COMMERCE 1-1-2012.

CLASS 25—CLOTHING

FOR FOOTWEAR, SHOES (U.S. CLS. 22 AND 39). FIRST USE 1-1-2012; IN COMMERCE 1-1-2012.

4,165,775. ALBER, WILLIAM F., SAN FRANCISCO, CA. SN 85-356,186. PUB. 11-15-2011, FILED 6-25-2011.



OWNER OF U.S. REG. NOS. 3,428,963, 3,586,545, AND OTHERS.

NO CLAIM IS MADE TO THE EXCLUSIVE RIGHT TO USE "GREENCLEAN", APART FROM THE MARK AS SHOWN.

THE COLOR(S) GREEN AND LIGHT GREEN IS/ARE CLAIMED AS A FEATURE OF THE MARK.

THE MARK CONSISTS OF THE COMBINED WORDS "GREENCLEAN" AND TWO CONCENTRIC CIRCLES CENTERED ABOVE THEM. THE COLOR GREEN APPEARS IN THE OUTERMOST CIRCLE AND IN THE LETTERS "CLEAN". THE COLOR LIGHT GREEN APPEARS IN THE INNERMOST CIRCLE AND IN THE LETTERS "GREEN".

CLASS 37—CONSTRUCTION AND REPAIR

FOR CLEANING OF CLOTHING; DRY CLEANING; LAUNDRY SERVICES (U.S. CLS. 100, 103 AND 106).

FIRST USE 6-24-2011; IN COMMERCE 12-16-2011.

CLASS 39—TRANSPORTATION AND STORAGE

FOR LAUNDRY PICK-UP AND DELIVERY SERVICES (U.S. CLS. 100 AND 105).

FIRST USE 6-24-2011; IN COMMERCE 12-16-2011.

4,165,794. OVATIONS FOOD SERVICES, L.P., LUTZ, FL. SN 85-363,899. PUB. 2-7-2012, FILED 7-6-2011.

COUNTRYVILLE

THE MARK CONSISTS OF STANDARD CHARACTERS

WITHOUT CLAIM TO ANY PARTICULAR FONT, STYLE, SIZE, OR COLOR.

CLASS 25—CLOTHING

FOR CLOTHING, NAMELY, SHIRTS, T-SHIRTS, PULLOVERS, SWEAT SHIRTS, PANTS, SHORTS, SOCKS, HATS, AND JACKETS (U.S. CLS. 22 AND 39);
FIRST USE 11-23-2011; IN COMMERCE 11-23-2011.

CLASS 43—HOTEL AND RESTAURANT SERVICES

FOR RESTAURANT AND BAR SERVICES (U.S. CLS. 100 AND 101).
FIRST USE 10-13-2011; IN COMMERCE 11-23-2011.

4,165,795. OVATIONS FOOD SERVICES, L.P., LUTZ, FL. SN 85-363,919. PUB. 2-7-2012, FILED 7-6-2011.



NO CLAIM IS MADE TO THE EXCLUSIVE RIGHT TO USE "BAR & GRILL", APART FROM THE MARK AS SHOWN.

THE MARK CONSISTS OF THE MARK "COUNTRYVILLE BAR & GRILL" IN AN ELLIPTICAL SHAPE WITH STARS AND WAVY LINES ABOVE AND BELOW.

CLASS 25—CLOTHING

FOR CLOTHING, NAMELY, SHIRTS, T-SHIRTS, PULLOVERS, SWEAT SHIRTS, PANTS, SHORTS, SOCKS, HATS, AND JACKETS (U.S. CLS. 22 AND 39);
FIRST USE 11-23-2011; IN COMMERCE 11-23-2011.

CLASS 43—HOTEL AND RESTAURANT SERVICES

FOR RESTAURANT AND BAR SERVICES (U.S. CLS. 100 AND 101).
FIRST USE 10-13-2011; IN COMMERCE 11-23-2011.

4,165,796. GOT POWER, INC., MARTINEZ, CA. SN 85-364,321. PUB. 1-10-2012, FILED 7-6-2011.

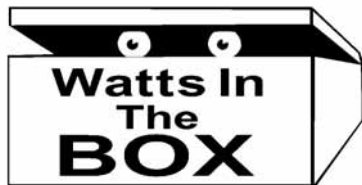

THE MARK CONSISTS OF A THREE DIMENSIONAL BOX WITH OPEN LID AND TWO EYES PEKING OUT WITH THE PHRASE "WATTS IN THE BOX" APPEARING UPON THE FRONT OF THE BOX.

CLASS 37—CONSTRUCTION AND REPAIR

FOR INSTALLATION AND REPAIR OF ELECTRICITY GENERATORS (U.S. CLS. 100, 103 AND 106).
FIRST USE 2-1-2012; IN COMMERCE 2-1-2012.

CLASS 40—MATERIAL TREATMENT

FOR RENTAL OF ELECTRICITY GENERATORS (U.S. CLS. 100, 103 AND 106).
FIRST USE 2-1-2012; IN COMMERCE 2-1-2012.

4,165,801. UNITED STATES POSTAL SERVICE, WASHINGTON, DC. SN 85-366,383. PUB. 9-27-2011, FILED 7-8-2011.

FIRST-CLASS PACKAGE RETURN

THE MARK CONSISTS OF STANDARD CHARACTERS WITHOUT CLAIM TO ANY PARTICULAR FONT, STYLE, SIZE, OR COLOR.

OWNER OF U.S. REG. NOS. 1,094,739, 3,683,505, AND 3,796,195.

NO CLAIM IS MADE TO THE EXCLUSIVE RIGHT TO USE "PACKAGE RETURN", APART FROM THE MARK AS SHOWN.

CLASS 35—ADVERTISING AND BUSINESS

FOR SORTING, HANDLING, AND RECEIVING PACKAGES AND LETTERS (U.S. CLS. 100, 101 AND 102).
FIRST USE 10-0-2011; IN COMMERCE 10-0-2011.

CLASS 39—TRANSPORTATION AND STORAGE

FOR PICKUP, TRANSPORTATION AND DELIVERY OF PACKAGES AND DOCUMENTS BY VARIOUS MODES OF TRANSPORTATION (U.S. CLS. 100 AND 105).
FIRST USE 10-0-2011; IN COMMERCE 10-0-2011.

4,165,806. QUALICARE FRANCHISE CORPORATION, TORONTO, ONTARIO, CANADA. SN 85-370,487. PUB. 12-6-2011, FILED 7-13-2011.



THE MARK CONSISTS OF THE WORD "QUALICARE" TO THE LEFT OF THE NUMBER "360," WITH A DEGREE SIGN TO THE IMMEDIATE RIGHT OF THE "0" IN "360".

CLASS 35—ADVERTISING AND BUSINESS

FOR RECRUITMENT AND PLACEMENT OF PERSONNEL IN THE FIELD OF NURSING AND HEALTH CARE; RETAIL SERVICES BY DIRECT SOLICITATION BY SALES AGENTS IN THE FIELD OF MEDICAL EQUIPMENT AND SUPPLIES (U.S. CLS. 100, 101 AND 102).
FIRST USE 11-18-2011; IN COMMERCE 11-18-2011.

CLASS 44—MEDICAL, BEAUTY AND AGRICULTURAL SERVICES

FOR HOME HEALTH CARE SERVICES; NURSING SERVICES AND HOME NURSING AID SERVICES; PROVIDING LIMITED IN-HOME PERSONAL MEDICAL SERVICES FOR INDIVIDUALS, INCLUDING CHECKING VITAL SIGNS, MED COMPLIANCE AND INDIVIDUAL HYGIENE, SCHEDULING DOCTOR APPOINTMENTS, PICKING UP PRESCRIPTIONS, CHECKING MEDICAL EQUIPMENT AND SUPPLIES AND PROVIDING ON-LINE INFORMATION RELATED TO THE PERSONAL MEDICAL SERVICES (U.S. CLS. 100 AND 101).

FIRST USE 11-18-2011; IN COMMERCE 11-18-2011.

CLASS 45—PERSONAL AND LEGAL SERVICES

FOR IN-HOME SUPPORT SERVICES TO SENIOR PERSONS, NAMELY, GERIATRIC CARE MANAGEMENT SERVICES AND PERSONAL AFFAIRS MANAGEMENT SERVICES IN THE NATURE OF THE COORDINATION OF NECESSARY SERVICES AND CARE FOR OLDER INDIVIDUALS; PROVIDING NON-MEDICAL PERSONAL ASSISTANT SERVICES FOR OTHERS IN THE NATURE OF PLANNING, ORGANIZING, COORDINATING, ARRANGING AND ASSISTING INDIVIDUALS TO PERFORM DAILY TASKS; PROVIDING NON-MEDICAL ASSISTED LIVING SERVICES FOR PERSONAL PURPOSES IN THE NATURE OF SCHEDULING APPOINTMENTS, ANSWERING THE TELEPHONE, CHECKING MESSAGES, MAIL SORTING, HANDLING AND RECEIVING, AND SECRETARIAL AND CLERICAL SERVICES; PERSONAL CARE ASSISTANCE OF ACTIVITIES OF DAILY LIVING, SUCH AS BATHING, GROOMING AND PERSONAL MOBILITY FOR MENTALLY AND PHYSICALLY CHALLENGED PEOPLE AND FOR THE ELDERLY; RUNNING ERRANDS FOR OTHERS; PERSONAL SHOPPING FOR OTHERS; PROVIDING PERSONAL SUPPORT SERVICES FOR FAMILIES OF PATIENTS WITH LIFE THREATENING DISORDERS AND OTHER ILLNESSES AND FAMILIES OF MENTALLY AND PHYSICALLY CHALLENGED INDIVIDUALS, NAMELY, COMPANIONSHIP, HELP WITH MEDICAL FORMS, COUNSELING AND EMOTIONAL SUPPORT (U.S. CLS. 100 AND 101).

FIRST USE 11-18-2011; IN COMMERCE 11-18-2011.

4,165,814. STEELWATERZ, LLC, CENTRE HALL, PA. SN 85-374,829. PUB. 1-24-2012, FILED 7-19-2011.



NO CLAIM IS MADE TO THE EXCLUSIVE RIGHT TO USE "STEEL WATERS" IN INTERNATIONAL CLASS 006 AND "WATERS" IN INTERNATIONAL CLASS 019, APART FROM THE MARK AS SHOWN.

THE COLOR(S) BLUE, YELLOW AND GRAY IS/ARE CLAIMED AS A FEATURE OF THE MARK.

THE MARK CONSISTS OF THE STYLIZED WORDING "STEEL WATERZ" APPEARING TO THE LEFT OF THE DEPICTION OF A TRIANGLE AND THREE STACKED TRAPEZOIDS. THE COLOR BLUE APPEARS IN THE DEPICTION OF THE THREE TRAPEZOIDS AS WELL AS THE LETTER "W" IN "WATERZ". THE COLOR YELLOW

APPEARS IN THE DECEPTION OF THE TRIANGLE AS WELL AS THE LETTER "S" IN "STEEL". THE LETTERS "TEEL" IN "STEEL" AS WELL AS "ATERZ" IN "WATERZ" APPEAR IN THE COLOR GRAY.

CLASS 6—METAL GOODS

FOR PORTABLE, FLEXIBLE STEEL-METAL DAMS FOR INDUSTRIAL AND CONSTRUCTION USE FOR USE IN THE ONSITE IMPOUNDMENT, STORAGE, CONTAINMENT OR SEPARATION OF FLUIDS (U.S. CLS. 2, 12, 13, 14, 23, 25 AND 50).

FIRST USE 7-20-2011; IN COMMERCE 7-25-2011.

CLASS 19—NON-METALLIC BUILDING MATERIALS

FOR PORTABLE, FLEXIBLE NON-METAL DAMS FOR INDUSTRIAL AND CONSTRUCTION USE FOR USE IN THE ONSITE IMPOUNDMENT, STORAGE, CONTAINMENT OR SEPARATION OF FLUIDS (U.S. CLS. 1, 12, 33 AND 50).

FIRST USE 7-20-2011; IN COMMERCE 7-25-2011.

4,165,825. WALLIS OIL COMPANY, INC., CUBA, MO. SN 85-379,521. PUB. 12-27-2011, FILED 7-25-2011.

ON THE WAY CAFE

THE MARK CONSISTS OF STANDARD CHARACTERS WITHOUT CLAIM TO ANY PARTICULAR FONT, STYLE, SIZE, OR COLOR.

NO CLAIM IS MADE TO THE EXCLUSIVE RIGHT TO USE "CAFE", APART FROM THE MARK AS SHOWN.

CLASS 35—ADVERTISING AND BUSINESS

FOR RETAIL CONVENIENCE STORES (U.S. CLS. 100, 101 AND 102).

FIRST USE 7-1-2011; IN COMMERCE 7-1-2011.

CLASS 43—HOTEL AND RESTAURANT SERVICES

FOR PROVIDING OF FOOD AND DRINK (U.S. CLS. 100 AND 101).

FIRST USE 7-1-2011; IN COMMERCE 7-1-2011.

4,165,838. ACTION AMERICA, INC., WILMINGTON, DE. SN 85-387,108. PUB. 2-7-2012, FILED 8-2-2011.

ACTION AMERICA

THE MARK CONSISTS OF STANDARD CHARACTERS WITHOUT CLAIM TO ANY PARTICULAR FONT, STYLE, SIZE, OR COLOR.

NO CLAIM IS MADE TO THE EXCLUSIVE RIGHT TO USE "AMERICA", APART FROM THE MARK AS SHOWN.

CLASS 25—CLOTHING

FOR CLOTHING, NAMELY, T-SHIRTS (U.S. CLS. 22 AND 39).
FIRST USE 9-0-2011; IN COMMERCE 9-0-2011.

CLASS 35—ADVERTISING AND BUSINESS

FOR PROMOTING PUBLIC AWARENESS OF TERRORIST ATTACKS AND THE VICTIMS OF TERRORIST ATTACKS, NATIONAL SECURITY, THE EVENTS OF 9/11, AND THE 9/11 MEMORIAL; CHARITABLE SERVICES, NAMELY, PROMOTING, ORGANIZING AND CONDUCTING VOLUNTEER PROGRAMS AND COMMUNITY SERVICE PROJECTS; PROMOTING PARTICIPATION IN CHARITABLE, COMMUNITY SERVICE AND EDUCATIONAL PROJECTS; PROMOTING THE CHARITABLE SERVICES OF OTHERS, NAMELY, PROVIDING INDIVIDUALS WITH INFORMATION FOR THE PURPOSE OF MAKING DONATIONS TO CHARITIES AND NON-PROFIT ORGANIZATIONS; PROMOTING PUBLIC AWARENESS OF CHARITIES AND NON-PROFIT ORGANIZATIONS OF OTHERS; PROMOTIONAL SERVICES, NAMELY, PROVIDING A WEBSITE FEATURING INFORMATION IN THE FIELD OF CHARITIES AND NON-PROFIT ORGANIZATIONS OF OTHERS; PROVIDING A WEBSITE ALLOWING USERS TO EXCHANGE AND SHARE EXPERIENCES, STORIES, AND IMAGES RELATED TO COMMUNITY SERVICE AND VOLUNTEER EXPERIENCES AND PROGRAMS (U.S. CLS. 100, 101 AND 102).

FIRST USE 9-0-2011; IN COMMERCE 9-0-2011.

4,165,842. NRG ENERGY, INC., PRINCETON, NJ. SN 85-389,831. PUB. 1-24-2012, FILED 8-4-2011.

energyservices
an NRG service

OWNER OF U.S. REG. NOS. 2,182,531, 3,925,126, AND OTHERS.

NO CLAIM IS MADE TO THE EXCLUSIVE RIGHT TO USE "ENERGYSERVICES" AND "SERVICE", APART FROM THE MARK AS SHOWN.

THE MARK CONSISTS OF THE WORD "ENERGYSERVICES" FOLLOWED BY A DESIGN OF THREE INTERLOCKING CROSSES WITH LIGHT TO DARK SHADING AND DIRECTLY BELOW THE WORDS "AN NRG SERVICE".

CLASS 35—ADVERTISING AND BUSINESS

FOR BUSINESS SERVICES, NAMELY, OPERATION OF RECIPROCATING ENGINE FACILITIES FOR OTHERS IN THE ELECTRIC GENERATION AND GAS COMPRESSION INDUSTRIES; RETAIL STORE AND WHOLESALE DISTRIBUTORSHIP SERVICES IN THE FIELD OF PARTS FOR ENGINES AND COMPRESSORS IN THE ELECTRIC GENERATION AND GAS COMPRESSION INDUSTRIES; BUSINESS CONSULTATION AND BUSINESS PROJECT MANAGEMENT SERVICES PROVIDED TO RECIPROCATING ENGINE FACILITIES IN THE ELECTRIC GENERATION AND GAS COMPRESSION INDUSTRIES IN THE AREAS OF MAINTENANCE, OVERHAUL AND OPERATION OF SUCH FACILITIES (U.S. CLS. 100, 101 AND 102).

FIRST USE 2-1-2012; IN COMMERCE 2-1-2012.

CLASS 37—CONSTRUCTION AND REPAIR

FOR MAINTENANCE AND OVERHAUL OF ENGINES, COMPRESSORS AND AUXILIARY EQUIPMENT FOR RECIPROCATING ENGINE FACILITIES IN THE ELECTRIC GENERATION AND GAS COMPRESSION INDUSTRIES (U.S. CLS. 100, 103 AND 106).

FIRST USE 2-1-2012; IN COMMERCE 2-1-2012.

4,165,844. GRUIDEL, RYAN, BOULDER, CO. AND GRUIDEL, DALTON, BOULDER, CO. AND KRAMER, COLE, BOULDER, CO. SN 85-390,732. PUB. 1-10-2012, FILED 8-5-2011.

**SEND
IT.** 

THE MARK CONSISTS OF THE STYLIZED TEXT "SEND IT.", WRITTEN IN TWO LINES AND WITH AN ENVELOPE AT THE END.

CLASS 16—PAPER GOODS AND PRINTED MATTER

FOR STICKERS (U.S. CLS. 2, 5, 22, 23, 29, 37, 38 AND 50).

FIRST USE 11-1-2010; IN COMMERCE 4-15-2011.

CLASS 25—CLOTHING

FOR HATS; JACKETS; PANTS; SHIRTS; SNOWBOARD JACKETS (U.S. CLS. 22 AND 39).

FIRST USE 2-10-2010; IN COMMERCE 4-15-2011.

4,165,856. CIRRUS THINKING LLC, NEW YORK, NY. SN 85-395,580. PUB. 1-10-2012, FILED 8-11-2011.

Dolly Drive

THE MARK CONSISTS OF STANDARD CHARACTERS WITHOUT CLAIM TO ANY PARTICULAR FONT, STYLE, SIZE, OR COLOR.

NO CLAIM IS MADE TO THE EXCLUSIVE RIGHT TO USE "DRIVE", APART FROM THE MARK AS SHOWN.

CLASS 9—ELECTRICAL AND SCIENTIFIC APPARATUS

FOR DOWNLOADABLE COMPUTER SOFTWARE FOR STORING ELECTRONIC DATA, INCLUDING BACKING UP AND ARCHIVING ELECTRONIC DATA (U.S. CLS. 21, 23, 26, 36 AND 38).

FIRST USE 1-1-2010; IN COMMERCE 7-1-2010.

CLASS 39—TRANSPORTATION AND STORAGE

FOR ELECTRONIC STORAGE OF DATA; STORAGE SERVICES FOR ARCHIVING DATABASES, IMAGES AND OTHER ELECTRONIC DATA (U.S. CLS. 100 AND 105).

FIRST USE 1-1-2010; IN COMMERCE 7-1-2010.

CLASS 42—SCIENTIFIC AND COMPUTER SERVICES

FOR REMOTE ONLINE BACK-UP OF ELECTRONIC DATA (U.S. CLS. 100 AND 101).

FIRST USE 1-1-2010; IN COMMERCE 7-1-2010.

4,165,861. DRESSER, KEVIN P, NEW PALTZ, NY. SN 85-397,337. PUB. 1-31-2012, FILED 8-13-2011.

Terminus

THE MARK CONSISTS OF STANDARD CHARACTERS WITHOUT CLAIM TO ANY PARTICULAR FONT, STYLE, SIZE, OR COLOR.

CLASS 9—ELECTRICAL AND SCIENTIFIC APPARATUS

FOR DOWNLOADABLE PRINTING FONTS; PRINTING FONTS THAT CAN BE DOWNLOADED PROVIDED BY MEANS OF ELECTRONIC TRANSMISSION; TYPEFACE FONTS RECORDED ON MAGNETIC MEDIA (U.S. CLS. 21, 23, 26, 36 AND 38).

FIRST USE 1-19-2012; IN COMMERCE 1-19-2012.

CLASS 16—PAPER GOODS AND PRINTED MATTER

FOR PRINTING FONTS (U.S. CLS. 2, 5, 22, 23, 29, 37, 38 AND 50).

FIRST USE 1-25-2012; IN COMMERCE 1-25-2012.

4,165,864. I LIFE WITH PURPOSE LLC, DBA 1PURPOSE, BOSTON, MA. SN 85-398,892. PUB. 2-7-2012, FILED 8-16-2011.



THE COLOR(S) DARK BLUE, LIGHT BLUE, ORANGE AND GREEN IS/ARE CLAIMED AS A FEATURE OF THE MARK.

THE MARK CONSISTS OF A TEXT LINE OF "1PURPOSE" IN DARK BLUE. A TEXT LINE OF "LIVE INSPIRED!" IN ORANGE. A DESIGN ELEMENT CONSISTING OF FOUR STYLIZE IMAGES OF PEOPLE IN DARK BLUE, GREEN,

ORANGE AND LIGHT BLUE ARRANGED IN A CIRCLE.

CLASS 35—ADVERTISING AND BUSINESS

FOR PROMOTING THE CHARITABLE GIVING OF OTHERS, NAMELY, TRACKING AND PUBLICIZING CHARITABLE DONATIONS AND RANDOM ACTS OF KINDNESS; PROMOTING THE CHARITABLE SERVICES OF OTHERS, NAMELY, PROVIDING INDIVIDUALS WITH INFORMATION ABOUT VARIOUS CHARITIES FOR THE PURPOSE OF MAKING DONATIONS TO CHARITIES (U.S. CLS. 100, 101 AND 102).

FIRST USE 6-25-2011; IN COMMERCE 6-25-2011.

CLASS 42—SCIENTIFIC AND COMPUTER SERVICES

FOR CHARITABLE SERVICES, NAMELY, PROVIDING A WEBSITE THAT FEATURES TECHNOLOGY THAT ENABLES USERS TO MAKE CHARITABLE CONTRIBUTIONS (U.S. CLS. 100 AND 101).

FIRST USE 6-25-2011; IN COMMERCE 6-25-2011.

4,165,870. THE PROCTER & GAMBLE COMPANY, CINCINNATI, OH. SN 85-401,240. PUB. 2-14-2012, FILED 8-18-2011.

STYLE UNITED

THE MARK CONSISTS OF STANDARD CHARACTERS WITHOUT CLAIM TO ANY PARTICULAR FONT, STYLE, SIZE, OR COLOR.

NO CLAIM IS MADE TO THE EXCLUSIVE RIGHT TO USE "STYLE", APART FROM THE MARK AS SHOWN.

CLASS 44—MEDICAL, BEAUTY AND AGRICULTURAL SERVICES

FOR BEAUTY CONSULTATION SERVICES IN THE SELECTION AND USE OF COSMETICS, FRAGRANCES, BEAUTY AIDS, PERSONAL CARE PRODUCTS, AND BATH, BODY AND BEAUTY PRODUCTS (U.S. CLS. 100 AND 101).

FIRST USE 1-11-2012; IN COMMERCE 1-11-2012.

CLASS 45—PERSONAL AND LEGAL SERVICES

FOR PROVIDING FASHION CONSULTING SERVICES AND NEWS AND INFORMATION IN THE FIELD OF FASHION (U.S. CLS. 100 AND 101).

FIRST USE 1-11-2012; IN COMMERCE 1-11-2012.

4,165,874. NRG ENERGY, INC., PRINCETON, NJ. SN 85-402,617. PUB. 1-24-2012, FILED 8-19-2011.



OWNER OF U.S. REG. NOS. 3,379,296, 3,940,229, AND OTHERS.

NO CLAIM IS MADE TO THE EXCLUSIVE RIGHT TO USE "INITIATIVE", APART FROM THE MARK AS SHOWN.

THE MARK CONSISTS OF THE LETTERS "ECO" IN LOWER CASE AND LIGHTER COLOR THEN THE LETTERS "NRG" IN LOWER CASE AND DARKER LETTERS FOLLOWED BY A DESIGN OF THREE INTERLOCKING CROSSES WITH LIGHT TO DARK SHADING AND DIRECTLY BELOW THE WORDS "AN NRG INITIATIVE".

CLASS 36—INSURANCE AND FINANCIAL

FOR CAPITAL INVESTMENT SERVICES FEATURING ENVIRONMENTALLY FOCUSED INVESTMENTS IN NEW LOW-CARBON TECHNOLOGIES SUCH AS WIND, COAL, GAS, AND POST CAPTURE TECHNOLOGIES IN THE GENERATION OF POWER (U.S. CLS. 100, 101 AND 102).

FIRST USE 4-1-2012; IN COMMERCE 4-1-2012.

CLASS 37—CONSTRUCTION AND REPAIR

FOR RENOVATION OF EXISTING POWER PLANTS UTILIZING TECHNOLOGY THAT REDUCES EMISSIONS AND REDUCES THEIR ENVIRONMENTAL FOOTPRINT (U.S. CLS. 100, 103 AND 106).

FIRST USE 4-1-2012; IN COMMERCE 4-1-2012.

CLASS 40—MATERIAL TREATMENT

FOR GENERATION OF POWER UTILIZING NEW LOW-CARBON TECHNOLOGIES, NAMELY, NUCLEAR, WIND, COAL, GAS, AND POST-COMBUSTION CAPTURE TECHNOLOGIES (U.S. CLS. 100, 103 AND 106).

FIRST USE 4-1-2012; IN COMMERCE 4-1-2012.

4,165,885. BIOMED REALTY TRUST, INC., SAN DIEGO, CA. SN 85-407,390. PUB. 11-8-2011, FILED 8-25-2011.

SPACE FOR INNOVATION

THE MARK CONSISTS OF STANDARD CHARACTERS WITHOUT CLAIM TO ANY PARTICULAR FONT, STYLE, SIZE, OR COLOR.

CLASS 36—INSURANCE AND FINANCIAL

FOR REAL ESTATE ACQUISITION, LEASING, AND MANAGEMENT SERVICES; REAL ESTATE INVESTMENT SERVICES; REAL ESTATE INVESTMENT TRUST SERVICES (U.S. CLS. 100, 101 AND 102).

FIRST USE 3-28-2012; IN COMMERCE 3-28-2012.

CLASS 37—CONSTRUCTION AND REPAIR

FOR REAL ESTATE DEVELOPMENT (U.S. CLS. 100, 103 AND 106).

FIRST USE 3-28-2012; IN COMMERCE 3-28-2012.

4,165,889. WALGREEN CO., DEERFIELD, IL. SN 85-413,813. PUB. 1-31-2012, FILED 9-2-2011.



OWNER OF U.S. REG. NOS. 3,268,858, 3,722,729, AND 3,921,113.

THE MARK CONSISTS OF THE WORDS "PET SHOPPE" WITH A STYLIZED ANIMAL PAW PRINT IN PLACE OF THE LETTER "O".

CLASS 16—PAPER GOODS AND PRINTED MATTER

FOR PLASTIC BAGS FOR DISPOSING OF PET WASTE; DISPOSABLE HOUSEBREAKING PADS FOR USE IN TRAINING PUPPIES (U.S. CLS. 2, 5, 22, 23, 29, 37, 38 AND 50).

FIRST USE 3-22-2011; IN COMMERCE 3-22-2011.

CLASS 18—LEATHER GOODS

FOR PET ACCESSORIES, NAMELY, PET CLOTHING, LEASHES, PET COLLARS; RAWHIDE CHEWS FOR DOGS (U.S. CLS. 1, 2, 3, 22 AND 41).

FIRST USE 1-22-2011; IN COMMERCE 1-22-2011.

CLASS 20—FURNITURE AND ARTICLES NOT OTHERWISE CLASSIFIED

FOR PET BEDS (U.S. CLS. 2, 13, 22, 25, 32 AND 50).

FIRST USE 4-17-2011; IN COMMERCE 4-17-2011.

CLASS 28—TOYS AND SPORTING GOODS

FOR PET TOYS (U.S. CLS. 22, 23, 38 AND 50).

FIRST USE 2-27-2011; IN COMMERCE 2-27-2011.

CLASS 31—NATURAL AGRICULTURAL PRODUCTS

FOR PET TREATS; PET FOOD; PET LITTER FOR DOMESTIC ANIMALS; PET TREATS IN THE NATURE OF PIG EARS (U.S. CLS. 1 AND 46).

FIRST USE 3-6-2011; IN COMMERCE 3-6-2011.

4,165,890. MARVELL FOODS, INC., BOCA RATON, FL. SN 85-414,212. PUB. 1-31-2012, FILED 9-2-2011.

LOVELLA

THE MARK CONSISTS OF STANDARD CHARACTERS WITHOUT CLAIM TO ANY PARTICULAR FONT, STYLE,

SIZE, OR COLOR.

CLASS 29—MEATS AND PROCESSED FOODS

FOR POULTRY; MEAT; FISH; SEAFOOD; CHEESE; VEGETABLES; FROZEN ENTREES CONSISTING PRIMARILY OF POULTRY, MEAT, FISH, SEAFOOD, CHEESE OR VEGETABLES; SOUPS AND PREPARATIONS FOR MAKING SOUPS (U.S. CL. 46).
FIRST USE 3-30-2012; IN COMMERCE 3-30-2012.

CLASS 30—STAPLE FOODS

FOR RAVIOLI; FROZEN ENTREES OR MEALS CONSISTING PRIMARILY OF PASTA OR RICE; PASTA FOR SOUPS (U.S. CL. 46).
FIRST USE 3-30-2012; IN COMMERCE 3-30-2012.

4,165,900. FASTENAL IP COMPANY, WINONA, MN. SN 85-432,783. PUB. 2-14-2012, FILED 9-27-2011.

BLUE TEAM SPORTS

THE MARK CONSISTS OF STANDARD CHARACTERS WITHOUT CLAIM TO ANY PARTICULAR FONT, STYLE, SIZE, OR COLOR.

OWNER OF U.S. REG. NO. 3,239,577.

NO CLAIM IS MADE TO THE EXCLUSIVE RIGHT TO USE "SPORTS" IN CLASS 25 AND "TEAM SPORTS" IN CLASS 36, APART FROM THE MARK AS SHOWN.

CLASS 25—CLOTHING

FOR SPORTSWEAR, NAMELY, HATS, SHIRTS, PANTS AND UNIFORMS (U.S. CLS. 22 AND 39).
FIRST USE 12-9-2011; IN COMMERCE 12-9-2011.

CLASS 36—INSURANCE AND FINANCIAL

FOR FINANCIAL SPONSORSHIP OF SPORTS TEAMS (U.S. CLS. 100, 101 AND 102).
FIRST USE 12-9-2011; IN COMMERCE 12-9-2011.

4,165,905. A&E TELEVISION NETWORKS, LLC, NEW YORK, NY. SN 85-450,793. PUB. 1-10-2012, FILED 10-19-2011.

MONSTER IN-LAWS

THE MARK CONSISTS OF STANDARD CHARACTERS WITHOUT CLAIM TO ANY PARTICULAR FONT, STYLE, SIZE, OR COLOR.

CLASS 9—ELECTRICAL AND SCIENTIFIC APPARATUS

FOR MULTIMEDIA GOODS, NAMELY, PRE-RECORDED DIGITAL VIDEO DISCS AND DVDS FEATURING SUBJECTS OF GENERAL HUMAN INTEREST; DIGITAL MEDIA, NAMELY, DOWNLOADABLE AUDIO AND VIDEO FILES FEATURING SUBJECTS OF GENERAL HUMAN INTEREST; DOWNLOADABLE WEBCASTS FEATURING SUBJECTS OF GENERAL HUMAN INTEREST; DOWNLOADABLE GRAPHICS FOR WIRELESS DEVICES; DOWNLOADABLE ON-LINE DISCUSSION BOARDS AND WEBCASTS FEATURING SUBJECTS OF GENERAL HUMAN INTEREST (U.S. CLS. 21, 23, 26, 36 AND 38).
FIRST USE 10-24-2011; IN COMMERCE 10-24-2011.

CLASS 41—EDUCATION AND ENTERTAINMENT

FOR ENTERTAINMENT SERVICES, NAMELY, A MULTIMEDIA PROGRAM SERIES FEATURING SUBJECTS OF GENERAL HUMAN INTEREST DISTRIBUTED VIA VARIOUS PLATFORMS ACROSS MULTIPLE FORMS OF TRANSMISSION MEDIA; ENTERTAINMENT SERVICES, NAMELY, AN ONGOING TELEVISION SERIES FEATURING SUBJECTS OF GENERAL HUMAN INTEREST; PROVIDING A WEBSITE ABOUT RELATIONSHIPS, FAMILY AND CONFLICT FOR ENTERTAINMENT PURPOSES ONLY (U.S. CLS. 100, 101 AND 107).
FIRST USE 10-24-2011; IN COMMERCE 10-24-2011.

4,165,923. FROHLICH UND STAINES GBR, SULZBACH, FED REP GERMANY. SN 85-976,597. PUB. 6-7-2011, FILED 2-1-2011.

SIMINDUSTRY

THE MARK CONSISTS OF STANDARD CHARACTERS WITHOUT CLAIM TO ANY PARTICULAR FONT, STYLE, SIZE, OR COLOR.

CLASS 28—TOYS AND SPORTING GOODS

FOR BOARD GAMES (U.S. CLS. 22, 23, 38 AND 50).
FIRST USE 1-1-2005; IN COMMERCE 5-1-2011.

CLASS 41—EDUCATION AND ENTERTAINMENT

FOR ARRANGING AND CONDUCTING WORKSHOPS, SEMINARS AND COURSES IN THE FIELD OF OPERATIONAL, FINANCIAL AND STRATEGIC DECISION-MAKING IN COMPANIES (U.S. CLS. 100, 101 AND 107).
FIRST USE 1-1-2005; IN COMMERCE 5-1-2011.

4,165,924. TARGET BRANDS, INC., MINNEAPOLIS, MN. SN 85-976,619. PUB. 8-16-2011, FILED 9-13-2010.

SPRITZ

THE MARK CONSISTS OF STANDARD CHARACTERS WITHOUT CLAIM TO ANY PARTICULAR FONT, STYLE, SIZE, OR COLOR.

CLASS 4—LUBRICANTS AND FUELS

FOR PARTY CANDLES FOR CAKE (U.S. CLS. 1, 6 AND 15).
FIRST USE 2-28-2011; IN COMMERCE 2-28-2011.

CLASS 16—PAPER GOODS AND PRINTED MATTER

FOR PAPER PARTY FAVORS; PAPER PARTY DECORATIONS; BANNERS; BAGS FOR FAVORS; PAPER TABLE CLOTHS; NAPKINS; DINNERWARE, NAMELY, PAPER PLATES AND PAPER CUPS; PAPER DECORATIVE GARLAND FOR PARTIES; NOTE CARDS; BLANK CARDS; INVITATIONS; PAPER GIFT WRAP; PAPER GIFT BAGS; PAPER BOWS AND RIBBON FOR GIFT WRAPPING; PAPER GIFT TAGS; TISSUE PAPER; STICKERS; TEMPORARY TATTOOS; STATIONERY; PAPER; CHALK AND CHALK ERASERS (U.S. CLS. 2, 5, 22, 23, 29, 37, 38 AND 50).
FIRST USE 2-28-2011; IN COMMERCE 2-28-2011.

4,165,925. GENERAL MILLS, INC., MINNEAPOLIS, MN. SN 85-976,650. PUB. 9-13-2011, FILED 10-27-2010.

EVERYTHING YOU NEED

THE MARK CONSISTS OF STANDARD CHARACTERS WITHOUT CLAIM TO ANY PARTICULAR FONT, STYLE, SIZE, OR COLOR.

CLASS 29—MEATS AND PROCESSED FOODS

FOR SOUP; BROTH; PACKAGED MAIN MEAL MIXES CONSISTING PRIMARILY OF POTATOES; PACKAGED ENTREES AND SIDE DISHES CONSISTING PRIMARILY OF POTATOES; FROZEN VEGETABLES WITH AND WITHOUT SAUCE; FROZEN VEGETABLES; FRUIT-BASED SNACK FOODS; POTATO-BASED SNACK FOODS; NUT-BASED SNACK BARS; ALL OF THE FOREGOING BEING GLUTEN-FREE (U.S. CL. 46).
FIRST USE 3-2-2011; IN COMMERCE 3-2-2011.

CLASS 30—STAPLE FOODS

FOR BAKERY GOODS; CEREAL BASED SNACK FOOD; PACKAGED MAIN MEAL MIXES AND SIDE DISHES HAVING EITHER A CEREAL BASE, RICE BASE, OR PASTA BASE; PASTA; PREPARED, REFRIGERATED AND FROZEN MEALS AND SIDE DISHES HAVING EITHER A CEREAL BASE, RICE BASE, OR PASTA BASE; BREAKFAST PASTRIES; BAKING MIXES; FROSTING AND FROSTING MIXES; PIE CRUSTS; PANCAKE AND WAFFLE MIXES; PROCESSED CEREAL-BASED FOOD TO BE USED AS A BREAKFAST FOOD, SNACK FOOD OR INGREDIENT FOR MAKING OTHER FOODS; GRANOLA; REFRIGERATED AND FROZEN DOUGH FOR COOKIES, BREAD, PIZZA, AND OTHER FOOD PRODUCTS; BREAD CRUMBS; CROUTONS; TEA; CRACKERS; PRETZELS; CANDY; CHOCOLATE; PIZZA; PIZZA CRUSTS; FLOUR; PROCESSED GRAINS; GRAVIES AND GRAVY MIXES; SAUCES AND SAUCE MIXES; ALL OF THE FOREGOING BEING GLUTEN-FREE (U.S. CL. 46).
FIRST USE 3-2-2011; IN COMMERCE 3-2-2011.

4,165,926. FOTOWATIO RENEWABLE VENTURES, INC., SAN FRANCISCO, CA. SN 85-976,660. PUB. 10-25-2011, FILED 5-17-2011.

ORO VERDE

THE MARK CONSISTS OF STANDARD CHARACTERS WITHOUT CLAIM TO ANY PARTICULAR FONT, STYLE, SIZE, OR COLOR.

THE ENGLISH TRANSLATION OF "ORO VERDE" IN THE MARK IS "GREEN GOLD".

CLASS 39—TRANSPORTATION AND STORAGE

FOR DISTRIBUTION AND TRANSMISSION OF ELECTRICITY; LEASING THE USE OF POWER LINES TO THIRD PARTIES FOR THE TRANSMISSION OF ELECTRICITY; UTILITY SERVICES, NAMELY, TRANSMISSION OF ELECTRICITY (U.S. CLS. 100 AND 105).
FIRST USE 2-24-2012; IN COMMERCE 2-24-2012.

CLASS 40—MATERIAL TREATMENT

FOR ELECTRICITY GENERATION; GENERATING OF ELECTRICITY; GENERATION OF ELECTRICITY FROM SOLAR ENERGY (U.S. CLS. 100, 103 AND 106).
FIRST USE 2-24-2012; IN COMMERCE 2-24-2012.

4,165,930. ESSENTIA PHARMA, L.L.C., ROSENBERG, TX. SN 85-976,699. PUB. 10-18-2011, FILED 4-26-2011.

ESSENTIA PHARMA

THE MARK CONSISTS OF STANDARD CHARACTERS WITHOUT CLAIM TO ANY PARTICULAR FONT, STYLE, SIZE, OR COLOR.

NO CLAIM IS MADE TO THE EXCLUSIVE RIGHT TO USE "PHARMA", APART FROM THE MARK AS SHOWN.

CLASS 35—ADVERTISING AND BUSINESS

FOR RETAIL PHARMACY SERVICES, MAIL ORDER AND ONLINE CATALOG SERVICES FEATURING OPHTHALMIC GOODS AND SKIN CLEANSERS; ADVERTISING, MARKETING, AND PROMOTION SERVICES IN THE FIELD OF OPHTHALMIC GOODS AND SKIN CLEANSERS (U.S. CLS. 100, 101 AND 102).
FIRST USE 1-16-2009; IN COMMERCE 1-16-2009.

CLASS 42—SCIENTIFIC AND COMPUTER SERVICES

FOR PHARMACEUTICAL RESEARCH AND DEVELOPMENT; PROVIDING MEDICAL AND SCIENTIFIC RESEARCH INFORMATION IN THE FIELD OF PHARMACEUTICALS AND CLINICAL TRIALS (U.S. CLS. 100 AND 101).
FIRST USE 1-16-2009; IN COMMERCE 1-16-2009.

CLASS 44—MEDICAL, BEAUTY AND AGRICULTURAL SERVICES

FOR PROVIDING MEDICAL INFORMATION (U.S. CLS. 100 AND 101).
FIRST USE 1-16-2009; IN COMMERCE 1-16-2009.

4,165,935. SOLTA MEDICAL, INC., HAYWARD, CA. SN 85-976,737. PUB. 5-24-2011, FILED 5-25-2010.

CLEAR + BRILLIANT

THE MARK CONSISTS OF STANDARD CHARACTERS WITHOUT CLAIM TO ANY PARTICULAR FONT, STYLE, SIZE, OR COLOR.

CLASS 10—MEDICAL APPARATUS

FOR MEDICAL DEVICES FOR NON-SURGICAL COSMETIC SKIN TREATMENTS (U.S. CLS. 26, 39 AND 44).
FIRST USE 2-22-2011; IN COMMERCE 2-22-2011.

CLASS 44—MEDICAL, BEAUTY AND AGRICULTURAL SERVICES

FOR DERMATOLOGY SERVICES; NON-INVASIVE COSMETIC MEDICAL SERVICES (U.S. CLS. 100 AND 101).
FIRST USE 5-17-2011; IN COMMERCE 5-17-2011.

4,165,939. ELEVATION PARTNERS LLC, LAWRENCE, KS. SN 85-976,761. PUB. 12-14-2010, FILED 5-17-2010.

TX

THE MARK CONSISTS OF STANDARD CHARACTERS WITHOUT CLAIM TO ANY PARTICULAR FONT, STYLE, SIZE, OR COLOR.

CLASS 35—ADVERTISING AND BUSINESS

FOR ADVERTISING AND PROMOTIONAL SERVICES, NAMELY, PROMOTING THE INCOME TAX AND FINANCIAL PLANNING GOODS AND SERVICES OF OTHERS THROUGH ONLINE ENTERTAINMENT AND ONLINE EDUCATION; PROVIDING INFORMATION TO CONSUMERS IN THE FIELD OF INCOME TAX PLANNING (U.S. CLS. 100, 101 AND 102).
FIRST USE 2-6-2012; IN COMMERCE 2-6-2012.

CLASS 38—COMMUNICATION

FOR AUDIO, VIDEO AND MULTIMEDIA BROADCASTING IN THE FIELDS OF INCOME TAX AND FINANCIAL PLANNING VIA THE INTERNET AND OTHER COMMUNICATIONS NETWORKS; WEBCASTING SERVICES IN THE FIELDS OF INCOME TAX AND FINANCIAL PLANNING; TRANSMISSION OF MESSAGES, DATA AND CONTENT IN THE FIELDS OF INCOME TAX AND FINANCIAL PLANNING VIA THE INTERNET AND OTHER COMMUNICATIONS NETWORKS; PROVIDING FORUMS AND CHAT ROOMS FOR THE TRANSMISSION OF MESSAGES, COMMENTS AND MULTIMEDIA CONTENT AMONG USERS IN THE FIELDS OF INCOME TAX AND FINANCIAL PLANNING VIA THE INTERNET AND OTHER COMMUNICATIONS NETWORKS; TRANSMISSION OF ELECTRONIC MEDIA, MULTIMEDIA CONTENT, VIDEOS, MOVIES, PICTURES, IMAGES, TEXT, PHOTOS, USER-GENERATED CONTENT, AUDIO CONTENT, AND INFORMATION IN THE FIELDS OF INCOME TAX AND FINANCIAL PLANNING VIA THE INTERNET AND OTHER COMMUNICATIONS NETWORKS; PROVIDING COMMUNITY FORUMS FOR USERS IN THE FIELDS OF INCOME TAX AND FINANCIAL PLANNING TO POST, SEARCH, WATCH, SHARE, CRITIQUE, RATE, AND COMMENT ON, VIDEOS AND OTHER MULTIMEDIA CONTENT VIA THE INTERNET AND OTHER COMMUNICATIONS NETWORKS (U.S. CLS. 100, 101 AND 104).
FIRST USE 2-6-2012; IN COMMERCE 2-6-2012.

4,165,940. ELEVATION PARTNERS LLC, LAWRENCE, KS. SN 85-976,762. PUB. 12-14-2010, FILED 5-12-2010.

BREAKING THE CODE

THE MARK CONSISTS OF STANDARD CHARACTERS WITHOUT CLAIM TO ANY PARTICULAR FONT, STYLE, SIZE, OR COLOR.

CLASS 35—ADVERTISING AND BUSINESS

FOR ADVERTISING AND PROMOTIONAL SERVICES, NAMELY, PROMOTING THE INCOME TAX AND FINANCIAL PLANNING GOODS AND SERVICES OF OTHERS THROUGH ONLINE ENTERTAINMENT AND ONLINE EDUCATION; PROVIDING INFORMATION TO CONSUMERS IN THE FIELD OF INCOME TAX PLANNING (U.S. CLS. 100, 101 AND 102).
FIRST USE 2-6-2012; IN COMMERCE 2-6-2012.

CLASS 38—COMMUNICATION

FOR AUDIO, VIDEO AND MULTIMEDIA BROADCASTING IN THE FIELDS OF INCOME TAX AND FINANCIAL PLANNING VIA THE INTERNET AND OTHER COMMUNICATIONS NETWORKS; WEBCASTING SERVICES IN THE FIELDS OF INCOME TAX AND FINANCIAL PLANNING; TRANSMISSION OF MESSAGES, DATA AND CONTENT IN THE FIELDS OF INCOME TAX AND FINANCIAL PLANNING VIA THE INTERNET AND OTHER COMMUNICATIONS NETWORKS; PROVIDING FORUMS AND CHAT ROOMS FOR THE TRANSMISSION OF MESSAGES, COMMENTS AND MULTIMEDIA CONTENT AMONG USERS IN THE FIELDS OF INCOME TAX AND FINANCIAL PLANNING VIA THE INTERNET AND OTHER COMMUNICATIONS NETWORKS; TRANSMISSION OF ELECTRONIC MEDIA, MULTIMEDIA CONTENT, VIDEOS, MOVIES, PICTURES, IMAGES, TEXT, PHOTOS, USER-GENERATED CONTENT, AUDIO CONTENT, AND INFORMATION IN THE FIELDS OF INCOME TAX AND FINANCIAL PLANNING VIA THE INTERNET AND OTHER COMMUNICATIONS NETWORKS; PROVIDING COMMUNITY FORUMS FOR USERS IN THE FIELDS OF INCOME TAX AND FINANCIAL PLANNING TO POST, SEARCH, WATCH, SHARE, CRITIQUE, RATE, AND COMMENT ON, VIDEOS AND OTHER MULTIMEDIA CONTENT VIA THE INTERNET AND OTHER COMMUNICATIONS NETWORKS (U.S. CLS. 100, 101 AND 104).

FIRST USE 2-6-2012; IN COMMERCE 2-6-2012.

4,165,942. FICHERA, JAMES, AMHERST, NH. SN 85-976,768. PUB. 4-19-2011, FILED 11-4-2010.

PARTY VISION

THE MARK CONSISTS OF STANDARD CHARACTERS WITHOUT CLAIM TO ANY PARTICULAR FONT, STYLE, SIZE, OR COLOR.

NO CLAIM IS MADE TO THE EXCLUSIVE RIGHT TO USE "PARTY", APART FROM THE MARK AS SHOWN.

CLASS 41—EDUCATION AND ENTERTAINMENT

FOR PROVIDING ENTERTAINERS IN THE NATURE OF MUSICIANS, BALLOON ARTISTS, CLOWNS, COMEDIANS, JUGGLERS, MIMES, PSYCHICS, HYPNOTISTS, FIRE EATERS AND MAGICIANS FOR PARTIES; RENTAL OF ENTERTAINMENT APPARATUS IN THE NATURE OF INFLATABLE JUMPERS, INFLATABLE BOUNCERS, INFLATABLE INTERACTIVE MOONWALKS, WET OR DRY SLIDES, GAMES, OBSTACLE COURSES, INFLATABLE WRECKING BALLS, MECHANICAL BULLS AND PHOTO STRIP BOOTHS (U.S. CLS. 100, 101 AND 107).

FIRST USE 4-11-2003; IN COMMERCE 4-11-2003.

CLASS 43—HOTEL AND RESTAURANT SERVICES

FOR RENTAL OF PARTY EQUIPMENT IN THE NATURE OF TENTS, TABLES, CHAIRS, POP CORN MACHINES AND COTTON CANDY MACHINES (U.S. CLS. 100 AND 101).

FIRST USE 4-11-2003; IN COMMERCE 4-11-2003.

4,165,945. TRUE SITE CORPORATION, MARIETTA, GA. SN 85-976,804. PUB. 3-15-2011, FILED 10-4-2010.

SOKOJIKARA

THE MARK CONSISTS OF STANDARD CHARACTERS WITHOUT CLAIM TO ANY PARTICULAR FONT, STYLE, SIZE, OR COLOR.

THE WORDING "SOKOJIKARA" HAS NO MEANING IN A FOREIGN LANGUAGE.

CLASS 8—HAND TOOLS

FOR BLADES FOR KNIVES CONSISTING OF FOLDING, HUNTING, JACK, JAPANESE CHOPPING KITCHEN, HOBBY USE, HUNTING, PEN, POCKET, SPORT, THROWING, WHITTILING, WORKING KNIVES; DAGGERS; FOLDING KNIVES; HUNTING KNIVES; JACK KNIVES; JAPANESE CHOPPING KITCHEN KNIVES; JAPANESE SWORDS; KNIVES; KNIVES FOR HOBBY USE; LEATHER SHEATHS FOR KNIVES; PEN KNIVES; POCKET KNIVES; SABRES; SHARPENING WHEELS FOR KNIVES AND BLADES; SIDE ARMS, NOT INCLUDING FIREARMS, NAMELY, HUNTING KNIVES; SIDE ARMS, NOT INCLUDING FIREARMS, NAMELY, SWORDS; SPORT KNIVES; SWORD CANES; SWORDS; THROWING KNIVES; WHITTILING KNIVES; WORKING KNIVES (U.S. CLS. 23, 28 AND 44).

FIRST USE 12-2-2011; IN COMMERCE 12-2-2011.

CLASS 20—FURNITURE AND ARTICLES NOT OTHERWISE CLASSIFIED

FOR DISPLAY STANDS; METAL DISPLAY STANDS (U.S. CLS. 2, 13, 22, 25, 32 AND 50).

FIRST USE 5-5-2012; IN COMMERCE 5-5-2012.

* * * * *

SECTION 2.— INTERNATIONAL CLASSIFICATION

The short titles associated below with the international class numbers are terms designed merely for quick identification and are not an official part of the international classification. The full names of international classes are given in section 6.1 of the trademark rules of practice.

The designation "U.S. Cl." appearing in this section refers to the U.S. class in effect prior to Sep. 1, 1973 rather than the international class which applies to applications filed on or after that date. For adoption of international classification see notice in the OFFICIAL GAZETTE of Jun. 26, 1973 (911 O.G. TM 210).

Application in one class

CLASS 1—CHEMICALS

4,164,795. ALPHA AROMATICS, LP, PITTSBURGH, PA. SN 76-705,075. PUB. 3-22-2011, FILED 10-27-2010.

CLASS 1—(Continued).

4,164,797. ALPHA AROMATICS, LP, PITTSBURGH, PA. SN 76-705,077. PUB. 3-22-2011, FILED 10-27-2010.

ALAMASK

THE MARK CONSISTS OF STANDARD CHARACTERS WITHOUT CLAIM TO ANY PARTICULAR FONT, STYLE, SIZE, OR COLOR.

FOR ODOR MODIFICATION, DEODORIZING AND REODORANT CHEMICAL ADDITIVES FOR INDUSTRIAL, INSTITUTIONAL, COMMERCIAL, AGRICULTURAL MUNICIPAL AND MANUFACTURING USE (U.S. CLS. 1, 5, 6, 10, 26 AND 46).

FIRST USE 4-30-2012; IN COMMERCE 4-30-2012.

RHO-D-BAN

THE MARK CONSISTS OF STANDARD CHARACTERS WITHOUT CLAIM TO ANY PARTICULAR FONT, STYLE, SIZE, OR COLOR.

FOR ODOR MODIFICATION, DEODORIZING AND REODORANT CHEMICAL ADDITIVES FOR INDUSTRIAL, INSTITUTIONAL, COMMERCIAL, AGRICULTURAL MUNICIPAL AND MANUFACTURING USE (U.S. CLS. 1, 5, 6, 10, 26 AND 46).

FIRST USE 4-30-2012; IN COMMERCE 4-30-2012.

4,164,796. ALPHA AROMATICS, LP, PITTSBURGH, PA. SN 76-705,076. PUB. 3-22-2011, FILED 10-27-2010.

MALABATE

THE MARK CONSISTS OF STANDARD CHARACTERS WITHOUT CLAIM TO ANY PARTICULAR FONT, STYLE, SIZE, OR COLOR.

FOR ODOR MODIFICATION, DEODORIZING AND REODORANT CHEMICAL ADDITIVES FOR INDUSTRIAL, INSTITUTIONAL, COMMERCIAL, AGRICULTURAL MUNICIPAL AND MANUFACTURING USE (U.S. CLS. 1, 5, 6, 10, 26 AND 46).

FIRST USE 4-30-2012; IN COMMERCE 4-30-2012.

4,164,820. NELSON BROTHERS, INC., BIRMINGHAM, AL. SN 77-455,937. PUB. 4-7-2009, FILED 4-23-2008.

OPTIMUL

THE MARK CONSISTS OF STANDARD CHARACTERS WITHOUT CLAIM TO ANY PARTICULAR FONT, STYLE, SIZE, OR COLOR.

FOR EMULSIFIERS FOR USE IN THE MANUFACTURE OF EXPLOSIVES (U.S. CLS. 1, 5, 6, 10, 26 AND 46).

FIRST USE 4-1-2012; IN COMMERCE 4-1-2012.

CLASS 1—(Continued).

4,164,879. WARREN OIL COMPANY, INC., DUNN, NC. SN 77-723,674. PUB. 8-18-2009, FILED 4-28-2009.

LUBRIGOLD

THE MARK CONSISTS OF STANDARD CHARACTERS WITHOUT CLAIM TO ANY PARTICULAR FONT, STYLE, SIZE, OR COLOR.

FOR TRANSMISSION FLUID (U.S. CLS. 1, 5, 6, 10, 26 AND 46).

FIRST USE 5-1-2012; IN COMMERCE 5-1-2012.

4,165,181. FUSION 360, TURLOCK, CA. SN 85-122,872. PUB. 3-8-2011, FILED 9-3-2010.



THE MARK CONSISTS OF TWO MIRROR IRREGULAR SHAPES SLANTED TO ONE SIDE.

FOR CHEMICALS, NAMELY, PLANT FOOD BLENDS OF MINERALS AND NUTRIENTS FOR AGRICULTURAL AND DOMESTIC USE (U.S. CLS. 1, 5, 6, 10, 26 AND 46).

FIRST USE 4-24-2012; IN COMMERCE 4-24-2012.

4,165,310. SYMRISE AG, HOLZMINDEN, FED REP GERMANY. SN 85-171,881. PUB. 3-1-2011, FILED 11-8-2010.

SYMFINITY

THE MARK CONSISTS OF STANDARD CHARACTERS WITHOUT CLAIM TO ANY PARTICULAR FONT, STYLE, SIZE, OR COLOR.

FOR CHEMICALS TO BE USED IN THE MANUFACTURE OF COSMETICS (U.S. CLS. 1, 5, 6, 10, 26 AND 46).

FIRST USE 3-29-2012; IN COMMERCE 3-29-2012.

CLASS 1—(Continued).

4,165,416. SINAK CORPORATION, SAN DIEGO, CA. SN 85-227,842. PUB. 8-16-2011, FILED 1-27-2011.



NO CLAIM IS MADE TO THE EXCLUSIVE RIGHT TO USE "LITHIUM", APART FROM THE MARK AS SHOWN.

THE MARK CONSISTS OF THE NUMBER "3" AND THE BLOCK LETTERS "LI" AND THE WORD "LITHIUM" IN A SQUARE, AND THE WORD "CURE" OUTSIDE THE SQUARE.

FOR CHEMICAL COMPOUNDS FOR CURING CONCRETE (U.S. CLS. 1, 5, 6, 10, 26 AND 46).

FIRST USE 1-4-2011; IN COMMERCE 1-4-2011.

4,165,418. INDUSTRIAL LABOR AND EQUIPMENT SERVICES, LLC, MARRERO, LA. SN 85-228,191. PUB. 6-21-2011, FILED 1-27-2011.

FLEXKO 300

THE MARK CONSISTS OF STANDARD CHARACTERS WITHOUT CLAIM TO ANY PARTICULAR FONT, STYLE, SIZE, OR COLOR.

FOR CHEMICAL BASED SOLVENT-FREE, TDI-FREE, SINGLE COMPONENT, LIQUID-APPLIED, WATER CATALYZED, POLYURETHANE ELASTOMERIC WATERPROOFING BASE MEMBRANE FOR USE IN INDUSTRIAL CONSTRUCTION AND AT ENVIRONMENTAL CONTAINMENT CONSTRUCTION SITES (U.S. CLS. 1, 5, 6, 10, 26 AND 46).

FIRST USE 1-0-2011; IN COMMERCE 1-0-2011.

4,165,428. TRUSOUTH OIL, LLC, SHREVEPORT, LA. SN 85-237,545. PUB. 6-14-2011, FILED 2-9-2011.

TF3

THE MARK CONSISTS OF STANDARD CHARACTERS WITHOUT CLAIM TO ANY PARTICULAR FONT, STYLE, SIZE, OR COLOR.

FOR CHEMICAL ADDITIVES FOR MOTOR FUELS (U.S. CLS. 1, 5, 6, 10, 26 AND 46).

FIRST USE 8-1-2011; IN COMMERCE 8-1-2011.

CLASS 1—(Continued).

4,165,504. JIFFY INTERNATIONAL AS, KRISTIANSAND, NORWAY. SN 85-267,667. PUB. 12-27-2011, FILED 3-15-2011.

MOTHER'S MIX

THE MARK CONSISTS OF STANDARD CHARACTERS WITHOUT CLAIM TO ANY PARTICULAR FONT, STYLE, SIZE, OR COLOR.
 NO CLAIM IS MADE TO THE EXCLUSIVE RIGHT TO USE "MIX", APART FROM THE MARK AS SHOWN.
 FOR GROWING MEDIUM MIX FOR PLANTS AND POTTING SOIL (U.S. CLS. 1, 5, 6, 10, 26 AND 46).
 FIRST USE 8-0-2011; IN COMMERCE 3-0-2012.

4,165,709. HERCULES INCORPORATED, WILMINGTON, DE. SN 85-316,567. PUB. 10-4-2011, FILED 5-10-2011.

ZENIX

THE MARK CONSISTS OF STANDARD CHARACTERS WITHOUT CLAIM TO ANY PARTICULAR FONT, STYLE, SIZE, OR COLOR.
 OWNER OF U.S. REG. NOS. 2,429,889 AND 2,626,255.
 FOR CHEMICALS USED AS CONDITIONING AGENTS IN THE MANUFACTURE OF PERSONAL CARE PRODUCTS, COSMETICS, PHARMACEUTICALS, AND HOUSEHOLD CLEANING PRODUCTS; CHEMICALS USED AS SURFACTANTS IN THE MANUFACTURE OF PERSONAL CARE PRODUCTS, COSMETICS, PHARMACEUTICALS AND HOUSEHOLD CLEANING PRODUCTS (U.S. CLS. 1, 5, 6, 10, 26 AND 46).
 FIRST USE 3-9-2012; IN COMMERCE 3-9-2012.

4,165,805. FOCRON, INC., ROSELAND, NJ. SN 85-369,600. PUB. 12-6-2011, FILED 7-12-2011.

Focron

THE MARK CONSISTS OF STANDARD CHARACTERS WITHOUT CLAIM TO ANY PARTICULAR FONT, STYLE, SIZE, OR COLOR.
 FOR CHEMICAL PREPARATIONS FOR USE IN INDUSTRY (U.S. CLS. 1, 5, 6, 10, 26 AND 46).
 FIRST USE 6-23-2011; IN COMMERCE 6-24-2011.

CLASS 1—(Continued).

4,165,878. HELENA HOLDING COMPANY, WILMINGTON, DE. SN 85-404,629. PUB. 1-10-2012, FILED 8-23-2011.

N-FIXX

THE MARK CONSISTS OF STANDARD CHARACTERS WITHOUT CLAIM TO ANY PARTICULAR FONT, STYLE, SIZE, OR COLOR.
 FOR PLANT GROWTH REGULATING PREPARATIONS (U.S. CLS. 1, 5, 6, 10, 26 AND 46).
 FIRST USE 12-20-2011; IN COMMERCE 12-20-2011.

4,165,893. SHEPHERD MATERIALS MANAGEMENT LLC, RAVENA, NY. SN 85-419,560. PUB. 2-28-2012, FILED 9-10-2011.

CUT-N-DRY

THE MARK CONSISTS OF STANDARD CHARACTERS WITHOUT CLAIM TO ANY PARTICULAR FONT, STYLE, SIZE, OR COLOR.
 FOR SOIL STABILIZERS AND DRYING AGENTS FOR USE IN DRYING AND STABILIZING DRILL CUTTINGS, MOISTURE LADEN SOILS, ROCK, AND OTHER EARTHEN MATERIALS (U.S. CLS. 1, 5, 6, 10, 26 AND 46).
 FIRST USE 2-21-2012; IN COMMERCE 2-21-2012.

4,165,946. SUN GRO HORTICULTURE CANADA LTD., SEBA BEACH, ALBERTA, CANADA. SN 85-976,815. PUB. 9-6-2011, FILED 1-27-2011.



THE COLOR(S) GREEN, BLUE, WHITE AND BROWN IS/ ARE CLAIMED AS A FEATURE OF THE MARK.

CLASS 1—(Continued).

THE MARK CONSISTS OF A GLOBE WITH GREEN LAND AND BLUE WATER BISECTED BY A WHITE OVAL WITH A BROWN OUTLINE CONTAINING THE WORDS "HYDRO-GARDEN-PONIC" IN BLUE SEPARATED BY LIGHT BLUE DOTS. THERE ARE FOUR GREEN LEAVES UNDER AND TO THE LEFT OF THE OVAL.

FOR FERTILIZERS; PLANTING SOIL FOR PLANTS; POTTING SOIL FOR PLANTS; GROWING, POTTING, PLANTING AND PLANTER BOX MIXES; POTTING SOIL SOLD IN A GROWING POT; SPECIALIZED GROWING MEDIA BLENDS FOR PLANTS, PLUGS AND SEEDS; POTTING AND PLANTING SOIL MIXES COMPRISED OF ORGANIC MATERIALS AND CONTAINING FERTILIZER; SOIL ADDITIVES, SOIL AMENDMENTS FOR HORTICULTURAL USE; PEAT MOSS CONTAINING HORTICULTURAL MIXES TO BE USED AS A SOIL SUBSTITUTE (U.S. CLS. 1, 5, 6, 10, 26 AND 46).

FIRST USE 2-8-2011; IN COMMERCE 2-8-2011.

CLASS 2—PAINTS

4,165,522. PREMIER DEALER SERVICES, INC., SAN DIEGO, CA. SN 85-272,464. PUB. 8-23-2011, FILED 3-21-2011.

Premier Defense Paint Sealant

THE MARK CONSISTS OF STANDARD CHARACTERS WITHOUT CLAIM TO ANY PARTICULAR FONT, STYLE, SIZE, OR COLOR.

NO CLAIM IS MADE TO THE EXCLUSIVE RIGHT TO USE "PAINT SEALANT", APART FROM THE MARK AS SHOWN.

FOR PAINT SEALANT FOR EXTERIOR SURFACE OF A VEHICLE (U.S. CLS. 6, 11 AND 16).

FIRST USE 4-13-2012; IN COMMERCE 4-13-2012.

4,165,523. PREMIER DEALER SERVICES, INC., SAN DIEGO, CA. SN 85-272,474. PUB. 8-23-2011, FILED 3-21-2011.

Premier Defense Rust Proofing

THE MARK CONSISTS OF STANDARD CHARACTERS WITHOUT CLAIM TO ANY PARTICULAR FONT, STYLE, SIZE, OR COLOR.

NO CLAIM IS MADE TO THE EXCLUSIVE RIGHT TO USE "RUST PROOFING", APART FROM THE MARK AS SHOWN.

FOR RUST INHIBITING PREPARATIONS IN THE NATURE OF A COATING FOR USE ON VEHICLES (U.S. CLS. 6, 11 AND 16).

FIRST USE 4-13-2012; IN COMMERCE 4-13-2012.

CLASS 2—(Continued).

4,165,524. PREMIER DEALER SERVICES, INC., SAN DIEGO, CA. SN 85-272,480. PUB. 8-23-2011, FILED 3-21-2011.

Premier Defense Undercoating

THE MARK CONSISTS OF STANDARD CHARACTERS WITHOUT CLAIM TO ANY PARTICULAR FONT, STYLE, SIZE, OR COLOR.

NO CLAIM IS MADE TO THE EXCLUSIVE RIGHT TO USE "UNDERCOATING", APART FROM THE MARK AS SHOWN.

FOR AUTOMOBILE UNDERCOATING TO PROTECT UNDERCARRIAGE AGAINST RUST AND TO REDUCE CABIN NOISE (U.S. CLS. 6, 11 AND 16).

FIRST USE 4-13-2012; IN COMMERCE 4-13-2012.

4,165,847. CALIFORNIA PRODUCTS CORPORATION, AND-OVER, ME. SN 85-391,912. PUB. 12-20-2011, FILED 8-8-2011.

NOVUS

THE MARK CONSISTS OF STANDARD CHARACTERS WITHOUT CLAIM TO ANY PARTICULAR FONT, STYLE, SIZE, OR COLOR.

FOR INTERIOR AND EXTERIOR PAINT (U.S. CLS. 6, 11 AND 16).

FIRST USE 4-1-2012; IN COMMERCE 4-1-2012.

4,165,914. HUNTSMAN ADVANCED MATERIALS (SWITZERLAND) GMBH, BASEL, SWITZERLAND. SN 85-481,745. PUB. 2-28-2012, FILED 11-28-2011.

NEOLAN

THE MARK CONSISTS OF STANDARD CHARACTERS WITHOUT CLAIM TO ANY PARTICULAR FONT, STYLE, SIZE, OR COLOR.

OWNER OF U.S. REG. NO. 161,838.

FOR DYES FOR USE WITH OR ON TEXTILES (U.S. CLS. 6, 11 AND 16).

FIRST USE 0-0-1914; IN COMMERCE 0-0-1914.

CLASS 3—COSMETICS AND CLEANING PREPARATIONS

CLASS 3—(Continued).

4,164,851. KARA VITA, INC., ST. PETERSBURG, FL. SN 77-586,048. PUB. 3-3-2009, FILED 10-6-2008.

JOE

THE MARK CONSISTS OF STANDARD CHARACTERS WITHOUT CLAIM TO ANY PARTICULAR FONT, STYLE, SIZE, OR COLOR.

FOR AFTER SHAVE LOTIONS; AFTER SUN CREAMS; AFTER-SHAVE CREAMS; AFTER-SUN LOTIONS; AGE RETARDANT GEL; AGE RETARDANT LOTION; ANTI-AGING CREAM; BAR SOAP; BODY CREAM SOAP; EXFOLIANT CREAMS; FACE AND BODY CREAMS; FACE AND BODY LOTIONS; FACE CREAMS; FACIAL CLEANSERS; FACIAL CREAMS; FACIAL LOTION; HAND SOAPS; MOISTURIZING CREAMS; NON-MEDICATED ACNE TREATMENT PREPARATIONS; NON-MEDICATED OINTMENTS FOR THE PREVENTION AND TREATMENT OF SUNBURN; NON-MEDICATED SKIN CARE PREPARATIONS; NON-MEDICATED SKIN CREAMS; NON-MEDICATED STIMULATING LOTIONS FOR THE SKIN; NON-MEDICATED SUN CARE PREPARATIONS; PERFUMES, AFTERSHAVES AND COGNES; PERFUMES, EAU DE COGNES AND AFTERSHAVES; SELF-TANNING PREPARATIONS; SHAVING CREAM; SHAVING GEL; SHAVING LOTION; SHAVING PREPARATIONS; SKIN ABRASIVE PREPARATIONS; SKIN BRONZING CREAMS; SKIN CLEANSERS; SKIN CLEANSING CREAM; SKIN CLEANSING LOTION; SKIN CONDITIONERS; SKIN CREAMS; SKIN EMOLLIENTS; SKIN GELS FOR ACCELERATING, ENHANCING OR EXTENDING TANS; SKIN LOTIONS; SKIN MOISTURIZER; SOAPS FOR BODY CARE; SUN BLOCK; SUN BLOCK PREPARATIONS; SUN CARE LOTIONS; SUN CREAMS; SUN SCREEN; SUN SCREEN PREPARATIONS; SUN TAN GEL; SUN TAN LOTION; SUN-BLOCK LOTIONS; SUNSCREEN CREAMS; SUNTANNING PREPARATIONS (U.S. CLS. 1, 4, 6, 50, 51 AND 52).

FIRST USE 9-19-2011; IN COMMERCE 9-19-2011.

4,164,852. RECKITT BENCKISER N.V., HOOFDDORP, NETHERLANDS. SN 77-591,503. PUB. 1-20-2009, FILED 10-13-2008.

FINISH ADVANCED

THE MARK CONSISTS OF STANDARD CHARACTERS WITHOUT CLAIM TO ANY PARTICULAR FONT, STYLE, SIZE, OR COLOR.

OWNER OF U.S. REG. NOS. 596,505, 2,874,265, AND 3,206,391.

CLASS 3—(Continued).

NO CLAIM IS MADE TO THE EXCLUSIVE RIGHT TO USE "ADVANCED", APART FROM THE MARK AS SHOWN.

FOR BLEACHING PREPARATIONS AND DETERGENTS FOR DISHWASHING IN SOLID, FLUID OR GEL FORM; DISHWASHER CLEANSER, FRESHENER AND DEODORIZER; POLISHING PREPARATIONS FOR KITCHEN AND GLASSWARE; CLEANING, POLISHING, SCOURING AND ABRASIVE PREPARATIONS FOR DISHWASHING; DECALCIFYING AND DESCALING PREPARATIONS FOR DOMESTIC USE; DISH DETERGENTS; STAIN REMOVING PREPARATIONS, ALL AFOREMENTIONED GOODS WITH OR WITHOUT A DISINFECTIVE COMPONENT (U.S. CLS. 1, 4, 6, 50, 51 AND 52).

FIRST USE 1-4-2007; IN COMMERCE 1-4-2007.

4,164,874. ARCH CHEMICALS, INC., NORWALK, CT. SN 77-705,189. PUB. 7-21-2009, FILED 4-2-2009.



OWNER OF U.S. REG. NOS. 252,200, 2,684,760, AND OTHERS.

THE COLOR(S) BLUE, WHITE, RED AND GRAY IS/ARE CLAIMED AS A FEATURE OF THE MARK.

THE MARK CONSISTS OF THE LETTERS "HTH" APPEARING IN THE COLOR RED, SURROUNDED BY A PARTIAL CIRCLE APPEARING IN THE COLOR GRAY SUPERIMPOSED ON A FIELD WHITE THAT EMULATES A STYLIZED REPRESENTATION OF A SPLASH EMANATING FROM A BLUE OVAL WITH VARIED WHITE LINES EMULATING REFLECTING WATER.

FOR CLEANING PREPARATIONS FOR SAND, DIATOMITE AND CARTRIDGE FILTERS USED IN WATER FILTRATION SYSTEMS; CLEANING PREPARATIONS FOR CLEANING FIBERGLASS, ACRYLIC, TILE, VINYL AND CONCRETE SURFACES, AND POOL AND PATIO SURFACES, AND FOR CLEANING OUTDOOR FURNITURE, AND SWIMMING POOL ACCESSORIES (U.S. CLS. 1, 4, 6, 50, 51 AND 52).

FIRST USE 6-0-2008; IN COMMERCE 6-0-2008.

4,164,892. DR. PALMER'S LLC, GREENWICH, CT. SN 77-785,670. PUB. 12-15-2009, FILED 7-21-2009.

REPLERE

THE MARK CONSISTS OF STANDARD CHARACTERS WITHOUT CLAIM TO ANY PARTICULAR FONT, STYLE, SIZE, OR COLOR.

CLASS 3—(Continued).

THE WORDING "REPLERE" HAS NO MEANING IN A FOREIGN LANGUAGE.

FOR EYE MAKEUP, FACIAL CLEANSERS, TONERS, FACIAL EXFOLIANTS, FACIAL SCRUBS, FACIAL CREAMS, FACIAL MOISTURIZERS, FACIAL LOTIONS AND NON-MEDICATED FACIAL TREATMENT PREPARATIONS, SKIN MOISTURIZERS, BODY AND HAND MOISTURIZING LOTIONS, BODY AND HAND LOTIONS, BODY EXFOLIANTS, BODY SCRUBS, NON-MEDICATED TOPICAL SKIN CREAMS, TONERS, LOTIONS, ALL FOR USE ON THE SKIN (U.S. CLS. 1, 4, 6, 50, 51 AND 52).

FIRST USE 9-15-2010; IN COMMERCE 9-15-2010.

4,164,900. L'OREAL, PARIS, FRANCE. SN 77-804,681. PUB. 8-30-2011, FILED 8-14-2009.

EVERSTYLE

THE MARK CONSISTS OF STANDARD CHARACTERS WITHOUT CLAIM TO ANY PARTICULAR FONT, STYLE, SIZE, OR COLOR.

FOR HAIR STYLING PREPARATIONS (U.S. CLS. 1, 4, 6, 50, 51 AND 52).

FIRST USE 12-1-2011; IN COMMERCE 12-1-2011.

4,164,960. Y.Z.Y. INC, MIAMI, FL. SN 77-902,660. PUB. 5-18-2010, FILED 12-30-2009.

TORVILLE

THE MARK CONSISTS OF STANDARD CHARACTERS WITHOUT CLAIM TO ANY PARTICULAR FONT, STYLE, SIZE, OR COLOR.

THE ENGLISH TRANSLATION OF "TORVILLE" IN THE MARK IS "TORPEDO".

FOR COLOGNES, PERFUMES AND COSMETICS; EAU DE TOILETTE AND EAU DE COLOGNE; PERFUMES, AFTERSHAVES AND COLOGNES (U.S. CLS. 1, 4, 6, 50, 51 AND 52).

FIRST USE 1-22-2012; IN COMMERCE 1-22-2012.

CLASS 3—(Continued).

4,164,981. A BETTER YOU, LLC, CHATTANOOGA, TN. SN 77-946,131. PUB. 8-10-2010, FILED 2-26-2010.

ELOCIN ORGANICS

THE MARK CONSISTS OF STANDARD CHARACTERS WITHOUT CLAIM TO ANY PARTICULAR FONT, STYLE, SIZE, OR COLOR.

NO CLAIM IS MADE TO THE EXCLUSIVE RIGHT TO USE "ORGANICS", APART FROM THE MARK AS SHOWN.

FOR ORGANIC BODY WASH; ORGANIC COSMETIC CREAMS FOR SKIN CARE; ORGANIC COSMETICS AND MAKE-UP; ORGANIC HAIR SHampoos AND CONDITIONERS; ORGANIC SKIN AND BODY TOPICAL LOTIONS, CREAMS AND OILS FOR COSMETIC USE; ORGANIC WRINKLE REMOVING SKIN CARE PREPARATIONS (U.S. CLS. 1, 4, 6, 50, 51 AND 52).

FIRST USE 5-1-2010; IN COMMERCE 5-1-2010.

4,164,999. ASPIRE BRANDS, INC., WESTLAKE, OH. SN 77-964,734. PUB. 8-17-2010, FILED 3-22-2010.

LIP HAPPINESS

THE MARK CONSISTS OF STANDARD CHARACTERS WITHOUT CLAIM TO ANY PARTICULAR FONT, STYLE, SIZE, OR COLOR.

NO CLAIM IS MADE TO THE EXCLUSIVE RIGHT TO USE "LIP", APART FROM THE MARK AS SHOWN.

FOR COSMETICS; LIP BALMS; LIP GLOSS; LIPSTICKS (U.S. CLS. 1, 4, 6, 50, 51 AND 52).

FIRST USE 12-1-2011; IN COMMERCE 12-1-2011.

4,165,045. NURSE JAMIE, INC., SANTA MONICA, CA. SN 85-014,081. PUB. 9-21-2010, FILED 4-14-2010.

Nurse Jamie

THE MARK CONSISTS OF STANDARD CHARACTERS WITHOUT CLAIM TO ANY PARTICULAR FONT, STYLE, SIZE, OR COLOR.

FOR SKIN CARE PRODUCTS, NAMELY, SKIN TIGHTENING CREAMS (U.S. CLS. 1, 4, 6, 50, 51 AND 52).

FIRST USE 2-29-2012; IN COMMERCE 3-16-2012.

CLASS 3—(Continued).

4,165,064. DERMADOCTOR, INC., KANSAS CITY, MO. SN 85-032,655. PUB. 10-5-2010, FILED 5-7-2010.

FALL IN LOVE WITH RETINOL
ALL OVER AGAIN

THE MARK CONSISTS OF STANDARD CHARACTERS WITHOUT CLAIM TO ANY PARTICULAR FONT, STYLE, SIZE, OR COLOR.

FOR NON-MEDICATED SKIN LOTION (U.S. CLS. 1, 4, 6, 50, 51 AND 52).

FIRST USE 11-0-2008; IN COMMERCE 1-0-2009.

4,165,086. SPA FAVOURITES, LLC, WEST BLOOMFIELD, MI. SN 85-058,427. PUB. 11-9-2010, FILED 6-9-2010.

Jordan Alexis

THE MARK CONSISTS OF STANDARD CHARACTERS WITHOUT CLAIM TO ANY PARTICULAR FONT, STYLE, SIZE, OR COLOR.

THE NAME(S), PORTRAIT(S), AND/OR SIGNATURE(S) SHOWN IN THE MARK DOES NOT IDENTIFY A PARTICULAR LIVING INDIVIDUAL.

FOR AROMATIC BODY CARE PRODUCTS, NAMELY, BODY LOTION, SHOWER GEL, CUTICLE CREAM, SHAMPOO, CONDITIONER, NON-MEDICATED LIP BALM, SOAP, BODY POLISH, BODY AND FOOT SCRUB AND NON-MEDICATED FOOT CREAM; BATH MILKS; BEAUTY CREAMS FOR BODY CARE; BEAUTY LOTIONS; BEAUTY MILKS; BEAUTY SERUMS; BODY AND BEAUTY CARE COSMETICS; BODY BUTTER; BODY CREAM SOAP; BODY OILS; BODY SPLASH; BODY SPRAYS; BODY WASH; CLEANSING MILK; COSMETIC FACIAL BLOTTERING PAPERS; COSMETIC HAIR DRESSING PREPARATIONS; COSMETIC OLIVE OIL FOR THE FACE AND BODY; COSMETIC PREPARATIONS FOR BODY CARE; COSMETIC PREPARATIONS FOR SKIN RENEWAL; COSMETIC PREPARATIONS FOR SLIMMING PURPOSES; COSMETIC PREPARATIONS FOR THE HAIR AND SCALP; COSMETICS IN THE FORM OF MILKS, LOTIONS AND EMULSIONS; DECORATIVE TRANSFERS AND SKIN JEWELS FOR COSMETIC PURPOSES; EYE COMPRESSES FOR COSMETIC PURPOSES; EYEBROW COSMETICS; FACE AND BODY BEAUTY CREAMS; FACE AND BODY MILK; FACIAL BEAUTY MASKS; GIFT BASKETS CONTAINING NON-MEDICATED BATH PREPARATIONS AND COSMETIC PREPARATIONS; GRAPE SEED OIL FOR COSMETIC USE; LOTIONS FOR FACE AND BODY CARE; MAKE-UP FOR THE FACE AND BODY; MAKE-UP REMOVING MILK, GEL, LOTIONS AND CREAMS; NUTRITIONAL OILS FOR COSMETIC PURPOSES; PRIVATE LABEL COSMETICS; ROSE OIL FOR COSMETIC PURPOSES; SCENTED BODY LOTIONS AND CREAMS; SCENTED BODY SPRAY; SHEA BUTTER FOR COSMETIC PURPOSES; SKIN CARE PREPARATIONS, NAMELY, BODY BALM; TANNING AND AFTER-SUN MILKS, GELS AND OILS; WRINKLE-MINIMIZING COSMETIC PREPARATIONS FOR TOPICAL FACIAL USE (U.S. CLS. 1, 4, 6, 50, 51 AND 52).

FIRST USE 7-13-2011; IN COMMERCE 7-13-2011.

CLASS 3—(Continued).

4,165,131. BEAUTYBANK INC., NEW YORK, NY. SN 85-107,956. PUB. 1-25-2011, FILED 8-16-2010.

LUV-A-LICIOUS

THE MARK CONSISTS OF STANDARD CHARACTERS WITHOUT CLAIM TO ANY PARTICULAR FONT, STYLE, SIZE, OR COLOR.

FOR FRAGRANCES (U.S. CLS. 1, 4, 6, 50, 51 AND 52).

FIRST USE 4-30-2011; IN COMMERCE 4-30-2011.

4,165,159. BEAUTY BOOTH LLC, CHICAGO, IL. SN 85-117,828. PUB. 2-8-2011, FILED 8-27-2010.

VENEFFECT

THE MARK CONSISTS OF STANDARD CHARACTERS WITHOUT CLAIM TO ANY PARTICULAR FONT, STYLE, SIZE, OR COLOR.

FOR SKIN MOISTURIZER; FACIAL CLEANSERS; FACIAL CONCEALER; FACIAL LOTION; EYE CREAM; LIP CREAM; NON-MEDICATED ACNE TREATMENT PREPARATIONS; SUNTAN CREAMS; BODY WASHES; SOAPS FOR BODY CARE; SHAMPOOS; HAIR CONDITIONERS; HAIR NOURISHERS; HAIR EMOLLIENTS (U.S. CLS. 1, 4, 6, 50, 51 AND 52).

FIRST USE 1-16-2012; IN COMMERCE 1-16-2012.

4,165,182. DJF ENTERPRISES, NEW YORK, NY. SN 85-123,285. PUB. 8-30-2011, FILED 9-3-2010.

SOFT EFFECTS

THE MARK CONSISTS OF STANDARD CHARACTERS WITHOUT CLAIM TO ANY PARTICULAR FONT, STYLE, SIZE, OR COLOR.

NO CLAIM IS MADE TO THE EXCLUSIVE RIGHT TO USE "SOFT", APART FROM THE MARK AS SHOWN.

FOR COSMETICS (U.S. CLS. 1, 4, 6, 50, 51 AND 52).

FIRST USE 1-18-2011; IN COMMERCE 1-18-2011.

CLASS 3—(Continued).

4,165,225. PCC LICENSING, INC., CALABASAS, CA. SN 85-136,076. PUB. 8-30-2011, FILED 9-22-2010.



THE NAME(S), PORTRAIT(S), AND/OR SIGNATURE(S) SHOWN IN THE MARK IDENTIFIES SUZANNE SOMERS, WHOSE CONSENT(S) TO REGISTER IS MADE OF RECORD.

THE MARK CONSISTS OF A LARGE LETTER "S" WITH THE WORD "SUZANNE" UNDER THE TOP CURL OF THE LETTER "S".

FOR ORGANIC COSMETICS, COSMETIC PREPARATIONS, NON-MEDICATED TOILETRIES, NON-MEDICATED SKIN SERUMS, ANTI-WRINKLE CREAMS, ANTI-AGING CREAM, SKIN TONERS, FACE AND BODY CREAMS, FACIAL MASKS, ANTI-AGING MOISTURIZER, SKIN MOISTURIZER, COSMETIC SUN-PROTECTING PREPARATIONS, COSMETIC SUN-TANNING PREPARATIONS, NON-MEDICATED SUN CARE PREPARATIONS, SUN BLOCK PREPARATIONS, SUN CARE LOTIONS, SUN SCREEN, SUN SCREEN PREPARATIONS, NON-MEDICATED SKIN CARE PREPARATIONS IN THE NATURE OF FIRING AND SMOOTHING GEL; NON-MEDICATED SKIN CARE PREPARATIONS, NAMELY, CREAMS, LOTIONS, GELS, TONERS, CLEANERS, AFTER SUN CREAMS, AFTER SUN LOTIONS, NON-MEDICATED SKIN CARE PRODUCTS, NAMELY, FACIAL CLEANSERS, SKIN CLEANSERS, SKIN MOISTURIZERS, AND FACIAL MOISTURIZERS; ALL THE FOREGOING BEING ORGANIC OR MADE FROM ORGANIC INGREDIENTS (U.S. CLS. 1, 4, 6, 50, 51 AND 52).

FIRST USE 6-0-2010; IN COMMERCE 6-0-2010.

4,165,257. PATRICK FOUCART, CEBAZAT, FRANCE. SN 85-150,059. PUB. 9-20-2011, FILED 10-11-2010.



NO CLAIM IS MADE TO THE EXCLUSIVE RIGHT TO USE "SAINT GERMAIN COSMETICS PARIS", APART FROM THE MARK AS SHOWN.

CLASS 3—(Continued).

THE MARK CONSISTS OF CURSIVE WRITING OF "SAINT GERMAIN" SEPARATED BY SILHOUETTE OF EIFFEL TOWER WITH NEXT LINE IN CURSIVE WRITING SHOWING "COSMETICS" AND "PARIS".

FOR ABRASIVE PASTE; BODY DEODORANTS; CLEANING AND POLISHING PREPARATIONS; CLEANING, POLISHING AND SCOURING PREPARATIONS; COSMETIC PREPARATIONS; COSMETIC SOAPS; ESSENTIAL OILS; HAIR CARE LOTIONS; HAIR CARE PREPARATIONS; PERFUME; PERFUMED SOAPS; SKIN SOAP; TEETH CLEANING LOTIONS; TOOTH CLEANING PREPARATIONS (U.S. CLS. 1, 4, 6, 50, 51 AND 52). FIRST USE 2-15-2011; IN COMMERCE 2-15-2011.

4,165,313. COSMETIC DERMATOLOGY, INC., MIAMI, FL. SN 85-172,235. PUB. 3-29-2011, FILED 11-9-2010.

FLEXITONE

THE MARK CONSISTS OF STANDARD CHARACTERS WITHOUT CLAIM TO ANY PARTICULAR FONT, STYLE, SIZE, OR COLOR.

FOR SKIN CREAMS, SKIN LOTIONS, SKIN MOISTURIZERS AND SKIN EMOLLIENTS (U.S. CLS. 1, 4, 6, 50, 51 AND 52).

FIRST USE 3-9-2012; IN COMMERCE 3-9-2012.

4,165,321. THE PROCTER & GAMBLE COMPANY, CINCINNATI, OH. SN 85-178,935. PUB. 3-8-2011, FILED 11-17-2010.

MYSTIC FOREST

THE MARK CONSISTS OF STANDARD CHARACTERS WITHOUT CLAIM TO ANY PARTICULAR FONT, STYLE, SIZE, OR COLOR.

FOR LAUNDRY DETERGENTS (U.S. CLS. 1, 4, 6, 50, 51 AND 52).

FIRST USE 2-21-2012; IN COMMERCE 2-21-2012.

4,165,322. THE PROCTER & GAMBLE COMPANY, CINCINNATI, OH. SN 85-178,938. PUB. 3-22-2011, FILED 11-17-2010.

OCEAN MIST

THE MARK CONSISTS OF STANDARD CHARACTERS WITHOUT CLAIM TO ANY PARTICULAR FONT, STYLE, SIZE, OR COLOR.

CLASS 3—(Continued).

OWNER OF U.S. REG. NOS. 2,920,087 AND 2,999,255.
 FOR LAUNDRY DETERGENTS (U.S. CLS. 1, 4, 6, 50,
 51 AND 52).
 FIRST USE 2-21-2012; IN COMMERCE 2-21-2012.

CLASS 3—(Continued).

4,165,604. TOO FACED COSMETICS, INC., IRVINE, CA. SN
 85-285,327. PUB. 1-24-2012, FILED 4-4-2011.

4,165,323. THE PROCTER & GAMBLE COMPANY, CINCIN-
 NATI, OH. SN 85-178,940. PUB. 3-8-2011, FILED 11-17-2010.

Shadow Insurance Lemon Drop

SPRING MEADOW

THE MARK CONSISTS OF STANDARD CHARACTERS
 WITHOUT CLAIM TO ANY PARTICULAR FONT, STYLE,
 SIZE, OR COLOR.
 FOR LAUNDRY DETERGENTS (U.S. CLS. 1, 4, 6, 50,
 51 AND 52).
 FIRST USE 2-21-2012; IN COMMERCE 2-21-2012.

THE MARK CONSISTS OF STANDARD CHARACTERS
 WITHOUT CLAIM TO ANY PARTICULAR FONT, STYLE,
 SIZE, OR COLOR.
 OWNER OF U.S. REG. NO. 3,573,413.
 NO CLAIM IS MADE TO THE EXCLUSIVE RIGHT TO
 USE "SHADOW". APART FROM THE MARK AS SHOWN.
 FOR COSMETICS (U.S. CLS. 1, 4, 6, 50, 51 AND 52).
 FIRST USE 6-15-2011; IN COMMERCE 6-15-2011.

4,165,415. AUSTRALIAN GOLD, LLC, INDIANAPOLIS, IN.
 SN 85-227,372. PUB. 5-31-2011, FILED 1-27-2011.

4,165,608. PRL USA HOLDINGS, INC., NEW YORK, NY. SN
 85-285,832. PUB. 1-31-2012, FILED 4-4-2011.

COCO DE VILLE

THE MARK CONSISTS OF STANDARD CHARACTERS
 WITHOUT CLAIM TO ANY PARTICULAR FONT, STYLE,
 SIZE, OR COLOR.
 FOR NON-MEDICATED INDOOR SKIN TANNING
 PREPARATIONS MARKETED FOR SALE IN INDOOR
 TANNING SALONS (U.S. CLS. 1, 4, 6, 50, 51 AND 52).
 FIRST USE 11-1-2011; IN COMMERCE 11-1-2011.



4,165,470. GRIGNARD COMPANY, LLC, RAHWAY, NJ. SN
 85-257,821. PUB. 8-16-2011, FILED 3-4-2011.

OWNER OF U.S. REG. NOS. 1,327,818, 3,902,780, AND
 OTHERS.

THE COLOR(S) PURPLE, PINK, SILVER AND YELLOW
 IS/ARE CLAIMED AS A FEATURE OF THE MARK.

THE MARK CONSISTS OF A THREE-DIMENSIONAL
 CONFIGURATION OF A BOTTLE OR CONTAINER FOR
 THE GOODS IN THE COLOR PURPLE WITH A SILVER CAP
 THEREFORE AND A DEPICTION OF A POLO PLAYER
 RIDING A HORSE ON THE FRONT OF SAID BOTTLE OR
 CONTAINER IN THE COLOR PINK; THE NUMBER "4" IN
 THE COLOR YELLOW APPEARS AT THE BACK OF THE
 BOTTLE AS IS SHOWN THROUGH THE BOTTLE OR
 CONTAINER IN REVERSE. THE COLORS WHITE, GRAY,
 AND BLACK APPEAR FOR HIGHLIGHTING/SHADING
 PURPOSES ONLY AND ARE NOT PARTS OF THE MARK.

SEC. 2(F) AS TO "THE THREE-DIMENSIONAL CONFIG-
 URATION OF THE BOTTLE OR THE CONTAINER FOR
 THE GOODS AND THE CAP DESIGN".
 FOR EAU DE TOILETTE (U.S. CLS. 1, 4, 6, 50, 51 AND
 52).

FIRST USE 3-16-2012; IN COMMERCE 3-16-2012.

DIRRECT POWER

THE MARK CONSISTS OF STANDARD CHARACTERS
 WITHOUT CLAIM TO ANY PARTICULAR FONT, STYLE,
 SIZE, OR COLOR.
 FOR INDUSTRIAL CLEANING AGENTS (U.S. CLS. 1,
 4, 6, 50, 51 AND 52).
 FIRST USE 5-0-2011; IN COMMERCE 5-0-2011.

CLASS 3—(Continued).

4,165,609. PRL USA HOLDINGS, INC., NEW YORK, NY. SN 85-285,837. PUB. 1-31-2012, FILED 4-4-2011.



OWNER OF U.S. REG. NOS. 1,327,818, 3,902,779, AND OTHERS.

THE COLOR(S) BLUE, YELLOW, SILVER AND ORANGE IS/ARE CLAIMED AS A FEATURE OF THE MARK.

THE MARK CONSISTS OF A THREE-DIMENSIONAL CONFIGURATION OF A BOTTLE OR CONTAINER FOR THE GOODS IN THE COLOR YELLOW WITH A SILVER CAP THEREFORE AND A DEPICTION OF A POLO PLAYER RIDING A HORSE ON THE FRONT OF SAID BOTTLE OR CONTAINER IN THE COLOR BLUE; THE NUMBER "3" IN THE COLOR ORANGE APPEARS AT THE BACK OF THE BOTTLE AS IS SHOWN THROUGH THE BOTTLE OR CONTAINER IN REVERSE. THE COLORS WHITE, GRAY, AND BLACK APPEAR FOR HIGHLIGHTING/SHADING PURPOSES ONLY AND ARE NOT PARTS OF THE MARK.

SEC. 2(F) AS TO "THE THREE-DIMENSIONAL CONFIGURATION OF THE BOTTLE OR THE CONTAINER FOR THE GOODS AND THE CAP DESIGN".

FOR EAU DE TOILETTE (U.S. CLS. 1, 4, 6, 50, 51 AND 52).

FIRST USE 3-16-2012; IN COMMERCE 3-16-2012.

4,165,676. SECRET KISSES, LLC., WESLEY CHAPEL, FL. SN 85-303,648. PUB. 9-6-2011, FILED 4-25-2011.



THE MARK CONSISTS OF STYLIZED LETTERS "S" AND "K".

FOR LIPSTICKS; EYE-SHADOW; LIP GLOSS; MASCARA; NAIL POLISH (U.S. CLS. 1, 4, 6, 50, 51 AND 52). FIRST USE 12-24-2010; IN COMMERCE 12-24-2010.

CLASS 3—(Continued).

4,165,683. YING, BIN, COLLEGE POINT, NY. SN 85-305,935. PUB. 9-13-2011, FILED 4-27-2011.

YING'S COLOR

THE MARK CONSISTS OF STANDARD CHARACTERS WITHOUT CLAIM TO ANY PARTICULAR FONT, STYLE, SIZE, OR COLOR.

NO CLAIM IS MADE TO THE EXCLUSIVE RIGHT TO USE "COLOR", APART FROM THE MARK AS SHOWN.

FOR BLUSH; COSMETICS, NAMELY, COMPACTS; EYE CREAM; EYE SHADOW; EYEBROW PENCILS; EYELINER; EYESHADOW; FACIAL CONCEALER; FACIAL MAKE-UP; FACIAL MASKS; FALSE NAILS; LIP GLOSS; LIP LINER; LIPSTICK; MAKE-UP REMOVER; MASCARA; NAIL HARDENERS; NAIL POLISH; NAIL POLISH BASE COAT; NAIL POLISH REMOVER; SKIN BRONZER (U.S. CLS. 1, 4, 6, 50, 51 AND 52).

FIRST USE 6-1-2011; IN COMMERCE 6-1-2011.

4,165,698. PEAK ENTERPRISES, INC., SARASOTA, FL. SN 85-311,217. PUB. 10-25-2011, FILED 5-3-2011.

PEAK ESSENTIALS THE ORIGINAL TUNG GEL

THE MARK CONSISTS OF STANDARD CHARACTERS WITHOUT CLAIM TO ANY PARTICULAR FONT, STYLE, SIZE, OR COLOR.

NO CLAIM IS MADE TO THE EXCLUSIVE RIGHT TO USE "THE ORIGINAL TONGUE GEL", APART FROM THE MARK AS SHOWN.

FOR GEL COMPOUND FOR CLEANSING THE TONGUE (U.S. CLS. 1, 4, 6, 50, 51 AND 52).

FIRST USE 9-30-2011; IN COMMERCE 9-30-2011.

4,165,731. PERFECT WORLD SOLUTIONS, INC., PHOENIX, AZ. SN 85-331,374. PUB. 2-7-2012, FILED 5-26-2011.

BIONICRELIEF

THE MARK CONSISTS OF STANDARD CHARACTERS WITHOUT CLAIM TO ANY PARTICULAR FONT, STYLE, SIZE, OR COLOR.

FOR TOPICAL SKIN AND BODY LOTION, CREAM, OIL, SALVE, BALM, OR OINTMENT (U.S. CLS. 1, 4, 6, 50, 51 AND 52).

FIRST USE 5-10-2011; IN COMMERCE 5-10-2011.

CLASS 3—(Continued).

4,165,756. PROCTER & GAMBLE COMPANY, THE, CINCINNATI, OH. SN 85-344,634. PUB. 1-24-2012, FILED 6-13-2011.

SWEET SIZZLE

THE MARK CONSISTS OF STANDARD CHARACTERS WITHOUT CLAIM TO ANY PARTICULAR FONT, STYLE, SIZE, OR COLOR.

FOR LAUNDRY ADDITIVES IN THE NATURE OF FRAGRANCE ENHANCERS (U.S. CLS. 1, 4, 6, 50, 51 AND 52).

FIRST USE 9-3-2011; IN COMMERCE 9-3-2011.

CLASS 3—(Continued).

4,165,836. SCHNEIDER, GALIT, COOPER CITY, FL. SN 85-386,108. PUB. 1-24-2012, FILED 8-1-2011.

Brows Gone Wow

THE MARK CONSISTS OF STANDARD CHARACTERS WITHOUT CLAIM TO ANY PARTICULAR FONT, STYLE, SIZE, OR COLOR.

NO CLAIM IS MADE TO THE EXCLUSIVE RIGHT TO USE "BROWS", APART FROM THE MARK AS SHOWN.

FOR COSMETICS AND MAKE-UP (U.S. CLS. 1, 4, 6, 50, 51 AND 52).

FIRST USE 9-20-2011; IN COMMERCE 9-20-2011.

4,165,829. EFIL LIFE, INC., WESTHAMPTON, NM. SN 85-382,424. PUB. 1-24-2012, FILED 7-27-2011.

PROFILE YOUR PASSION

THE MARK CONSISTS OF STANDARD CHARACTERS WITHOUT CLAIM TO ANY PARTICULAR FONT, STYLE, SIZE, OR COLOR.

FOR COSMETIC SUNSCREEN AND SKIN PREPARATIONS (U.S. CLS. 1, 4, 6, 50, 51 AND 52).

FIRST USE 3-17-2012; IN COMMERCE 3-17-2012.

4,165,855. GROSS, DENNIS, NEW YORK, NY. SN 85-394,610. PUB. 2-28-2012, FILED 8-10-2011.

GLOW PAD

THE MARK CONSISTS OF STANDARD CHARACTERS WITHOUT CLAIM TO ANY PARTICULAR FONT, STYLE, SIZE, OR COLOR.

NO CLAIM IS MADE TO THE EXCLUSIVE RIGHT TO USE "PAD", APART FROM THE MARK AS SHOWN.

FOR ANTI-AGING CLEANSER; ANTI-AGING TONER; SELF-TANNING PREPARATIONS (U.S. CLS. 1, 4, 6, 50, 51 AND 52).

FIRST USE 1-0-2011; IN COMMERCE 1-0-2011.

4,165,831. CHURCH & DWIGHT CO., INC., PRINCETON, NJ. SN 85-382,655. PUB. 1-3-2012, FILED 7-27-2011.

OXICLEAN

THE MARK CONSISTS OF STANDARD CHARACTERS WITHOUT CLAIM TO ANY PARTICULAR FONT, STYLE, SIZE, OR COLOR.

OWNER OF U.S. REG. NOS. 2,430,077, 3,655,476, AND OTHERS.

FOR AUTOMATIC DISHWASHING DETERGENT BOOSTERS (U.S. CLS. 1, 4, 6, 50, 51 AND 52).

FIRST USE 1-27-2012; IN COMMERCE 1-27-2012.

4,165,894. ALDEN MEDICAL LLC, WEST SPRINGFIELD, MA. SN 85-424,653. PUB. 2-28-2012, FILED 9-16-2011.

CleanTree Enzymatic

THE MARK CONSISTS OF STANDARD CHARACTERS WITHOUT CLAIM TO ANY PARTICULAR FONT, STYLE, SIZE, OR COLOR.

NO CLAIM IS MADE TO THE EXCLUSIVE RIGHT TO USE "ENZYMATIC", APART FROM THE MARK AS SHOWN.

FOR CLEANER FOR USE ON HEAT SENSITIVE MEDICAL DEVICES (U.S. CLS. 1, 4, 6, 50, 51 AND 52).

FIRST USE 3-1-2011; IN COMMERCE 11-12-2011.

CLASS 3—(Continued).

4,165,896. RARITY BEAUTY, LLC, NEW HOPE, PA. SN 85-428,130. PUB. 2-14-2012, FILED 9-21-2011.

IS YOUR DOG A FRESH DOG?

THE MARK CONSISTS OF STANDARD CHARACTERS WITHOUT CLAIM TO ANY PARTICULAR FONT, STYLE, SIZE, OR COLOR.

NO CLAIM IS MADE TO THE EXCLUSIVE RIGHT TO USE "DOG", APART FROM THE MARK AS SHOWN.

FOR DRY SHAMPOO FOR DOGS (U.S. CLS. 1, 4, 6, 50, 51 AND 52).

FIRST USE 2-21-2012; IN COMMERCE 2-21-2012.

4,165,897. RARITY BEAUTY, LLC, NEW HOPE, PA. SN 85-428,635. PUB. 2-14-2012, FILED 9-21-2011.

FRESH DOG, HAPPY FAMILY

THE MARK CONSISTS OF STANDARD CHARACTERS WITHOUT CLAIM TO ANY PARTICULAR FONT, STYLE, SIZE, OR COLOR.

NO CLAIM IS MADE TO THE EXCLUSIVE RIGHT TO USE "DOG", APART FROM THE MARK AS SHOWN.

FOR DRY SHAMPOO FOR DOGS (U.S. CLS. 1, 4, 6, 50, 51 AND 52).

FIRST USE 2-21-2012; IN COMMERCE 2-21-2012.

4,165,901. N.V. PERRICONE LLC, MERIDEN, CT. SN 85-436,343. PUB. 1-3-2012, FILED 9-30-2011.

NO CONCEALER CONCEALER

THE MARK CONSISTS OF STANDARD CHARACTERS WITHOUT CLAIM TO ANY PARTICULAR FONT, STYLE, SIZE, OR COLOR.

OWNER OF U.S. REG. NO. 3,763,210.

NO CLAIM IS MADE TO THE EXCLUSIVE RIGHT TO USE "CONCEALER", APART FROM THE MARK AS SHOWN.

FOR FACIAL CONCEALER (U.S. CLS. 1, 4, 6, 50, 51 AND 52).

FIRST USE 3-19-2012; IN COMMERCE 3-19-2012.

CLASS 3—(Continued).

4,165,911. RARITY BEAUTY, LLC, NEW HOPE, PA. SN 85-468,565. PUB. 2-14-2012, FILED 11-9-2011.



NO CLAIM IS MADE TO THE EXCLUSIVE RIGHT TO USE "DOG", APART FROM THE MARK AS SHOWN.

THE MARK CONSISTS OF THE WORD "FRESH", WHICH APPEARS IN CAPITAL LETTERS. A SHADED, BORDERED CIRCLE APPEARS NEXT TO THE WORD "FRESH." THE CIRCLE PARTIALLY COVERS THE LETTER "H" IN THE WORD "FRESH." THE WORD "DOG" APPEARS IN LOWER CASE LETTERS INSIDE OF THE CIRCLE. THE LETTER "O" IN THE WORD "DOG" HAS STYLIZED EARS. THE GREY SHOWN IN THE MARK IS FOR SHADING PURPOSES ONLY.

FOR DRY SHAMPOO FOR DOGS (U.S. CLS. 1, 4, 6, 50, 51 AND 52).

FIRST USE 2-21-2012; IN COMMERCE 2-21-2012.

4,165,912. RARITY BEAUTY, LLC, NEW HOPE, PA. SN 85-468,817. PUB. 2-14-2012, FILED 11-9-2011.



THE MARK CONSISTS OF A SHADED CIRCLE, WITH AN EXTERIOR BORDER. A STYLIZED DOG FACE APPEARS INSIDE OF THE CIRCLE. THE DOG'S EARS ARE RAISED AND THE DOG'S EYES ARE CLOSED. THE DOG'S NOSE IS OVAL SHAPED. THE GREY SHOWN IN THE MARK IS FOR SHADING PURPOSES ONLY.

FOR DRY SHAMPOO FOR DOGS (U.S. CLS. 1, 4, 6, 50, 51 AND 52).

FIRST USE 2-21-2012; IN COMMERCE 2-21-2012.

CLASS 3—(Continued).

4,165,932. MARY KAY INC., ADDISON, TX. SN 85-976,710.
PUB. 3-1-2011, FILED 9-3-2010.

CLASS 5—(Continued).

4,164,897. MCCARTHY, ROBERT, MELVILLE, NY. SN 77-795,255. PUB. 9-28-2010, FILED 8-3-2009.

BOTANICAL EFFECTS

THE MARK CONSISTS OF STANDARD CHARACTERS WITHOUT CLAIM TO ANY PARTICULAR FONT, STYLE, SIZE, OR COLOR.

NO CLAIM IS MADE TO THE EXCLUSIVE RIGHT TO USE "BOTANICAL", APART FROM THE MARK AS SHOWN.

FOR COSMETICS; NON-MEDICATED SKIN CARE PREPARATIONS; SKIN CLEANSERS (U.S. CLS. 1, 4, 6, 50, 51 AND 52).

FIRST USE 1-8-2012; IN COMMERCE 2-16-2012.

Follicle Fuel

THE MARK CONSISTS OF STANDARD CHARACTERS WITHOUT CLAIM TO ANY PARTICULAR FONT, STYLE, SIZE, OR COLOR.

NO CLAIM IS MADE TO THE EXCLUSIVE RIGHT TO USE "FOLLICLE", APART FROM THE MARK AS SHOWN.

FOR DIETARY SUPPLEMENTS FOR HUMAN CONSUMPTION (U.S. CLS. 6, 18, 44, 46, 51 AND 52).
FIRST USE 3-31-2012; IN COMMERCE 3-31-2012.

CLASS 5—PHARMACEUTICALS

4,164,842. ANGSTROM PHARMACEUTICALS, INC., SOLANA BEACH, CA. SN 77-578,529. PUB. 2-24-2009, FILED 9-25-2008.

4,164,905. ASO CORPORATION, SARASOTA, FL. SN 77-809,120. PUB. 8-24-2010, FILED 8-20-2009.

ANGSTROM

THE MARK CONSISTS OF STANDARD CHARACTERS WITHOUT CLAIM TO ANY PARTICULAR FONT, STYLE, SIZE, OR COLOR.

OWNER OF U.S. REG. NOS. 2,115,403 AND 2,115,514.

FOR PHARMACEUTICAL PREPARATIONS USED FOR THE TREATMENT OF CANCER, OCULAR DISEASES AND DISORDERS, VASCULAR DISEASES AND DISORDERS, AND INFLAMMATORY DISEASES AND DISORDERS (U.S. CLS. 6, 18, 44, 46, 51 AND 52).

FIRST USE 8-0-2009; IN COMMERCE 8-0-2009.



4,164,844. IMMUNOGENETIX THERAPEUTICS, INC., LENEXA, KS. SN 77-579,763. PUB. 2-17-2009, FILED 9-26-2008.

OWNER OF U.S. REG. NO. 3,469,038.
NO CLAIM IS MADE TO THE EXCLUSIVE RIGHT TO USE "PROTECTS ON ALL SIDES" AND THE PICTORIAL REPRESENTATION OF AN ADHESIVE BANDAGE, APART FROM THE MARK AS SHOWN.

THE COLOR(S) TAN, BLACK, GOLD, WHITE AND RED IS/ARE CLAIMED AS A FEATURE OF THE MARK.

THE MARK CONSISTS OF THE FOLLOWING: A GOLD CIRCLE DESIGN THAT INCORPORATES AN ARROW OUTLINED IN RED, THE WORDING "THE SEAL THAT HEALS PROTECTS ON ALL SIDES" IN BLACK, A DESIGN OF A BANDAGE IN TAN, AND A DASHED LINE IN BLACK ON TOP OF THE BANDAGE DESIGN. THE PORTION INSIDE THE CIRCLE DESIGN NEXT TO THE BANDAGE ON EACH SIDE IS WHITE.

FOR ADHESIVE BANDAGES WITH ANTIBACTERIAL PROPERTIES AND RELATED FIRST-AID SUPPLIES, NAMELY, BANDAGES FOR SKIN WOUNDS, MEDICAL ADHESIVE TAPE AND HYDROCOLLOID WOUND DRESSINGS, NAMELY, HYDROCOLLOID PADS (U.S. CLS. 6, 18, 44, 46, 51 AND 52).

FIRST USE 5-0-2010; IN COMMERCE 5-0-2010.

GENEPRO

THE MARK CONSISTS OF STANDARD CHARACTERS WITHOUT CLAIM TO ANY PARTICULAR FONT, STYLE, SIZE, OR COLOR.

FOR VACCINE (U.S. CLS. 6, 18, 44, 46, 51 AND 52).

FIRST USE 4-6-2012; IN COMMERCE 4-6-2012.

CLASS 5—(Continued).

4,164,908. MISSION PHARMACAL COMPANY, SAN ANTONIO, TX. SN 77-818,690. PUB. 1-26-2010, FILED 9-2-2009.

THE SPORTS DRINK IN A PILL

THE MARK CONSISTS OF STANDARD CHARACTERS WITHOUT CLAIM TO ANY PARTICULAR FONT, STYLE, SIZE, OR COLOR.

FOR SODIUM SALT TABLETS FOR USE IN THE TREATMENT OF LOW BLOOD LEVEL SODIUM (U.S. CLS. 6, 18, 44, 46, 51 AND 52).

FIRST USE 9-30-2011; IN COMMERCE 9-30-2011.

4,164,918. JOHNSON & JOHNSON, NEW BRUNSWICK, NJ. SN 77-828,753. PUB. 9-7-2010, FILED 9-17-2009.



NO CLAIM IS MADE TO THE EXCLUSIVE RIGHT TO USE "ITCH" AND THE SERPENT AND STAFF CADUCEUS SYMBOL, APART FROM THE MARK AS SHOWN.

THE MARK CONSISTS OF A SHIELD/CREST DESIGN WITH THE WORDING "ITCH SHIELD" DISPLAYED WITHIN THE TOP OF THE SHIELD/CREST AND THE WORDING "TECHNOLOGY" DISPLAYED WITHIN THE BOTTOM OF THE SHIELD/CREST WITH A SECOND SHIELD/CREST IN THE CENTER OF THE FIRST WITH AN IMAGE OF A SERPENT AND STAFF CADUCEUS SYMBOL CENTERED INSIDE.

FOR BLEND OF INGREDIENTS SOLD AS AN INTEGRAL COMPONENT OF TOPICAL ANTI-ITCH PREPARATIONS (U.S. CLS. 6, 18, 44, 46, 51 AND 52).

FIRST USE 12-0-2009; IN COMMERCE 12-0-2009.

CLASS 5—(Continued).

4,164,961. DOW AGROSCIENCES LLC, INDIANAPOLIS, IN. SN 77-902,695. PUB. 4-13-2010, FILED 12-30-2009.

BLACKHAWK

THE MARK CONSISTS OF STANDARD CHARACTERS WITHOUT CLAIM TO ANY PARTICULAR FONT, STYLE, SIZE, OR COLOR.

FOR PESTICIDES, NAMELY, INSECTICIDES FOR AGRICULTURE, HORTICULTURE, FORESTRY, TURF AND ORNAMENTAL USE (U.S. CLS. 6, 18, 44, 46, 51 AND 52).

FIRST USE 2-17-2012; IN COMMERCE 2-17-2012.

4,164,979. PFIZER INC., NEW YORK, NY. SN 77-945,930. PUB. 9-28-2010, FILED 2-26-2010.

ADVOCIN

THE MARK CONSISTS OF STANDARD CHARACTERS WITHOUT CLAIM TO ANY PARTICULAR FONT, STYLE, SIZE, OR COLOR.

FOR VETERINARY PREPARATIONS AND SUBSTANCES FOR USE IN THE TREATMENT OF RESPIRATORY DISEASES IN LIVESTOCK (U.S. CLS. 6, 18, 44, 46, 51 AND 52).

FIRST USE 2-10-2012; IN COMMERCE 2-10-2012.

4,165,001. STOUGH, DOWLING B., HOT SPRINGS, AR. SN 77-965,148. PUB. 3-8-2011, FILED 3-22-2010.

BURKE PHARMACEUTICALS

THE MARK CONSISTS OF STANDARD CHARACTERS WITHOUT CLAIM TO ANY PARTICULAR FONT, STYLE, SIZE, OR COLOR.

NO CLAIM IS MADE TO THE EXCLUSIVE RIGHT TO USE "PHARMACEUTICALS", APART FROM THE MARK AS SHOWN.

FOR OVER THE COUNTER PHARMACEUTICALS IN THE FIELD OF DERMATOLOGY (U.S. CLS. 6, 18, 44, 46, 51 AND 52).

FIRST USE 12-31-2011; IN COMMERCE 12-31-2011.

CLASS 5—(Continued).

4,165,093. LANNETT HOLDINGS, INC., WILMINGTON, DE. SN 85-073,929. PUB. 10-5-2010, FILED 6-29-2010.

LCI

THE MARK CONSISTS OF STANDARD CHARACTERS WITHOUT CLAIM TO ANY PARTICULAR FONT, STYLE, SIZE, OR COLOR.

FOR FULL LINE OF PHARMACEUTICAL PREPARATIONS AND SUBSTANCES (U.S. CLS. 6, 18, 44, 46, 51 AND 52).

FIRST USE 8-11-2011; IN COMMERCE 8-11-2011.

CLASS 5—(Continued).

4,165,220. ALPHATEC SPINE, INC., CARLSBAD, CA. SN 85-134,435. PUB. 3-8-2011, FILED 9-21-2010.

PureGen

THE MARK CONSISTS OF STANDARD CHARACTERS WITHOUT CLAIM TO ANY PARTICULAR FONT, STYLE, SIZE, OR COLOR.

FOR BIOLOGICAL TISSUES, NAMELY, EMBRYONIC-LIKE ADULT STEM CELLS FOR MEDICAL USE IN HUMAN AND ANIMAL CELLULAR THERAPIES (U.S. CLS. 6, 18, 44, 46, 51 AND 52).

FIRST USE 4-5-2012; IN COMMERCE 4-5-2012.

4,165,171. NORTHERN INNOVATIONS HOLDING CORP., OAKVILLE, CANADA. SN 85-121,069. PUB. 9-6-2011, FILED 9-1-2010.

AMINOFX

THE MARK CONSISTS OF STANDARD CHARACTERS WITHOUT CLAIM TO ANY PARTICULAR FONT, STYLE, SIZE, OR COLOR.

FOR PROPRIETARY NUTRITIONAL INGREDIENT BLEND SOLD AS AN INTEGRAL PART OF NUTRITIONAL SUPPLEMENTS FOR PERFORMANCE AND STRENGTH ENHANCEMENT, BODY COMPOSITION ENHANCEMENT AND MUSCLE BUILDING ENHANCEMENT (U.S. CLS. 6, 18, 44, 46, 51 AND 52).

FIRST USE 5-16-2011; IN COMMERCE 5-16-2011.

4,165,293. WESTERN HOLDINGS, LLC, CARSON CITY, NV. SN 85-163,429. PUB. 2-22-2011, FILED 10-28-2010.

FIT SCIENCE

THE MARK CONSISTS OF STANDARD CHARACTERS WITHOUT CLAIM TO ANY PARTICULAR FONT, STYLE, SIZE, OR COLOR.

FOR DIETARY SUPPLEMENTS (U.S. CLS. 6, 18, 44, 46, 51 AND 52).

FIRST USE 11-1-2011; IN COMMERCE 11-1-2011.

4,165,187. MONSANTO TECHNOLOGY LLC, ST. LOUIS, MO. SN 85-124,250. PUB. 2-8-2011, FILED 9-7-2010.

ROUNDUP READY PLUS

THE MARK CONSISTS OF STANDARD CHARACTERS WITHOUT CLAIM TO ANY PARTICULAR FONT, STYLE, SIZE, OR COLOR.

OWNER OF U.S. REG. NOS. 1,889,104, 2,101,872, AND 3,828,659.

FOR HERBICIDES FOR AGRICULTURAL USE (U.S. CLS. 6, 18, 44, 46, 51 AND 52).

FIRST USE 1-18-2012; IN COMMERCE 1-18-2012.

4,165,298. WHOLE FOODS MARKET IP, L.P., AUSTIN, TX. SN 85-166,893. PUB. 8-16-2011, FILED 11-2-2010.

**TAKE CARE OF YOURSELF –
AZALEA**

THE MARK CONSISTS OF STANDARD CHARACTERS WITHOUT CLAIM TO ANY PARTICULAR FONT, STYLE, SIZE, OR COLOR.

FOR FEMININE HYGIENE PADS; SANITARY NAPKINS; TAMPONS (U.S. CLS. 6, 18, 44, 46, 51 AND 52).

FIRST USE 5-2-2011; IN COMMERCE 5-2-2011.

CLASS 5—(Continued).

4,165,320. THE FOSTER PORTER COMPANY, LLC, RIVERTON, UT. SN 85-177,003. PUB. 11-22-2011, FILED 11-15-2010.

IN A PIKLE

THE MARK CONSISTS OF STANDARD CHARACTERS WITHOUT CLAIM TO ANY PARTICULAR FONT, STYLE, SIZE, OR COLOR.

FOR CUSTOM MADE EMERGENCY MEDICAL CARE KITS PRIMARILY FOR MEDICAL PURPOSES, HAVING INTERCHANGEABLE INSERTS AND COMPRISING ONE OR MORE OF THE FOLLOWING ITEMS, PAIN RELIEF MEDICATION, COUGH DROPS, ANTIBIOTIC OINTMENT, HAND SANITIZER, ADHESIVE BANDAGES, MEDICATED LIP BALM, ANTACIDS, DENTAL FLOSS, FACIAL TISSUES, CHEWING GUM, TWEEZERS, NAIL CLIPPERS, NAIL FILE, GLUE, SCREW DRIVERS, TAMPONS, PRE-MOISTENED TOWELETTES, BOBBY-PINS, SAFETY PINS, RUBBER BANDS, PAPER CLIPS, MIRROR, PEN, ADHESIVE NOTE PAPER, STAIN REMOVAL PEN FOR REMOVAL OF STAINS FROM CLOTHES AND FABRICS, AND SEWING KIT COMPRISED PRIMARILY OF SEWING THREADS, SEWING NEEDLES AND SEWING SCISSORS (U.S. CLS. 6, 18, 44, 46, 51 AND 52).

FIRST USE 10-25-2011; IN COMMERCE 10-25-2011.

4,165,391. OMADA NUTRITION, INC., FORT MYERS, FL. SN 85-213,190. PUB. 8-2-2011, FILED 1-7-2011.

OMADA NUTRITION

THE MARK CONSISTS OF STANDARD CHARACTERS WITHOUT CLAIM TO ANY PARTICULAR FONT, STYLE, SIZE, OR COLOR.

NO CLAIM IS MADE TO THE EXCLUSIVE RIGHT TO USE "NUTRITION", APART FROM THE MARK AS SHOWN.

THE ENGLISH TRANSLATION OF "OMADA" IN THE MARK IS "TEAM".

FOR NUTRITIONAL SUPPLEMENTS (U.S. CLS. 6, 18, 44, 46, 51 AND 52).

FIRST USE 11-29-2011; IN COMMERCE 11-29-2011.

CLASS 5—(Continued).

4,165,401. DENMARK, THEODORE C., SCOTTSDALE, AZ. AND DENMARK, KATHLEEN L., SCOTTSDALE, AZ. SN 85-219,416. PUB. 5-17-2011, FILED 1-17-2011.

ClearFlush

THE MARK CONSISTS OF STANDARD CHARACTERS WITHOUT CLAIM TO ANY PARTICULAR FONT, STYLE, SIZE, OR COLOR.

FOR NUTRITIONAL SUPPLEMENT FOR ELIMINATING TOXINS FROM THE BODY (U.S. CLS. 6, 18, 44, 46, 51 AND 52).

FIRST USE 3-1-2001; IN COMMERCE 3-1-2001.

4,165,454. BLUE MOON HOLDINGS, LLC, CINCINNATI, OH. SN 85-251,423. PUB. 10-11-2011, FILED 2-25-2011.

WE BE WELL

THE MARK CONSISTS OF STANDARD CHARACTERS WITHOUT CLAIM TO ANY PARTICULAR FONT, STYLE, SIZE, OR COLOR.

FOR DIETARY AND NUTRITIONAL SUPPLEMENTS (U.S. CLS. 6, 18, 44, 46, 51 AND 52).

FIRST USE 8-31-2011; IN COMMERCE 8-31-2011.

4,165,464. ESSENTIAL BEGINNINGS, LLC, MILL VALLEY, CA. SN 85-255,052. PUB. 8-30-2011, FILED 3-1-2011.

Essential Beginnings

THE MARK CONSISTS OF STANDARD CHARACTERS WITHOUT CLAIM TO ANY PARTICULAR FONT, STYLE, SIZE, OR COLOR.

NO CLAIM IS MADE TO THE EXCLUSIVE RIGHT TO USE "ESSENTIAL", APART FROM THE MARK AS SHOWN.

FOR DIETARY AND NUTRITIONAL SUPPLEMENTS (U.S. CLS. 6, 18, 44, 46, 51 AND 52).

FIRST USE 8-13-2010; IN COMMERCE 5-10-2011.

CLASS 5—(Continued).

4,165,474. BENTON THERAPEUTICS, INC., DIAMOND BAR, CA. SN 85-259,295. PUB. 7-26-2011, FILED 3-7-2011.

IT'S CLEAR BREATHING FROM
HERE ON OUT

THE MARK CONSISTS OF STANDARD CHARACTERS WITHOUT CLAIM TO ANY PARTICULAR FONT, STYLE, SIZE, OR COLOR.

FOR NASAL SPRAY PREPARATIONS (U.S. CLS. 6, 18, 44, 46, 51 AND 52).

FIRST USE 2-1-2011; IN COMMERCE 9-26-2011.

4,165,489. DALE MCQUEEN, DBA GAND ENTERPRISE, LOVELAND, CO. SN 85-263,981. PUB. 8-16-2011, FILED 3-10-2011.

Sweet Dreams Scents

THE MARK CONSISTS OF STANDARD CHARACTERS WITHOUT CLAIM TO ANY PARTICULAR FONT, STYLE, SIZE, OR COLOR.

NO CLAIM IS MADE TO THE EXCLUSIVE RIGHT TO USE "SCENTS", APART FROM THE MARK AS SHOWN.

FOR HERBAL PRODUCTS, NAMELY, AROMATHERAPY PACKS CONTAINING HERBS USED FOR RELIEF FROM HEADACHES, INSOMNIA AND SINUS DISCOMFORT; HERBS FOR MEDICINAL PURPOSES; NATURAL SLEEP AID PREPARATIONS (U.S. CLS. 6, 18, 44, 46, 51 AND 52).

FIRST USE 3-1-2011; IN COMMERCE 3-1-2011.

4,165,498. FIRST AIRBORNE SERVICE TRADING CORP, MIAMI, FL. SN 85-266,116. PUB. 9-6-2011, FILED 3-14-2011.

Power Slim

THE MARK CONSISTS OF STANDARD CHARACTERS WITHOUT CLAIM TO ANY PARTICULAR FONT, STYLE, SIZE, OR COLOR.

NO CLAIM IS MADE TO THE EXCLUSIVE RIGHT TO USE "SLIM", APART FROM THE MARK AS SHOWN.

FOR WEIGHT LOSS MASSAGE GEL USED FOR SKIN APPLICATION TO TONE BODY (U.S. CLS. 6, 18, 44, 46, 51 AND 52).

FIRST USE 5-4-2011; IN COMMERCE 6-13-2011.

CLASS 5—(Continued).

4,165,548. SUNTRITION INC., TECUMSEH, ONTARIO, CANADA. SN 85-275,864. PUB. 8-9-2011, FILED 3-24-2011.

SUNTRITION

THE MARK CONSISTS OF STANDARD CHARACTERS WITHOUT CLAIM TO ANY PARTICULAR FONT, STYLE, SIZE, OR COLOR.

FOR DIETARY AND NUTRITIONAL SUPPLEMENTS (U.S. CLS. 6, 18, 44, 46, 51 AND 52).

FIRST USE 3-28-2012; IN COMMERCE 3-28-2012.

4,165,629. SHINE, LE CHE, GIBSONTON, FL. SN 85-289,967. PUB. 8-16-2011, FILED 4-8-2011.

Nineto5

THE MARK CONSISTS OF STANDARD CHARACTERS WITHOUT CLAIM TO ANY PARTICULAR FONT, STYLE, SIZE, OR COLOR.

FOR DIETARY SUPPLEMENTS (U.S. CLS. 6, 18, 44, 46, 51 AND 52).

FIRST USE 5-1-2011; IN COMMERCE 10-1-2011.

4,165,748. ADVANCED NUTRACEUTICAL ENGINEERS & MARKETERS, BOYNTON BEACH, FL. SN 85-341,564. PUB. 1-24-2012, FILED 6-8-2011.

Ronnie Coleman Signature
Series

THE MARK CONSISTS OF STANDARD CHARACTERS WITHOUT CLAIM TO ANY PARTICULAR FONT, STYLE, SIZE, OR COLOR.

NO CLAIM IS MADE TO THE EXCLUSIVE RIGHT TO USE "SIGNATURE SERIES", APART FROM THE MARK AS SHOWN.

THE NAME(S), PORTRAIT(S), AND/OR SIGNATURE(S) SHOWN IN THE MARK IDENTIFIES "RONNIE COLEMAN", WHOSE CONSENT(S) TO REGISTER IS MADE OF RECORD.

FOR DIETARY SUPPLEMENTS (U.S. CLS. 6, 18, 44, 46, 51 AND 52).

FIRST USE 9-1-2011; IN COMMERCE 10-1-2011.

CLASS 5—(Continued).

4,165,876. SAFETY JUNCTION, THE, SAINT LOUIS, MO. SN 85-403,203. PUB. 2-14-2012, FILED 8-21-2011.

The Safety Junction

THE MARK CONSISTS OF STANDARD CHARACTERS WITHOUT CLAIM TO ANY PARTICULAR FONT, STYLE, SIZE, OR COLOR.

NO CLAIM IS MADE TO THE EXCLUSIVE RIGHT TO USE "SAFETY", APART FROM THE MARK AS SHOWN. FOR FIRST AID KITS (U.S. CLS. 6, 18, 44, 46, 51 AND 52).

FIRST USE 10-10-2011; IN COMMERCE 4-10-2012.

4,165,899. S2 SYNERGY LLC, DBA POO-POURRI DOODY FREE, ADDISON, TX. SN 85-430,576. PUB. 2-14-2012, FILED 9-23-2011.

Poopourri Doody Free

THE MARK CONSISTS OF STANDARD CHARACTERS WITHOUT CLAIM TO ANY PARTICULAR FONT, STYLE, SIZE, OR COLOR.

OWNER OF U.S. REG. NOS. 3,428,805, 3,576,912, AND 3,678,445.

FOR AIR DEODORIZER; AIR FRESHENER SPRAYS; AIR FRESHENERS (U.S. CLS. 6, 18, 44, 46, 51 AND 52).

FIRST USE 1-3-2012; IN COMMERCE 1-3-2012.

4,165,908. PRIMARY INVESTMENTS GROUP LIMITED, ROAD TOWN, TORTOLA, BR.VIRGIN ISLANDS. SN 85-455,981. PUB. 2-7-2012, FILED 10-25-2011.

FULL DIET

THE MARK CONSISTS OF STANDARD CHARACTERS WITHOUT CLAIM TO ANY PARTICULAR FONT, STYLE, SIZE, OR COLOR.

NO CLAIM IS MADE TO THE EXCLUSIVE RIGHT TO USE "DIET", APART FROM THE MARK AS SHOWN.

FOR DIETARY SUPPLEMENTS; FOOD SUPPLEMENTS; HERBAL SUPPLEMENTS; NUTRITIONAL SUPPLEMENTS; VITAMIN SUPPLEMENTS; MINERAL SUPPLEMENTS; MULTI-VITAMIN AND MINERAL SUPPLEMENTS (U.S. CLS. 6, 18, 44, 46, 51 AND 52).

FIRST USE 1-20-2012; IN COMMERCE 1-20-2012.

CLASS 6—METAL GOODS

4,165,060. LEADING EDGE INNOVATIONS, INC., VANCOUVER, CANADA. SN 85-027,800. PUB. 12-21-2010, FILED 4-30-2010.

FORCEGUARD

THE MARK CONSISTS OF STANDARD CHARACTERS WITHOUT CLAIM TO ANY PARTICULAR FONT, STYLE, SIZE, OR COLOR.

FOR METAL LOCKS (U.S. CLS. 2, 12, 13, 14, 23, 25 AND 50).

FIRST USE 11-1-2011; IN COMMERCE 11-1-2011.

4,165,309. OLYMPIA FABRIC STRUCTURES, LUCKNOW, ONTARIO, CANADA. SN 85-171,734. PUB. 10-18-2011, FILED 11-8-2010.

BRITESPAN

THE MARK CONSISTS OF STANDARD CHARACTERS WITHOUT CLAIM TO ANY PARTICULAR FONT, STYLE, SIZE, OR COLOR.

PRIORITY CLAIMED UNDER SEC. 44(D) ON CANADA APPLICATION NO. 1495001, FILED 9-8-2010, REG. NO. 804195, DATED 8-11-2011, EXPIRES 8-11-2026.

FOR BUILDINGS MADE OF A METAL FRAMEWORK COVERED IN FABRIC (U.S. CLS. 2, 12, 13, 14, 23, 25 AND 50).

FIRST USE 10-31-2011; IN COMMERCE 10-31-2011.

4,165,324. ILLINOIS TOOL WORKS INC., GLENVIEW, IL. SN 85-179,668. PUB. 12-6-2011, FILED 11-18-2010.

HOMESCAPES

THE MARK CONSISTS OF STANDARD CHARACTERS WITHOUT CLAIM TO ANY PARTICULAR FONT, STYLE, SIZE, OR COLOR.

FOR METAL HOOKS (U.S. CLS. 2, 12, 13, 14, 23, 25 AND 50).

FIRST USE 6-30-2011; IN COMMERCE 6-30-2011.

CLASS 6—(Continued).

4,165,421. JENSEN ENTERPRISES, SPARKS, NV. SN 85-233,123. PUB. 8-9-2011, FILED 2-3-2011.

CLASS 6—(Continued).

4,165,541. NINGBO XINYANG WEIYE IMPORT & EXPORT CO., LTD., NINGBO, CHINA. SN 85-275,188. PUB. 8-9-2011, FILED 3-23-2011.

TRAXPLATE



THE MARK CONSISTS OF STANDARD CHARACTERS WITHOUT CLAIM TO ANY PARTICULAR FONT, STYLE, SIZE, OR COLOR.

FOR METAL BUILDING MATERIALS, NAMELY, METAL PLATES, METAL PLATES TO COVER SERVICES ACCESS OPENINGS INTO MANHOLES, VAULTS, PITS, HAND HOLES AND UNDERGROUND ENCLOSURES, METAL GRATES, AND METAL PANELS; METAL FLOORING WITH NON-SLIP SURFACES (U.S. CLS. 2, 12, 13, 14, 23, 25 AND 50).
FIRST USE 7-0-2010; IN COMMERCE 7-0-2010.

THE MARK CONSISTS OF STYLIZED CAPITAL LETTER "W".

FOR BUCKLES OF COMMON METAL; CABLE JUNCTION SLEEVES OF METAL; DOOR FITTINGS OF METAL; METAL BINS; METAL FLANGES; METAL NUTS; METAL PIPE FITTINGS; METAL PIPES; METALLIC MATERIALS FOR RAILWAY TRACKS; METALS AND METAL ALLOYS; NON-ELECTRIC CABLES OF METAL; REINFORCING MATERIALS OF METAL FOR BUILDING PURPOSES (U.S. CLS. 2, 12, 13, 14, 23, 25 AND 50).
FIRST USE 8-26-2011; IN COMMERCE 8-26-2011.

4,165,431. TRACTOR SUPPLY CO. OF TEXAS, LP. BRENTWOOD, TN. SN 85-238,586. PUB. 4-19-2011, FILED 2-10-2011.

4,165,551. TRICON PRECAST, LTD., HOUSTON, TX. SN 85-276,534. PUB. 8-9-2011, FILED 3-25-2011.

REDSTONE

CRIMPLOCK

THE MARK CONSISTS OF STANDARD CHARACTERS WITHOUT CLAIM TO ANY PARTICULAR FONT, STYLE, SIZE, OR COLOR.

FOR FIREPLACE GRATES (U.S. CLS. 2, 12, 13, 14, 23, 25 AND 50).
FIRST USE 10-1-2011; IN COMMERCE 10-1-2011.

THE MARK CONSISTS OF STANDARD CHARACTERS WITHOUT CLAIM TO ANY PARTICULAR FONT, STYLE, SIZE, OR COLOR.

FOR ROAD CONSTRUCTION MATERIALS, NAMELY, WELDED WIRE CONNECTION SYSTEMS FOR PRECAST CONCRETE WALLS AND MECHANICALLY STABILIZED RETAINING WALLS (U.S. CLS. 2, 12, 13, 14, 23, 25 AND 50).
FIRST USE 10-4-2011; IN COMMERCE 10-4-2011.

CLASS 6—(Continued).

4,165,653. METALÚRGICA HASSMANN S.A., IMIGRANTE, RS, BRAZIL. SN 85-296,549. PUB. 8-30-2011, FILED 4-15-2011.

HBR

THE MARK CONSISTS OF STANDARD CHARACTERS WITHOUT CLAIM TO ANY PARTICULAR FONT, STYLE, SIZE, OR COLOR.

THE WORDING "HBR" HAS NO MEANING IN A FOREIGN LANGUAGE.

FOR METAL FASTENERS, NAMELY, HEXAGON BOLTS, CARRIAGE BOLTS, HEAD CAP SCREWS, HEX FLANGE BOLTS, SOCKET HEAD CAP SCREWS, PLOW BOLTS, STRUCTURAL BOLTS, SEMI-FINISHED BOLTS AND SCREWS; METAL SCREWS (U.S. CLS. 2, 12, 13, 14, 23, 25 AND 50).

FIRST USE 2-21-2012; IN COMMERCE 2-21-2012.

4,165,690. HANDI-FOIL CORPORATION, WHEELING, IL. SN 85-308,404. PUB. 8-2-2011, FILED 4-29-2011.

JIF-FOIL

THE MARK CONSISTS OF STANDARD CHARACTERS WITHOUT CLAIM TO ANY PARTICULAR FONT, STYLE, SIZE, OR COLOR.

OWNER OF U.S. REG. NOS. 3,663,685, 3,903,065, AND OTHERS.

FOR ALUMINUM FOIL AND ALUMINUM FOIL PAPER (U.S. CLS. 2, 12, 13, 14, 23, 25 AND 50).

FIRST USE 10-15-2011; IN COMMERCE 10-15-2011.

CLASS 7—MACHINERY

4,164,969. TSUBAKIMOTO CHAIN CO., OSAKA, JAPAN. SN 77-924,570. PUB. 12-21-2010, FILED 2-1-2010.

O-Carry

THE MARK CONSISTS OF STANDARD CHARACTERS WITHOUT CLAIM TO ANY PARTICULAR FONT, STYLE, SIZE, OR COLOR.

FOR LOADING-UNLOADING MACHINES AND CONVEYORS (U.S. CLS. 13, 19, 21, 23, 31, 34 AND 35).

FIRST USE 6-30-2010; IN COMMERCE 6-30-2010.

CLASS 7—(Continued).

4,165,035. MOTOWORKS, INC., LAKE ELSINORE, CA. SN 85-005,187. PUB. 2-15-2011, FILED 4-2-2010.

MOTOWORKS

THE MARK CONSISTS OF STANDARD CHARACTERS WITHOUT CLAIM TO ANY PARTICULAR FONT, STYLE, SIZE, OR COLOR.

FOR EXHAUST SYSTEMS AND COMPONENTS FOR MOTORCYCLES AND FOR ALL TERRAIN VEHICLES, NAMELY, EXHAUST PIPES, HEADER PIPES, MUFFLERS, EXHAUST PIPE BRACKETS, FLANGES, HEAT SHIELDS, CLAMPS AND HEADERS; NUTS, BOLTS OR GASKETS SOLD AS A UNIT WITH ONE OR MORE OF THE FOREGOING ITEMS; AND MUFFLER KITS CONSISTING OF MUFFLERS, BAFFLES AND MUFFLER INSULATION MATERIALS, ALL SOLD AS A UNIT (U.S. CLS. 13, 19, 21, 23, 31, 34 AND 35).

FIRST USE 10-1-2005; IN COMMERCE 10-1-2005.

4,165,036. MOTOWORKS, INC., LAKE ELSINORE, CA. SN 85-005,472. PUB. 2-15-2011, FILED 4-2-2010.



The logo for MotoWorks, featuring the word "Moto" in a stylized, italicized font with a red outline, and "works" in a bold, sans-serif font with a red outline.

THE COLOR(S) BLACK, WHITE AND RED IS/ARE CLAIMED AS A FEATURE OF THE MARK.

THE MARK CONSISTS OF A STYLIZED VERSION OF THE WORD "MOTOWORKS", WITH A BLACK OUTLINE AROUND THE LETTERS, THE WORD "MOTO" IN WHITE AND THE WORD "WORKS" IN RED.

FOR EXHAUST SYSTEMS AND COMPONENTS FOR MOTORCYCLES AND FOR ALL TERRAIN VEHICLES, NAMELY, EXHAUST PIPES, HEADER PIPES, MUFFLERS, EXHAUST PIPE BRACKETS, FLANGES, HEAT SHIELDS, CLAMPS AND HEADERS; NUTS, BOLTS OR GASKETS SOLD AS A UNIT WITH ONE OR MORE OF THE FOREGOING ITEMS; AND MUFFLER KITS CONSISTING OF MUFFLERS, BAFFLES AND MUFFLER INSULATION MATERIALS, ALL SOLD AS A UNIT (U.S. CLS. 13, 19, 21, 23, 31, 34 AND 35).

FIRST USE 10-1-2005; IN COMMERCE 10-1-2005.

CLASS 7—(Continued).

4,165,110. FIBERIO TECHNOLOGY CORPORATION, MCALLEN, TX. SN 85-090,783. PUB. 7-19-2011, FILED 7-22-2010.



THE MARK CONSISTS OF A STYLIZED DEPICTION OF AN ANGLED VORTEX COMPRISING A SERIES OF TWELVE ARROWS WITH A SPACE BETWEEN THE BOTTOM THREE AND THE TOP NINE ARROWS ALONG APPROXIMATELY THE RIGHT AND TOP SIDE OF AN ELLIPSE, WITH A CURVED BAND ALONG THE LEFT SIDE OF THE ELLIPSE.

FOR CENTRIFUGAL FIBER MANUFACTURING MACHINES AND STRUCTURAL PARTS THEREFORE, NAMELY, CENTRIFUGAL FIBER PROCESSING CHAMBERS, FIBER COLLECTORS, NOZZLES USED WITH EQUIPMENT TO MAKE FIBERS, NEEDLES USED WITH EQUIPMENT TO MAKE FIBERS, SPINNERETS USED WITH EQUIPMENT TO MAKE FIBERS, NEEDLE HOLDERS USED WITH EQUIPMENT TO MAKE FIBERS, NOZZLE AND NEEDLE HOLDER SETS USED WITH EQUIPMENT TO MAKE FIBERS, AND HEATING ELEMENTS BEING MACHINE PARTS USED WITH EQUIPMENT TO MAKE FIBERS (U.S. CLS. 13, 19, 21, 23, 31, 34 AND 35).

FIRST USE 1-1-2011; IN COMMERCE 1-1-2011.

4,165,136. KUHN KRAUSE, INC., HUTCHINSON, KS. SN 85-108,534. PUB. 1-3-2012, FILED 8-16-2010.

EXCALIBUR

THE MARK CONSISTS OF STANDARD CHARACTERS WITHOUT CLAIM TO ANY PARTICULAR FONT, STYLE, SIZE, OR COLOR.

FOR EARTH ENGAGING, EARTH CUTTING, AND EARTH PULVERIZING DISCS AND COULTER BLADES FOR PLOWS, HARROWS, AND LIKE AGRICULTURAL MACHINES, SOLD SEPARATELY AND AS AN INTEGRAL PART OF AN AGRICULTURAL TILLAGE MACHINE (U.S. CLS. 13, 19, 21, 23, 31, 34 AND 35).

FIRST USE 2-0-2011; IN COMMERCE 2-0-2011.

CLASS 7—(Continued).

4,165,168. EXCEL INDUSTRIES, INC., HESSTON, KS. SN 85-119,871. PUB. 2-15-2011, FILED 8-31-2010.

CUTTING GRASS NOT CORNERS

THE MARK CONSISTS OF STANDARD CHARACTERS WITHOUT CLAIM TO ANY PARTICULAR FONT, STYLE, SIZE, OR COLOR.

FOR LAWN MOWERS (U.S. CLS. 13, 19, 21, 23, 31, 34 AND 35).

FIRST USE 3-15-2012; IN COMMERCE 3-15-2012.

4,165,169. 14 NORTHVIEW, LLC, LAFAYETTE, LA. SN 85-119,935. PUB. 2-15-2011, FILED 8-31-2010.

Pile Driv'r

THE MARK CONSISTS OF STANDARD CHARACTERS WITHOUT CLAIM TO ANY PARTICULAR FONT, STYLE, SIZE, OR COLOR.

FOR MECHANIZED FEEDERS FOR WILDLIFE (U.S. CLS. 13, 19, 21, 23, 31, 34 AND 35).

FIRST USE 1-5-2012; IN COMMERCE 1-5-2012.

4,165,175. JUNG PUMPEN GMBH, STEINHAGEN, FED REP GERMANY. SN 85-121,437. PUB. 8-30-2011, FILED 9-2-2010.

Jung Pumpen

THE MARK CONSISTS OF STANDARD CHARACTERS WITHOUT CLAIM TO ANY PARTICULAR FONT, STYLE, SIZE, OR COLOR.

NO CLAIM IS MADE TO THE EXCLUSIVE RIGHT TO USE "PUMPEN", APART FROM THE MARK AS SHOWN.

CLASS 7—(Continued).

THE ENGLISH TRANSLATION OF "PUMPEN" IN THE MARK IS "PUMP".

FOR CENTRIFUGAL PUMPS FOR CLEAN WATER, WASTE WATER, AND SEWAGE; POSITIVE DISPLACEMENT PUMPS FOR CLEAN WATER, WASTE WATER, AND SEWAGE; CENTRIFUGAL SUMP PUMPS; DIAPHRAGM AND CENTRIFUGAL PUMPS FOR USE IN THE REMOVAL OF CONDENSATES; MACHINE-LIFTING DEVICES FOR SEWAGE AND WASTEWATER COMPRISED OF SEWAGE AND WASTEWATER PUMPS, RAILS, GUIDE PLATES, MOUNTING BASES, PIPELINES, ISOLATION VALVES, RESERVOIRS, AND ELECTRICAL CONTROL UNITS; MACHINE-MIXERS FOR LIQUIDS FOR FLUSHING DEBRIS FROM PUMP SURFACES; AIR INJECTORS FOR THE INJECTION OF OXYGEN INTO LIQUIDS FOR ODOR CONTROL; PNEUMATIC PUMPING DEVICES CONSISTING OF COMPRESSED AIR GENERATORS, PIPELINES, STORAGE TANKS, ISOLATION VALVES, AIR SILENCERS, AND ELECTRICAL CONTROL DEVICES FOR TEMPORARY STORAGE AND REMOVAL OF GROUND RUN-OFF WATER; PORTABLE HOUSES FOR PUMPING STATIONS, NAMELY, SEWAGE LIFTING STATIONS; VENTILATION EQUIPMENT FOR WASTE WATER UNDER PRESSURE, NAMELY, BLOWER FANS AND VENTS; IRRIGATION FOR DRAINS, NAMELY, WATER PIPES, VALVES AND CENTRIFUGAL WASTE WATER PUMPS; AND FLOOD EMERGENCY KITS COMPRISED OF CENTRIFUGAL SUMP PUMPS, HOSES, AND CARRYING CASES THEREFORE (U.S. CLS. 13, 19, 21, 23, 31, 34 AND 35).

FIRST USE 12-15-2010; IN COMMERCE 12-15-2010.

4,165,207. SMITH, DONALD, GUILFORD, CT. SN 85-130,324. PUB. 9-27-2011, FILED 9-15-2010.

sbcleansite

THE MARK CONSISTS OF STANDARD CHARACTERS WITHOUT CLAIM TO ANY PARTICULAR FONT, STYLE, SIZE, OR COLOR.

FOR MACHINE ENCLOSURES, NAMELY, NON-METAL MODULAR ENCLOSURES FOR ENCLOSING TILE CUTTING MACHINES, ELECTRIC TOOLS AND PAINT SPRAYING MACHINES; NON-METAL MODULAR WALL ENCLOSURES FOR ENCLOSING TILE CUTTING MACHINES, ELECTRIC TOOLS AND PAINT SPRAYING MACHINES; MACHINE ENCLOSURE KITS COMPRISED OF FLOORING AND WALLS THAT CAN BE ASSEMBLED AND DISASSEMBLED (U.S. CLS. 13, 19, 21, 23, 31, 34 AND 35).

FIRST USE 2-29-2012; IN COMMERCE 2-29-2012.

4,165,218. CHEN HSONG ASSET MANAGEMENT LIMITED, TAI PO, NEW TERRITORIES, HONG KONG. SN 85-134,197. PUB. 7-12-2011, FILED 9-21-2010.

CHEN HSONG

"CHEN HSONG" DOES NOT IDENTIFY A LIVING INDIVIDUAL.

CLASS 7—(Continued).

THE MARK CONSISTS OF THE STYLIZED LETTERS "CH" TO THE LEFT OF THE WORDING "CHEN HSONG", WITH A SOLID HORIZONTAL BAR UNDER SAID WORDING.

FOR PLASTIC INJECTION MOULDING MACHINES (U.S. CLS. 13, 19, 21, 23, 31, 34 AND 35).

FIRST USE 11-0-2006; IN COMMERCE 2-0-2011.

4,165,379. UNITED GENERAL SUPPLY CO., INC., HOUSTON, TX. SN 85-208,212. PUB. 9-6-2011, FILED 12-30-2010.



NO CLAIM IS MADE TO THE EXCLUSIVE RIGHT TO USE "TOOLS", APART FROM THE MARK AS SHOWN.

THE COLOR(S) BLACK, RED, SILVER, LIGHT SILVER IS/ARE CLAIMED AS A FEATURE OF THE MARK.

THE MARK CONSISTS OF THE TERM "DAYTONA" IN BLACK, STYLIZED LETTERING ABOVE THE TERM "TOOLS" IN RED, STYLIZED LETTERING WITH BOTH TERMS PLACED ON TOP OF A DRAWING OF A TABLE SAW CIRCULAR BLADE WITH THE INNER CIRCLE IN LIGHT SILVER AND THE TEETH OF THE BLADE IN SILVER. THE COLOR WHITE IS USED TO INDICATE BACKGROUND OR TRANSPARENT PORTIONS AND IS NOT PART OF THE MARK.

FOR POWER TOOLS, NAMELY, DRILLS, POWER-OPERATED SAWS, GRINDERS, ELECTRIC SANDERS; AIR-OPERATED POWER TOOLS, NAMELY, IMPACT WRENCHES, ELECTRIC SANDERS, GRINDERS, PNEUMATIC HAMMERS, RATCHET WRENCHES, POWER-OPERATED SPRAYERS; POWER TOOL PARTS AND ACCESSORIES, NAMELY, ABRASIVE DISKS FOR POWER-OPERATED SANDERS, POWER DRILL BITS, BLADES FOR POWER TOOLS, POWER-OPERATED GRINDING WHEELS; METAL PARTS AND FITTINGS FOR POWER-OPERATED TOOLS (U.S. CLS. 13, 19, 21, 23, 31, 34 AND 35).

FIRST USE 1-0-2010; IN COMMERCE 1-0-2010.

4,165,419. LTF S.P.A., 24051 ANTEGNATE (BG), ITALY. SN 85-228,950. PUB. 10-18-2011, FILED 1-28-2011.



NO CLAIM IS MADE TO THE EXCLUSIVE RIGHT TO USE "AEROGRAFI ORIGINALI", APART FROM THE MARK AS SHOWN.

CLASS 7—(Continued).

THE MARK CONSISTS OF THE WORDING "AOM AEROGRAFI ORIGINALI" IN STYLIZED FORM, WITH THE WORDS "AEROGRAFI ORIGINALI" CONTAINED WITHIN A CIRCULAR SHAPE RESEMBLING A MACHINE GEAR, AND THE WORDING "AOM" CONTAINED WITHIN A RECTANGULAR SHAPE IN THE CENTER OF THE DESIGN.

THE ENGLISH TRANSLATION OF "AEROGRAFI ORIGINALI" IN THE MARK IS "AEROGRAPHS ORIGINAL".

FOR PUMPS, NAMELY, PUMPS FOR PAINTING; COMPRESSED AIR PUMPS; AEROGRAPHS, NAMELY, AIR BRUSHES FOR APPLYING SPRAY PAINTS (U.S. CLS. 13, 19, 21, 23, 31, 34 AND 35).

FIRST USE 0-0-1999; IN COMMERCE 0-0-1999.

4,165,457. YING, YIFENG, ST. LOUIS, MO. SN 85-253,125. PUB. 8-16-2011, FILED 2-28-2011.



NO CLAIM IS MADE TO THE EXCLUSIVE RIGHT TO USE "BEARINGS", APART FROM THE MARK AS SHOWN.

THE MARK CONSISTS OF THE STYLIZED WORDS "JOBAC BEARINGS" AND AN ABSTRACT BEARING.

FOR MACHINE PARTS, NAMELY, BEARINGS (U.S. CLS. 13, 19, 21, 23, 31, 34 AND 35).

FIRST USE 11-11-2011; IN COMMERCE 11-11-2011.

4,165,525. BELANGER, INC., NORTHVILLE, MI. SN 85-272,486. PUB. 8-2-2011, FILED 3-21-2011.

Kondor

THE MARK CONSISTS OF STANDARD CHARACTERS WITHOUT CLAIM TO ANY PARTICULAR FONT, STYLE, SIZE, OR COLOR.

FOR VEHICLE LAUNDRY EQUIPMENT, NAMELY, AUTOMATIC CAR WASH MACHINES (U.S. CLS. 13, 19, 21, 23, 31, 34 AND 35).

FIRST USE 5-2-2011; IN COMMERCE 8-19-2011.

CLASS 7—(Continued).

4,165,567. LUBROMATION INC., CHARLOTTE, NC. SN 85-278,251. PUB. 8-30-2011, FILED 3-28-2011.

We take the friction out
of your life.

THE MARK CONSISTS OF STANDARD CHARACTERS WITHOUT CLAIM TO ANY PARTICULAR FONT, STYLE, SIZE, OR COLOR.

FOR AUTOMATIC LUBRICATING SYSTEMS COMPRISED OF LUBRICATION MACHINES, LUBRICATING PUMPS, AND PARTS THEREFOR, FOR USE WITH MACHINERY WITH MOVING PARTS AND FOR USE IN THE MINING, CONSTRUCTION, AGRICULTURE AND MANUFACTURING INDUSTRIES (U.S. CLS. 13, 19, 21, 23, 31, 34 AND 35).

FIRST USE 10-15-2011; IN COMMERCE 10-15-2011.

4,165,749. FLEXICON CORPORATION, BETHLEHEM, PA. SN 85-341,870. PUB. 8-23-2011, FILED 6-9-2011.

FLEXI-FORCE

THE MARK CONSISTS OF STANDARD CHARACTERS WITHOUT CLAIM TO ANY PARTICULAR FONT, STYLE, SIZE, OR COLOR.

OWNER OF U.S. REG. NOS. 1,048,025, 1,682,650, AND 3,484,984.

FOR BULK MATERIAL HANDLING MACHINES, NAMELY, LUMP BREAKERS (U.S. CLS. 13, 19, 21, 23, 31, 34 AND 35).

FIRST USE 7-20-2011; IN COMMERCE 7-20-2011.

CLASS 8—HAND TOOLS

4,164,921. M/S GARDEX, JALANDHAR, PUNJAB, INDIA. SN 77-831,033. PUB. 7-5-2011, FILED 9-21-2009.



THE COLOR(S) BLACK, GREY AND ORANGE IS/ARE CLAIMED AS A FEATURE OF THE MARK.

CLASS 8—(Continued).

THE MARK CONSISTS OF THE WORDING "ROCKFORGE" IN BLACK WITH ORANGE FLAMES ON EITHER SIDE. THERE ARE GRAY LINES AT THE TOP AND BOTTOM. THE WHITE IN THE MARK IS FOR BACKGROUND AND IS NOT CLAIMED AS A FEATURE OF THE MARK.

FOR HAND OPERATED TOOLS, NAMELY, GARDEN TOOLS, NAMELY, PICK MATTOCK AND TILLER MATTOCK; HAND OPERATED TOOLS, NAMELY, STRIKING TOOLS, NAMELY, AXE, CAMP AXE, SLEDGE HAMMER, DRILLING HAMMER, DIAMOND WEDGE, SINGLE BIT AXE, PREMIUM AXE, DOUBLE FACE HAMMER, LANDSCAPE AXE, PICK MATTOCK, SPLITTING WEDGE, SLATE BAR, PINCH POINT BAR, TAMPER HEAD DIGGING BAR, SAN ANGELO BAR, MAUL, CUTTER MATTOCK, FIBERGLASS RAILROAD PICK, PREMIUM LOG SPLITTER; HAND TOOLS, NAMELY, MACHINISTS FILES, SAW FILES, RASP FILES AND NEEDLE FILES (U.S. CLS. 23, 28 AND 44).
FIRST USE 12-31-2009; IN COMMERCE 12-31-2009.

4,165,189. WIDE BRAND (HONG KONG) LIMITED, WAN-CHAI, HONG KONG. SN 85-125,664. PUB. 9-20-2011, FILED 9-9-2010.



THE COLOR(S) RUST, GRAY, RED, WHITE, BRONZE, BLACK, BROWN IS/ARE CLAIMED AS A FEATURE OF THE MARK.

THE MARK CONSISTS OF A STYLIZED DEPICTION OF A MAMMOTH CENTERED ON THE TOP HALF OF A BRONZE SHIELD LIKE DEVICE. THE MAMMOTH HAS LARGE CURVED WHITE TUSKS OUTLINED IN BLACK ON BOTH SIDES OF THE MAMMOTH'S HEAD THAT EXTEND FROM APPROXIMATELY THE MAMMOTH'S JAW TO ABOVE AND PARTIALLY OUTSIDE THE TOP OF THE SHIELD. THE MAMMOTH HAS GRAY FUR, RED EYES, STYLIZED BROWN EYEBROWS AND BROWN HORNS ABOVE ITS EYEBROWS AND ITS EARS ARE GRAY AND BLACK. THE UPPER PART OF THE MAMMOTH'S TRUNK IS COVERED BY A BROWN BOLTED AMOUR PLATE. THE PLATE DISAPPEARS AFTER THREE LINKS AND THE WORD "IRON" APPEARS IN BROWN STYLIZED BLOCK LETTERS ON A BLACK BACKGROUND. THE LOWER PART OF THE SHIELD CONTAINS A RECTANGULAR BROWN METAL PLATE WITH SER-RATED ENDS. THIS RECTANGULAR BROWN METAL PLATE IS COVERED IN PART BY THE MAMMOTH'S TUSKS AND THE WORD "IRON". THE RECTANGULAR PLATE APPEARS TO CONTAIN A RECESSED SURFACE ON WHICH IN RAISED STYLIZED BROWN LETTERS IS THE WORD "MAMMOTH". BELOW THE RECTANGULAR PLATE IS THE FINAL ELEMENT OF THE BROWN AMOUR PLATE COVERING THE MAMMOTH'S GRAY TRUNK, WITH THE TRUNK EXTENDING PAST SUCH AMOUR PLATE AND CURVING TO THE RIGHT AS ONE VIEWS THE DRAWING. THE TRUNK HOVERS ABOVE THE BRONZE SHIELD AND THEN RISES TO PARTIALLY COVER THE BROWN RECTANGULAR PLATE.

FOR UTILITY KNIVES (U.S. CLS. 23, 28 AND 44).
FIRST USE 2-8-2012; IN COMMERCE 2-8-2012.

CLASS 8—(Continued).

4,165,302. TARGET BRANDS, INC., MINNEAPOLIS, MN. SN 85-169,973. PUB. 2-1-2011, FILED 11-5-2010.

SPRITZ

THE MARK CONSISTS OF STANDARD CHARACTERS WITHOUT CLAIM TO ANY PARTICULAR FONT, STYLE, SIZE, OR COLOR.

FOR DISPOSABLE TABLEWARE, NAMELY, KNIVES, FORKS AND SPOONS; TABLEWARE, NAMELY, KNIVES, FORKS AND SPOONS (U.S. CLS. 23, 28 AND 44).
FIRST USE 2-0-2011; IN COMMERCE 2-0-2011.

4,165,352. FISH TALES, LLC, ORO VALLEY, AZ. SN 85-196,272. PUB. 5-10-2011, FILED 12-13-2010.



NO CLAIM IS MADE TO THE EXCLUSIVE RIGHT TO USE "BLADE", APART FROM THE MARK AS SHOWN.

THE NAME "BUBBA" DOES NOT IDENTIFY A LIVING INDIVIDUAL.

THE COLOR(S) RED, BLACK, YELLOW, PURPLE, DARK BLUE, MEDIUM BLUE AND LIGHT BLUE IS/ARE CLAIMED AS A FEATURE OF THE MARK.

THE MARK CONSISTS OF THE WORDING "BUBBA BLADE" IN RED LETTERING, OUTLINED IN BLACK AND YELLOW, SUPERIMPOSED OVER THE DESIGN OF A CHOPPY SEA WHICH APPEARS IN SHADES OF BLUE INCLUDING DARK BLUE, MEDIUM BLUE AND LIGHT BLUE. ABOVE THE WORDING IS A DESIGN OF A FISH WHICH IS PURPLE AND DARK BLUE, WITH ONE BLACK EYE AND OUTLINED IN YELLOW. THE COLOR WHITE REPRESENTS BACKGROUND AND TRANSPARENT AREAS AND IS NOT PART OF THE MARK.

FOR KNIFE (U.S. CLS. 23, 28 AND 44).

FIRST USE 9-15-2011; IN COMMERCE 9-15-2011.

4,165,569. PRIMESOURCE BUILDING PRODUCTS, INC., IRVING, TX. SN 85-279,371. PUB. 8-9-2011, FILED 3-29-2011.

GRIP-RITE

THE MARK CONSISTS OF STANDARD CHARACTERS WITHOUT CLAIM TO ANY PARTICULAR FONT, STYLE, SIZE, OR COLOR.

CLASS 8—(Continued).

OWNER OF U.S. REG. NOS. 907,843, 2,995,884, AND OTHERS.
FOR HAND TOOLS, NAMELY, KNIVES (U.S. CLS. 23, 28 AND 44).
FIRST USE 11-16-2011; IN COMMERCE 11-16-2011.

CLASS 8—(Continued).

4,165,648. PLATINUM INDUSTRIAL EQUIPMENT, LAKE RONKONKOMA, NY. SN 85-295,830. PUB. 12-13-2011, FILED 4-14-2011.

4,165,570. PRIMESOURCE BUILDING PRODUCTS, INC., IRVING, TX. SN 85-279,398. PUB. 10-25-2011, FILED 3-29-2011.



OWNER OF U.S. REG. NOS. 2,953,644, 3,032,141, AND OTHERS.
THE MARK CONSISTS OF THE WORDS "GRIP RITE" INSIDE A QUADRILATERAL.
FOR HAND TOOLS, NAMELY, KNIVES (U.S. CLS. 23, 28 AND 44).
FIRST USE 11-16-2011; IN COMMERCE 11-16-2011.

4,165,646. JORDAN DREW CORPORATION, TARRYTOWN, NY. SN 85-295,478. PUB. 7-12-2011, FILED 4-14-2011.

Samurai Pro

THE MARK CONSISTS OF STANDARD CHARACTERS WITHOUT CLAIM TO ANY PARTICULAR FONT, STYLE, SIZE, OR COLOR.
OWNER OF U.S. REG. NOS. 3,422,625 AND 3,556,013.
FOR KITCHEN KNIVES FOR USE IN COOKING, NAMELY, CHEF'S KNIVES AND PARING KNIVES (U.S. CLS. 23, 28 AND 44).
FIRST USE 9-9-2011; IN COMMERCE 9-9-2011.

The Bull Saw

THE MARK CONSISTS OF STANDARD CHARACTERS WITHOUT CLAIM TO ANY PARTICULAR FONT, STYLE, SIZE, OR COLOR.
NO CLAIM IS MADE TO THE EXCLUSIVE RIGHT TO USE "SAW", APART FROM THE MARK AS SHOWN.
FOR HAND-OPERATED LANDSCAPING TOOLS, NAMELY, POLE SAW HEADS (U.S. CLS. 23, 28 AND 44).
FIRST USE 4-1-2011; IN COMMERCE 4-1-2011.

CLASS 9—ELECTRICAL AND SCIENTIFIC APPARATUS

4,164,787. WILBUR CURTIS COMPANY, MONTEBELLO, CA. SN 76-693,222. PUB. 3-3-2009, FILED 10-1-2008.

FRESHTRAC

THE MARK CONSISTS OF STANDARD CHARACTERS WITHOUT CLAIM TO ANY PARTICULAR FONT, STYLE, SIZE, OR COLOR.
FOR AN ATTACHMENT FOR COFFEE DECANTERS AND SATELLITE COFFEE MAKERS IN THE NATURE OF AN ELECTRONIC TIMER THAT SHOWS HOW MUCH TIME HAS ELAPSED SINCE THE COFFEE WAS BREWED TO INDICATE FRESHNESS (U.S. CLS. 21, 23, 26, 36 AND 38).
FIRST USE 3-3-2012; IN COMMERCE 3-3-2012.

4,164,791. SAKAR ACQUISITION, LLC, EDISON, NJ. SN 76-702,928. PUB. 7-19-2011, FILED 5-13-2010.

SERIES 1

THE MARK CONSISTS OF STANDARD CHARACTERS WITHOUT CLAIM TO ANY PARTICULAR FONT, STYLE, SIZE, OR COLOR.
FOR BINOCULARS; CAMERA LENSES, BINOCULAR LENSES AND TELESCOPE LENSES (U.S. CLS. 21, 23, 26, 36 AND 38).
FIRST USE 0-0-1985; IN COMMERCE 0-0-1985.

CLASS 9—(Continued).

4,164,794. KABUSHIKI KAISHA TAITO, SHIBUYAKU, TOKYO, JAPAN. SN 76-705,035. PUB. 8-2-2011, FILED 10-25-2010.

DRAWIN' GROWIN'

NO CLAIM IS MADE TO THE EXCLUSIVE RIGHT TO USE "DRAWING", APART FROM THE MARK AS SHOWN.

FOR COMPUTER GAME PROGRAMS FOR MOBILE PHONES; DOWNLOADABLE COMPUTER GAME SOFTWARE FOR USE ON MOBILE AND CELLULAR TELEPHONES; COMPUTER GAME PROGRAMS FOR PERSONAL DIGITAL ASSISTANTS; DOWNLOADABLE COMPUTER GAME PROGRAMS FOR PERSONAL DIGITAL ASSISTANTS; COMPUTER GAME PROGRAMS FOR PERSONAL COMPUTERS; DOWNLOADABLE COMPUTER GAME SOFTWARE FOR USE WITH PERSONAL COMPUTERS (U.S. CLS. 21, 23, 26, 36 AND 38).
FIRST USE 10-20-2011; IN COMMERCE 10-20-2011.

4,164,799. E&B GIFTWARE, LLC, YONKERS, NY. SN 76-706,329. PUB. 1-24-2012, FILED 2-8-2011.

USB ! KEY

THE MARK CONSISTS OF STANDARD CHARACTERS WITHOUT CLAIM TO ANY PARTICULAR FONT, STYLE, SIZE, OR COLOR.

NO CLAIM IS MADE TO THE EXCLUSIVE RIGHT TO USE "USB", APART FROM THE MARK AS SHOWN.

FOR COMPUTER SOFTWARE AND HARDWARE FOR THE INTEGRATION OF TEXT AND GRAPHICS INTO AN INTERACTIVE DELIVERY FOR NOVELTY STRESS RELEASE (U.S. CLS. 21, 23, 26, 36 AND 38).

FIRST USE 10-21-2011; IN COMMERCE 10-21-2011.

4,164,827. CYMBET CORPORATION, ELK RIVER, MN. SN 77-527,536. PUB. 3-3-2009, FILED 7-21-2008.

ENERCARD

THE MARK CONSISTS OF STANDARD CHARACTERS WITHOUT CLAIM TO ANY PARTICULAR FONT, STYLE, SIZE, OR COLOR.

FOR ENERGY PRODUCTS, NAMELY, BATTERIES; SUPERCAPACITORS; CHARGE CONTROL CIRCUITS; ENERGY HARVESTING, CONVERSION, COLLECTION AND STORAGE CELLS THAT ARE COUPLED WITH ONE OR MORE OF AN ENERGY TRANSDUCER, SENSOR, BATTERY, PROCESSOR, SUPERCAPACITOR, OR ENERGY MANAGEMENT CIRCUITRY (U.S. CLS. 21, 23, 26, 36 AND 38).

FIRST USE 6-16-2010; IN COMMERCE 6-16-2010.

CLASS 9—(Continued).

4,164,833. PARIS TECHNOLOGIES, INC., DOYLESTOWN, PA. SN 77-557,540. PUB. 1-27-2009, FILED 8-28-2008.

OLATION

THE MARK CONSISTS OF STANDARD CHARACTERS WITHOUT CLAIM TO ANY PARTICULAR FONT, STYLE, SIZE, OR COLOR.

OWNER OF U.S. REG. NO. 2,267,583.

FOR COMPUTER SOFTWARE FOR DOCUMENT MANAGEMENT AND ANALYTICAL FUNCTIONS IN THE AREAS OF FINANCE, MARKETING AND PRODUCTION (U.S. CLS. 21, 23, 26, 36 AND 38).

FIRST USE 4-12-2012; IN COMMERCE 4-12-2012.

4,164,849. RIOT GAMES, INC., SANTA MONICA, CA. SN 77-583,719. PUB. 3-10-2009, FILED 10-2-2008.

LEAGUE OF LEGENDS

THE MARK CONSISTS OF STANDARD CHARACTERS WITHOUT CLAIM TO ANY PARTICULAR FONT, STYLE, SIZE, OR COLOR.

FOR VIDEO GAME SOFTWARE FOR USE ON MOBILE PHONES (U.S. CLS. 21, 23, 26, 36 AND 38).

FIRST USE 1-6-2010; IN COMMERCE 1-6-2010.

4,164,854. STMICROELECTRONICS NV, AMSTERDAM, NETHERLANDS. SN 77-595,271. PUB. 4-7-2009, FILED 10-17-2008.

HARDCACHE

THE MARK CONSISTS OF STANDARD CHARACTERS WITHOUT CLAIM TO ANY PARTICULAR FONT, STYLE, SIZE, OR COLOR.

FOR SEMICONDUCTORS; INTEGRATED CIRCUITS; MICROPROCESSORS; MICROCONTROLLERS; AND EMBEDDED MICROPROCESSORS (U.S. CLS. 21, 23, 26, 36 AND 38).

FIRST USE 9-0-2010; IN COMMERCE 9-0-2010.

CLASS 9—(Continued).

4,164,871. ALTICOR INC., ADA, MI. SN 77-693,510. PUB. 6-29-2010, FILED 3-18-2009.

ARTISTRY

THE MARK CONSISTS OF STANDARD CHARACTERS WITHOUT CLAIM TO ANY PARTICULAR FONT, STYLE, SIZE, OR COLOR.

OWNER OF U.S. REG. NOS. 856,184, 1,519,877, AND OTHERS.

FOR DIGITAL MEDIA, NAMELY, PRE-RECORDED DIGITAL VIDEO DISCS, DOWNLOADABLE AUDIO AND VIDEO RECORDINGS FEATURING MOTIVATIONAL PRESENTATIONS, MARKETING INSTRUCTION, AND MARKETING INFORMATION DIRECTED TO COSMETICS AND TOILETRY DISTRIBUTORS AND CUSTOMERS AND USED IN THE PROMOTION OF COSMETICS AND TOILETRIES (U.S. CLS. 21, 23, 26, 36 AND 38).

FIRST USE 11-30-2007; IN COMMERCE 11-30-2007.

4,164,877. CHENGPIN, HUANG, TAIPEI COUNTY, TAIWAN. SN 77-722,199. PUB. 2-9-2010, FILED 4-24-2009.



THE STIPPLING IS FOR SHADING PURPOSES.
THE MARK CONSISTS OF THE LETTER "R" ABOVE THE WORDING "RATTAN".

FOR ELECTRICAL CABLES; ELECTRICAL CONNECTORS; LOUD SPEAKERS; COMPUTER MICE; KEYBOARDS; EARPHONES; HEADSETS FOR WIRELESS MOBILE PHONES, TELEPHONES, AND COMPUTERS; BATTERY CHARGERS; COMMUTATORS; CASES FOR MOBILE PHONES; COMPUTER NETWORK HUBS AND DIGITAL MEDIA HUBS; ELECTRICAL CABLES FOR USE IN CONNECTIONS FOR COMPUTER AND VIDEO GAMES; REMOTE CONTROLS FOR COMPUTER AND VIDEO GAMES, TELEVISIONS, AND DVD PLAYERS; WEBCAMS; COMPUTER CARRYING CASES ESPECIALLY ADAPTED FOR HOLDING LAPTOPS AND NOTEBOOK COMPUTERS; AND CLEAR PROTECTIVE COVERS SPECIALLY ADAPTED FOR PERSONAL ELECTRONIC DEVICES (U.S. CLS. 21, 23, 26, 36 AND 38).

FIRST USE 10-1-2009; IN COMMERCE 4-25-2012.

CLASS 9—(Continued).

4,164,882. OYSTER CONSULTING LLC, NEEDHAM, MA. SN 77-748,775. PUB. 6-15-2010, FILED 6-1-2009.

Hospital Heartbeat

THE MARK CONSISTS OF STANDARD CHARACTERS WITHOUT CLAIM TO ANY PARTICULAR FONT, STYLE, SIZE, OR COLOR.

NO CLAIM IS MADE TO THE EXCLUSIVE RIGHT TO USE "HOSPITAL", APART FROM THE MARK AS SHOWN.

FOR PORTABLE AND HANDHELD DIGITAL ELECTRONIC DEVICES FOR RECORDING, ORGANIZING, TRANSMITTING, MANIPULATING, AND REVIEWING TEXT, DATA, IMAGE, AND AUDIO FILES WITHIN HEALTHCARE, AND HOTEL INDUSTRIES; WIRELESS TRANSCEIVERS WITH COLLECTION AND DISPLAY TECHNOLOGY FOR CHECKING THE STATUS OF PATIENT CARE PROCESSES WITHIN HEALTHCARE AND HOSPITAL ENVIRONMENTS (U.S. CLS. 21, 23, 26, 36 AND 38).

FIRST USE 1-1-2010; IN COMMERCE 10-1-2010.

4,164,895. GUARD RFID SOLUTIONS INC., DELTA, BC, CANADA. SN 77-793,868. PUB. 7-27-2010, FILED 7-30-2009.

ALLGUARD

THE MARK CONSISTS OF STANDARD CHARACTERS WITHOUT CLAIM TO ANY PARTICULAR FONT, STYLE, SIZE, OR COLOR.

FOR ACTIVE RADIO FREQUENCY IDENTIFICATION TAGS FOR PATIENT PROTECTION, INFANT SECURITY AND ASSET TRACKING; WIRELESS SYSTEMS COMPRISED OF RADIO RECEIVERS AND TRANSMITTERS FOR TRACKING TAG LOCATION, HARDWARE AND SOFTWARE INTERFACES FOR TRANSMITTING TAG LOCATION DATA TO THE COMMUNICATIONS DEVICES AND SOFTWARE OF OTHERS, COMPUTER SOFTWARE FOR EVALUATING ACTIVITIES AND EVENTS ASSOCIATED WITH TAG LOCATION; COMPUTER SOFTWARE PROVIDING CUSTOMIZABLE ALERTS AND ALARMS AND CUSTOM REPORTING OF DATA RELATING TO TRACKED TAGS; HIGH SPEED HARDWARE AND SOFTWARE SYSTEMS COMPRISED OF RADIO RECEIVERS, COMPUTERS, AND COMPUTER SOFTWARE FOR READING A MULTIPLICITY OF RADIO FREQUENCY IDENTIFICATION TAGS TRANSVERSING A CHOKE POINT; HIGH SPEED HARDWARE AND SOFTWARE SYSTEMS COMPRISED OF RADIO RECEIVERS, COMPUTERS, AND COMPUTER SOFTWARE FOR MONITORING THE LOCATIONS OF A MULTIPLICITY OF RADIO FREQUENCY IDENTIFICATION TAGS WITHIN A ZONE OF COVERAGE; DOORWAY-MOUNTABLE RECEIVERS AND SENSORS FOR RADIO FREQUENCY IDENTIFICATION TAGS; RADIO FREQUENCY IDENTIFICATION TAGS ADAPTED FOR MOUNTING ON PACKAGING (U.S. CLS. 21, 23, 26, 36 AND 38).

FIRST USE 12-31-2010; IN COMMERCE 7-18-2011.

CLASS 9—(Continued).

4,164,896. NASUNI CORPORATION, NATICK, MA. SN 77-794,089. PUB. 7-20-2010, FILED 7-31-2009.

UNIFS

THE MARK CONSISTS OF STANDARD CHARACTERS WITHOUT CLAIM TO ANY PARTICULAR FONT, STYLE, SIZE, OR COLOR.

FOR DOWNLOADABLE COMPUTER SOFTWARE FOR PROVIDING ACCESS TO THIRD PARTY STORAGE PROVIDERS (U.S. CLS. 21, 23, 26, 36 AND 38).

FIRST USE 2-9-2010; IN COMMERCE 2-9-2010.

4,164,923. BOOM RIGHT, PHOENIX, AZ. SN 77-835,912. PUB. 9-28-2010, FILED 9-27-2009.



THE MARK CONSISTS OF THE STYLIZED WORDING "BOOM RIGHT" WITH THE TOP OF THE "T" IN "RIGHT" EXTENDED TO HOLD A DESIGN OF A CAMERA.

FOR ELECTRONIC CONTROLS FOR MOTORS AND MACHINES, NAMELY, EQUIPMENT FOR SUPPORTING AND MOVING MOVIE AND TELEVISION CAMERAS (U.S. CLS. 21, 23, 26, 36 AND 38).

FIRST USE 2-1-2012; IN COMMERCE 4-1-2012.

4,164,925. CORRELATED MAGNETICS RESEARCH, LLC, NEW HOPE, AL. SN 77-838,287. PUB. 8-17-2010, FILED 9-30-2009.

Polymagnet

THE MARK CONSISTS OF STANDARD CHARACTERS WITHOUT CLAIM TO ANY PARTICULAR FONT, STYLE, SIZE, OR COLOR.

FOR MAGNETS; COMPUTER SOFTWARE AND COMPUTER PROGRAMS FOR DETERMINING, MANIPULATING, AND PROGRAMMING THE MAGNETIC FIELDS OF MAGNETS OR MAGNETIC STRUCTURES (U.S. CLS. 21, 23, 26, 36 AND 38).

FIRST USE 2-0-2011; IN COMMERCE 4-11-2012.

CLASS 9—(Continued).

4,164,932. DIGITAL DEIVERY NETWORKS, INC., SCOTTS VALLEY, CA. SN 77-851,250. PUB. 9-28-2010, FILED 10-18-2009.

GREENDISC

THE MARK CONSISTS OF STANDARD CHARACTERS WITHOUT CLAIM TO ANY PARTICULAR FONT, STYLE, SIZE, OR COLOR.

FOR COMPUTER HARDWARE AND COMPUTER SOFTWARE FOR SELECTIVELY ENABLING ACCESS TO ELEMENTS OF A MEMORY STORAGE MODULE, NAMELY, DISC MEMORY, ELECTRONIC MEMORY, OPTICAL MEMORY, MAGNETIC MEMORY, AND SOLID STATE MEMORY FOR INCREASING COMPUTING POWER (U.S. CLS. 21, 23, 26, 36 AND 38).

FIRST USE 5-25-2011; IN COMMERCE 5-25-2011.

4,164,940. EMBARCADERO TECHNOLOGIES, INC., SAN FRANCISCO, CA. SN 77-871,696. PUB. 5-10-2011, FILED 11-12-2009.

EMBARCADERO TOOLCLOUD

THE MARK CONSISTS OF STANDARD CHARACTERS WITHOUT CLAIM TO ANY PARTICULAR FONT, STYLE, SIZE, OR COLOR.

OWNER OF U.S. REG. NO. 2,705,249.
NO CLAIM IS MADE TO THE EXCLUSIVE RIGHT TO USE "TOOLCLOUD", APART FROM THE MARK AS SHOWN.

FOR COMPUTER SOFTWARE TO CENTRALLY PROVIDE, MANAGE, UPDATE, DISTRIBUTE, CONTROL, ADMINISTER, TRACK AND DELIVER SOFTWARE APPLICATIONS AND SOFTWARE TOOLS AND UTILITIES TO USERS; COMPUTER SOFTWARE TO MANAGE SOFTWARE LICENSES AND TRACK USAGE; COMPUTER SOFTWARE FOR CENTRALIZED LICENSE MANAGEMENT, VERSION CONTROL AND DEPLOYMENT OF SOFTWARE APPLICATIONS, TOOLS AND UTILITIES, AND FOR CREATION OF ACCESS, USAGE AND MANAGEMENT REPORTS (U.S. CLS. 21, 23, 26, 36 AND 38).

FIRST USE 11-3-2009; IN COMMERCE 11-3-2009.

CLASS 9—(Continued).

4,164,956. SONY CORPORATION, TOKYO, JAPAN. SN 77-897,952. PUB. 6-21-2011, FILED 12-21-2009.

A-MOUNT

THE MARK CONSISTS OF STANDARD CHARACTERS WITHOUT CLAIM TO ANY PARTICULAR FONT, STYLE, SIZE, OR COLOR.

FOR DIGITAL SINGLE-LENS REFLEX CAMERAS, DIGITAL CAMERAS, CAMERA LENSES, LENS MOUNT ADAPTERS, LENS CONVERTERS (U.S. CLS. 21, 23, 26, 36 AND 38).

FIRST USE 4-30-2006; IN COMMERCE 4-30-2006.

4,164,972. VITASCOPE MEDIA, LLC, ENGLEWOOD, NJ. SN 77-935,865. PUB. 3-15-2011, FILED 2-15-2010.

VITASCOPE MEDIA

THE MARK CONSISTS OF STANDARD CHARACTERS WITHOUT CLAIM TO ANY PARTICULAR FONT, STYLE, SIZE, OR COLOR.

NO CLAIM IS MADE TO THE EXCLUSIVE RIGHT TO USE "MEDIA", APART FROM THE MARK AS SHOWN.

FOR DIGITAL MEDIA, NAMELY, PRE-RECORDED VIDEO CASSETTES, DIGITAL VIDEO DISCS, DIGITAL VERSATILE DISCS, DOWNLOADABLE AUDIO AND VIDEO RECORDINGS, DVDS, AND HIGH DEFINITION DIGITAL DISCS FEATURING WORKS BY FILMMAKERS IN THE FIELDS OF DOCUMENTARIES, ANIMATION, DRAMA AND COMEDIES (U.S. CLS. 21, 23, 26, 36 AND 38).

FIRST USE 10-5-2010; IN COMMERCE 10-5-2010.

4,164,985. VKGS LLC, DBA VIDEO KING, OMAHA, NE. SN 77-950,703. PUB. 2-22-2011, FILED 3-4-2010.

TAB-E

THE MARK CONSISTS OF STANDARD CHARACTERS WITHOUT CLAIM TO ANY PARTICULAR FONT, STYLE, SIZE, OR COLOR.

FOR PORTABLE AND HANDHELD DIGITAL ELECTRONIC DEVICES FOR STORING, ORGANIZING, TRANSMITTING, MANIPULATING, AND REVIEWING ELECTRONIC FILES SUCH AS TEXT, DATA, IMAGE, AND AUDIO FILES (U.S. CLS. 21, 23, 26, 36 AND 38).

FIRST USE 4-1-2010; IN COMMERCE 4-1-2010.

CLASS 9—(Continued).

4,165,011. VERTAFORE, INC., BOTHELL, WA. SN 77-983,145. PUB. 3-1-2011, FILED 3-22-2010.

WORKSMART

THE MARK CONSISTS OF STANDARD CHARACTERS WITHOUT CLAIM TO ANY PARTICULAR FONT, STYLE, SIZE, OR COLOR.

FOR COMPUTER SOFTWARE FOR BUSINESS PROCESS MANAGEMENT AND WORKFLOW MANAGEMENT FOR USE IN THE FIELDS OF INSURANCE, EMPLOYEE BENEFITS, FINANCIAL RISK MANAGEMENT, AND FINANCIAL PLANNING (U.S. CLS. 21, 23, 26, 36 AND 38).

FIRST USE 3-26-2010; IN COMMERCE 3-26-2010.

4,165,027. NINTENDO OF AMERICA INC., REDMOND, WA. SN 78-973,950. PUB. 1-3-2012, FILED 9-13-2006.

WII FIT

THE MARK CONSISTS OF STANDARD CHARACTERS WITHOUT CLAIM TO ANY PARTICULAR FONT, STYLE, SIZE, OR COLOR.

FOR COMPACT DISCS AND OPTICAL DISCS FEATURING ENTERTAINMENT CONTENT, NAMELY, GAMES AND SPORTS; COMPACT DISCS AND OPTICAL DISCS FEATURING EDUCATIONAL INSTRUCTION, NAMELY, EDUCATIONAL INSTRUCTION ON BALANCE, COORDINATION, MOTION, SPORTS AND EXERCISE; COMPACT DISCS AND OPTICAL DISCS FEATURING INFORMATIONAL CONTENT, NAMELY, INFORMATION ON BALANCE, COORDINATION, MOTION, SPORTS AND EXERCISE; COMPUTER GAME DISCS; COMPUTER GAME PROGRAMS; COMPUTER GAME SOFTWARE; ELECTRONIC GAME DISCS; ELECTRONIC GAME PROGRAMS; ELECTRONIC GAME SOFTWARE; INTERACTIVE GAME DISCS; INTERACTIVE GAME PROGRAMS; INTERACTIVE GAME SOFTWARE; DISCS FEATURING GAME PROGRAM AND DATA CONTENT; VIDEO GAME DISCS; VIDEO GAME PROGRAMS; VIDEO GAME SOFTWARE (U.S. CLS. 21, 23, 26, 36 AND 38).

FIRST USE 5-21-2008; IN COMMERCE 5-21-2008.

CLASS 9—(Continued).

4,165,030. PARHAM, LUCIANA, CAPE CORAL, FL. SN 85-002,970. PUB. 2-22-2011, FILED 3-31-2010.



NO CLAIM IS MADE TO THE EXCLUSIVE RIGHT TO USE "WRISTLETS", APART FROM THE MARK AS SHOWN. THE MARK CONSISTS OF THE TERM "WRISTLETZ" WITH A STYLIZED BACKGROUND PHANTOM IMAGE OF A CELLULAR TELEPHONE CARRYING CASE WHICH IS FADED OUT AT THE TOP.

FOR CARRYING CASES FOR CELL PHONES (U.S. CLS. 21, 23, 26, 36 AND 38).

FIRST USE 4-18-2012; IN COMMERCE 4-18-2012.

4,165,032. SHUFFLE MASTER AUSTRALASIA PTY LIMITED, MILPERRA, NSW 2214, AUSTRALIA. SN 85-004,686. PUB. 8-24-2010, FILED 4-1-2010.

GRAND TIE

THE MARK CONSISTS OF STANDARD CHARACTERS WITHOUT CLAIM TO ANY PARTICULAR FONT, STYLE, SIZE, OR COLOR.

FOR MULTIPLE PLAYER INTERACTIVE GAMING MACHINES WITH VIDEO OUTPUT (U.S. CLS. 21, 23, 26, 36 AND 38).

FIRST USE 6-8-2010; IN COMMERCE 12-14-2011.

4,165,038. WARNER BROS. ENTERTAINMENT INC., BURBANK, CA. SN 85-006,780. PUB. 7-27-2010, FILED 4-5-2010.

NETHERREALM STUDIOS

THE MARK CONSISTS OF STANDARD CHARACTERS WITHOUT CLAIM TO ANY PARTICULAR FONT, STYLE, SIZE, OR COLOR.

CLASS 9—(Continued).

NO CLAIM IS MADE TO THE EXCLUSIVE RIGHT TO USE "STUDIOS", APART FROM THE MARK AS SHOWN.

FOR COMPUTER GAME PROGRAMS; COMPUTER GAME SOFTWARE; ELECTRONIC GAME PROGRAMS; ELECTRONIC GAME SOFTWARE; INTERACTIVE VIDEO GAME PROGRAMS; INTERACTIVE VIDEO GAME SOFTWARE; VIDEO GAME CARTRIDGES AND DISCS; COMPUTER GAME SOFTWARE FOR USE ON MOBILE AND CELLULAR PHONES; DOWNLOADABLE COMPUTER AND VIDEO GAME SOFTWARE; DOWNLOADABLE INTERACTIVE ENTERTAINMENT SOFTWARE FOR PLAYING VIDEO GAMES (U.S. CLS. 21, 23, 26, 36 AND 38).

FIRST USE 4-19-2011; IN COMMERCE 4-19-2011.

4,165,041. HITACHI SOLUTIONS, LTD., TOKYO, JAPAN. SN 85-008,662. PUB. 5-10-2011, FILED 4-7-2010.

SuperJ

THE MARK CONSISTS OF STANDARD CHARACTERS WITHOUT CLAIM TO ANY PARTICULAR FONT, STYLE, SIZE, OR COLOR.

FOR COMPUTER APPLICATION SOFTWARE CONSISTING OF SERVER SYSTEM SOFTWARE THAT MANAGES DEPLOYMENT, OPERATION AND UPGRADE OF THE APPLICATION; MIDDLEWARE SOFTWARE THAT CAN REMOTELY CONTROL APPLICATIONS SOFTWARE/PROGRAMMING; SOFTWARE THAT RESIDES ON END-USER CONSUMER/BUSINESS OR TELECOM DEVICES, INCLUDING BUT NOT LIMITED TO MOBILE PHONES, NAVIGATION SYSTEMS, AND INFORMATIONAL CONSUMER ELECTRONICS, NAMELY, SOFTWARE FOR USE IN APPLICATION PLATFORM FOR THE DEVELOPMENT, DEPLOYMENT AND MANAGEMENT OF SUBSCRIBER APPLICATIONS; OPEN APPLICATION PROGRAMMING INTERFACE (API) SOFTWARE USED IN BUILDING SOFTWARE APPLICATIONS; AND COMPUTER SOFTWARE DEVELOPMENT KITS CONSISTING OF COMPUTER SOFTWARE DEVELOPMENT TOOLS THAT ENABLE THE DEVELOPMENT OF APPLICATIONS THAT RUN ON ALL THE FORGOING SOFTWARE PRODUCTS (U.S. CLS. 21, 23, 26, 36 AND 38).

FIRST USE 10-31-2011; IN COMMERCE 10-31-2011.

CLASS 9—(Continued).

4,165,055. EMC CORPORATION, HOPKINTON, MA. SN 85-022,709. PUB. 10-25-2011, FILED 4-26-2010.

SMARTPOOLS

THE MARK CONSISTS OF STANDARD CHARACTERS WITHOUT CLAIM TO ANY PARTICULAR FONT, STYLE, SIZE, OR COLOR.

FOR COMPUTER SOFTWARE, NAMELY, INTELLIGENT STORAGE SYSTEMS CAPABLE OF NETWORK COMMUNICATION, NAMELY, NETWORK ACCESS SERVER OPERATING SOFTWARE; COMPUTER SOFTWARE FOR USE IN MANAGING, ANALYZING, REPORTING, AND AUTOMATION IN CONJUNCTION WITH CUSTOMER WORKFLOWS, STORAGE PATTERNS, AND FILE CONTENT FOR DATA STORAGE SYSTEMS (U.S. CLS. 21, 23, 26, 36 AND 38).
FIRST USE 7-13-2010; IN COMMERCE 7-31-2010.

4,165,074. SONY CORPORATION, TOKYO, JAPAN. SN 85-039,913. PUB. 3-8-2011, FILED 5-17-2010.



THE MARK CONSISTS OF THE MARK CONSISTS OF A HIGHLY STYLIZED FIGURE "8" DESIGN WITH THE LETTER "X" SUGGESTED IN THE MIDDLE THEREOF.

FOR MICROPHONES; DIGITAL WIRELESS MICROPHONE SYSTEMS, NAMELY, ELECTRONIC TRANSMITTERS AND RECEIVERS FOR MICROPHONES, AND DIGITAL WIRELESS ADAPTERS (U.S. CLS. 21, 23, 26, 36 AND 38).
FIRST USE 4-30-2010; IN COMMERCE 4-30-2010.

CLASS 9—(Continued).

4,165,079. INTELLIGENT SOFTWARE SOLUTIONS, INC., COLORADO SPRINGS, CO. SN 85-046,052. PUB. 12-7-2010, FILED 5-24-2010.



THE MARK CONSISTS OF A HAND WITH THE INDEX FINGER POINTING TO THE CENTER OF A CIRCLE WITH THE WORD "TACTUS" TO THE RIGHT.

FOR COMPUTER SOFTWARE FOR DESIGNING AND IMPLEMENTING DATA ACCESS AND VISUALIZATION APPLICATIONS INCORPORATING COMPUTER TOUCHSCREENS WITH MULTI-TOUCH-ENABLED USER INTERFACES (U.S. CLS. 21, 23, 26, 36 AND 38).
FIRST USE 9-0-2011; IN COMMERCE 9-0-2011.

4,165,085. SMARTRUNK SYSTEMS, INC, CHULA VISTA, CA. SN 85-057,768. PUB. 11-2-2010, FILED 6-8-2010.

smartxpress

THE MARK CONSISTS OF STANDARD CHARACTERS WITHOUT CLAIM TO ANY PARTICULAR FONT, STYLE, SIZE, OR COLOR.

FOR DEVICES FOR USE FOR WIRELESS TRUNKED COMMUNICATIONS, NAMELY, CONTROLLERS, LOGIC BOARDS, TRANSCEIVERS AND REPEATERS (U.S. CLS. 21, 23, 26, 36 AND 38).
FIRST USE 4-9-2012; IN COMMERCE 4-9-2012.

4,165,089. BENTLY NEVADA, INC., MINDEN, NV. SN 85-065,152. PUB. 2-15-2011, FILED 6-17-2010.

RANGER

THE MARK CONSISTS OF STANDARD CHARACTERS WITHOUT CLAIM TO ANY PARTICULAR FONT, STYLE, SIZE, OR COLOR.

FOR PERMANENTLY INSTALLED VIBRATION DATA COLLECTION INSTRUMENTS FOR USE IN ANALYSIS OF VIBRATIONS IN RELATION TO MACHINE AND EQUIPMENT DIAGNOSTICS AND MAINTENANCE; PERMANENTLY INSTALLED VIBRATION DATA COLLECTION INSTRUMENTS SOLD AS A UNIT FOR USE IN ANALYSIS OF VIBRATIONS IN RELATION TO MACHINE AND EQUIPMENT DIAGNOSTICS AND MAINTENANCE (U.S. CLS. 21, 23, 26, 36 AND 38).
FIRST USE 6-30-2011; IN COMMERCE 6-30-2011.

CLASS 9—(Continued).

4,165,097. NINTENDO OF AMERICA INC., REDMOND, WA.
SN 85-080,087. PUB. 8-9-2011, FILED 7-8-2010.

Nintendo 3DS

OWNER OF JAPAN REG. NO. 5354504, DATED 9-17-2010,
EXPIRES 9-17-2020.

OWNER OF JAPAN REG. NO. 5368117, DATED 11-12-2010,
EXPIRES 11-12-2020.

OWNER OF U.S. REG. NOS. 1,213,822, 1,628,966, AND
OTHERS.

THE MARK CONSISTS OF THE WORDS "NINTENDO
3DS" ON ONE LINE.

FOR VIDEO GAME CONSOLES FOR USE WITH AN
EXTERNAL DISPLAY SCREEN OR MONITOR; COMPU-
TER GAME PROGRAMS FOR CONSUMER VIDEO
GAME APPARATUS; OPTICAL DISCS, ROM CARDS,
ROM CARTRIDGES, CD-ROMS, AND DVD-ROMS RE-
CORDED WITH PROGRAMS FOR CONSUMER VIDEO
GAME APPARATUS; DIGITAL STORAGE MEDIA RE-
CORDED WITH PROGRAMS FOR CONSUMER VIDEO
GAME APPARATUS; ELECTRONIC STORAGE MEDIA
RECORDED WITH PROGRAMS FOR CONSUMER VI-
DEO GAME APPARATUS; CONTROLLERS, JOYSTICKS
AND MEMORY CARDS FOR CONSUMER VIDEO
GAME APPARATUS; AC ADAPTERS FOR CONSUMER
GAME APPARATUS; PARTS AND FITTINGS FOR CON-
SUMER VIDEO GAMES, NAMELY, POWER SUPPLIES,
TRANSFORMERS, CABLES, BATTERY CHARGERS;
COMPUTER GAME PROGRAMS FOR HAND-HELD
GAME APPARATUS WITH LIQUID CRYSTAL DIS-
PLAYS; OPTICAL DISCS, ROM CARDS, ROM CAR-
TRIDGES, CD-ROMS, AND DVD-ROMS RECORDED
WITH PROGRAMS FOR HAND-HELD GAME APPARA-
TUS WITH LIQUID CRYSTAL DISPLAYS; DIGITAL
STORAGE MEDIA RECORDED WITH PROGRAMS
FOR HAND-HELD GAME APPARATUS WITH LIQUID
CRYSTAL DISPLAYS; ELECTRONIC STORAGE MEDIA
RECORDED WITH PROGRAMS FOR HAND-HELD
GAME APPARATUS WITH LIQUID CRYSTAL DIS-
PLAYS; HAND-HELD TERMINALS FOR DISPLAYING
ELECTRONIC PUBLICATIONS; ELECTRONIC MA-
CHINES, APPARATUS AND THEIR PARTS, NAMELY,
ELECTRONIC GAME SOFTWARE; DIGITAL CAMERAS;
VIDEO CAMERAS; AUDIO PLAYERS; AUDIO REC-
ORDERS; STORABLE MUSIC FILES DOWNLOADABLE VIA
A GLOBAL COMPUTER NETWORK; STORABLE IMAGE
FILES DOWNLOADABLE VIA A GLOBAL COMPUTER
NETWORK FEATURING PHOTOGRAPHS, ART, VIDEO/
COMPUTER GAME CHARACTERS, VIDEO/COMPUTER
GAME SCENES, AND VIDEO/COMPUTER GAME
IMAGES; ELECTRONIC PUBLICATIONS NAMELY, MA-
GAZINES, MANUALS AND PLAYERS' GUIDES FEAT-
URING VIDEO GAMES, RECORDED ON COMPUTER
MEDIA; PEDOMETERS; CAMERAS; PHOTOGRAPHIC
MACHINES AND APPARATUS, NAMELY, HAND-HELD
VIDEO GAME APPARATUS WITH LIQUID CRYSTAL
DISPLAY, WITH AN INTERNAL CAMERA; CINEMATO-
GRAPHIC MACHINES AND APPARATUS, NAMELY,
HAND-HELD VIDEO GAME APPARATUS WITH LI-
QUID CRYSTAL DISPLAY, WITH AN INTERNAL VI-
DEO CAMERA; BATTERIES; CHARGEABLE
BATTERIES; PRE-RECORDED CARTRIDGES AND
MEMORY CARDS FEATURING ENTERTAINMENT,
EDUCATIONAL, AND INFORMATIONAL CONTENT,
PERTAINING TO VIDEO GAMES, COMPUTER GAMES,
PUZZLES, MUSIC AND STORIES; SPECIALLY
ADAPTED CASES FOR VIDEO GAME CARTRIDGES
AND VIDEO GAME MEMORY CARDS; COMPUTER
GAME CARTRIDGES; COMPUTER GAME MEMORY
CARDS; COMPUTER GAME PROGRAMS; COMPUTER
GAME SOFTWARE; ELECTRONIC GAME CAR-
TRIDGES; ELECTRONIC GAME MEMORY CARDS;
ELECTRONIC GAME PROGRAMS; ELECTRONIC
GAME SOFTWARE; HEADPHONES AND HEADSETS;
INTERACTIVE ELECTRONIC GAME CARTRIDGES;
INTERACTIVE ELECTRONIC GAME MEMORY CARDS;
INTERACTIVE ELECTRONIC GAME PROGRAMS; IN-
TERACTIVE ELECTRONIC GAME SOFTWARE; INTER-
ACTIVE VIDEO GAME CARTRIDGES; INTERACTIVE

CLASS 9—(Continued).

VIDEO GAME MEMORY CARDS; INTERACTIVE VIDEO
GAME PROGRAMS; INTERACTIVE VIDEO GAME
SOFTWARE; PRE-MADE WRAPS AND SKINS FOR
VIDEO GAME MACHINES; VIDEO GAME CAR-
TRIDGES; VIDEO GAME MEMORY CARDS; VIDEO
GAME PROGRAMS; VIDEO GAME SOFTWARE; WRIT-
ING INSTRUMENTS FOR USE WITH COMPUTER/VI-
DEO GAME MACHINE TOUCH SCREEN DISPLAYS,
NAMELY, COMPUTER STYLUS; DOWNLOADABLE
MULTIMEDIA FILES, NAMELY, GAMES; DOWNLOA-
DABLE COMPUTER GAME PROGRAMS; DOWNLOA-
DABLE COMPUTER GAME SOFTWARE;
DOWNLOADABLE ELECTRONIC GAME PROGRAMS;
DOWNLOADABLE ELECTRONIC GAME SOFTWARE;
DOWNLOADABLE INTERACTIVE ELECTRONIC GAME
PROGRAMS; DOWNLOADABLE INTERACTIVE GAME
SOFTWARE; DOWNLOADABLE VIDEO GAME PRO-
GRAMS; DOWNLOADABLE VIDEO GAME SOFTWARE;
DOWNLOADABLE ELECTRONIC PUBLICATIONS,
NAMELY, GAME INSTRUCTION BOOKLETS (U.S.
CLS. 21, 23, 26, 36 AND 38).

FIRST USE 3-27-2011; IN COMMERCE 3-27-2011.

4,165,113. POINT HORIZON INSTITUTE, RAVENDALE, CA.
SN 85-092,495. PUB. 7-19-2011, FILED 7-26-2010.

CLAIRVISION

THE MARK CONSISTS OF STANDARD CHARACTERS
WITHOUT CLAIM TO ANY PARTICULAR FONT, STYLE,
SIZE, OR COLOR.

OWNER OF U.S. REG. NOS. 1,848,357 AND 1,851,946.

FOR DVDS, CDS, CD-ROMS, CASSETTE TAPES,
ELECTRONIC PUBLICATIONS, NAMELY, BOOKS,
DOWNLOADABLE SOFTWARE FOR DOWNLOADING
EDUCATIONAL COURSES ONLINE, ALL IN THE
FIELDS OF CONSCIOUSNESS STUDIES, MEDITATION,
SPIRITUALITY, RELIGION, ALTERNATIVE THERA-
PIES, NATURAL THERAPY, HEALING AND ENER-
GETIC MANAGEMENT TECHNIQUES, DEATH AND
DYING AND GRIEF AND BEREAVEMENT MANAGE-
MENT, SPIRITUAL PHILOSOPHY, ASTROLOGY, ES-
OTERICISM, PSYCHOLOGY, PSYCHOTHERAPY,
PERSONAL DEVELOPMENT, SELF-EXPLORATION
AND SELF-TRANSFORMATION; DOWNLOADABLE
MUSIC (U.S. CLS. 21, 23, 26, 36 AND 38).

FIRST USE 1-1-2001; IN COMMERCE 1-1-2001.

CLASS 9—(Continued).

4,165,120. CORSAIR MEMORY INC, FREEMONT, CA. SN 85-100,638. PUB. 7-26-2011, FILED 8-5-2010.

CLASS 9—(Continued).

4,165,134. CAPCOM CO., LTD., OSAKA, JAPAN. SN 85-108,421. PUB. 6-7-2011, FILED 8-16-2010.

ASURA'S WRATH



THE MARK CONSISTS OF STANDARD CHARACTERS WITHOUT CLAIM TO ANY PARTICULAR FONT, STYLE, SIZE, OR COLOR.

FOR COMPUTER GAME SOFTWARE; COMPUTER GAMES IN THE FORM OF CARTRIDGES, CASSETTES, DISCS OR TAPES; VIDEO GAME CARTRIDGES; VIDEO GAME MACHINES FOR USE WITH TELEVISION RECEIVERS; DOWNLOADABLE GAME SOFTWARE; DOWNLOADABLE COMPUTER GAMES; DOWNLOADABLE GAME PROGRAM FOR PLAYING ON MOBILE PHONES; DOWNLOADABLE GAME SOFTWARE FOR PLAYING ON MOBILE PHONES; SCREEN SAVER SOFTWARE AND WALLPAPER SOFTWARE; DOWNLOADABLE SCREEN SAVER SOFTWARE AND WALLPAPER SOFTWARE FOR MOBILE PHONES; DOWNLOADABLE GRAPHICS AND MUSIC VIA A GLOBAL COMPUTER NETWORK; DOWNLOADABLE GRAPHICS, MUSIC AND RING TONES FOR MOBILE PHONES (U.S. CLS. 21, 23, 26, 36 AND 38).

FIRST USE 2-21-2012; IN COMMERCE 2-21-2012.

4,165,137. MICRO-CLEAN, INC., BETHLEHEM, PA. SN 85-109,126. PUB. 3-8-2011, FILED 8-17-2010.

OWNER OF U.S. REG. NOS. 3,209,882 AND 3,278,784. THE MARK CONSISTS OF SAILS OFFSET IN FRONT OF EACH OTHER TO THE LEFT OF THE WORD "CORSAIR".

FOR COMPUTER COMPONENTS AND INSTRUCTION MANUALS PACKAGED AND SOLD AS A UNIT THEREWITH, NAMELY, MEMORY MODULES, POWER SUPPLY UNITS, SOLID-STATE DRIVES, LIQUID-COOLING SOLUTIONS FOR CPUS AND MEMORY MODULES, AIR-COOLING SOLUTIONS FOR CPUS AND MEMORY MODULES, FANS, AND CASES AND ENCLOSURES FOR COMPUTERS; COMPUTER PERIPHERALS, COMPUTER HARDWARE, AND INSTRUCTION MANUALS PACKAGED AS A UNIT THEREWITH, NAMELY, USB FLASH DRIVES, EXTERNAL SOLID-STATE DRIVES, MICE, KEYBOARDS; COMPUTER PERIPHERALS, COMPUTER HARDWARE, AND INSTRUCTION MANUALS PACKAGED AS A UNIT THEREWITH, NAMELY, JOYSTICKS, GAME CONTROLLERS, STEERING WHEELS, FLIGHT CONTROLLERS, AND SPECIALIZED MICE AND KEYBOARDS USED AS INPUT DEVICES FOR COMPUTER GAMES AND CONSOLE GAMES; COMPUTER HARDWARE, AND INSTRUCTION MANUALS PACKAGED AS A UNIT THEREWITH, NAMELY, HEADSETS, HEADPHONES, AND MULTIMEDIA SPEAKERS (U.S. CLS. 21, 23, 26, 36 AND 38).

FIRST USE 1-0-1994; IN COMMERCE 1-0-1994.



THE MARK CONSISTS OF THE CAPITAL LETTERS "M" AND "C", FOLLOWED BY A LOWERCASE "I", THE "I" REPRESENTING AN ANTENNA AND INCLUDING TWO ARCS DEPICTING RADIO WAVES EMANATING FROM THE DOT OVER THE "I", ENDING WITH A CAPITAL LETTER "D".

FOR RFID TAGS FOR INDUSTRIAL CALIBRATION EQUIPMENT; RFID TAGS FOR INDUSTRIAL AIR FILTERS (U.S. CLS. 21, 23, 26, 36 AND 38).

FIRST USE 1-4-2012; IN COMMERCE 1-4-2012.

CLASS 9—(Continued).

4,165,138. MICRO-CLEAN, INC., BETHLEHEM, PA. SN 85-109,330. PUB. 3-8-2011, FILED 8-17-2010.



NO CLAIM IS MADE TO THE EXCLUSIVE RIGHT TO USE "MICRO-ID", APART FROM THE MARK AS SHOWN. THE MARK CONSISTS OF THE TERM "MICRO" IN CAPITAL LETTERS, FOLLOWED BY A HYPHEN AND THEN THE TERM "ID", WITH THE "I" BEING LOWER-CASE AND TAKING THE FORM OF AN ANTENNA INCLUDING TWO ARCS OVER THE DOT IN THE "I", REPRESENTING RF WAVES.
 FOR RFID TAGS FOR INDUSTRIAL CALIBRATION EQUIPMENT; RFID TAGS FOR INDUSTRIAL AIR FILTERS (U.S. CLS. 21, 23, 26, 36 AND 38).
 FIRST USE 1-4-2012; IN COMMERCE 1-4-2012.

CLASS 9—(Continued).

4,165,161. CYBERSPA, LLC, BALTIMORE, MD. SN 85-118,506. PUB. 2-15-2011, FILED 8-30-2010.



THE MARK CONSISTS OF STANDARD CHARACTERS WITHOUT CLAIM TO ANY PARTICULAR FONT, STYLE, SIZE, OR COLOR.
 FOR COMPUTER SOFTWARE AND HARDWARE FOR MANAGING AND IMPROVING PERFORMANCE OF COMPUTER OPERATING SYSTEMS AND APPLICATIONS (U.S. CLS. 21, 23, 26, 36 AND 38).
 FIRST USE 7-1-2010; IN COMMERCE 5-6-2011.

4,165,143. PURE STORAGE, INC., MOUNTAIN VIEW, CA. SN 85-111,683. PUB. 1-24-2012, FILED 8-19-2010.



THE MARK CONSISTS OF STYLIZED HEXAGON "P". FOR FLASH MEMORY ARRAY (U.S. CLS. 21, 23, 26, 36 AND 38).
 FIRST USE 8-1-2011; IN COMMERCE 8-1-2011.

4,165,163. NUVERA FUEL CELLS, INC., BILLERICA, MA. SN 85-118,629. PUB. 8-16-2011, FILED 8-30-2010.



THE MARK CONSISTS OF STANDARD CHARACTERS WITHOUT CLAIM TO ANY PARTICULAR FONT, STYLE, SIZE, OR COLOR.
 FOR HYDROGEN FUEL CELL SYSTEMS, COMPRISED OF, HYDROGEN FUEL CELL STACKS FOR GENERATING ELECTRICITY (U.S. CLS. 21, 23, 26, 36 AND 38).
 FIRST USE 3-31-2012; IN COMMERCE 3-31-2012.

4,165,144. PURE STORAGE, INC., MOUNTAIN VIEW, CA. SN 85-111,690. PUB. 1-24-2012, FILED 8-19-2010.



THE MARK CONSISTS OF STYLIZED HEXAGON "P" IN FRONT OF THE WORD "PURESTORAGE". THE LETTERS "PURE" ARE IN BOLD TYPE FACE.
 FOR FLASH MEMORY ARRAY (U.S. CLS. 21, 23, 26, 36 AND 38).
 FIRST USE 8-1-2011; IN COMMERCE 8-1-2011.

4,165,167. CYBERSPA, LLC, BALTIMORE, MD. SN 85-119,417. PUB. 2-15-2011, FILED 8-31-2010.



THE MARK CONSISTS OF THE WORD "CYBERSPA" AND DESIGNS. THE DESIGNS FEATURE A SERIES OF FOUR, CONCENTRIC, INCOMPLETE CIRCLES THAT PARTIALLY SPIRAL AROUND THE "A" IN THE WORDING.
 FOR COMPUTER SOFTWARE AND HARDWARE FOR MANAGING AND IMPROVING PERFORMANCE OF COMPUTER OPERATING SYSTEMS AND APPLICATIONS (U.S. CLS. 21, 23, 26, 36 AND 38).
 FIRST USE 7-1-2010; IN COMMERCE 5-6-2011.

CLASS 9—(Continued).

4,165,170. AMERICA ACTION, INC., POMONA, CA. SN 85-120,383. PUB. 2-22-2011, FILED 8-31-2010.

actionpad

THE MARK CONSISTS OF THE WORD "ACTIONPAD" IN STYLIZED FORM.
FOR HANDHELD PERSONAL COMPUTERS (U.S. CLS. 21, 23, 26, 36 AND 38).
FIRST USE 11-1-2011; IN COMMERCE 12-12-2011.

4,165,174. IGT, RENO, NV. SN 85-121,199. PUB. 3-8-2011, FILED 9-1-2010.

T-SHAPE PROGRESSIVE

THE MARK CONSISTS OF STANDARD CHARACTERS WITHOUT CLAIM TO ANY PARTICULAR FONT, STYLE, SIZE, OR COLOR.
NO CLAIM IS MADE TO THE EXCLUSIVE RIGHT TO USE "PROGRESSIVE", APART FROM THE MARK AS SHOWN.
FOR GAMING MACHINES, NAMELY, DEVICES WHICH ACCEPT A WAGER (U.S. CLS. 21, 23, 26, 36 AND 38).
FIRST USE 4-12-2012; IN COMMERCE 4-12-2012.

4,165,185. NAMCO BANDAI GAMES INC., SHINAGAWA-KU TOKYO, JAPAN. SN 85-124,188. PUB. 1-25-2011, FILED 9-7-2010.

BODY AND BRAIN CONNECTION

THE MARK CONSISTS OF STANDARD CHARACTERS WITHOUT CLAIM TO ANY PARTICULAR FONT, STYLE, SIZE, OR COLOR.
NO CLAIM IS MADE TO THE EXCLUSIVE RIGHT TO USE "BRAIN", APART FROM THE MARK AS SHOWN.
FOR COMPUTER GAME PROGRAMS; COMPUTER GAME SOFTWARE; DOWNLOADABLE COMPUTER GAME PROGRAMS; DOWNLOADABLE COMPUTER GAME SOFTWARE VIA A GLOBAL COMPUTER NETWORK AND WIRELESS DEVICES; VIDEO GAME SOFTWARE (U.S. CLS. 21, 23, 26, 36 AND 38).
FIRST USE 2-8-2011; IN COMMERCE 2-8-2011.

CLASS 9—(Continued).

4,165,186. IGT, RENO, NV. SN 85-124,202. PUB. 3-8-2011, FILED 9-7-2010.

CRISSCROSS PROGRESSIVE

THE MARK CONSISTS OF STANDARD CHARACTERS WITHOUT CLAIM TO ANY PARTICULAR FONT, STYLE, SIZE, OR COLOR.
NO CLAIM IS MADE TO THE EXCLUSIVE RIGHT TO USE "PROGRESSIVE", APART FROM THE MARK AS SHOWN.
FOR GAMING MACHINES, NAMELY, DEVICES WHICH ACCEPT A WAGER (U.S. CLS. 21, 23, 26, 36 AND 38).
FIRST USE 4-12-2012; IN COMMERCE 4-12-2012.

4,165,190. GAUMARD SCIENTIFIC COMPANY, INC., MIAMI, FL. SN 85-125,678. PUB. 2-22-2011, FILED 9-9-2010.

SIMULATION MADE EASY

THE MARK CONSISTS OF STANDARD CHARACTERS WITHOUT CLAIM TO ANY PARTICULAR FONT, STYLE, SIZE, OR COLOR.
FOR GRAPHICAL USER INTERFACE SOFTWARE FOR USE WITH MEDICAL SIMULATORS (U.S. CLS. 21, 23, 26, 36 AND 38).
FIRST USE 9-0-2010; IN COMMERCE 9-0-2010.

4,165,194. WILFORD STICH, FRANKLIN, TX. SN 85-126,392. PUB. 9-20-2011, FILED 9-9-2010.

Rockin Dave Allen

THE MARK CONSISTS OF STANDARD CHARACTERS WITHOUT CLAIM TO ANY PARTICULAR FONT, STYLE, SIZE, OR COLOR.
THE NAME(S), PORTRAIT(S), AND/OR SIGNATURE(S) SHOWN IN THE MARK DOES NOT IDENTIFY A PARTICULAR LIVING INDIVIDUAL.
FOR AUDIO AND VIDEO RECORDINGS FEATURING MUSIC AND ARTISTIC PERFORMANCES (U.S. CLS. 21, 23, 26, 36 AND 38).
FIRST USE 12-1-2011; IN COMMERCE 12-1-2011.

CLASS 9—(Continued).

4,165,247. CELESTRON ACQUISITION, LLC, TORRANCE, CA. SN 85-143,687. PUB. 2-15-2011, FILED 10-2-2010.

CLASS 9—(Continued).

4,165,280. NEUROSKY, INC., SAN JOSE, CA. SN 85-158,236. PUB. 9-27-2011, FILED 10-21-2010.

MINDWAVE**CELESTRON NIGHTSCAPE**

THE MARK CONSISTS OF STANDARD CHARACTERS WITHOUT CLAIM TO ANY PARTICULAR FONT, STYLE, SIZE, OR COLOR.

OWNER OF U.S. REG. NOS. 1,139,857 AND 3,005,393. FOR DIGITAL CAMERAS (U.S. CLS. 21, 23, 26, 36 AND 38).

FIRST USE 10-1-2011; IN COMMERCE 10-1-2011.

THE MARK CONSISTS OF STANDARD CHARACTERS WITHOUT CLAIM TO ANY PARTICULAR FONT, STYLE, SIZE, OR COLOR.

FOR BRAIN MACHINE INTERFACE (BMI) PRODUCTS, NAMELY, HUMAN HEAD BIO-SIGNAL READING AND MENTAL STATE INTERPRETATION SENSORS NOT FOR MEDICAL PURPOSES; SOFTWARE FOR EXTRACTION, FILTRATION AND AMPLIFICATION OF HUMAN HEAD BIOSIGNALS AND ANALYSIS AND INTERPRETATION INTO MENTAL STATE OUTPUTS; HEADSET WITH BMI SENSORS FOR SENSING HUMAN HEAD BIO-SIGNALS TO PRODUCE MENTAL STATE OUTPUTS NOT FOR MEDICAL PURPOSES AND COMPUTER SOFTWARE THAT USES MENTAL STATE READINGS RETRIEVED FROM BRAIN MACHINE INTERFACE SENSORS AS INPUT TO ALTER THE INFORMATION THAT'S PRESENTED TO THE USER, AS CONTROL TO CHANGE THE EXECUTION FLOW OF THE SOFTWARE, OR AS USER INFORMATION RECORD FOR USE IN A VARIETY OF FIELDS, INCLUDING TOY, GAMING, MUSIC, SPORTS, EDUCATION, INDUSTRIAL AND MEDICAL USES (U.S. CLS. 21, 23, 26, 36 AND 38).

FIRST USE 8-5-2010; IN COMMERCE 9-16-2010.

4,165,262. SABINE INC., ALACHUA, FL. SN 85-151,827. PUB. 9-6-2011, FILED 10-13-2010.

4,165,294. ADVANCE MAGAZINE PUBLISHERS INC., NEW YORK, NY. SN 85-163,724. PUB. 3-15-2011, FILED 10-28-2010.

SACOM**LUCKY**

THE MARK CONSISTS OF STANDARD CHARACTERS WITHOUT CLAIM TO ANY PARTICULAR FONT, STYLE, SIZE, OR COLOR.

FOR MICROPHONES; WIRELESS MICROPHONE SYSTEMS, PRINCIPALLY COMPRISING MICROPHONES AND RECEIVERS SOLD WITH AND WITHOUT WIRE ATTACHABLE MICROPHONES AND EXTERNAL ANTENNAS, THE FOREGOING ALL SOLD AS A UNIT AND SOLD SEPARATELY; ELECTRONIC PRODUCTS FOR THE MANIPULATION OF THE FREQUENCY, TIME, AND AMPLITUDE CHARACTERISTICS OF AUDIO SIGNALS, NAMELY, AUDIO PROCESSORS (U.S. CLS. 21, 23, 26, 36 AND 38).

FIRST USE 12-0-2011; IN COMMERCE 12-0-2011.

THE MARK CONSISTS OF STANDARD CHARACTERS WITHOUT CLAIM TO ANY PARTICULAR FONT, STYLE, SIZE, OR COLOR.

OWNER OF U.S. REG. NOS. 2,469,245, 2,953,777, AND OTHERS.

FOR COMPUTER APPLICATION SOFTWARE FOR USE WITH SMARTPHONES, PDA DEVICES AND TABLET COMPUTERS, NAMELY, SOFTWARE FOR ACCESSING, VIEWING, INTERACTING WITH AND DOWNLOADING EDITORIAL AND ADVERTISING CONTENT FROM MAGAZINES AND WEBSITES AND SOFTWARE FOR BROWSING AND MAKING PURCHASES THROUGH SUCH DEVICES (U.S. CLS. 21, 23, 26, 36 AND 38).

FIRST USE 12-15-2011; IN COMMERCE 12-15-2011.

CLASS 9—(Continued).

4,165,295. BALLY GAMING, INC., DBA BALLY TECHNOLOGIES, LAS VEGAS, NV. SN 85-164,003. PUB. 3-15-2011, FILED 10-28-2010.

BLAZING DRAGONS

THE MARK CONSISTS OF STANDARD CHARACTERS WITHOUT CLAIM TO ANY PARTICULAR FONT, STYLE, SIZE, OR COLOR.

FOR COMPUTER GAMING SOFTWARE, GAMING SOFTWARE THAT GENERATES OR DISPLAYS WAGER OUTCOMES OF GAMING MACHINES, DOWNLOADABLE COMPUTER GAME SOFTWARE FOR GAMING, GAMING MACHINES, NAMELY, DEVICES THAT ACCEPT A WAGER, SLOT MACHINES (U.S. CLS. 21, 23, 26, 36 AND 38).

FIRST USE 10-10-2011; IN COMMERCE 10-10-2011.

CLASS 9—(Continued).

4,165,297. BALLY GAMING, INC., DBA BALLY TECHNOLOGIES, LAS VEGAS, NV. SN 85-164,635. PUB. 3-15-2011, FILED 10-29-2010.

RAMSES GOLD

THE MARK CONSISTS OF STANDARD CHARACTERS WITHOUT CLAIM TO ANY PARTICULAR FONT, STYLE, SIZE, OR COLOR.

FOR COMPUTER GAMING SOFTWARE, GAMING SOFTWARE THAT GENERATES OR DISPLAYS WAGER OUTCOMES OF GAMING MACHINES, DOWNLOADABLE COMPUTER GAME SOFTWARE FOR GAMING, GAMING MACHINES, NAMELY, DEVICES THAT ACCEPT A WAGER; SLOT MACHINES (U.S. CLS. 21, 23, 26, 36 AND 38).

FIRST USE 11-17-2011; IN COMMERCE 11-17-2011.

4,165,311. ISYS TECHNOLOGIES, INC., SALT LAKE CITY, UT. SN 85-172,000. PUB. 8-30-2011, FILED 11-8-2010.

XI3 MODULAR

THE MARK CONSISTS OF STANDARD CHARACTERS WITHOUT CLAIM TO ANY PARTICULAR FONT, STYLE, SIZE, OR COLOR.

OWNER OF U.S. REG. NO. 3,393,226.
NO CLAIM IS MADE TO THE EXCLUSIVE RIGHT TO USE "MODULAR", APART FROM THE MARK AS SHOWN.
FOR COMPUTER CARRYING CASES; COMPUTER CHASSIS; COMPUTER EXPANSION BOARDS; COMPUTER HARDWARE; COMPUTER INTERFACE BOARDS; COMPUTER PERIPHERALS; COMPUTERS (U.S. CLS. 21, 23, 26, 36 AND 38).

FIRST USE 1-0-2011; IN COMMERCE 1-0-2011.

4,165,296. BALLY GAMING, INC., DBA BALLY TECHNOLOGIES, LAS VEGAS, NV. SN 85-164,034. PUB. 3-15-2011, FILED 10-28-2010.

DRAGON WONDER

THE MARK CONSISTS OF STANDARD CHARACTERS WITHOUT CLAIM TO ANY PARTICULAR FONT, STYLE, SIZE, OR COLOR.

FOR COMPUTER GAMING SOFTWARE, GAMING SOFTWARE THAT GENERATES OR DISPLAYS WAGER OUTCOMES OF GAMING MACHINES, DOWNLOADABLE COMPUTER GAME SOFTWARE FOR GAMING, GAMING MACHINES, NAMELY, DEVICES THAT ACCEPT A WAGER, SLOT MACHINES (U.S. CLS. 21, 23, 26, 36 AND 38).

FIRST USE 11-17-2011; IN COMMERCE 11-17-2011.

4,165,314. NANOTROPIC S.A., ATHENS, GREECE. SN 85-172,448. PUB. 3-29-2011, FILED 11-9-2010.

NANOPOWER

THE MARK CONSISTS OF STANDARD CHARACTERS WITHOUT CLAIM TO ANY PARTICULAR FONT, STYLE, SIZE, OR COLOR.

FOR COMPUTER AIDED DESIGN SOFTWARE FOR USE IN THE DESIGN OF ANALOG AND DIGITAL INTEGRATED CIRCUITS AND SYSTEMS (U.S. CLS. 21, 23, 26, 36 AND 38).

FIRST USE 2-6-2012; IN COMMERCE 2-6-2012.

CLASS 9—(Continued).

4,165,317. ENVISION PERIPHERALS INC., FREMONT, CA.
SN 85-174,973. PUB. 4-12-2011, FILED 11-11-2010.

AIRE|LED

THE MARK CONSISTS OF STANDARD CHARACTERS WITHOUT CLAIM TO ANY PARTICULAR FONT, STYLE, SIZE, OR COLOR.

NO CLAIM IS MADE TO THE EXCLUSIVE RIGHT TO USE "LED", APART FROM THE MARK AS SHOWN.

FOR COMPUTER MONITORS; LIGHT EMITTING DIODE (LED) DISPLAYS; LIQUID CRYSTAL DISPLAY (LCD) MONITORS; LIQUID CRYSTAL DISPLAY (LCD) TELEVISIONS; TELEVISIONS AND MONITORS (U.S. CLS. 21, 23, 26, 36 AND 38).

FIRST USE 10-0-2010; IN COMMERCE 10-0-2010.

4,165,318. ENVISION PERIPHERALS INC., FREMONT, CA.
SN 85-174,979. PUB. 4-12-2011, FILED 11-11-2010.

AIRE BLK|LED

THE MARK CONSISTS OF STANDARD CHARACTERS WITHOUT CLAIM TO ANY PARTICULAR FONT, STYLE, SIZE, OR COLOR.

NO CLAIM IS MADE TO THE EXCLUSIVE RIGHT TO USE "BLK" AND "LED", APART FROM THE MARK AS SHOWN.

FOR COMPUTER MONITORS; LIGHT EMITTING DIODE (LED) DISPLAYS; LIQUID CRYSTAL DISPLAY (LCD) MONITORS; LIQUID CRYSTAL DISPLAY (LCD) TELEVISIONS; TELEVISIONS AND MONITORS (U.S. CLS. 21, 23, 26, 36 AND 38).

FIRST USE 2-0-2011; IN COMMERCE 3-0-2011.

4,165,338. KONAMI GAMING, INC., LAS VEGAS, NV. SN 85-185,232. PUB. 2-22-2011, FILED 11-25-2010.

FAIRY'S WISH

THE MARK CONSISTS OF STANDARD CHARACTERS WITHOUT CLAIM TO ANY PARTICULAR FONT, STYLE, SIZE, OR COLOR.

CLASS 9—(Continued).

OWNER OF U.S. REG. NOS. 3,360,822, 3,861,660, AND OTHERS.

FOR ELECTRONIC GAME PROGRAMS; GAMING EQUIPMENT, NAMELY, SLOT MACHINES WITH OR WITHOUT VIDEO OUTPUT; GAMING MACHINES; MACHINES FOR PLAYING GAMES OF CHANCE; SLOT MACHINES (U.S. CLS. 21, 23, 26, 36 AND 38).

FIRST USE 10-0-2011; IN COMMERCE 10-0-2011.

4,165,339. KONAMI GAMING, INC., LAS VEGAS, NV. SN 85-185,234. PUB. 2-22-2011, FILED 11-25-2010.

GODDESS OF WILDS

THE MARK CONSISTS OF STANDARD CHARACTERS WITHOUT CLAIM TO ANY PARTICULAR FONT, STYLE, SIZE, OR COLOR.

OWNER OF U.S. REG. NOS. 3,673,627 AND 3,726,145.

FOR ELECTRONIC GAME PROGRAMS; GAMING EQUIPMENT, NAMELY, SLOT MACHINES WITH OR WITHOUT VIDEO OUTPUT; GAMING MACHINES; MACHINES FOR PLAYING GAMES OF CHANCE; SLOT MACHINES (U.S. CLS. 21, 23, 26, 36 AND 38).

FIRST USE 10-0-2011; IN COMMERCE 10-0-2011.

4,165,340. KONAMI GAMING, INC., LAS VEGAS, NV. SN 85-185,239. PUB. 2-22-2011, FILED 11-25-2010.

ELECTRIFYING RICHES

THE MARK CONSISTS OF STANDARD CHARACTERS WITHOUT CLAIM TO ANY PARTICULAR FONT, STYLE, SIZE, OR COLOR.

OWNER OF U.S. REG. NOS. 3,110,342, 3,803,901, AND OTHERS.

FOR ELECTRONIC GAME PROGRAMS; GAMING EQUIPMENT, NAMELY, SLOT MACHINES WITH OR WITHOUT VIDEO OUTPUT; GAMING MACHINES; MACHINES FOR PLAYING GAMES OF CHANCE; SLOT MACHINES (U.S. CLS. 21, 23, 26, 36 AND 38).

FIRST USE 10-0-2011; IN COMMERCE 10-0-2011.

CLASS 9—(Continued).

4,165,347. SCI DIRECT, LLC, NORTH CANTON, OH. SN 85-194,011. PUB. 3-15-2011, FILED 12-9-2010.

SCALERID

THE MARK CONSISTS OF STANDARD CHARACTERS WITHOUT CLAIM TO ANY PARTICULAR FONT, STYLE, SIZE, OR COLOR.

FOR WATER TREATMENT APPARATUS, NAMELY, ELECTROMAGNETIC DEVICES TO BE ATTACHED TO A WATER PIPE TO INHIBIT OR TREAT BUILDUP OF SCALE IN THE WATER PIPE (U.S. CLS. 21, 23, 26, 36 AND 38).

FIRST USE 4-30-2012; IN COMMERCE 4-30-2012.

CLASS 9—(Continued).

4,165,377. PLURIBUS NETWORKS INC., PALO ALTO, CA. SN 85-207,780. PUB. 5-17-2011, FILED 12-30-2010.

VMANAGE

THE MARK CONSISTS OF STANDARD CHARACTERS WITHOUT CLAIM TO ANY PARTICULAR FONT, STYLE, SIZE, OR COLOR.

FOR COMPUTER SOFTWARE, NAMELY, SOFTWARE FOR MANAGING DISTRIBUTED OPERATING SYSTEMS EXECUTING ON SWITCHES AND OTHER NETWORK DEVICES (U.S. CLS. 21, 23, 26, 36 AND 38).

FIRST USE 2-2-2012; IN COMMERCE 2-2-2012.

4,165,356. TIMES FIBER COMMUNICATIONS, INC., WALLINGFORD, CT. SN 85-198,615. PUB. 10-25-2011, FILED 12-15-2010.

QuickShield

THE MARK CONSISTS OF STANDARD CHARACTERS WITHOUT CLAIM TO ANY PARTICULAR FONT, STYLE, SIZE, OR COLOR.

FOR ELECTRICAL CONNECTORS (U.S. CLS. 21, 23, 26, 36 AND 38).

FIRST USE 3-31-2011; IN COMMERCE 3-31-2011.

4,165,380. KONAMI GAMING, INC., LAS VEGAS, NV. SN 85-208,598. PUB. 2-15-2011, FILED 12-31-2010.

NUMBER BONUS WINNING STARS

THE MARK CONSISTS OF STANDARD CHARACTERS WITHOUT CLAIM TO ANY PARTICULAR FONT, STYLE, SIZE, OR COLOR.

OWNER OF U.S. REG. NOS. 3,379,588, 3,803,990, AND OTHERS.

NO CLAIM IS MADE TO THE EXCLUSIVE RIGHT TO USE "BONUS", APART FROM THE MARK AS SHOWN.

FOR ELECTRONIC GAME PROGRAMS; GAMING EQUIPMENT, NAMELY, SLOT MACHINES WITH OR WITHOUT VIDEO OUTPUT; GAMING MACHINES; MACHINES FOR PLAYING GAMES OF CHANCE; SLOT MACHINES (U.S. CLS. 21, 23, 26, 36 AND 38).

FIRST USE 10-0-2011; IN COMMERCE 10-0-2011.

4,165,375. PLURIBUS NETWORKS INC., PALO ALTO, CA. SN 85-207,764. PUB. 5-3-2011, FILED 12-30-2010.

VRENDER

THE MARK CONSISTS OF STANDARD CHARACTERS WITHOUT CLAIM TO ANY PARTICULAR FONT, STYLE, SIZE, OR COLOR.

FOR COMPUTER SOFTWARE, NAMELY, SOFTWARE THAT PROVIDES A UNIFIED, NEAR-REAL TIME VIEW OF THE TOPOLOGY AND UTILIZATION OF ONE OR MORE NETWORKS; GRAPHICAL USER INTERFACE SOFTWARE FOR USE IN GRAPHICALLY DISPLAYING BOTH NETWORK TOPOLOGY AND UTILIZATION (U.S. CLS. 21, 23, 26, 36 AND 38).

FIRST USE 2-2-2012; IN COMMERCE 2-2-2012.

4,165,382. MICROSOFT CORPORATION, REDMOND, WA. SN 85-209,546. PUB. 8-30-2011, FILED 1-3-2011.

PIXELSENSE

THE MARK CONSISTS OF STANDARD CHARACTERS WITHOUT CLAIM TO ANY PARTICULAR FONT, STYLE, SIZE, OR COLOR.

FOR COMPUTER HARDWARE AND COMPUTER SOFTWARE FOR ENABLING OBJECT RECOGNITION ON MULTI-USER, MULTI-TOUCH DEVICES (U.S. CLS. 21, 23, 26, 36 AND 38).

FIRST USE 1-0-2012; IN COMMERCE 1-0-2012.

CLASS 9—(Continued).

4,165,390. IBATTZ PRIVATE LIMITED, SINGAPORE, SINGAPORE. SN 85-213,168. PUB. 5-31-2011, FILED 1-7-2011.



THE MARK CONSISTS OF A STYLIZED LOWER-CASE LETTERING OF "IBATTZ" WITH A STYLIZED CROSS DESIGN IN THE LETTER "B".

FOR BATTERIES; BATTERY CHARGERS; CASES FOR MOBILE PHONES; ELECTRIC STORAGE BATTERIES; ELECTRIC WIRES AND CABLES; ELECTRICAL STORAGE BATTERIES; MOBILE PHONES; NOTEBOOK COMPUTERS; PLUG-IN CONNECTORS; WALKIE-TALKIES (U.S. CLS. 21, 23, 26, 36 AND 38).

FIRST USE 10-1-2010; IN COMMERCE 10-1-2010.

CLASS 9—(Continued).

NANTS FOR THE PURPOSE OF MONITORING AND MEASURING CORROSION; SENSORS, NAMELY, REPLACEABLE ELECTRIC OR ELECTRONIC SENSORS FOR SENSING THE CONCENTRATION OF ATMOSPHERIC CONTAMINANTS FOR THE PURPOSE OF MONITORING AND MEASURING ENVIRONMENTAL REACTIVITY; SENSORS, NAMELY, REPLACEABLE ELECTRIC OR ELECTRONIC SENSORS FOR SENSING THE CONCENTRATION OF ATMOSPHERIC CONTAMINANTS FOR THE PURPOSE OF MONITORING AND MEASURING AIR REACTIVITY; SENSORS, NAMELY, REPLACEABLE ELECTRIC OR ELECTRONIC SENSORS FOR SENSING THE CONCENTRATION OF ATMOSPHERIC CONTAMINANTS FOR THE PURPOSE OF MONITORING AND MEASURING AIR QUALITY; SENSORS, NAMELY, REPLACEABLE ELECTRIC OR ELECTRONIC SENSORS FOR SENSING THE CONCENTRATION OF ATMOSPHERIC CONTAMINANTS FOR THE PURPOSE OF MONITORING AND MEASURING CORROSION (U.S. CLS. 21, 23, 26, 36 AND 38).

FIRST USE 10-0-2011; IN COMMERCE 10-0-2011.

4,165,395. AAF-MCQUAY INC., LOUISVILLE, KY. SN 85-216,052. PUB. 2-7-2012, FILED 1-12-2011.



THE MARK CONSISTS OF STANDARD CHARACTERS WITHOUT CLAIM TO ANY PARTICULAR FONT, STYLE, SIZE, OR COLOR.

OWNER OF U.S. REG. NO. 3,844,568.

FOR ENVIRONMENTAL REACTIVITY ELECTRONIC MONITORS FOR DETECTING THE PRESENCE OF REACTIVE ACIDIC AND BASIC ATMOSPHERIC CONTAMINANTS; AIR REACTIVITY ELECTRONIC MONITORS FOR DETERMINING THE PRESENCE OF REACTIVE GASES; AIR QUALITY ELECTRONIC MONITORS FOR DETERMINING THE PRESENCE OF AND THE QUANTITY OF ACIDIC AND BASIC REACTIVE ATMOSPHERIC CONTAMINANT GASES; CORROSION ELECTRONIC MONITORS THAT REACT TO THE ATMOSPHERIC ACIDIC AND BASIC GASES TO DETERMINE THE RATE OF CORROSION; ELECTRIC OR ELECTRONIC SENSORS FOR MEASURING THE CONCENTRATION OF REACTIVE ATMOSPHERIC CONTAMINANTS FOR THE PURPOSE OF MEASURING ENVIRONMENTAL REACTIVITY; ELECTRIC OR ELECTRONIC SENSORS FOR SENSING THE CONCENTRATION OF ATMOSPHERIC CONTAMINANTS FOR THE PURPOSE OF MONITORING AND MEASURING AIR REACTIVITY; ELECTRIC OR ELECTRONIC SENSORS FOR SENSING THE CONCENTRATION OF ATMOSPHERIC CONTAMINANTS FOR THE PURPOSE OF MONITORING AND MEASURING AIR QUALITY; ELECTRIC OR ELECTRONIC SENSORS FOR SENSING THE CONCENTRATION OF ATMOSPHERIC CONTAMI-

4,165,404. QUALMARK CORPORATION, DENVER, CO. SN 85-219,543. PUB. 11-29-2011, FILED 1-18-2011.



THE MARK CONSISTS OF STANDARD CHARACTERS WITHOUT CLAIM TO ANY PARTICULAR FONT, STYLE, SIZE, OR COLOR.

FOR TESTING APPARATUS, NAMELY, TESTING EQUIPMENT FOR DETECTING MANUFACTURING DEFECTS AND DESIGN FLAWS IN ELECTRONICS AND ELECTROMECHANICAL DEVICES; TESTING APPARATUS, NAMELY, HIGHLY ACCELERATED STRESS SCREEN (HASS) AND HIGHLY ACCELERATED STRESS AUDIT (HASA) TESTING EQUIPMENT WHICH SUBJECTS A PRODUCT TO A SERIES OF OVERSTRESSES FOR DETECTING MANUFACTURING DEFECTS AND DESIGN FLAWS IN ELECTRONIC AND ELECTROMECHANICAL ASSEMBLIES (U.S. CLS. 21, 23, 26, 36 AND 38).

FIRST USE 3-20-2012; IN COMMERCE 3-20-2012.

CLASS 9—(Continued).

4,165,411. BALLY GAMING, INC., DBA BALLY TECHNOLOGIES, LAS VEGAS, NV. SN 85-226,029. PUB. 5-31-2011, FILED 1-25-2011.

WILD STRIPES

THE MARK CONSISTS OF STANDARD CHARACTERS WITHOUT CLAIM TO ANY PARTICULAR FONT, STYLE, SIZE, OR COLOR.

FOR COMPUTER-GAMING SOFTWARE; GAMING SOFTWARE THAT GENERATES OR DISPLAYS WAGER OUTCOMES OF GAMING MACHINES; DOWNLOADABLE COMPUTER GAME SOFTWARE FOR GAMING; GAMING MACHINES, NAMELY, DEVICES THAT ACCEPT A WAGER; SLOT MACHINES (U.S. CLS. 21, 23, 26, 36 AND 38).

FIRST USE 9-23-2011; IN COMMERCE 9-23-2011.

CLASS 9—(Continued).

4,165,433. TYPESAFE, INC., MENLO PARK, MA. SN 85-240,198. PUB. 1-24-2012, FILED 2-11-2011.

TYPESAFE

THE MARK CONSISTS OF STANDARD CHARACTERS WITHOUT CLAIM TO ANY PARTICULAR FONT, STYLE, SIZE, OR COLOR.

FOR COMPUTER PROGRAMS FOR CREATING OTHER COMPUTER PROGRAMS; COMPUTER PROGRAMS FOR IMPLEMENTING A COMPUTER PROGRAMMING LANGUAGE, NAMELY, COMPILER; COMPUTER SOFTWARE DEVELOPMENT TOOLS; COMPUTER SOFTWARE LIBRARIES FOR USE IN GENERAL PURPOSE COMPUTATION, MANIPULATION OF COLLECTIONS OF DATA, DATA TRANSFORMATION, INPUT/OUTPUT, COMMUNICATIONS, GRAPHICS DISPLAY, AND TESTING; COMPUTER SOFTWARE RUNTIME SYSTEMS COMPRISED OF COMPUTER SOFTWARE LIBRARIES FOR USE IN GENERAL PURPOSE COMPUTATION, MANIPULATION OF COLLECTIONS OF DATA, DATA TRANSFORMATION, INPUT/OUTPUT, COMMUNICATIONS, GRAPHICS DISPLAY, AND TESTING (U.S. CLS. 21, 23, 26, 36 AND 38).

FIRST USE 5-12-2011; IN COMMERCE 5-12-2011.

4,165,412. BALLY GAMING, INC., DBA BALLY TECHNOLOGIES, LAS VEGAS, NV. SN 85-226,031. PUB. 5-31-2011, FILED 1-25-2011.

PEACOCK PLENTY

THE MARK CONSISTS OF STANDARD CHARACTERS WITHOUT CLAIM TO ANY PARTICULAR FONT, STYLE, SIZE, OR COLOR.

FOR COMPUTER-GAMING SOFTWARE; GAMING SOFTWARE THAT GENERATES OR DISPLAYS WAGER OUTCOMES OF GAMING MACHINES; DOWNLOADABLE COMPUTER GAME SOFTWARE FOR GAMING; GAMING MACHINES, NAMELY, DEVICES THAT ACCEPT A WAGER; SLOT MACHINES (U.S. CLS. 21, 23, 26, 36 AND 38).

FIRST USE 10-14-2011; IN COMMERCE 10-14-2011.

4,165,434. J. SCHNEIDER POWER SUPPLIES, INC., DENVER, CO. SN 85-241,292. PUB. 8-23-2011, FILED 2-14-2011.

**J. Schneider Power
Supplies, Inc.**

THE MARK CONSISTS OF STANDARD CHARACTERS WITHOUT CLAIM TO ANY PARTICULAR FONT, STYLE, SIZE, OR COLOR.

NO CLAIM IS MADE TO THE EXCLUSIVE RIGHT TO USE "POWER SUPPLIES, INC.", APART FROM THE MARK AS SHOWN.

THE NAME(S), PORTRAIT(S), AND/OR SIGNATURE(S) SHOWN IN THE MARK DOES NOT IDENTIFY A PARTICULAR LIVING INDIVIDUAL.

FOR DRY-TYPE TRANSFORMERS; OIL TRANSFORMERS; LOW AND HIGH VOLTAGE ELECTRICAL POWER SUPPLIES; DC-UPS-SYSTEMS, NAMELY, DIRECT CURRENT UNINTERRUPTIBLE ELECTRICAL POWER SUPPLIES; MAGNETIC VOLTAGE STABILIZERS; TRANSFORMER-TYPE VOLTAGE STABILIZERS (U.S. CLS. 21, 23, 26, 36 AND 38).

FIRST USE 3-31-2012; IN COMMERCE 3-31-2012.

CLASS 9—(Continued).

4,165,449. BARNES, TERRENCE D, DBA MIND OVER MONEY, ALCOLU, SC. SN 85-248,979. PUB. 7-19-2011, FILED 2-22-2011.

MIND OVER MONEY

THE MARK CONSISTS OF STANDARD CHARACTERS WITHOUT CLAIM TO ANY PARTICULAR FONT, STYLE, SIZE, OR COLOR.

FOR MUSICAL SOUND RECORDINGS (U.S. CLS. 21, 23, 26, 36 AND 38).

FIRST USE 1-12-2011; IN COMMERCE 1-12-2011.

4,165,461. DGM (HK) LIMITED, KOWLOON, HONG KONG. SN 85-254,054. PUB. 10-4-2011, FILED 2-28-2011.

DGM

THE MARK CONSISTS OF THE WORDING "DGM" WITH TWO QUADRILATERALS STACKED ON TOP OF ONE ANOTHER APPEARING ON THE UPPER LEFT PORTION OF THE LETTER "D". THE UPPER LEFT PORTION OF THE LETTER "D" IS CARVED OUT IN A TRIANGLE SHAPE AND THE QUADRILATERALS APPEAR INSIDE THAT CARVED OUT SPACE. THE TOP LEFT PORTION OF THE LETTER "M" IS CARVED OUT IN A TRIANGLE SHAPE.

FOR AMUSEMENT APPARATUS ADAPTED FOR USE WITH AN EXTERNAL DISPLAY SCREEN OR MONITOR; AUTOMATIC VENDING MACHINES AND MECHANISMS FOR COIN-OPERATED APPARATUS; CALCULATING MACHINES; CASH REGISTERS; CHIP CARD READERS; COIN-OPERATED MECHANISMS FOR TELEVISION SETS; DATA PROCESSORS; DISTANCE MEASURING APPARATUS; ELECTRONIC NAVIGATIONAL AND POSITIONING APPARATUS AND INSTRUMENTS; JUKE BOXES; LENGTH MEASURING GAUGES; SCANNERS; SOUND RECORDING APPARATUS; SOUND REPRODUCTION APPARATUS; SOUND TRANSMITTING APPARATUS; SURVEYING INSTRUMENTS; TOOL MEASURING INSTRUMENTS; VENDING MACHINES (U.S. CLS. 21, 23, 26, 36 AND 38).

FIRST USE 7-24-2004; IN COMMERCE 3-1-2012.

CLASS 9—(Continued).

4,165,465. SHENZHEN HIGHFOUND ELECTRONICS CO., LTD., SHENZHEN, CHINA. SN 85-255,777. PUB. 7-19-2011, FILED 3-2-2011.

WINSEMI

THE MARK CONSISTS OF THE WORD "WINSEMI" IN STYLIZED LETTERS.

THE WORDING "WINSEMI" HAS NO MEANING IN A FOREIGN LANGUAGE.

FOR COMPUTER CHIPS; ELECTRIC CONDUCTORS; ELECTRIC CONTROL PANELS; ELECTRONIC CHIPS FOR THE MANUFACTURER OF INTEGRATED CIRCUITS; INTEGRATED CIRCUITS; LIGHTING BALLASTS; MICROCHIPS; PHOTOVOLTAIC CELLS; SEMICONDUCTORS; SILICON WAFERS; TRANSISTORS; VACUUM TUBES FOR RADIOS (U.S. CLS. 21, 23, 26, 36 AND 38).

FIRST USE 4-30-2009; IN COMMERCE 3-31-2011.

4,165,467. ACTIFIO, INC., WALTHAM, MA. SN 85-257,448. PUB. 7-19-2011, FILED 3-3-2011.

ANYIT

THE MARK CONSISTS OF STANDARD CHARACTERS WITHOUT CLAIM TO ANY PARTICULAR FONT, STYLE, SIZE, OR COLOR.

FOR COMPUTER SOFTWARE FOR MANAGING NETWORK STORAGE AND NON-NETWORK STORAGE (U.S. CLS. 21, 23, 26, 36 AND 38).

FIRST USE 3-12-2012; IN COMMERCE 3-12-2012.

4,165,472. CAANES, LLC, ALBUQUERQUE, NM. SN 85-259,100. PUB. 9-6-2011, FILED 3-6-2011.

MVP: MINING FOR
VULNERABLE PATTERNS

THE MARK CONSISTS OF STANDARD CHARACTERS WITHOUT CLAIM TO ANY PARTICULAR FONT, STYLE, SIZE, OR COLOR.

CLASS 9—(Continued).

NO CLAIM IS MADE TO THE EXCLUSIVE RIGHT TO USE "MINING FOR VULNERABLE PATTERNS", APART FROM THE MARK AS SHOWN.

FOR COMPUTER SOFTWARE ALLOWING USERS IN CLASSIFYING VULNERABLE PROGRAMS, APPLICATIONS, AND SYSTEMS FROM NORMAL ONES BY USING PATTERN MINING TECHNIQUES TO PROVIDE COMPREHENSIVE TREND AND PATTERN ANALYSIS (U.S. CLS. 21, 23, 26, 36 AND 38).

FIRST USE 4-5-2012; IN COMMERCE 4-5-2012.



4,165,481. THE CHAMBERLAIN GROUP, INC., ELMHURST, IL. SN 85-260,793. PUB. 7-26-2011, FILED 3-8-2011.

MyQ

THE MARK CONSISTS OF STANDARD CHARACTERS WITHOUT CLAIM TO ANY PARTICULAR FONT, STYLE, SIZE, OR COLOR.

FOR POWER CONTROLLERS; REMOTE CONTROLS FOR DOORS OR GATES; ELECTRIC DOOR OPENING AND CLOSING SYSTEM; ELECTRONIC SECURITY DEVICES, NAMELY, ELECTRONIC CONTROLS FOR GRANTING ACCESS AND EGRESS THROUGH DOORS OR GATES; RADIO RECEIVER UNITS, RADIO TRANSMITTER UNITS, KEYPADS AND CARD READERS; ACCESS CONTROL SYSTEMS FOR PROVIDING, AND RESTRICTING ACCESS TO ELECTRONICALLY MONITORED AND SECURED ENCLOSURES; FACILITIES MANAGEMENT SOFTWARE, NAMELY, SOFTWARE TO CONTROL BUILDING ACCESS AND SECURITY SYSTEMS; HOME, OFFICE AND INDUSTRIAL AUTOMATION SYSTEMS COMPRISING WIRELESS AND WIRED CONTROLLERS, CONTROLLED DEVICES, AND SOFTWARE FOR LIGHTING, SECURITY, SAFETY AND OTHER HOME, OFFICE AND INDUSTRIAL MONITORING AND CONTROL APPLICATIONS; LIGHTING CONTROLS; COMPUTER HARDWARE; COMPUTER HARDWARE AND SOFTWARE SYSTEM FOR REMOTELY MONITORING CONTROLLING DEVICES WITHIN A BUILDING, FACILITY, GROUNDS, OR DESIGNATED SPATIAL AREA; COMPUTER HARDWARE AND COMPUTER PERIPHERAL DEVICES; COMPUTER HARDWARE AND SOFTWARE SYSTEMS FOR REMOTELY CONTROLLING LIGHTING DEVICES, ACCESS DEVICES, SECURITY DEVICES WITHIN A BUILDING OR BUILDING PERIMETER; SECURITY ALARM CONTROLLERS; SECURITY ALARMS; SECURITY CONTROL PANELS; SECURITY LIGHTS FOR OUTDOOR USE; SECURITY PRODUCTS, NAMELY, ENTRY DOOR SYSTEMS COMPRISING TOUCH PADS; ELECTRIC MONITORING APPARATUS, NAMELY, COMPUTER HARDWARE AND SOFTWARE USED TO TRANSMIT ELECTRONIC MESSAGES AND DATA VIA COMMUNICATIONS NETWORKS (U.S. CLS. 21, 23, 26, 36 AND 38).

FIRST USE 9-0-2011; IN COMMERCE 9-0-2011.

CLASS 9—(Continued).

4,165,501. DOT HILL SYSTEMS CORP, LONGMONT, CO. SN 85-266,610. PUB. 7-26-2011, FILED 3-14-2011.

ASSUREDVRA

THE MARK CONSISTS OF STANDARD CHARACTERS WITHOUT CLAIM TO ANY PARTICULAR FONT, STYLE, SIZE, OR COLOR.

FOR COMPUTER HARDWARE AND SOFTWARE SYSTEMS FOR STORING, MANAGING, AND MONITORING DATA (U.S. CLS. 21, 23, 26, 36 AND 38).

FIRST USE 3-16-2012; IN COMMERCE 3-16-2012.



4,165,519. COOPER TECHNOLOGIES COMPANY, HOUSTON, TX. SN 85-271,923. PUB. 8-16-2011, FILED 3-21-2011.

SUNNECTOR

THE MARK CONSISTS OF STANDARD CHARACTERS WITHOUT CLAIM TO ANY PARTICULAR FONT, STYLE, SIZE, OR COLOR.

FOR ELECTRICAL CONNECTORS FOR ELECTRICAL ENERGY EQUIPMENT; ELECTRICAL CONNECTORS; ELECTRICAL AND ELECTRONIC CONNECTORS; ELECTRICAL POWER CONNECTORS; ELECTRIC CONNECTIONS AND CONNECTORS; PLUG CONNECTORS; PLUG-IN CONNECTORS; DECORATIVE SWITCH PLATE COVERS; ELECTRIC CURRENT SWITCHES; ELECTRIC LIGHT SWITCHES; ELECTRIC SWITCH HOUSINGS; ELECTRIC SWITCH PLATES; ELECTRIC SWITCHES; ELECTRICAL SWITCHES; ELECTRONIC MOTION SENSITIVE SWITCHES; ELECTRONIC PROXIMITY SENSORS AND SWITCHES; ELECTRONIC TOUCH SENSITIVE SWITCHES; LIGHT SWITCHES; POWER SWITCHES; ELECTRICAL RECEPTACLES; ELECTRIC PLUGS; ELECTRICAL PLUGS; ELECTRICAL PLUGS AND SOCKETS; PLUG ADAPTORS; PLUG CONNECTORS FOR SOLAR APPLICATIONS (U.S. CLS. 21, 23, 26, 36 AND 38).

FIRST USE 4-30-2011; IN COMMERCE 4-30-2011.

CLASS 9—(Continued).

4,165,527. GONATION, LLC, MILFORD, CT. SN 85-272,869. PUB. 8-2-2011, FILED 3-21-2011.

GoNation

THE MARK CONSISTS OF THE WORD "GONATION" IN STYLIZED FORM.

FOR DOWNLOADABLE SOFTWARE IN THE NATURE OF A MOBILE APPLICATION FOR DISPLAYING AND SHARING A USER'S LOCATION AND FINDING, LOCATING AND INTERACTING WITH OTHER USERS AND PLACES; COMPUTER SOFTWARE DEVELOPMENT TOOLS; COMPUTER SOFTWARE FOR USE AS AN APPLICATION PROGRAMMING INTERFACE (API); APPLICATION PROGRAMMING INTERFACE (API) FOR COMPUTER SOFTWARE WHICH FACILITATES ONLINE SERVICES FOR SOCIAL NETWORKING, BUILDING SOCIAL NETWORKING APPLICATIONS AND FOR ALLOWING DATA RETRIEVAL, UPLOAD, DOWNLOAD, ACCESS AND MANAGEMENT; COMPUTER SOFTWARE TO ENABLE UPLOADING, DOWNLOADING, ACCESSING, POSTING, DISPLAYING, TAGGING, BLOGGING, STREAMING, LINKING, SHARING OR OTHERWISE PROVIDING ELECTRONIC MEDIA OR INFORMATION VIA COMPUTER AND COMMUNICATION NETWORKS (U.S. CLS. 21, 23, 26, 36 AND 38).

FIRST USE 1-1-2012; IN COMMERCE 1-1-2012.

4,165,530. INNOVATIVE TIMING SYSTEMS, LLC, ST. LOUIS, MO. SN 85-273,246. PUB. 8-23-2011, FILED 3-22-2011.

CHEETAH

THE MARK CONSISTS OF STANDARD CHARACTERS WITHOUT CLAIM TO ANY PARTICULAR FONT, STYLE, SIZE, OR COLOR.

FOR TIMING SYSTEMS, NAMELY, COMPUTER SYSTEMS, SOFTWARE, TRANSCEIVERS, AND RFID TRANSCEIVER CHIPS FOR IDENTIFYING AND TRACKING EVENT OR RACE PARTICIPANTS AND OBJECTS HAVING TIMING SENSORS ASSOCIATED THEREWITH AND DETERMINING TIMES, MOVEMENT AND LOCATIONS OF INDIVIDUAL PARTICIPANTS OR OBJECTS, FOR ALL RACING INCLUDING HIGH SPEED CRITERIUMS, MOTORCYCLE, KAYAK, CYCLING, AUTOMOTIVE AND HORSE RACING (U.S. CLS. 21, 23, 26, 36 AND 38).

FIRST USE 1-26-2012; IN COMMERCE 1-26-2012.

CLASS 9—(Continued).

4,165,533. AGILENT TECHNOLOGIES, INC., SANTA CLARA, CA. SN 85-273,938. PUB. 1-3-2012, FILED 3-22-2011.

SureCycler

THE MARK CONSISTS OF STANDARD CHARACTERS WITHOUT CLAIM TO ANY PARTICULAR FONT, STYLE, SIZE, OR COLOR.

FOR LABORATORY APPARATUS, INSTRUMENTS AND ACCESSORIES, NAMELY, MICROARRAYS FOR USE IN EVALUATING GENETIC MATERIALS BY DETECTING GENETIC SEQUENCES; LABORATORY APPARATUS, NAMELY, THERMOCYCLERS USED TO AMPLIFY SEGMENTS OF DNA VIA THE POLYMERASE CHAIN REACTION (PCR) PROCESS (U.S. CLS. 21, 23, 26, 36 AND 38).

FIRST USE 4-0-2011; IN COMMERCE 4-0-2011.

4,165,546. DEBORAH DICKINSON, SOUTH DENNIS, NJ. SN 85-275,685. PUB. 11-22-2011, FILED 3-24-2011.

DIM IT

THE MARK CONSISTS OF STANDARD CHARACTERS WITHOUT CLAIM TO ANY PARTICULAR FONT, STYLE, SIZE, OR COLOR.

NO CLAIM IS MADE TO THE EXCLUSIVE RIGHT TO USE "DIM", APART FROM THE MARK AS SHOWN.

FOR OPTICAL FILTERS IN THE NATURE OF LIGHT REDUCING FILM SHEETS FOR LED DISPLAYS (U.S. CLS. 21, 23, 26, 36 AND 38).

FIRST USE 1-4-2012; IN COMMERCE 1-4-2012.

4,165,552. DUGUE, JEAN, J. FORT LAUDERDALE, FL. AND DUGUE, JUNIOR, FORT LAUDERDALE, FL. SN 85-276,627. PUB. 8-9-2011, FILED 3-25-2011.

Bro Workers

THE MARK CONSISTS OF STANDARD CHARACTERS WITHOUT CLAIM TO ANY PARTICULAR FONT, STYLE, SIZE, OR COLOR.

FOR COMPACT DISCS FEATURING MUSIC; COMPACT DISCS FEATURING MUSIC AND SPOKEN WORD IN THE FORM OF POETRY; DIGITAL MUSIC DOWNLOADABLE FROM THE INTERNET; MUSICAL RECORDINGS; MUSICAL SOUND RECORDINGS; MUSICAL VIDEO RECORDINGS (U.S. CLS. 21, 23, 26, 36 AND 38).

FIRST USE 7-20-2011; IN COMMERCE 7-20-2011.

CLASS 9—(Continued).

4,165,553. FAIRVIEW IMPORT CORPORATION, SANTA FE SPRINGS, CA. SN 85-276,835. PUB. 8-9-2011, FILED 3-25-2011.



THE MARK CONSISTS OF A REPRESENTATION OF A BULL IN FRONTAL VIEW WITH THE WORDS "RAGING BULL" DIRECTLY UNDERNEATH.

FOR CASES FOR EYEGLASSES AND SUNGLASSES; CASES FOR SPECTACLES AND SUNGLASSES; EYEWEAR, NAMELY, SUNGLASSES, EYEGLASSES AND OPHTHALMIC FRAMES AND CASES THEREFOR; FRAMES FOR SPECTACLES AND SUNGLASSES; LENSES FOR SUNGLASSES; SPECTACLES AND SUNGLASSES; SUNGLASS LENSES; SUNGLASSES; SUNGLASSES AND SPECTACLES (U.S. CLS. 21, 23, 26, 36 AND 38).

FIRST USE 1-31-2012; IN COMMERCE 1-31-2012.

CLASS 9—(Continued).

4,165,555. FAIRVIEW IMPORT CORPORATION, SANTA FE SPRINGS, CA. SN 85-276,861. PUB. 8-9-2011, FILED 3-25-2011.



THE MARK CONSISTS OF THE LETTER "C", FACING BACKWARDS, AND THE LETTER "B", BOTH IN STYLIZED LETTERING.

FOR CASES FOR EYEGLASSES AND SUNGLASSES; CASES FOR SPECTACLES AND SUNGLASSES; EYEWEAR, NAMELY, SUNGLASSES, EYEGLASSES AND OPHTHALMIC FRAMES AND CASES THEREFOR; FRAMES FOR SPECTACLES AND SUNGLASSES; LENSES FOR SUNGLASSES; SPECTACLES AND SUNGLASSES; SUNGLASS LENSES; SUNGLASSES; SUNGLASSES AND SPECTACLES (U.S. CLS. 21, 23, 26, 36 AND 38).

FIRST USE 4-25-2011; IN COMMERCE 4-25-2011.

4,165,554. FAIRVIEW IMPORT CORPORATION, SANTA FE SPRINGS, CA. SN 85-276,846. PUB. 8-16-2011, FILED 3-25-2011.



THE MARK CONSISTS OF THE LETTERS "P" AND "X" IN STYLIZED LETTERING.

FOR CASES FOR EYEGLASSES AND SUNGLASSES; CASES FOR SPECTACLES AND SUNGLASSES; EYEWEAR, NAMELY, SUNGLASSES, EYEGLASSES AND OPHTHALMIC FRAMES AND CASES THEREFOR; FRAMES FOR SPECTACLES AND SUNGLASSES; LENSES FOR SUNGLASSES; SPECTACLES AND SUNGLASSES; SUNGLASS LENSES; SUNGLASSES; SUNGLASSES AND SPECTACLES (U.S. CLS. 21, 23, 26, 36 AND 38).

FIRST USE 1-31-2012; IN COMMERCE 1-31-2012.

4,165,561. GRIDTEST SYSTEMS, INC., WESTLAKE VILLAGE, CA. SN 85-277,517. PUB. 8-30-2011, FILED 3-25-2011.



THE MARK CONSISTS OF STANDARD CHARACTERS WITHOUT CLAIM TO ANY PARTICULAR FONT, STYLE, SIZE, OR COLOR.

FOR PORTABLE ELECTRONIC DEVICES AND ASSOCIATED SOFTWARE FOR USE IN DEVELOPING, INSTALLING, AND MAINTAINING ELECTRIC VEHICLE CHARGERS (U.S. CLS. 21, 23, 26, 36 AND 38).

FIRST USE 7-28-2011; IN COMMERCE 7-28-2011.

CLASS 9—(Continued).

4,165,562. GREEN GOOSE, INC., CAMBRIDGE, MA. SN 85-277,638. PUB. 8-9-2011, FILED 3-25-2011.

PLAY REAL LIFE

THE MARK CONSISTS OF STANDARD CHARACTERS WITHOUT CLAIM TO ANY PARTICULAR FONT, STYLE, SIZE, OR COLOR.

FOR COMPUTER SOFTWARE, NAMELY, COMPUTER SOFTWARE THAT RECEIVES INFORMATION FROM SENSORS DESCRIBING BEHAVIORS OF A USER OF THE SOFTWARE, AND THAT RESPONDS TO SUCH INFORMATION BY PROVIDING REWARDS AND INCENTIVES FOR ENGAGING IN THE BEHAVIORS (U.S. CLS. 21, 23, 26, 36 AND 38).

FIRST USE 4-1-2011; IN COMMERCE 12-1-2011.

4,165,573. SUREFIRRE LLC, APPLETON, WI. SN 85-279,860. PUB. 8-9-2011, FILED 3-29-2011.

SNAGG

THE MARK CONSISTS OF STANDARD CHARACTERS WITHOUT CLAIM TO ANY PARTICULAR FONT, STYLE, SIZE, OR COLOR.

FOR ANTI-THEFT ELECTRONIC TRANSPONDER UNIT (U.S. CLS. 21, 23, 26, 36 AND 38).

FIRST USE 3-29-2011; IN COMMERCE 4-15-2011.

4,165,576. PIMENTEL, ALEJANDRO, MARACAIBO, ZUILA, VENEZUELA. SN 85-280,738. PUB. 8-9-2011, FILED 3-30-2011.

Capitan Audio

THE MARK CONSISTS OF STANDARD CHARACTERS WITHOUT CLAIM TO ANY PARTICULAR FONT, STYLE, SIZE, OR COLOR.

NO CLAIM IS MADE TO THE EXCLUSIVE RIGHT TO USE "AUDIO", APART FROM THE MARK AS SHOWN.

FOR AUDIO AMPLIFIERS; AUDIO SPEAKER ENCLOSURES; AUDIO SPEAKERS; MICROPHONE STANDS (U.S. CLS. 21, 23, 26, 36 AND 38).

FIRST USE 9-1-2011; IN COMMERCE 9-1-2011.

CLASS 9—(Continued).

4,165,577. PIMENTEL, ALEJANDRO, MARACAIBO, ZUILA, VENEZUELA. SN 85-280,743. PUB. 8-9-2011, FILED 3-30-2011.



NO CLAIM IS MADE TO THE EXCLUSIVE RIGHT TO USE "AUDIO", APART FROM THE MARK AS SHOWN.

THE COLOR(S) CYAN, BLACK, AND WHITE IS/ARE CLAIMED AS A FEATURE OF THE MARK.

THE MARK CONSISTS OF A STYLISTIC WHITE SEA CAPTAIN'S HAT, WITH AN EMBLEM IN CYAN, BLACK, AND WHITE ON THE FRONT OF THE HAT, THE HAT HAVING A CYAN BAND AND BLACK BILL AND THE HAT ITSELF OUTLINED IN BLACK; CENTERED ABOVE THE WORD, "CAPITAN", IN LARGE BLACK LETTERS; CENTERED ABOVE A SOLID, CYAN COLORED, UPSIDE-DOWN TRAPEZOID, CONTAINING THE WORD, "AUDIO", IN SMALLER WHITE LETTERS.

FOR AUDIO AMPLIFIERS; AUDIO SPEAKER ENCLOSURES; AUDIO SPEAKERS; MICROPHONE STANDS (U.S. CLS. 21, 23, 26, 36 AND 38).

FIRST USE 9-1-2011; IN COMMERCE 9-1-2011.

4,165,579. BEIJING ZHIRUI TECHNOLOGY LIMITED, BEIJING, CHINA. SN 85-281,036. PUB. 8-23-2011, FILED 3-30-2011.

AnTuTu

THE MARK CONSISTS OF THE STYLISED LETTERING "ANTUTU".

THE WORDING "ANTUTU" HAS NO MEANING IN A FOREIGN LANGUAGE.

FOR ACOUSTIC COUPLERS; APPARATUS FOR RECORDING, TRANSMISSION, PROCESSING AND REPRODUCTION OF SOUND, IMAGES OR DATA; BLANK OPTICAL DISCS; BLANK OPTICAL DISKS; CALCULATING MACHINES AND DATA PROCESSING EQUIPMENT; CARRYING CASES, HOLDERS, PROTECTIVE CASES AND STANDS FEATURING POWER SUPPLY CONNECTORS, ADAPTORS, SPEAKERS AND BATTERY CHARGING DEVICES, SPECIALLY ADAPTED FOR USE WITH HANDHELD DIGITAL ELECTRONIC DEVICES; COMPUTER CURSOR CONTROL DEVICES, NAMELY, COMPUTER MOUSE; COMPUTER GAME PROGRAMS; COMPUTER KEYBOARDS; COMPUTER MOUSE; COMPUTER MOUSE IN THE NATURE OF A TRACKPAD; COMPUTER OPERATING PROGRAMS AND COMPUTER OPERATING SYSTEMS; COMPUTER OPERATING PROGRAMS, RECORDED;

CLASS 9—(Continued).

COMPUTER OPERATING RECORDED PROGRAMS; COMPUTER OPERATING SOFTWARE; COMPUTER PROGRAMS FOR PRE-RECORDED GAMES; COMPUTER PROGRAMS RECORDED ON DATA MEDIA (SOFTWARE) DESIGNED FOR USE IN CONSTRUCTION AND AUTOMATED MANUFACTURING (CAD/CAM); COMPUTER-GAMING SOFTWARE; COMPUTERS; CONSUMER ELECTRONIC PRODUCTS, NAMELY, AUDIO AMPLIFIERS, AUDIO SPEAKERS, AUDIO RECEIVERS, ELECTRICAL AUDIO AND SPEAKER CABLES AND CONNECTORS, AUDIO DECODERS, VIDEO DECODERS, SPEAKERS, POWER CONVERSION DEVICES, POWER CONVERTERS, AND POWER INVERTERS; DATA PROCESSORS; DOWNLOADABLE COMPUTER SOFTWARE FOR USE AS A SPREADSHEET, WORD PROCESSING; DOWNLOADABLE COMPUTER SOFTWARE IN THE FIELD OF MEMORY TRAINING ACTIVITIES SOLD AS A UNIT WITH POSITIONABLE FIGURES; DOWNLOADABLE SOFTWARE FOR USE IN DATABASE MANAGEMENT, FOR USE AS A SPREADSHEET, FOR WORD PROCESSING; ELECTRONIC NAVIGATIONAL AND POSITIONING APPARATUS AND INSTRUMENTS; ELECTRONIC SOFTWARE UPDATES, NAMELY, DOWNLOADABLE COMPUTER SOFTWARE AND ASSOCIATED DATA FILES FOR UPDATING COMPUTER SOFTWARE IN THE FIELDS OF TELECOMMUNICATION, PROVIDED VIA COMPUTER AND COMMUNICATION NETWORKS; LAPTOP COMPUTERS; MULTIMEDIA SOFTWARE RECORDED ON CD-ROM FEATURING HANDLING, OPERATING AND ADJUSTING MECHANICALLY-OPERATED MACHINE TOOLS; NAVIGATION APPARATUS FOR VEHICLES IN THE NATURE OF ON-BOARD COMPUTERS; NOTEBOOK COMPUTERS; OPTICAL DISC DRIVES; OPTICAL DISC PLAYERS; OPTICAL DISCS CONTAINING SOFTWARE AND PROGRAMMING, USED TO SET-UP AND CALIBRATE TELEVISIONS AND VIDEO OUTPUT DEVICES; PORTABLE TELEPHONES; RECORDED COMPUTER GAME PROGRAMS; SATELLITE NAVIGATIONAL SYSTEM, NAMELY, A GLOBAL POSITIONING SYSTEM (GPS); TELEPHONE APPARATUS; VIDEO TELEPHONES; WRIST SUPPORTS FOR COMPUTER MOUSE USERS (U.S. CLS. 21, 23, 26, 36 AND 38).
FIRST USE 1-25-2011; IN COMMERCE 12-4-2011.

4,165,590. WILLOW GARAGE, INC., MENLO PARK, CA. SN 85-283,180. PUB. 8-9-2011, FILED 3-31-2011.

TURTLEBOT

THE MARK CONSISTS OF STANDARD CHARACTERS WITHOUT CLAIM TO ANY PARTICULAR FONT, STYLE, SIZE, OR COLOR.

FOR COMPUTER HARDWARE; COMPUTER SOFTWARE FOR USE IN CONTROLLING AND OPERATING ROBOTS; ROBOTS FOR PERSONAL, EDUCATIONAL AND HOBBY USE AND STRUCTURAL PARTS THEREFOR (U.S. CLS. 21, 23, 26, 36 AND 38).
FIRST USE 4-18-2011; IN COMMERCE 4-18-2011.

CLASS 9—(Continued).

4,165,593. HME INCORPORATED, WYOMING, MI. SN 85-283,785. PUB. 8-9-2011, FILED 4-1-2011.

DESIGNED SMART. BUILT TOUGH.

THE MARK CONSISTS OF STANDARD CHARACTERS WITHOUT CLAIM TO ANY PARTICULAR FONT, STYLE, SIZE, OR COLOR.

FOR FIRE TRUCKS (U.S. CLS. 21, 23, 26, 36 AND 38).
FIRST USE 1-6-2011; IN COMMERCE 1-6-2011.

4,165,616. UNIVERSAL ENTERTAINMENT CORPORATION, KOTO-KU, TOKYO, JAPAN. SN 85-287,064. PUB. 12-6-2011, FILED 4-5-2011.



THE MARK CONSISTS OF THE WORDS "CHINESE PHOENIX" IN A SMALL FONT SUPERIMPOSED IN AN ARC SHAPED AND SPANNING THE DISTANCE BETWEEN TWO LARGE, STYLIZED AND OUTLINED CHINESE CHARACTERS THAT APPEAR ABOVE THE "CHIN" IN "CHINESE" AND THE "NIX" IN "PHOENIX".

THE NON-LATIN CHARACTERS IN THE MARK TRANSLITERATE TO FENG HUANG AND THIS MEANS "CHINESE PHOENIX" IN ENGLISH.

FOR SLOT MACHINES AND REPLACEMENT PARTS THEREFOR; VIDEO SLOT MACHINES AND REPLACEMENT PARTS THEREFOR; GAMING MACHINES AND REPLACEMENT PARTS THEREFOR; GAMING MACHINES WITH A LIQUID CRYSTAL DISPLAY AND REPLACEMENT PARTS THEREFOR (U.S. CLS. 21, 23, 26, 36 AND 38).
FIRST USE 10-4-2011; IN COMMERCE 10-4-2011.

4,165,622. HELENA LABORATORIES CORPORATION, BEAUMONT, TX. SN 85-288,002. PUB. 8-16-2011, FILED 4-6-2011.

C-PETTE

THE MARK CONSISTS OF STANDARD CHARACTERS WITHOUT CLAIM TO ANY PARTICULAR FONT, STYLE, SIZE, OR COLOR.

CLASS 9—(Continued).

OWNER OF U.S. REG. NO. 2,234,998.
FOR LABORATORY EQUIPMENT, NAMELY, BLOOD DISPENSING AND LABORATORY SLIDE PREPARATION APPARATUS (U.S. CLS. 21, 23, 26, 36 AND 38).
FIRST USE 6-1-2011; IN COMMERCE 6-1-2011.

4,165,626. EMTEK PRODUCTS, INC., CITY OF INDUSTRY, CA. SN 85-289,434. PUB. 8-16-2011, FILED 4-7-2011.

EMTOUCH

THE MARK CONSISTS OF STANDARD CHARACTERS WITHOUT CLAIM TO ANY PARTICULAR FONT, STYLE, SIZE, OR COLOR.
FOR ELECTRONIC LOCKS (U.S. CLS. 21, 23, 26, 36 AND 38).
FIRST USE 4-0-2011; IN COMMERCE 4-0-2011.

4,165,642. SURFEASY, INC., TORONTO, ONTARIO, CANADA. SN 85-294,142. PUB. 9-20-2011, FILED 4-13-2011.

SURFEASY

THE MARK CONSISTS OF STANDARD CHARACTERS WITHOUT CLAIM TO ANY PARTICULAR FONT, STYLE, SIZE, OR COLOR.
FOR USB COMPUTER ACCESS CONTROL KEY (U.S. CLS. 21, 23, 26, 36 AND 38).
FIRST USE 3-7-2012; IN COMMERCE 3-7-2012.

4,165,649. EBBERT, PHILIP D., PASADENA, CA. SN 85-295,842. PUB. 8-30-2011, FILED 4-14-2011.

REZTEK

THE MARK CONSISTS OF STANDARD CHARACTERS WITHOUT CLAIM TO ANY PARTICULAR FONT, STYLE, SIZE, OR COLOR.
FOR TOUCH PADS (U.S. CLS. 21, 23, 26, 36 AND 38).
FIRST USE 5-11-2011; IN COMMERCE 9-14-2011.

CLASS 9—(Continued).

4,165,654. THE VAN DER ROEST GROUP, INC., ORANGE, CA. SN 85-296,628. PUB. 8-30-2011, FILED 4-15-2011.

ALCOVE9

THE MARK CONSISTS OF STANDARD CHARACTERS WITHOUT CLAIM TO ANY PARTICULAR FONT, STYLE, SIZE, OR COLOR.

FOR DOWNLOADABLE SOFTWARE FOR PROVIDING AN ON-PREMISES SEARCH ENGINE FOR ENGINEERING MANUFACTURING APPLICATIONS (U.S. CLS. 21, 23, 26, 36 AND 38).
FIRST USE 4-18-2011; IN COMMERCE 5-27-2011.

4,165,662. KELLWOOD COMPANY, CHESTERFIELD, MO. SN 85-298,750. PUB. 8-23-2011, FILED 4-19-2011.

BLK DNM

THE MARK CONSISTS OF THE LETTERS "BLK DNM" IN A STYLIZED FONT.

FOR CASES FOR EYEGLASSES AND SUNGLASSES; EYEWEAR; FRAMES FOR SPECTACLES AND SUNGLASSES; LENSES FOR SUNGLASSES; SUNGLASSES AND SPECTACLES (U.S. CLS. 21, 23, 26, 36 AND 38).
FIRST USE 9-13-2011; IN COMMERCE 9-13-2011.

4,165,675. ARISTOCRAT TECHNOLOGIES AUSTRALIA PTY LTD., NORTH RYDE, NSW, AUSTRALIA. SN 85-303,303. PUB. 9-13-2011, FILED 4-25-2011.

TIKI SUN

THE MARK CONSISTS OF STANDARD CHARACTERS WITHOUT CLAIM TO ANY PARTICULAR FONT, STYLE, SIZE, OR COLOR.

FOR ELECTRONIC GAMING MACHINES, NAMELY, DEVICES WHICH ACCEPT A WAGER (U.S. CLS. 21, 23, 26, 36 AND 38).
FIRST USE 10-1-2011; IN COMMERCE 10-1-2011.

CLASS 9—(Continued).

4,165,677. F-MATIC, INC., LEHI, UT. SN 85-304,745. PUB. 9-20-2011, FILED 4-26-2011.

BESTROOM

THE MARK CONSISTS OF STANDARD CHARACTERS WITHOUT CLAIM TO ANY PARTICULAR FONT, STYLE, SIZE, OR COLOR.

FOR COMPUTER APPLICATION SOFTWARE FOR USE BY CELLULAR AND MOBILE PHONES, PDAS, COMPUTERS AND OTHER ELECTRONIC DEVICES FOR PLANNING, CONTROLLING, MONITORING, ORDERING SUPPLIES FOR, AND PROVIDING INFORMATION ABOUT THE CONDITION, CARE AND MAINTENANCE OF PUBLIC-RELATED ROOMS AND FACILITIES, INCLUDING RESTROOMS, HOTEL AND MOTEL ROOMS AND KITCHENS (U.S. CLS. 21, 23, 26, 36 AND 38).

FIRST USE 6-6-2011; IN COMMERCE 6-6-2011.

CLASS 9—(Continued).

4,165,706. ARISTOCRAT TECHNOLOGIES AUSTRALIA PTY LTD., NORTH RYDE, NSW, AUSTRALIA. SN 85-315,640. PUB. 9-20-2011, FILED 5-9-2011.

IMMORTAL PRINCE

THE MARK CONSISTS OF STANDARD CHARACTERS WITHOUT CLAIM TO ANY PARTICULAR FONT, STYLE, SIZE, OR COLOR.

FOR ELECTRONIC GAMING MACHINES, NAMELY, DEVICES WHICH ACCEPT A WAGER (U.S. CLS. 21, 23, 26, 36 AND 38).

FIRST USE 12-1-2011; IN COMMERCE 12-1-2011.

4,165,697. BALLY GAMING, INC., DBA BALLY TECHNOLOGIES, LAS VEGAS, NV. SN 85-311,187. PUB. 9-13-2011, FILED 5-3-2011.

REEL WILD JAGUAR

THE MARK CONSISTS OF STANDARD CHARACTERS WITHOUT CLAIM TO ANY PARTICULAR FONT, STYLE, SIZE, OR COLOR.

FOR GAMING MACHINES, NAMELY, DEVICES WHICH ACCEPT A WAGER AND GAMING SOFTWARE THAT GENERATES OR DISPLAYS OUTCOMES FOR GAMING MACHINES (U.S. CLS. 21, 23, 26, 36 AND 38).

FIRST USE 10-7-2011; IN COMMERCE 10-7-2011.

4,165,708. UNIVERSITY OF GEORGIA RESEARCH FOUNDATION, INC., ATHENS, GA. SN 85-315,687. PUB. 10-4-2011, FILED 5-9-2011.



THE MARK CONSISTS OF THE TERM "VETVIEW" WITH THE LETTER "I" IN LOWER CASE AND A DESIGN ELEMENT COMPRISING A CENTRAL CIRCLE AND TWO SERIES OF CONCENTRIC CIRCLES ABOUT THE CENTRAL CIRCLE POSITIONED OVER THE LETTER "T" IN THE TERM.

FOR SOFTWARE FOR USE FOR VETERINARY CLIENT DATABASE MANAGEMENT, RECORDS MANAGEMENT AND ACCOUNTING; SOFTWARE FOR USE FOR VETERINARY HOSPITAL AND CLINIC INFORMATION SYSTEMS, NAMELY, ELECTRONIC MEDICAL RECORDS (EMR), ACCOUNTING FUNCTIONS, CLIENT REFERRALS, APPOINTMENTS AND SCHEDULES, CLIENT MANAGEMENT, AND DOCUMENT MANAGEMENT; SOFTWARE FOR USE FOR VETERINARY LABORATORY INFORMATION MANAGEMENT, NAMELY, CLIENT MANAGEMENT, SAMPLE TRACKING, CASE MANAGEMENT, ACCOUNTING FUNCTIONS, DOCUMENT MANAGEMENT, AND TEST DOCUMENTATION AND MANAGEMENT; SOFTWARE FOR MANAGING THE FUNCTIONS OF A VETERINARY HOSPITAL OR CLINIC (U.S. CLS. 21, 23, 26, 36 AND 38).

FIRST USE 3-1-2011; IN COMMERCE 3-1-2011.

4,165,705. ARISTOCRAT TECHNOLOGIES AUSTRALIA PTY LTD., NORTH RYDE, NSW, AUSTRALIA. SN 85-315,631. PUB. 9-20-2011, FILED 5-9-2011.

LAUGHING FORTUNE

THE MARK CONSISTS OF STANDARD CHARACTERS WITHOUT CLAIM TO ANY PARTICULAR FONT, STYLE, SIZE, OR COLOR.

FOR ELECTRONIC GAMING MACHINES, NAMELY, DEVICES WHICH ACCEPT A WAGER (U.S. CLS. 21, 23, 26, 36 AND 38).

FIRST USE 3-1-2012; IN COMMERCE 3-1-2012.

CLASS 9—(Continued).

4,165,717. LANDMARK GRAPHICS CORPORATION, HOUSTON, TX. SN 85-323,062. PUB. 11-1-2011, FILED 5-17-2011.

FRAMEWORKS TO FILL

THE MARK CONSISTS OF STANDARD CHARACTERS WITHOUT CLAIM TO ANY PARTICULAR FONT, STYLE, SIZE, OR COLOR.

NO CLAIM IS MADE TO THE EXCLUSIVE RIGHT TO USE "FRAMEWORKS", APART FROM THE MARK AS SHOWN.

FOR COMPUTER SOFTWARE FOR SEISMIC INTERPRETATION, MAPPING AND MODELING TO ACQUIRE SEISMIC DATA FOR USE IN THE EXPLORATION AND PRODUCTION OF HYDROCARBONS (U.S. CLS. 21, 23, 26, 36 AND 38).

FIRST USE 9-15-2011; IN COMMERCE 9-15-2011.

CLASS 9—(Continued).

4,165,726. K-2 CORPORATION, SEATTLE, WA. SN 85-330,503. PUB. 11-8-2011, FILED 5-25-2011.



THE MARK CONSISTS OF THE LETTERS "MM" IN STYLIZED FORM.

FOR HELMETS, NAMELY, SPORTS HELMETS AND GOGGLES, NAMELY, GOGGLES FOR SPORTS (U.S. CLS. 21, 23, 26, 36 AND 38).

FIRST USE 9-0-2009; IN COMMERCE 9-0-2009.

4,165,718. MELLANOX TECHNOLOGIES, LTD., YOKNEAM, ISRAEL. SN 85-323,488. PUB. 1-31-2012, FILED 5-18-2011.

MLNX-OS

THE MARK CONSISTS OF STANDARD CHARACTERS WITHOUT CLAIM TO ANY PARTICULAR FONT, STYLE, SIZE, OR COLOR.

FOR SOFTWARE DRIVERS; NETWORK MANAGEMENT SOFTWARE FOR HOST CHANNEL ADAPTERS; NETWORK MANAGEMENT SOFTWARE FOR TARGET CHANNEL ADAPTERS; NETWORK MANAGEMENT SOFTWARE FOR SWITCHES; NETWORK MANAGEMENT SOFTWARE FOR ROUTERS (U.S. CLS. 21, 23, 26, 36 AND 38).

FIRST USE 6-20-2011; IN COMMERCE 6-20-2011.

4,165,727. K-2 CORPORATION, SEATTLE, WA. SN 85-330,507. PUB. 11-8-2011, FILED 5-25-2011.

MORROW

THE MARK CONSISTS OF STANDARD CHARACTERS WITHOUT CLAIM TO ANY PARTICULAR FONT, STYLE, SIZE, OR COLOR.

FOR HELMETS, NAMELY, SPORTS HELMETS AND GOGGLES, NAMELY, GOGGLES FOR SPORTS (U.S. CLS. 21, 23, 26, 36 AND 38).

FIRST USE 9-0-2009; IN COMMERCE 9-0-2009.

CLASS 9—(Continued).

4,165,737. BLAIR, ELIZABETH L., KANSAS CITY, MO. SN 85-335,625. PUB. 10-25-2011, FILED 6-1-2011.

descaid

THE MARK CONSISTS OF STANDARD CHARACTERS WITHOUT CLAIM TO ANY PARTICULAR FONT, STYLE, SIZE, OR COLOR.

FOR COMPUTER APPLICATION SOFTWARE FOR HANDHELD COMPUTERS, PERSONAL DIGITAL ASSISTANTS, ELECTRONIC ORGANIZERS, ELECTRONIC NOTEPADS, MOBILE PHONES, AND VIDEOPHONES, NAMELY, SOFTWARE FOR RECEIVING REMINDERS TO ENGAGE IN HEALTH AND WELLNESS ACTIVITIES, NAMELY, EXERCISE, STRETCHING, DRINKING WATER, AND UTILIZING HEALTHY EATING HABITS; COMPUTER SOFTWARE FOR A PROGRAM THAT DISTRIBUTES REMINDERS TO ENGAGE IN HEALTH AND WELLNESS ACTIVITIES, NAMELY, EXERCISE, STRETCHING, DRINKING WATER, AND UTILIZING HEALTHY EATING HABITS (U.S. CLS. 21, 23, 26, 36 AND 38).

FIRST USE 5-11-2011; IN COMMERCE 8-24-2011.

4,165,738. PATEL, MITA, MEMPHIS, TN. SN 85-336,578. PUB. 12-27-2011, FILED 6-2-2011.

JetLag MD

THE MARK CONSISTS OF STANDARD CHARACTERS WITHOUT CLAIM TO ANY PARTICULAR FONT, STYLE, SIZE, OR COLOR.

NO CLAIM IS MADE TO THE EXCLUSIVE RIGHT TO USE "JETLAG", APART FROM THE MARK AS SHOWN.

FOR AN ELECTRONIC APPLICATION APPARATUS, NAMELY, SOFTWARE FOR SMART PHONES AND TABLET COMPUTERS ALLOWING FOR THE CREATION OF A SLEEP SCHEDULE FOR TRAVEL ACROSS MULTIPLE TIME ZONES TO LESSEN THE EFFECTS OF JET LAG (U.S. CLS. 21, 23, 26, 36 AND 38).

FIRST USE 12-12-2011; IN COMMERCE 12-12-2011.

CLASS 9—(Continued).

4,165,740. LEARNING WITH MOMMY, ANNA, TX. SN 85-338,008. PUB. 11-8-2011, FILED 6-3-2011.



NO CLAIM IS MADE TO THE EXCLUSIVE RIGHT TO USE "LEARNING WITH MOMMY", APART FROM THE MARK AS SHOWN.

THE MARK CONSISTS OF A SILHOUETTE OF A MOTHER WITH A TODDLER IN A GROCERY CART INSIDE AN OVAL. THE STYLIZED TEXT "LEARNING WITH MOMMY" ALSO APPEARS INSIDE THE OVAL.

FOR COMPUTER APPLICATION SOFTWARE FOR MOBILE PHONES, PORTABLE MEDIA PLAYERS, HANDHELD COMPUTERS, AND TABLET COMPUTERS, NAMELY, SOFTWARE FOR PROVIDING INSTRUCTION ON HOW MOTHERS CAN TEACH THEIR CHILDREN WHILE DOING DAILY ACTIVITIES SUCH AS SHOPPING, DRIVING, CLEANING, AND COOKING; DIGITAL MEDIA, NAMELY, DVDS FEATURING INSTRUCTION ON HOW MOTHERS CAN TEACH AND THEIR CHILDREN WHILE DOING DAILY ACTIVITIES SUCH AS SHOPPING, DRIVING, CLEANING, AND COOKING (U.S. CLS. 21, 23, 26, 36 AND 38).

FIRST USE 1-19-2012; IN COMMERCE 1-19-2012.

4,165,760. SAMSUNG ELECTRONICS CO., LTD., SUWON-SI, GYEONGGI-DO, REPUBLIC OF KOREA. SN 85-346,277. PUB. 10-25-2011, FILED 6-14-2011.



THE MARK CONSISTS OF A LOWER CASE "I" IN CURSIVE, UPPER CASE "F" AND LOWER CASE "N" WITH A DESIGN OF A HALF CIRCLE ENCOMPASSING THE LOWER CASE "I".

FOR LENSES FOR CAMERAS; DIGITAL CAMERAS; CAMCORDERS; CAMERA CASES; FLASH LAMPS FOR CAMERAS; TRIPODS FOR CAMERAS (U.S. CLS. 21, 23, 26, 36 AND 38).

FIRST USE 10-28-2011; IN COMMERCE 10-28-2011.

CLASS 9—(Continued).

4,165,766. TRUE KNOWLEDGE LIMITED, CAMBRIDGE, UNITED KINGDOM. SN 85-353,412. PUB. 11-1-2011, FILED 6-22-2011.



THE MARK CONSISTS OF CIRCLE WITH A DOT SLIGHTLY ABOVE THE CENTER OF THE CIRCLE. BELOW THE DOT IS A SEMI-CIRCLE CURVED UPWARD.

FOR COMPUTER SOFTWARE FOR VOICE-ACTIVATED AND TEXT-RESPONSIVE ONLINE SEARCH SERVICES; COMPUTER APPLICATION SOFTWARE TO FACILITATE SOCIAL NETWORKING AND REALTIME CHAT (U.S. CLS. 21, 23, 26, 36 AND 38).

FIRST USE 1-17-2012; IN COMMERCE 1-17-2012.

CLASS 9—(Continued).

4,165,772. BAUMGARTNER ENVIRONICS, INC., OLIVIA, MN. SN 85-355,127. PUB. 1-31-2012, FILED 6-24-2011.



THE MARK CONSISTS OF A CIRCULAR DESIGN WITH A STYLIZED SUN ON A UPPER PORTION AND A STYLIZED AGRICULTURAL FIELD ON A LOWER PORTION.

FOR DUST CONTROL SYSTEMS COMPRISED OF POWER SUPPLIES, GROUND ELECTRODES AND DISCHARGE ELECTRODES (U.S. CLS. 21, 23, 26, 36 AND 38).

FIRST USE 4-9-2008; IN COMMERCE 9-0-2008.

4,165,771. FIREYE, INC., DERRY, NH. SN 85-353,921. PUB. 12-6-2011, FILED 6-23-2011.

NEXUS

THE MARK CONSISTS OF STANDARD CHARACTERS WITHOUT CLAIM TO ANY PARTICULAR FONT, STYLE, SIZE, OR COLOR.

FOR ELECTRONIC CONTROLLERS FOR BURNERS AND BOILERS AND COMPONENTS PARTS THEREFOR (U.S. CLS. 21, 23, 26, 36 AND 38).

FIRST USE 0-0-2000; IN COMMERCE 0-0-2000.

4,165,788. GREENFISH LLC, SAN CLEMENTE, CA. SN 85-362,450. PUB. 12-20-2011, FILED 7-2-2011.

GREENFISH

THE MARK CONSISTS OF STANDARD CHARACTERS WITHOUT CLAIM TO ANY PARTICULAR FONT, STYLE, SIZE, OR COLOR.

OWNER OF U.S. REG. NO. 3,948,454.
FOR CAMERA MOUNTS AND SUPPORTS (U.S. CLS. 21, 23, 26, 36 AND 38).

FIRST USE 6-1-2010; IN COMMERCE 12-31-2011.

CLASS 9—(Continued).

4,165,790. RICKYJIMMY LLC, DBA R&J RECORDS, NASHVILLE, TN. SN 85-363,212. PUB. 12-27-2011, FILED 7-5-2011.



NO CLAIM IS MADE TO THE EXCLUSIVE RIGHT TO USE "RECORDS", APART FROM THE MARK AS SHOWN.

THE MARK CONSISTS OF THE STYLIZED LOWER CASE LETTER "R" ADJACENT TO THE STYLIZED CAPITAL LETTER "J" AND WITH AN AMPERSAND ("&") IN THE SPACE BETWEEN THE TWO LETTERS CONTAINS. BENEATH THE LETTERS IS THE WORD "RECORDS" IN AN ALL CAPS FONT SIZE THAT SPANS THE WIDTH OF THE "R&J" LETTERS ABOVE IT. THE DESIGN IS FRAMED BY A GENERALLY RECTANGULAR BORDER WITH CURVED CORNERS.

FOR MUSICAL SOUND RECORDINGS; AUDIOVISUAL RECORDINGS FEATURING MUSIC AND MUSICAL BASED ENTERTAINMENT; DOWNLOADABLE MUSICAL SOUND FEATURING MUSIC AND MUSICAL ENTERTAINMENT; DOWNLOADABLE RINGTONES, GRAPHICS AND MUSIC VIA A GLOBAL COMPUTER NETWORK AND WIRELESS DEVICES (U.S. CLS. 21, 23, 26, 36 AND 38).

FIRST USE 11-22-2011; IN COMMERCE 11-22-2011.

4,165,791. RICKYJIMMY LLC, DBA R&J RECORDS, NASHVILLE, TN. SN 85-363,221. PUB. 12-27-2011, FILED 7-5-2011.

R&J RECORDS

THE MARK CONSISTS OF STANDARD CHARACTERS WITHOUT CLAIM TO ANY PARTICULAR FONT, STYLE, SIZE, OR COLOR.

NO CLAIM IS MADE TO THE EXCLUSIVE RIGHT TO USE "RECORDS", APART FROM THE MARK AS SHOWN.

FOR MUSICAL SOUND RECORDINGS; AUDIOVISUAL RECORDINGS FEATURING MUSIC AND MUSICAL BASED ENTERTAINMENT; DOWNLOADABLE MUSICAL SOUND FEATURING MUSIC AND MUSICAL ENTERTAINMENT; DOWNLOADABLE RINGTONES, GRAPHICS AND MUSIC VIA A GLOBAL COMPUTER NETWORK AND WIRELESS DEVICES (U.S. CLS. 21, 23, 26, 36 AND 38).

FIRST USE 11-22-2011; IN COMMERCE 11-22-2011.

CLASS 9—(Continued).

4,165,797. SUPPLYPRO, INC., SAN DIEGO, CA. SN 85-364,496. PUB. 11-29-2011, FILED 7-6-2011.

SUPPLY POD

THE MARK CONSISTS OF STANDARD CHARACTERS WITHOUT CLAIM TO ANY PARTICULAR FONT, STYLE, SIZE, OR COLOR.

NO CLAIM IS MADE TO THE EXCLUSIVE RIGHT TO USE "SUPPLY", APART FROM THE MARK AS SHOWN.

FOR COMPUTER HARDWARE AND SOFTWARE SYSTEMS FOR INVENTORY CONTROL AND MANAGEMENT, NAMELY, ELECTRONIC CONTROLS OR CONTROL PANEL APPLIED TO SHELVES, CABINETS OR REFRIGERATION USED TO STORE AND DISPENSE OFFICE SUPPLIES, MAINTENANCE REPAIR AND OPERATING SUPPLIES, AND MANUFACTURING ENVIRONMENT SUPPLIES; INVENTORY CONTROL SYSTEM, NAMELY, ELECTRONIC CONTROLS OR CONTROL PANEL APPLIED TO SHELVES, CABINETS OR REFRIGERATION USED TO STORE AND DISPENSE OFFICE SUPPLIES, MAINTENANCE REPAIR AND OPERATING SUPPLIES, AND MANUFACTURING ENVIRONMENT SUPPLIES (U.S. CLS. 21, 23, 26, 36 AND 38).

FIRST USE 9-0-2011; IN COMMERCE 9-0-2011.

4,165,799. OLSSON ASSOCIATES, INC., LINCOLN, NE. SN 85-365,115. PUB. 1-17-2012, FILED 7-7-2011.



NO CLAIM IS MADE TO THE EXCLUSIVE RIGHT TO USE "CENTRAL POWER", APART FROM THE MARK AS SHOWN.

THE COLOR(S) YELLOW IS/ARE CLAIMED AS A FEATURE OF THE MARK.

THE MARK CONSISTS OF THE LETTERS "CPR" IN WHITE CAPITAL LETTERS. UNDERNEATH THE LETTERS "CPR" IS A STRAIGHT YELLOW LINE THAT THEN BECOMES JAGGED TO THE RIGHT OF THE LETTERS. THE YELLOW LINE FADES TO BLACK ON EACH END. UNDERNEATH THE STRAIGHT PART OF THE YELLOW LINE ARE THE WORDS "CENTRAL POWER" IN CAPITAL LETTERS. THE BLACK BACKGROUND APPEARS AS A BACKGROUND ONLY AND IS NOT A PART OF THE MARK.

FOR FIBER OPTICS JUNCTION BOX SYSTEM FOR RESIDENTIAL USE (U.S. CLS. 21, 23, 26, 36 AND 38).

FIRST USE 10-8-2011; IN COMMERCE 12-1-2011.

CLASS 9—(Continued).

4,165,804. ARTIST GROWTH, LLC, NASHVILLE, TN. SN 85-366,694. PUB. 12-27-2011, FILED 7-8-2011.

ARTIST GROWTH

THE MARK CONSISTS OF STANDARD CHARACTERS WITHOUT CLAIM TO ANY PARTICULAR FONT, STYLE, SIZE, OR COLOR.

NO CLAIM IS MADE TO THE EXCLUSIVE RIGHT TO USE "ARTIST", APART FROM THE MARK AS SHOWN.

FOR COMPUTER APPLICATION SOFTWARE FOR MOBILE PHONES, PORTABLE COMPUTER DEVICES AND HANDHELD COMPUTERS, NAMELY, SOFTWARE FOR BUSINESS MANAGEMENT (U.S. CLS. 21, 23, 26, 36 AND 38).

FIRST USE 1-17-2012; IN COMMERCE 1-17-2012.

4,165,816. CRAM, DOUGLAS, ACWORTH, GA. SN 85-375,827. PUB. 1-3-2012, FILED 7-20-2011.



NO CLAIM IS MADE TO THE EXCLUSIVE RIGHT TO USE "TRANSPONDER AND READER ENGINEERED SYSTEMS", APART FROM THE MARK AS SHOWN.

THE COLOR(S) DARK GREEN AND GREEN IS/ARE CLAIMED AS A FEATURE OF THE MARK.

THE MARK CONSISTS OF THE STYLIZED TERM "TRES". THE TOP HALF OF "TRES" IS IN DARK GREEN AND THE BOTTOM HALF IS IN GREEN. THE GREEN PORTION CREATES A WAVE-LIKE AFFECT. ABOVE AND BELOW THE TERM "TRES" IS A DARK GREEN LINE THAT STARTS THIN AND BECOME THICKER AT THE END. UNDERNEATH THE LINE AT THE BOTTOM ARE THE STYLIZED TERMS "TRANSPONDER AND READER ENGINEERED SYSTEMS" IN DARK GREEN.

FOR RADIO FREQUENCY IDENTIFICATION (RFID) CREDENTIALS, NAMELY, CARDS AND TAGS, AND READERS FOR RADIO FREQUENCY IDENTIFICATION CREDENTIALS; RADIO FREQUENCY IDENTIFICATION (RFID) TAGS; RFID READERS (U.S. CLS. 21, 23, 26, 36 AND 38).

FIRST USE 1-0-2012; IN COMMERCE 1-0-2012.

CLASS 9—(Continued).

4,165,820. ENHANCED INFORMATION SOLUTIONS, INC., STILLWATER, MN. SN 85-377,957. PUB. 12-20-2011, FILED 7-21-2011.

OpsTrakker

THE MARK CONSISTS OF STANDARD CHARACTERS WITHOUT CLAIM TO ANY PARTICULAR FONT, STYLE, SIZE, OR COLOR.

FOR COMPUTER SOFTWARE THAT PROVIDES REAL-TIME, INTEGRATED BUSINESS MANAGEMENT INTELLIGENCE BY COMBINING INFORMATION FROM VARIOUS DATABASES AND PRESENTING IT IN AN EASY-TO-UNDERSTAND USER INTERFACE (U.S. CLS. 21, 23, 26, 36 AND 38).

FIRST USE 7-22-2010; IN COMMERCE 8-16-2011.

4,165,823. SYNQOR, INC., BOXBOROUGH, MA. SN 85-378,604. PUB. 12-20-2011, FILED 7-22-2011.



THE COLOR(S) RED, BLUE AND BLACK IS/ARE CLAIMED AS A FEATURE OF THE MARK.

THE MARK CONSISTS OF A DESIGN OF A STYLIZED TRAIN IN THE COLOR RED WITH THE WORD "RAIL" IN BLUE INSIDE THE TRAIN DESIGN; THE LETTERS "Q", "O", AND "R" APPEAR TO THE RIGHT OF THE DESIGN. THE TRAPEZOIDAL TAIL ON THE LETTER "Q" IS RED AND THE REMINDER OF THE LETTER "Q" AND THE LETTERS "O" AND "R" ARE BLACK.

FOR ISOLATED DIRECT CURRENT TO DIRECT CURRENT POWER CONVERTERS (U.S. CLS. 21, 23, 26, 36 AND 38).

FIRST USE 9-14-2011; IN COMMERCE 9-14-2011.

4,165,835. MARPAC LLC, ROCKY POINT, NC. SN 85-386,053. PUB. 1-24-2012, FILED 8-1-2011.

DOHM

THE MARK CONSISTS OF STANDARD CHARACTERS WITHOUT CLAIM TO ANY PARTICULAR FONT, STYLE, SIZE, OR COLOR.

FOR SOUND CONDITIONERS, NAMELY, ELECTRONIC SOLID STATE PLAYERS FOR PLAYING PRE-RECORDED NATURAL AND ENVIRONMENTAL SOUNDS (U.S. CLS. 21, 23, 26, 36 AND 38).

FIRST USE 11-11-2011; IN COMMERCE 11-11-2011.

CLASS 9—(Continued).

4,165,849. PRIME SOURCE CAPITAL, INC., MONTECITO, CA. SN 85-392,603. PUB. 1-24-2012, FILED 8-8-2011.

AquaSync

THE MARK CONSISTS OF STANDARD CHARACTERS WITHOUT CLAIM TO ANY PARTICULAR FONT, STYLE, SIZE, OR COLOR.

FOR COMPUTER HARDWARE AND SOFTWARE SYSTEMS FOR REMOTELY CONTROLLING SWIMMING POOL FUNCTIONS (U.S. CLS. 21, 23, 26, 36 AND 38).

FIRST USE 4-7-2012; IN COMMERCE 4-7-2012.

4,165,850. PRIME SOURCE CAPITAL, INC., MONTECITO, CA. SN 85-392,609. PUB. 1-24-2012, FILED 8-8-2011.

TotalSync

THE MARK CONSISTS OF STANDARD CHARACTERS WITHOUT CLAIM TO ANY PARTICULAR FONT, STYLE, SIZE, OR COLOR.

FOR COMPUTER APPLICATION SOFTWARE FOR MOBILE PHONES, PORTABLE MEDIA PLAYERS AND HANDHELD COMPUTERS, NAMELY, SOFTWARE FOR AUTOMATION SYSTEMS ALLOWING USERS TO REMOTELY CONTROL FUNCTIONS OF THEIR HOME LIGHTING AND SECURITY (U.S. CLS. 21, 23, 26, 36 AND 38).

FIRST USE 4-7-2012; IN COMMERCE 4-7-2012.

CLASS 9—(Continued).

4,165,866. LEE, HAROLD D. C/O., DBA JENIX, SAN ANTONIO, TX. SN 85-400,207. PUB. 2-7-2012, FILED 8-17-2011.

JeNIX

THE MARK CONSISTS OF STANDARD CHARACTERS WITHOUT CLAIM TO ANY PARTICULAR FONT, STYLE, SIZE, OR COLOR.

FOR COMPUTER SOFTWARE DEVELOPMENT TOOLS FOR NETWORKING, BUILDING NETWORKING APPLICATIONS AND FOR ALLOWING DATA RETRIEVAL, UPLOAD, ACCESS, AND MANAGEMENT; APPLICATION PROGRAMMING INTERFACE (API), NAMELY, COMPUTER NETWORK INTERFACE DEVICES FOR USE WITH THIRD-PARTY SOFTWARE AND FOR USE WITH ONLINE SERVICES FOR NETWORKING APPLICATIONS AND FOR ALLOWING DATA RETRIEVAL, UPLOAD, ACCESS AND MANAGEMENT; SOFTWARE TO ENABLE UPLOADING, DOWNLOADING, ACCESSING, POSTING, SHOWING, DISPLAYING, TAGGING, BLOGGING, STREAMING, LINKING, SHARING OR OTHERWISE PROVIDING ELECTRONIC MEDIA OR INFORMATION OVER THE INTERNET, COMMUNICATIONS NETWORKS AND COMPUTERS (U.S. CLS. 21, 23, 26, 36 AND 38).

FIRST USE 8-8-2011; IN COMMERCE 8-18-2011.

4,165,871. IGT, RENO, NV. SN 85-401,824. PUB. 1-17-2012, FILED 8-18-2011.

WIN ZEROS!

THE MARK CONSISTS OF STANDARD CHARACTERS WITHOUT CLAIM TO ANY PARTICULAR FONT, STYLE, SIZE, OR COLOR.

FOR GAMING MACHINES, NAMELY, DEVICES WHICH ACCEPT A WAGER (U.S. CLS. 21, 23, 26, 36 AND 38).

FIRST USE 2-22-2012; IN COMMERCE 2-27-2012.

4,165,886. STYLEMARK, INC., SMITHFIELD, RI. SN 85-411,421. PUB. 2-14-2012, FILED 8-31-2011.

DESIGNER ELEMENTS

THE MARK CONSISTS OF STANDARD CHARACTERS WITHOUT CLAIM TO ANY PARTICULAR FONT, STYLE, SIZE, OR COLOR.

OWNER OF U.S. REG. NO. 3,113,092.

CLASS 9—(Continued).

NO CLAIM IS MADE TO THE EXCLUSIVE RIGHT TO USE "DESIGNER", APART FROM THE MARK AS SHOWN.
FOR EYEGLASSES; READING GLASSES; SUNGLASSES (U.S. CLS. 21, 23, 26, 36 AND 38).
FIRST USE 1-0-2009; IN COMMERCE 1-0-2009.

4,165,895. JOHN MEZZALINGUA ASSOCIATES, INC., DBA PPC, EAST SYRACUSE, NY. SN 85-425,071. PUB. 2-14-2012, FILED 9-16-2011.

UXP

THE MARK CONSISTS OF STANDARD CHARACTERS WITHOUT CLAIM TO ANY PARTICULAR FONT, STYLE, SIZE, OR COLOR.
FOR CABLE CONNECTORS (U.S. CLS. 21, 23, 26, 36 AND 38).
FIRST USE 12-5-2011; IN COMMERCE 12-5-2011.

4,165,927. AT&T INTELLECTUAL PROPERTY II, L.P., RENO, NV. SN 85-976,681. PUB. 8-16-2011, FILED 3-31-2011.

JUSTUS

THE MARK CONSISTS OF STANDARD CHARACTERS WITHOUT CLAIM TO ANY PARTICULAR FONT, STYLE, SIZE, OR COLOR.
FOR COMPUTER SOFTWARE OFFERED AS A FEATURE OF MOBILE COMMUNICATIONS DEVICES TO BROWSE OR ACCESS TEXT AND MULTIMEDIA MESSAGES, PHOTOS AND SOCIAL MEDIA POSTS (U.S. CLS. 21, 23, 26, 36 AND 38).
FIRST USE 5-4-2011; IN COMMERCE 5-4-2011.

4,165,928. DISNEY ENTERPRISES, INC., BURBANK, CA. SN 85-976,682. PUB. 9-6-2011, FILED 6-21-2010.

PHINEAS AND FERB

THE MARK CONSISTS OF STANDARD CHARACTERS WITHOUT CLAIM TO ANY PARTICULAR FONT, STYLE, SIZE, OR COLOR.

CLASS 9—(Continued).

OWNER OF U.S. REG. NOS. 3,578,149 AND 3,610,415.
FOR AUDIO RECORDINGS FEATURING PROGRAMMING FOR CHILDREN AND TEENS; VIDEO RECORDINGS FEATURING PROGRAMMING FOR CHILDREN AND TEENS; AUDIO AND VISUAL RECORDINGS IN ALL MEDIA FEATURING PROGRAMMING FOR CHILDREN AND TEENS; VIDEO GAME CARTRIDGES, DISCS AND SOFTWARE; CONSUMER ELECTRONICS AND ACCESSORIES THEREFOR, NAMELY, CAMERAS, COMPACT DISC PLAYERS, DIGITAL CAMERAS, HEADPHONES, KARAOKE MACHINES, MOUSE PADS, RADIOS, WALKIE-TALKIES; SUNGLASSES; DECORATIVE REFRIGERATOR MAGNETS; HAND-HELD UNITS FOR PLAYING ELECTRONIC GAMES FOR USE WITH AN EXTERNAL DISPLAY SCREEN OR MONITOR (U.S. CLS. 21, 23, 26, 36 AND 38).
FIRST USE 10-1-2011; IN COMMERCE 10-1-2011.

4,165,934. MASTER LOCK COMPANY LLC, OAK CREEK, WI. SN 85-976,722. PUB. 8-23-2011, FILED 6-8-2010.

MASTER LOCK

THE MARK CONSISTS OF STANDARD CHARACTERS WITHOUT CLAIM TO ANY PARTICULAR FONT, STYLE, SIZE, OR COLOR.

OWNER OF U.S. REG. NOS. 230,311 AND 1,643,334.
NO CLAIM IS MADE TO THE EXCLUSIVE RIGHT TO USE "LOCK", APART FROM THE MARK AS SHOWN.

FOR ELECTRIC, ELECTRONIC AND ELECTRO-MECHANICAL SECURITY DEVICES FOR DOORS, NAMELY, DOOR OPENERS, DOOR CLOSERS, DOOR LOCKS, INTELLIGENT ACCESS CONTROLS, LOCKING AND UNLOCKING CONTROLS; SOLENOID LOCKS; AUDIBLE SIGNAL SENSING DOOR LOCKS; AUDIBLE SIGNAL GENERATION KEYS AND KEY PARTS; ELECTRIC DOOR OPENERS AND DOOR CLOSERS AND REPLACEMENT AND COMPONENT PARTS THEREFOR; ACCESS CONTROL AND ALARM MONITORING SYSTEMS; ELECTRONIC AND ELECTRIC CODE LOCKS, NAMELY, CODE LOCKS WITH KEYPADS, ELECTRONIC CODE LOCK WITH CONTACT FREE READERS, ENCODED ELECTRONIC CHIP; ELECTRIC LOCKS ACTUATED BY A TIMER OR WEB-BASED ACCESS CONTROL DEVICES; PUSH BUTTON ELECTRONIC CODED SWITCHES; COMPUTER SOFTWARE FOR FACILITY ACCESS CONTROL; SECURITY ALARM MONITORING AND COMPUTER HARDWARE ASSOCIATED THEREWITH; ELECTRONIC KEYS, CARD READERS AND READER MODULES; ALL OF THE ABOVE EXCLUDING GARAGE DOOR OPENERS, COMMERCIAL DOOR OPERATORS FOR OVERHEAD ROLLING DOORS OR GATE OPERATORS (U.S. CLS. 21, 23, 26, 36 AND 38).

FIRST USE 11-0-2010; IN COMMERCE 11-0-2010.

CLASS 9—(Continued).

4,165,941. CIPHERCLOUD, INC., SAN JOSE, CA. SN 85-976,766. PUB. 12-20-2011, FILED 1-13-2011.

CIPHERCLOUD

THE MARK CONSISTS OF STANDARD CHARACTERS WITHOUT CLAIM TO ANY PARTICULAR FONT, STYLE, SIZE, OR COLOR.

FOR COMPUTER SOFTWARE OPERATING AS A GATEWAY IN A COMPUTER NETWORK; COMPUTER SOFTWARE OPERATING AS A GATEWAY AND PROVIDING DATA SECURITY, AND RISK MANAGEMENT FOR DATA TRANSMITTED OVER A COMPUTER NETWORK (U.S. CLS. 21, 23, 26, 36 AND 38).
FIRST USE 4-1-2011; IN COMMERCE 4-0-2011.

CLASS 10—MEDICAL APPARATUS

4,164,965. HARBINGER MEDICAL GROUP, LLC, MARBLEHEAD, MA. SN 77-909,898. PUB. 8-17-2010, FILED 1-12-2010.

TIDES MEDICAL

THE MARK CONSISTS OF STANDARD CHARACTERS WITHOUT CLAIM TO ANY PARTICULAR FONT, STYLE, SIZE, OR COLOR.

NO CLAIM IS MADE TO THE EXCLUSIVE RIGHT TO USE "MEDICAL", APART FROM THE MARK AS SHOWN.

FOR MEDICAL APPARATUS, NAMELY, ORTHOPEDIC HIP, KNEE AND OTHER JOINT IMPLANTS; AND RELATED DEVICES, NAMELY, CEMENTED, CEMENTLESS, AND HYBRID HIP AND KNEE JOINT IMPLANTS; METALLIC, CERAMIC, PLASTIC, AND COMPOSITE JOINT IMPLANTS; MOVING AND ROTATIONAL JOINT IMPLANTS; AND ARTIFICIAL JOINTS (U.S. CLS. 26, 39 AND 44).
FIRST USE 12-16-2010; IN COMMERCE 1-25-2011.

4,164,980. FUJIFILM CORPORATION, TOKYO, JAPAN. SN 77-946,034. PUB. 3-1-2011, FILED 2-26-2010.

SONART

THE MARK CONSISTS OF STANDARD CHARACTERS WITHOUT CLAIM TO ANY PARTICULAR FONT, STYLE, SIZE, OR COLOR.

CLASS 10—(Continued).

PRIORITY CLAIMED UNDER SEC. 44(D) ON JAPAN APPLICATION NO. 2009-095157, FILED 12-16-2009, REG. NO. 5330864, DATED 6-18-2010, EXPIRES 6-18-2020.

FOR MEDICAL ENDOSCOPES; ENDOSCOPIC EQUIPMENT; FORCEPS FOR ENDOSCOPIC BIOPSIES; EQUIPMENT FOR ENDOSCOPIC EXAMINATIONS, SURGICAL ENDOSCOPES; MEDICAL ULTRASOUND DIAGNOSTIC EQUIPMENT; MEDICAL DIAGNOSTIC DEVICES IN THE NATURE OF ULTRASOUND DIAGNOSTIC APPARATUS CONTAINING COMPUTER SOFTWARE, COMPUTER DISPLAY DEVICES, COMPUTER HARDWARE, AND ENDOSCOPES FOR MEDICAL ULTRASOUND IMAGE PROCESSING, ALL SOLD TOGETHER THEREWITH AS A UNIT (U.S. CLS. 26, 39 AND 44).
FIRST USE 11-16-2011; IN COMMERCE 11-16-2011.

4,164,988. EMERALD TOUCH INC., KELLER, TX. SN 77-956,931. PUB. 2-22-2011, FILED 3-11-2010.

INTEGRATED SUPPORT EXOSPINE

THE MARK CONSISTS OF STANDARD CHARACTERS WITHOUT CLAIM TO ANY PARTICULAR FONT, STYLE, SIZE, OR COLOR.

NO CLAIM IS MADE TO THE EXCLUSIVE RIGHT TO USE "INTEGRATED SUPPORT", APART FROM THE MARK AS SHOWN.

FOR BODY SUPPORT DEVICE FOR MEDICAL PURPOSES, NAMELY, AN EXOSKELETAL DEVICE THAT TRANSFERS BACK AND SHOULDER LOADINGS TO OTHER PARTS OF THE BODY (U.S. CLS. 26, 39 AND 44).
FIRST USE 11-11-2011; IN COMMERCE 11-11-2011.

4,164,989. EMERALD TOUCH INC., KELLER, TX. SN 77-957,019. PUB. 2-22-2011, FILED 3-11-2010.

ISE

THE MARK CONSISTS OF STANDARD CHARACTERS WITHOUT CLAIM TO ANY PARTICULAR FONT, STYLE, SIZE, OR COLOR.

FOR BODY SUPPORT DEVICE FOR MEDICAL PURPOSES, NAMELY, AN EXOSKELETAL DEVICE THAT TRANSFERS BACK AND SHOULDER LOADINGS TO OTHER PARTS OF THE BODY (U.S. CLS. 26, 39 AND 44).
FIRST USE 11-11-2011; IN COMMERCE 11-11-2011.

CLASS 10—(Continued).

4,165,000. MAMADOC, MASON, OH. SN 77-964,788. PUB. 10-5-2010, FILED 3-22-2010.

NOX

THE MARK CONSISTS OF STANDARD CHARACTERS WITHOUT CLAIM TO ANY PARTICULAR FONT, STYLE, SIZE, OR COLOR.

FOR A MATERNITY BRA IN THE NATURE OF A COMPRESSION GARMENT DESIGNED TO HELP STOP LACTATION AND PAIN ASSOCIATED WITH IT, FOR THERAPEUTIC AND MEDICAL PURPOSES (U.S. CLS. 26, 39 AND 44).

FIRST USE 1-24-2011; IN COMMERCE 1-24-2011.

4,165,020. ACUMED LLC, HILLSBORO, OR. SN 78-639,141. PUB. 1-31-2012, FILED 5-27-2005.

BIOTRAK

THE MARK CONSISTS OF STANDARD CHARACTERS WITHOUT CLAIM TO ANY PARTICULAR FONT, STYLE, SIZE, OR COLOR.

FOR ORTHOPEDIC FASTENING DEVICES FOR USE IN THE SURGICAL REPAIR OF BONES AND JOINTS, NAMELY, SCREWS, PINS AND WIRES; MEDICAL INSTRUMENTS AND OTHER MATERIALS FOR SURGICALLY INSTALLING AND REMOVING FASTENING DEVICES, NAMELY, RADIOGRAPH TEMPLATES, DEPTH GAUGES, DRILL GUIDES, CANNULAS, PILOT WIRES, SAWS, DRILLS AND DRIVERS; KITS COMPRISING COLLECTIONS OF ORTHOPEDIC SURGICAL SCREWS, PINS AND WIRES AND MEDICAL INSTRUMENTS FOR SURGICALLY INSTALLING AND REMOVING SURGICAL ORTHOPEDIC FASTENING DEVICES (U.S. CLS. 26, 39 AND 44).

FIRST USE 2-0-2009; IN COMMERCE 2-0-2009.

CLASS 10—(Continued).

4,165,047. WRIGHT MEDICAL TECHNOLOGY, INC., ARLINGTON, TN. SN 85-014,962. PUB. 9-14-2010, FILED 4-15-2010.

PRO-TOE

THE MARK CONSISTS OF STANDARD CHARACTERS WITHOUT CLAIM TO ANY PARTICULAR FONT, STYLE, SIZE, OR COLOR.

FOR MEDICAL APPARATUS, NAMELY, AN ORTHOPEDIC IMPLANT COMPRISING ARTIFICIAL MATERIAL FOR TREATMENT OF HAMMER TOES (U.S. CLS. 26, 39 AND 44).

FIRST USE 10-31-2010; IN COMMERCE 10-31-2010.

4,165,058. PAN-OSTON CO., BOWLING GREEN, KY. SN 85-024,211. PUB. 9-28-2010, FILED 4-27-2010.

SHOP HEAR

THE MARK CONSISTS OF STANDARD CHARACTERS WITHOUT CLAIM TO ANY PARTICULAR FONT, STYLE, SIZE, OR COLOR.

FOR ASSISTIVE LISTENING DEVICE KITS FOR ELIMINATION OF BACKGROUND NOISE AND FACILITATION OF PRIVATE COMMUNICATION BETWEEN CUSTOMERS WITH HEARING AIDS AND COUNTER ATTENDANTS IN RETAIL STORES (U.S. CLS. 26, 39 AND 44).

FIRST USE 5-12-2009; IN COMMERCE 10-10-2011.

4,165,071. PIPEDREAM PRODUCTS, INC., CHATSWORTH, CA. SN 85-037,031. PUB. 10-26-2010, FILED 5-12-2010.

FETISH FANTASY ELITE

THE MARK CONSISTS OF STANDARD CHARACTERS WITHOUT CLAIM TO ANY PARTICULAR FONT, STYLE, SIZE, OR COLOR.

OWNER OF U.S. REG. NO. 3,556,369.

NO CLAIM IS MADE TO THE EXCLUSIVE RIGHT TO USE "FETISH", APART FROM THE MARK AS SHOWN.

FOR ADULT SEXUAL STIMULATION AIDS, NAMELY, ARTIFICIAL PENISES, VIBRATORS, PLUGS FOR INSERTION INTO BODY CAVITIES, TICKLERS, PADDLES, NIPPLE CLIPS, PACIFIERS AND GAGS COMPRISED PRIMARILY OF LATEX OR NEOPRENE (U.S. CLS. 26, 39 AND 44).

FIRST USE 9-30-2011; IN COMMERCE 9-30-2011.

CLASS 10—(Continued).

4,165,145. ARMADILLO BIOMEDICAL LLC, ENCINO, CA. SN 85-111,789. PUB. 2-7-2012, FILED 8-19-2010.

DacryoCath

THE MARK CONSISTS OF STANDARD CHARACTERS WITHOUT CLAIM TO ANY PARTICULAR FONT, STYLE, SIZE, OR COLOR.

FOR BALLOON CATHETERS FOR USE IN THE LACRIMAL SYSTEM (U.S. CLS. 26, 39 AND 44).
FIRST USE 3-25-2012; IN COMMERCE 3-25-2012.

4,165,215. ARMADILLO BIOMEDICAL, ENCINO, CA. SN 85-133,436. PUB. 3-8-2011, FILED 9-20-2010.



NO CLAIM IS MADE TO THE EXCLUSIVE RIGHT TO USE "BIOMEDICAL", APART FROM THE MARK AS SHOWN.

THE MARK CONSISTS OF AN ARMADILLO AND THE WORDS "ARMADILLO BIOMEDICAL".

FOR MEDICAL DEVICES, NAMELY, BALLOON CATHETERS, STENTS, AND SYRINGES (U.S. CLS. 26, 39 AND 44).

FIRST USE 3-25-2012; IN COMMERCE 3-25-2012.

4,165,266. NOVARTIS AG, BASEL, SWITZERLAND. SN 85-152,387. PUB. 3-22-2011, FILED 10-14-2010.



OWNER OF U.S. REG. NO. 3,669,632.
THE MARK CONSISTS OF A STYLIZED BIRD.
FOR MEDICAL APPARATUS FOR DIAGNOSING OR TREATING RESPIRATORY CONDITIONS; MEDICAL APPARATUS FOR FACILITATING THE INHALATION OF PHARMACEUTICAL PREPARATIONS (U.S. CLS. 26, 39 AND 44).

FIRST USE 3-19-2012; IN COMMERCE 3-19-2012.

CLASS 10—(Continued).

4,165,285. CROSSTEX INTERNATIONAL, INC., HAUPPAUGE, NY. SN 85-160,257. PUB. 5-17-2011, FILED 10-25-2010.

ULTRA PURE

THE MARK CONSISTS OF STANDARD CHARACTERS WITHOUT CLAIM TO ANY PARTICULAR FONT, STYLE, SIZE, OR COLOR.

FOR SPONGES FOR MEDICAL AND DENTAL PLACEMENT ON INCISION AND EXTRACTION SITES (U.S. CLS. 26, 39 AND 44).

FIRST USE 12-31-2011; IN COMMERCE 12-31-2011.

4,165,332. NUVASIVE, INC., SAN DIEGO, CA. SN 85-183,697. PUB. 2-22-2011, FILED 11-23-2010.

BENDINI

THE MARK CONSISTS OF STANDARD CHARACTERS WITHOUT CLAIM TO ANY PARTICULAR FONT, STYLE, SIZE, OR COLOR.

FOR MEDICAL APPARATUS AND INSTRUMENTS FOR USE IN SURGERY (U.S. CLS. 26, 39 AND 44).

FIRST USE 2-17-2012; IN COMMERCE 2-17-2012.

4,165,359. SAFE-T-SLEEVE, LLC, LAS VEGAS, NV. SN 85-200,128. PUB. 9-6-2011, FILED 12-16-2010.



NO CLAIM IS MADE TO THE EXCLUSIVE RIGHT TO USE "SAFETY SLEEVE", APART FROM THE MARK AS SHOWN.

THE COLOR(S) BLUE, RED, AND WHITE IS/ARE CLAIMED AS A FEATURE OF THE MARK.

CLASS 10—(Continued).

THE MARK CONSISTS OF A LARGE BLUE SCRIPT "S" WITH THE BLUE LETTERS "AFE" AND "LEEVE" ADJACENT THERETO, WITH A BLUE "." AND RED "T" AFTER THE "AFE" LETTERS AND AN ANTHROPOMORPHIC RED DROP WITH WHITE MOUTH AND EYES LOCATED WITHIN THE LOWER SWIRL OF THE SCRIPT "S".

FOR MEDICAL APPARATUS, NAMELY, PROTECTIVE AND ABSORBENT OVERLYING OUTER BANDAGE IN THE NATURE OF A SLEEVE FOR VASCULAR ACCESS FISTULAS AND GRAFTS (U.S. CLS. 26, 39 AND 44).

FIRST USE 3-12-2012; IN COMMERCE 3-12-2012.

4,165,453. TAMI L. FEATHERSTON, GRAIN VALLEY, MO. SN 85-250,783. PUB. 7-5-2011, FILED 2-24-2011.

JUST-TITE

THE MARK CONSISTS OF STANDARD CHARACTERS WITHOUT CLAIM TO ANY PARTICULAR FONT, STYLE, SIZE, OR COLOR.

FOR MEDICAL APPARATUS, NAMELY, VENTILATOR TUBING CONNECTOR APPARATUS (U.S. CLS. 26, 39 AND 44).

FIRST USE 12-20-2011; IN COMMERCE 12-20-2011.

4,165,688. AVANTECH, INC., NAPLES, FL. SN 85-307,549. PUB. 2-14-2012, FILED 4-28-2011.

CPR RSQ ASSIST

THE MARK CONSISTS OF STANDARD CHARACTERS WITHOUT CLAIM TO ANY PARTICULAR FONT, STYLE, SIZE, OR COLOR.

NO CLAIM IS MADE TO THE EXCLUSIVE RIGHT TO USE "CPR", APART FROM THE MARK AS SHOWN.

FOR MEDICAL DEVICE FOR USE IN CARDIOPULMONARY RESUSCITATION (CPR) (U.S. CLS. 26, 39 AND 44).

FIRST USE 3-15-2012; IN COMMERCE 3-15-2012.

CLASS 10—(Continued).

4,165,832. CONVERTER LAB, MIAMI BEACH, FL. SN 85-384,602. PUB. 1-17-2012, FILED 7-29-2011.



THE MARK CONSISTS OF A CROSS WITH A HUMAN BODY SILHOUETTE WITH HANDS UP, ABOVE THE CROSS IS A WANING CRESCENT MOON, AND BELOW THE IMAGE IS THE TEXT "SIZEDOCTOR".

FOR ADULT SEXUAL STIMULATION AIDS, NAMELY, PENIS ENLARGERS (U.S. CLS. 26, 39 AND 44).

FIRST USE 2-1-2010; IN COMMERCE 2-1-2010.

CLASS 11—ENVIRONMENTAL CONTROL APPARATUS

4,164,919. JO MALONE INC., NEW YORK, NY. SN 77-829,600. PUB. 2-16-2010, FILED 9-18-2009.

SCENT SURROUND

THE MARK CONSISTS OF STANDARD CHARACTERS WITHOUT CLAIM TO ANY PARTICULAR FONT, STYLE, SIZE, OR COLOR.

OWNER OF U.S. REG. NO. 3,505,896.

NO CLAIM IS MADE TO THE EXCLUSIVE RIGHT TO USE "SCENT", APART FROM THE MARK AS SHOWN.

FOR DIFFUSERS FOR EMITTING SCENT (U.S. CLS. 13, 21, 23, 31 AND 34).

FIRST USE 4-30-2012; IN COMMERCE 4-30-2012.

4,164,974. AIR SYSTEM COMPONENTS, INC., RICHARDSON, TX. SN 77-936,938. PUB. 2-22-2011, FILED 2-16-2010.

MISTER-MINI

THE MARK CONSISTS OF STANDARD CHARACTERS WITHOUT CLAIM TO ANY PARTICULAR FONT, STYLE, SIZE, OR COLOR.

FOR HUMIDIFIER WITH BUILT-IN TEMPERATURE SWITCH FOR RESIDENTIAL USE (U.S. CLS. 13, 21, 23, 31 AND 34).

FIRST USE 9-28-2011; IN COMMERCE 9-28-2011.

CLASS 11—(Continued).

4,165,096. MODINE MANUFACTURING COMPANY, RACINE, WI. SN 85-078,836. PUB. 2-22-2011, FILED 7-6-2010.



OWNER OF U.S. REG. NO. 1,471,356.
 THE MARK CONSISTS OF THE LETTERS "PF" WITH AN UPSIDE DOWN SWOOSH MARK GOING FROM LEFT TO RIGHT ABOVE THE LETTERS "PF" AND A UPRIGHT SWOOSH MARK GOING FROM RIGHT TO LEFT UNDER THE LETTERS "PF".
 FOR HEAT EXCHANGERS NOT BEING PARTS OF MACHINES, NAMELY, CONDENSERS, HEATER CORES, RADIATORS, WATER COILS, EVAPORATORS, OIL AND GAS COOLERS FOR RESIDENTIAL AND COMMERCIAL AIR CONDITIONERS, DEHUMIDIFIERS, AND REFRIGERATION SYSTEMS; HEAT EXCHANGERS BEING PARTS OF AIR CONDITIONING SYSTEMS FOR VEHICLES, NAMELY, CONDENSERS AND EVAPORATORS; PARTS FOR HEATING AND AIR CONDITIONING SYSTEMS, NAMELY, HEATER CORES, RADIATORS AND OIL AND GAS COOLERS FOR VEHICLES (U.S. CLS. 13, 21, 23, 31 AND 34).
 FIRST USE 9-13-2011; IN COMMERCE 9-13-2011.

CLASS 11—(Continued).

4,165,528. PBM CAPITAL, LLC, DBA PLATINUM BRANDS, LAGUNA NIGUEL, CA. SN 85-273,145. PUB. 8-30-2011, FILED 3-22-2011.

Platinum Brands

THE MARK CONSISTS OF STANDARD CHARACTERS WITHOUT CLAIM TO ANY PARTICULAR FONT, STYLE, SIZE, OR COLOR.
 NO CLAIM IS MADE TO THE EXCLUSIVE RIGHT TO USE "BRANDS", APART FROM THE MARK AS SHOWN.
 FOR ELECTRIC LIGHTING FIXTURES; LED LIGHTING FIXTURES FOR INDOOR AND OUTDOOR LIGHTING APPLICATIONS; LED LIGHTS FOR STRINGS, FLOWERS, BRANCHES AND OTHER ORNAMENTAL DECORATIONS; LIGHTED PARTY-THEMED DECORATIONS, ELECTRIC LIGHT DECORATIVE STRINGS; LIGHTING FIXTURES; SOLAR LIGHT FIXTURES, NAMELY, INDOOR AND OUTDOOR SOLAR POWERED LIGHTING UNITS AND FIXTURES (U.S. CLS. 13, 21, 23, 31 AND 34).
 FIRST USE 1-1-2012; IN COMMERCE 1-1-2012.

4,165,549. HEALTHY FOODS, LLC, CLEVELAND, OH. SN 85-275,892. PUB. 8-9-2011, FILED 3-24-2011.

4,165,155. MAN-D-TEC, INC., SCOTTSDALE, AZ. SN 85-116,478. PUB. 2-8-2011, FILED 8-26-2010.

ELEVATING LIGHTING

THE MARK CONSISTS OF STANDARD CHARACTERS WITHOUT CLAIM TO ANY PARTICULAR FONT, STYLE, SIZE, OR COLOR.
 NO CLAIM IS MADE TO THE EXCLUSIVE RIGHT TO USE "LIGHTING", APART FROM THE MARK AS SHOWN.
 FOR ELEVATOR LIGHT FIXTURES (U.S. CLS. 13, 21, 23, 31 AND 34).
 FIRST USE 11-15-2010; IN COMMERCE 11-15-2010.



THE MARK CONSISTS OF SWIRL DESIGN WITHOUT CLAIM OF COLOR OR COLORS AS FEATURE OF THE MARK.
 FOR FROZEN DESSERT DISPENSER (U.S. CLS. 13, 21, 23, 31 AND 34).
 FIRST USE 5-2-2011; IN COMMERCE 5-2-2011.

CLASS 11—(Continued).

4,165,592. STINGRAY SYSTEMS, LLC, INDIANAPOLIS, IN. SN 85-283,444. PUB. 8-9-2011, FILED 4-1-2011.

CHILL LAB BY STINGRAY

THE MARK CONSISTS OF STANDARD CHARACTERS WITHOUT CLAIM TO ANY PARTICULAR FONT, STYLE, SIZE, OR COLOR.

NO CLAIM IS MADE TO THE EXCLUSIVE RIGHT TO USE "CHILL", APART FROM THE MARK AS SHOWN.

FOR WATER FOUNTAINS AND PARTS THEREOF; REFRIGERATION EQUIPMENT, NAMELY, FOOD AND BEVERAGE CHILLING UNITS, AND PARTS THEREOF (U.S. CLS. 13, 21, 23, 31 AND 34).

FIRST USE 4-0-2011; IN COMMERCE 4-0-2011.

4,165,715. BESTDISC TECHNOLOGY CORP., KEELUNG, TAIWAN. SN 85-321,894. PUB. 10-11-2011, FILED 5-16-2011.

BESTDELIGHT

THE MARK CONSISTS OF STANDARD CHARACTERS WITHOUT CLAIM TO ANY PARTICULAR FONT, STYLE, SIZE, OR COLOR.

FOR BICYCLE LIGHTS; BURNERS FOR LAMPS; CEILING LIGHTS; ELECTRIC DISCHARGE TUBES FOR LIGHTING; ELECTRIC LAMPS; ELECTRIC LIGHT BULBS; ELECTRIC LIGHTS FOR CHRISTMAS TREES; ELECTRIC TORCHES FOR LIGHTING; FLARES; FLASHLIGHTS; GLOBES FOR LAMPS; HEADLIGHTS FOR VEHICLES; LAMP MANTLES; LAMP REFLECTORS; LAMP SHADES; LAMPS; LAMP SHADE HOLDERS; LIGHT BULBS; LIGHT DIFFUSERS; LIGHT FOR VEHICLES; LIGHTING APPARATUS FOR VEHICLES; LIGHTING APPARATUS, NAMELY, LIGHTING INSTALLATIONS; LIGHTING FIXTURES; LUMINOUS HOUSE NUMBERS; POCKET SEARCH LIGHTS; PROJECTOR LAMPS; STREET LAMPS (U.S. CLS. 13, 21, 23, 31 AND 34).

FIRST USE 12-8-2011; IN COMMERCE 12-8-2011.

CLASS 11—(Continued).

4,165,728. SUNBEAM PRODUCTS, INC., BOCA RATON, FL. SN 85-330,652. PUB. 8-16-2011, FILED 5-26-2011.



THE MARK CONSISTS OF THE LITERAL ELEMENT "OSTER" WITH A FOUR POINT STAR POSITIONED CENTRALLY WITHIN THE "O" AND HAVING A ONE STAR POINT EXTENDING Laterally OUTWARD INTO THE LETTER "S" OF THE LITERAL ELEMENT.

FOR ELECTRIC PRESSURE COOKERS (U.S. CLS. 13, 21, 23, 31 AND 34).

FIRST USE 8-31-2011; IN COMMERCE 8-31-2011.

4,165,732. BE AEROSPACE, INC., WELLINGTON, FL. SN 85-331,498. PUB. 10-25-2011, FILED 5-26-2011.

ESSENCE

THE MARK CONSISTS OF STANDARD CHARACTERS WITHOUT CLAIM TO ANY PARTICULAR FONT, STYLE, SIZE, OR COLOR.

FOR AIRPLANE GALLERY EQUIPMENT, NAMELY, ELECTRIC FOOD AND BEVERAGE PREPARATION UNITS, NAMELY, COOKING OVENS, COFFEE MAKERS, HOT WATER DISPENSERS; FOOD AND BEVERAGE CHILLING UNITS, NAMELY, REFRIGERATORS, FREEZERS AND BEVERAGE DISPENSERS; AND FOOD AND BEVERAGE HEATING UNITS (U.S. CLS. 13, 21, 23, 31 AND 34).

FIRST USE 2-2-2012; IN COMMERCE 2-2-2012.

4,165,764. IVALO LIGHTING INC., COOPERSBURG, PA. SN 85-350,525. PUB. 1-24-2012, FILED 6-20-2011.

FINIRÉ

THE MARK CONSISTS OF STANDARD CHARACTERS WITHOUT CLAIM TO ANY PARTICULAR FONT, STYLE, SIZE, OR COLOR.

THE ENGLISH TRANSLATION OF "FINIRE" IN THE MARK IS "FINISH".

FOR ELECTRIC LIGHTING FIXTURES (U.S. CLS. 13, 21, 23, 31 AND 34).

FIRST USE 7-27-2011; IN COMMERCE 7-27-2011.

CLASS 11—(Continued).

4,165,817. MAAX SPAS INDUSTRIES CORP., CHANDLER, AZ. SN 85-375,932. PUB. 1-24-2012, FILED 7-20-2011.

LIFESTYLE SPAS

THE MARK CONSISTS OF STANDARD CHARACTERS WITHOUT CLAIM TO ANY PARTICULAR FONT, STYLE, SIZE, OR COLOR.

NO CLAIM IS MADE TO THE EXCLUSIVE RIGHT TO USE "SPAS", APART FROM THE MARK AS SHOWN, FOR HOT TUBS; SPAS IN THE NATURE OF HEATED POOLS (U.S. CLS. 13, 21, 23, 31 AND 34).

FIRST USE 8-0-2011; IN COMMERCE 8-0-2011.

4,165,857. MODINE MANUFACTURING COMPANY, RACINE, WI. SN 85-396,321. PUB. 2-14-2012, FILED 8-12-2011.



THE MARK CONSISTS OF A STYLIZED "X" TO THE LEFT OF THE WORD "ATHERION".

THE WORD "ATHERION" HAS NO MEANING IN A FOREIGN LANGUAGE.

FOR ROOFTOP VENTILATION UNITS USED TO FILTER, HEAT, COOL, OR DEHUMIDIFY AIR FOR COMMERCIAL OR INDUSTRIAL USE (U.S. CLS. 13, 21, 23, 31 AND 34).

FIRST USE 6-0-2011; IN COMMERCE 9-0-2011.

4,165,873. WHIRLPOOL PROPERTIES, INC. ST. JOSEPH, MI. SN 85-402,401. PUB. 2-7-2012, FILED 8-19-2011.

WHIRLPOOL

THE MARK CONSISTS OF STANDARD CHARACTERS WITHOUT CLAIM TO ANY PARTICULAR FONT, STYLE, SIZE, OR COLOR.

OWNER OF U.S. REG. NOS. 581,480, 622,079, AND OTHERS.

FOR PORTABLE ELECTRIC FANS (U.S. CLS. 13, 21, 23, 31 AND 34).

FIRST USE 4-10-2011; IN COMMERCE 4-10-2011.

CLASS 12—VEHICLES**CLASS 12—(Continued).**

4,164,943. NISSAN JIDOSHA KABUSHIKI KAISHA, DBA NISSAN MOTOR CO., LTD., YOKOHAMA-SHI, KANAGAWA, JAPAN. SN 77-873,078. PUB. 4-13-2010, FILED 11-16-2009.



THE MARK CONSISTS OF STANDARD CHARACTERS WITHOUT CLAIM TO ANY PARTICULAR FONT, STYLE, SIZE, OR COLOR.

FOR LIGHT COMMERCIAL VEHICLES, NAMELY, VANS, TRUCKS, PICK-UP TRUCKS AND STRUCTURAL PARTS THEREFOR (U.S. CLS. 19, 21, 23, 31, 35 AND 44).

FIRST USE 3-17-2011; IN COMMERCE 3-17-2011.

4,164,986. MOTOCOMPONENTS PTY LTD, AKA GAZI SUSPENSION, MOUNT CROSBY, AUSTRALIA. SN 77-951,229. PUB. 5-17-2011, FILED 3-4-2010.



NO CLAIM IS MADE TO THE EXCLUSIVE RIGHT TO USE "SUSPENSION", APART FROM THE MARK AS SHOWN.

THE COLOR(S) GREEN, BLACK, WHITE AND GRAY IS/ARE CLAIMED AS A FEATURE OF THE MARK.

THE MARK CONSISTS OF THE STYLIZED WORDING "GAZI SUSPENSION". THE TERM "GAZI" IS GREEN WITH WHITE HIGHLIGHTS AND A GRAY SHADOW. THE TERM "SUSPENSION" IS BLACK WITH A GRAY SHADOW.

THE WORDING "GAZI" HAS NO MEANING IN A FOREIGN LANGUAGE.

FOR MOTORCYCLE SUSPENSION (U.S. CLS. 19, 21, 23, 31, 35 AND 44).

FIRST USE 10-10-2007; IN COMMERCE 1-1-2008.

4,165,156. ALCORE, INC., EDGEWOOD, MD. SN 85-117,295. PUB. 2-15-2011, FILED 8-27-2010.



THE MARK CONSISTS OF STANDARD CHARACTERS WITHOUT CLAIM TO ANY PARTICULAR FONT, STYLE, SIZE, OR COLOR.

FOR STRUCTURAL COMPONENTS FOR AIRCRAFT THAT PROVIDE SOUND DAMPENING (U.S. CLS. 19, 21, 23, 31, 35 AND 44).

FIRST USE 3-2-2012; IN COMMERCE 3-2-2012.

CLASS 12—(Continued).

4,165,165. SPRAYING SYSTEMS CO., WHEATON, IL. SN 85-118,804. PUB. 2-15-2011, FILED 8-30-2010.

UniPilot

THE MARK CONSISTS OF STANDARD CHARACTERS WITHOUT CLAIM TO ANY PARTICULAR FONT, STYLE, SIZE, OR COLOR.

FOR A STEERING WHEEL ATTACHMENT COMPRISED OF AN ELECTRIC MOTOR AND DRIVE GEAR AND A RING GEAR THAT WHEN ACTIVATED BY AN EXTERNAL CONTROLLER, TURNS THE STEERING WHEEL TO EFFECT AUTOMATIC VEHICLE STEERING IN STRAIGHT OR CURVED PATHS (U.S. CLS. 19, 21, 23, 31, 35 AND 44).

FIRST USE 4-3-2012; IN COMMERCE 4-3-2012.

4,165,400. TREK BICYCLE CORPORATION, WATERLOO, WI. SN 85-219,166. PUB. 12-27-2011, FILED 1-17-2011.

HYBRID AIR

THE MARK CONSISTS OF STANDARD CHARACTERS WITHOUT CLAIM TO ANY PARTICULAR FONT, STYLE, SIZE, OR COLOR.

NO CLAIM IS MADE TO THE EXCLUSIVE RIGHT TO USE "AIR", APART FROM THE MARK AS SHOWN.

FOR BICYCLE PARTS, NAMELY, BICYCLE SUSPENSION FORKS (U.S. CLS. 19, 21, 23, 31, 35 AND 44).

FIRST USE 8-0-2011; IN COMMERCE 8-0-2011.

4,165,494. HWA FONG RUBBER (USA), INC., DBA DURO TIRE & WHEEL, COVINGTON, GA. SN 85-265,015. PUB. 7-26-2011, FILED 3-11-2011.

QUICK

THE MARK CONSISTS OF STANDARD CHARACTERS WITHOUT CLAIM TO ANY PARTICULAR FONT, STYLE, SIZE, OR COLOR.

FOR TIRES (U.S. CLS. 19, 21, 23, 31, 35 AND 44).
FIRST USE 5-0-2008; IN COMMERCE 5-0-2008.

CLASS 12—(Continued).

4,165,538. OPEN RANGE RV COMPANY, INC., SHIPSHEWANA, IN. SN 85-274,929. PUB. 8-9-2011, FILED 3-23-2011.



THE MARK CONSISTS OF RAYS OF RADIATING LIGHT BEHIND THE WORD "LIGHT" IN WHICH A STAR FORMS PART OF THE LETTER "I".

FOR RECREATIONAL VEHICLES, NAMELY, FIFTH WHEELS AND TRAVEL TRAILERS (U.S. CLS. 19, 21, 23, 31, 35 AND 44).

FIRST USE 6-6-2011; IN COMMERCE 6-6-2011.

4,165,686. DANA LIMITED, MAUMEE, OH. SN 85-307,472. PUB. 10-4-2011, FILED 4-28-2011.



THE COLOR(S) BLACK AND BLUE IS/ARE CLAIMED AS A FEATURE OF THE MARK.

THE MARK CONSISTS OF BLACK BORDER WITH A THICK BOTTOM LINE AND THE LETTERS "SVL" IN BLUE WITHIN THE BORDER OUTLINE.

FOR LAND VEHICLE DRIVE TRAIN COMPONENTS, NAMELY, DRIVE SHAFTS, AXLES, AXLE GEARS, AXLE HOUSINGS, STEERING ASSEMBLIES, UNIVERSAL JOINTS, DIFFERENTIALS, TORQUE CONVERTERS, TRANSFER CASES, GEAR BOXES, TRANSMISSIONS, TRANSMISSION GEARS, RING AND PINION GEAR SETS, BRAKES AND STRUCTURAL PARTS THEREFOR, CLUTCHES AND STRUCTURAL PARTS THEREFOR (U.S. CLS. 19, 21, 23, 31, 35 AND 44).

FIRST USE 8-31-2011; IN COMMERCE 8-31-2011.

CLASS 12—(Continued).

4,165,692. BRUNO INDEPENDENT LIVING AIDS, INC., OCONOMOWOC, WI. SN 85-310,208. PUB. 9-27-2011, FILED 5-2-2011.

CHARIOT

THE MARK CONSISTS OF STANDARD CHARACTERS WITHOUT CLAIM TO ANY PARTICULAR FONT, STYLE, SIZE, OR COLOR.
FOR EQUIPMENT TRAILERS (U.S. CLS. 19, 21, 23, 31, 35 AND 44).
FIRST USE 11-16-2011; IN COMMERCE 11-16-2011.

CLASS 13—(Continued).

4,165,282. BERETTA U.S.A. CORP., ACCOKEEK, MD. SN 85-158,901. PUB. 4-19-2011, FILED 10-22-2010.

NANO

THE MARK CONSISTS OF STANDARD CHARACTERS WITHOUT CLAIM TO ANY PARTICULAR FONT, STYLE, SIZE, OR COLOR.
FOR FIREARMS, NAMELY, PISTOLS (U.S. CLS. 2 AND 9).
FIRST USE 11-0-2011; IN COMMERCE 11-0-2011.

4,165,781. LIQUID ROBOTICS, INC., SUNNYVALE, CA. SN 85-360,046. PUB. 11-22-2011, FILED 6-29-2011.

SHARC

THE MARK CONSISTS OF STANDARD CHARACTERS WITHOUT CLAIM TO ANY PARTICULAR FONT, STYLE, SIZE, OR COLOR.
FOR WATER VEHICLES, NAMELY, UNMANNED BOAT-LIKE VEHICLES WHICH ARE WAVE-POWERED AND CAN OPERATE EITHER AUTONOMOUSLY OR BY REMOTE CONTROL VIA A SATELLITE COMMUNICATIONS LINK, FOR USE AS PLATFORMS FOR MARINE DATA COLLECTION AND SURVEILLANCE EQUIPMENT (U.S. CLS. 19, 21, 23, 31, 35 AND 44).
FIRST USE 3-1-2012; IN COMMERCE 3-1-2012.

4,165,558. DEAD RINGER, LLC, ROCHESTER, NY. SN 85-277,249. PUB. 8-9-2011, FILED 3-25-2011.

DEAD RINGER



THE MARK CONSISTS OF THE WORDS "DEAD" AND "RINGER" WITH A CIRCLE IN BETWEEN THE TWO WORDS. ON THE INNER SURFACE OF THE CIRCLE ARE FOUR SMALL TRIANGLES WITH ONE AT THE TOP, ONE AT THE BOTTOM AND ONE AT EACH SIDE. THERE IS A SMALL SOLID CIRCLE IN THE MIDDLE OF THIS LARGER CIRCLE.
FOR FIREARM SIGHTS (U.S. CLS. 2 AND 9).
FIRST USE 6-15-2011; IN COMMERCE 6-15-2011.

4,165,913. HEARTLAND RECREATIONAL VEHICLES, LLC, ELKART, IN. SN 85-470,612. PUB. 2-21-2012, FILED 11-11-2011.

TORQUE

THE MARK CONSISTS OF STANDARD CHARACTERS WITHOUT CLAIM TO ANY PARTICULAR FONT, STYLE, SIZE, OR COLOR.
FOR RECREATIONAL VEHICLES, NAMELY, TRAVEL TRAILERS, FIFTH WHEEL TRAILERS AND SPORT UTILITY TRAILERS (U.S. CLS. 19, 21, 23, 31, 35 AND 44).
FIRST USE 0-0-2011; IN COMMERCE 0-0-2011.

4,165,812. HOLIWELL EXECUTIVE TRAINING LLC, SEATTLE, WA. SN 85-374,547. PUB. 12-20-2011, FILED 7-19-2011.

velox

THE MARK CONSISTS OF STANDARD CHARACTERS WITHOUT CLAIM TO ANY PARTICULAR FONT, STYLE, SIZE, OR COLOR.
FOR AMMUNITION MAGAZINES AND COMPONENT PARTS FOR AMMUNITION MAGAZINES; CARTRIDGE POUCHES; HOLSTERS; PISTOL HOLSTERS (U.S. CLS. 2 AND 9).
FIRST USE 3-9-2012; IN COMMERCE 3-9-2012.

CLASS 14—(Continued).

4,164,830. W.R. COBB COMPANY, EAST PROVIDENCE, RI.
SN 77-550,321. PUB. 1-20-2009, FILED 8-19-2008.

CLAIRE STEWART

THE MARK CONSISTS OF STANDARD CHARACTERS WITHOUT CLAIM TO ANY PARTICULAR FONT, STYLE, SIZE, OR COLOR.

THE NAME(S), PORTRAIT(S), AND/OR SIGNATURE(S) SHOWN IN THE MARK DOES NOT IDENTIFY A PARTICULAR LIVING INDIVIDUAL.

FOR JEWELRY (U.S. CLS. 2, 27, 28 AND 50).
FIRST USE 3-14-2012; IN COMMERCE 3-14-2012.

4,164,862. EK SUCCESS, LTD., CLIFTON, NJ. SN 77-663,101.
PUB. 7-19-2011, FILED 2-4-2009.

Jolee's Jewels

THE MARK CONSISTS OF STANDARD CHARACTERS WITHOUT CLAIM TO ANY PARTICULAR FONT, STYLE, SIZE, OR COLOR.

OWNER OF U.S. REG. NOS. 2,758,913, 3,845,982, AND OTHERS.

NO CLAIM IS MADE TO THE EXCLUSIVE RIGHT TO USE "JEWELS", APART FROM THE MARK AS SHOWN.

FOR JEWELRY-MAKING COMPONENTS FOR USE IN JEWELRY-MAKING CRAFTS, NAMELY, GEMS AND WORKED METAL (U.S. CLS. 2, 27, 28 AND 50).

FIRST USE 12-31-2010; IN COMMERCE 12-31-2010.

4,164,885. TISSOT SA, 2400 LE LOCLE, SWITZERLAND. SN 77-762,160. PUB. 8-3-2010, FILED 6-17-2009.

TISSOT VELOCI-T

THE MARK CONSISTS OF STANDARD CHARACTERS WITHOUT CLAIM TO ANY PARTICULAR FONT, STYLE, SIZE, OR COLOR.

OWNER OF SWITZERLAND REG. NO. 581672, DATED 1-9-2009, EXPIRES 1-9-2019.

OWNER OF U.S. REG. NOS. 1,639,684, 3,213,659, AND OTHERS.

FOR HOROLOGICAL AND CHRONOMETRIC INSTRUMENTS (U.S. CLS. 2, 27, 28 AND 50).
FIRST USE 4-20-2009; IN COMMERCE 4-20-2009.

CLASS 14—(Continued).

4,164,937. GENESIS TIME GROUP, LLC, NEW YORK, NY.
SN 77-858,004. PUB. 9-7-2010, FILED 10-27-2009.

MONTEGO BAY

THE MARK CONSISTS OF STANDARD CHARACTERS WITHOUT CLAIM TO ANY PARTICULAR FONT, STYLE, SIZE, OR COLOR.

FOR WATCHES AND COSTUME JEWELRY (U.S. CLS. 2, 27, 28 AND 50).

FIRST USE 7-1-2010; IN COMMERCE 7-1-2010.

4,165,014. LIONS GATE ENTERTAINMENT, INC., SANTA MONICA, CA. SN 77-983,162. PUB. 9-21-2010, FILED 1-21-2010.



THE COLOR(S) BLACK, RED AND WHITE IS/ARE CLAIMED AS A FEATURE OF THE MARK.

THE MARK CONSISTS OF THE IMAGE OF A SMOKING MAN. THE BACK OF HIS HEAD AND HIS SUIT ARE BLACK. HIS COLLAR AND CUFFS ARE WHITE. AS IS THE CIGARETTE. BELOW THE IMAGE IS THE WORDING "MAD MEN" ON A BLACK RECTANGULAR BACKGROUND, WITH THE "MAD" PORTION IN RED AND THE "MEN" PORTION IN WHITE.

FOR WATCHES (U.S. CLS. 2, 27, 28 AND 50).
FIRST USE 2-28-2012; IN COMMERCE 2-28-2012.

4,165,076. NINE TREASURES LLC, AKA NINE TREASURES, ESPANOLA, NM. SN 85-041,683. PUB. 4-19-2011, FILED 5-18-2010.

Tantric Necklace

THE MARK CONSISTS OF STANDARD CHARACTERS WITHOUT CLAIM TO ANY PARTICULAR FONT, STYLE, SIZE, OR COLOR.

NO CLAIM IS MADE TO THE EXCLUSIVE RIGHT TO USE "NECKLACE", APART FROM THE MARK AS SHOWN.
FOR NECKLACES (U.S. CLS. 2, 27, 28 AND 50).
FIRST USE 6-18-1987; IN COMMERCE 4-8-2009.

CLASS 14—(Continued).

4,165,115. KELLY WEARSTLER LLLP, LOS ANGELES, CA.
SN 85-096,070. PUB. 1-11-2011, FILED 7-29-2010.

KELLY WEARSTLER

THE MARK CONSISTS OF STANDARD CHARACTERS WITHOUT CLAIM TO ANY PARTICULAR FONT, STYLE, SIZE, OR COLOR.

OWNER OF U.S. REG. NO. 3,725,918.
THE NAME(S), PORTRAIT(S), AND/OR SIGNATURE(S) SHOWN IN THE MARK IDENTIFIES "KELLY WEARSTLER", WHOSE CONSENT(S) TO REGISTER IS MADE OF RECORD.

FOR JEWELRY (U.S. CLS. 2, 27, 28 AND 50).
FIRST USE 9-19-2011; IN COMMERCE 9-19-2011.

4,165,116. KIMSAPRINCESS INC., WOODLAND HILLS, CA.
SN 85-096,629. PUB. 1-11-2011, FILED 7-30-2010.

BELLE NOEL

THE MARK CONSISTS OF STANDARD CHARACTERS WITHOUT CLAIM TO ANY PARTICULAR FONT, STYLE, SIZE, OR COLOR.

THE NAME "NOEL" IS THE MIDDLE NAME OF A LIVING INDIVIDUAL WHOSE CONSENT IS OF RECORD.

FOR JEWELRY (U.S. CLS. 2, 27, 28 AND 50).
FIRST USE 1-25-2011; IN COMMERCE 1-25-2011.

4,165,211. PAYLESS SHOESOURCE WORLDWIDE, INC.,
TOPEKA, KS. SN 85-131,578. PUB. 3-22-2011, FILED 9-16-2010.

MINICCI GIRL

THE MARK CONSISTS OF STANDARD CHARACTERS WITHOUT CLAIM TO ANY PARTICULAR FONT, STYLE, SIZE, OR COLOR.

OWNER OF U.S. REG. NOS. 2,846,898, 2,992,430, AND OTHERS.

NO CLAIM IS MADE TO THE EXCLUSIVE RIGHT TO USE "GIRL", APART FROM THE MARK AS SHOWN.

FOR COSTUME JEWELRY (U.S. CLS. 2, 27, 28 AND 50).
FIRST USE 2-0-2012; IN COMMERCE 2-0-2012.

CLASS 14—(Continued).

4,165,221. CORD-WEAR, LLC, SUMMIT, NJ. SN 85-134,478.
PUB. 7-26-2011, FILED 9-21-2010.

CORD-WEAR

THE MARK CONSISTS OF STANDARD CHARACTERS WITHOUT CLAIM TO ANY PARTICULAR FONT, STYLE, SIZE, OR COLOR.

FOR JEWELRY, NAMELY, RINGS, EARRINGS, NECKLACES, CHARMS, BRACELETS, PENDANTS, BRACELET CUFFS AND BANGLES, PINS, ANKLETS AND BROOCHES (U.S. CLS. 2, 27, 28 AND 50).

FIRST USE 11-17-2010; IN COMMERCE 12-0-2010.

4,165,230. HOLMBERG, TRISTA J, FREDERICKSBURG, VA.
SN 85-138,228. PUB. 3-8-2011, FILED 9-25-2010.



NO CLAIM IS MADE TO THE EXCLUSIVE RIGHT TO USE "DESIGNS", APART FROM THE MARK AS SHOWN.

THE NAME "TRISTA JANE" IDENTIFIES A LIVING INDIVIDUAL WHOSE CONSENT IS OF RECORD.

THE COLOR(S) GREEN AND PINK IS/ARE CLAIMED AS A FEATURE OF THE MARK.

THE MARK CONSISTS OF THE WORDING "TRISTA JANE DESIGNS" IN PINK. AROUND THE WORDING IS A GREEN OVAL VINE DESIGN CONTAINING FOUR PINK ROSES.

SEC. 2(F).

FOR JEWELRY (U.S. CLS. 2, 27, 28 AND 50).
FIRST USE 3-15-2011; IN COMMERCE 3-15-2011.

CLASS 14—(Continued).

4,165,303. TARGET BRANDS, INC., MINNEAPOLIS, MN. SN 85-169,980. PUB. 2-1-2011, FILED 11-5-2010.

SPRITZ

THE MARK CONSISTS OF STANDARD CHARACTERS WITHOUT CLAIM TO ANY PARTICULAR FONT, STYLE, SIZE, OR COLOR.

FOR JEWELRY; JEWELRY MAKING KITS; TIARAS (U.S. CLS. 2, 27, 28 AND 50).
FIRST USE 2-0-2011; IN COMMERCE 2-0-2011.

4,165,336. AMUSEMENT ART LLC, LOS ANGELES, CA. SN 85-185,010. PUB. 6-7-2011, FILED 11-24-2010.

MR BRAINWASH

THE MARK CONSISTS OF STANDARD CHARACTERS WITHOUT CLAIM TO ANY PARTICULAR FONT, STYLE, SIZE, OR COLOR.

FOR ANKLE BRACELETS; BRACELETS; CHARMS FOR COLLAR JEWELRY AND BRACELET; CLOCKS; CUFF LINKS; DIAMOND JEWELRY; EARRINGS; IMITATION JEWELRY; JEWELRY; NECK CHAINS; PENDANTS; RINGS; TIE CLIPS; TROPHIES OF PRECIOUS METALS; WALL CLOCKS; WATCH BANDS AND STRAPS; WATCH BOXES; WATCH BRACELETS; WATCH CASES; WATCHES; WOMEN'S JEWELRY; WRISTWATCHES (U.S. CLS. 2, 27, 28 AND 50).
FIRST USE 5-24-2010; IN COMMERCE 3-26-2012.

4,165,399. NEW DOVER GROUP, VALLEY COTTAGE, NY. SN 85-219,057. PUB. 9-20-2011, FILED 1-17-2011.

RÜDIGER

THE MARK CONSISTS OF STANDARD CHARACTERS WITHOUT CLAIM TO ANY PARTICULAR FONT, STYLE, SIZE, OR COLOR.

THE NAME(S), PORTRAIT(S), AND/OR SIGNATURE(S) SHOWN IN THE MARK DOES NOT IDENTIFY A PARTICULAR LIVING INDIVIDUAL.

THE ENGLISH TRANSLATION OF "RÜDIGER" IN THE MARK IS "ROGER".

FOR CHRONOGRAPHS AS WATCHES; JEWELRY WATCHES; SPORTS WATCHES; WATCHES (U.S. CLS. 2, 27, 28 AND 50).
FIRST USE 2-9-2012; IN COMMERCE 2-19-2012.

CLASS 14—(Continued).

4,165,406. VA BIEN INTERNATIONAL, INC., AGUAS BUENAS, PUERTO RICO. SN 85-219,997. PUB. 5-31-2011, FILED 1-18-2011.

Original Interest

THE MARK CONSISTS OF STANDARD CHARACTERS WITHOUT CLAIM TO ANY PARTICULAR FONT, STYLE, SIZE, OR COLOR.

FOR JEWELRY (U.S. CLS. 2, 27, 28 AND 50).
FIRST USE 2-1-2011; IN COMMERCE 12-5-2011.

4,165,505. CARLA MARINA INC., FORT LEE, NJ. SN 85-267,821. PUB. 8-23-2011, FILED 3-15-2011.



THE NAME "CARLA MARINA" IDENTIFIES A LIVING INDIVIDUAL WHOSE CONSENT IS OF RECORD.

THE MARK CONSISTS OF THE SIGNATURE OF THE NAME "CARLA MARINA".

FOR JEWELRY (U.S. CLS. 2, 27, 28 AND 50).
FIRST USE 11-21-2011; IN COMMERCE 11-21-2011.

4,165,508. STULLER, INC., LAFAYETTE, LA. SN 85-268,231. PUB. 8-16-2011, FILED 3-16-2011.

RING GARDEN

THE MARK CONSISTS OF STANDARD CHARACTERS WITHOUT CLAIM TO ANY PARTICULAR FONT, STYLE, SIZE, OR COLOR.

NO CLAIM IS MADE TO THE EXCLUSIVE RIGHT TO USE "RING", APART FROM THE MARK AS SHOWN.

FOR JEWELRY, NAMELY, RINGS (U.S. CLS. 2, 27, 28 AND 50).
FIRST USE 6-0-2011; IN COMMERCE 6-0-2011.

CLASS 14—(Continued).

4,165,559. J.S. JOHNSON, LTD., COLUMBUS, OH. SN 85-277,333. PUB. 8-9-2011, FILED 3-25-2011.

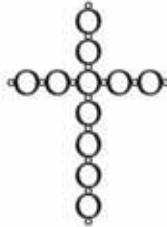

THE MARK CONSISTS OF ALTERNATING LARGE AND SMALL CIRCLES FORMING A CROSS SHAPE. FOR JEWELLERY AND PRECIOUS STONES; JEWELRY (U.S. CLS. 2, 27, 28 AND 50). FIRST USE 11-17-2011; IN COMMERCE 11-17-2011.

4,165,891. MOREJON, LILIANA, POMPANO, FL. SN 85-415,220. PUB. 2-28-2012, FILED 9-6-2011.

RETRO 100

THE MARK CONSISTS OF STANDARD CHARACTERS WITHOUT CLAIM TO ANY PARTICULAR FONT, STYLE, SIZE, OR COLOR. NO CLAIM IS MADE TO THE EXCLUSIVE RIGHT TO USE "RETRO", APART FROM THE MARK AS SHOWN. FOR JEWELRY (U.S. CLS. 2, 27, 28 AND 50). FIRST USE 12-11-2011; IN COMMERCE 12-11-2011.

CLASS 15—MUSICAL INSTRUMENTS

4,164,860. DR MUSIC INC., EMERSON, NJ. SN 77-647,385. PUB. 4-28-2009, FILED 1-12-2009.

HARD CORE

THE MARK CONSISTS OF STANDARD CHARACTERS WITHOUT CLAIM TO ANY PARTICULAR FONT, STYLE, SIZE, OR COLOR. FOR GUITAR STRINGS; MUSICAL INSTRUMENT STRINGS; STRINGS FOR MUSICAL INSTRUMENTS (U.S. CLS. 2, 21 AND 36). FIRST USE 7-27-2011; IN COMMERCE 7-27-2011.

CLASS 15—(Continued).

4,165,477. HOHNER, INC., GLEN ALLEN, VA. SN 85-259,812. PUB. 8-30-2011, FILED 3-7-2011.



THE MARK CONSISTS OF THE DESIGN OF A DANCING MAN. FOR MUSICAL INSTRUMENTS, NAMELY, UKULELES; MUSICAL INSTRUMENT ACCESSORIES, NAMELY, STANDS, CASES, CARRYING BAGS AND STORAGE BAGS; TUNERS FOR MUSICAL INSTRUMENTS (U.S. CLS. 2, 21 AND 36). FIRST USE 8-0-2011; IN COMMERCE 8-0-2011.

CLASS 16—PAPER GOODS AND PRINTED MATTER

4,164,803. RATTE, GEOFFREY S, SAINT PAUL, MN. SN 76-708,446. PUB. 1-24-2012, FILED 7-21-2011.

FISHING KIDS

THE MARK CONSISTS OF STANDARD CHARACTERS WITHOUT CLAIM TO ANY PARTICULAR FONT, STYLE, SIZE, OR COLOR. NO CLAIM IS MADE TO THE EXCLUSIVE RIGHT TO USE "KIDS", APART FROM THE MARK AS SHOWN. FOR CHILDREN'S BOOKS FEATURING CHARACTERS FROM ANIMATED, ACTION ADVENTURE, COMEDY AND/OR DRAMA FEATURES (U.S. CLS. 2, 5, 22, 23, 29, 37, 38 AND 50). FIRST USE 1-13-2012; IN COMMERCE 1-13-2012.

CLASS 16—(Continued).

4,164,843. MORGAN, LISA BAKER, LOS ANGELES, CA. SN 77-579,277. PUB. 2-17-2009, FILED 9-25-2008.

CIAO YUMMY!

THE MARK CONSISTS OF STANDARD CHARACTERS WITHOUT CLAIM TO ANY PARTICULAR FONT, STYLE, SIZE, OR COLOR.

FOR COOKBOOKS (U.S. CLS. 2, 5, 22, 23, 29, 37, 38 AND 50).

FIRST USE 11-1-2011; IN COMMERCE 5-10-2012.

4,164,913. WORLD WRESTLING ENTERTAINMENT, INC., STAMFORD, CT. SN 77-824,130. PUB. 8-31-2010, FILED 9-10-2009.

**TLC TABLES LADDERS
CHAIRS**

THE MARK CONSISTS OF STANDARD CHARACTERS WITHOUT CLAIM TO ANY PARTICULAR FONT, STYLE, SIZE, OR COLOR.

FOR PAPER HANGTAGS, CARDBOARD HANGTAGS; COLLECTOR ALBUMS, NAMELY, ALBUMS FOR STICKER COLLECTABLE CARDS; PAPER TABLEWARE, NAMELY, PAPER PLACE MATS, PAPER TABLE MATS, PAPER NAPKINS, PAPER TABLE LINENS, PAPER TABLECLOTHS; PAPER LUNCH BAGS; STICKERS; BUMPER STICKERS; WINDOW DECALS; PENS; PENCILS; PENCIL SHARPENERS; PENCIL CASES; CHALK; ERASERS, NAMELY, RUBBER ERASERS; POSTERS; NOTEBOOKS; TRADING CARDS; CALENDARS; PHOTOGRAPHS; FRAMED PICTURES; PHOTOGRAPHIC PRINTS; PICTURES; BROCHURES, NEWSLETTERS, MAGAZINES, AND NEWSPAPERS CONCERNING SPORTS ENTERTAINMENT; POSTCARDS; GREETING CARDS; DECALS; TEMPORARY TATTOO TRANSFERS; COLORING BOOKS; CHILDREN'S ACTIVITY BOOKS; SOUVENIR PROGRAMS CONCERNING SPORTS ENTERTAINMENT; BOOKS FEATURING PICTORIAL BIOGRAPHIES; AUTOGRAPH BOOKS; PICTURE BOOKS; STICKER ALBUMS; BOOK COVERS; PAPER BOOK MARKERS; MEMO PADS; SCRIBBLE PADS; DATE BOOKS; ADDRESS BOOKS; PRINTED PAPER SIGNS FOR DOORS; DRAWING RULERS; LITHOGRAPHS; PAPER PARTY BAGS; PAPER PARTY FAVORS, NAMELY, PAPER HATS; ALL OF THE FOREMENTIONED GOODS ADORNED WITH WRESTLING PHOTOS, AND MARKETED TOWARD THE WRESTLING FAN, FOR HOUSEHOLD USE (U.S. CLS. 2, 5, 22, 23, 29, 37, 38 AND 50).

FIRST USE 12-13-2009; IN COMMERCE 12-13-2009.

CLASS 16—(Continued).

4,164,915. ARCHIE COMIC PUBLICATIONS, INC., MARONECK, NY. SN 77-824,745. PUB. 2-15-2011, FILED 9-11-2009.

PIPSQUEAK

THE MARK CONSISTS OF STANDARD CHARACTERS WITHOUT CLAIM TO ANY PARTICULAR FONT, STYLE, SIZE, OR COLOR.

FOR COMIC MAGAZINES, JOKE BOOK MAGAZINES FEATURING CHARACTERS FROM ANIMATED, ACTION ADVENTURE, COMEDY AND DRAMA FEATURES, COMIC MAGAZINE SERIES, COMICS, AND MAGAZINES FEATURING CHARACTERS FROM ANIMATED FILMS; CHILDREN'S BOOKS; MAGAZINES FEATURING CHARACTERS FROM ANIMATED, ACTION ADVENTURE, COMEDY AND DRAMA FEATURES (U.S. CLS. 2, 5, 22, 23, 29, 37, 38 AND 50).

FIRST USE 1-3-2012; IN COMMERCE 1-3-2012.

4,165,042. STEPHANIE R. DAWKINS INTERNATIONAL, INC., CHARLOTTE, NC. SN 85-010,776. PUB. 9-28-2010, FILED 4-9-2010.



NO CLAIM IS MADE TO THE EXCLUSIVE RIGHT TO USE "INTERNATIONAL, INC.", APART FROM THE MARK AS SHOWN.

THE NAME(S), PORTRAIT(S), AND/OR SIGNATURE(S) SHOWN IN THE MARK IDENTIFIES "STEPHANIE R. DAWKINS", WHOSE CONSENT(S) TO REGISTER IS MADE OF RECORD.

THE MARK CONSISTS OF A HEAD SHOT OF A WOMAN ON THE LEFT SIDE OF THE MARK. THE RIGHT SIDE OF THE MARK CONTAINS A HALF-GLOBE WITH AN URBAN SETTING/SEVERAL-STORIED BUILDINGS SUPERIMPOSED INSIDE OF THE HALF-GLOBE. DIRECTLY UNDERNEATH THE HALF-GLOBE, THE WORDS "STEPHANIE R. DAWKINS INTERNATIONAL, INC." APPEAR.

FOR EDUCATIONAL PUBLICATIONS, NAMELY, BOOKS IN THE FIELDS OF BUSINESS CONSULTING (U.S. CLS. 2, 5, 22, 23, 29, 37, 38 AND 50).

FIRST USE 6-1-2010; IN COMMERCE 6-1-2010.

CLASS 16—(Continued).

4,165,065. JASPER STATE BRAND, INC., BEVERLY HILLS, CA. SN 85-033,830. PUB. 5-3-2011, FILED 5-10-2010.

JASPER STATE

THE MARK CONSISTS OF STANDARD CHARACTERS WITHOUT CLAIM TO ANY PARTICULAR FONT, STYLE, SIZE, OR COLOR.

FOR CHILDREN'S BOOKS (U.S. CLS. 2, 5, 22, 23, 29, 37, 38 AND 50).

FIRST USE 5-16-2011; IN COMMERCE 5-16-2011.

CLASS 16—(Continued).

4,165,103. MULTI PACKAGING SOLUTIONS, INC., LANSING, MI. SN 85-085,140. PUB. 5-10-2011, FILED 7-15-2010.

MOMENTS

THE MARK CONSISTS OF STANDARD CHARACTERS WITHOUT CLAIM TO ANY PARTICULAR FONT, STYLE, SIZE, OR COLOR.

FOR SPECIALTY PAPER PACKAGING, DISPLAYS, CARDS, AND BOWS FOR HOLIDAYS AND SPECIAL EVENTS, NAMELY, PAPER FOR WRAPPING AND PACKING FOR GIFTS, PARTY FAVORS, CORSAGES, FLOWERS AND PLANTS; TREATED PAPER FOR WRAPPING FLOWERS AND FLORAL DISPLAYS; PAPER DISPLAY BOXES; GIFT CARDS FOR GIFTS, PARTY FAVORS, CORSAGES, FLOWERS AND PLANTS, DECORATIVE PAPER BOWS FOR WRAPPING (U.S. CLS. 2, 5, 22, 23, 29, 37, 38 AND 50).

FIRST USE 7-12-2010; IN COMMERCE 7-12-2010.

4,165,157. JACKSON BASEBALL CLUB, L.P., JACKSON, TN. SN 85-117,694. PUB. 8-30-2011, FILED 8-27-2010.



NO CLAIM IS MADE TO THE EXCLUSIVE RIGHT TO USE "JACKSON", APART FROM THE MARK AS SHOWN.

THE COLOR(S) TAN, GREEN, BLACK, WHITE AND GRAY IS/ARE CLAIMED AS A FEATURE OF THE MARK.

THE MARK CONSISTS OF A SHIELD DESIGN WITH GRAY ON THE LEFT HALF OUTLINED IN BLACK AND GRAY WITH THE WORD "JACKSON" IN TAN AT THE TOP OF THE SHIELD WITH THE STYLIZED WORD "GENERALS" DEPICTED IN THE COLOR WHITE SUPERIMPOSED ON THE SHIELD WITH A GREEN DESIGN SET IN THE BLACK FIELD BELOW. A TAN AND WHITE BULLDOG HEAD OUTLINED IN BLACK WITH GRAY SHADING IS PLACED IN THE CENTER OF THE SHIELD. THE BULLDOG HEAD DESIGN FEATURES A GREEN HELMET BEARING THREE TAN STARS AND A BLACK DESIGN WITH WHITE ON THE RIGHT SIDE OF THE HELMET WITH A SUPERIMPOSED TAN BAT OUTLINED IN BLACK IN THE MOUTH OF THE BULLDOG.

FOR BOOKMARKS, BUMPER STICKERS, CALENDARS, DECALS, MERCHANDISE BAGS, PAPER PENNANTS, PAPER SCHEDULES, POSTERS, PRINTED GAME TICKETS, PRINTED GUIDES IN THE FIELD OF BASEBALL, SCORE CARDS, SCORE SHEETS, STICKERS AND TRADING CARDS (U.S. CLS. 2, 5, 22, 23, 29, 37, 38 AND 50).

FIRST USE 9-6-2010; IN COMMERCE 9-6-2010.

4,165,102. MULTI PACKAGING SOLUTIONS, INC., LANSING, MI. SN 85-085,125. PUB. 5-10-2011, FILED 7-15-2010.

CHARISMA

THE MARK CONSISTS OF STANDARD CHARACTERS WITHOUT CLAIM TO ANY PARTICULAR FONT, STYLE, SIZE, OR COLOR.

FOR PROMOTIONAL MATERIALS, NAMELY, BUSINESS CARDS, STATIONERY, ENVELOPES, PAPER, BROCHURES ABOUT HORTICULTURAL PRODUCTS, POSTCARDS, BOOKLETS IN THE FIELD OF HORTICULTURAL PRODUCTS, INFORMATIONAL FLYERS FEATURING FLORAL AND PLANT INFORMATION, CALENDARS, PRINTED PAPER SIGNS, BANNERS OF PAPER, FAN DECKS, NAMELY, FLORAL AND PLANT SAMPLE BOOKS, PAPER TAGS, PRICING TAGS, NAMELY, TAGS FOR ATTACHING TO HORTICULTURE GOODS FOR SALE, LABELS, FOLDERS, BLANK NOTE CARDS AND CORRESPONDENCE CARDS (U.S. CLS. 2, 5, 22, 23, 29, 37, 38 AND 50).

FIRST USE 7-12-2010; IN COMMERCE 7-12-2010.

CLASS 16—(Continued).

4,165,226. TRIP EDITORA E PROPAGANDA S/A, PINHEIROS, SÃO PAULO, BRAZIL. SN 85-136,788. PUB. 3-8-2011, FILED 9-23-2010.

THE MARK CONSISTS OF THE WORD "TRIP" IN STYLIZED LETTERS.
FOR GENERAL INTEREST PERIODICALS (U.S. CLS. 2, 5, 22, 23, 29, 37, 38 AND 50).
FIRST USE 7-23-1986; IN COMMERCE 12-6-2011.

4,165,233. GEORGIA-PACIFIC CONSUMER PRODUCTS LP, ATLANTA, GA. SN 85-139,496. PUB. 3-8-2011, FILED 9-28-2010.

**BIG BENEFITS FOR YOUR
SMALL BUSINESS**

THE MARK CONSISTS OF STANDARD CHARACTERS WITHOUT CLAIM TO ANY PARTICULAR FONT, STYLE, SIZE, OR COLOR.
FOR BATHROOM TISSUE (U.S. CLS. 2, 5, 22, 23, 29, 37, 38 AND 50).
FIRST USE 1-0-2011; IN COMMERCE 1-0-2011.

4,165,249. ESSENTIAL MEDIA PARTNERS, LLC, AKA EMP LLC, WASHINGTON, DC. SN 85-146,010. PUB. 3-22-2011, FILED 10-6-2010.

NO CLAIM IS MADE TO THE EXCLUSIVE RIGHT TO USE "WASHINGTON DC", APART FROM THE MARK AS SHOWN.

CLASS 16—(Continued).

THE MARK CONSISTS OF STYLIZED LETTERING SPELLING "NOW" WITH AN IMAGE OF THE UNITED STATES CAPITOL DOME DEPICTED INSIDE LETTER "O". THE LETTERS "N" AND "O" ARE UNDERLINED, FOLLOWING THE UNDERLINE APPEARS THE STYLIZED WORDING "WASHINGTON DC".

FOR MAGAZINES FEATURING DESTINATION-ORIENTED SUBJECT AND OTHER TRAVEL MATTER (U.S. CLS. 2, 5, 22, 23, 29, 37, 38 AND 50).

FIRST USE 10-6-2010; IN COMMERCE 10-6-2010.

4,165,252. GIFT IT GREEN, LLC, CHICAGO, IL. SN 85-147,359. PUB. 8-30-2011, FILED 10-7-2010.

GIFT IT GREEN

THE MARK CONSISTS OF STANDARD CHARACTERS WITHOUT CLAIM TO ANY PARTICULAR FONT, STYLE, SIZE, OR COLOR.

NO CLAIM IS MADE TO THE EXCLUSIVE RIGHT TO USE "GREEN", APART FROM THE MARK AS SHOWN.

FOR ENVIRONMENTALLY FRIENDLY REUSABLE FABRIC GIFT WRAPPING BOXES FOR WRAPPING GIFTS (U.S. CLS. 2, 5, 22, 23, 29, 37, 38 AND 50).

FIRST USE 3-12-2012; IN COMMERCE 3-30-2012.

4,165,432. K & COMPANY LLC, KANSAS CITY, MO 64108, MO. SN 85-240,194. PUB. 6-21-2011, FILED 2-11-2011.

**LIVE IT UP, GLUE IT DOWN &
SMASH IT IN.**

THE MARK CONSISTS OF STANDARD CHARACTERS WITHOUT CLAIM TO ANY PARTICULAR FONT, STYLE, SIZE, OR COLOR.

FOR SCRAPBOOKS (U.S. CLS. 2, 5, 22, 23, 29, 37, 38 AND 50).

FIRST USE 5-31-2011; IN COMMERCE 5-31-2011.

CLASS 16—(Continued).

4,165,462. BUTLER, DAVID MARK, KANSAS CITY, MO. SN 85-254,254. PUB. 7-19-2011, FILED 3-1-2011.

...yell, No! Let's Go!

THE MARK CONSISTS OF STANDARD CHARACTERS WITHOUT CLAIM TO ANY PARTICULAR FONT, STYLE, SIZE, OR COLOR.

FOR A SERIES OF BOOKS AND WRITTEN ARTICLES IN THE FIELD OF DANGEROUS SITUATIONS, CHILD ABDUCTION, AND DRUG AWARENESS; A SERIES OF BOOKS, WRITTEN ARTICLES, HANDOUTS AND WORKSHEETS IN THE FIELD OF DANGEROUS SITUATIONS, CHILD ABDUCTION, AND DRUG AWARENESS; BOOK MARKS; BUMPER STICKERS; CHILDREN'S ACTIVITY BOOKS; CHILDREN'S BOOKS; CHILDREN'S INTERACTIVE EDUCATIONAL BOOKS; CHILDREN'S WALL STICKERS AND MURALS; CHILDREN'S ARTS AND CRAFTS PAPER KITS; COLORING BOOKS; EDUCATIONAL AND LEARNING PUBLICATIONS, NAMELY, BOOKLETS AND FLASH CARDS ON A VARIETY OF EDUCATIONAL DISCIPLINES IN PRE-SCHOOL THROUGH EIGHTH GRADE; EDUCATIONAL BOOKS FEATURING ELEMENTARY LEVEL MATH AND SCIENCE; EDUCATIONAL PUBLICATIONS, NAMELY, BOOKS, COLORING BOOKS IN THE FIELDS OF DANGEROUS SITUATIONS, CHILD ABDUCTION, AND DRUG AWARENESS; FLIP BOOKS; PERSONALIZED COLORING BOOKS FOR CHILDREN; PICTURE BOOKS; RELIGIOUS BOOKS; SCHOOL SUPPLY KITS CONTAINING VARIOUS COMBINATIONS OF SELECTED SCHOOL SUPPLIES, NAMELY, WRITING INSTRUMENTS, PENS, PENCILS, MECHANICAL PENCILS, ERASERS, MARKERS, CRAYONS, HIGHLIGHTER PENS, FOLDERS, NOTEBOOKS, PAPER, PROTRACTORS, PAPER CLIPS, PENCIL SHARPENERS, WRITING GRIPS, GLUE AND BOOK MARKS; STICKERS; STORY BOOKS; TALKING CHILDREN'S BOOKS (U.S. CLS. 2, 5, 22, 23, 29, 37, 38 AND 50).
FIRST USE 5-23-2011; IN COMMERCE 8-26-2011.

4,165,488. HOPE MICHELLE HOLMAN, SUFFOLK, VA. SN 85-263,349. PUB. 11-1-2011, FILED 3-10-2011.



THE COLOR(S) BLACK AND YELLOW IS/ARE CLAIMED AS A FEATURE OF THE MARK.

CLASS 16—(Continued).

THE MARK CONSISTS OF A BLACK ROUND CIRCLE DEPICTING A HEAD ABOVE A BLACK STEERING WHEEL AND BLACK FINGERS GRIPPING THE WHEEL, UNDER WHICH ARE THE WORDS "HOPE 4 MY TEEN" IN BLACK; ALL OF WHICH APPEARS ON A YELLOW BACKGROUND SURROUNDED BY TWO CONCENTRIC RECTANGLES OUTLINED IN BLACK.

FOR MAGNETIC STICKERS FOR USE ON AUTOMOBILES FEATURING DRIVER INFORMATION (U.S. CLS. 2, 5, 22, 23, 29, 37, 38 AND 50).
FIRST USE 3-22-2012; IN COMMERCE 3-22-2012.

4,165,512. CREATIVE LEARNING STUDIOS, LLC, GREENVILLE, DE. SN 85-269,742. PUB. 8-16-2011, FILED 3-17-2011.

LORIKEET LEARNING

THE MARK CONSISTS OF STANDARD CHARACTERS WITHOUT CLAIM TO ANY PARTICULAR FONT, STYLE, SIZE, OR COLOR.

NO CLAIM IS MADE TO THE EXCLUSIVE RIGHT TO USE "LEARNING", APART FROM THE MARK AS SHOWN.
FOR EDUCATIONAL KITS SOLD AS A UNIT IN THE FIELD OF AUTISM CONSISTING PRIMARILY OF PAMPHLETS, BOOKS, FLASH CARDS AND ALSO INCLUDING AUDIO CD'S (U.S. CLS. 2, 5, 22, 23, 29, 37, 38 AND 50).
FIRST USE 11-0-2011; IN COMMERCE 11-0-2011.

4,165,518. PRINCE, JEANNETTE, CARDIFF, CA. SN 85-271,319. PUB. 1-24-2012, FILED 3-18-2011.

Cardiff Town Cards

THE MARK CONSISTS OF STANDARD CHARACTERS WITHOUT CLAIM TO ANY PARTICULAR FONT, STYLE, SIZE, OR COLOR.

NO CLAIM IS MADE TO THE EXCLUSIVE RIGHT TO USE "CARDIFF AND CARDS", APART FROM THE MARK AS SHOWN.
FOR GREETING CARDS (U.S. CLS. 2, 5, 22, 23, 29, 37, 38 AND 50).
FIRST USE 9-30-2011; IN COMMERCE 9-30-2011.

CLASS 16—(Continued).

4,165,537. JAIL LIFE GREETING CARDS LLC, COLORADO SPRINGS, CO. SN 85-274,834. PUB. 8-9-2011, FILED 3-23-2011.



THE MARK CONSISTS OF THE STYLIZED TEXT "JAIL LIFE" WITH THE LETTER "E" SYMBOLIZED BY A BALL AND CHAIN.

FOR ARTISTICALLY DRAWN AND DESIGNED GREETING CARDS (U.S. CLS. 2, 5, 22, 23, 29, 37, 38 AND 50).

FIRST USE 7-12-2011; IN COMMERCE 10-14-2011.

4,165,545. BUGNON, DAVID. WOODBURY, MN. SN 85-275,478. PUB. 8-9-2011, FILED 3-24-2011.

Mobopolis

THE MARK CONSISTS OF STANDARD CHARACTERS WITHOUT CLAIM TO ANY PARTICULAR FONT, STYLE, SIZE, OR COLOR.

FOR ART PRINTS COMPRISED OF DIGITAL ILLUSTRATIONS ORIGINATING FROM PHOTOGRAPHS (U.S. CLS. 2, 5, 22, 23, 29, 37, 38 AND 50).

FIRST USE 3-6-2012; IN COMMERCE 3-6-2012.

CLASS 16—(Continued).

4,165,547. SJOERDSMA, TOM, DBA ART ATTACK GREETINGS, AUSTIN, TX. SN 85-275,853. PUB. 8-9-2011, FILED 3-24-2011.

CARDIACTS

THE MARK CONSISTS OF STANDARD CHARACTERS WITHOUT CLAIM TO ANY PARTICULAR FONT, STYLE, SIZE, OR COLOR.

FOR POSTCARDS AND GREETING CARDS (U.S. CLS. 2, 5, 22, 23, 29, 37, 38 AND 50).

FIRST USE 3-29-2012; IN COMMERCE 3-29-2012.

4,165,578. PRISON FELLOWSHIP MINISTRIES, LANS-DOWNE, VA. SN 85-280,896. PUB. 8-9-2011, FILED 3-30-2011.



THE MARK CONSISTS OF A CIRCLE WITH AN ANGLED LINE INSIDE REPRESENTING A BENT REED OF GRASS.

FOR PRINTED ARTICLES IN THE FIELDS OF THE ARTS, COMMUNICATIONS, JOURNALISM, EDUCATION, HISTORY, POLITICAL SCIENCE, LAW, LITERATURE, PHILOSOPHY, CHRISTIANITY, RELIGION, SCIENCE, MATHEMATICS, SOCIAL SCIENCES, PSYCHOLOGY, THEOLOGY, SPIRITUALITY, SOCIAL AND ETHICAL ISSUES, JUSTICE, CRIMINAL JUSTICE, HUMAN RIGHTS, BIOETHICS, INTERPERSONAL RELATIONSHIPS, ETHICS, VALUES, SOCIAL ISSUES, AND A WIDE VARIETY OF TOPICS OF GENERAL INTEREST FROM A CHRISTIAN WORLDVIEW PERSPECTIVE; STUDY GUIDES, INSTRUCTIONAL AND TEACHING MANUALS, EDUCATIONAL CURRICULA, STUDY GUIDES, BOOKLETS, PAMPHLETS, BROCHURES, NEWSLETTERS, WORKBOOKS, REPORTS, JOURNALS, ALL IN THE FIELDS OF THE ARTS, COMMUNICATIONS, JOURNALISM, EDUCATION, HISTORY, POLITICAL SCIENCE, LAW, LITERATURE, PHILOSOPHY, CHRISTIANITY, RELIGION, SCIENCE, MATHEMATICS, SOCIAL SCIENCES, PSYCHOLOGY, THEOLOGY, SPIRITUALITY, SOCIAL AND ETHICAL ISSUES, JUSTICE, CRIMINAL JUSTICE, HUMAN RIGHTS, BIOETHICS, INTERPERSONAL RELATIONSHIPS, ETHICS, VALUES, SOCIAL ISSUES, AND A WIDE VARIETY OF TOPICS OF GENERAL INTEREST FROM A CHRISTIAN WORLDVIEW PERSPECTIVE (U.S. CLS. 2, 5, 22, 23, 29, 37, 38 AND 50).

FIRST USE 10-0-2009; IN COMMERCE 10-0-2009.

CLASS 16—(Continued).

4,165,585. PRISON FELLOWSHIP MINISTRIES, LANS-
DOWNE, VA. SN 85-282,034. PUB. 8-9-2011, FILED 3-31-
2011.

BREAK  **POINT**

OWNER OF U.S. REG. NOS. 1,829,643, 1,837,751, AND
OTHERS.

THE MARK CONSISTS OF THE WORDS "BREAK" AND
"POINT" SEPARATED BY A CIRCLE WITH AN ANGLED
LINE INSIDE REPRESENTING A BENT REED OF GRASS.

FOR PRINTED ARTICLES IN THE FIELDS OF THE
ARTS, COMMUNICATIONS, JOURNALISM, EDUCA-
TION, HISTORY, POLITICAL SCIENCE, LAW, LITERA-
TURE, PHILOSOPHY, CHRISTIANITY, RELIGION,
SCIENCE, MATHEMATICS, SOCIAL SCIENCES, PSY-
CHOLOGY, THEOLOGY, SPIRITUALITY, SOCIAL AND
ETHICAL ISSUES, JUSTICE, CRIMINAL JUSTICE, HU-
MAN RIGHTS, BIOETHICS, INTERPERSONAL RELA-
TIONSHIPS, ETHICS, VALUES, SOCIAL ISSUES, AND A
WIDE VARIETY OF TOPICS OF GENERAL INTEREST
FROM A CHRISTIAN WORLDVIEW PERSPECTIVE;
STUDY GUIDES, INSTRUCTIONAL AND TEACHING
MANUALS, EDUCATIONAL CURRICULA, STUDY
GUIDES, BOOKLETS, PAMPHLETS, BROCHURES,
NEWSLETTERS, WORKBOOKS, REPORTS, JOURNALS,
ALL IN THE FIELDS OF THE ARTS, COMMUNICA-
TIONS, JOURNALISM, EDUCATION, HISTORY, POLI-
TICAL SCIENCE, LAW, LITERATURE, PHILOSOPHY,
CHRISTIANITY, RELIGION, SCIENCE, MATHE-
MATICS, SOCIAL SCIENCES, PSYCHOLOGY, THEOL-
OGY, SPIRITUALITY, SOCIAL AND ETHICAL ISSUES,
JUSTICE, CRIMINAL JUSTICE, HUMAN RIGHTS,
BIOETHICS, INTERPERSONAL RELATIONSHIPS,
ETHICS, VALUES, SOCIAL ISSUES, AND A WIDE
VARIETY OF TOPICS OF GENERAL INTEREST FROM
A CHRISTIAN WORLDVIEW PERSPECTIVE (U.S. CLS. 2,
5, 22, 23, 29, 37, 38 AND 50).
FIRST USE 10-0-2009; IN COMMERCE 10-0-2009.

4,165,602. STELMACK, AMY SUZANNE, DBA IVAN, AMY,
CENTERVILLE, OH. SN 85-284,649. PUB. 8-30-2011, FILED
4-2-2011.

**The pen marks the line
between love and murder**

THE MARK CONSISTS OF STANDARD CHARACTERS
WITHOUT CLAIM TO ANY PARTICULAR FONT, STYLE,
SIZE, OR COLOR.

FOR NOVELS; ROMANCE NOVELS; SERIES OF FIC-
TION BOOKS; SERIES OF FICTION WORKS, NAMELY,
NOVELS AND BOOKS (U.S. CLS. 2, 5, 22, 23, 29, 37, 38
AND 50).
FIRST USE 4-4-2012; IN COMMERCE 4-7-2012.

CLASS 16—(Continued).

4,165,628. ANNE-MARIE WEBER, INC., CRYSTAL BAY, NV.
SN 85-289,579. PUB. 8-16-2011, FILED 4-7-2011.

TRANSITIONS

THE MARK CONSISTS OF STANDARD CHARACTERS
WITHOUT CLAIM TO ANY PARTICULAR FONT, STYLE,
SIZE, OR COLOR.

FOR ART PRINTS; PHOTOGRAPHIC PRINTS (U.S.
CLS. 2, 5, 22, 23, 29, 37, 38 AND 50).

FIRST USE 10-1-2011; IN COMMERCE 4-8-2012.

4,165,633. ARONS, RONALD E, OAKLAND, CA. SN 85-
291,167. PUB. 9-6-2011, FILED 4-10-2011.

Life Chronology

THE MARK CONSISTS OF STANDARD CHARACTERS
WITHOUT CLAIM TO ANY PARTICULAR FONT, STYLE,
SIZE, OR COLOR.

FOR LEGAL PADS (U.S. CLS. 2, 5, 22, 23, 29, 37, 38
AND 50).

FIRST USE 4-12-2012; IN COMMERCE 4-12-2012.

4,165,778. STEVEN P. DEMME, LITITZ, PA. SN 85-359,060.
PUB. 1-31-2012, FILED 6-29-2011.

I Can Teach Math

THE MARK CONSISTS OF STANDARD CHARACTERS
WITHOUT CLAIM TO ANY PARTICULAR FONT, STYLE,
SIZE, OR COLOR.

FOR EDUCATIONAL KITS SOLD AS A UNIT IN THE
FIELD OF MATHEMATICS CONSISTING PRIMARILY
OF EDUCATIONAL BOOKS, FLASH CARDS AND
WORKSHEETS, AND ALSO INCLUDING AN EDUCA-
TIONAL DVD (U.S. CLS. 2, 5, 22, 23, 29, 37, 38 AND 50).
FIRST USE 7-23-2009; IN COMMERCE 12-16-2011.

CLASS 16—(Continued).

4,165,800. WHERE'S IT @? MEDIA, LLC, ST LOUIS, MO. SN 85-365,515. PUB. 1-3-2012, FILED 7-7-2011.

CLASS 17—RUBBER GOODS

4,165,126. HAMMERHEAD INDUSTRIES, INC., VENTURA, CA. SN 85-104,479. PUB. 8-23-2011, FILED 8-10-2010.

OFF THE CHAIN

THE MARK CONSISTS OF STANDARD CHARACTERS WITHOUT CLAIM TO ANY PARTICULAR FONT, STYLE, SIZE, OR COLOR.

FOR SERIES OF NON-FICTION BOOKS IN THE FIELD OF TEEN AND YOUNG ADULT ISSUES; BOOKMARKS; PRINTED EDUCATIONAL AND ENTERTAINMENT PUBLICATIONS, NAMELY, HANDOUTS, WORKSHEETS, WORKBOOKS, TEACHER GUIDES, MANUALS, POSTERS AND EDUCATIONAL BOOKLETS ALL IN THE FIELD OF TEEN AND YOUNG ADULT ISSUES; PRINTED CHARTS; GREETING CARDS; POST CARDS; TRADING CARDS (U.S. CLS. 2, 5, 22, 23, 29, 37, 38 AND 50).

FIRST USE 6-1-2010; IN COMMERCE 3-12-2012.

GLASS KEEPER

THE MARK CONSISTS OF STANDARD CHARACTERS WITHOUT CLAIM TO ANY PARTICULAR FONT, STYLE, SIZE, OR COLOR.

NO CLAIM IS MADE TO THE EXCLUSIVE RIGHT TO USE "GLASS", APART FROM THE MARK AS SHOWN.

FOR GLASS SAFETY DEVICE, NAMELY, A DEVICE FOR REDUCING SPREAD OF BROKEN GLASS WHEN BREAKING A WINDOW OR WINDSHIELD IN THE NATURE OF ADHESIVE FILM (U.S. CLS. 1, 5, 12, 13, 35 AND 50).

FIRST USE 4-25-2011; IN COMMERCE 4-25-2011.

4,165,834. M & W, LLC, ATLANTA, GA. SN 85-384,948. PUB. 1-3-2012, FILED 7-29-2011.

Expressionary

THE MARK CONSISTS OF STANDARD CHARACTERS WITHOUT CLAIM TO ANY PARTICULAR FONT, STYLE, SIZE, OR COLOR.

FOR DICTIONARIES (U.S. CLS. 2, 5, 22, 23, 29, 37, 38 AND 50).

FIRST USE 9-29-2011; IN COMMERCE 11-23-2011.

4,165,196. MILITARY WRAPS RESEARCH & DEVELOPMENT, INC., LUMBERTON, NC. SN 85-127,004. PUB. 8-30-2011, FILED 9-10-2010.

4,165,902. PLAYWORLD SYSTEMS, INC., LEWISBURG, PA. SN 85-437,739. PUB. 2-7-2012, FILED 10-3-2011.



NO CLAIM IS MADE TO THE EXCLUSIVE RIGHT TO USE "PLAY DESIGN GUIDE", APART FROM THE MARK AS SHOWN.

THE MARK CONSISTS OF THE WORDS "INCLUSIVE PLAY DESIGN GUIDE". A DESIGN OF A CIRCLE ON A STEM CONNECTED WITH ELEVEN SMALLER CIRCLES ATTACHED TO A LARGER CIRCLE ON THE STEM AND ALL OF WHICH APPEARS UPON A SQUARE WITH ROUNDED EDGES.

FOR PRINTED GUIDES FOR DESIGNING PLAY-GROUNDS (U.S. CLS. 2, 5, 22, 23, 29, 37, 38 AND 50).

FIRST USE 11-1-2011; IN COMMERCE 11-1-2011.

P.I.R.A.T.E.

THE MARK CONSISTS OF STANDARD CHARACTERS WITHOUT CLAIM TO ANY PARTICULAR FONT, STYLE, SIZE, OR COLOR.

FOR MATERIALS AND AIDS FOR TRAINING SYSTEMS, NAMELY, PRINTED VINYL WRAPPING FOR ATTACHMENT TO WINDOWS, WALLS, AND OTHER SOLID SURFACES (U.S. CLS. 1, 5, 12, 13, 35 AND 50).

FIRST USE 4-9-2012; IN COMMERCE 4-9-2012.

CLASS 17—(Continued).

4,165,229. SAINT-GOBAIN PERFORMANCE PLASTICS CORPORATION, AURORA, OH. SN 85-137,748. PUB. 8-30-2011, FILED 9-24-2010.

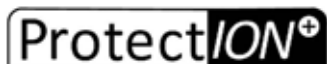

THE MARK CONSISTS OF THE STYLIZED WORD "PROTECTION" WITHIN A RECTANGLE WITH TWO ROUNDED CORNERS ON THE UPPER LEFT AND RIGHT. THE RECTANGLE IS DIVIDED VERTICALLY BY SHADING, WITH THE "PROTECT" PORTION OF "PROTECTION" APPEARING ON ONE SIDE AND THE "ION" PORTION OF "PROTECTION" ON THE OTHER. IN ADDITION, "ION" APPEARS IN ALL CAPS, WITH A PLUS SYMBOL IN A CIRCLE IMMEDIATELY TO THE UPPER RIGHT OF THE "N".

FOR SUBSTRATES IN THE FORM OF ROLLS AND SHEETS, AND SPONGES AND FOAMS, ALL THE FOREGOING PRIMARILY COMPOSED OF SILICONE OR URETHANE, USED FOR CUSHIONING, THERMAL BRIDGING, ELECTRICALLY AND THERMALLY INSULATING AND PACKAGING OF RECHARGEABLE BATTERIES (U.S. CLS. 1, 5, 12, 13, 35 AND 50).
FIRST USE 1-2-2011; IN COMMERCE 1-2-2011.

4,165,254. ROGERS CORPORATION, ROGERS, CT. SN 85-147,745. PUB. 4-26-2011, FILED 10-7-2010.

SHOCK SEAL

THE MARK CONSISTS OF STANDARD CHARACTERS WITHOUT CLAIM TO ANY PARTICULAR FONT, STYLE, SIZE, OR COLOR.

FOR SEMI-FINISHED AND FINISHED MICROPOROUS PLASTIC MATERIAL IN THE NATURE OF PLASTIC FOAMS USED IN THE FURTHER MANUFACTURE OF VARIOUS PRODUCTS FOR APPLICATIONS WITHIN THE ELECTRONICS AND GENERAL INDUSTRIAL MARKET SEGMENTS; MICROPOROUS PLASTIC MATERIAL AS SEMI-FINISHED PRODUCTS IN SHEET OR ROLL FORM, OR MOLDED SHAPE FORM FOR USE IN THE FURTHER MANUFACTURE OF VARIOUS PRODUCTS IN A VARIETY OF INDUSTRIES (U.S. CLS. 1, 5, 12, 13, 35 AND 50).

FIRST USE 5-28-2010; IN COMMERCE 5-28-2010.

CLASS 17—(Continued).

4,165,514. SEALED AIR CORPORATION (US), ELMWOOD PARK, NJ. SN 85-270,712. PUB. 8-30-2011, FILED 3-18-2011.

ETHAFOAM WHISPER

THE MARK CONSISTS OF STANDARD CHARACTERS WITHOUT CLAIM TO ANY PARTICULAR FONT, STYLE, SIZE, OR COLOR.

OWNER OF U.S. REG. NOS. 726,386 AND 1,734,811.
FOR FOAMED PLASTICS IN THE FORM OF SHEETS, PANELS AND PLANKS FOR USE IN AND AS ACOUSTIC INSULATORS, SOUND ABSORBERS AND VIBRATION DAMPENING MATERIALS FOR USE IN BUILDING CONSTRUCTION, ACOUSTICAL INSULATION BARRIER PANELS AND PLANKS (U.S. CLS. 1, 5, 12, 13, 35 AND 50).
FIRST USE 3-28-2012; IN COMMERCE 3-28-2012.

CLASS 18—LEATHER GOODS

4,165,039. ANDREW ACKERMANN, OXNARD, CA. SN 85-007,754. PUB. 8-31-2010, FILED 4-6-2010.

MAISON FORTE

THE MARK CONSISTS OF STANDARD CHARACTERS WITHOUT CLAIM TO ANY PARTICULAR FONT, STYLE, SIZE, OR COLOR.

FOR LEATHER GOODS, NAMELY, WALLETS AND BAGS (U.S. CLS. 1, 2, 3, 22 AND 41).
FIRST USE 3-5-2012; IN COMMERCE 4-2-2012.

4,165,056. K. HANSOTIA & CO., INC., MIAMI, FL. SN 85-023,731. PUB. 3-8-2011, FILED 4-27-2010.

STRIDER

THE MARK CONSISTS OF STANDARD CHARACTERS WITHOUT CLAIM TO ANY PARTICULAR FONT, STYLE, SIZE, OR COLOR.

FOR CARRY-ALL BAGS, CANVAS ALL-PURPOSE CARRYING BAGS, NYLON FABRIC ALL-PURPOSE CARRYING BAGS, LEATHER POUCHES, POUCHES OF CANVAS TEXTILE, RUCKSACKS, DUFFLE BAGS, GARMENT BAGS FOR TRAVEL, TOOL BAGS SOLD EMPTY, BACKPACKS, TRUNKS, SUITCASES, BILLFOLDS, WALLETS, HARNESES, LEATHER BAGS, LEATHER BAG LACES, VALISES (U.S. CLS. 1, 2, 3, 22 AND 41).

FIRST USE 1-1-2012; IN COMMERCE 1-1-2012.

CLASS 18—(Continued).

4,165,210. PAYLESS SHOESOURCE WORLDWIDE, INC., TOPEKA, KS. SN 85-131,571. PUB. 3-22-2011, FILED 9-16-2010.

MINICCI GIRL

THE MARK CONSISTS OF STANDARD CHARACTERS WITHOUT CLAIM TO ANY PARTICULAR FONT, STYLE, SIZE, OR COLOR.

OWNER OF U.S. REG. NOS. 2,846,898, 2,992,430, AND OTHERS.

NO CLAIM IS MADE TO THE EXCLUSIVE RIGHT TO USE "GIRL", APART FROM THE MARK AS SHOWN.

FOR HANDBAGS, SHOULDER BAGS, PURSES, WALLETS AND TOTE BAGS (U.S. CLS. 1, 2, 3, 22 AND 41). FIRST USE 2-0-2010; IN COMMERCE 2-0-2010.

4,165,383. LI, ZHI YONG, GUANGZHOU, GUANGDONG,, CHINA. SN 85-209,647. PUB. 8-23-2011, FILED 1-4-2011.



NO CLAIM IS MADE TO THE EXCLUSIVE RIGHT TO USE "1995", APART FROM THE MARK AS SHOWN.

THE MARK CONSISTS OF A CROSS APPEARING AT THE TOP OF THE MARK ABOVE A STYLIZED CROWN. BENEATH THE CROWN APPEARS A STYLIZED WING SHAPE DESIGN. THE WORDING "YUNNIKA" APPEARS BENEATH THE WING DESIGN, FOLLOWED BY THE NUMBERS OR YEAR 1995.

CLASS 18—(Continued).

THE WORDING "YUNNIKA" HAS NO MEANING IN A FOREIGN LANGUAGE.

FOR ALL-PURPOSE ATHLETIC BAGS; ALL-PURPOSE CARRYING BAGS; ANIMAL SKINS; ARTIFICIAL FUR; ATTACHE CASES; BACKPACKS; NAMELY, BOOK BAGS, SPORTS BAGS, BUM BAGS, WALLETS AND HANDBAGS; BEACHBAGS; BELT BAGS AND HIP BAGS; BRIEFCASES; BUSINESS CARD CASES; CANVAS SHOPPING BAGS; CARD WALLETS; CASES FOR KEYS; CLUTCH BAGS; COIN PURSES; COSMETIC BAGS SOLD EMPTY; CREDIT CARD CASES AND HOLDERS; DRY BAGS; EVENING HANDBAGS; FASHION HANDBAGS; FUR, NAMELY, SYNTHETIC FUR, FUR PELTS, FURS SOLD IN BULK AND FIGURES MADE OF FUR; GARMENT BAGS FOR TRAVEL; GYM BAGS; HANDBAGS, PURSES AND WALLETS; LEATHER AND IMITATION LEATHER; IMITATION LEATHER KEY CHAINS; KEY BAGS; KEYCASES; LEATHER BAGS, NAMELY, SUITCASES AND WALLETS; LUGGAGE AND TRUNKS; MULTI-PURPOSE PURSES; POCHETTES; PURSES AND WALLETS; SATCHELS; SCHOOLBAGS; SHOULDER BAGS; TRAVELING BAGS; UMBRELLAS; VALISES; WALLETS MADE OF LEATHER OR OTHER MATERIALS; WINE CARRYING CASES (U.S. CLS. 1, 2, 3, 22 AND 41).

FIRST USE 8-1-2011; IN COMMERCE 8-1-2011.

4,165,394. IRON FIST INTERNTIONAL, INC., LOS ANGELES, CA. SN 85-215,290. PUB. 3-15-2011, FILED 1-11-2011.

DEADBOY

THE MARK CONSISTS OF STANDARD CHARACTERS WITHOUT CLAIM TO ANY PARTICULAR FONT, STYLE, SIZE, OR COLOR.

FOR ALL PURPOSE SPORTS BAGS; ALL PURPOSE ATHLETIC CARRYING BAGS; BACK PACKS; BOOK BAGS; DUFFEL BAGS; GYM BAGS; TOTE BAGS; KNAPSACKS; LUGGAGE; BACKPACKS; BEACH BAGS; WAIST PACKS; SHOPPING BAGS OF LEATHER AND VINYL; WALLETS; HANDBAGS; PURSES (U.S. CLS. 1, 2, 3, 22 AND 41).

FIRST USE 3-1-2012; IN COMMERCE 3-1-2012.

4,165,439. WAGGONER, LINDA R., PLANO, TX. SN 85-243,358. PUB. 12-13-2011, FILED 2-16-2011.

MARGARITA MONEY

THE MARK CONSISTS OF STANDARD CHARACTERS WITHOUT CLAIM TO ANY PARTICULAR FONT, STYLE, SIZE, OR COLOR.

NO CLAIM IS MADE TO THE EXCLUSIVE RIGHT TO USE "MONEY", APART FROM THE MARK AS SHOWN.

FOR WRIST MOUNTED PURSES; PURSES (U.S. CLS. 1, 2, 3, 22 AND 41).

FIRST USE 5-16-2011; IN COMMERCE 3-22-2012.

CLASS 18—(Continued).

4,165,776. SUN YA TECHNOLOGY INDUSTRIAL CO., LTD.,
CHANGHUA COUNTY, TAIWAN. SN 85-356,279. PUB. 1-
24-2012, FILED 6-25-2011.

STÖDENKEL

THE MARK CONSISTS OF STANDARD CHARACTERS
WITHOUT CLAIM TO ANY PARTICULAR FONT, STYLE,
SIZE, OR COLOR.

FOR LEATHER AND IMITATION LEATHER BAGS,
SUITCASES AND WALLET; LEATHER AND IMITATION
LEATHER SPORT BAGS AND GENERAL PURPOSE
TROLLEY BAGS; DUFFEL BAGS; WHEELED BAGS;
WHEELED DUFFEL BAGS (U.S. CLS. 1, 2, 3, 22 AND 41).
FIRST USE 5-27-2011; IN COMMERCE 3-29-2012.

4,165,786. WILLIAMS & WILLIAMS, INC., LAKELAND, FL.
SN 85-361,907. PUB. 11-1-2011, FILED 7-1-2011.

IDENTISTRAP

THE MARK CONSISTS OF STANDARD CHARACTERS
WITHOUT CLAIM TO ANY PARTICULAR FONT, STYLE,
SIZE, OR COLOR.

FOR LUGGAGE LABEL HOLDERS; LUGGAGE TAGS;
STRAPS FOR LUGGAGE (U.S. CLS. 1, 2, 3, 22 AND 41).
FIRST USE 2-6-2012; IN COMMERCE 2-27-2012.

4,165,852. INFANTINO, LLC, SAN DIEGO, CA. SN 85-393,657.
PUB. 1-10-2012, FILED 8-9-2011.

SYNC

THE MARK CONSISTS OF STANDARD CHARACTERS
WITHOUT CLAIM TO ANY PARTICULAR FONT, STYLE,
SIZE, OR COLOR.

FOR INFANT CARRIERS WORN ON THE BODY (U.S.
CLS. 1, 2, 3, 22 AND 41).
FIRST USE 10-24-2011; IN COMMERCE 10-24-2011.

CLASS 18—(Continued).

4,165,937. BOLLYDOLL, LLC, LOS ANGELES, CA. SN 85-
976,742. PUB. 10-25-2011, FILED 3-31-2011.

BOLLYDOLL

THE MARK CONSISTS OF STANDARD CHARACTERS
WITHOUT CLAIM TO ANY PARTICULAR FONT, STYLE,
SIZE, OR COLOR.

FOR BAGS, NAMELY, TOILETRY BAGS SOLD
EMPTY, AND TOTES; CARRYING BAGS, TOTE BAGS;
ALL-PURPOSE CARRYING BAGS; PURSES, HAND-
BAGS, COSMETIC BAGS SOLD EMPTY; DRAWSTRING
BAGS, DRAWSTRING POUCHES (U.S. CLS. 1, 2, 3, 22
AND 41).

FIRST USE 4-10-2012; IN COMMERCE 4-10-2012.

4,165,943. ROBERT P. NICKELL, TORRANCE, CA. SN 85-
976,780. PUB. 3-15-2011, FILED 10-1-2010.

I'M THE DADDY

THE MARK CONSISTS OF STANDARD CHARACTERS
WITHOUT CLAIM TO ANY PARTICULAR FONT, STYLE,
SIZE, OR COLOR.

FOR DIAPER BAGS (U.S. CLS. 1, 2, 3, 22 AND 41).
FIRST USE 4-27-2012; IN COMMERCE 4-27-2012.

**CLASS 19—NON-METALLIC BUILDING MA-
TERIALS**

4,164,839. SEALMARK MANUFACTURING CORPORA-
TION, DONORA, PA. SN 77-572,332. PUB. 2-24-2009, FILED
9-17-2008.

Q-DECK

THE MARK CONSISTS OF STANDARD CHARACTERS
WITHOUT CLAIM TO ANY PARTICULAR FONT, STYLE,
SIZE, OR COLOR.

FOR NON-METAL BUILDING PRODUCTS HAVING A
DECORATIVE OR NON-SLIP COATING, NAMELY,
DECKING BOARDS, TONGUE-AND-GROOVE BOARDS,
CERAMIC TILE, VINYL FLOOR TILES, CONCRETE
STEPS, CONCRETE PADS, AND FENCING MATERIAL
IN THE NATURE OF FENCING POSTS, PANELS, AND
GATES (U.S. CLS. 1, 12, 33 AND 50).

FIRST USE 11-3-2011; IN COMMERCE 11-3-2011.

CLASS 19—(Continued).

4,164,841. LUMETA, INC., IRVINE, CA. SN 77-574,834. PUB. 1-27-2009, FILED 9-19-2008.

Lumeta^o

THE MARK CONSISTS OF STYLIZED LETTERS, "L", "U", "M", "E", "T", "A" AND AN ELEVATED CIRCLE AFTER THE LETTER "A".

FOR NON-METAL ROOFING TILES HAVING INTEGRATED SOLAR PANELS (U.S. CLS. 1, 12, 33 AND 50). FIRST USE 6-30-2011; IN COMMERCE 6-30-2011.

CLASS 19—(Continued).

4,165,228. SWIFF-TRAIN COMPANY, LLC, CORPUS CHRISTI, TX. SN 85-137,613. PUB. 8-30-2011, FILED 9-24-2010.

RAPID CLIC

THE MARK CONSISTS OF STANDARD CHARACTERS WITHOUT CLAIM TO ANY PARTICULAR FONT, STYLE, SIZE, OR COLOR.

FOR FLOOR TILE, NAMELY, PVC VINYL TILES AND PLANKS (U.S. CLS. 1, 12, 33 AND 50). FIRST USE 1-31-2011; IN COMMERCE 4-25-2012.

4,164,930. FORZASTONE, LLC, MESA, AZ. SN 77-846,982. PUB. 2-22-2011, FILED 10-12-2009.

Forzastone

THE MARK CONSISTS OF STANDARD CHARACTERS WITHOUT CLAIM TO ANY PARTICULAR FONT, STYLE, SIZE, OR COLOR.

FOR PREMANUFACTURED STONE PAVER COVERING MOUNTED ON A FRAMEWORK OR LATTICE FOR INTERIOR OR EXTERIOR USE SUCH AS A FLOOR, WALL, CEILING AND ROOF COVERING (U.S. CLS. 1, 12, 33 AND 50).

FIRST USE 10-22-2009; IN COMMERCE 11-1-2009.

4,165,301. WEYERHAEUSER NR COMPANY, FEDERAL WAY, WA. SN 85-169,096. PUB. 9-13-2011, FILED 11-4-2010.

WEYERHAEUSER

THE MARK CONSISTS OF STANDARD CHARACTERS WITHOUT CLAIM TO ANY PARTICULAR FONT, STYLE, SIZE, OR COLOR.

OWNER OF U.S. REG. NOS. 817,189, 818,501, AND OTHERS.

SEC. 2(F). FOR WOODEN FLOORING (U.S. CLS. 1, 12, 33 AND 50).

FIRST USE 4-30-2008; IN COMMERCE 4-30-2008.

4,165,122. LOSETAS ASFALTICAS, S. DE R.L. DE C.V., DELEG. IZTACALCO, C.P., MEXICO. SN 85-102,327. PUB. 1-18-2011, FILED 8-6-2010.

ACCUCARPET

THE MARK CONSISTS OF STANDARD CHARACTERS WITHOUT CLAIM TO ANY PARTICULAR FONT, STYLE, SIZE, OR COLOR.

FOR VINYL FLOORING (U.S. CLS. 1, 12, 33 AND 50). FIRST USE 3-1-2011; IN COMMERCE 3-1-2011.

4,165,443. GUARDIAN INDUSTRIES CORP., AUBURN HILLS, MI. SN 85-245,281. PUB. 6-28-2011, FILED 2-17-2011.

TWILIGHTGREEN

THE MARK CONSISTS OF STANDARD CHARACTERS WITHOUT CLAIM TO ANY PARTICULAR FONT, STYLE, SIZE, OR COLOR.

FOR GLASS PANELS AND SHEETS FOR USE IN BUILDINGS (U.S. CLS. 1, 12, 33 AND 50). FIRST USE 2-0-2011; IN COMMERCE 2-0-2011.

CLASS 19—(Continued).

4,165,500. ODL, INCORPORATED, ZEELAND, MI. SN 85-266,274. PUB. 7-26-2011, FILED 3-14-2011.

FLEX BBG

THE MARK CONSISTS OF STANDARD CHARACTERS WITHOUT CLAIM TO ANY PARTICULAR FONT, STYLE, SIZE, OR COLOR.
FOR NON-METAL WINDOWS, NAMELY, DOOR-GLASS (U.S. CLS. 1, 12, 33 AND 50).
FIRST USE 2-15-2012; IN COMMERCE 2-15-2012.

4,165,610. BEDFORD REINFORCED PLASTICS INC., BEDFORD, PA. SN 85-286,217. PUB. 8-9-2011, FILED 4-5-2011.

PROGRID

THE MARK CONSISTS OF STANDARD CHARACTERS WITHOUT CLAIM TO ANY PARTICULAR FONT, STYLE, SIZE, OR COLOR.
FOR MOLDED FIBERGLASS GRATING (U.S. CLS. 1, 12, 33 AND 50).
FIRST USE 9-0-2011; IN COMMERCE 9-0-2011.

4,165,611. BEDFORD REINFORCED PLASTICS INC., BEDFORD, PA. SN 85-286,223. PUB. 8-9-2011, FILED 4-5-2011.

PROGRATE

THE MARK CONSISTS OF STANDARD CHARACTERS WITHOUT CLAIM TO ANY PARTICULAR FONT, STYLE, SIZE, OR COLOR.
FOR PULTRUDED FIBERGLASS GRATING (U.S. CLS. 1, 12, 33 AND 50).
FIRST USE 9-0-2011; IN COMMERCE 9-0-2011.

CLASS 19—(Continued).

4,165,751. UNITED STATES GYPSUM COMPANY, CHICAGO, IL. SN 85-343,544. PUB. 8-23-2011, FILED 6-10-2011.

LEVELROCK UltraArmor

THE MARK CONSISTS OF STANDARD CHARACTERS WITHOUT CLAIM TO ANY PARTICULAR FONT, STYLE, SIZE, OR COLOR.
OWNER OF U.S. REG. NO. 2,498,435.
FOR FLOORING UNDERLAYMENTS (U.S. CLS. 1, 12, 33 AND 50).
FIRST USE 9-30-2011; IN COMMERCE 9-30-2011.

CLASS 20—FURNITURE AND ARTICLES NOT OTHERWISE CLASSIFIED

4,164,863. FRUMOVITZ, ANDREW A., MARINA DEL REY, CA. SN 77-664,537. PUB. 12-29-2009, FILED 2-5-2009.

Theo

THE MARK CONSISTS OF STANDARD CHARACTERS WITHOUT CLAIM TO ANY PARTICULAR FONT, STYLE, SIZE, OR COLOR.
FOR FURNITURE; RESIDENTIAL AND COMMERCIAL FURNITURE; INDOOR AND OUTDOOR FURNITURE; FURNITURE MIRRORS, BEDS, TABLES, CHAIRS, DRESSERS, CABINETS, AND SOFAS; ALL OF THE ABOVE SPECIFICALLY EXCLUDING FURNITURE FOR PETS (U.S. CLS. 2, 13, 22, 25, 32 AND 50).
FIRST USE 3-17-2011; IN COMMERCE 3-17-2011.

4,164,890. COLUMBIA SPORTSWEAR NORTH AMERICA, INC., PORTLAND, OR. SN 77-777,626. PUB. 11-10-2009, FILED 7-9-2009.

OMNI-HEAT

THE MARK CONSISTS OF STANDARD CHARACTERS WITHOUT CLAIM TO ANY PARTICULAR FONT, STYLE, SIZE, OR COLOR.
FOR SLEEPING BAGS (U.S. CLS. 2, 13, 22, 25, 32 AND 50).
FIRST USE 5-0-2011; IN COMMERCE 5-0-2011.

CLASS 20—(Continued).

4,164,941. OLY-OLA EDGINGS, INC., VILLA PARK, IL. SN 77-871,883. PUB. 4-20-2010, FILED 11-13-2009.

TECO-EDG

THE MARK CONSISTS OF STANDARD CHARACTERS WITHOUT CLAIM TO ANY PARTICULAR FONT, STYLE, SIZE, OR COLOR.

FOR PLASTIC LANDSCAPE EDGING (U.S. CLS. 2, 13, 22, 25, 32 AND 50).

FIRST USE 4-2-2012; IN COMMERCE 4-2-2012.

4,165,242. BICOR PROCESSING CORP., BROOKLYN, NY. SN 85-143,345. PUB. 3-22-2011, FILED 10-1-2010.

THE SNORE LESS PILLOW

THE MARK CONSISTS OF STANDARD CHARACTERS WITHOUT CLAIM TO ANY PARTICULAR FONT, STYLE, SIZE, OR COLOR.

NO CLAIM IS MADE TO THE EXCLUSIVE RIGHT TO USE "PILLOW", APART FROM THE MARK AS SHOWN.

FOR PILLOWS (U.S. CLS. 2, 13, 22, 25, 32 AND 50).

FIRST USE 6-30-2011; IN COMMERCE 6-30-2011.

4,165,256. GEIST, ROBERT, NEEDHAM, MA. SN 85-148,368. PUB. 3-22-2011, FILED 10-8-2010.

Every Fan Needs A Fan

THE MARK CONSISTS OF STANDARD CHARACTERS WITHOUT CLAIM TO ANY PARTICULAR FONT, STYLE, SIZE, OR COLOR.

FOR HAND-HELD, JAPANESE-STYLE FANS INCORPORATING SPORTS TEAM LOGOS (U.S. CLS. 2, 13, 22, 25, 32 AND 50).

FIRST USE 4-19-2012; IN COMMERCE 4-19-2012.

CLASS 20—(Continued).

4,165,259. LUBE HOLDING S.R.L., TREIA, ITALY. SN 85-150,630. PUB. 7-26-2011, FILED 10-12-2010.



NO CLAIM IS MADE TO THE EXCLUSIVE RIGHT TO USE "CUCINE", APART FROM THE MARK AS SHOWN.

THE COLOR(S) WHITE AND RED IS/ARE CLAIMED AS A FEATURE OF THE MARK.

THE MARK CONSISTS OF THE WORDS "CUCINE LUBE" IN WHITE LETTERS ON A RED SQUARE BACKGROUND.

THE ENGLISH TRANSLATION OF "CUCINE" IN THE MARK IS "KITCHENS".

FOR KITCHEN FURNITURE, NAMELY, CHEST OF DRAWERS, KITCHEN CABINETS, WALL UNITS, SHELVES, KITCHEN WORK SURFACES, CUPBOARDS (U.S. CLS. 2, 13, 22, 25, 32 AND 50).

FIRST USE 1-31-2004; IN COMMERCE 1-31-2004.

4,165,410. WUXI TAIHU TRACTOR CO., LTD, WUXI, CHINA. SN 85-224,357. PUB. 11-22-2011, FILED 1-24-2011.

TAIHU

THE MARK CONSISTS OF STANDARD CHARACTERS WITHOUT CLAIM TO ANY PARTICULAR FONT, STYLE, SIZE, OR COLOR.

OWNER OF U.S. REG. NO. 3,849,647.

THE ENGLISH TRANSLATION OF "TAIHU" IN THE MARK IS "GRAND LAKE".

FOR CASKETS; COFFINS; FUNERARY URNS (U.S. CLS. 2, 13, 22, 25, 32 AND 50).

FIRST USE 1-1-2000; IN COMMERCE 1-1-2012.

CLASS 20—(Continued).

4,165,424. SEALY TECHNOLOGY LLC, TRINITY, NC. SN 85-235,724. PUB. 8-16-2011, FILED 2-7-2011.

TITANIUM SS

THE MARK CONSISTS OF STANDARD CHARACTERS WITHOUT CLAIM TO ANY PARTICULAR FONT, STYLE, SIZE, OR COLOR.

NO CLAIM IS MADE TO THE EXCLUSIVE RIGHT TO USE "TITANIUM", APART FROM THE MARK AS SHOWN. FOR TITANIUM MATTRESS SPRINGS SOLD AS AN INTEGRAL COMPONENT OF MATTRESSES (U.S. CLS. 2, 13, 22, 25, 32 AND 50).

FIRST USE 1-0-2011; IN COMMERCE 1-0-2011.

4,165,425. SEALY TECHNOLOGY LLC, TRINITY, NC. SN 85-235,736. PUB. 8-16-2011, FILED 2-7-2011.

TITANIUM DSx

THE MARK CONSISTS OF STANDARD CHARACTERS WITHOUT CLAIM TO ANY PARTICULAR FONT, STYLE, SIZE, OR COLOR.

NO CLAIM IS MADE TO THE EXCLUSIVE RIGHT TO USE "TITANIUM", APART FROM THE MARK AS SHOWN. FOR TITANIUM MATTRESS SPRINGS SOLD AS AN INTEGRAL COMPONENT OF MATTRESSES (U.S. CLS. 2, 13, 22, 25, 32 AND 50).

FIRST USE 1-0-2011; IN COMMERCE 1-0-2011.

4,165,473. SANFORD, PETER B., MORRO BAY, CA. SN 85-259,248. PUB. 8-23-2011, FILED 3-6-2011.



NO CLAIM IS MADE TO THE EXCLUSIVE RIGHT TO USE "THE ULTIMATE PAINTING SYSTEM", APART FROM THE MARK AS SHOWN.

THE MARK CONSISTS OF THE PHRASE "SNAPNSAVE" POSITIONED ABOVE THE WORDS "THE ULTIMATE PAINTING SYSTEM" WITH LIQUID APPEARING TO DRAIN FROM THE MIDDLE "N" IN "SNAPNSAVE" INTO THE "U" IN THE WORD "ULTIMATE".

FOR CAN LIDS MADE OUT OF PLASTIC AND SPECIALLY ADAPTED FOR TRANSFERRING THE CONTENTS OF A CAN TO ANOTHER CAN, POURING THE CONTENTS FROM A CAN, SEALING A CAN AND STACKING CANS (U.S. CLS. 2, 13, 22, 25, 32 AND 50).

FIRST USE 6-1-2011; IN COMMERCE 3-1-2012.

CLASS 20—(Continued).

4,165,655. GROUPE CABICO INC., COATICOOK (QUEBEC), CANADA. SN 85-297,438. PUB. 10-18-2011, FILED 4-18-2011.



OWNER OF U.S. REG. NOS. 3,078,846 AND 3,850,438.

NO CLAIM IS MADE TO THE EXCLUSIVE RIGHT TO USE "CUSTOM CABINETRY", APART FROM THE MARK AS SHOWN.

THE COLOR(S) BLACK, RED AND LIGHT YELLOW IS/ARE CLAIMED AS A FEATURE OF THE MARK.

THE MARK CONSISTS OF THE WORD "TANGO" COLORED IN RED ABOVE A RECTANGLE OUTLINED IN BLACK AND SHADED IN LIGHT YELLOW CONTAINING THE WORD "CABICO" COLORED IN BLACK AND THE WORDS "CUSTOM CABINETRY" COLORED IN RED.

FOR BATHROOM VANITIES (U.S. CLS. 2, 13, 22, 25, 32 AND 50).

FIRST USE 1-4-2011; IN COMMERCE 1-4-2011.

4,165,667. FERNANDEZ, REBECCA, GREENWOOD, SC. SN 85-300,087. PUB. 9-6-2011, FILED 4-20-2011.

BUMP IT ALL

THE MARK CONSISTS OF STANDARD CHARACTERS WITHOUT CLAIM TO ANY PARTICULAR FONT, STYLE, SIZE, OR COLOR.

FOR PILLOWS (U.S. CLS. 2, 13, 22, 25, 32 AND 50).

FIRST USE 3-24-2011; IN COMMERCE 4-20-2011.

4,165,703. SLANSKY, CINDY ANN, AKA CINDY SCHIFF, HUNTINGTON STATION, NY. SN 85-313,432. PUB. 12-20-2011, FILED 5-5-2011.



THE COLOR(S) BLUE, GREEN, BLACK, WHITE, AND GREY IS/ARE CLAIMED AS A FEATURE OF THE MARK.

THE MARK CONSISTS OF TWO BLUE HORIZONTAL LINES IN BETWEEN WHICH IS A GREEN HORIZONTAL LINE. THE CENTER OF SAID GREEN HORIZONTAL LINE

CLASS 20—(Continued).

ENCIRCLES AN IMAGE OF PLANET EARTH GIVING SAID GREEN LINE AN UPPER AND LOWER ARCH IN WHICH SAID IMAGE OF PLANET EARTH IS HOUSED. SAID IMAGE OF PLANET EARTH IS IN SHADES OF BLUE FOR THE WATER AND THE CONTINENTS IN GREY AND WHITE. IN THE CENTER OF SAID IMAGE OF PLANET EARTH IS THE LITERAL ELEMENT OF THE MARK "GREENPAXX". THE LITERAL ELEMENT "GREENPAXX" IS IN FONT SHERMLOCK AND THE "GREEN" LETTERS ARE SLIGHTLY SMALLER THAN THE "PAXX" LETTERS. SAID LITERAL ELEMENT IS OUTLINED IN THE SAME GREEN AS THE CENTER HORIZONTAL STRIPE. THE COLOR BLACK APPEARS IN THE WORDING "GREENPAXX" AND OUTLINES THE DESIGN OF THE EARTH.

FOR DRINKING STRAWS; NON-METALLIC SEALING CAPS (U.S. CLS. 2, 13, 22, 25, 32 AND 50).

FIRST USE 10-25-2011; IN COMMERCE 12-30-2011.

4,165,769. CORE DISTRIBUTION, INC., MINNEAPOLIS, MN. SN 85-353,596. PUB. 12-13-2011, FILED 6-22-2011.

XTEND+CLIMB

THE MARK CONSISTS OF STANDARD CHARACTERS WITHOUT CLAIM TO ANY PARTICULAR FONT, STYLE, SIZE, OR COLOR.

OWNER OF U.S. REG. NOS. 2,821,779 AND 4,035,779.

FOR NON-METAL LADDER ACCESSORIES, NAMELY, PLASTIC WORK SURFACES FEATURING TOOL AND ACCESSORY ORGANIZERS, FOR USE ON AND ATTACHMENT TO LADDERS, AND CLOTH ACCESSORY ORGANIZERS FOR USE ON AND ATTACHMENTS TO LADDERS (U.S. CLS. 2, 13, 22, 25, 32 AND 50).

FIRST USE 4-4-2012; IN COMMERCE 4-4-2012.

4,165,810. 3 DAY BLINDS CORPORATION, IRVINE, CA. SN 85-372,920. PUB. 1-24-2012, FILED 7-15-2011.

SIMPLY SHEER

THE MARK CONSISTS OF STANDARD CHARACTERS WITHOUT CLAIM TO ANY PARTICULAR FONT, STYLE, SIZE, OR COLOR.

NO CLAIM IS MADE TO THE EXCLUSIVE RIGHT TO USE "SHEER", APART FROM THE MARK AS SHOWN.

FOR WINDOW SHADES (U.S. CLS. 2, 13, 22, 25, 32 AND 50).

FIRST USE 10-17-2011; IN COMMERCE 10-18-2011.

CLASS 20—(Continued).

4,165,909. ZINUS INC., HAYWARD, CA. SN 85-460,756. PUB. 2-7-2012, FILED 10-31-2011.

MyGel

THE MARK CONSISTS OF STANDARD CHARACTERS WITHOUT CLAIM TO ANY PARTICULAR FONT, STYLE, SIZE, OR COLOR.

FOR MATTRESS TOPPERS; MATTRESSES AND PILLOWS (U.S. CLS. 2, 13, 22, 25, 32 AND 50).

FIRST USE 12-15-2011; IN COMMERCE 1-15-2012.

4,165,910. ZINUS INC., HAYWARD, CA. SN 85-464,052. PUB. 2-7-2012, FILED 11-3-2011.

THE COLOR(S) BRIGHT PINK AND BLACK IS/ARE CLAIMED AS A FEATURE OF THE MARK.

THE MARK CONSISTS OF BRIGHT PINK STYLIZED "V" NEXT TO THE WORD "GEL" IN BLACK LETTERING.

FOR BEDS, MATTRESSES, PILLOWS AND BOLSTERS; MATTRESS TOPPERS (U.S. CLS. 2, 13, 22, 25, 32 AND 50).

FIRST USE 12-1-2011; IN COMMERCE 1-15-2012.

4,165,915. CARPENTER CO., RICHMOND, VA. SN 85-976,222. PUB. 11-8-2011, FILED 4-26-2011.

The Name You Know The Comfort You Deserve For the Sleep You Need

THE MARK CONSISTS OF STANDARD CHARACTERS WITHOUT CLAIM TO ANY PARTICULAR FONT, STYLE, SIZE, OR COLOR.

FOR PILLOWS (U.S. CLS. 2, 13, 22, 25, 32 AND 50).

FIRST USE 8-0-2011; IN COMMERCE 8-0-2011.

CLASS 21—HOUSEWARES AND GLASS

CLASS 21—(Continued).

4,164,798. WEAN GREEN INC, CALGARY, ALBERTA, CANADA. SN 76-705,194. PUB. 8-23-2011, FILED 11-1-2010.

WEAN GREEN

THE MARK CONSISTS OF STANDARD CHARACTERS WITHOUT CLAIM TO ANY PARTICULAR FONT, STYLE, SIZE, OR COLOR.

PRIORITY CLAIMED UNDER SEC. 44(D) ON CANADA APPLICATION NO. 1,498,105, FILED 10-1-2010.

NO CLAIM IS MADE TO THE EXCLUSIVE RIGHT TO USE "GREEN", APART FROM THE MARK AS SHOWN.

FOR HOUSEHOLD CONTAINERS FOR FOOD AND BEVERAGES (U.S. CLS. 2, 13, 23, 29, 30, 33, 40 AND 50). FIRST USE 6-30-2010; IN COMMERCE 6-30-2010.

4,164,829. RAPALA, GREGG R., ARLINGTON HEIGHTS, IL. SN 77-541,651. PUB. 4-7-2009, FILED 8-7-2008.

SWEEPER SHEET

THE MARK CONSISTS OF STANDARD CHARACTERS WITHOUT CLAIM TO ANY PARTICULAR FONT, STYLE, SIZE, OR COLOR.

NO CLAIM IS MADE TO THE EXCLUSIVE RIGHT TO USE "SHEET", APART FROM THE MARK AS SHOWN.

FOR DUSTPAN OR A DUSTPAN SHAPED MORE LIKE A SHEET, AND A DUSTPAN OR A DUSTPAN SHAPED MORE LIKE A SHEET AND RECEPTACLE SOLD AS A UNIT (U.S. CLS. 2, 13, 23, 29, 30, 33, 40 AND 50).

FIRST USE 4-26-2012; IN COMMERCE 4-26-2012.

4,164,970. INTEX DIY, INC., AKA INTEX SUPPLY, VILLA RICA, GA. SN 77-933,332. PUB. 8-30-2011, FILED 2-11-2010.

Snow Cloth

THE MARK CONSISTS OF STANDARD CHARACTERS WITHOUT CLAIM TO ANY PARTICULAR FONT, STYLE, SIZE, OR COLOR.

NO CLAIM IS MADE TO THE EXCLUSIVE RIGHT TO USE "CLOTH", APART FROM THE MARK AS SHOWN.

FOR CLEANING AND POLISHING CLOTHS; CLEANING CLOTH; CLEANING CLOTHS; CLEANING RAGS; CLEANING, DUSTING AND POLISHING CLOTHS; CLOTH FOR WIPING OR DUSTING; CLOTHS FOR CLEANING; DUSTING OR CLEANING CLOTHS; POLISHING CLOTHS (U.S. CLS. 2, 13, 23, 29, 30, 33, 40 AND 50).

FIRST USE 4-7-2010; IN COMMERCE 4-7-2010.

CLASS 21—(Continued).

4,164,984. AGS LABS, INC., DALLAS, TX. SN 77-950,344. PUB. 8-17-2010, FILED 3-4-2010.

E-Z CAMPING

THE MARK CONSISTS OF STANDARD CHARACTERS WITHOUT CLAIM TO ANY PARTICULAR FONT, STYLE, SIZE, OR COLOR.

NO CLAIM IS MADE TO THE EXCLUSIVE RIGHT TO USE "CAMPING", APART FROM THE MARK AS SHOWN.

FOR COOKWARE, NAMELY, POTS AND PANS AND PORTABLE COOKING PAN SETS FOR OUTDOOR USE; TABLEWARE, NAMELY, DISHES, PLATES AND BOWLS; AND CONTAINERS, NAMELY, PLASTIC STORAGE CONTAINERS FOR DOMESTIC USE AND FOR PREPARING, SERVING AND CONTAINING FOOD AND BEVERAGES FOR CAMPING AND INDOOR AND OUTDOOR USE (U.S. CLS. 2, 13, 23, 29, 30, 33, 40 AND 50).

FIRST USE 1-19-2012; IN COMMERCE 1-19-2012.

4,165,108. HWB, L.L.C., FAIRFAX, IA. SN 85-087,779. PUB. 3-1-2011, FILED 7-19-2010.

STOALE

THE MARK CONSISTS OF STANDARD CHARACTERS WITHOUT CLAIM TO ANY PARTICULAR FONT, STYLE, SIZE, OR COLOR.

FOR PLASTIC NOZZLE FOR DIRECTING AND DEFLECTING THE FLOW OF BEER FROM A FAUCET (U.S. CLS. 2, 13, 23, 29, 30, 33, 40 AND 50).

FIRST USE 4-10-2012; IN COMMERCE 4-10-2012.

4,165,119. SYNAPSE TRADE SOLUTIONS LLC, SUNNYVALE, CA. SN 85-100,265. PUB. 1-18-2011, FILED 8-4-2010.

WOOF 'N' MEOW

THE MARK CONSISTS OF STANDARD CHARACTERS WITHOUT CLAIM TO ANY PARTICULAR FONT, STYLE, SIZE, OR COLOR.

FOR CANISTER SETS; HOUSEHOLD STORAGE CONTAINERS FOR PET FOOD; PANS; PET FEEDING AND DRINKING BOWLS; PET FEEDING DISHES; PET TREAT JARS (U.S. CLS. 2, 13, 23, 29, 30, 33, 40 AND 50).

FIRST USE 11-1-2010; IN COMMERCE 11-1-2010.

CLASS 21—(Continued).

4,165,492. SLY BOARD COMPANY, NORTH MIAMI BEACH, FL. SN 85-264,965. PUB. 8-23-2011, FILED 3-11-2011.

L'BORD

THE MARK CONSISTS OF STANDARD CHARACTERS WITHOUT CLAIM TO ANY PARTICULAR FONT, STYLE, SIZE, OR COLOR.

FOR CUTTING BOARDS (U.S. CLS. 2, 13, 23, 29, 30, 33, 40 AND 50).

FIRST USE 4-10-2011; IN COMMERCE 4-10-2011.

4,165,511. LIFETIME BRANDS, INC., GARDEN CITY, NY. SN 85-269,348. PUB. 8-2-2011, FILED 3-17-2011.

I DO

THE MARK CONSISTS OF STANDARD CHARACTERS WITHOUT CLAIM TO ANY PARTICULAR FONT, STYLE, SIZE, OR COLOR.

FOR DINNERWARE (U.S. CLS. 2, 13, 23, 29, 30, 33, 40 AND 50).

FIRST USE 10-13-2011; IN COMMERCE 10-13-2011.

4,165,536. MARIA CURCIO, FREEHOLD, NJ. SN 85-274,682. PUB. 8-30-2011, FILED 3-23-2011.



NO CLAIM IS MADE TO THE EXCLUSIVE RIGHT TO USE "BED BUGS", APART FROM THE MARK AS SHOWN.

THE MARK CONSISTS OF THE STYLIZED WORDING "BUGGYBED" WITH A CARTOON IMAGE OF A BEDBUG CRAWLING THROUGH THE LOWER PORTION OF THE FIRST LETTER "B" WITH DROPLETS UNDER IT, AND THE WORDS "STOPS BED BUGS DEAD" WRITTEN INSIDE THE LOWER PORTION OF THE LETTER "Y".

FOR INSECT TRAPS (U.S. CLS. 2, 13, 23, 29, 30, 33, 40 AND 50).

FIRST USE 9-15-2011; IN COMMERCE 9-15-2011.

CLASS 21—(Continued).

4,165,544. LIFETIME BRANDS, INC., GARDEN CITY, NY. SN 85-275,347. PUB. 8-9-2011, FILED 3-24-2011.

BARMASTER'S

THE MARK CONSISTS OF STANDARD CHARACTERS WITHOUT CLAIM TO ANY PARTICULAR FONT, STYLE, SIZE, OR COLOR.

FOR BEVERAGE GLASSWARE; BEVERAGEWARE (U.S. CLS. 2, 13, 23, 29, 30, 33, 40 AND 50).

FIRST USE 8-1-2011; IN COMMERCE 8-1-2011.

4,165,565. MCCULLOUGH, CHERYL, NORTHRIDGE, CA. SN 85-278,099. PUB. 8-9-2011, FILED 3-27-2011.

FOOD FOR THOUGHT...THINK ORGANIC

THE MARK CONSISTS OF STANDARD CHARACTERS WITHOUT CLAIM TO ANY PARTICULAR FONT, STYLE, SIZE, OR COLOR.

FOR BOTTLE SQUEEGEES, BEVERAGE GLASSWARE, BEVERAGEWARE, BOWLS, COASTERS NOT OF PAPER AND NOT BEING TABLE LINEN, COASTERS, NOT OF PAPER AND OTHER THAN TABLE LINEN, CANDLE HOLDERS, CANISTER SETS, COFFEE CUPS, TEA CUPS AND MUGS, COFFEE MUGS, CONTAINERS FOR HOUSEHOLD OR KITCHEN USE NOT OF PRECIOUS METAL, COOLERS FOR WINE, CUPS AND MUGS, DECORATIVE PLATES, DISHES, DISHWARE, DINNERWARE, NAMELY, PLATES, CUPS AND SAUCERS, INSULATING SLEEVE HOLDER FOR BEVERAGE CUPS, KNIFE BOARDS, KNIFE BLOCKS, DRINKING CUPS AND SAUCERS, DRINKING VESSELS, GLASS MUGS, LUNCH BOXES, LUNCH BOXES MADE OF PLASTIC, LUNCH BOXES MADE OF METAL, MIXING BOWLS, PASTRY BAGS, PLASTIC BOTTLE WITH BLOWN CAVITY INSERT SOLD EMPTY, PLASTIC WATER BOTTLES SOLD EMPTY, PLASTIC WATER BOTTLE HOLDERS AND ATTACHED CARABINER CLIP SOLD AS A UNIT, PORCELAIN MUGS, PORTABLE BEVERAGE DISPENSERS, PORTABLE COOLERS, RECYCLABLE FLEXIBLE PLASTIC POUCHES SOLD EMPTY FOR HOLDING WATER OR NUTRITIONAL LIQUIDS, RINSING BOWLS, SALAD BOWLS, SALT AND PEPPER SHAKERS, SERVING DISHES, SOAP DISHES, SQUEEZE BOTTLE SOLD EMPTY, SQUEEGEES, TABLE PLACE CARD HOLDERS NOT OF PRECIOUS METAL, TEA CANISTERS, TEA POTS, THERMAL INSULATED BAGS FOR FOOD OR BEVERAGES, THERMAL INSULATED CONTAINERS FOR FOOD OR BEVERAGES, THERMAL INSULATED WRAP FOR CANS TO KEEP THE CONTENTS COLD OR HOT, WINE BOTTLE VESTS SPECIALLY ADAPTED FOR DECORATING WINE BOTTLES, WINE BUCKETS, WINE COASTERS OF PRECIOUS METAL, WINE GLASSES, WINE OPENERS, WINE POURERS, WINE TASTERS, WOKS, WOOD CHOPPING BOARDS FOR KITCHEN USE (U.S. CLS. 2, 13, 23, 29, 30, 33, 40 AND 50).

FIRST USE 11-4-2011; IN COMMERCE 11-4-2011.

CLASS 21—(Continued).

4,165,606. IGLOO PRODUCTS CORP., KATY, TX. SN 85-285,798. PUB. 8-9-2011, FILED 4-4-2011.

DUO

THE MARK CONSISTS OF STANDARD CHARACTERS WITHOUT CLAIM TO ANY PARTICULAR FONT, STYLE, SIZE, OR COLOR.

FOR PORTABLE CONTAINERS FOR ICE, FOOD, AND BEVERAGES (U.S. CLS. 2, 13, 23, 29, 30, 33, 40 AND 50).
FIRST USE 4-15-2011; IN COMMERCE 4-15-2011.

4,165,617. Q10 PRODUCTS LLC, TENAFLY, NJ. SN 85-287,433. PUB. 8-16-2011, FILED 4-6-2011.

BREW PAD

THE MARK CONSISTS OF STANDARD CHARACTERS WITHOUT CLAIM TO ANY PARTICULAR FONT, STYLE, SIZE, OR COLOR.

FOR METAL WIRE FORMED ACCESSORIES FOR KITCHEN AND HOME DÉCOR USE, NAMELY, HOLDERS FOR PLASTIC CARTRIDGES CONTAINING SINGLE SERVINGS OF COFFEE AND TEA; NON-METAL ACCESSORIES FOR KITCHEN AND HOME DÉCOR USE, NAMELY, HOLDERS FOR PLASTIC CARTRIDGES CONTAINING SINGLE SERVINGS OF COFFEE AND TEA (U.S. CLS. 2, 13, 23, 29, 30, 33, 40 AND 50).
FIRST USE 12-0-2010; IN COMMERCE 12-0-2010.

4,165,680. UFP TECHNOLOGIES, INC., GEORGETOWN, MA. SN 85-305,664. PUB. 9-27-2011, FILED 4-27-2011.

SPOT ERASER

THE MARK CONSISTS OF STANDARD CHARACTERS WITHOUT CLAIM TO ANY PARTICULAR FONT, STYLE, SIZE, OR COLOR.

NO CLAIM IS MADE TO THE EXCLUSIVE RIGHT TO USE "SPOT", APART FROM THE MARK AS SHOWN.

FOR INDUSTRIAL AND HOUSEHOLD CLEANING TOOLS, NAMELY, SPONGES AND CLEANING PADS (U.S. CLS. 2, 13, 23, 29, 30, 33, 40 AND 50).
FIRST USE 3-20-2012; IN COMMERCE 3-20-2012.

CLASS 21—(Continued).

4,165,689. HANDI-FOIL CORPORATION, WHEELING, IL. SN 85-308,384. PUB. 8-2-2011, FILED 4-29-2011.

JIF-FOIL

THE MARK CONSISTS OF STANDARD CHARACTERS WITHOUT CLAIM TO ANY PARTICULAR FONT, STYLE, SIZE, OR COLOR.

OWNER OF U.S. REG. NOS. 3,663,685, 3,903,065, AND OTHERS.

FOR NON-ELECTRIC ALUMINUM AND ROASTING PANS WITH PLASTIC LIDS, CONTAINERS FORMED OF ALUMINUM FOIL WITH PLASTIC LIDS FOR HOUSEHOLD USE, PANS FORMED OF ALUMINUM FOIL WITH WIRE HANDLES AND PLASTIC LIDS, AND PANS FORMED OF ALUMINUM FOIL WITH PLASTIC LIDS (U.S. CLS. 2, 13, 23, 29, 30, 33, 40 AND 50).

FIRST USE 9-30-2011; IN COMMERCE 9-30-2011.

4,165,699. PEAK ENTERPRISES, INC., SARASOTA, FL. SN 85-311,221. PUB. 10-25-2011, FILED 5-3-2011.

PEAK ESSENTIALS THE ORIGINAL TUNG BRUSH

THE MARK CONSISTS OF STANDARD CHARACTERS WITHOUT CLAIM TO ANY PARTICULAR FONT, STYLE, SIZE, OR COLOR.

NO CLAIM IS MADE TO THE EXCLUSIVE RIGHT TO USE "THE ORIGINAL TONGUE BRUSH", APART FROM THE MARK AS SHOWN.

FOR ORAL HYGIENE BRUSH FOR THE TONGUE (U.S. CLS. 2, 13, 23, 29, 30, 33, 40 AND 50).

FIRST USE 9-30-2011; IN COMMERCE 9-30-2011.

4,165,723. BALOGH, ERIN, SAN MARCOS, CA. SN 85-329,742. PUB. 11-15-2011, FILED 5-25-2011.

HOT IRON HOLSTER

THE MARK CONSISTS OF STANDARD CHARACTERS WITHOUT CLAIM TO ANY PARTICULAR FONT, STYLE, SIZE, OR COLOR.

NO CLAIM IS MADE TO THE EXCLUSIVE RIGHT TO USE "HOT IRON", APART FROM THE MARK AS SHOWN.

FOR CADDIES FOR HOLDING HAIR APPLIANCES (U.S. CLS. 2, 13, 23, 29, 30, 33, 40 AND 50).
FIRST USE 12-1-2010; IN COMMERCE 4-1-2012.

CLASS 21—(Continued).

4,165,761. MARCHFIVE LLC, WYNDMOOR, PA. SN 85-346,877. PUB. 2-7-2012, FILED 6-15-2011.

TOYDOZER

THE MARK CONSISTS OF STANDARD CHARACTERS WITHOUT CLAIM TO ANY PARTICULAR FONT, STYLE, SIZE, OR COLOR.

FOR DUST PAN STYLED APPARATUS FEATURING A NON-METAL BIN AND SCOOPER FOR PICKING UP TOYS (U.S. CLS. 2, 13, 23, 29, 30, 33, 40 AND 50).

FIRST USE 3-10-2012; IN COMMERCE 3-10-2012.

4,165,807. FORTESSA, INC., STERLING, VA. SN 85-371,360. PUB. 12-13-2011, FILED 7-14-2011.

FORTALITE

THE MARK CONSISTS OF STANDARD CHARACTERS WITHOUT CLAIM TO ANY PARTICULAR FONT, STYLE, SIZE, OR COLOR.

OWNER OF U.S. REG. NO. 2,672,923.

FOR COOKWARE (U.S. CLS. 2, 13, 23, 29, 30, 33, 40 AND 50).

FIRST USE 7-0-2011; IN COMMERCE 8-0-2011.

4,165,921. SUMMIT ENTERTAINMENT, LLC, SANTA MONICA, CA. SN 85-976,573. PUB. 7-5-2011, FILED 3-29-2011.

THE TWILIGHT SAGA

THE MARK CONSISTS OF STANDARD CHARACTERS WITHOUT CLAIM TO ANY PARTICULAR FONT, STYLE, SIZE, OR COLOR.

OWNER OF U.S. REG. NOS. 3,756,560, 3,884,386, AND OTHERS.

FOR BEVERAGEWARE, LUNCH BOXES WITH THERMAL CONTAINERS, PLASTIC WATER BOTTLES SOLD EMPTY; CANDY BOXES, COASTERS NOT OF PAPER AND NOT TABLE LINEN, DECORATIVE CERAMIC TILES NOT FOR USE AS BUILDING MATERIALS, DISHES, TRAVEL MUGS, AND HAIR BRUSHES; AND DINNERWARE, NAMELY, PLATES AND CUPS NOT OF METAL (U.S. CLS. 2, 13, 23, 29, 30, 33, 40 AND 50).

FIRST USE 10-1-2009; IN COMMERCE 10-1-2009.

CLASS 22—CORDAGE AND FIBERS**CLASS 22—(Continued).**

4,165,124. STARCHTECH INTERNATIONAL PTE. LTD., KUALA LUMPUR, MALAYSIA. SN 85-103,309. PUB. 1-25-2011, FILED 8-9-2010.



NO CLAIM IS MADE TO THE EXCLUSIVE RIGHT TO USE "ZERO PLASTIC", APART FROM THE MARK AS SHOWN.

FOR AWNINGS; CLOTH BAGS FOR STORAGE; COMMERCIAL NETS; COTTON BAGS; GENERAL UTILITY BAGS FOR COMMERCIAL USE; LAUNDRY BAGS; MESH BAGS FOR STORAGE; MULTI-PURPOSE CLOTH BAGS; PACKAGING BAGS OF TEXTILE MATERIAL; PADDING AND STUFFING MATERIALS NOT OF RUBBER, PAPER OR PLASTIC; RAW FIBROUS TEXTILE MATERIALS; ROPES; SACKS OR BAGS FOR THE TRANSPORTATION OR STORAGE OF MATERIALS IN BULK; SAILS; STORAGE BAGS FOR INDUSTRIAL USE; STRING; TARPAULINS; TENTS; TEXTILE BAGS FOR MERCHANDISE PACKAGING; ALL OF THE FOREGOING NOT MADE OF PLASTIC (U.S. CLS. 1, 2, 7, 19, 22, 42 AND 50).

FIRST USE 9-0-2011; IN COMMERCE 4-23-2012.

4,165,650. AE TENT, LLC, MIAMI, FL. SN 85-296,031. PUB. 9-27-2011, FILED 4-15-2011.

SLIDEWALL TRAC

THE MARK CONSISTS OF STANDARD CHARACTERS WITHOUT CLAIM TO ANY PARTICULAR FONT, STYLE, SIZE, OR COLOR.

NO CLAIM IS MADE TO THE EXCLUSIVE RIGHT TO USE "TRACK", APART FROM THE MARK AS SHOWN.

FOR TENTS AND TENT COMPONENTS, NAMELY, MOVABLE TENT PARTITIONS (U.S. CLS. 1, 2, 7, 19, 22, 42 AND 50).

FIRST USE 2-24-2011; IN COMMERCE 3-4-2011.

CLASS 22—(Continued).

4,165,700. REYNOLDS, CHARLES H., SAN JOSE, CA. AND NEWCOMB, DAVID VANCE, SOQUEL, CA. AND OS-TERHOUT, GLEN WILLIAM, PLEASANTON, CA. SN 85-312,087. PUB. 9-27-2011, FILED 5-4-2011.

Com Dangles

THE MARK CONSISTS OF STANDARD CHARACTERS WITHOUT CLAIM TO ANY PARTICULAR FONT, STYLE, SIZE, OR COLOR.

FOR CABLE TIES AND STRAPS FOR FASTENING AND SECURING OBJECTS SUCH AS BUNDLES OF WIRE TOGETHER (U.S. CLS. 1, 2, 7, 19, 22, 42 AND 50).
FIRST USE 11-7-2011; IN COMMERCE 2-8-2012.

CLASS 24—FABRICS

4,164,875. CAMPBELL, NATALIE MONACO, VIENNA, OH. SN 77-711,795. PUB. 9-22-2009, FILED 4-10-2009.

COVERMADE.

THE MARK CONSISTS OF STANDARD CHARACTERS WITHOUT CLAIM TO ANY PARTICULAR FONT, STYLE, SIZE, OR COLOR.

FOR BED LINEN; COMFORTERS; DUVETS (U.S. CLS. 42 AND 50).
FIRST USE 4-10-2009; IN COMMERCE 4-13-2012.

4,164,958. LORO PIANA S.P.A., QUARONA (VC), ITALY. SN 77-899,012. PUB. 9-7-2010, FILED 12-22-2009.

LORO PIANA WISH

THE MARK CONSISTS OF STANDARD CHARACTERS WITHOUT CLAIM TO ANY PARTICULAR FONT, STYLE, SIZE, OR COLOR.

THE NAME(S), PORTRAIT(S), AND/OR SIGNATURE(S) SHOWN IN THE MARK IDENTIFIES "LORO PIANA", WHOSE CONSENT(S) TO REGISTER IS MADE OF RECORD.

FOR FABRICS FOR TEXTILE USE (U.S. CLS. 42 AND 50).
FIRST USE 12-15-2008; IN COMMERCE 12-15-2008.

CLASS 24—(Continued).

4,165,112. QVC, INC., WEST CHESTER, PA. SN 85-091,485. PUB. 12-7-2010, FILED 7-23-2010.

BLEUSTRETCH

THE MARK CONSISTS OF STANDARD CHARACTERS WITHOUT CLAIM TO ANY PARTICULAR FONT, STYLE, SIZE, OR COLOR.

OWNER OF U.S. REG. NO. 2,861,476.
FOR FABRICS MADE OF A BLEND OF 62% COTTON, 32% POLYESTER, AND 6% SPANDEX (U.S. CLS. 42 AND 50).

FIRST USE 2-28-2011; IN COMMERCE 2-28-2011.

4,165,188. HEIRLOOM HOLDINGS, LLC, MIAMI, FL. SN 85-124,852. PUB. 2-22-2011, FILED 9-8-2010.

NPF

THE MARK CONSISTS OF STANDARD CHARACTERS WITHOUT CLAIM TO ANY PARTICULAR FONT, STYLE, SIZE, OR COLOR.

FOR UPHOLSTERY FABRICS FOR BUSES AND OTHER COMMERCIAL VEHICLES (U.S. CLS. 42 AND 50).

FIRST USE 9-30-2011; IN COMMERCE 9-30-2011.

4,165,660. MARSHALL QUENTIN LLC, NEW YORK, NY. SN 85-298,426. PUB. 9-6-2011, FILED 4-19-2011.

POWERSEAT

THE MARK CONSISTS OF STANDARD CHARACTERS WITHOUT CLAIM TO ANY PARTICULAR FONT, STYLE, SIZE, OR COLOR.

FOR INDOOR AND OUTDOOR FABRIC, NAMELY, POLYESTER FABRIC (U.S. CLS. 42 AND 50).

FIRST USE 5-15-2011; IN COMMERCE 5-15-2011.

CLASS 25—CLOTHING

CLASS 25—(Continued).

4,164,793. BURRESS, TIFFANY J., TOTOWA, NJ. SN 76-704,420. PUB. 9-6-2011, FILED 9-9-2010.

JOIFUL

THE MARK CONSISTS OF STANDARD CHARACTERS WITHOUT CLAIM TO ANY PARTICULAR FONT, STYLE, SIZE, OR COLOR.

FOR MATERNITY CLOTHING AND WEAR, NAMELY, DRESSES, SUITS, T-SHIRTS, JUMPERS, TROUSERS, BLOUSES, SKIRTS, JACKETS, DUNGAREES, JEANS, CARDIGANS, SWEAT SUITS, JOGGING SUITS, MUFFLERS, HEADBANDS, HALTER TOPS, SMOCK TOPS, SKI PANTS, SHAWLS, PONCHOS, SHOULDER WRAPS, NECKERCHIEFS; MATERNITY SWIMWEAR, NAMELY, BATHING SUITS, COVER-UPS; MATERNITY RAINWEAR, NAMELY, RAINCOATS; MATERNITY HOSIERY, NAMELY, STOCKINGS, SOCKS, TIGHTS, LEGGINGS, LEOTARDS; MATERNITY SLEEPWEAR, NAMELY, NIGHTGOWNS, PAJAMAS, MATERNITY SLIPS; MATERNITY LINGERIE, NAMELY, PANTIES, BRAS; FOOTWEAR AND HEADWEAR; ALL OF THE FOREGOING GOODS BEING DESIGNED AND MARKETED FOR MATERNITY USE (U.S. CLS. 22 AND 39).

FIRST USE 3-16-2012; IN COMMERCE 3-16-2012.

4,164,804. RATTE, GEOFFREY S., SAINT PAUL, MN. SN 76-708,570. PUB. 1-24-2012, FILED 8-1-2011.

FISHING KIDS

THE MARK CONSISTS OF STANDARD CHARACTERS WITHOUT CLAIM TO ANY PARTICULAR FONT, STYLE, SIZE, OR COLOR.

NO CLAIM IS MADE TO THE EXCLUSIVE RIGHT TO USE "KIDS", APART FROM THE MARK AS SHOWN.

FOR CLOTHING FOR MEN, WOMEN AND CHILDREN, NAMELY, SHIRTS, T-SHIRTS, POLO SHIRTS, SWEATSHIRTS, JOGGING SUITS, TROUSERS, PANTS, SHORTS, TANK TOPS, RAINWEAR, CLOTH BIBS, SKIRTS, BLOUSES, DRESSES, SUSPENDERS, SWEATERS, JACKETS, COATS, RAINCOATS, SNOW SUITS, TIES, ROBES, HATS, CAPS, SUN VISORS, BELTS, SCARVES, SLEEPWEAR, PAJAMAS, UNDERWEAR, BOOTS, SHOES, SNEAKERS, SANDALS, BOOTIES, SLIPPER SOCKS, SWIMWEAR AND MASQUERADE AND HALLOWEEN COSTUMES AND MASKS SOLD IN CONNECTION THEREWITH (U.S. CLS. 22 AND 39).

FIRST USE 1-13-2012; IN COMMERCE 1-13-2012.

CLASS 25—(Continued).

4,164,811. THE TOPLINE CORPORATION, BELLEVUE, WA. SN 77-396,018. PUB. 12-30-2008, FILED 2-13-2008.

REPORT

THE MARK CONSISTS OF STANDARD CHARACTERS WITHOUT CLAIM TO ANY PARTICULAR FONT, STYLE, SIZE, OR COLOR.

OWNER OF U.S. REG. NOS. 2,169,637, 3,246,085, AND 3,358,128.

FOR WOMEN'S AND GIRLS' APPAREL, NAMELY, T-SHIRTS (U.S. CLS. 22 AND 39).

FIRST USE 8-0-2003; IN COMMERCE 8-0-2003.

4,164,817. BRODAR, ERIC, KENNEBUNK, ME. SN 77-421,886. PUB. 2-17-2009, FILED 3-14-2008.



NO CLAIM IS MADE TO THE EXCLUSIVE RIGHT TO USE "SWEATS", APART FROM THE MARK AS SHOWN.

THE MARK CONSISTS OF THE STYLIZED WORDS "SWEATS BI EBE" WITH TWO DROPS TO THE RIGHT OF THE WORD "SWEATS", THE WORD "SWEATS" IN A LARGER, BOLDFACE FONT, AND A LINE OVER THE LETTER I IN THE WORD "BI" TO INDICATE A LONG PRONUNCIATION OF THE VOWEL.

FOR ACTIVE CLOTHING, NAMELY, PANTS AND SHIRTS (U.S. CLS. 22 AND 39).

FIRST USE 3-16-2012; IN COMMERCE 3-16-2012.

4,164,850. ANTHONY M. RAGO, WESTERN SPRINGS, IL. SN 77-584,521. PUB. 7-28-2009, FILED 10-2-2008.

CHAMPS IN BACK TO BACK CENTURIES

THE MARK CONSISTS OF STANDARD CHARACTERS WITHOUT CLAIM TO ANY PARTICULAR FONT, STYLE, SIZE, OR COLOR.

FOR CLOTHING, NAMELY, SHIRTS AND HATS (U.S. CLS. 22 AND 39).

FIRST USE 1-0-2012; IN COMMERCE 1-0-2012.

CLASS 25—(Continued).

4,164,856. SCOTT STRODE, DENVER, CO. SN 77-621,323.
 PUB. 8-11-2009, FILED 11-25-2008.



THE MARK CONSISTS OF THE GENERAL SHAPE OF A CLOSED FIST IN A SHIELD DESIGN WITH THE WORD "4KNUCKLES" ABOVE IT.
 FOR HATS; SHORT-SLEEVED OR LONG-SLEEVED T-SHIRTS (U.S. CLS. 22 AND 39).
 FIRST USE 5-1-2012; IN COMMERCE 5-1-2012.

CLASS 25—(Continued).

4,164,868. FRERMAN, ANTHONY H., VERSAILLES, KY. SN 77-678,244. PUB. 6-30-2009, FILED 2-25-2009.

WINNING IS A SPORT

THE MARK CONSISTS OF STANDARD CHARACTERS WITHOUT CLAIM TO ANY PARTICULAR FONT, STYLE, SIZE, OR COLOR.
 FOR JERSEYS; TOPS; TRIATHLON CLOTHING, NAMELY, TRIATHLON TIGHTS, TRIATHLON SHORTS, TRIATHLON SINGLETS, TRIATHLON SHIRTS, TRIATHLON SUITS; WEARABLE GARMENTS AND CLOTHING, NAMELY, SHIRTS (U.S. CLS. 22 AND 39).
 FIRST USE 3-16-2011; IN COMMERCE 3-16-2011.

4,164,869. BABEL CLOTHING L.L.C., COLLINSVILLE, IL. SN 77-680,187. PUB. 9-6-2011, FILED 2-27-2009.

Babel Clothing

4,164,867. FRED GARCIA, SAN BRUNO, CA. SN 77-677,607.
 PUB. 7-21-2009, FILED 2-24-2009.



THE MARK CONSISTS OF A MUSCULAR MALE CHILD WITH A PACIFIER IN HIS MOUTH.
 FOR SHIRTS, T-SHIRTS, TANK TOPS, LONG SLEEVE T-SHIRTS, SHORT SLEEVE T-SHIRTS, SWEATSHIRTS, HOODED SWEATSHIRTS, POLO SHIRTS, PULLOVERS, BUTTONED SHIRTS (U.S. CLS. 22 AND 39).
 FIRST USE 12-9-2011; IN COMMERCE 12-22-2011.

THE MARK CONSISTS OF STANDARD CHARACTERS WITHOUT CLAIM TO ANY PARTICULAR FONT, STYLE, SIZE, OR COLOR.
 NO CLAIM IS MADE TO THE EXCLUSIVE RIGHT TO USE "CLOTHING", APART FROM THE MARK AS SHOWN.
 FOR T-SHIRTS, BELTS, BATHING SUITS, BATHING TRUNKS, BASEBALL CAPS, BEANIES, BIKINIS, BLAZERS, BOMBER JACKETS, BOXER SHORTS, COLLARS, DRESS SHIRTS, FOOTWEAR FOR MEN AND WOMEN, GLOVES, HEADGEAR, NAMELY, BANDANAS, HATS, SWEAT BANDS; HOODED SWEAT SHIRTS, LINGERIE, LONG-SLEEVED SHIRTS, LOUNGEWEAR, NECKERCHIEVES, NECKTIES, PAJAMAS, POCKET KERCHIEFS, POLO SHIRTS, SHIRTS, SCARVES, SHOES, SKIRTS, SKULL CAPS, SLACKS, SOCKS, SURF WEAR, SWEAT-BANDS, SWEAT PANTS, SWEAT SHIRTS, SWIMMING TRUNKS, SWIMMING SUITS, TANK TOPS, TIES, TOPS, UNDERGARMENTS, VESTS, WEARABLE GARMENTS AND CLOTHING, NAMELY, SARONGS, PAREOS, BLOUSES, SHIRTS; WRIST BANDS (U.S. CLS. 22 AND 39).
 FIRST USE 5-4-2010; IN COMMERCE 9-9-2011.

CLASS 25—(Continued).

4,164,870. PRO LINE MANUFACTURING CO., WAYNE, NJ. SN 77-691,239. PUB. 7-21-2009, FILED 3-14-2009.

PROLINERS

THE MARK CONSISTS OF STANDARD CHARACTERS WITHOUT CLAIM TO ANY PARTICULAR FONT, STYLE, SIZE, OR COLOR.

OWNER OF U.S. REG. NOS. 1,454,341 AND 3,057,178. FOR FOOTWEAR, NAMELY, THREE PLY WADERS (U.S. CLS. 22 AND 39).

FIRST USE 12-31-2000; IN COMMERCE 12-31-2000.

4,164,903. ROJAS, MARIO, BAKERSFIELD, CA. AND BARON, MARTIN, BAKERSFIELD, CA. SN 77-806,493. PUB. 1-19-2010, FILED 8-17-2009.

CRAZY AZZ DINGO DOGGZ FOR THE DOG IN YOU

THE MARK CONSISTS OF STANDARD CHARACTERS WITHOUT CLAIM TO ANY PARTICULAR FONT, STYLE, SIZE, OR COLOR.

FOR BELTS; BOTTOMS; BOXER BRIEFS; BOXER SHORTS; CAPS; HEADWEAR; PANTS; SHIRTS; SOCKS; SWEAT PANTS; SWEATERS; TOPS; UNDERWEAR (U.S. CLS. 22 AND 39).

FIRST USE 4-13-2012; IN COMMERCE 4-13-2012.

4,164,910. SOCIAL BUTTERFLY INTERNATIONAL, INC., WEST HILLS, CA. SN 77-821,567. PUB. 2-2-2010, FILED 9-8-2009.

REVERE

THE MARK CONSISTS OF STANDARD CHARACTERS WITHOUT CLAIM TO ANY PARTICULAR FONT, STYLE, SIZE, OR COLOR.

FOR BELTS; BLOUSES; BOOTS; BRAS; DRESSES; HATS; JACKETS; JEANS; LINGERIE; PANTIES; SANDALS; SHIRTS; SHOES; SOCKS; STOCKINGS; T-SHIRTS; TANK-TOPS; TIES; TOPS; UNDERWEAR (U.S. CLS. 22 AND 39).

FIRST USE 4-18-2012; IN COMMERCE 4-18-2012.

CLASS 25—(Continued).

4,164,922. CHICO'S BRANDS INVESTMENTS, INC., FORT MYERS, FL. SN 77-835,229. PUB. 2-16-2010, FILED 9-25-2009.

VANISHING TUMMY

THE MARK CONSISTS OF STANDARD CHARACTERS WITHOUT CLAIM TO ANY PARTICULAR FONT, STYLE, SIZE, OR COLOR.

NO CLAIM IS MADE TO THE EXCLUSIVE RIGHT TO USE "TUMMY", APART FROM THE MARK AS SHOWN. FOR FOUNDATION GARMENTS (U.S. CLS. 22 AND 39).

FIRST USE 5-0-2011; IN COMMERCE 5-0-2011.

4,164,927. COLUMBIA INSURANCE COMPANY, OMAHA, NE. SN 77-842,079. PUB. 3-30-2010, FILED 10-6-2009.

BABY B.Ø.C.

THE MARK CONSISTS OF STANDARD CHARACTERS WITHOUT CLAIM TO ANY PARTICULAR FONT, STYLE, SIZE, OR COLOR.

OWNER OF U.S. REG. NO. 3,379,333. NO CLAIM IS MADE TO THE EXCLUSIVE RIGHT TO USE "BABY", APART FROM THE MARK AS SHOWN. FOR FOOTWEAR (U.S. CLS. 22 AND 39).

FIRST USE 12-0-2009; IN COMMERCE 12-0-2009.

4,164,959. BEYOND THE BOX, INC., LEWISVILLE, NC. SN 77-900,545. PUB. 5-18-2010, FILED 12-23-2009.

Fight Like a Carolina Girl

THE MARK CONSISTS OF STANDARD CHARACTERS WITHOUT CLAIM TO ANY PARTICULAR FONT, STYLE, SIZE, OR COLOR.

FOR ATHLETIC APPAREL, NAMELY, SHIRTS, PANTS, JACKETS, HATS AND CAPS, ATHLETIC UNIFORMS EXCLUDING FOOTWEAR (U.S. CLS. 22 AND 39).

FIRST USE 12-18-2008; IN COMMERCE 12-18-2008.

CLASS 25—(Continued).

4,164,968. TAKE 'EM OFFS, LTD., NEW YORK, NY. SN 77-920,137. PUB. 6-14-2011, FILED 1-26-2010.

TAKE 'EM OFFS

THE MARK CONSISTS OF STANDARD CHARACTERS WITHOUT CLAIM TO ANY PARTICULAR FONT, STYLE, SIZE, OR COLOR.

FOR UNDERWEAR AND UNDERCLOTHES, INCLUDING, PANTIES, BRASSIERES, SLIPS, CAMISOLES; LINGERIE; NIGHTGOWNS, NIGHTIES, SLEEPWEAR COVER-UPS AND ROBES (U.S. CLS. 22 AND 39).

FIRST USE 4-9-2012; IN COMMERCE 4-9-2012.

4,164,977. THE GROVE LICENSING AND DESIGN CORPORATION, SANTA BARBARA, CA. SN 77-945,147. PUB. 2-8-2011, FILED 2-25-2010.

PARLOR

THE MARK CONSISTS OF STANDARD CHARACTERS WITHOUT CLAIM TO ANY PARTICULAR FONT, STYLE, SIZE, OR COLOR.

FOR CLOTHING, NAMELY, SHIRTS, T-SHIRTS, AND TOPS (U.S. CLS. 22 AND 39).

FIRST USE 4-21-2010; IN COMMERCE 4-21-2010.

4,165,003. KRIEGER, MICHAEL W, DBA THE HIGHER PLANE, YOUNGSTOWN, OH. SN 77-967,429. PUB. 8-17-2010, FILED 3-24-2010.



The Higher Plane

THE MARK CONSISTS OF AN ASCENDING PLANE (NOSE TOWARD NORTHEAST CORNER) INSIDE OF A CIRCLE. THE WORDS "THE HIGHER PLANE" SIT BELOW THE ASCENDING PLANE INSIDE THE CIRCLE.

FOR SHIRTS (U.S. CLS. 22 AND 39).

FIRST USE 11-1-2009; IN COMMERCE 1-1-2011.

CLASS 25—(Continued).

4,165,008. REEBOK INTERNATIONAL LTD., CANTON, MA. SN 77-983,130. PUB. 4-29-2008, FILED 6-13-2007.

SMOOTHFIT

THE MARK CONSISTS OF STANDARD CHARACTERS WITHOUT CLAIM TO ANY PARTICULAR FONT, STYLE, SIZE, OR COLOR.

FOR ATHLETIC FOOTWEAR (U.S. CLS. 22 AND 39).

FIRST USE 12-1-2007; IN COMMERCE 12-1-2007.

4,165,013. SKECHERS U.S.A., INC. II, MANHATTAN BEACH, CA. SN 77-983,155. PUB. 8-31-2010, FILED 3-16-2010.

TONE-UPS

THE MARK CONSISTS OF STANDARD CHARACTERS WITHOUT CLAIM TO ANY PARTICULAR FONT, STYLE, SIZE, OR COLOR.

OWNER OF U.S. REG. NO. 3,759,127.

FOR FOOTWEAR (U.S. CLS. 22 AND 39).

FIRST USE 11-17-2009; IN COMMERCE 11-17-2009.

4,165,019. SOSA, ALEJANDRO, MIAMI, FL. SN 78-444,490. PUB. 8-26-2008, FILED 7-1-2004.

NUG BRAND

NO CLAIM IS MADE TO THE EXCLUSIVE RIGHT TO USE "BRAND", APART FROM THE MARK AS SHOWN.

FOR CLOTHING, NAMELY, SHIRTS, PANTS, SHORTS, HATS, AND PAJAMAS (U.S. CLS. 22 AND 39).

FIRST USE 10-1-2010; IN COMMERCE 10-1-2010.

CLASS 25—(Continued).

4,165,033. REID, LINDA J., MILWAUKEE, WI. AND BRO-
DESKE, KURT H., MILWAUKEE, WI. SN 85-005,042. PUB.
8-17-2010, FILED 4-2-2010.

CLASS 25—(Continued).

4,165,080. MIAMI MERCHANDISING SALES, INC., MIAMI,
FL. SN 85-046,440. PUB. 10-26-2010, FILED 5-24-2010.

FERAL STYLE

THE MARK CONSISTS OF STANDARD CHARACTERS
WITHOUT CLAIM TO ANY PARTICULAR FONT, STYLE,
SIZE, OR COLOR.

NO CLAIM IS MADE TO THE EXCLUSIVE RIGHT TO
USE "STYLE", APART FROM THE MARK AS SHOWN.

FOR CAPS; COATS; FOOTWEAR FOR WOMEN; HATS;
JACKETS; PANTS; SHIRTS; SOCKS; SWEAT SHIRTS;
SWEATERS; T-SHIRTS; VESTS (U.S. CLS. 22 AND 39).
FIRST USE 4-0-2011; IN COMMERCE 4-11-2012.

On The Rite Path

THE MARK CONSISTS OF STANDARD CHARACTERS
WITHOUT CLAIM TO ANY PARTICULAR FONT, STYLE,
SIZE, OR COLOR.

FOR CLOTHING, NAMELY, SHIRTS, PANTS, SHOES,
JACKETS, SOCKS, BASEBALL CAPS (U.S. CLS. 22 AND
39).

FIRST USE 5-23-2011; IN COMMERCE 5-23-2011.

4,165,072. MICKLES, DEMETRIUS, HASLET, TX. SN 85-
037,956. PUB. 10-19-2010, FILED 5-13-2010.

4,165,088. STAY IN PLACE INTERNATIONAL AB, 70006
ÖREBRO, SWEDEN. SN 85-060,614. PUB. 11-9-2010, FILED
6-11-2010.



NO CLAIM IS MADE TO THE EXCLUSIVE RIGHT TO
USE "CLOTHING", APART FROM THE MARK AS SHOWN.

THE MARK CONSISTS OF THE WORDS "TOOLS" AND
"TRADE" IN LARGE BLOCK LETTERING, THE WORDING
"OF THE" IN THE MIDDLE IN SMALL LETTERING, AND
"CLOTHING" IN LARGE LETTERING BENEATH THE
WORDING "TRADE"; BELOW AND ABOVE THE MARK
IS A HERALDRY TYPE LION, TO THE LEFT AND RIGHT
OF THE WORDING "OF THE" IS A MISCELLANEOUS
DESIGN.

FOR CLOTHING, NAMELY, T-SHIRTS, SHIRTS,
CAPES FOR USE IN SALONS AND BARBER SHOPS,
BARBER AND STYLIST JACKETS (U.S. CLS. 22 AND 39).
FIRST USE 1-1-2011; IN COMMERCE 1-1-2011.



THE MARK CONSISTS OF THE STYLIZED WORDING
"STAY IN PLACE" WITHIN A RECTANGLE WITH
ROUNDED CORNERS.

FOR CLOTHING, NAMELY, BRAS, BRA TOPS,
TIGHTS, LEGGINGS, UNITARDS, LEOTARDS, BI-
CYCLE SHORTS, VESTS, SWIM SUITS, BATHROBES,
TOPS, PANTS, SOCKS, SHOES, HEADWEAR (U.S. CLS.
22 AND 39).

FIRST USE 9-0-2008; IN COMMERCE 5-13-2011.

CLASS 25—(Continued).

4,165,091. JEFFREY DOORNBOS, DBA BAD ROMANCE, BURR RIDGE, IL. SN 85-070,433. PUB. 12-27-2011, FILED 6-24-2010.

Bad Romance

THE MARK CONSISTS OF STANDARD CHARACTERS WITHOUT CLAIM TO ANY PARTICULAR FONT, STYLE, SIZE, OR COLOR.

FOR MEN'S AND WOMEN'S CLOTHING, NAMELY, SHIRTS, SHORTS, JEANS, JACKETS, SKIRTS, SLACKS, BLOUSES, DRESSES, VESTS, COATS, SWEATERS, SCARVES, SWIMSUITS, UNDERWEAR, UNDERPANTS, SLIPS, CAMISOLES, BRAS, NIGHTGOWNS, ROBES, SOCKS, HOSIERY; INFANTS' AND CHILDREN'S CLOTHING, NAMELY, T-SHIRTS, SWEATERS, LONG SLEEVED SHIRTS, SHORTS, PANTS, JUMPERS, JUMPSUITS, OVERALLS, ONE-PIECE PAYSUITS, PAJAMAS, SOCKS, DRESSES, SKIRTS; MEN'S, WOMEN'S, CHILDREN'S AND INFANT'S FOOTWEAR AND HEADWEAR; BELTS (U.S. CLS. 22 AND 39).
FIRST USE 4-10-2011; IN COMMERCE 4-10-2011.

CLASS 25—(Continued).

4,165,160. MAD MAN INTERNATIONAL, INC., PALM BEACH GARDENS, FL. SN 85-118,434. PUB. 2-15-2011, FILED 8-30-2010.



THE MARK CONSISTS OF A CHARACTER WITHIN AN OUTLINED PERIMETER WITH AN OPEN MOUTH, SPIKED HAIR AND WIDE OPEN EYES WITH THE HAIR AND RIGHT SIDE OF THEIR FACE BEING ILLUMINATED AND THE LEFT SIDE OF THEIR FACE BEING SHADED.

FOR APPAREL, NAMELY, SHORT-SLEEVED AND LONG-SLEEVED T-SHIRTS; SHORTS, SURFER SHORTS AND HATS (U.S. CLS. 22 AND 39).
FIRST USE 2-1-2012; IN COMMERCE 2-1-2012.

4,165,201. BERNARD, MARY C., HOUSTON, TX. SN 85-127,597. PUB. 9-6-2011, FILED 9-11-2010.

4,165,106. WALZ, TREVOR, NORRISTOWN, PA. AND BRADY, SCOTT, NORRISTOWN, PA. SN 85-086,463. PUB. 5-24-2011, FILED 7-16-2010.

devil may care clothing company

THE MARK CONSISTS OF STANDARD CHARACTERS WITHOUT CLAIM TO ANY PARTICULAR FONT, STYLE, SIZE, OR COLOR.

NO CLAIM IS MADE TO THE EXCLUSIVE RIGHT TO USE "CLOTHING COMPANY", APART FROM THE MARK AS SHOWN.

FOR HEADWEAR; SHIRTS AND SHORT-SLEEVED SHIRTS; SHORT-SLEEVED OR LONG-SLEEVED T-SHIRTS; T-SHIRTS; TEE SHIRTS; WEARABLE GARMENTS AND CLOTHING, NAMELY, SHIRTS (U.S. CLS. 22 AND 39).
FIRST USE 6-14-2011; IN COMMERCE 6-14-2011.



THE COLOR(S) BLACK AND PURPLE IS/ARE CLAIMED AS A FEATURE OF THE MARK.

THE MARK CONSIST OF A BLACK CROSS OUTLINED IN PURPLE. THE WORDS "WHEN YOU" ARE WRITTEN IN PURPLE HORIZONTALLY INSIDE OF THE CROSS, WITH A PURPLE HEART IN THE CENTER OF THE CROSS. THE LETTERS "TT" ARE PURPLE AND OUTLINED IN BLACK, AND ARE LOCATED IN THE NORTHWEST AND SOUTHWEST CORNERS OF THE CROSS. THE LETTERS "JD" ARE PURPLE AND OUTLINED IN BLACK, AND LOCATED IN THE NORTHEAST AND SOUTHEAST CORNERS OF THE CROSS.

FOR BASEBALL CAPS AND HATS; T-SHIRTS (U.S. CLS. 22 AND 39).
FIRST USE 4-1-2012; IN COMMERCE 4-1-2012.

CLASS 25—(Continued).

4,165,209. PAYLESS SHOESOURCE WORLDWIDE, INC., TOPEKA, KS. SN 85-131,544. PUB. 3-22-2011, FILED 9-16-2010.

MINICCI GIRL

THE MARK CONSISTS OF STANDARD CHARACTERS WITHOUT CLAIM TO ANY PARTICULAR FONT, STYLE, SIZE, OR COLOR.

OWNER OF U.S. REG. NOS. 2,846,898, 2,902,408, AND OTHERS.

NO CLAIM IS MADE TO THE EXCLUSIVE RIGHT TO USE "GIRL", APART FROM THE MARK AS SHOWN.

FOR CLOTHING ACCESSORIES, NAMELY, HEADWEAR, SOCKS, HOSIERY, PANTYHOSE, KNEE-HIGH STOCKINGS, AND TIGHTS (U.S. CLS. 22 AND 39).

FIRST USE 1-0-2012; IN COMMERCE 1-0-2012.

4,165,305. HBI BRANDED APPAREL LIMITED, INC., WINSTON-SALEM, NC. SN 85-170,129. PUB. 4-12-2011, FILED 11-5-2010.

COMFORT STARTS WITH HANES

THE MARK CONSISTS OF STANDARD CHARACTERS WITHOUT CLAIM TO ANY PARTICULAR FONT, STYLE, SIZE, OR COLOR.

OWNER OF U.S. REG. NOS. 847,649, 2,121,985, AND OTHERS.

FOR CAMISOLES; T-SHIRTS; TANK TOPS; UNDERWEAR (U.S. CLS. 22 AND 39).

FIRST USE 8-31-2011; IN COMMERCE 8-31-2011.

4,165,308. MSD CONSUMER CARE, INC., MEMPHIS, TN. SN 85-171,581. PUB. 3-1-2011, FILED 11-8-2010.



THE MARK CONSISTS OF A STYLIZED LETTER "D", AND A STYLIZED LETTER "S" FORMING AN OPEN OVAL. FOR FOOTWEAR (U.S. CLS. 22 AND 39). FIRST USE 1-1-2010; IN COMMERCE 1-1-2010.

CLASS 25—(Continued).

4,165,330. PRO CUBE, TA TEE STAR ACTIVE WEAR, INC., LOS ANGELES, CA. SN 85-182,840. PUB. 7-12-2011, FILED 11-22-2010.



THE MARK CONSISTS OF THE SHARE OF LOGO "CUBE" IS IN BETWEEN THE LETTERS "PRO" AND "CUBE".

FOR APPAREL FOR DANCERS, NAMELY, TEE SHIRTS, SWEATSHIRTS, PANTS, LEGGINGS, SHORTS AND JACKETS (U.S. CLS. 22 AND 39).

FIRST USE 4-2-2012; IN COMMERCE 4-2-2012.

4,165,381. V-THONG LLC, DORAL, FL. SN 85-209,342. PUB. 8-2-2011, FILED 1-3-2011.



THE MARK CONSISTS OF THE WORD "VTHONG" WITH A SQUARE TO THE LEFT OF THE WORD "VTHONG" AND INSIDE OF THE SQUARE IS A STYLIZED LETTER "V".

FOR CLOTHING, NAMELY, SWIMSUITS, SHORTS, T-SHIRTS, DRESSES, SKIRTS, PANTS, BEACH WRAPS, SWEATERS, CAPS (U.S. CLS. 22 AND 39).

FIRST USE 3-2-2012; IN COMMERCE 3-2-2012.

4,165,389. SKR INTERNATIONAL, LLC, WOODINVILLE, WA. SN 85-211,456. PUB. 12-13-2011, FILED 1-5-2011.

kai

OWNER OF U.S. REG. NO. 3,148,688.

CLASS 25—(Continued).

THE MARK CONSISTS OF THE TEXT "KAI" IN STYLIZED LOWER CASE LETTERS.

THE ENGLISH TRANSLATION OF "KAI" IN THE MARK IS "BEGINNING" OR "OPENING".
FOR CHILDREN'S SHOES (U.S. CLS. 22 AND 39).
FIRST USE 8-8-2011; IN COMMERCE 8-8-2011.

CLASS 25—(Continued).

4,165,458. POLARIS INDUSTRIES INC., MEDINA, MN. SN 85-253,213. PUB. 11-29-2011, FILED 2-28-2011.

4,165,429. THRONEBURG, JAMES L., STATESVILLE, NC. SN 85-237,757. PUB. 8-30-2011, FILED 2-9-2011.



THE MARK CONSISTS OF HIGHLY STYLIZED LETTERS "P" AND "A", WITH THE LETTERS BEING MIRROR IMAGES OF EACH OTHER.

FOR CLOTHING, NAMELY, ATHLETIC APPAREL, NAMELY, SWEATPANTS, SHORTS, SOCKS, AND JACKETS (U.S. CLS. 22 AND 39).
FIRST USE 5-20-2010; IN COMMERCE 5-20-2010.

PURE-HEAT

THE MARK CONSISTS OF STANDARD CHARACTERS WITHOUT CLAIM TO ANY PARTICULAR FONT, STYLE, SIZE, OR COLOR.

FOR APPAREL AND CLOTHING, NAMELY, JACKETS, BASE LAYER INSULATED SHIRTS AND UNDERGARMENTS, BIBS NOT OF PAPER, SHIRT, PANTS, GLOVE, SOCKS, HATS; AND FOOTWEAR (U.S. CLS. 22 AND 39).

FIRST USE 3-0-2012; IN COMMERCE 3-0-2012.

4,165,450. WIRED 4 MISCHIEF, LLC, WEDDINGTON, NC. SN 85-249,335. PUB. 7-19-2011, FILED 2-23-2011.



THE MARK CONSISTS OF THE WORDING "WIRED FOR MISCHIEF" IN STYLIZED FORM, WITH A HALO OVER "WIRED" AND A TAIL EXTENDING FROM THE "H" IN "MISCHIEF".

FOR HATS, SHIRTS, T-SHIRTS (U.S. CLS. 22 AND 39).
FIRST USE 1-0-2012; IN COMMERCE 1-0-2012.

4,165,460. R.N'OVATE, INC., LOS ANGELES, CA. SN 85-253,890. PUB. 7-19-2011, FILED 2-28-2011.

CLOVER CANYON

THE MARK CONSISTS OF STANDARD CHARACTERS WITHOUT CLAIM TO ANY PARTICULAR FONT, STYLE, SIZE, OR COLOR.

FOR CLOTHING, NAMELY, TOPS, BOTTOMS, SHIRTS, PANTS, SWEATERS, HEADWEAR, SHORTS, SWIMWEAR, LINGERIE, UNDERWEAR, JACKETS, COATS, WRAPS, DRESSES, SKIRTS, SCARVES (U.S. CLS. 22 AND 39).

FIRST USE 4-0-2011; IN COMMERCE 4-0-2011.

CLASS 25—(Continued).

4,165,486. THEALLET, SOPHIE, NEW YORK, NY. SN 85-262,481. PUB. 7-26-2011, FILED 3-9-2011.



THE MARK CONSISTS OF A CAPITAL "S" LETTER WITH A STAR ON THE LETTER'S TOP RIGHT CORNER. THE LETTER "S" IS WRAPPED AROUND THE POST OF A CAPITAL "T" LETTER. THE LETTERS "S" AND "T" ARE POSITIONED OVER A CIRCLE. THE ENTIRE IMAGE IS SURROUNDED BY THE OUTLINE OF A SQUARE.

FOR CLOTHING, NAMELY, WOMEN'S AND MEN'S SHIRTS, PANTS, DRESSES, SKIRTS, JACKETS, COATS, FOOTWEAR AND HEADWEAR; LEATHER BELTS AND WRISTBANDS (U.S. CLS. 22 AND 39).

FIRST USE 3-20-2012; IN COMMERCE 3-20-2012.

CLASS 25—(Continued).

4,165,521. VICTORY MEDIA, INC., CORAOPOLIS, PA. SN 85-271,973. PUB. 8-16-2011, FILED 3-21-2011.

FIFTY THIRTEEN

THE MARK CONSISTS OF STANDARD CHARACTERS WITHOUT CLAIM TO ANY PARTICULAR FONT, STYLE, SIZE, OR COLOR.

FOR PATRIOTIC CLOTHING AND WEARING APPAREL, NAMELY, OUTER CLOTHING, NAMELY, JACKETS, PONCHOS, SWEATSHIRTS, AND VESTS; SHIRTS, NAMELY, POLO SHIRTS, T-SHIRTS, TANK TOPS, HOODED SWEATSHIRTS AND TIES; UNDERGARMENTS, NAMELY, UNDERSHIRTS, BOXER SHORTS AND PANTIES; SLEEP WEAR, NAMELY, PAJAMAS AND ROBES; SWIM WEAR; SOCKS; HEADWEAR, NAMELY, HATS, BASEBALL CAPS, KNIT CAPS, AND VISORS; PANTS, NAMELY, SWEAT PANTS, JEANS, DRESS AND CASUAL SLACKS, DRESS SHORTS AND ATHLETIC SHORTS; BABY WEAR, NAMELY, BIBS NOT OF PAPER, JUMP SUITS, PAJAMAS, BOOTIES, AND HATS (U.S. CLS. 22 AND 39).

FIRST USE 3-21-2011; IN COMMERCE 6-1-2011.

4,165,520. VICTORY MEDIA, INC., CORAOPOLIS, PA. SN 85-271,961. PUB. 8-16-2011, FILED 3-21-2011.

5013

THE MARK CONSISTS OF STANDARD CHARACTERS WITHOUT CLAIM TO ANY PARTICULAR FONT, STYLE, SIZE, OR COLOR.

FOR PATRIOTIC CLOTHING AND WEARING APPAREL, NAMELY, OUTER CLOTHING, NAMELY, JACKETS, PONCHOS, SWEATSHIRTS, AND VESTS; SHIRTS, NAMELY, POLO SHIRTS, T-SHIRTS, TANK TOPS, HOODED SWEATSHIRTS AND TIES; UNDERGARMENTS, NAMELY, UNDERSHIRTS, BOXER SHORTS AND PANTIES; SLEEP WEAR, NAMELY, PAJAMAS AND ROBES; SWIM WEAR; SOCKS; HEADWEAR, NAMELY, HATS, BASEBALL CAPS, KNIT CAPS, AND VISORS; PANTS, NAMELY, SWEAT PANTS, JEANS, DRESS AND CASUAL SLACKS, DRESS SHORTS AND ATHLETIC SHORTS; BABY WEAR, NAMELY, BIBS NOT OF PAPER, JUMP SUITS, PAJAMAS, BOOTIES, AND HATS (U.S. CLS. 22 AND 39).

FIRST USE 3-21-2011; IN COMMERCE 6-1-2011.

4,165,542. UNITED STATES FOOTBALL LEAGUE, LLC, SAN DIEGO, CA. SN 85-275,213. PUB. 9-13-2011, FILED 3-24-2011.

USFL

THE MARK CONSISTS OF STANDARD CHARACTERS WITHOUT CLAIM TO ANY PARTICULAR FONT, STYLE, SIZE, OR COLOR.

OWNER OF U.S. REG. NO. 3,644,761.

FOR ATHLETIC APPAREL, NAMELY, SHIRTS, PANTS, JACKETS, FOOTWEAR, HATS AND CAPS, ATHLETIC UNIFORMS; HATS; HEADWEAR; JACKETS; PANTS; SHIRTS; SHORTS; SOCKS; SPORTS JERSEYS; SWEATSHIRTS; UNDERGARMENTS; WARM UP OUTFITS (U.S. CLS. 22 AND 39).

FIRST USE 12-31-2011; IN COMMERCE 12-31-2011.

CLASS 25—(Continued).

4,165,586. CHAFFIN, TIMOTHY R., GREAT FALLS, MT. SN 85-282,405. PUB. 8-9-2011, FILED 3-31-2011.

Force Reducer

THE MARK CONSISTS OF STANDARD CHARACTERS WITHOUT CLAIM TO ANY PARTICULAR FONT, STYLE, SIZE, OR COLOR.

FOR SHOES (U.S. CLS. 22 AND 39).

FIRST USE 3-1-2012; IN COMMERCE 3-1-2012.

4,165,614. WARNER, JASON N., BROOKLYN, NY. SN 85-286,929. PUB. 8-30-2011, FILED 4-5-2011.



THE MARK CONSISTS OF AN UN-SHADED INNER CIRCLE, CONTAINING A SHADED VERTICAL AND HORIZONTAL ARROW, INTERSECTING AT THE CENTER, WITH THE VERTICAL ARROW CONTAINING A CROWN AT THE TOP, WITH BOTH ARROWS CONTAINING AN UN-SHADED AND SHADED BORDER; WITH A SHADED OUTER CIRCLE CONTAINING THE UN-SHADED WORD, "BLESSED" IN ALL CAPS IN A CIRCULAR FASHION AT THE TOP, AND THE UN-SHADED WORDING, "ADDICTION" IN ALL CAPS IN A CIRCULAR FASHION AT THE BOTTOM, WITH A SHADED FIVE-POINT STAR CENTERED ON THE LEFT AND RIGHT OF THE OUTER CIRCLE, WITH EACH STAR CONTAINING A SHADED AND UN-SHADED BORDER.

FOR COLLARED SHIRTS; DRESS SHIRTS; HEADGEAR, NAMELY, HATS, HEADBANDS, SWEATER-HATS, AND BANDANAS; HOODED SWEATSHIRTS; JEANS; LEGGINS; PANTS; SHIRTS; SWEAT SHIRTS; T-SHIRTS (U.S. CLS. 22 AND 39).

FIRST USE 0-0-2011; IN COMMERCE 0-0-2011.

CLASS 25—(Continued).

4,165,623. LIN, XIAOGU, ARCADIA, CA. SN 85-288,354. PUB. 9-6-2011, FILED 4-6-2011.

FASHION MIC

THE MARK CONSISTS OF STANDARD CHARACTERS WITHOUT CLAIM TO ANY PARTICULAR FONT, STYLE, SIZE, OR COLOR.

NO CLAIM IS MADE TO THE EXCLUSIVE RIGHT TO USE "FASHION", APART FROM THE MARK AS SHOWN.

FOR APPAREL FOR DANCERS, NAMELY, TEE SHIRTS, SWEATSHIRTS, PANTS, LEGGINGS, SHORTS AND JACKETS; BRIEFS; HATS; HOSIERY; JEGGINGS, NAMELY, PANTS THAT ARE PARTIALLY JEANS AND PARTIALLY LEGGINGS; SCARFS; SOCKS AND STOCKINGS; TIGHTS; UNDERWEAR; WOMEN'S UNDERWEAR; WOVEN OR KNITTED UNDERWEAR (U.S. CLS. 22 AND 39).

FIRST USE 4-1-2012; IN COMMERCE 4-1-2012.

4,165,634. HARD NINETY, INC., GILROY, CA. SN 85-291,342. PUB. 8-23-2011, FILED 4-11-2011.

DEDICATION HEART AND SOUL

THE MARK CONSISTS OF STANDARD CHARACTERS WITHOUT CLAIM TO ANY PARTICULAR FONT, STYLE, SIZE, OR COLOR.

FOR SPORTS APPAREL AND GARMENTS, NAMELY, T-SHIRTS, SWEATSHIRTS, SHORTS AND TANK TOPS (U.S. CLS. 22 AND 39).

FIRST USE 1-0-2012; IN COMMERCE 1-0-2012.

4,165,647. UNDERWARES LLC, HIGHLAND PARK, IL. SN 85-295,636. PUB. 8-23-2011, FILED 4-14-2011.

comfyKitty

THE MARK CONSISTS OF STANDARD CHARACTERS WITHOUT CLAIM TO ANY PARTICULAR FONT, STYLE, SIZE, OR COLOR.

FOR WOMEN'S UNDERWEAR (U.S. CLS. 22 AND 39).

FIRST USE 4-14-2011; IN COMMERCE 4-9-2012.

CLASS 25—(Continued).

4,165,657. MULCH, CLYDE, MANAHAWKIN, NJ. SN 85-297,936. PUB. 8-30-2011, FILED 4-18-2011.



THE MARK CONSISTS OF THE WORDING "DOWN THE MIDDLE" IN FRONT OF A STYLIZED SWIRL. FOR HATS; JACKETS; PANTS; SHIRTS; SOCKS (U.S. CLS. 22 AND 39). FIRST USE 4-0-2011; IN COMMERCE 4-0-2011.

4,165,668. CALLIET, DOLTON, NEW ORLEANS, LA. SN 85-300,558. PUB. 9-6-2011, FILED 4-20-2011.



THE MARK CONSISTS OF A SHIELD WITH THE STYLIZED TEXT "JTD". THE GRAPHIC INCLUDES A FLEUR DE LIS ACROSS BEHIND THE LETTERS "JTD". ON THE OUTER TOP EDGES OF THE SHIELD THERE IS A SYMBOL OF A DIPLOMA ON THE RIGHT HAND SIDE AND AN ARROW ON THE OTHER SIDE. FOR HATS; SHOES; SOCKS; T-SHIRTS (U.S. CLS. 22 AND 39). FIRST USE 3-30-2011; IN COMMERCE 7-1-2011.

CLASS 25—(Continued).

4,165,672. BARREL SPORTSWEAR, LTD, NEW YORK, NY. SN 85-301,945. PUB. 11-8-2011, FILED 4-22-2011.

ADAMO

THE MARK CONSISTS OF STANDARD CHARACTERS WITHOUT CLAIM TO ANY PARTICULAR FONT, STYLE, SIZE, OR COLOR. THE ENGLISH TRANSLATION OF THE MARK IS "TO FALL IN LOVE WITH". FOR SWEATERS (U.S. CLS. 22 AND 39). FIRST USE 4-18-2011; IN COMMERCE 4-18-2011.

4,165,673. 5.11, INC., MODESTO, CA. SN 85-302,387. PUB. 9-20-2011, FILED 4-22-2011.

FLEX-TAC

THE MARK CONSISTS OF STANDARD CHARACTERS WITHOUT CLAIM TO ANY PARTICULAR FONT, STYLE, SIZE, OR COLOR. OWNER OF U.S. REG. NOS. 3,813,086 AND 3,974,554. FOR FABRIC SOLD AS AN INTEGRAL COMPONENT OF FINISHED CLOTHING ITEMS, NAMELY, PANTS, SHIRTS, VESTS; PANTS; SHIRTS; VESTS (U.S. CLS. 22 AND 39). FIRST USE 8-1-2011; IN COMMERCE 8-1-2011.

4,165,674. SECRET CHARM LLC, LOS ANGELES, CA. SN 85-302,716. PUB. 2-7-2012, FILED 4-22-2011.

LILY ROSE

THE MARK CONSISTS OF STANDARD CHARACTERS WITHOUT CLAIM TO ANY PARTICULAR FONT, STYLE, SIZE, OR COLOR. THE NAME(S), PORTRAIT(S), AND/OR SIGNATURE(S) SHOWN IN THE MARK DOES NOT IDENTIFY A PARTICULAR LIVING INDIVIDUAL. FOR BOTTOMS; DRESSES; JACKETS; SKIRTS; TOPS (U.S. CLS. 22 AND 39). FIRST USE 10-0-2011; IN COMMERCE 10-0-2011.

CLASS 25—(Continued).

4,165,687. WORLD OF MOTUS LAURAGE INC, HOLLYWOOD, FL. SN 85-307,503. PUB. 9-13-2011, FILED 4-28-2011.



THE MARK CONSISTS OF THREE VERTICAL LINES WITH THE STYLIZED TEXT "L".

FOR CLOTHING, NAMELY, T-SHIRTS, V-NECK SWEATERS, DRESS SHIRTS, JACKETS, SWEATERS, TANK TOPS, BUTTON DOWN SHIRTS, LONG SLEEVED SHIRTS, COATS, VESTS, DRESSES, JEANS, SLACKS, CARGO SHORTS, BERMUDA SHORTS, CAPRIS, SUITS, SKIRTS, BLOUSES, FLEECE PULLOVERS, FLEECE TOPS, FLEECE VEST, FLEECE BOTTOMS, BOXER BRIEFS, BOXER SHORTS, THONGS, SHOES, SOCKS, BELTS, HATS, TIES, SCARFS, FLIP FLOPS, SANDALS, HEELS, BOOTS (U.S. CLS. 22 AND 39).

FIRST USE 1-1-2012; IN COMMERCE 1-1-2012.

CLASS 25—(Continued).

4,165,704. GONZALEZ, EDGAR, HUNTINGTON BEACH, CA. SN 85-315,044. PUB. 9-27-2011, FILED 5-7-2011.



THE MARK CONSISTS OF A LETTER "H" IN THE FORM OF TWO WAVES CRASHING TO THE RIGHT AS SHOWN IN THE MARK.

FOR CLOTHING, NAMELY, T-SHIRTS, HATS, SWEATERS, JACKETS (U.S. CLS. 22 AND 39).

FIRST USE 10-1-2011; IN COMMERCE 10-1-2011.

4,165,702. WHAT SAY GOD, LLC, PERRY HALL, MD. SN 85-313,134. PUB. 9-27-2011, FILED 5-5-2011.



THE COLOR(S) BLUE, YELLOW, WHITE, BLACK AND PURPLE IS/ARE CLAIMED AS A FEATURE OF THE MARK.

THE MARK CONSISTS OF A BLUE CIRCLE CONTAINING THE ARTISTIC RENDERING OF A CROSS IN WHITE AND THE BIBLE IN BLUE, YELLOW, WHITE AND PURPLE. ABOVE THE BIBLE ARE THE STYLIZED WORDS "WHAT SAY GOD?" IN BLACK AND WHITE. ON THE PAGES OF THE BIBLE IS THE STYLIZED LETTER "A" IN PURPLE AND AN OMEGA SYMBOL IN PURPLE. BELOW THE BIBLE ARE THE STYLIZED WORDS "2TIM 3:16" IN WHITE. BELOW THE BLUE CIRCLE ARE THE STYLIZED WORDS "WWW.WHATSAYGOD.COM" IN BLACK. THERE ARE YELLOW LINES COMING OUT OF THE BIBLE AND EXTENDING BEYOND THE BLUE CIRCLE.

FOR SHIRTS, T-SHIRTS, POLO SHIRTS, PANTS, HATS, COATS AND SCARFS (U.S. CLS. 22 AND 39).

FIRST USE 3-0-2012; IN COMMERCE 3-0-2012.

4,165,707. LITTLE THUMBKIN, INC., CHICAGO, IL. SN 85-315,646. PUB. 9-27-2011, FILED 5-9-2011.



THE COLOR(S) WHITE, BLACK, AND SHADES OF GRAY IS/ARE CLAIMED AS A FEATURE OF THE MARK.

THE MARK CONSISTS OF A CARTOON CHARACTER IN STYLIZED FORM OF A THUMB, WITH A FACE, TWO HANDS, AND TWO LEGS; IN BLACK, WHITE, AND LIGHTER SHADES OF GRAY.

FOR HATS FOR INFANTS, BABIES, TODDLERS AND CHILDREN; HEAD SCARVES; HEADBANDS; HEADBANDS FOR CLOTHING; INFANTS' SHOES AND BOOTS; MITTENS; OUTDOOR MITTENS; SCARFS; SCARVES; SHAWLS AND HEADSCARVES (U.S. CLS. 22 AND 39).

FIRST USE 4-11-2011; IN COMMERCE 2-26-2012.

CLASS 25—(Continued).

4,165,714. JOHN PAUL MERKEL, ORLANDO, FL. SN 85-319,558. PUB. 10-4-2011, FILED 5-12-2011.



THE MARK CONSISTS OF "KÄMPFER" STYLIZED FONT WITH STARS OVER THE LETTER "A" AND BRASS KNUCKLES AS PART OF THE LETTER "E".

THE ENGLISH TRANSLATION OF "KÄMPFER" IN THE MARK IS "FIGHTER".

FOR CLOTHING, NAMELY, SHIRTS, T-SHIRTS, SWEAT SHIRTS, JACKETS, SHORTS, PANTS, CAPS, HATS (U.S. CLS. 22 AND 39).

FIRST USE 4-9-2012; IN COMMERCE 4-9-2012.

CLASS 25—(Continued).

4,165,784. GAHR, JAMES, MURRIETA, CA. SN 85-361,362. PUB. 11-29-2011, FILED 7-1-2011.

DYING TO WIN

THE MARK CONSISTS OF STANDARD CHARACTERS WITHOUT CLAIM TO ANY PARTICULAR FONT, STYLE, SIZE, OR COLOR.

FOR CLOTHING, NAMELY, TOPS, BOTTOMS, T-SHIRTS, HATS, BANDANAS, JACKETS, COATS, UNDERWEAR, GLOVES, SWEATSHIRTS (U.S. CLS. 22 AND 39).

FIRST USE 11-1-2011; IN COMMERCE 11-1-2011.

4,165,789. GREENFISH LLC, SAN CLEMENTE, CA. SN 85-362,453. PUB. 12-20-2011, FILED 7-2-2011.

GREENFISH

THE MARK CONSISTS OF STANDARD CHARACTERS WITHOUT CLAIM TO ANY PARTICULAR FONT, STYLE, SIZE, OR COLOR.

OWNER OF U.S. REG. NO. 3,948,454.

FOR HATS; HEADWEAR; POLO SHIRTS; TEE SHIRTS; VISORS (U.S. CLS. 22 AND 39).

FIRST USE 6-1-2010; IN COMMERCE 6-1-2010.

4,165,754. WEEMS, BRUCE, CUMMING, GA. SN 85-344,398. PUB. 11-1-2011, FILED 6-13-2011.



The Swingers Club

THE MARK CONSISTS OF THE STYLIZED WORDS "THE SWINGERS CLUB". AN IMAGE OF A TRACED SWING PATH OF A GOLF CLUB WITH AN IMAGE OF A GOLFER IN THE CENTER.

FOR HATS; PANTS; SHIRTS; SHORTS (U.S. CLS. 22 AND 39).

FIRST USE 12-0-2011; IN COMMERCE 12-0-2011.

4,165,819. ACI INTERNATIONAL, LOS ANGELES, CA. SN 85-376,585. PUB. 11-1-2011, FILED 7-20-2011.

HELPING SOULS IN NEED

THE MARK CONSISTS OF STANDARD CHARACTERS WITHOUT CLAIM TO ANY PARTICULAR FONT, STYLE, SIZE, OR COLOR.

FOR FOOTWEAR (U.S. CLS. 22 AND 39).

FIRST USE 1-7-2012; IN COMMERCE 1-7-2012.

CLASS 25—(Continued).

4,165,841. BISSLAND, MARVIN, MT PLEASANT, SC. SN 85-389,370. PUB. 1-24-2012, FILED 8-4-2011.

Wine Sippin' Socks

THE MARK CONSISTS OF STANDARD CHARACTERS WITHOUT CLAIM TO ANY PARTICULAR FONT, STYLE, SIZE, OR COLOR.

NO CLAIM IS MADE TO THE EXCLUSIVE RIGHT TO USE "SOCKS", APART FROM THE MARK AS SHOWN. FOR SOCKS (U.S. CLS. 22 AND 39). FIRST USE 1-11-2012; IN COMMERCE 2-23-2012.

4,165,854. JING FU, LLC, CHICAGO, IL. SN 85-394,590. PUB. 1-10-2012, FILED 8-10-2011.

CHICOR

THE MARK CONSISTS OF STANDARD CHARACTERS WITHOUT CLAIM TO ANY PARTICULAR FONT, STYLE, SIZE, OR COLOR.

FOR CLOTHING, NAMELY, KHAKIS; DENIMS; PANTS (U.S. CLS. 22 AND 39). FIRST USE 3-0-2012; IN COMMERCE 3-0-2012.

4,165,862. TRETTIN, DOUGLAS FREDERICK, ATLANTA, GA. SN 85-397,486. PUB. 2-7-2012, FILED 8-14-2011.

SONOFAHON

THE MARK CONSISTS OF STANDARD CHARACTERS WITHOUT CLAIM TO ANY PARTICULAR FONT, STYLE, SIZE, OR COLOR.

FOR BOTTOMS; FABRIC SOLD AS AN INTEGRAL COMPONENT OF FINISHED CLOTHING ITEMS, NAMELY, JACKET LINERS AND WAIST BANDS; JACKETS; JERSEYS; TIES; TOPS; WEARABLE GARMENTS AND CLOTHING, NAMELY, SHIRTS; WOMEN'S CLOTHING, NAMELY, SHIRTS, DRESSES, SKIRTS AND BLOUSES (U.S. CLS. 22 AND 39). FIRST USE 2-15-2012; IN COMMERCE 2-20-2012.

CLASS 25—(Continued).

4,165,868. WHAT SAY GOD, LLC, PERRY HALL, MD. SN 85-400,434. PUB. 1-17-2012, FILED 8-17-2011.

BIBLE ON YOUR BACK

THE MARK CONSISTS OF STANDARD CHARACTERS WITHOUT CLAIM TO ANY PARTICULAR FONT, STYLE, SIZE, OR COLOR.

FOR COATS; HATS; JACKETS; SCARVES; SHIRTS (U.S. CLS. 22 AND 39). FIRST USE 3-0-2012; IN COMMERCE 3-0-2012.

4,165,887. FRANK & ADAM APPAREL LLC, CLEARWATER, FL. SN 85-413,238. PUB. 1-31-2012, FILED 9-1-2011.

DRESSESANDOTHERDRUGS

THE MARK CONSISTS OF STANDARD CHARACTERS WITHOUT CLAIM TO ANY PARTICULAR FONT, STYLE, SIZE, OR COLOR.

FOR DRESSES (U.S. CLS. 22 AND 39). FIRST USE 8-31-2011; IN COMMERCE 8-31-2011.

4,165,904. RUBIE'S COSTUME CO., INC., RICHMOND HILL, NY. SN 85-446,871. PUB. 2-7-2012, FILED 10-13-2011.

DOUBLE TAKE

THE MARK CONSISTS OF STANDARD CHARACTERS WITHOUT CLAIM TO ANY PARTICULAR FONT, STYLE, SIZE, OR COLOR.

FOR HALLOWEEN COSTUMES AND MASKS SOLD IN CONNECTION THEREWITH; MASQUERADE COSTUMES AND MASKS SOLD IN CONNECTION THEREWITH (U.S. CLS. 22 AND 39). FIRST USE 1-26-2012; IN COMMERCE 1-26-2012.

CLASS 25—(Continued).

4,165,919. MITCHELL, NATE, LOS ANGELES, CA. SN 85-976,508. PUB. 7-19-2011, FILED 3-2-2011.

SQUIBS

THE MARK CONSISTS OF STANDARD CHARACTERS WITHOUT CLAIM TO ANY PARTICULAR FONT, STYLE, SIZE, OR COLOR.

OWNER OF U.S. REG. NO. 3,723,423.

FOR ATHLETIC APPAREL, NAMELY, SHIRTS, PANTS, JACKETS, FOOTWEAR, HATS AND CAPS, ATHLETIC UNIFORMS; CHILDREN'S AND INFANT'S APPAREL, NAMELY, JUMPERS, OVERALL SLEEPWEAR, PAJAMAS, ROMPERS AND ONE-PIECE GARMENTS; CHILDREN'S AND INFANTS' APPAREL TREATED WITH FIRE AND HEAT RETARDANTS, NAMELY, JUMPERS, OVERALL SLEEPWEAR, PAJAMAS, ROMPERS AND ONE-PIECE GARMENTS (U.S. CLS. 22 AND 39).

FIRST USE 3-1-2011; IN COMMERCE 3-1-2011.

4,165,922. WOLVERINE WORLD WIDE, INC., ROCKFORD, MI. SN 85-976,596. PUB. 2-22-2011, FILED 10-18-2010.



OWNER OF U.S. REG. NOS. 730,465, 2,208,845, AND OTHERS.

NO CLAIM IS MADE TO THE EXCLUSIVE RIGHT TO USE "SINCE 1883" "ROCKFORD, MI" "WELT CONSTRUCTION", APART FROM THE MARK AS SHOWN.

THE MARK CONSISTS OF THE WORDS "WOLVERINE 1000 MILE ROCKFORD", "MI" INSIDE OF AN OVAL DESIGN, STYLIZED LETTERS "L", "T" AND "W" INSIDE OF A GEOMETRIC DESIGN, THE WORD AND NUMBERS "SINCE 1883" ABOVE THE OVAL DESIGN, AND THE WORDS "WELT CONSTRUCTION" BELOW THE OVAL DESIGN.

FOR FOOTWEAR FEATURING WELT CONSTRUCTION (U.S. CLS. 22 AND 39).

FIRST USE 9-30-2009; IN COMMERCE 9-30-2009.

CLASS 25—(Continued).

4,165,929. SIMMS FISHING PRODUCTS, LLC, BOZEMAN, MT. SN 85-976,697. PUB. 8-9-2011, FILED 3-24-2011.

FLYTE

THE MARK CONSISTS OF STANDARD CHARACTERS WITHOUT CLAIM TO ANY PARTICULAR FONT, STYLE, SIZE, OR COLOR.

FOR CLOTHING MADE FOR AND MARKETED TO THE FISHING INDUSTRY, NAMELY, JACKETS, PANTS AND SHORTS (U.S. CLS. 22 AND 39).

FIRST USE 8-3-2011; IN COMMERCE 8-3-2011.

4,165,938. THRIV NP, INC., METAIRIE, LA. SN 85-976,757. PUB. 3-8-2011, FILED 11-15-2010.

TASC

THE MARK CONSISTS OF STANDARD CHARACTERS WITHOUT CLAIM TO ANY PARTICULAR FONT, STYLE, SIZE, OR COLOR.

FOR CLOTHING, NAMELY, PANTS, SWEATPANTS, ATHLETIC PANTS, SWEATSHIRTS, JACKETS, UNDERWEAR, AND SPORTS BRAS (U.S. CLS. 22 AND 39).

FIRST USE 5-16-2011; IN COMMERCE 8-1-2011.

CLASS 26—FANCY GOODS

4,165,436. ROYAL IMEX INC., SANTA FE SPRINGS, CA. SN 85-242,583. PUB. 1-17-2012, FILED 2-15-2011.

NO CLAIM IS MADE TO THE EXCLUSIVE RIGHT TO USE "100% HUMAN HAIR NATURAL MIX", APART FROM THE MARK AS SHOWN.

THE MARK CONSISTS OF THE WORD "BOOM" IN STYLISH DESIGN AND THE WORDS "100% HUMAN HAIR NATURAL MIX".

FOR HAIR EXTENSIONS; HAIR PIECES; WIGS, ALL WHOLLY COMPOSED OF HUMAN HAIR NATURAL MIX (U.S. CLS. 37, 39, 40, 42 AND 50).

FIRST USE 12-30-2010; IN COMMERCE 12-30-2010.

CLASS 26—(Continued).

4,165,574. STAY FLY SOLUTIONS, LLC, WEST PALM BEACH, FL. SN 85-280,352. PUB. 8-30-2011, FILED 3-29-2011.

CLASS 27—(Continued).

4,165,598. MOHAWK CARPET DISTRIBUTION, INC., CHATSWORTH, GA. SN 85-283,908. PUB. 8-23-2011, FILED 4-1-2011.

ZIPPERADE

UNIBOND FLEX

THE MARK CONSISTS OF STANDARD CHARACTERS WITHOUT CLAIM TO ANY PARTICULAR FONT, STYLE, SIZE, OR COLOR.

FOR ZIPPER FASTENERS; CLOTHING ACCESSORIES, NAMELY, FASTENERS FOR SECURING ZIPPERS FASTENERS AND ZIPPER PULLS (U.S. CLS. 37, 39, 40, 42 AND 50).

FIRST USE 6-1-2011; IN COMMERCE 6-1-2011.

THE MARK CONSISTS OF STANDARD CHARACTERS WITHOUT CLAIM TO ANY PARTICULAR FONT, STYLE, SIZE, OR COLOR.

OWNER OF U.S. REG. NOS. 1,844,537, 3,734,643, AND OTHERS.

NO CLAIM IS MADE TO THE EXCLUSIVE RIGHT TO USE "FLEX", APART FROM THE MARK AS SHOWN.

FOR CARPET BACKING (U.S. CLS. 19, 20, 37, 42 AND 50).

FIRST USE 7-12-2011; IN COMMERCE 7-12-2011.

4,165,643. TONI BRATTIN & CO., INC., OKLAHOMA CITY, OK. SN 85-294,448. PUB. 9-6-2011, FILED 4-13-2011.

4,165,599. MOHAWK CARPET DISTRIBUTION, INC., CHATSWORTH, GA. SN 85-283,938. PUB. 8-23-2011, FILED 4-1-2011.

HAIR FABULOUS

UNIBOND FLEX BLOC

THE MARK CONSISTS OF STANDARD CHARACTERS WITHOUT CLAIM TO ANY PARTICULAR FONT, STYLE, SIZE, OR COLOR.

NO CLAIM IS MADE TO THE EXCLUSIVE RIGHT TO USE "HAIR", APART FROM THE MARK AS SHOWN.

FOR HAIR EXTENSIONS AND WIGS (U.S. CLS. 37, 39, 40, 42 AND 50).

FIRST USE 11-30-2011; IN COMMERCE 11-30-2011.

THE MARK CONSISTS OF STANDARD CHARACTERS WITHOUT CLAIM TO ANY PARTICULAR FONT, STYLE, SIZE, OR COLOR.

OWNER OF U.S. REG. NOS. 1,844,537, 3,734,643, AND OTHERS.

NO CLAIM IS MADE TO THE EXCLUSIVE RIGHT TO USE "FLEX", APART FROM THE MARK AS SHOWN.

FOR CARPET BACKING (U.S. CLS. 19, 20, 37, 42 AND 50).

FIRST USE 8-15-2011; IN COMMERCE 8-15-2011.

CLASS 27—FLOOR COVERINGS

4,165,002. INTERNATIONAL AUTOMOTIVE COMPONENTS GROUP NORTH AMERICA, INC., DEARBORN, MI. SN 77-966,779. PUB. 8-17-2010, FILED 3-24-2010.

4,165,787. L&P PROPERTY MANAGEMENT COMPANY, SOUTH GATE, CA. SN 85-361,909. PUB. 2-14-2012, FILED 7-1-2011.

INTERCEPT

ADVANCED COMFORT SYSTEM

THE MARK CONSISTS OF STANDARD CHARACTERS WITHOUT CLAIM TO ANY PARTICULAR FONT, STYLE, SIZE, OR COLOR.

FOR STAIN REPELLENTS FOR CARPETS AND FLOOR MATS IN VEHICLES SOLD AS AN INTEGRAL COMPONENT OF CARPET (U.S. CLS. 19, 20, 37, 42 AND 50).

FIRST USE 3-30-2012; IN COMMERCE 3-30-2012.

THE MARK CONSISTS OF STANDARD CHARACTERS WITHOUT CLAIM TO ANY PARTICULAR FONT, STYLE, SIZE, OR COLOR.

FOR CARPET PADDING (U.S. CLS. 19, 20, 37, 42 AND 50).

FIRST USE 10-1-2011; IN COMMERCE 10-1-2011.

CLASS 28—TOYS AND SPORTING GOODS

4,164,786. ROBERT W. HARDIE, ASTORIA, NY. SN 76-692,400. PUB. 2-3-2009, FILED 8-25-2008.

YOGEEZ

THE MARK CONSISTS OF STANDARD CHARACTERS WITHOUT CLAIM TO ANY PARTICULAR FONT, STYLE, SIZE, OR COLOR.

FOR TOYS, NAMELY, MOLDED PLASTIC TOY FIGURINES, CLAY FIGURINES AND ACTION FIGURES (U.S. CLS. 22, 23, 38 AND 50).

FIRST USE 3-17-2012; IN COMMERCE 3-17-2012.

4,164,800. E&B GIFTWARE, LLC, YONKERS, NY. SN 76-706,331. PUB. 1-24-2012, FILED 2-8-2011.

BIG GAME SHOOTING CHALLENGE

THE MARK CONSISTS OF STANDARD CHARACTERS WITHOUT CLAIM TO ANY PARTICULAR FONT, STYLE, SIZE, OR COLOR.

NO CLAIM IS MADE TO THE EXCLUSIVE RIGHT TO USE "SHOOTING", APART FROM THE MARK AS SHOWN. FOR ACTION TARGET GAME (U.S. CLS. 22, 23, 38 AND 50).

FIRST USE 10-22-2011; IN COMMERCE 10-22-2011.

4,164,883. ROBERT J. BETTINARDI, TINLEY PARK, IL. SN 77-749,047. PUB. 4-19-2011, FILED 6-1-2009.

QUEEN B

THE MARK CONSISTS OF STANDARD CHARACTERS WITHOUT CLAIM TO ANY PARTICULAR FONT, STYLE, SIZE, OR COLOR.

FOR COVERS FOR GOLF CLUBS; GOLF BAGS; GOLF CLUBS; HEAD COVERS FOR GOLF CLUBS (U.S. CLS. 22, 23, 38 AND 50).

FIRST USE 1-1-2009; IN COMMERCE 6-1-2009.

CLASS 28—(Continued).

4,164,916. THE JAMES VALLEY CO., INC., MELLETTE, SD. SN 77-825,727. PUB. 3-9-2010, FILED 9-14-2009.

WOW

THE MARK CONSISTS OF STANDARD CHARACTERS WITHOUT CLAIM TO ANY PARTICULAR FONT, STYLE, SIZE, OR COLOR.

FOR HUNTERS' SCENT LURES FOR USE IN CONNECTION WITH HUNTING DEER (U.S. CLS. 22, 23, 38 AND 50).

FIRST USE 10-11-2011; IN COMMERCE 11-15-2011.

4,165,023. NEW WAVE GROUP LICENSING S.A., CORTAILLOD 2016, SWITZERLAND. SN 78-702,522. PUB. 4-28-2009, FILED 8-30-2005.

GOLF IS LIFE

THE MARK CONSISTS OF STANDARD CHARACTERS WITHOUT CLAIM TO ANY PARTICULAR FONT, STYLE, SIZE, OR COLOR.

FOR GOLF BALL MARKERS AND GOLF DIVOT REPAIR TOOLS, ALL OF NON-PRECIOUS METAL (U.S. CLS. 22, 23, 38 AND 50).

FIRST USE 12-31-2010; IN COMMERCE 12-31-2010.

4,165,043. HOLMES, CHARLES, ROXIE, MS. SN 85-013,878. PUB. 2-22-2011, FILED 4-14-2010.

VAPOR MAKER

THE MARK CONSISTS OF STANDARD CHARACTERS WITHOUT CLAIM TO ANY PARTICULAR FONT, STYLE, SIZE, OR COLOR.

NO CLAIM IS MADE TO THE EXCLUSIVE RIGHT TO USE "VAPOR", APART FROM THE MARK AS SHOWN.

FOR OUTDOORSMAN'S SCENT CAMOUFLAGE IN THE NATURE OF A SPRAY (U.S. CLS. 22, 23, 38 AND 50).

FIRST USE 8-9-2009; IN COMMERCE 8-9-2009.

CLASS 28—(Continued).

4,165,057. FOCUS BRAND LIMITED, 379-381 KING'S ROAD,, HONG KONG. SN 85-023,775. PUB. 10-4-2011, FILED 4-27-2010.

TEACUP PIGGY

THE MARK CONSISTS OF STANDARD CHARACTERS WITHOUT CLAIM TO ANY PARTICULAR FONT, STYLE, SIZE, OR COLOR.

NO CLAIM IS MADE TO THE EXCLUSIVE RIGHT TO USE "PIGGY", APART FROM THE MARK AS SHOWN.

FOR BATTERY OPERATED ACTION TOYS; COLLECTABLE TOY FIGURES; DOLLS AND DOLL ACCESSORIES, NAMELY, CLOTHING FOR DOLLS, DOLL ROOMS, DOLL BEDS, DOLL HOUSES, TOY FABRICS AND LINENS FOR DOLLS AND STROLLERS FOR DOLLS; ELECTRONIC TOY VEHICLES; FANTASY CHARACTER TOYS; MECHANICAL TOYS; MODELED PLASTIC TOY FIGURINES; MOLDED TOY FIGURES; PLASTIC CHARACTER TOYS; PLAY HOUSES AND TOY ACCESSORIES THEREFOR; PLAY MATS CONTAINING INFANT TOYS; PLUSH TOYS; POSITIONABLE TOY FIGURES; ROLE PLAYING TOYS IN THE NATURE OF PLAY SETS FOR CHILDREN TO IMITATE REAL LIFE OCCUPATIONS; SAND TOYS; SANDBOX TOYS; SOFT SCULPTURE PLUSH TOYS; SOFT SCULPTURE TOYS; STUFFED AND PLUSH TOYS; TALKING ELECTRONIC PRESS-DOWN TOY; TALKING TOYS; TOY ANIMALS; TOY ANIMALS AND ACCESSORIES THEREFOR; TOY HOUSES; TOYS FOR DOMESTIC PETS; TWO AND THREE DIMENSIONAL POSITIONABLE FIGURES SOLD AS AN INTEGRAL COMPONENT OF TOYS; TWO AND THREE DIMENSIONAL POSITIONABLE TOY FIGURES SOLD AS A UNIT WITH OTHER TOYS (U.S. CLS. 22, 23, 38 AND 50).

FIRST USE 2-1-2010; IN COMMERCE 10-1-2010.

4,165,062. FORT MAGIC, LLC, SARASOTA, FL. SN 85-031,143. PUB. 2-15-2011, FILED 5-5-2010.

FORT MAGIC BUILD A FORT AS BIG AS YOUR IMAGINATION

THE MARK CONSISTS OF STANDARD CHARACTERS WITHOUT CLAIM TO ANY PARTICULAR FONT, STYLE, SIZE, OR COLOR.

NO CLAIM IS MADE TO THE EXCLUSIVE RIGHT TO USE "FORT", APART FROM THE MARK AS SHOWN.

FOR TOY KITS PRIMARILY COMPOSED OF PVC PIPES, FITTINGS AND PLASTIC CLIPS FOR BUILDING CHILDREN'S PLAY FORTS (U.S. CLS. 22, 23, 38 AND 50).

FIRST USE 12-15-2011; IN COMMERCE 12-15-2011.

CLASS 28—(Continued).

4,165,130. EXIM-DYNAMICS INC, DBA EXIM GAMES, KETTERING, OH. SN 85-107,944. PUB. 9-6-2011, FILED 8-16-2010.



THE MARK CONSISTS OF A SKULL WITH HOLES WHERE THE EYES AND NOSE WOULD APPEAR; A TURBAN APPEARS AROUND THE TOP OF THE SKULL; AND BELOW APPEARS THE WORDING "XPIRATE".

FOR GAME EQUIPMENT SOLD AS A UNIT COMPRISED PRIMARILY OF A PLAYING BOARD, PLAYING PIECES, INTERACTIVE SOFTWARE AS AN INTEGRAL PART OF THE GAME FOR PROVIDING CONSEQUENCES OF PLAYER ACTIONS, STRENGTHS OF PLAYER POSITIONS DURING THE GAME, KEEPING SCORE AND RECORDING PLAYER MOVES, DOWNLOADABLE ONTO A HANDHELD DEVICE, AND RULES OF PLAY (U.S. CLS. 22, 23, 38 AND 50).

FIRST USE 11-18-2011; IN COMMERCE 11-18-2011.

4,165,198. SEKKOIA, S.A.S., RUNGIS CEDEX, FRANCE. SN 85-127,042. PUB. 2-22-2011, FILED 9-10-2010.



OWNER OF U.S. REG. NO. 3,240,177.

THE MARK CONSISTS OF A GEOMETRICALLY SHAPED CHARACTER WEARING A SUIT, TIE AND SQUARE GLASSES THAT HAS ONE HAND ON ITS HIP AND THE OTHER POINTING UPWARD.

FOR PARLOR GAMES (U.S. CLS. 22, 23, 38 AND 50). FIRST USE 3-14-2012; IN COMMERCE 3-14-2012.

CLASS 28—(Continued).

4,165,232. HOOPER, JOSHUA P., HONOLULU, HI. AND HOOPER, NIKOLAYA S., HONOLULU, HI. AND JACKSON, THOMAS E., HONOLULU, HI. AND JACKSON, ASTRID I., HONOLULU, HI. SN 85-139,242. PUB. 9-6-2011, FILED 9-27-2010.

INQUIRE

THE MARK CONSISTS OF STANDARD CHARACTERS WITHOUT CLAIM TO ANY PARTICULAR FONT, STYLE, SIZE, OR COLOR.

FOR BOARD GAMES; EQUIPMENT SOLD AS A UNIT FOR PLAYING BOARD GAMES (U.S. CLS. 22, 23, 38 AND 50).

FIRST USE 3-3-2012; IN COMMERCE 3-3-2012.

4,165,238. MATTEL, INC., EL SEGUNDO, CA. SN 85-141,890. PUB. 3-15-2011, FILED 9-30-2010.

SISTERS SLEEP OUT!

THE MARK CONSISTS OF STANDARD CHARACTERS WITHOUT CLAIM TO ANY PARTICULAR FONT, STYLE, SIZE, OR COLOR.

FOR DOLLS, DOLL CLOTHING AND DOLL ACCESSORIES (U.S. CLS. 22, 23, 38 AND 50).

FIRST USE 4-11-2012; IN COMMERCE 4-11-2012.

4,165,261. ABIDE FAMILY BLESSINGS, LLC, ELLICOTT CITY, MD. SN 85-151,145. PUB. 7-12-2011, FILED 10-12-2010.

Abide Scripture Cards

THE MARK CONSISTS OF STANDARD CHARACTERS WITHOUT CLAIM TO ANY PARTICULAR FONT, STYLE, SIZE, OR COLOR.

NO CLAIM IS MADE TO THE EXCLUSIVE RIGHT TO USE "SCRIPTURE CARDS", APART FROM THE MARK AS SHOWN.

FOR CARD GAMES; EDUCATIONAL CARD GAMES; PLAYING CARDS; PLAYING CARDS AND CARD GAMES (U.S. CLS. 22, 23, 38 AND 50).

FIRST USE 10-21-2010; IN COMMERCE 10-21-2010.

CLASS 28—(Continued).

4,165,273. GEORGE, ZAK, DBA PLAY2HELP.ORG, WESTBOROUGH, MA. SN 85-155,597. PUB. 9-20-2011, FILED 10-19-2010.

 The logo for Play2Help features the word "Play" in a bold, sans-serif font, followed by a stylized human figure with arms raised, and the word "Help" in a similar font. The figure is positioned between "Play" and "Help", with its arms reaching towards the top of the "2" in "Play2Help".

THE MARK CONSISTS OF THE LITERAL ELEMENTS "PLAY2HELP" ARRANGED IN HORIZONTAL CONFIGURATION, WHEREIN THE LETTER "Y" IS MODIFIED GRAPHICALLY WITH A HUMAN LIKE SYMBOL, TRYING TO REACH FOR A BALL WHICH APPEARS AT THE TOP RIGHT SIDE, NEXT TO THE LETTER "PLAY" IS THE NUMBER "2" WHICH HAS BEEN GRAPHICALLY MODIFIED TO LOOK LIKE A HAND-WRITTEN NUMBER "2", THAT VISUALLY LINKS THE WORD "PLAY" TO THE NEXT WORD "HELP". THE LETTER "H" IN THE WORD "HELP" HAS BEEN GRAPHICALLY MODIFIED TO ANOTHER HUMAN LIKE SYMBOL WITH BOTH HANDS RAISED, ALL AS SHOWN IN THE MARK.

FOR TENNIS BALLS, GOLF BALLS, BASEBALLS, SOCCER BALLS, LACROSSE BALLS, BASKETBALLS, FOOTBALLS AND OTHER SPORTS BALLS (U.S. CLS. 22, 23, 38 AND 50).

FIRST USE 3-4-2011; IN COMMERCE 3-4-2011.

4,165,417. FRANKLIN SPORTS, INC., STOUGHTON, MA. SN 85-228,148. PUB. 1-24-2012, FILED 1-27-2011.

PRIMAL

THE MARK CONSISTS OF STANDARD CHARACTERS WITHOUT CLAIM TO ANY PARTICULAR FONT, STYLE, SIZE, OR COLOR.

FOR BASKETBALLS; FOOTBALLS; SOCCER BALLS; VOLLEYBALLS (U.S. CLS. 22, 23, 38 AND 50).

FIRST USE 10-26-2011; IN COMMERCE 10-26-2011.

4,165,459. MARKY SPARKY, INC., ESCONDIDO, NY. SN 85-253,331. PUB. 7-19-2011, FILED 2-28-2011.

ANIMAILS

THE MARK CONSISTS OF STANDARD CHARACTERS WITHOUT CLAIM TO ANY PARTICULAR FONT, STYLE, SIZE, OR COLOR.

FOR INFLATABLE TOYS (U.S. CLS. 22, 23, 38 AND 50).

FIRST USE 1-1-2011; IN COMMERCE 1-1-2011.

CLASS 28—(Continued).

4,165,594. MATTEL, INC., EL SEGUNDO, CA. SN 85-283,799.
PUB. 8-9-2011, FILED 4-1-2011.

POSITIVELY PARIS

THE MARK CONSISTS OF STANDARD CHARACTERS WITHOUT CLAIM TO ANY PARTICULAR FONT, STYLE, SIZE, OR COLOR.
FOR DOLLS, DOLL CLOTHING AND DOLL ACCESSORIES (U.S. CLS. 22, 23, 38 AND 50).
FIRST USE 9-22-2011; IN COMMERCE 9-22-2011.

4,165,595. MATTEL, INC., EL SEGUNDO, CA. SN 85-283,805.
PUB. 8-9-2011, FILED 4-1-2011.

TOKYO TOUR

THE MARK CONSISTS OF STANDARD CHARACTERS WITHOUT CLAIM TO ANY PARTICULAR FONT, STYLE, SIZE, OR COLOR.
FOR DOLLS, DOLL CLOTHING AND DOLL ACCESSORIES (U.S. CLS. 22, 23, 38 AND 50).
FIRST USE 9-22-2011; IN COMMERCE 9-22-2011.

4,165,596. MATTEL, INC., EL SEGUNDO, CA. SN 85-283,816.
PUB. 8-9-2011, FILED 4-1-2011.

SPEED SEEKER

THE MARK CONSISTS OF STANDARD CHARACTERS WITHOUT CLAIM TO ANY PARTICULAR FONT, STYLE, SIZE, OR COLOR.
FOR TOY VEHICLES AND ACCESSORIES THEREFOR (U.S. CLS. 22, 23, 38 AND 50).
FIRST USE 9-1-2011; IN COMMERCE 9-1-2011.

CLASS 28—(Continued).

4,165,597. MATTEL, INC., EL SEGUNDO, CA. SN 85-283,820.
PUB. 8-9-2011, FILED 4-1-2011.

PLAY ON THE EDGE

THE MARK CONSISTS OF STANDARD CHARACTERS WITHOUT CLAIM TO ANY PARTICULAR FONT, STYLE, SIZE, OR COLOR.
FOR TOY VEHICLES AND ACCESSORIES THEREFOR; TOY VEHICLE PLAYSETS AND ACCESSORIES THEREFOR (U.S. CLS. 22, 23, 38 AND 50).
FIRST USE 3-5-2012; IN COMMERCE 3-5-2012.

4,165,627. HUTCHINGS, LEROI E., CRYSTAL LAKE, IL. SN 85-289,533. PUB. 8-16-2011, FILED 4-7-2011.

THREE FOR BRIDGE

THE MARK CONSISTS OF STANDARD CHARACTERS WITHOUT CLAIM TO ANY PARTICULAR FONT, STYLE, SIZE, OR COLOR.
NO CLAIM IS MADE TO THE EXCLUSIVE RIGHT TO USE "BRIDGE", APART FROM THE MARK AS SHOWN.
FOR EQUIPMENT SOLD AS A UNIT FOR PLAYING CARD GAMES (U.S. CLS. 22, 23, 38 AND 50).
FIRST USE 6-1-2011; IN COMMERCE 6-1-2011.

4,165,645. OVERSTREET, J'ME, OKLAHOMA CITY, OK. SN 85-294,904. PUB. 9-20-2011, FILED 4-14-2011.



THE MARK CONSISTS OF A DESIGN OF A CHICKEN WITH POLKA DOTS AND FAIRY-TYPE WINGS WEARING A CROWN; HAVING EYES WITH LONG EYELASHES, A BEAK AND PROMINENT LIPS. THE WORDS "GREEN FAIRY CHICKS" ARE SHOWN ACROSS THE BODY ATOP THE DESIGN.
FOR CHILDREN'S TOYS, NAMELY, DOLLS, DOLL CLOTHING AND DOLL ACCESSORIES (U.S. CLS. 22, 23, 38 AND 50).
FIRST USE 5-1-2011; IN COMMERCE 11-29-2011.

CLASS 28—(Continued).

4,165,701. BARNES, BRIAN, ISLAMORADA, FL. SN 85-312,804. PUB. 10-11-2011, FILED 5-5-2011.

OLDE FLY SHOP

THE MARK CONSISTS OF STANDARD CHARACTERS WITHOUT CLAIM TO ANY PARTICULAR FONT, STYLE, SIZE, OR COLOR.

NO CLAIM IS MADE TO THE EXCLUSIVE RIGHT TO USE "FLY SHOP", APART FROM THE MARK AS SHOWN. FOR TOYS AND SPORTING GOODS, NAMELY, FISHING TACKLE (U.S. CLS. 22, 23, 38 AND 50). FIRST USE 1-1-2012; IN COMMERCE 1-1-2012.

4,165,724. FORTUNEGOLF INDUSTRIAL (HK) CO., LIMITED, CAUSEWAY BAY, HONG KONG. SN 85-329,966. PUB. 10-18-2011, FILED 5-25-2011.



THE MARK CONSISTS OF THE WORDING "EAGLEEYED" AND IN THE BACKGROUND, AN OUTLINE OF AN EAGLE HEAD.

THE WORDING "EAGLEEYED" HAS NO MEANING IN A FOREIGN LANGUAGE.

FOR GLOVES FOR GOLF; GOLF ACCESSORIES, NAMELY, CARRIERS AND DISPENSERS FOR GOLF BALLS; GOLF ACCESSORY POUCHES; GOLF BAG PEGS; GOLF BAGS WITH OR WITHOUT WHEELS; GOLF BALL MARKERS; GOLF BALL RETRIEVERS; GOLF BALL SLEEVES; GOLF BALLS; GOLF CLUB BAGS; GOLF CLUB COVERS; GOLF CLUB GRIPS; GOLF CLUB HEADS; GOLF CLUBS; GOLF FLAGS; GOLF PRACTICE NETS; NON-MOTORIZED GOLF TROLLEYS (U.S. CLS. 22, 23, 38 AND 50).

FIRST USE 3-31-2008; IN COMMERCE 11-16-2011.

CLASS 28—(Continued).

4,165,742. INC INTERNATIONAL COMPANY, KENNETT SQUARE, PA. SN 85-338,297. PUB. 12-20-2011, FILED 6-5-2011.

REPEL

THE MARK CONSISTS OF STANDARD CHARACTERS WITHOUT CLAIM TO ANY PARTICULAR FONT, STYLE, SIZE, OR COLOR.

FOR ATHLETIC PROTECTIVE PADS FOR FOOTBALL, SOCCER, BASEBALL, BASKETBALL, HOCKEY, SKATEBOARDING, MARTIAL ARTS, EQUESTRIAN, AND LACROSSE; ELBOW PADS FOR ATHLETIC USE; FIELD HOCKEY GOALIE PADS; FOOTBALL CHEST PADS; FOOTBALL ELBOW PADS; FOOTBALL KNEE PADS; FOOTBALL LEG PADS; FOOTBALL SHOULDER PADS; HAND PADS FOR ATHLETIC USE; ICE HOCKEY GOALIE PADS; KARATE KICK PADS; KARATE SHIN PADS; KARATE TARGET PADS; KNEE PADS FOR ATHLETIC USE, ATHLETIC PROTECTIVE PADS, NAMELY, SHOULDER PADS, SHIN PADS, KNEE PADS; PADS FOR USE IN FOOTBALL, SOCCER, BASEBALL, BASKETBALL, HOCKEY, SKATEBOARDING, MARTIAL ARTS, EQUESTRIAN, AND LACROSSE; PROTECTIVE PADDING FOR PLAYING FOOTBALL, SOCCER, BASEBALL, BASKETBALL, HOCKEY, SKATEBOARDING, MARTIAL ARTS, EQUESTRIAN, AND LACROSSE; PROTECTIVE PADDING FOR SKATEBOARDING; PROTECTIVE PADDING FOR SNOWBOARDING; SAFETY PADDING FOR FOOTBALL, SOCCER, BASEBALL, BASKETBALL, HOCKEY, SKATEBOARDING, MARTIAL ARTS, EQUESTRIAN, AND LACROSSE; SHIN PADS FOR USE IN FOOTBALL, SOCCER, BASEBALL, BASKETBALL, HOCKEY, SKATEBOARDING, MARTIAL ARTS, EQUESTRIAN, AND LACROSSE; SHOULDER PADS FOR ATHLETIC USE; SOCCER BALL KNEE PADS (U.S. CLS. 22, 23, 38 AND 50).

FIRST USE 6-7-2011; IN COMMERCE 6-7-2011.

4,165,768. GUILLERMO, TENA, MEXICO, MEXICO. SN 85-353,592. PUB. 11-8-2011, FILED 6-22-2011.

FLY TO FLAG

THE MARK CONSISTS OF STANDARD CHARACTERS WITHOUT CLAIM TO ANY PARTICULAR FONT, STYLE, SIZE, OR COLOR.

FOR GOLF BALLS (U.S. CLS. 22, 23, 38 AND 50). FIRST USE 10-17-2007; IN COMMERCE 10-17-2007.

CLASS 28—(Continued).

4,165,840. MATTEL, INC., EL SEGUNDO, CA. SN 85-388,327.
PUB. 12-13-2011, FILED 8-3-2011.

LONG GONE

THE MARK CONSISTS OF STANDARD CHARACTERS WITHOUT CLAIM TO ANY PARTICULAR FONT, STYLE, SIZE, OR COLOR.

FOR TOY VEHICLES AND ACCESSORIES THEREFOR (U.S. CLS. 22, 23, 38 AND 50).

FIRST USE 3-29-2012; IN COMMERCE 3-29-2012.

CLASS 29—MEATS AND PROCESSED FOODS

4,164,821. LUBERSKI, INC., SAN MARCOS, CA. SN 77-462,583. PUB. 1-27-2009, FILED 4-30-2008.

PERFECTLY FRESH

THE MARK CONSISTS OF STANDARD CHARACTERS WITHOUT CLAIM TO ANY PARTICULAR FONT, STYLE, SIZE, OR COLOR.

OWNER OF U.S. REG. NO. 3,053,013.
NO CLAIM IS MADE TO THE EXCLUSIVE RIGHT TO USE "FRESH", APART FROM THE MARK AS SHOWN.

FOR EGGS (U.S. CL. 46).
FIRST USE 1-17-2012; IN COMMERCE 1-17-2012.

4,164,859. HOME MARKET FOODS, INC., NORWOOD, MA.
SN 77-641,522. PUB. 4-21-2009, FILED 12-30-2008.

WHAT GOES AROUND . . . TASTES INCREDIBLE

THE MARK CONSISTS OF STANDARD CHARACTERS WITHOUT CLAIM TO ANY PARTICULAR FONT, STYLE, SIZE, OR COLOR.

FOR PROCESSED MEAT PRODUCTS, NAMELY, FORMED HAMBURGER (U.S. CL. 46).

FIRST USE 4-25-2012; IN COMMERCE 4-25-2012.

CLASS 29—(Continued).

4,164,866. KALAMATA FOOD PURVEYORS, INC., HAYWARD, CA. SN 77-670,078. PUB. 6-16-2009, FILED 2-13-2009.

Athia

THE MARK CONSISTS OF STANDARD CHARACTERS WITHOUT CLAIM TO ANY PARTICULAR FONT, STYLE, SIZE, OR COLOR.

FOR CHEESE; OLIVE OILS; PROCESSED DATES; PROCESSED FRUITS; PROCESSED NUTS; PROCESSED OLIVES; PROCESSED PEPPERONCINIS; YOGURT (U.S. CL. 46).

FIRST USE 11-24-2009; IN COMMERCE 11-24-2009.

4,164,909. CASTELLA IMPORTS, INC., HAUPPAUGE, NY.
SN 77-820,541. PUB. 2-2-2010, FILED 9-4-2009.

TAPENADE CREATIONS

THE MARK CONSISTS OF STANDARD CHARACTERS WITHOUT CLAIM TO ANY PARTICULAR FONT, STYLE, SIZE, OR COLOR.

NO CLAIM IS MADE TO THE EXCLUSIVE RIGHT TO USE "TAPENADE", APART FROM THE MARK AS SHOWN.

FOR TAPENADES (U.S. CL. 46).
FIRST USE 12-1-2011; IN COMMERCE 12-1-2011.

4,164,949. PROMOTION IN MOTION, INC., ALLENDALE, NJ. SN 77-886,225. PUB. 5-4-2010, FILED 12-4-2009.

SUNNY FRUITS

THE MARK CONSISTS OF STANDARD CHARACTERS WITHOUT CLAIM TO ANY PARTICULAR FONT, STYLE, SIZE, OR COLOR.

NO CLAIM IS MADE TO THE EXCLUSIVE RIGHT TO USE "FRUITS", APART FROM THE MARK AS SHOWN.

FOR PROCESSED FRUIT SNACKS MADE FROM FRUIT JUICE AND/OR FRUIT PUREE; FRUIT BASED SNACK FOODS COMPRISED OF FRUIT COMPONENTS; FRUIT BASED SNACK FOODS COMPRISED OF FRUIT AND YOGURT COMPONENTS (U.S. CL. 46).

FIRST USE 2-8-2010; IN COMMERCE 2-8-2010.

CLASS 29—(Continued).

4,164,992. JOHNSON & JOHNSON, NEW BRUNSWICK, NJ. SN 77-957,735. PUB. 2-22-2011, FILED 3-12-2010.



OWNER OF U.S. REG. NOS. 1,356,166, 3,760,760, AND OTHERS.

NO CLAIM IS MADE TO THE EXCLUSIVE RIGHT TO USE "BRAND" AND "EASY TO DIGEST", APART FROM THE MARK AS SHOWN.

THE MARK CONSISTS OF PACKAGING FOR THE GOODS FEATURING A VERTICAL RECTANGLE WITH AN OPENING FOR THE CAP FEATURING A RIBBON DESIGN WITH THE STYLIZED WORD "LACTAID BRAND" IN IT AND AN IMAGE OF A PERSON DANCING WITH A COW IN STYLIZED CIRCLE AND THE LOWER HALF OF THE RECTANGLE CONTAINING TWO RECTANGLES ABOVE THE WORDING "EASY TO DIGEST" WITH TWO DASHES ON EITHER SIDE OF THE WORDING ABOVE A GLASS WITH MILK BEING Poured INTO THE GLASS. THE MATTER SHOWN IN BROKEN LINES IS NOT PART OF THE MARK AND SERVES ONLY TO SHOW THE PLACEMENT OF THE MARK.

FOR MILK (U.S. CL. 46).

FIRST USE 7-6-2010; IN COMMERCE 7-6-2010.

4,165,348. SCHWAN'S IP, LLC, MARSHALL, MN. SN 85-194,065. PUB. 10-4-2011, FILED 12-9-2010.

PAGODA EXPRESS

THE MARK CONSISTS OF STANDARD CHARACTERS WITHOUT CLAIM TO ANY PARTICULAR FONT, STYLE, SIZE, OR COLOR.

OWNER OF U.S. REG. NO. 3,905,100.

FOR FROZEN ENTREES CONSISTING PRIMARILY OF MEAT, POULTRY, OR PORK AND PREPARED WITH OR WITHOUT VEGETABLES, PASTA, RICE AND SAUCE (U.S. CL. 46).

FIRST USE 8-22-2011; IN COMMERCE 8-22-2011.

CLASS 29—(Continued).

4,165,349. SCHWAN'S IP, LLC, MARSHALL, MN. SN 85-194,124. PUB. 10-4-2011, FILED 12-9-2010.



OWNER OF U.S. REG. NO. 3,905,100.

THE MARK CONSISTS OF THE WORDS "PAGODA EXPRESS" AND THE CHINESE SYMBOL FOR "MEI" IN THE LETTER "O" IN "PAGODA". "PAGODA" IS IN A RECTANGULAR BORDER.

THE NON-LATIN CHARACTERS IN THE MARK TRANSLITERATE TO "MEI" AND THIS MEANS "BEAUTIFUL" IN ENGLISH.

FOR FROZEN ENTREES CONSISTING PRIMARILY OF MEAT, POULTRY, OR PORK AND PREPARED WITH OR WITHOUT VEGETABLES, PASTA, RICE AND SAUCE (U.S. CL. 46).

FIRST USE 8-22-2011; IN COMMERCE 8-22-2011.

4,165,409. A&D TRADING, INC., FAYETTEVILLE, AR. SN 85-223,020. PUB. 7-5-2011, FILED 1-21-2011.

BUSH VALLEY FARMS

THE MARK CONSISTS OF STANDARD CHARACTERS WITHOUT CLAIM TO ANY PARTICULAR FONT, STYLE, SIZE, OR COLOR.

NO CLAIM IS MADE TO THE EXCLUSIVE RIGHT TO USE "FARMS", APART FROM THE MARK AS SHOWN.

FOR POULTRY, NAMELY, PROCESSED CHICKEN (U.S. CL. 46).

FIRST USE 1-4-2012; IN COMMERCE 1-4-2012.

4,165,430. SO BILL HOLDINGS, INC., SCARBOROUGH, ONTARIO, CANADA. SN 85-238,100. PUB. 1-31-2012, FILED 2-9-2011.



THE MARK CONSISTS OF THREE CHINESE CHARACTERS ABOVE THE WORDS "HAPPY & HAPPY".

CLASS 29—(Continued).

THE NON-LATIN CHARACTERS IN THE MARK TRANSLITERATE TO "XI DUO XI" AND THIS MEANS "HAPPY & HAPPY" IN ENGLISH.

FOR CHINESE SAUSAGES (U.S. CL. 46).
FIRST USE 11-0-2011; IN COMMERCE 11-0-2011.

4,165,510. PRODUCTOS INDUSTRIALES DE LEON S.A. DE C.V., LEON, GTO, MEXICO. SN 85-268,711. PUB. 8-2-2011, FILED 3-16-2011.

PILSAC

THE MARK CONSISTS OF STANDARD CHARACTERS WITHOUT CLAIM TO ANY PARTICULAR FONT, STYLE, SIZE, OR COLOR.

FOR UNFLAVORED AND UNSWEETENED GELATINS (U.S. CL. 46).
FIRST USE 4-24-2011; IN COMMERCE 9-27-2011.

4,165,605. SNIKIDDY, LLC, BOULDER, CO. SN 85-285,433. PUB. 8-2-2011, FILED 4-4-2011.

SNIKIDDY

THE MARK CONSISTS OF STANDARD CHARACTERS WITHOUT CLAIM TO ANY PARTICULAR FONT, STYLE, SIZE, OR COLOR.

FOR VEGETABLE-BASED SNACK FOODS (U.S. CL. 46).
FIRST USE 9-1-2011; IN COMMERCE 9-1-2011.

4,165,641. R B & T'S EMPIRES, LLC, ST. LOUIS, MO. SN 85-293,689. PUB. 12-6-2011, FILED 4-13-2011.



OWNER OF U.S. REG. NOS. 3,766,997 AND 3,860,438.

CLASS 29—(Continued).

NO CLAIM IS MADE TO THE EXCLUSIVE RIGHT TO USE "SPICY", "CHIP COMPANY" AND "SAINT LOUIS, MISSOURI", APART FROM THE MARK AS SHOWN.

THE MARK CONSISTS OF THE WORDS "THE SPICY BILLY GOAT CHIP COMPANY" ARRANGED IN A CIRCLE WITH A GOAT DESIGN AND THE WORD "KICKER" IN THE CENTER. THE WORDS "SAINT LOUIS, MISSOURI" APPEAR BELOW THE WORDS "CHIP COMPANY".

FOR POTATO CHIPS (U.S. CL. 46).
FIRST USE 4-7-2011; IN COMMERCE 4-7-2011.

4,165,746. FRIENDSHIP DAIRIES, LLC, DALLAS, TX. SN 85-339,699. PUB. 10-4-2011, FILED 6-7-2011.

FIT TO GO

THE MARK CONSISTS OF STANDARD CHARACTERS WITHOUT CLAIM TO ANY PARTICULAR FONT, STYLE, SIZE, OR COLOR.

FOR COTTAGE CHEESE (U.S. CL. 46).
FIRST USE 10-0-2011; IN COMMERCE 10-0-2011.

4,165,759. SNIKIDDY, LLC, BOULDER, CO. SN 85-346,015. PUB. 11-1-2011, FILED 6-14-2011.

EAT YOUR VEGETABLES

THE MARK CONSISTS OF STANDARD CHARACTERS WITHOUT CLAIM TO ANY PARTICULAR FONT, STYLE, SIZE, OR COLOR.

FOR VEGETABLE-BASED SNACK FOODS (U.S. CL. 46).
FIRST USE 9-1-2011; IN COMMERCE 9-1-2011.

4,165,936. SUSAN LEONE, BROOKLYN, NY. SN 85-976,741. PUB. 12-27-2011, FILED 8-1-2011.

FRUIT BLISS

THE MARK CONSISTS OF STANDARD CHARACTERS WITHOUT CLAIM TO ANY PARTICULAR FONT, STYLE, SIZE, OR COLOR.

CLASS 29—(Continued).

NO CLAIM IS MADE TO THE EXCLUSIVE RIGHT TO USE "FRUIT", APART FROM THE MARK AS SHOWN.

FOR DEHYDRATED FRUIT SNACKS; DRIED FRUIT MIXES; DRIED FRUITS; PROCESSED FRUIT- AND NUT-BASED FOOD BARS (U.S. CL. 46).
FIRST USE 3-21-2012; IN COMMERCE 3-21-2012.

CLASS 30—(Continued).

NO CLAIM IS MADE TO THE EXCLUSIVE RIGHT TO USE "MARSHMALLOW", APART FROM THE MARK AS SHOWN.

FOR BREAKFAST CEREAL (U.S. CL. 46).
FIRST USE 12-26-2011; IN COMMERCE 12-26-2011.

CLASS 30—STAPLE FOODS

4,164,824. MURRAY'S CHEESE LLC, NEW YORK, NY. SN 77-514,543. PUB. 1-27-2009, FILED 7-3-2008.

4,165,005. WAYNE YEHIA LIMITED, MISSISSAUGA, CANADA. AND BREADKO NATIONAL BAKING LIMITED, MISSISSAUGA, CANADA. SN 77-969,785. PUB. 3-8-2011, FILED 3-26-2010.

MURRAY'S MELTS

THE MARK CONSISTS OF STANDARD CHARACTERS WITHOUT CLAIM TO ANY PARTICULAR FONT, STYLE, SIZE, OR COLOR.

NO CLAIM IS MADE TO THE EXCLUSIVE RIGHT TO USE "MELTS", APART FROM THE MARK AS SHOWN.

FOR SANDWICHES, NAMELY, GOURMET AND TOASTED SANDWICHES WITH FRESH MEATS AND CHEESES (U.S. CL. 46).

FIRST USE 8-31-2011; IN COMMERCE 8-31-2011.

Thin a Bagel

THE MARK CONSISTS OF STANDARD CHARACTERS WITHOUT CLAIM TO ANY PARTICULAR FONT, STYLE, SIZE, OR COLOR.

NO CLAIM IS MADE TO THE EXCLUSIVE RIGHT TO USE "BAGEL", APART FROM THE MARK AS SHOWN.

FOR BAGELS; PITA (U.S. CL. 46).
FIRST USE 11-29-2011; IN COMMERCE 11-29-2011.

4,164,917. BLACK TOOTH BRAND, LLC, BURBANK, CA. SN 77-826,671. PUB. 2-9-2010, FILED 9-15-2009.

BLACK TOOTH INN

THE MARK CONSISTS OF STANDARD CHARACTERS WITHOUT CLAIM TO ANY PARTICULAR FONT, STYLE, SIZE, OR COLOR.

FOR BARBEQUE SAUCE; SAUCES FOR BARBECUED MEAT; READY MADE SAUCES (U.S. CL. 46).

FIRST USE 1-15-2012; IN COMMERCE 5-7-2012.

4,165,009. VAN'S INTERNATIONAL FOODS, INC., PHOENIX, AZ. SN 77-983,137. PUB. 8-2-2011, FILED 10-21-2009.

VAN'S NATURAL FOODS

4,164,973. MOM BRANDS COMPANY, MINNEAPOLIS, MN. SN 77-936,408. PUB. 6-29-2010, FILED 2-16-2010.

MARSHMALLOW MOMENT

THE MARK CONSISTS OF STANDARD CHARACTERS WITHOUT CLAIM TO ANY PARTICULAR FONT, STYLE, SIZE, OR COLOR.

OWNER OF U.S. REG. NOS. 1,888,006, 3,414,135, AND OTHERS.

THE MARK CONSISTS OF STANDARD CHARACTERS WITHOUT CLAIM TO ANY PARTICULAR FONT, STYLE, SIZE, OR COLOR.

OWNER OF U.S. REG. NO. 2,486,992.

NO CLAIM IS MADE TO THE EXCLUSIVE RIGHT TO USE "NATURAL FOODS", APART FROM THE MARK AS SHOWN.

FOR MUFFINS (U.S. CL. 46).
FIRST USE 1-3-2011; IN COMMERCE 1-3-2011.

CLASS 30—(Continued).

4,165,028. MCNEIL NUTRITIONALS LLC, FORT WASHINGTON, PA. SN 85-000,365. PUB. 3-29-2011, FILED 3-29-2010.



OWNER OF U.S. REG. NOS. 1,544,079, 3,346,910, AND OTHERS.

NO CLAIM IS MADE TO THE EXCLUSIVE RIGHT TO USE "SWEETENER" AND THE PICTORIAL REPRESENTATIONS OF A BOWL OF SUGAR, SLICE OF CAKE AND TWO CUPCAKES, APART FROM THE MARK AS SHOWN.

THE MARK CONSISTS OF THE STYLIZED WORDS "IDEAL FOR THE WHOLE FAMILY SPLENDA SWEETENER" INSIDE AN OVAL WITH A CENTERED BANNER BELOW IT FOLLOWED BY IMAGES OF CUPCAKES, A SLICE OF CAKE, BOWL OF SUGAR, A CIRCLE TO THE LEFT OF THE CAKE AND A BANNER AT THE BOTTOM OF THE MARK.

FOR SWEETENERS, NAMELY, SUGAR SUBSTITUTES (U.S. CL. 46).

FIRST USE 6-8-2011; IN COMMERCE 6-8-2011.

4,165,029. MCNEIL NUTRITIONALS LLC, FORT WASHINGTON, PA. SN 85-000,370. PUB. 3-29-2011, FILED 3-29-2010.

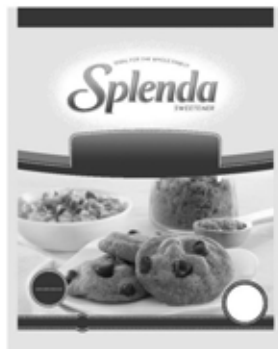

OWNER OF U.S. REG. NOS. 1,544,079, 3,346,910, AND OTHERS.

NO CLAIM IS MADE TO THE EXCLUSIVE RIGHT TO USE "SWEETENER" AND THE PICTORIAL REPRESENTATIONS OF A BOWL OF OATMEAL, A CUP AND MEASURING SPOON OF BROWN SUGAR AND A PLATE OF COOKIES, APART FROM THE MARK AS SHOWN.

CLASS 30—(Continued).

THE MARK CONSISTS OF THE STYLIZED WORDS "IDEAL FOR THE WHOLE FAMILY SPLENDA SWEETENER" INSIDE AN OVAL WITH A CENTERED BANNER BELOW IT FOLLOWED BY IMAGES OF A BOWL OF OATMEAL, A CUP AND MEASURING SPOON OF BROWN SUGAR, A PLATE OF COOKIES, CIRCLES TO THE LEFT AND RIGHT OF THE PLATE AND A BANNER AT THE BOTTOM OF THE MARK.

FOR SWEETENERS, NAMELY, SUGAR SUBSTITUTES (U.S. CL. 46).

FIRST USE 8-23-2005; IN COMMERCE 8-23-2005.

4,165,237. NEW ENGLAND TEA & COFFEE CO., INC., MALDEN, MA. SN 85-141,715. PUB. 3-22-2011, FILED 9-30-2010.

TRY ME ICED

THE MARK CONSISTS OF STANDARD CHARACTERS WITHOUT CLAIM TO ANY PARTICULAR FONT, STYLE, SIZE, OR COLOR.

NO CLAIM IS MADE TO THE EXCLUSIVE RIGHT TO USE "ICED", APART FROM THE MARK AS SHOWN, FOR COFFEE BASED BEVERAGES (U.S. CL. 46).

FIRST USE 7-0-2008; IN COMMERCE 7-0-2008.

4,165,253. WILLIAM BHASKAR, SCOTTSDALE, AZ. SN 85-147,423. PUB. 3-22-2011, FILED 10-7-2010.

The Surgeon's Breakfast

THE MARK CONSISTS OF STANDARD CHARACTERS WITHOUT CLAIM TO ANY PARTICULAR FONT, STYLE, SIZE, OR COLOR.

NO CLAIM IS MADE TO THE EXCLUSIVE RIGHT TO USE "BREAKFAST", APART FROM THE MARK AS SHOWN.

FOR BREAKFAST CEREALS (U.S. CL. 46).
FIRST USE 10-19-2009; IN COMMERCE 1-30-2012.

CLASS 30—(Continued).

4,165,264. THE GARLIC COMPANY, BAKERSFIELD, CA. SN 85-151,843. PUB. 12-20-2011, FILED 10-13-2010.



NO CLAIM IS MADE TO THE EXCLUSIVE RIGHT TO USE "THE GARLIC COMPANY OF CALIFORNIA", APART FROM THE MARK AS SHOWN.

THE MARK CONSISTS OF AN ARTISTIC AND STYLIZED REPRESENTATION OF A GARLIC BULB AND LOOSE STRANDS INSIDE A SHADED CIRCLE WITHIN AN UNSHADED CIRCLE, WHICH APPEARS ABOVE THE STYLIZED WORDS "THE GARLIC COMPANY OF CALIFORNIA".

FOR MINCED GARLIC; PROCESSED GARLIC FOR USE AS SEASONING (U.S. CL. 46).

FIRST USE 12-15-2011; IN COMMERCE 12-15-2011.

4,165,270. FOOD AND CULINARY TECHNOLOGY GROUP, INC., CALGARY, CANADA. SN 85-153,300. PUB. 7-26-2011, FILED 10-15-2010.

DELICIOUSLY NUTRITIOUS

THE MARK CONSISTS OF STANDARD CHARACTERS WITHOUT CLAIM TO ANY PARTICULAR FONT, STYLE, SIZE, OR COLOR.

NO CLAIM IS MADE TO THE EXCLUSIVE RIGHT TO USE "NUTRITIOUS", APART FROM THE MARK AS SHOWN.

FOR BREAD MIXES; BROWNIE MIXES; CAKE MIXES; CAKE MIXES, NAMELY, CAKE BASES; COOKIE MIXES; INSTANT DOUGHNUT MIXES; INSTANT PANCAKE MIXES; MIXES FOR MAKING BAKING BATTERS; MIXES FOR MAKING BREADING; MUFFIN MIXES (U.S. CL. 46).

FIRST USE 8-1-2011; IN COMMERCE 8-1-2011.

CLASS 30—(Continued).

4,165,384. LEWIS BROTHERS BAKERIES, INCORPORATED, DBA LEWIS BAKERIES, INC., EVANSVILLE, IN. SN 85-209,997. PUB. 5-24-2011, FILED 1-4-2011.

DIETER'S DREAM COME TRUE

THE MARK CONSISTS OF STANDARD CHARACTERS WITHOUT CLAIM TO ANY PARTICULAR FONT, STYLE, SIZE, OR COLOR.

OWNER OF U.S. REG. NOS. 3,309,325 AND 3,482,245.

NO CLAIM IS MADE TO THE EXCLUSIVE RIGHT TO USE "DIETER'S", APART FROM THE MARK AS SHOWN. FOR BAKERY PRODUCTS (U.S. CL. 46).

FIRST USE 10-4-2011; IN COMMERCE 10-4-2011.

4,165,385. LEWIS BROTHERS BAKERIES, INCORPORATED, DBA LEWIS BAKERIES, INC., EVANSVILLE, IN. SN 85-210,009. PUB. 5-17-2011, FILED 1-4-2011.

HEALTHY LIFE DIETER'S DREAM COME TRUE

THE MARK CONSISTS OF STANDARD CHARACTERS WITHOUT CLAIM TO ANY PARTICULAR FONT, STYLE, SIZE, OR COLOR.

OWNER OF U.S. REG. NOS. 1,815,479, 3,309,325, AND OTHERS.

NO CLAIM IS MADE TO THE EXCLUSIVE RIGHT TO USE "DIETER'S", APART FROM THE MARK AS SHOWN. FOR BAKERY PRODUCTS (U.S. CL. 46).

FIRST USE 10-4-2011; IN COMMERCE 10-4-2011.

4,165,386. LEWIS BROTHERS BAKERIES, INCORPORATED, DBA LEWIS BAKERIES, INC., EVANSVILLE, IN. SN 85-210,022. PUB. 5-17-2011, FILED 1-4-2011.

HEALTHY LIFE IS A DIETER'S DREAM COME TRUE

THE MARK CONSISTS OF STANDARD CHARACTERS WITHOUT CLAIM TO ANY PARTICULAR FONT, STYLE, SIZE, OR COLOR.

OWNER OF U.S. REG. NOS. 1,815,479, 3,309,325, AND OTHERS.

FOR BAKERY PRODUCTS (U.S. CL. 46).

FIRST USE 10-4-2011; IN COMMERCE 10-4-2011.

CLASS 30—(Continued).

4,165,471. RECKITT BENCKISER LLC, PARSIPPANY, NJ. SN 85-258,351. PUB. 8-2-2011, FILED 3-4-2011.

KICKIN' BBQ

THE MARK CONSISTS OF STANDARD CHARACTERS WITHOUT CLAIM TO ANY PARTICULAR FONT, STYLE, SIZE, OR COLOR.

NO CLAIM IS MADE TO THE EXCLUSIVE RIGHT TO USE "BBQ", APART FROM THE MARK AS SHOWN.

FOR MARINADES; SAUCES AND GLAZES FOR FOOD; CONDIMENTS, NAMELY, HOT PEPPER SAUCE; CHICKEN WING SAUCE (U.S. CL. 46).

FIRST USE 11-1-2011; IN COMMERCE 11-1-2011.



4,165,490. JIL HEALTH PRODUCTS, LLC, BEAUMONT, TX. SN 85-264,634. PUB. 9-13-2011, FILED 3-11-2011.

EASY CAKE

THE MARK CONSISTS OF STANDARD CHARACTERS WITHOUT CLAIM TO ANY PARTICULAR FONT, STYLE, SIZE, OR COLOR.

NO CLAIM IS MADE TO THE EXCLUSIVE RIGHT TO USE "CAKE", APART FROM THE MARK AS SHOWN.

FOR BROWNIES (U.S. CL. 46).

FIRST USE 4-1-2011; IN COMMERCE 4-1-2011.



4,165,543. LEWIS BROTHERS BAKERIES, INCORPORATED, DBA LEWIS BAKERIES, INC., EVANSVILLE, IN. SN 85-275,333. PUB. 8-9-2011, FILED 3-24-2011.

¡VIDA SANA ES LA RESPUESTA!

OWNER OF U.S. REG. NOS. 1,815,479, 3,015,645, AND OTHERS.

THE MARK CONSISTS OF THE STYLIZED WORDS "VIDA SANA ES LA RESPUESTA" WHICH ARE PRECEDED BY AND FOLLOWED BY EXCLAMATION MARKS.

THE ENGLISH TRANSLATION OF "VIDA SANA ES LA RESPUESTA" IN THE MARK IS "HEALTHY LIFE IS THE ANSWER".

FOR BAKERY PRODUCTS (U.S. CL. 46).

FIRST USE 11-1-2011; IN COMMERCE 11-1-2011.

CLASS 30—(Continued).

4,165,556. MOM BRANDS COMPANY, MINNEAPOLIS, MN. SN 85-277,104. PUB. 7-5-2011, FILED 3-25-2011.

SCRUMPTIOUS

THE MARK CONSISTS OF STANDARD CHARACTERS WITHOUT CLAIM TO ANY PARTICULAR FONT, STYLE, SIZE, OR COLOR.

FOR BREAKFAST CEREAL (U.S. CL. 46).

FIRST USE 12-26-2011; IN COMMERCE 12-26-2011.



4,165,557. NEW ENGLAND CONFECTIONERY COMPANY, INC., REVERE, MA. SN 85-277,128. PUB. 8-9-2011, FILED 3-25-2011.

POUR YOUR HEART OUT

THE MARK CONSISTS OF STANDARD CHARACTERS WITHOUT CLAIM TO ANY PARTICULAR FONT, STYLE, SIZE, OR COLOR.

FOR CANDY (U.S. CL. 46).

FIRST USE 11-1-2011; IN COMMERCE 11-1-2011.



4,165,613. DE BEST GOURMET FOOD PRODUCTS LTD., NIAGARA FALLS, ONTARIO, CANADA. SN 85-286,359. PUB. 8-30-2011, FILED 4-5-2011.



THE COLOR(S) BLACK, GRAY, RED, ORANGE AND YELLOW IS/ARE CLAIMED AS A FEATURE OF THE MARK.

CLASS 30—(Continued).

THE MARK CONSISTS OF A STYLIZED HUMAN FACE, WITH FOOD. THE FACIAL FEATURES ARE OUTLINED IN BLACK, WITH GREY SHADOWS. THE FOOD IN THE MOUTH OF THE FACE IS IN TONES OF RED, ORANGE AND YELLOW.

FOR PASTA SAUCE (U.S. CL. 46).
FIRST USE 9-15-2011; IN COMMERCE 3-29-2012.

4,165,621. BRIDGE BRANDS, SAN FRANCISCO, CA. SN 85-287,977. PUB. 8-16-2011, FILED 4-6-2011.

TECH LOVER'S CHOCOLATE

THE MARK CONSISTS OF STANDARD CHARACTERS WITHOUT CLAIM TO ANY PARTICULAR FONT, STYLE, SIZE, OR COLOR.

NO CLAIM IS MADE TO THE EXCLUSIVE RIGHT TO USE "CHOCOLATE", APART FROM THE MARK AS SHOWN.

FOR CHOCOLATE (U.S. CL. 46).
FIRST USE 12-14-2011; IN COMMERCE 12-22-2011.

4,165,630. CRYSTAL RIVER ORGANICS LLC, CARBONDALE, CO. SN 85-290,759. PUB. 8-16-2011, FILED 4-8-2011.

Nature's Goddess

THE MARK CONSISTS OF STANDARD CHARACTERS WITHOUT CLAIM TO ANY PARTICULAR FONT, STYLE, SIZE, OR COLOR.

FOR CEREAL BASED SNACK BARS; CEREAL BASED HIGH PROTEIN SNACK BARS AND POWDERS; CEREAL BASED HIGH ENERGY BARS NOT FOR USE AS A MEAL REPLACEMENT; CEREALS AND PREPARATIONS MADE FROM CEREALS, NAMELY, BREAKFAST CEREALS, PROCESSED CEREALS AND CEREAL BASED SNACK FOODS; SALAD DRESSINGS, CONDIMENTS, NAMELY, SALSAS, MARINADES; PREPARED AND PACKAGED READY TO EAT MEALS CONSISTING PRIMARILY OF PASTA OR RICE (U.S. CL. 46).

FIRST USE 1-1-2012; IN COMMERCE 1-1-2012.

CLASS 30—(Continued).

4,165,631. CRYSTAL RIVER ORGANICS LLC, CARBONDALE, CO. SN 85-290,779. PUB. 8-16-2011, FILED 4-8-2011.

NuDeFul

THE MARK CONSISTS OF STANDARD CHARACTERS WITHOUT CLAIM TO ANY PARTICULAR FONT, STYLE, SIZE, OR COLOR.

FOR CEREAL BASED SNACK BARS; CEREAL BASED HIGH PROTEIN SNACK BARS AND POWDERS; CEREAL BASED HIGH ENERGY BARS NOT FOR USE AS A MEAL REPLACEMENT; CEREALS AND PREPARATIONS MADE FROM CEREALS, NAMELY, BREAKFAST CEREALS, PROCESSED CEREALS AND CEREAL BASED SNACK FOODS; SALAD DRESSINGS, CONDIMENTS, NAMELY, SALSAS, MARINADES; PREPARED AND PACKAGED READY TO EAT MEALS CONSISTING PRIMARILY OF PASTA OR RICE (U.S. CL. 46).

FIRST USE 1-1-2012; IN COMMERCE 1-1-2012.

4,165,632. CRYSTAL RIVER ORGANICS LLC, CARBONDALE, CO. SN 85-290,781. PUB. 8-16-2011, FILED 4-8-2011.

Precious Life

THE MARK CONSISTS OF STANDARD CHARACTERS WITHOUT CLAIM TO ANY PARTICULAR FONT, STYLE, SIZE, OR COLOR.

FOR CEREAL BASED SNACK BARS; CEREAL BASED HIGH PROTEIN SNACK BARS AND POWDERS; CEREAL BASED HIGH ENERGY BARS NOT FOR USE AS A MEAL REPLACEMENT; CEREALS AND PREPARATIONS MADE FROM CEREALS, NAMELY, BREAKFAST CEREALS, PROCESSED CEREALS AND CEREAL BASED SNACK FOODS; SALAD DRESSINGS, CONDIMENTS, NAMELY, SALSAS, MARINADES; PREPARED AND PACKAGED READY TO EAT MEALS CONSISTING PRIMARILY OF PASTA OR RICE (U.S. CL. 46).

FIRST USE 1-1-2012; IN COMMERCE 1-1-2012.

4,165,722. FIREDROPS, LLC, BEVERLY, MA. SN 85-326,160. PUB. 11-8-2011, FILED 5-20-2011.

FIREDROPS

NO CLAIM IS MADE TO THE EXCLUSIVE RIGHT TO USE "DROPS", APART FROM THE MARK AS SHOWN.

THE COLOR(S) BROWN, RED IS/ARE CLAIMED AS A FEATURE OF THE MARK.

CLASS 30—(Continued).

THE MARK CONSISTS OF THE STYLIZED WORDING "FIRE DROPS", WHERE THE LETTER "I" IS FORMED BY THE REPRESENTATION OF A RED CHILI, AND ALL OTHER LETTERS IN THE MARK APPEAR IN THE COLOR BROWN.

FOR NON-MEDICATED LOZENGES AND CANDY (U.S. CL. 46).
FIRST USE 11-1-2011; IN COMMERCE 11-1-2011.

4,165,750. CORRAL WEST SPICES, L.L.C., TAYLORSVILLE, UT. SN 85-341,883. PUB. 12-6-2011, FILED 6-9-2011.

PAPA'S SPICE DUST

THE MARK CONSISTS OF STANDARD CHARACTERS WITHOUT CLAIM TO ANY PARTICULAR FONT, STYLE, SIZE, OR COLOR.

NO CLAIM IS MADE TO THE EXCLUSIVE RIGHT TO USE "SPICE", APART FROM THE MARK AS SHOWN.
FOR SPICES (U.S. CL. 46).
FIRST USE 3-15-2012; IN COMMERCE 3-15-2012.

4,165,869. UNION SUPPLY COMPANY, RANCHO DOMINGUEZ, CA. SN 85-401,151. PUB. 11-8-2011, FILED 8-18-2011.

DRAGON EXPRESS

THE MARK CONSISTS OF STANDARD CHARACTERS WITHOUT CLAIM TO ANY PARTICULAR FONT, STYLE, SIZE, OR COLOR.

FOR RAMEN NOODLES (U.S. CL. 46).
FIRST USE 2-23-2012; IN COMMERCE 2-23-2012.

4,165,917. SOCIETE DES PRODUITS NESTLE S.A., 1800 VEVEY, SWITZERLAND. SN 85-976,346. PUB. 7-12-2011, FILED 2-18-2011.

SKINNY COW

THE MARK CONSISTS OF STANDARD CHARACTERS WITHOUT CLAIM TO ANY PARTICULAR FONT, STYLE, SIZE, OR COLOR.

CLASS 30—(Continued).

OWNER OF U.S. REG. NOS. 2,324,506, 3,360,435, AND 3,403,713.

FOR CANDY; CHOCOLATE CONFECTIONS (U.S. CL. 46).
FIRST USE 5-1-2011; IN COMMERCE 5-1-2011.

CLASS 31—NATURAL AGRICULTURAL PRODUCTS

4,164,858. FUTURE FRUIT, LLC, VISALIA, CA. SN 77-633,187. PUB. 4-14-2009, FILED 12-15-2008.

MANDALATE

THE MARK CONSISTS OF STANDARD CHARACTERS WITHOUT CLAIM TO ANY PARTICULAR FONT, STYLE, SIZE, OR COLOR.

FOR FRESH CITRUS FRUIT (U.S. CLS. 1 AND 46).
FIRST USE 5-1-2012; IN COMMERCE 5-1-2012.

4,165,061. TUCKER DEAN D. SUMNER, GA. SN 85-028,764. PUB. 3-22-2011, FILED 5-3-2010.

**Slice of Life Nature's
Candy**

THE MARK CONSISTS OF STANDARD CHARACTERS WITHOUT CLAIM TO ANY PARTICULAR FONT, STYLE, SIZE, OR COLOR.

FOR WATERMELON, FRESH (U.S. CLS. 1 AND 46).
FIRST USE 4-0-2011; IN COMMERCE 4-0-2011.

4,165,239. ORCHARD SUPPLY HARDWARE LLC, SAN JOSE, CA. SN 85-142,154. PUB. 9-6-2011, FILED 9-30-2010.

SUPER SELECT

THE MARK CONSISTS OF STANDARD CHARACTERS WITHOUT CLAIM TO ANY PARTICULAR FONT, STYLE, SIZE, OR COLOR.

NO CLAIM IS MADE TO THE EXCLUSIVE RIGHT TO USE "SELECT", APART FROM THE MARK AS SHOWN.
FOR GRASS SEEDS (U.S. CLS. 1 AND 46).
FIRST USE 4-0-2007; IN COMMERCE 4-0-2007.

CLASS 31—(Continued).

4,165,263. THE GARLIC COMPANY, BAKERSFIELD, CA. SN 85-151,830. PUB. 1-17-2012, FILED 10-13-2010.



NO CLAIM IS MADE TO THE EXCLUSIVE RIGHT TO USE "THE GARLIC COMPANY OF CALIFORNIA", APART FROM THE MARK AS SHOWN.

THE MARK CONSISTS OF AN ARTISTIC AND STYLIZED REPRESENTATION OF A GARLIC BULB AND LOOSE STRANDS INSIDE A SHADED CIRCLE WITHIN AN UNSHADED CIRCLE, WHICH APPEARS ABOVE THE STYLIZED WORDS "THE GARLIC COMPANY OF CALIFORNIA".

FOR FRESH GARLIC; FRESH ONIONS; RAW GARLIC; RAW ONIONS; UNPROCESSED GARLIC; UNPROCESSED ONIONS (U.S. CLS. 1 AND 46).

FIRST USE 12-15-2011; IN COMMERCE 12-15-2011.

4,165,275. EUROFRESH, INC., WILLCOX, AZ. SN 85-155,990. PUB. 8-30-2011, FILED 10-19-2010.



OWNER OF U.S. REG. NOS. 1,679,579, 2,969,367, AND 2,969,368.

NO CLAIM IS MADE TO THE EXCLUSIVE RIGHT TO USE "FRESH FARMS" OR "SYSTEM", APART FROM THE MARK AS SHOWN.

THE MARK CONSISTS OF A LINE WITH A BOX IN THE CENTER OF IT, IN THE BOX ARE THE WORDS "EURO FRESH FARMS", BELOW THAT IS THE WORD "ENVIROLOCK" WITH A PICTURE OF TWO HANDS AND A LEAF BETWEEN THE LETTERS "R" AND "L", BELOW THAT IS THE WORD "SYSTEM".

FOR FRESH PRODUCE, NAMELY, FRESH FRUITS AND VEGETABLES GROWN IN A CONTAMINANT CONTROLLED ENVIRONMENT (U.S. CLS. 1 AND 46).

FIRST USE 4-23-2012; IN COMMERCE 4-23-2012.

CLASS 31—(Continued).

4,165,373. PENNINGTON SEED, INC. OF NEBRASKA, MADISON, GA. SN 85-207,322. PUB. 5-17-2011, FILED 12-29-2010.

DR DISEASE RESISTANT

THE MARK CONSISTS OF STANDARD CHARACTERS WITHOUT CLAIM TO ANY PARTICULAR FONT, STYLE, SIZE, OR COLOR.

OWNER OF U.S. REG. NO. 2,973,223.

NO CLAIM IS MADE TO THE EXCLUSIVE RIGHT TO USE "DISEASE RESISTANT", APART FROM THE MARK AS SHOWN.

FOR GRASS SEED (U.S. CLS. 1 AND 46).

FIRST USE 7-0-2008; IN COMMERCE 7-0-2008.

4,165,535. KELLY FOODS CORPORATION, BERLIN, MD. SN 85-274,550. PUB. 8-23-2011, FILED 3-23-2011.

CAT TREATS PLUS

THE MARK CONSISTS OF STANDARD CHARACTERS WITHOUT CLAIM TO ANY PARTICULAR FONT, STYLE, SIZE, OR COLOR.

NO CLAIM IS MADE TO THE EXCLUSIVE RIGHT TO USE "CAT TREATS", APART FROM THE MARK AS SHOWN.

FOR PET TREATS (U.S. CLS. 1 AND 46).

FIRST USE 7-21-2011; IN COMMERCE 7-21-2011.

4,165,539. AGRAPLUS, INC., EAGLE, ID. SN 85-275,125. PUB. 8-9-2011, FILED 3-23-2011.

UNO

THE MARK CONSISTS OF STANDARD CHARACTERS WITHOUT CLAIM TO ANY PARTICULAR FONT, STYLE, SIZE, OR COLOR.

FOR PEA SEADS (U.S. CLS. 1 AND 46).

FIRST USE 2-24-2012; IN COMMERCE 2-24-2012.

CLASS 31—(Continued).

4,165,583. WILDGAME INNOVATIONS, LLC, BROUSSARD, LA. SN 85-281,853. PUB. 8-9-2011, FILED 3-30-2011.

BONES & BEARD

THE MARK CONSISTS OF STANDARD CHARACTERS WITHOUT CLAIM TO ANY PARTICULAR FONT, STYLE, SIZE, OR COLOR.

FOR MIXTURE OF FORAGE SEEDS USED IN FOOD PLOTS WHICH ARE PLANTED TO ATTRACT WILD-LIFE (U.S. CLS. 1 AND 46).

FIRST USE 4-20-2011; IN COMMERCE 4-20-2011.

4,165,770. JFFALASKA, LLC, FAIRBANKS, AK. SN 85-353,902. PUB. 12-6-2011, FILED 6-23-2011.

Better'n Organic

THE MARK CONSISTS OF STANDARD CHARACTERS WITHOUT CLAIM TO ANY PARTICULAR FONT, STYLE, SIZE, OR COLOR.

FOR LIVING PLANTS AND MICROGREENS THAT ARE HYDROPONICALLY GROWN, USING INDOOR-CONTROLLED ENVIRONMENT AGRICULTURAL METHODS (U.S. CLS. 1 AND 46).

FIRST USE 1-28-2011; IN COMMERCE 1-28-2011.

4,165,815. SUPHACHATWONG INNOVATION CO, LTD., BANGPHRA, CONBURI, THAILAND. SN 85-375,692. PUB. 12-20-2011, FILED 7-20-2011.

KANCHANA

THE MARK CONSISTS OF STANDARD CHARACTERS WITHOUT CLAIM TO ANY PARTICULAR FONT, STYLE, SIZE, OR COLOR.

FOR NATURAL PLANTS AND FLOWERS (U.S. CLS. 1 AND 46).

FIRST USE 0-0-2011; IN COMMERCE 0-0-2011.

CLASS 31—(Continued).

4,165,821. BEAUDOIN, JEFFREY, ELYRIA, OH. SN 85-378,151. PUB. 1-10-2012, FILED 7-22-2011.

**RUFF STICKS All Natural
Dog Treats**

THE MARK CONSISTS OF STANDARD CHARACTERS WITHOUT CLAIM TO ANY PARTICULAR FONT, STYLE, SIZE, OR COLOR.

NO CLAIM IS MADE TO THE EXCLUSIVE RIGHT TO USE "STICKS ALL NATURAL DOG TREATS", APART FROM THE MARK AS SHOWN.

FOR DOG TREATS (U.S. CLS. 1 AND 46).

FIRST USE 11-12-2011; IN COMMERCE 11-12-2011.

4,165,824. FROMM FAMILY FOODS, LLC, MEQUON, WI. SN 85-378,790. PUB. 12-20-2011, FILED 7-22-2011.

SALMON TUNALINI

THE MARK CONSISTS OF STANDARD CHARACTERS WITHOUT CLAIM TO ANY PARTICULAR FONT, STYLE, SIZE, OR COLOR.

NO CLAIM IS MADE TO THE EXCLUSIVE RIGHT TO USE "SALMON", APART FROM THE MARK AS SHOWN.

FOR FOOD FOR ANIMALS (U.S. CLS. 1 AND 46).

FIRST USE 1-3-2012; IN COMMERCE 1-3-2012.

4,165,881. JOHANSSON, KEITH G., FORT WORTH, TX. SN 85-406,607. PUB. 1-24-2012, FILED 8-24-2011.

BABY DRAGON

THE MARK CONSISTS OF STANDARD CHARACTERS WITHOUT CLAIM TO ANY PARTICULAR FONT, STYLE, SIZE, OR COLOR.

OWNER OF U.S. REG. NO. 3,084,188.

FOR HORTICULTURAL PRODUCTS, NAMELY, LIVE MAPLE TREES (U.S. CLS. 1 AND 46).

FIRST USE 3-30-2012; IN COMMERCE 3-30-2012.

CLASS 31—(Continued).

4,165,882. JOHANSSON, KEITH G., FORT WORTH, TX. SN 85-406,610. PUB. 1-24-2012, FILED 8-24-2011.

SUPER DRAGON

THE MARK CONSISTS OF STANDARD CHARACTERS WITHOUT CLAIM TO ANY PARTICULAR FONT, STYLE, SIZE, OR COLOR.

OWNER OF U.S. REG. NO. 3,084,188.
FOR HORTICULTURAL PRODUCTS, NAMELY, LIVE MAPLE TREES (U.S. CLS. 1 AND 46).
FIRST USE 3-30-2012; IN COMMERCE 3-30-2012.

CLASS 32—LIGHT BEVERAGES

4,164,962. GT BEVERAGE COMPANY, LLC, LAGUNA NIGUEL, CA. SN 77-904,719. PUB. 8-16-2011, FILED 1-4-2010.



THE MARK CONSISTS OF A THREE-DIMENSIONAL CONFIGURATION OF THE PACKAGING FOR THE GOODS, NAMELY, A BEVERAGE CONTAINER FEATURING A GLOBULAR BOTTLE SHAPE RESEMBLING A JACK-O-LANTERN. THE BROKEN LINES IN THE BOTTOM OF THE BOTTLE AND IN THE NECK AND CAP OF THE BOTTLE ARE NOT CLAIMED AS PART OF THE MARK BUT ARE INSTEAD FOR CONTEXT AND TO SHOW PLACEMENT OF THE MARK ON THE BEVERAGE CONTAINER.

FOR SPORTS DRINKS (U.S. CLS. 45, 46 AND 48).
FIRST USE 10-10-2010; IN COMMERCE 10-10-2010.

4,165,197. HARD 8 BEVERAGE COMPANY, SEATTLE, WA. SN 85-127,026. PUB. 2-22-2011, FILED 9-10-2010.

HARD 8

THE MARK CONSISTS OF STANDARD CHARACTERS WITHOUT CLAIM TO ANY PARTICULAR FONT, STYLE, SIZE, OR COLOR.

FOR MALT BEER (U.S. CLS. 45, 46 AND 48).
FIRST USE 2-25-2011; IN COMMERCE 3-4-2012.

CLASS 32—(Continued).

4,165,364. SIMKO LLC, HERMOSA BEACH, CA. SN 85-202,373. PUB. 10-11-2011, FILED 12-21-2010.

Hermosa Blonde

THE MARK CONSISTS OF STANDARD CHARACTERS WITHOUT CLAIM TO ANY PARTICULAR FONT, STYLE, SIZE, OR COLOR.

NO CLAIM IS MADE TO THE EXCLUSIVE RIGHT TO USE "BLONDE", APART FROM THE MARK AS SHOWN.
THE ENGLISH TRANSLATION OF THE WORD "HERMOSA" IN THE MARK IS "BEAUTIFUL".
FOR BEER (U.S. CLS. 45, 46 AND 48).
FIRST USE 3-1-2012; IN COMMERCE 3-1-2012.

4,165,365. SIMKO LLC, HERMOSA BEACH, CA. SN 85-202,376. PUB. 10-11-2011, FILED 12-21-2010.

Hermosa Red

THE MARK CONSISTS OF STANDARD CHARACTERS WITHOUT CLAIM TO ANY PARTICULAR FONT, STYLE, SIZE, OR COLOR.

NO CLAIM IS MADE TO THE EXCLUSIVE RIGHT TO USE "RED", APART FROM THE MARK AS SHOWN.
THE ENGLISH TRANSLATION OF THE WORD "HERMOSA" IN THE MARK IS "BEAUTIFUL".
FOR BEER (U.S. CLS. 45, 46 AND 48).
FIRST USE 3-1-2012; IN COMMERCE 3-1-2012.

4,165,366. SIMKO LLC, HERMOSA BEACH, CA. SN 85-202,379. PUB. 10-25-2011, FILED 12-21-2010.

Hermosa Brunette

THE MARK CONSISTS OF STANDARD CHARACTERS WITHOUT CLAIM TO ANY PARTICULAR FONT, STYLE, SIZE, OR COLOR.

THE ENGLISH TRANSLATION OF THE WORD "HERMOSA" IN THE MARK IS "BEAUTIFUL".
FOR BEER (U.S. CLS. 45, 46 AND 48).
FIRST USE 3-1-2012; IN COMMERCE 3-1-2012.

CLASS 32—(Continued).

4,165,367. SIMKO LLC, HERMOSA BEACH, CA. SN 85-202,381. PUB. 10-11-2011, FILED 12-21-2010.

Hermosa Auburn

THE MARK CONSISTS OF STANDARD CHARACTERS WITHOUT CLAIM TO ANY PARTICULAR FONT, STYLE, SIZE, OR COLOR.

THE ENGLISH TRANSLATION OF THE WORD "HERMOSA" IN THE MARK IS "BEAUTIFUL".
FOR BEER (U.S. CLS. 45, 46 AND 48).
FIRST USE 3-1-2012; IN COMMERCE 3-1-2012.

4,165,368. SIMKO LLC, HERMOSA BEACH, CA. SN 85-202,383. PUB. 10-11-2011, FILED 12-21-2010.

Hermosa Amber

THE MARK CONSISTS OF STANDARD CHARACTERS WITHOUT CLAIM TO ANY PARTICULAR FONT, STYLE, SIZE, OR COLOR.

NO CLAIM IS MADE TO THE EXCLUSIVE RIGHT TO USE "AMBER", APART FROM THE MARK AS SHOWN.

THE ENGLISH TRANSLATION OF THE WORD "HERMOSA" IN THE MARK IS "BEAUTIFUL".
FOR BEER (U.S. CLS. 45, 46 AND 48).
FIRST USE 3-1-2012; IN COMMERCE 3-1-2012.

4,165,422. FOLTZ, TIMOTHY JOSEPH, PHILADELPHIA, PA. SN 85-233,931. PUB. 6-14-2011, FILED 2-4-2011.

HumanKind

THE MARK CONSISTS OF STANDARD CHARACTERS WITHOUT CLAIM TO ANY PARTICULAR FONT, STYLE, SIZE, OR COLOR.

FOR BOTTLED DRINKING WATER; BOTTLED WATER; CARBONATED WATERS; DRINKING WATER; DRINKING WATER WITH VITAMINS; DRINKING WATERS; FLAVORED BOTTLED WATER; FLAVORED WATERS; FLAVOURED MINERAL WATER; FLAVOURED WATERS; MINERAL AND AERATED WATER; MINERAL AND AERATED WATERS; MINERAL AND CARBONATED WATERS; MINERAL WATER; SELTZER WATER; SODA WATER; SPARKLING WATER; SPRING WATER; WATER BEVERAGES (U.S. CLS. 45, 46 AND 48).
FIRST USE 10-1-2011; IN COMMERCE 10-1-2011.

CLASS 32—(Continued).

4,165,607. RED ROCK BREWING COMPANY, SALT LAKE CITY, UT. SN 85-285,817. PUB. 1-31-2012, FILED 4-4-2011.



NO CLAIM IS MADE TO THE EXCLUSIVE RIGHT TO USE "BREWERY", APART FROM THE MARK AS SHOWN.

THE MARK CONSISTS OF THE WORDS "RED ROCK" WITH THE WORD "BREWERY" BELOW, OUTLINED BY A DOUBLE IRREGULAR HEXAGON SHAPE.

FOR BEER (U.S. CLS. 45, 46 AND 48).
FIRST USE 2-28-2011; IN COMMERCE 4-7-2011.

4,165,625. STAFFENBERG, EDDIE, ODESSA, FL. AND GARDNER, MICHAEL A., DUNEDIN, FL. SN 85-289,254. PUB. 2-28-2012, FILED 4-7-2011.

THIN ENERGY

THE MARK CONSISTS OF STANDARD CHARACTERS WITHOUT CLAIM TO ANY PARTICULAR FONT, STYLE, SIZE, OR COLOR.

NO CLAIM IS MADE TO THE EXCLUSIVE RIGHT TO USE "ENERGY", APART FROM THE MARK AS SHOWN.

FOR BEAUTY BEVERAGES, NAMELY, FRUIT JUICES AND ENERGY DRINKS CONTAINING NUTRITIONAL SUPPLEMENTS (U.S. CLS. 45, 46 AND 48).
FIRST USE 2-13-2012; IN COMMERCE 2-13-2012.

4,165,684. GO GUNG-HO, LLC, HIGHLAND, UT. SN 85-306,390. PUB. 9-13-2011, FILED 4-27-2011.



THE COLOR(S) BLACK AND YELLOW IS/ARE CLAIMED AS A FEATURE OF THE MARK.

THE MARK CONSISTS OF STYLIZED LETTERS COMBINED TO FORM "GUNGHO". THE COLOR BLACK APPEARS ON THE STYLIZED LETTERING OF "GUNG", AND THE COLOR YELLOW APPEARS ON THE STYLIZED LETTERING OF "HO".

FOR ENERGY DRINKS (U.S. CLS. 45, 46 AND 48).
FIRST USE 10-15-2010; IN COMMERCE 10-15-2010.

CLASS 32—(Continued).

4,165,851. LEADING EDGE MARKETING, INC. PTE LTD., SINGAPORE, SINGAPORE. SN 85-393,267. PUB. 1-31-2012, FILED 8-9-2011.

Brain Tea

THE MARK CONSISTS OF STANDARD CHARACTERS WITHOUT CLAIM TO ANY PARTICULAR FONT, STYLE, SIZE, OR COLOR.
FOR BOTTLED DRINKING WATER FORTIFIED WITH VITAMINS, MINERALS, AND HERBS (U.S. CLS. 45, 46 AND 48).
FIRST USE 6-1-2011; IN COMMERCE 4-1-2012.

CLASS 33—WINES AND SPIRITS

4,164,802. OFFICER, MICHAEL R., SANTA ROSA, CA. AND OFFICER, KENDALL H., SANTA ROSA, CA. SN 76-707,789. PUB. 10-25-2011, FILED 5-31-2011.

THE DERIVATIVE

THE MARK CONSISTS OF STANDARD CHARACTERS WITHOUT CLAIM TO ANY PARTICULAR FONT, STYLE, SIZE, OR COLOR.
FOR WINE (U.S. CLS. 47 AND 49).
FIRST USE 1-18-2012; IN COMMERCE 2-8-2012.

4,164,819. SUTTER HOME WINERY, INC., ST. HELENA, CA. SN 77-454,881. PUB. 3-24-2009, FILED 4-22-2008.

HIGHWAY ONE

THE MARK CONSISTS OF STANDARD CHARACTERS WITHOUT CLAIM TO ANY PARTICULAR FONT, STYLE, SIZE, OR COLOR.
FOR WINE (U.S. CLS. 47 AND 49).
FIRST USE 4-27-2012; IN COMMERCE 4-27-2012.

CLASS 33—(Continued).

4,164,846. THACKREY, SEAN HALEY, BOLINAS, CA. SN 77-581,006. PUB. 2-17-2009, FILED 9-29-2008.

CASSIOPEIA

THE MARK CONSISTS OF STANDARD CHARACTERS WITHOUT CLAIM TO ANY PARTICULAR FONT, STYLE, SIZE, OR COLOR.
FOR WINES (U.S. CLS. 47 AND 49).
FIRST USE 11-14-2010; IN COMMERCE 11-14-2010.

4,164,847. THACKREY, SEAN HALEY, BOLINAS, CA. SN 77-581,017. PUB. 2-17-2009, FILED 9-29-2008.

LYRA

THE MARK CONSISTS OF STANDARD CHARACTERS WITHOUT CLAIM TO ANY PARTICULAR FONT, STYLE, SIZE, OR COLOR.
FOR WINES (U.S. CLS. 47 AND 49).
FIRST USE 1-28-2011; IN COMMERCE 1-28-2011.

4,164,878. THE WINE GROUP LLC, TRACY, CA. SN 77-723,376. PUB. 7-21-2009, FILED 4-27-2009.

PLUSH

THE MARK CONSISTS OF STANDARD CHARACTERS WITHOUT CLAIM TO ANY PARTICULAR FONT, STYLE, SIZE, OR COLOR.
FOR WINE (U.S. CLS. 47 AND 49).
FIRST USE 4-13-2012; IN COMMERCE 4-13-2012.

CLASS 33—(Continued).

4,164,880. STACY A. CLARK, ST. HELENA, CA. SN 77-733,830. PUB. 9-22-2009, FILED 5-11-2009.

galland clark

THE MARK CONSISTS OF STANDARD CHARACTERS WITHOUT CLAIM TO ANY PARTICULAR FONT, STYLE, SIZE, OR COLOR.

"GALLAND CLARK DOES NOT IDENTIFY A LIVING INDIVIDUAL."

FOR WINE (U.S. CLS. 47 AND 49).
FIRST USE 1-10-2009; IN COMMERCE 2-19-2012.

4,164,946. CK3 LLC, NEW YORK, NY. SN 77-877,530. PUB. 10-5-2010, FILED 11-20-2009.

DEFIANTLY DELICIOUS

THE MARK CONSISTS OF STANDARD CHARACTERS WITHOUT CLAIM TO ANY PARTICULAR FONT, STYLE, SIZE, OR COLOR.

NO CLAIM IS MADE TO THE EXCLUSIVE RIGHT TO USE "DELICIOUS", APART FROM THE MARK AS SHOWN. FOR ALCOHOLIC BEVERAGES EXCEPT BEERS (U.S. CLS. 47 AND 49).

FIRST USE 9-0-2009; IN COMMERCE 9-0-2009.

4,164,948. BREUCKELEN DISTILLING COMPANY INCORPORATED, BROOKLYN, NY. SN 77-886,132. PUB. 4-27-2010, FILED 12-4-2009.

BREUCKELEN

THE MARK CONSISTS OF STANDARD CHARACTERS WITHOUT CLAIM TO ANY PARTICULAR FONT, STYLE, SIZE, OR COLOR.

FOR GIN (U.S. CLS. 47 AND 49).
FIRST USE 7-24-2010; IN COMMERCE 7-24-2010.

CLASS 33—(Continued).

4,165,040. SOUTHERN COMFORT PROPERTIES, INC., SAN RAFAEL, CA. SN 85-007,805. PUB. 1-25-2011, FILED 4-6-2010.



OWNER OF U.S. REG. NOS. 1,522,030, 2,650,503, AND OTHERS.

NO CLAIM IS MADE TO THE EXCLUSIVE RIGHT TO USE "NEW ORLEANS ORIGINAL", APART FROM THE MARK AS SHOWN.

THE MARK CONSISTS OF A SHIELD DESIGN WITH THE WORDS "NEW ORLEANS ORIGINAL" ARCHED OVER THE STACKED WORDS "SOUTHERN COMFORT" WHICH ARE SEPARATED BY A DECORATIVE DIVIDER OF CURVED AND SWIRLED LINES, OVER A CRESCENT MOON WITH A SMALLER DECORATIVE DIVIDER WITH "18" ON THE LEFT OF THE BORDER AND "74" ON THE RIGHT OF THE BORDER, AND UNDER THAT THE LETTERS "SC".

FOR DISTILLED SPIRITS (U.S. CLS. 47 AND 49).
FIRST USE 5-1-2010; IN COMMERCE 5-1-2010.

4,165,067. DOUBLE DIAMOND DISTILLERY, LLC, PUEBLO, CO. SN 85-034,605. PUB. 5-10-2011, FILED 5-10-2010.

VODKA WITH AN ALTITUDE

THE MARK CONSISTS OF STANDARD CHARACTERS WITHOUT CLAIM TO ANY PARTICULAR FONT, STYLE, SIZE, OR COLOR.

NO CLAIM IS MADE TO THE EXCLUSIVE RIGHT TO USE "VODKA", APART FROM THE MARK AS SHOWN.

FOR VODKA (U.S. CLS. 47 AND 49).
FIRST USE 5-27-2010; IN COMMERCE 5-27-2010.

4,165,147. LAS JOYAS DEL AGAVE, SA DE CV, GUADALAJARA, JAL, MEXICO. SN 85-113,334. PUB. 9-13-2011, FILED 8-23-2010.

ARTENOM SELECCIÓN DE 1414

THE MARK CONSISTS OF STANDARD CHARACTERS WITHOUT CLAIM TO ANY PARTICULAR FONT, STYLE, SIZE, OR COLOR.

NO CLAIM IS MADE TO THE EXCLUSIVE RIGHT TO USE "SELECCION" AND "1414", APART FROM THE MARK AS SHOWN.

CLASS 33—(Continued).

THE ENGLISH TRANSLATION OF "SELECCION" IN THE MARK IS "SELECTION".
FOR TEQUILA (U.S. CLS. 47 AND 49).
FIRST USE 4-4-2012; IN COMMERCE 4-4-2012.

4,165,162. DESTILERIA SERRALLES, INC., MERCEDITA, PUERTO RICO. SN 85-118,567. PUB. 2-15-2011, FILED 8-30-2010.

CALICHE

THE MARK CONSISTS OF STANDARD CHARACTERS WITHOUT CLAIM TO ANY PARTICULAR FONT, STYLE, SIZE, OR COLOR.
FOR RUM (U.S. CLS. 47 AND 49).
FIRST USE 3-1-2012; IN COMMERCE 3-1-2012.

4,165,231. SANITY WINE AND SPIRITS, LLC, NAPA, CA. SN 85-138,931. PUB. 8-30-2011, FILED 9-27-2010.

COTES DU SOLEIL

THE MARK CONSISTS OF STANDARD CHARACTERS WITHOUT CLAIM TO ANY PARTICULAR FONT, STYLE, SIZE, OR COLOR.
THE ENGLISH TRANSLATION OF "COTES DU SOLEIL" IN THE MARK IS "HILLS OF THE SUN".
FOR ALCOHOLIC BEVERAGES EXCEPT BEERS (U.S. CLS. 47 AND 49).
FIRST USE 11-28-2011; IN COMMERCE 11-28-2011.

4,165,277. H.D.D. LLC, DBA TRUETT HURST WINERY, HEALDSBURG, CA. SN 85-156,366. PUB. 3-22-2011, FILED 10-19-2010.

SIMPLY PURE

THE MARK CONSISTS OF STANDARD CHARACTERS WITHOUT CLAIM TO ANY PARTICULAR FONT, STYLE, SIZE, OR COLOR.
FOR ALCOHOLIC BEVERAGES EXCEPT BEERS (U.S. CLS. 47 AND 49).
FIRST USE 6-17-2011; IN COMMERCE 6-17-2011.

CLASS 33—(Continued).

4,165,283. PROJECT O, LLC, MIAMI BEACH, FL. SN 85-159,064. PUB. 2-14-2012, FILED 10-22-2010.

SUPRAFRUTA

THE MARK CONSISTS OF STANDARD CHARACTERS WITHOUT CLAIM TO ANY PARTICULAR FONT, STYLE, SIZE, OR COLOR.

THE WORDING "SUPRAFRUTA" HAS NO MEANING IN A FOREIGN LANGUAGE.
FOR WINE; WINE-BASED DRINKS (U.S. CLS. 47 AND 49).

FIRST USE 7-14-2011; IN COMMERCE 7-14-2011.

4,165,316. HARD 8 BEVERAGE COMPANY, DBA HARD 8 BEVERAGE, SEATTLE, WA. SN 85-174,957. PUB. 2-22-2011, FILED 11-11-2010.

Hard 8

THE MARK CONSISTS OF STANDARD CHARACTERS WITHOUT CLAIM TO ANY PARTICULAR FONT, STYLE, SIZE, OR COLOR.

FOR DISTILLED SPIRITS (U.S. CLS. 47 AND 49).

FIRST USE 2-25-2011; IN COMMERCE 3-25-2012.

4,165,358. TURN KEY WINE BRANDS LLC, SANTA BARBARA, CA. SN 85-198,842. PUB. 4-26-2011, FILED 12-15-2010.

TURN KEY

THE MARK CONSISTS OF STANDARD CHARACTERS WITHOUT CLAIM TO ANY PARTICULAR FONT, STYLE, SIZE, OR COLOR.

FOR WINES (U.S. CLS. 47 AND 49).

FIRST USE 12-13-2010; IN COMMERCE 3-20-2012.

CLASS 33—(Continued).

4,165,469. VERT, JAMES D., SEATTLE, WA. AND STARK, JAMES W., SEATTLE, WA. AND FINAMORE, NICOLE S., SEATTLE, WA. SN 85-257,734. PUB. 8-30-2011, FILED 3-4-2011.

JOE SCHMOE

THE MARK CONSISTS OF STANDARD CHARACTERS WITHOUT CLAIM TO ANY PARTICULAR FONT, STYLE, SIZE, OR COLOR.

"JOE SCHMO" DOES NOT IDENTIFY A LIVING INDIVIDUAL.

FOR DISTILLED SPIRITS (U.S. CLS. 47 AND 49).
FIRST USE 4-1-2012; IN COMMERCE 4-1-2012.

CLASS 33—(Continued).

4,165,859. CONTINENTAL VINEYARDS, LLC, PASO ROBLES, CA. SN 85-396,720. PUB. 1-17-2012, FILED 8-12-2011.

QUADRANT

THE MARK CONSISTS OF STANDARD CHARACTERS WITHOUT CLAIM TO ANY PARTICULAR FONT, STYLE, SIZE, OR COLOR.

FOR WINE (U.S. CLS. 47 AND 49).
FIRST USE 8-25-2011; IN COMMERCE 8-25-2011.

4,165,575. SUTTER HOME WINERY, INC., ST. HELENA, CA. SN 85-280,603. PUB. 8-2-2011, FILED 3-29-2011.

FANCY PANTS

THE MARK CONSISTS OF STANDARD CHARACTERS WITHOUT CLAIM TO ANY PARTICULAR FONT, STYLE, SIZE, OR COLOR.

FOR ALCOHOLIC BEVERAGES EXCEPT BEERS (U.S. CLS. 47 AND 49).
FIRST USE 5-9-2012; IN COMMERCE 5-9-2012.

4,165,860. CONTINENTAL VINEYARDS, LLC, PASO ROBLES, CA. SN 85-396,761. PUB. 1-17-2012, FILED 8-12-2011.

PULL

THE MARK CONSISTS OF STANDARD CHARACTERS WITHOUT CLAIM TO ANY PARTICULAR FONT, STYLE, SIZE, OR COLOR.

FOR WINE (U.S. CLS. 47 AND 49).
FIRST USE 11-10-2011; IN COMMERCE 11-10-2011.

4,165,664. BCTLD, LLC, SEATTLE, WA. SN 85-299,461. PUB. 10-4-2011, FILED 4-20-2011.

BIG GIN

THE MARK CONSISTS OF STANDARD CHARACTERS WITHOUT CLAIM TO ANY PARTICULAR FONT, STYLE, SIZE, OR COLOR.

NO CLAIM IS MADE TO THE EXCLUSIVE RIGHT TO USE "GIN", APART FROM THE MARK AS SHOWN.

FOR ALCOHOLIC BEVERAGES EXCEPT BEERS (U.S. CLS. 47 AND 49).
FIRST USE 3-1-2012; IN COMMERCE 3-1-2012.

4,165,892. ZHANG'S WINERY INC., SAN MARINO, CA. SN 85-419,079. PUB. 2-7-2012, FILED 9-9-2011.

PURLIEU

THE MARK CONSISTS OF STANDARD CHARACTERS WITHOUT CLAIM TO ANY PARTICULAR FONT, STYLE, SIZE, OR COLOR.

FOR ALCOHOLIC BEVERAGES EXCEPT BEERS; WINE (U.S. CLS. 47 AND 49).
FIRST USE 12-5-2011; IN COMMERCE 12-5-2011.

CLASS 33—(Continued).

4,165,907. WINERY EXCHANGE, INC., NOVATO, CA. SN 85-453,374. PUB. 1-10-2012, FILED 10-21-2011.

PANTAGO

THE MARK CONSISTS OF STANDARD CHARACTERS WITHOUT CLAIM TO ANY PARTICULAR FONT, STYLE, SIZE, OR COLOR.

FOR ALCOHOLIC BEVERAGES EXCEPT BEERS (U.S. CLS. 47 AND 49).

FIRST USE 2-0-2012; IN COMMERCE 2-0-2012.

CLASS 34—SMOKERS' ARTICLES

4,164,901. NATIONAL TOBACCO COMPANY, L.P., LOUISVILLE, KY. SN 77-804,794. PUB. 1-5-2010, FILED 8-14-2009.

BIG RED

THE MARK CONSISTS OF STANDARD CHARACTERS WITHOUT CLAIM TO ANY PARTICULAR FONT, STYLE, SIZE, OR COLOR.

OWNER OF U.S. REG. NO. 2,760,222.

FOR CHEWING TOBACCO (U.S. CLS. 2, 8, 9 AND 17).

FIRST USE 10-6-2011; IN COMMERCE 10-6-2011.

4,164,996. RENEGADE TOBACCO COMPANY, MOCKSVILLE, NC. SN 77-964,517. PUB. 8-10-2010, FILED 3-22-2010.

Gem

THE MARK CONSISTS OF STANDARD CHARACTERS WITHOUT CLAIM TO ANY PARTICULAR FONT, STYLE, SIZE, OR COLOR.

FOR TOBACCO, CIGARS AND CIGARETTES (U.S. CLS. 2, 8, 9 AND 17).

FIRST USE 5-1-2012; IN COMMERCE 5-1-2012.

CLASS 34—(Continued).

4,165,711. SMOKER FRIENDLY INTERNATIONAL LLC, BOULDER, CO. SN 85-317,132. PUB. 10-18-2011, FILED 5-10-2011.



OWNER OF U.S. REG. NOS. 1,942,618, 3,028,215, AND OTHERS.

NO CLAIM IS MADE TO THE EXCLUSIVE RIGHT TO USE "SMOKER", APART FROM THE MARK AS SHOWN.

THE MARK CONSISTS OF THE WORDS "SMOKER FRIENDLY" ABOVE A CREST BEARING THE LETTERS "SF" AND FLANKED BY LIONS.

FOR CIGARS, ASHTRAYS NOT OF PRECIOUS METAL, CIGAR CUTTERS, CIGARETTE LIGHTERS NOT OF PRECIOUS METAL, MATCHES (U.S. CLS. 2, 8, 9 AND 17).

FIRST USE 12-15-2011; IN COMMERCE 12-15-2011.

4,165,725. THE 101 CORPORATION, LOS ANGELES, CA. SN 85-330,376. PUB. 12-27-2011, FILED 5-25-2011.

PAPI CHULO

THE MARK CONSISTS OF STANDARD CHARACTERS WITHOUT CLAIM TO ANY PARTICULAR FONT, STYLE, SIZE, OR COLOR.

THE ENGLISH TRANSLATION OF "PAPI CHULO" IN THE MARK IS SEXY DADDY.

FOR CIGARS, CIGARETTES, HUMIDORS, LIGHTERS NOT OF PRECIOUS METAL, ASHTRAYS NOT OF PRECIOUS METAL; LIGHTERS AND ASHTRAYS OF PRECIOUS METAL (U.S. CLS. 2, 8, 9 AND 17).

FIRST USE 1-20-2011; IN COMMERCE 1-20-2011.

SERVICE MARKS**CLASS 35—ADVERTISING AND BUSINESS**

CLASS 35—(Continued).

4,164,785. CLEAN ENERGY, SEAL BEACH, CA. SN 76-682,915. PUB. 8-26-2008, FILED 10-15-2007.

H80

THE MARK CONSISTS OF STANDARD CHARACTERS WITHOUT CLAIM TO ANY PARTICULAR FONT, STYLE, SIZE, OR COLOR.

FOR ALTERNATIVE FUEL STATIONS, NAMELY, RETAIL BIOFUELS SUPPLY SERVICES (U.S. CLS. 100, 101 AND 102).

FIRST USE 6-29-2011; IN COMMERCE 6-29-2011.

4,164,788. CENTRAL VERMONT PUBLIC SERVICE CORPORATION, RUTLAND, VT. SN 76-701,755. PUB. 1-18-2011, FILED 2-22-2010.

CVPS SMARTPOWER

THE MARK CONSISTS OF STANDARD CHARACTERS WITHOUT CLAIM TO ANY PARTICULAR FONT, STYLE, SIZE, OR COLOR.

OWNER OF U.S. REG. NOS. 3,059,290 AND 3,559,398.

NO CLAIM IS MADE TO THE EXCLUSIVE RIGHT TO USE "SMART POWER", APART FROM THE MARK AS SHOWN.

FOR RETAIL ELECTRICITY PROVIDER SERVICES, NAMELY, PROVIDING A SERVICE THAT ALLOWS CUSTOMERS TO PURCHASE ENERGY, NAMELY, ELECTRICITY WITH THE AID OF ADVANCED TWO WAY COMMUNICATION-ENABLED AUTOMATED METERING INFRASTRUCTURE THAT COLLECTS TIME DIFFERENTIATED ENERGY USAGE FROM SMART METERS AT CUSTOMER PREMISES THEREBY ENABLING ADVANCE PRICING INCLUDING DYNAMIC PRICING, TIME OF USE RATE DESIGNS AND THE DELIVERY OF ELECTRICITY DEMAND RESPONSE PROGRAMS (U.S. CLS. 100, 101 AND 102).

FIRST USE 4-7-2010; IN COMMERCE 1-30-2012.

CLASS 35—(Continued).

4,164,825. MAISATIVO INTERMEDIACAO DE ATIVOS LTDA., SAO PAULO, BRAZIL. SN 77-523,663. PUB. 3-3-2009, FILED 7-16-2008.



THE COLOR(S) BLUE AND BLACK IS/ARE CLAIMED AS A FEATURE OF THE MARK.

THE MARK CONSISTS OF THE WORD "SUPERBID" ACCOMPANIED BY THE DESIGN ELEMENT FEATURING AN ANGLED OVAL COMPRISED OF TWO ARCS. THE MARK CONSISTS OF THE COLORS BLACK AND BLUE, WITH THE COLOR BLACK APPEARING IN THE WORD "SUPERBID" AND THE COLOR BLUE IS APPEARING IN THE DESIGN ELEMENT FEATURING AN ANGLED OVAL COMPRISED OF TWO ARCS.

FOR AUCTIONEERING SERVICES AND ONLINE AUCTION SERVICES (U.S. CLS. 100, 101 AND 102).

FIRST USE 10-4-2011; IN COMMERCE 10-4-2011.

4,164,831. THE BROOKESIDE GROUP, INC., ACTON, MA. SN 77-551,980. PUB. 7-14-2009, FILED 8-20-2008.

Loyalty Matters

THE MARK CONSISTS OF STANDARD CHARACTERS WITHOUT CLAIM TO ANY PARTICULAR FONT, STYLE, SIZE, OR COLOR.

FOR BUSINESS CONSULTING, MANAGEMENT, PLANNING AND SUPERVISION; BUSINESS MANAGEMENT CONSULTANCY AND ADVISORY SERVICES; BUSINESS MANAGEMENT CONSULTANCY AS WELL AS DEVELOPMENT OF PROCESSES FOR THE ANALYSIS AND THE IMPLEMENTATION OF STRATEGY PLANS AND MANAGEMENT PROJECTS; CUSTOMER LOYALTY SERVICES, FOR COMMERCIAL, PROMOTIONAL AND/OR ADVERTISING PURPOSES; CUSTOMER RELATIONSHIP MANAGEMENT (U.S. CLS. 100, 101 AND 102).

FIRST USE 3-29-2012; IN COMMERCE 3-29-2012.

CLASS 35—(Continued).

4,164,834. SANCHEZ, JULIAN, ORLANDO, FL. AND CECARELLI, EDWARD KODY, NEW YORK, NY. SN 77-563,263. PUB. 1-27-2009, FILED 9-5-2008.

WORLDTOPUS

THE MARK CONSISTS OF STANDARD CHARACTERS WITHOUT CLAIM TO ANY PARTICULAR FONT, STYLE, SIZE, OR COLOR.

FOR PROVIDING AN ONLINE COMMERCIAL INFORMATION DIRECTORY AND MARKETPLACE FOR BUYERS AND SELLERS OF GOODS AND SERVICES VIA THE INTERNET; ADVERTISING SERVICES, NAMELY, PROMOTING THE GOODS AND SERVICES OF OTHERS BY PREPARING AND PLACING ADVERTISEMENTS IN DIRECTORY LISTING DATABASES ACCESSED THROUGH A GLOBAL INFORMATION NETWORK; ONLINE BUSINESS NETWORKING SERVICES; PROVIDING A WEBSITE WHERE USER CAN POST REAL TIME RATINGS, REVIEWS AND RECOMMENDATIONS PERTAINING TO PRODUCTS AND SERVICES OF BUSINESSES AND BUSINESS ORGANIZATIONS (U.S. CLS. 100, 101 AND 102).
FIRST USE 1-0-2012; IN COMMERCE 3-1-2012.

4,164,835. ROSE, VICTORIA LASDON, NEW YORK, NY. SN 77-564,830. PUB. 2-10-2009, FILED 9-8-2008.

GOOD FOR YOU GOURMET

THE MARK CONSISTS OF STANDARD CHARACTERS WITHOUT CLAIM TO ANY PARTICULAR FONT, STYLE, SIZE, OR COLOR.

NO CLAIM IS MADE TO THE EXCLUSIVE RIGHT TO USE "GOURMET", APART FROM THE MARK AS SHOWN.

FOR ON-LINE RETAIL STORE SERVICES FEATURING SPECIALTY GOURMET FOODS (U.S. CLS. 100, 101 AND 102).

FIRST USE 5-4-2012; IN COMMERCE 5-4-2012.

CLASS 35—(Continued).

4,164,881. SCHOOLHOUSE OUTFITTERS, LLC, CINCINNATI, OH. SN 77-747,579. PUB. 10-13-2009, FILED 5-29-2009.

SPROGS

THE MARK CONSISTS OF STANDARD CHARACTERS WITHOUT CLAIM TO ANY PARTICULAR FONT, STYLE, SIZE, OR COLOR.

FOR MAIL ORDER AND ONLINE RETAIL STORE SERVICES FEATURING CHILDREN'S FURNITURE (U.S. CLS. 100, 101 AND 102).

FIRST USE 2-1-2012; IN COMMERCE 2-1-2012.

4,164,926. DESMOND TUTU PEACE FOUNDATION, NEW YORK, NY. SN 77-839,213. PUB. 3-8-2011, FILED 10-1-2009.



FOR CHARITABLE SERVICES, NAMELY, ORGANIZING AND CONDUCTING VOLUNTEER PROGRAMS AND COMMUNITY SERVICE PROJECTS; CHARITABLE SERVICES, NAMELY, ORGANIZING YOUTH GROUPS TO UNDERTAKE PROJECTS TO BENEFIT THE NEEDY AND THE COMMUNITY TO ENCOURAGE LEADERSHIP, CHARACTER, COMPASSION, AND GOOD CITIZENSHIP; DEVELOPING AND COORDINATING VOLUNTEER PROJECTS FOR CHARITABLE ORGANIZATIONS; PUBLIC ADVOCACY TO PROMOTE AWARENESS OF PEACE-BUILDING AND CONFLICT RESOLUTION PRACTICES FROM AROUND THE WORLD AND CONFLICT SITUATIONS IN THE UNITED STATES AND AROUND THE WORLD (U.S. CLS. 100, 101 AND 102).

FIRST USE 6-1-2009; IN COMMERCE 6-1-2009.

CLASS 35—(Continued).

4,164,928. SHARK BAIT INTERNATIONAL, INC., VERO BEACH, FL. SN 77-843,065. PUB. 9-7-2010, FILED 10-7-2009.

SHARK BAIT

THE MARK CONSISTS OF STANDARD CHARACTERS WITHOUT CLAIM TO ANY PARTICULAR FONT, STYLE, SIZE, OR COLOR.

FOR ADMINISTRATION OF A DISCOUNT PROGRAM FOR ENABLING PARTICIPANTS TO OBTAIN DISCOUNTS ON GOODS AND SERVICES, EXCLUDING FISHING TACKLE AND BOATING SUPPLIES, THROUGH USE OF A DISCOUNT MEMBERSHIP CARD (U.S. CLS. 100, 101 AND 102).

FIRST USE 8-1-2009; IN COMMERCE 8-1-2009.

CLASS 35—(Continued).

THE NAME(S), PORTRAIT(S), AND/OR SIGNATURE(S) SHOWN IN THE MARK IDENTIFIES "LISA FRANK", WHOSE CONSENT(S) TO REGISTER IS MADE OF RECORD.

FOR ELECTRONIC CATALOGUE SERVICES, ONLINE RETAIL STORE SERVICES AND RETAIL OUTLET STORE SERVICES, ALL FEATURING ITEMS FOR CHILDREN, NAMELY, STICKERS, STICKER ALBUMS AND BOOKS, BINDERS, STATIONERY, STATIONERY-TYPE PORTFOLIOS, PERSONAL ORGANIZERS, DIARIES, NOTE PADS, NOTEBOOKS, WRITING PADS, ADDRESS BOOKS, PENS, PENCILS, PEN AND PENCIL CASES, MARKERS, ERASERS, RUBBER STAMPS AND PADS, COLORING BOOKS, ACTIVITY BOOKS, STORY BOOKS, PAPER PARTY GOODS, PLAYING CARDS, BOARD GAMES, ELECTRONIC GAMES, PAINTING AND DRAWING KITS, COMPUTER-ASSISTED DRAWING KITS, COMPUTER-ASSISTED DESIGN KITS, TRADING CARDS, POSTERS, BACKPACKS, TOTE BAGS, PURSES, SCHOOL BAGS, ALL-PURPOSE SPORT BAGS, OVERNIGHT BAGS, LUNCH BAGS AND BOXES, WATER BOTTLES SOLD EMPTY, ACTIVITY AND HOBBY CRAFT KITS, DRESS-UP KITS, TOY MAKE-UP KITS, TOY OVENS, TOY CRAFT OVENS, STUFFED AND PLUSH TOYS, DOLLS AND DOLL ACCESSORIES, TOY JEWELRY AND COSMETICS, HAIR ACCESSORIES AND HIGHLIGHTERS, CLOTHING FOR CHILDREN, NAMELY, SHIRTS, PANTS, JEANS, BLOUSES, SKIRTS, SHORTS, DRESSES, COATS, JACKETS, SHOES, SOCKS, BOOTS, FLIP-FLOPS, HATS, CAPS, HEADBANDS, SCARVES, AND UNDERWEAR, AND CHILDREN'S HOME DECOR AND BEDDING ITEMS (U.S. CLS. 100, 101 AND 102).

FIRST USE 9-1-1982. THE MARK WAS FIRST USED ANYWHERE IN A DIFFERENT FORM OTHER THAN THAT SOUGHT TO BE REGISTERED AT LEAST AS EARLY AS 09/01/1982.; IN COMMERCE 9-1-1982, THE MARK WAS FIRST USED IN COMMERCE IN A DIFFERENT FORM OTHER THAN THAT SOUGHT TO BE REGISTERED AT LEAST AS EARLY AS 09/01/1982..

4,164,936. SORORITY SPIRIT LLC, ATLANTA, GA. SN 77-856,542. PUB. 4-20-2010, FILED 10-23-2009.



LISA FRANK

NO CLAIM IS MADE TO THE EXCLUSIVE RIGHT TO USE "YOUR ONLINE SOURCE FOR SORORITY GIFTS", APART FROM THE MARK AS SHOWN.

THE MARK CONSISTS OF TWO CURVED CAPITAL "S" LETTERS ENCIRCLED IN A ROUND CURVE AND THE TEXT "SORORITYSPIRIT.COM YOUR ONLINE SOURCE FOR SORORITY GIFTS" TO THE RIGHT, WITH "YOUR ONLINE SOURCE FOR SORORITY GIFTS" LISTED BENEATH "SORORITYSPIRIT.COM".

FOR ON-LINE RETAIL STORE SERVICES FEATURING SORORITY MERCHANDISE (U.S. CLS. 100, 101 AND 102).

FIRST USE 4-16-2012; IN COMMERCE 4-16-2012.

THE MARK CONSISTS OF STANDARD CHARACTERS WITHOUT CLAIM TO ANY PARTICULAR FONT, STYLE, SIZE, OR COLOR.

OWNER OF U.S. REG. NOS. 1,642,039 AND 2,267,632.

CLASS 35—(Continued).

4,164,953. PREMIER, INC., CHARLOTTE, NC. SN 77-892,674. PUB. 9-28-2010, FILED 12-14-2009.



NO CLAIM IS MADE TO THE EXCLUSIVE RIGHT TO USE "CATHOLIC CONTRACTING GROUP", APART FROM THE MARK AS SHOWN.

THE MARK CONSISTS OF THE LETTERS "C", "C" AND "G" SEPARATED BY DESIGN OF A CHRISTIAN CROSS WITH THE WORDS "CATHOLIC CONTRACTING GROUP" APPEARING UNDERNEATH.

FOR ADMINISTERING A DISCOUNT GROUP CONTRACTING PROGRAM, NAMELY, NEGOTIATING CONTRACTS WITH PROVIDERS OF PRODUCTS UTILIZED IN HEALTHCARE TO ENABLE MEMBERS TO COMBINE THEIR MARKET SHARE AND COLLECTIVE SPENDING POWERS TO NEGOTIATE MORE FAVORABLE CONTRACT TERMS FOR SUPPLY CHAIN COSTS THROUGH THE USE OF COLLABORATIVE EFFORTS OF ITS MEMBERS (U.S. CLS. 100, 101 AND 102). FIRST USE 1-0-2011; IN COMMERCE 1-0-2011.

4,164,966. CREATIVE NAPKIN, DBA PINKOINK, AUSTIN, TX. SN 77-911,942. PUB. 3-1-2011, FILED 1-14-2010.



THE COLOR(S) AQUA, GREY IS/ARE CLAIMED AS A FEATURE OF THE MARK.

"THE MARK CONSISTS OF THE WORDING "CREATIVE NAPKIN", WITH "CREATIVE" IN AQUA AND "NAPKIN" IN GREY. TO THE LEFT OF THIS WORDING IS AN AQUA CHEVRON DESIGN. THE WHITE IN THE MARK REPRESENTS BACKGROUND AREA WHICH IS NOT A PART OF THE MARK."

FOR ADVERTISING AND MARKETING (U.S. CLS. 100, 101 AND 102).

FIRST USE 2-1-2008; IN COMMERCE 11-1-2011.

CLASS 35—(Continued).

4,164,987. INNOVATION GLOBAL NETWORK, LLC, RANDOLPH, NJ. SN 77-952,828. PUB. 10-19-2010, FILED 3-8-2010.

Innovation Global Network

THE MARK CONSISTS OF STANDARD CHARACTERS WITHOUT CLAIM TO ANY PARTICULAR FONT, STYLE, SIZE, OR COLOR.

NO CLAIM IS MADE TO THE EXCLUSIVE RIGHT TO USE "GLOBAL NETWORK", APART FROM THE MARK AS SHOWN.

FOR ADVERTISING, INCLUDING PROMOTION RELATING TO THE SALE OF ARTICLES AND SERVICES FOR THIRD PARTIES BY THE TRANSMISSION OF ADVERTISING MATERIAL AND THE DISSEMINATION OF ADVERTISING MESSAGES ON COMPUTER NETWORKS; ADVERTISING, MARKETING AND PROMOTIONAL SERVICES RELATED TO ALL INDUSTRIES FOR THE PURPOSE OF FACILITATING NETWORKING AND SOCIALIZING OPPORTUNITIES FOR BUSINESS PURPOSES; ADVICE AND INFORMATION CONCERNING COMMERCIAL BUSINESS MANAGEMENT; BUSINESS NETWORKING (U.S. CLS. 100, 101 AND 102).

FIRST USE 2-2-2012; IN COMMERCE 2-2-2012.

4,164,993. INNOVATION GLOBAL NETWORK, LLC, RANDOLPH, NJ. SN 77-958,678. PUB. 2-15-2011, FILED 3-15-2010.



NO CLAIM IS MADE TO THE EXCLUSIVE RIGHT TO USE "GLOBAL NETWORK", APART FROM THE MARK AS SHOWN.

THE COLOR(S) BLUE, WHITE, GRAY AND BLACK IS/ARE CLAIMED AS A FEATURE OF THE MARK.

THE MARK CONSISTS OF THE WORDS "INNOVATION" IN BLUE. BELOW THIS ARE THE WORDS "GLOBAL NETWORK" IN BLACK. TO THE LEFT IS A BLUE TRANSLUCENT LIGHT BULB FEATURING WHITE AND BLUE CONTINENTS. THE METAL END OF THE LIGHT BULB IS GRAY AND BLACK COLOR.

FOR ADVERTISING, INCLUDING PROMOTION RELATING TO THE SALE OF ARTICLES AND SERVICES FOR THIRD PARTIES BY THE TRANSMISSION OF ADVERTISING MATERIAL AND THE DISSEMINATION OF ADVERTISING MESSAGES ON COMPUTER NETWORKS; ADVERTISING, MARKETING AND PROMOTIONAL SERVICES RELATED TO ALL INDUSTRIES FOR THE PURPOSE OF FACILITATING NETWORKING AND SOCIALIZING OPPORTUNITIES FOR BUSINESS PURPOSES; ADVICE AND INFORMATION CONCERNING COMMERCIAL BUSINESS MANAGEMENT; BUSINESS NETWORKING (U.S. CLS. 100, 101 AND 102).

FIRST USE 2-2-2012; IN COMMERCE 2-2-2012.

CLASS 35—(Continued).

4,164,997. THE TOBIN PROJECT, CAMBRIDGE, MA. SN 77-964,552. PUB. 3-22-2011, FILED 3-22-2010.

DEMOCRACY & MARKETS

THE MARK CONSISTS OF STANDARD CHARACTERS WITHOUT CLAIM TO ANY PARTICULAR FONT, STYLE, SIZE, OR COLOR.

FOR PROMOTING THE EXCHANGE OF INFORMATION AND RESOURCES REGARDING SOCIAL SCIENCE RESEARCH AND POLICY (U.S. CLS. 100, 101 AND 102).

FIRST USE 4-30-2010; IN COMMERCE 4-30-2010.

4,165,016. WOLVERINE OUTDOORS, INC., ROCKFORD, MI. SN 77-983,188. PUB. 8-10-2010, FILED 3-22-2010.

CHACO

THE MARK CONSISTS OF STANDARD CHARACTERS WITHOUT CLAIM TO ANY PARTICULAR FONT, STYLE, SIZE, OR COLOR.

OWNER OF U.S. REG. NO. 1,894,639.

FOR ONLINE RETAIL STORE SERVICES FEATURING FOOTWEAR AND ACCESSORIES (U.S. CLS. 100, 101 AND 102).

FIRST USE 2-19-2003; IN COMMERCE 2-19-2003.

4,165,046. HOME BREW MART, INC., SAN DIEGO, CA. SN 85-014,129. PUB. 9-7-2010, FILED 4-14-2010.



OWNER OF U.S. REG. NOS. 3,475,098 AND 3,693,175. NO CLAIM IS MADE TO THE EXCLUSIVE RIGHT TO USE "BREWING & SPIRITS", APART FROM THE MARK AS SHOWN.

THE MARK CONSISTS OF THE TERMS "BALLAST POINT BREWING & SPIRITS" IN STYLIZED FORM. A SEXTANT DESIGN IN A CIRCLE WITH A ROPE BORDER BETWEEN "BALLAST" AND "POINT", AND BENEATH IS A RIBBON/BANNER WITH THE TERMS "BREWING & SPIRITS".

FOR RETAIL STORE AND ON-LINE RETAIL STORE SERVICES FEATURING BEER, T-SHIRTS, CAPS, HATS, BEVERAGE GLASSWARE, COLLECTOR COASTERS, LABELS AND BOTTLE CAPS (U.S. CLS. 100, 101 AND 102).

FIRST USE 6-2-2010; IN COMMERCE 6-2-2010.

CLASS 35—(Continued).

4,165,075. STARCOM MEDIAVEST GROUP, INC., CHICAGO, IL. SN 85-041,672. PUB. 8-24-2010, FILED 5-18-2010.

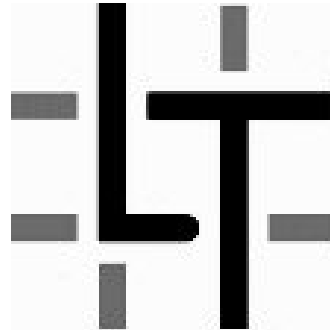

THE MARK CONSISTS OF THE LETTERS "LT" SURROUNDED BY FOUR RECTANGLE LINES.

FOR ADVERTISING AGENCY SERVICES; PREPARING AND PLACING ADVERTISEMENTS FOR OTHERS; PROVIDING ADVERTISING CONSULTING AND CONSULTING SERVICES IN THE FIELD OF FACILITATING THE PLANNING, BUYING AND SELLING OF MEDIA; ARRANGING AND CONDUCTING MARKETING PROMOTIONAL EVENTS FOR OTHERS; BUSINESS MARKETING CONSULTATION, NAMELY, PROVIDING ADVICE AND INFORMATION ABOUT CUSTOMER SERVICES AND PRODUCT MANAGEMENT AND PRICES ON INTERNET SITES IN CONNECTION WITH PURCHASES MADE OVER THE INTERNET; ARRANGING PERSONAL APPEARANCES BY PERSONS WORKING IN THE FIELD OF FILM, MUSIC, TELEVISION, ENTERTAINMENT OR SPORT, AND ARRANGING ENDORSEMENT DEALS FOR SAID PERSONS TO PROMOTE THE GOODS AND SERVICES OF OTHERS; PROMOTING SPORTS COMPETITIONS AND/OR EVENTS OF OTHERS; PROMOTING THE CONCERTS OF OTHERS; FACILITATION AND EXECUTION OF CUSTOMER/CONSUMER RELATIONSHIPS FOR THE PURPOSES OF MARKETING, AND CONSULTING SERVICES IN CONNECTION THEREWITH; DATA CONSULTATION AND MANAGEMENT FOR THE PURPOSES OF MARKETING AND IMPROVING MARKETING EFFECTIVENESS; DEVELOPMENT OF ADVERTISING MESSAGES FOR THE PURPOSES OF MARKETING, AND CONSULTING SERVICES IN CONNECTION THEREWITH (U.S. CLS. 100, 101 AND 102).

FIRST USE 4-26-2010; IN COMMERCE 4-26-2010.

4,165,077. AMAZON TECHNOLOGIES, INC., RENO, NV. SN 85-043,859. PUB. 3-22-2011, FILED 5-20-2010.

AMAZONCROSSING

THE MARK CONSISTS OF STANDARD CHARACTERS WITHOUT CLAIM TO ANY PARTICULAR FONT, STYLE, SIZE, OR COLOR.

CLASS 35—(Continued).

OWNER OF U.S. REG. NOS. 2,649,373, 3,709,331, AND OTHERS.

FOR RETAIL STORE SERVICES FEATURING PRINTED MATTER, BOOKS, VISUAL WORKS, LITERARY WORKS, ELECTRONIC BOOKS; DISTRIBUTORSHIP SERVICES IN THE FIELD OF PRINTED MATTER AND BOOKS; PROVIDING AN ONLINE SEARCHABLE DATABASE FEATURING BOOKS, ELECTRONIC BOOKS, PRINTED MATTER, LITERARY WORKS, AND ELECTRONIC PUBLICATIONS OFFERED FOR SALE; ORDER FULFILLMENT SERVICES; ONLINE ORDERING SERVICES FEATURING BOOKS, ELECTRONIC BOOKS, PRINTED MATTER, LITERARY WORKS, AND ELECTRONIC PUBLICATIONS (U.S. CLS. 100, 101 AND 102).

FIRST USE 5-18-2010; IN COMMERCE 5-18-2010.

4,165,082. BARTER PLANET INC., BETHEL, CT. SN 85-050,207. PUB. 10-26-2010, FILED 5-28-2010.

One World, One Barter At A
Time

THE MARK CONSISTS OF STANDARD CHARACTERS WITHOUT CLAIM TO ANY PARTICULAR FONT, STYLE, SIZE, OR COLOR.

FOR BARTER EXCHANGE SERVICES, NAMELY, PROVIDING COMMERCIAL BARTER AND TRADE EXCHANGE OF PRODUCTS AND SERVICES VIA A GLOBAL COMPUTER INFORMATION NETWORK (U.S. CLS. 100, 101 AND 102).

FIRST USE 3-29-2012; IN COMMERCE 3-29-2012.

4,165,083. P. H. GLATFELTER COMPANY, YORK, PA. SN 85-051,964. PUB. 8-31-2010, FILED 6-1-2010.

WECOLOGY

THE MARK CONSISTS OF STANDARD CHARACTERS WITHOUT CLAIM TO ANY PARTICULAR FONT, STYLE, SIZE, OR COLOR.

FOR PROMOTING PUBLIC AWARENESS OF THE NEED FOR CONSERVATION OF NATURAL RESOURCES (U.S. CLS. 100, 101 AND 102).

FIRST USE 2-24-2012; IN COMMERCE 2-24-2012.

CLASS 35—(Continued).

4,165,118. SINT, LLC, HICKSVILLE, NY. SN 85-098,812. PUB. 2-1-2011, FILED 8-3-2010.

DEFINE YOUR SLEEP. DEFINE
YOURSELF. EXPRESSIONS

THE MARK CONSISTS OF STANDARD CHARACTERS WITHOUT CLAIM TO ANY PARTICULAR FONT, STYLE, SIZE, OR COLOR.

OWNER OF U.S. REG. NO. 3,851,571.

FOR RETAIL AND ONLINE STORE SERVICES IN THE FIELD OF BEDS, BEDDING AND SLEEP PRODUCTS (U.S. CLS. 100, 101 AND 102).

FIRST USE 2-0-2011; IN COMMERCE 2-0-2011.

4,165,146. FIGUEROA, ERIC J., AVENTURA, FL. SN 85-113,059. PUB. 8-16-2011, FILED 8-22-2010.

Yeah Baby

THE MARK CONSISTS OF STANDARD CHARACTERS WITHOUT CLAIM TO ANY PARTICULAR FONT, STYLE, SIZE, OR COLOR.

FOR ADVERTISING AND MARKETING SERVICES, NAMELY, PROMOTING THE GOODS AND SERVICES OF THIRD PARTIES THROUGH PRINT, AUDIO, VIDEO, DIGITAL AND ON-LINE MEDIUM IN THE AGRICULTURAL, AIRCRAFT, AIRLINE, APPAREL, APPLIANCE, AUTOMOBILE, BANKING, BOOK, BUSINESS, COMPUTER, CONSTRUCTION, COSMETIC, EDUCATIONAL, ELECTRICAL, ELECTRONICS, ENERGY, ENGINEERING, ENVIRONMENTAL, FINANCIAL, FOOD, HARDWARE, HEALTH, INSURANCE, INTERNET, INVESTMENT, LEGAL, MACHINERY, MANAGEMENT, MANUFACTURING, MEDIA, MEDICAL, NEWS, OFFICE, PHARMACEUTICAL, REAL ESTATE, RETAIL, SHIPPING, SOFTWARE, TECHNOLOGY, TELECOMMUNICATIONS, TEXTILE, TRANSPORTATION AND TRAVEL FIELDS, NOT INCLUDING ANY BABY PRODUCTS OR SERVICES (U.S. CLS. 100, 101 AND 102).

FIRST USE 8-22-2010; IN COMMERCE 8-22-2010.

4,165,151. METABANK, SIOUX FALLS, SD. SN 85-115,210. PUB. 8-16-2011, FILED 8-25-2010.

Shield Your Pin

THE MARK CONSISTS OF STANDARD CHARACTERS WITHOUT CLAIM TO ANY PARTICULAR FONT, STYLE, SIZE, OR COLOR.

CLASS 35—(Continued).

NO CLAIM IS MADE TO THE EXCLUSIVE RIGHT TO USE "PIN", APART FROM THE MARK AS SHOWN.

FOR PROVIDING PUBLIC POLICY INFORMATION IN THE FIELDS OF CONSUMER PROTECTION AND CONSUMER CREDIT; AND PROMOTING PUBLIC AWARENESS OF THE NEED TO SAFEGUARD PERSONAL IDENTIFICATION NUMBERS (U.S. CLS. 100, 101 AND 102).

FIRST USE 9-0-2011; IN COMMERCE 9-0-2011.

CLASS 35—(Continued).

4,165,177. MOBILE 500 ALLIANCE, SEATTLE, WA. SN 85-121,810. PUB. 9-6-2011, FILED 9-2-2010.

Mobile500

4,165,152. CONNECTING POINT MARKETING GROUP, INC., RYE, NH. SN 85-115,484. PUB. 2-8-2011, FILED 8-25-2010.

"500" APPEARING IN THE MARK HAS NO SIGNIFICANCE NOR IS IT A TERM OF ART IN THE RELEVANT TRADE OR INDUSTRY OR AS APPLIED TO THE GOODS/SERVICES LISTED IN THE APPLICATION, OR ANY GEOGRAPHICAL SIGNIFICANCE.

FOR ASSOCIATION SERVICES, NAMELY, PROMOTING THE INTERESTS OF USERS OF TELEVISION BROADBAND SPECTRUM SERVICES, INCLUDING MOBILE DIGITAL TELEVISION (MOBILE DTV) SERVICES, NAMELY, LOCAL TELEVISION BROADCASTERS IN THE FIELD OF MOBILE DIGITAL TELEVISION (MOBILE DTV); LOBBYING SERVICES, NAMELY, PROMOTING THE INTERESTS OF LOCAL TELEVISION BROADCASTERS IN THE FIELD OF MOBILE DIGITAL TELEVISION (MOBILE DTV) SERVICES, IN THE FIELDS OF LEGISLATION AND REGULATION (U.S. CLS. 100, 101 AND 102).

FIRST USE 9-1-2010; IN COMMERCE 9-1-2010.

RestaurantPoint

4,165,179. ALLEGIANCE EA FUND LLC, CHARLOTTE, NC. SN 85-121,966. PUB. 8-9-2011, FILED 9-2-2010.

THE MARK CONSISTS OF STANDARD CHARACTERS WITHOUT CLAIM TO ANY PARTICULAR FONT, STYLE, SIZE, OR COLOR.

OWNER OF U.S. REG. NOS. 3,189,767, 3,354,988, AND OTHERS.

FOR BUSINESS SERVICES IN THE NATURE OF ARRANGING AND CONDUCTING MARKETING PROMOTIONAL EVENTS FOR OTHERS AMONG VENDORS AND CUSTOMERS BOTH IN PERSON AND VIA THE INTERNET; PROVIDING STRATEGIC BUSINESS MARKETING SERVICES RELATING TO SUCH EVENTS AND MARKETING, PROMOTING THE SALE OF GOODS AND SERVICES OF OTHER CORPORATIONS, PARTNERSHIPS OR INDIVIDUALS BY AND THROUGH THE MEANS OF THE ARRANGING VARIOUS EVENTS, NAMELY, PREPARING AND DISTRIBUTING INDUSTRY-DEFINING AND EDUCATIONAL CONTENT PROMOTIONAL MATERIALS; PROMOTIONAL NEWSLETTERS, ADVERTISING BROCHURES AND OTHER PRINTED MARKETING MATERIAL, AND ARRANGING AND CONDUCTING MARKETING PROMOTIONAL EVENTS WITH SELECT AND GUARANTEED AUDIENCES AND PRE-QUALIFIED PRIVATE APPOINTMENTS (U.S. CLS. 100, 101 AND 102).

FIRST USE 6-16-2011; IN COMMERCE 6-16-2011.

MIGHTY KIDS MEDIA

THE MARK CONSISTS OF STANDARD CHARACTERS WITHOUT CLAIM TO ANY PARTICULAR FONT, STYLE, SIZE, OR COLOR.

NO CLAIM IS MADE TO THE EXCLUSIVE RIGHT TO USE "KIDS MEDIA", APART FROM THE MARK AS SHOWN.

FOR WHOLESALE AND RETAIL STORE SERVICES AND ON-LINE RETAIL STORE SERVICES FEATURING CHILDREN'S DVDS AND CDS, COLORING BOOKS, AND CHILDREN'S ACTIVITY BOOKS (U.S. CLS. 100, 101 AND 102).

FIRST USE 10-15-2010; IN COMMERCE 11-27-2010.

CLASS 35—(Continued).

4,165,183. MOBILE 500 ALLIANCE, SEATTLE, WA. SN 85-123,994. PUB. 8-30-2011, FILED 9-7-2010.



NO CLAIM IS MADE TO THE EXCLUSIVE RIGHT TO USE "MOBILE AND ALLIANCE", APART FROM THE MARK AS SHOWN.

THE COLOR(S) LIGHT GREY, DARK GREY, BLUE AND RED IS/ARE CLAIMED AS A FEATURE OF THE MARK.

THE MARK CONSISTS OF THE STACKED WORDS "THE MOBILE 500 ALLIANCE" WITH THREE GREY CURVED BANDS DIAGONALLY EXTENDING FROM THE SECOND "0" OF THE NUMBER 500. THE WORD "THE" IS THE COLOR LIGHT GREY, THE WORD "MOBILE" IS THE COLOR BLUE, THE NUMBER "500" IS THE COLOR DARK GREY AND THE WORD "ALLIANCE" IS THE COLOR RED.

"500" APPEARING IN THE MARK HAS NO SIGNIFICANCE NOR IS IT A TERM OF ART IN THE RELEVANT TRADE OR INDUSTRY OR AS APPLIED TO THE GOODS/SERVICES LISTED IN THE APPLICATION, OR ANY GEOGRAPHICAL SIGNIFICANCE.

FOR ASSOCIATION SERVICES, NAMELY, PROMOTING THE INTERESTS OF USERS OF TELEVISION BROADBAND SPECTRUM SERVICES, INCLUDING MOBILE DIGITAL TELEVISION (MOBILE DTV) SERVICES, NAMELY, LOCAL TELEVISION BROADCASTERS IN THE FIELD OF MOBILE DIGITAL TELEVISION (MOBILE DTV); LOBBYING SERVICES, NAMELY, PROMOTING THE INTERESTS OF LOCAL TELEVISION BROADCASTERS IN THE FIELD OF MOBILE DIGITAL TELEVISION (MOBILE DTV) SERVICES, IN THE FIELDS OF LEGISLATION AND REGULATION (U.S. CLS. 100, 101 AND 102).

FIRST USE 9-1-2010; IN COMMERCE 9-1-2010.

4,165,192. JEWELX NEW YORK, LTD., NEW YORK, NY. SN 85-126,166. PUB. 2-22-2011, FILED 9-9-2010.

THE ESSENCE OF NATURAL LOVE

THE MARK CONSISTS OF STANDARD CHARACTERS WITHOUT CLAIM TO ANY PARTICULAR FONT, STYLE, SIZE, OR COLOR.

FOR DISTRIBUTORSHIP SERVICES FOR OTHERS IN THE FIELD OF GOLD, PLATINUM, TITANIUM AND SILVER JEWELRY AND GOLD, PLATINUM, TITANIUM AND SILVER JEWELRY WITH PRECIOUS STONES, NAMELY, DIAMONDS, RUBIES, EMERALDS, SAPPHIRES, AND SEMI-PRECIOUS COLORED STONES EMBEDDED THEREIN, AND PEARLS EMBEDDED THEREIN (U.S. CLS. 100, 101 AND 102).

FIRST USE 11-3-2011; IN COMMERCE 11-3-2011.

CLASS 35—(Continued).

4,165,202. MARGUERITE E. GRAY, COATS, NC. SN 85-128,321. PUB. 8-30-2011, FILED 9-13-2010.



NO CLAIM IS MADE TO THE EXCLUSIVE RIGHT TO USE "URBAN", APART FROM THE MARK AS SHOWN.

THE MARK CONSISTS OF THE WORDING "URBAN PEARL" IN STYLIZED FONT.

FOR PUBLIC RELATIONS (U.S. CLS. 100, 101 AND 102).

FIRST USE 7-31-2010; IN COMMERCE 7-31-2010.

4,165,260. SYNAPSE WIRELESS, INC., HUNTSVILLE, AL. SN 85-150,801. PUB. 9-13-2011, FILED 10-12-2010.

SNAP Mark

THE MARK CONSISTS OF STANDARD CHARACTERS WITHOUT CLAIM TO ANY PARTICULAR FONT, STYLE, SIZE, OR COLOR.

FOR PROVIDING PERFORMANCE RATINGS FOR COMPUTER EQUIPMENT OF OTHERS, NAMELY, PROCESSORS; PROVIDING RATINGS VIA A GLOBAL COMPUTER NETWORK FOR COMPARING PERFORMANCE OF COMPUTER PRODUCTS OF OTHERS, NAMELY, MICROCONTROLLERS IN PROCESSING APPLICATION SCRIPTS (U.S. CLS. 100, 101 AND 102).

FIRST USE 5-8-2012; IN COMMERCE 5-8-2012.

4,165,271. E.A. SWEEN COMPANY, EDEN PRAIRIE, MN. SN 85-153,895. PUB. 9-6-2011, FILED 10-15-2010.

QUICK TIME DELI

THE MARK CONSISTS OF STANDARD CHARACTERS WITHOUT CLAIM TO ANY PARTICULAR FONT, STYLE, SIZE, OR COLOR.

NO CLAIM IS MADE TO THE EXCLUSIVE RIGHT TO USE "DELI", APART FROM THE MARK AS SHOWN.

FOR RETAIL CONVENIENCE STORE SERVICES (U.S. CLS. 100, 101 AND 102).

FIRST USE 2-22-2011; IN COMMERCE 3-18-2011.

CLASS 35—(Continued).

4,165,274. GENERAL MILLS, INC., MINNEAPOLIS, MN. SN 85-155,725. PUB. 9-6-2011, FILED 10-19-2010.

FOODGPS

THE MARK CONSISTS OF STANDARD CHARACTERS WITHOUT CLAIM TO ANY PARTICULAR FONT, STYLE, SIZE, OR COLOR.

FOR MARKET RESEARCH AND MARKET INSIGHT SERVICES, NAMELY, MARKET PLANNING CONSISTING OF PROVIDING CONSUMER INSIGHTS AND MARKET RESEARCH FOR USE IN RETAIL MARKETING; ANALYTICAL SERVICES, NAMELY, ANALYZING AND COMPILING DATA RELATING TO CONSUMER BEHAVIOR, MARKET SALES AND PROMOTIONAL ACTIVITIES; ADVISORY AND CONSULTING SERVICES IN THE FIELD OF CATEGORY MANAGEMENT, NAMELY, WORKING WITH RETAILERS AND CONSUMER PRODUCT GOODS COMPANIES TO MAXIMIZE SALES PROFITABILITY OF PRODUCT CATEGORIES (U.S. CLS. 100, 101 AND 102).

FIRST USE 10-6-2011; IN COMMERCE 10-6-2011.

4,165,276. PRESS4, INC., MOUNT PLEASANT, SC. SN 85-156,323. PUB. 3-22-2011, FILED 10-19-2010.

**ONE BUTTON, FOR THE REST
OF YOUR LIFE**

THE MARK CONSISTS OF STANDARD CHARACTERS WITHOUT CLAIM TO ANY PARTICULAR FONT, STYLE, SIZE, OR COLOR.

FOR ADVERTISING SERVICES, NAMELY, PROMOTING AND MARKETING THE GOODS AND SERVICES OF OTHERS THROUGH ALL PUBLIC COMMUNICATION MEANS (U.S. CLS. 100, 101 AND 102).

FIRST USE 12-14-2011; IN COMMERCE 12-14-2011.

4,165,284. FOCUS ON LIFE ENTERPRISES, INC., CARLSBAD, CA. SN 85-159,593. PUB. 4-26-2011, FILED 10-22-2010.



NO CLAIM IS MADE TO THE EXCLUSIVE RIGHT TO USE "UTILIZES SIGNIFICANT EVENT COMPRESSION", APART FROM THE MARK AS SHOWN.

THE COLOR(S) BLUE AND GOLD IS/ARE CLAIMED AS A FEATURE OF THE MARK.

THE MARK CONSISTS THE WORDING "TRADINGOP-

CLASS 35—(Continued).

TIMIZER" THE TERM "TRADING" IS IN BLUE AND THE TERM "OPTIMIZER" APPEARS IN GOLD; A BLUE LINE APPEARS BELOW THE TERM "TRADINGOPTIMIZER" AND ABOVE THE WORDING "UTILIZES SIGNIFICANT EVENT COMPRESSION" WHICH APPEARS IN GOLD; ABOVE THE WORDING "TRADINGOPTIMIZER" APPEARS A DESIGN ELEMENT WHICH CONSISTS OF A LONG UPWARDLY CURVED BLUE ARROW; AND RISING OUT OF THE CURVE OF THE ARROW APPEARS THREE GOLD AND BLUE BARS.

FOR ADVERTISING SERVICES FOR PROMOTING THE BROKERAGE OF STOCKS AND OTHER SECURITIES; COMPILING FINANCIAL, SECURITIES, STOCK EXCHANGE, TRADE AND QUOTE, INDEX VALUE AND OTHER FINANCIAL MARKET INFORMATION FOR BUSINESS PURPOSES; DIRECTING ORDERS FOR SECURITIES TRADES BY MEANS OF COMPUTER SOFTWARE WHICH AUTOMATICALLY DIRECTS TRADES TO THE BEST LOCATION FOR EXECUTING SUCH ORDERS; OFFICE FUNCTIONS IN THE NATURE OF MAINTAINING RECORDS OF OWNERSHIP OF STOCKS, SHARES AND SECURITIES; OFFICE FUNCTIONS IN THE NATURE OF MAINTAINING RECORDS OF SETTLEMENTS FOR TRANSFERS OF STOCKS, SHARES AND SECURITIES (U.S. CLS. 100, 101 AND 102).

FIRST USE 1-1-2011; IN COMMERCE 7-7-2011.

4,165,288. DOMBIA ENTERPRISE INCORPORATED, VILLA PARK, IL. SN 85-161,899. PUB. 3-22-2011, FILED 10-26-2010.

Dombia

THE MARK CONSISTS OF STANDARD CHARACTERS WITHOUT CLAIM TO ANY PARTICULAR FONT, STYLE, SIZE, OR COLOR.

FOR ADVERTISING AND MARKETING SERVICES IN THE FIELD OF THE THIRD PARTY BRAND PROMOTION (U.S. CLS. 100, 101 AND 102).

FIRST USE 5-3-2012; IN COMMERCE 5-3-2012.

4,165,289. DOMBIA ENTERPRISE INCORPORATED, VILLA PARK, IL. SN 85-161,905. PUB. 3-22-2011, FILED 10-26-2010.



THE MARK CONSISTS OF STYLIZED LETTERS "D" AND "I".

FOR ADVERTISING AND MARKETING SERVICES IN THE FIELD OF THE THIRD PARTY BRAND PROMOTION (U.S. CLS. 100, 101 AND 102).

FIRST USE 5-3-2012; IN COMMERCE 5-3-2012.

CLASS 35—(Continued).

4,165,315. PBS ENTERPRISES, INC., DBA PREMIER BEAUTY SOLUTIONS, LAGUNA NIGUEL, CA. SN 85-173,755. PUB. 11-8-2011, FILED 11-10-2010.



NO CLAIM IS MADE TO THE EXCLUSIVE RIGHT TO USE "PREMIER BEAUTY SOLUTIONS", APART FROM THE MARK AS SHOWN.

THE MARK CONSISTS OF A FLOWER IMAGE WITH THE WORDS "PREMIER BEAUTY SOLUTIONS ENERGIZE YOUR CAREER . ENHANCE YOUR EXPERTISE . ELEVATE YOUR STYLE" APPEARING CENTERED BELOW THE IMAGE.

FOR ADVERTISING AND DIRECTORY SERVICES, NAMELY, PROMOTING THE SERVICES OF OTHERS BY PROVIDING A WEB PAGE FEATURING LINKS TO THE WEBSITES OF OTHERS; ON-LINE RETAIL STORE SERVICES FEATURING SPA CLOTHING, DVDS, CDS, AND BOOKS; RENTAL OF ADVERTISING SPACE ON WEB SITES (U.S. CLS. 100, 101 AND 102).

FIRST USE 11-11-2010; IN COMMERCE 11-11-2010.

4,165,333. RETAIL 101, LLC, BEACON FALLS, CT. SN 85-183,743. PUB. 9-13-2011, FILED 11-23-2010.

RETAIL 101

THE MARK CONSISTS OF STANDARD CHARACTERS WITHOUT CLAIM TO ANY PARTICULAR FONT, STYLE, SIZE, OR COLOR.

NO CLAIM IS MADE TO THE EXCLUSIVE RIGHT TO USE "RETAIL", APART FROM THE MARK AS SHOWN.

FOR RETAIL STORE SERVICES FEATURING CLOTHING, JEWELRY, FOOTWEAR, SPORTING GOODS, SUNGLASSES, BED LINENS, BED COVERINGS, KITCHENWARE AND GLASSWARE (U.S. CLS. 100, 101 AND 102).

FIRST USE 6-17-2000; IN COMMERCE 6-17-2000.

CLASS 35—(Continued).

4,165,334. RETAIL 101, LLC, BEACON FALLS, CT. SN 85-183,760. PUB. 9-13-2011, FILED 11-23-2010.

RETAIL SALES 101

THE MARK CONSISTS OF STANDARD CHARACTERS WITHOUT CLAIM TO ANY PARTICULAR FONT, STYLE, SIZE, OR COLOR.

NO CLAIM IS MADE TO THE EXCLUSIVE RIGHT TO USE "RETAIL SALES", APART FROM THE MARK AS SHOWN.

FOR RETAIL STORE SERVICES FEATURING CLOTHING, JEWELRY, FOOTWEAR, SPORTING GOODS, SUNGLASSES, BED LINENS, BED COVERINGS, KITCHENWARE AND GLASSWARE (U.S. CLS. 100, 101 AND 102).

FIRST USE 6-17-2000; IN COMMERCE 6-17-2000.

4,165,337. BATALLA, YESENIA, DBA YB CREATIONS, NORTHRIDGE, CA. SN 85-185,064. PUB. 6-7-2011, FILED 11-24-2010.

~ FROM A LOVE STATE OF BLING ~

THE COLOR(S) YELLOW-GOLD IS/ARE CLAIMED AS A FEATURE OF THE MARK.

THE MARK CONSISTS OF THE STYLIZED WORDING "FROM A LOVE STATE OF BEING" IN THE COLOR YELLOW-GOLD.

FOR PROMOTING, ADVERTISING AND MARKETING OF THE BRANDS, PRODUCTS, SERVICES OR ONLINE WEBSITES OF INDIVIDUALS, BUSINESSES AND NONPROFIT ORGANIZATIONS (U.S. CLS. 100, 101 AND 102).

FIRST USE 3-17-2011; IN COMMERCE 7-15-2011.

4,165,342. CADUCEUS OCCUPATIONAL MEDICINE, LLC, ATLANTA, GA. SN 85-187,787. PUB. 1-10-2012, FILED 11-30-2010.

CADUCEUS OCCUPATIONAL MEDICINE

THE MARK CONSISTS OF STANDARD CHARACTERS WITHOUT CLAIM TO ANY PARTICULAR FONT, STYLE, SIZE, OR COLOR.

NO CLAIM IS MADE TO THE EXCLUSIVE RIGHT TO USE "OCCUPATIONAL MEDICINE", APART FROM THE MARK AS SHOWN.

FOR FRANCHISING SERVICES IN THE FIELD OF HEALTHCARE, NAMELY, CONSULTATION AND ASSISTANCE IN BUSINESS MANAGEMENT FOR, AND ORGANIZATION AND PROMOTION OF MEDICAL CARE FACILITIES AND PROMOTION OF OCCUPATIONAL MEDICINE FACILITIES (U.S. CLS. 100, 101 AND 102).

FIRST USE 9-1-2010; IN COMMERCE 9-1-2011.

CLASS 35—(Continued).

4,165,362. CAREINGTON INTERNATIONAL CORPORATION, FRISCO, TX. SN 85-201,107. PUB. 11-29-2011, FILED 12-17-2010.



NO CLAIM IS MADE TO THE EXCLUSIVE RIGHT TO USE "DISCOUNTS NORTH AMERICA", APART FROM THE MARK AS SHOWN.

THE COLOR(S) RED, BLUE AND GREEN IS/ARE CLAIMED AS A FEATURE OF THE MARK.

THE MARK CONSISTS OF THREE CONCENTRIC HEART OUTLINES IN RED, BLUE AND GREEN, TO THE LEFT OF THE WORD "HEALTHY" IN BLUE, OVER THE WORD "DISCOUNTS" IN RED, SEPARATED BY A GREEN LINE, OVER THE WORDING "NORTH AMERICA" IN GREEN AND THE PHRASE "LIVING A HEALTHY LIFE, FOR LESS" IN BLUE.

FOR ADMINISTRATION OF PRE-PAID DISCOUNT HEALTH CARE PROGRAMS ENABLING PARTICIPANTS TO OBTAIN DISCOUNTS ON DENTAL CARE, VISION CARE, CHIROPRACTIC CARE AND PRESCRIPTION DRUGS, THROUGH THE USE OF A DISCOUNT HEALTH CARE PROGRAM MEMBERSHIP CARD (U.S. CLS. 100, 101 AND 102).

FIRST USE 12-0-2010; IN COMMERCE 12-0-2010.

CLASS 35—(Continued).

4,165,405. AMPEGY, LLC, HOUSTON, TX. SN 85-219,818. PUB. 8-2-2011, FILED 1-18-2011.



THE MARK CONSISTS OF THE WORD "AMPEGY" IN DISTINCTIVE TYPE WITH A CLUSTER OF LEAVES OVER THE "Y" IN THE WORD MARK.

FOR MARKETING OF ENERGY RELATED SERVICES TO RESIDENTIAL AND COMMERCIAL CUSTOMERS, NAMELY, MARKETING SERVICES IN THE NATURE OF PROMOTING OR ADVERTISING THE ELECTRICITY AND NATURAL GAS SUPPLY SERVICES OF OTHERS TO RESIDENTIAL AND COMMERCIAL CUSTOMERS THROUGH IN PERSON SOLICITATION BY SALES PEOPLE; ON-LINE ENERGY MANAGEMENT SERVICES, NAMELY, PROVIDING AN ONLINE SERVICE THAT ALLOWS RESIDENTIAL AND COMMERCIAL CUSTOMERS TO PURCHASE ENERGY, NAMELY, ELECTRICITY, NATURAL GAS AND RENEWABLE ENERGY, FROM VARIOUS ENERGY PROVIDERS; MULTILEVEL MARKETING BUSINESS SERVICES, IN THE NATURE OF PROVIDING MARKETING AND INCOME OPPORTUNITIES TO OTHERS IN THE FIELDS OF ELECTRICITY, NATURAL GAS, AND RENEWABLE ENERGY, AND THROUGH THE DEVELOPMENT OF MARKETING ORGANIZATIONS (U.S. CLS. 100, 101 AND 102).

FIRST USE 2-24-2011; IN COMMERCE 2-24-2011.

4,165,413. PROFESSIONAL ASSOCIATION OF INNKEEPERS INTERNATIONAL, CHARLESTON, SC. SN 85-226,407. PUB. 8-30-2011, FILED 1-26-2011.

4,165,397. RADIO DIRECT MARKETING 360, INC., FORT COLLINS, CO. SN 85-216,289. PUB. 8-9-2011, FILED 1-12-2011.

RDM360 RADIO DIRECT MARKETING

THE MARK CONSISTS OF STANDARD CHARACTERS WITHOUT CLAIM TO ANY PARTICULAR FONT, STYLE, SIZE, OR COLOR.

NO CLAIM IS MADE TO THE EXCLUSIVE RIGHT TO USE "RADIO DIRECT MARKETING", APART FROM THE MARK AS SHOWN.

FOR CONDUCTING MARKETING STUDIES; BUSINESS MARKETING CONSULTATION SERVICES; MARKET RESEARCH SERVICES (U.S. CLS. 100, 101 AND 102).

FIRST USE 12-14-2010; IN COMMERCE 12-14-2010.

BETTER WAY TO STAY

THE MARK CONSISTS OF STANDARD CHARACTERS WITHOUT CLAIM TO ANY PARTICULAR FONT, STYLE, SIZE, OR COLOR.

FOR ASSOCIATION SERVICES, NAMELY, PROMOTING THE INTERESTS OF BED AND BREAKFASTS AND INNS; PROMOTING THE SERVICES OF OTHERS BY PROVIDING A WEBSITE FEATURING LINKS TO THE WEBSITES OF OTHERS IN THE FIELD OF BED AND BREAKFASTS AND INNS; PROVIDING ADVERTISING, MARKETING AND PROMOTIONAL SERVICES, NAMELY, DEVELOPMENT OF ADVERTISING CAMPAIGNS FOR BED AND BREAKFASTS AND INNS; ADVERTISING, PROMOTION AND MARKETING SERVICES IN THE NATURE OF A VIRAL MARKETING CAMPAIGN FOR BED AND BREAKFASTS AND INNS; PROVIDING A SEARCHABLE WEBSITE AND ON-LINE GUIDE FEATURING THE SERVICES AND GOODS OF OTHERS IN THE FIELD OF BED AND BREAKFASTS AND INNS (U.S. CLS. 100, 101 AND 102).

FIRST USE 5-1-2010; IN COMMERCE 6-1-2010.

CLASS 35—(Continued).

4,165,435. COLLETTA, FRANKLIN, FORT PIERCE, FL. SN 85-242,250. PUB. 6-14-2011, FILED 2-15-2011.

Play Better Golf in Better Shoes. Name of individual, company or other entity.

THE MARK CONSISTS OF STANDARD CHARACTERS WITHOUT CLAIM TO ANY PARTICULAR FONT, STYLE, SIZE, OR COLOR.

FOR AD SERVING, NAMELY, PLACING ADVERTISEMENTS ON WEBSITES FOR OTHERS USING SPECIALIZED COMPUTER SOFTWARE (U.S. CLS. 100, 101 AND 102).

FIRST USE 1-1-2011; IN COMMERCE 1-1-2011.

4,165,455. SAVORY SPICE SHOP, INC., DENVER, CO. SN 85-252,340. PUB. 1-31-2012, FILED 2-25-2011.

SAVORY SPICE STOP

THE MARK CONSISTS OF STANDARD CHARACTERS WITHOUT CLAIM TO ANY PARTICULAR FONT, STYLE, SIZE, OR COLOR.

OWNER OF U.S. REG. NOS. 3,798,127, 3,840,094, AND OTHERS.

NO CLAIM IS MADE TO THE EXCLUSIVE RIGHT TO USE "SPICE", APART FROM THE MARK AS SHOWN.

FOR FRANCHISE SERVICES, NAMELY, OFFERING BUSINESS MANAGEMENT ASSISTANCE IN THE ESTABLISHMENT AND OPERATION OF RETAIL STORES FEATURING SPICES, SPICE BLENDS, SEASONINGS, PROCESSED HERBS, EXTRACTS USED FOR FLAVORING; ONLINE RETAIL STORES FEATURING SPICES, SPICE BLENDS, SEASONINGS, PROCESSED HERBS, AND EXTRACTS USED FOR FLAVORING; RETAIL STORE AND ON-LINE RETAIL STORE SERVICES FEATURING SPICES, SPICE BLENDS, SEASONINGS, PROCESSED HERBS, EXTRACTS USED FOR FLAVORING; ONLINE RETAIL STORES FEATURING SPICES, SPICE BLENDS, SEASONINGS, PROCESSED HERBS, AND EXTRACTS USED FOR FLAVORING (U.S. CLS. 100, 101 AND 102).

FIRST USE 11-6-2011; IN COMMERCE 11-6-2011.

CLASS 35—(Continued).

4,165,463. QUETOS, INC, SAN FRANCISCO, CA. SN 85-254,922. PUB. 7-19-2011, FILED 3-1-2011.

masalaminds

THE MARK CONSISTS OF STANDARD CHARACTERS WITHOUT CLAIM TO ANY PARTICULAR FONT, STYLE, SIZE, OR COLOR.

FOR PROVIDING A WEB SITE WHERE USERS CAN POST RATINGS, REVIEWS AND RECOMMENDATIONS ON PRODUCTS AND SERVICES FOR COMMERCIAL PURPOSES (U.S. CLS. 100, 101 AND 102).

FIRST USE 1-9-2012; IN COMMERCE 3-1-2012.

4,165,479. BUTLER ANIMAL HEALTH SUPPLY, LLC, DBA BUTLER SCHEIN ANIMAL HEALTH, DUBLIN, OH. SN 85-260,505. PUB. 7-26-2011, FILED 3-8-2011.

MyVetDirect.com

THE MARK CONSISTS OF STANDARD CHARACTERS WITHOUT CLAIM TO ANY PARTICULAR FONT, STYLE, SIZE, OR COLOR.

FOR PROVIDING A WEBSITE USED TO PLACE ONLINE COMMERCIAL ORDERS IN THE FIELD OF VETERINARY PHARMACEUTICALS AND PRODUCTS (U.S. CLS. 100, 101 AND 102).

FIRST USE 4-26-2005; IN COMMERCE 4-26-2005.

4,165,480. BUTLER ANIMAL HEALTH SUPPLY, LLC, DBA BUTLER SCHEIN ANIMAL HEALTH, DUBLIN, OH. SN 85-260,513. PUB. 7-26-2011, FILED 3-8-2011.

MyVetDirect

THE MARK CONSISTS OF STANDARD CHARACTERS WITHOUT CLAIM TO ANY PARTICULAR FONT, STYLE, SIZE, OR COLOR.

FOR PROVIDING A WEBSITE USED TO PLACE ONLINE COMMERCIAL ORDERS IN THE FIELD OF VETERINARY PHARMACEUTICALS AND PRODUCTS (U.S. CLS. 100, 101 AND 102).

FIRST USE 4-26-2005; IN COMMERCE 4-26-2005.

CLASS 35—(Continued).

4,165,496. FOODSERVICEPLANET.COM LLC, HARRISON, OH. SN 85-265,845. PUB. 8-30-2011, FILED 3-14-2011.



NO CLAIM IS MADE TO THE EXCLUSIVE RIGHT TO USE "CATERING", APART FROM THE MARK AS SHOWN. THE MARK CONSISTS OF THE WORDING "CATERING-PLANET.COM"; THE WORDS "SUPPLY", "SETUP", "SERVE", "SAVE", ALL OF WHICH ARE SEPARATED BY THREE RAISED DOTS; A STYLIZED FOUR POINTED STAR WITH A TAIL APPEARING ACROSS A STYLIZED PLANET ALL OF WHICH APPEARS UPON A RECTANGLE WITH ROUNDED CORNERS. FOR DISTRIBUTORSHIP, SERVICES IN THE FIELD OF EQUIPMENT, NAMELY, BARWARE, BEVERAGE SERVICE, FOOD SERVING AND PREPARATION SUPPLIES AND EQUIPMENT, FOOD COOKING AND WARMING EQUIPMENT, TABLE LINENS, MAINTENANCE AND CLEANING SUPPLIES, FOOD STORAGE, SHELVING AND TRANSPORT EQUIPMENT, EVENT DECOR AND SUPPLIES TO CATERERS, FOOD AND BEVERAGE PERSONNEL, EVENT PLANNERS, AND OTHER FOOD SERVICES PROFESSIONALS (U.S. CLS. 100, 101 AND 102). FIRST USE 8-1-2011; IN COMMERCE 8-1-2011.

4,165,497. FOODSERVICEPLANET.COM LLC, HARRISON, OH. SN 85-265,855. PUB. 8-30-2011, FILED 3-14-2011.



NO CLAIM IS MADE TO THE EXCLUSIVE RIGHT TO USE "CATERING", APART FROM THE MARK AS SHOWN. THE MARK CONSISTS OF THE WORDING "CATERING-PLANET.COM" AND A STYLIZED FOUR POINTED STAR WITH A TAIL APPEARING ACROSS A STYLIZED PLANET ALL OF WHICH APPEARS UPON A RECTANGLE WITH ROUNDED CORNERS. FOR DISTRIBUTORSHIP SERVICES IN THE FIELD OF EQUIPMENT, NAMELY, BARWARE, BEVERAGE SERVICE, FOOD SERVING AND PREPARATION SUPPLIES AND EQUIPMENT, FOOD COOKING AND WARMING EQUIPMENT, TABLE LINENS, MAINTENANCE AND CLEANING SUPPLIES, FOOD STORAGE, SHELVING AND TRANSPORT EQUIPMENT, EVENT DECOR AND SUPPLIES TO CATERERS, FOOD AND BEVERAGE PERSONNEL, EVENT PLANNERS, AND OTHER FOOD SERVICES PROFESSIONALS (U.S. CLS. 100, 101 AND 102). FIRST USE 8-1-2011; IN COMMERCE 8-1-2011.

CLASS 35—(Continued).

4,165,502. NOONAN, SPENCER, LONDON, CANADA. SN 85-266,869. PUB. 8-2-2011, FILED 3-15-2011.

COMCLASS

THE MARK CONSISTS OF STANDARD CHARACTERS WITHOUT CLAIM TO ANY PARTICULAR FONT, STYLE, SIZE, OR COLOR. FOR ON-LINE ADVERTISING ON COMPUTER NETWORKS (U.S. CLS. 100, 101 AND 102). FIRST USE 3-9-2011; IN COMMERCE 3-9-2011.

4,165,515. SMITH, AMANDA, FAIRFIELD, CA. SN 85-270,806. PUB. 8-2-2011, FILED 3-18-2011.

Holding Aces

THE MARK CONSISTS OF STANDARD CHARACTERS WITHOUT CLAIM TO ANY PARTICULAR FONT, STYLE, SIZE, OR COLOR. FOR RETAIL STORE AND ON-LINE RETAIL STORE SERVICES FEATURING FASHION CLOTHING AND FASHION ACCESSORIES INCLUDING BRACELETS, NECKLACES, RINGS, HAIRCLIPS, HANDBAGS, BUTTONS, AND KEYCHAINS (U.S. CLS. 100, 101 AND 102). FIRST USE 7-2-2011; IN COMMERCE 7-24-2011.

4,165,534. LAKE, III, CLIFFORD F., MINNETONKA, MN. SN 85-274,197. PUB. 8-9-2011, FILED 3-23-2011.

RESTLESS FINGER SYNDROME

THE MARK CONSISTS OF STANDARD CHARACTERS WITHOUT CLAIM TO ANY PARTICULAR FONT, STYLE, SIZE, OR COLOR. FOR CONSULTATION AND ADVICE FOR THE PURCHASE OF MUSICAL INSTRUMENTS AND SOUND RECORDING DEVICES; RETAIL STORE SERVICES FEATURING MUSICAL INSTRUMENTS (U.S. CLS. 100, 101 AND 102). FIRST USE 6-30-2011; IN COMMERCE 6-30-2011.

CLASS 35—(Continued).

4,165,564. XPLORE, INC., MCKINNEY, TX. SN 85-278,050. PUB. 12-6-2011, FILED 3-27-2011.

Xplore

THE MARK CONSISTS OF STANDARD CHARACTERS WITHOUT CLAIM TO ANY PARTICULAR FONT, STYLE, SIZE, OR COLOR.

FOR BUSINESS STRATEGIC PLANNING SERVICES (U.S. CLS. 100, 101 AND 102).

FIRST USE 2-11-1993; IN COMMERCE 2-11-1993.

4,165,571. MARITZ HOLDINGS INC., FENTON, MO. SN 85-279,775. PUB. 8-9-2011, FILED 3-29-2011.

YOUR INSTANT SAVINGS

THE MARK CONSISTS OF STANDARD CHARACTERS WITHOUT CLAIM TO ANY PARTICULAR FONT, STYLE, SIZE, OR COLOR.

FOR ADMINISTRATION OF A DISCOUNT PROGRAM FOR ENABLING PARTICIPANTS TO OBTAIN DISCOUNTS ON GOODS AND SERVICES THROUGH USE OF A DISCOUNT MEMBERSHIP CODE; REDEMPTION OF DISCOUNTS FOR ITEMS IN MAIL-ORDER OR ELECTRONIC ONLINE CATALOGS FEATURING MERCHANDISE AND SERVICES OFFERED IN CONNECTION WITH SALES, PERFORMANCE AND LOYALTY INCENTIVE PROGRAMS FOR CUSTOMERS, EMPLOYEES, OR SALES PARTNERS (U.S. CLS. 100, 101 AND 102).

FIRST USE 4-0-2011; IN COMMERCE 4-0-2011.

4,165,581. CHRISTOPHER D. STOUT, TWIN FALLS, ID. SN 85-281,630. PUB. 8-9-2011, FILED 3-30-2011.

EQUIPMENTHUNTERS

THE MARK CONSISTS OF STANDARD CHARACTERS WITHOUT CLAIM TO ANY PARTICULAR FONT, STYLE, SIZE, OR COLOR.

FOR ADVERTISING SERVICES, NAMELY, PROVIDING A WEBSITE FEATURING THE GOODS AND SERVICES OF OTHER VENDORS; ON-LINE AUCTION SERVICES (U.S. CLS. 100, 101 AND 102).

FIRST USE 6-14-2011; IN COMMERCE 6-14-2011.

CLASS 35—(Continued).

4,165,600. THE GOYAK GROUP, INC., LAS VEGAS, NV. SN 85-284,315. PUB. 8-9-2011, FILED 4-1-2011.

TODAY'S PERFORMANCE IS TOMORROW'S PAST PERFORMANCE

THE MARK CONSISTS OF STANDARD CHARACTERS WITHOUT CLAIM TO ANY PARTICULAR FONT, STYLE, SIZE, OR COLOR.

FOR ASSISTANCE, ADVISORY SERVICES AND CONSULTANCY WITH REGARD TO BUSINESS PLANNING, BUSINESS ANALYSIS, BUSINESS MANAGEMENT, AND BUSINESS ORGANIZATION; BUSINESS ADVISORY SERVICES, CONSULTANCY AND INFORMATION; BUSINESS CONSULTATION; BUSINESS CONSULTATION IN THE FIELD OF BUSINESS LEADERSHIP DEVELOPMENT; BUSINESS CONSULTING AND INFORMATION SERVICES; BUSINESS CONSULTING SERVICES, NAMELY, PROVIDING ASSISTANCE IN DEVELOPMENT OF BUSINESS STRATEGIES AND CREATIVE IDEATION; BUSINESS CONSULTING, MANAGEMENT, PLANNING AND SUPERVISION; BUSINESS DEVELOPMENT CONSULTING SERVICES; BUSINESS MANAGEMENT ADVICE; BUSINESS MANAGEMENT AND ADVICE; BUSINESS MANAGEMENT AND CONSULTATION; BUSINESS MANAGEMENT CONSULTANCY AND ADVISORY SERVICES; BUSINESS MANAGEMENT CONSULTANCY SERVICES; BUSINESS MANAGEMENT CONSULTATION; CONSULTANCY AND ADVISORY SERVICES IN THE FIELD OF BUSINESS STRATEGY (U.S. CLS. 100, 101 AND 102).

FIRST USE 3-0-2012; IN COMMERCE 3-0-2012.

4,165,601. PACIFIC BROTHERS WINE COMPANY, LLC, SAN FRANCISCO, CA. SN 85-284,589. PUB. 8-9-2011, FILED 4-2-2011.



THE MARK CONSISTS OF A WINE BOTTLE WITH THE LETTER "P" DISPLAYED DIRECTLY ABOVE THE LETTER "B" ON THE FRONT OF THE BOTTLE. THE LETTERS "P" AND "B" REPRESENT THE NAME PACIFIC BROTHERS.

FOR EXPORT AND IMPORT AGENCIES IN THE FIELD OF WINE (U.S. CLS. 100, 101 AND 102).

FIRST USE 1-1-2011; IN COMMERCE 2-13-2012.

CLASS 35—(Continued).

4,165,638. BROOKSHIRE BROTHERS, INC., LUFKIN, TX. SN 85-293,219. PUB. 10-18-2011, FILED 4-12-2011.

B•BROS RX\$AVER

THE MARK CONSISTS OF STANDARD CHARACTERS WITHOUT CLAIM TO ANY PARTICULAR FONT, STYLE, SIZE, OR COLOR.

FOR ADMINISTRATION OF A DISCOUNT PROGRAM FOR ENABLING PARTICIPANTS TO OBTAIN DISCOUNTS ON GOODS AND SERVICES THROUGH USE OF A DISCOUNT MEMBERSHIP CARD (U.S. CLS. 100, 101 AND 102).

FIRST USE 8-11-2011; IN COMMERCE 8-11-2011.

CLASS 35—(Continued).

4,165,661. THE ASSOCIATION FOR CORPORATE GROWTH, INC., CHICAGO, IL. SN 85-298,647. PUB. 8-16-2011, FILED 4-19-2011.

DRIVING MIDDLE MARKET GROWTH

THE MARK CONSISTS OF STANDARD CHARACTERS WITHOUT CLAIM TO ANY PARTICULAR FONT, STYLE, SIZE, OR COLOR.

FOR BUSINESS NETWORKING; GENERAL BUSINESS NETWORKING REFERRAL SERVICES, NAMELY, PROMOTING THE GOODS AND SERVICES OF OTHERS BY PASSING BUSINESS LEADS AND REFERRALS AMONG GROUP MEMBERS; ON-LINE BUSINESS NETWORKING SERVICES (U.S. CLS. 100, 101 AND 102).

FIRST USE 1-27-2011; IN COMMERCE 1-27-2011.

4,165,644. SPACEBOUND, INC., LAGRANGE, OH. SN 85-294,632. PUB. 8-23-2011, FILED 4-13-2011.

NOTHINGBUTSAVINGS

THE MARK CONSISTS OF STANDARD CHARACTERS WITHOUT CLAIM TO ANY PARTICULAR FONT, STYLE, SIZE, OR COLOR.

OWNER OF U.S. REG. NOS. 2,530,940 AND 2,545,398. FOR COMPUTERIZED ON-LINE ORDERING FEATURING GENERAL MERCHANDISE AND GENERAL CONSUMER GOODS; ON-LINE RETAIL STORE SERVICES FEATURING A WIDE VARIETY OF CONSUMER GOODS OF OTHERS; PROMOTING THE GOODS AND SERVICES OF OTHERS THROUGH ON-LINE ORDERING AND CATALOGING OF THOSE GOODS AND SERVICES (U.S. CLS. 100, 101 AND 102).

FIRST USE 4-9-2012; IN COMMERCE 4-9-2012.

4,165,670. WHOZAGOOD, INC., CALGARY, CANADA. SN 85-300,956. PUB. 10-18-2011, FILED 4-21-2011.

WhoZaGood

4,165,651. U.S. MEDICAL MANAGEMENT LLC, TROY, MI. SN 85-296,068. PUB. 8-30-2011, FILED 4-15-2011.

Homescripts

OWNER OF U.S. REG. NO. 3,975,906. THE MARK CONSISTS OF THE WORD "HOMESCRIPTS", WITH THE "H" HAVING A CIRCLE SPLIT IN HALF ABOVE IT AS TO FORM A TABLET AND THE ENTIRE WORD WITHIN THE SHAPE OF A CAPSULE.

FOR MAIL ORDER PHARMACY AND MAIL ORDER OVER THE COUNTER MEDICATION SERVICES; PHARMACEUTICAL SERVICES, NAMELY, PROCESSING MAIL ORDER, ON-LINE AND TELEPHONE PRESCRIPTION AND OVER THE COUNTER MEDICATION ORDERS; ON-LINE MAIL ORDER AND RETAIL PHARMACY SERVICES (U.S. CLS. 100, 101 AND 102).

FIRST USE 7-0-2011; IN COMMERCE 7-0-2011.

THE MARK CONSISTS OF THE TELESCOPED PHRASE "WHOZAGOOD" IN UPPER-AND-LOWER-CASE STANDARD CHARACTERS INTERRUPTED BY A LARGE, LOOMING "Z", STYLIZED TO APPEAR AS IF FORMED BY THREE PAINT-BRUSH STROKES.

FOR BUSINESS RESEARCH AND SURVEYS; CONDUCTING ON-LINE BUSINESS MANAGEMENT RESEARCH SURVEYS; PROVIDING A SEARCHABLE WEBSITE FEATURING THE GOODS AND SERVICES OF OTHER VENDORS; PROVIDING A WEB SITE WHERE USERS CAN POST RATINGS, REVIEWS AND RECOMMENDATIONS ON PRODUCTS AND SERVICES FOR COMMERCIAL PURPOSES (U.S. CLS. 100, 101 AND 102).

FIRST USE 11-11-2011; IN COMMERCE 11-11-2011.

CLASS 35—(Continued).

4,165,685. WISTEEZ, LLC, HAYWARD, CA. SN 85-307,179.
PUB. 9-13-2011, FILED 4-28-2011.



THE MARK CONSISTS OF AN OVAL SURROUNDING THE WORD "WISTEEZ" THE "W" IN "WISTEEZ" IS CENTERED IN A DIAMOND SHAPED BOX.

FOR RETAIL STORE AND ON-LINE RETAIL STORE SERVICES FEATURING COLLECTIBLE PLAYING CARDS AND CARD GAMES (U.S. CLS. 100, 101 AND 102).

FIRST USE 10-6-2010; IN COMMERCE 3-1-2012.

4,165,719. ANNCO, INC., NEW YORK, NY. SN 85-324,948.
PUB. 9-13-2011, FILED 5-19-2011.

THIS IS YOU. THIS IS NOW.

THE MARK CONSISTS OF STANDARD CHARACTERS WITHOUT CLAIM TO ANY PARTICULAR FONT, STYLE, SIZE, OR COLOR.

FOR ON-LINE AND IN STORE RETAIL STORE SERVICES IN THE FIELDS OF CLOTHING, FOOTWEAR, HANDBAGS, SMALL LEATHER ACCESSORIES, TOILETRIES, CONSUMABLE BATH PRODUCTS AND COSMETIC PRODUCTS (U.S. CLS. 100, 101 AND 102).

FIRST USE 2-27-2012; IN COMMERCE 2-27-2012.

4,165,757. BACONERY, LLC, NEW YORK, NY. SN 85-344,662.
PUB. 11-1-2011, FILED 6-13-2011.

BACONERY

THE MARK CONSISTS OF STANDARD CHARACTERS WITHOUT CLAIM TO ANY PARTICULAR FONT, STYLE, SIZE, OR COLOR.

FOR ON-LINE RETAIL STORE SERVICES FEATURING BAKERY GOODS; RETAIL BAKERY SHOPS (U.S. CLS. 100, 101 AND 102).

FIRST USE 0-0-2011; IN COMMERCE 0-0-2011.

CLASS 35—(Continued).

4,165,767. USA VOLLEYBALL, COLORADO SPRINGS, CO. SN 85-353,489. PUB. 12-13-2011, FILED 6-22-2011.



OWNER OF U.S. REG. NOS. 2,144,649, 3,887,032, AND OTHERS.

NO CLAIM IS MADE TO THE EXCLUSIVE RIGHT TO USE "USA SITTING VOLLEYBALL", APART FROM THE MARK AS SHOWN.

THE COLOR(S) RED, WHITE AND BLUE IS/ARE CLAIMED AS A FEATURE OF THE MARK.

THE MARK CONSISTS OF A VOLLEYBALL SHAPED DESIGN THAT INCORPORATES WHITE STARS ON A BLUE BACKGROUND AND RED AND WHITE STRIPES ALL TO EMULATE ELEMENTS OF THE AMERICAN FLAG WITH THE WORDS "USA" IN BLUE AND "SITTING VOLLEYBALL" IN RED BELOW IT.

FOR ASSOCIATION SERVICES, NAMELY, PROMOTING THE SPORT OF VOLLEYBALL (U.S. CLS. 100, 101 AND 102).

FIRST USE 11-30-2011; IN COMMERCE 11-30-2011.

4,165,774. MASSINGALE, CLIFTON, CORONA, CA. SN 85-356,022. PUB. 11-29-2011, FILED 6-24-2011.

**Career Development through
Lifelong Learning!**

THE MARK CONSISTS OF STANDARD CHARACTERS WITHOUT CLAIM TO ANY PARTICULAR FONT, STYLE, SIZE, OR COLOR.

FOR EMPLOYMENT HIRING, RECRUITING, PLACEMENT, STAFFING AND CAREER NETWORKING SERVICES (U.S. CLS. 100, 101 AND 102).

FIRST USE 6-10-2011; IN COMMERCE 1-20-2012.

CLASS 35—(Continued).

4,165,777. MEDICAL JUSTICE SERVICES, INC., GREENSBORO, NC. SN 85-359,049. PUB. 1-17-2012, FILED 6-29-2011.

EMERIT

THE MARK CONSISTS OF STANDARD CHARACTERS WITHOUT CLAIM TO ANY PARTICULAR FONT, STYLE, SIZE, OR COLOR.

FOR BUSINESS MARKETING CONSULTING, NAMELY, REPUTATION MANAGEMENT AND ONLINE REPUTATION MANAGEMENT FOR DOCTORS (U.S. CLS. 100, 101 AND 102).

FIRST USE 5-19-2011; IN COMMERCE 5-19-2011.

4,165,782. APPLE SUPPLY COMPANY, LLC, FALL RIVER, MA. SN 85-360,631. PUB. 1-10-2012, FILED 6-30-2011.

PILGRIM MEDICAL EQUIPMENT

THE MARK CONSISTS OF STANDARD CHARACTERS WITHOUT CLAIM TO ANY PARTICULAR FONT, STYLE, SIZE, OR COLOR.

NO CLAIM IS MADE TO THE EXCLUSIVE RIGHT TO USE "MEDICAL EQUIPMENT", APART FROM THE MARK AS SHOWN.

FOR TELEPHONE, ONLINE AND MAIL ORDER CATALOG SERVICES AND ONLINE RETAIL STORE SERVICES IN THE FIELD OF MEDICAL EQUIPMENT AND SUPPLIES; WHOLESALE DISTRIBUTORSHIPS FEATURING MEDICAL EQUIPMENT AND SUPPLIES; COMPUTERIZED ONLINE ORDERING SERVICES IN THE FIELD OF MEDICAL EQUIPMENT AND SUPPLIES; AUTOMATED INVENTORY CONTROL AND INVENTORY CONTROL CONSULTING FOR CUSTOMERS IN THE FIELD OF MEDICAL EQUIPMENT AND SUPPLIES (U.S. CLS. 100, 101 AND 102).

FIRST USE 3-1-2011; IN COMMERCE 2-1-2012.

CLASS 35—(Continued).

4,165,802. BOB WEISS, NEW YORK, NY. SN 85-366,549. PUB. 10-18-2011, FILED 7-8-2011.

Adverbarkment

THE MARK CONSISTS OF STANDARD CHARACTERS WITHOUT CLAIM TO ANY PARTICULAR FONT, STYLE, SIZE, OR COLOR.

FOR ADVERTISING AND MARKETING; ADVERTISING, PROMOTION AND MARKETING SERVICES; ONLINE ADVERTISING AND MARKETING SERVICES; BUSINESS DATA ANALYSIS; PROMOTIONAL SERVICES, NAMELY, PROMOTING THE GOODS AND SERVICES OF OTHERS BY TRANSMITTING SMS OR TEXT MESSAGES VIA A WEBSITE ON THE INTERNET OR WIRELESS DEVICE OR BY MEANS OF PROVIDING ONLINE COUPONS AND ADVERTISEMENTS; CREATIVE MARKETING DESIGN SERVICES; BRANDING SERVICES, NAMELY, CONSULTING, DEVELOPMENT, AND MARKETING OF BRANDS FOR BUSINESS; DEVELOPMENT OF MARKETING STRATEGIES AND CONCEPTS; ADVERTISING SERVICES, NAMELY, CREATING CORPORATE BRAND IDENTITIES AND PRODUCT ADVERTISING CAMPAIGNS; POST-PRODUCTION EDITING SERVICES FOR VIDEO AND AUDIO COMMERCIALS; ADVERTISING AND MARKETING SERVICES, NAMELY, PROMOTING THE GOODS AND SERVICES OF OTHERS; PROVIDING ONLINE COMPUTER DATABASES AND ONLINE SEARCHABLE DATABASES IN THE FIELD OF BUSINESS INFORMATION AND BUSINESS NAMES AND CONTACTS; BUSINESS NETWORKING; DISSEMINATION OF ADVERTISING FOR OTHERS VIA THE INTERNET OR WIRELESS DEVICE; ONLINE SERVICE FOR CONNECTING SOCIAL NETWORK USERS WITH BUSINESSES FOR THE PURPOSE OF FACILITATING PURCHASES; BUSINESS MONITORING AND CONSULTING SERVICES, NAMELY, TRACKING USERS AND ADVERTISING OF OTHERS TO PROVIDE STRATEGY, INSIGHT, MARKETING GUIDANCE, AND FOR ANALYZING, UNDERSTANDING AND PREDICTING CONSUMER BEHAVIOR AND MOTIVATIONS, AND MARKET TRENDS; PROMOTING THE GOODS OF OTHERS BY MEANS OF OPERATING AN ON-LINE SHOPPING MALL WITH LINKS TO THE RETAIL WEBSITES OF OTHERS; ON-LINE RETAIL STORE SERVICES FEATURING DOWNLOADABLE PRERECORDED DIGITAL SOUND, VIDEO AND DATA RECORDINGS FEATURING MUSIC, TEXT, VIDEO, GAMES, COMEDY, DRAMA, ACTION, ADVENTURE OR ANIMATION, VIDEO AND COMPUTER GAMES, GAME-RELATED PRODUCTS IN THE NATURE OF SOFTWARE AND GAME CONTROLLERS THAT ENABLE THE COMPUTER GAMES TO FUNCTION, COMIC BOOKS, CLOTHING, ACCESSORIES IN THE NATURE OF BELTS, HATS, BUTTONS, RINGS, CHAINS, NECKLACES, T-SHIRTS AND BOOKS; COMPARISON SHOPPING SERVICES; PROVIDING AND RENTAL OF ADVERTISING SPACE ON THE INTERNET; PROVIDING ONLINE AUCTION SERVICES; PROMOTING CONCERTS AND ENTERTAINMENT EVENTS FOR OTHERS, NAMELY, PARTIES, PERSONAL, FAMILY AND COMPANY GATHERINGS, MUSIC CONCERTS, GRADUATIONS, COMPETITIONS (U.S. CLS. 100, 101 AND 102).

FIRST USE 6-24-2011; IN COMMERCE 6-24-2011.

CLASS 35—(Continued).

4,165,803. ARTIST GROWTH, LLC, NASHVILLE, TN. SN 85-366,681. PUB. 12-27-2011, FILED 7-8-2011.

ARTIST GROWTH

THE MARK CONSISTS OF STANDARD CHARACTERS WITHOUT CLAIM TO ANY PARTICULAR FONT, STYLE, SIZE, OR COLOR.

NO CLAIM IS MADE TO THE EXCLUSIVE RIGHT TO USE "ARTIST", APART FROM THE MARK AS SHOWN.

FOR BUSINESS MANAGEMENT AND CONSULTATION (U.S. CLS. 100, 101 AND 102).

FIRST USE 1-17-2012; IN COMMERCE 1-17-2012.

4,165,808. W.L. PETREY WHOLESALE, INC., MONTGOMERY, AL. SN 85-371,937. PUB. 1-24-2012, FILED 7-14-2011.

ProfitScan

THE MARK CONSISTS OF STANDARD CHARACTERS WITHOUT CLAIM TO ANY PARTICULAR FONT, STYLE, SIZE, OR COLOR.

FOR INVENTORY CONTROL AND MANAGEMENT SERVICES IN THE NATURE OF ORDERING AND INVENTORY MONITORING OF CONVENIENCE STORE GOODS FOR OTHERS; INVENTORY CONTROL IN THE FIELD OF CONVENIENCE STORE GOODS; BUSINESS MANAGEMENT AND BUSINESS ADMINISTRATION IN THE FIELD OF CONVENIENCE STORE GOODS (U.S. CLS. 100, 101 AND 102).

FIRST USE 3-14-2012; IN COMMERCE 3-14-2012.

4,165,809. HAMRICK, MARK, PRINCETON, NJ. SN 85-372,042. PUB. 1-17-2012, FILED 7-15-2011.

STERLING JAMES

THE MARK CONSISTS OF STANDARD CHARACTERS WITHOUT CLAIM TO ANY PARTICULAR FONT, STYLE, SIZE, OR COLOR.

THE NAME(S), PORTRAIT(S), AND/OR SIGNATURE(S) SHOWN IN THE MARK DOES NOT IDENTIFY A PARTICULAR LIVING INDIVIDUAL.

FOR EXECUTIVE SEARCH SERVICES FOR THE INSURANCE INDUSTRY (U.S. CLS. 100, 101 AND 102).

FIRST USE 3-8-2011; IN COMMERCE 3-8-2011.

CLASS 35—(Continued).

4,165,839. AUTISM UNTANGLED LLC, BOTHELL, WA. SN 85-387,549. PUB. 1-24-2012, FILED 8-2-2011.

AUTISM UNTANGLED

THE MARK CONSISTS OF STANDARD CHARACTERS WITHOUT CLAIM TO ANY PARTICULAR FONT, STYLE, SIZE, OR COLOR.

NO CLAIM IS MADE TO THE EXCLUSIVE RIGHT TO USE "AUTISM", APART FROM THE MARK AS SHOWN.

FOR ON-LINE RETAIL STORE SERVICES FEATURING A WIDE VARIETY OF CONSUMER GOODS FOR INDIVIDUALS WITH AUTISM AND OTHER DEVELOPMENTAL DISORDERS (U.S. CLS. 100, 101 AND 102).

FIRST USE 3-22-2012; IN COMMERCE 3-22-2012.

4,165,846. PDA PROS, LLC, PORTLAND, OR. SN 85-391,680. PUB. 1-24-2012, FILED 8-7-2011.



THE COLOR(S) GREEN AND GRAY IS/ARE CLAIMED AS A FEATURE OF THE MARK.

THE MARK CONSISTS OF THE LETTERS "PDAPROS" AND "COM" WITH A GREEN DOT BETWEEN THEM; THE LETTERS "PDA" ARE IN GREEN, WHILE "PROS" AND "COM" ARE IN GRAY; THERE ARE THREE THIN CONCENTRIC GREEN OVAL ARCS ABOVE AND BELOW THE LETTERS, CENTERED HORIZONTALLY ON THE GREEN DOT AND EXTENDING HORIZONTALLY FROM THE "R" TO THE "M", AND VERTICALLY ABOVE AND BELOW THE LETTERS BY SLIGHTLY MORE THAN THE HEIGHT OF THE LETTERS. THE COLOR WHITE IS MERELY EMPLOYED AS BACKGROUND.

FOR ON-LINE WHOLESALE AND RETAIL STORE SERVICES FEATURING BUYING, SELLING AND RECYCLING OF EQUIPMENT AND ACCESSORIES FOR MOBILE PHONES, PORTABLE ELECTRONIC DEVICES AND PERSONAL DATA ASSISTANTS (U.S. CLS. 100, 101 AND 102).

FIRST USE 2-28-2012; IN COMMERCE 2-28-2012.

CLASS 35—(Continued).

4,165,858. ABERCROMBIE & FITCH TRADING CO., NEW ALBANY, OH. SN 85-396,360. PUB. 11-8-2011, FILED 8-12-2011.

A&F PRIVILEGED

THE MARK CONSISTS OF STANDARD CHARACTERS WITHOUT CLAIM TO ANY PARTICULAR FONT, STYLE, SIZE, OR COLOR.

OWNER OF U.S. REG. NOS. 1,169,714, 3,349,895, AND OTHERS.

FOR RETAIL STORE AND ON-LINE RETAIL STORE SERVICES FEATURING CLOTHING, CLOTHING ACCESSORIES, JEWELRY, BAGS AND PERSONAL CARE PRODUCTS; CUSTOMER LOYALTY SERVICES, FOR COMMERCIAL, PROMOTIONAL AND/OR ADVERTISING PURPOSES (U.S. CLS. 100, 101 AND 102).

FIRST USE 11-30-2011; IN COMMERCE 11-30-2011.

CLASS 35—(Continued).

4,165,875. GRAVES, LEWIS, BROOMFIELD, CO. SN 85-402,983. PUB. 1-17-2012, FILED 8-20-2011.

**STRONG-SIDE
TACTICAL**

THE MARK CONSISTS OF THE STYLIZED TEXT "STRONG-SIDE" WHICH IS POSITIONED ABOVE THE STYLIZED WORD "TACTICAL". BOTH WORDS SHARE AN IMAGE OF A BULLET AS A COMMON "I".

FOR RETAIL STORE AND ON-LINE RETAIL STORE SERVICES FEATURING FIREARMS AND FIREARMS ACCESSORIES (U.S. CLS. 100, 101 AND 102).

FIRST USE 10-31-2011; IN COMMERCE 10-31-2011.

4,165,879. ADVENA ARTEMIS LLC, HOUSTON, TX. SN 85-405,536. PUB. 2-7-2012, FILED 8-24-2011.

CLONE YOUR FAVORITE

THE MARK CONSISTS OF STANDARD CHARACTERS WITHOUT CLAIM TO ANY PARTICULAR FONT, STYLE, SIZE, OR COLOR.

FOR BUSINESS MANAGEMENT CONSULTING SERVICES IN THE FIELD OF BUSINESS DEVELOPMENT SERVICES, SALES TECHNIQUES, SALES MANAGEMENT, SALES IMPROVEMENT, BUSINESS MARKETING, EMPLOYEE RECRUITING, VENDOR RELATIONS, VOLUNTEER RECRUITING, CORPORATE BOARD RECRUITING, ATTRACTING INVESTORS, AND ATTRACTING TENANTS (U.S. CLS. 100, 101 AND 102).

FIRST USE 11-6-2011; IN COMMERCE 11-6-2011.

4,165,865. BRACES DIRECT, LLC, COCONUT CREEK, FL. SN 85-400,047. PUB. 2-7-2012, FILED 8-17-2011.

SportsBraces.com

NO CLAIM IS MADE TO THE EXCLUSIVE RIGHT TO USE "SPORTSBRACES.COM", APART FROM THE MARK AS SHOWN.

THE MARK CONSISTS OF THE STYLIZED TEXT "SPORTSBRACES.COM" WITH A SWOOSH AROUND. THERE IS A SOCCER BALL IN PLACE OF THE LETTER "O".

FOR ON-LINE WHOLESALE AND RETAIL STORE SERVICES FEATURING MEDICAL PRODUCTS, NAMELY, EXTREMITY BRACES FOR KNEES, ANKLES, WRISTS, BACK AND OTHER BODY PARTS (U.S. CLS. 100, 101 AND 102).

FIRST USE 8-12-2011; IN COMMERCE 8-12-2011.

4,165,906. INDA, ASSOCIATION OF THE NONWOVEN FABRICS INDUSTRY, CARY, NC. SN 85-453,337. PUB. 1-31-2012, FILED 10-21-2011.

CAB

CONVERTING AND BONDING CONFERENCE

NO CLAIM IS MADE TO THE EXCLUSIVE RIGHT TO USE "CONVERTING AND BONDING CONFERENCE", APART FROM THE MARK AS SHOWN.

CLASS 35—(Continued).

THE MARK CONSISTS OF THE WORD "CAB" IN BLOCK LETTERS WITH A DESIGN CONSISTING OF FOUR INTER-LOCKING SQUARES TO THE LEFT AND THE WORDS "CONVERTING AND BONDING CONFERENCE" UNDERNEATH.

FOR ARRANGING AND CONDUCTING BUSINESS CONFERENCES; ASSOCIATION SERVICES, NAMELY, PROMOTING THE INTERESTS OF THE NONWOVEN FABRICS INDUSTRY (U.S. CLS. 100, 101 AND 102).

FIRST USE 11-15-2011; IN COMMERCE 11-15-2011.

CLASS 36—INSURANCE AND FINANCIAL

4,164,807. MASTERCARD INTERNATIONAL INCORPORATED, PURCHASE, NY. SN 77-183,865. PUB. 8-10-2010, FILED 5-17-2007.



The logo for MoneySend features the word "MoneySend" in a bold, black, sans-serif font. The "S" in "Send" is significantly larger and more prominent than the other letters, and the "e" is lowercase. The letters are closely spaced, with the "y" and "S" overlapping slightly.

FOR FINANCIAL SERVICES IN THE NATURE OF PERSONAL BANKING AND MONEY TRANSFER SERVICES IN THE NATURE OF WEB-BASED MONEY TRANSFERS PROVIDED BY MEANS OF A GLOBAL COMPUTER NETWORK; PROVIDING MONETARY PAYMENT SERVICES TO CONSUMERS AND BUSINESSES VIA A GLOBAL COMPUTER NETWORK IN THE NATURE OF PERSON TO PERSON, PERSON TO BUSINESS AND BUSINESS TO BUSINESS PAYMENTS; ELECTRONIC FINANCIAL CLEARING HOUSE SERVICES; ELECTRONIC PAYMENT, NAMELY, ELECTRONIC PROCESSING AND TRANSMISSION OF BILL PAYMENT DATA; STORED VALUE ELECTRONIC PURSE SERVICES, NAMELY, PROVIDING ON-LINE STORED VALUE ACCOUNTS IN AN ELECTRONIC ENVIRONMENT; PROVIDING ELECTRONIC FUNDS AND CURRENCY TRANSFER SERVICES; ELECTRONIC PAYMENT SERVICES FOR PERSONAL BANKING IN THE NATURE OF ELECTRONIC FUNDS TRANSFER AND FINANCIAL CLEARINGHOUSE SERVICES VIA A GLOBAL COMPUTER NETWORK; ELECTRONIC BILL PAYMENT; CLEARING AND RECONCILING FINANCIAL TRANSACTIONS VIA A GLOBAL COMPUTER NETWORK; PERSON-TO-PERSON AND PERSON-TO-BUSINESS MONEY TRANSFER SERVICES TRANSACTED BY MEANS OF A COMPUTER NETWORK; BILL PAYMENT REMITTANCE SERVICES; ELECTRONIC TRANSFER OF MONEY FROM CUSTOMER TO CUSTOMER; CHEQUE VERIFICATION SERVICES; THE PROVISION OF FINANCIAL INFORMATION FOR THE SUPPORT OF RETAIL SERVICES PROVIDED ON-LINE, THROUGH NETWORKS OR OTHER ELECTRONIC MEANS USING ELECTRONICALLY DIGITIZED INFORMATION, IN THE NATURE OF BILL REMITTANCE AND PAYMENT DATA; ELECTRONIC BILL PAYMENT SERVICES PROVIDED THROUGH A WEBSITE; ON-LINE BANKING; FINANCIAL SERVICES IN THE NATURE OF WEB-BASED MONEY TRANSFER PROVIDED OVER THE TELEPHONE AND BY MEANS OF A GLOBAL COMPUTER NETWORK OR THE INTERNET (U.S. CLS. 100, 101 AND 102).

FIRST USE 11-1-2007; IN COMMERCE 11-1-2007.

CLASS 36—(Continued).

4,164,836. STATTRADER, LLC, EAST GREENWICH, RI. SN 77-566,426. PUB. 2-3-2009, FILED 9-10-2008.



The logo for StatTrader features the word "StatTrader" in a bold, black, serif font. The letters are closely spaced, with the "T" in "Trader" being particularly large and prominent.

THE MARK CONSISTS OF STANDARD CHARACTERS WITHOUT CLAIM TO ANY PARTICULAR FONT, STYLE, SIZE, OR COLOR.

FOR PROVIDING FINANCIAL DATA AND INFORMATION VIA THE INTERNET REGARDING PUBLICLY TRADED AND PRIVATELY HELD COMPANIES; PROVIDING A WEBSITE AT WHICH USERS MAY UPLOAD AND SHARE FINANCIAL DATA AND INFORMATION REGARDING PUBLIC AND PRIVATE COMPANIES (U.S. CLS. 100, 101 AND 102).

FIRST USE 2-29-2012; IN COMMERCE 2-29-2012.

4,164,876. RAVEN CAPITAL MANAGEMENT LLC, NEW YORK, NY. SN 77-719,794. PUB. 9-1-2009, FILED 4-22-2009.

RAVEN CAPITAL MANAGEMENT

THE MARK CONSISTS OF STANDARD CHARACTERS WITHOUT CLAIM TO ANY PARTICULAR FONT, STYLE, SIZE, OR COLOR.

NO CLAIM IS MADE TO THE EXCLUSIVE RIGHT TO USE "CAPITAL MANAGEMENT", APART FROM THE MARK AS SHOWN.

FOR FINANCIAL SERVICES, NAMELY, INVESTMENT MANAGEMENT SERVICES; PRIVATE EQUITY FUND INVESTMENT SERVICES (U.S. CLS. 100, 101 AND 102).

FIRST USE 4-1-2012; IN COMMERCE 4-1-2012.

4,164,894. ALPHA CASERO, INC, DBA EZQUAILFY, SAN JOSE, CA. SN 77-788,610. PUB. 7-13-2010, FILED 7-23-2009.



THE COLOR(S) BLACK, RED, AND BLUE IS/ARE CLAIMED AS A FEATURE OF THE MARK.

CLASS 36—(Continued).

THE MARK CONSISTS OF WORDS "EZQUALIFY" WITH THE CAPITAL LETTER "E" IN RED AND THE CAPITAL LETTER "Z" IN BLUE WITHIN THE SHAPE OF A BLACK OUT LINED HOUSE. THE "E" IS CROOKED, WITH THE OPEN SIDE OF THE "E" TILTED UPWARDS. THE CAPITAL LETTER(S) "QUALIFY" WRITTEN IN BLACK ARE PLACED DIRECTLY UNDER THE OUTLINED HOUSE SHAPE.

FOR MORTGAGE BANKING SERVICES, NAMELY, ORIGINATION, ACQUISITION, SERVICING, SECURITIZATION AND BROKERAGE OF MORTGAGE LOANS (U.S. CLS. 100, 101 AND 102).

FIRST USE 10-20-2004; IN COMMERCE 10-20-2004.

4,164,971. RELIEF INTERNATIONAL, LOS ANGELES, CA. SN 77-933,830. PUB. 8-9-2011, FILED 2-11-2010.

BUY ONE GIVE ONE FREE

THE MARK CONSISTS OF STANDARD CHARACTERS WITHOUT CLAIM TO ANY PARTICULAR FONT, STYLE, SIZE, OR COLOR.

FOR CHARITABLE FUND RAISING, ALL THE FOREGOING SERVICES NOT FOR USE IN CONNECTION WITH BEDDING (U.S. CLS. 100, 101 AND 102).

FIRST USE 10-7-2010; IN COMMERCE 10-7-2010.

4,164,976. SKYDANCE PRODUCTIONS, LLC, SANTA MONICA, CA. SN 77-940,866. PUB. 9-7-2010, FILED 2-21-2010.

SKYDANCE PRODUCTIONS

THE MARK CONSISTS OF STANDARD CHARACTERS WITHOUT CLAIM TO ANY PARTICULAR FONT, STYLE, SIZE, OR COLOR.

NO CLAIM IS MADE TO THE EXCLUSIVE RIGHT TO USE "PRODUCTIONS", APART FROM THE MARK AS SHOWN.

FOR FINANCING OF MOTION PICTURES (U.S. CLS. 100, 101 AND 102).

FIRST USE 1-1-2006; IN COMMERCE 1-1-2006.

CLASS 36—(Continued).

4,165,140. PERFICIO NETWORKS, INC., IRVINE, CA. SN 85-109,809. PUB. 2-1-2011, FILED 8-17-2010.



YOR Health
FOUNDATION
Transforming Lives

OWNER OF U.S. REG. NOS. 3,546,597, 3,546,774, AND 3,708,677.

NO CLAIM IS MADE TO THE EXCLUSIVE RIGHT TO USE "HEALTH FOUNDATION", APART FROM THE MARK AS SHOWN.

THE MARK CONSISTS OF A BUTTERFLY DESIGN WITH THE WORDING "YOR HEALTH FOUNDATION TRANSFORMING LIVES".

FOR CHARITABLE FOUNDATION SERVICES, NAMELY, PROVIDING FUNDRAISING ACTIVITIES, FUNDING, SCHOLARSHIPS AND/OR FINANCIAL ASSISTANCE FOR PROMOTING GOOD HEALTH ACROSS THE COUNTRY; CHARITABLE FUNDRAISING; CHARITABLE FUNDRAISING SERVICES; CHARITABLE SERVICES, NAMELY, ORGANIZING FUNDRAISING SERVICES AND EVENTS TO RAISE FUNDS IN THE FIELD OF PROMOTING GOOD HEALTH ACROSS THE COUNTRY (U.S. CLS. 100, 101 AND 102).

FIRST USE 8-0-2011; IN COMMERCE 8-0-2011.

4,165,319. FIFTH THIRD BANCORP, CINCINNATI, OH. SN 85-176,771. PUB. 2-22-2011, FILED 11-15-2010.

FIFTH THIRD CREDIT BUILDER PROGRAM

THE MARK CONSISTS OF STANDARD CHARACTERS WITHOUT CLAIM TO ANY PARTICULAR FONT, STYLE, SIZE, OR COLOR.

OWNER OF U.S. REG. NOS. 1,645,502, 3,863,038, AND OTHERS.

NO CLAIM IS MADE TO THE EXCLUSIVE RIGHT TO USE "CREDIT BUILDER PROGRAM", APART FROM THE MARK AS SHOWN.

FOR BANKING SERVICES, NAMELY, CHECKING AND SAVINGS ACCOUNTS AND CREDIT CARD SERVICES (U.S. CLS. 100, 101 AND 102).

FIRST USE 1-31-2011; IN COMMERCE 1-31-2011.

CLASS 36—(Continued).

4,165,335. GLOBAL INDEMNITY, PLC, DUBLIN 2, IRELAND. SN 85-184,510. PUB. 10-25-2011, FILED 11-24-2010.



GLOBAL INDEMNITY PLC
Insurance & Reinsurance

NO CLAIM IS MADE TO THE EXCLUSIVE RIGHT TO USE "GLOBAL INDEMNITY PLC" AND "INSURANCE & REINSURANCE", APART FROM THE MARK AS SHOWN.

THE MARK CONSISTS OF A MAN HOLDING A GLOBE ABOVE HIS HEAD AND THE WORDS "GLOBAL INDEMNITY PLC INSURANCE & REINSURANCE".

FOR INSURANCE AND REINSURANCE UNDERWRITING IN THE FIELDS OF PROPERTY, CASUALTY AND MARINE INSURANCE (U.S. CLS. 100, 101 AND 102).

FIRST USE 2-16-2010; IN COMMERCE 2-16-2010.

4,165,363. DOMINANT BRANDS LLC, NEW YORK, NY. SN 85-201,855. PUB. 3-29-2011, FILED 12-20-2010.



THE MARK CONSISTS OF AN EAGLE IN AN OVAL FOR BANKING SERVICES AND FINANCIAL PLANNING SERVICES (U.S. CLS. 100, 101 AND 102).

FIRST USE 10-27-2011; IN COMMERCE 10-27-2011.

4,165,370. DEER ISLE GROUP, LLC, NEW YORK, NY. SN 85-204,812. PUB. 8-30-2011, FILED 12-23-2010.



DEER ISLE
FINANCIAL LLC

NO CLAIM IS MADE TO THE EXCLUSIVE RIGHT TO USE "FINANCIAL LLC", APART FROM THE MARK AS SHOWN.

THE MARK CONSISTS OF A LIGHTHOUSE AND A TREE TO THE LEFT OF THE WORDS "DEER ISLE FINANCIAL LLC", WHERE THE WORDS "DEER ISLE" ARE ABOVE THE WORDS "FINANCIAL LLC".

FOR FINANCIAL SERVICES, NAMELY, ASSET MANAGEMENT SERVICES, INVESTMENT MANAGEMENT SERVICES AND INVESTMENT ADVISORY SERVICES (U.S. CLS. 100, 101 AND 102).

FIRST USE 12-5-2010; IN COMMERCE 12-15-2010.

CLASS 36—(Continued).

4,165,371. CETERA FINANCIAL HOLDINGS, INC., EL SEGUNDO, CA. SN 85-204,976. PUB. 11-1-2011, FILED 12-23-2010.

SMARTWORKS ADVISER

THE MARK CONSISTS OF STANDARD CHARACTERS WITHOUT CLAIM TO ANY PARTICULAR FONT, STYLE, SIZE, OR COLOR.

NO CLAIM IS MADE TO THE EXCLUSIVE RIGHT TO USE "ADVISER", APART FROM THE MARK AS SHOWN.

FOR FINANCIAL SERVICES IN THE NATURE OF PROVIDING A MULTI-FUNCTIONAL INTRANET SITE, FOR USE EXCLUSIVELY BY INVESTMENT ADVISER REPRESENTATIVES, TO FACILITATE THE PROCESSING OF MANAGED ACCOUNTS BY PROVIDING GENERATION OF INVESTMENT PROPOSALS, MANAGING FINANCIAL PORTFOLIO ACCOUNTS, REBALANCING PORTFOLIOS, AND MAINTAINING INFORMATION ASSOCIATED WITH FINANCIAL ACCOUNTS (U.S. CLS. 100, 101 AND 102).

FIRST USE 6-0-2011; IN COMMERCE 6-0-2011.

4,165,408. DELTA GREEN, MADERA, CA. SN 85-221,207. PUB. 5-31-2011, FILED 1-19-2011.

MAKE YOUR ONE GLASS COUNT

THE MARK CONSISTS OF STANDARD CHARACTERS WITHOUT CLAIM TO ANY PARTICULAR FONT, STYLE, SIZE, OR COLOR.

FOR CHARITABLE FUNDRAISING SERVICES BY MEANS OF SELLING GOODS TO RAISE FUNDS (U.S. CLS. 100, 101 AND 102).

FIRST USE 4-27-2011; IN COMMERCE 5-10-2011.

4,165,440. PENTAIR RESIDENTIAL FILTRATION, LLC, GOLDEN VALLEY, MN. SN 85-243,685. PUB. 7-19-2011, FILED 2-16-2011.

AQUAFIRST FUNDING

THE MARK CONSISTS OF STANDARD CHARACTERS WITHOUT CLAIM TO ANY PARTICULAR FONT, STYLE, SIZE, OR COLOR.

CLASS 36—(Continued).

NO CLAIM IS MADE TO THE EXCLUSIVE RIGHT TO USE "FUNDING", APART FROM THE MARK AS SHOWN.
 FOR CREDIT CARD SERVICES AND FINANCING SERVICES FOR THE PURCHASE OF WATER TREATMENT EQUIPMENT (U.S. CLS. 100, 101 AND 102).
 FIRST USE 6-15-2011; IN COMMERCE 6-15-2011.

4,165,441. METROPOLITAN LIFE INSURANCE COMPANY, NEW YORK, NY. SN 85-244,153. PUB. 8-30-2011, FILED 2-16-2011.

**QUALIFIED RETIREMENT PLAN
 BAROMETER**

THE MARK CONSISTS OF STANDARD CHARACTERS WITHOUT CLAIM TO ANY PARTICULAR FONT, STYLE, SIZE, OR COLOR.
 NO CLAIM IS MADE TO THE EXCLUSIVE RIGHT TO USE "QUALIFIED RETIREMENT PLAN", APART FROM THE MARK AS SHOWN.
 FOR FINANCIAL SERVICES, NAMELY, FINANCIAL RESEARCH, NAMELY, PROVIDING PENSION AND RETIREMENT PLAN RESEARCH STUDIES ABOUT QUALIFIED RETIREMENT PLAN DESIGN, OBJECTIVES AND OUTCOMES (U.S. CLS. 100, 101 AND 102).
 FIRST USE 1-23-2011; IN COMMERCE 1-23-2011.

4,165,503. ALLOYA CORPORATE FCU, ALBANY, NY. SN 85-266,951. PUB. 8-9-2011, FILED 3-15-2011.

ALLOYA

THE MARK CONSISTS OF STANDARD CHARACTERS WITHOUT CLAIM TO ANY PARTICULAR FONT, STYLE, SIZE, OR COLOR.
 FOR CREDIT UNION SERVICES; CREDIT UNIONS (U.S. CLS. 100, 101 AND 102).
 FIRST USE 10-24-2011; IN COMMERCE 10-24-2011.

4,165,513. CONWAY, MICHAEL W., CALIFON, NJ. SN 85-269,806. PUB. 8-23-2011, FILED 3-17-2011.

CONWAY WEALTH GROUP

THE MARK CONSISTS OF STANDARD CHARACTERS WITHOUT CLAIM TO ANY PARTICULAR FONT, STYLE, SIZE, OR COLOR.

CLASS 36—(Continued).

NO CLAIM IS MADE TO THE EXCLUSIVE RIGHT TO USE "WEALTH GROUP", APART FROM THE MARK AS SHOWN.
 FOR FINANCIAL SERVICES, NAMELY, WEALTH MANAGEMENT SERVICES; PROVIDING FINANCIAL SERVICES WITH RESPECT TO SECURITIES AND OTHER FINANCIAL INSTRUMENTS AND PRODUCTS, NAMELY, MONEY MANAGEMENT SERVICES (U.S. CLS. 100, 101 AND 102).
 FIRST USE 4-17-2012; IN COMMERCE 4-17-2012.

4,165,588. SAND DOLLAR BEACH, LLC, WESTPORT, CT. AND RANGER CAPITAL GROUP HOLDINGS, L.P., DALLAS, TX. SN 85-283,080. PUB. 8-16-2011, FILED 3-31-2011.



THE MARK CONSISTS OF THE WORDS "THE ACTIVE BEAR" IN CAPITAL LETTERS WITH THE WORDS "ACTIVE BEAR" IN LARGER BOLD LETTERS ABOVE THE WORDS "STALKING THE MARKET FOR PROTECTION & OPPORTUNITY" WITH A DESIGN TO THE RIGHT OF THESE WORDS OF THE PROFILE OF A BEAR STANDING ON FOUR LEGS FACING TO THE RIGHT IN THE FOREGROUND AND AN ARC IN THE BACKGROUND.
 FOR FINANCIAL SERVICES, NAMELY, INVESTMENT MANAGEMENT SERVICES IN THE FIELD OF EXCHANGE-TRADED FUNDS, GLOBAL SECURITIES, INCLUDING STOCKS, OPTIONS AND COMMODITIES (U.S. CLS. 100, 101 AND 102).
 FIRST USE 12-1-2010; IN COMMERCE 12-1-2010.

4,165,589. SAND DOLLAR BEACH, LLC, WESTPORT, CT. AND RANGER CAPITAL GROUP HOLDINGS, L.P., DALLAS, TX. SN 85-283,086. PUB. 8-16-2011, FILED 3-31-2011.

**STALKING THE MARKET FOR
 PROTECTION & OPPORTUNITY**

THE MARK CONSISTS OF STANDARD CHARACTERS WITHOUT CLAIM TO ANY PARTICULAR FONT, STYLE, SIZE, OR COLOR.
 FOR FINANCIAL SERVICES, NAMELY, INVESTMENT MANAGEMENT SERVICES IN THE FIELD OF EXCHANGE-TRADED FUNDS, GLOBAL SECURITIES, INCLUDING STOCKS, OPTIONS AND COMMODITIES (U.S. CLS. 100, 101 AND 102).
 FIRST USE 12-1-2010; IN COMMERCE 12-1-2010.

CLASS 36—(Continued).

4,165,658. AFFINION PUBLISHING, LLC, LAS VEGAS, NV.
SN 85-298,047. PUB. 9-27-2011, FILED 4-18-2011.

BUYERS ULTIMATE ADVANTAGE

THE MARK CONSISTS OF STANDARD CHARACTERS WITHOUT CLAIM TO ANY PARTICULAR FONT, STYLE, SIZE, OR COLOR.

OWNER OF U.S. REG. NOS. 2,484,963, 2,786,868, AND 2,858,661.

FOR PROVIDING TO CONSUMERS A COMPREHENSIVE PACKAGE WHICH ENTITLES THEM TO PRODUCT RETURN GUARANTEES, FULL AND PARTIAL PURCHASE PRICE REIMBURSEMENT, REIMBURSEMENT FOR POST-PURCHASE PRICE REDUCTIONS AND REBATES AND COUPONS FOR REIMBURSEMENT OR DISCOUNTS ON SHIPPING COSTS, IN CONNECTION WITH A WIDE RANGE OF CONSUMER MERCHANDISE (U.S. CLS. 100, 101 AND 102).

FIRST USE 11-1-2011; IN COMMERCE 11-1-2011.

4,165,679. WHITCLEM ENTERPRISES, INC., PALO ALTO, CA. SN 85-305,493. PUB. 9-13-2011, FILED 4-26-2011.

SPOLOAN

THE MARK CONSISTS OF STANDARD CHARACTERS WITHOUT CLAIM TO ANY PARTICULAR FONT, STYLE, SIZE, OR COLOR.

FOR MORTGAGE BANKING; MORTGAGE BROKERAGE (U.S. CLS. 100, 101 AND 102).

FIRST USE 2-10-2012; IN COMMERCE 2-10-2012.

4,165,712. MARK KOTCH, LIVERMORE, CA. SN 85-317,576.
PUB. 12-20-2011, FILED 5-10-2011.



THE STIPPLING IS FOR SHADING PURPOSES ONLY.

CLASS 36—(Continued).

THE COLOR(S) PURPLE, RED, WHITE, GRAY AND TURQUOISE IS/ARE CLAIMED AS A FEATURE OF THE MARK.

THE MARK CONSISTS OF DESIGN OF THREE DIALOGUE BOXES IN WHICH THE ONE ON THE LEFT IS OF AN OVERALL RECTANGULAR SHAPE IN PURPLE, THE ONE ON THE LEFT IS ALSO OF AN OVERALL RECTANGULAR SHAPE IN RED AND THE MIDDLE IS OF AN OVERALL SQUARE SHAPE IN TURQUOISE FORMING A DESIGN OF A HOUSE WITH A CHIMNEY IN WHITE IN THE MIDDLE. BELOW THE DESIGN IS THE PHRASE "OUR PLAN FOR LIFE" UNDERLINED WITH THE WORDING "...LET THE CONVERSATION BEGIN". THE TERM "PLAN" IS IN TURQUOISE WHILE THE REST OF THEM ARE IN GRAY.

FOR REAL ESTATE CONSULTANCY (U.S. CLS. 100, 101 AND 102).

FIRST USE 11-1-2011; IN COMMERCE 3-1-2012.

4,165,735. VALEO COMMERCIAL REAL ESTATE, LLC, DALLAS, TX. SN 85-333,787. PUB. 2-7-2012, FILED 5-31-2011.

VELOCIS

THE MARK CONSISTS OF STANDARD CHARACTERS WITHOUT CLAIM TO ANY PARTICULAR FONT, STYLE, SIZE, OR COLOR.

FOR REAL ESTATE INVESTMENTS AND FUNDS INVESTMENT; REAL ESTATE BROKERAGE AND REAL ESTATE ASSET MANAGEMENT SERVICES, FINANCE ASSET MANAGEMENT; REAL ESTATE ADVISORY AND CONSULTING SERVICES (U.S. CLS. 100, 101 AND 102).

FIRST USE 7-8-2011; IN COMMERCE 7-8-2011.

4,165,736. ROTARY CLUB OF ROSEVILLE, CALIFORNIA, ROSEVILLE, CA. SN 85-334,074. PUB. 10-25-2011, FILED 5-31-2011.

A TASTE OF ROSEVILLE

THE MARK CONSISTS OF STANDARD CHARACTERS WITHOUT CLAIM TO ANY PARTICULAR FONT, STYLE, SIZE, OR COLOR.

NO CLAIM IS MADE TO THE EXCLUSIVE RIGHT TO USE "ROSEVILLE", APART FROM THE MARK AS SHOWN.

FOR CHARITABLE FUNDRAISING SERVICES, NAMELY, ORGANIZING AND CONDUCTING MUSICAL ENTERTAINMENT EVENTS FEATURING FOOD AND WINE (U.S. CLS. 100, 101 AND 102).

FIRST USE 5-1-2011; IN COMMERCE 5-1-2011.

CLASS 36—(Continued).

4,165,752. HOMETOWN BANCORP, INC., KENT, OH. SN 85-343,640. PUB. 12-6-2011, FILED 6-10-2011.



THE MARK CONSISTS OF A STYLIZED LETTER "H" COMPOSED OF TWO COLUMNS AND TWO WAVY LINES. FOR BANKING SERVICES, LOAN FINANCING, CORRESPONDENT BANKING SERVICES (U.S. CLS. 100, 101 AND 102).
FIRST USE 6-8-2011; IN COMMERCE 6-8-2011.

4,165,755. KEMP & ASSOCIATES RETIREMENT SERVICES, INC., HARLEYSVILLE, PA. SN 85-344,589. PUB. 1-3-2012, FILED 6-13-2011.

CRISIS ANTICIPATION PLAN

THE MARK CONSISTS OF STANDARD CHARACTERS WITHOUT CLAIM TO ANY PARTICULAR FONT, STYLE, SIZE, OR COLOR.
NO CLAIM IS MADE TO THE EXCLUSIVE RIGHT TO USE "PLAN", APART FROM THE MARK AS SHOWN.
FOR FINANCIAL PLANNING FOR RETIREMENT; INDIVIDUAL RETIREMENT ACCOUNT SERVICES; ADVICE RELATING TO INVESTMENTS (U.S. CLS. 100, 101 AND 102).
FIRST USE 4-0-2011; IN COMMERCE 4-3-2012.

CLASS 36—(Continued).

4,165,762. THE MARK A. FORESTER FOUNDATION, INC., HALEYVILLE, AL. SN 85-347,748. PUB. 12-13-2011, FILED 6-16-2011.

JAG 28

THE MARK CONSISTS OF STANDARD CHARACTERS WITHOUT CLAIM TO ANY PARTICULAR FONT, STYLE, SIZE, OR COLOR.
FOR CHARITABLE FOUNDATION SERVICES, NAMELY, PROVIDING CHARITABLE FUNDRAISING (U.S. CLS. 100, 101 AND 102).
FIRST USE 4-6-2012; IN COMMERCE 4-6-2012.

4,165,763. LUNG CANCER RESEARCH FOUNDATION, NEW YORK, NY. SN 85-348,768. PUB. 11-8-2011, FILED 6-17-2011.

LIVING. BREATHING. SCIENCE.

THE MARK CONSISTS OF STANDARD CHARACTERS WITHOUT CLAIM TO ANY PARTICULAR FONT, STYLE, SIZE, OR COLOR.
FOR CHARITABLE FUND RAISING SERVICES FOR LUNG CANCER RESEARCH (U.S. CLS. 100, 101 AND 102).
FIRST USE 11-2-2011; IN COMMERCE 11-2-2011.

CLASS 37—CONSTRUCTION AND REPAIR

4,164,801. DVCC, INC., CHESTERTOWN, MD. SN 76-707,682. PUB. 11-1-2011, FILED 5-20-2011.

KING CRIMP SYSTEM

THE MARK CONSISTS OF STANDARD CHARACTERS WITHOUT CLAIM TO ANY PARTICULAR FONT, STYLE, SIZE, OR COLOR.
OWNER OF U.S. REG. NOS. 441,561 AND 783,096.
NO CLAIM IS MADE TO THE EXCLUSIVE RIGHT TO USE "CRIMP SYSTEM", APART FROM THE MARK AS SHOWN.
FOR PROVIDING INFORMATION REGARDING THE INSTALLATION OF FITTINGS AND COUPLINGS ONTO FLUID HOSES BY DISTRIBUTING INFORMATION TO PURCHASERS AND INSTALLERS OF SUCH FITTINGS AND COUPLINGS AS A MEANS OF BEST PRACTICE (U.S. CLS. 100, 103 AND 106).
FIRST USE 12-31-2011; IN COMMERCE 12-31-2011.

CLASS 37—(Continued).

4,165,250. LIN R. ROGERS ELECTRICAL CONTRACTORS, INC., ALPHARETTA, GA. SN 85-147,096. PUB. 9-20-2011, FILED 10-7-2010.

THE POWER TO GET THE JOB
DONE

THE MARK CONSISTS OF STANDARD CHARACTERS WITHOUT CLAIM TO ANY PARTICULAR FONT, STYLE, SIZE, OR COLOR.

FOR ELECTRICAL CONTRACTOR SERVICES; ELECTRICAL REPAIRS, MAINTENANCE AND INSTALLATION OF ELECTRICAL WIRING, OUTLETS, LIGHT FIXTURES AND ELECTRICAL PANELS; INSTALLATION OF POWER GENERATORS; RETROFIT OF EXISTING ELECTRICAL SYSTEMS; COMPREHENSIVE PREVENTIVE MAINTENANCE SERVICE FOR ELECTRICAL SYSTEMS; DISASTER RECOVERY SERVICES IN THE FIELD OF ELECTRICAL SERVICES, NAMELY, REPAIR OF ELECTRICAL WIRING DAMAGES CAUSED BY A DISASTER AND INSTALLATION OF POWER GENERATORS FOR USE AS BACKUP UNTIL THE MAIN POWER SOURCE IS RESTORED; CONSULTING IN THE FIELD OF LIGHTING ANALYSIS FOR BUILDINGS, NAMELY, TECHNICAL CONSULTATION IN THE FIELD OF INSTALLATION OF LIGHTING APPARATUS, LIGHTING INSTRUMENTS AND LIGHTING SYSTEMS (U.S. CLS. 100, 103 AND 106).

FIRST USE 10-0-2010; IN COMMERCE 10-0-2010.

4,165,251. THE BRAKE SHOP, LLC, LINCOLN PARK, MI. SN 85-147,291. PUB. 8-30-2011, FILED 10-7-2010.

the 
**Brake
Shop**

NO CLAIM IS MADE TO THE EXCLUSIVE RIGHT TO USE "BRAKE SHOP", APART FROM THE MARK AS SHOWN.

THE MARK CONSISTS OF A STYLIZED VERSION OF THE WORDS THE "BRAKE SHOP" WITH AN AUTOMOBILE DESIGN ELEMENT ATOP THE "K" IN THE WORD "BRAKE".

FOR AUTOMOBILE REPAIR AND MAINTENANCE; AUTOMOTIVE MAINTENANCE AND REPAIR; GARAGE SERVICES, NAMELY, REPAIR OF AUTOMOBILES; MOTOR VEHICLE MAINTENANCE AND REPAIR; REPAIR AND MAINTENANCE OF VEHICLES; REPAIR OF AUTOMOBILES; REPAIR OR MAINTENANCE OF AUTOMOBILES; VEHICLE MAINTENANCE AND REPAIR; VEHICLE REPAIR AND MAINTENANCE; VEHICLE REPAIR SERVICES (U.S. CLS. 100, 103 AND 106).

FIRST USE 12-12-2010; IN COMMERCE 12-12-2010.

CLASS 37—(Continued).

4,165,307. LIN R. ROGERS ELECTRICAL CONTRACTORS, INC., ALPHARETTA, GA. SN 85-171,184. PUB. 9-13-2011, FILED 11-8-2010.



THE COLOR(S) WHITE AND BLUE IS/ARE CLAIMED AS A FEATURE OF THE MARK.

THE MARK CONSISTS OF A BLUE CIRCLE WITH A WHITE CIRCLE INSIDE THE BLUE CIRCLE, THEN A BLUE CIRCLE WITH A WHITE LETTER "R" IN THE CENTER.

FOR ELECTRICAL CONTRACTOR SERVICES; ELECTRICAL REPAIRS, MAINTENANCE AND INSTALLATION OF ELECTRICAL WIRING, OUTLETS, LIGHT FIXTURES AND ELECTRICAL PANELS; INSTALLATION OF POWER GENERATORS; RETROFIT OF EXISTING ELECTRICAL SYSTEMS; COMPREHENSIVE PREVENTIVE MAINTENANCE SERVICE FOR ELECTRICAL SYSTEMS; DISASTER RECOVERY SERVICES IN THE FIELD OF ELECTRICAL SERVICES, NAMELY, REPAIR OF ELECTRICAL WIRING DAMAGES CAUSED BY A DISASTER AND INSTALLATION OF POWER GENERATORS FOR USE AS BACKUP UNTIL THE MAIN POWER SOURCE IS RESTORED; CONSULTING IN THE FIELD OF LIGHTING ANALYSIS FOR BUILDINGS, NAMELY, TECHNICAL CONSULTATION IN THE FIELD OF INSTALLATION OF LIGHTING APPARATUS, LIGHTING INSTRUMENTS AND LIGHTING SYSTEMS (U.S. CLS. 100, 103 AND 106).

FIRST USE 10-0-2010; IN COMMERCE 10-0-2010.

4,165,792. TONER2PRINT INC, ONTARIO, CA. SN 85-363,378. PUB. 11-29-2011, FILED 7-5-2011.

do you need IT

THE MARK CONSISTS OF STANDARD CHARACTERS WITHOUT CLAIM TO ANY PARTICULAR FONT, STYLE, SIZE, OR COLOR.

FOR INSTALLATION, REPAIR AND MAINTENANCE OF COMPUTERS AND COMPUTER PERIPHERALS (U.S. CLS. 100, 103 AND 106).

FIRST USE 1-25-2011; IN COMMERCE 2-10-2012.

CLASS 37—(Continued).

4,165,853. NELSON, ROBERT, DIMMITT, TX. SN 85-394,009. PUB. 1-31-2012, FILED 8-10-2011.

BLUE WAVE HYDROJET

THE MARK CONSISTS OF STANDARD CHARACTERS WITHOUT CLAIM TO ANY PARTICULAR FONT, STYLE, SIZE, OR COLOR.

NO CLAIM IS MADE TO THE EXCLUSIVE RIGHT TO USE "HYDROJET", APART FROM THE MARK AS SHOWN. FOR CLEANING OF WELLS (U.S. CLS. 100, 103 AND 106).

FIRST USE 12-0-2011; IN COMMERCE 1-3-2012.

CLASS 38—(Continued).

4,165,037. THELIQUORSTORECHANNEL.COM, LLC, COLORADO SPRINGS, CO. SN 85-005,615. PUB. 8-31-2010, FILED 4-3-2010.



4,165,877. 1323-KATHY CORPORATION, BLACKWOOD, NJ. SN 85-404,495. PUB. 2-7-2012, FILED 8-23-2011.



NO CLAIM IS MADE TO THE EXCLUSIVE RIGHT TO USE "COLLISION", APART FROM THE MARK AS SHOWN. THE COLOR(S) RED, GREY AND BLACK IS/ARE CLAIMED AS A FEATURE OF THE MARK.

THE MARK CONSISTS OF CONSISTS OF THE WORD "ROCCO'S" IN STYLIZED RED LETTERING OUTLINED IN GREY WITH BLACK SHADOWING AND THE WORD "COLLISION" IN BLACK LETTERS UNDERNEATH.

FOR VEHICLE REPAIR (U.S. CLS. 100, 103 AND 106). FIRST USE 6-22-1981; IN COMMERCE 6-22-1981.

NO CLAIM IS MADE TO THE EXCLUSIVE RIGHT TO USE "THE LIQUOR STORE CHANNEL .COM" OR "THE LIQUOR STORE TV CHANNEL", APART FROM THE MARK AS SHOWN.

THE COLOR(S) BLUE, BLACK, GRAY, AND RED IS/ARE CLAIMED AS A FEATURE OF THE MARK.

THE MARK CONSISTS OF THE STYLIZED WORDING "THE LIQUOR STORE CHANNEL" SET ABOVE A HORIZONTAL LINE WITH THE WORDING ".COM" AT THE RIGHT END OF THE HORIZONTAL LINE. ALL ABOVE THE WORDING "THE LIQUOR STORE TV CHANNEL", WITH A STYLIZED DEPICTION OF A GLASS OF WINE SET BEHIND THE WORDING "THE LIQUOR STORE CHANNEL". THE COLOR BLUE APPEARS IN THE SHADING IN THE WORDING "LIQUOR STORE" IN THE WORDING "THE LIQUOR STORE CHANNEL"; THE COLOR BLACK APPEARS IN THE BORDER OF THE WORDING "LIQUOR STORE" IN THE WORDING "THE LIQUOR STORE CHANNEL", IN HORIZONTAL LINE BELOW THE WORDING "THE LIQUOR STORE CHANNEL", IN THE TERM ".COM", IN THE WORDING "THE LIQUOR STORE TV CHANNEL", IN THE TERM "THE" IN THE WORDING "THE LIQUOR STORE CHANNEL", IN THE OUTLINE OF THE TERM "CHANNEL" IN THE WORDING "THE LIQUOR STORE CHANNEL", AND IN THE OUTLINE OF THE WINE GLASS; THE COLOR GRAY APPEARS IN THE SHADING IN THE TERM "CHANNEL" IN THE WORDING "THE LIQUOR STORE CHANNEL"; THE COLOR RED APPEARS IN THE DEPICTION OF WINE IN THE WINE GLASS; THE AREAS SHOWN IN WHITE ARE NOT PART OF THE MARK AND MERELY SHOW THE SURFACE UPON WHICH THE MARK IS AFFIXED.

FOR AUDIO AND VIDEO BROADCASTING SERVICES OVER THE INTERNET; BROADCASTING OF VIDEO AND AUDIO PROGRAMMING OVER THE INTERNET; BROADCASTING SERVICES, NAMELY, TRANSMISSION OF ADVERTISING PROGRAMS AND MEDIA ADVERTISING COMMUNICATIONS VIA DIGITAL COMMUNICATIONS NETWORKS; INTERNET PROTOCOL TELEVISION (IPTV) TRANSMISSION SERVICES (U.S. CLS. 100, 101 AND 104).

FIRST USE 3-1-2010; IN COMMERCE 3-3-2010.

CLASS 38—COMMUNICATION

CLASS 38—(Continued).

4,165,176. COBRIDGE COMMUNICATIONS, ST. LOUIS, MO.
SN 85-121,808. PUB. 3-1-2011, FILED 9-2-2010.

COBRIDGE COMMUNICATIONS

THE MARK CONSISTS OF STANDARD CHARACTERS WITHOUT CLAIM TO ANY PARTICULAR FONT, STYLE, SIZE, OR COLOR.

NO CLAIM IS MADE TO THE EXCLUSIVE RIGHT TO USE "COMMUNICATIONS", APART FROM THE MARK AS SHOWN.

FOR TELECOMMUNICATIONS SERVICES, NAMELY, TRANSMISSION OF VOICE, DATA, IMAGES, SIGNALS, AUDIO, VIDEO, AND GRAPHICS BY MEANS OF TELEPHONE AND GLOBAL COMMUNICATION NETWORKS; TELECOMMUNICATIONS SERVICES, NAMELY, CABLE AND INTERNET TELEPHONY SERVICES; CABLE TELEVISION BROADCASTING SERVICES; TRANSMISSION AND BROADCAST OF AUDIO AND VIDEO PROGRAMS VIA SATELLITE; INTERACTIVE TELEVISION BROADCASTING SERVICES; BROADCASTING AND PROVIDING TELECOMMUNICATIONS ACCESS TO FILMS AND TELEVISION PROGRAMS PROVIDED VIA VIDEO-ON-DEMAND SERVICE; PROVIDING INTERNET ACCESS; PROVIDING MULTIPLE-USER ACCESS TO A GLOBAL COMMUNICATIONS NETWORK; AND ELECTRONIC MAIL SERVICES (U.S. CLS. 100, 101 AND 104).

FIRST USE 10-0-2010; IN COMMERCE 10-0-2010.

CLASS 38—(Continued).

4,165,393. THREE RINGS DESIGN, INC., SAN FRANCISCO, CA. SN 85-215,133. PUB. 9-13-2011, FILED 1-11-2011.

SPIRAL KNIGHTS

THE MARK CONSISTS OF STANDARD CHARACTERS WITHOUT CLAIM TO ANY PARTICULAR FONT, STYLE, SIZE, OR COLOR.

FOR PROVIDING ON-LINE FACILITIES, NAMELY, VIRTUAL CHAT ROOMS FOR REAL-TIME INTERACTION WITH OTHER COMPUTER USERS CONCERNING COMPUTER GAMES (U.S. CLS. 100, 101 AND 104).

FIRST USE 4-4-2011; IN COMMERCE 4-4-2011.

4,165,442. AVI-SPL, INC., TAMPA, FL. SN 85-245,167. PUB. 6-28-2011, FILED 2-17-2011.

4,165,353. IRA HOROWITZ, SHERMAN OAKS, CA. SN 85-196,515. PUB. 4-26-2011, FILED 12-13-2010.

Soundcurve

THE MARK CONSISTS OF STANDARD CHARACTERS WITHOUT CLAIM TO ANY PARTICULAR FONT, STYLE, SIZE, OR COLOR.

FOR VOICE OVER INTERNET PROTOCOL (VOIP) SERVICES (U.S. CLS. 100, 101 AND 104).

FIRST USE 3-20-2011; IN COMMERCE 6-12-2011.

UNIFY ME

THE MARK CONSISTS OF THE WORDS "UNIFY ME" WITH "UN" IN CAPITAL LETTERS, AND A LARGER LOWER-CASE "I" AND "FY" IN CAPITAL LETTERS FOLLOWED BY THE SMALLER CAPITAL LETTERS "ME".

FOR DIGITAL NETWORK TELECOMMUNICATIONS SERVICES; ELECTRONIC TRANSMISSION AND STREAMING OF DIGITAL MEDIA CONTENT FOR OTHERS VIA GLOBAL AND LOCAL COMPUTER NETWORKS; INTERACTIVE DELIVERY OF VIDEO OVER DIGITAL NETWORKS; PROVIDING FACILITIES AND EQUIPMENT FOR TELEPRESENCE CONFERENCING; PROVIDING FACILITIES AND EQUIPMENT FOR VIDEO CONFERENCING; TELEPRESENCE CONFERENCING SERVICES; VIDEO CONFERENCING SERVICES; WEB CONFERENCING SERVICES (U.S. CLS. 100, 101 AND 104).

FIRST USE 4-11-2011; IN COMMERCE 4-11-2011.

CLASS 38—(Continued).

4,165,495. CHATTER, INC., IRVINE, CA. SN 85-265,066. PUB. 7-26-2011, FILED 3-11-2011.

BUZZMOB

THE MARK CONSISTS OF STANDARD CHARACTERS WITHOUT CLAIM TO ANY PARTICULAR FONT, STYLE, SIZE, OR COLOR.

FOR PROVIDING ONLINE CHAT ROOMS AND ELECTRONIC BULLETIN BOARDS FOR REGISTERED USERS FOR TRANSMISSION OF MESSAGES FOR THE PURPOSE OF SOCIAL NETWORKING, PHOTO SHARING, AND TRANSMISSION OF PHOTOGRAPHIC IMAGES; PROVIDING SERVICES TO FACILITATE TRANSMISSION OF MESSAGES AND ONLINE DIRECTORY INFORMATION FOR REGISTERED USERS IN THE NATURE OF SOCIAL NETWORKING; TELECOMMUNICATION SERVICES, NAMELY, TEXT, VISUAL AND AUDITORY TRANSMISSION SERVICES IN RELATION TO USING MOBILE DEVICES (U.S. CLS. 100, 101 AND 104).

FIRST USE 8-15-2011; IN COMMERCE 8-15-2011.

CLASS 38—(Continued).

4,165,517. THE ALPHAMED COMPANY, INC., DURHAM, NC. SN 85-271,052. PUB. 8-16-2011, FILED 3-18-2011.

 **STEM CELLS App**

OWNER OF U.S. REG. NOS. 2,417,439, 3,860,691, AND OTHERS.

NO CLAIM IS MADE TO THE EXCLUSIVE RIGHT TO USE "STEM CELLS APP", APART FROM THE MARK AS SHOWN.

THE STIPPLING IS FOR SHADING PURPOSES ONLY.

THE MARK CONSISTS OF CELL DESIGN WITH THE WORDS "STEM CELLS APP".

FOR TELECOMMUNICATIONS AND INFORMATION TECHNOLOGY SERVICES, NAMELY, PROVIDING ACCESS TO TELECOMMUNICATION NETWORKS FOR THE PURPOSES OF ACCESSING, DOWNLOADING, UPLOADING, STORING, EDITING, SHARING, CREATING AND SENDING ELECTRONIC CONTENT IN THE FIELDS OF STEM CELLS AND REGENERATIVE MEDICINE (U.S. CLS. 100, 101 AND 104).

FIRST USE 6-15-2011; IN COMMERCE 6-15-2011.

4,165,516. THE ALPHAMED COMPANY, INC., DURHAM, NC. SN 85-271,046. PUB. 8-16-2011, FILED 3-18-2011.

4,165,624. UNIVERSAL INTERNATIONAL MUSIC B.V., BAARN, NETHERLANDS. SN 85-288,385. PUB. 9-13-2011, FILED 4-6-2011.

 **STEM CELLS
TRANSLATIONAL
MEDICINE App**

DIGSTER

OWNER OF U.S. REG. NOS. 2,417,439, 3,860,691, AND OTHERS.

NO CLAIM IS MADE TO THE EXCLUSIVE RIGHT TO USE "STEM CELLS TRANSLATIONAL MEDICINE APP", APART FROM THE MARK AS SHOWN.

THE STIPPLING IS FOR SHADING PURPOSES ONLY.

THE MARK CONSISTS OF CELL DESIGN WITH THE WORDS "STEM CELLS TRANSLATIONAL MEDICINE APP".

FOR TELECOMMUNICATIONS AND INFORMATION TECHNOLOGY SERVICES, NAMELY, PROVIDING ACCESS TO TELECOMMUNICATION NETWORKS FOR THE PURPOSES OF ACCESSING, DOWNLOADING, UPLOADING, STORING, EDITING, SHARING, CREATING AND SENDING ELECTRONIC CONTENT IN THE FIELD IMPROVING HUMAN HEALTH BY ADVANCING BIOLOGICAL DISCOVERIES THROUGH RESEARCH, CLINICAL TRIALS, REGULATORY APPROVAL AND THE DEVELOPMENT OF BEST MEDICAL PRACTICES (U.S. CLS. 100, 101 AND 104).

FIRST USE 3-10-2011; IN COMMERCE 3-10-2011.

THE MARK CONSISTS OF STANDARD CHARACTERS WITHOUT CLAIM TO ANY PARTICULAR FONT, STYLE, SIZE, OR COLOR.

FOR DELIVERY OF DIGITAL MUSIC BY ELECTRONIC TRANSMISSION; TRANSMISSION OF AUDIO AND VIDEO FILES VIA COMMUNICATIONS NETWORKS; PROVIDING ELECTRONIC BULLETIN BOARDS; TRANSMISSION OF SOUND AND VISION VIA SATELLITE OR INTERACTIVE MULTIMEDIA NETWORKS; TRANSMISSION AND DISSEMINATION OF DATA AND INFORMATION BY ELECTRONIC MEANS, COMPUTER, CABLE, RADIO, ELECTRONIC MAIL, TELEVISION, LASER BEAM OR SATELLITE; TRANSMISSION OF INFORMATION BY ELECTRONIC COMMUNICATIONS NETWORK; COMMUNICATIONS VIA THE INTERNET; PLAYLIST SUBSCRIPTION SERVICES, NAMELY, PROVIDING PLAY LIST SERVICES FOR WHEREBY SUBSCRIBERS CAN SELECT FROM A VARIETY OF MUSIC SUGGESTIONS; TRANSMITTING STREAMED SOUND AND AUDIO-VISUAL RECORDINGS VIA THE INTERNET; STREAMING OF AUDIO

CLASS 38—(Continued).

AND VIDEO MATERIAL ON THE INTERNET; DIGITAL AND ELECTRONIC TRANSMISSION OF VOICE, DATA, SOUND, IMAGES, AUDIO AND VIDEO CONTENT, AND MESSAGES; PROVIDING ON-LINE CHAT ROOMS AND FORUMS AND ELECTRONIC BULLETIN BOARDS FOR TRANSMISSION OF MESSAGES AMONG USERS CONCERNING MUSIC AND ENTERTAINMENT; WIRELESS COMMUNICATIONS SERVICES, NAMELY, TRANSMISSION OF GRAPHICS AND SOUND FILES TO MOBILE PHONES; SENDING AND RECEIVING VOICE AND TEXT MESSAGES BETWEEN WIRELESS COMMUNICATION DEVICES; PROVIDING WIRELESS COMMUNICATION SERVICES, NAMELY, TRANSMISSION OF RINGTONES TO MOBILE TELEPHONES AND MOBILE DEVICES; MOBILE RINGTONE SUBSCRIPTION SERVICES, NAMELY, PROVIDING RINGTONE SERVICES FOR MOBILE TELEPHONES WHEREBY USERS CAN SELECT FROM A VARIETY OF CALL NOTIFICATION SOUNDS AND MUSIC; PROVIDING MULTIPLE-USER ACCESS TO A GLOBAL COMPUTER INFORMATION NETWORK (U.S. CLS. 100, 101 AND 104).

FIRST USE 8-1-2011; IN COMMERCE 8-1-2011.

4,165,656. FLASH WIRELESS, LLC, CONCORD, NC. SN 85-297,876. PUB. 9-13-2011, FILED 4-18-2011.

FLASH WIRELESS

THE MARK CONSISTS OF STANDARD CHARACTERS WITHOUT CLAIM TO ANY PARTICULAR FONT, STYLE, SIZE, OR COLOR.

NO CLAIM IS MADE TO THE EXCLUSIVE RIGHT TO USE "WIRELESS", APART FROM THE MARK AS SHOWN.

FOR TELECOMMUNICATION SERVICES, NAMELY, LOCAL AND LONG DISTANCE TRANSMISSION OF AUDIO, DATA, GRAPHICS, VIDEO, VISUAL IMAGES, AND VOICE BY MEANS OF WIRELESS NETWORKS; TELECOMMUNICATION SERVICES, NAMELY, PROVIDING INTERNET ACCESS VIA WIRELESS NETWORKS; TELECOMMUNICATION SERVICES, NAMELY, WIRELESS MOBILE TELEPHONE VOICE, MESSAGING, AND DATA PLANS; AND MOBILE TELEPHONE SERVICES (U.S. CLS. 100, 101 AND 104).

FIRST USE 8-2-2011; IN COMMERCE 8-2-2011.

4,165,691. BISCOTTI INC., BOULDER, TX. SN 85-308,884. PUB. 9-13-2011, FILED 4-29-2011.

BISCOTTI

THE MARK CONSISTS OF STANDARD CHARACTERS WITHOUT CLAIM TO ANY PARTICULAR FONT, STYLE, SIZE, OR COLOR.

FOR TELECONFERENCING AND VIDEO CONFERENCING SERVICES; VIDEO MAIL SERVICES, NAMELY, THE RECORDING AND TRANSMITTING OF VIDEO MESSAGES FROM ONE USER TO ANOTHER USER; VOICE OVER INTERNET PROTOCOL ("VOIP") SERVICES (U.S. CLS. 100, 101 AND 104).

FIRST USE 11-22-2011; IN COMMERCE 11-22-2011.

CLASS 39—TRANSPORTATION AND STORAGE

4,164,832. BARON SBD LLC, SARASOTA, FL. SN 77-555,881. PUB. 1-13-2009, FILED 8-26-2008.

SECURITY BEFORE DISASTER

THE MARK CONSISTS OF STANDARD CHARACTERS WITHOUT CLAIM TO ANY PARTICULAR FONT, STYLE, SIZE, OR COLOR.

FOR ELECTRONIC STORAGE OF VITAL PERSONAL AND BUSINESS DOCUMENTS AND INFORMATION (U.S. CLS. 100 AND 105).

FIRST USE 4-2-2012; IN COMMERCE 4-2-2012.

4,165,081. LIBERMOTUS LOGISTICS, LLC, GREENSBORO, NC. SN 85-047,569. PUB. 11-2-2010, FILED 5-25-2010.

Pombai

THE MARK CONSISTS OF STANDARD CHARACTERS WITHOUT CLAIM TO ANY PARTICULAR FONT, STYLE, SIZE, OR COLOR.

FOR AIR TRANSPORTATION OF PASSENGERS AND FREIGHT; BOAT TRANSPORT; BUS TRANSPORT; CAR TRANSPORT; PASSENGER SHIP TRANSPORT; PASSENGER TRANSPORT; RAILWAY TRANSPORT; RIVER TRANSPORT BY BOAT; SAILBOAT TRANSPORTATION SERVICES; TRANSPORT BY AIRCRAFT; TRANSPORT OF PASSENGERS; TRANSPORT OF PERSONS; TRANSPORT OF PERSONS AND GOODS; TRANSPORT OF TRAVELLERS; TRANSPORTATION AND DELIVERY SERVICES BY AIR, ROAD, RAIL AND SEA; TRANSPORTATION CONSULTING; TRANSPORTATION INFORMATION; TRANSPORTATION OF GOODS, PASSENGERS AND TRAVELLERS BY AIR; TRANSPORTATION OF PASSENGERS AND GOODS BY RAIL; TRAVEL AGENCY SERVICES, NAMELY, MAKING RESERVATIONS AND BOOKINGS FOR TRANSPORTATION (U.S. CLS. 100 AND 105).

FIRST USE 8-1-2009; IN COMMERCE 8-1-2010.

CLASS 39—(Continued).

4,165,219. EGT, LLC, LONGVIEW, WA. SN 85-134,388. PUB. 8-16-2011, FILED 9-21-2010.

EGT

THE MARK CONSISTS OF STANDARD CHARACTERS WITHOUT CLAIM TO ANY PARTICULAR FONT, STYLE, SIZE, OR COLOR.

FOR STORAGE, CARGO HANDLING AND TRANSPORTING SERVICES IN THE FIELD OF OPERATING GRAIN ELEVATORS, NAMELY, LOADING AND UNLOADING SHIPS, UNLOADING OF CARGO, STORAGE OF GOODS NAMELY, CORN, SOYBEANS, GRAIN, OIL SEEDS, MEALS AND DRIED DISTILLERS GRAIN, SHIPPING OF SUCH GOODS, SHIP BROKERAGE AND TRANSPORT BROKERAGE OF SUCH GOODS (U.S. CLS. 100 AND 105).

FIRST USE 12-5-2011; IN COMMERCE 12-5-2011.

4,165,402. TRASH ON WHEELS LLC, DALTON, OH. SN 85-219,484. PUB. 5-31-2011, FILED 1-18-2011.

TRASH ON WHEELS

THE MARK CONSISTS OF STANDARD CHARACTERS WITHOUT CLAIM TO ANY PARTICULAR FONT, STYLE, SIZE, OR COLOR.

NO CLAIM IS MADE TO THE EXCLUSIVE RIGHT TO USE "TRASH", APART FROM THE MARK AS SHOWN.

FOR RENTAL OF TRAILER MOUNTED DUMPSTERS (U.S. CLS. 100 AND 105).

FIRST USE 3-21-2011; IN COMMERCE 3-21-2011.

4,165,403. TRASH ON WHEELS LLC, DALTON, OH. SN 85-219,502. PUB. 5-31-2011, FILED 1-18-2011.



NO CLAIM IS MADE TO THE EXCLUSIVE RIGHT TO USE "TRASH", APART FROM THE MARK AS SHOWN.

THE COLOR(S) BLACK, WHITE AND ORANGE IS/ARE CLAIMED AS A FEATURE OF THE MARK.

CLASS 39—(Continued).

THE MARK CONSISTS OF THE WORDS "T.O.W. AND TRASH ON WHEELS" SEPARATED BY BLACK COLOR HORIZONTAL LINE WRITTEN IN WHITE COLOR WITH BLACK OUTLINE. THE WORDS ARE WRITTEN INSIDE AN OVAL WITH BLACK COLOR DOUBLE OUTLINE HAVING ORANGE COLOR BACKGROUND.

FOR RENTAL OF TRAILER MOUNTED DUMPSTERS (U.S. CLS. 100 AND 105).

FIRST USE 3-21-2011; IN COMMERCE 3-21-2011.

4,165,637. CONFORMAL SYSTEMS LLC, CHICAGO, IL. SN 85-292,950. PUB. 7-12-2011, FILED 4-12-2011.



THE MARK CONSISTS OF TWO SQUARES, ARRANGED SIDE BY SIDE WITH A SLIGHT SPACE BETWEEN THEM, AND ONE HORIZONTAL WAVY LINE THAT PASSES BEHIND THE TWO SQUARES BUT DOES NOT APPEAR IN THE SPACE BETWEEN THE TWO SQUARES.

FOR ELECTRONIC STORAGE OF DATA (U.S. CLS. 100 AND 105).

FIRST USE 4-5-2011; IN COMMERCE 2-14-2012.

4,165,716. TEN THIRTY ONE PRODUCTIONS, LLC, LOS ANGELES, CA. SN 85-322,694. PUB. 12-13-2011, FILED 5-17-2011.



NO CLAIM IS MADE TO THE EXCLUSIVE RIGHT TO USE "GHOST SHIP", APART FROM THE MARK AS SHOWN.

THE MARK CONSISTS OF A POLYGON WITH AN OVERALL RECTANGULAR SHAPE WITH A DARK BACKGROUND AND LIGHTER BORDER WITH RIVETS ALONG THE BORDER AND THE WORDING "GHOST SHIP" IN THE MIDDLE.

FOR BOAT CRUISES (U.S. CLS. 100 AND 105).

FIRST USE 7-15-2011; IN COMMERCE 7-15-2011.

CLASS 40—MATERIAL TREATMENT

CLASS 40—(Continued).

4,165,903. MARSH INC., CINCINNATI, OH. SN 85-440,965. PUB. 12-27-2011, FILED 10-6-2011.

MARSH BRAND PARTNERS

THE MARK CONSISTS OF STANDARD CHARACTERS WITHOUT CLAIM TO ANY PARTICULAR FONT, STYLE, SIZE, OR COLOR.

NO CLAIM IS MADE TO THE EXCLUSIVE RIGHT TO USE "BRAND PARTNERS", APART FROM THE MARK AS SHOWN.

FOR PHOTOGRAPHIC RETOUCHING (U.S. CLS. 100, 103 AND 106).

FIRST USE 1-20-2012; IN COMMERCE 1-20-2012.

CLASS 41—EDUCATION AND ENTERTAINMENT

4,164,805. VERGENCE ENTERTAINMENT, LLC, GLENDALE, CA. SN 77-054,575. PUB. 9-13-2011, FILED 11-30-2006.

RINGORANG

THE MARK CONSISTS OF STANDARD CHARACTERS WITHOUT CLAIM TO ANY PARTICULAR FONT, STYLE, SIZE, OR COLOR.

FOR ENTERTAINMENT SERVICES, NAMELY, PROVIDING ON-LINE COMPUTER GAMES (U.S. CLS. 100, 101 AND 107).

FIRST USE 1-0-2007; IN COMMERCE 8-0-2008.

4,164,806. SPORTS BRANDS CORPORATION, LUXEMBOURG, LUXEMBOURG. SN 77-153,131. PUB. 9-9-2008, FILED 4-10-2007.

WIGHTMAN CUP

THE MARK CONSISTS OF STANDARD CHARACTERS WITHOUT CLAIM TO ANY PARTICULAR FONT, STYLE, SIZE, OR COLOR.

NO CLAIM IS MADE TO THE EXCLUSIVE RIGHT TO USE "CUP", APART FROM THE MARK AS SHOWN.

FOR ORGANIZING AND CONDUCTING TOURNAMENTS IN THE FIELD OF TENNIS (U.S. CLS. 100, 101 AND 107).

FIRST USE 12-1-2011; IN COMMERCE 12-1-2011.

CLASS 41—(Continued).

4,164,808. BIERMANN PRODUCTIONS LLC, WICHITA, KS. SN 77-232,973. PUB. 1-27-2009, FILED 7-18-2007.

FIGHTCENTRAL PRESENTS

THE MARK CONSISTS OF STANDARD CHARACTERS WITHOUT CLAIM TO ANY PARTICULAR FONT, STYLE, SIZE, OR COLOR.

NO CLAIM IS MADE TO THE EXCLUSIVE RIGHT TO USE "PRESENTS", APART FROM THE MARK AS SHOWN.

FOR PRODUCTION AND CONTENT PREPARATION OF AUDIO AND VIDEO ENTERTAINMENT PROGRAMS AND RECORDINGS DELIVERED VIA TELEVISION (U.S. CLS. 100, 101 AND 107).

FIRST USE 4-13-2012; IN COMMERCE 4-13-2012.

4,164,812. AMERICAN NURSES CREDENTIALING CENTER, SILVER SPRING, MD. SN 77-411,435. PUB. 12-30-2008, FILED 3-3-2008.

CNS-BC

THE MARK CONSISTS OF STANDARD CHARACTERS WITHOUT CLAIM TO ANY PARTICULAR FONT, STYLE, SIZE, OR COLOR.

FOR EDUCATION AND TESTING SERVICES, NAMELY, DEVELOPING AND ADMINISTERING TESTS; TESTING AND CREDENTIALING PROGRAM IN THE FIELD OF NURSING; AND EDUCATIONAL SERVICES, NAMELY, CONDUCTING COURSES IN THE FIELD OF NURSING AND DISTRIBUTING COURSE MATERIALS IN CONNECTION THEREWITH (U.S. CLS. 100, 101 AND 107).

FIRST USE 1-1-2008; IN COMMERCE 1-1-2008.

CLASS 41—(Continued).

4,164,813. AMERICAN NURSES CREDENTIALING CENTER, SILVER SPRING, MD. SN 77-411,536. PUB. 12-30-2008, FILED 3-3-2008.

CLASS 41—(Continued).

4,164,815. AMERICAN NURSES CREDENTIALING CENTER, SILVER SPRING, MD. SN 77-411,596. PUB. 12-30-2008, FILED 3-3-2008.

PCNS-BC

GCNS-BC

THE MARK CONSISTS OF STANDARD CHARACTERS WITHOUT CLAIM TO ANY PARTICULAR FONT, STYLE, SIZE, OR COLOR.

FOR EDUCATION AND TESTING SERVICES, NAMELY, DEVELOPING AND ADMINISTERING TESTS; TESTING AND CREDENTIALING PROGRAM IN THE FIELD OF NURSING; AND EDUCATIONAL SERVICES, NAMELY, CONDUCTING COURSES IN THE FIELD OF NURSING AND DISTRIBUTING COURSE MATERIALS IN CONNECTION THEREWITH (U.S. CLS. 100, 101 AND 107).

FIRST USE 1-1-2008; IN COMMERCE 1-1-2008.

THE MARK CONSISTS OF STANDARD CHARACTERS WITHOUT CLAIM TO ANY PARTICULAR FONT, STYLE, SIZE, OR COLOR.

FOR EDUCATION AND TESTING SERVICES, NAMELY, DEVELOPING AND ADMINISTERING TESTS; TESTING AND CREDENTIALING PROGRAM IN THE FIELD OF NURSING; AND EDUCATIONAL SERVICES, NAMELY, CONDUCTING COURSES IN THE FIELD OF NURSING AND DISTRIBUTING COURSE MATERIALS IN CONNECTION THEREWITH (U.S. CLS. 100, 101 AND 107).

FIRST USE 1-1-2008; IN COMMERCE 1-1-2008.

4,164,814. AMERICAN NURSES CREDENTIALING CENTER, SILVER SPRING, MD. SN 77-411,566. PUB. 12-30-2008, FILED 3-3-2008.

4,164,826. DREXEL UNIVERSITY, PHILADELPHIA, PA. SN 77-525,987. PUB. 2-3-2009, FILED 7-18-2008.

ACNS-BC

THE DREXEL NETWORK

THE MARK CONSISTS OF STANDARD CHARACTERS WITHOUT CLAIM TO ANY PARTICULAR FONT, STYLE, SIZE, OR COLOR.

FOR EDUCATION AND TESTING SERVICES, NAMELY, DEVELOPING AND ADMINISTERING TESTS; TESTING AND CREDENTIALING PROGRAM IN THE FIELD OF NURSING; AND EDUCATIONAL SERVICES, NAMELY, CONDUCTING COURSES IN THE FIELD OF NURSING AND DISTRIBUTING COURSE MATERIALS IN CONNECTION THEREWITH (U.S. CLS. 100, 101 AND 107).

FIRST USE 1-1-2008; IN COMMERCE 1-1-2008.

THE MARK CONSISTS OF STANDARD CHARACTERS WITHOUT CLAIM TO ANY PARTICULAR FONT, STYLE, SIZE, OR COLOR.

OWNER OF U.S. REG. NOS. 2,539,213, 2,965,544, AND 2,965,545.

NO CLAIM IS MADE TO THE EXCLUSIVE RIGHT TO USE "NETWORK", APART FROM THE MARK AS SHOWN.

FOR EDUCATIONAL SERVICES, NAMELY, PROVIDING COURSES OF INSTRUCTION AT THE GRADUATE AND UNDERGRADUATE LEVEL (U.S. CLS. 100, 101 AND 107).

FIRST USE 3-0-2012; IN COMMERCE 3-0-2012.

CLASS 41—(Continued).

4,164,828. 2 HOUR HOUSE, LLC, TYLER, TX. SN 77-535,222.
PUB. 1-19-2010, FILED 7-30-2008.

2 HOUR HOUSE

THE MARK CONSISTS OF STANDARD CHARACTERS WITHOUT CLAIM TO ANY PARTICULAR FONT, STYLE, SIZE, OR COLOR.

FOR ENTERTAINMENT SERVICES IN THE NATURE OF LIVE TELEVISION, SATELLITE, CABLE, RADIO, AND INTERNET SHOWS AND ONLINE VIDEOS, IN THE FIELD OF EFFICIENCY, COLLABORATION, AND TEAMWORK; ENTERTAINMENT SERVICES IN THE NATURE OF REALITY SHOWS ABOUT EFFICIENCY, COLLABORATION, AND TEAMWORK; AND ENTERTAINMENT SERVICES IN THE NATURE OF ORGANIZING PUBLIC EVENTS, NAMELY, COMMUNITY FESTIVALS, CARNIVALS, AND SPORTING EVENTS, NAMELY, PROFESSIONAL AND COLLEGIATE GAMES AND CONTESTS, FOR THE PROMOTION OF EFFICIENCY, COLLABORATION, AND TEAMWORK (U.S. CLS. 100, 101 AND 107).

FIRST USE 12-31-2006; IN COMMERCE 12-31-2006.

4,164,840. BRISTOL-MYERS SQUIBB COMPANY, NEW YORK, NY. SN 77-574,420. PUB. 1-26-2010, FILED 9-19-2008.

Bristol-Myers Squibb
Delivering Hope
Hepatitis Awareness, Prevention and Care

OWNER OF U.S. REG. NO. 2,953,586.
NO CLAIM IS MADE TO THE EXCLUSIVE RIGHT TO USE "HEPATITIS AWARENESS, PREVENTION AND CARE", APART FROM THE MARK AS SHOWN.

FOR EDUCATIONAL SERVICES, NAMELY, CONDUCTING SEMINARS AND PROGRAMS IN THE FIELD OF HEALTH, MEDICINE AND PHARMACEUTICALS (U.S. CLS. 100, 101 AND 107).

FIRST USE 12-31-2002; IN COMMERCE 12-31-2002.

CLASS 41—(Continued).

4,164,864. GORDON, JEFFREY M., SANTA MONICA, CA. SN 77-668,144. PUB. 11-9-2010, FILED 2-11-2009.



OWNER OF U.S. REG. NO. 2,620,852.
NO CLAIM IS MADE TO THE EXCLUSIVE RIGHT TO USE "WRITERS", APART FROM THE MARK AS SHOWN.

THE COLOR(S) GREEN AND BLACK IS/ARE CLAIMED AS A FEATURE OF THE MARK.

THE MARK CONSISTS OF SILHOUETTES OF THREE GREEN AND BLACK MEN IN MILITARY UNIFORM, PUSHING A LARGE GREEN AND BLACK PENCIL UPRIGHT, WITH A BLACK HORIZONTAL BAR UNDERNEATH, WITH THE STYLIZED WORD "WRITERS" IN BLACK, AND THE WORDS "BOOT CAMP" IN GREEN LETTERS, UNDERLINED IN BLACK.

FOR CONDUCTING WORKSHOPS AND SEMINARS IN SCREEN WRITING (U.S. CLS. 100, 101 AND 107).

FIRST USE 6-1-1989; IN COMMERCE 6-1-1989.

4,164,872. DUAL GROUP, LLC, NEW YORK, NY. SN 77-697,974. PUB. 2-1-2011, FILED 3-24-2009.

DAY & NIGHT

THE MARK CONSISTS OF STANDARD CHARACTERS WITHOUT CLAIM TO ANY PARTICULAR FONT, STYLE, SIZE, OR COLOR.

FOR SPECIAL EVENT PLANNING; SPECIAL EVENT PLANNING CONSULTATION (U.S. CLS. 100, 101 AND 107).

FIRST USE 6-1-2008; IN COMMERCE 2-12-2012.

CLASS 41—(Continued).

4,164,888. TURTLE POND PUBLICATIONS LLC, NEW YORK, NY. SN 77-772,641. PUB. 7-27-2010, FILED 7-1-2009.

THE GALILEO CHRONICLES

THE MARK CONSISTS OF STANDARD CHARACTERS WITHOUT CLAIM TO ANY PARTICULAR FONT, STYLE, SIZE, OR COLOR.

FOR PROVIDING ONLINE, NON-DOWNLOADABLE PUBLICATIONS IN THE NATURE OF AUDIO/VISUAL JOURNALS, AND WEB MAGAZINES IN THE FIELDS OF MUSIC AND MIND MAPPING; ONLINE JOURNALS, NAMELY, BLOGS IN THE FIELDS OF MUSIC AND MIND MAPPING (U.S. CLS. 100, 101 AND 107).

FIRST USE 2-18-2009; IN COMMERCE 2-18-2009.

4,164,907. RAY ELLIN PRODUCTIONS, INC., NEW YORK, NY. SN 77-817,988. PUB. 2-2-2010, FILED 9-1-2009.

MOMS OF COMEDY

THE MARK CONSISTS OF STANDARD CHARACTERS WITHOUT CLAIM TO ANY PARTICULAR FONT, STYLE, SIZE, OR COLOR.

NO CLAIM IS MADE TO THE EXCLUSIVE RIGHT TO USE "COMEDY", APART FROM THE MARK AS SHOWN.

FOR ENTERTAINMENT SERVICES, NAMELY, PRODUCTION OF COMEDY, DRAMA, VARIETY SERIES PROVIDED THROUGH THE GLOBAL COMPUTER INFORMATION NETWORK; PRODUCTION OF TELEVISION PROGRAMS FEATURING COMEDIANS; ENTERTAINMENT IN THE NATURE OF VISUAL AND AUDIO PERFORMANCES AND DRAMA, MUSICAL AND VARIETY PROGRAMS; PRODUCTION OF LIVE COMEDY PERFORMANCES AND PROGRAMS; ENTERTAINMENT SERVICES, NAMELY, PROVIDING A WEBSITE FEATURING AUDIO, VIDEO, PHOTOGRAPHIC AND PROSE PRESENTATIONS FEATURING COMEDIANS, COMEDY AND DRAMA (U.S. CLS. 100, 101 AND 107).

FIRST USE 10-1-2010; IN COMMERCE 11-1-2011.

CLASS 41—(Continued).

4,164,929. GILLMAN, MATTHEW JOHN, MELBOURNE, AUSTRALIA. AND WHITE, JASON SAMUEL, MELBOURNE, AUSTRALIA. AND DOE, ALYSSA PAMELA, MELBOURNE, AUSTRALIA. SN 77-844,047. PUB. 8-23-2011, FILED 10-8-2009.

car stereo wars

THE MARK CONSISTS OF STANDARD CHARACTERS WITHOUT CLAIM TO ANY PARTICULAR FONT, STYLE, SIZE, OR COLOR.

FOR ENTERTAINMENT SERVICES IN THE NATURE OF LIVE MUSICAL PERFORMANCES; ENTERTAINMENT SERVICES, NAMELY, DANCE EVENTS BY A RECORDING ARTIST; ENTERTAINMENT SERVICES, NAMELY, PROVIDING INFORMATION ABOUT A RECORDING ARTIST VIA AN ONLINE NETWORK; ENTERTAINMENT, NAMELY, LIVE MUSIC CONCERTS; MUSIC PRODUCTION SERVICES; MUSIC VIDEO PRODUCTION; PRODUCTION OF MUSICAL SOUND RECORDING; PRODUCTION OF SOUND AND MUSIC VIDEO RECORDINGS; PROVISION OF INFORMATION RELATING TO MUSIC (U.S. CLS. 100, 101 AND 107).

FIRST USE 1-1-2007; IN COMMERCE 1-1-2007.

4,164,942. SKYUNION PTE. LTD., 159308, SINGAPORE. SN 77-872,716. PUB. 4-5-2011, FILED 11-14-2009.



THE COLOR(S) GOLD AND RED IS/ARE CLAIMED AS A FEATURE OF THE MARK.

THE MARK CONSISTS OF THE WORDING "TALES OF FANTASY" IN GOLD SUPERIMPOSED OVER A RED DRAGON.

FOR EDUCATIONAL EXAMINATION; ORGANIZATION OF SPORTS COMPETITIONS; ORGANIZATION OF EXHIBITIONS FOR CULTURAL OR EDUCATIONAL PURPOSES; PUBLICATION OF BOOKS; PUBLICATION OF ELECTRONIC MAGAZINES; PUBLICATION OF TEXTS, BOOKS, MAGAZINES AND OTHER PRINTED MATTER; PUBLISHING OF ELECTRONIC PUBLICATIONS; SOCIAL CLUB SERVICES, NAMELY, ARRANGING, ORGANIZING, AND HOSTING SOCIAL EVENTS, GET-TOGETHERS, AND PARTIES FOR CLUB MEMBERS (U.S. CLS. 100, 101 AND 107).

FIRST USE 1-1-2010; IN COMMERCE 1-1-2010.

CLASS 41—(Continued).

4,164,945. NADIA ALLAUDIN, NORTHRIDGE, CA. SN 77-876,930. PUB. 9-6-2011, FILED 11-19-2009.

Women, Wealth and Wisdom

THE MARK CONSISTS OF STANDARD CHARACTERS WITHOUT CLAIM TO ANY PARTICULAR FONT, STYLE, SIZE, OR COLOR.

FOR DEVELOPING AND CONDUCTING SEMINARS, CLASSES, AND PRESENTATIONS FEATURING MOTIVATIONAL AND INSPIRATIONAL CONTENT FOR WOMEN (U.S. CLS. 100, 101 AND 107).

FIRST USE 9-28-2006; IN COMMERCE 9-28-2006.

4,164,982. O'CONNOR JR., HAROLD JOHN, FAIRFAX, VA. SN 77-948,887. PUB. 12-7-2010, FILED 3-2-2010.

PROJECTXERCISE

FOR EDUCATIONAL SERVICES, NAMELY, CLASSES, SEMINARS, CONFERENCES, WORKSHOPS, AND WEBINARS IN THE FIELDS OF HEALTH CARE AND FITNESS, STATIONARY BIKE SPIN, WEIGHT TRAINING, YOGA, NUTRITION, AND WEIGHT MANAGEMENT; ENTERTAINMENT AND EDUCATIONAL SERVICES, NAMELY, PROVIDING A WEB SITE FEATURING NON-DOWNLOADABLE PHOTOGRAPHS, RELATED FILM CLIPS, AUDIO, VIDEO, AND PROSE WRITTEN PRESENTATIONS IN THE FIELDS OF HEALTH AND FITNESS, STATIONARY BICYCLES SPIN, WEIGHT TRAINING, YOGA, NUTRITION, WEIGHT MANAGEMENT, AND THAI MASSAGE (U.S. CLS. 100, 101 AND 107).

FIRST USE 1-1-2012; IN COMMERCE 1-1-2012.

4,164,994. PENNY-FARTHING PRESS, INC., HOUSTON, TX. SN 77-959,281. PUB. 6-15-2010, FILED 3-15-2010.

TERMINALS

THE MARK CONSISTS OF STANDARD CHARACTERS WITHOUT CLAIM TO ANY PARTICULAR FONT, STYLE, SIZE, OR COLOR.

FOR PROVIDING ONLINE NON-DOWNLOADABLE COMIC BOOKS AND GRAPHIC NOVELS (U.S. CLS. 100, 101 AND 107).

FIRST USE 7-19-2010; IN COMMERCE 7-19-2010.

CLASS 41—(Continued).

4,164,998. THE TOBIN PROJECT, CAMBRIDGE, MA. SN 77-964,588. PUB. 3-22-2011, FILED 3-22-2010.

DEMOCRACY & MARKETS

THE MARK CONSISTS OF STANDARD CHARACTERS WITHOUT CLAIM TO ANY PARTICULAR FONT, STYLE, SIZE, OR COLOR.

FOR ARRANGING AND CONDUCTING CONFERENCES IN THE FIELD OF SOCIAL SCIENCE RESEARCH AND POLICY (U.S. CLS. 100, 101 AND 107).

FIRST USE 4-30-2010; IN COMMERCE 4-30-2010.

4,165,004. CENTER FOR INNOVATION & APPLIED DESIGN, HOLLAND, MI. SN 77-967,523. PUB. 8-23-2011, FILED 3-24-2010.

NEWNORTH CENTER

THE MARK CONSISTS OF STANDARD CHARACTERS WITHOUT CLAIM TO ANY PARTICULAR FONT, STYLE, SIZE, OR COLOR.

NO CLAIM IS MADE TO THE EXCLUSIVE RIGHT TO USE "CENTER", APART FROM THE MARK AS SHOWN.

FOR EDUCATION SERVICES, NAMELY, CONDUCTING CLASSES, SEMINARS, LECTURES, AND WORKSHOPS IN THE FIELDS OF BUSINESS INNOVATION PROCESS AND DESIGN-DRIVEN INNOVATION; BUSINESS TRAINING (U.S. CLS. 100, 101 AND 107).

FIRST USE 8-28-2009; IN COMMERCE 7-0-2010.

4,165,044. REMICK, JOHN A., LOS ANGELES, CA. SN 85-013,938. PUB. 9-28-2010, FILED 4-14-2010.

**Make a RIGHT
TURN for PEACE**



THE COLOR(S) RED, WHITE, AND BLACK IS/ARE CLAIMED AS A FEATURE OF THE MARK.

CLASS 41—(Continued).

THE MARK CONSISTS OF THE WORDING "MAKE A RIGHT TURN FOR PEACE" IN THE COLOR BLACK ABOVE A WHITE DIAMOND OUTLINED IN BLACK CONTAINING A RED CIRCLE WITH A RED VERTICAL LINE ACROSS THE CENTER. INSIDE THE RED CIRCLE IS A THICK BLACK ARROW THAT IS BENT AT A 90 DEGREE ANGLE.

FOR ENTERTAINMENT SERVICES IN THE NATURE OF AN ON-GOING REALITY BASED DOCUMENTARY-STYLE SERIES PROVIDED THROUGH CABLE TELEVISION, NETWORK TELEVISION BROADCAST, AND INTERNET WEBCAST (U.S. CLS. 100, 101 AND 107).

FIRST USE 3-25-2010; IN COMMERCE 3-25-2010.

4,165,049. COMPETITOR GROUP, INC., SAN DIEGO, CA. SN 85-015,102. PUB. 7-13-2010, FILED 4-15-2010.



THE MARK CONSISTS OF THE WORD "TRIROCK" WITH THE LETTER "O" REPRESENTED BY A STYLIZED MUSIC NOTE SURROUNDED BY AN INCOMPLETE CIRCLE.

FOR ENTERTAINMENT SERVICES, NAMELY, ARRANGING, ORGANIZING, OPERATING AND CONDUCTING RUNNING, CYCLING AND MOUNTAIN BIKING RACES, TRIATHLONS, AND RELATED SPORTING AND ENTERTAINMENT EVENTS, NAMELY, ORGANIZING COMMUNITY FAIRS FEATURING VENDOR BOOTHS OF FOOD AND RACE RELATED SPORTING GOODS, AND PLANNING PARTIES AND DINNERS (U.S. CLS. 100, 101 AND 107).

FIRST USE 9-12-2010; IN COMMERCE 9-12-2010.

4,165,050. DEVRY EDUCATIONAL DEVELOPMENT CORPORATION, DOWNERS GROVE, IL. SN 85-015,556. PUB. 3-29-2011, FILED 4-16-2010.



OWNER OF U.S. REG. NO. 2,686,285.
THE COLOR(S) BLUE, GOLD, WHITE, AND RED IS/ARE CLAIMED AS A FEATURE OF THE MARK.

CLASS 41—(Continued).

THE MARK CONSISTS OF A SHIELD DESIGN WITH COLOR BLOCKED TRIANGLES THAT FORM THE LETTER "V" WITHIN THE SHIELD. THE OUTER EDGES OF THE SHIELD CONSIST OF BLUE TRIANGLES. THE INTERIOR OF THE SHIELD CONSISTS OF A GOLD TRIANGLE ON THE LEFT AND A WHITE TRIANGLE ON THE RIGHT. THE TOP OF THE SHIELD CONSISTS OF A WHITE TRIANGLE ON THE LEFT AND A RED TRIANGLE ON THE RIGHT.

FOR EDUCATION SERVICES, NAMELY, PROVIDING COURSES OF INSTRUCTION AT THE COLLEGE AND POSTGRADUATE LEVEL; ARRANGING AND CONDUCTING EDUCATIONAL CONFERENCES; EDUCATIONAL SERVICES, NAMELY, CONDUCTING CLASSES, SEMINARS AND WORKSHOPS IN THE FIELDS OF BUSINESS, BUSINESS MANAGEMENT, ENGINEERING, COMPUTER INFORMATION SYSTEMS, HEALTH SCIENCES, LIBERAL ARTS, SCIENCE, MEDIA ARTS, AND TECHNOLOGY (U.S. CLS. 100, 101 AND 107).

FIRST USE 2-28-2002; IN COMMERCE 2-28-2002.

4,165,078. AMAZON TECHNOLOGIES, INC., RENO, NV. SN 85-043,860. PUB. 3-22-2011, FILED 5-20-2010.

AMAZONCROSSING

THE MARK CONSISTS OF STANDARD CHARACTERS WITHOUT CLAIM TO ANY PARTICULAR FONT, STYLE, SIZE, OR COLOR.

OWNER OF U.S. REG. NOS. 2,649,373, 3,709,331, AND OTHERS.

FOR PUBLISHING OF PRINTED MATTER, BOOKS, ELECTRONIC PUBLICATIONS, LITERARY WORKS, AND ELECTRONIC BOOKS; PROVIDING INFORMATION IN THE FIELD OF PUBLISHING; ENTERTAINMENT SERVICES, NAMELY, PROVIDING INFORMATION AND COMMENTARY PERTAINING TO BOOKS, LITERARY WORKS, AUTHORS AND RECOMMENDATIONS AS TO THE SAME; PUBLISHING OF REVIEWS OF LITERARY WORKS; PROVIDING A WEB SITE WHERE USERS CAN POST RATINGS, REVIEWS AND RECOMMENDATIONS ON LITERARY WORKS, BOOKS AND PRINTED MATTER; CONSULTING SERVICES IN THE FIELD OF PUBLISHING, PRINTED MATTER, LITERARY WORKS, AND BOOKS; TRANSLATION SERVICES; PROVIDING A WEBSITE THAT MAKES AVAILABLE WORKS OF FICTION AND NON-FICTION EXCERPTS THEREFROM (U.S. CLS. 100, 101 AND 107).

FIRST USE 5-18-2010; IN COMMERCE 5-18-2010.

CLASS 41—(Continued).

4,165,095. INVIADATA, SHAE, OAKVILLE, CANADA. SN 85-076,986. PUB. 5-17-2011, FILED 7-2-2010.

FREE THEM - BUY ONE TO
FREE ONE

THE MARK CONSISTS OF STANDARD CHARACTERS WITHOUT CLAIM TO ANY PARTICULAR FONT, STYLE, SIZE, OR COLOR.

FOR EDUCATIONAL SERVICES, NAMELY, PROVIDING COURSES OF INSTRUCTION AND TRAINING BY WAY OF WORKSHOPS, SEMINARS, CLASSES, FORUMS AND SPEECHES IN THE FIELDS OF SOCIAL JUSTICE AND HUMAN RIGHTS, AND DISTRIBUTING PRINTED EDUCATIONAL MATERIALS IN CONNECTION THEREWITH; PROVIDING ONLINE COURSES OF INSTRUCTION AND TRAINING VIA A GLOBAL COMMUNICATIONS NETWORK FEATURING WORKSHOPS, SEMINARS, CLASSES, FORUMS AND SPEECHES IN THE FIELDS OF SOCIAL INJUSTICE AND HUMAN RIGHTS (U.S. CLS. 100, 101 AND 107).

FIRST USE 7-2-2010; IN COMMERCE 4-29-2011.

4,165,121. SILVERTON CASINO, LLC, LAS VEGAS, NV. SN 85-101,519. PUB. 8-16-2011, FILED 8-5-2010.

BLINGO BINGO

THE MARK CONSISTS OF STANDARD CHARACTERS WITHOUT CLAIM TO ANY PARTICULAR FONT, STYLE, SIZE, OR COLOR.

NO CLAIM IS MADE TO THE EXCLUSIVE RIGHT TO USE "BINGO", APART FROM THE MARK AS SHOWN.

FOR CONDUCTING AND PROVIDING FACILITIES FOR SPECIAL EVENTS FEATURING CASINO AND GAMING CONTESTS AND TOURNAMENTS; ENTERTAINMENT SERVICES, NAMELY, CASINO GAMING (U.S. CLS. 100, 101 AND 107).

FIRST USE 2-28-2011; IN COMMERCE 2-28-2011.

CLASS 41—(Continued).

4,165,158. JACKSON BASEBALL CLUB, L.P., JACKSON, TN. SN 85-117,722. PUB. 8-30-2011, FILED 8-27-2010.



NO CLAIM IS MADE TO THE EXCLUSIVE RIGHT TO USE "JACKSON", APART FROM THE MARK AS SHOWN.

THE COLOR(S) TAN, GREEN, BLACK, WHITE AND GRAY IS/ARE CLAIMED AS A FEATURE OF THE MARK.

THE MARK CONSISTS OF A SHIELD DESIGN WITH GRAY ON THE LEFT HALF OUTLINED IN BLACK AND GRAY WITH THE WORD "JACKSON" IN TAN AT THE TOP OF THE SHIELD WITH THE STYLIZED WORD "GENERALS" DEPICTED IN THE COLOR WHITE SUPERIMPOSED ON THE SHIELD WITH A GREEN DESIGN SET IN THE BLACK FIELD BELOW. A TAN AND WHITE BULLDOG HEAD OUTLINED IN BLACK WITH GRAY SHADING IS PLACED IN THE CENTER OF THE SHIELD. THE BULLDOG HEAD DESIGN FEATURES A GREEN HELMET BEARING THREE TAN STARS AND A BLACK DESIGN WITH WHITE ON THE RIGHT SIDE OF THE HELMET WITH A SUPERIMPOSED TAN BAT OUTLINED IN BLACK IN THE MOUTH OF THE BULLDOG.

FOR ENTERTAINMENT SERVICES IN THE NATURE OF BASEBALL GAMES AND EXHIBITIONS, AND PERSONAL APPEARANCES BY A SPORTS MASCOT (U.S. CLS. 100, 101 AND 107).

FIRST USE 9-6-2010; IN COMMERCE 9-6-2010.

4,165,164. SENDELMANN HALL, LLC, DBA SENDELMANN HALL, HOUSTON, TX. SN 85-118,795. PUB. 8-9-2011, FILED 8-30-2010.

HOME IS WHERE THE HALL IS

THE MARK CONSISTS OF STANDARD CHARACTERS WITHOUT CLAIM TO ANY PARTICULAR FONT, STYLE, SIZE, OR COLOR.

FOR ENTERTAINMENT SERVICES, NAMELY, PROVIDING MUSIC-HALLS AND DANCE HALLS (U.S. CLS. 100, 101 AND 107).

FIRST USE 5-19-2010; IN COMMERCE 5-19-2010.

CLASS 41—(Continued).

4,165,173. BROWN BAG BIBLE BUDDIES MINISTRY, CANTON, MS. SN 85-121,150. PUB. 2-22-2011, FILED 9-1-2010.

WHOA MINISTRIES

THE MARK CONSISTS OF STANDARD CHARACTERS WITHOUT CLAIM TO ANY PARTICULAR FONT, STYLE, SIZE, OR COLOR.

NO CLAIM IS MADE TO THE EXCLUSIVE RIGHT TO USE "MINISTRIES", APART FROM THE MARK AS SHOWN.

FOR EDUCATION AND ENTERTAINMENT SERVICES, NAMELY, PRODUCTION AND DISTRIBUTION OF ONGOING RADIO AND TELEVISION PROGRAMS IN THE FIELDS OF THE BIBLE, CHRISTIANITY, SPIRITUALITY AND FAMILY LIFE; CONDUCTING SEMINARS IN THE FIELDS OF THE BIBLE, CHRISTIANITY, SPIRITUALITY AND FAMILY LIFE; ONLINE JOURNALS, NAMELY, BLOGS FEATURING THE BIBLE, CHRISTIANITY, SPIRITUALITY AND FAMILY LIFE (U.S. CLS. 100, 101 AND 107).

FIRST USE 7-0-2009; IN COMMERCE 7-0-2009.

4,165,195. WARNER BROS. ENTERTAINMENT INC., BURBANK, CA. SN 85-126,473. PUB. 6-14-2011, FILED 9-9-2010.

TOOFAB.COM

THE MARK CONSISTS OF STANDARD CHARACTERS WITHOUT CLAIM TO ANY PARTICULAR FONT, STYLE, SIZE, OR COLOR.

FOR INTERNET SERVICES PROVIDING INFORMATION VIA AN ELECTRONIC GLOBAL COMPUTER NETWORK IN THE FIELD OF ENTERTAINMENT RELATING SPECIFICALLY TO MOVIES, AND TELEVISION; PROVIDING NEWS ABOUT CURRENT EVENTS AND ENTERTAINMENT, AND INFORMATION RELATED TO EDUCATION AND CULTURAL EVENTS VIA A GLOBAL COMPUTER NETWORK (U.S. CLS. 100, 101 AND 107).

FIRST USE 2-26-2010; IN COMMERCE 2-26-2010.

CLASS 41—(Continued).

4,165,212. KABAM, INC., REDWOOD CITY, CA. SN 85-131,671. PUB. 8-16-2011, FILED 9-16-2010.

GLORY OF ROME

THE MARK CONSISTS OF STANDARD CHARACTERS WITHOUT CLAIM TO ANY PARTICULAR FONT, STYLE, SIZE, OR COLOR.

FOR ENTERTAINMENT SERVICES, NAMELY, PROVIDING ON-LINE COMPUTER GAMES OF MILITARY STRATEGY (U.S. CLS. 100, 101 AND 107).

FIRST USE 10-25-2010; IN COMMERCE 10-25-2010.

4,165,223. AOPS INCORPORATED, ALPINE, CA. SN 85-135,043. PUB. 2-8-2011, FILED 9-21-2010.

Beast Academy

THE MARK CONSISTS OF STANDARD CHARACTERS WITHOUT CLAIM TO ANY PARTICULAR FONT, STYLE, SIZE, OR COLOR.

NO CLAIM IS MADE TO THE EXCLUSIVE RIGHT TO USE "ACADEMY", APART FROM THE MARK AS SHOWN.

FOR EDUCATION SERVICES IN THE NATURE OF EARLY CHILDHOOD INSTRUCTION; PROVIDING A WEBSITE FEATURING RESOURCES, NAMELY, A WEBSITE FEATURING PRIMARILY NON-DOWNLOADABLE PUBLICATIONS IN THE NATURE OF BOOKS, HAND-OUTS, WORKBOOKS, VIDEOS, STUDY GUIDES, AND EDUCATIONAL INSTRUCTION GUIDES IN THE FIELD OF MATHEMATICS AND PROBLEM SOLVING AND ALSO FEATURING NON-DOWNLOADABLE SOFTWARE FOR TEACHING MATHEMATICS AND PROBLEM SOLVING; PROVIDING ON-LINE PUBLICATIONS IN THE NATURE OF BOOKS, HAND-OUTS, WORKBOOKS, VIDEOS, STUDY GUIDES, AND EDUCATIONAL INSTRUCTION GUIDES IN THE FIELD OF MATHEMATICS AND PROBLEM SOLVING (U.S. CLS. 100, 101 AND 107).

FIRST USE 3-12-2012; IN COMMERCE 3-12-2012.

4,165,227. WILLIAMS, MALVANIE, RAHWAY, NJ. SN 85-136,814. PUB. 3-15-2011, FILED 9-23-2010.

PALM TREE ENTERTAINMENT

THE MARK CONSISTS OF STANDARD CHARACTERS WITHOUT CLAIM TO ANY PARTICULAR FONT, STYLE, SIZE, OR COLOR.

CLASS 41—(Continued).

NO CLAIM IS MADE TO THE EXCLUSIVE RIGHT TO USE "ENTERTAINMENT", APART FROM THE MARK AS SHOWN.

FOR ENTERTAINMENT, NAMELY, PRODUCTION OF MUSIC; SONG WRITING SERVICES (U.S. CLS. 100, 101 AND 107).

FIRST USE 3-13-2010; IN COMMERCE 9-1-2010.

4,165,234. ART.SY, INC., NEW YORK, NY. SN 85-140,869. PUB. 3-22-2011, FILED 9-29-2010.

THE ART GENOME PROJECT

THE MARK CONSISTS OF STANDARD CHARACTERS WITHOUT CLAIM TO ANY PARTICULAR FONT, STYLE, SIZE, OR COLOR.

NO CLAIM IS MADE TO THE EXCLUSIVE RIGHT TO USE "ART" AND "PROJECT", APART FROM THE MARK AS SHOWN.

FOR ENTERTAINMENT SERVICES, NAMELY, PROVIDING NON-DOWNLOADABLE IMAGES OF ARTISTIC WORKS, AND INFORMATION CONCERNING ARTISTIC WORKS, ARTISTS, ARTISTIC STYLES, AND RELATIONSHIPS BETWEEN ARTISTS, ARTISTIC WORKS, AND ARTISTIC STYLES VIA GLOBAL COMMUNICATIONS NETWORKS; PROVIDING A WEBSITE FEATURING INFORMATION ABOUT ARTISTIC STYLES (U.S. CLS. 100, 101 AND 107).

FIRST USE 7-9-2010; IN COMMERCE 7-9-2010.

4,165,258. FEDERKEIL, EDWARD, FT. LAUDERDALE, FL. SN 85-150,560. PUB. 4-5-2011, FILED 10-12-2010.

FIREMAN ED

THE MARK CONSISTS OF STANDARD CHARACTERS WITHOUT CLAIM TO ANY PARTICULAR FONT, STYLE, SIZE, OR COLOR.

THE NAME "FIREMAN ED" IDENTIFIES A LIVING INDIVIDUAL WHOSE CONSENT IS OF RECORD.

FOR ON-LINE JOURNALS, NAMELY, BLOGS FEATURING ADVICE TO INDIVIDUALS AND TIPS ON WHAT TO PURCHASE FOR THEIR MATE OR SIGNIFICANT OTHER (U.S. CLS. 100, 101 AND 107).

FIRST USE 9-6-2011; IN COMMERCE 9-6-2011.

CLASS 41—(Continued).

4,165,278. SHERMAN, DAVID J., CLAREMONT, CA. SN 85-156,475. PUB. 5-24-2011, FILED 10-19-2010.

STRESS-FREE PRODUCTIVITY

THE MARK CONSISTS OF STANDARD CHARACTERS WITHOUT CLAIM TO ANY PARTICULAR FONT, STYLE, SIZE, OR COLOR.

NO CLAIM IS MADE TO THE EXCLUSIVE RIGHT TO USE "PRODUCTIVITY", APART FROM THE MARK AS SHOWN.

FOR LIFE COACHING SERVICES IN THE FIELD OF PRODUCTIVITY; PEER TO PEER COACHING SERVICES IN THE FIELD OF PRODUCTIVITY; PERSONAL COACHING SERVICES IN THE FIELD OF PRODUCTIVITY; PROFESSIONAL COACHING SERVICES IN THE FIELD OF PRODUCTIVITY; PROVIDING GROUP COACHING AND LEARNING FORUMS IN THE FIELD OF LEADERSHIP DEVELOPMENT; PROVIDING GROUP COACHING IN THE FIELD OF PRODUCTIVITY (U.S. CLS. 100, 101 AND 107).

FIRST USE 1-1-2010; IN COMMERCE 5-1-2010.

4,165,290. WILLIAMS, LONNIE PAUL, JR., AKA L.P. WILLIAMS, COLUMBIA, SC. SN 85-162,252. PUB. 9-27-2011, FILED 10-27-2010.

$$D2 + C = C$$

(Dedication x Devotion) +
Consistency = Commitment

THE MARK CONSISTS OF STANDARD CHARACTERS WITHOUT CLAIM TO ANY PARTICULAR FONT, STYLE, SIZE, OR COLOR.

FOR EDUCATIONAL SERVICES, NAMELY, CONDUCTING CLASSES, CONFERENCES, SEMINARS, WORKSHOPS AND OTHER RELEVANT TRAINING EVENTS IN THE FIELD OF RELIGION (SPIRITUAL) AND PERSONAL HEALTH, NAMELY, SPIRITUAL, PHYSICAL AND/OR PERSONAL FITNESS INSTRUCTIONAL TRAINING AND DISTRIBUTION OF COURSE AND EDUCATIONAL MATERIALS IN CONNECTION THEREWITH (U.S. CLS. 100, 101 AND 107).

FIRST USE 7-9-2011; IN COMMERCE 9-4-2011.

CLASS 41—(Continued).

4,165,299. WE: WOMEN'S ENTERTAINMENT LLC, NEW YORK, NY. SN 85-168,316. PUB. 2-15-2011, FILED 11-3-2010.

I DO OVER

THE MARK CONSISTS OF STANDARD CHARACTERS WITHOUT CLAIM TO ANY PARTICULAR FONT, STYLE, SIZE, OR COLOR.

FOR ENTERTAINMENT SERVICES IN THE NATURE OF AN ON-GOING REALITY BASED TELEVISION PROGRAM (U.S. CLS. 100, 101 AND 107).

FIRST USE 7-6-2011; IN COMMERCE 11-13-2011.

4,165,304. LAGGIS, MELISSA, WASILLA, AK. SN 85-170,040. PUB. 4-19-2011, FILED 11-5-2010.

THE PICTURE LADY

THE MARK CONSISTS OF STANDARD CHARACTERS WITHOUT CLAIM TO ANY PARTICULAR FONT, STYLE, SIZE, OR COLOR.

NO CLAIM IS MADE TO THE EXCLUSIVE RIGHT TO USE "PICTURE", APART FROM THE MARK AS SHOWN.

FOR PHOTOGRAPHY SERVICES (U.S. CLS. 100, 101 AND 107).

FIRST USE 2-25-2001; IN COMMERCE 1-2-2002.

4,165,341. THE TENNIS CHANNEL, INC., SANTA MONICA, CA. SN 85-186,361. PUB. 11-1-2011, FILED 11-29-2010.

T-LINE

THE MARK CONSISTS OF STANDARD CHARACTERS WITHOUT CLAIM TO ANY PARTICULAR FONT, STYLE, SIZE, OR COLOR.

FOR NEWS REPORTING SERVICES, NAMELY, REPORTING NEWS AND INFORMATION IN THE FIELD OF TENNIS VIA AN ONLINE SCREEN CRAWL FOR TELEVISION AND OTHER VIDEO MEDIA (U.S. CLS. 100, 101 AND 107).

FIRST USE 7-6-2010; IN COMMERCE 7-6-2010.

CLASS 41—(Continued).

4,165,343. KNIGHTON, CHRISTINE, SPRINGFIELD, VA. SN 85-187,889. PUB. 11-1-2011, FILED 12-1-2010.



THE COLOR(S) GRAY AND ORANGE IS/ARE CLAIMED AS A FEATURE OF THE MARK.

THE MARK CONSISTS OF THE WORD "WINNERS" WITH AN EXCLAMATION MARK IN GRAY COLOR AND THE DOT OF THE LETTER "I" DEPICTING THE SUN WITH RAYS IN ORANGE COLOR.

FOR PROVIDING BUSINESS AND EDUCATION SERVICES, NAMELY, DEVELOPING AND FACILITATING LEADERSHIP AND EXECUTIVE DEVELOPMENT PROGRAMS, PROVIDING EXECUTIVE COACHING SERVICES, AND PROVIDING BUSINESS EDUCATION PROGRAMS TO EXECUTIVES AND EMPLOYEES (U.S. CLS. 100, 101 AND 107).

FIRST USE 11-23-2010; IN COMMERCE 2-1-2011.

4,165,344. COSTANZA, ROCCO, STANHOPE, NJ. SN 85-188,796. PUB. 4-19-2011, FILED 12-1-2010.

GOODBYE FRIDAY

THE MARK CONSISTS OF STANDARD CHARACTERS WITHOUT CLAIM TO ANY PARTICULAR FONT, STYLE, SIZE, OR COLOR.

FOR ENTERTAINMENT IN THE NATURE OF VISUAL AND AUDIO PERFORMANCES, NAMELY, MUSICAL BAND, ROCK GROUP, GYMNASTIC, DANCE, AND BALLET PERFORMANCES (U.S. CLS. 100, 101 AND 107).

FIRST USE 11-1-2007; IN COMMERCE 3-2-2008.

4,165,350. YOUNG WOMEN'S LEADERSHIP NETWORK, INC., NEW YORK, NY. SN 85-194,328. PUB. 5-10-2011, FILED 12-9-2010.

THE YOUNG WOMEN'S LEADERSHIP SCHOOLS

THE MARK CONSISTS OF STANDARD CHARACTERS WITHOUT CLAIM TO ANY PARTICULAR FONT, STYLE, SIZE, OR COLOR.

OWNER OF U.S. REG. NOS. 2,828,749 AND 3,848,378. NO CLAIM IS MADE TO THE EXCLUSIVE RIGHT TO USE "SCHOOLS", APART FROM THE MARK AS SHOWN.

CLASS 41—(Continued).

SEC. 2(F).

FOR EDUCATIONAL SERVICES, NAMELY, CONDUCTING SUPPLEMENTAL IN-SCHOOL AND AFTER-SCHOOL ACADEMIC ENRICHMENT AND TUTORING PROGRAMS IN THE FIELDS OF SCIENCE, TECHNOLOGY, MATH, READING, HEALTH, WELLNESS AND LEADERSHIP; PROVIDING AFTER SCHOOL, SATURDAY AND SUMMER EDUCATIONAL AND ENRICHMENT ACADEMIC CLASSES AND TUTORIAL SESSIONS FOR GIRLS AND YOUNG WOMEN IN GRADES 6 TO 12 IN THE FIELDS OF SCIENCE, TECHNOLOGY, MATH, READING, HEALTH, WELLNESS AND LEADERSHIP; EDUCATIONAL SERVICES, NAMELY, EDUCATIONAL MENTORING SERVICES AND PROGRAMS IN THE FIELDS OF SCHOOL MANAGEMENT, TEACHER RECRUITMENT, STUDENT AND TEACHER ORIENTATION, AND TEACHING TECHNIQUES; EDUCATIONAL SERVICES, NAMELY, DEVELOPING CURRICULUM FOR EDUCATORS; DEVELOPMENT AND DISSEMINATION OF EDUCATIONAL MATERIALS OF OTHERS IN THE FIELDS OF SCIENCE, TECHNOLOGY, MATH, READING, HEALTH, WELLNESS AND LEADERSHIP; CONSULTATION IN THE FIELD OF K-12 EDUCATIONAL SYSTEMS; PROVIDING TEACHER TRAINING ABOUT TEACHING METHODS AND TECHNIQUES; PROVIDING WORKSHOPS AND LECTURES ABOUT CURRENT EVENT ISSUES AND TEACHING TECHNIQUES IN THE FIELD OF EDUCATION (U.S. CLS. 100, 101 AND 107).

FIRST USE 12-31-2004; IN COMMERCE 12-31-2004.

4,165,360. DISCOVERY COMMUNICATIONS, LLC, SILVER SPRING, MD. SN 85-200,759. PUB. 8-2-2011, FILED 12-17-2010.

PAWN QUEENS

THE MARK CONSISTS OF STANDARD CHARACTERS WITHOUT CLAIM TO ANY PARTICULAR FONT, STYLE, SIZE, OR COLOR.

NO CLAIM IS MADE TO THE EXCLUSIVE RIGHT TO USE "PAWN", APART FROM THE MARK AS SHOWN.

FOR ENTERTAINMENT AND EDUCATIONAL SERVICES IN THE NATURE OF TELEVISION AND MULTIMEDIA PROGRAM SERIES FEATURING SUBJECTS OF GENERAL HUMAN INTEREST DISTRIBUTED VIA VARIOUS PLATFORMS ACROSS MULTIPLE FORMS OF TRANSMISSION MEDIA; PROVIDING ENTERTAINMENT INFORMATION TO OTHERS VIA A GLOBAL COMPUTER NETWORK (U.S. CLS. 100, 101 AND 107).

FIRST USE 11-18-2010; IN COMMERCE 11-18-2010.

4,165,398. IMI PLC, BIRMINGHAM, UNITED KINGDOM. SN 85-216,399. PUB. 8-23-2011, FILED 1-12-2011.

IMI SEVERE SERVICE UNIVERSITY

THE MARK CONSISTS OF STANDARD CHARACTERS WITHOUT CLAIM TO ANY PARTICULAR FONT, STYLE, SIZE, OR COLOR.

CLASS 41—(Continued).

OWNER OF U.S. REG. NO. 3,308,032.

NO CLAIM IS MADE TO THE EXCLUSIVE RIGHT TO USE "SEVERE SERVICE UNIVERSITY", APART FROM THE MARK AS SHOWN.

FOR TRAINING IN THE USE OF SYSTEMS AND EQUIPMENT FOR CONTROLLING INDUSTRIAL PROCESSES; TRAINING IN THE USE OF CONTROL VALVES AND VALVE ACTUATORS FOR REGULATING THE FLOW OF GASES AND LIQUIDS; PROVIDING ONLINE TUTORING ON THE USE OF INDUSTRIAL PROCESS CONTROL SYSTEMS, CONTROL VALVES, AND VALVE ACTUATORS (U.S. CLS. 100, 101 AND 107).

FIRST USE 1-31-2011; IN COMMERCE 8-31-2011.

4,165,414. BALLY TOTAL FITNESS HOLDING CORPORATION, CHICAGO, IL. SN 85-226,412. PUB. 8-9-2011, FILED 1-26-2011.

BALLY SPORT

THE MARK CONSISTS OF STANDARD CHARACTERS WITHOUT CLAIM TO ANY PARTICULAR FONT, STYLE, SIZE, OR COLOR.

NO CLAIM IS MADE TO THE EXCLUSIVE RIGHT TO USE "SPORT", APART FROM THE MARK AS SHOWN.

FOR HEALTH CLUB SERVICES, NAMELY, PROVIDING INSTRUCTION AND EQUIPMENT IN THE FIELD OF PHYSICAL EXERCISE (U.S. CLS. 100, 101 AND 107).

FIRST USE 12-31-2010; IN COMMERCE 12-31-2010.

4,165,468. TWENTIETH CENTURY FOX FILM CORPORATION, LOS ANGELES, CA. SN 85-257,517. PUB. 5-24-2011, FILED 3-3-2011.

DON'T TRUST THE B---- IN APT 23

THE MARK CONSISTS OF STANDARD CHARACTERS WITHOUT CLAIM TO ANY PARTICULAR FONT, STYLE, SIZE, OR COLOR.

FOR ENTERTAINMENT SERVICES IN THE NATURE OF A TELEVISION SERIES FEATURING COMEDY; PROVIDING ON-LINE INFORMATION IN THE FIELD OF TELEVISION AND VIDEO ENTERTAINMENT FEATURING COMEDY VIA THE INTERNET; ENTERTAINMENT SERVICES IN THE NATURE OF NON-DOWNLOADABLE VIDEOS AND IMAGES FEATURING TELEVISION SHOWS AND ENTERTAINMENT TRANSMITTED VIA THE INTERNET AND WIRELESS COMMUNICATION NETWORKS; ON-LINE JOURNALS, NAMELY, BLOGS FEATURING PERSONAL OPINIONS IN THE FIELD OF GENERAL INTEREST AND COMEDY (U.S. CLS. 100, 101 AND 107).

FIRST USE 3-0-2012; IN COMMERCE 3-0-2012.

CLASS 41—(Continued).

4,165,482. BRANDY LIBRARY LOUNGE, LLC, NEW YORK, NY. SN 85-261,283. PUB. 8-9-2011, FILED 3-8-2011.

THE SAVVY BACHELOR

THE MARK CONSISTS OF STANDARD CHARACTERS WITHOUT CLAIM TO ANY PARTICULAR FONT, STYLE, SIZE, OR COLOR.

NO CLAIM IS MADE TO THE EXCLUSIVE RIGHT TO USE "BACHELOR", APART FROM THE MARK AS SHOWN.

FOR ENTERTAINMENT SERVICES, NAMELY, ALCOHOLIC SPIRIT TASTINGS; HOSTING PARTIES AND EVENTS, NAMELY, HOSTING SOCIAL ENTERTAINMENT EVENTS, HOSTING OF EVENTS FOR CULTURAL PURPOSES, SOCIAL CLUB SERVICES IN THE NATURE OF HOSTING SOCIAL EVENTS AND PARTIES FOR CLUB MEMBERS (U.S. CLS. 100, 101 AND 107).

FIRST USE 2-18-2010; IN COMMERCE 2-18-2010.

4,165,487. LARSON, JOHN, FOND DU LAC, WI. SN 85-263,178. PUB. 7-26-2011, FILED 3-10-2011.

FROM THE WRECKAGE

THE MARK CONSISTS OF STANDARD CHARACTERS WITHOUT CLAIM TO ANY PARTICULAR FONT, STYLE, SIZE, OR COLOR.

FOR ENTERTAINMENT IN THE NATURE OF LIVE PERFORMANCES BY A MUSICAL BAND (U.S. CLS. 100, 101 AND 107).

FIRST USE 6-10-2010; IN COMMERCE 6-10-2010.

4,165,491. CABLE NEWS NETWORK, INC., ATLANTA, GA. SN 85-264,766. PUB. 9-20-2011, FILED 3-11-2011.

OPEN STORY

THE MARK CONSISTS OF STANDARD CHARACTERS WITHOUT CLAIM TO ANY PARTICULAR FONT, STYLE, SIZE, OR COLOR.

NO CLAIM IS MADE TO THE EXCLUSIVE RIGHT TO USE "STORY", APART FROM THE MARK AS SHOWN.

FOR EDUCATION AND ENTERTAINMENT SERVICES, NAMELY, PROVIDING A WEBSITE FEATURING NON-DOWNLOADABLE USER GENERATED AUDIO AND VIDEO CLIPS REGARDING NEWS AND CURRENT EVENTS THAT MAY BE DISTRIBUTED VIA VARIOUS PLATFORMS ACROSS MULTIPLE FORMS OF MEDIA (U.S. CLS. 100, 101 AND 107).

FIRST USE 3-14-2011; IN COMMERCE 3-14-2011.

CLASS 41—(Continued).

4,165,526. MATT OLMSTEAD PRODUCTIONS, INC., SANTA MONICA, CA. SN 85-272,858. PUB. 8-23-2011, FILED 3-21-2011.

NO CLAIM IS MADE TO THE EXCLUSIVE RIGHT TO USE "PRODUCTIONS", APART FROM THE MARK AS SHOWN.

THE NAME "MATT OLMSTEAD" IDENTIFIES A LIVING INDIVIDUAL WHOSE CONSENT IS OF RECORD.

THE MARK CONSISTS OF "MATT OLMSTEAD" (CHAMPION BANTAMWEIGHT FONT) "PRODUCTIONS" (CHAMPION MIDDLEWEIGHT FONT) IN CAPITAL LETTERS. "MATT OLMSTEAD" IS ON ONE LINE, WHILE "PRODUCTIONS" IS IN SMALLER TYPE ON THE LINE BELOW IT.

FOR CREATION AND PRODUCTION OF TELEVISION, FILM, AND THEATRICAL PRODUCTIONS (U.S. CLS. 100, 101 AND 107).

FIRST USE 3-21-2011; IN COMMERCE 3-21-2011.

4,165,529. FOTL, LLC, CONSHOHOCKEN, PA. SN 85-273,243. PUB. 8-23-2011, FILED 3-22-2011.

LINE ROCKET

THE MARK CONSISTS OF STANDARD CHARACTERS WITHOUT CLAIM TO ANY PARTICULAR FONT, STYLE, SIZE, OR COLOR.

NO CLAIM IS MADE TO THE EXCLUSIVE RIGHT TO USE "LINE", APART FROM THE MARK AS SHOWN.

FOR ON-LINE ENTERTAINMENT TICKET AGENCY SERVICES FOR PROVIDING SPECIAL ACCESS TO NIGHTCLUBS (U.S. CLS. 100, 101 AND 107).

FIRST USE 2-0-2011; IN COMMERCE 2-0-2011.

CLASS 41—(Continued).

4,165,532. POLLARD BANKNOTE LIMITED PARTNERSHIP, WINNIPEG, MB, CANADA. SN 85-273,907. PUB. 8-23-2011, FILED 3-22-2011.

PlayOn

THE MARK CONSISTS OF STANDARD CHARACTERS WITHOUT CLAIM TO ANY PARTICULAR FONT, STYLE, SIZE, OR COLOR.

FOR PROVIDING LOTTERY SERVICES FEATURING A PLAYERS REWARD PROGRAM FOR LOTTERY TICKET PURCHASERS (U.S. CLS. 100, 101 AND 107). FIRST USE 4-1-2011; IN COMMERCE 4-1-2011.

4,165,563. TRACY, ALVA, LEXINGTON, KY. SN 85-277,825. PUB. 8-9-2011, FILED 3-26-2011.

KENPOKIDZ

THE MARK CONSISTS OF STANDARD CHARACTERS WITHOUT CLAIM TO ANY PARTICULAR FONT, STYLE, SIZE, OR COLOR.

FOR MARTIAL ARTS INSTRUCTION; PROVIDING A WEBSITE FEATURING INFORMATION ON MARTIAL ARTS (U.S. CLS. 100, 101 AND 107).

FIRST USE 2-1-2011; IN COMMERCE 2-24-2012.

4,165,612. EVE PEARL, LLC, NEW YORK, NY. SN 85-286,336. PUB. 9-6-2011, FILED 4-5-2011.

BEYOND THE BRAND

THE MARK CONSISTS OF STANDARD CHARACTERS WITHOUT CLAIM TO ANY PARTICULAR FONT, STYLE, SIZE, OR COLOR.

NO CLAIM IS MADE TO THE EXCLUSIVE RIGHT TO USE "BRAND", APART FROM THE MARK AS SHOWN.

FOR ENTERTAINMENT SERVICES, NAMELY, AN ON-GOING SERIES IN THE NATURE OF A REALITY BASED TELEVISION AND INTERNET PROGRAM THAT FOCUSES ON A BEHIND-THE-SCENE LOOK AT THE PROCESS OF DEVELOPING A BRAND (U.S. CLS. 100, 101 AND 107).

FIRST USE 10-27-2011; IN COMMERCE 10-27-2011.

CLASS 41—(Continued).

4,165,636. E. & J. GALLO WINERY, MODESTO, CA. SN 85-291,983. PUB. 6-7-2011, FILED 4-11-2011.

ONE BEACH

THE MARK CONSISTS OF STANDARD CHARACTERS WITHOUT CLAIM TO ANY PARTICULAR FONT, STYLE, SIZE, OR COLOR.

FOR ENTERTAINMENT SERVICES, NAMELY, DISPLAYING A SERIES OF FILMS (U.S. CLS. 100, 101 AND 107).

FIRST USE 9-20-2011; IN COMMERCE 9-20-2011.

4,165,652. HOME BOX OFFICE, INC., NEW YORK, NY. SN 85-296,284. PUB. 8-23-2011, FILED 4-15-2011.



OWNER OF U.S. REG. NOS. 1,349,993, 3,904,923, AND OTHERS.

THE MARK CONSISTS OF "CINEMAX" IN SLANTED BLOCK LETTERS ON A QUADRILATERAL BACKGROUND.

FOR ENTERTAINMENT SERVICES, IN THE NATURE OF PROVIDING NON-DOWNLOADABLE ENTERTAINMENT PROGRAMS AND CONTENT, NAMELY, FILMS, TELEVISION PROGRAMS AND RELATED CLIPS, GRAPHICS AND INFORMATION IN THE FIELDS OF DRAMA, COMEDY, ACTION, ADVENTURE, DOCUMENTARY, SPORTS, MUSIC, VARIETY, ENTERTAINMENT NEWS, DOCUMENTARY AND ANIMATION RENDERED THROUGH THE MEDIA OF TELEVISION, CABLE AND SATELLITE SYSTEMS, THE INTERNET, ELECTRONIC COMMUNICATIONS NETWORKS AND WIRELESS COMMUNICATION NETWORKS; PRODUCTION AND DISTRIBUTION OF TELEVISION PROGRAMS AND MOTION PICTURES RENDERED THROUGH THE MEDIA OF TELEVISION, CABLE AND SATELLITE SYSTEMS, AND THE INTERNET; TELEVISION PROGRAMMING SERVICES; INTERACTIVE ONLINE ENTERTAINMENT IN THE NATURE OF A WEBSITE CONTAINING NON-DOWNLOADABLE PHOTOGRAPHIC, VIDEO AND PROSE PRESENTATIONS, RELATED VIDEO CLIPS AND OTHER MULTIMEDIA MATERIALS FEATURING CONTENT FROM OR RELATING TO TELEVISION PROGRAMS AND TELEVISION FILMS IN THE FIELDS OF DRAMA, COMEDY, ACTION, ADVENTURE, DOCUMENTARY, SPORTS, MUSIC, VARIETY, ENTERTAINMENT NEWS, DOCUMENTARY AND ANIMATION (U.S. CLS. 100, 101 AND 107).

FIRST USE 8-15-2011; IN COMMERCE 8-15-2011.

CLASS 41—(Continued).

4,165,694. BROWN, WESLEY B., LOS ANGELES, CA. SN 85-310,358. PUB. 9-20-2011, FILED 5-2-2011.

eyedee.com

THE MARK CONSISTS OF STANDARD CHARACTERS WITHOUT CLAIM TO ANY PARTICULAR FONT, STYLE, SIZE, OR COLOR.

FOR ENTERTAINMENT SERVICES, NAMELY, PROVIDING A WEB SITE FEATURING PHOTOGRAPHIC, VIDEO AND PROSE PRESENTATIONS FEATURING PHOTOGRAPHS TAKEN BY MOBILE PHONE USERS FOR ENTERTAINMENT AND INFORMATIONAL PURPOSES (U.S. CLS. 100, 101 AND 107).

FIRST USE 8-25-2011; IN COMMERCE 8-25-2011.

4,165,710. DIGITAL ENTERTAINMENT CORPORATION OF AMERICA, SANTA MONICA, CA. SN 85-317,088. PUB. 9-13-2011, FILED 5-10-2011.



THE MARK CONSISTS OF THE WORDS "HER" AND "SAY" SET FORTH IN SEPARATE COMIC BOOK BALLOONS.

FOR AN ON-GOING SERIES IN THE FIELDS OF NEWS AND ENTERTAINMENT PROVIDED THROUGH WEBCASTS (U.S. CLS. 100, 101 AND 107).

FIRST USE 5-16-2011; IN COMMERCE 5-16-2011.

4,165,713. STULLER, INC., LAFAYETTE, LA. SN 85-317,900. PUB. 10-11-2011, FILED 5-11-2011.

**BRIDGE
BE TOMORROW'S JEWELER**

THE MARK CONSISTS OF STANDARD CHARACTERS WITHOUT CLAIM TO ANY PARTICULAR FONT, STYLE, SIZE, OR COLOR.

FOR CONDUCTING WORKSHOPS AND SEMINARS IN THE FIELD OF JEWELRY, JEWELRY SERVICES AND JEWELRY RETAIL (U.S. CLS. 100, 101 AND 107).

FIRST USE 2-0-2011; IN COMMERCE 2-0-2011.

CLASS 41—(Continued).

4,165,721. NORTHWEST FLORIDA PROFESSIONAL BASEBALL, LLC, PENSACOLA, FL. SN 85-326,021. PUB. 10-11-2011, FILED 5-20-2011.

BLUE WAHOOS

THE MARK CONSISTS OF STANDARD CHARACTERS WITHOUT CLAIM TO ANY PARTICULAR FONT, STYLE, SIZE, OR COLOR.

FOR ENTERTAINMENT SERVICES IN THE NATURE OF BASEBALL GAMES AND EXHIBITIONS, AND PERSONAL APPEARANCES BY A SPORTS MASCOT (U.S. CLS. 100, 101 AND 107).

FIRST USE 11-18-2011; IN COMMERCE 11-18-2011.

4,165,734. POEM, SANTA MONICA, CA. SN 85-333,289. PUB. 11-1-2011, FILED 5-30-2011.

POEM

THE MARK CONSISTS OF STANDARD CHARACTERS WITHOUT CLAIM TO ANY PARTICULAR FONT, STYLE, SIZE, OR COLOR.

FOR VIDEO PRODUCTION SERVICES (U.S. CLS. 100, 101 AND 107).

FIRST USE 6-2-2011; IN COMMERCE 8-23-2011.

4,165,741. FOOD FAMILY FARMING FOUNDATION, BOULDER, CO. SN 85-338,249. PUB. 1-31-2012, FILED 6-5-2011.



NO CLAIM IS MADE TO THE EXCLUSIVE RIGHT TO USE "SALAD BAR", APART FROM THE MARK AS SHOWN.

THE COLOR(S) GREY, WHITE, RED, ORANGE, YELLOW, GREEN, BLUE, AND PURPLE IS/ARE CLAIMED AS A FEATURE OF THE MARK.

THE MARK CONSISTS OF A CIRCULAR SHAPE MADE

CLASS 41—(Continued).

UP OF AN ARRAY OF FRUITS AND VEGETABLES ON THE TOP HALF OF THE CIRCLE AND A CIRCULAR LINE IN A RAINBOW OF COLORS RED, ORANGE, YELLOW, GREEN, BLUE, AND PURPLE AS THE BOTTOM HALF OF THE CIRCLE. THE FRUITS AND VEGETABLES ARE, STARTING FROM THE LEFT, A RED APPLE WITH A GREEN LEAF AND RED STEM, TWO ORANGE CARROTS WITH THREE GREEN LEAVES ON TOP OF EACH CARROT, A YELLOW CORN ON THE COB WITH TWO GREEN LEAVES, A GREEN LETTUCE LEAF, A CROWN OF GREEN BROCCOLI FLORETS, ELEVEN BLUE BLUEBERRIES AND TWO PURPLE PLUMS. INSIDE THE CIRCLE IS THE COLOR WHITE AND THE WORDS "I MADE A" IN GREY ABOVE THE WORD "RAINBOW" IN GREY, WHICH IS ABOVE THE WORDS "AT THE SALAD BAR TODAY" IN GREEN. THE WORDS "WWW.THELUNCHBOX.ORG" IN GREY FOLLOW THE CURVE OF THE BOTTOM HALF OF THE CIRCLE. THE COLOR WHITE ALSO APPEARS INSIDE THE FRUITS.

FOR EDUCATION SERVICES, NAMELY, PROVIDING EDUCATION RESOURCE INFORMATION ABOUT EDUCATING CHILDREN ON THE SUBJECT MATTERS OF SALAD BARS AND THE CONSUMPTION OF FRUITS AND VEGETABLES IN SCHOOL ENVIRONMENTS; SCHOOL FOOD SERVICE EDUCATION, NAMELY, PROVIDING WEBINARS IN THE SUBJECT MATTER OF SALAD BAR IMPLEMENTATION (U.S. CLS. 100, 101 AND 107).

FIRST USE 8-23-2011; IN COMMERCE 12-8-2011.

4,165,747. RIVER ROCK ENTERTAINMENT AUTHORITY, A GOVERNMENT INSTRUMENTALITY OF THE DRY CREEK RANCHERIA OF POMO INDIANS, DBA RIVER ROCK CASINO, GEYSERVILLE, CA. SN 85-341,512. PUB. 2-28-2012, FILED 6-8-2011.

WE COMP FUN

THE MARK CONSISTS OF STANDARD CHARACTERS WITHOUT CLAIM TO ANY PARTICULAR FONT, STYLE, SIZE, OR COLOR.

FOR CASINOS (U.S. CLS. 100, 101 AND 107).
FIRST USE 1-1-2010; IN COMMERCE 1-1-2010.

4,165,758. MARIA BALINSKA, CAMBRIDGE, MA. SN 85-345,705. PUB. 12-6-2011, FILED 6-14-2011.

Latitude News

THE MARK CONSISTS OF STANDARD CHARACTERS WITHOUT CLAIM TO ANY PARTICULAR FONT, STYLE, SIZE, OR COLOR.

CLASS 41—(Continued).

NO CLAIM IS MADE TO THE EXCLUSIVE RIGHT TO USE "NEWS", APART FROM THE MARK AS SHOWN.

FOR NEWS AGENCIES, NAMELY, GATHERING AND DISSEMINATION OF NEWS; NEWS REPORTER SERVICES IN THE NATURE OF NEWS ANALYSIS AND NEWS COMMENTARY; NEWS REPORTERS SERVICES (U.S. CLS. 100, 101 AND 107).

FIRST USE 11-1-2010; IN COMMERCE 11-1-2010.

4,165,811. THE PARTY PORTFOLIO, INC., MCLEAN, VA. SN 85-373,664. PUB. 12-13-2011, FILED 7-18-2011.

TIME 2 BE WED

THE MARK CONSISTS OF STANDARD CHARACTERS WITHOUT CLAIM TO ANY PARTICULAR FONT, STYLE, SIZE, OR COLOR.

NO CLAIM IS MADE TO THE EXCLUSIVE RIGHT TO USE "WED", APART FROM THE MARK AS SHOWN.

FOR PROVIDING A WEBSITE FEATURING WEDDING PLANNING INFORMATION (U.S. CLS. 100, 101 AND 107).

FIRST USE 1-1-2012; IN COMMERCE 1-1-2012.

4,165,826. WILLIAM SCHWEIBINZ, ALBUQUERQUE, NM. SN 85-379,867. PUB. 1-24-2012, FILED 7-25-2011.

DANZATORE PUBLISHING

THE MARK CONSISTS OF STANDARD CHARACTERS WITHOUT CLAIM TO ANY PARTICULAR FONT, STYLE, SIZE, OR COLOR.

NO CLAIM IS MADE TO THE EXCLUSIVE RIGHT TO USE "PUBLISHING", APART FROM THE MARK AS SHOWN.

THE ENGLISH TRANSLATION OF "DANZATORE" IN THE MARK IS "DANCER".

FOR PUBLICATION OF BOOKS (U.S. CLS. 100, 101 AND 107).

FIRST USE 2-1-2012; IN COMMERCE 2-1-2012.

CLASS 41—(Continued).

4,165,827. GAY & LESBIAN ALLIANCE AGAINST DEFAMATION, INC., LOS ANGELES, CA. SN 85-380,950. PUB. 1-24-2012, FILED 7-26-2011.

AMPLIFIER AWARDS

THE MARK CONSISTS OF STANDARD CHARACTERS WITHOUT CLAIM TO ANY PARTICULAR FONT, STYLE, SIZE, OR COLOR.

NO CLAIM IS MADE TO THE EXCLUSIVE RIGHT TO USE "AWARDS", APART FROM THE MARK AS SHOWN.

FOR ENTERTAINMENT SERVICES, NAMELY, PROVIDING RECOGNITION AND INCENTIVES BY THE WAY OF ORGANIZING AND CONDUCTING CELEBRATION EVENTS AND AWARD CEREMONIES TO DEMONSTRATE EXCELLENCE IN THE FIELD OF LESBIAN, GAY, BISEXUAL AND TRANSGENDER ISSUES (U.S. CLS. 100, 101 AND 107).

FIRST USE 10-4-2011; IN COMMERCE 10-4-2011.

4,165,848. ARTIX ENTERTAINMENT, LLC, LAND O' LAKES, FL. SN 85-392,557. PUB. 1-10-2012, FILED 8-8-2011.

Pony vs Pony

THE MARK CONSISTS OF STANDARD CHARACTERS WITHOUT CLAIM TO ANY PARTICULAR FONT, STYLE, SIZE, OR COLOR.

FOR ENTERTAINMENT SERVICES, NAMELY, PROVIDING AN ONLINE, REAL-TIME COMPUTER GAME FOR OTHERS OVER GLOBAL AND LOCAL AREA COMPUTER NETWORKS (U.S. CLS. 100, 101 AND 107).

FIRST USE 9-2-2011; IN COMMERCE 9-2-2011.

4,165,880. VAMPIAR EMPYRE, FAIRBORN, OH. SN 85-405,716. PUB. 2-7-2012, FILED 8-24-2011.

Vampiar Empyre

THE MARK CONSISTS OF STANDARD CHARACTERS WITHOUT CLAIM TO ANY PARTICULAR FONT, STYLE, SIZE, OR COLOR.

FOR PHOTOGRAPHY (U.S. CLS. 100, 101 AND 107).

FIRST USE 4-1-2012; IN COMMERCE 4-1-2012.

CLASS 41—(Continued).

4,165,883. A F.I.T. LLC, NEWBERG, OR. SN 85-406,968. PUB. 2-7-2012, FILED 8-25-2011.

MOTA FITNESS

THE MARK CONSISTS OF STANDARD CHARACTERS WITHOUT CLAIM TO ANY PARTICULAR FONT, STYLE, SIZE, OR COLOR.

NO CLAIM IS MADE TO THE EXCLUSIVE RIGHT TO USE "FITNESS", APART FROM THE MARK AS SHOWN.

FOR HEALTH CLUB SERVICES, NAMELY, PROVIDING INSTRUCTION AND EQUIPMENT IN THE FIELD OF PHYSICAL EXERCISE; PROVIDING FITNESS AND EXERCISE FACILITIES (U.S. CLS. 100, 101 AND 107).

FIRST USE 9-28-2011; IN COMMERCE 9-28-2011.

4,165,888. MUSICAL INSTRUMENT MUSEUM, PHOENIX, AZ. SN 85-413,364. PUB. 2-21-2012, FILED 9-1-2011.

I AM AZ MUSIC

THE MARK CONSISTS OF STANDARD CHARACTERS WITHOUT CLAIM TO ANY PARTICULAR FONT, STYLE, SIZE, OR COLOR.

FOR MUSEUM SERVICES; GUIDED TOURS OF A MUSEUM; ORGANIZING EXHIBITIONS FOR EDUCATIONAL, CULTURAL AND ENTERTAINMENT PURPOSES FEATURING EXHIBITS IN THE FIELD OF MUSIC AND IN THE HISTORY AND SCIENCE OF MUSICAL INSTRUMENTS; ENTERTAINMENT SERVICES, NAMELY, LIVE MUSICAL CONCERTS AND MUSICAL INSTRUMENTAL PERFORMANCES; EDUCATIONAL SERVICES, NAMELY, PROVIDING COURSES OF INSTRUCTION, CLASSES, ONLINE EXHIBITIONS, CONFERENCES, WORKSHOPS, SEMINARS, AUDIO AND VIDEO PRESENTATIONS AND LECTURES IN THE FIELD OF MUSIC AND IN THE HISTORY AND SCIENCE OF MUSICAL INSTRUMENTS; MUSEUM SERVICES, NAMELY, CONDUCTING ONLINE EXHIBITIONS AND DISPLAYS IN THE FIELD OF MUSIC AND MUSICAL INSTRUMENTS; DEVELOPMENT AND DISSEMINATION OF EDUCATIONAL AND CURRICULAR MATERIALS OF OTHERS DEALING WITH THE HISTORY AND SCIENCE OF MUSIC AND MUSICAL INSTRUMENTS (U.S. CLS. 100, 101 AND 107).

FIRST USE 7-11-2011; IN COMMERCE 2-18-2012.

CLASS 41—(Continued).

4,165,898. NETWORK ENTERPRISES, INC., NEW YORK, NY. SN 85-429,574. PUB. 1-10-2012, FILED 9-22-2011.

FLIP MEN

THE MARK CONSISTS OF STANDARD CHARACTERS WITHOUT CLAIM TO ANY PARTICULAR FONT, STYLE, SIZE, OR COLOR.

FOR ENTERTAINMENT SERVICES, NAMELY, PROVIDING ON-GOING TELEVISION PROGRAMS FEATURING LIVE ACTION, DRAMA, COMEDY, ANIMATION, MUSIC, NEWS, AND GENERAL ENTERTAINMENT; PROVIDING ONLINE INFORMATION IN THE FIELD OF ENTERTAINMENT CONCERNING TELEVISION PROGRAMS (U.S. CLS. 100, 101 AND 107).
FIRST USE 7-17-2011; IN COMMERCE 7-17-2011.

4,165,918. AOL INC., DULLES, VA. SN 85-976,374. PUB. 8-2-2011, FILED 4-11-2011.

MAKERS

THE MARK CONSISTS OF STANDARD CHARACTERS WITHOUT CLAIM TO ANY PARTICULAR FONT, STYLE, SIZE, OR COLOR.

FOR ENTERTAINMENT SERVICES, NAMELY, PROVIDING A WEBSITE FEATURING DOCUMENTARY INFORMATION ABOUT NOTABLE WOMEN; PROVIDING A WEBSITE FEATURING INTERVIEWS OF AND FILM CLIPS ABOUT NOTABLE WOMEN; PROVIDING A WEBSITE FEATURING INFORMATION ABOUT WOMEN'S ISSUES AND INFORMATION ABOUT AND ANALYSIS OF THE ACHIEVEMENTS AND CONTRIBUTIONS OF NOTABLE WOMEN; EDUCATIONAL SERVICES, NAMELY, CONDUCTING ON-LINE EXHIBITIONS AND DISPLAYS AND INTERACTIVE EXHIBITS IN THE FIELDS OF ACHIEVEMENTS AND CONTRIBUTIONS OF NOTABLE WOMEN AND WOMEN'S ISSUES (U.S. CLS. 100, 101 AND 107).
FIRST USE 2-28-2012; IN COMMERCE 2-28-2012.

CLASS 41—(Continued).

4,165,933. BUTTERFLY ARTISTIC MEDIA, LLC, NEW YORK, NY. SN 85-976,718. PUB. 8-16-2011, FILED 3-16-2011.

CHET THE ARCHITECT

THE MARK CONSISTS OF STANDARD CHARACTERS WITHOUT CLAIM TO ANY PARTICULAR FONT, STYLE, SIZE, OR COLOR.

FOR ENTERTAINMENT SERVICES, NAMELY, PROVIDING A WEBSITE FEATURING GAMES AND PUZZLES; ENTERTAINMENT SERVICES, NAMELY, PROVIDING AN ON-LINE COMPUTER GAME; PROVIDING A WEBSITE FEATURING INFORMATION IN THE FIELDS OF EDUCATION AND ENTERTAINMENT FOR CHILDREN (U.S. CLS. 100, 101 AND 107).
FIRST USE 3-23-2011; IN COMMERCE 3-23-2011.

CLASS 42—SCIENTIFIC AND COMPUTER SERVICES

4,164,845. LIBERTY COACH, INC., NORTH CHICAGO, IL. SN 77-580,934. PUB. 2-17-2009, FILED 9-29-2008.

LIBERTY I-LINK

THE MARK CONSISTS OF STANDARD CHARACTERS WITHOUT CLAIM TO ANY PARTICULAR FONT, STYLE, SIZE, OR COLOR.

FOR ON-LINE DIAGNOSTIC SERVICES IN THE FIELD OF MOTOR COACHES (U.S. CLS. 100 AND 101).
FIRST USE 2-7-2012; IN COMMERCE 5-8-2012.

4,164,855. 6N SYSTEMS, INC., CLIFTON PARK, NY. SN 77-595,419. PUB. 3-10-2009, FILED 10-17-2008.

6N EMR

THE MARK CONSISTS OF STANDARD CHARACTERS WITHOUT CLAIM TO ANY PARTICULAR FONT, STYLE, SIZE, OR COLOR.

OWNER OF U.S. REG. NO. 3,159,816.
NO CLAIM IS MADE TO THE EXCLUSIVE RIGHT TO USE "EMR", APART FROM THE MARK AS SHOWN.
FOR APPLICATION SERVICE PROVIDER (ASP) FEATURING SOFTWARE FOR USE IN MEDICAL RECORDS MANAGEMENT (U.S. CLS. 100 AND 101).
FIRST USE 3-27-2012; IN COMMERCE 3-27-2012.

CLASS 42—(Continued).

4,164,884. INSPIRE FOUNDATION, BALMAIN NSW, AUSTRALIA. SN 77-758,727. PUB. 8-31-2010, FILED 6-12-2009.

REACHOUT.COM

THE MARK CONSISTS OF STANDARD CHARACTERS WITHOUT CLAIM TO ANY PARTICULAR FONT, STYLE, SIZE, OR COLOR.

FOR COMPUTER SERVICES IN THE NATURE OF CREATING CUSTOMIZED WEB PAGES FEATURING USER-DEFINED INFORMATION, PERSONAL PROFILES AND INFORMATION, ALL IN THE FIELD OF MENTAL HEALTH (U.S. CLS. 100 AND 101).

FIRST USE 3-1-2010; IN COMMERCE 3-1-2010.

4,164,931. CAREER EDUCATION CORPORATION, SCHAUMBURG, IL. SN 77-848,610. PUB. 8-31-2010, FILED 10-14-2009.



NO CLAIM IS MADE TO THE EXCLUSIVE RIGHT TO USE "VIRTUAL TRAINER", APART FROM THE MARK AS SHOWN.

THE MARK CONSISTS OF THE STYLIZED WORDING "SIMPRO VIRTUAL TRAINER", WITH THE WORDS "VIRTUAL TRAINER" APPEARING BELOW "SIMPRO". TO THE RIGHT OF "SIMPRO" ARE FOUR OVERLAPPING DIAMOND SHAPES.

FOR PROVIDING ON-LINE NON-DOWNLOADABLE COMPUTER SOFTWARE FOR USE IN EDUCATING AND TRAINING STUDENTS IN THE HEALTHCARE FIELD (U.S. CLS. 100 AND 101).

FIRST USE 9-29-2009; IN COMMERCE 9-29-2009.

4,164,938. FUGRO AIRBORNE SURVEYS CORP., MISSISSAUGA, ONTARIO, CANADA. SN 77-871,342. PUB. 8-23-2011, FILED 11-12-2009.

TEMPEST

THE MARK CONSISTS OF STANDARD CHARACTERS WITHOUT CLAIM TO ANY PARTICULAR FONT, STYLE, SIZE, OR COLOR.

CLASS 42—(Continued).

PRIORITY CLAIMED UNDER SEC. 44(D) ON CANADA APPLICATION NO. 1458363, FILED 11-9-2009, REG. NO. TMA788,002, DATED 1-19-2011, EXPIRES 1-19-2026.

FOR PROVIDING AIRBORNE ELECTROMAGNETIC SURVEYING; PROVIDING AIRBORNE ELECTROMAGNETIC SURVEYING DATA, AND ANALYZING AIRBORNE ELECTROMAGNETIC SURVEYING DATA; CONDUCTING GEOPHYSICAL SURVEYS (U.S. CLS. 100 AND 101).

FIRST USE 1-0-2008; IN COMMERCE 1-0-2008.

4,165,024. GLOBAL ALLIANCE FOR IMPROVED NUTRITION, THE, 1202 GENEVA, SWITZERLAND. SN 78-738,973. PUB. 2-17-2009, FILED 10-24-2005.



OWNER OF SWITZERLAND REG. NO. 534302, DATED 6-7-2005, EXPIRES 4-22-2015.

NO CLAIM IS MADE TO THE EXCLUSIVE RIGHT TO USE "GLOBAL ALLIANCE FOR IMPROVED NUTRITION", APART FROM THE MARK AS SHOWN.

THE MARK CONSISTS OF THE CUT-AWAY REPRESENTATION OF A BOWL FILLED WITH STYLIZED LEAF-LIKE DESIGNS WITH WORDING APPEARING TO THE RIGHT OF THE BOWL.

FOR SCIENTIFIC AND TECHNOLOGICAL RESEARCH AND DEVELOPMENT IN THE FIELD OF HEALTH AND NUTRITION (U.S. CLS. 100 AND 101).

FIRST USE 8-1-2009; IN COMMERCE 5-12-2010.

4,165,051. UNIVERSAL SOFTWARE CORP., BROOKLYN, NY. SN 85-017,916. PUB. 9-21-2010, FILED 4-20-2010.

UNIVERSAL SOFTWARE

THE MARK CONSISTS OF STANDARD CHARACTERS WITHOUT CLAIM TO ANY PARTICULAR FONT, STYLE, SIZE, OR COLOR.

NO CLAIM IS MADE TO THE EXCLUSIVE RIGHT TO USE "SOFTWARE", APART FROM THE MARK AS SHOWN.

FOR DESIGN AND DEVELOPMENT OF COMPUTER SOFTWARE IN THE FIELD OF MEDICAL RECORDS MANAGEMENT (U.S. CLS. 100 AND 101).

FIRST USE 5-1-2012; IN COMMERCE 5-1-2012.

CLASS 42—(Continued).

4,165,052. INTUIT INC., MOUNTAIN VIEW, CA. SN 85-018,658. PUB. 3-15-2011, FILED 4-20-2010.

INTUIT TRENDS

THE MARK CONSISTS OF STANDARD CHARACTERS WITHOUT CLAIM TO ANY PARTICULAR FONT, STYLE, SIZE, OR COLOR.

OWNER OF U.S. REG. NOS. 2,729,119, 2,729,360, AND OTHERS.

NO CLAIM IS MADE TO THE EXCLUSIVE RIGHT TO USE "TRENDS", APART FROM THE MARK AS SHOWN.

FOR PROVIDING TEMPORARY USE OF NON-DOWNLOADABLE COMPUTER SOFTWARE FOR USE BY SMALL BUSINESSES TO ANALYZE INDUSTRY TRENDS, SHARE BUSINESS AND FINANCIAL OBSERVATIONS, AND COMPARE PERFORMANCE WITH USER-DEFINED GROUPS; PROVIDING TEMPORARY USE OF NON-DOWNLOADABLE SOFTWARE THAT PROVIDES FINANCIAL DATA FOR USE BY SMALL BUSINESSES; PROVIDING TEMPORARY USE OF NON-DOWNLOADABLE SOFTWARE FOR USE IN MEASURING, PLOTTING, AND ANALYZING FINANCIAL MICRO AND MACRO TRENDS, REVENUE, SALES, EXPENSES, AND PROFITS; PROVIDING TEMPORARY USE OF NON-DOWNLOADABLE SOFTWARE FOR USE IN COMPARING EXPENSES, INCOME, PROFIT, PROFIT MARGINS, LIQUIDITY, SALES GROWTH, AND CASH FLOW WITH USER-DEFINED GROUPS OF BUSINESSES; PROVIDING TEMPORARY USE OF NON-DOWNLOADABLE BUSINESS MANAGEMENT SOFTWARE; PROVIDING TEMPORARY USE OF NON-DOWNLOADABLE FINANCIAL MANAGEMENT SOFTWARE; PROVIDING A WEBSITE FEATURING TECHNOLOGY THAT ENABLES USERS TO IDENTIFY AND HIGHLIGHT MARKET, BUSINESS, FINANCIAL, INDUSTRY, AND SALES TRENDS AND SHARE OBSERVATIONS WITH A COMMUNITY OF OTHER USERS (U.S. CLS. 100 AND 101).

FIRST USE 10-29-2009; IN COMMERCE 10-29-2009.

4,165,070. IAM ENTERPRISING CORP., DBA KEYSTONE CERTIFICATION, CHESAPEAKE, VA. SN 85-036,646. PUB. 1-25-2011, FILED 5-12-2010.



NO CLAIM IS MADE TO THE EXCLUSIVE RIGHT TO USE "CERTIFICATION", APART FROM THE MARK AS SHOWN.

THE COLOR(S) BLUE AND GOLD IS/ARE CLAIMED AS A FEATURE OF THE MARK.

THE MARK CONSISTS OF A BLUE STAR-SHAPED IMAGE OF INTERLOCKING OVALS WITH FOUR GOLD CIRCLES, RESEMBLING AN ATOMIC MODEL, TO THE LEFT OF THE WORDING "KEYSTONE CERTIFICATION" IN BLUE.

FOR TESTING, ANALYSIS AND EVALUATION OF THE GOODS OF OTHERS FOR THE PURPOSE OF CERTIFICATION IN THE FIELD OF BIOSAFETY EQUIPMENT (U.S. CLS. 100 AND 101).

FIRST USE 1-1-2010; IN COMMERCE 1-1-2010.

CLASS 42—(Continued).

4,165,073. MACHEEN INC., AUSTIN, TX. SN 85-038,209. PUB. 8-30-2011, FILED 5-13-2010.

MACHEEN

THE MARK CONSISTS OF STANDARD CHARACTERS WITHOUT CLAIM TO ANY PARTICULAR FONT, STYLE, SIZE, OR COLOR.

FOR APPLICATION SERVICE PROVIDER (ASP) FEATURING SOFTWARE FOR DELIVERY OF INTERNET CONNECTIVITY, CLOUD COMPUTING, AND CONNECTIVITY TO PUBLIC AND PRIVATE NETWORKS, ALL FOR USERS OF MOBILE WIRELESS COMMUNICATIONS DEVICES IN THE FIELDS OF ELECTRONICS, MEDIA, ENTERTAINMENT, COMPUTING AND OTHER SECTORS REQUIRING INTERNET ACCESSIBLE DEVICES (U.S. CLS. 100 AND 101).

FIRST USE 2-28-2011; IN COMMERCE 2-28-2011.

4,165,090. MISENHEIMER, COREY, MONROE, NC. SN 85-070,321. PUB. 4-19-2011, FILED 6-24-2010.

YOUR STRUCTURAL SPECIALISTS

THE MARK CONSISTS OF STANDARD CHARACTERS WITHOUT CLAIM TO ANY PARTICULAR FONT, STYLE, SIZE, OR COLOR.

FOR COMPUTER SERVICES, NAMELY, PROVIDING COMPUTER-AIDED DESIGN OF WOOD TRUSSES FOR ARCHITECTS AND ENGINEERS IN THE FIELD OF ENGINEERING (U.S. CLS. 100 AND 101).

FIRST USE 8-1-2010; IN COMMERCE 6-13-2011.

4,165,109. GRIECO, MICHELLE, BEDMINSTER, NJ. SN 85-089,961. PUB. 12-28-2010, FILED 7-21-2010.

**Late Great Bloomers
Late Start ~ Great Finish**

THE MARK CONSISTS OF STANDARD CHARACTERS WITHOUT CLAIM TO ANY PARTICULAR FONT, STYLE, SIZE, OR COLOR.

FOR COMPUTER SERVICES, NAMELY, CREATING AN ON-LINE COMMUNITY FOR REGISTERED USERS TO PARTICIPATE IN DISCUSSIONS, GET FEEDBACK FROM THEIR PEERS, FORM VIRTUAL COMMUNITIES, AND ENGAGE IN SOCIAL NETWORKING (U.S. CLS. 100 AND 101).

FIRST USE 7-1-2010; IN COMMERCE 7-1-2010.

CLASS 42—(Continued).

4,165,133. PRESORT SERVICES, INC., LANSING, MI. SN 85-108,235. PUB. 8-16-2011, FILED 8-16-2010.



THE MARK CONSISTS OF THE WORDING "DOCUSMART" IN STYLIZED LETTERING AND A DESIGN OF FOUR SIDED GEOMETRIC FIGURES WHICH TRAIL OFF INTO THE DISTANCE.

FOR PROVIDING TEMPORARY USE OF ON-LINE NON-DOWNLOADABLE SOFTWARE FOR ENTERPRISE RESOURCE PLANNING (ERP) (U.S. CLS. 100 AND 101). FIRST USE 9-7-2010; IN COMMERCE 9-7-2010.

4,165,180. SCHLUMBERGER TECHNOLOGY CORPORATION, SUGAR LAND, TX. SN 85-122,061. PUB. 8-16-2011, FILED 9-2-2010.

GEO-FRAC

THE MARK CONSISTS OF STANDARD CHARACTERS WITHOUT CLAIM TO ANY PARTICULAR FONT, STYLE, SIZE, OR COLOR.

FOR WELL LOGGING (U.S. CLS. 100 AND 101). FIRST USE 12-15-2010; IN COMMERCE 12-15-2010.

4,165,203. BROADRIDGE FINANCIAL SOLUTIONS, INC., JERSEY CITY, NJ. SN 85-128,992. PUB. 8-16-2011, FILED 9-14-2010.

VOTE CONNECT

THE MARK CONSISTS OF STANDARD CHARACTERS WITHOUT CLAIM TO ANY PARTICULAR FONT, STYLE, SIZE, OR COLOR.

NO CLAIM IS MADE TO THE EXCLUSIVE RIGHT TO USE "VOTE", APART FROM THE MARK AS SHOWN.

FOR PROVIDING TEMPORARY USE OF A NON-DOWNLOADABLE COMPUTER SOFTWARE APPLICATION FOR PROXY MANAGEMENT AND PROCESSING VIA A GLOBAL TELECOMMUNICATIONS NETWORK (U.S. CLS. 100 AND 101).

FIRST USE 8-0-2011; IN COMMERCE 8-0-2011.

CLASS 42—(Continued).

4,165,236. GLOBECOM ONE, LLC, PALO ALTO, CA. SN 85-141,147. PUB. 3-15-2011, FILED 9-29-2010.



THE COLOR(S) BLACK, RED, ORANGE, YELLOW, GREEN, LIGHT BLUE, INDIGO AND VIOLET IS/ARE CLAIMED AS A FEATURE OF THE MARK.

THE MARK CONSISTS OF A RAINBOW COLORED CIRCLE, WITH A COLOR GRADIENT OF THE VISIBLE SPECTRUM, ORIGINATING IN THE UPPER LEFTHAND QUADRANT WITH RED THEN ORANGE THEN YELLOW, THEN GREEN, THEN LIGHT BLUE, THEN INDIGO, AND FINALLY ENDING WITH VIOLET IN THE LOWER LEFT HAND QUADRANT. THERE IS AN OPAQUE BLACK UNEVEN QUADRILATERAL WITH CURVED LINES FOR THE EDGES WITHIN THE CENTER OF THE RAINBOW GRADIATED CIRCLE. DIRECTLY TO THE RIGHT OF THE PREVIOUSLY DESCRIBED CIRCLE IS THE WORD "ENERWINGS" IN BLACK.

FOR SOFTWARE AS A SERVICE (SAAS) SERVICES FEATURING SOFTWARE FOR WEB DESIGN WITH CONTROL MANAGEMENT SYSTEM (U.S. CLS. 100 AND 101).

FIRST USE 11-1-2010; IN COMMERCE 11-7-2011.

4,165,240. TICKENOFF, JOSHUA, COSTA MESA, CA. SN 85-142,615. PUB. 3-15-2011, FILED 9-30-2010.

KALOS ARCHITECTURE

THE MARK CONSISTS OF STANDARD CHARACTERS WITHOUT CLAIM TO ANY PARTICULAR FONT, STYLE, SIZE, OR COLOR.

NO CLAIM IS MADE TO THE EXCLUSIVE RIGHT TO USE "ARCHITECTURE", APART FROM THE MARK AS SHOWN.

THE ENGLISH TRANSLATION OF THE WORD "KALOS" IN THE MARK IS "GOOD".

FOR ARCHITECTURAL SERVICES (U.S. CLS. 100 AND 101).

FIRST USE 3-1-2011; IN COMMERCE 3-1-2011.

CLASS 42—(Continued).

4,165,300. SPERO SOFTWARE, LLC, FRESNO, CA. SN 85-168,517. PUB. 9-6-2011, FILED 11-3-2010.



NO CLAIM IS MADE TO THE EXCLUSIVE RIGHT TO USE "SOFTWARE", APART FROM THE MARK AS SHOWN. THE COLOR(S) "ORANGE", "GRAY" AND "WHITE" IS/ARE CLAIMED AS A FEATURE OF THE MARK.

THE MARK CONSISTS OF A WHITE LETTER "S" SET WITHIN AN ORANGE FLAME; BELOW THAT THE WORD "SPERO" APPEARS IN GRAY LETTERS; BELOW THAT, IN SMALLER, ORANGE LETTERS, APPEARS THE WORD "SOFTWARE".

FOR WEB-BASED SOFTWARE, NAMELY, ON-LINE NON-DOWNLOADABLE SOFTWARE FOR DATA TRACKING AND ANALYSIS, AND FOR REPORT BUILDING (U.S. CLS. 100 AND 101).

FIRST USE 2-22-2011; IN COMMERCE 2-22-2011.

4,165,306. MOZART NETWORKS, LLC, NEW YORK, NY. SN 85-170,162. PUB. 8-23-2011, FILED 11-5-2010.

Her Mozart

THE MARK CONSISTS OF STANDARD CHARACTERS WITHOUT CLAIM TO ANY PARTICULAR FONT, STYLE, SIZE, OR COLOR.

NO CLAIM IS MADE TO THE EXCLUSIVE RIGHT TO USE "MOZART", APART FROM THE MARK AS SHOWN.

FOR PROVIDING A WEBSITE FEATURING TECHNOLOGY THAT ENABLES USERS TO UPLOAD, EXCHANGE, AND SHARE VIDEO, PHOTOS, AND OTHER FORMS OF MEDIA ON THE INTERNET AND MOBILE DEVICES (U.S. CLS. 100 AND 101).

FIRST USE 1-23-2011; IN COMMERCE 1-23-2011.

CLASS 42—(Continued).

4,165,376. G&G COMMERCE, LTD., YEONGDEUNGPO-GU, SEOUL, REPUBLIC OF KOREA. SN 85-207,775. PUB. 11-22-2011, FILED 12-30-2010.

canvasee

THE MARK CONSISTS OF STANDARD CHARACTERS WITHOUT CLAIM TO ANY PARTICULAR FONT, STYLE, SIZE, OR COLOR.

FOR TOOL DESIGN, DESIGN OF INDUSTRIAL PRODUCTS, JEWELRY DESIGN FOR OTHERS, GRAPHIC DESIGN, SHOP INTERIOR DESIGN, STATIONERY DESIGN, INDUSTRIAL DESIGN, DESIGN OF INTERIOR DECOR FOR OTHERS, TOY DESIGN, GRAPHIC ARTS DESIGN, CHARACTER DESIGN, PACKAGING DESIGN SERVICES, DRESS DESIGN, FASHION DESIGN, DEVELOPMENT OF GAME SOFTWARE, DEVELOPMENT OF DATA PROCESSING PROGRAMS, DEVELOPING OF DRIVER AND OPERATING SYSTEM SOFTWARE, PROGRAMMING OF MULTIMEDIA APPLICATIONS, WEB SITE DEVELOPMENT, WEB SITE MANAGEMENT, WEB SITE DESIGN, WEB SITE MAINTENANCE, CREATING AND MAINTAINING WEB SITES FOR OTHERS, WEB PAGE DESIGN, RENTAL OF APPLICATION SOFTWARE, PROVIDING SEARCH ENGINES FOR THE INTERNET, PROVIDING TEMPORARY USE OF NON-DOWNLOADABLE COMPUTER PROGRAMS FOR INTERNET SECURITY, CONVERSION OF DATA OR DOCUMENTS FROM PHYSICAL TO ELECTRONIC MEDIA, MANAGEMENT OF WEB SITES FOR ELECTRONIC COMMERCE, MAINTENANCE OF WEB SITES FOR ELECTRONIC COMMERCE, COMPUTER PROGRAMMING FOR ELECTRONIC COMMERCE, DEVELOPMENT OF COMPUTER GAME SOFTWARE, DUPLICATION OF COMPUTER GAME SOFTWARE, MAINTENANCE OF COMPUTER GAME SOFTWARE, COMPUTER GAME PROGRAMMING, ADVISORY SERVICES RELATING TO COMPUTER HARDWARE AND SOFTWARE, COMPUTER SOFTWARE DEVELOPMENT, RENTAL OF COMPUTER SOFTWARE, COMPUTER SOFTWARE DESIGN, COMPUTER SOFTWARE CONSULTANCY, INSTALLATION OF COMPUTER SOFTWARE, REPAIR OF COMPUTER SOFTWARE, UPDATING OF COMPUTER SOFTWARE, COMPUTER SOFTWARE RESEARCH, MAINTENANCE OF COMPUTER SOFTWARE, ADVISORY AND DEVELOPMENT SERVICE OF COMPUTER SOFTWARE, COMPUTER SYSTEM DESIGN, COMPUTER SYSTEMS ANALYSIS, DESIGN AND DEVELOPMENT OF COMPUTER SYSTEMS, COMPUTER RENTAL, COMPUTER PROGRAMMING, DATA CONVERSION OF COMPUTER PROGRAMS AND DATA, NOT PHYSICAL CONVERSION, DEVELOPMENT OF COMPUTER PROGRAMS, DUPLICATION OF COMPUTER PROGRAMS, RENTAL OF COMPUTER PROGRAMS, COMPUTER HARDWARE DEVELOPMENT, DESIGN OF COMPUTER HARDWARE, CONSULTANCY IN THE FIELD OF COMPUTER HARDWARE (U.S. CLS. 100 AND 101).

FIRST USE 11-21-2011; IN COMMERCE 11-21-2011.

CLASS 42—(Continued).

4,165,448. RED BRICK DESIGNS LLC, OKLAHOMA CITY, OK. SN 85-248,123. PUB. 7-19-2011, FILED 2-22-2011.



THE MARK CONSISTS OF A STYLIZED FISH DESIGN TOGETHER WITH THE WORDS "LIQUIDFISH".
FOR GRAPHIC DESIGN SERVICES; WEB SITE DEVELOPMENT SERVICES FOR OTHERS (U.S. CLS. 100 AND 101).

FIRST USE 11-30-2010; IN COMMERCE 11-30-2010.

4,165,478. PREMIER CONSULTING INTERNATIONAL, MIAMI, FL. SN 85-259,908. PUB. 8-30-2011, FILED 3-7-2011.

SMARTER COMMERCE

THE MARK CONSISTS OF STANDARD CHARACTERS WITHOUT CLAIM TO ANY PARTICULAR FONT, STYLE, SIZE, OR COLOR.

NO CLAIM IS MADE TO THE EXCLUSIVE RIGHT TO USE "COMMERCE", APART FROM THE MARK AS SHOWN.

FOR PROVIDING A WEB SITE FEATURING TEMPORARY USE OF NON-DOWNLOADABLE SOFTWARE FOR CUSTOMER SERVICE, NAMELY, PROVIDING ORDER PROCESSING AND VARIOUS RELATED POST-ORDER CUSTOMER SUPPORT SERVICES, FOR RETAIL SALES, NAMELY, POINT-OF-SALE SOFTWARE TO SUPPORT STORE OPERATIONS AND RELATED INTEGRATION WITH ACCOUNTING SOFTWARE FOR INVENTORY MANAGEMENT AND OVERALL RETAIL OPERATIONS MANAGEMENT, FOR PAYMENT PROCESSING, NAMELY, PROVIDING SOFTWARE FOR CREDIT CARD PROCESSING, CHECK PROCESSING, ONLINE ELECTRONIC PAYMENTS AND VARIOUS OTHER PAYMENT METHODS, AND FOR ELECTRONIC COMMERCE, BUSINESS TO BUSINESS (B2B) AND BUSINESS TO CONSUMER (B2C) WEB-BASED COMMERCE CAPABILITIES TO ALLOW USERS TO PERFORM ELECTRONIC BUSINESS TRANSACTIONS VIA A GLOBAL COMPUTER NETWORK (U.S. CLS. 100 AND 101).

FIRST USE 4-2-2012; IN COMMERCE 4-2-2012.

CLASS 42—(Continued).

4,165,566. HYLAND SOFTWARE, INC., WESTLAKE, OH. SN 85-278,198. PUB. 9-6-2011, FILED 3-28-2011.



THE COLOR(S) RED AND WHITE IS/ARE CLAIMED AS A FEATURE OF THE MARK.

THE MARK CONSISTS OF THE WORD "BE" IN RED WITH A WHITE BACKGROUND, THE WORD "REMARKABLE" IN WHITE WITH A RED BACKGROUND, AND THE "L" IN "REMARKABLE" IS DEPICTED BY AN EXCLAMATION POINT INSTEAD OF AN "L".

FOR CONSULTATION SERVICES IN THE FIELD OF SOFTWARE FOR ENTERPRISE CONTENT MANAGEMENT AND BUSINESS PROCESS SOLUTIONS FOR OTHERS; CUSTOMIZATION, INSTALLATION, IMPLEMENTATION, AND CONVERSION OF SOFTWARE FOR ENTERPRISE CONTENT MANAGEMENT AND BUSINESS PROCESS SOLUTIONS FOR OTHERS (U.S. CLS. 100 AND 101).

FIRST USE 3-1-2012; IN COMMERCE 3-1-2012.

4,165,635. TAPPIN, INC., SEATTLE, WA. SN 85-291,829. PUB. 8-16-2011, FILED 4-11-2011.

TAPPIN

THE MARK CONSISTS OF STANDARD CHARACTERS WITHOUT CLAIM TO ANY PARTICULAR FONT, STYLE, SIZE, OR COLOR.

FOR PROVIDING TEMPORARY USE OF NONDOWNLOADABLE COMPUTER SOFTWARE FOR USE IN ACCESSING, UPDATING, MANIPULATING, MODIFYING, ORGANIZING, STORING, BACKING UP, SYNCHRONIZING, TRANSMITTING, AND SHARING DATA, DOCUMENTS, FILES, INFORMATION, TEXT, PHOTOS, IMAGES, GRAPHICS, MUSIC, AUDIO, VIDEO, AND MULTIMEDIA CONTENT VIA WIRELESS NETWORK, MOBILE TELECOMMUNICATION DEVICES, GLOBAL COMPUTER NETWORK AND OTHER COMMUNICATIONS NETWORKS; HOSTING OF DIGITAL CONTENT ON THE INTERNET; CLOUD COMPUTING FEATURING SOFTWARE FOR USE IN SECURE STORAGE OF CONTENT (U.S. CLS. 100 AND 101).

FIRST USE 9-14-2011; IN COMMERCE 9-14-2011.

CLASS 42—(Continued).

4,165,681. SPIDERROCK EXS, LLC, CHICAGO, IL. SN 85-305,749. PUB. 9-13-2011, FILED 4-27-2011.

EAGLE ORDER

THE MARK CONSISTS OF STANDARD CHARACTERS WITHOUT CLAIM TO ANY PARTICULAR FONT, STYLE, SIZE, OR COLOR.

FOR PROVIDING TEMPORARY USE OF ONLINE, NON-DOWNLOADABLE SOFTWARE TO ANONYMOUSLY SOURCE LIQUIDITY IN LISTED EXCHANGE TRADED SECURITIES, USING A TRADING ALGORITHM THAT ANALYZES HIGH-SPEED MARKET DATA AND ADVANCED MODELING TECHNIQUES TO SELECT CONDITIONS FOR TRADING WHICH HAVE MARKET IMPACT CONSISTENT WITH USER DEFINED PARAMETERS, FOR USE IN THE FIELD OF INVESTING AND FINANCIAL SERVICES (U.S. CLS. 100 AND 101).

FIRST USE 10-5-2011; IN COMMERCE 10-5-2011.

4,165,682. SPIDERROCK EXS, LLC, CHICAGO, IL. SN 85-305,751. PUB. 9-13-2011, FILED 4-27-2011.

HAWK ORDER

THE MARK CONSISTS OF STANDARD CHARACTERS WITHOUT CLAIM TO ANY PARTICULAR FONT, STYLE, SIZE, OR COLOR.

FOR PROVIDING TEMPORARY USE OF ONLINE, NON-DOWNLOADABLE SOFTWARE TO ANONYMOUSLY SOURCE LIQUIDITY IN LISTED EXCHANGE TRADED SECURITIES, USING A TRADING ALGORITHM THAT ANALYZES HIGH-SPEED MARKET DATA AND ADVANCED MODELING TECHNIQUES TO SELECT CONDITIONS FOR TRADING WHICH HAVE MARKET IMPACT CONSISTENT WITH USER DEFINED PARAMETERS, FOR USE IN THE FIELD OF INVESTING AND FINANCIAL SERVICES (U.S. CLS. 100 AND 101).

FIRST USE 10-5-2011; IN COMMERCE 10-5-2011.

CLASS 42—(Continued).

4,165,765. TRUE KNOWLEDGE LIMITED, CAMBRIDGE, UNITED KINGDOM. SN 85-353,372. PUB. 11-1-2011, FILED 6-22-2011.



THE MARK CONSISTS OF A CIRCLE WITH A DOT SLIGHTLY ABOVE THE CENTER OF THE CIRCLE. BELOW THE DOT IS A SEMI-CIRCLE CURVED UPWARD.

FOR COMPUTER SERVICES, NAMELY, SEARCH ENGINE SERVICES; COMPUTER SERVICES, NAMELY, ACTING AS AN APPLICATION SERVICE PROVIDER TO HOST THE APPLICATIONS OF OTHERS (U.S. CLS. 100 AND 101).

FIRST USE 1-17-2012; IN COMMERCE 1-17-2012.

4,165,773. LATTICE ENGINES, INC., SAN MATEO, CA. SN 85-355,340. PUB. 11-15-2011, FILED 6-24-2011.

FUNDPRISM

THE MARK CONSISTS OF STANDARD CHARACTERS WITHOUT CLAIM TO ANY PARTICULAR FONT, STYLE, SIZE, OR COLOR.

FOR APPLICATION SERVICE PROVIDER SERVICES FEATURING SOFTWARE FOR COLLECTING, INTEGRATING, CLEANSING, MANAGING, ANALYZING, UPDATING, FORECASTING AND DISTRIBUTING DATA TO IMPROVE SALES FORCE PRODUCTIVITY, SALES RESULTS, SALES AND MARKETING REPORTING, SALES AND MARKETING COACHING, SALES AND MARKETING TRAINING AND SALES AND MARKETING PLANNING, RELATING TO THE DISTRIBUTION OF FINANCIAL ASSET PRODUCTS TO RETAIL AND INSTITUTIONAL CUSTOMERS (U.S. CLS. 100 AND 101).

FIRST USE 2-29-2012; IN COMMERCE 2-29-2012.

CLASS 42—(Continued).

4,165,779. OBJECT PUBLISHING SOFTWARE, INC., SEATTLE, WA. SN 85-359,779. PUB. 11-29-2011, FILED 6-29-2011.

ALWAYS FRESH

THE MARK CONSISTS OF STANDARD CHARACTERS WITHOUT CLAIM TO ANY PARTICULAR FONT, STYLE, SIZE, OR COLOR.

FOR COMPUTER SERVICES, NAMELY, PROVIDING UPDATES AND AUTOMATIC UPDATES TO ON-LINE DOCUMENTS AND ELECTRONIC CATALOGS (U.S. CLS. 100 AND 101).

FIRST USE 4-20-2010; IN COMMERCE 4-20-2010.



4,165,785. IPAYMENT, INC., NASHVILLE, TN. SN 85-361,493. PUB. 12-6-2011, FILED 7-1-2011.

IFILESAFE

THE MARK CONSISTS OF STANDARD CHARACTERS WITHOUT CLAIM TO ANY PARTICULAR FONT, STYLE, SIZE, OR COLOR.

FOR COMPUTER SERVICES, NAMELY, CLOUD HOSTING PROVIDER SERVICES; HOSTING OF DIGITAL CONTENT ON THE INTERNET (U.S. CLS. 100 AND 101).

FIRST USE 1-1-2012; IN COMMERCE 1-1-2012.



4,165,837. SILICON MESA CORPORATION, ALBUQUERQUE, NM. SN 85-386,632. PUB. 2-28-2012, FILED 8-2-2011.

Silicon Mesa

THE MARK CONSISTS OF STANDARD CHARACTERS WITHOUT CLAIM TO ANY PARTICULAR FONT, STYLE, SIZE, OR COLOR.

NO CLAIM IS MADE TO THE EXCLUSIVE RIGHT TO USE "MESA", APART FROM THE MARK AS SHOWN.

FOR SOFTWARE AS A SERVICE (SAAS) FEATURING SOFTWARE FOR USE IN DATABASE MANAGEMENT AND STORAGE OF ELECTRONIC DATA (U.S. CLS. 100 AND 101).

FIRST USE 4-4-2012; IN COMMERCE 4-4-2012.

CLASS 42—(Continued).

4,165,867. TRIPGRAM, INC., NEW YORK, NY. SN 85-400,304. PUB. 1-17-2012, FILED 8-17-2011.

TRIPGRAM

THE MARK CONSISTS OF STANDARD CHARACTERS WITHOUT CLAIM TO ANY PARTICULAR FONT, STYLE, SIZE, OR COLOR.

FOR PROVIDING A WEB SITE FEATURING TECHNOLOGY THAT ENABLES INTERNET USERS TO BOOK TRAVEL (U.S. CLS. 100 AND 101).

FIRST USE 10-31-2011; IN COMMERCE 10-31-2011.



4,165,920. MULTITASK123, LLC, SUNRISE, FL. SN 85-976,509. PUB. 9-20-2011, FILED 5-5-2011.



THE MARK CONSISTS OF AN OVAL SHAPE DESIGN WITH STYLIZED LETTERING SPELLING "CYBERTRAM" WITH ONE LIGHTNING BOLT TRANSECTING THE OVAL SHAPE.

FOR COMPUTER SERVICES, NAMELY, HOSTING AND MAINTAINING AN ON-LINE WEB SITE FOR OTHERS TO CREATE, STORE, ORGANIZE, SEND AND SHARE DIGITAL DATA (U.S. CLS. 100 AND 101).

FIRST USE 10-1-2011; IN COMMERCE 3-7-2012.



4,165,944. NURSING HOME QUALITY, LLC, CENTENNIAL, CO. SN 85-976,782. PUB. 8-30-2011, FILED 2-7-2011.

PROVIDIGM

THE MARK CONSISTS OF STANDARD CHARACTERS WITHOUT CLAIM TO ANY PARTICULAR FONT, STYLE, SIZE, OR COLOR.

FOR COMPUTER AND CONSULTING SERVICES, NAMELY, TECHNICAL SUPPORT IN THE NATURE OF INSTALLATION, ADMINISTRATION, AND TROUBLESHOOTING, AND DEVELOPMENT AND PROVISION OF A WEB-BASED SYSTEM FEATURING NON-DOWNLOADABLE SOFTWARE FOR USE IN THE FIELD OF MEDICAL SERVICES THAT ANALYZES ASSESSMENT DATA TO FACILITATE QUALITY AUDITING AND TRAINING AND RESOURCE MANAGEMENT IN MEDICAL AND RESIDENT CARE FACILITIES (U.S. CLS. 100 AND 101).

FIRST USE 8-22-2011; IN COMMERCE 8-22-2011.

CLASS 43—HOTEL AND RESTAURANT SERVICES

4,164,899. FIGUEREDO, DANIEL, MIAMI, FL. SN 77-800,420. PUB. 7-26-2011, FILED S.R. 8-9-2009; AM. P.R. 11-17-2009.



The logo for "melt'wich" features the word "melt'wich" in a stylized font. The word "melt'" is in yellow and "wich" is in purple. The apostrophe in "melt'" is also yellow.

THE COLOR(S) YELLOW AND PURPLE IS/ARE CLAIMED AS A FEATURE OF THE MARK.

THE MARK CONSISTS OF THE WORD "MELT'WICH" IN STYLIZED FORM USING ONLY LOWER CASE LETTERS. THE FIRST PART OF THE WORD, "MELT'", AND THE APOSTROPHE ARE IN YELLOW. THE SECOND PART OF THE WORD, "WICH", IS IN PURPLE.

FOR CAFE AND RESTAURANT SERVICES; CAFE-RESTAURANTS; RESTAURANT; RESTAURANT AND CATERING SERVICES; RESTAURANT SERVICES FEATURING SANDWICHES; RESTAURANTS (U.S. CLS. 100 AND 101).

FIRST USE 1-10-2012; IN COMMERCE 1-10-2012.

4,165,087. GARY H. ARMOUR, HULL, GA. SN 85-058,575. PUB. 1-18-2011, FILED 6-9-2010.



NO CLAIM IS MADE TO THE EXCLUSIVE RIGHT TO USE THE DESIGN OF THE BURGER AND BISCUITS, APART FROM THE MARK AS SHOWN.

THE MARK CONSISTS OF THE TEXT "TEAM" VERTICALLY DISPLAYED ABOVE THE TEXT "B & B" HORIZONTALLY DISPLAYED WITH "TEAM" BEING IN A LARGER FONT THAN "B & B" AND "B & B" BEING HORIZONTALLY CENTERED UNDER THE LETTERS OF THE TEXT "TEAM". A PLATE OF BISCUITS SUBSTANTIALLY HORIZONTALLY TO THE LEFT OF THE TEXT "B & B" AND A PLATE WITH A HAMBURGER SUBSTANTIALLY HORIZONTALLY TO THE RIGHT OF THE TEXT "B & B", THE BISCUITS BEING PLACED ON TOP OF A PLATE, THE BISCUITS BEING PILED ON TOP OF EACH OTHER, THE BURGER BEING PLACED ON TOP OF A PLATE, THE BURGER INCLUDING AN UPPER BUN AND A LOWER BUN WITH A HAMBURGER PATTY BEING PLACED ON TOP OF THE LOWER BUN, A SLICE OF CHEESE SHOWN AS BEING MELTED ON TOP OF THE HAMBURGER PATTY, A SLICE OF TOMATO SHOWN AS BEING POSITIONED ON TOP OF THE CHEESE, LEAFY LETTUCE SHOWN AS BEING POSITIONED ON TOP OF THE TOMATO SLICE AND THE UPPER BUN BEING POSITIONED ON TOP OF THE LETTUCE.

FOR CAFE AND RESTAURANT SERVICES; CARRY-OUT RESTAURANTS; FAST FOOD AND NON-STOP RESTAURANT SERVICES; FOOD PREPARATION SERVICES; PROVIDING OF FOOD AND DRINK; RESTAURANT; RESTAURANT SERVICES; RESTAURANT SERVICES FEATURING SANDWICHES (U.S. CLS. 100 AND 101).

FIRST USE 10-17-2011; IN COMMERCE 10-17-2011.

CLASS 43—(Continued).

4,165,139. BABY BLUES BOTTLING LLC, VENICE, CA. SN 85-109,338. PUB. 2-1-2011, FILED 8-17-2010.



OWNER OF U.S. REG. NO. 7,774,129.

NO CLAIM IS MADE TO THE EXCLUSIVE RIGHT TO USE "VENICE" AND "B-B-Q", APART FROM THE MARK AS SHOWN.

THE COLOR(S) BLACK, WHITE, AND BLUE IS/ARE CLAIMED AS A FEATURE OF THE MARK.

THE MARK CONSISTS OF A RECTANGLE, LAYING SO THAT THE LONGER SIDES ARE HORIZONTAL, WITH THE HORIZONTAL SIDES BOWED, THE UPPER SIDE CONCAVE, THE LOWER CONVEX; THE BORDER OF THE RECTANGLE IS WHITE, ITSELF BORDERED WITHIN AND WITHOUT BY BLACK; INSIDE THE RECTANGLE THE FIELD IS DARK BLUE; ON THE FIELD OF BLUE APPEAR IN WHITE LETTERING THE WORDS "VENICE BABY BLUES B-B-Q", OF WHICH THE WORDS "BABY BLUES" ARE WRITTEN IN A CURSIVE FONT; THREE 4-POINTED STARS APPEAR UNDERNEATH THE TERM "BLUES".

FOR BAR AND RESTAURANT SERVICES (U.S. CLS. 100 AND 101).

FIRST USE 12-4-2004; IN COMMERCE 12-4-2004.

4,165,154. CHONGQING LIUYISHOU RESTAURANT MANAGEMENT CO., LTD., CHONGQING, CHINA. SN 85-116,257. PUB. 2-8-2011, FILED 8-26-2010.



"PIN" MEANS "TASTE" IN ENGLISH; "DAO" MEANS "WAY" IN ENGLISH AND "JU" MEANS "HOUSE" IN ENGLISH. THERE IS NO FIXED MEANING OF THE THREE CHINESE CHARACTERS "PIN DAO JU" AS A WHOLE. "PINDAOJU" IS MEANINGLESS IN THE ENGLISH LANGUAGE.

CLASS 43—(Continued).

THE TRANSLITERATION OF THE CHINESE CHARACTERS IS "PIN DAO JU".

FOR CATERING OF FOOD AND DRINKS; HOTELS; CAFETERIAS; CANTEEN SERVICES; RESTAURANTS; SELF-SERVICE RESTAURANTS; SNACK-BARS; MOBILE CAFÉ SERVICES FOR PROVIDING FOOD AND DRINKS (U.S. CLS. 100 AND 101).

FIRST USE 10-0-2009; IN COMMERCE 3-0-2012.

4,165,217. STRAW HAT RESTAURANTS, INC., SAN RAMON, CA. SN 85-134,060. PUB. 3-8-2011, FILED 9-20-2010.

TOWER 27

THE MARK CONSISTS OF STANDARD CHARACTERS WITHOUT CLAIM TO ANY PARTICULAR FONT, STYLE, SIZE, OR COLOR.

FOR RESTAURANT SERVICES (U.S. CLS. 100 AND 101).

FIRST USE 10-6-2010; IN COMMERCE 10-6-2010.

4,165,265. BANANA KRAZE, WASHINGTON, UT. SN 85-151,900. PUB. 3-29-2011, FILED 10-13-2010.



NO CLAIM IS MADE TO THE EXCLUSIVE RIGHT TO USE "BANANA", APART FROM THE MARK AS SHOWN.

THE STIPPLING IS FOR SHADING PURPOSES ONLY.

THE MARK CONSISTS OF THE STYLIZED WORDING "BANANA KRAZE" SET TO THE LEFT OF A STYLIZED DEPICTION OF A MONKEY WEARING A SHIRT, SHORTS, FLIP-FLOPS, AND A VISOR AND HOLDING A CHOCOLATE COVERED BANANA, WITH THE WORDING "BANANA KRAZE" WRITTEN ON THE FRONT OF THE VISOR.

FOR SNACK BAR SERVICES FEATURING MELTED CHOCOLATE COVERED FROZEN BANANAS, HOT CHOCOLATES, SHAKES AND SMOOTHIES (U.S. CLS. 100 AND 101).

FIRST USE 10-31-2011; IN COMMERCE 10-31-2011.

CLASS 43—(Continued).

4,165,267. TYSONS FRIENDS KABOB LLC, VIENNA, VA. SN 85-152,486. PUB. 3-1-2011, FILED 10-14-2010.



NO CLAIM IS MADE TO THE EXCLUSIVE RIGHT TO USE "KABOB", APART FROM THE MARK AS SHOWN.

THE MARK CONSISTS OF THE LITERAL ELEMENT "FRIENDS" IN A RECTANGLE ABOVE THE LITERAL ELEMENT "KABOB" IN A RECTANGLE, WITH SMALL BARS TO THE LEFT AND RIGHT OF THE TERM "KABOB", AND WITH ONE HORIZONTAL BAR BELOW "KABOB".

FOR CARRY-OUT RESTAURANTS; CATERING SERVICES; RESTAURANT SERVICES (U.S. CLS. 100 AND 101).

FIRST USE 1-0-2010; IN COMMERCE 1-0-2010.

4,165,279. CITYSCAPE COMEDY, LLC, DELRAY BEACH, FL. SN 85-157,103. PUB. 10-4-2011, FILED 10-20-2010.

COPPER BLUES

THE MARK CONSISTS OF STANDARD CHARACTERS WITHOUT CLAIM TO ANY PARTICULAR FONT, STYLE, SIZE, OR COLOR.

NO CLAIM IS MADE TO THE EXCLUSIVE RIGHT TO USE "BLUES", APART FROM THE MARK AS SHOWN.

FOR RESTAURANT AND BAR SERVICES (U.S. CLS. 100 AND 101).

FIRST USE 6-1-2011; IN COMMERCE 6-1-2011.

4,165,423. VILLA HOLDING, LLC, MORRISTOWN, NJ. SN 85-235,674. PUB. 9-13-2011, FILED 2-7-2011.

THE MARKET BY VILLA

THE MARK CONSISTS OF STANDARD CHARACTERS WITHOUT CLAIM TO ANY PARTICULAR FONT, STYLE, SIZE, OR COLOR.

OWNER OF U.S. REG. NOS. 1,749,093, 2,953,696, AND 3,146,774.

NO CLAIM IS MADE TO THE EXCLUSIVE RIGHT TO USE "MARKET", APART FROM THE MARK AS SHOWN.

FOR RESTAURANT SERVICES (U.S. CLS. 100 AND 101).

FIRST USE 3-31-2012; IN COMMERCE 3-31-2012.

CLASS 43—(Continued).

4,165,426. VINOMATCH, INC., SAN DIEGO, CA. SN 85-236,037. PUB. 10-18-2011, FILED 2-7-2011.

VinoMatch

THE MARK CONSISTS OF STANDARD CHARACTERS WITHOUT CLAIM TO ANY PARTICULAR FONT, STYLE, SIZE, OR COLOR.

THE ENGLISH TRANSLATION OF "VINO" IN THE MARK IS "WINE".

FOR PROVIDING ON-LINE INFORMATION ACCESSIBLE VIA THE INTERNET AND MOBILE PHONES AND ELECTRONIC DEVICES ABOUT WINE, NAMELY, WINE RATINGS, WINE CHARACTERISTICS, VINTNER AND VARIETAL INFORMATION, FOOD PAIRINGS AND WINE REVIEWS; PROVIDING A WEB SITE ACCESSIBLE VIA THE INTERNET AND MOBILE PHONES AND ELECTRONIC DEVICES WHERE USERS CAN POST AND REVIEW RATINGS, REVIEWS AND RECOMMENDATIONS ON WINES; PROVIDING ON-LINE CONSUMER PRODUCT INFORMATION ACCESSIBLE VIA THE INTERNET AND MOBILE PHONES ABOUT WINE AVAILABILITY AND RATINGS; PROVIDING WINE RATINGS AND WINE CHARACTERISTIC INFORMATION ON RESTAURANT MENUS (U.S. CLS. 100 AND 101).

FIRST USE 2-11-2007; IN COMMERCE 2-11-2007.

4,165,447. THE KITCHEN CAFE, LLC, BOULDER, CO. SN 85-246,758. PUB. 1-17-2012, FILED 2-18-2011.

THE KITCHEN NEXT DOOR

THE MARK CONSISTS OF STANDARD CHARACTERS WITHOUT CLAIM TO ANY PARTICULAR FONT, STYLE, SIZE, OR COLOR.

SEC. 2(F) AS TO "KITCHEN".
FOR RESTAURANT AND CAFE SERVICES (U.S. CLS. 100 AND 101).

FIRST USE 6-13-2011; IN COMMERCE 6-13-2011.

4,165,452. JJ&K HOSPITALITY, INC., WILLINGBORO, NJ. SN 85-250,290. PUB. 7-26-2011, FILED 2-24-2011.

SBRAGA

THE MARK CONSISTS OF STANDARD CHARACTERS WITHOUT CLAIM TO ANY PARTICULAR FONT, STYLE, SIZE, OR COLOR.

CLASS 43—(Continued).

THE NAME "KEVIN SBRAGA" SHOWN IN THE MARK IDENTIFIES A LIVING INDIVIDUAL WHOSE CONSENT IS OF RECORD.

FOR RESTAURANT AND BAR SERVICES (U.S. CLS. 100 AND 101).

FIRST USE 10-6-2011; IN COMMERCE 10-6-2011.

4,165,531. PRESTIGE CLUB, FRANKLIN PARK, IL. SN 85-273,694. PUB. 8-9-2011, FILED 3-22-2011.

AURA

THE MARK CONSISTS OF STANDARD CHARACTERS WITHOUT CLAIM TO ANY PARTICULAR FONT, STYLE, SIZE, OR COLOR.

FOR PRIVATE ROOM CLUB SERVICES, NAMELY, PROVIDING CLUB MEMBERS TEMPORARY ACCOMMODATIONS IN COMPANY OWNED OR LEASED PRIVATE ROOMING ESTABLISHMENTS (U.S. CLS. 100 AND 101).

FIRST USE 4-1-2011; IN COMMERCE 4-1-2011.

4,165,591. CRASH MY PAD, INC., FOSTER CITY, CA. AND EVANS, DAVID W, GILBERT, AZ. SN 85-283,350. PUB. 11-15-2011, FILED 4-1-2011.

CRASHMYPAD

THE MARK CONSISTS OF STANDARD CHARACTERS WITHOUT CLAIM TO ANY PARTICULAR FONT, STYLE, SIZE, OR COLOR.

FOR PROVIDING TRAVEL AGENCY SERVICES, NAMELY, MAKING RESERVATIONS AND BOOKINGS FOR LODGING; PROVIDING LODGING INFORMATION THROUGH GLOBAL COMMUNICATION NETWORKS AND MOBILE NETWORKS; FACILITATING SHORT TERM LODGING ACCOMMODATIONS VIA THE INTERNET BY PROVIDING PERSONALIZED INFORMATION ABOUT TEMPORARY ACCOMMODATIONS FOR TRAVEL VIA THE INTERNET; PROVIDING AN INTERACTIVE WEBSITE WHERE MEMBERS CAN SUBMIT REVIEWS, RECOMMENDATIONS AND RATINGS FOR LODGING (U.S. CLS. 100 AND 101).

FIRST USE 5-1-2011; IN COMMERCE 6-1-2011.

CLASS 43—(Continued).

4,165,640. ADAMS, MICHAEL C, LOS ALAMITOS, CA. SN 85-293,543. PUB. 9-6-2011, FILED 4-13-2011.

Inhale BBQ

THE MARK CONSISTS OF STANDARD CHARACTERS WITHOUT CLAIM TO ANY PARTICULAR FONT, STYLE, SIZE, OR COLOR.

NO CLAIM IS MADE TO THE EXCLUSIVE RIGHT TO USE "BBQ", APART FROM THE MARK AS SHOWN.

FOR RESTAURANT AND CATERING SERVICES (U.S. CLS. 100 AND 101).

FIRST USE 6-12-2010; IN COMMERCE 6-12-2010.

4,165,671. PRIVATE OPERATIONS, INC., CUMMING, GA. SN 85-301,891. PUB. 9-13-2011, FILED 4-22-2011.

THE VELVET NOTE

THE MARK CONSISTS OF STANDARD CHARACTERS WITHOUT CLAIM TO ANY PARTICULAR FONT, STYLE, SIZE, OR COLOR.

FOR RESTAURANT AND HOTEL SERVICES, NAMELY, A RESTAURANT AND A JAZZ BAR (U.S. CLS. 100 AND 101).

FIRST USE 1-24-2011; IN COMMERCE 4-1-2011.

4,165,695. IMALLIN CORPORATION, JERSEY CITY, NJ. SN 85-310,971. PUB. 9-20-2011, FILED 5-3-2011.



THE MARK CONSISTS OF THE LITERAL ELEMENT WITH THE WORD "HOPS" ON THE UPPER LEFT AND THE WORD "SCOTCH" ON THE LOWER RIGHT, WITH THE "S" IN "HOPS" AND THE "S" IN "SCOTCH" ADJACENT ONE ANOTHER, A RENDERING OF A PROFILE VIEW OF A SCOTTISH TERRIER DIRECTLY ABOVE THE WORD "SCOTCH" AND A RENDERING OF HOPS FLOWERS DIRECTLY BELOW THE WORD "HOPS".

FOR BAR AND RESTAURANT SERVICES (U.S. CLS. 100 AND 101).

FIRST USE 3-28-2012; IN COMMERCE 3-28-2012.

CLASS 43—(Continued).

4,165,818. BLACK'S 14TH STREET LLC, BETHESDA, MD. SN 85-376,064. PUB. 2-7-2012, FILED 7-20-2011.

PEARL DIVE OYSTER PALACE

THE MARK CONSISTS OF STANDARD CHARACTERS WITHOUT CLAIM TO ANY PARTICULAR FONT, STYLE, SIZE, OR COLOR.

NO CLAIM IS MADE TO THE EXCLUSIVE RIGHT TO USE "OYSTER", APART FROM THE MARK AS SHOWN.

FOR RESTAURANT AND BAR SERVICES (U.S. CLS. 100 AND 101).

FIRST USE 9-14-2011; IN COMMERCE 9-14-2011.

4,165,828. THE JOHNS HOPKINS HEALTH SYSTEM CORPORATION, BALTIMORE, MD. SN 85-381,944. PUB. 12-27-2011, FILED 7-27-2011.



THE MARK CONSISTS OF THE STYLIZED DESIGN OF A COFFEE CUP AND THE WORDS "GRAND GROUNDS" IN STYLIZED FORMAT.

FOR COFFEE SHOPS (U.S. CLS. 100 AND 101).

FIRST USE 8-15-2011; IN COMMERCE 8-15-2011.

4,165,830. E S ROBBINS CORPORATION, MUSCLE SHOALS, AL. SN 85-382,445. PUB. 1-24-2012, FILED 7-27-2011.

HOME OF THE FLYING SHRIMP

THE MARK CONSISTS OF STANDARD CHARACTERS WITHOUT CLAIM TO ANY PARTICULAR FONT, STYLE, SIZE, OR COLOR.

NO CLAIM IS MADE TO THE EXCLUSIVE RIGHT TO USE "SHRIMP", APART FROM THE MARK AS SHOWN.

FOR BAR AND RESTAURANT SERVICES; RESTAURANT AND BAR SERVICES, INCLUDING RESTAURANT CARRYOUT SERVICES (U.S. CLS. 100 AND 101).

FIRST USE 8-30-2011; IN COMMERCE 8-30-2011.

CLASS 43—(Continued).

4,165,845. RIVKA'S CATERING, DEAL, NJ. SN 85-391,365. PUB. 1-3-2012, FILED 8-6-2011.

SARAH'S TENT

THE MARK CONSISTS OF STANDARD CHARACTERS WITHOUT CLAIM TO ANY PARTICULAR FONT, STYLE, SIZE, OR COLOR.
FOR CATERING SERVICES (U.S. CLS. 100 AND 101).
FIRST USE 3-1-1985; IN COMMERCE 6-1-1985.

4,165,863. UMAMI BURGER LICENSING USA, LLC, LOS ANGELES, CA. SN 85-398,566. PUB. 1-3-2012, FILED 8-15-2011.

UMAMICATESSEN

THE MARK CONSISTS OF STANDARD CHARACTERS WITHOUT CLAIM TO ANY PARTICULAR FONT, STYLE, SIZE, OR COLOR.
FOR RESTAURANT SERVICES AND TAKEOUT RESTAURANT SERVICES (U.S. CLS. 100 AND 101).
FIRST USE 3-3-2012; IN COMMERCE 3-3-2012.

CLASS 44—MEDICAL, BEAUTY AND AGRICULTURAL SERVICES

4,164,902. GENETIC TECHNOLOGIES, LTD., FITZROY, VICTORIA, AUSTRALIA. SN 77-805,267. PUB. 5-25-2010, FILED 8-14-2009.

BREVAGEN

THE MARK CONSISTS OF STANDARD CHARACTERS WITHOUT CLAIM TO ANY PARTICULAR FONT, STYLE, SIZE, OR COLOR.
FOR PROVIDING DIAGNOSTIC SERVICES FOR OTHERS IN THE FIELD OF MEDICINE FOR MEDICAL PURPOSES; GENETIC TESTING FOR MEDICAL PURPOSES, NAMELY, GENOME ANALYSIS AND GENOME SCANNING (U.S. CLS. 100 AND 101).
FIRST USE 7-21-2011; IN COMMERCE 7-21-2011.

CLASS 44—(Continued).

4,165,193. MERIDIAN HEALTH SYSTEM, INC., NEPTUNE, NJ. SN 85-126,229. PUB. 8-2-2011, FILED 9-9-2010.

MERIDIAN AT HOME

THE MARK CONSISTS OF STANDARD CHARACTERS WITHOUT CLAIM TO ANY PARTICULAR FONT, STYLE, SIZE, OR COLOR.

OWNER OF U.S. REG. NOS. 2,188,836 AND 2,911,541.
NO CLAIM IS MADE TO THE EXCLUSIVE RIGHT TO USE "AT HOME", APART FROM THE MARK AS SHOWN.
FOR HEALTH CARE FACILITIES, NAMELY, LONG TERM CARE FACILITIES AND HOSPITALS; PROVIDING IN HOME CERTIFIED HOME CARE IN THE FIELDS OF PEDIATRIC CARE, MATERNAL-CHILD HEALTH SERVICES, WOUND CARE AND OSTOMY SERVICES, PHYSICAL THERAPY SERVICES, REHABILITATION SERVICES, OCCUPATIONAL THERAPY SERVICES, SPEECH AND LANGUAGE PATHOLOGY SERVICES, PRIVATE DUTY SERVICES, HOSPICE SERVICES, PALLIATIVE CARE SERVICES AND INFUSION THERAPY SERVICES PROVIDED BY REGISTERED NURSES, LICENSED PRACTICAL NURSES, CERTIFIED HOME HEALTH AIDES, SPEECH PATHOLOGISTS, PHYSICAL AND OCCUPATIONAL THERAPISTS, MEDICAL SOCIAL WORKERS, PHARMACISTS, CHAPLAINS, COMPANIONS AND VOLUNTEERS, NAMELY, HOME HEALTH CARE SERVICES (U.S. CLS. 100 AND 101).
FIRST USE 9-10-2010; IN COMMERCE 9-10-2010.

4,165,243. AVALERE HEALTH, LLC, WASHINGTON, DC. SN 85-143,493. PUB. 9-6-2011, FILED 10-1-2010.

Avalere EBM Navigator

THE MARK CONSISTS OF STANDARD CHARACTERS WITHOUT CLAIM TO ANY PARTICULAR FONT, STYLE, SIZE, OR COLOR.

OWNER OF U.S. REG. NO. 3,294,805.
NO CLAIM IS MADE TO THE EXCLUSIVE RIGHT TO USE "EBM", APART FROM THE MARK AS SHOWN.
FOR PROVIDING AN INTERNET WEBSITE PORTAL OFFERING INFORMATION IN THE FIELD OF MEDICINE AND HEALTHCARE (U.S. CLS. 100 AND 101).
FIRST USE 4-12-2012; IN COMMERCE 4-12-2012.

CLASS 44—(Continued).

4,165,244. AVALERE HEALTH, LLC, WASHINGTON, DC. SN 85-143,496. PUB. 9-6-2011, FILED 10-1-2010.

Avalere EBM Insights

THE MARK CONSISTS OF STANDARD CHARACTERS WITHOUT CLAIM TO ANY PARTICULAR FONT, STYLE, SIZE, OR COLOR.

OWNER OF U.S. REG. NO. 3,294,805.

NO CLAIM IS MADE TO THE EXCLUSIVE RIGHT TO USE "EBM", APART FROM THE MARK AS SHOWN.

FOR PROVIDING A FEATURE OF AN INTERNET WEBSITE PORTAL OFFERING INFORMATION IN THE FIELD OF MEDICINE AND HEALTHCARE (U.S. CLS. 100 AND 101).

FIRST USE 4-12-2012; IN COMMERCE 4-12-2012.

4,165,312. DR. G'S FRANCHISING COMPANIES, LLC., DAVIE, FL. AND JDJ OF MIAMI, INC., AVENTURA, FL. SN 85-172,169. PUB. 8-23-2011, FILED 11-9-2010.



NO CLAIM IS MADE TO THE EXCLUSIVE RIGHT TO USE "WEIGHT LOSS & WELLNESS", APART FROM THE MARK AS SHOWN.

THE NAME(S), PORTRAIT(S), AND/OR SIGNATURE(S) SHOWN IN THE MARK IDENTIFIES THE NICKNAME OF CHARLES L. GOLDSMITH, A LIVING INDIVIDUAL, WHOSE CONSENT(S) TO REGISTER IS MADE OF RECORD.

THE COLOR(S) BLACK AND PURPLE IS/ARE CLAIMED AS A FEATURE OF THE MARK.

THE MARK CONSISTS OF THE STYLIZED WORDING "DR. G'S WEIGHTLOSS & WELLNESS". THE "G" IN "G'S" IS PURPLE. THE REMAINDER OF THE LETTERING IS BLACK. A BLACK, SINGLE LINE RECTANGLE OUTLINES THE WORDING. THE WHITE REPRESENTS BACKGROUND AND IS NOT PART OF THE MARK.

FOR MEDICAL CLINICS FEATURING WEIGHT LOSS SOLUTIONS, SERVICES AND PROGRAMS (U.S. CLS. 100 AND 101).

FIRST USE 8-31-2010; IN COMMERCE 8-31-2010.

4,165,345. ALTA VISTA CENTER FOR AUTISM, DENVER, CO. SN 85-190,297. PUB. 12-6-2011, FILED 12-3-2010.

FIREFLY AUTISM

THE MARK CONSISTS OF STANDARD CHARACTERS WITHOUT CLAIM TO ANY PARTICULAR FONT, STYLE, SIZE, OR COLOR.

CLASS 44—(Continued).

NO CLAIM IS MADE TO THE EXCLUSIVE RIGHT TO USE "AUTISM", APART FROM THE MARK AS SHOWN.

FOR OCCUPATIONAL THERAPY, PHYSICAL THERAPY, SPEECH THERAPY, BEHAVIORAL THERAPY AND APPLIED BEHAVIORAL ANALYSIS SERVICES FOR CHILDREN WITH AUTISM; PSYCHOLOGICAL EVALUATIONS OF CHILDREN TO DIAGNOSE AUTISM (U.S. CLS. 100 AND 101).

FIRST USE 12-31-2010; IN COMMERCE 12-31-2010.

4,165,485. MENDIAS & MILTON, LLC, HOUSTON, TX. SN 85-262,081. PUB. 9-6-2011, FILED 3-9-2011.



NO CLAIM IS MADE TO THE EXCLUSIVE RIGHT TO USE "21 DAY", APART FROM THE MARK AS SHOWN.

THE COLOR(S) RED, WHITE, GOLD, GRAY, AND BLACK IS/ARE CLAIMED AS A FEATURE OF THE MARK.

THE MARK CONSISTS OF CIRCLE DESIGN WITH "21" IN WHITE; STICK FIGURE PLACED TO THE LEFT OF "2" AND THE WORD "DAY" IN RED, WRITTEN VERTICALLY TO THE RIGHT OF "1"; A BACKGROUND OF GOLD SURROUNDED BY A BLACK BORDER WHICH IS SURROUNDED BY A RED BORDER; THE WORDING "IT'S NOT JUST 21 DAYS, IT'S A LIFESTYLE." IN GRAY IN THE UPPER PORTION OF THE RED BORDER; THE WORD "CHALLENGE" WRITTEN IN WHITE ON A GRAY RIBBON PLACED UNDER "21".

FOR PROVIDING HEALTHY LIFESTYLE AND NUTRITION SERVICES, NAMELY, PERSONAL ASSESSMENTS, PERSONALIZED ROUTINES, MAINTENANCE SCHEDULES, AND COUNSELING (U.S. CLS. 100 AND 101).

FIRST USE 2-0-2011; IN COMMERCE 2-0-2011.

4,165,550. M. SAMIR QAMAR, M.D., INC., MONTEREY, CA. SN 85-276,211. PUB. 8-2-2011, FILED 3-24-2011.

MEDLION

THE MARK CONSISTS OF STANDARD CHARACTERS WITHOUT CLAIM TO ANY PARTICULAR FONT, STYLE, SIZE, OR COLOR.

FOR MEDICAL CLINICS (U.S. CLS. 100 AND 101).

FIRST USE 3-26-2011; IN COMMERCE 4-7-2011.

CLASS 44—(Continued).

4,165,663. WALKER, DANNY, GEORGETOWN, TX. SN 85-299,183. PUB. 9-13-2011, FILED 4-19-2011.

ROSE OF TEXAS HOSPICE

THE MARK CONSISTS OF STANDARD CHARACTERS WITHOUT CLAIM TO ANY PARTICULAR FONT, STYLE, SIZE, OR COLOR.

NO CLAIM IS MADE TO THE EXCLUSIVE RIGHT TO USE "TEXAS HOSPICE", APART FROM THE MARK AS SHOWN.

FOR HOSPICE SERVICES (U.S. CLS. 100 AND 101).
FIRST USE 9-7-2011; IN COMMERCE 9-7-2011.

4,165,730. FIT AND TRIM CORP., SUNRISE, FL. SN 85-331,282. PUB. 10-18-2011, FILED 5-26-2011.

FIT AND TRIM

THE MARK CONSISTS OF STANDARD CHARACTERS WITHOUT CLAIM TO ANY PARTICULAR FONT, STYLE, SIZE, OR COLOR.

FOR DIET AND WELLNESS CONSULTANTS (U.S. CLS. 100 AND 101).
FIRST USE 9-1-2011; IN COMMERCE 9-1-2011.

4,165,743. RISING TIDE FOUNDATION, SCHAFFHAUSEN, SWITZERLAND. SN 85-338,580. PUB. 8-16-2011, FILED 6-6-2011.

CAREEDGE

THE MARK CONSISTS OF STANDARD CHARACTERS WITHOUT CLAIM TO ANY PARTICULAR FONT, STYLE, SIZE, OR COLOR.

FOR HEALTHCARE AND MEDICAL SERVICES IN THE FIELD OF ONCOLOGY (U.S. CLS. 100 AND 101).
FIRST USE 8-4-2011; IN COMMERCE 8-4-2011.

CLASS 44—(Continued).

4,165,798. THE ARIZONA BOARD OF REGENTS ON BEHALF OF THE UNIVERSITY OF ARIZONA. TUCSON, AZ. SN 85-364,727. PUB. 1-3-2012, FILED 7-6-2011.

**THE UNIVERSITY OF ARIZONA
HEALTH NETWORK**

THE MARK CONSISTS OF STANDARD CHARACTERS WITHOUT CLAIM TO ANY PARTICULAR FONT, STYLE, SIZE, OR COLOR.

OWNER OF U.S. REG. NOS. 1,678,170 AND 3,574,619.
NO CLAIM IS MADE TO THE EXCLUSIVE RIGHT TO USE "UNIVERSITY" OR "HEALTH NETWORK", APART FROM THE MARK AS SHOWN.

SEC. 2(F) "UNIVERSITY OF ARIZONA".
FOR HEALTH CARE SERVICES; DIAGNOSTIC MEDICAL IMAGING SERVICES AND LABORATORY SERVICES, NAMELY, MEDICAL TESTING FOR DIAGNOSTIC AND TREATMENT PURPOSES; CLINICAL MEDICAL SERVICES FOR CANCER DIAGNOSIS AND TREATMENT; INPATIENT AND OUTPATIENT MEDICAL CONSULTATIONS AND EVALUATIONS; HEALTH CARE SERVICES, NAMELY, CLINICAL APPLICATION OF THE USE OF MEDICAL PROCEDURES AS A RESULT OF MEDICAL RESEARCH; HEALTH CARE SERVICES, NAMELY, CANCER PREVENTION AND WELLNESS PROGRAMS; DIETARY AND NUTRITIONAL GUIDANCE SERVICES; MEDICAL EVALUATION SERVICES, NAMELY, FUNCTIONAL ASSESSMENT PROGRAM FOR PATIENTS; COMMUNITY OUTREACH AND PATIENT COUNSELING REGARDING CANCER PREVENTION AND WELLNESS PROGRAMS (U.S. CLS. 100 AND 101).
FIRST USE 9-9-2011; IN COMMERCE 9-9-2011.

4,165,813. DUPONT SHIAH ENTERPRISES LLC, DANVILLE, CA. SN 85-374,689. PUB. 1-10-2012, FILED 7-19-2011.



NO CLAIM IS MADE TO THE EXCLUSIVE RIGHT TO USE "HAIRCUTS", APART FROM THE MARK AS SHOWN.
FOR HAIR SALON SERVICES; HAIR CUTTING SERVICES; HAIR STYLING SERVICES; BARBER SHOP SERVICES (U.S. CLS. 100 AND 101).

FIRST USE 11-1-2011; IN COMMERCE 11-1-2011.

CLASS 44—(Continued).

4,165,833. LCA-VISION, INC., CINCINNATI, OH. SN 85-384,912. PUB. 1-24-2012, FILED 7-29-2011.

VI SIUM EYE INSTITUTE

THE MARK CONSISTS OF STANDARD CHARACTERS WITHOUT CLAIM TO ANY PARTICULAR FONT, STYLE, SIZE, OR COLOR.

NO CLAIM IS MADE TO THE EXCLUSIVE RIGHT TO USE "EYE INSTITUTE", APART FROM THE MARK AS SHOWN.

FOR OPHTHALMOLOGY SERVICES AND OPTOMETRY SERVICES; OPHTHALMOLOGIC SERVICES TO TREAT EYE AND VISION DEFICIENCIES WITH SURGERY (U.S. CLS. 100 AND 101).

FIRST USE 9-15-2011; IN COMMERCE 9-15-2011.

CLASS 44—(Continued).

4,165,872. HEALTHY LIFE AND NUTRITION, LLC, VESTA-VIA, AL. SN 85-402,105. PUB. 1-3-2012, FILED 8-19-2011.

Sensibalance

THE MARK CONSISTS OF STANDARD CHARACTERS WITHOUT CLAIM TO ANY PARTICULAR FONT, STYLE, SIZE, OR COLOR.

FOR NUTRITION COUNSELING; PROVIDING A WEB SITE FEATURING INFORMATION ON HEALTH AND NUTRITION; WEIGHT REDUCTION DIET PLANNING AND SUPERVISION (U.S. CLS. 100 AND 101).

FIRST USE 1-1-2011; IN COMMERCE 1-1-2011.

4,165,884. DYAX CORP., BURLINGTON, MA. SN 85-407,241. PUB. 2-7-2012, FILED 8-25-2011.

KALBITOR HOME INFUSION SERVICES

THE MARK CONSISTS OF STANDARD CHARACTERS WITHOUT CLAIM TO ANY PARTICULAR FONT, STYLE, SIZE, OR COLOR.

OWNER OF U.S. REG. NOS. 3,545,081, 3,871,455, AND OTHERS.

NO CLAIM IS MADE TO THE EXCLUSIVE RIGHT TO USE "HOME INFUSION SERVICES", APART FROM THE MARK AS SHOWN.

FOR HEALTH CARE; HOME HEALTH CARE SERVICES; HOME HEALTH CARE SERVICES, NAMELY, ADMINISTERING MEDICATION FOR THE TREATMENT OF ANGIOEDEMA (U.S. CLS. 100 AND 101).

FIRST USE 2-16-2012; IN COMMERCE 2-16-2012.

4,165,843. NIQUE DENTAL PLLC, SUGAR LAND, TX. SN 85-390,138. PUB. 1-24-2012, FILED 8-4-2011.

 The logo for NIQUE DENTAL features the word "nique" in a lowercase, red, sans-serif font, followed by "dental" in a lowercase, red, sans-serif font. A small red vertical bar is positioned between the two words, acting as a separator.

4,165,931. I C D C, INC., DBA DEXTERITY HAIR DESIGN, SALT LAKE CITY, UT. SN 85-976,701. PUB. 1-17-2012, FILED 8-15-2011.

DEXTERITY

NO CLAIM IS MADE TO THE EXCLUSIVE RIGHT TO USE "DENTAL", APART FROM THE MARK AS SHOWN.

THE COLOR(S) RED AND WHITE IS/ARE CLAIMED AS A FEATURE OF THE MARK.

THE MARK CONSISTS OF THE LITERAL ELEMENTS "NIQUE DENTAL" IN RED COLOR WHEREIN THE IMAGE CONSISTS OF A WHITE TOOTH BRUSH IN A RED VERTICAL RECTANGLE REPRESENTING THE LETTER "I" IN "NIQUE".

FOR DENTISTRY (U.S. CLS. 100 AND 101).

FIRST USE 7-10-2011; IN COMMERCE 9-28-2011.

THE MARK CONSISTS OF STANDARD CHARACTERS WITHOUT CLAIM TO ANY PARTICULAR FONT, STYLE, SIZE, OR COLOR.

FOR HAIR SALON SERVICES, NAMELY, HAIR CUTTING, STYLING, COLORING, AND HAIR EXTENSION SERVICES (U.S. CLS. 100 AND 101).

FIRST USE 2-1-2005; IN COMMERCE 2-1-2005.

CLASS 45—PERSONAL AND LEGAL SERVICES

4,164,784. MOTHER IMAGE LLC, JERSEY CITY, NJ. SN 76-682,123. PUB. 7-28-2009, FILED 9-20-2007.

MOTHER IMAGE

THE MARK CONSISTS OF STANDARD CHARACTERS WITHOUT CLAIM TO ANY PARTICULAR FONT, STYLE, SIZE, OR COLOR.

NO CLAIM IS MADE TO THE EXCLUSIVE RIGHT TO USE "IMAGE", APART FROM THE MARK AS SHOWN.

FOR STOCK PHOTOGRAPHY SERVICES, NAMELY, THE LICENSING OF STOCK IMAGES BY MEANS OF GLOBAL COMPUTER NETWORK, LEASING REPRODUCTION RIGHTS OF PHOTOGRAPHS TO OTHERS (U.S. CLS. 100 AND 101).

FIRST USE 4-20-2012; IN COMMERCE 4-20-2012.

4,164,935. MPEG LA, LLC, GREENWOOD VILLAGE, CO. SN 77-855,083. PUB. 5-4-2010, FILED 10-22-2009.

TAGIVAN

THE MARK CONSISTS OF STANDARD CHARACTERS WITHOUT CLAIM TO ANY PARTICULAR FONT, STYLE, SIZE, OR COLOR.

FOR MANAGEMENT OF INTELLECTUAL PROPERTY, NAMELY, LICENSING OF INTELLECTUAL PROPERTY TO OTHERS; INTELLECTUAL PROPERTY CONSULTATION AND PROVIDING INFORMATION ABOUT INTELLECTUAL PROPERTY AND INDUSTRIAL PROPERTY RIGHTS (U.S. CLS. 100 AND 101).

FIRST USE 12-16-2011; IN COMMERCE 12-16-2011.

4,165,107. STINSON MORRISON HECKER LLP, KANSAS CITY, MO. SN 85-086,498. PUB. 8-9-2011, FILED 7-16-2010.



NO CLAIM IS MADE TO THE EXCLUSIVE RIGHT TO USE "LLP", APART FROM THE MARK AS SHOWN. THE COLOR(S) RED AND BLACK IS/ARE CLAIMED AS A FEATURE OF THE MARK.

CLASS 45—(Continued).

THE MARK CONSISTS OF A RED, LOWERCASE "E" FOLLOWED BY A BLACK, VERTICAL LINE, FOLLOWED BY THE WORD "SPARK" IN BLACK, UNDERNEATH THE "ESPAK" TERM IS THE NAME "STINSON MORRISON HECKER" IN BLACK, CAPITAL LETTERS, FOLLOWED BY A BLACK, VERTICAL LINE WHICH IS FOLLOWED BY THE ENTITY DESIGNATION "LLP" IN BLACK, CAPITAL LETTERS WHICH IS PLACED PERPENDICULAR TO THE NAME "STINSON MORRISON HECKER".

FOR LEGAL SERVICES (U.S. CLS. 100 AND 101). FIRST USE 8-12-2010; IN COMMERCE 8-13-2010.

4,165,150. THE TRUSTEES OF THE WHITLEY FAMILY TRUST, DATED JULY 14, 2009, SCOTTSDALE, AZ. SN 85-115,032. PUB. 4-12-2011, FILED 8-24-2010.

Document Lab

THE MARK CONSISTS OF STANDARD CHARACTERS WITHOUT CLAIM TO ANY PARTICULAR FONT, STYLE, SIZE, OR COLOR.

NO CLAIM IS MADE TO THE EXCLUSIVE RIGHT TO USE "DOCUMENT", APART FROM THE MARK AS SHOWN.

FOR LEGAL DOCUMENT PREPARATION SERVICES AND PROVIDING GENERAL LEGAL INFORMATION VIA A WEBSITE ON GLOBAL COMPUTER NETWORKS (U.S. CLS. 100 AND 101).

FIRST USE 10-1-2011; IN COMMERCE 10-1-2011.

4,165,172. BROWN BAG BIBLE BUDDIES MINISTRY, CANTON, MS. SN 85-121,133. PUB. 2-22-2011, FILED 9-1-2010.

BROWN BAG BIBLE BUDDIES

THE MARK CONSISTS OF STANDARD CHARACTERS WITHOUT CLAIM TO ANY PARTICULAR FONT, STYLE, SIZE, OR COLOR.

FOR CONDUCTING RELIGIOUS PRAYER SERVICES, ORGANIZING AND CONDUCTING GATHERINGS TO DEVELOP AND ENHANCE THE CHRISTIAN AND SPIRITUAL LIVES OF INDIVIDUALS AND PROVIDING INFORMATION IN THE FIELDS OF CHRISTIANITY, RELIGION AND SPIRITUALITY (U.S. CLS. 100 AND 101).

FIRST USE 9-0-2007; IN COMMERCE 9-0-2007.

CLASS 45—(Continued).

4,165,291. LIFESTYLE ENTERTAINMENT, INC., EVERGREEN, CO. SN 85-162,541. PUB. 3-8-2011, FILED 10-27-2010.

GET WICKED TONIGHT

THE MARK CONSISTS OF STANDARD CHARACTERS WITHOUT CLAIM TO ANY PARTICULAR FONT, STYLE, SIZE, OR COLOR.

FOR INTERNET BASED SOCIAL NETWORKING, INTRODUCTION, AND DATING SERVICES; PROVIDING A SOCIAL NETWORKING WEBSITE FOR ENTERTAINMENT PURPOSES (U.S. CLS. 100 AND 101).

FIRST USE 2-14-2012; IN COMMERCE 2-14-2012.

4,165,427. E.J. CONFIDENTIAL, INC., DBA MARRYMEYESTERDAY.COM, SOUTHFIELD, MI. SN 85-237,086. PUB. 8-23-2011, FILED 2-8-2011.



THE MARK CONSISTS OF THE FOLLOWING: A HEART DESIGN WITH A TOP HAT INSIDE OF IT, CURVED BANDS AROUND THE HEART DESIGN, THE WORDING "MARRY ME YESTERDAY.COM" WITH THE WORDING "MARRY ME" APPEARING ABOVE THE WORDING "YESTERDAY.COM", ROSES AND CURVED BANDS THAT APPEAR ON EACH SIDE OF THE WORDING, A DIAMOND RING, AND A PLAIN RING.

FOR COMPUTER DATING SERVICES; DATING SERVICES; DATING SERVICES, NAMELY, PROVIDING AN ON-LINE COMPUTER DATABASE FEATURING SINGLE PEOPLE INTERESTED IN MEETING OTHER SINGLE PEOPLE; INTERNET BASED SOCIAL NETWORKING, INTRODUCTION, AND DATING SERVICES; INTERNET-BASED DATING, SOCIAL INTRODUCTION AND SOCIAL NETWORKING SERVICES; MARRIAGE PARTNER INTRODUCTION OR DATING SERVICES; MATCHMAKING SERVICES (U.S. CLS. 100 AND 101).

FIRST USE 2-7-2012; IN COMMERCE 2-7-2012.

CLASS 45—(Continued).

4,165,568. C & L SERVICE CORPORATION, DBA EXCLUSIVELY FOR MEN, PORTSMOUTH, VA. SN 85-278,531. PUB. 8-30-2011, FILED 3-28-2011.



NO CLAIM IS MADE TO THE EXCLUSIVE RIGHT TO USE "EXCLUSIVELY FOR MEN", APART FROM THE MARK AS SHOWN.

THE MARK CONSISTS OF A BUSINESS MAN IN A SUIT AND TIE WITH HIS HANDS IN HIS POCKETS INSIDE OF AN OVAL WITH THE WORDS "EXCLUSIVELY FOR MEN" AROUND THE OUTSIDE OF THE OVAL.

FOR CONCIERGE SERVICES FOR OTHERS COMPRISING MAKING REQUESTED PERSONAL ARRANGEMENTS AND RESERVATIONS AND PROVIDING CUSTOMER-SPECIFIC INFORMATION TO MEET INDIVIDUAL NEEDS RENDERED TOGETHER IN A BUSINESS ESTABLISHMENT (U.S. CLS. 100 AND 101).

FIRST USE 5-1-2011; IN COMMERCE 5-1-2011.

4,165,639. REFINED LIVING, LLC, CHEVY CHASE, MD. SN 85-293,244. PUB. 8-30-2011, FILED 4-12-2011.

The Refined Concierge Agency

THE MARK CONSISTS OF STANDARD CHARACTERS WITHOUT CLAIM TO ANY PARTICULAR FONT, STYLE, SIZE, OR COLOR.

NO CLAIM IS MADE TO THE EXCLUSIVE RIGHT TO USE "CONCIERGE AGENCY", APART FROM THE MARK AS SHOWN.

FOR PERSONAL CONCIERGE SERVICES FOR OTHERS COMPRISING MAKING REQUESTED PERSONAL ARRANGEMENTS AND RESERVATIONS, RUNNING ERRANDS AND PROVIDING CUSTOMER SPECIFIC INFORMATION TO MEET INDIVIDUAL NEEDS, ALL RENDERED IN BUSINESS ESTABLISHMENTS, OFFICE BUILDINGS, HOTELS, RESIDENTIAL COMPLEXES AND HOMES (U.S. CLS. 100 AND 101).

FIRST USE 4-19-2011; IN COMMERCE 7-30-2011.

CLASS 45—(Continued).

4,165,678. FLOYD, SKEREN & KELLY, LLP, CALABASAS, CA. SN 85-305,116. PUB. 8-23-2011, FILED 4-26-2011.

**PLEADING GUILTY... NOT
SMART**

THE MARK CONSISTS OF STANDARD CHARACTERS WITHOUT CLAIM TO ANY PARTICULAR FONT, STYLE, SIZE, OR COLOR.
FOR LEGAL SERVICES (U.S. CLS. 100 AND 101).
FIRST USE 1-14-2012; IN COMMERCE 1-14-2012.

4,165,780. RODIN, RACHEL, NEW YORK, NY. SN 85-359,904. PUB. 11-22-2011, FILED 6-29-2011.



THE MARK CONSISTS OF THE STYLIZED LETTERS "RR" CENTERED WITHIN A CIRCLE.
FOR ORGANIZATIONAL SERVICES FOR PERSONAL PURPOSES, NAMELY, WARDROBES, CLOSET SPACE AND SHOPPING; PERSONAL FASHION CONSULTING SERVICES; PERSONAL IMAGE CONSULTING SERVICES AND PERSONAL LIFESTYLE CONSULTING SERVICES (U.S. CLS. 100 AND 101).
FIRST USE 7-1-2011; IN COMMERCE 7-1-2011.

4,165,783. SOUTHCARE, LLC, MARIETTA, GA. SN 85-361,287. PUB. 12-20-2011, FILED 6-30-2011.

**SOUTHCARE CREMATION &
FUNERAL SOCIETY**

THE MARK CONSISTS OF STANDARD CHARACTERS WITHOUT CLAIM TO ANY PARTICULAR FONT, STYLE, SIZE, OR COLOR.
OWNER OF U.S. REG. NO. 3,870,508.

CLASS 45—(Continued).

NO CLAIM IS MADE TO THE EXCLUSIVE RIGHT TO USE "CREMATION & FUNERAL SOCIETY", APART FROM THE MARK AS SHOWN.

FOR FUNERAL HOMES; FUNERAL ARRANGEMENT SERVICES; FUNERAL SERVICE UNDERTAKING; AND FUNERAL SERVICES ACCOMPANYING CREMATION (U.S. CLS. 100 AND 101).
FIRST USE 4-7-2012; IN COMMERCE 4-7-2012.

4,165,822. MICHIGAN MASONIC HOME INCORPORATED, DBA MASONIC PATHWAYS, ALMA, MI. SN 85-378,225. PUB. 1-17-2012, FILED 7-22-2011.

LIVE BETTER AT HOME

THE MARK CONSISTS OF STANDARD CHARACTERS WITHOUT CLAIM TO ANY PARTICULAR FONT, STYLE, SIZE, OR COLOR.

FOR IN-HOME CARE COORDINATION, NAMELY, PROVIDING NON-MEDICAL ASSISTED PERSONAL LIVING SERVICES FOR OTHERS IN THE NATURE OF PLANNING, ORGANIZING, COORDINATING, ARRANGING AND ASSISTING INDIVIDUALS TO PERFORM DAILY TASKS; CONCIERGE SERVICES FOR OTHERS COMPRISING MAKING REQUESTED PERSONAL ARRANGEMENTS AND RESERVATIONS AND PROVIDE CUSTOMER-SPECIFIC INFORMATION TO MEET INDIVIDUAL NEEDS RENDERED IN AN IN-HOME LIVING ENVIRONMENT; IN-HOME SUPPORT SERVICES TO SENIOR PERSONS, NAMELY, GERIATRIC CARE MANAGEMENT SERVICES IN THE NATURE OF THE COORDINATION OF NECESSARY SERVICES AND PERSONAL CARE FOR OLDER INDIVIDUALS (U.S. CLS. 100 AND 101).

FIRST USE 10-10-2011; IN COMMERCE 10-10-2011.

4,165,916. THE BUFFALO CITY CEMETERY, INC., BUFFALO, NY. SN 85-976,342. PUB. 8-30-2011, FILED 11-19-2010.



NO CLAIM IS MADE TO THE EXCLUSIVE RIGHT TO USE "CEMETERY", APART FROM THE MARK AS SHOWN.

CLASS 45—(Continued).

THE MARK CONSISTS OF STYLIZED TREES BEARING LEAVES PLACED ON BOTH SIDES OF A PATHWAY EXTENDING FROM THE FOREGROUND INTO THE BACKGROUND, ALL PLACED ABOVE THE WORDS "LAKE-SIDE" AND "CEMETERY", WITH A HORIZONTAL LINE ON BOTH SIDES OF THE WORD "CEMETERY".

FOR CEMETERY SERVICES, NAMELY, PROVIDING GRAVE, PLOT, CRYPT AND NICHE CEMETERY SPACES; PROVIDING SERVICES CONSISTING OF INTERMENTS, BURIALS AND ENTOMBMENTS (U.S. CLS. 100 AND 101).

FIRST USE 7-2-2010; IN COMMERCE 7-2-2010.

* * * * *

PRIOR UNITED STATES CLASSIFICATION

APPLICATION IN ONE CLASS

COLLECTIVE MEMBERSHIP MARKS

CLASS 200—COLLECTIVE MEMBERSHIP

4,164,848. CHURCH COMMUNITIES, INC., RIFTON, NY. SN 77-583,221. PUB. 9-8-2009, FILED 10-1-2008.

BRUDERHOF

THE MARK CONSISTS OF STANDARD CHARACTERS WITHOUT CLAIM TO ANY PARTICULAR FONT, STYLE, SIZE, OR COLOR.

THE ENGLISH TRANSLATION OF "BRUDERHOF" IN THE MARK IS PLACE OF THE BROTHERS.

FOR INDICATING MEMBERSHIP IN A RELIGIOUS ORDER (U.S. CL. 200).

FIRST USE 1-30-2012; IN COMMERCE 1-30-2012.

4,165,793. EXTREMETIX, INC., HOUSTON, TX. SN 85-363,890. PUB. 1-3-2012, FILED 7-6-2011.

VENUE ALLIANCE

NO CLAIM IS MADE TO THE EXCLUSIVE RIGHT TO USE "VENUE ALLIANCE", APART FROM THE MARK AS SHOWN.

THE MARK CONSISTS OF A FIGURE OF AN OVERALL SHIELD HAVING A THICK SOLID BORDER, WITH AN INTERMEDIATE WHITE ZONE WITHIN THE BORDER OF THE SHIELD, THE WHITE ZONE INTERNALLY BORDERED BY A CONGRUENT THIN OUTLINE OF A CENTERMOST SHIELD WITHIN THE OVERALL SHIELD, A VERTICAL ONE-HALF OF THE CENTERMOST SHIELD BEING SOLID, THE OTHER VERTICAL ONE-HALF OF THE CENTERMOST SHIELD BEING WHITE, WITH THE WORD "VENUE" TO THE LEFT OF THE OVERALL SHIELD AND THE WORD "ALLIANCE" TO THE RIGHT OF THE OVERALL SHIELD.

FOR INDICATING MEMBERSHIP IN A GROUP, THE GROUP HAVING MEMBERS WHOSE AREA OF ACTIVITY IS PROVIDING ARENAS, THEATERS, OR AMPHITHEATERS FOR ENTERTAINMENT PURPOSES (U.S. CL. 200).

FIRST USE 3-6-2012; IN COMMERCE 3-6-2012.

CERTIFICATION MARKS

CLASS B—SERVICES

4,165,374. NATIONAL REGISTRY OF EMERGENCY MEDICAL TECHNICIANS, COLUMBUS, OH. SN 85-207,386. PUB. 1-10-2012, FILED 12-29-2010.



OWNER OF U.S. REG. NOS. 3,065,178, 3,075,762, AND OTHERS.

NO CLAIM IS MADE TO THE EXCLUSIVE RIGHT TO USE "NATIONALLY CERTIFIED ADVANCED EMT" AND THE CADUCEUS SYMBOL OR STAR OF LIFE SYMBOL, APART FROM THE MARK AS SHOWN.

THE MARK CONSISTS OF THE WORDING "NATIONALLY CERTIFIED ADVANCED EMT" AND A CADUCEUS SYMBOL, A STAR OF LIFE SYMBOL AND THE LETTERS "NREMT", ALL INSIDE A CIRCLE. THE WORDS "NATIONALLY CERTIFIED" ARE AT THE TOP CURVE AND "ADVANCED EMT" IS ACROSS THE BOTTOM CURVE OF THE OUTER CIRCLE. INSIDE THIS CIRCLE IS A SHADED CIRCLE WITH A CADUCEUS SYMBOL, A STAR OF LIFE SYMBOL AND THE LETTERS "NREMT".

THE CERTIFICATION MARK, AS USED OR INTENDED TO BE USED BY PERSONS AUTHORIZED BY THE CERTIFIER, CERTIFIES OR IS INTENDED TO CERTIFY THAT THE SERVICES PROVIDED HAVE BEEN OR WILL BE PERFORMED BY A PERSON WHO MEETS CERTAIN EDUCATIONAL AND EXPERIENCE STANDARDS AND TESTS OF COMPETENCY IN THE FIELD OF EMERGENCY MEDICAL CARE AS ESTABLISHED BY THE CERTIFIER.

FOR MEDICAL CARE SERVICES (U.S. CL. B).
FIRST USE 6-1-2011; IN COMMERCE 6-1-2011.

* * * * *

SUPPLEMENTAL REGISTER

These registrations are not subject to opposition.

SECTION 1.— INTERNATIONAL CLASSIFICATION

The short titles associated below with the international class numbers are terms designed merely for quick identification and are not an official part of the international classification. The full names of international classes are given in section 6.1 of the trademark rules of practice.

The designation "U.S. Cl." appearing in this section refers to the U.S. class in effect prior to Sep. 1, 1973 rather than the international class which applies to applications filed on or after that date. For adoption of international classification see notice in the OFFICIAL GAZETTE of Jun. 26, 1973 (911 O.G. TM 210).

Application in more than one class

4,165,958. RODAN & FIELDS, LLC, SAN FRANCISCO, CA.
SN 85-026,344. FILED P.R. 4-29-2010; AM. S.R. 4-12-2012.

4,165,989. KINLEY, JEFFREY TODD, GREENSBORO, NC.
AND ANDERSON, LESLIE LEIGH, GREENSBORO, NC.
SN 85-237,977. FILED P.R. 2-9-2011; AM. S.R. 5-21-2012.

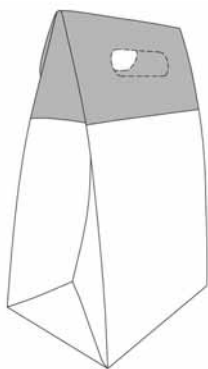

THE MARK CONSISTS OF A THREE-DIMENSIONAL CONFIGURATION OF PRODUCT PACKAGING IN THE FORM OF A VERTICALLY RECTANGULAR PHARMACY-STYLE BAG WITH A HANDLE. THE LOWER THREE-QUARTERS OF THE BAG ARE DISPLAYED IN WHITE AND THE UPPER ONE-QUARTER OF THE BAG IS DISPLAYED IN A COLOR OTHER THAN WHITE. THE GRAY IN THE DRAWING MERELY SHOWS THE PLACEMENT OF THE NON-WHITE COLOR. THE BROKEN LINES DEPICTING THE HANDLE INDICATE PLACEMENT OF THE MARK ON THE GOODS AND ARE NOT PART OF THE MARK.

CLASS 3—COSMETICS AND CLEANING PREPARATIONS

FOR NON-MEDICATED SKIN CARE PREPARATIONS (U.S. CLS. 1, 4, 6, 50, 51 AND 52).
FIRST USE 6-30-2003; IN COMMERCE 6-30-2003.

CLASS 5—PHARMACEUTICALS

FOR MEDICATED SKIN CARE PREPARATIONS (U.S. CLS. 6, 18, 44, 46, 51 AND 52).
FIRST USE 6-30-2003; IN COMMERCE 6-30-2003.

FOR THE ATHLETIC PROFESSIONAL

THE MARK CONSISTS OF STANDARD CHARACTERS WITHOUT CLAIM TO ANY PARTICULAR FONT, STYLE, SIZE, OR COLOR.

CLASS 25—CLOTHING

FOR SOCKS (U.S. CLS. 22 AND 39).
FIRST USE 3-21-2012; IN COMMERCE 3-21-2012.

CLASS 35—ADVERTISING AND BUSINESS

FOR ELECTRONIC CATALOG SERVICES FEATURING CLOTHING; MAIL ORDER CATALOG SERVICES FEATURING CLOTHING; ON-LINE WHOLESALE AND RETAIL STORE SERVICES FEATURING CLOTHING (U.S. CLS. 100, 101 AND 102).
FIRST USE 4-18-2012; IN COMMERCE 4-18-2012.

4,166,013. INVOICE CLOUD, INC., BRAINTREE, VA. SN 85-341,766. FILED P.R. 6-9-2011; AM. S.R. 3-9-2012.

INVOICE CLOUD

THE MARK CONSISTS OF STANDARD CHARACTERS WITHOUT CLAIM TO ANY PARTICULAR FONT, STYLE, SIZE, OR COLOR.
NO CLAIM IS MADE TO THE EXCLUSIVE RIGHT TO USE "INVOICE", APART FROM THE MARK AS SHOWN.

CLASS 35—ADVERTISING AND BUSINESS

FOR ELECTRONIC INVOICE PRESENTMENT, BEING INVOICING SERVICES (U.S. CLS. 100, 101 AND 102).
FIRST USE 5-1-2009; IN COMMERCE 5-1-2009.

CLASS 36—INSURANCE AND FINANCIAL

FOR BILL PAYMENT SERVICES; CHECK PROCESSING; CREDIT CARD AND PAYMENT CARD SERVICES; ELECTRONIC PAYMENT, NAMELY, ELECTRONIC PROCESSING AND TRANSMISSION OF BILL PAYMENT DATA; PROVIDING ELECTRONIC PROCESSING OF AUTOMATED CLEARING HOUSE (ACH), ELECTRONIC CHECK AND CREDIT CARD TRANSACTIONS AND ELECTRONIC PAYMENTS VIA A GLOBAL COMPUTER NETWORK; PROVIDING ELECTRONIC PROCESSING OF ELECTRONIC FUNDS TRANSFER, ACH, CREDIT CARD, DEBIT CARD, ELECTRONIC CHECK AND ELECTRONIC PAYMENTS (U.S. CLS. 100, 101 AND 102).
FIRST USE 5-1-2009; IN COMMERCE 5-1-2009.

4,166,040. NATIONAL ASSOCIATION OF TOURNAMENT DIRECTORS, LLC, FLEMINGTON, NJ. SN 85-403,998. FILED P.R. 8-22-2011; AM. S.R. 4-10-2012.

National Association of Tournament Directors

THE MARK CONSISTS OF STANDARD CHARACTERS WITHOUT CLAIM TO ANY PARTICULAR FONT, STYLE, SIZE, OR COLOR.

CLASS 16—PAPER GOODS AND PRINTED MATTER

FOR PRINTED MATERIALS, NAMELY, MANUALS, PERIODICALS, NEWSLETTERS, AND INSTRUCTION AND TEACHING MATERIALS IN THE FIELD OF DIRECTING AND ORGANIZING AMATEUR SPORTS TOURNAMENTS (U.S. CLS. 2, 5, 22, 23, 29, 37, 38 AND 50).
FIRST USE 8-22-2011; IN COMMERCE 8-22-2011.

CLASS 35—ADVERTISING AND BUSINESS

FOR ASSOCIATION SERVICES, NAMELY, PROMOTING THE INTERESTS OF AMATEUR SPORTS TOURNAMENT DIRECTORS; PROVISION OF CONSULTING AND ADVICE IN THE FIELD OF DIRECTING AND ORGANIZING AMATEUR SPORTS TOURNAMENTS (U.S. CLS. 100, 101 AND 102).
FIRST USE 8-22-2011; IN COMMERCE 8-22-2011.

CLASS 41—EDUCATION AND ENTERTAINMENT

FOR CONDUCTING AND ARRANGING EDUCATIONAL SEMINARS AND CONFERENCES IN THE FIELD OF THE DIRECTING AND ORGANIZING OF AMATEUR SPORTS TOURNAMENTS (U.S. CLS. 100, 101 AND 107).
FIRST USE 8-22-2011; IN COMMERCE 8-22-2011.

4,166,044. SEAT SACK, INC., NAPLES, FL. SN 85-431,874. FILED P.R. 9-26-2011; AM. S.R. 5-4-2012.

The Original
SEAT SACK
Company

NO CLAIM IS MADE TO THE EXCLUSIVE RIGHT TO USE "SACK COMPANY", APART FROM THE MARK AS SHOWN.

THE MARK CONSISTS OF THE WORDS "THE ORIGINAL" IN SCRIPT LETTERS WITH THE WORDS "SEAT SACK" BELOW IN LARGER PRINT LETTERS AND THE WORD "COMPANY" BELOW "SEAT SACK" IN SCRIPT LETTERS.

CLASS 18—LEATHER GOODS

FOR STORAGE POUCHES, BAGS AND TOTES FOR USE IN THE HOME, SCHOOL OR OFFICE FOR STORING AND CARRYING OFFICE AND SCHOOL SUPPLIES, NAMELY, BOOK BAGS, TOTE BAGS, POUCHES OF TEXTILE (U.S. CLS. 1, 2, 3, 22 AND 41).
FIRST USE 12-8-2007; IN COMMERCE 12-8-2007.

CLASS 35—ADVERTISING AND BUSINESS

FOR ONLINE RETAIL STORE SERVICES FEATURING STORAGE POUCHES, BAGS AND TOTES FOR USE IN THE HOME, SCHOOL OR OFFICE (U.S. CLS. 100, 101 AND 102).
FIRST USE 12-8-2007; IN COMMERCE 12-8-2007.

4,166,048. BEST BEVERAGE, LLC, NEWPORT BEACH, CA. SN 85-441,797. FILED P.R. 10-7-2011; AM. S.R. 5-1-2012.

BARTENDER'S BEST

THE MARK CONSISTS OF STANDARD CHARACTERS WITHOUT CLAIM TO ANY PARTICULAR FONT, STYLE, SIZE, OR COLOR.

CLASS 32—LIGHT BEVERAGES

FOR FRUIT JUICES; NON-ALCOHOLIC COCKTAIL MIXES (U.S. CLS. 45, 46 AND 48).
FIRST USE 1-31-2011; IN COMMERCE 1-31-2011.

CLASS 33—WINES AND SPIRITS

FOR SPIRITS AND LIQUEURS (U.S. CLS. 47 AND 49).
FIRST USE 1-31-2011; IN COMMERCE 1-31-2011.

4,166,055. NIEMANN FOODS, INC., QUINCY, IL. SN 85-461,060. FILED P.R. 11-1-2011; AM. S.R. 4-25-2012.

SLOW ROASTERS

THE MARK CONSISTS OF STANDARD CHARACTERS WITHOUT CLAIM TO ANY PARTICULAR FONT, STYLE, SIZE, OR COLOR.

CLASS 29—MEATS AND PROCESSED FOODS

FOR PREPARED MEAT, NAMELY, MEATLOAF, PULLED PORK, ITALIAN BEEF, ROAST BEEF, AND ROTISSERIE CHICKEN; PREPACKAGED MEALS, NAMELY, HASH BROWN POTATOES, MASHED POTATOES, AND GREEN BEAN CASSEROLES (U.S. CL. 46).
FIRST USE 10-31-2008; IN COMMERCE 10-31-2008.

CLASS 30—STAPLE FOODS

FOR SAGE DRESSING; NOODLE-BASED PREPARED MEALS, NAMELY, CHICKEN AND NOODLES, BEEF AND NOODLES, AND MACARONI AND CHEESE (U.S. CL. 46).
FIRST USE 10-31-2008; IN COMMERCE 10-31-2008.

4,166,057. KAJEET, INC., BETHESDA, MD. SN 85-463,050. FILED 11-2-2011.

THE SMART PHONE FOR KIDS

THE MARK CONSISTS OF STANDARD CHARACTERS WITHOUT CLAIM TO ANY PARTICULAR FONT, STYLE, SIZE, OR COLOR.

NO CLAIM IS MADE TO THE EXCLUSIVE RIGHT TO USE "SMART PHONE" FOR CLASS 9 ONLY, APART FROM THE MARK AS SHOWN.

CLASS 9—ELECTRICAL AND SCIENTIFIC APPARATUS

FOR MOBILE ELECTRONIC DEVICE PROVIDING TRANSMISSION AND STORAGE OF VOICE AND DATA, MESSAGING, GAMES, LOCATION SERVICES, PHOTOGRAPHY, AND OTHER MEDIA AND CONTENT AND RELATED TELECOMMUNICATIONS SERVICES, WITH OPTIONAL PARENTAL CONTROLS; COMPUTER HARDWARE AND SOFTWARE RELATED THERETO, AND DOWNLOADABLE COMPUTER GAMES, MUSIC AND EDUCATIONAL ACTIVITIES AND GAMES (U.S. CLS. 21, 23, 26, 36 AND 38).
FIRST USE 10-31-2011; IN COMMERCE 10-31-2011.

CLASS 38—COMMUNICATION

FOR TELECOMMUNICATIONS SERVICES VIA A MOBILE ELECTRONIC DEVICE, NAMELY, TRANSMISSION OF VOICE AND DATA, MESSAGING, GAMES, LOCATION SERVICES, PHOTOGRAPHY, AND OTHER MEDIA AND CONTENT, WITH OPTIONAL PARENTAL CONTROLS (U.S. CLS. 100, 101 AND 104).
FIRST USE 10-31-2011; IN COMMERCE 10-31-2011.

4,166,069. EUROPEANMARKET LLC, MIDDLETON, WI. SN 85-509,018. FILED P.R. 1-5-2012; AM. S.R. 5-1-2012.

EUROPEANMARKET

THE MARK CONSISTS OF STANDARD CHARACTERS WITHOUT CLAIM TO ANY PARTICULAR FONT, STYLE, SIZE, OR COLOR.

CLASS 35—ADVERTISING AND BUSINESS

FOR ONLINE RETAIL STORE SERVICES FEATURING HOUSE WARES, HOME ACCESSORIES, COOKWARE, LINENS, CANDLES, FRAGRANCES, CHOCOLATE, CANDY, BAKERY ITEMS, COOKING OIL, TOYS, GAMES, PUZZLES, PURSES, TOTE BAGS, ANTIQUES, CLOTHING AND ACCESSORIES, SOAP, SKIN CARE PRODUCTS, BOOKS, COFFEE, TEA, HOLIDAY AND SEASONAL GIFTS, AND POSTCARDS (U.S. CLS. 100, 101 AND 102).
FIRST USE 1-0-2010; IN COMMERCE 1-0-2010.

CLASS 41—EDUCATION AND ENTERTAINMENT

FOR ON-LINE JOURNALS, NAMELY, BLOGS FEATURING INFORMATION REGARDING TRAVEL AND SHOPPING (U.S. CLS. 100, 101 AND 107).
FIRST USE 8-8-2010; IN COMMERCE 8-8-2010.

4,166,070. MASALA DANCE & FITNESS, INC., IRVINE, CA. SN 85-512,125. FILED P.R. 1-9-2012; AM. S.R. 5-21-2012.

Bar Bhangra

THE MARK CONSISTS OF STANDARD CHARACTERS WITHOUT CLAIM TO ANY PARTICULAR FONT, STYLE, SIZE, OR COLOR.

OWNER OF U.S. REG. NO. 8,518,313.
NO CLAIM IS MADE TO THE EXCLUSIVE RIGHT TO USE "BAR", APART FROM THE MARK AS SHOWN.

CLASS 9—ELECTRICAL AND SCIENTIFIC APPARATUS

4,166,082. EDUCATIONDYNAMICS, LLC, HOBOKEN, NJ. SN 85-535,849. FILED P.R. 2-7-2012; AM. S.R. 5-21-2012.

FOR PRE-RECORDED CDS, VIDEO TAPES, LASER DISKS AND DVDS FEATURING PHYSICAL EXERCISE AND ORIGINALLY COMPOSED MUSIC (U.S. CLS. 21, 23, 26, 36 AND 38).

FIRST USE 1-1-2010; IN COMMERCE 1-1-2010.

CHRISTIANEDUCATION.COM

CLASS 28—TOYS AND SPORTING GOODS

FOR EXERCISE BARS; EXERCISE EQUIPMENT, NAMELY, WEIGHTED BARS, WEIGHTED STICKS, BAR BELLS FOR WEIGHT LIFTING, EXERCISE BANDS, TRAINING BARS.; PHYSICAL FITNESS EQUIPMENT, NAMELY, WEIGHTED BARS, BAR BELLS FOR WEIGHT LIFTING, EXERCISE BANDS, TRAINING BARS, WEIGHTED STICKS (U.S. CLS. 22, 23, 38 AND 50).

FIRST USE 1-1-2010; IN COMMERCE 1-1-2010.

THE MARK CONSISTS OF STANDARD CHARACTERS WITHOUT CLAIM TO ANY PARTICULAR FONT, STYLE, SIZE, OR COLOR.

CLASS 35—ADVERTISING AND BUSINESS

FOR PROVIDING AN ON-LINE DIRECTORY INFORMATION SERVICE FEATURING INFORMATION AND LINKS TO THE WEB SITES OF OTHERS PERTAINING TO EDUCATION, EDUCATIONAL OPPORTUNITIES, EDUCATIONAL RESOURCES AND FAITH BASED PROGRAMS; ADVERTISING, MARKETING AND PROMOTION SERVICES (U.S. CLS. 100, 101 AND 102).

FIRST USE 11-16-2011; IN COMMERCE 11-16-2011.

CLASS 41—EDUCATION AND ENTERTAINMENT

FOR DANCE INSTRUCTION; DANCE INSTRUCTION FOR CHILDREN; EDUCATION SERVICES, NAMELY, PROVIDING CLASSES AND INSTRUCTION IN THE FIELD OF DANCE; EDUCATIONAL SERVICES, NAMELY, CONDUCTING SEMINARS AND PROVIDING INSTRUCTION IN THE FIELD OF PHYSICAL EXERCISE, PHYSICAL FITNESS, STRENGTH CONDITIONING AND DISTRIBUTION OF EDUCATIONAL MATERIALS IN CONNECTION THEREWITH; ENTERTAINMENT IN THE NATURE OF DANCE PERFORMANCES; ORGANIZING COMMUNITY FESTIVALS FEATURING A VARIETY OF ACTIVITIES, NAMELY, ART EXHIBITIONS, HERITAGE MARKETS, ETHNIC DANCES, AND THE LIKE; PROVIDING A WEB SITE FEATURING INFORMATION ON EXERCISE AND FITNESS (U.S. CLS. 100, 101 AND 107).

FIRST USE 1-1-2010; IN COMMERCE 1-1-2010.

CLASS 41—EDUCATION AND ENTERTAINMENT

FOR PROVISION OF INFORMATION RELATING TO EDUCATION, EDUCATIONAL OPPORTUNITIES, EDUCATIONAL RESOURCES AND FAITH BASED EDUCATIONAL PROGRAMS (U.S. CLS. 100, 101 AND 107).

FIRST USE 11-16-2011; IN COMMERCE 11-16-2011.

4,166,079. OPEN SOURCE GROUP LLC, HENDERSON, NV. SN 85-526,572. FILED P.R. 1-26-2012; AM. S.R. 5-3-2012.

4,166,085. CRESCENT REAL ESTATE EQUITIES LIMITED PARTNERSHIP, FORT WORTH, TX. SN 85-568,444. FILED P.R. 3-13-2012; AM. S.R. 5-4-2012.

NEVADA'S BUSINESS DISTRICT

|opensourcearchitect|

THE MARK CONSISTS OF STANDARD CHARACTERS WITHOUT CLAIM TO ANY PARTICULAR FONT, STYLE, SIZE, OR COLOR.

CLASS 41—EDUCATION AND ENTERTAINMENT

FOR IT TRAINING SERVICES (U.S. CLS. 100, 101 AND 107).

FIRST USE 1-1-2011; IN COMMERCE 12-1-2011.

CLASS 35—ADVERTISING AND BUSINESS

FOR OPERATION OF A BUSINESS FOR OTHERS, NAMELY, OPERATION OF OFFICE BUILDINGS, RETAIL PROPERTIES, HOTELS, CONFERENCE CENTERS (U.S. CLS. 100, 101 AND 102).

FIRST USE 4-0-2010; IN COMMERCE 4-0-2010.

CLASS 42—SCIENTIFIC AND COMPUTER SERVICES

FOR COMPUTER SOFTWARE CONSULTING (U.S. CLS. 100 AND 101).

FIRST USE 1-1-2011; IN COMMERCE 12-1-2011.

CLASS 36—INSURANCE AND FINANCIAL

FOR LEASING OF REAL ESTATE, NAMELY, OFFICE BUILDINGS, RETAIL PROPERTIES, HOTELS, CONFERENCE CENTERS (U.S. CLS. 100, 101 AND 102).

FIRST USE 4-0-2010; IN COMMERCE 4-0-2010.

SECTION 2.— INTERNATIONAL CLASSIFICATION

The short titles associated below with the international class numbers are terms designed merely for quick identification and are not an official part of the international classification. The full names of international classes are given in section 6.1 of the trademark rules of practice.

The designation "U.S. Cl." appearing in this section refers to the U.S. class in effect prior to Sep. 1, 1973 rather than the international class which applies to applications filed on or after that date. For adoption of international classification see notice in the OFFICIAL GAZETTE of Jun. 26, 1973 (911 O.G. TM 210).

Application in one class

CLASS 1—CHEMICALS

4,165,990. CHEMPLEX INDUSTRIES, INC., PALM CITY, FL. SN 85-251,565. FILED P.R. 2-25-2011; AM. S.R. 4-23-2012.

LIQUID-BINDER

THE MARK CONSISTS OF STANDARD CHARACTERS WITHOUT CLAIM TO ANY PARTICULAR FONT, STYLE, SIZE, OR COLOR.

FOR ADDITIVES USED IN SPECTROCHEMICAL ANALYSIS, NAMELY, CHEMICAL ADDITIVES CONTAINING A POLYMERIC COMPONENT IN A SOLVENT FOR BINDING POWDERS TOGETHER FOR USE IN PREPARING SAMPLES USED IN SPECTROCHEMICAL ANALYSIS (U.S. CLS. 1, 5, 6, 10, 26 AND 46).

FIRST USE 1-31-1992; IN COMMERCE 1-31-1992.

CLASS 3—(Continued).

4,165,974. ESCA TECH, INC., MILWAUKEE, WI. SN 85-189,500. FILED P.R. 12-2-2010; AM. S.R. 4-12-2012.

WIPE OR RINSE

THE MARK CONSISTS OF STANDARD CHARACTERS WITHOUT CLAIM TO ANY PARTICULAR FONT, STYLE, SIZE, OR COLOR.

FOR NON-MEDICATED SKIN CLEANING COMPOSITIONS AND DISPOSABLE WIPES IMPREGNATED WITH SKIN CLEANING COMPOSITIONS (U.S. CLS. 1, 4, 6, 50, 51 AND 52).

FIRST USE 4-3-2012; IN COMMERCE 4-3-2012.

CLASS 2—PAINTS

4,166,022. MICRO SOLUTIONS ENTERPRISES, VAN NUYS, CA. SN 85-368,322. FILED P.R. 7-11-2011; AM. S.R. 5-15-2012.

MPS ENGINEERED

THE MARK CONSISTS OF STANDARD CHARACTERS WITHOUT CLAIM TO ANY PARTICULAR FONT, STYLE, SIZE, OR COLOR.

FOR FILLED INK CARTRIDGES; TONER; TONER CARTRIDGES (U.S. CLS. 6, 11 AND 16).

FIRST USE 7-1-2011; IN COMMERCE 7-1-2011.

4,166,017. PORTIONPAC CHEMICAL CORPORATION, CHICAGO, IL. SN 85-353,400. FILED P.R. 6-22-2011; AM. S.R. 4-4-2012.

DISH PAC

THE MARK CONSISTS OF STANDARD CHARACTERS WITHOUT CLAIM TO ANY PARTICULAR FONT, STYLE, SIZE, OR COLOR.

FOR MACHINE DISH WASHING DETERGENT (U.S. CLS. 1, 4, 6, 50, 51 AND 52).

FIRST USE 5-2-2011; IN COMMERCE 5-2-2011.

CLASS 3—COSMETICS AND CLEANING PREPARATIONS

CLASS 5—PHARMACEUTICALS

CLASS 5—(Continued).

4,165,963. JOHNSON & JOHNSON, NEW BRUNSWICK, NJ.
SN 85-130,858. FILED P.R. 9-16-2010; AM. S.R. 5-8-2012.

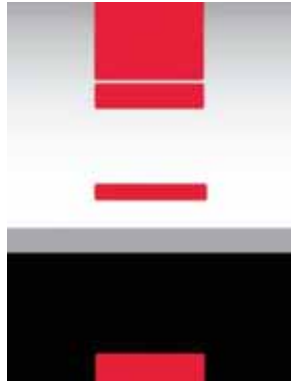

THE COLOR(S) RED, GRAY, WHITE AND BLACK IS/ ARE CLAIMED AS A FEATURE OF THE MARK.

THE MARK CONSISTS OF THE FOLLOWING: A RECTANGLE DIVIDED HORIZONTALLY INTO THIRDS. THE TOP THIRD APPEARS IN GRAY WITH TWO RED RECTANGLES OF DIFFERENT LENGTHS IN THE CENTER. THE CENTER THIRD IS PRIMARILY WHITE WITH A SMALL RED RECTANGLE CENTERED IN THE MIDDLE PORTION AND A NARROW DARK GRAY RECTANGLE AT THE BOTTOM OF THIS SECTION. THE LOWER THIRD OF THE RECTANGLE APPEARS IN BLACK WITH A NARROW RED BANNER CENTERED AT THE BOTTOM OF THE RECTANGLE.

FOR OVER THE COUNTER PHARMACEUTICAL PREPARATION, NAMELY, PAIN RELIEVING PATCH (U.S. CLS. 6, 18, 44, 46, 51 AND 52).

FIRST USE 7-1-2010; IN COMMERCE 7-1-2010.

4,165,964. JOHNSON & JOHNSON, NEW BRUNSWICK, NJ.
SN 85-130,866. FILED P.R. 9-16-2010; AM. S.R. 5-8-2012.



THE COLOR(S) RED, GRAY, WHITE AND BLACK IS/ ARE CLAIMED AS A FEATURE OF THE MARK.

THE MARK CONSISTS OF THE FOLLOWING: A RECTANGLE DIVIDED HORIZONTALLY INTO THIRDS. THE TOP THIRD APPEARS IN GRAY WITH A LARGE RED SQUARE ABOVE A THIN RED RECTANGLE; THE CENTER THIRD IS PRIMARILY WHITE WITH A SMALL GRAY

CLASS 5—(Continued).

RECTANGLE CENTERED IN THE BOTTOM PORTION OF THIS SECTION; THE LOWER THIRD OF MARK IS COMPOSED OF A GRAY RECTANGLE ACROSS THE TOP OF THIS SECTION, BELOW WHICH IS A BLACK SQUARE COMPRISING THE BACKGROUND TO A GRAY IMAGE OF A HAND TOUCHING A NECK, WITH A WHITE CIRCLE RADIATING OUT BENEATH THE HAND WHERE IT TOUCHES THE NECK, AND A NARROW RED RECTANGLE CENTERED AT THE BOTTOM OF THE BLACK SECTION.

FOR OVER THE COUNTER PHARMACEUTICAL PREPARATION, NAMELY, PAIN RELIEVING CREAM (U.S. CLS. 6, 18, 44, 46, 51 AND 52).

FIRST USE 7-1-2010; IN COMMERCE 7-1-2010.

4,165,965. JOHNSON & JOHNSON, NEW BRUNSWICK, NJ.
SN 85-130,867. FILED P.R. 9-16-2010; AM. S.R. 5-8-2012.

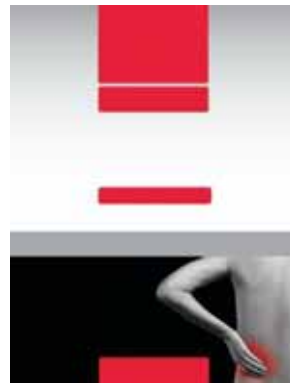

THE COLOR(S) RED, GRAY, WHITE AND BLACK IS/ ARE CLAIMED AS A FEATURE OF THE MARK.

THE MARK CONSISTS OF THE FOLLOWING: A RECTANGLE DIVIDED HORIZONTALLY INTO THIRDS. THE TOP THIRD APPEARS IN GRAY WITH A LARGE RED SQUARE ABOVE A THIN RED RECTANGLE; THE CENTER THIRD IS PRIMARILY WHITE WITH A SMALL RED RECTANGLE CENTERED IN THE BOTTOM PORTION OF THIS SECTION; THE LOWER THIRD OF MARK IS COMPOSED OF A GRAY RECTANGLE ACROSS THE TOP OF THIS SECTION, BELOW WHICH IS A BLACK SQUARE COMPRISING THE BACKGROUND FOR AN IMAGE LOCATED ON THE RIGHT SIDE OF THIS SECTION; THE IMAGE IS IN SHADES OF GRAY AND IS OF A HUMAN BACK WITH THE LEFT ARM REACHING ACROSS TO TOUCH THE LOWER BACK, WITH A RED CIRCLE RADIATING OUT BENEATH THE HAND WHERE IT TOUCHES THE LOWER BACK, AND A NARROW RED RECTANGLE CENTERED AT THE BOTTOM OF THE BLACK SECTION.

FOR OVER THE COUNTER PHARMACEUTICAL PREPARATION, NAMELY, PAIN RELIEVING PATCH (U.S. CLS. 6, 18, 44, 46, 51 AND 52).

FIRST USE 7-1-2010; IN COMMERCE 7-1-2010.

CLASS 5—(Continued).

4,165,966. JOHNSON & JOHNSON, NEW BRUNSWICK, NJ. SN 85-130,869. FILED P.R. 9-16-2010; AM. S.R. 5-8-2012.



THE COLOR(S) RED, GRAY, WHITE AND BLACK IS/ ARE CLAIMED AS A FEATURE OF THE MARK.

THE MARK CONSISTS OF THE FOLLOWING: A RECTANGLE DIVIDED HORIZONTALLY INTO THIRDS. THE TOP THIRD APPEARS IN GRAY WITH A LARGE RED SQUARE ABOVE A THIN RED RECTANGLE; THE CENTER THIRD IS PRIMARILY WHITE WITH A SMALL RED RECTANGLE CENTERED IN THE BOTTOM PORTION OF THIS SECTION; THE LOWER THIRD OF MARK IS COMPOSED OF A GRAY RECTANGLE ACROSS THE TOP OF THIS SECTION, BELOW WHICH IS A BLACK SQUARE COMPRISING THE BACKGROUND FOR 2 IMAGES, ONE ON THE RIGHT SIDE OF THIS SECTION AND THE OTHER ON THE LEFT; THE IMAGE ON THE RIGHT IS IN SHADES OF GRAY AND IS OF A PAIR OF HUMAN LEGS WITH THE RIGHT KNEE RAISED AND BENT WITH TWO HANDS ON IT AND A RED CIRCLE RADIATING OUT BENEATH THE RIGHT HAND WHERE IT TOUCHES THE KNEE; THE IMAGE ON THE LEFT IS OF THE BACK OF AN UPPER ARM WITH A HAND REACHING AROUND RUBBING IT WITH A RED CIRCLE RADIATING OUT BENEATH THE HAND WHERE IT TOUCHES THE ARM; THERE IS A NARROW RED RECTANGLE CENTERED AT THE BOTTOM OF THE BLACK SECTION.

FOR OVER THE COUNTER PHARMACEUTICAL PREPARATION, NAMELY, PAIN RELIEVING PATCH (U.S. CLS. 6, 18, 44, 46, 51 AND 52). FIRST USE 7-1-2010; IN COMMERCE 7-1-2010.

CLASS 5—(Continued).

4,165,967. JOHNSON & JOHNSON, NEW BRUNSWICK, NJ. SN 85-130,871. FILED P.R. 9-16-2010; AM. S.R. 5-8-2012.



THE COLOR(S) RED, GRAY, WHITE AND BLACK IS/ ARE CLAIMED AS A FEATURE OF THE MARK.

THE MARK CONSISTS OF THE FOLLOWING: A RECTANGLE DIVIDED HORIZONTALLY INTO THIRDS. THE TOP THIRD APPEARS IN GRAY WITH A LARGE RED SQUARE ABOVE A THIN RED RECTANGLE. THE CENTER THIRD IS PRIMARILY WHITE WITH A SMALL GREY RECTANGLE CENTERED IN THE MIDDLE PORTION OF THE LOWER PART OF THIS SECTION AND A NARROW DARK GRAY RECTANGLE ACROSS THE BOTTOM OF THIS SECTION. THE LOWER THIRD OF THE RECTANGLE APPEARS IN BLACK WITH A NARROW RED BANNER CENTERED AT THE BOTTOM OF THE SECTION.

FOR OVER THE COUNTER PHARMACEUTICAL PREPARATION, NAMELY, PAIN RELIEVING CREAM (U.S. CLS. 6, 18, 44, 46, 51 AND 52). FIRST USE 7-1-2010; IN COMMERCE 7-1-2010.

4,166,015. DRUCKER IP, LLC, PLANO, TX. SN 85-348,446. FILED P.R. 6-16-2011; AM. S.R. 5-3-2012.

NO SYNTHETIC CHEMICAL NUTRIENTS.

THE MARK CONSISTS OF STANDARD CHARACTERS WITHOUT CLAIM TO ANY PARTICULAR FONT, STYLE, SIZE, OR COLOR.

FOR NUTRACEUTICALS FOR USE AS A DIETARY SUPPLEMENT (U.S. CLS. 6, 18, 44, 46, 51 AND 52). FIRST USE 1-13-2009; IN COMMERCE 1-13-2009.

CLASS 5—(Continued).

4,166,018. INNERTHRIVE, LLC, MINDEN, NV. SN 85-358,509. FILED P.R. 6-28-2011; AM. S.R. 4-19-2012.

Ultimate Natural Testosterone System

THE MARK CONSISTS OF STANDARD CHARACTERS WITHOUT CLAIM TO ANY PARTICULAR FONT, STYLE, SIZE, OR COLOR.

FOR DIETARY AND NUTRITIONAL SUPPLEMENTS (U.S. CLS. 6, 18, 44, 46, 51 AND 52).
FIRST USE 3-1-2011; IN COMMERCE 3-1-2011.

4,166,064. ASEPSIS PHARMACEUTICALS INC., NORTH STONINGTON, CT. SN 85-488,086. FILED P.R. 12-6-2011; AM. S.R. 4-26-2012.

Asepsis Pharmaceuticals

THE MARK CONSISTS OF STANDARD CHARACTERS WITHOUT CLAIM TO ANY PARTICULAR FONT, STYLE, SIZE, OR COLOR.

OWNER OF U.S. REG. NO. 4,011,462.
NO CLAIM IS MADE TO THE EXCLUSIVE RIGHT TO USE "PHARMACEUTICALS", APART FROM THE MARK AS SHOWN.

FOR ANTI-INFECTIVES; ANTIEMETICS; CARDIO-VASCULAR PHARMACEUTICALS; DERMATOLOGICAL PHARMACEUTICAL PRODUCTS; DRUG DELIVERY AGENTS CONSISTING OF COMPOUNDS THAT FACILITATE DELIVERY OF A WIDE RANGE OF PHARMACEUTICALS; INHALED PHARMACEUTICAL PREPARATIONS FOR THE TREATMENT OF RESPIRATORY DISEASES AND DISORDERS; INTRAVENOUS FLUIDS USED FOR REHYDRATION, NUTRITION AND THE DELIVERY OF PHARMACEUTICAL PREPARATIONS; OCULAR PHARMACEUTICALS; PHARMACEUTICAL ANTI-ALLERGIC PREPARATIONS AND SUBSTANCES; PHARMACEUTICAL ANTITUSSIVE-COLD PREPARATIONS; PHARMACEUTICAL PREPARATION FOR THE TREATMENT OF GOUT; PHARMACEUTICAL PREPARATIONS ACTING ON THE CENTRAL NERVOUS SYSTEM; PHARMACEUTICAL PREPARATIONS AND SUBSTANCES FOR THE TREATMENT OF GASTRO-INTESTINAL DISEASES; PHARMACEUTICAL PREPARATIONS FOR INHALATION FOR THE TREATMENT OF PULMONARY HYPERTENSION; PHARMACEUTICAL PREPARATIONS FOR OCULAR OR INTRAOCULAR SURGERY; PHARMACEUTICAL PREPARATIONS FOR SKIN CARE; PHARMACEUTICAL PREPARATIONS FOR THE TREATMENT OF HEART RHYTHM DISORDERS; PHARMACEUTICAL PREPARATIONS FOR THE TREATMENT OF HORMONAL DISORDERS AND THE PREVENTION OF OSTEOPOROSIS; PHARMACEUTICAL PREPARATIONS FOR THE TREATMENT OF INFECTIOUS DISEASES; PHARMACEUTICAL PREPARATIONS FOR TREATING ALLERGIC RHINITIS AND ASTHMA; PHARMACEUTICAL PREPARATIONS FOR

CLASS 5—(Continued).

TREATING DIABETES; PHARMACEUTICAL PREPARATIONS FOR TREATING SKIN DISORDERS; PHARMACEUTICAL PREPARATIONS FOR USE IN DERMATOLOGY; PHARMACEUTICAL PREPARATIONS FOR WOUNDS; PHARMACEUTICAL PREPARATIONS FOR THE PREVENTION AND TREATMENT OF DISORDERS OF THE NERVOUS SYSTEM, THE IMMUNE SYSTEM, THE CARDIO-VASCULAR SYSTEM, THE METABOLIC SYSTEM, THE RESPIRATORY SYSTEM, THE MUSCULO-SKELETAL SYSTEM, THE GENITOURINARY SYSTEM, FOR THE TREATMENT OF INFLAMMATORY DISORDERS, FOR USE IN DERMATOLOGY, ONCOLOGY, HEMATOLOGY AND IN TISSUE AND ORGAN TRANSPLANTATION, IN OPHTHALMOLOGY AND FOR GASTROENTEROLOGICAL DISORDERS; PHARMACEUTICAL PRODUCTS FOR OPHTHALMOLOGICAL USE; POTASSIUM PREPARATIONS FOR PHARMACEUTICAL PURPOSES; VITAMIN AND MINERAL PREPARATIONS FOR USE AS INGREDIENTS IN THE FOOD AND PHARMACEUTICAL INDUSTRY (U.S. CLS. 6, 18, 44, 46, 51 AND 52).
FIRST USE 8-8-2010; IN COMMERCE 8-8-2010.

CLASS 6—METAL GOODS

4,165,952. SEASHELL INTERNATIONAL, INC., CARLSBAD, CA. SN 77-698,400. FILED P.R. 3-25-2009; AM. S.R. 4-25-2012.

the360

THE MARK CONSISTS OF STANDARD CHARACTERS WITHOUT CLAIM TO ANY PARTICULAR FONT, STYLE, SIZE, OR COLOR.

FOR AWNINGS, NAMELY, METAL PATIO OUTDOOR AND INDOOR AWNINGS (U.S. CLS. 2, 12, 13, 14, 23, 25 AND 50).

FIRST USE 3-18-2003; IN COMMERCE 3-18-2003.

4,166,061. EVER ENERGY, INC., DBA RUSTICA HARDWARE, SPRINGVILLE, UT. SN 85-469,840. FILED P.R. 11-10-2011; AM. S.R. 4-5-2012.

RUSTICA HARDWARE

THE MARK CONSISTS OF STANDARD CHARACTERS WITHOUT CLAIM TO ANY PARTICULAR FONT, STYLE, SIZE, OR COLOR.

NO CLAIM IS MADE TO THE EXCLUSIVE RIGHT TO USE "HARDWARE", APART FROM THE MARK AS SHOWN.

THE ENGLISH TRANSLATION OF "RUSTICA" IN THE MARK IS "PEASANT".

FOR METAL GARAGE DOOR ROLLERS; METAL ROLLERS FOR BARN DOORS (U.S. CLS. 2, 12, 13, 14, 23, 25 AND 50).

FIRST USE 2-20-2007; IN COMMERCE 2-20-2007.

CLASS 8—HAND TOOLS

4,166,027. CONAIR CORPORATION, STAMFORD, CT. SN 85-376,379. FILED P.R. 7-20-2011; AM. S.R. 5-1-2012.

Even Cut

THE MARK CONSISTS OF STANDARD CHARACTERS WITHOUT CLAIM TO ANY PARTICULAR FONT, STYLE, SIZE, OR COLOR.

OWNER OF U.S. REG. NOS. 3,578,210, 3,603,844, AND OTHERS.

FOR HAIR CLIPPERS; HAIR TRIMMERS (U.S. CLS. 23, 28 AND 44).

FIRST USE 4-1-2011; IN COMMERCE 4-1-2011.

4,166,028. FROST CUTLERY COMPANY LLC, OOLTEWAH, TN. SN 85-378,592. FILED P.R. 7-22-2011; AM. S.R. 5-2-2012.

VOSS CUTLERY CO.

THE MARK CONSISTS OF STANDARD CHARACTERS WITHOUT CLAIM TO ANY PARTICULAR FONT, STYLE, SIZE, OR COLOR.

NO CLAIM IS MADE TO THE EXCLUSIVE RIGHT TO USE "CUTLERY CO.", APART FROM THE MARK AS SHOWN.

FOR CUTLERY, NAMELY, POCKET KNIVES, BOOT KNIVES, HUNTING KNIVES AND COLLECTOR'S KNIVES (U.S. CLS. 23, 28 AND 44).

FIRST USE 4-19-2012; IN COMMERCE 4-19-2012.

4,166,050. PLEWS, INC., DIXON, IL. SN 85-447,446. FILED P.R. 10-14-2011; AM. S.R. 5-23-2012.

TWIST PUMP

THE MARK CONSISTS OF STANDARD CHARACTERS WITHOUT CLAIM TO ANY PARTICULAR FONT, STYLE, SIZE, OR COLOR.

NO CLAIM IS MADE TO THE EXCLUSIVE RIGHT TO USE "PUMP", APART FROM THE MARK AS SHOWN.

FOR HAND OPERATED TIRE SEALANT DISPENSING PUMP AND DISPENSER (U.S. CLS. 23, 28 AND 44).

FIRST USE 11-1-2011; IN COMMERCE 11-1-2011.

CLASS 9—ELECTRICAL AND SCIENTIFIC APPARATUS

CLASS 9—(Continued).

4,165,975. INFORMATIONAL DATA TECHNOLOGIES, LLC, WATERTOWN, SD. SN 85-197,658. FILED P.R. 12-14-2010; AM. S.R. 8-25-2011.

INFORMATIONAL DATA TECHNOLOGIES

THE MARK CONSISTS OF STANDARD CHARACTERS WITHOUT CLAIM TO ANY PARTICULAR FONT, STYLE, SIZE, OR COLOR.

FOR COMMUNICATION HARDWARE AND SOFTWARE FOR USE IN REMOTE UTILITY METER READING (U.S. CLS. 21, 23, 26, 36 AND 38).

FIRST USE 6-15-2011; IN COMMERCE 6-15-2011.

4,165,988. BAKER, DAVID, MEADOW VISTA, CA. SN 85-235,465. FILED P.R. 2-7-2011; AM. S.R. 5-1-2012.

Blues Vandals

THE MARK CONSISTS OF STANDARD CHARACTERS WITHOUT CLAIM TO ANY PARTICULAR FONT, STYLE, SIZE, OR COLOR.

NO CLAIM IS MADE TO THE EXCLUSIVE RIGHT TO USE "BLUES", APART FROM THE MARK AS SHOWN.

FOR COMPACT DISCS FEATURING MUSIC (U.S. CLS. 21, 23, 26, 36 AND 38).

FIRST USE 2-12-2010; IN COMMERCE 8-1-2011.

4,165,991. DELSON GROUP INC, CUPERTINO, CA. SN 85-259,231. FILED P.R. 3-6-2011; AM. S.R. 2-16-2012.

MOBILECLOUD

THE MARK CONSISTS OF STANDARD CHARACTERS WITHOUT CLAIM TO ANY PARTICULAR FONT, STYLE, SIZE, OR COLOR.

CLASS 9—(Continued).

OWNER OF U.S. REG. NO. 3,856,008.

FOR HANDHELD AND MOBILE DIGITAL ELECTRONIC DEVICES, NAMELY, TELECOMMUNICATION TERMINAL FOR THE SENDING AND RECEIVING OF TELEPHONE CALLS, FAXES, ELECTRONIC MAIL, VIDEO, AND OTHER DIGITAL DATA; DIGITAL AUDIO PLAYERS, NAMELY, DIGITAL MUSIC PLAYERS, AND SOFTWARE USED TO ACCESS, OPERATE, AND COMMUNICATE WITH SUCH PLAYERS; DIGITAL VIDEO PLAYERS AND SOFTWARE USED TO ACCESS, OPERATE, AND COMMUNICATE WITH SUCH PLAYERS; HANDHELD COMPUTERS, PERSONAL DIGITAL ASSISTANTS, ELECTRONIC PERSONAL ORGANIZERS, ELECTRONIC NOTEPADS; TELEPHONES, MOBILE CELLULAR TELEPHONES, COMPUTER GAMING MACHINES, VIDEOPHONES, CAMERAS; PRERECORDED COMPUTER PROGRAMS FOR PERSONAL INFORMATION MANAGEMENT; DATABASE MANAGEMENT SOFTWARE FOR TELECOMMUNICATIONS, TELEPHONY MANAGEMENT SOFTWARE, CHARACTER RECOGNITION SOFTWARE, ELECTRONIC MAIL AND MESSAGING SOFTWARE, PAGING SOFTWARE, DATABASE SYNCHRONIZATION SOFTWARE; COMPUTER PROGRAMS FOR ACCESSING, BROWSING AND SEARCHING ONLINE DATABASES; COMPUTER SOFTWARE AND FIRMWARE, NAMELY, OPERATING SYSTEM PROGRAMS, DATA SYNCHRONIZATION PROGRAMS, AND APPLICATION DEVELOPMENT TOOL PROGRAMS FOR PERSONAL AND HANDHELD COMPUTERS; ELECTRONIC HANDHELD UNITS, NAMELY, PERSONAL COMMUNICATORS FOR THE WIRELESS RECEIPT AND TRANSMISSION OF DATA THAT ENABLE THE USER TO KEEP TRACK OF OR MANAGE PERSONAL INFORMATION; COMPUTER HARDWARE AND SOFTWARE FOR PROVIDING INTEGRATED TELEPHONE COMMUNICATION WITH COMPUTERIZED GLOBAL INFORMATION NETWORKS; TELECOMMUNICATION SYSTEMS AND NETWORKS FOR TRANSMITTING AND RECEIVING VIDEO, DATA AND VOICE SIGNALS OVER WIRELESS COMMUNICATION NETWORKS OR SYSTEMS, NAMELY, MOBILE AND ACCESS COMPUTER AND MOBILE TELEPHONE TERMINALS, BASE TRANSCEIVER STATIONS AND WIRELESS RADIO PARTS THEREFOR, TRANSMISSION CIRCUITS, INTEGRATED CIRCUITS, COMPUTER HARDWARE, MULTIPLEXERS, DIGITAL SIGNAL PROCESSORS, RADIO FREQUENCY SIGNAL PROCESSORS, MOBILE SWITCHING CIRCUITS, AIR TRAFFIC ELECTRICAL CONTROLLERS, MOBILITY ELECTRICAL CONTROLLERS, ACCESS ELECTRICAL CONTROLLERS, REMOTE PORT ELECTRICAL CONTROLLERS, RADIO PORTS, ANTENNAS, ELECTRONIC RADIO COMPONENTS, SOFTWARE FOR TELECOMMUNICATIONS APPLICATIONS, AND MOBILE CORE NETWORKS COMPRISING DATA TRANSCEIVERS, WIRELESS NETWORKS AND GATEWAYS FOR COLLECTION, TRANSMISSION AND MANAGEMENT OF DATA, VOICE AND VIDEO (U.S. CLS. 21, 23, 26, 36 AND 38).

FIRST USE 10-11-2004; IN COMMERCE 10-11-2004.

4,165,996. BENTLEY INSTRUMENTS INC, CHASKA, MN. SN 85-287,620. FILED P.R. 4-6-2011; AM. S.R. 4-13-2012.

DAIRYSPEC

THE MARK CONSISTS OF STANDARD CHARACTERS WITHOUT CLAIM TO ANY PARTICULAR FONT, STYLE, SIZE, OR COLOR.

CLASS 9—(Continued).

OWNER OF U.S. REG. NO. 2,352,470.

FOR LABORATORY INSTRUMENTS, NAMELY, SPECTROMETERS FOR USE IN TESTING THE CONCENTRATION OF FAT, PROTEIN, LACTOSE AND SOLIDS IN DAIRY PRODUCTS (U.S. CLS. 21, 23, 26, 36 AND 38).

FIRST USE 10-0-2010; IN COMMERCE 10-0-2010.

4,166,011. THE ERICSON MANUFACTURING CO., WILLOUGHBY, OH. SN 85-336,688. FILED P.R. 6-2-2011; AM. S.R. 3-29-2012.

SMARTMONITOR

THE MARK CONSISTS OF STANDARD CHARACTERS WITHOUT CLAIM TO ANY PARTICULAR FONT, STYLE, SIZE, OR COLOR.

FOR ELECTRICAL APPARATUS, NAMELY, ELECTRICAL MONITOR FOR THE CONTROL, CONNECTION AND DETECTION OF ELECTRICAL ENERGY; ELECTRICAL PLUG AND CONNECTOR DEVICES, SOLD AS A COMPONENT OF ELECTRONIC MONITORS, USED FOR THE DETECTION OF MISWIRING, MISSING EARTH GROUND AND/OR POWER INDICATED THROUGH THE USE OF ONE OR MORE COLOR INDICATORS THROUGH OPAQUE OR CLEAR OUTER HOUSING; ELECTRONIC MONITOR USED FOR THE DETECTION OF MISWIRING WITHIN PERMANENTLY MOUNTED FLIP COVER RECEPTACLE ASSEMBLIES AND POWER INLET ASSEMBLIES (U.S. CLS. 21, 23, 26, 36 AND 38).

FIRST USE 8-1-2009; IN COMMERCE 10-1-2009.

4,166,012. GIGMARK, LLC, KNOXVILLE, TN. SN 85-339,621. FILED P.R. 6-7-2011; AM. S.R. 10-16-2011.

Interactive Flash Drive

THE MARK CONSISTS OF STANDARD CHARACTERS WITHOUT CLAIM TO ANY PARTICULAR FONT, STYLE, SIZE, OR COLOR.

NO CLAIM IS MADE TO THE EXCLUSIVE RIGHT TO USE "FLASH DRIVE", APART FROM THE MARK AS SHOWN.

FOR SOFTWARE USED ON A FLASH DRIVE FOR THE PURPOSE OF DELIVERING AND RECEIVING INTERACTIVE DIGITAL CONTENT TO AND FROM THE FLASH DRIVE (U.S. CLS. 21, 23, 26, 36 AND 38).

FIRST USE 6-3-2008; IN COMMERCE 6-3-2008.

CLASS 9—(Continued).

4,166,037. VOIP DIALING, INC., LAS VEGAS, NV. SN 85-397,461. FILED P.R. 8-14-2011; AM. S.R. 2-14-2012.

VOIP DIALING

THE MARK CONSISTS OF STANDARD CHARACTERS WITHOUT CLAIM TO ANY PARTICULAR FONT, STYLE, SIZE, OR COLOR.

NO CLAIM IS MADE TO THE EXCLUSIVE RIGHT TO USE "VOIP", APART FROM THE MARK AS SHOWN.

FOR VOICE OVER INTERNET PROTOCOL (VOIP) PRODUCTS AND TELECOMMUNICATIONS EQUIPMENT, NAMELY, IP-PBX (INTERNET PROTOCOL PRIVATE BRANCH EXCHANGE) TELEPHONE EXCHANGES, INTERNET PHONES, HEADSETS FOR TELEPHONES, AND VIDEO CAMERAS (U.S. CLS. 21, 23, 26, 36 AND 38).

FIRST USE 7-1-2010; IN COMMERCE 7-1-2010.

CLASS 9—(Continued).

4,166,052. GUNS BUILDER CLUB AND BULIDING 3D GUN DISASSEMBLY GUNAPP MAKER CO., LIMITED, HOUSTON, TX. SN 85-451,544. FILED P.R. 10-19-2011; AM. S.R. 4-15-2012.

guns builder

THE MARK CONSISTS OF STANDARD CHARACTERS WITHOUT CLAIM TO ANY PARTICULAR FONT, STYLE, SIZE, OR COLOR.

FOR COMPUTER-GAMING SOFTWARE (U.S. CLS. 21, 23, 26, 36 AND 38).

FIRST USE 10-8-2011; IN COMMERCE 10-17-2011.

4,166,062. RICHARD A. HOPPER, FULLERTON, CA. SN 85-480,231. FILED P.R. 11-23-2011; AM. S.R. 4-19-2012.

SPECSECURE

THE MARK CONSISTS OF STANDARD CHARACTERS WITHOUT CLAIM TO ANY PARTICULAR FONT, STYLE, SIZE, OR COLOR.

FOR EYEWEAR ACCESSORIES, NAMELY, STRAPS, NECK CORDS AND HEAD STRAPS WHICH RESTRAIN EYEWEAR FROM MOVEMENT ON A WEARER (U.S. CLS. 21, 23, 26, 36 AND 38).

FIRST USE 9-1-2011; IN COMMERCE 11-1-2011.

4,166,042. ZHAO, GUOQING, MONTCLAIR, CA. SN 85-427,647. FILED P.R. 9-20-2011; AM. S.R. 4-7-2012.

SINOMETER

THE MARK CONSISTS OF STANDARD CHARACTERS WITHOUT CLAIM TO ANY PARTICULAR FONT, STYLE, SIZE, OR COLOR.

FOR MULTIMETER, VOLTAGE METER, OSCILLOSCOPE, POWER SUPPLY, TESTER FOR COAXIAL CABLES, SOUND LEVEL METER, SPEEDOMETER, DISTANCE METER, LIGHT METER, ANEMOMETER, INSULATION TESTER, HUMIDOMETER, AIR PRESSURE METER, ALTITUDE METER, SATELLITE SIGNAL DETECTOR, ETHERNET SIGNAL DETECTOR, THERMOMETER, BATTERY TESTER, CAR IGNITION SYSTEM TESTER, MOTION DETECTOR, ULTRASONIC TESTER, CAPACITOR TESTER, FREQUENCY METER, INFRARED TESTER, LASER TESTER, ALTERNATIVE CURRENT PHASE TESTER, ELECTRICAL POWER METER, SEQUENCE TESTER, GOLD CONTENT TESTER, METAL DETECTOR, ELECTRONIC REMOTE CONTROLLER, HARDNESS TESTER FOR DIAMOND, THICKNESS TESTER, LOGIC ANALYZER (U.S. CLS. 21, 23, 26, 36 AND 38).

FIRST USE 5-1-2003; IN COMMERCE 5-1-2003.

4,166,068. HOFER, TIMOTHY, MANCHESTER, MO. SN 85-506,431. FILED P.R. 12-30-2011; AM. S.R. 4-18-2012.

E-STAND

THE MARK CONSISTS OF STANDARD CHARACTERS WITHOUT CLAIM TO ANY PARTICULAR FONT, STYLE, SIZE, OR COLOR.

FOR PORTABLE AND ADJUSTABLE HEIGHT FLOOR STAND THAT HOLDS AND SUPPORTS ELECTRONIC TABLETS AND READERS (U.S. CLS. 21, 23, 26, 36 AND 38).

FIRST USE 11-28-2011; IN COMMERCE 11-30-2011.

CLASS 10—MEDICAL APPARATUS

CLASS 10—(Continued).

4,165,956. SYNOVIS LIFE TECHNOLOGIES, INC., ST. PAUL, MN. SN 85-010,191. FILED P.R. 4-9-2010; AM. S.R. 8-2-2011.

THE SAFE, FAST, EASY WAY TO
PERFORM MICROVASCULAR
ANASTOMOSIS

THE MARK CONSISTS OF STANDARD CHARACTERS WITHOUT CLAIM TO ANY PARTICULAR FONT, STYLE, SIZE, OR COLOR.

NO CLAIM IS MADE TO THE EXCLUSIVE RIGHT TO USE "MICROVASCULAR ANASTOMOSIS", APART FROM THE MARK AS SHOWN.

FOR MEDICAL DEVICE FOR PERFORMING ANASTOMOSIS AND MONITORING PARAMETERS DURING AND AFTER SURGERY (U.S. CLS. 26, 39 AND 44).
FIRST USE 3-31-2010; IN COMMERCE 3-31-2010.

4,165,957. SYNOVIS LIFE TECHNOLOGIES, INC., ST. PAUL, MN. SN 85-010,256. FILED P.R. 4-9-2010; AM. S.R. 8-2-2011.

THE WORLD'S SMALLEST
MICROCLIP

THE MARK CONSISTS OF STANDARD CHARACTERS WITHOUT CLAIM TO ANY PARTICULAR FONT, STYLE, SIZE, OR COLOR.

NO CLAIM IS MADE TO THE EXCLUSIVE RIGHT TO USE "MICROCLIP", APART FROM THE MARK AS SHOWN.

FOR SURGICAL MICROCLIPS (U.S. CLS. 26, 39 AND 44).
FIRST USE 3-31-2010; IN COMMERCE 3-31-2010.

4,165,959. MEDBAG INC., COMMERCE, CA. SN 85-048,230. FILED P.R. 5-26-2010; AM. S.R. 10-22-2010.

MEDBAG

THE MARK CONSISTS OF STANDARD CHARACTERS WITHOUT CLAIM TO ANY PARTICULAR FONT, STYLE, SIZE, OR COLOR.

FOR PLASTIC MEDICAL BAGS FOR USE IN HOSPITALS, MEDICAL OFFICES AND PHARMACIES, NAMELY, GENERAL PURPOSE, HOME CARE, HOSPITAL, LABORATORY, PHARMACY, TRANSFER SPECIMEN, BEDSIDE, STERILIZATION, RESPIRATORY, SICKNESS, BLOOD TRANSPORT, MATTRESS, CHEMO TRANSFER, PRE-OP MEDICATIONS AND SYRINGE BAGS; INFECTIOUS WASTE LINER BAGS (U.S. CLS. 26, 39 AND 44).
FIRST USE 7-0-2010; IN COMMERCE 7-0-2010.

CLASS 10—(Continued).

4,166,036. ASCEND EAGLE, INC, PINOLE, CA. SN 85-396,026. FILED P.R. 8-11-2011; AM. S.R. 4-27-2012.

Pink Vinyl

THE MARK CONSISTS OF STANDARD CHARACTERS WITHOUT CLAIM TO ANY PARTICULAR FONT, STYLE, SIZE, OR COLOR.

FOR DENTAL GLOVES; GLOVES FOR MEDICAL PURPOSES; GLOVES FOR MEDICAL USE; PROTECTIVE GLOVES FOR MEDICAL USE (U.S. CLS. 26, 39 AND 44).
FIRST USE 1-1-2012; IN COMMERCE 1-1-2012.

CLASS 11—ENVIRONMENTAL CONTROL APPARATUS

4,165,972. TMB, INC, PACOIMA, CA. SN 85-185,738. FILED P.R. 11-28-2010; AM. S.R. 3-29-2012.

Intelligent Marquee Systems

THE MARK CONSISTS OF STANDARD CHARACTERS WITHOUT CLAIM TO ANY PARTICULAR FONT, STYLE, SIZE, OR COLOR.

FOR ELECTRIC LIGHTS ARRAYED IN A STRING OR CLUSTERS, LARGE AND SMALL, AND OPERATE TOGETHER TO CREATE EFFECTS (U.S. CLS. 13, 21, 23, 31 AND 34).
FIRST USE 11-23-2010; IN COMMERCE 11-23-2010.

CLASS 12—VEHICLES

4,165,953. ADM21 CO., LTD., GYEONGGI-DO, REPUBLIC OF KOREA. SN 77-962,323. FILED P.R. 3-18-2010; AM. S.R. 5-3-2012.

TWO IN ONE

THE MARK CONSISTS OF STANDARD CHARACTERS WITHOUT CLAIM TO ANY PARTICULAR FONT, STYLE, SIZE, OR COLOR.

CLASS 12—(Continued).

PRIORITY CLAIMED UNDER SEC. 44(D) ON REPUBLIC OF KOREA APPLICATION NO. 2010-0009737, FILED 2-23-2010, REG. NO. 0883370, DATED 10-5-2011, EXPIRES 10-5-2021.

FOR WINDSHIELD WIPER BLADES FOR AUTOMOBILES; WINDSHIELD WIPERS FOR AUTOMOBILES; WINDSHIELD WIPERS FOR FRONT-GLASS OF AUTOMOBILES; WINDSHIELD WIPER BLADES FOR VEHICLES; WINDSHIELD WIPER ARMS FOR VEHICLES (U.S. CLS. 19, 21, 23, 31, 35 AND 44).

4,165,954. ADM21 CO., LTD., GYEONGGI-DO, REPUBLIC OF KOREA. SN 77-962,327. FILED P.R. 3-18-2010; AM. S.R. 5-3-2012.

SEVEN IN ONE

THE MARK CONSISTS OF STANDARD CHARACTERS WITHOUT CLAIM TO ANY PARTICULAR FONT, STYLE, SIZE, OR COLOR.

PRIORITY CLAIMED UNDER SEC. 44(D) ON REPUBLIC OF KOREA APPLICATION NO. 2010-0009738, FILED 2-23-2010, REG. NO. 0883369, DATED 10-5-2011, EXPIRES 10-5-2021.

FOR WINDSHIELD WIPER BLADES FOR AUTOMOBILES; WINDSHIELD WIPERS FOR AUTOMOBILES; WINDSHIELD WIPERS FOR FRONT-GLASS OF AUTOMOBILES; WINDSHIELD WIPER BLADES FOR VEHICLES; WINDSHIELD WIPER ARMS FOR VEHICLES (U.S. CLS. 19, 21, 23, 31, 35 AND 44).

4,166,059. IDEEA CALIFORNIA, LLC, BREA, CA. SN 85-465,952. FILED P.R. 11-7-2011; AM. S.R. 5-8-2012.

DUAL-STEP

THE MARK CONSISTS OF STANDARD CHARACTERS WITHOUT CLAIM TO ANY PARTICULAR FONT, STYLE, SIZE, OR COLOR.

FOR AUTOMOTIVE VEHICLE SIDE BARS (U.S. CLS. 19, 21, 23, 31, 35 AND 44).
FIRST USE 10-28-2011; IN COMMERCE 10-28-2011.

CLASS 12—(Continued).

4,166,063. ALTORR CORPORATION, LARGO, FL. SN 85-482,749. FILED P.R. 11-29-2011; AM. S.R. 5-23-2012.

Solar Shield

THE MARK CONSISTS OF STANDARD CHARACTERS WITHOUT CLAIM TO ANY PARTICULAR FONT, STYLE, SIZE, OR COLOR.

NO CLAIM IS MADE TO THE EXCLUSIVE RIGHT TO USE "SOLAR", APART FROM THE MARK AS SHOWN. FOR SOLAR CANOPY FOR WHEELCHAIRS (U.S. CLS. 19, 21, 23, 31, 35 AND 44).

FIRST USE 11-1-2011; IN COMMERCE 11-1-2011.

CLASS 18—LEATHER GOODS

4,166,031. MCKEON, THOMAS, LARGO, FL. SN 85-379,856. FILED P.R. 7-25-2011; AM. S.R. 3-29-2012.

Peg Tube Pouch

THE MARK CONSISTS OF STANDARD CHARACTERS WITHOUT CLAIM TO ANY PARTICULAR FONT, STYLE, SIZE, OR COLOR.

NO CLAIM IS MADE TO THE EXCLUSIVE RIGHT TO USE "POUCH", APART FROM THE MARK AS SHOWN.

FOR POUCHES MADE OUT OF CLOTH (U.S. CLS. 1, 2, 3, 22 AND 41).

FIRST USE 9-7-2010; IN COMMERCE 7-9-2011.

CLASS 19—NON-METALLIC BUILDING MATERIALS

4,165,979. NATIONAL DIVERSIFIED SALES, INC., WOODLAND HILLS, CA. SN 85-207,380. FILED P.R. 12-29-2010; AM. S.R. 4-24-2012.

CLAMP-N-PIERCE

THE MARK CONSISTS OF STANDARD CHARACTERS WITHOUT CLAIM TO ANY PARTICULAR FONT, STYLE, SIZE, OR COLOR.

FOR IRRIGATION CONNECTORS, NAMELY, NON-METAL CONNECTORS USED TO CONNECT RIGID FEEDER LINES TO SUPPLY TUBING IN IRRIGATION SYSTEMS (U.S. CLS. 1, 12, 33 AND 50).

FIRST USE 1-1-2011; IN COMMERCE 1-1-2011.

CLASS 19—(Continued).

4,165,995. OWENS CORNING INTELLECTUAL CAPITAL, LLC, TOLEDO, OH. SN 85-274,714. FILED 3-23-2011.

TRIPLE LAYER PROTECTION

THE MARK CONSISTS OF STANDARD CHARACTERS WITHOUT CLAIM TO ANY PARTICULAR FONT, STYLE, SIZE, OR COLOR.

FOR NON-METAL SHINGLES (U.S. CLS. 1, 12, 33 AND 50).

FIRST USE 8-0-2011; IN COMMERCE 8-0-2011.

CLASS 25—CLOTHING

4,165,950. BSA COMPANY LIMITED, SOUTHAMPTON, UNITED KINGDOM. SN 77-601,597. FILED P.R. 10-27-2008; AM. S.R. 5-15-2012.



OWNER OF U.S. REG. NO. 3,245,704.

THE MARK CONSISTS OF THE LETTER "B" WITH A WING DESIGN.

FOR CLOTHING, FOOTWEAR AND HEADWEAR, NAMELY, SHIRTS, T-SHIRTS, SWEAT-SHIRTS, POLO SHIRTS, RUGBY SHIRTS, HOODED TOPS, SWEATERS, TROUSERS, OVERTROUSERS, BOILER SUITS, SHORTS, JACKETS, COATS, ANORAKS, HATS, CAPS, BOOTS AND SHOES; BELTS (U.S. CLS. 22 AND 39).

FIRST USE 12-31-2011; IN COMMERCE 12-31-2011.

4,165,960. LEWIS, SR., RALPH A., PHILADELPHIA, PA. SN 85-063,317. FILED P.R. 6-15-2010; AM. S.R. 5-4-2012.

FOR GOLFERS ONLY

THE MARK CONSISTS OF STANDARD CHARACTERS WITHOUT CLAIM TO ANY PARTICULAR FONT, STYLE, SIZE, OR COLOR.

CLASS 25—(Continued).

NO CLAIM IS MADE TO THE EXCLUSIVE RIGHT TO USE "GOLFERS", APART FROM THE MARK AS SHOWN.

FOR CLOTHING, NAMELY, MEN'S AND WOMEN'S APPAREL AND SPORTSWEAR, NAMELY, CAPS, HATS, VISORS, SHIRTS, GOLF SHIRTS, JERSEYS, KNIT SHIRTS, WOVEN SHIRTS, T-SHIRTS, AND SWEATERS (U.S. CLS. 22 AND 39).

FIRST USE 4-23-2012; IN COMMERCE 4-23-2012.

4,165,961. SAMMY LEE ENTERPRISES, INC., BIRMINGHAM, AL. SN 85-076,840. FILED P.R. 7-2-2010; AM. S.R. 5-3-2012.

LAND OF LUNCKERS

THE MARK CONSISTS OF STANDARD CHARACTERS WITHOUT CLAIM TO ANY PARTICULAR FONT, STYLE, SIZE, OR COLOR.

FOR FOOTWEAR; HEADWEAR; PANTS; SHIRTS (U.S. CLS. 22 AND 39).

FIRST USE 7-24-2010; IN COMMERCE 7-24-2010.

4,165,976. KANFI, YANIV, BROOKLYN, NY. AND BUSH-ELLE, CHANTAL A, BROOKLYN, NY. SN 85-199,127. FILED P.R. 12-16-2010; AM. S.R. 5-1-2012.

RELIGION KILLS

THE MARK CONSISTS OF STANDARD CHARACTERS WITHOUT CLAIM TO ANY PARTICULAR FONT, STYLE, SIZE, OR COLOR.

FOR HATS; HEADWEAR; SHIRTS; TOPS (U.S. CLS. 22 AND 39).

FIRST USE 9-0-2011; IN COMMERCE 9-0-2011.

4,165,986. GFM LICENSING GROUP LLC, WESTBROOK, CT. SN 85-229,867. FILED P.R. 1-31-2011; AM. S.R. 5-4-2012.



THE COLOR(S) RED, WHITE, BLUE, BLACK AND BEIGE IS/ARE CLAIMED AS A FEATURE OF THE MARK.

CLASS 25—(Continued).

THE MARK CONSISTS OF A DESIGN OF A GUITAR WITH RED AND WHITE STRIPES; WITH WHITE STARS OVER A BLUE BACKGROUND ON THE TOP END OF THE GUITAR BODY; THE NECK OF THE GUITAR IS BEIGE WITH BLACK STRINGS AND OUTLINING AND EXTENDS THROUGH THE "O" IN THE TERM "OLD"; TO THE RIGHT OF THIS IS THE WORDING "OLD GLORY" IN WHITE WITH BLACK OUTLINING; THIS IS UNDERLINED BY A BLUE AND RED BAR WITH WHITE STARS RUNNING THROUGH THE MIDDLE OF THE BAR.

FOR CLOTHING, NAMELY, T-SHIRTS, BANDANAS, JACKETS, PANTS, CAPS, SHIRTS, SHORTS, TIES (U.S. CLS. 22 AND 39).

FIRST USE 0-0-1969; IN COMMERCE 0-0-1969.

4,165,987. GFM LICENSING GROUP LLC, WESTBROOK, CT. SN 85-230,024. FILED P.R. 1-31-2011; AM. S.R. 5-4-2012.



THE COLOR(S) RED, BLUE, BLACK, WHITE IS/ARE CLAIMED AS A FEATURE OF THE MARK.

THE MARK CONSISTS OF A DESIGN OF A GUITAR WITH RED AND WHITE STRIPES WITH WHITE STARS OVER A BLUE BACKGROUND ON THE TOP HALF OF THE BODY OF THE GUITAR; THE NECK OF THE GUITAR IS BLACK WITH WHITE STRINGS AND OUTLINING; THE GUITAR IS FLANKED BY WHITE WINGS; BELOW THIS IS THE WORDING "OLD GLORY" IN WHITE WITH BLACK OUTLINING; THIS IS UNDERLINED BY A BLUE AND RED BAR WITH WHITE STARS WITHIN THE RED PORTIONS OF THE BAR; ALL OF THIS IS OVER A BLACK BACKGROUND.

FOR CLOTHING, NAMELY, T-SHIRTS, BANDANAS, JACKETS, PANTS, CAPS, SHIRTS, SHORTS, TIES (U.S. CLS. 22 AND 39).

FIRST USE 0-0-1969; IN COMMERCE 0-0-1969.

4,166,003. TRISTAR PRODUCTS, INC., EAST FAIRFIELD, NJ. SN 85-312,948. FILED P.R. 5-5-2011; AM. S.R. 5-1-2012.

CAMISHAPER

THE MARK CONSISTS OF STANDARD CHARACTERS WITHOUT CLAIM TO ANY PARTICULAR FONT, STYLE, SIZE, OR COLOR.

FOR UNDERGARMENTS (U.S. CLS. 22 AND 39).
FIRST USE 8-1-2011; IN COMMERCE 8-1-2011.

CLASS 25—(Continued).

4,166,009. GAKM RESOURCES LLC, NEWTON, NC. SN 85-330,655. FILED P.R. 5-26-2011; AM. S.R. 3-22-2012.



OWNER OF U.S. REG. NOS. 308,608 AND 2,831,431. THE COLOR(S) BLUE, GOLD AND GREY IS/ARE CLAIMED AS A FEATURE OF THE MARK.

THE MARK CONSISTS OF GOLD COLORING ON THE TOE OF A BLUE SOCK WITH A GREY LINE THAT ENCIRCLES THE ENTIRE SOCK; THE DOTTED LINE AROUND THE SOCK DENOTES THAT APPLICANT IS NOT CLAIMING RIGHTS TO THE SHAPE OF THE SOCK BUT HAS INCLUDED THE SOCK TO INDICATE THE PLACEMENT OF THE MARK.

FOR SOCKS (U.S. CLS. 22 AND 39).

FIRST USE 12-11-2011; IN COMMERCE 12-11-2011.

4,166,081. JONES, AVERY, BROOKLYN, NY. AND JONES JR., AVERY, BROOKLYN, NY. AND EMMANUEL, JOSHUA, BROOKLYN, NY. AND GARCIA, KAHMIL, QUEENS, NY. AND EMMANUEL, DARRYL, BROOKLYN, NY. AND VINES, ZAYANAHLA, BROOKLYN, NY. AND GRAY JR., GARFIELD, BROOKLYN, NY. AND BARROW JR., RONY, BROOKLYN, NY. AND LIVERMAN, OLIVIA, BROOKLYN, NY. SN 85-531,990. FILED P.R. 2-2-2012; AM. S.R. 5-14-2012.

THE MURRYS

THE MARK CONSISTS OF STANDARD CHARACTERS WITHOUT CLAIM TO ANY PARTICULAR FONT, STYLE, SIZE, OR COLOR.

FOR CLOTHING, NAMELY, TOPS, BOTTOMS, HATS, SWEATSHIRTS, HOODED SWEATSHIRTS, T-SHIRTS, BANDANNAS, AND SCARVES (U.S. CLS. 22 AND 39).
FIRST USE 6-1-2011; IN COMMERCE 6-15-2011.

CLASS 28—TOYS AND SPORTING GOODS

CLASS 28—(Continued).

4,165,997. GILLESPIE, THOMAS E., CLEVELAND, OH. SN 85-294,522. FILED P.R. 4-13-2011; AM. S.R. 4-9-2012.

TRAVEL TUBE

THE MARK CONSISTS OF STANDARD CHARACTERS WITHOUT CLAIM TO ANY PARTICULAR FONT, STYLE, SIZE, OR COLOR.

FOR BAGS SPECIALLY ADAPTED FOR SPORTS EQUIPMENT; CASES SPECIALLY ADAPTED FOR SPORTS EQUIPMENT; GOLF ACCESSORY, NAMELY, SUPPORT FOR HOLDING A GOLF CLUB; GOLF BAGS; GOLF BAGS WITH OR WITHOUT WHEELS; GOLF CLUB BAGS; GOLF CLUB HOLDERS FOR USE ON A DRIVING RANGE OR GOLF COURSE (U.S. CLS. 22, 23, 38 AND 50).

FIRST USE 6-27-2011; IN COMMERCE 6-27-2011.

CLASS 29—MEATS AND PROCESSED FOODS

4,166,023. MOUNTAINSIDE FARMS - A DIVISION OF WORCESTER CREAMERIES CORP., ROXBURY, NY. SN 85-368,672. FILED 7-12-2011.

Filtered Fresh

THE MARK CONSISTS OF STANDARD CHARACTERS WITHOUT CLAIM TO ANY PARTICULAR FONT, STYLE, SIZE, OR COLOR.

FOR MILK (U.S. CL. 46).

FIRST USE 2-0-2011; IN COMMERCE 2-0-2011.

CLASS 30—STAPLE FOODS

4,165,970. BOGHOSIAN, CHARLIE, JAMUL, CA. SN 85-153,306. FILED P.R. 10-15-2010; AM. S.R. 3-20-2012.

TOTALLY FRIED

THE MARK CONSISTS OF STANDARD CHARACTERS WITHOUT CLAIM TO ANY PARTICULAR FONT, STYLE, SIZE, OR COLOR.

CLASS 30—(Continued).

NO CLAIM IS MADE TO THE EXCLUSIVE RIGHT TO USE "FRIED", APART FROM THE MARK AS SHOWN.

FOR FOOD PRODUCTS, NAMELY, CORN BASED SNACK FOODS THAT ARE FAIRGROUND STYLE BATTER COATED AND DEEP FRIED; FOOD PRODUCTS, NAMELY, RICE BASED SNACK FOODS THAT ARE FAIRGROUND STYLE BATTER COATED AND DEEP FRIED; FOOD PRODUCTS, NAMELY, CHEESE BASED SNACK FOODS THAT ARE FAIRGROUND STYLE BATTER COATED AND DEEP FRIED; FOOD PRODUCTS, NAMELY, CHOCOLATE BASED SNACK FOODS THAT ARE FAIRGROUND STYLE BATTER COATED AND DEEP FRIED; FOOD PRODUCTS, NAMELY, COOKIE BASED SNACK FOODS THAT ARE FAIRGROUND STYLE BATTER COATED AND DEEP FRIED; FOOD PRODUCTS, NAMELY, ICE CREAM BASED SNACK FOODS THAT ARE FAIRGROUND STYLE BATTER COATED AND DEEP FRIED (U.S. CL. 46).

FIRST USE 2-1-2009; IN COMMERCE 5-1-2009.

CLASS 32—LIGHT BEVERAGES

4,166,004. TASTE NIRVANA INT'L, INC., DBA TASTE NIRVANA INTERNATIONAL INC., WALNUT, CA. SN 85-314,664. FILED P.R. 5-6-2011; AM. S.R. 3-29-2012.

NO CLAIM IS MADE TO THE EXCLUSIVE RIGHT TO USE "COCO" OR "COCONUT JUICE", APART FROM THE MARK AS SHOWN.

THE MARK CONSISTS OF THE STYLIZED WORD "COCO" CENTERED ABOVE THE STYLIZED WORD "FRESCO". THE WORDS "COCONUT JUICE WITH PULP" ARE POSITIONED BELOW THE WORD "FRESCO" IN STYLIZED FONT.

THE ENGLISH TRANSLATION OF "COCO" IN THE MARK IS "COCONUT". THE ENGLISH TRANSLATION OF "FRESCO" IN THE MARK IS "FRESH".

FOR COCONUT WATER (U.S. CLS. 45, 46 AND 48).

FIRST USE 4-0-2009; IN COMMERCE 4-0-2009.

CLASS 33—WINES AND SPIRITS

CLASS 33—(Continued).

4,165,994. STONE WOLF VINEYARDS, INC., MCMINN-VILLE, OR. SN 85-267,621. FILED P.R. 3-15-2011; AM. S.R. 4-11-2012.

ROSE CITY

THE MARK CONSISTS OF STANDARD CHARACTERS WITHOUT CLAIM TO ANY PARTICULAR FONT, STYLE, SIZE, OR COLOR.

FOR WINE (U.S. CLS. 47 AND 49).
FIRST USE 4-0-2011; IN COMMERCE 4-0-2011.

4,166,010. WICKER, IZABEL, AUSTIN, TX. SN 85-335,853. FILED P.R. 6-1-2011; AM. S.R. 4-26-2012.

Skinny Caipirinha

THE MARK CONSISTS OF STANDARD CHARACTERS WITHOUT CLAIM TO ANY PARTICULAR FONT, STYLE, SIZE, OR COLOR.

NO CLAIM IS MADE TO THE EXCLUSIVE RIGHT TO USE "CAIPIRINHA", APART FROM THE MARK AS SHOWN.

FOR REDUCED CALORIE ALCOHOLIC BEVERAGES EXCEPT BEERS (U.S. CLS. 47 AND 49).
FIRST USE 5-17-2011; IN COMMERCE 5-17-2011.

4,166,041. FABULOUS AMERICAN BEVERAGES LTD., PALISADES, NY. SN 85-423,540. FILED P.R. 9-15-2011; AM. S.R. 5-2-2012.

KANSAS CLEAN DISTILLED

NO CLAIM IS MADE TO THE EXCLUSIVE RIGHT TO USE "DISTILLED", APART FROM THE MARK AS SHOWN. THE MARK CONSISTS OF THE WORD "KANSAS" IN STYLIZED LETTERING, BELOW WHICH ARE THE WORDS "CLEAN DISTILLED" IN STYLIZED LETTERING. FOR WHISKEY (U.S. CLS. 47 AND 49).
FIRST USE 9-4-2011; IN COMMERCE 9-14-2011.

SERVICE MARKS

CLASS 35—ADVERTISING AND BUSINESS

CLASS 35—(Continued).

4,165,969. STRATEGIC MARKS, LLC, NEWPORT COAST, CA. SN 85-137,185. FILED P.R. 9-24-2010; AM. S.R. 4-2-2012.

ROBINSON'S

THE MARK CONSISTS OF STANDARD CHARACTERS WITHOUT CLAIM TO ANY PARTICULAR FONT, STYLE, SIZE, OR COLOR.

FOR RETAIL DEPARTMENT STORE AND ON-LINE RETAIL DEPARTMENT STORE SERVICES; RETAIL AND ON-LINE RETAIL CLOTHING BOUTIQUES; RETAIL AND ON-LINE RETAIL CLOTHING STORES; RETAIL AND ON-LINE RETAIL APPAREL STORES; RETAIL AND ON-LINE RETAIL STORE SERVICES FEATURING CLOTHING AND FASHION ACCESSORIES (U.S. CLS. 100, 101 AND 102).

FIRST USE 10-30-2011; IN COMMERCE 10-30-2011.

4,165,981. LAUNCH INTERNATIONAL, INC., DOYLES-TOWN, PA. SN 85-211,766. FILED P.R. 1-6-2011; AM. S.R. 4-24-2012.

The Sales Enablement Content Company

THE MARK CONSISTS OF STANDARD CHARACTERS WITHOUT CLAIM TO ANY PARTICULAR FONT, STYLE, SIZE, OR COLOR.

NO CLAIM IS MADE TO THE EXCLUSIVE RIGHT TO USE "COMPANY", APART FROM THE MARK AS SHOWN.

FOR ADVERTISING AND BUSINESS SERVICES, NAMELY, PROVIDING AN ONLINE WEBSITE WHERE ADVERTISERS, MARKETERS, AND CONTENT PROVIDERS CAN INTERACT WITH USERS FOR ADVERTISING, BRANDING, AND PROMOTING KNOWLEDGE, PRODUCTS, AND SERVICES, AND TRADESHOWS, ON BEHALF OF THEMSELVES AND OTHERS, AND FOR EVALUATING AND RATING THE SAME, ALL THE FOREGOING RELEVANT TO HUMAN ACTIVITIES AFFECTING CLIMATE CHANGE AND RELATED FIELDS; ADVERTISING AND MARKETING CONSULTANCY; ADVERTISING AND MARKETING SERVICES PROVIDED BY MEANS OF INDIRECT METHODS OF MARKETING COMMUNICATIONS, NAMELY, SOCIAL MEDIA, SEARCH ENGINE MARKETING, INQUIRY MARKETING, INTERNET MARKETING, MOBILE MARKETING, BLOGGING AND OTHER FORMS OF PASSIVE, SHARABLE OR VIRAL COMMUNICATIONS CHANNELS; ADVERTISING SERVICES, PUBLIC RELATIONS AND MARKETING SERVICES, NAMELY, PROMOTING AND MARKETING THE GOODS AND SERVICES OF OTHERS THROUGH ALL PUBLIC COMMUNICATION MEANS; ADVERTISING, PROMOTION AND MARKETING SERVICES IN THE NATURE OF E-MAIL BLAST CAMPAIGNS FOR OTHERS; ADVICE IN THE FIELD OF BUSINESS MANAGEMENT AND MARKETING; ASSISTANCE, ADVISORY SERVICES AND CONSULTANCY WITH REGARD TO BUSINESS PLANNING, BUSINESS ANALYSIS, BUSINESS MANAGEMENT, BUSINESS ORGANIZATION, MARKETING AND CUSTOMER ANALYSIS; BRANDING SERVICES, NAMELY, CONSULTING, DEVELOPMENT, MANAGEMENT AND MARKETING OF BRANDS FOR BUSINESSES; BUSINESS CONSULTATION AND

CLASS 35—(Continued).

MANAGEMENT REGARDING MARKETING ACTIVITIES AND LAUNCHING OF NEW PRODUCTS; BUSINESS MANAGEMENT AND CONSULTING SERVICES FOR THE HEALTH CARE INDUSTRY, NAMELY, CUSTOMER SERVICE, ACCOUNTING SERVICES, AND WEB-BASED ADVERTISING AND MARKETING SERVICES; BUSINESS MARKETING CONSULTING SERVICES; BUSINESS MARKETING SERVICES; BUSINESS TO BUSINESS DIRECT MARKETING SERVICES; CONSULTATION SERVICES, NAMELY, CREATIVE AND STRATEGIC CONSULTATION REGARDING DEVELOPMENT AND PRODUCTION OF MARKETING CAMPAIGNS FOR OTHERS; CREATION OF MARKETING TOOLS DESIGNED TO INCREASE A CLIENT COMPANY'S KNOWLEDGE OF CUSTOMER NEEDS, AND ITS COMPETITORS' PRODUCTS AND SERVICES, PRICING, ADVERTISING STRATEGY AND SALES STRATEGY; CUSTOM WRITING SERVICES COMPRISING PUBLIC RELATIONS AND MARKETING MATERIALS FOR THE AUDIO, VIDEO AND TECHNOLOGY INDUSTRIES; DEVELOPMENT OF MARKETING STRATEGIES AND CONCEPTS; DIRECT MARKETING CONSULTING SERVICES; IMPLEMENTATION AND FOLLOW-UP OF ADVICE IN THE FIELDS OF MARKETING; INFORMATION OR ENQUIRIES ON BUSINESS AND MARKETING; MARKETING AND CONSULTING SERVICES IN THE FIELD OF PROMOTING AND TRACKING THE GOODS, SERVICES, AND BRANDS OF OTHERS THROUGH ALL PUBLIC COMMUNICATION MEANS, PARTICULARLY SPECIALIZING IN THE USE OF MOBILE, SOCIAL, AND PRINT MEDIA TO DRIVE CONSUMER INTEREST, ENGAGEMENT AND ACTION; MARKETING PLAN DEVELOPMENT; MARKETING RESEARCH SERVICES; OUTSOURCING IN THE FIELD OF SALES AND MARKETING OF COMPUTER SOFTWARE; PROMOTION AND MARKETING SERVICES AND RELATED CONSULTING; RENTAL OF ALL PUBLICITY AND MARKETING PRESENTATION MATERIALS (U.S. CLS. 100, 101 AND 102).

FIRST USE 10-1-2010; IN COMMERCE 10-1-2010.

4,165,982. KARMALoop, INC., BOSTON, MA. SN 85-213,804. FILED P.R. 1-10-2011; AM. S.R. 1-4-2012.

BOYLSTON TRADING CO.

THE MARK CONSISTS OF STANDARD CHARACTERS WITHOUT CLAIM TO ANY PARTICULAR FONT, STYLE, SIZE, OR COLOR.

NO CLAIM IS MADE TO THE EXCLUSIVE RIGHT TO USE "TRADING CO.", APART FROM THE MARK AS SHOWN.

FOR ON-LINE RETAIL STORE FEATURING CLOTHING, FOOTWEAR, WATCHES, WALLETS, HATS, BAGS, UNDERGARMENTS, JEWELRY, AND ACCESSORIES (U.S. CLS. 100, 101 AND 102).

FIRST USE 11-2-2011; IN COMMERCE 11-2-2011.

CLASS 35—(Continued).

4,165,985. NEWS CANADA INC., TORONTO, ONTARIO, CANADA. SN 85-218,116. FILED P.R. 1-14-2011; AM. S.R. 10-13-2011.

IN-VIDEO

THE MARK CONSISTS OF STANDARD CHARACTERS WITHOUT CLAIM TO ANY PARTICULAR FONT, STYLE, SIZE, OR COLOR.

PRIORITY CLAIMED UNDER SEC. 44(D) ON CANADA APPLICATION NO. 1511019, FILED 1-13-2011.

FOR PUBLIC RELATIONS SERVICES, NAMELY, DEVELOPING VIDEOS FOR CORPORATIONS, GOVERNMENTS AND SIMILAR ENTITIES SO THAT SUCH AN ENTITY CAN EDUCATE ITS EMPLOYEES ABOUT THE ENTITY IN QUESTION SO THAT EMPLOYEES ARE BETTER INFORMED ABOUT THAT ENTITY WHEN COMMUNICATING AND PUBLICLY RELATING WITH THE PUBLIC (U.S. CLS. 100, 101 AND 102).

FIRST USE 9-8-2011; IN COMMERCE 9-15-2011.

4,166,000. TORRES, VICTOR, SAN JUAN, PUERTO RICO. SN 85-297,261. FILED P.R. 4-17-2011; AM. S.R. 4-5-2012.

Eco Plagas Control Center

THE MARK CONSISTS OF STANDARD CHARACTERS WITHOUT CLAIM TO ANY PARTICULAR FONT, STYLE, SIZE, OR COLOR.

NO CLAIM IS MADE TO THE EXCLUSIVE RIGHT TO USE "PLAGAS CONTROL CENTER", APART FROM THE MARK AS SHOWN.

THE ENGLISH TRANSLATION OF "PLAGAS" IN THE MARK IS PESTS.

FOR RETAIL STORE SERVICES FEATURING PEST CONTROL PRODUCTS (U.S. CLS. 100, 101 AND 102).

FIRST USE 7-4-2007; IN COMMERCE 7-4-2007.

4,166,001. DIRECT GLOBAL SALES, INC., SEATTLE, WA. SN 85-305,420. FILED P.R. 4-26-2011; AM. S.R. 2-10-2012.

DIRECT GLOBAL SALES

THE MARK CONSISTS OF STANDARD CHARACTERS WITHOUT CLAIM TO ANY PARTICULAR FONT, STYLE, SIZE, OR COLOR.

CLASS 35—(Continued).

NO CLAIM IS MADE TO THE EXCLUSIVE RIGHT TO USE "DIRECT" AND "SALES", APART FROM THE MARK AS SHOWN.

FOR MARKETING PLAN DEVELOPMENT FOR GOODS IN THE FIELD OF OUTDOOR COOKING; WHOLESALE AND RETAIL STORE SERVICES IN THE FIELD OF OUTDOOR COOKING GOODS; DISTRIBUTORSHIP SERVICES IN THE FIELD OF OUTDOOR COOKING GOODS; MARKETING SERVICES, NAMELY, PROMOTING OR ADVERTISING THE GOODS OF OTHERS IN THE FIELD OF OUTDOOR COOKING AND OUTDOOR LIVING; WHOLESALE STORE SERVICES IN THE FIELD OF A WIDE VARIETY OF CONSUMER GOODS IN THE FIELD OF OUTDOOR COOKING AND OUTDOOR LIVING; AND ONLINE RETAIL STORE SERVICES FEATURING A VARIETY OF CONSUMER GOODS (U.S. CLS. 100, 101 AND 102).

FIRST USE 5-31-2011; IN COMMERCE 5-31-2011.

4,166,002. CANDIDATE SEEKER, INC., ROBBINSVILLE, NJ.
SN 85-309,492. FILED 5-2-2011.

NORTH AMERICAN JOB BANK

THE MARK CONSISTS OF STANDARD CHARACTERS WITHOUT CLAIM TO ANY PARTICULAR FONT, STYLE, SIZE, OR COLOR.

NO CLAIM IS MADE TO THE EXCLUSIVE RIGHT TO USE "JOB BANK", APART FROM THE MARK AS SHOWN.

FOR EMPLOYMENT HIRING, RECRUITING, PLACEMENT, STAFFING AND CAREER NETWORKING SERVICES; EMPLOYMENT SERVICES, NAMELY, PROVIDING A WEB SITE WITH ONLINE VIDEO, AUDIO AND TEXTUAL INTERVIEWING APPLICATIONS TO SUPPORT RECRUITING, ADMISSIONS, AND GENERAL CANDIDATE SCREENING PROCESSES; PROVIDING ON-LINE EMPLOYMENT INFORMATION IN THE FIELD OF JOB RESOURCES (U.S. CLS. 100, 101 AND 102).

FIRST USE 5-2-2011; IN COMMERCE 5-2-2011.

4,166,008. GRADY & GRADY, LLC, OPELIKA, AL. SN 85-323,975. FILED P.R. 5-18-2011; AM. S.R. 5-17-2012.

LOE INDEX

THE MARK CONSISTS OF STANDARD CHARACTERS WITHOUT CLAIM TO ANY PARTICULAR FONT, STYLE, SIZE, OR COLOR.

NO CLAIM IS MADE TO THE EXCLUSIVE RIGHT TO USE "INDEX", APART FROM THE MARK AS SHOWN.

FOR BUSINESS CONSULTING SERVICES IN THE FIELD OF ORGANIZATIONAL CHANGE MANAGEMENT, NAMELY, TESTING OF INDIVIDUALS WITHIN AN ORGANIZATION FOR THEIR BEHAVIORS, PERCEPTIONS, AND ATTITUDES THAT EMERGE AS A RESPONSE TO ORGANIZATIONAL CHANGE (U.S. CLS. 100, 101 AND 102).

FIRST USE 9-0-2007; IN COMMERCE 2-0-2008.

CLASS 35—(Continued).

4,166,014. FIZZ TECHNOLOGIES, LLC, DEL MAR, CA. SN 85-346,178. FILED P.R. 6-14-2011; AM. S.R. 4-13-2012.

DIVERSITYBIDS.COM

THE MARK CONSISTS OF STANDARD CHARACTERS WITHOUT CLAIM TO ANY PARTICULAR FONT, STYLE, SIZE, OR COLOR.

NO CLAIM IS MADE TO THE EXCLUSIVE RIGHT TO USE "COM", APART FROM THE MARK AS SHOWN.

FOR ONLINE BUSINESS SERVICES, NAMELY, MATCHING BUSINESSES NEEDING GOODS AND SERVICES WITH PROVIDERS OF GOODS AND SERVICES; PROVIDING A WEB SITE WHEREBY BUYERS OF GOODS OR SERVICES LOCATE AND RECEIVE QUOTATIONS FROM MULTIPLE COMPETITIVE SOURCES AND SELLERS OF GOODS OR SERVICES IDENTIFY AND BID ON MULTIPLE NEW SALES OPPORTUNITIES (U.S. CLS. 100, 101 AND 102).

FIRST USE 2-15-2012; IN COMMERCE 2-15-2012.

4,166,016. THE COLLECTOR CAR NETWORK, INC., DBA CLASSICCARS.COM, PHOENIX, AZ. SN 85-350,429. FILED P.R. 6-20-2011; AM. S.R. 3-7-2012.

Certified Classic Vehicle

THE MARK CONSISTS OF STANDARD CHARACTERS WITHOUT CLAIM TO ANY PARTICULAR FONT, STYLE, SIZE, OR COLOR.

NO CLAIM IS MADE TO THE EXCLUSIVE RIGHT TO USE "CLASSIC VEHICLE", APART FROM THE MARK AS SHOWN.

FOR ADVERTISING AND PUBLICITY SERVICES, NAMELY, PROMOTING THE GOODS, SERVICES, AND BRAND IDENTITY OF THIRD PARTIES VIA A WEBSITE ON THE INTERNET (U.S. CLS. 100, 101 AND 102).

FIRST USE 3-1-2011; IN COMMERCE 4-1-2011.

CLASS 35—(Continued).

4,166,019. ROI VENTURES, LLC, CHICAGO, IL. SN 85-359,105. FILED P.R. 6-29-2011; AM. S.R. 5-11-2012.

CLASS 35—(Continued).

4,166,029. KREPS DEMARIA, CORAL GABLES, FL. SN 85-379,159. FILED P.R. 7-23-2011; AM. S.R. 4-11-2012.

Social Impact Branding

THE MARK CONSISTS OF STANDARD CHARACTERS WITHOUT CLAIM TO ANY PARTICULAR FONT, STYLE, SIZE, OR COLOR.

FOR BUSINESS CONSULTING SERVICES, NAMELY, CONSULTING BUSINESSES AND ENTREPRENEURS TO DEVELOP AND LAUNCH BUSINESS VENTURES, IDEAS, PRODUCTS AND SERVICES IN NON-PROFIT AND FOR-PROFIT ORGANIZATIONS (U.S. CLS. 100, 101 AND 102).

FIRST USE 2-10-2011; IN COMMERCE 2-10-2011.

PR ON THE NET

THE MARK CONSISTS OF STANDARD CHARACTERS WITHOUT CLAIM TO ANY PARTICULAR FONT, STYLE, SIZE, OR COLOR.

FOR ON LINE PUBLIC RELATION SERVICES (U.S. CLS. 100, 101 AND 102).

FIRST USE 7-31-2010; IN COMMERCE 7-31-2010.

4,166,021. ROEBUCK, TIA M., LARGO, MD. SN 85-366,399. FILED P.R. 7-8-2011; AM. S.R. 4-26-2012.

4,166,034. MISSIORECK, LAURA, MANHATTAN BEACH, CA. SN 85-387,061. FILED P.R. 8-2-2011; AM. S.R. 5-12-2012.

Black Blog Catalog

THE MARK CONSISTS OF STANDARD CHARACTERS WITHOUT CLAIM TO ANY PARTICULAR FONT, STYLE, SIZE, OR COLOR.

FOR ADVERTISING AND DIRECTORY SERVICES, NAMELY, PROMOTING THE SERVICES OF OTHERS BY PROVIDING A WEB PAGE FEATURING LINKS TO THE WEBSITES OF OTHERS; PROVIDING AN ON-LINE DIRECTORY INFORMATION SERVICE FEATURING INFORMATION REGARDING BLOGGERS OF AFRICAN DESCENT; PROVIDING ON-LINE DIRECTORY INFORMATION SERVICES ALSO FEATURING HYPERLINKS TO OTHER WEBSITE ADVERTISING AND DIRECTORY SERVICES, NAMELY, PROMOTING THE SERVICES OF OTHERS BY PROVIDING A WEB PAGE FEATURING LINKS TO THE WEBSITES OF OTHERS; PROVIDING AN ON-LINE DIRECTORY INFORMATION SERVICE FEATURING INFORMATION REGARDING BLOGGERS OF AFRICAN DESCENT; PROVIDING ON-LINE DIRECTORY INFORMATION SERVICES ALSO FEATURING HYPERLINKS TO OTHER WEB SITES (U.S. CLS. 100, 101 AND 102).

FIRST USE 2-1-2011; IN COMMERCE 2-1-2011.

The Graphic Element

THE MARK CONSISTS OF STANDARD CHARACTERS WITHOUT CLAIM TO ANY PARTICULAR FONT, STYLE, SIZE, OR COLOR.

FOR ADVERTISING AGENCIES SPECIALIZING IN DESIGN; CREATIVE MARKETING DESIGN SERVICES; DESIGN OF ADVERTISING BROCHURES FOR OTHERS; DESIGN OF ADVERTISING FLYERS FOR OTHERS; DESIGN OF ADVERTISING MATERIALS FOR OTHERS; DESIGN OF INTERNET ADVERTISING (U.S. CLS. 100, 101 AND 102).

FIRST USE 9-17-2003; IN COMMERCE 11-26-2003.

CLASS 35—(Continued).

4,166,043. CELLULAR SOUTH, INC., RIDGELAND, MS. SN 85-429,894. FILED P.R. 9-22-2011; AM. S.R. 4-25-2012.

Percs

THE MARK CONSISTS OF STANDARD CHARACTERS WITHOUT CLAIM TO ANY PARTICULAR FONT, STYLE, SIZE, OR COLOR.

FOR ADMINISTRATION OF A CUSTOMER LOYALTY PROGRAM WHICH PROVIDES REWARDS TO CURRENT AND PROSPECTIVE CUSTOMERS FOR SHARING THEIR VIEWS IN COMMUNITY SOCIAL FORUMS, JOINING COMPANY PROGRAMS, AND FOR BEING LOYAL CUSTOMERS; ARRANGING AND CONDUCTING INCENTIVE REWARD PROGRAMS TO PROMOTE THE SALE OF TELECOMMUNICATION SERVICES, NAMELY, TRANSMISSION OF VOICE, DATA, GRAPHICS, IMAGES, AUDIO AND VIDEO BY MEANS OF TELECOMMUNICATIONS NETWORKS, WIRELESS COMMUNICATION NETWORKS, AND THE INTERNET; PROVIDING INCENTIVE AWARD PROGRAMS FOR CUSTOMERS AND EMPLOYEES THROUGH THE DISTRIBUTION OF PREPAID STORED VALUE CARDS FOR THE PURPOSE OF PROMOTING AND REWARDING LOYALTY; RETAIL STORE SERVICES IN THE FIELD OF TELECOMMUNICATION SERVICES, NAMELY, TRANSMISSION OF VOICE, DATA, GRAPHICS, IMAGES, AUDIO AND VIDEO BY MEANS OF TELECOMMUNICATIONS NETWORKS, WIRELESS COMMUNICATION NETWORKS, AND THE INTERNET, FEATURING A BONUS INCENTIVE PROGRAM FOR CUSTOMERS (U.S. CLS. 100, 101 AND 102).

FIRST USE 11-1-2011; IN COMMERCE 11-1-2011.

4,166,060. INSULATION DISTRIBUTORS, INC., CHANHASSEN, MN. SN 85-466,688. FILED P.R. 11-8-2011; AM. S.R. 4-27-2012.

AMERICA'S INSULATION SOURCE

THE MARK CONSISTS OF STANDARD CHARACTERS WITHOUT CLAIM TO ANY PARTICULAR FONT, STYLE, SIZE, OR COLOR.

NO CLAIM IS MADE TO THE EXCLUSIVE RIGHT TO USE "INSULATION", APART FROM THE MARK AS SHOWN.

FOR DISTRIBUTORSHIP SERVICES FEATURING THE INSULATION PRODUCTS OF OTHERS (U.S. CLS. 100, 101 AND 102).

FIRST USE 8-0-2011; IN COMMERCE 8-0-2011.

CLASS 35—(Continued).

4,166,071. CLOUD PARTNERS, WESTFIELD, NJ. SN 85-517,992. FILED P.R. 1-17-2012; AM. S.R. 5-3-2012.

Cloud Partners

THE MARK CONSISTS OF STANDARD CHARACTERS WITHOUT CLAIM TO ANY PARTICULAR FONT, STYLE, SIZE, OR COLOR.

NO CLAIM IS MADE TO THE EXCLUSIVE RIGHT TO USE "PARTNERS", APART FROM THE MARK AS SHOWN. FOR BUSINESS DEVELOPMENT SERVICES (U.S. CLS. 100, 101 AND 102).

FIRST USE 1-5-2011; IN COMMERCE 1-5-2011.

4,166,076. VACPARTSWAREHOUSE.COM LLC, ROCKWALL, TX. SN 85-524,282. FILED P.R. 1-24-2012; AM. S.R. 5-3-2012.

Vac Parts Warehouse.com 866-243-2721

NO CLAIM IS MADE TO THE EXCLUSIVE RIGHT TO USE "WAREHOUSE.COM", APART FROM THE MARK AS SHOWN.

THE MARK CONSISTS OF THE TEXT "VAC PARTS" OVER A LINE, OVER "WAREHOUSE.COM", OVER "866-243-2721".

FOR ON-LINE RETAIL STORE SERVICES FEATURING DOMESTIC, COMMERCIAL, AND INDUSTRIAL VACUUM COMPONENTS AND CLEANING SUPPLIES (U.S. CLS. 100, 101 AND 102).

FIRST USE 12-1-2008; IN COMMERCE 1-31-2009.

4,166,078. NORTHWOOD PL HOLDINGS, LLC, NEW YORK, NY. SN 85-526,551. FILED P.R. 1-26-2012; AM. S.R. 5-3-2012.

Food Truck Fridays

THE MARK CONSISTS OF STANDARD CHARACTERS WITHOUT CLAIM TO ANY PARTICULAR FONT, STYLE, SIZE, OR COLOR.

FOR PROMOTIONAL SPONSORSHIP OF THE GATHERING OF VARIOUS FOOD TRUCKS ON FRIDAYS (U.S. CLS. 100, 101 AND 102).

FIRST USE 12-1-2011; IN COMMERCE 12-2-2011.

CLASS 36—INSURANCE AND FINANCIAL

4,165,947. LONESTAR SOCCER CLUB OF AUSTIN, INC., AUSTIN, TX. SN 76-703,133. FILED P.R. 5-27-2010; AM. S.R. 11-29-2011.

LONESTAR SOCCER CLUB

THE MARK CONSISTS OF STANDARD CHARACTERS WITHOUT CLAIM TO ANY PARTICULAR FONT, STYLE, SIZE, OR COLOR.

NO CLAIM IS MADE TO THE EXCLUSIVE RIGHT TO USE "SOCCER CLUB", APART FROM THE MARK AS SHOWN.

FOR CHARITABLE FUNDRAISING (U.S. CLS. 100, 101 AND 102).

FIRST USE 6-0-2004; IN COMMERCE 6-0-2004.

4,165,973. RUDERER, RICHARD, ST. LOUIS, MO. SN 85-186,086. FILED P.R. 11-29-2010; AM. S.R. 3-17-2011.

ORNAMENTS FOR OFFICERS

THE MARK CONSISTS OF STANDARD CHARACTERS WITHOUT CLAIM TO ANY PARTICULAR FONT, STYLE, SIZE, OR COLOR.

FOR CHARITABLE SERVICES, NAMELY, RAISING MONEY FOR THE FAMILIES OF POLICE AND FIREMEN WHO HAVE FALLEN OR BEEN DISABLED IN THE LINE OF DUTY (U.S. CLS. 100, 101 AND 102).

FIRST USE 9-10-2010; IN COMMERCE 9-10-2010.

4,165,977. KBRA HOLDINGS, INC., NEW YORK, NY. SN 85-200,138. FILED P.R. 12-16-2010; AM. S.R. 4-11-2012.

KROLL BOND RATINGS

THE MARK CONSISTS OF STANDARD CHARACTERS WITHOUT CLAIM TO ANY PARTICULAR FONT, STYLE, SIZE, OR COLOR.

NO CLAIM IS MADE TO THE EXCLUSIVE RIGHT TO USE "BOND RATINGS", APART FROM THE MARK AS SHOWN.

FOR PROVIDING BOND RATING SERVICES, NAMELY, SUBSCRIPTION BASED BOND RATINGS AND PUBLICLY RELEASED ISSUER-PAID BOND RATINGS; PROVIDING BANK AND FINANCIAL INVESTMENT RATING SERVICES (U.S. CLS. 100, 101 AND 102).

FIRST USE 5-1-2010; IN COMMERCE 5-1-2010.

CLASS 36—(Continued).

4,166,045. CANYONROAD CAPITAL LP, SANTA FE, NM. SN 85-432,534. FILED P.R. 9-27-2011; AM. S.R. 4-7-2012.

CANYON ROAD CAPITAL

THE MARK CONSISTS OF STANDARD CHARACTERS WITHOUT CLAIM TO ANY PARTICULAR FONT, STYLE, SIZE, OR COLOR.

NO CLAIM IS MADE TO THE EXCLUSIVE RIGHT TO USE "CAPITAL", APART FROM THE MARK AS SHOWN. FOR FINANCIAL SERVICES, NAMELY, REAL ESTATE FUNDS INVESTMENT SERVICES (U.S. CLS. 100, 101 AND 102).

FIRST USE 9-20-2011; IN COMMERCE 9-20-2011.

4,166,046. RECLAIM RECOVERY GROUP, INC., NESCONSET, NY. SN 85-433,420. FILED P.R. 9-27-2011; AM. S.R. 5-16-2012.

ReClaim Recovery Group

THE MARK CONSISTS OF STANDARD CHARACTERS WITHOUT CLAIM TO ANY PARTICULAR FONT, STYLE, SIZE, OR COLOR.

NO CLAIM IS MADE TO THE EXCLUSIVE RIGHT TO USE "RECOVERY GROUP", APART FROM THE MARK AS SHOWN.

FOR DEBT RECOVERY AND COLLECTION AGENCIES; INSURANCE SUBROGATION (U.S. CLS. 100, 101 AND 102).

FIRST USE 5-1-2011; IN COMMERCE 5-1-2011.

4,166,072. THE PINK RIBBON FOUNDATION, INC., FORT LAUDERDALE, FL. SN 85-518,437. FILED P.R. 1-17-2012; AM. S.R. 4-24-2012.

The Pink Ribbon Foundation

THE MARK CONSISTS OF STANDARD CHARACTERS WITHOUT CLAIM TO ANY PARTICULAR FONT, STYLE, SIZE, OR COLOR.

NO CLAIM IS MADE TO THE EXCLUSIVE RIGHT TO USE "FOUNDATION", APART FROM THE MARK AS SHOWN.

FOR CHARITABLE FUNDRAISING SERVICES, NAMELY, RAISING FUNDS TO BENEFIT BREAST CANCER PATIENTS (U.S. CLS. 100, 101 AND 102).

FIRST USE 1-1-2011; IN COMMERCE 1-1-2011.

CLASS 37—CONSTRUCTION AND REPAIR

4,166,051. MASTER WINDOW REPAIR, INC, BROOKLYN, NY. SN 85-448,505. FILED P.R. 10-17-2011; AM. S.R. 4-20-2012.

CLASS 38—(Continued).

4,165,992. COLUMBIA BIBLE COLLEGE BROADCASTING CO., COLUMBIA, SC. SN 85-261,619. FILED P.R. 3-8-2011; AM. S.R. 1-3-2012.

MASTER WINDOW REPAIR INC

THE MARK CONSISTS OF STANDARD CHARACTERS WITHOUT CLAIM TO ANY PARTICULAR FONT, STYLE, SIZE, OR COLOR.

NO CLAIM IS MADE TO THE EXCLUSIVE RIGHT TO USE "WINDOW REPAIR, INC.", APART FROM THE MARK AS SHOWN.

FOR BUILDING CONSTRUCTION SERVICES, NAMELY, WINDOW REPAIR, WINDOW REPLACEMENT, INSTALLATION OF NEW WINDOWS, WINDOW GLASS REPAIR, WINDOW GLASS REPLACEMENT, WINDOW SCREEN REPAIR, WINDOW SCREEN REPLACEMENT, WINDOW GUARDS INSTALLATION AND REPAIR (U.S. CLS. 100, 103 AND 106).
FIRST USE 9-12-2009; IN COMMERCE 10-30-2009.

FAMILY FRIENDLY

THE MARK CONSISTS OF STANDARD CHARACTERS WITHOUT CLAIM TO ANY PARTICULAR FONT, STYLE, SIZE, OR COLOR.

FOR AUDIO BROADCASTING; BROADCASTING PROGRAMS VIA A GLOBAL COMPUTER NETWORK; RADIO BROADCASTING (U.S. CLS. 100, 101 AND 104).
FIRST USE 1-3-2012; IN COMMERCE 1-3-2012.

4,166,049. SMS SOLUTIONS, INC., GAINESVILLE, TX. SN 85-444,437. FILED P.R. 10-11-2011; AM. S.R. 4-27-2012.

SMS VALET

THE MARK CONSISTS OF STANDARD CHARACTERS WITHOUT CLAIM TO ANY PARTICULAR FONT, STYLE, SIZE, OR COLOR.

NO CLAIM IS MADE TO THE EXCLUSIVE RIGHT TO USE "SMS", APART FROM THE MARK AS SHOWN.

FOR WIRELESS DIGITAL MESSAGING SERVICES (U.S. CLS. 100, 101 AND 104).
FIRST USE 9-1-2011; IN COMMERCE 9-1-2011.

CLASS 38—COMMUNICATION

4,165,951. AFB PRODUCTIONS, INC, WEST ORANGE, NJ. SN 77-625,074. FILED P.R. 12-2-2008; AM. S.R. 4-16-2012.

CLAUDE MONET TV

THE MARK CONSISTS OF STANDARD CHARACTERS WITHOUT CLAIM TO ANY PARTICULAR FONT, STYLE, SIZE, OR COLOR.

NO CLAIM IS MADE TO THE EXCLUSIVE RIGHT TO USE "TV", APART FROM THE MARK AS SHOWN.

FOR VIDEO BROADCASTING SERVICES OVER THE INTERNET OR OTHER COMMUNICATIONS NETWORK FEATURING THE UPLOADED, POSTED AND TAGGED VIDEOS OF OTHERS (U.S. CLS. 100, 101 AND 104).
FIRST USE 11-1-2006; IN COMMERCE 12-2-2008.

4,166,077. VOIP DIALING, INC., LAS VEGAS, NV. SN 85-524,701. FILED 1-25-2012.

VOIP DIALING

THE MARK CONSISTS OF STANDARD CHARACTERS WITHOUT CLAIM TO ANY PARTICULAR FONT, STYLE, SIZE, OR COLOR.

NO CLAIM IS MADE TO THE EXCLUSIVE RIGHT TO USE "VOIP", APART FROM THE MARK AS SHOWN.

FOR TELEPHONY COMMUNICATION SERVICES (U.S. CLS. 100, 101 AND 104).
FIRST USE 7-0-2010; IN COMMERCE 7-0-2010.

CLASS 38—(Continued).

4,166,084. BANDER-NET COMMUNICATIONS, INC., DBA FASTQ COMMUNICATIONS, PHOENIX, AZ. SN 85-536,431. FILED 2-7-2012.

FASTQ

THE MARK CONSISTS OF STANDARD CHARACTERS WITHOUT CLAIM TO ANY PARTICULAR FONT, STYLE, SIZE, OR COLOR.

FOR PROVIDING TELECOMMUNICATIONS CONNECTIONS TO A GLOBAL COMPUTER NETWORK (U.S. CLS. 100, 101 AND 104).

FIRST USE 5-7-1999; IN COMMERCE 5-7-1999.

CLASS 39—TRANSPORTATION AND STORAGE

4,165,980. UNISHIPPERS GLOBAL LOGISTICS, LLC, SALT LAKE CITY, UT. SN 85-207,659. FILED P.R. 12-29-2010; AM. S.R. 4-25-2012.

EXPRESS MANAGER

THE MARK CONSISTS OF THE WORDS "EXPRESS MANAGER" IN STYLIZED LETTERING WITH THE LETTER "X" IN THE WORD "EXPRESS" BEING HORIZONTALLY BIASECTED IN THE MIDDLE.

FOR PARCEL SHIPPING SERVICES; SHIPPING AND DELIVERY SERVICES, NAMELY, PICKUP, TRANSPORTATION, AND DELIVERY OF PACKAGES AND LETTERS BY VARIOUS MODES OF TRANSPORTATION (U.S. CLS. 100 AND 105).

FIRST USE 6-28-2011; IN COMMERCE 6-28-2011.

4,166,030. BEENE, LANDON, GRAY, TN. SN 85-379,507. FILED P.R. 7-25-2011; AM. S.R. 4-30-2012.

Gospel Music Celebration

THE MARK CONSISTS OF STANDARD CHARACTERS WITHOUT CLAIM TO ANY PARTICULAR FONT, STYLE, SIZE, OR COLOR.

FOR ARRANGING OF CRUISES (U.S. CLS. 100 AND 105).

FIRST USE 6-1-2009; IN COMMERCE 8-1-2009.

CLASS 40—MATERIAL TREATMENT

4,166,080. SNUGZ/USA INCORPORATED, SALT LAKE CITY, UT. SN 85-526,738. FILED 1-27-2012.

SWEETZ

THE MARK CONSISTS OF STANDARD CHARACTERS WITHOUT CLAIM TO ANY PARTICULAR FONT, STYLE, SIZE, OR COLOR.

FOR PRINTING; CUSTOMIZED PRINTING OF COMPANY NAMES AND LOGOS FOR PROMOTIONAL AND ADVERTISING PURPOSES; CUSTOMIZED PRINTING OF ADVERTISING AND PROMOTIONAL MATTER FOR OTHERS; PROVIDING INFORMATION IN THE FIELD OF PRINTING (U.S. CLS. 100, 103 AND 106).

FIRST USE 1-24-2012; IN COMMERCE 1-24-2012.

CLASS 41—EDUCATION AND ENTERTAINMENT

4,165,949. 300 STEWART AVENUE CORPORATION, LAS VEGAS, NV. SN 77-600,265. FILED P.R. 10-24-2008; AM. S.R. 3-17-2011.

THE MOB MUSEUM

THE MARK CONSISTS OF STANDARD CHARACTERS WITHOUT CLAIM TO ANY PARTICULAR FONT, STYLE, SIZE, OR COLOR.

NO CLAIM IS MADE TO THE EXCLUSIVE RIGHT TO USE "MUSEUM", APART FROM THE MARK AS SHOWN.

FOR MUSEUMS; GUIDED TOURS OF MUSEUMS; ENTERTAINMENT SERVICES, NAMELY, LIVE HISTORICAL SKITS; EDUCATIONAL SERVICES, NAMELY, SEMINARS ABOUT LAW ENFORCEMENT AGAINST ORGANIZED CRIME AND HISTORICAL EVENTS (U.S. CLS. 100, 101 AND 107).

FIRST USE 3-17-2011; IN COMMERCE 3-17-2011.

4,165,955. FRIENDS OF THE SPRING LAKE 5, A NEW JERSEY NONPROFIT CORPORATION, SPRING LAKE, NJ. SN 85-007,072. FILED P.R. 4-6-2010; AM. S.R. 8-17-2011.

THE SPRING LAKE 5

THE MARK CONSISTS OF STANDARD CHARACTERS WITHOUT CLAIM TO ANY PARTICULAR FONT, STYLE, SIZE, OR COLOR.

CLASS 41—(Continued).

NO CLAIM IS MADE TO THE EXCLUSIVE RIGHT TO USE "SPRING LAKE", APART FROM THE MARK AS SHOWN. FOR ATHLETIC AND SPORTS EVENT SERVICES, NAMELY, ARRANGING, ORGANIZING, OPERATING AND CONDUCTING ROAD RACES (U.S. CLS. 100, 101 AND 107).

FIRST USE 2-0-2000; IN COMMERCE 6-1-2011.

CLASS 41—(Continued).

4,165,971. CAROLINE H. TOWNSEND, BOSTON, MA. SN 85-179,387. FILED P.R. 11-17-2010; AM. S.R. 5-3-2012.

4,165,962. IRIS GROUP, INC., DBA MODERN POSTCARD, CARLSBAD, CA. SN 85-115,341. FILED 8-25-2010.

Sun Ocean Photography**DIRECT MAIL CRASH COURSE**

THE MARK CONSISTS OF STANDARD CHARACTERS WITHOUT CLAIM TO ANY PARTICULAR FONT, STYLE, SIZE, OR COLOR.

NO CLAIM IS MADE TO THE EXCLUSIVE RIGHT TO USE "CRASH COURSE", APART FROM THE MARK AS SHOWN.

FOR EDUCATION SERVICES, NAMELY, PROVIDING SEMINARS, WEBINARS AND CLASSES IN THE FIELDS OF ADVERTISING AND ADVERTISING STRATEGIES AND TECHNIQUES (U.S. CLS. 100, 101 AND 107).

FIRST USE 1-9-2007; IN COMMERCE 1-9-2007.

THE MARK CONSISTS OF STANDARD CHARACTERS WITHOUT CLAIM TO ANY PARTICULAR FONT, STYLE, SIZE, OR COLOR.

NO CLAIM IS MADE TO THE EXCLUSIVE RIGHT TO USE "OCEAN PHOTOGRAPHY", APART FROM THE MARK AS SHOWN.

FOR PHOTOGRAPHY (U.S. CLS. 100, 101 AND 107).
FIRST USE 12-27-2009; IN COMMERCE 1-1-2010.

4,165,968. AMERICAN INSTITUTE OF CERTIFIED PUBLIC ACCOUNTANTS, NEW YORK, NY. SN 85-136,882. FILED P.R. 9-23-2010; AM. S.R. 6-9-2011.

**SERVICE ORGANIZATION
CONTROL REPORTS**

THE MARK CONSISTS OF STANDARD CHARACTERS WITHOUT CLAIM TO ANY PARTICULAR FONT, STYLE, SIZE, OR COLOR.

NO CLAIM IS MADE TO THE EXCLUSIVE RIGHT TO USE "REPORTS", APART FROM THE MARK AS SHOWN.

FOR EDUCATIONAL AND TRAINING SERVICES, NAMELY, CONDUCTING EDUCATIONAL CLASSES, SEMINARS, WEBCASTS AND PODCASTS IN THE FIELDS OF SERVICE ORGANIZATIONS' INTERNAL CONTROLS OVER FINANCIAL REPORTING, SECURITY, AVAILABILITY, PROCESSING INTEGRITY, CONFIDENTIALITY AND PRIVACY SERVICES, AND HOW TO USE THE UNIFORM STANDARD TO ISSUE REPORTS (U.S. CLS. 100, 101 AND 107).

FIRST USE 5-30-2011; IN COMMERCE 5-30-2011.

4,165,978. WEDNET LLC, WOODINVILLE, WA. SN 85-205,999. FILED P.R. 12-27-2010; AM. S.R. 9-23-2011.

WEDNET

THE MARK CONSISTS OF STANDARD CHARACTERS WITHOUT CLAIM TO ANY PARTICULAR FONT, STYLE, SIZE, OR COLOR.

FOR PROVIDING INFORMATION IN THE FIELD OF WEDDING PLANNING, NAMELY, INFORMATION REGARDING WEDDING CLOTHING, WEDDING RINGS, WEDDING RELATED PARTIES AND GATHERINGS, WEDDING FLOWERS, WEDDING MUSIC, WEDDING PHOTOGRAPHS, WEDDING CEREMONIES, WEDDING CAKES, WEDDING RECEPTIONS, WEDDING GIFTS, SPEECHES FOR WEDDING OCCASIONS, WEDDING ANNIVERSARIES (U.S. CLS. 100, 101 AND 107).

FIRST USE 9-6-1995; IN COMMERCE 9-6-1995.

CLASS 41—(Continued).

4,165,998. LIGHT WITHOUT HEAT, INC., ENCINO, CA. SN 85-294,580. FILED P.R. 4-13-2011; AM. S.R. 10-19-2011.

GuitarTV

THE MARK CONSISTS OF STANDARD CHARACTERS WITHOUT CLAIM TO ANY PARTICULAR FONT, STYLE, SIZE, OR COLOR.

FOR ENTERTAINMENT AND EDUCATIONAL SERVICES IN THE NATURE OF INFORMATION ABOUT GUITARS AND GUITARISTS OFFERED VIA A WEB SITE ON A GLOBAL COMPUTER NETWORK; ENTERTAINMENT IN THE NATURE OF LIVE MUSICAL PERFORMANCES FEATURING THE GUITAR; ENTERTAINMENT IN THE NATURE OF ON-GOING TELEVISION AND RADIO PROGRAMS ABOUT GUITARS AND GUITARISTS (U.S. CLS. 100, 101 AND 107).

FIRST USE 8-1-2011; IN COMMERCE 8-1-2011.

4,165,999. CINEMA ASIA RELEASING, SANTA MONICA, CA. SN 85-295,579. FILED P.R. 4-14-2011; AM. S.R. 4-3-2012.



THE MARK CONSISTS OF THE WORDING "CINEMA ASIA RELEASING" IN 3 LINES, EACH WORD IN EACH LINE; "CINEMA" IS IN BLACK WITH GRAY BACKGROUND, "ASIA" IS TOP-HALF IN BLACK WITH GRAY BACKGROUND AND BOTTOM-HALF IN WHITE WITH BLACK BACKGROUND, "RELEASING" IS IN WHITE WITH BLACK BACKGROUND.

FOR FILM DISTRIBUTION (U.S. CLS. 100, 101 AND 107).

FIRST USE 3-20-2011; IN COMMERCE 3-20-2011.

4,166,007. CAMPUS MENTORS, LLC, OXFORD, OH. SN 85-319,970. FILED P.R. 5-13-2011; AM. S.R. 4-13-2012.

Campus Mentors

THE MARK CONSISTS OF STANDARD CHARACTERS WITHOUT CLAIM TO ANY PARTICULAR FONT, STYLE, SIZE, OR COLOR.

CLASS 41—(Continued).

NO CLAIM IS MADE TO THE EXCLUSIVE RIGHT TO USE "MENTORS", APART FROM THE MARK AS SHOWN.

FOR EDUCATION SERVICES, NAMELY, PROVIDING MENTORING AND TUTORING, THROUGH A MODEL ALTERNATIVE SCHOOL LOCATED ON A COLLEGE OR UNIVERSITY CAMPUS, TO AT-RISK SECONDARY STUDENTS (U.S. CLS. 100, 101 AND 107).

FIRST USE 3-23-2011; IN COMMERCE 3-23-2011.

4,166,020. S. D. MYERS, INC., TALLMADGE, OH. SN 85-360,612. FILED P.R. 6-30-2011; AM. S.R. 4-17-2012.

TRANSFORMER SPECIALIST CERTIFICATION PROGRAM

THE MARK CONSISTS OF STANDARD CHARACTERS WITHOUT CLAIM TO ANY PARTICULAR FONT, STYLE, SIZE, OR COLOR.

NO CLAIM IS MADE TO THE EXCLUSIVE RIGHT TO USE "CERTIFICATION PROGRAM", APART FROM THE MARK AS SHOWN.

FOR EDUCATION SERVICES, NAMELY, PROVIDING LIVE AND ON-LINE CLASSES, SEMINARS, AND WORKSHOPS IN THE FIELD OF THE DEVELOPMENT AND EQUIPPING OF EXPERT TRANSFORMERS; PROVIDING TRAINING AND ON-LINE TRAINING, NAMELY, FUNDAMENTAL AND ADVANCED TECHNICAL TRAINING IN THE FORM OF ON-LINE CLASSES, SEMINARS, AND WORKSHOPS DIRECTED TO ALL INDIVIDUALS INVOLVED IN THE LIFE OF THE TRANSFORMER IN THE FIELDS OF PLANNING, PURCHASING, TRANSPORTING, INSTALLING, SERVING, MAINTAINING, MANAGING, AND INSURING TRANSFORMERS (U.S. CLS. 100, 101 AND 107).

FIRST USE 6-30-2011; IN COMMERCE 6-30-2011.

4,166,035. BOULDER MARATHON, LLC, BOULDER, CO. SN 85-393,662. FILED P.R. 8-9-2011; AM. S.R. 5-1-2012.

BOULDER MARATHON

THE MARK CONSISTS OF STANDARD CHARACTERS WITHOUT CLAIM TO ANY PARTICULAR FONT, STYLE, SIZE, OR COLOR.

NO CLAIM IS MADE TO THE EXCLUSIVE RIGHT TO USE "MARATHON", APART FROM THE MARK AS SHOWN.

FOR ORGANIZING, ARRANGING, AND CONDUCTING RUNNING EVENTS (U.S. CLS. 100, 101 AND 107).

FIRST USE 1-15-2007; IN COMMERCE 1-15-2007.

CLASS 41—(Continued).

4,166,039. JEFFERY, INC., MIAMI BEACH, FL. SN 85-400,548. FILED P.R. 8-17-2011; AM. S.R. 4-12-2012.

ACCENT REDUCTION MIAMI

THE MARK CONSISTS OF STANDARD CHARACTERS WITHOUT CLAIM TO ANY PARTICULAR FONT, STYLE, SIZE, OR COLOR.

NO CLAIM IS MADE TO THE EXCLUSIVE RIGHT TO USE "ACCENT REDUCTION", APART FROM THE MARK AS SHOWN.

FOR BUSINESS EDUCATION SERVICES AND TRAINING SERVICES, NAMELY, CLASSES SEMINARS, WORKSHOPS, AND TRAINING IN THE FIELDS OF PUBLIC PRESENTATIONS, COMMUNICATION SKILLS, BUSINESS WRITING, SPEECH, ARTICULATION AND ACCENT REDUCTION (U.S. CLS. 100, 101 AND 107). FIRST USE 5-0-2008; IN COMMERCE 5-0-2008.

4,166,066. AIRBRUSH ACTION, INC., ALLENWOOD, NJ. SN 85-502,074. FILED P.R. 12-22-2011; AM. S.R. 3-26-2012.



THE MARK CONSISTS OF THE TERMS "AIRBRUSHTV" IN STYLIZED FORM.

FOR CONDUCTING WORKSHOPS AND SEMINARS IN ARTS AND CRAFTS; EDUCATIONAL SERVICES, NAMELY, PROVIDING ONLINE INSTRUCTION IN THE FIELD OF ARTS AND CRAFTS VIA AN ONLINE WEBSITE; WORKSHOPS AND SEMINARS IN THE FIELD OF ARTS AND CRAFTS (U.S. CLS. 100, 101 AND 107).

FIRST USE 10-28-2011; IN COMMERCE 10-28-2011.

4,166,074. NATIONAL COUNCIL OF YOUNG MEN'S CHRISTIAN ASSOCIATIONS OF THE UNITED STATES OF AMERICA, CHICAGO, IL. SN 85-519,294. FILED P.R. 1-18-2012; AM. S.R. 4-27-2012.

**POR LA FORMACIÓN DE NIÑOS
Y JÓVENES
POR UNA VIDA SALUDABLE
POR LA RESPONSABILIDAD
SOCIAL**

THE MARK CONSISTS OF STANDARD CHARACTERS WITHOUT CLAIM TO ANY PARTICULAR FONT, STYLE, SIZE, OR COLOR.

OWNER OF U.S. REG. NO. 3,987,423.

CLASS 41—(Continued).

THE ENGLISH TRANSLATION OF POR LA FORMACIÓN DE NIÑOS Y JÓVENES POR UNA VIDA SALUDABLE POR LA RESPONSABILIDAD SOCIAL IN THE MARK IS "FOR YOUTH DEVELOPMENT FOR HEALTHY LIVING FOR SOCIAL RESPONSIBILITY".

FOR EDUCATIONAL AND ENTERTAINMENT SERVICES, NAMELY, CONDUCTING CLASSES, SEMINARS, CONFERENCES AND WORKSHOPS IN THE FIELDS OF PHYSICAL AND MENTAL HEALTH AND FITNESS AND SPIRITUAL DEVELOPMENT; AND ORGANIZING SPORTING AND CULTURAL EVENTS (U.S. CLS. 100, 101 AND 107).

FIRST USE 11-30-2011; IN COMMERCE 11-30-2011.

CLASS 42—SCIENTIFIC AND COMPUTER SERVICES

4,165,948. DOCTATIONS, INC., GARDEN CITY, NY. SN 77-583,716. FILED P.R. 10-2-2008; AM. S.R. 10-10-2011.

VIRTUAL MEDICAL GROUP

THE MARK CONSISTS OF STANDARD CHARACTERS WITHOUT CLAIM TO ANY PARTICULAR FONT, STYLE, SIZE, OR COLOR.

NO CLAIM IS MADE TO THE EXCLUSIVE RIGHT TO USE "VIRTUAL", APART FROM THE MARK AS SHOWN.

FOR PROVIDING ON-LINE NON-DOWNLOADABLE SOFTWARE FOR ALLOWING PHYSICIANS AND DOCTORS TO CREATE ONLINE GROUPS FOR VARIOUS PURPOSES, INCLUDING GIVING ALL MEMBERS ACCESS TO A COMMON CALL SCHEDULE, AND INTER-MEMBER PROXY ACCESS TO PATIENT DATA; PROVIDING TEMPORARY USE OF ON-LINE NON-DOWNLOADABLE SOFTWARE FOR ALLOWING PHYSICIANS AND DOCTORS TO CREATE ONLINE GROUPS FOR VARIOUS PURPOSES, INCLUDING GIVING ALL MEMBERS ACCESS TO A COMMON CALL SCHEDULE, AND INTER-MEMBER PROXY ACCESS TO PATIENT DATA; PROVIDING A WEB SITE FOR USE BY PHYSICIANS TO GENERATE, MANAGE AND EXCHANGE MEDICAL INFORMATION AND DOCUMENTS REGARDLESS OF MEDICAL ORGANIZATION OR GEOGRAPHIC LOCATION; PROVIDING AN INTERACTIVE WEB SITE THAT ENABLES PHYSICIANS AND DOCTORS TO CREATE ONLINE GROUPS FOR VARIOUS PURPOSES, INCLUDING GIVING ALL MEMBERS ACCESS TO A COMMON CALL SCHEDULE, AND INTER-MEMBER PROXY ACCESS TO PATIENT DATA (U.S. CLS. 100 AND 101).

FIRST USE 10-6-2011; IN COMMERCE 10-6-2011.

CLASS 42—(Continued).

4,165,983. HEALTHSTREAM, INC., NASHVILLE, TN. SN 85-214,500. FILED P.R. 1-10-2011; AM. S.R. 5-1-2012.

SIMDEVELOPER

THE MARK CONSISTS OF STANDARD CHARACTERS WITHOUT CLAIM TO ANY PARTICULAR FONT, STYLE, SIZE, OR COLOR.

FOR SOFTWARE AS A SERVICE (SAAS) SERVICES FEATURING SOFTWARE IN THE FIELD OF HEALTHCARE THAT ENABLES USERS TO CREATE, CATEGORIZE AND MANAGE MEDICAL SIMULATION CONTENT AND RESOURCES (U.S. CLS. 100 AND 101).

FIRST USE 1-24-2011; IN COMMERCE 1-24-2011.

4,165,984. HEALTHSTREAM, INC., NASHVILLE, TN. SN 85-215,059. FILED P.R. 1-11-2011; AM. S.R. 5-1-2012.

SIMMANAGER

THE MARK CONSISTS OF STANDARD CHARACTERS WITHOUT CLAIM TO ANY PARTICULAR FONT, STYLE, SIZE, OR COLOR.

FOR SOFTWARE AS A SERVICE (SAAS) SERVICES FEATURING SOFTWARE IN THE FIELD OF HEALTHCARE THAT ENABLES USERS TO MANAGE, OPERATE AND RUN HEALTHCARE AND MEDICAL SIMULATION MANAGEMENT AND TRAINING PROGRAMS ONLINE (U.S. CLS. 100 AND 101).

FIRST USE 8-11-2011; IN COMMERCE 8-11-2011.

4,165,993. AMERICAN ASSOCIATION OF PHYSICIAN SPECIALISTS, INC., TAMPA, FL. SN 85-266,042. FILED P.R. 3-14-2011; AM. S.R. 4-24-2012.

AMERICAN BOARD OF INTEGRATIVE MEDICINE

THE MARK CONSISTS OF STANDARD CHARACTERS WITHOUT CLAIM TO ANY PARTICULAR FONT, STYLE, SIZE, OR COLOR.

NO CLAIM IS MADE TO THE EXCLUSIVE RIGHT TO USE "BOARD OF INTEGRATIVE MEDICINE", APART FROM THE MARK AS SHOWN.

FOR ACCREDITATION SERVICES, NAMELY, DEVELOPING, EVALUATING, AND TESTING STANDARDS FOR PHYSICIANS IN THE FIELD OF INTEGRATIVE MEDICINE FOR THE PURPOSE OF ACCREDITATION (U.S. CLS. 100 AND 101).

FIRST USE 3-23-2012; IN COMMERCE 3-23-2012.

CLASS 42—(Continued).

4,166,005. SALAD NATION, LLC, LUTZ, FL. SN 85-315,680. FILED P.R. 5-9-2011; AM. S.R. 5-17-2012.

THE WORLD'S FIRST INTERNET BASED RESTAURANT

THE MARK CONSISTS OF STANDARD CHARACTERS WITHOUT CLAIM TO ANY PARTICULAR FONT, STYLE, SIZE, OR COLOR.

NO CLAIM IS MADE TO THE EXCLUSIVE RIGHT TO USE "INTERNET BASED RESTAURANT", APART FROM THE MARK AS SHOWN.

FOR PROVIDING A WEBSITE FEATURING TECHNOLOGY WHERE USERS CUSTOM BUILD SALADS BASED UPON NUTRITIONAL, MEDICINAL, VITAMIN, AND MINERAL CONTENT (U.S. CLS. 100 AND 101).

FIRST USE 5-5-2012; IN COMMERCE 5-14-2012.

4,166,006. SAJJA, GOPICHAND, ISELIN, NJ. SN 85-318,760. FILED P.R. 5-12-2011; AM. S.R. 3-7-2012.

COMPARISONENGINE

THE MARK CONSISTS OF STANDARD CHARACTERS WITHOUT CLAIM TO ANY PARTICULAR FONT, STYLE, SIZE, OR COLOR.

FOR COMPUTER SERVICES, NAMELY, PROVIDING A SEARCH ENGINE FOR FINDING, DESCRIBING, AND ANALYZING A WIDE VARIETY OF PRODUCTS AND SERVICES ON A GLOBAL COMPUTER NETWORK; COMPUTER SERVICES, NAMELY, PROVIDING A SEARCH ENGINE FOR PROVIDING FACTS, REVIEWS, RATINGS AND RECOMMENDATIONS ON TOPICS, PRODUCTS AND SERVICES ON A GLOBAL COMPUTER NETWORK (U.S. CLS. 100 AND 101).

FIRST USE 4-12-2010; IN COMMERCE 5-8-2011.

4,166,038. AMERICAN BOARD OF OBESITY MEDICINE, DENVER, CO. SN 85-398,895. FILED P.R. 8-16-2011; AM. S.R. 1-16-2012.

AMERICAN BOARD OF OBESITY MEDICINE

THE MARK CONSISTS OF STANDARD CHARACTERS WITHOUT CLAIM TO ANY PARTICULAR FONT, STYLE, SIZE, OR COLOR.

CLASS 42—(Continued).

NO CLAIM IS MADE TO THE EXCLUSIVE RIGHT TO USE "BOARD OF OBESITY MEDICINE", APART FROM THE MARK AS SHOWN.

FOR TESTING, ANALYSIS, AND EVALUATION OF THE KNOWLEDGE, SKILLS AND ABILITIES OF OTHERS FOR THE PURPOSE OF CERTIFICATION AND RE-CERTIFICATION IN THE FIELD OF OBESITY MEDICINE (U.S. CLS. 100 AND 101).

FIRST USE 11-16-2011; IN COMMERCE 1-16-2012.

4,166,058. ASSELIN, BRAD, DBA CARMAPS LLC, MARSHALL, MI. SN 85-463,318. FILED P.R. 11-3-2011; AM. S.R. 5-3-2012.

CarMaps

THE MARK CONSISTS OF STANDARD CHARACTERS WITHOUT CLAIM TO ANY PARTICULAR FONT, STYLE, SIZE, OR COLOR.

FOR PROVIDING AN ONLINE SEARCH ENGINE SERVICE FOR NEW AND USED AUTOMOBILE LISTINGS AND AUTOMOBILE RELATED INFORMATION (U.S. CLS. 100 AND 101).

FIRST USE 10-19-2011; IN COMMERCE 10-19-2011.

4,166,065. DOME9 SECURITY, MENLO PARK, CA. SN 85-490,605. FILED P.R. 12-8-2011; AM. S.R. 3-28-2012.

Secure Your Cloud

THE MARK CONSISTS OF STANDARD CHARACTERS WITHOUT CLAIM TO ANY PARTICULAR FONT, STYLE, SIZE, OR COLOR.

FOR COMPUTER SECURITY SERVICE, NAMELY, RESTRICTING ACCESS TO AND BY COMPUTER NETWORKS TO AND OF UNDESIREED WEB SITES, MEDIA AND INDIVIDUALS AND FACILITIES (U.S. CLS. 100 AND 101).

FIRST USE 5-1-2011; IN COMMERCE 5-1-2011.

CLASS 43—HOTEL AND RESTAURANT SERVICES

CLASS 43—(Continued).

4,166,032. AREAS USA, INC., MIAMI, FL. SN 85-382,733. FILED P.R. 7-27-2011; AM. S.R. 5-1-2012.

MCGINLEY'S IRISH PUB

THE MARK CONSISTS OF STANDARD CHARACTERS WITHOUT CLAIM TO ANY PARTICULAR FONT, STYLE, SIZE, OR COLOR.

NO CLAIM IS MADE TO THE EXCLUSIVE RIGHT TO USE "IRISH PUB", APART FROM THE MARK AS SHOWN.

FOR RESTAURANT AND BAR SERVICES (U.S. CLS. 100 AND 101).

FIRST USE 11-22-2011; IN COMMERCE 11-22-2011.

4,166,083. LEMONADE RESTAURANT GROUP, LLC, LOS ANGELES, CA. SN 85-536,082. FILED 2-7-2012.

LEMONADE

THE MARK CONSISTS OF STANDARD CHARACTERS WITHOUT CLAIM TO ANY PARTICULAR FONT, STYLE, SIZE, OR COLOR.

FOR RESTAURANT AND CATERING SERVICES (U.S. CLS. 100 AND 101).

FIRST USE 4-30-2008; IN COMMERCE 4-30-2008.

CLASS 44—MEDICAL, BEAUTY AND AGRICULTURAL SERVICES

4,166,024. SEDATION ON CALL, PLLC, SPRING, TX. SN 85-371,793. FILED P.R. 7-14-2011; AM. S.R. 5-1-2012.

Sedation on Call

THE MARK CONSISTS OF STANDARD CHARACTERS WITHOUT CLAIM TO ANY PARTICULAR FONT, STYLE, SIZE, OR COLOR.

NO CLAIM IS MADE TO THE EXCLUSIVE RIGHT TO USE "SEDATION", APART FROM THE MARK AS SHOWN.

FOR DENTISTRY SERVICES, NAMELY, ADMINISTERING PORTABLE INTRAVENOUS SEDATION (U.S. CLS. 100 AND 101).

FIRST USE 10-14-2009; IN COMMERCE 10-14-2009.

CLASS 44—(Continued).

4,166,025. BEVERLY HILLS ONCOLOGY MEDICAL GROUP, INC., BEVERLY HILLS, CA. SN 85-371,900. FILED P.R. 7-14-2011; AM. S.R. 5-3-2012.

Beverly Hills Cancer Center

THE MARK CONSISTS OF STANDARD CHARACTERS WITHOUT CLAIM TO ANY PARTICULAR FONT, STYLE, SIZE, OR COLOR.

NO CLAIM IS MADE TO THE EXCLUSIVE RIGHT TO USE "CANCER CENTER", APART FROM THE MARK AS SHOWN.

FOR PROVISION OF MEDICAL SERVICES; PROVISION OF WELLNESS SERVICES, NAMELY, WELLNESS PROGRAMS AND ALTERNATIVE MEDICINE SERVICES; INTEGRATIVE MEDICINE AND HEALTH CARE SERVICES, NAMELY, WELLNESS PROGRAMS (U.S. CLS. 100 AND 101).

FIRST USE 3-0-2005; IN COMMERCE 3-0-2005.

4,166,026. BEVERLY HILLS ONCOLOGY MEDICAL GROUP, INC., BEVERLY HILLS, CA. SN 85-373,975. FILED P.R. 7-18-2011; AM. S.R. 5-3-2012.

Beverly Hills Health Center

THE MARK CONSISTS OF STANDARD CHARACTERS WITHOUT CLAIM TO ANY PARTICULAR FONT, STYLE, SIZE, OR COLOR.

NO CLAIM IS MADE TO THE EXCLUSIVE RIGHT TO USE "HEALTH CENTER", APART FROM THE MARK AS SHOWN.

FOR PROVISION OF MEDICAL SERVICES; PROVISION OF WELLNESS SERVICES, NAMELY, WELLNESS PROGRAMS AND ALTERNATIVE MEDICINE SERVICES; INTEGRATIVE MEDICINE AND HEALTH CARE SERVICES, NAMELY, WELLNESS PROGRAMS (U.S. CLS. 100 AND 101).

FIRST USE 3-0-2005; IN COMMERCE 3-0-2005.

CLASS 44—(Continued).

4,166,067. KNOX, ANNE DILLON, SPRINGFIELD, MA. SN 85-503,051. FILED P.R. 12-23-2011; AM. S.R. 4-16-2012.

Therapeutic Energetic Reconnection (TER)

THE MARK CONSISTS OF STANDARD CHARACTERS WITHOUT CLAIM TO ANY PARTICULAR FONT, STYLE, SIZE, OR COLOR.

FOR PROVIDING IN-PERSON ENERGY HEALING SERVICES (U.S. CLS. 100 AND 101).

FIRST USE 8-22-2011; IN COMMERCE 9-3-2011.

4,166,073. SOUTHWESTERN PATHOLOGY ASSOCIATES, DBA PATHOLOGY CORPORATION OF AMERICA, LAWTON, OK. SN 85-518,869. FILED P.R. 1-18-2012; AM. S.R. 5-17-2012.

PATHOLOGY CORPORATION OF AMERICA

THE MARK CONSISTS OF STANDARD CHARACTERS WITHOUT CLAIM TO ANY PARTICULAR FONT, STYLE, SIZE, OR COLOR.

FOR MEDICAL TESTING FOR DIAGNOSTIC, PROGNOSTIC AND MEDICAL TREATMENT PURPOSES (U.S. CLS. 100 AND 101).

FIRST USE 5-1-2009; IN COMMERCE 5-1-2009.

CLASS 45—PERSONAL AND LEGAL SERVICES

4,166,033. DEPARTMENT OF THE ARMY, WASHINGTON, DC. SN 85-383,599. FILED P.R. 7-28-2011; AM. S.R. 4-23-2012.

MILITARY KIDS CONNECT

THE MARK CONSISTS OF STANDARD CHARACTERS WITHOUT CLAIM TO ANY PARTICULAR FONT, STYLE, SIZE, OR COLOR.

FOR INTERNET-BASED SOCIAL NETWORKING SERVICES (U.S. CLS. 100 AND 101).

FIRST USE 12-8-2011; IN COMMERCE 1-18-2012.

CLASS 45—(Continued).

4,166,047. MANDOUR & ASSOCIATES, APC, SAN DIEGO, CA. SN 85-436,823. FILED P.R. 9-30-2011; AM. S.R. 4-2-2012.

CLASS 45—(Continued).

4,166,056. FIESTA CATERING INTERNATIONAL, INC., THE VALLEY, ANGUILLA. SN 85-462,293. FILED P.R. 11-2-2011; AM. S.R. 4-16-2012.

PATENTATTORNEY

ADULTDATINGNYC.COM

THE MARK CONSISTS OF STANDARD CHARACTERS WITHOUT CLAIM TO ANY PARTICULAR FONT, STYLE, SIZE, OR COLOR.

FOR NEWS REPORTING AND EXPERT LEGAL COMMENTARY SERVICES IN THE FIELD OF LEGAL NEWS (U.S. CLS. 100 AND 101).

FIRST USE 9-30-2011; IN COMMERCE 9-30-2011.

THE MARK CONSISTS OF STANDARD CHARACTERS WITHOUT CLAIM TO ANY PARTICULAR FONT, STYLE, SIZE, OR COLOR.

FOR DATING SERVICES; AND INTERNET BASED SOCIAL NETWORKING AND INTRODUCTION SERVICES (U.S. CLS. 100 AND 101).

FIRST USE 5-11-2011; IN COMMERCE 5-11-2011.

4,166,053. LEGACY HEALTHCARE FINANCIAL SERVICES, LLC, LINCOLNWOOD, IL. SN 85-453,069. FILED P.R. 10-21-2011; AM. S.R. 3-5-2012.

4,166,075. CHARM CITY ORGANIZERS, LLC, BALTIMORE, MD. SN 85-520,232. FILED P.R. 1-19-2012; AM. S.R. 5-2-2012.

COMPLETE CONCIERGE COVERAGE

Charm City Organizers

THE MARK CONSISTS OF STANDARD CHARACTERS WITHOUT CLAIM TO ANY PARTICULAR FONT, STYLE, SIZE, OR COLOR.

NO CLAIM IS MADE TO THE EXCLUSIVE RIGHT TO USE "CONCIERGE", APART FROM THE MARK AS SHOWN.

FOR PERSONAL CONCIERGE SERVICES FOR OTHERS COMPRISING MAKING REQUESTED PERSONAL ARRANGEMENTS AND RESERVATIONS, RUNNING ERRANDS AND PROVIDING CUSTOMER SPECIFIC INFORMATION TO MEET INDIVIDUAL NEEDS, ALL RENDERED IN BUSINESS ESTABLISHMENTS AND HEALTHCARE FACILITIES (U.S. CLS. 100 AND 101).

FIRST USE 11-22-2011; IN COMMERCE 11-22-2011.

THE MARK CONSISTS OF STANDARD CHARACTERS WITHOUT CLAIM TO ANY PARTICULAR FONT, STYLE, SIZE, OR COLOR.

NO CLAIM IS MADE TO THE EXCLUSIVE RIGHT TO USE "ORGANIZERS", APART FROM THE MARK AS SHOWN.

FOR ORGANIZATIONAL SERVICES FOR HOME OR PERSONAL PURPOSES, NAMELY, ORGANIZING AND DECLUTTERING LIVING SPACES, STORAGE SPACES, BUSINESS AND CORPORATE SPACES, CLOSETS, DRAWERS, DESKS AND GARAGES (U.S. CLS. 100 AND 101).

FIRST USE 8-16-2010; IN COMMERCE 8-16-2010.

* * * * *

PRIOR UNITED STATES CLASSIFICATION

APPLICATION IN ONE CLASS

CERTIFICATION MARKS

CLASS B—SERVICES

4,166,054. **BIOFEEDBACK CERTIFICATION INSTITUTE OF AMERICA, WHEAT RIDGE, CO. SN 85-454,510. FILED P.R. 10-24-2011; AM. S.R. 4-18-2012.**

**BOARD CERTIFIED IN
BIOFEEDBACK - PELVIC
MUSCLE DYSFUNCTION**

THE CERTIFICATION MARK, AS INTENDED TO BE USED BY AUTHORIZED PERSONS, IS INTENDED TO CERTIFY THE CERTIFICATION MARK, AS INTENDED TO BE USED BY AUTHORIZED PERSONS, IS INTENDED TO CERTIFY THAT THE INDIVIDUAL HAS MET ENTRY-LEVEL REQUIREMENTS FOR THE CLINICAL PRACTICE OF PELVIC MUSCLE DYSFUNCTION BIOFEEDBACK. THE CERTIFICATION MARK DEMONSTRATES THAT THE RECIPIENT HAS SUCCESSFULLY COMPLETED THE ACADEMIC AND PRACTICAL TRAINING DESIGNATION REQUIREMENTS.

FOR HEALTHCARE AND WELLNESS FIELDS, NAMELY, CERTIFICATION OF PROFESSIONS, PRACTITIONERS, TECHNICIANS, ACADEMICS OR THERAPISTS IN PELVIC MUSCLE DYSFUNCTION BIOFEEDBACK FIELDS (U.S. CL. B).

FIRST USE 3-1-2010; IN COMMERCE 3-1-2010.

THE MARK CONSISTS OF STANDARD CHARACTERS WITHOUT CLAIM TO ANY PARTICULAR FONT, STYLE, SIZE, OR COLOR.

* * * * *

TRADEMARK REGISTRATIONS RENEWED

The designation "U.S. Cl." appearing in this section refers to the U.S. class in effect prior to Sep. 1, 1973 rather than the international class which applies to applications filed on or after that date. For adoption of international classification see notice in the OFFICIAL GAZETTE of Jun. 26, 1973 (911 O.G. TM 210).

155,517.	RP AND DESIGN. U.S. CL. 30. (INT. CL. 21). REG. 5-30-1922.	735,246.	KENWOOD. U.S. CL. 21. (INT. CL. 9). REG. 7-31-1962.
155,518.	RP (STYLIZED). U.S. CL. 30. (INT. CL. 21). REG. 5-30-1922.	735,843.	AMBITROL. U.S. CL. 6. (INT. CL. 1). REG. 8-14-1962.
294,075.	COTE D'OR (STYLIZED). U.S. CL. 46. (INT. CL. 30). REG. 5-17-1932.	738,733.	BAG BALM. U.S. CL. 44. (INT. CL. 10). REG. 10-2-1962.
294,323.	KIWI AND DESIGN. U.S. CL. 4. (INT. CL. 3). REG. 5-24-1932.	739,370.	MODULINE (STYLIZED). U.S. CL. 34. (INT. CL. 11). REG. 10-16-1962.
392,325.	MISCELLANEOUS DESIGN. U.S. CL. 46. (INT. CL. 32). REG. 12-23-1941.	740,677.	LOLLIPOP. INT. CL. 25. (U.S. CLS. 22 AND 39). REG. 11-13-1962.
395,596.	FIXPENCIL. U.S. CL. 37. (INT. CL. 16). REG. 6-2-1942.	740,701.	SURGILON. U.S. CL. 44. (INT. CL. 10). REG. 11-13-1962.
557,353.	BEEBLE BAILEY (STYLIZED). U.S. CL. 38. (INT. CL. 16). REG. 4-8-1952.	741,478.	CYMEL. U.S. CL. 6. (INT. CL. 1). REG. 12-4-1962.
557,611.	OILGEAR (STYLIZED). U.S. CL. 13. (INT. CL. 7). REG. 4-15-1952.	742,647.	MASTER POWER. U.S. CL. 23. (INT. CLS. 6, 7, 8, 9, 11, 12, 16, 21 AND 28). REG. 12-25-1962.
557,725.	FR. U.S. CL. 23. (INT. CL. 7). REG. 4-15-1952.	746,675.	VASSARETTE. U.S. CL. 39. (INT. CLS. 10, 25 AND 26). REG. 3-12-1963.
558,481.	DAY-GLO (STYLIZED). U.S. CL. 16. (INT. CL. 2). REG. 5-6-1952.	749,432.	FRESH-GARD. U.S. CL. 37. (INT. CL. 16). REG. 5-14-1963.
558,955.	ROLSCREEN. U.S. CL. 12. (INT. CL. 6). REG. 5-20-1952.	928,614.	CROCK-POT. U.S. CL. 21. (INT. CL. 11). REG. 2-8-1972.
559,086.	CALVER (STYLIZED). U.S. CL. 6. (INT. CL. 1). REG. 5-20-1952.	930,470.	CHRISTY. U.S. CL. 23. (INT. CL. 7). REG. 3-7-1972.
559,151.	BAXTER (STYLIZED). U.S. CL. 18. (INT. CL. 5). REG. 5-20-1952.	930,659.	GET THE DALY HABIT. U.S. CL. 100. (INT. CL. 42). REG. 3-7-1972.
559,686.	ETS AND DESIGN. U.S. CL. 38. (INT. CL. 16). REG. 6-3-1952.	932,957.	MISCELLANEOUS DESIGN. U.S. CL. 46. (INT. CL. 30). REG. 4-25-1972.
559,919.	BANGSITE. U.S. CL. 9. (INT. CL. 28). REG. 6-10-1952.	933,806.	HESPAN. U.S. CL. 18. (INT. CL. 5). REG. 5-16-1972.
561,015.	SUPER HYBOND (STYLIZED). U.S. CL. 12. (INT. CL. 19). REG. 7-1-1952.	933,943.	AMMCO. U.S. CL. 26. (INT. CL. 9). REG. 5-16-1972.
561,950.	MELROSE. U.S. CL. 28. (INT. CLS. 8 AND 14). REG. 7-22-1952.	933,944.	AMMCO AND DESIGN. U.S. CL. 26. (INT. CL. 9). REG. 5-16-1972.
562,386.	DAY-GLO (STYLIZED). U.S. CL. 6. (INT. CLS. 1, 2, 3, 4 AND 5). REG. 7-29-1952.	934,272.	LEVN-LITE. U.S. CL. 46. (INT. CL. 1). REG. 5-16-1972.
563,056.	+GF+ AND DESIGN. U.S. CL. 23. (INT. CL. 7). REG. 8-19-1952.	934,285.	PRO AND DESIGN. U.S. CLS. 2, 4, 6, 15, 16, 23, 29 AND 39 ONLY. (INT. CLS. 2, 3, 4, 5, 7, 8, 20, 21 AND 25). REG. 5-23-1972.
563,580.	CUPOLINE (STYLIZED). U.S. CL. 12. (INT. CL. 19). REG. 9-2-1952.	934,410.	MAGNE-MATIC. U.S. CL. 22. (INT. CL. 28). REG. 5-23-1972.
565,820.	SILVER-BRITE. U.S. CL. 16. (INT. CL. 2). REG. 10-21-1952.	934,895.	LESLIE SUPERTYFON. U.S. CL. 23. (INT. CL. 9). REG. 5-30-1972.
566,735.	DYMEREX. U.S. CL. 6. (INT. CL. 1). REG. 11-11-1952.	935,110.	WENDY'S. U.S. CL. 100. (INT. CL. 42). REG. 5-30-1972.
567,779.	IMAGE. U.S. CL. 38. (INT. CL. 16). REG. 12-9-1952.	935,320.	TAMROCK. U.S. CL. 23. (INT. CL. 7). REG. 6-6-1972.
572,477.	DOUBLE COLA. U.S. CL. 45. (INT. CL. 32). REG. 3-31-1953.	935,326.	FOG-BAN. U.S. CL. 26. (INT. CL. 9). REG. 6-6-1972.
724,796.	HERALUX. U.S. CL. 26. (INT. CLS. 1, 9 AND 10). REG. 12-5-1961.	935,580.	TIDELAND. U.S. CL. 19. (INT. CL. 6). REG. 6-13-1972.
726,326.	APPLE RIDGE. U.S. CL. 46. (INT. CL. 31). REG. 1-9-1962.	935,779.	ICE BLUE. U.S. CL. 51. (INT. CL. 3). REG. 6-13-1972.
726,887.	LL AND DESIGN. U.S. CL. 13. (INT. CL. 6). REG. 1-30-1962.	936,158.	LUKI. U.S. CL. 44. (INT. CL. 10). REG. 6-20-1972.
727,481.	VANITY FAIR (STYLIZED). U.S. CL. 28. (INT. CL. 14). REG. 2-13-1962.	936,879.	ILLVA AMARETTO DI SARONNOORIGINALE INDUSTRIA LOMBARDA LIQUORI VINI AFFINI ILLVA AND DESIGN. U.S. CL. 49. (INT. CL. 33). REG. 6-27-1972.
729,354.	CORVEL. U.S. CL. 16. (INT. CL. 2). REG. 4-3-1962.	936,979.	NURSE GRO. U.S. CL. 18. (INT. CL. 31). REG. 7-4-1972.
730,194.	ARDAMINE. U.S. CL. 46. (INT. CL. 30). REG. 4-17-1962.	936,999.	AA CORP. AND DESIGN. U.S. CL. 21. (INT. CL. 9). REG. 7-4-1972.
731,368.	PLASTIGLIDE. U.S. CL. 13. (INT. CL. 6). REG. 5-15-1962.	937,392.	XTRA RANGE. U.S. CL. 13. (INT. CL. 6). REG. 7-11-1972.
731,371.	PARKER. U.S. CL. 13. (INT. CL. 6). REG. 5-15-1962.	937,412.	NEVER-SEEZ. U.S. CL. 15. (INT. CL. 4). REG. 7-11-1972.
731,965.	MISCELLANEOUS DESIGN. U.S. CL. 6. (INT. CL. 5). REG. 5-22-1962.	938,213.	NBA AND DESIGN. U.S. CL. 100. (INT. CL. 42). REG. 7-18-1972.
732,906.	CRICKET. U.S. CL. 8. (INT. CL. 34). REG. 6-19-1962.	938,378.	NEOBEE. U.S. CL. 6. (INT. CLS. 1, 2, 3, 4 AND 5). REG. 7-25-1972.
733,064.	LEITZ. U.S. CL. 23. (INT. CL. 7). REG. 6-19-1962.	938,882.	LOVE IS... (STYLIZED). U.S. CL. 38. (INT. CL. 16). REG. 7-25-1972.
733,222.	CIDEX. U.S. CL. 6. (INT. CL. 5). REG. 6-26-1962.	939,286.	PIONEER (STYLIZED). U.S. CL. 1. (INT. CL. 31). REG. 8-1-1972.
734,799.	YELLOW 77. U.S. CL. 15. (INT. CL. 4). REG. 7-24-1962.		

- 940,435. REEF RUNNER. U.S. CL. 22. (INT. CL. 28). REG. 8-8-1972.
- 941,806. DOWTHERM. U.S. CL. 6. (INT. CL. 1). REG. 8-29-1972.
- 941,931. TELELIFT. U.S. CL. 23. (INT. CL. 7). REG. 8-29-1972.
- 942,927. JOHNSON'S. U.S. CL. 51. (INT. CL. 3). REG. 9-12-1972.
- 943,251. MISCELLANEOUS DESIGN. U.S. CL. 35. (INT. CL. 12). REG. 9-19-1972.
- 949,816. P AND DESIGN. U.S. CL. 38. (INT. CL. 16). REG. 1-2-1973.
- 958,913. MISCO (STYLIZED). U.S. CL. 21. (INT. CL. 9). REG. 5-15-1973.
- 959,030. E.C.A.. U.S. CL. 46. (INT. CL. 31). REG. 5-15-1973.
- 1,172,837. BERRY METAL AND DESIGN. INT. CLS. 6, 7 AND 11. (U.S. CLS. 13, 14, 19, 21, 23, 31, 34 AND 35). REG. 10-13-1981.
- 1,173,395. FENN WRIGHT AND MANSON. INT. CL. 25. (U.S. CLS. 22 AND 39). REG. 10-13-1981.
- 1,174,188. THE ACES ON BRIDGE. INT. CL. 16. (U.S. CL. 38). REG. 10-20-1981.
- 1,177,537. POLAR AND DESIGN. INT. CL. 32. (U.S. CL. 45). REG. 11-10-1981.
- 1,188,599. BEATRIX POTTER. INT. CL. 15. (U.S. CL. 36). REG. 2-2-1982.
- 1,191,424. MARKET. INT. CL. 42. (U.S. CL. 100). REG. 3-2-1982.
- 1,192,598. IT'S THE BEST YE EVER TASTED SCOTT'S BARBECUE SAUCE AND DESIGN. INT. CL. 30. (U.S. CL. 46). REG. 3-23-1982.
- 1,192,936. L'ORBETTE. INT. CL. 3. (U.S. CLS. 50, 51 AND 52). REG. 4-6-1982.
- 1,193,442. MRS. NEMO'S. INT. CL. 29. (U.S. CL. 46). REG. 4-6-1982.
- 1,193,557. MISCELLANEOUS DESIGN. INT. CL. 10. (U.S. CL. 44). REG. 4-13-1982.
- 1,193,558. BLUE LINE. INT. CL. 10. (U.S. CL. 44). REG. 4-13-1982.
- 1,194,124. CACHE. INT. CL. 42. (U.S. CL. 101). REG. 4-20-1982.
- 1,194,493. EASY-KARY. INT. CL. 7. (U.S. CL. 23). REG. 4-27-1982.
- 1,195,087. POWERPLEX. INT. CL. 9. (U.S. CL. 38). REG. 5-11-1982.
- 1,195,214. AM AND DESIGN. INT. CL. 19. (U.S. CL. 12). REG. 5-11-1982.
- 1,195,332. ALFAPET (STYLIZED). INT. CL. 31. (U.S. CLS. 1 AND 46). REG. 5-11-1982.
- 1,195,519. MYCENTER-2 (STYLIZED). INT. CL. 7. (U.S. CL. 23). REG. 5-18-1982.
- 1,195,580. POROSCOPE. INT. CL. 9. (U.S. CL. 26). REG. 5-18-1982.
- 1,195,581. MISCELLANEOUS DESIGN. INT. CLS. 9 AND 11. (U.S. CLS. 21, 26 AND 34). REG. 5-18-1982.
- 1,195,643. THE ARIZONIAN. INT. CL. 12. (U.S. CL. 35). REG. 5-18-1982.
- 1,195,693. FIRESIDE. INT. CL. 16. (U.S. CL. 38). REG. 5-18-1982.
- 1,195,835. SWENSEN'S (STYLIZED). INT. CLS. 30, 35 AND 42. (U.S. CLS. 46, 100 AND 101). REG. 5-18-1982.
- 1,195,879. AS AND DESIGN. INT. CLS. 37 AND 42. (U.S. CLS. 100 AND 103). REG. 5-18-1982.
- 1,195,914. SUNBELT AGRICULTURAL EXPOSITION AND DESIGN. INT. CL. 41. (U.S. CL. 107). REG. 5-18-1982.
- 1,195,975. QUIK-MOUNT. INT. CL. 12. (U.S. CL. 19). REG. 5-18-1982.
- 1,196,015. THE INSURANCE STORE. INT. CL. 36. (U.S. CL. 102). REG. 5-18-1982.
- 1,196,112. MARSH. INT. CLS. 6 AND 9. (U.S. CLS. 13, 23 AND 26). REG. 5-25-1982.
- 1,196,163. HAGUE. INT. CL. 11. (U.S. CL. 31). REG. 5-25-1982.
- 1,196,372. POPEMS (STYLIZED). INT. CL. 30. (U.S. CL. 46). REG. 5-25-1982.
- 1,196,554. FLYNN. INT. CL. 25. (U.S. CL. 39). REG. 5-25-1982.
- 1,196,576. MAROXOL. INT. CL. 1. (U.S. CL. 6). REG. 6-1-1982.
- 1,197,111. GE. INT. CL. 7. (U.S. CLS. 21, 23 AND 24). REG. 6-8-1982.
- 1,197,156. GILBERT. INT. CL. 9. (U.S. CL. 21). REG. 6-8-1982.
- 1,197,185. SOFSPEC (STYLIZED). INT. CL. 10. (U.S. CL. 44). REG. 6-8-1982.
- 1,197,547. EGANAL. INT. CL. 1. (U.S. CL. 6). REG. 6-15-1982.
- 1,197,701. TOYO AND DESIGN. INT. CL. 6. (U.S. CL. 13). REG. 6-15-1982.
- 1,197,796. GERBER. INT. CL. 11. (U.S. CLS. 13, 21, 23, 31 AND 34). REG. 6-15-1982.
- 1,198,188. S (STYLIZED). INT. CL. 32. (U.S. CL. 45). REG. 6-15-1982.
- 1,198,551. SURGISTAT. INT. CL. 9. (U.S. CLS. 21 AND 44). REG. 6-22-1982.
- 1,198,562. UFO. INT. CL. 9. (U.S. CL. 26). REG. 6-22-1982.
- 1,198,575. VARIMAC. INT. CL. 9. (U.S. CL. 26). REG. 6-22-1982.
- 1,198,674. I CAN READ BOOK. INT. CL. 16. (U.S. CL. 38). REG. 6-22-1982.
- 1,199,015. CHATEAU DOISY VEDRINES. INT. CL. 33. (U.S. CL. 47). REG. 6-22-1982.
- 1,200,098. SONG SHU PAI PINE BRAND AND DESIGN. INT. CL. 5. (U.S. CL. 18). REG. 7-6-1982.
- 1,200,354. LSI (STYLIZED). INT. CL. 11. (U.S. CL. 21). REG. 7-6-1982.
- 1,200,501. MISCELLANEOUS DESIGN. INT. CL. 25. (U.S. CL. 39). REG. 7-6-1982.
- 1,200,853. DANA AND DESIGN. INT. CLS. 8, 11, 14, 16, 18, 21, 24, 25, 26 AND 28 ONLY. (U.S. CLS. 1, 2, 3, 5, 13, 21, 22, 23, 27, 28, 29, 30, 33, 37, 38, 39, 40, 41, 42 AND 50). REG. 7-13-1982.
- 1,200,955. VICRYL. INT. CL. 10. (U.S. CL. 44). REG. 7-13-1982.
- 1,201,319. PICOSOS'. INT. CL. 29. (U.S. CL. 46). REG. 7-13-1982.
- 1,201,467. PRICO. INT. CLS. 37 AND 42. (U.S. CLS. 100 AND 103). REG. 7-13-1982.
- 1,201,682. HYDROSPICE. INT. CL. 1. (U.S. CL. 6). REG. 7-20-1982.
- 1,202,217. HYE DELITES. INT. CL. 30. (U.S. CL. 46). REG. 7-20-1982.
- 1,202,483. TEXSPORT. INT. CLS. 9 AND 20 ONLY. (U.S. CLS. 2, 13, 21, 22, 23, 25, 26, 32, 36, 38 AND 50). REG. 7-27-1982.
- 1,205,177. ALBI. INT. CL. 8. (U.S. CL. 23). REG. 8-17-1982.
- 1,205,358. UNIQUE. INT. CL. 12. (U.S. CL. 35). REG. 8-17-1982.
- 1,206,033. GARDEN. INT. CL. 9. (U.S. CLS. 21, 23, 26, 36 AND 38). REG. 8-24-1982.
- 1,206,221. KONTROL. INT. CL. 22. (U.S. CL. 50). REG. 8-24-1982.
- 1,207,084. EVACUATOR. INT. CL. 9. (U.S. CL. 21). REG. 9-7-1982.
- 1,207,700. EMCOSOY. INT. CL. 1. (U.S. CL. 6). REG. 9-14-1982.
- 1,208,129. SILICORE. INT. CL. 12. (U.S. CLS. 19 AND 32). REG. 9-14-1982.
- 1,210,473. VISPORE. INT. CL. 17. (U.S. CL. 1). REG. 9-28-1982.
- 1,213,646. DO HWI IT CENTER AND DESIGN. INT. CL. 42. (U.S. CL. 101). REG. 10-19-1982.
- 1,213,724. CXI AND DESIGN. INT. CLS. 1 AND 4. (U.S. CLS. 6 AND 15). REG. 10-26-1982.
- 1,213,953. KIT 'N' CARLYLE. INT. CL. 16. (U.S. CL. 38). REG. 10-26-1982.
- 1,214,054. P (STYLIZED). INT. CL. 25. (U.S. CL. 39). REG. 10-26-1982.
- 1,214,823. MASTER-FLEX. INT. CL. 17. (U.S. CL. 35). REG. 11-2-1982.
- 1,215,200. WORLD OF CONCRETE. INT. CLS. 35 AND 41. (U.S. CLS. 101 AND 107). REG. 11-2-1982.
- 1,215,218. TRUST UNIVERSE COMPARISON SERVICE. INT. CL. 36. (U.S. CL. 102). REG. 11-2-1982.
- 1,216,016. PRO LINE MASTERS. INT. CL. 28. (U.S. CL. 22). REG. 11-9-1982.
- 1,216,030. SPECKLED HEART. INT. CL. 30. (U.S. CL. 46). REG. 11-9-1982.
- 1,216,796. M (STYLIZED). INT. CL. 25. (U.S. CL. 39). REG. 11-16-1982.
- 1,217,629. MOOSEHEAD BEER CANADIAN LAGER AND DESIGN. INT. CL. 25. (U.S. CL. 39). REG. 11-23-1982.
- 1,221,099. CANILLA DORADO. INT. CL. 30. (U.S. CL. 46). REG. 12-21-1982.
- 1,223,142. UNI-LOAD. INT. CL. 7. (U.S. CL. 23). REG. 1-11-1983.
- 1,223,196. STANDARD REGISTER. INT. CL. 9 ONLY. (U.S. CLS. 21, 23, 26, 36 AND 38). REG. 1-11-1983.
- 1,224,109. U.S. COFFEE. INT. CL. 42 ONLY. (U.S. CL. 101). REG. 1-18-1983.
- 1,225,706. RCF. INT. CL. 5. (U.S. CL. 18). REG. 2-1-1983.

- 1,229,747. PREMIERE. INT. CL. 16. (U.S. CL. 37). REG. 3-8-1983.
- 1,230,577. THE CAT & THE CUSTARD CUP AND DESIGN. INT. CL. 42. (U.S. CL. 100). REG. 3-8-1983.
- 1,230,979. HOSHIZAKI. INT. CL. 11. (U.S. CL. 31). REG. 3-15-1983.
- 1,231,378. TT (STYLIZED). INT. CL. 39. (U.S. CL. 105). REG. 3-15-1983.
- 1,234,065. DIP-AN-EGG. INT. CL. 2. (U.S. CL. 6). REG. 4-5-1983.
- 1,235,667. KATENA. INT. CL. 10. (U.S. CL. 44). REG. 4-26-1983.
- 1,236,078. QUIC RELEASE. INT. CL. 9. (U.S. CLS. 13, 26 AND 44). REG. 5-3-1983.
- 1,236,829. GEOREF. INT. CL. 42. (U.S. CLS. 100 AND 101). REG. 5-3-1983.
- 1,237,046. PLANAR PLUS. INT. CL. 6. (U.S. CL. 12). REG. 5-10-1983.
- 1,237,768. AMERICAN ACADEMY OF DERMATOLOGY. INT. CL. 42. (U.S. CLS. 100 AND 101). REG. 5-10-1983.
- 1,237,769. AAD AMERICAN ACADEMY OF DERMATOLOGY 1938 AAD AND DESIGN. INT. CL. 42. (U.S. CLS. 100 AND 101). REG. 5-10-1983.
- 1,238,000. ALUM-A-POLE (STYLIZED). INT. CL. 6. (U.S. CL. 12). REG. 5-17-1983.
- 1,238,120. SYSD. INT. CL. 9. (U.S. CL. 38). REG. 5-17-1983.
- 1,661,260. CHAMBERS. INT. CL. 42. (U.S. CL. 101). REG. 10-15-1991.
- 1,662,288. GLASSCANVAS PRODUCTIONS, INC. (STYLIZED). INT. CL. 9. (U.S. CL. 38). REG. 10-29-1991.
- 1,663,920. VITACARE. INT. CL. 5. (U.S. CL. 18). REG. 11-12-1991.
- 1,664,326. COLLORYS. INT. CL. 34. (U.S. CL. 17). REG. 11-12-1991.
- 1,665,160. PREMIERE. INT. CL. 30. (U.S. CL. 46). REG. 11-19-1991.
- 1,665,300. VIDEO CONNECTION AND DESIGN. INT. CL. 42. (U.S. CL. 101). REG. 11-19-1991.
- 1,665,381. COLI CONFIRM. INT. CL. 1. (U.S. CL. 18). REG. 11-19-1991.
- 1,665,521. SAN LUIS. INT. CL. 30. (U.S. CL. 46). REG. 11-19-1991.
- 1,666,746. FORUM. INT. CL. 19. (U.S. CLS. 13 AND 23). REG. 12-3-1991.
- 1,666,769. DASCO. INT. CL. 21. (U.S. CLS. 2, 13, 23, 29, 30, 33, 40 AND 50). REG. 12-3-1991.
- 1,666,986. LYNDEN AIR FREIGHT AND DESIGN. INT. CL. 39. (U.S. CL. 105). REG. 12-3-1991.
- 1,668,578. THE CITADEL. INT. CL. 25. (U.S. CL. 39). REG. 12-17-1991.
- 1,678,523. JOURNEYMAN. INT. CL. 16. (U.S. CL. 29). REG. 3-10-1992.
- 1,679,565. HAWAIIAN DELIGHT. INT. CL. 30. (U.S. CL. 46). REG. 3-17-1992.
- 1,680,349. SADDLE-PAK. INT. CL. 16. (U.S. CL. 37). REG. 3-24-1992.
- 1,682,125. 404. INT. CL. 28. (U.S. CL. 22). REG. 4-7-1992.
- 1,682,571. SELECT BRAND THE LOWER PRICE NAME BRAND AND DESIGN. INT. CLS. 3, 5 AND 8. (U.S. CLS. 15, 18, 23, 44 AND 51). REG. 4-14-1992.
- 1,682,603. SAMPLERS. INT. CL. 4. (U.S. CL. 15). REG. 4-14-1992.
- 1,683,115. TOWER OF CHOCOLATES. INT. CL. 30. (U.S. CL. 46). REG. 4-14-1992.
- 1,683,157. TEJON RANCH. INT. CL. 33. (U.S. CL. 47). REG. 4-14-1992.
- 1,683,344. BASKETS BY YOU. INT. CL. 42. (U.S. CL. 101). REG. 4-14-1992.
- 1,683,678. BUICK. INT. CL. 9. (U.S. CL. 26). REG. 4-21-1992.
- 1,684,392. SMALL WONDERS. INT. CL. 14. (U.S. CL. 28). REG. 4-28-1992.
- 1,684,462. MULTITAG. INT. CL. 20. (U.S. CL. 32). REG. 4-28-1992.
- 1,685,037. YODOXIN. INT. CL. 5. (U.S. CL. 18). REG. 5-5-1992.
- 1,685,314. X-FORCE. INT. CL. 16. (U.S. CLS. 2, 5, 22, 23, 29, 37, 38 AND 50). REG. 5-5-1992.
- 1,685,429. LIFELIKE. INT. CL. 26. (U.S. CLS. 37, 39, 40, 42 AND 50). REG. 5-5-1992.
- 1,685,962. DIAMOND V. INT. CL. 5. (U.S. CLS. 16 AND 18). REG. 5-12-1992.
- 1,686,019. MINTRX. INT. CL. 6. (U.S. CL. 13). REG. 5-12-1992.
- 1,686,290. MISCELLANEOUS DESIGN. INT. CL. 13. (U.S. CL. 9). REG. 5-12-1992.
- 1,686,293. AGATHA (STYLIZED). INT. CL. 14. (U.S. CLS. 27 AND 28). REG. 5-12-1992.
- 1,686,317. TRIELLE. INT. CL. 14. (U.S. CL. 28). REG. 5-12-1992.
- 1,686,322. JEZLAINE. INT. CL. 14. (U.S. CL. 28). REG. 5-12-1992.
- 1,686,339. THINK ON YOUR FEET. INT. CL. 16. (U.S. CLS. 37 AND 38). REG. 5-12-1992.
- 1,686,346. VECTOR. INT. CLS. 16 AND 17. (U.S. CLS. 1 AND 37). REG. 5-12-1992.
- 1,686,442. MISCELLANEOUS DESIGN. INT. CL. 19. (U.S. CL. 12). REG. 5-12-1992.
- 1,686,515. AIR FLIGHT. INT. CL. 25. (U.S. CL. 39). REG. 5-12-1992.
- 1,686,610. BOXER. INT. CL. 30. (U.S. CL. 46). REG. 5-12-1992.
- 1,686,630. DG (STYLIZED). INT. CL. 32. (U.S. CL. 48). REG. 5-12-1992.
- 1,686,715. GREAT-WEST LIFE & ANNUITY INSURANCE COMPANY. INT. CL. 36. (U.S. CL. 102). REG. 5-12-1992.
- 1,686,723. GMAC. INT. CL. 36. (U.S. CL. 102). REG. 5-12-1992.
- 1,686,829. APOGEE AND DESIGN. INT. CL. 41. (U.S. CL. 107). REG. 5-12-1992.
- 1,687,116. DYNASYMS (STYLIZED). INT. CL. 16. (U.S. CL. 38). REG. 5-12-1992.
- 1,687,235. THUNDERTOAD (STYLIZED). INT. CL. 28. (U.S. CL. 22). REG. 5-12-1992.
- 1,687,369. WRITING INSTRUMENT MANUFACTURERS ASSN. CONFORMS TO ASTM D 4236 AND DESIGN. U.S. CL. A. REG. 5-12-1992.
- 1,687,400. C & A MEIER FOODS. INT. CL. 29. (U.S. CL. 46). REG. 5-12-1992.
- 1,687,442. TIOVEIL. INT. CL. 1. (U.S. CL. 6). REG. 5-19-1992.
- 1,687,452. T-MULZ. INT. CL. 1. (U.S. CL. 6). REG. 5-19-1992.
- 1,687,581. FURON. INT. CLS. 7, 9 AND 20. (U.S. CLS. 2, 13, 21, 22, 23, 25, 26, 32 AND 50). REG. 5-19-1992.
- 1,687,647. SWEEP. INT. CL. 9. (U.S. CL. 26). REG. 5-19-1992.
- 1,687,707. PROTECT-A-TERMINAL. INT. CL. 9. (U.S. CLS. 21 AND 26). REG. 5-19-1992.
- 1,687,709. MISCELLANEOUS DESIGN. INT. CLS. 9 AND 11. (U.S. CLS. 26 AND 31). REG. 5-19-1992.
- 1,687,726. SUPRASSON. INT. CL. 10. (U.S. CL. 44). REG. 5-19-1992.
- 1,687,728. ISOLA. INT. CL. 10. (U.S. CL. 44). REG. 5-19-1992.
- 1,687,736. LAPIDES. INT. CL. 10. (U.S. CLS. 2, 5 AND 44). REG. 5-19-1992.
- 1,687,750. FIELD & STREAM. INT. CLS. 11, 14, 18 AND 21 ONLY. (U.S. CLS. 2, 3, 13, 21, 23, 27, 29, 30, 33, 40 AND 50). REG. 5-19-1992.
- 1,687,770. 222. INT. CL. 12. (U.S. CL. 19). REG. 5-19-1992.
- 1,687,773. 204. INT. CL. 12. (U.S. CL. 19). REG. 5-19-1992.
- 1,687,795. ULTIMATE AND DESIGN. INT. CLS. 15 AND 20. (U.S. CLS. 32 AND 36). REG. 5-19-1992.
- 1,687,816. SDI AND DESIGN. INT. CL. 16. (U.S. CLS. 13, 23, 26, 37 AND 38). REG. 5-19-1992.
- 1,687,833. ULTRA PRO AND DESIGN. INT. CL. 16. (U.S. CL. 37). REG. 5-19-1992.
- 1,687,836. THE METROPOLITAN MUSEUM OF ART. INT. CL. 16. (U.S. CLS. 2, 37 AND 38). REG. 5-19-1992.
- 1,687,875. P AND DESIGN. INT. CLS. 18 AND 25. (U.S. CLS. 3, 39 AND 41). REG. 5-19-1992.
- 1,687,912. CANYON RIVER BLUES. INT. CL. 25. (U.S. CL. 39). REG. 5-19-1992.
- 1,687,935. JAKE & CO.. INT. CL. 25. (U.S. CL. 39). REG. 5-19-1992.
- 1,687,997. FISCHER'S AND DESIGN. INT. CL. 29. (U.S. CL. 46). REG. 5-19-1992.
- 1,688,006. VICTOR AND DESIGN. INT. CL. 30. (U.S. CL. 46). REG. 5-19-1992.
- 1,688,021. COLLIE. INT. CL. 30. (U.S. CL. 46). REG. 5-19-1992.
- 1,688,022. PUPPY. INT. CL. 30. (U.S. CL. 46). REG. 5-19-1992.
- 1,688,023. OL' YELLOW. INT. CL. 30. (U.S. CL. 46). REG. 5-19-1992.
- 1,688,037. OV OLD VIENNA PREMIUM QUALITY SINCE 1862 AND DESIGN. INT. CL. 32. (U.S. CL. 48). REG. 5-19-1992.
- 1,688,097. SCPIE. INT. CL. 36. (U.S. CL. 102). REG. 5-19-1992.
- 1,688,113. PLATINUM CARD. INT. CL. 36. (U.S. CL. 102). REG. 5-19-1992.
- 1,688,270. GAS JACK. INT. CLS. 7 AND 37. (U.S. CLS. 23 AND 100). REG. 5-19-1992.

- 1,688,308. CHANGEMASTER. INT. CL. 9. (U.S. CL. 38). REG. 5-19-1992.
- 1,688,343. ULTRAFLASH (STYLIZED). INT. CL. 9. (U.S. CL. 21). REG. 5-19-1992.
- 1,688,495. PEOPLING OF AMERICA. INT. CL. 41. (U.S. CLS. 100, 101 AND 107). REG. 5-19-1992.
- 1,688,521. HYATT REGENCY RAVINIA AND DESIGN. INT. CL. 42. (U.S. CL. 100). REG. 5-19-1992.
- 1,688,542. DIGITALMICROGRAPH. INT. CL. 9. (U.S. CL. 38). REG. 5-19-1992.
- 1,688,603. NATURAL GUARD. INT. CL. 1. (U.S. CL. 10). REG. 5-26-1992.
- 1,688,672. NATURAL GUARD. INT. CL. 5. (U.S. CLS. 6 AND 18). REG. 5-26-1992.
- 1,688,931. JACE. INT. CL. 10. (U.S. CL. 44). REG. 5-26-1992.
- 1,688,935. ROOMAIR. INT. CL. 11. (U.S. CL. 31). REG. 5-26-1992.
- 1,688,984. STERLING CREATIONS. INT. CL. 14. (U.S. CL. 28). REG. 5-26-1992.
- 1,689,015. NINTENDO AND DESIGN. INT. CLS. 16, 28 AND 37. (U.S. CLS. 2, 5, 22, 23, 29, 37, 38, 50 AND 103). REG. 5-26-1992.
- 1,689,129. COMFORT CORE. INT. CL. 25. (U.S. CL. 39). REG. 5-26-1992.
- 1,689,254. FAPCO, INC.. INT. CL. 35. (U.S. CL. 101). REG. 5-26-1992.
- 1,689,275. GE AND DESIGN. INT. CLS. 36, 37, 38, 39 AND 42. (U.S. CLS. 100, 101, 102, 103, 104 AND 105). REG. 5-26-1992.
- 1,689,394. PREFERRED CUSTOMER CARD. INT. CL. 42. (U.S. CLS. 100 AND 101). REG. 5-26-1992.
- 1,689,425. MISCELLANEOUS DESIGN. INT. CL. 42. (U.S. CL. 100). REG. 5-26-1992.
- 1,689,454. THE GREEN BURRITO AND DESIGN. INT. CL. 42. (U.S. CL. 100). REG. 5-26-1992.
- 1,689,478. TREASURES FROM HOME. INT. CL. 41. (U.S. CLS. 100, 101 AND 107). REG. 5-26-1992.
- 1,689,509. SAFE PASSAGE. INT. CL. 9. (U.S. CLS. 21 AND 38). REG. 5-26-1992.
- 1,689,537. HARMONIC SCALPEL. INT. CL. 10. (U.S. CL. 44). REG. 5-26-1992.
- 1,689,570. DYNATECH. INT. CL. 19. (U.S. CL. 12). REG. 5-26-1992.
- 1,689,810. PAIN-A-TRATE. INT. CL. 5. (U.S. CLS. 6, 18, 44, 46, 51 AND 52). REG. 6-2-1992.
- 1,689,837. DAYCO AND DESIGN. INT. CLS. 7 AND 12. (U.S. CLS. 19, 23 AND 35). REG. 6-2-1992.
- 1,689,883. SPAN. INT. CL. 9. (U.S. CL. 38). REG. 6-2-1992.
- 1,689,982. MICROFLEX. INT. CL. 9. (U.S. CL. 26). REG. 6-2-1992.
- 1,690,034. BROASTER. INT. CLS. 11 AND 30. (U.S. CLS. 31, 34 AND 46). REG. 6-2-1992.
- 1,690,070. 214. INT. CL. 12. (U.S. CL. 19). REG. 6-2-1992.
- 1,690,071. 212. INT. CL. 12. (U.S. CL. 19). REG. 6-2-1992.
- 1,690,186. TEKSEAL. INT. CL. 19. (U.S. CL. 12). REG. 6-2-1992.
- 1,690,193. TERRASET. INT. CL. 19. (U.S. CL. 12). REG. 6-2-1992.
- 1,690,413. GREEN VASE. INT. CL. 31. (U.S. CL. 1). REG. 6-2-1992.
- 1,690,706. DIGESTA-LAC. INT. CL. 5. (U.S. CL. 18). REG. 6-2-1992.
- 1,690,725. D A WORKBENCH. INT. CL. 9. (U.S. CL. 38). REG. 6-2-1992.
- 1,690,800. GRANDPLANNER. INT. CL. 16. (U.S. CL. 37). REG. 6-2-1992.
- 1,690,816. PRIVATEPLANNER. INT. CL. 20. (U.S. CL. 32). REG. 6-2-1992.
- 1,691,439. PETERSON FIELD GUIDE SERIES. INT. CL. 16. (U.S. CL. 38). REG. 6-9-1992.
- 1,691,531. RIVERWATCH. INT. CL. 16. (U.S. CL. 38). REG. 6-9-1992.
- 1,691,680. GW. INT. CL. 25. (U.S. CL. 39). REG. 6-9-1992.
- 1,691,822. MEXIMELT. INT. CL. 30. (U.S. CL. 46). REG. 6-9-1992.
- 1,691,914. LYNDEN INTERNATIONAL AND DESIGN. INT. CLS. 36 AND 39. (U.S. CLS. 101, 102 AND 105). REG. 6-9-1992.
- 1,692,019. BEARCATS. INT. CL. 41. (U.S. CL. 107). REG. 6-9-1992.
- 1,692,224. SUNKIST. INT. CLS. 29 AND 31. (U.S. CL. 46). REG. 6-9-1992.
- 1,692,521. ACCU-MOUNT. INT. CL. 9. (U.S. CL. 26). REG. 6-9-1992.
- 1,692,549. SONICTRAC. INT. CL. 9. (U.S. CL. 26). REG. 6-9-1992.
- 1,692,844. TRANSCRAFT EAGLE. INT. CL. 12. (U.S. CL. 19). REG. 6-9-1992.
- 1,692,858. STANDING OVATION. INT. CL. 13. (U.S. CLS. 2 AND 9). REG. 6-9-1992.
- 1,692,861. SUN SHOWER. INT. CL. 13. (U.S. CLS. 2 AND 9). REG. 6-9-1992.
- 1,692,903. FLEXAGENDA. INT. CL. 16. (U.S. CL. 37). REG. 6-9-1992.
- 1,692,910. GELLY ROLL. INT. CL. 16. (U.S. CLS. 2, 5, 22, 23, 29, 37, 38 AND 50). REG. 6-9-1992.
- 1,693,203. GRAPHLAR. INT. CL. 27. (U.S. CL. 42). REG. 6-9-1992.
- 1,693,375. ULTIMATE CHUNKS. INT. CL. 30. (U.S. CL. 46). REG. 6-9-1992.
- 1,694,013. M AND DESIGN. INT. CL. 7. (U.S. CL. 23). REG. 6-16-1992.
- 1,694,018. POULAN. INT. CLS. 7 AND 12. (U.S. CLS. 19 AND 23). REG. 6-16-1992.
- 1,694,316. MISCELLANEOUS DESIGN. INT. CL. 16. (U.S. CL. 37). REG. 6-16-1992.
- 1,694,363. VECTOGRAM. INT. CL. 16. (U.S. CL. 38). REG. 6-16-1992.
- 1,694,383. GLASER DESIGNS SAN FRANCISCO AND DESIGN. INT. CL. 18. (U.S. CLS. 2 AND 3). REG. 6-16-1992.
- 1,694,632. DE-LISH-US (STYLIZED). INT. CLS. 29 AND 30. (U.S. CL. 46). REG. 6-16-1992.
- 1,695,129. PLANT SCIENCES. INT. CLS. 1 AND 31. (U.S. CLS. 1, 6 AND 18). REG. 6-16-1992.
- 1,695,130. PSI. INT. CLS. 1 AND 31. (U.S. CLS. 1, 6 AND 18). REG. 6-16-1992.
- 1,695,276. SES. INT. CL. 10. (U.S. CLS. 34 AND 44). REG. 6-16-1992.
- 1,695,460. TRU-FIRE. INT. CL. 28. (U.S. CL. 22). REG. 6-16-1992.
- 1,695,653. NAXONAC. INT. CL. 1. (U.S. CLS. 6 AND 52). REG. 6-23-1992.
- 1,695,726. MISCELLANEOUS DESIGN. INT. CL. 5. (U.S. CL. 6). REG. 6-23-1992.
- 1,696,341. MOONSTRIPS. INT. CL. 30. (U.S. CL. 46). REG. 6-23-1992.
- 1,696,391. BIG ROCK. INT. CL. 32. (U.S. CL. 48). REG. 6-23-1992.
- 1,696,727. PARTS OF A LARGER WORLD (STYLIZED). INT. CLS. 16 AND 20. (U.S. CLS. 38 AND 50). REG. 6-23-1992.
- 1,696,744. KENT CREME BLEACH. INT. CL. 3. (U.S. CL. 51). REG. 6-23-1992.
- 1,696,860. SLIPGUARD. INT. CL. 9. (U.S. CLS. 26 AND 39). REG. 6-23-1992.
- 1,696,905. WHIZZER. INT. CL. 12. (U.S. CL. 19). REG. 6-23-1992.
- 1,697,069. JT (STYLIZED). INT. CL. 34. (U.S. CL. 17). REG. 6-23-1992.
- 1,697,156. PRACTICE PROFILES. INT. CL. 16. (U.S. CL. 38). REG. 6-23-1992.
- 1,697,272. PLEXTURE. INT. CL. 2. (U.S. CL. 16). REG. 6-30-1992.
- 1,697,316. SUTURE STRIP. INT. CL. 5. (U.S. CLS. 6, 18, 44, 46, 51 AND 52). REG. 6-30-1992.
- 1,697,476. MEDISCRIBE. INT. CL. 9. (U.S. CL. 38). REG. 6-30-1992.
- 1,697,518. PACIFIC COAST. INT. CL. 11. (U.S. CL. 21). REG. 6-30-1992.
- 1,697,558. KAPPA ALPHA THETA. INT. CL. 16. (U.S. CLS. 37 AND 38). REG. 6-30-1992.
- 1,697,598. DURALITE MAILER. INT. CL. 16. (U.S. CL. 37). REG. 6-30-1992.
- 1,697,674. KAPPA ALPHA THETA. INT. CL. 21. (U.S. CLS. 2, 13 AND 33). REG. 6-30-1992.
- 1,697,776. BOBS SPACE RACERS AND DESIGN. INT. CL. 28. (U.S. CL. 22). REG. 6-30-1992.
- 1,697,811. MINNESOTA BRAND GOLD AND DESIGN. INT. CL. 29. (U.S. CL. 46). REG. 6-30-1992.
- 1,697,883. MCBRIDE'S HAND PACKED HAND MIXED AND DESIGN. INT. CL. 31. (U.S. CL. 46). REG. 6-30-1992.
- 1,698,136. BEING IN MOVEMENT. INT. CL. 41. (U.S. CL. 107). REG. 6-30-1992.
- 1,698,138. SPACE ACADEMY. INT. CL. 41. (U.S. CL. 107). REG. 6-30-1992.
- 1,698,659. FLUX-RITE 90. INT. CL. 1. (U.S. CL. 6). REG. 7-7-1992.

- 1,698,744. CONCERTO. INT. CL. 5. (U.S. CL. 6). REG. 7-7-1992.
- 1,699,568. THE AMERICAN TRAVELER MOTOR CLUB AND DESIGN. INT. CL. 42. (U.S. CLS. 100 AND 102). REG. 7-7-1992.
- 1,699,600. HILLEL. INT. CL. 42. (U.S. CL. 100). REG. 7-7-1992.
- 1,699,619. PIERRE CRAWDEAUX AND COMPANY. INT. CL. 42. (U.S. CL. 101). REG. 7-7-1992.
- 1,700,160. PRECOR 2000. INT. CL. 5. (U.S. CL. 6). REG. 7-14-1992.
- 1,700,556. LUBE TUBE (STYLIZED). INT. CL. 17. (U.S. CLS. 23 AND 35). REG. 7-14-1992.
- 1,700,568. MP-3. INT. CL. 19. (U.S. CLS. 12 AND 14). REG. 7-14-1992.
- 1,700,647. HOOSIERS. INT. CL. 25. (U.S. CLS. 22 AND 39). REG. 7-14-1992.
- 1,701,428. AIRSNIP. INT. CL. 7. (U.S. CL. 23). REG. 7-21-1992.
- 1,702,051. BRANDEQUITY. INT. CL. 35. (U.S. CL. 101). REG. 7-21-1992.
- 1,702,687. POLY D-TAC. INT. CL. 1. (U.S. CL. 6). REG. 7-28-1992.
- 1,702,816. FLUOROKOTE#1 AND DESIGN. INT. CL. 6. (U.S. CL. 13). REG. 7-28-1992.
- 1,702,836. EVERLOY. INT. CL. 7. (U.S. CL. 23). REG. 7-28-1992.
- 1,705,524. CIRM. INT. CL. 41. (U.S. CL. 107). REG. 8-4-1992.
- 1,706,109. UNIPURGE. INT. CL. 1. (U.S. CL. 6). REG. 8-11-1992.
- 1,706,191. AIM HERBAL FIBERBLEND (STYLIZED). INT. CL. 5. (U.S. CL. 46). REG. 8-11-1992.
- 1,707,031. FIFTH AVENUE. INT. CL. 30. (U.S. CL. 46). REG. 8-11-1992.
- 1,707,768. ASB. INT. CL. 6. (U.S. CLS. 13 AND 14). REG. 8-18-1992.
- 1,708,552. CINCINNATI BAR ASSOCIATION. INT. CLS. 35, 41 AND 42. (U.S. CLS. 100, 101 AND 107). REG. 8-18-1992.
- 1,709,670. ICEMATIC. INT. CL. 4. (U.S. CL. 15). REG. 8-25-1992.
- 1,709,824. DRB II. INT. CL. 9. (U.S. CL. 26). REG. 8-25-1992.
- 1,710,333. MISCELLANEOUS DESIGN. INT. CLS. 35, 41 AND 42. (U.S. CLS. 100, 101 AND 107). REG. 8-25-1992.
- 1,710,574. THE RIVER CAFE. INT. CL. 42. (U.S. CL. 100). REG. 8-25-1992.
- 1,710,718. DEPOSIT PRO. INT. CL. 9. (U.S. CL. 38). REG. 8-25-1992.
- 1,710,959. SI-LINK. INT. CL. 1. (U.S. CLS. 1 AND 6). REG. 9-1-1992.
- 1,713,817. TIBHAR. INT. CLS. 25 AND 28. (U.S. CLS. 22 AND 39). REG. 9-8-1992.
- 1,714,548. TOYS YOU'LL FEEL GOOD ABOUT GIVING. INT. CL. 42. (U.S. CL. 101). REG. 9-8-1992.
- 1,716,073. PICK TWO. INT. CL. 28. (U.S. CL. 22). REG. 9-15-1992.
- 1,716,648. R - I - T (STYLIZED). INT. CL. 41. (U.S. CL. 107). REG. 9-15-1992.
- 1,716,652. ROCHESTER INSTITUTE OF TECHNOLOGY. INT. CL. 41. (U.S. CL. 107). REG. 9-15-1992.
- 1,716,751. BANK UP. INT. CL. 42. (U.S. CLS. 100 AND 101). REG. 9-15-1992.
- 1,716,817. CAJUN LOUISIANA PC AND DESIGN. INT. CL. 42. (U.S. CL. 101). REG. 9-15-1992.
- 1,718,897. CAPTAIN PLANET AND THE PLANETEERS. INT. CL. 41. (U.S. CL. 107). REG. 9-22-1992.
- 1,719,647. CLOTHES THAT WILL MAKE YOU, NOT BREAK YOU. INT. CL. 42. (U.S. CL. 101). REG. 9-22-1992.
- 1,719,838. HEINZMANN (STYLIZED). INT. CL. 7. (U.S. CLS. 21 AND 23). REG. 9-29-1992.
- 1,720,109. FEATHER BRAND CAVINESS WOODWORKING CO., INC. CALHOUN CITY, MISS. U.S.A. AND DESIGN. INT. CL. 12. (U.S. CL. 19). REG. 9-29-1992.
- 1,721,351. BIG D (STYLIZED). INT. CL. 5. (U.S. CLS. 6, 18, 44, 46, 51 AND 52). REG. 10-6-1992.
- 1,722,179. POWER POINT. INT. CL. 28. (U.S. CL. 22). REG. 10-6-1992.
- 1,723,385. FIRETRAINER (STYLIZED). INT. CLS. 9 AND 37. (U.S. CLS. 38 AND 103). REG. 10-13-1992.
- 1,724,102. VEGA-SICILIA "UNICO" AND DESIGN. INT. CL. 33. (U.S. CL. 47). REG. 10-13-1992.
- 1,724,400. NEWS CAFE. INT. CL. 42. (U.S. CL. 100). REG. 10-13-1992.
- 1,724,417. CALHOUN'S. INT. CL. 42. (U.S. CLS. 100 AND 101). REG. 10-13-1992.
- 1,724,880. COST CUTTERS. INT. CLS. 3 AND 42. (U.S. CLS. 1, 4, 6, 50, 51, 52, 100 AND 101). REG. 10-20-1992.
- 1,725,205. VENSIM. INT. CL. 9. (U.S. CL. 38). REG. 10-20-1992.
- 1,725,503. PROGNOSIS. INT. CL. 16. (U.S. CL. 38). REG. 10-20-1992.
- 1,725,744. MANAR. INT. CL. 20. (U.S. CL. 50). REG. 10-20-1992.
- 1,725,787. EXPOS. INT. CL. 25. (U.S. CLS. 22 AND 39). REG. 10-20-1992.
- 1,725,875. VOLCOM. INT. CL. 25. (U.S. CL. 39). REG. 10-20-1992.
- 1,726,436. PROGNOSIS. INT. CL. 42. (U.S. CLS. 100 AND 101). REG. 10-20-1992.
- 1,726,664. UTILIMASTER AND DESIGN. INT. CL. 12. (U.S. CL. 19). REG. 10-20-1992.
- 1,728,762. VAPORGARD. INT. CL. 1. (U.S. CL. 6). REG. 11-3-1992.
- 1,729,161. LIL' DIGGITY. INT. CL. 11. (U.S. CL. 34). REG. 11-3-1992.
- 1,729,564. TRACK AND DESIGN. INT. CL. 28. (U.S. CL. 22). REG. 11-3-1992.
- 1,729,706. CITRUS WORLD. INT. CL. 32. (U.S. CL. 45). REG. 11-3-1992.
- 1,729,719. FORO. INT. CL. 33. (U.S. CL. 47). REG. 11-3-1992.
- 1,730,549. SIEVER'S PROVOLUM. INT. CL. 3. (U.S. CL. 51). REG. 11-10-1992.
- 1,731,057. FLEXO COLOR GUIDE. INT. CL. 16. (U.S. CL. 38). REG. 11-10-1992.
- 1,733,355. HOO COME HOO COME CORP. AND DESIGN. INT. CL. 29. (U.S. CL. 46). REG. 11-17-1992.
- 1,733,395. CAJUN ICE. INT. CL. 30. (U.S. CL. 46). REG. 11-17-1992.
- 1,734,011. MISCELLANEOUS DESIGN. INT. CL. 14. (U.S. CL. 28). REG. 11-17-1992.
- 1,734,131. LAMADERM. INT. CL. 31. (U.S. CL. 46). REG. 11-17-1992.
- 1,735,073. NEW ORLEANS BLEND (STYLIZED). INT. CL. 30. (U.S. CL. 46). REG. 11-24-1992.
- 1,735,098. DUM-DUMS AND DESIGN. INT. CL. 30. (U.S. CL. 46). REG. 11-24-1992.
- 1,735,763. ZESTIES!. INT. CL. 29. (U.S. CL. 46). REG. 11-24-1992.
- 1,736,065. SPRAYMATION AND DESIGN. INT. CL. 7. (U.S. CL. 23). REG. 12-1-1992.
- 1,736,961. FIRSTMARK (STYLIZED). INT. CL. 35. (U.S. CL. 101). REG. 12-1-1992.
- 1,737,507. EMIX. INT. CL. 9. (U.S. CL. 38). REG. 12-1-1992.
- 1,738,550. LOBELIA WHITE PALACE. INT. CL. 31. (U.S. CL. 1). REG. 12-8-1992.
- 1,739,043. A/A LINER. INT. CL. 17. (U.S. CLS. 1, 13 AND 35). REG. 12-8-1992.
- 1,739,583. LIL' AUTO STORE. INT. CL. 11 ONLY. (U.S. CLS. 12 AND 21). REG. 12-15-1992.
- 1,741,792. CLIMATRON. INT. CL. 41. (U.S. CL. 107). REG. 12-22-1992.
- 1,741,928. 99c ONLY STORES AND DESIGN. INT. CL. 42. (U.S. CL. 101). REG. 12-22-1992.
- 1,741,975. THE NEWS. INT. CL. 42. (U.S. CL. 100). REG. 12-22-1992.
- 1,742,546. HEART SMART RESTAURANTS INTERNATIONAL. U.S. CL. B. REG. 12-22-1992.
- 1,743,561. AMERICAN BRIDGE. INT. CL. 37. (U.S. CL. 103). REG. 12-29-1992.
- 1,743,805. NOBLE EXCELLENCE. INT. CL. 24 ONLY. (U.S. CLS. 42 AND 50). REG. 12-29-1992.
- 1,744,171. AQUAVAR. INT. CL. 2. (U.S. CL. 16). REG. 1-5-1993.
- 1,746,410. A/A GRIP LINER. INT. CL. 17. (U.S. CL. 50). REG. 1-12-1993.
- 1,746,411. A/A DRAIN LINER. INT. CL. 17. (U.S. CL. 1). REG. 1-12-1993.
- 1,746,447. MISCELLANEOUS DESIGN. INT. CL. 25. (U.S. CL. 39). REG. 1-12-1993.
- 1,748,393. DECORATING DIGEST. INT. CL. 16. (U.S. CL. 38). REG. 1-26-1993.
- 1,748,680. REDDI-EGG. INT. CL. 29. (U.S. CL. 46). REG. 1-26-1993.
- 1,749,068. WINKING LIZARD. INT. CL. 42. (U.S. CL. 100). REG. 1-26-1993.
- 1,749,349. CYCLOMAX. INT. CL. 11. (U.S. CL. 34). REG. 1-26-1993.

- 1,750,472. NATIONAL ELEVATOR INDUSTRY EDUCATIONAL PROGRAM NEIEP AND DESIGN. INT. CL. 41. (U.S. CL. 107). REG. 2-2-1993.
- 1,752,221. DISCON. INT. CL. 7 ONLY. (U.S. CLS. 13, 19, 21, 23, 31, 34 AND 35). REG. 2-16-1993.
- 1,753,601. M & I. INT. CLS. 7 AND 9. (U.S. CLS. 21, 23 AND 26). REG. 2-23-1993.
- 1,754,961. THERMONITOR. INT. CL. 9. (U.S. CL. 38). REG. 3-2-1993.
- 1,756,318. GLACIER-GUARD. INT. CL. 1. (U.S. CL. 6). REG. 3-9-1993.
- 1,756,325. SHER-CLAD. INT. CL. 2. (U.S. CLS. 6, 11 AND 16). REG. 3-9-1993.
- 1,758,137. GENEVA. INT. CL. 9. (U.S. CLS. 21, 23, 26, 36 AND 38). REG. 3-16-1993.
- 1,758,869. "SHAPE UP WITH SHARON" AND DESIGN. INT. CL. 41. (U.S. CLS. 100, 101 AND 107). REG. 3-16-1993.
- 1,759,225. SANTA MARINA. INT. CL. 33. (U.S. CL. 47). REG. 3-16-1993.
- 1,759,380. KISS. INT. CL. 3. (U.S. CLS. 5, 40 AND 51). REG. 3-23-1993.
- 1,760,382. IRMI. INT. CL. 41. (U.S. CLS. 101 AND 107). REG. 3-23-1993.
- 1,760,879. HEICO. INT. CL. 1. (U.S. CL. 6). REG. 3-30-1993.
- 1,761,395. BROOKWOOD. INT. CL. 20. (U.S. CL. 32). REG. 3-30-1993.
- 1,762,283. STRETCH-GUARD. INT. CL. 2. (U.S. CL. 16). REG. 4-6-1993.
- 1,763,466. BANG ZOOM DESIGN INC. AND DESIGN. INT. CL. 42. (U.S. CL. 100). REG. 4-6-1993.
- 1,764,000. BIONEEM. INT. CL. 5. (U.S. CL. 6). REG. 4-13-1993.
- 1,765,348. MISCELLANEOUS DESIGN. INT. CL. 30. (U.S. CL. 46). REG. 4-13-1993.
- 1,766,051. LOST CREEK FARMS. INT. CL. 29. (U.S. CL. 46). REG. 4-20-1993.
- 1,766,200. MISCELLANEOUS DESIGN. INT. CL. 36. (U.S. CLS. 100, 101 AND 102). REG. 4-20-1993.
- 1,766,384. JAPONESQUE AND DESIGN. INT. CL. 42. (U.S. CL. 100). REG. 4-20-1993.
- 1,766,641. BIOLET. INT. CL. 11. (U.S. CL. 13). REG. 4-20-1993.
- 1,767,505. MINNEAPOLIS LAKERS. INT. CL. 25. (U.S. CL. 39). REG. 4-27-1993.
- 1,767,983. DURACON. INT. CL. 10. (U.S. CL. 44). REG. 4-27-1993.
- 1,768,029. THE CALL OF THE WILD. INT. CL. 13. (U.S. CL. 9). REG. 4-27-1993.
- 1,768,902. MILKY WAY. INT. CL. 39. (U.S. CL. 105). REG. 5-4-1993.
- 1,768,931. THE NATIONAL MAGAZINE AWARDS AND DESIGN. INT. CL. 41. (U.S. CL. 107). REG. 5-4-1993.
- 1,769,050. VUALL. INT. CLS. 11 AND 21. (U.S. CLS. 2, 13, 23 AND 34). REG. 5-4-1993.
- 1,770,804. ROYAL PRINCE. INT. CL. 21. (U.S. CLS. 29 AND 50). REG. 5-11-1993.
- 1,770,805. ROYAL KNIGHT. INT. CL. 21. (U.S. CLS. 29 AND 50). REG. 5-11-1993.
- 2,419,526. RAINSHIELD (STYLIZED). INT. CL. 19. (U.S. CLS. 1, 12, 33 AND 50). REG. 1-9-2001.
- 2,460,877. SOUP FACTORY. INT. CL. 42. (U.S. CLS. 100 AND 101). REG. 6-19-2001.
- 2,470,108. WWW.ESPRIT.COM. INT. CL. 35. (U.S. CLS. 100, 101 AND 102). REG. 7-17-2001.
- 2,477,965. LIVE LARGE. INT. CL. 42. (U.S. CLS. 100 AND 101). REG. 8-14-2001.
- 2,502,173. GROWING A WILD TOMORROW!. INT. CL. 35. (U.S. CLS. 100, 101 AND 102). REG. 10-30-2001.
- 2,503,943. DRIVE AND DESIGN. INT. CL. 36. (U.S. CLS. 100, 101 AND 102). REG. 11-6-2001.
- 2,503,946. MISCELLANEOUS DESIGN. INT. CL. 36. (U.S. CLS. 100, 101 AND 102). REG. 11-6-2001.
- 2,504,638. BIGCAT. INT. CL. 9. (U.S. CLS. 21, 23, 26, 36 AND 38). REG. 11-6-2001.
- 2,504,831. HAIR READING (STYLIZED). INT. CL. 16. (U.S. CLS. 2, 5, 22, 23, 29, 37, 38 AND 50). REG. 11-6-2001.
- 2,505,728. K AND DESIGN. INT. CL. 6. (U.S. CLS. 2, 12, 13, 14, 23, 25 AND 50). REG. 11-13-2001.
- 2,506,229. LITTLE FINGERS (STYLIZED). INT. CL. 21. (U.S. CLS. 2, 13, 23, 29, 30, 33, 40 AND 50). REG. 11-13-2001.
- 2,506,411. MNX. INT. CL. 36. (U.S. CLS. 100, 101 AND 102). REG. 11-13-2001.
- 2,506,481. WHAT WOULD YOU DO FOR A KLONDIKE BAR?. INT. CL. 30. (U.S. CL. 46). REG. 11-13-2001.
- 2,506,536. TRUE GRIT. INT. CL. 16. (U.S. CLS. 2, 5, 22, 23, 29, 37, 38 AND 50). REG. 11-13-2001.
- 2,506,652. OTF. INT. CL. 35. (U.S. CLS. 100, 101 AND 102). REG. 11-13-2001.
- 2,506,769. EDWARDS PRIMA PLUS. INT. CL. 10. (U.S. CLS. 26, 39 AND 44). REG. 11-13-2001.
- 2,506,974. THE SETAI. INT. CLS. 36, 37 AND 42. (U.S. CLS. 100, 101, 102, 103 AND 106). REG. 11-13-2001.
- 2,507,291. NICKELODEON. INT. CL. 30. (U.S. CL. 46). REG. 11-13-2001.
- 2,507,330. GOODNESS FROM THE GROUND UP. INT. CL. 31. (U.S. CLS. 1 AND 46). REG. 11-13-2001.
- 2,507,350. ACUCORP. INT. CL. 9. (U.S. CLS. 21, 23, 26, 36 AND 38). REG. 11-13-2001.
- 2,507,638. DON GUSTAVO. INT. CL. 30. (U.S. CL. 46). REG. 11-13-2001.
- 2,507,640. CHEMPLAST. INT. CLS. 17, 40 AND 42. (U.S. CLS. 1, 5, 12, 13, 35, 50, 100, 101, 103 AND 106). REG. 11-13-2001.
- 2,507,647. KICK BACK. INT. CL. 25. (U.S. CLS. 22 AND 39). REG. 11-13-2001.
- 2,508,197. LOKK LATCH AND DESIGN. INT. CL. 20. (U.S. CLS. 2, 13, 22, 25, 32 AND 50). REG. 11-13-2001.
- 2,508,283. SISLEY AND DESIGN. INT. CLS. 18, 25 AND 35. (U.S. CLS. 1, 2, 3, 22, 39, 41, 100, 101 AND 102). REG. 11-20-2001.
- 2,508,507. FROG AND DESIGN. INT. CL. 11. (U.S. CLS. 13, 21, 23, 31 AND 34). REG. 11-20-2001.
- 2,508,509. FROG AND DESIGN. INT. CLS. 1 AND 11. (U.S. CLS. 1, 5, 6, 10, 13, 21, 23, 26, 31, 34 AND 46). REG. 11-20-2001.
- 2,508,510. AMERICAN SAFETY & HEALTH INSTITUTE AND DESIGN. INT. CLS. 9 AND 16. (U.S. CLS. 2, 5, 21, 22, 23, 26, 29, 36, 37, 38 AND 50). REG. 11-20-2001.
- 2,508,863. RESERVA DEL SENOR. INT. CL. 33. (U.S. CLS. 47 AND 49). REG. 11-20-2001.
- 2,509,464. HOPLAND BREWERY. INT. CL. 42. (U.S. CLS. 100 AND 101). REG. 11-20-2001.
- 2,509,611. KAUFMAN AND BROAD. INT. CL. 37 ONLY. (U.S. CLS. 100, 103 AND 106). REG. 11-20-2001.
- 2,510,318. DREAMS & DESTINY. INT. CL. 41. (U.S. CLS. 100, 101 AND 107). REG. 11-20-2001.
- 2,510,338. ULTRACISION. INT. CL. 10. (U.S. CLS. 26, 39 AND 44). REG. 11-20-2001.
- 2,510,468. MASTERPATCH. INT. CL. 19. (U.S. CLS. 1, 12, 33 AND 50). REG. 11-20-2001.
- 2,510,740. SILVER LEGACY. INT. CL. 25. (U.S. CLS. 22 AND 39). REG. 11-20-2001.
- 2,510,788. BERKELEY ENERGY SERVICES. INT. CL. 39. (U.S. CLS. 100 AND 105). REG. 11-20-2001.
- 2,511,011. MISCELLANEOUS DESIGN. INT. CL. 25. (U.S. CLS. 22 AND 39). REG. 11-20-2001.
- 2,511,211. ASPIRA RAISING HOPE (STYLIZED). INT. CL. 42. (U.S. CLS. 100 AND 101). REG. 11-20-2001.
- 2,512,046. HISTORICAL REMEDIES. INT. CL. 5. (U.S. CLS. 6, 18, 44, 46, 51 AND 52). REG. 11-27-2001.
- 2,512,630. I3. INT. CL. 25. (U.S. CLS. 22 AND 39). REG. 11-27-2001.
- 2,512,923. USA*USA*USA. INT. CL. 38. (U.S. CLS. 100, 101 AND 104). REG. 11-27-2001.
- 2,514,055. WELLOGIC. INT. CL. 9. (U.S. CLS. 21, 23, 26, 36 AND 38). REG. 12-4-2001.
- 2,514,952. AVALON TATTOO. INT. CL. 42. (U.S. CLS. 100 AND 101). REG. 12-4-2001.
- 2,515,294. GUGGULEAN. INT. CL. 5 ONLY. (U.S. CLS. 6, 18, 44, 46, 51 AND 52). REG. 12-4-2001.
- 2,516,314. NSI. INT. CLS. 35, 38 AND 42. (U.S. CLS. 100, 101, 102 AND 104). REG. 12-11-2001.
- 2,516,366. CRESCENDO PRESENTS. INT. CL. 9. (U.S. CLS. 21, 23, 26, 36 AND 38). REG. 12-11-2001.
- 2,518,639. TONY STEWART. INT. CLS. 16, 25, 26 AND 28 ONLY. (U.S. CLS. 2, 5, 22, 23, 29, 37, 38, 39, 40, 42 AND 50). REG. 12-11-2001.
- 2,524,923. RED LION INN & SUITES AND DESIGN. INT. CL. 42. (U.S. CLS. 100 AND 101). REG. 1-1-2002.
- 2,526,192. INFANT FLOW. INT. CL. 10. (U.S. CLS. 26, 39 AND 44). REG. 1-1-2002.
- 2,526,278. HUNT FISH CAMP. INT. CL. 42. (U.S. CLS. 100 AND 101). REG. 1-1-2002.
- 2,527,331. RED LION INN & SUITES. INT. CL. 42. (U.S. CLS. 100 AND 101). REG. 1-8-2002.

- 2,527,707. KAMASUTRA. INT. CL. 33. (U.S. CLS. 47 AND 49). REG. 1-8-2002.
- 2,531,511. CREATIONS METAPHORES (STYLIZED). INT. CL. 24. (U.S. CLS. 42 AND 50). REG. 1-22-2002.
- 2,534,139. RED LION HOTELS & INNS AND DESIGN. INT. CL. 42. (U.S. CLS. 100 AND 101). REG. 1-29-2002.
- 2,534,892. AVAST!. INT. CL. 5. (U.S. CLS. 6, 18, 44, 46, 51 AND 52). REG. 1-29-2002.
- 2,535,332. MISCELLANEOUS DESIGN. INT. CLS. 35 AND 36. (U.S. CLS. 100, 101 AND 102). REG. 2-5-2002.
- 2,537,981. GENERATIONTAX AND DESIGN. INT. CL. 35. (U.S. CLS. 100, 101 AND 102). REG. 2-12-2002.
- 2,538,106. MISCELLANEOUS DESIGN. INT. CL. 41. (U.S. CLS. 100, 101 AND 107). REG. 2-12-2002.
- 2,539,903. TGM AND DESIGN. INT. CL. 11. (U.S. CLS. 13, 21, 23, 31 AND 34). REG. 2-19-2002.
- 2,540,462. MAYO CLINIC STANDARD CHARACTER MARK. INT. CL. 42. (U.S. CLS. 100 AND 101). REG. 2-19-2002.
- 2,545,703. PRICCI AND DESIGN. INT. CL. 42. (U.S. CLS. 100 AND 101). REG. 3-12-2002.
- 2,546,287. ZY. INT. CL. 42. (U.S. CLS. 100 AND 101). REG. 3-12-2002.
- 2,546,303. MICROVOTE. INT. CL. 9. (U.S. CLS. 21, 23, 26, 36 AND 38). REG. 3-12-2002.
- 2,549,618. MEDIA CENTER DENTAL AND DESIGN. INT. CL. 42. (U.S. CLS. 100 AND 101). REG. 3-19-2002.
- 2,550,568. CYPEK. INT. CL. 1. (U.S. CLS. 1, 5, 6, 10, 26 AND 46). REG. 3-19-2002.
- 2,553,026. DUST-RITE. INT. CL. 7. (U.S. CLS. 13, 19, 21, 23, 31, 34 AND 35). REG. 3-26-2002.
- 2,553,137. PYROGRAF. INT. CL. 17. (U.S. CLS. 1, 5, 12, 13, 35 AND 50). REG. 3-26-2002.
- 2,554,825. COLORSCALA. INT. CL. 16. (U.S. CLS. 2, 5, 22, 23, 29, 37, 38 AND 50). REG. 4-2-2002.
- 2,554,964. FIDELIO. INT. CLS. 9, 35 AND 42. (U.S. CLS. 21, 23, 26, 36, 38, 100, 101 AND 102). REG. 4-2-2002.
- 2,555,808. BLUE ZONE. INT. CL. 30. (U.S. CL. 46). REG. 4-2-2002.
- 2,555,844. V & S. INT. CL. 42. (U.S. CLS. 100 AND 101). REG. 4-2-2002.
- 2,557,549. SMARTBOARD. INT. CL. 19 ONLY. (U.S. CLS. 1, 12, 33 AND 50). REG. 4-9-2002.
- 2,558,727. VALENTINA AND DESIGN. INT. CL. 30. (U.S. CL. 46). REG. 4-9-2002.
- 2,559,029. SUNBRITE. INT. CL. 24. (U.S. CLS. 42 AND 50). REG. 4-9-2002.
- 2,559,666. KIT KITTREDGE. INT. CLS. 35 AND 42. (U.S. CLS. 100, 101 AND 102). REG. 4-9-2002.
- 2,560,301. MEDMEASURES. INT. CL. 9. (U.S. CLS. 21, 23, 26, 36 AND 38). REG. 4-9-2002.
- 2,560,346. SANTA FE. INT. CL. 11. (U.S. CLS. 13, 21, 23, 31 AND 34). REG. 4-9-2002.
- 2,561,367. MYSWEEPSTAKES.COM. INT. CL. 41. (U.S. CLS. 100, 101 AND 107). REG. 4-16-2002.
- 2,561,494. TAQUERIA ARANDAS SABROSO...SABROSITO!! AND DESIGN. INT. CLS. 16, 25, 35 AND 42. (U.S. CLS. 2, 5, 22, 23, 29, 37, 38, 39, 50, 100, 101 AND 102). REG. 4-16-2002.
- 2,562,362. TIG SPECIALTY AND DESIGN. INT. CL. 36. (U.S. CLS. 100, 101 AND 102). REG. 4-16-2002.
- 2,563,178. JCR AND DESIGN. INT. CL. 41. (U.S. CLS. 100, 101 AND 107). REG. 4-23-2002.
- 2,564,008. DURA TECH. INT. CL. 6. (U.S. CLS. 2, 12, 13, 14, 23, 25 AND 50). REG. 4-23-2002.
- 2,564,398. RESURRECTION BLVD. INT. CL. 41. (U.S. CLS. 100, 101 AND 107). REG. 4-23-2002.
- 2,564,414. ELANTE. INT. CL. 6. (U.S. CLS. 2, 12, 13, 14, 23, 25 AND 50). REG. 4-23-2002.
- 2,564,422. IROX. INT. CL. 10. (U.S. CLS. 26, 39 AND 44). REG. 4-23-2002.
- 2,565,057. MARINE CORPS MARATHON. INT. CLS. 14, 16, 21, 25, 26 AND 41. (U.S. CLS. 2, 5, 13, 22, 23, 27, 28, 29, 30, 33, 37, 38, 39, 40, 42, 50, 100, 101 AND 107). REG. 4-30-2002.
- 2,565,767. HEARTBREAK HOTEL. INT. CLS. 8 AND 28. (U.S. CLS. 22, 23, 28, 38, 44 AND 50). REG. 4-30-2002.
- 2,565,932. MUCCELL. INT. CL. 7. (U.S. CLS. 13, 19, 21, 23, 31, 34 AND 35). REG. 4-30-2002.
- 2,565,987. G E Z E R AND DESIGN. INT. CL. 25 ONLY. (U.S. CLS. 22 AND 39). REG. 4-30-2002.
- 2,566,529. SMILEY. INT. CL. 28 ONLY. (U.S. CLS. 22, 23, 38 AND 50). REG. 5-7-2002.
- 2,567,140. MAMMOTH. INT. CL. 12. (U.S. CLS. 19, 21, 23, 31, 35 AND 44). REG. 5-7-2002.
- 2,567,224. FIRST ROUND AND DESIGN. INT. CL. 25. (U.S. CLS. 22 AND 39). REG. 5-7-2002.
- 2,567,269. PORTLAND BEAVERS. INT. CL. 41. (U.S. CLS. 100, 101 AND 107). REG. 5-7-2002.
- 2,567,270. TRAVEL SEQUENCE. INT. CL. 28. (U.S. CLS. 22, 23, 38 AND 50). REG. 5-7-2002.
- 2,567,326. WOLVERINE TECHNICAL STAFFING INC. AND DESIGN. INT. CL. 35. (U.S. CLS. 100, 101 AND 102). REG. 5-7-2002.
- 2,567,408. BODY MOODS. INT. CL. 11. (U.S. CLS. 13, 21, 23, 31 AND 34). REG. 5-7-2002.
- 2,567,801. DIMENSIONAL PEOPLE SKILLS. INT. CL. 41. (U.S. CLS. 100, 101 AND 107). REG. 5-7-2002.
- 2,567,893. OPTI-RAIL. INT. CL. 12. (U.S. CLS. 19, 21, 23, 31, 35 AND 44). REG. 5-7-2002.
- 2,568,105. HYPERTHERM AUTOMATION. INT. CL. 9. (U.S. CLS. 21, 23, 26, 36 AND 38). REG. 5-7-2002.
- 2,568,106. HYPERTHERM AUTOMATION. INT. CL. 9. (U.S. CLS. 21, 23, 26, 36 AND 38). REG. 5-7-2002.
- 2,568,180. SARA LEE. INT. CL. 30. (U.S. CL. 46). REG. 5-7-2002.
- 2,568,387. LOX. INT. CLS. 6 AND 7 ONLY. (U.S. CLS. 2, 12, 13, 14, 19, 21, 23, 25, 31, 34, 35 AND 50). REG. 5-7-2002.
- 2,568,572. NETWORK VAULT. INT. CL. 9. (U.S. CLS. 21, 23, 26, 36 AND 38). REG. 5-7-2002.
- 2,568,741. CELLREADER. INT. CL. 9. (U.S. CLS. 21, 23, 26, 36 AND 38). REG. 5-14-2002.
- 2,568,773. REDHAWKS. INT. CL. 41. (U.S. CLS. 100, 101 AND 107). REG. 5-14-2002.
- 2,568,798. MISCELLANEOUS DESIGN. INT. CLS. 7 AND 9. (U.S. CLS. 13, 19, 21, 23, 26, 31, 34, 35, 36 AND 38). REG. 5-14-2002.
- 2,568,813. AM.PM. INT. CLS. 16 AND 20. (U.S. CLS. 2, 5, 13, 22, 23, 25, 29, 32, 37, 38 AND 50). REG. 5-14-2002.
- 2,568,828. MISCELLANEOUS DESIGN. INT. CLS. 9, 16, 19, 20, 21, 25, 36, 37 AND 38. (U.S. CLS. 1, 2, 5, 12, 13, 21, 22, 23, 25, 26, 29, 30, 32, 33, 36, 37, 38, 39, 40, 50, 100, 101, 102, 103, 104 AND 106). REG. 5-14-2002.
- 2,568,832. APACHE. INT. CL. 9. (U.S. CLS. 21, 23, 26, 36 AND 38). REG. 5-14-2002.
- 2,568,843. COLBACK EASYTUFT. INT. CL. 22. (U.S. CLS. 1, 2, 7, 19, 22, 42 AND 50). REG. 5-14-2002.
- 2,568,849. DOTS. INT. CL. 35. (U.S. CLS. 100, 101 AND 102). REG. 5-14-2002.
- 2,568,882. INJURY FREE COALITION FOR KIDS AND DESIGN. INT. CL. 42. (U.S. CLS. 100 AND 101). REG. 5-14-2002.
- 2,568,905. JOTTUM (STYLIZED). INT. CL. 25. (U.S. CLS. 22 AND 39). REG. 5-14-2002.
- 2,568,917. THE PARSONS- FEIN TRAINING INSTITUTE. INT. CL. 41. (U.S. CLS. 100, 101 AND 107). REG. 5-14-2002.
- 2,568,918. DIRECTPREP. INT. CLS. 1 AND 9 ONLY. (U.S. CLS. 1, 5, 6, 10, 21, 23, 26, 36, 38 AND 46). REG. 5-14-2002.
- 2,568,938. ALKYFINING. INT. CLS. 40 AND 42. (U.S. CLS. 100, 101, 103 AND 106). REG. 5-14-2002.
- 2,568,958. LIFA AIR AND DESIGN. INT. CLS. 7 AND 11 ONLY. (U.S. CLS. 13, 19, 21, 23, 31, 34 AND 35). REG. 5-14-2002.
- 2,568,999. 999.9 FOUR NINES (STYLIZED). INT. CL. 9. (U.S. CLS. 21, 23, 26, 36 AND 38). REG. 5-14-2002.
- 2,569,000. 4 9 FOUR NINES (STYLIZED). INT. CL. 9. (U.S. CLS. 21, 23, 26, 36 AND 38). REG. 5-14-2002.
- 2,569,059. INTERNATIONAL ACHIEVEMENT SUMMIT. INT. CL. 41. (U.S. CLS. 100, 101 AND 107). REG. 5-14-2002.
- 2,569,064. X 75-S. INT. CL. 1. (U.S. CLS. 1, 5, 6, 10, 26 AND 46). REG. 5-14-2002.
- 2,569,074. SOURCINGPARTNER AND DESIGN. INT. CL. 35. (U.S. CLS. 100, 101 AND 102). REG. 5-14-2002.
- 2,569,089. MDS. INT. CLS. 16 AND 41. (U.S. CLS. 2, 5, 22, 23, 29, 37, 38, 50, 100, 101 AND 107). REG. 5-14-2002.
- 2,569,105. THE FAMOUS KING OF PIZZA. INT. CL. 30. (U.S. CL. 46). REG. 5-14-2002.
- 2,569,107. NOCATEE. INT. CL. 37. (U.S. CLS. 100, 103 AND 106). REG. 5-14-2002.
- 2,569,113. AROMA DOLCE. INT. CLS. 35 AND 42. (U.S. CLS. 100, 101 AND 102). REG. 5-14-2002.
- 2,569,129. LISA HO. INT. CLS. 18 AND 25 ONLY. (U.S. CLS. 1, 2, 3, 22, 39 AND 41). REG. 5-14-2002.

- 2,569,140. LCR ELECTRONICS, INC. AND DESIGN. INT. CL. 9. (U.S. CLS. 21, 23, 26, 36 AND 38). REG. 5-14-2002.
- 2,569,158. S AND DESIGN. INT. CLS. 35 AND 41. (U.S. CLS. 100, 101, 102 AND 107). REG. 5-14-2002.
- 2,569,239. KIEWIT. INT. CLS. 35 AND 37. (U.S. CLS. 100, 101, 102, 103 AND 106). REG. 5-14-2002.
- 2,569,251. LUMINOR. INT. CLS. 16, 18 AND 25 ONLY. (U.S. CLS. 1, 2, 3, 5, 22, 23, 29, 37, 38, 39, 41 AND 50). REG. 5-14-2002.
- 2,569,313. MERCY SHIPS. INT. CL. 41. (U.S. CLS. 100, 101 AND 107). REG. 5-14-2002.
- 2,569,328. VALVETRONIC. INT. CLS. 7, 9 AND 12. (U.S. CLS. 13, 19, 21, 23, 26, 31, 34, 35, 36, 38 AND 44). REG. 5-14-2002.
- 2,569,334. IMS. INT. CLS. 7 AND 16 ONLY. (U.S. CLS. 2, 5, 13, 19, 21, 22, 23, 29, 31, 34, 35, 37, 38 AND 50). REG. 5-14-2002.
- 2,569,357. WEBDEWEY. INT. CL. 41. (U.S. CLS. 100, 101 AND 107). REG. 5-14-2002.
- 2,569,366. HELLER. INT. CL. 7. (U.S. CLS. 13, 19, 21, 23, 31, 34 AND 35). REG. 5-14-2002.
- 2,569,377. ACREDULA. INT. CLS. 16 AND 42. (U.S. CLS. 2, 5, 22, 23, 29, 37, 38, 50, 100 AND 101). REG. 5-14-2002.
- 2,569,385. FLEXITIME. INT. CL. 5. (U.S. CLS. 6, 18, 44, 46, 51 AND 52). REG. 5-14-2002.
- 2,569,395. FARMERS THE FURNITURE STORE. INT. CL. 35. (U.S. CLS. 100, 101 AND 102). REG. 5-14-2002.
- 2,569,426. AQS. INT. CLS. 9 AND 42. (U.S. CLS. 21, 23, 26, 36, 38, 100 AND 101). REG. 5-14-2002.
- 2,569,430. THE FINANCIAL POLICE. INT. CL. 36. (U.S. CLS. 100, 101 AND 102). REG. 5-14-2002.
- 2,569,433. BONITA BAY AND DESIGN. INT. CL. 25. (U.S. CLS. 22 AND 39). REG. 5-14-2002.
- 2,569,440. PRINCE LORDON. INT. CL. 33. (U.S. CLS. 47 AND 49). REG. 5-14-2002.
- 2,569,441. H HOUSEWARES INTERNATIONAL INC. AND DESIGN. INT. CL. 21. (U.S. CLS. 2, 13, 23, 29, 30, 33, 40 AND 50). REG. 5-14-2002.
- 2,569,473. FAITHPOINT AND DESIGN. INT. CL. 35. (U.S. CLS. 100, 101 AND 102). REG. 5-14-2002.
- 2,569,491. NATIONAL INVITATION TOURNAMENT. INT. CL. 41. (U.S. CLS. 100, 101 AND 107). REG. 5-14-2002.
- 2,569,503. ENCOMPASS. INT. CL. 20. (U.S. CLS. 2, 13, 22, 25, 32 AND 50). REG. 5-14-2002.
- 2,569,534. MICROMINTS. INT. CL. 30. (U.S. CL. 46). REG. 5-14-2002.
- 2,569,551. DROOPY. INT. CL. 41. (U.S. CLS. 100, 101 AND 107). REG. 5-14-2002.
- 2,569,557. ACLASS. INT. CL. 42. (U.S. CLS. 100 AND 101). REG. 5-14-2002.
- 2,569,562. LUBE-4-LIFE (STYLIZED). INT. CLS. 1 AND 4. (U.S. CLS. 1, 5, 6, 10, 15, 26 AND 46). REG. 5-14-2002.
- 2,569,624. ENPORION. INT. CL. 35. (U.S. CLS. 100, 101 AND 102). REG. 5-14-2002.
- 2,569,625. WHITONE. INT. CL. 16. (U.S. CLS. 2, 5, 22, 23, 29, 37, 38 AND 50). REG. 5-14-2002.
- 2,569,631. WHEELER (STYLIZED). INT. CL. 14. (U.S. CLS. 2, 27, 28 AND 50). REG. 5-14-2002.
- 2,569,640. SOLVANON. INT. CL. 42. (U.S. CLS. 100 AND 101). REG. 5-14-2002.
- 2,569,669. THE STATE BAR OF CALIFORNIA LEX JULY 29TH 1927 AND DESIGN. INT. CL. 16. (U.S. CLS. 2, 5, 22, 23, 29, 37, 38 AND 50). REG. 5-14-2002.
- 2,569,674. COLLEGETOWN. INT. CL. 36. (U.S. CLS. 100, 101 AND 102). REG. 5-14-2002.
- 2,569,676. LITTLE BOOMEY. INT. CL. 33. (U.S. CLS. 47 AND 49). REG. 5-14-2002.
- 2,569,715. ATREX. INT. CL. 7. (U.S. CLS. 13, 19, 21, 23, 31, 34 AND 35). REG. 5-14-2002.
- 2,569,723. V (STYLIZED). INT. CLS. 18, 25 AND 28. (U.S. CLS. 1, 2, 3, 22, 23, 38, 39, 41 AND 50). REG. 5-14-2002.
- 2,569,726. CENTENNIAL AG SUPPLY CO.. INT. CL. 35. (U.S. CLS. 100, 101 AND 102). REG. 5-14-2002.
- 2,569,734. PRIMANTI BROTHERS PIZZA AND DESIGN. INT. CL. 42. (U.S. CLS. 100 AND 101). REG. 5-14-2002.
- 2,569,752. ULTRA PRECISE. INT. CL. 3. (U.S. CLS. 1, 4, 6, 50, 51 AND 52). REG. 5-14-2002.
- 2,569,755. PERFECTION FENCE. INT. CLS. 6 AND 19. (U.S. CLS. 1, 2, 12, 13, 14, 23, 25, 33 AND 50). REG. 5-14-2002.
- 2,569,756. PERFECTION FENCE AND DESIGN. INT. CLS. 6 AND 19. (U.S. CLS. 1, 2, 12, 13, 14, 23, 25, 33 AND 50). REG. 5-14-2002.
- 2,569,775. MISCELLANEOUS DESIGN. INT. CL. 16. (U.S. CLS. 2, 5, 22, 23, 29, 37, 38 AND 50). REG. 5-14-2002.
- 2,569,777. TB AND DESIGN. INT. CL. 16. (U.S. CLS. 2, 5, 22, 23, 29, 37, 38 AND 50). REG. 5-14-2002.
- 2,569,790. V. INT. CL. 1. (U.S. CLS. 1, 5, 6, 10, 26 AND 46). REG. 5-14-2002.
- 2,569,791. YOU CAN BE SURE... IF IT'S WESTINGHOUSE. INT. CL. 11. (U.S. CLS. 13, 21, 23, 31 AND 34). REG. 5-14-2002.
- 2,569,798. HOT OR NOT. INT. CL. 42. (U.S. CLS. 100 AND 101). REG. 5-14-2002.
- 2,569,850. FENCE CROWN. INT. CL. 19. (U.S. CLS. 1, 12, 33 AND 50). REG. 5-14-2002.
- 2,569,851. HOLLANDIA. INT. CL. 31. (U.S. CLS. 1 AND 46). REG. 5-14-2002.
- 2,569,898. ELECTROMARK AND DESIGN. INT. CL. 35. (U.S. CLS. 100, 101 AND 102). REG. 5-14-2002.
- 2,569,910. RELAXED SLEEP SURFACE. INT. CL. 20. (U.S. CLS. 2, 13, 22, 25, 32 AND 50). REG. 5-14-2002.
- 2,569,950. DESTINATION COLLEGE. INT. CL. 41. (U.S. CLS. 100, 101 AND 107). REG. 5-14-2002.
- 2,569,968. LA TOUR EIFFEL AND DESIGN. INT. CL. 18. (U.S. CLS. 1, 2, 3, 22 AND 41). REG. 5-14-2002.
- 2,569,976. AMERISPAN UNLIMITED THE BRIDGE BETWEEN CULTURES AND DESIGN. INT. CL. 41. (U.S. CLS. 100, 101 AND 107). REG. 5-14-2002.
- 2,570,013. THE SPRINGFIELD COLLECTION. INT. CL. 28. (U.S. CLS. 22, 23, 38 AND 50). REG. 5-14-2002.
- 2,570,027. INFOEL. INT. CL. 42. (U.S. CLS. 100 AND 101). REG. 5-14-2002.
- 2,570,037. MISCELLANEOUS DESIGN. INT. CL. 29. (U.S. CL. 46). REG. 5-14-2002.
- 2,570,042. MISCELLANEOUS DESIGN. INT. CL. 42. (U.S. CLS. 100 AND 101). REG. 5-14-2002.
- 2,570,053. MARKETING U. INT. CL. 35. (U.S. CLS. 100, 101 AND 102). REG. 5-14-2002.
- 2,570,084. HI-FRIES. INT. CL. 29. (U.S. CL. 46). REG. 5-14-2002.
- 2,570,105. AUTONOMY. INT. CL. 25. (U.S. CLS. 22 AND 39). REG. 5-14-2002.
- 2,570,119. POSE. INT. CLS. 35, 41 AND 42. (U.S. CLS. 100, 101, 102 AND 107). REG. 5-14-2002.
- 2,570,124. GLUTAPAK (STYLIZED). INT. CL. 5. (U.S. CLS. 6, 18, 44, 46, 51 AND 52). REG. 5-14-2002.
- 2,570,131. THE USAA EDUCATIONAL FOUNDATION WWW.USAAEDFOUNDATION.ORG AND DESIGN. INT. CLS. 9 AND 16. (U.S. CLS. 2, 5, 21, 22, 23, 26, 29, 36, 37, 38 AND 50). REG. 5-14-2002.
- 2,570,138. E AND DESIGN. INT. CL. 42. (U.S. CLS. 100 AND 101). REG. 5-14-2002.
- 2,570,157. LOGIXGURU. INT. CL. 42. (U.S. CLS. 100 AND 101). REG. 5-14-2002.
- 2,570,166. GETACTIVE. INT. CL. 42. (U.S. CLS. 100 AND 101). REG. 5-14-2002.
- 2,570,176. PACKET CLEARING HOUSE. INT. CLS. 41 AND 42. (U.S. CLS. 100, 101 AND 107). REG. 5-14-2002.
- 2,570,199. ARISTOTLEWEAR. INT. CL. 35. (U.S. CLS. 100, 101 AND 102). REG. 5-14-2002.
- 2,570,230. FLESH N BLOOD AND DESIGN. INT. CLS. 9 AND 41. (U.S. CLS. 21, 23, 26, 36, 38, 100, 101 AND 107). REG. 5-14-2002.
- 2,570,247. CLEAR BASE. INT. CL. 5. (U.S. CLS. 6, 18, 44, 46, 51 AND 52). REG. 5-14-2002.
- 2,570,302. ROTARY AND DESIGN. INT. CL. 7. (U.S. CLS. 13, 19, 21, 23, 31, 34 AND 35). REG. 5-14-2002.
- 2,570,314. AANNEWS. INT. CL. 16. (U.S. CLS. 2, 5, 22, 23, 29, 37, 38 AND 50). REG. 5-14-2002.
- 2,570,365. MISCELLANEOUS DESIGN. INT. CL. 25. (U.S. CLS. 22 AND 39). REG. 5-14-2002.
- 2,570,372. QVALE MODENA. INT. CL. 12. (U.S. CLS. 19, 21, 23, 31, 35 AND 44). REG. 5-14-2002.
- 2,570,381. PET STAR. INT. CL. 7. (U.S. CLS. 13, 19, 21, 23, 31, 34 AND 35). REG. 5-14-2002.
- 2,570,399. QUICK FIX. INT. CL. 10. (U.S. CLS. 26, 39 AND 44). REG. 5-14-2002.
- 2,570,410. SPACE GANG. INT. CL. 32. (U.S. CLS. 45, 46 AND 48). REG. 5-14-2002.

- 2,570,416. FIBERWAVE (STYLIZED). INT. CL. 9. (U.S. CLS. 21, 23, 26, 36 AND 38). REG. 5-14-2002.
- 2,570,448. AMPED. INT. CL. 9. (U.S. CLS. 21, 23, 26, 36 AND 38). REG. 5-14-2002.
- 2,570,493. POSI-LOCK. INT. CL. 9. (U.S. CLS. 21, 23, 26, 36 AND 38). REG. 5-21-2002.
- 2,570,563. QVF QUALITY VALUE FUN BIG DOGS AND DESIGN. INT. CL. 35. (U.S. CLS. 100, 101 AND 102). REG. 5-21-2002.
- 2,570,624. MICRONAS AND DESIGN. INT. CL. 9. (U.S. CLS. 21, 23, 26, 36 AND 38). REG. 5-21-2002.
- 2,570,641. ANGRY LITTLE ASIAN GIRL. INT. CLS. 16 AND 41. (U.S. CLS. 2, 5, 22, 23, 29, 37, 38, 50, 100, 101 AND 107). REG. 5-21-2002.
- 2,570,656. QUE BUENO! MEXICAN GRILLE AND DESIGN. INT. CL. 42. (U.S. CLS. 100 AND 101). REG. 5-21-2002.
- 2,570,690. NORTHEAST GARAGE DOOR SYSTEMS LLC WE'LLHELP YOUR DOORS THROUGH THEIR UPS AND DOWNS. INT. CL. 37. (U.S. CLS. 100, 103 AND 106). REG. 5-21-2002.
- 2,570,718. KRIS. INT. CL. 33. (U.S. CLS. 47 AND 49). REG. 5-21-2002.
- 2,570,722. FIZGIG. INT. CLS. 35 AND 42. (U.S. CLS. 100, 101 AND 102). REG. 5-21-2002.
- 2,570,761. INFOTERIA AND DESIGN. INT. CL. 9. (U.S. CLS. 21, 23, 26, 36 AND 38). REG. 5-21-2002.
- 2,570,801. ORGANIC ROOT STIMULATOR. INT. CL. 3. (U.S. CLS. 1, 4, 6, 50, 51 AND 52). REG. 5-21-2002.
- 2,570,815. SNAP SHOT. INT. CL. 28. (U.S. CLS. 22, 23, 38 AND 50). REG. 5-21-2002.
- 2,570,822. LYDIA HOUSE. INT. CL. 42. (U.S. CLS. 100 AND 101). REG. 5-21-2002.
- 2,570,865. MERCY SHIPS. INT. CL. 42. (U.S. CLS. 100 AND 101). REG. 5-21-2002.
- 2,570,911. MISCELLANEOUS DESIGN. INT. CL. 38. (U.S. CLS. 100, 101 AND 104). REG. 5-21-2002.
- 2,570,928. B BELLAGIO (STYLIZED). INT. CL. 41. (U.S. CLS. 100, 101 AND 107). REG. 5-21-2002.
- 2,570,954. BOUMATIC AND DESIGN. INT. CLS. 3, 4, 7, 9, 17 AND 20 ONLY. (U.S. CLS. 1, 2, 4, 5, 6, 12, 13, 15, 19, 21, 22, 23, 25, 26, 31, 32, 34, 35, 36, 38, 50, 51 AND 52). REG. 5-21-2002.
- 2,570,993. CREW WORKS. INT. CL. 37. (U.S. CLS. 100, 103 AND 106). REG. 5-21-2002.
- 2,570,994. THE CREW WORKS. INT. CL. 37. (U.S. CLS. 100, 103 AND 106). REG. 5-21-2002.
- 2,571,013. NY ENET AND DESIGN. INT. CL. 38. (U.S. CLS. 100, 101 AND 104). REG. 5-21-2002.
- 2,571,025. TRANSHIELD. INT. CL. 16. (U.S. CLS. 2, 5, 22, 23, 29, 37, 38 AND 50). REG. 5-21-2002.
- 2,571,031. LIFESKILLS AND DESIGN. INT. CL. 41. (U.S. CLS. 100, 101 AND 107). REG. 5-21-2002.
- 2,571,063. MISCELLANEOUS DESIGN. INT. CL. 9. (U.S. CLS. 21, 23, 26, 36 AND 38). REG. 5-21-2002.
- 2,571,076. ARC AND DESIGN. INT. CL. 42. (U.S. CLS. 100 AND 101). REG. 5-21-2002.
- 2,571,151. SAPPHIRE BLUE. INT. CL. 3. (U.S. CLS. 1, 4, 6, 50, 51 AND 52). REG. 5-21-2002.
- 2,571,183. X MINE. INT. CL. 12. (U.S. CLS. 19, 21, 23, 31, 35 AND 44). REG. 5-21-2002.
- 2,571,196. LECTORA. INT. CL. 9. (U.S. CLS. 21, 23, 26, 36 AND 38). REG. 5-21-2002.
- 2,571,248. BRING BACK BAG. INT. CL. 16. (U.S. CLS. 2, 5, 22, 23, 29, 37, 38 AND 50). REG. 5-21-2002.
- 2,571,271. PEACEBIKE. INT. CL. 41. (U.S. CLS. 100, 101 AND 107). REG. 5-21-2002.
- 2,571,288. ELDERSHARING. INT. CL. 41. (U.S. CLS. 100, 101 AND 107). REG. 5-21-2002.
- 2,571,312. COME FLEA WITH ME. INT. CL. 42. (U.S. CLS. 100 AND 101). REG. 5-21-2002.
- 2,571,314. DRI-FIT. INT. CLS. 25 AND 28. (U.S. CLS. 22, 23, 38, 39 AND 50). REG. 5-21-2002.
- 2,571,329. SPA BLENDS. INT. CL. 3. (U.S. CLS. 1, 4, 6, 50, 51 AND 52). REG. 5-21-2002.
- 2,571,341. DATAVOX. INT. CL. 41. (U.S. CLS. 100, 101 AND 107). REG. 5-21-2002.
- 2,571,362. DANGER MEN DRINKING. INT. CL. 21. (U.S. CLS. 2, 13, 23, 29, 30, 33, 40 AND 50). REG. 5-21-2002.
- 2,571,434. SAWTOOTH. INT. CL. 32. (U.S. CLS. 45, 46 AND 48). REG. 5-21-2002.
- 2,571,435. MAD BISHOP. INT. CL. 32. (U.S. CLS. 45, 46 AND 48). REG. 5-21-2002.
- 2,571,439. STORM KING. INT. CL. 32. (U.S. CLS. 45, 46 AND 48). REG. 5-21-2002.
- 2,571,455. FENCETECH. INT. CL. 35. (U.S. CLS. 100, 101 AND 102). REG. 5-21-2002.
- 2,571,473. HYDRO-REZ. INT. CL. 1. (U.S. CLS. 1, 5, 6, 10, 26 AND 46). REG. 5-21-2002.
- 2,571,534. DUAL DENSITY. INT. CL. 10. (U.S. CLS. 26, 39 AND 44). REG. 5-21-2002.
- 2,571,563. 1-800-GET-LENS. INT. CL. 35. (U.S. CLS. 100, 101 AND 102). REG. 5-21-2002.
- 2,571,576. 4MYHEART. INT. CL. 42. (U.S. CLS. 100 AND 101). REG. 5-21-2002.
- 2,571,731. UNDERSTANDING BY DESIGN. INT. CL. 42. (U.S. CLS. 100 AND 101). REG. 5-21-2002.
- 2,571,755. TWIN TUSK LENG HENG BRAND TRADEMARK AND DESIGN. INT. CLS. 29 AND 30. (U.S. CL. 46). REG. 5-21-2002.
- 2,571,779. MORANGAK- RESTAURANT AND DESIGN. INT. CL. 42. (U.S. CLS. 100 AND 101). REG. 5-21-2002.
- 2,571,795. NINE WEST. INT. CLS. 1, 3 AND 21. (U.S. CLS. 1, 2, 4, 5, 6, 10, 13, 23, 26, 29, 30, 33, 40, 46, 50, 51 AND 52). REG. 5-21-2002.
- 2,571,815. PULTRU. INT. CL. 1. (U.S. CLS. 1, 5, 6, 10, 26 AND 46). REG. 5-21-2002.
- 2,571,916. 3DSMART. INT. CL. 9. (U.S. CLS. 21, 23, 26, 36 AND 38). REG. 5-21-2002.
- 2,571,928. GENERATIONS FINANCIAL ADVISORS AND DESIGN. INT. CL. 36. (U.S. CLS. 100, 101 AND 102). REG. 5-21-2002.
- 2,571,935. AQUA PLY. INT. CL. 19. (U.S. CLS. 1, 12, 33 AND 50). REG. 5-21-2002.
- 2,571,936. AQUA PLY PLUS. INT. CL. 19. (U.S. CLS. 1, 12, 33 AND 50). REG. 5-21-2002.
- 2,571,962. CONTRACTORS HEAVEN. INT. CL. 35. (U.S. CLS. 100, 101 AND 102). REG. 5-21-2002.
- 2,572,064. WRITING ON THE WALL. INT. CL. 37. (U.S. CLS. 100, 103 AND 106). REG. 5-21-2002.
- 2,572,088. INTACS (STYLIZED). INT. CL. 10. (U.S. CLS. 26, 39 AND 44). REG. 5-21-2002.
- 2,572,136. BOXXI. INT. CL. 28. (U.S. CLS. 22, 23, 38 AND 50). REG. 5-21-2002.
- 2,572,151. SAFE BASE. INT. CL. 36. (U.S. CLS. 100, 101 AND 102). REG. 5-21-2002.
- 2,572,279. FLOORWASH. INT. CL. 3. (U.S. CLS. 1, 4, 6, 50, 51 AND 52). REG. 5-21-2002.
- 2,572,309. FIRST STORIES. INT. CL. 16. (U.S. CLS. 2, 5, 22, 23, 29, 37, 38 AND 50). REG. 5-21-2002.
- 2,572,349. DYNAMIC PERFORMANCE. INT. CL. 7. (U.S. CLS. 13, 19, 21, 23, 31, 34 AND 35). REG. 5-21-2002.
- 2,572,410. AMERICA'S FAVORITE COOKIE. INT. CL. 30. (U.S. CL. 46). REG. 5-21-2002.
- 2,572,517. TAKE CONTROL. INT. CL. 12. (U.S. CLS. 19, 21, 23, 31, 35 AND 44). REG. 5-28-2002.
- 2,572,558. MARLIT. INT. CL. 19. (U.S. CLS. 1, 12, 33 AND 50). REG. 5-28-2002.
- 2,572,710. QUICKEN. INT. CL. 16. (U.S. CLS. 2, 5, 22, 23, 29, 37, 38 AND 50). REG. 5-28-2002.
- 2,572,905. FOR EYES DIRECT. INT. CL. 35. (U.S. CLS. 100, 101 AND 102). REG. 5-28-2002.
- 2,572,977. ICPLATE. INT. CL. 9. (U.S. CLS. 21, 23, 26, 36 AND 38). REG. 5-28-2002.
- 2,573,149. REZI. INT. CL. 3. (U.S. CLS. 1, 4, 6, 50, 51 AND 52). REG. 5-28-2002.
- 2,573,186. NYSTAR AND DESIGN. INT. CLS. 35, 36 AND 42. (U.S. CLS. 100, 101 AND 102). REG. 5-28-2002.
- 2,573,193. COFFIN CASE. INT. CL. 15. (U.S. CLS. 2, 21 AND 36). REG. 5-28-2002.
- 2,573,200. THE COLLECTED WORKS OF WATCHMAN NEE. INT. CL. 16. (U.S. CLS. 2, 5, 22, 23, 29, 37, 38 AND 50). REG. 5-28-2002.
- 2,573,230. THE STATE BAR OF CALIFORNIA. INT. CL. 16. (U.S. CLS. 2, 5, 22, 23, 29, 37, 38 AND 50). REG. 5-28-2002.
- 2,573,255. TRIM SPA. INT. CL. 5. (U.S. CLS. 6, 18, 44, 46, 51 AND 52). REG. 5-28-2002.
- 2,573,295. VISIWARE. INT. CLS. 9 AND 41. (U.S. CLS. 21, 23, 26, 36, 38, 100, 101 AND 107). REG. 5-28-2002.
- 2,573,302. OXINET. INT. CL. 9. (U.S. CLS. 21, 23, 26, 36 AND 38). REG. 5-28-2002.
- 2,573,339. YOUNG PERSON'S SCHOOL OF MAGIC AND MYSTERY. INT. CL. 16. (U.S. CLS. 2, 5, 22, 23, 29, 37, 38 AND 50). REG. 5-28-2002.

- 2,573,354. L. INT. CL. 1. (U.S. CLS. 1, 5, 6, 10, 26 AND 46). REG. 5-28-2002.
- 2,573,409. NAAREF. INT. CL. 42. (U.S. CLS. 100 AND 101). REG. 5-28-2002.
- 2,573,485. MARK 7 CUSTOM SYSTEMS. INT. CL. 11. (U.S. CLS. 13, 21, 23, 31 AND 34). REG. 5-28-2002.
- 2,573,506. WHEATRIX. INT. CL. 1. (U.S. CLS. 1, 5, 6, 10, 26 AND 46). REG. 5-28-2002.
- 2,573,629. SAVE-N-SYNC. INT. CL. 9. (U.S. CLS. 21, 23, 26, 36 AND 38). REG. 5-28-2002.
- 2,573,709. ERICA LYONS. INT. CL. 14. (U.S. CLS. 2, 27, 28 AND 50). REG. 5-28-2002.
- 2,573,786. ATLAS SOUND. INT. CL. 9. (U.S. CLS. 21, 23, 26, 36 AND 38). REG. 5-28-2002.
- 2,573,849. MOLteni (STYLIZED). INT. CL. 25. (U.S. CLS. 22 AND 39). REG. 5-28-2002.
- 2,573,921. SUPERCAT (STYLIZED). INT. CL. 9. (U.S. CLS. 21, 23, 26, 36 AND 38). REG. 5-28-2002.
- 2,573,929. SUPERSTRATEGY. INT. CL. 41. (U.S. CLS. 100, 101 AND 107). REG. 5-28-2002.
- 2,573,992. G MATERIALS. INT. CL. 9. (U.S. CLS. 21, 23, 26, 36 AND 38). REG. 5-28-2002.
- 2,574,026. BOTTOM LINE HEALTH. INT. CL. 42. (U.S. CLS. 100 AND 101). REG. 5-28-2002.
- 2,574,047. ACTIVEANSWERS. INT. CL. 42 ONLY. (U.S. CLS. 100 AND 101). REG. 5-28-2002.
- 2,574,081. EXTREME PITA. INT. CLS. 35 AND 42. (U.S. CLS. 100, 101 AND 102). REG. 5-28-2002.
- 2,574,118. RAPIDOCs. INT. CL. 9. (U.S. CLS. 21, 23, 26, 36 AND 38). REG. 5-28-2002.
- 2,574,120. POINTING YOU TO POSSIBILITIES. INT. CLS. 35 AND 41 ONLY. (U.S. CLS. 100, 101, 102 AND 107). REG. 5-28-2002.
- 2,574,147. APPS-ON-TAP. INT. CL. 42 ONLY. (U.S. CLS. 100 AND 101). REG. 5-28-2002.
- 2,574,257. IRGAGUARD. INT. CL. 5. (U.S. CLS. 6, 18, 44, 46, 51 AND 52). REG. 5-28-2002.
- 2,574,311. GUARDSERVER. INT. CL. 9. (U.S. CLS. 21, 23, 26, 36 AND 38). REG. 5-28-2002.
- 2,574,319. MISCELLANEOUS DESIGN. INT. CL. 20. (U.S. CLS. 2, 13, 22, 25, 32 AND 50). REG. 5-28-2002.
- 2,574,342. MULTI ASSET MULTI STYLE MULTI MANAGER. INT. CL. 36. (U.S. CLS. 100, 101 AND 102). REG. 5-28-2002.
- 2,574,352. PLAYS SO SMART SOUNDS SO REAL. INT. CL. 28. (U.S. CLS. 22, 23, 38 AND 50). REG. 5-28-2002.
- 2,574,376. CHIQUITA. INT. CL. 39. (U.S. CLS. 100 AND 105). REG. 5-28-2002.
- 2,574,421. TEAM ALL PURPOSE STANDARD CHARACTER MARK. INT. CL. 30. (U.S. CL. 46). REG. 5-28-2002.
- 2,574,538. SQUARE ONE RECORDS. INT. CL. 9. (U.S. CLS. 21, 23, 26, 36 AND 38). REG. 5-28-2002.
- 2,574,555. MOTIV. INT. CL. 21. (U.S. CLS. 2, 13, 23, 29, 30, 33, 40 AND 50). REG. 5-28-2002.
- 2,574,693. MOLECULAR AND CELLULAR PROTEOMICS. INT. CL. 16. (U.S. CLS. 2, 5, 22, 23, 29, 37, 38 AND 50). REG. 5-28-2002.
- 2,574,701. COAL-BINDER. INT. CL. 1. (U.S. CLS. 1, 5, 6, 10, 26 AND 46). REG. 5-28-2002.
- 2,574,704. THE #1 GLOVE IN FIRE. INT. CL. 9. (U.S. CLS. 21, 23, 26, 36 AND 38). REG. 5-28-2002.
- 2,574,742. KEY WEST OLD TOWN ROAST. INT. CL. 30. (U.S. CL. 46). REG. 5-28-2002.
- 2,574,883. MISCELLANEOUS DESIGN. INT. CL. 9. (U.S. CLS. 21, 23, 26, 36 AND 38). REG. 6-4-2002.
- 2,575,082. SUNBOARD. INT. CL. 11. (U.S. CLS. 13, 21, 23, 31 AND 34). REG. 6-4-2002.
- 2,575,155. EDUCAUSE REVIEW. INT. CLS. 16 AND 42. (U.S. CLS. 2, 5, 22, 23, 29, 37, 38, 50, 100 AND 101). REG. 6-4-2002.
- 2,575,247. POINTING THE WAY. INT. CLS. 36 AND 42. (U.S. CLS. 100, 101 AND 102). REG. 6-4-2002.
- 2,575,349. SOUTHWEST CHOICE. INT. CL. 31. (U.S. CLS. 1 AND 46). REG. 6-4-2002.
- 2,575,504. WSJ.COM. INT. CL. 42. (U.S. CLS. 100 AND 101). REG. 6-4-2002.
- 2,575,505. WSJ.COM. INT. CL. 35. (U.S. CLS. 100, 101 AND 102). REG. 6-4-2002.
- 2,575,582. SAN JUAN POOLS AND DESIGN. INT. CLS. 19 AND 37. (U.S. CLS. 1, 12, 33, 50, 100, 103 AND 106). REG. 6-4-2002.
- 2,575,610. IU (STYLIZED). INT. CL. 25. (U.S. CLS. 22 AND 39). REG. 6-4-2002.
- 2,575,804. DIRECT ADVANTAGE. INT. CL. 36. (U.S. CLS. 100, 101 AND 102). REG. 6-4-2002.
- 2,576,358. CREDIT UNION AUTO BUYING SERVICE & DESIGN AND DESIGN. INT. CLS. 35 AND 36. (U.S. CLS. 100, 101 AND 102). REG. 6-4-2002.
- 2,576,406. M5. INT. CL. 12. (U.S. CLS. 19, 21, 23, 31, 35 AND 44). REG. 6-4-2002.
- 2,576,555. INSTAXML. INT. CL. 9. (U.S. CLS. 21, 23, 26, 36 AND 38). REG. 6-4-2002.
- 2,576,556. INSTAHTML. INT. CL. 9. (U.S. CLS. 21, 23, 26, 36 AND 38). REG. 6-4-2002.
- 2,576,557. PROFECTIV. INT. CL. 3. (U.S. CLS. 1, 4, 6, 50, 51 AND 52). REG. 6-4-2002.
- 2,576,689. CHICK 'N CRISP. INT. CL. 30. (U.S. CL. 46). REG. 6-4-2002.
- 2,576,720. AN INTERNET OF THE PEOPLE, BY THE PEOPLE, FOR THE PEOPLE. INT. CL. 35. (U.S. CLS. 100, 101 AND 102). REG. 6-4-2002.
- 2,576,753. EVERYDAY LUXURIES. INT. CL. 24. (U.S. CLS. 42 AND 50). REG. 6-4-2002.
- 2,576,849. ADVANCES IN SKIN AND WOUND CARE. INT. CL. 16. (U.S. CLS. 2, 5, 22, 23, 29, 37, 38 AND 50). REG. 6-4-2002.
- 2,576,874. MISCELLANEOUS DESIGN. INT. CL. 14. (U.S. CLS. 2, 27, 28 AND 50). REG. 6-4-2002.
- 2,576,932. MAX C.A.P. AND DESIGN. INT. CL. 17. (U.S. CLS. 1, 5, 12, 13, 35 AND 50). REG. 6-11-2002.
- 2,576,989. SEAFOAM TOURMALINE. INT. CL. 14. (U.S. CLS. 2, 27, 28 AND 50). REG. 6-11-2002.
- 2,577,149. BEST WELDS. INT. CLS. 6 AND 9. (U.S. CLS. 2, 12, 13, 14, 21, 23, 25, 26, 36, 38 AND 50). REG. 6-11-2002.
- 2,577,365. DAYMARK. INT. CL. 40. (U.S. CLS. 100, 103 AND 106). REG. 6-11-2002.
- 2,577,386. MSRA. INT. CL. 42. (U.S. CLS. 100 AND 101). REG. 6-11-2002.
- 2,577,594. NIT. INT. CL. 41. (U.S. CLS. 100, 101 AND 107). REG. 6-11-2002.
- 2,577,817. ALAMO CAFE TORTILLA FACTORY AND DESIGN. INT. CL. 42. (U.S. CLS. 100 AND 101). REG. 6-11-2002.
- 2,577,831. RICHMOND INTERNATIONAL RACEWAY. INT. CL. 25. (U.S. CLS. 22 AND 39). REG. 6-11-2002.
- 2,577,919. PEERLESS FENCE. INT. CL. 37. (U.S. CLS. 100, 103 AND 106). REG. 6-11-2002.
- 2,577,941. FATS OF LIFE AND DESIGN. INT. CL. 16. (U.S. CLS. 2, 5, 22, 23, 29, 37, 38 AND 50). REG. 6-11-2002.
- 2,578,001. BASS & HAYS. INT. CL. 6. (U.S. CLS. 2, 12, 13, 14, 23, 25 AND 50). REG. 6-11-2002.
- 2,578,017. ORLANDO TOURISM BUREAU. INT. CL. 35. (U.S. CLS. 100, 101 AND 102). REG. 6-11-2002.
- 2,578,052. FRAMING WIZARD. INT. CL. 9. (U.S. CLS. 21, 23, 26, 36 AND 38). REG. 6-11-2002.
- 2,578,055. SIGNATURE. INT. CL. 15. (U.S. CLS. 2, 21 AND 36). REG. 6-11-2002.
- 2,578,176. TAFFORD. INT. CL. 35. (U.S. CLS. 100, 101 AND 102). REG. 6-11-2002.
- 2,578,180. HEAL THE BAY AND DESIGN. INT. CLS. 25 AND 42. (U.S. CLS. 22, 39, 100 AND 101). REG. 6-11-2002.
- 2,578,211. HYDEX. INT. CL. 8. (U.S. CLS. 23, 28 AND 44). REG. 6-11-2002.
- 2,578,278. ESTATE PLANNING SUCCESS. INT. CLS. 16 AND 41. (U.S. CLS. 2, 5, 22, 23, 29, 37, 38, 50, 100, 101 AND 107). REG. 6-11-2002.
- 2,578,310. PHYTO-PLUS NUTRA-GREEN 5-10-5. INT. CL. 1. (U.S. CLS. 1, 5, 6, 10, 26 AND 46). REG. 6-11-2002.
- 2,578,313. HELIXCHANGER. INT. CL. 11. (U.S. CLS. 13, 21, 23, 31 AND 34). REG. 6-11-2002.
- 2,578,370. ELLISON'S AND DESIGN. INT. CL. 31. (U.S. CLS. 1 AND 46). REG. 6-11-2002.
- 2,578,371. WHERE QUALITY IS A DEEP ROOTED TRADITION. INT. CL. 31. (U.S. CLS. 1 AND 46). REG. 6-11-2002.
- 2,578,430. YOU ARE WHAT YOU DO WITH YOUR MIND. INT. CL. 42. (U.S. CLS. 100 AND 101). REG. 6-11-2002.
- 2,578,692. SUPER SMASH BROS.. INT. CL. 9. (U.S. CLS. 21, 23, 26, 36 AND 38). REG. 6-11-2002.
- 2,578,694. INTERMAS. INT. CLS. 16 AND 22. (U.S. CLS. 1, 2, 5, 7, 19, 22, 23, 29, 37, 38, 42 AND 50). REG. 6-11-2002.

- 2,578,844. VIRTUAL JUSTICE. INT. CL. 9. (U.S. CLS. 21, 23, 26, 36 AND 38). REG. 6-11-2002.
- 2,578,867. ENCHANTED WOODS. INT. CL. 41. (U.S. CLS. 100, 101 AND 107). REG. 6-11-2002.
- 2,578,893. LA CAR. INT. CL. 42. (U.S. CLS. 100 AND 101). REG. 6-11-2002.
- 2,578,996. SPIKESHIELD AND DESIGN. INT. CL. 9. (U.S. CLS. 21, 23, 26, 36 AND 38). REG. 6-11-2002.
- 2,579,009. LIFTMASTER. INT. CLS. 6, 22 AND 37 ONLY. (U.S. CLS. 1, 2, 7, 12, 13, 14, 19, 22, 23, 25, 42, 50, 100, 103 AND 106). REG. 6-11-2002.
- 2,579,050. T36-C5. INT. CL. 5. (U.S. CLS. 6, 18, 44, 46, 51 AND 52). REG. 6-11-2002.
- 2,579,093. MISCELLANEOUS DESIGN. INT. CL. 30. (U.S. CL. 46). REG. 6-11-2002.
- 2,579,149. CHEVYS EXPRESS MEX AND DESIGN. INT. CL. 42. (U.S. CLS. 100 AND 101). REG. 6-11-2002.
- 2,579,190. SUPREME COURT. INT. CL. 16. (U.S. CLS. 2, 5, 22, 23, 29, 37, 38 AND 50). REG. 6-11-2002.
- 2,579,206. STI SUCCESS TEAM INTERNATIONAL MAKING DREAMS A REALITY AND DESIGN. INT. CLS. 9 AND 41. (U.S. CLS. 21, 23, 26, 36, 38, 100, 101 AND 107). REG. 6-11-2002.
- 2,579,365. AB ELITE. INT. CL. 6. (U.S. CLS. 2, 12, 13, 14, 23, 25 AND 50). REG. 6-11-2002.
- 2,579,453. INTERNET PROMISE GROUP. INT. CL. 35. (U.S. CLS. 100, 101 AND 102). REG. 6-11-2002.
- 2,579,724. PAUL-SON FX. INT. CL. 40. (U.S. CLS. 100, 103 AND 106). REG. 6-11-2002.
- 2,579,800. CAMOFLEX. INT. CL. 16. (U.S. CLS. 2, 5, 22, 23, 29, 37, 38 AND 50). REG. 6-11-2002.
- 2,580,044. SAFETYCRAFT. INT. CL. 20. (U.S. CLS. 2, 13, 22, 25, 32 AND 50). REG. 6-11-2002.
- 2,580,057. PRAWDUCT AND DESIGN. INT. CL. 3. (U.S. CLS. 1, 4, 6, 50, 51 AND 52). REG. 6-11-2002.
- 2,580,104. GOLDHEN. INT. CL. 29. (U.S. CL. 46). REG. 6-11-2002.
- 2,580,176. HIT PARADE. INT. CL. 42. (U.S. CLS. 100 AND 101). REG. 6-11-2002.
- 2,580,214. BOUNCE BLOCKER. INT. CL. 36. (U.S. CLS. 100, 101 AND 102). REG. 6-11-2002.
- 2,580,225. ACTION GRIP. INT. CL. 28. (U.S. CLS. 22, 23, 38 AND 50). REG. 6-11-2002.
- 2,580,469. ORIGINAL PEBBLE PATTERN. INT. CL. 21. (U.S. CLS. 2, 13, 23, 29, 30, 33, 40 AND 50). REG. 6-11-2002.
- 2,580,479. BEST ON THE STREET. INT. CL. 16. (U.S. CLS. 2, 5, 22, 23, 29, 37, 38 AND 50). REG. 6-11-2002.
- 2,580,508. QWIKSCAN. INT. CL. 9. (U.S. CLS. 21, 23, 26, 36 AND 38). REG. 6-18-2002.
- 2,580,536. OH! NUTS. INT. CL. 35. (U.S. CLS. 100, 101 AND 102). REG. 6-18-2002.
- 2,580,611. CLIMAX. INT. CL. 3. (U.S. CLS. 1, 4, 6, 50, 51 AND 52). REG. 6-18-2002.
- 2,580,673. MISCELLANEOUS DESIGN. INT. CLS. 9, 16, 35 AND 42. (U.S. CLS. 2, 5, 21, 22, 23, 26, 29, 36, 37, 38, 50, 100, 101 AND 102). REG. 6-18-2002.
- 2,580,693. VTC. INT. CL. 7. (U.S. CLS. 13, 19, 21, 23, 31, 34 AND 35). REG. 6-18-2002.
- 2,580,887. YUMMY. INT. CL. 42. (U.S. CLS. 100 AND 101). REG. 6-18-2002.
- 2,581,071. DICK CEPEK. INT. CL. 12. (U.S. CLS. 19, 21, 23, 31, 35 AND 44). REG. 6-18-2002.
- 2,581,103. THE DEVA METHOD. INT. CL. 41. (U.S. CLS. 100, 101 AND 107). REG. 6-18-2002.
- 2,581,174. KITCHEN CONSERVATORY. INT. CLS. 35 AND 41. (U.S. CLS. 100, 101, 102 AND 107). REG. 6-18-2002.
- 2,581,314. RIDERWEARHOUSE. INT. CL. 35. (U.S. CLS. 100, 101 AND 102). REG. 6-18-2002.
- 2,581,373. MEGATREK. INT. CL. 12. (U.S. CLS. 19, 21, 23, 31, 35 AND 44). REG. 6-18-2002.
- 2,581,432. GUY GRAY MANUFACTURING COMPANY, INC.. INT. CL. 11. (U.S. CLS. 13, 21, 23, 31 AND 34). REG. 6-18-2002.
- 2,581,471. AMERICAN COLLEGE OF VETERINARY BEHAVIORISTS AND DESIGN. U.S. CL. 200. REG. 6-18-2002.
- 2,581,513. LABOR ONE, INC.. INT. CL. 35. (U.S. CLS. 100, 101 AND 102). REG. 6-18-2002.
- 2,581,525. CASES2GO (STYLIZED). INT. CL. 18. (U.S. CLS. 1, 2, 3, 22 AND 41). REG. 6-18-2002.
- 2,581,638. SIGNATURE (STYLIZED). INT. CL. 15. (U.S. CLS. 2, 21 AND 36). REG. 6-18-2002.
- 2,581,764. M. D. ANDERSON CANCER CENTER ORLANDO. INT. CLS. 41 AND 42. (U.S. CLS. 100, 101 AND 107). REG. 6-18-2002.
- 2,581,946. AMERICA'S HEALTHIEST WEB SITE. INT. CL. 35. (U.S. CLS. 100, 101 AND 102). REG. 6-18-2002.
- 2,582,303. QCFSSBO. INT. CL. 35. (U.S. CLS. 100, 101 AND 102). REG. 6-18-2002.
- 2,582,429. WONDER SLIM. INT. CL. 5. (U.S. CLS. 6, 18, 44, 46, 51 AND 52). REG. 6-18-2002.
- 2,582,447. GREEN TEA PLUS. INT. CL. 5. (U.S. CLS. 6, 18, 44, 46, 51 AND 52). REG. 6-18-2002.
- 2,582,460. CHOLESTAME. INT. CL. 5. (U.S. CLS. 6, 18, 44, 46, 51 AND 52). REG. 6-18-2002.
- 2,582,793. EYECOM. INT. CL. 38. (U.S. CLS. 100, 101 AND 104). REG. 6-18-2002.
- 2,582,830. RESOLUTION. INT. CL. 15. (U.S. CLS. 2, 21 AND 36). REG. 6-18-2002.
- 2,582,867. GAROTO AND DESIGN. INT. CL. 30. (U.S. CL. 46). REG. 6-18-2002.
- 2,583,017. FIRST RATE. INT. CL. 31. (U.S. CLS. 1 AND 46). REG. 6-18-2002.
- 2,583,175. EQUIP. INT. CL. 12. (U.S. CLS. 19, 21, 23, 31, 35 AND 44). REG. 6-18-2002.
- 2,583,267. 1-800-BE4-U-TOW. INT. CLS. 35 AND 37. (U.S. CLS. 100, 101, 102, 103 AND 106). REG. 6-18-2002.
- 2,583,319. RACK SENTRY AND DESIGN. INT. CL. 17. (U.S. CLS. 1, 5, 12, 13, 35 AND 50). REG. 6-18-2002.
- 2,583,441. METZ FRESH. INT. CL. 31. (U.S. CLS. 1 AND 46). REG. 6-18-2002.
- 2,583,532. LOVE THAT SHINE. INT. CL. 3. (U.S. CLS. 1, 4, 6, 50, 51 AND 52). REG. 6-18-2002.
- 2,583,533. SHINE BOOSTER. INT. CL. 3. (U.S. CLS. 1, 4, 6, 50, 51 AND 52). REG. 6-18-2002.
- 2,583,617. TURBO RIG. INT. CL. 28. (U.S. CLS. 22, 23, 38 AND 50). REG. 6-18-2002.
- 2,583,648. NEUTROGENA CLEAN VOLUME. INT. CL. 3. (U.S. CLS. 1, 4, 6, 50, 51 AND 52). REG. 6-18-2002.
- 2,583,863. FACILITYFORECAST. INT. CL. 9. (U.S. CLS. 21, 23, 26, 36 AND 38). REG. 6-18-2002.
- 2,584,146. WILSON AUDIO (STYLIZED). INT. CL. 9. (U.S. CLS. 21, 23, 26, 36 AND 38). REG. 6-25-2002.
- 2,584,173. PYROCERAM. INT. CL. 21. (U.S. CLS. 2, 13, 23, 29, 30, 33, 40 AND 50). REG. 6-25-2002.
- 2,584,427. MISCELLANEOUS DESIGN. INT. CL. 45. (U.S. CLS. 100 AND 101). REG. 6-25-2002.
- 2,584,450. TRU-COOL. INT. CL. 7. (U.S. CLS. 13, 19, 21, 23, 31, 34 AND 35). REG. 6-25-2002.
- 2,584,477. A 7 (STYLIZED). INT. CL. 35. (U.S. CLS. 100, 101 AND 102). REG. 6-25-2002.
- 2,584,482. MSRA MINNESOTA STREET ROD ASSOCIATION AND DESIGN. INT. CL. 42. (U.S. CLS. 100 AND 101). REG. 6-25-2002.
- 2,585,174. S.T.A.R. TECH.. INT. CL. 41. (U.S. CLS. 100, 101 AND 107). REG. 6-25-2002.
- 2,585,310. PRIMARE. INT. CL. 9. (U.S. CLS. 21, 23, 26, 36 AND 38). REG. 6-25-2002.
- 2,585,545. AIR SCENSE. INT. CL. 5. (U.S. CLS. 6, 18, 44, 46, 51 AND 52). REG. 6-25-2002.
- 2,585,985. LAZER JEANS. INT. CL. 25. (U.S. CLS. 22 AND 39). REG. 6-25-2002.
- 2,586,044. SUPERSPEED. INT. CLS. 9 AND 16. (U.S. CLS. 2, 5, 21, 22, 23, 26, 29, 36, 37, 38 AND 50). REG. 6-25-2002.
- 2,586,495. DISKLAVIER. INT. CLS. 9 AND 15. (U.S. CLS. 2, 21, 23, 26, 36 AND 38). REG. 6-25-2002.
- 2,586,811. PIPE-LIFT. INT. CL. 7. (U.S. CLS. 13, 19, 21, 23, 31, 34 AND 35). REG. 6-25-2002.
- 2,586,864. DOUBLE EYE. INT. CL. 26. (U.S. CLS. 37, 39, 40, 42 AND 50). REG. 6-25-2002.
- 2,587,356. RIBS AND DESIGN. INT. CL. 8. (U.S. CLS. 23, 28 AND 44). REG. 7-2-2002.
- 2,587,524. RICH (STYLIZED). INT. CL. 31. (U.S. CLS. 1 AND 46). REG. 7-2-2002.
- 2,587,880. PUR-FECT LOK. INT. CL. 1. (U.S. CLS. 1, 5, 6, 10, 26 AND 46). REG. 7-2-2002.
- 2,588,024. GRANT. INT. CLS. 35, 37 AND 42. (U.S. CLS. 100, 101, 102, 103 AND 106). REG. 7-2-2002.
- 2,588,204. MTSU. INT. CLS. 25 AND 41. (U.S. CLS. 22, 39, 100, 101 AND 107). REG. 7-2-2002.
- 2,588,481. LEGENDARY CUTS. INT. CL. 16. (U.S. CLS. 2, 5, 22, 23, 29, 37, 38 AND 50). REG. 7-2-2002.
- 2,588,627. LAW & ORDER: SPECIAL VICTIMS UNIT. INT. CL. 41. (U.S. CLS. 100, 101 AND 107). REG. 7-2-2002.

- 2,588,691. HEALTHFINDER TV. INT. CL. 41. (U.S. CLS. 100, 101 AND 107). REG. 7-2-2002.
- 2,589,121. MISCELLANEOUS DESIGN. INT. CL. 41. (U.S. CLS. 100, 101 AND 107). REG. 7-2-2002.
- 2,589,207. PHOENIX. INT. CL. 10. (U.S. CLS. 26, 39 AND 44). REG. 7-2-2002.
- 2,589,213. SKYHAWK. INT. CL. 14. (U.S. CLS. 2, 27, 28 AND 50). REG. 7-2-2002.
- 2,589,230. INSTASERVE. INT. CL. 9. (U.S. CLS. 21, 23, 26, 36 AND 38). REG. 7-2-2002.
- 2,589,300. OTTIMINO. INT. CL. 33. (U.S. CLS. 47 AND 49). REG. 7-2-2002.
- 2,589,431. NEURO-PS. INT. CL. 5. (U.S. CLS. 6, 18, 44, 46, 51 AND 52). REG. 7-2-2002.
- 2,589,433. CHIQUITA AND DESIGN. INT. CL. 39. (U.S. CLS. 100 AND 105). REG. 7-2-2002.
- 2,589,649. WORLD WIDE REPUTATION. INT. CL. 35. (U.S. CLS. 100, 101 AND 102). REG. 7-2-2002.
- 2,589,794. THAT TAKES OVARIES!. INT. CL. 41. (U.S. CLS. 100, 101 AND 107). REG. 7-2-2002.
- 2,589,801. SORINE. INT. CL. 5. (U.S. CLS. 6, 18, 44, 46, 51 AND 52). REG. 7-2-2002.
- 2,590,083. CARDCLIP. INT. CL. 20. (U.S. CLS. 2, 13, 22, 25, 32 AND 50). REG. 7-2-2002.
- 2,590,502. TRU-COOL (STYLIZED). INT. CL. 7. (U.S. CLS. 13, 19, 21, 23, 31, 34 AND 35). REG. 7-9-2002.
- 2,590,521. THE PEABODY (STYLIZED). INT. CL. 21. (U.S. CLS. 2, 13, 23, 29, 30, 33, 40 AND 50). REG. 7-9-2002.
- 2,590,522. THE PEABODY. INT. CL. 21. (U.S. CLS. 2, 13, 23, 29, 30, 33, 40 AND 50). REG. 7-9-2002.
- 2,590,733. LONGABERGER GOLF CLUB AND DESIGN. INT. CLS. 24, 25 AND 28. (U.S. CLS. 22, 23, 38, 39, 42 AND 50). REG. 7-9-2002.
- 2,590,743. LONGABERGER GOLF CLUB AND DESIGN. INT. CLS. 6 AND 14 ONLY. (U.S. CLS. 2, 12, 13, 14, 23, 25, 27, 28 AND 50). REG. 7-9-2002.
- 2,590,875. VICTOR REINZ. INT. CL. 17. (U.S. CLS. 1, 5, 12, 13, 35 AND 50). REG. 7-9-2002.
- 2,590,877. CLEAN AIR. CLEAN HOME.. INT. CL. 7. (U.S. CLS. 13, 19, 21, 23, 31, 34 AND 35). REG. 7-9-2002.
- 2,591,335. ALPHA FACTOR. INT. CL. 35. (U.S. CLS. 100, 101 AND 102). REG. 7-9-2002.
- 2,591,411. THE WAY OF THE HORSE. INT. CL. 41. (U.S. CLS. 100, 101 AND 107). REG. 7-9-2002.
- 2,591,580. RECALL. INT. CL. 9. (U.S. CLS. 21, 23, 26, 36 AND 38). REG. 7-9-2002.
- 2,591,631. ARISTOTLE. INT. CLS. 21 AND 35. (U.S. CLS. 2, 13, 23, 29, 30, 33, 40, 50, 100, 101 AND 102). REG. 7-9-2002.
- 2,591,650. ULTIMATE SPIDER-MAN. INT. CL. 16. (U.S. CLS. 2, 5, 22, 23, 29, 37, 38 AND 50). REG. 7-9-2002.
- 2,591,880. SELCOPY. INT. CL. 9. (U.S. CLS. 21, 23, 26, 36 AND 38). REG. 7-9-2002.
- 2,591,999. CENTRILOCK. INT. CL. 7. (U.S. CLS. 13, 19, 21, 23, 31, 34 AND 35). REG. 7-9-2002.
- 2,592,666. AQUAKIDS. INT. CL. 41. (U.S. CLS. 100, 101 AND 107). REG. 7-9-2002.
- 2,592,917. PREVENT. INT. CL. 10. (U.S. CLS. 26, 39 AND 44). REG. 7-9-2002.
- 2,593,447. ROYSE AND DESIGN. INT. CL. 11. (U.S. CLS. 13, 21, 23, 31 AND 34). REG. 7-16-2002.
- 2,593,459. ENVESTNET. INT. CL. 36. (U.S. CLS. 100, 101 AND 102). REG. 7-16-2002.
- 2,593,526. ACCUMATE (STYLIZED). INT. CL. 9. (U.S. CLS. 21, 23, 26, 36 AND 38). REG. 7-16-2002.
- 2,593,777. FURUKAWA. INT. CL. 9. (U.S. CLS. 21, 23, 26, 36 AND 38). REG. 7-16-2002.
- 2,593,816. INNER LOK 8. INT. CL. 10. (U.S. CLS. 26, 39 AND 44). REG. 7-16-2002.
- 2,594,038. MISCELLANEOUS DESIGN. INT. CL. 40. (U.S. CLS. 100, 103 AND 106). REG. 7-16-2002.
- 2,594,101. FLIGHT EXPLORER. INT. CLS. 9 AND 42. (U.S. CLS. 21, 23, 26, 36, 38, 100 AND 101). REG. 7-16-2002.
- 2,594,304. XODIAX. INT. CLS. 38 AND 42. (U.S. CLS. 100, 101 AND 104). REG. 7-16-2002.
- 2,595,136. GAMBRO AND DESIGN. INT. CL. 9. (U.S. CLS. 21, 23, 26, 36 AND 38). REG. 7-16-2002.
- 2,595,150. FEDEX HOME DELIVERY AND DESIGN. INT. CLS. 35 AND 39. (U.S. CLS. 100, 101, 102 AND 105). REG. 7-16-2002.
- 2,595,318. COCOTEK. INT. CL. 1. (U.S. CLS. 1, 5, 6, 10, 26 AND 46). REG. 7-16-2002.
- 2,595,504. ADVENTURE RANGERS. INT. CL. 16 ONLY. (U.S. CLS. 2, 5, 22, 23, 29, 37, 38 AND 50). REG. 7-16-2002.
- 2,595,801. NOVVA. INT. CL. 23. (U.S. CL. 43). REG. 7-16-2002.
- 2,596,187. CONTINUOUSWAVE. INT. CL. 9. (U.S. CLS. 21, 23, 26, 36 AND 38). REG. 7-16-2002.
- 2,596,531. U.S. CELLULAR AND DESIGN. INT. CL. 9. (U.S. CLS. 21, 23, 26, 36 AND 38). REG. 7-23-2002.
- 2,596,615. APPLEWOOD AND DESIGN. INT. CL. 29. (U.S. CL. 46). REG. 7-23-2002.
- 2,597,177. MONTECITO. INT. CL. 30. (U.S. CL. 46). REG. 7-23-2002.
- 2,597,253. CITIZENLINK. INT. CL. 42. (U.S. CLS. 100 AND 101). REG. 7-23-2002.
- 2,597,476. ANDERSEN'S. INT. CL. 29. (U.S. CL. 46). REG. 7-23-2002.
- 2,597,488. GROUND EFFECTS LANDSCAPING, INC.. INT. CL. 42. (U.S. CLS. 100 AND 101). REG. 7-23-2002.
- 2,597,670. THE RELIABLE BRAND SINCE 1880 "ALAMO" ALAMO CEMENT CO. SAN ANTONIO, TEXAS AND DESIGN. INT. CL. 19. (U.S. CLS. 1, 12, 33 AND 50). REG. 7-23-2002.
- 2,597,885. MONOLOCK (STYLIZED). INT. CL. 7. (U.S. CLS. 13, 19, 21, 23, 31, 34 AND 35). REG. 7-23-2002.
- 2,597,953. MEMEC. INT. CL. 35. (U.S. CLS. 100, 101 AND 102). REG. 7-23-2002.
- 2,597,972. AUTO PRIDE. INT. CL. 35. (U.S. CLS. 100, 101 AND 102). REG. 7-23-2002.
- 2,598,026. CORNERING DISCOVER THE ART. INT. CL. 41. (U.S. CLS. 100, 101 AND 107). REG. 7-23-2002.
- 2,598,067. CORNERING LEARN THE SKILLS DISCOVER THE ART. INT. CL. 41. (U.S. CLS. 100, 101 AND 107). REG. 7-23-2002.
- 2,598,115. ARKANSASBUSINESS.COM. INT. CL. 42. (U.S. CLS. 100 AND 101). REG. 7-23-2002.
- 2,598,380. PUNTA MITA. INT. CLS. 35 AND 37 ONLY. (U.S. CLS. 100, 101, 102, 103 AND 106). REG. 7-23-2002.
- 2,598,695. THE LOUIS L'AMOUR TRADING POST. INT. CL. 41. (U.S. CLS. 100, 101 AND 107). REG. 7-23-2002.
- 2,599,150. METPORE. INT. CL. 6. (U.S. CLS. 2, 12, 13, 14, 23, 25 AND 50). REG. 7-23-2002.
- 2,599,689. CONTACTWORX. INT. CL. 9. (U.S. CLS. 21, 23, 26, 36 AND 38). REG. 7-23-2002.
- 2,599,892. AVEMAR. INT. CL. 5. (U.S. CLS. 6, 18, 44, 46, 51 AND 52). REG. 7-30-2002.
- 2,599,952. COTTON COUNTRY. INT. CL. 25. (U.S. CLS. 22 AND 39). REG. 7-30-2002.
- 2,599,978. WINE LIBRARY. INT. CL. 35. (U.S. CLS. 100, 101 AND 102). REG. 7-30-2002.
- 2,599,990. LIBRI AND DESIGN. INT. CLS. 9, 16, 35, 38, 41 AND 42. (U.S. CLS. 2, 5, 21, 22, 23, 26, 29, 36, 37, 38, 50, 100, 101, 102, 104 AND 107). REG. 7-30-2002.
- 2,600,316. KNOWLAGENT AND DESIGN. INT. CL. 9. (U.S. CLS. 21, 23, 26, 36 AND 38). REG. 7-30-2002.
- 2,600,321. NK ENEKA (STYLIZED). INT. CL. 25. (U.S. CLS. 22 AND 39). REG. 7-30-2002.
- 2,600,689. ARROWHEAD. INT. CLS. 7 AND 42. (U.S. CLS. 13, 19, 21, 23, 31, 34, 35, 100 AND 101). REG. 7-30-2002.
- 2,600,785. RED BAG. INT. CL. 19. (U.S. CLS. 1, 12, 33 AND 50). REG. 7-30-2002.
- 2,600,786. ALAMO. INT. CL. 19. (U.S. CLS. 1, 12, 33 AND 50). REG. 7-30-2002.
- 2,601,335. MULAN. INT. CL. 16 ONLY. (U.S. CLS. 2, 5, 22, 23, 29, 37, 38 AND 50). REG. 7-30-2002.
- 2,601,351. GRANITE. INT. CL. 12. (U.S. CLS. 19, 21, 23, 31, 35 AND 44). REG. 7-30-2002.
- 2,601,630. PHAYANAK BRAND AND DESIGN. INT. CL. 30. (U.S. CL. 46). REG. 7-30-2002.
- 2,601,899. ARESTIN. INT. CLS. 5 AND 10. (U.S. CLS. 6, 18, 26, 39, 44, 46, 51 AND 52). REG. 7-30-2002.
- 2,601,934. LA PALETERA. INT. CL. 42. (U.S. CLS. 100 AND 101). REG. 7-30-2002.
- 2,602,059. KALSPICE. INT. CLS. 1, 2 AND 30. (U.S. CLS. 1, 5, 6, 10, 11, 16, 26 AND 46). REG. 7-30-2002.
- 2,602,320. CG4 CENTRAL. INT. CL. 9. (U.S. CLS. 21, 23, 26, 36 AND 38). REG. 7-30-2002.
- 2,602,468. REVITALIFT COMPLETE. INT. CL. 3. (U.S. CLS. 1, 4, 6, 50, 51 AND 52). REG. 7-30-2002.
- 2,602,523. CHEF SAL'S. INT. CL. 29. (U.S. CL. 46). REG. 7-30-2002.
- 2,602,670. NORTHERN PRAIRIE. INT. CL. 30. (U.S. CL. 46). REG. 7-30-2002.

- 2,602,707. NOBODY GOES THERE IT'S TOO CROWDED. INT. CL. 39. (U.S. CLS. 100 AND 105). REG. 7-30-2002.
- 2,602,708. SO FAR YET SO NEAR. INT. CL. 39. (U.S. CLS. 100 AND 105). REG. 7-30-2002.
- 2,602,827. LINKASAURUS. INT. CL. 42. (U.S. CLS. 100 AND 101). REG. 7-30-2002.
- 2,602,850. A SERVICE COMPANY DEDICATED TO PROVIDE INTELLIGENT SOLUTIONS. INT. CL. 42. (U.S. CLS. 100 AND 101). REG. 7-30-2002.
- 2,603,043. MISCELLANEOUS DESIGN. INT. CL. 10. (U.S. CLS. 26, 39 AND 44). REG. 7-30-2002.
- 2,603,044. BAUSCH AND DESIGN. INT. CL. 10. (U.S. CLS. 26, 39 AND 44). REG. 7-30-2002.
- 2,603,292. TARGETBASE. INT. CL. 35. (U.S. CLS. 100, 101 AND 102). REG. 8-6-2002.
- 2,603,329. ORS. INT. CL. 7. (U.S. CLS. 13, 19, 21, 23, 31, 34 AND 35). REG. 8-6-2002.
- 2,603,422. GATESFACTS. INT. CL. 35. (U.S. CLS. 100, 101 AND 102). REG. 8-6-2002.
- 2,604,185. MISCELLANEOUS DESIGN. INT. CL. 32. (U.S. CLS. 45, 46 AND 48). REG. 8-6-2002.
- 2,604,292. BILLY CLUB STANDARD CHARACTER MARK. INT. CL. 30. (U.S. CL. 46). REG. 8-6-2002.
- 2,604,987. PLUG FAST AND DESIGN. INT. CL. 1. (U.S. CLS. 1, 5, 6, 10, 26 AND 46). REG. 8-6-2002.
- 2,604,997. HYP AND DESIGN. INT. CL. 25. (U.S. CLS. 22 AND 39). REG. 8-6-2002.
- 2,605,537. HUB TAMER (STYLIZED). INT. CL. 8. (U.S. CLS. 23, 28 AND 44). REG. 8-6-2002.
- 2,606,162. SAMOAN STYLE. INT. CL. 29. (U.S. CL. 46). REG. 8-6-2002.
- 2,606,373. LACE RELEASE PLUS. INT. CL. 3. (U.S. CLS. 1, 4, 6, 50, 51 AND 52). REG. 8-13-2002.
- 2,606,392. WASTE SOLUTIONS WSI AND DESIGN. INT. CL. 37. (U.S. CLS. 100, 103 AND 106). REG. 8-13-2002.
- 2,606,982. VIZARI. INT. CLS. 18, 25 AND 28. (U.S. CLS. 1, 2, 3, 22, 23, 38, 39, 41 AND 50). REG. 8-13-2002.
- 2,607,001. NEW YORK DOG AND DESIGN. INT. CL. 18. (U.S. CLS. 1, 2, 3, 22 AND 41). REG. 8-13-2002.
- 2,607,347. MT AND DESIGN. INT. CLS. 16 AND 25. (U.S. CLS. 2, 5, 22, 23, 29, 37, 38, 39 AND 50). REG. 8-13-2002.
- 2,607,442. BLOOM. INT. CLS. 9, 11 AND 42 ONLY. (U.S. CLS. 13, 21, 23, 26, 31, 34, 36, 38, 100 AND 101). REG. 8-13-2002.
- 2,607,463. ATOM-MISER. INT. CL. 7. (U.S. CLS. 13, 19, 21, 23, 31, 34 AND 35). REG. 8-13-2002.
- 2,607,528. ANN'S CHOICE. INT. CL. 43. (U.S. CLS. 100 AND 101). REG. 8-13-2002.
- 2,607,592. ACCU-TRACK. INT. CL. 20. (U.S. CLS. 2, 13, 22, 25, 32 AND 50). REG. 8-13-2002.
- 2,607,877. VALIDUS. INT. CL. 7. (U.S. CLS. 13, 19, 21, 23, 31, 34 AND 35). REG. 8-13-2002.
- 2,608,230. ON LINE. INT. CL. 1. (U.S. CLS. 1, 5, 6, 10, 26 AND 46). REG. 8-13-2002.
- 2,608,756. XII. INT. CL. 25. (U.S. CLS. 22 AND 39). REG. 8-20-2002.
- 2,608,912. THE WEALTH ENGINEER. INT. CL. 36. (U.S. CLS. 100, 101 AND 102). REG. 8-20-2002.
- 2,609,548. CIF 20/20. INT. CL. 9. (U.S. CLS. 21, 23, 26, 36 AND 38). REG. 8-20-2002.
- 2,609,571. CHRISTIAN COUNSELING & TRAINING CENTER RENEWED LIVING THROUGH SCRIPTURE AND DESIGN. INT. CL. 41. (U.S. CLS. 100, 101 AND 107). REG. 8-20-2002.
- 2,609,915. YOUR LINK WITH THE GLOBAL INVESTMENT COMMUNITY. INT. CL. 36. (U.S. CLS. 100, 101 AND 102). REG. 8-20-2002.
- 2,610,386. E AND DESIGN. INT. CL. 9. (U.S. CLS. 21, 23, 26, 36 AND 38). REG. 8-20-2002.
- 2,610,387. E AND DESIGN. INT. CL. 42. (U.S. CLS. 100 AND 101). REG. 8-20-2002.
- 2,610,580. UNIVERSAL'S ISLANDS OF ADVENTURE. INT. CL. 21. (U.S. CLS. 2, 13, 23, 29, 30, 33, 40 AND 50). REG. 8-20-2002.
- 2,610,979. SUPER SCRATCH. INT. CL. 31. (U.S. CLS. 1 AND 46). REG. 8-20-2002.
- 2,611,272. STAR LINE AND DESIGN. INT. CL. 31. (U.S. CLS. 1 AND 46). REG. 8-27-2002.
- 2,611,648. BAYCOM. INT. CL. 9. (U.S. CLS. 21, 23, 26, 36 AND 38). REG. 8-27-2002.
- 2,612,116. SNOWBASIN. INT. CLS. 25, 41 AND 42. (U.S. CLS. 22, 39, 100, 101 AND 107). REG. 8-27-2002.
- 2,612,137. KIRIN. INT. CL. 32. (U.S. CLS. 45, 46 AND 48). REG. 8-27-2002.
- 2,612,281. FO-RING. INT. CL. 7. (U.S. CLS. 13, 19, 21, 23, 31, 34 AND 35). REG. 8-27-2002.
- 2,612,455. TH. INT. CL. 25. (U.S. CLS. 22 AND 39). REG. 8-27-2002.
- 2,612,953. PRECISE. INT. CL. 10. (U.S. CLS. 26, 39 AND 44). REG. 8-27-2002.
- 2,613,247. KATE SPADE NEW YORK. INT. CL. 25. (U.S. CLS. 22 AND 39). REG. 8-27-2002.
- 2,614,027. KIDS ON HANDS. INT. CL. 16. (U.S. CLS. 2, 5, 22, 23, 29, 37, 38 AND 50). REG. 9-3-2002.
- 2,614,182. CREATIVE DIRECT RESPONSE INTERNATIONAL. INT. CLS. 35 AND 36. (U.S. CLS. 100, 101 AND 102). REG. 9-3-2002.
- 2,614,630. TOMSED. INT. CLS. 6 AND 9. (U.S. CLS. 2, 12, 13, 14, 21, 23, 25, 26, 36, 38 AND 50). REG. 9-3-2002.
- 2,614,712. GIBSON DUNN. INT. CL. 42. (U.S. CLS. 100 AND 101). REG. 9-3-2002.
- 2,614,714. S-GAL. INT. CL. 1. (U.S. CLS. 1, 5, 6, 10, 26 AND 46). REG. 9-3-2002.
- 2,615,180. ADD-A-PEARL. INT. CL. 14. (U.S. CLS. 2, 27, 28 AND 50). REG. 9-3-2002.
- 2,615,278. RICE. INT. CL. 18. (U.S. CLS. 1, 2, 3, 22 AND 41). REG. 9-3-2002.
- 2,615,800. FROM TOUCHDOWN TO TAKEOFF. INT. CL. 39. (U.S. CLS. 100 AND 105). REG. 9-3-2002.
- 2,616,540. BACK TO THE 50'S. INT. CL. 41. (U.S. CLS. 100, 101 AND 107). REG. 9-10-2002.
- 2,616,547. PACIFIC INTERNATIONAL RICE MILLS. INT. CL. 30. (U.S. CL. 46). REG. 9-10-2002.
- 2,616,958. SUPER-OX. INT. CL. 5. (U.S. CLS. 6, 18, 44, 46, 51 AND 52). REG. 9-10-2002.
- 2,617,195. THE THREE WAITERS. INT. CL. 41. (U.S. CLS. 100, 101 AND 107). REG. 9-10-2002.
- 2,617,783. MAJA. INT. CL. 41. (U.S. CLS. 100, 101 AND 107). REG. 9-10-2002.
- 2,617,932. BONNE BELL. INT. CLS. 3 AND 5. (U.S. CLS. 1, 4, 6, 18, 44, 46, 50, 51 AND 52). REG. 9-10-2002.
- 2,617,948. JEANNIE DEVA. INT. CLS. 9 AND 41. (U.S. CLS. 21, 23, 26, 36, 38, 100, 101 AND 107). REG. 9-10-2002.
- 2,618,084. THE KENYON REVIEW. INT. CL. 16. (U.S. CLS. 2, 5, 22, 23, 29, 37, 38 AND 50). REG. 9-10-2002.
- 2,618,255. COLOCORT. INT. CL. 5. (U.S. CLS. 6, 18, 44, 46, 51 AND 52). REG. 9-10-2002.
- 2,618,563. REPUBLIC OF TANGO. INT. CL. 25. (U.S. CLS. 22 AND 39). REG. 9-10-2002.
- 2,619,074. TRAFIX. INT. CL. 1. (U.S. CLS. 1, 5, 6, 10, 26 AND 46). REG. 9-10-2002.
- 2,619,129. GESTION. INT. CL. 16. (U.S. CLS. 2, 5, 22, 23, 29, 37, 38 AND 50). REG. 9-10-2002.
- 2,619,313. FIESTA. INT. CL. 27. (U.S. CLS. 19, 20, 37, 42 AND 50). REG. 9-17-2002.
- 2,619,479. POWERBID. INT. CL. 35. (U.S. CLS. 100, 101 AND 102). REG. 9-17-2002.
- 2,619,524. SOMAK. INT. CLS. 39 AND 42. (U.S. CLS. 100, 101 AND 105). REG. 9-17-2002.
- 2,619,673. ZESTI ADVANTAGE. INT. CL. 30. (U.S. CL. 46). REG. 9-17-2002.
- 2,619,719. J JOVIAL AND DESIGN. INT. CL. 14. (U.S. CLS. 2, 27, 28 AND 50). REG. 9-17-2002.
- 2,619,802. BIBLICAL CHOICES. INT. CL. 16. (U.S. CLS. 2, 5, 22, 23, 29, 37, 38 AND 50). REG. 9-17-2002.
- 2,620,366. TOM SED CORP.N.C. AND DESIGN. INT. CLS. 6 AND 9. (U.S. CLS. 2, 12, 13, 14, 21, 23, 25, 26, 36, 38 AND 50). REG. 9-17-2002.
- 2,620,520. COOL CAPP. INT. CL. 30. (U.S. CL. 46). REG. 9-17-2002.
- 2,620,638. MISCELLANEOUS DESIGN. INT. CL. 19. (U.S. CLS. 1, 12, 33 AND 50). REG. 9-17-2002.
- 2,621,023. DUNLOP. INT. CL. 12. (U.S. CLS. 19, 21, 23, 31, 35 AND 44). REG. 9-17-2002.
- 2,621,177. RICE. INT. CL. 16. (U.S. CLS. 2, 5, 22, 23, 29, 37, 38 AND 50). REG. 9-17-2002.
- 2,621,178. RICE. INT. CL. 28. (U.S. CLS. 22, 23, 38 AND 50). REG. 9-17-2002.
- 2,621,284. CRIBWICH. INT. CL. 30. (U.S. CL. 46). REG. 9-17-2002.
- 2,621,330. SAMURAI JACK. INT. CL. 16. (U.S. CLS. 2, 5, 22, 23, 29, 37, 38 AND 50). REG. 9-17-2002.
- 2,622,203. FINETEC. INT. CL. 19. (U.S. CLS. 1, 12, 33 AND 50). REG. 9-17-2002.

- 2,623,082. PACIFIC INTERNATIONAL RICE MILLS AND DESIGN. INT. CL. 30. (U.S. CL. 46). REG. 9-24-2002.
- 2,623,128. KIDS ON HANDS. INT. CL. 41. (U.S. CLS. 100, 101 AND 107). REG. 9-24-2002.
- 2,623,386. ALPHADRI. INT. CL. 1. (U.S. CLS. 1, 5, 6, 10, 26 AND 46). REG. 9-24-2002.
- 2,623,482. MISCELLANEOUS DESIGN. INT. CLS. 35, 36, 37 AND 39. (U.S. CLS. 100, 101, 102, 103, 105 AND 106). REG. 9-24-2002.
- 2,623,576. JAVA CITY. INT. CL. 30. (U.S. CL. 46). REG. 9-24-2002.
- 2,624,085. INTOWN SUITES AND DESIGN. INT. CL. 42. (U.S. CLS. 100 AND 101). REG. 9-24-2002.
- 2,624,422. CITYMEALS-ON-WHEELS. INT. CLS. 36 AND 42. (U.S. CLS. 100, 101 AND 102). REG. 9-24-2002.
- 2,624,490. OFFICER SNOOK. INT. CLS. 16, 25, 28 AND 42. (U.S. CLS. 2, 5, 22, 23, 29, 37, 38, 39, 50, 100 AND 101). REG. 9-24-2002.
- 2,624,521. BUSINESS AND THE ENVIRONMENT. INT. CL. 16. (U.S. CLS. 2, 5, 22, 23, 29, 37, 38 AND 50). REG. 9-24-2002.
- 2,624,530. L.E.A.D.S. LIVE ENZYME ACTIVATED DELIVERY SYSTEM. INT. CL. 5. (U.S. CLS. 6, 18, 44, 46, 51 AND 52). REG. 9-24-2002.
- 2,624,941. ATWATER CAREY. INT. CL. 5. (U.S. CLS. 6, 18, 44, 46, 51 AND 52). REG. 9-24-2002.
- 2,624,986. PHARMAWARE. INT. CL. 35. (U.S. CLS. 100, 101 AND 102). REG. 9-24-2002.
- 2,625,477. ALTEK. INT. CL. 1. (U.S. CLS. 1, 5, 6, 10, 26 AND 46). REG. 9-24-2002.
- 2,625,730. CLICKON (STYLIZED). INT. CL. 9. (U.S. CLS. 21, 23, 26, 36 AND 38). REG. 9-24-2002.
- 2,625,778. TOOLKIT FOR INFORMATION REPRESENTATION AND AGENT COLLABORATION TIRAC. INT. CL. 9. (U.S. CLS. 21, 23, 26, 36 AND 38). REG. 9-24-2002.
- 2,626,194. MEDILITE. INT. CL. 9. (U.S. CLS. 21, 23, 26, 36 AND 38). REG. 9-24-2002.
- 2,627,689. BIOCUBE. INT. CL. 11. (U.S. CLS. 13, 21, 23, 31 AND 34). REG. 10-1-2002.
- 2,627,867. SUITE DREAMS PROJECT. INT. CL. 36. (U.S. CLS. 100, 101 AND 102). REG. 10-1-2002.
- 2,628,248. DC-3. INT. CL. 29. (U.S. CL. 46). REG. 10-1-2002.
- 2,629,574. FRIGO. INT. CL. 29. (U.S. CL. 46). REG. 10-8-2002.
- 2,630,403. JAVA CITY AND DESIGN. INT. CL. 42 ONLY. (U.S. CLS. 100 AND 101). REG. 10-8-2002.
- 2,630,432. POWER UP. INT. CL. 16. (U.S. CLS. 2, 5, 22, 23, 29, 37, 38 AND 50). REG. 10-8-2002.
- 2,631,070. INFINITY. INT. CL. 9. (U.S. CLS. 21, 23, 26, 36 AND 38). REG. 10-8-2002.
- 2,631,173. CHRISTIAN COUNSEING & TRAINING CENTER, INC. RENEWED LIVING THROUGH SCRIPTURE AND DESIGN. INT. CL. 16. (U.S. CLS. 2, 5, 22, 23, 29, 37, 38 AND 50). REG. 10-8-2002.
- 2,631,628. THE BEACH BOYS. INT. CL. 9. (U.S. CLS. 21, 23, 26, 36 AND 38). REG. 10-8-2002.
- 2,632,579. SAFE-FIRE. INT. CL. 1. (U.S. CLS. 1, 5, 6, 10, 26 AND 46). REG. 10-8-2002.
- 2,633,178. INNERGE (STYLIZED). INT. CL. 35. (U.S. CLS. 100, 101 AND 102). REG. 10-8-2002.
- 2,634,153. SARGENT ART. INT. CLS. 2 AND 16. (U.S. CLS. 2, 5, 6, 11, 16, 22, 23, 29, 37, 38 AND 50). REG. 10-15-2002.
- 2,634,169. GENTRACK. INT. CL. 9. (U.S. CLS. 21, 23, 26, 36 AND 38). REG. 10-15-2002.
- 2,635,122. WOMEN REINVENTING PHILANTHROPY. INT. CL. 36. (U.S. CLS. 100, 101 AND 102). REG. 10-15-2002.
- 2,635,263. KEEPSAFE. INT. CL. 35. (U.S. CLS. 100, 101 AND 102). REG. 10-15-2002.
- 2,635,627. TABLE BUDDY. INT. CL. 20. (U.S. CLS. 2, 13, 22, 25, 32 AND 50). REG. 10-15-2002.
- 2,635,696. DURAGEN. INT. CL. 5. (U.S. CLS. 6, 18, 44, 46, 51 AND 52). REG. 10-15-2002.
- 2,635,759. AVISION. INT. CL. 9. (U.S. CLS. 21, 23, 26, 36 AND 38). REG. 10-15-2002.
- 2,636,289. RAPAD. INT. CL. 1. (U.S. CLS. 1, 5, 6, 10, 26 AND 46). REG. 10-15-2002.
- 2,636,967. PET-N-GO. INT. CL. 18. (U.S. CLS. 1, 2, 3, 22 AND 41). REG. 10-15-2002.
- 2,637,326. C CUADRA AND DESIGN. INT. CLS. 18 AND 25. (U.S. CLS. 1, 2, 3, 22, 39 AND 41). REG. 10-15-2002.
- 2,637,654. CORDA-ROY'S ORIGINALS. INT. CL. 20. (U.S. CLS. 2, 13, 22, 25, 32 AND 50). REG. 10-15-2002.
- 2,638,944. USADA. INT. CL. 41. (U.S. CLS. 100, 101 AND 107). REG. 10-22-2002.
- 2,639,133. A TEAM AND DESIGN. INT. CLS. 35 AND 42. (U.S. CLS. 100, 101 AND 102). REG. 10-22-2002.
- 2,639,309. RAIL PRO. INT. CL. 19. (U.S. CLS. 1, 12, 33 AND 50). REG. 10-22-2002.
- 2,639,790. SEA-SPEED. INT. CL. 2. (U.S. CLS. 6, 11 AND 16). REG. 10-22-2002.
- 2,640,129. MISCELLANEOUS DESIGN. INT. CL. 9. (U.S. CLS. 21, 23, 26, 36 AND 38). REG. 10-22-2002.
- 2,640,653. WHET BLU. INT. CL. 25. (U.S. CLS. 22 AND 39). REG. 10-22-2002.
- 2,640,731. CAP-GLIDE. INT. CL. 20. (U.S. CLS. 2, 13, 22, 25, 32 AND 50). REG. 10-22-2002.
- 2,640,802. AMERICINN MOTEL AND DESIGN. INT. CL. 42. (U.S. CLS. 100 AND 101). REG. 10-22-2002.
- 2,640,811. SIMPLE TRIBUTE. INT. CLS. 36 AND 42. (U.S. CLS. 100, 101 AND 102). REG. 10-22-2002.
- 2,640,865. I AND DESIGN. INT. CL. 5. (U.S. CLS. 6, 18, 44, 46, 51 AND 52). REG. 10-22-2002.
- 2,641,036. TOMMY BAHAMA. INT. CL. 9. (U.S. CLS. 21, 23, 26, 36 AND 38). REG. 10-22-2002.
- 2,641,156. CARB-RITE. INT. CL. 5. (U.S. CLS. 6, 18, 44, 46, 51 AND 52). REG. 10-22-2002.
- 2,641,828. QUALTREND. INT. CLS. 9 AND 42. (U.S. CLS. 21, 23, 26, 36, 38, 100 AND 101). REG. 10-29-2002.
- 2,641,954. M J A. INT. CL. 31. (U.S. CLS. 1 AND 46). REG. 10-29-2002.
- 2,642,063. OPTICON. INT. CL. 9. (U.S. CLS. 21, 23, 26, 36 AND 38). REG. 10-29-2002.
- 2,642,107. FLYWHEEL VENTURES. INT. CLS. 9, 35, 36, 41 AND 42. (U.S. CLS. 21, 23, 26, 36, 38, 100, 101, 102 AND 107). REG. 10-29-2002.
- 2,642,472. CHARGETRON. INT. CL. 9. (U.S. CLS. 21, 23, 26, 36 AND 38). REG. 10-29-2002.
- 2,642,708. HANGAR. INT. CL. 29. (U.S. CL. 46). REG. 10-29-2002.
- 2,643,011. COSMIC. INT. CL. 42. (U.S. CLS. 100 AND 101). REG. 10-29-2002.
- 2,643,925. TASTE DELIGHT. INT. CL. 30. (U.S. CL. 46). REG. 10-29-2002.
- 2,644,247. LIGNAMAX. INT. CL. 5. (U.S. CLS. 6, 18, 44, 46, 51 AND 52). REG. 10-29-2002.
- 2,644,546. SSABR. INT. CL. 9. (U.S. CLS. 21, 23, 26, 36 AND 38). REG. 10-29-2002.
- 2,645,098. MISCELLANEOUS DESIGN. INT. CL. 21. (U.S. CLS. 2, 13, 23, 29, 30, 33, 40 AND 50). REG. 11-5-2002.
- 2,645,153. RESULTS MATTER. INT. CL. 42. (U.S. CLS. 100 AND 101). REG. 11-5-2002.
- 2,645,951. VIRTUAL. INT. CL. 12. (U.S. CLS. 19, 21, 23, 31, 35 AND 44). REG. 11-5-2002.
- 2,646,394. FT FINTECH.NET AND DESIGN. INT. CLS. 36 AND 38. (U.S. CLS. 100, 101, 102 AND 104). REG. 11-5-2002.
- 2,646,658. JUST DIP IT. INT. CL. 29. (U.S. CL. 46). REG. 11-5-2002.
- 2,646,932. BLUEPAY. INT. CL. 36. (U.S. CLS. 100, 101 AND 102). REG. 11-5-2002.
- 2,647,031. G2 (STYLIZED). INT. CL. 7. (U.S. CLS. 13, 19, 21, 23, 31, 34 AND 35). REG. 11-5-2002.
- 2,647,195. INDIGO STAR. INT. CL. 25. (U.S. CLS. 22 AND 39). REG. 11-5-2002.
- 2,648,326. THE SOURCE ALLIANCE. INT. CL. 35. (U.S. CLS. 100, 101 AND 102). REG. 11-12-2002.
- 2,648,543. LIBERTY SAFE. INT. CL. 6. (U.S. CLS. 2, 12, 13, 14, 23, 25 AND 50). REG. 11-12-2002.
- 2,649,010. MAXLINER. INT. CL. 7. (U.S. CLS. 13, 19, 21, 23, 31, 34 AND 35). REG. 11-12-2002.
- 2,650,112. MENTAL WEIGHT. INT. CLS. 41 AND 42. (U.S. CLS. 100, 101 AND 107). REG. 11-12-2002.
- 2,650,427. STOPTECH. INT. CL. 35. (U.S. CLS. 100, 101 AND 102). REG. 11-12-2002.
- 2,650,681. UNI-FIT. INT. CL. 11. (U.S. CLS. 13, 21, 23, 31 AND 34). REG. 11-12-2002.
- 2,650,943. U.S. CELLULAR AND DESIGN. INT. CL. 38. (U.S. CLS. 100, 101 AND 104). REG. 11-19-2002.
- 2,651,253. GET THE POINT. INT. CL. 36. (U.S. CLS. 100, 101 AND 102). REG. 11-19-2002.
- 2,651,374. EL SABROSO AND DESIGN. INT. CL. 30. (U.S. CL. 46). REG. 11-19-2002.

- 2,651,505. H2OPE PEDIATRIC EXERCISES AND DESIGN. INT. CL. 41. (U.S. CLS. 100, 101 AND 107). REG. 11-19-2002.
- 2,651,568. M MARICOPA COMMUNITY COLLEGES AND DESIGN. INT. CL. 16. (U.S. CLS. 2, 5, 22, 23, 29, 37, 38 AND 50). REG. 11-19-2002.
- 2,651,569. M MARICOPA COMMUNITY COLLEGES AND DESIGN. INT. CL. 18. (U.S. CLS. 1, 2, 3, 22 AND 41). REG. 11-19-2002.
- 2,651,995. ESPARES AND DESIGN. INT. CL. 35. (U.S. CLS. 100, 101 AND 102). REG. 11-19-2002.
- 2,652,326. FUEL. INT. CL. 12. (U.S. CLS. 19, 21, 23, 31, 35 AND 44). REG. 11-19-2002.
- 2,652,337. FEDEX HOME DELIVERY AND DESIGN. INT. CLS. 35 AND 39. (U.S. CLS. 100, 101, 102 AND 105). REG. 11-19-2002.
- 2,652,888. ANNUITYBIZ.COM. INT. CL. 36. (U.S. CLS. 100, 101 AND 102). REG. 11-19-2002.
- 2,653,484. NORLAKE. INT. CLS. 9 AND 11. (U.S. CLS. 13, 21, 23, 26, 31, 34, 36 AND 38). REG. 11-26-2002.
- 2,654,645. ICCITY. INT. CL. 35. (U.S. CLS. 100, 101 AND 102). REG. 11-26-2002.
- 2,654,973. POWR-TEK. INT. CL. 11. (U.S. CLS. 13, 21, 23, 31 AND 34). REG. 11-26-2002.
- 2,656,096. REX RESTAURANT EQUIPMENT SEARCH ENGINE. INT. CL. 35. (U.S. CLS. 100, 101 AND 102). REG. 12-3-2002.
- 2,656,312. LOUDOUN COLLISION CENTER (STYLIZED). INT. CL. 37. (U.S. CLS. 100, 103 AND 106). REG. 12-3-2002.
- 2,656,385. VITALITY FOR LIFE AND DESIGN. INT. CL. 5 ONLY. (U.S. CLS. 6, 18, 44, 46, 51 AND 52). REG. 12-3-2002.
- 2,656,720. APEX. INT. CL. 9. (U.S. CLS. 21, 23, 26, 36 AND 38). REG. 12-3-2002.
- 2,658,106. FAS. INT. CL. 9. (U.S. CLS. 21, 23, 26, 36 AND 38). REG. 12-10-2002.
- 2,658,185. PAGEO. INT. CLS. 35 AND 42. (U.S. CLS. 100, 101 AND 102). REG. 12-10-2002.
- 2,658,328. MOHAWK AMBULANCE SERVICE AND DESIGN. INT. CLS. 39 AND 44. (U.S. CLS. 100, 101 AND 105). REG. 12-10-2002.
- 2,658,666. O N S AND DESIGN. INT. CL. 3. (U.S. CLS. 1, 4, 6, 50, 51 AND 52). REG. 12-10-2002.
- 2,659,593. WE ARE SCIENTISTS. INT. CL. 41. (U.S. CLS. 100, 101 AND 107). REG. 12-10-2002.
- 2,662,200. HAPPY HOOKER. INT. CL. 21. (U.S. CLS. 2, 13, 23, 29, 30, 33, 40 AND 50). REG. 12-17-2002.
- 2,662,286. M MARICOPA COMMUNITY COLLEGES AND DESIGN. INT. CL. 21. (U.S. CLS. 2, 13, 23, 29, 30, 33, 40 AND 50). REG. 12-17-2002.
- 2,662,387. CITYMEALS. INT. CLS. 36 AND 42 ONLY. (U.S. CLS. 100, 101 AND 102). REG. 12-17-2002.
- 2,663,378. TIREMAN TORQUE WRENCH. INT. CL. 8. (U.S. CLS. 23, 28 AND 44). REG. 12-17-2002.
- 2,664,274. ELEMIS. INT. CL. 42. (U.S. CLS. 100 AND 101). REG. 12-17-2002.
- 2,664,875. NUTRIENT NEWS. INT. CL. 35. (U.S. CLS. 100, 101 AND 102). REG. 12-17-2002.
- 2,666,109. DICKIES AND DESIGN. INT. CLS. 20 AND 25. (U.S. CLS. 2, 13, 22, 25, 32, 39 AND 50). REG. 12-24-2002.
- 2,666,588. IGUANA ICE WANNA IGUANA? AND DESIGN. INT. CL. 32. (U.S. CLS. 45, 46 AND 48). REG. 12-24-2002.
- 2,666,777. CHICKEN SOUP FOR THE GOLFER'S SOUL. INT. CL. 16. (U.S. CLS. 2, 5, 22, 23, 29, 37, 38 AND 50). REG. 12-24-2002.
- 2,668,273. DAYSPOT. INT. CL. 11. (U.S. CLS. 13, 21, 23, 31 AND 34). REG. 12-31-2002.
- 2,668,279. SEWFREE (STYLIZED). INT. CL. 17. (U.S. CLS. 1, 5, 12, 13, 35 AND 50). REG. 12-31-2002.
- 2,671,231. HUTZLER AND DESIGN. INT. CL. 21. (U.S. CLS. 2, 13, 23, 29, 30, 33, 40 AND 50). REG. 1-7-2003.
- 2,671,864. RENT A FROG. INT. CL. 39. (U.S. CLS. 100 AND 105). REG. 1-7-2003.
- 2,671,958. RTP. INT. CLS. 35 AND 42. (U.S. CLS. 100, 101 AND 102). REG. 1-7-2003.
- 2,672,944. ART-TIME. INT. CL. 16. (U.S. CLS. 2, 5, 22, 23, 29, 37, 38 AND 50). REG. 1-7-2003.
- 2,674,129. RED STAR BRAND RED STAR ER GUO TOU JIU AND DESIGN. INT. CL. 33. (U.S. CLS. 47 AND 49). REG. 1-14-2003.
- 2,674,870. JAMZ. INT. CL. 41. (U.S. CLS. 100, 101 AND 107). REG. 1-14-2003.
- 2,675,475. SMF-28E (STYLIZED). INT. CL. 9. (U.S. CLS. 21, 23, 26, 36 AND 38). REG. 1-14-2003.
- 2,675,534. MYDOCTOR'SDR.. INT. CL. 42. (U.S. CLS. 100 AND 101). REG. 1-14-2003.
- 2,676,269. CREATIVE CRAFT PAINT. INT. CL. 2. (U.S. CLS. 6, 11 AND 16). REG. 1-21-2003.
- 2,676,748. LILACS & PEARLS. INT. CL. 25. (U.S. CLS. 22 AND 39). REG. 1-21-2003.
- 2,676,806. ACTION TARGET. INT. CL. 13. (U.S. CLS. 2 AND 9). REG. 1-21-2003.
- 2,677,461. VALIDATE AND DESIGN. INT. CL. 1. (U.S. CLS. 1, 5, 6, 10, 26 AND 46). REG. 1-21-2003.
- 2,678,214. N S E W AND DESIGN. INT. CL. 16. (U.S. CLS. 2, 5, 22, 23, 29, 37, 38 AND 50). REG. 1-21-2003.
- 2,678,544. THE INTERNET LINK TO HEALTH. INT. CL. 42. (U.S. CLS. 100 AND 101). REG. 1-21-2003.
- 2,678,684. ALFIO MORICONI SELECTION. INT. CL. 33. (U.S. CLS. 47 AND 49). REG. 1-21-2003.
- 2,678,739. CREATEFORLESS. INT. CL. 35. (U.S. CLS. 100, 101 AND 102). REG. 1-21-2003.
- 2,679,068. MUSIC AND THE BRAIN. INT. CL. 41. (U.S. CLS. 100, 101 AND 107). REG. 1-21-2003.
- 2,679,886. PAINLESS WIRING!. INT. CL. 9. (U.S. CLS. 21, 23, 26, 36 AND 38). REG. 1-28-2003.
- 2,680,370. CALIBRA. INT. CL. 10. (U.S. CLS. 26, 39 AND 44). REG. 1-28-2003.
- 2,680,570. ELDORADO COFFEE ROASTERS AND DESIGN. INT. CL. 30. (U.S. CL. 46). REG. 1-28-2003.
- 2,680,844. THE BLOCK SHOP. INT. CL. 19. (U.S. CLS. 1, 12, 33 AND 50). REG. 1-28-2003.
- 2,682,373. MARCH OF DIMES. INT. CL. 28. (U.S. CLS. 22, 23, 38 AND 50). REG. 2-4-2003.
- 2,682,773. GENERAL CASUALTY. INT. CL. 36. (U.S. CLS. 100, 101 AND 102). REG. 2-4-2003.
- 2,682,865. BFDEALS.COM AND DESIGN. INT. CL. 35. (U.S. CLS. 100, 101 AND 102). REG. 2-4-2003.
- 2,683,351. DECRA MOLD. INT. CL. 19. (U.S. CLS. 1, 12, 33 AND 50). REG. 2-4-2003.
- 2,683,396. NO-MITER SYSTEM. INT. CL. 19. (U.S. CLS. 1, 12, 33 AND 50). REG. 2-4-2003.
- 2,683,700. ICBX. INT. CL. 25. (U.S. CLS. 22 AND 39). REG. 2-4-2003.
- 2,684,245. LUXNET. INT. CL. 9. (U.S. CLS. 21, 23, 26, 36 AND 38). REG. 2-4-2003.
- 2,684,644. STEDI-EYE. INT. CL. 9. (U.S. CLS. 21, 23, 26, 36 AND 38). REG. 2-4-2003.
- 2,685,762. SEATTLE CHOCOLATES. INT. CL. 30. (U.S. CL. 46). REG. 2-11-2003.
- 2,686,000. AUTOMOTIVE RESOURCES INTERNATIONAL ARI AND DESIGN. INT. CL. 35. (U.S. CLS. 100, 101 AND 102). REG. 2-11-2003.
- 2,686,073. WORKCOMP CENTRAL. INT. CL. 35. (U.S. CLS. 100, 101 AND 102). REG. 2-11-2003.
- 2,688,305. JL AND DESIGN. INT. CL. 35. (U.S. CLS. 100, 101 AND 102). REG. 2-18-2003.
- 2,688,553. CUBAN HONEY'S! AND DESIGN. INT. CL. 34. (U.S. CLS. 2, 8, 9 AND 17). REG. 2-18-2003.
- 2,689,325. TUFF SPORT. INT. CL. 9. (U.S. CLS. 21, 23, 26, 36 AND 38). REG. 2-18-2003.
- 2,690,855. ARBUTUS. INT. CLS. 9 AND 14. (U.S. CLS. 2, 21, 23, 26, 27, 28, 36, 38 AND 50). REG. 2-25-2003.
- 2,691,219. ECLIPSE. INT. CL. 1. (U.S. CLS. 1, 5, 6, 10, 26 AND 46). REG. 2-25-2003.
- 2,692,651. FRANTZ WARD. INT. CL. 42. (U.S. CLS. 100 AND 101). REG. 3-4-2003.
- 2,693,276. ABLE EYES. INT. CL. 5. (U.S. CLS. 6, 18, 44, 46, 51 AND 52). REG. 3-4-2003.
- 2,694,511. MI (STYLIZED). INT. CL. 35. (U.S. CLS. 100, 101 AND 102). REG. 3-11-2003.
- 2,694,650. FLYING BIKES. INT. CL. 25. (U.S. CLS. 22 AND 39). REG. 3-11-2003.
- 2,694,707. YOUR FIRST PLACE ON THE INTERNET. INT. CL. 42. (U.S. CLS. 100 AND 101). REG. 3-11-2003.
- 2,695,146. DOC HOLLYWOOD. INT. CL. 41. (U.S. CLS. 100, 101 AND 107). REG. 3-11-2003.
- 2,695,278. PGB TRUST & INVESTMENTS. INT. CL. 36. (U.S. CLS. 100, 101 AND 102). REG. 3-11-2003.
- 2,695,703. LIZARD LIPS. INT. CL. 3. (U.S. CLS. 1, 4, 6, 50, 51 AND 52). REG. 3-11-2003.
- 2,695,799. DISCOVERY CONCERT. INT. CL. 41. (U.S. CLS. 100, 101 AND 107). REG. 3-11-2003.
- 2,695,904. WAGWORKS. INT. CL. 9. (U.S. CLS. 21, 23, 26, 36 AND 38). REG. 3-11-2003.
- 2,695,994. CERTIFIED PLUS. INT. CL. 1. (U.S. CLS. 1, 5, 6, 10, 26 AND 46). REG. 3-11-2003.

- 2,696,528. BALANCE AND BURN. INT. CL. 5. (U.S. CLS. 6, 18, 44, 46, 51 AND 52). REG. 3-11-2003.
- 2,697,897. VA VISUALAPEX AND DESIGN. INT. CL. 35. (U.S. CLS. 100, 101 AND 102). REG. 3-18-2003.
- 2,698,036. SLYCE. INT. CL. 9. (U.S. CLS. 21, 23, 26, 36 AND 38). REG. 3-18-2003.
- 2,699,078. MISCELLANEOUS DESIGN. INT. CL. 9. (U.S. CLS. 21, 23, 26, 36 AND 38). REG. 3-25-2003.
- 2,699,136. HARMONIC ATTUNEMENT. INT. CL. 41. (U.S. CLS. 100, 101 AND 107). REG. 3-25-2003.
- 2,700,006. SPEEDNEWS. INT. CL. 35. (U.S. CLS. 100, 101 AND 102). REG. 3-25-2003.
- 2,700,164. WORTH GROUP. INT. CLS. 37 AND 42. (U.S. CLS. 100, 101, 103 AND 106). REG. 3-25-2003.
- 2,701,050. TIENET. INT. CL. 9. (U.S. CLS. 21, 23, 26, 36 AND 38). REG. 3-25-2003.
- 2,701,053. OATSWEET. INT. CL. 30. (U.S. CL. 46). REG. 3-25-2003.
- 2,701,296. ENCLOS. INT. CLS. 37, 40 AND 42. (U.S. CLS. 100, 101, 103 AND 106). REG. 3-25-2003.
- 2,702,167. NTW (STYLIZED). INT. CL. 9. (U.S. CLS. 21, 23, 26, 36 AND 38). REG. 4-1-2003.
- 2,702,353. EASY CARE. INT. CL. 36. (U.S. CLS. 100, 101 AND 102). REG. 4-1-2003.
- 2,702,664. ESCAPE FROM FORT DELAWARE. INT. CL. 41. (U.S. CLS. 100, 101 AND 107). REG. 4-1-2003.
- 2,703,482. PRIMAX. INT. CL. 36. (U.S. CLS. 100, 101 AND 102). REG. 4-8-2003.
- 2,703,488. ARISTOTLE. INT. CL. 42. (U.S. CLS. 100 AND 101). REG. 4-8-2003.
- 2,703,624. DAYTON AUDIO. INT. CL. 9. (U.S. CLS. 21, 23, 26, 36 AND 38). REG. 4-8-2003.
- 2,704,209. V AND DESIGN. INT. CL. 44. (U.S. CLS. 100 AND 101). REG. 4-8-2003.
- 2,704,234. HEALTH CAP. INT. CL. 36. (U.S. CLS. 100, 101 AND 102). REG. 4-8-2003.
- 2,704,303. NIVEOUS (STYLIZED). INT. CL. 10. (U.S. CLS. 26, 39 AND 44). REG. 4-8-2003.
- 2,704,853. HELIFLOW. INT. CL. 11. (U.S. CLS. 13, 21, 23, 31 AND 34). REG. 4-8-2003.
- 2,704,913. VERTEX. INT. CL. 5. (U.S. CLS. 6, 18, 44, 46, 51 AND 52). REG. 4-8-2003.
- 2,705,216. SFLOW. INT. CL. 9. (U.S. CLS. 21, 23, 26, 36 AND 38). REG. 4-8-2003.
- 2,705,331. THE FIXX. INT. CL. 5. (U.S. CLS. 6, 18, 44, 46, 51 AND 52). REG. 4-8-2003.
- 2,706,284. RPBW (STYLIZED). INT. CLS. 37 AND 42. (U.S. CLS. 100, 101, 103 AND 106). REG. 4-15-2003.
- 2,706,654. JDI AND DESIGN. INT. CL. 42. (U.S. CLS. 100 AND 101). REG. 4-15-2003.
- 2,706,672. REX PLUS. INT. CL. 9. (U.S. CLS. 21, 23, 26, 36 AND 38). REG. 4-15-2003.
- 2,706,724. MISCELLANEOUS DESIGN. INT. CL. 43. (U.S. CLS. 100 AND 101). REG. 4-15-2003.
- 2,707,034. THE PALACE COURT. INT. CL. 41. (U.S. CLS. 100, 101 AND 107). REG. 4-15-2003.
- 2,707,822. JOINTAGEN. INT. CL. 5. (U.S. CLS. 6, 18, 44, 46, 51 AND 52). REG. 4-15-2003.
- 2,709,268. AMERICAN INDUSTRIAL SERVICES AND DESIGN. INT. CLS. 39 AND 40. (U.S. CLS. 100, 103, 105 AND 106). REG. 4-22-2003.
- 2,709,582. THE ULTIMATE DIET DRINK. INT. CL. 31. (U.S. CLS. 1 AND 46). REG. 4-22-2003.
- 2,710,769. AMERICAN RAG CIE. INT. CL. 25. (U.S. CLS. 22 AND 39). REG. 4-29-2003.
- 2,710,774. PGO. INT. CL. 12. (U.S. CLS. 19, 21, 23, 31, 35 AND 44). REG. 4-29-2003.
- 2,710,830. POLYNESIAN AIRLINE OF SAMOA. INT. CL. 39. (U.S. CLS. 100 AND 105). REG. 4-29-2003.
- 2,711,056. EM ENGLISH MOUNTAIN SPRING WATER CO. (STYLIZED). INT. CL. 40. (U.S. CLS. 100, 103 AND 106). REG. 4-29-2003.
- 2,711,178. SOUNDSTREAM. INT. CL. 9. (U.S. CLS. 21, 23, 26, 36 AND 38). REG. 4-29-2003.
- 2,711,894. GTT. INT. CL. 36. (U.S. CLS. 100, 101 AND 102). REG. 4-29-2003.
- 2,711,910. SLINGCHUTE. INT. CL. 28. (U.S. CLS. 22, 23, 38 AND 50). REG. 4-29-2003.
- 2,711,978. SCHOLASTIC. INT. CL. 41. (U.S. CLS. 100, 101 AND 107). REG. 4-29-2003.
- 2,712,672. MAR BRAND AND DESIGN. INT. CL. 29. (U.S. CL. 46). REG. 5-6-2003.
- 2,712,864. MISCELLANEOUS DESIGN. INT. CL. 31. (U.S. CLS. 1 AND 46). REG. 5-6-2003.
- 2,713,032. TIMBERLINE. INT. CL. 35. (U.S. CLS. 100, 101 AND 102). REG. 5-6-2003.
- 2,713,065. RELCO. INT. CLS. 6, 7, 9, 40 AND 42. (U.S. CLS. 2, 12, 13, 14, 19, 21, 23, 25, 26, 31, 34, 35, 36, 38, 50, 100, 101, 103 AND 106). REG. 5-6-2003.
- 2,713,066. RUC AND DESIGN. INT. CLS. 6, 7, 9, 40 AND 42. (U.S. CLS. 2, 12, 13, 14, 19, 21, 23, 25, 26, 31, 34, 35, 36, 38, 50, 100, 101, 103 AND 106). REG. 5-6-2003.
- 2,713,651. FREEWAY. INT. CL. 9. (U.S. CLS. 21, 23, 26, 36 AND 38). REG. 5-6-2003.
- 2,713,657. COSMIC BREEZE. INT. CL. 20. (U.S. CLS. 2, 13, 22, 25, 32 AND 50). REG. 5-6-2003.
- 2,713,727. LEGAL SEA FOODS. INT. CL. 30 ONLY. (U.S. CL. 46). REG. 5-6-2003.
- 2,713,892. INFOMEDIARY. INT. CL. 36. (U.S. CLS. 100, 101 AND 102). REG. 5-6-2003.
- 2,713,905. TRICOM. INT. CL. 9. (U.S. CLS. 21, 23, 26, 36 AND 38). REG. 5-6-2003.
- 2,714,366. VAPOR PRO RX. INT. CL. 10. (U.S. CLS. 26, 39 AND 44). REG. 5-6-2003.
- 2,714,461. PROLIGN. INT. CL. 10. (U.S. CLS. 26, 39 AND 44). REG. 5-6-2003.
- 2,715,002. RESOURCE OF FIRST CHOICE. INT. CL. 36. (U.S. CLS. 100, 101 AND 102). REG. 5-13-2003.
- 2,715,067. COMPASSION IN ACTION. INT. CL. 42. (U.S. CLS. 100 AND 101). REG. 5-13-2003.
- 2,715,676. HARMONIC VISION. INT. CL. 9. (U.S. CLS. 21, 23, 26, 36 AND 38). REG. 5-13-2003.
- 2,715,894. SLEEP STIMULUS. INT. CL. 20. (U.S. CLS. 2, 13, 22, 25, 32 AND 50). REG. 5-13-2003.
- 2,716,014. SOFT TOUCH. INT. CL. 7. (U.S. CLS. 13, 19, 21, 23, 31, 34 AND 35). REG. 5-13-2003.
- 2,716,606. MOVING AHEAD TO RELIEVE JOINT DISEASES. INT. CL. 42. (U.S. CLS. 100 AND 101). REG. 5-13-2003.
- 2,717,570. CHANTAL. INT. CL. 20. (U.S. CLS. 2, 13, 22, 25, 32 AND 50). REG. 5-20-2003.

* * * * *

TRADEMARK REGISTRATIONS CANCELED

The designation "U.S. Cl." appearing in this section refers to the U.S. class in effect prior to Sep. 1, 1973 rather than the international class which applies to applications filed on or after that date. For adoption of international classification see notice in the OFFICIAL GAZETTE of Jun. 26, 1973 (911 O.G. TM 210).

SECTION 7(D)

1,185,153.	WASHCO AND DESIGN.	501,699.	KABON. U.S. CL. 6. REG. 8-17-1948.
1,701,282.	PRESSTEK.	501,998.	KOWLYK (STYLIZED). U.S. CL. 46. REG. 9-7-1948.
2,602,017.	AXELINA. INT. CL. 16. REG. 7-30-2002.	502,019.	BANJO AND DESIGN. U.S. CL. 17. REG. 9-7-1948.
2,966,955.	DRONEVER STANDARD CHARACTER MARK. INT. CL. 5. REG. 7-12-2005.	502,067.	VULCA (STYLIZED). U.S. CL. 6. REG. 9-14-1948.
3,007,023.	WEBCAMPUS (STYLIZED). INT. CL. 16. REG. 10-18-2005.	502,069.	COW (STYLIZED). U.S. CL. 6. REG. 9-14-1948.
3,007,067.	T-HOTSPOT (STYLIZED). INT. CL. 42. REG. 10-18-2005.	502,103.	KS AND DESIGN. U.S. CL. 35. REG. 9-14-1948.
3,008,694.	MISCELLANEOUS DESIGN. INT. CL. 38. REG. 10-25-2005.	502,264.	COW BRAND (STYLIZED). U.S. CL. 6. REG. 9-21-1948.
3,019,586.	GO-GO. INT. CLS. 20 AND 27. REG. 11-29-2005.	502,265.	COW (STYLIZED). U.S. CL. 46. REG. 9-21-1948.
3,064,196.	EPITOME STANDARD CHARACTER MARK. INT. CLS. 6 AND 21. REG. 2-28-2006.	502,288.	VISTEX (STYLIZED). U.S. CL. 50. REG. 9-21-1948.
3,147,229.	PREPPY PUPPY AND DESIGN. INT. CL. 31. REG. 9-26-2006.	502,356.	KELLY SPRINGFIELD (STYLIZED). U.S. CL. 35. REG. 9-21-1948.
3,374,298.	BD ATOMIC EDGE AND DESIGN. INT. CL. 10. REG. 1-22-2008.	502,481.	V (STYLIZED). U.S. CL. 26. REG. 9-28-1948.
3,873,893.	TRUSTY VET STANDARD CHARACTER MARK. INT. CL. 43 ONLY. REG. 11-9-2010.	502,904.	RICHARDSON AND DESIGN. U.S. CL. 45. REG. 10-12-1948.
3,889,326.	ROUGH LUXE AND DESIGN. INT. CL. 33 ONLY. REG. 12-14-2010.	502,936.	FARRINGTON (STYLIZED). U.S. CL. 2. REG. 10-12-1948.
3,897,894.	CLEANCHECK STANDARD CHARACTER MARK. INT. CL. 11. REG. 12-28-2010.	503,065.	WAVESETTA (STYLIZED). U.S. CL. 40. REG. 10-19-1948.
3,959,706.	MAX'S CORNER BAKERY STANDARD CHARACTER MARK. INT. CL. 30. REG. 5-10-2011.	503,092.	INDRALATUM (STYLIZED). U.S. CL. 15. REG. 10-19-1948.
4,124,457.	MAKI MADNESS STANDARD CHARACTER MARK. INT. CL. 41. REG. 4-10-2012.	503,191.	MARACELL (STYLIZED). U.S. CL. 6. REG. 10-19-1948.

SECTION 8

127,985.	"BIG YANK". U.S. CL. 39. REG. 12-16-1919.	503,584.	MISCELLANEOUS DESIGN. U.S. CL. 38. REG. 11-2-1948.
246,722.	SUNARC. U.S. CL. 44. REG. 9-11-1928.	503,620.	WRIGHT'S HEALTH UNDERWEAR AND DESIGN. U.S. CL. 39. REG. 11-2-1948.
247,181.	SOLARC. U.S. CL. 44. REG. 9-25-1928.	503,869.	COW (STYLIZED). U.S. CL. 52. REG. 11-16-1948.
250,435.	KWIKSOLV (STYLIZED). U.S. CL. 52. REG. 12-11-1928.	503,871.	COW BRAND (STYLIZED). U.S. CL. 52. REG. 11-16-1948.
250,601.	KNIGHT-O-REST AND DESIGN. U.S. CL. 32. REG. 12-11-1928.	503,877.	DAZOR FLOATING FIXTURE (STYLIZED). U.S. CL. 21. REG. 11-16-1948.
250,691.	FEEN-A-MINT AND DESIGN. U.S. CL. 18. REG. 12-11-1928.	503,951.	COTY AND DESIGN. U.S. CL. 51. REG. 11-16-1948.
251,201.	ALLIGATOR (STYLIZED). U.S. CL. 39. REG. 1-1-1929.	504,039.	KANT-SLIP (STYLIZED). U.S. CL. 35. REG. 11-16-1948.
251,257.	FIRST LADY (STYLIZED). U.S. CL. 42. REG. 1-1-1929.	504,066.	CORDLEY (STYLIZED). U.S. CL. 31. REG. 11-23-1948.
440,911.	BRANDY PROCER BRANDY PROCER CARBONELL Y CO. DE CORDOBA, S.A. AND DESIGN. U.S. CL. 49. REG. 10-12-1948.	504,340.	ALPENOPAKE. U.S. CL. 37. REG. 11-30-1948.
441,043.	SUNTAO (STYLIZED). U.S. CL. 15. REG. 10-19-1948.	504,752.	COW BRAND (STYLIZED). U.S. CL. 46. REG. 12-14-1948.
441,349.	SAFeway NEWS (STYLIZED). U.S. CL. 38. REG. 11-16-1948.	504,854.	C & NW (STYLIZED). U.S. CL. 105. REG. 12-14-1948.
441,766.	KOROSEAL (STYLIZED). U.S. CL. 1. REG. 1-4-1949.	504,858.	HARDWARE MUTUALS (STYLIZED). U.S. CL. 102. REG. 12-14-1948.
501,455.	AUTOTECHNICON. U.S. CL. 26. REG. 8-10-1948.	504,937.	JUNIATA (STYLIZED). INT. CL. 1. REG. 12-21-1948.
501,533.	GREEN TURTLE. U.S. CL. 17. REG. 8-10-1948.	504,995.	STELCON. U.S. CL. 12. REG. 12-21-1948.
		505,009.	SEA MAGIC. U.S. CL. 46. REG. 12-21-1948.
		505,077.	DERMATERGENT. U.S. CL. 52. REG. 12-21-1948.
		505,302.	A-535. U.S. CL. 18. REG. 12-28-1948.
		505,508.	HOME OF THE YES MAN (STYLIZED). U.S. CL. 102. REG. 1-4-1949.
		505,618.	THE COMPANY THAT LIKES TO SAY YES. U.S. CL. 102. REG. 1-11-1949.
		505,673.	EXCELLENCY. U.S. CL. 27. REG. 1-18-1949.
		505,963.	OWENS OVALS. U.S. CL. 33. REG. 1-25-1949.
		571,130.	SHELL OUTS. U.S. CL. 46. REG. 2-24-1953.
		697,005.	NEODECADRON (STYLIZED). U.S. CL. 18. REG. 5-3-1960.
		703,160.	PERIACTIN. U.S. CL. 18. REG. 8-23-1960.
		762,562.	NIZ. U.S. CL. 6. REG. 1-7-1964.

- 779,739. BYCOSIN AND DESIGN. U.S. CL. 15. REG. 11-10-1964.
- 779,740. BYCOSIN. U.S. CL. 15. REG. 11-10-1964.
- 780,079. WHIP-O (STYLIZED). U.S. CL. 46. REG. 11-10-1964.
- 780,113. RESOGEN. U.S. CL. 6. REG. 11-17-1964.
- 780,385. OLGA AND DESIGN. U.S. CL. 39. REG. 11-17-1964.
- 780,468. QUICK TYPE AND DESIGN. U.S. CL. 14. REG. 11-17-1964.
- 780,532. CHEM-SILATE. U.S. CL. 6. REG. 11-24-1964.
- 781,295. TEN AND DESIGN. U.S. CL. 21. REG. 12-8-1964.
- 781,529. ANGLE-CUT. INT. CL. 1. REG. 12-8-1964.
- 781,744. FABRI-COMB. U.S. CL. 29. REG. 12-15-1964.
- 781,979. MISCELLANEOUS DESIGN. U.S. CL. 21. REG. 12-22-1964.
- 802,426. SAN ANDRES TOBACCO. U.S. CL. 17. REG. 1-18-1966.
- 810,949. PUNCHEON SELECTION (STYLIZED). U.S. CL. 17. REG. 7-12-1966.
- 848,256. SAY "CHEESE" AND DESIGN. U.S. CL. 46. REG. 4-30-1968.
- 853,912. NORCO. U.S. CL. 2. REG. 8-6-1968.
- 853,936. BEACON. U.S. CL. 6. REG. 8-6-1968.
- 854,010. RANCHEROS. U.S. CL. 17. REG. 8-6-1968.
- 854,014. DINO. U.S. CL. 17. REG. 8-6-1968.
- 854,084. KELGRAF. U.S. CL. 23. REG. 8-6-1968.
- 854,151. ACIDOX. U.S. CL. 31. REG. 8-6-1968.
- 854,222. BLACKER. U.S. CL. 39. REG. 8-6-1968.
- 854,227. PRIZE POSSESSIONS. U.S. CL. 39. REG. 8-6-1968.
- 854,311. MAKE OVER. U.S. CL. 51. REG. 8-6-1968.
- 854,316. DISPOS-A-PAD. U.S. CL. 51. REG. 8-6-1968.
- 854,412. SCOTT. U.S. CL. 2. REG. 8-13-1968.
- 854,458. FABRIFORM. U.S. CL. 12. REG. 8-13-1968.
- 854,503. CAMACO. U.S. CL. 14. REG. 8-13-1968.
- 854,580. S SUNDSTRAND AND DESIGN. U.S. CL. 23. REG. 8-13-1968.
- 854,602. HANIMEX. U.S. CL. 26. REG. 8-13-1968.
- 854,628. QUICKI-DEX. U.S. CL. 37. REG. 8-13-1968.
- 854,629. RED SNAPPER. U.S. CL. 37. REG. 8-13-1968.
- 854,675. SEA & SKI. U.S. CL. 39. REG. 8-13-1968.
- 854,677. SALTY DOG. U.S. CL. 39. REG. 8-13-1968.
- 854,692. NPC. U.S. CL. 39. REG. 8-13-1968.
- 854,696. THE TOTALLY TERRIFICS. U.S. CL. 39. REG. 8-13-1968.
- 854,700. THE GLOW-TOGETHERS. U.S. CL. 39. REG. 8-13-1968.
- 854,928. GRO-N-GRAZE (STYLIZED). U.S. CL. 1. REG. 8-20-1968.
- 854,945. LIFE STRIDE. U.S. CL. 3. REG. 8-20-1968.
- 855,033. SEAELECTROSWITCH AND DESIGN. U.S. CL. 21. REG. 8-20-1968.
- 855,125. STENSO. U.S. CL. 38. REG. 8-20-1968.
- 855,166. BURLINGTON AND DESIGN. U.S. CL. 43. REG. 8-20-1968.
- 855,169. PENGUIN. U.S. CL. 45. REG. 8-20-1968.
- 855,247. FRESH DAY. U.S. CL. 51. REG. 8-20-1968.
- 855,279. SIRLOIN STOCKADE AND DESIGN. U.S. CL. 100. REG. 8-20-1968.
- 855,427. CANCER. U.S. CL. 17. REG. 8-27-1968.
- 855,437. FP-BLEN. U.S. CL. 18. REG. 8-27-1968.
- 855,478. CENTRAX. U.S. CLS. 21 AND 23. REG. 8-27-1968.
- 855,481. SEAELECTROBOARD AND DESIGN. U.S. CL. 21. REG. 8-27-1968.
- 855,521. RECIPROMATIC (STYLIZED). U.S. CL. 23. REG. 8-27-1968.
- 855,610. CROSS HATCH (STYLIZED). U.S. CL. 39. REG. 8-27-1968.
- 855,792. FLORALTONE. U.S. CL. 10. REG. 9-3-1968.
- 855,897. VU FINDER (STYLIZED). U.S. CL. 21. REG. 9-3-1968.
- 855,952. TJ AND DESIGN. U.S. CL. 23. REG. 9-3-1968.
- 856,109. C AND DESIGN. U.S. CL. 46. REG. 9-3-1968.
- 856,145. COMMENT COFFEE. U.S. CL. 46. REG. 9-3-1968.
- 856,158. RESERVE DU DOMAINE. U.S. CL. 47. REG. 9-3-1968.
- 856,161. SOHO (STYLIZED). U.S. CL. 49. REG. 9-3-1968.
- 856,180. ETERNALLY EVE. U.S. CL. 51. REG. 9-3-1968.
- 856,333. SUPREMETAL AND DESIGN. U.S. CL. 13. REG. 9-10-1968.
- 856,406. ISOTHERM. U.S. CL. 21. REG. 9-10-1968.
- 856,467. CARPENTER'S PRIDE (STYLIZED). U.S. CL. 23. REG. 9-10-1968.
- 856,472. FANTASY. U.S. CL. 23. REG. 9-10-1968.
- 856,522. DUKE AND DESIGN. U.S. CL. 35. REG. 9-10-1968.
- 856,611. PORT COAT. U.S. CL. 39. REG. 9-10-1968.
- 856,615. PHILADELPHIA 76ER AND DESIGN. U.S. CL. 39. REG. 9-10-1968.
- 856,665. DUBUQUE FLEUR DE LIS AND DESIGN. U.S. CL. 46. REG. 9-10-1968.
- 856,707. BLAZE. U.S. CL. 51. REG. 9-10-1968.
- 856,819. GRIPNEAT. U.S. CL. 2. REG. 9-17-1968.
- 856,902. HISTABID. U.S. CL. 18. REG. 9-17-1968.
- 856,939. DIGARD. U.S. CL. 21. REG. 9-17-1968.
- 856,987. DREXAMATIC. U.S. CL. 23. REG. 9-17-1968.
- 856,993. MISCELLANEOUS DESIGN. U.S. CL. 23. REG. 9-17-1968.
- 856,994. LILY (STYLIZED). U.S. CL. 23. REG. 9-17-1968.
- 856,995. LILY. U.S. CL. 23. REG. 9-17-1968.
- 856,996. LILY AND DESIGN. U.S. CL. 23. REG. 9-17-1968.
- 857,029. GYROFREEZE. U.S. CL. 31. REG. 9-17-1968.
- 857,090. ROYAL KNIGHT. U.S. CL. 41. REG. 9-17-1968.
- 857,406. SLIMLINE. U.S. CL. 21. REG. 9-24-1968.
- 857,487. XL FORMULA 100 AND DESIGN. U.S. CL. 35. REG. 9-24-1968.
- 857,508. COLORTONE. U.S. CL. 37. REG. 9-24-1968.
- 857,729. ACTIBON. U.S. CL. 6. REG. 10-1-1968.
- 857,746. PLYSTRAN. U.S. CL. 6. REG. 10-1-1968.
- 857,773. SHASTA-KAST. U.S. CL. 12. REG. 10-1-1968.
- 857,774. LINCOLN. U.S. CL. 12. REG. 10-1-1968.
- 857,775. GREENSTRIPE. U.S. CL. 12. REG. 10-1-1968.
- 857,787. SPRING SHOWERS. U.S. CLS. 13 AND 35. REG. 10-1-1968.
- 857,794. DESOFLUR. U.S. CL. 16. REG. 10-1-1968.
- 857,830. STRATOCLAD. U.S. CL. 21. REG. 10-1-1968.
- 857,855. THRUMMING. U.S. CL. 22. REG. 10-1-1968.
- 857,987. CAROSET. U.S. CL. 42. REG. 10-1-1968.
- 858,248. CIP. U.S. CL. 23. REG. 10-8-1968.
- 858,349. FESTIVAL. U.S. CL. 46. REG. 10-8-1968.
- 858,388. FOODMAKER. U.S. CL. 100. REG. 10-8-1968.
- 858,399. PARAPHERNALIA. U.S. CL. 101. REG. 10-8-1968.
- 858,439. INDAR TEA INDAR THE INDAR BOUDOIR TEA AND DESIGN. U.S. CL. 46. REG. 10-8-1968.
- 858,447. SMELL SWEET (STYLIZED). U.S. CL. 51. REG. 10-8-1968.
- 858,687. LANCER AND DESIGN. U.S. CL. 100. REG. 10-15-1968.
- 858,746. BISOSPRAY (STYLIZED). U.S. CL. 4. REG. 10-22-1968.
- 858,800. HOME PRIDE AND DESIGN. U.S. CL. 14. REG. 10-22-1968.
- 858,811. HMS. U.S. CL. 18. REG. 10-22-1968.
- 858,815. LIQUITAB. U.S. CL. 18. REG. 10-22-1968.
- 858,891. DRI-FLO. U.S. CL. 23. REG. 10-22-1968.
- 858,927. TOUCH ALARM. U.S. CL. 27. REG. 10-22-1968.
- 858,995. MOORESVILLE AND DESIGN. U.S. CL. 42. REG. 10-22-1968.
- 859,065. RESPOND. U.S. CL. 52. REG. 10-22-1968.
- 859,106. MISCELLANEOUS DESIGN. U.S. CL. 200. REG. 10-22-1968.
- 859,127. SHAKE'N FRY. U.S. CL. 46. REG. 10-22-1968.
- 859,143. EISENHOWER COLLEGE. U.S. CL. 107. REG. 10-22-1968.
- 859,325. STARDUST. U.S. CL. 38. REG. 10-29-1968.
- 859,350. JOYCE OF CALIFORNIA (STYLIZED). U.S. CL. 39. REG. 10-29-1968.
- 859,428. BONAPARTE. U.S. CL. 49. REG. 10-29-1968.
- 859,463. INTERCONTINENTAL. U.S. CL. 100. REG. 10-29-1968.
- 859,483. RCA (STYLIZED). U.S. CL. 103. REG. 10-29-1968.
- 859,484. RCA. U.S. CL. 103. REG. 10-29-1968.
- 859,520. ETHYL. U.S. CL. 6. REG. 11-5-1968.
- 859,613. CARIBBEAN. U.S. CL. 20. REG. 11-5-1968.
- 859,614. VENTURA. U.S. CL. 20. REG. 11-5-1968.
- 859,630. F AND DESIGN. U.S. CL. 21. REG. 11-5-1968.
- 859,667. NAUTILUS. U.S. CL. 23. REG. 11-5-1968.

859,678. TACH-TROL. U.S. CL. 26. REG. 11-5-1968.
 859,703. POLYGLAS (STYLIZED). U.S. CL. 35. REG. 11-5-1968.
 859,814. MR. STEAK. U.S. CL. 100. REG. 11-5-1968.
 859,821. CONSEL XICOM CONFRONTATION SEARCH LABORATORY AND DESIGN. U.S. CL. 101. REG. 11-5-1968.
 859,835. TUBOSCAN. U.S. CL. 103. REG. 11-5-1968.
 859,908. DETRON-D. U.S. CL. 6. REG. 11-12-1968.
 859,941. PLA-BORDER. U.S. CL. 13. REG. 11-12-1968.
 860,081. COLONY HOUSE. U.S. CL. 34. REG. 11-12-1968.
 860,086. G800 (STYLIZED). U.S. CL. 35. REG. 11-12-1968.
 860,094. EMPIRE. U.S. CL. 36. REG. 11-12-1968.
 860,104. MISCELLANEOUS DESIGN. U.S. CL. 37. REG. 11-12-1968.
 860,111. CAMERATA. U.S. CL. 37. REG. 11-12-1968.
 860,150. GLAMOUR-KNIT (STYLIZED). U.S. CL. 39. REG. 11-12-1968.
 860,266. SAMBUCA ROMANA. U.S. CL. 49. REG. 11-12-1968.
 860,271. SOUTHERN SOUR MASH. U.S. CL. 49. REG. 11-12-1968.
 860,273. XL AND DESIGN. U.S. CL. 49. REG. 11-12-1968.
 860,288. GET SET. U.S. CLS. 51 AND 52. REG. 11-12-1968.
 860,304. NIC INTERFRATERNITY AND DESIGN. U.S. CL. 100. REG. 11-12-1968.
 860,349. PIDDLE-PAK. U.S. CL. 44. REG. 11-12-1968.
 860,418. XP 400 RUST RESIST. U.S. CL. 16. REG. 11-19-1968.
 860,419. XP 300 MET-L PRO-TEC. U.S. CL. 16. REG. 11-19-1968.
 860,512. BRISTOLINE. U.S. CL. 26. REG. 11-19-1968.
 860,519. XACTOHM. U.S. CL. 26. REG. 11-19-1968.
 860,534. LINDOR. U.S. CL. 28. REG. 11-19-1968.
 860,784. AJAX. U.S. CL. 4. REG. 11-26-1968.
 861,294. LINCOCIN FORTE. U.S. CL. 18. REG. 12-3-1968.
 861,305. VISTA. U.S. CL. 19. REG. 12-3-1968.
 861,351. MSE AND DESIGN. U.S. CL. 26. REG. 12-3-1968.
 861,359. BRINN'S. U.S. CL. 30. REG. 12-3-1968.
 861,477. ZAMBRA. U.S. CL. 51. REG. 12-3-1968.
 861,487. CURTISOL. U.S. CL. 52. REG. 12-3-1968.
 861,581. YOUNG PEOPLE. U.S. CL. 18. REG. 12-10-1968.
 861,629. LIHIT. U.S. CL. 23. REG. 12-10-1968.
 861,687. FONTANA AND DESIGN. U.S. CL. 36. REG. 12-10-1968.
 861,696. ALCO AND DESIGN. U.S. CL. 37. REG. 12-10-1968.
 861,868. CONTROMATICS. U.S. CL. 13. REG. 12-17-1968.
 862,032. STYLIST (STYLIZED). U.S. CL. 40. REG. 12-17-1968.
 862,090. HEAVENLY LOAF. U.S. CL. 46. REG. 12-17-1968.
 862,201. MISCELLANEOUS DESIGN. U.S. CL. 1. REG. 12-24-1968.
 862,249. ITHACAGUN AND DESIGN. U.S. CL. 9. REG. 12-24-1968.
 862,261. MISCELLANEOUS DESIGN. U.S. CL. 12. REG. 12-24-1968.
 862,286. REWARD. U.S. CL. 17. REG. 12-24-1968.
 862,293. STIM-O-STAM. U.S. CL. 18. REG. 12-24-1968.
 862,299. HATTERAS AND DESIGN. U.S. CL. 19. REG. 12-24-1968.
 862,308. HP AND DESIGN. U.S. CLS. 21, 26 AND 44. REG. 12-24-1968.
 862,314. PRO-TEK-ALL AND DESIGN. U.S. CL. 21. REG. 12-24-1968.
 862,409. ROLL-A-FLOW (STYLIZED). U.S. CL. 34. REG. 12-24-1968.
 862,413. CLUB AND DESIGN. U.S. CL. 35. REG. 12-24-1968.
 862,436. TRADE WINDS (STYLIZED). U.S. CL. 38. REG. 12-24-1968.
 862,455. "KIPPER". U.S. CL. 39. REG. 12-24-1968.
 862,523. STEAK AND ALE (STYLIZED). U.S. CL. 100. REG. 12-24-1968.
 862,658. RCA. U.S. CL. 21. REG. 12-31-1968.
 862,705. ALCO AND DESIGN. U.S. CL. 26. REG. 12-31-1968.
 862,843. UNOX. U.S. CL. 46. REG. 12-31-1968.
 862,857. NATURALLY BLONDE. U.S. CL. 51. REG. 12-31-1968.
 862,870. DEMOLISH. U.S. CL. 52. REG. 12-31-1968.
 862,883. RR (STYLIZED). U.S. CLS. 100 AND 101. REG. 12-31-1968.
 862,899. THE EVERYTHING CARD. U.S. CL. 102. REG. 12-31-1968.
 862,928. OUTSTANDING YOUNG WOMEN OF AMERICA (STYLIZED). U.S. CL. 38. REG. 12-31-1968.
 862,982. MILOGARD. U.S. CL. 6. REG. 1-7-1969.
 863,111. TASCO AND DESIGN. U.S. CL. 26. REG. 1-7-1969.
 863,117. BOOMERANG (STYLIZED). U.S. CL. 26. REG. 1-7-1969.
 863,170. RCA. U.S. CL. 38. REG. 1-7-1969.
 863,207. LEAPIN LEMON AND DESIGN. U.S. CL. 45. REG. 1-7-1969.
 863,220. LACTACEL. U.S. CL. 46. REG. 1-7-1969.
 863,226. JIM DANDY AND DESIGN. U.S. CL. 46. REG. 1-7-1969.
 863,297. DUB'L SEAL. U.S. CL. 2. REG. 1-7-1969.
 863,316. COURNAND. U.S. CL. 44. REG. 1-7-1969.
 863,351. MISS BERGDORF. U.S. CLS. 3 AND 39. REG. 1-14-1969.
 863,375. HARMIX FEP. U.S. CL. 12. REG. 1-14-1969.
 863,492. QUIK PIK. U.S. CL. 23. REG. 1-14-1969.
 863,515. BENNINGTON. U.S. CL. 32. REG. 1-14-1969.
 863,566. RESUME (STYLIZED). U.S. CL. 39. REG. 1-14-1969.
 863,580. MELOTUK. U.S. CL. 43. REG. 1-14-1969.
 863,801. TAGUS. U.S. CL. 13. REG. 1-21-1969.
 863,815. FLUISIL. U.S. CL. 15. REG. 1-21-1969.
 863,821. SCORBATE. U.S. CL. 18. REG. 1-21-1969.
 863,830. TRAMISOL. U.S. CL. 18. REG. 1-21-1969.
 863,845. CIRCLE F. U.S. CL. 21. REG. 1-21-1969.
 863,967. SHAGGY KNIT. U.S. CL. 39. REG. 1-21-1969.
 863,993. MANGANARO'S HERO BOY AND DESIGN. U.S. CL. 46. REG. 1-21-1969.
 864,007. POLY BLOND. U.S. CLS. 51 AND 52. REG. 1-21-1969.
 864,036. LE BARON. U.S. CL. 100. REG. 1-21-1969.
 864,053. COACH AND DESIGN. U.S. CL. 103. REG. 1-21-1969.
 864,068. AMBER GLOW. U.S. CL. 51. REG. 1-21-1969.
 864,242. CLAIRMONT. U.S. CL. 29. REG. 1-28-1969.
 864,278. PEDIGREE (STYLIZED). U.S. CL. 37. REG. 1-28-1969.
 864,335. MISS DEN PARIS AND DESIGN. U.S. CL. 51. REG. 1-28-1969.
 864,345. S AND DESIGN. U.S. CL. 52. REG. 1-28-1969.
 864,346. S SANDOZ AND DESIGN. U.S. CL. 52. REG. 1-28-1969.
 864,347. SANDOZ. U.S. CL. 52. REG. 1-28-1969.
 864,387. IPI AND DESIGN. U.S. CL. 106. REG. 1-28-1969.
 868,186. REMASEAL. U.S. CL. 35. REG. 4-15-1969.
 1,131,844. TAHARA. INT. CL. 25. REG. 3-11-1980.
 1,143,570. POPOLO (STYLIZED). INT. CL. 29. REG. 12-16-1980.
 1,163,061. STAND BY 7. INT. CL. 37. REG. 7-28-1981.
 1,169,886. GRATITE. INT. CL. 7. REG. 9-22-1981.
 1,171,543. MATUK ROYALE. INT. CL. 33. REG. 9-29-1981.
 1,171,705. EMMA PAGE. INT. CL. 42. REG. 9-29-1981.
 1,172,828. PAGUAG. INT. CLS. 6, 7 AND 17. REG. 10-13-1981.
 1,173,164. GODZILLA KING OF THE MONSTERS (STYLIZED). INT. CLS. 16 AND 28. REG. 10-13-1981.
 1,195,352. PARTNERS. INT. CL. 35. REG. 5-11-1982.
 1,196,365. SUNBRITOS. INT. CL. 29. REG. 5-25-1982.
 1,200,853. DANA AND DESIGN. INT. CLS. 9, 20 AND 34 ONLY. REG. 7-13-1982.
 1,206,488. MONEY MARKET, PLUS.... INT. CL. 36. REG. 8-24-1982.
 1,219,802. BROOKS. INT. CLS. 9, 40 AND 42. REG. 12-14-1982.
 1,223,196. STANDARD REGISTER. INT. CL. 16 ONLY. REG. 1-11-1983.
 1,230,491. STAR BLAZERS. INT. CL. 41. REG. 3-8-1983.
 1,230,492. STAR BLAZERS AND DESIGN. INT. CL. 41. REG. 3-8-1983.
 1,233,449. ALVEOGRAF. INT. CL. 10. REG. 4-5-1983.

- 1,248,424. BLUE SUNSHINE AND DESIGN. INT. CL. 25. REG. 8-16-1983.
- 1,251,404. EDITH SEREI (STYLIZED). INT. CLS. 3 AND 21. REG. 9-20-1983.
- 1,252,633. ES (STYLIZED). INT. CLS. 3 AND 21. REG. 10-4-1983.
- 1,256,414. PIONEER PETE. INT. CL. 42. REG. 11-1-1983.
- 1,257,999. PIONEER PETE AND DESIGN. INT. CL. 42. REG. 11-15-1983.
- 1,259,591. CRYSTAL CREEK. INT. CL. 32. REG. 11-29-1983.
- 1,260,594. MISCELLANEOUS DESIGN. INT. CL. 29. REG. 12-6-1983.
- 1,271,518. HYDROFLO CORPORATION AND DESIGN. INT. CLS. 7 AND 9. REG. 3-27-1984.
- 1,273,534. SUPREMESLEEP. INT. CL. 20. REG. 4-10-1984.
- 1,277,231. GOLD 'N HONEY. INT. CL. 29. REG. 5-8-1984.
- 1,277,383. B C AND DESIGN. INT. CL. 37. REG. 5-8-1984.
- 1,278,120. SPORTO A.C.. INT. CL. 25. REG. 5-15-1984.
- 1,280,122. NASDAQ/NMS. INT. CL. 36. REG. 5-29-1984.
- 1,290,699. DERACYN. INT. CL. 5. REG. 8-21-1984.
- 1,295,134. MISCELLANEOUS DESIGN. INT. CL. 42. REG. 9-11-1984.
- 1,295,201. HOMEWAY. INT. CL. 42. REG. 9-11-1984.
- 1,295,995. TERRA-TOTE. INT. CL. 12. REG. 9-18-1984.
- 1,302,040. NORSTAR. INT. CL. 36. REG. 10-23-1984.
- 1,316,025. BLUE SKY (STYLIZED). INT. CL. 32. REG. 1-22-1985.
- 1,319,806. NDL (STYLIZED). INT. CL. 35. REG. 2-12-1985.
- 1,358,893. ROLLING STONES. INT. CLS. 9 AND 41. REG. 9-10-1985.
- 1,572,252. MUNCHERS. INT. CL. 31. REG. 12-19-1989.
- 1,585,477. STERION. INT. CL. 10. REG. 3-6-1990.
- 1,660,766. D AND DESIGN. INT. CL. 14. REG. 10-15-1991.
- 1,660,772. PACKAGING DEPOT. INT. CLS. 16, 17, 36, 39 AND 42. REG. 10-15-1991.
- 1,661,097. GROUND CONTROL AND DESIGN. INT. CLS. 37 AND 42. REG. 10-15-1991.
- 1,662,960. GLITZ. INT. CL. 16. REG. 10-29-1991.
- 1,687,750. FIELD & STREAM. INT. CL. 16 ONLY. REG. 5-19-1992.
- 1,750,501. C.H.A.M.P.. INT. CL. 41. REG. 2-2-1993.
- 1,893,848. AMERICA'S KIDS. INT. CL. 42. REG. 5-9-1995.
- 1,899,139. F FACILICORP PROJECT MANAGEMENT CONSULTING AND DESIGN. INT. CL. 35. REG. 6-13-1995.
- 2,353,788. GERMSTAR AND DESIGN. INT. CL. 9. REG. 5-30-2000.
- 2,395,297. R. K. CAFE RICE KING. INT. CL. 42. REG. 10-17-2000.
- 2,497,391. SUNSET BEACH. INT. CLS. 14, 16, 18, 24 AND 25. REG. 10-16-2001.
- 2,497,403. STCU'S NETTELLER. INT. CL. 36. REG. 10-16-2001.
- 2,497,433. THE ATRIUM DOOR. INT. CL. 19. REG. 10-16-2001.
- 2,497,444. FAIRWAY. INT. CL. 12. REG. 10-16-2001.
- 2,497,446. AMULET AND DESIGN. INT. CL. 7. REG. 10-16-2001.
- 2,497,451. ENLIVEN/IMPLUSE. INT. CLS. 35 AND 42. REG. 10-16-2001.
- 2,497,459. THE UNITED STATES POWER SQUADRONS AND DESIGN. INT. CL. 41. REG. 10-16-2001.
- 2,497,466. DIRECT RENTAL CAR SALES AND DESIGN. INT. CL. 35. REG. 10-16-2001.
- 2,497,470. PRINCESS PINAFORE. INT. CL. 25. REG. 10-16-2001.
- 2,497,472. EQ (STYLIZED). INT. CL. 42. REG. 10-16-2001.
- 2,497,498. MR MISSISSIPPI RICK'S AND DESIGN. INT. CL. 42. REG. 10-16-2001.
- 2,497,504. PRINTSTREAM. INT. CLS. 7 AND 9. REG. 10-16-2001.
- 2,497,514. NETAGENT. INT. CL. 9. REG. 10-16-2001.
- 2,497,531. XDRIVE. INT. CL. 39. REG. 10-16-2001.
- 2,497,532. LIVING BUDDHISM. INT. CL. 16. REG. 10-16-2001.
- 2,497,547. CENTERGY. INT. CL. 9. REG. 10-16-2001.
- 2,497,551. AGUA DEL ALAMO AND DESIGN. INT. CL. 32. REG. 10-16-2001.
- 2,497,555. VENICE TOOLS. INT. CL. 8. REG. 10-16-2001.
- 2,497,567. INXIGHT. INT. CL. 9. REG. 10-16-2001.
- 2,497,572. INTEL SPEEDSTEP. INT. CL. 9. REG. 10-16-2001.
- 2,497,575. LOVE SEX MONEY. INT. CL. 25. REG. 10-16-2001.
- 2,497,586. FEDERAL EMPLOYEE BENEFITS GROUP. INT. CL. 36. REG. 10-16-2001.
- 2,497,588. ARENA. INT. CLS. 9, 16 AND 41. REG. 10-16-2001.
- 2,497,594. EARTH CAMP (STYLIZED). INT. CL. 25. REG. 10-16-2001.
- 2,497,595. COVER WORLD. INT. CL. 14. REG. 10-16-2001.
- 2,497,599. SUN MICROSYSTEMS AND DESIGN. INT. CL. 37. REG. 10-16-2001.
- 2,497,602. CHARISMA. INT. CL. 33. REG. 10-16-2001.
- 2,497,604. VOCALTEC. INT. CLS. 16, 36 AND 38. REG. 10-16-2001.
- 2,497,608. MV5. INT. CL. 9. REG. 10-16-2001.
- 2,497,641. DIRECTORYSMART. INT. CL. 9. REG. 10-16-2001.
- 2,497,664. PRODUCE CAREERS. INT. CL. 35. REG. 10-16-2001.
- 2,497,665. BEYOND YOUR EXPECTATIONS. INT. CL. 36. REG. 10-16-2001.
- 2,497,667. BITTER FILMS. INT. CL. 41. REG. 10-16-2001.
- 2,497,670. C AND DESIGN. INT. CLS. 35 AND 38. REG. 10-16-2001.
- 2,497,705. SHOP-VAC B R A N D BULLDOG AND DESIGN. INT. CL. 7. REG. 10-16-2001.
- 2,497,712. MISCELLANEOUS DESIGN. INT. CL. 36. REG. 10-16-2001.
- 2,497,717. LIL O'CUB. INT. CL. 28. REG. 10-16-2001.
- 2,497,721. INTERNET FITNESS.COM AND DESIGN. INT. CL. 35. REG. 10-16-2001.
- 2,497,725. AMERICANA SCRAPBOOK. INT. CL. 35. REG. 10-16-2001.
- 2,497,728. FCG FIRST CONSULTING GROUP AND DESIGN. INT. CL. 35. REG. 10-16-2001.
- 2,497,730. E-SLIPS (STYLIZED). INT. CL. 9. REG. 10-16-2001.
- 2,497,736. BE 21. INT. CL. 3. REG. 10-16-2001.
- 2,497,747. MISCELLANEOUS DESIGN. INT. CL. 25. REG. 10-16-2001.
- 2,497,751. BRITE SMILE PROFESSIONAL TEETH WHITENING CENTERS AND DESIGN. INT. CL. 42. REG. 10-16-2001.
- 2,497,757. DOUGHEY THE PANCAKE MAN. INT. CLS. 9 AND 41. REG. 10-16-2001.
- 2,497,759. UMPY RECORDS AND DESIGN. INT. CLS. 9 AND 41. REG. 10-16-2001.
- 2,497,764. "LIFT AND SELL". INT. CLS. 8, 16 AND 21. REG. 10-16-2001.
- 2,497,766. PLUG 'N PAY. INT. CL. 35. REG. 10-16-2001.
- 2,497,768. OLYMPIA DENTAL AND DESIGN. INT. CL. 36. REG. 10-16-2001.
- 2,497,784. ITS. INT. CL. 41. REG. 10-16-2001.
- 2,497,787. CENTRAL HIGH AND DESIGN. INT. CL. 9. REG. 10-16-2001.
- 2,497,792. LENOX GIFTS THAT CELEBRATE LIFE AND DESIGN. INT. CLS. 16 AND 35. REG. 10-16-2001.
- 2,497,800. KLEERWITE. INT. CL. 3. REG. 10-16-2001.
- 2,497,802. LASTING WOOD. INT. CL. 20. REG. 10-16-2001.
- 2,497,804. DOTSGOOD. INT. CL. 35. REG. 10-16-2001.
- 2,497,830. MISCELLANEOUS DESIGN. INT. CL. 9. REG. 10-16-2001.
- 2,497,837. PRESTIGE. INT. CL. 20. REG. 10-16-2001.
- 2,497,850. JUMPER (STYLIZED). INT. CL. 9. REG. 10-16-2001.
- 2,497,852. ACTSPARK AND DESIGN. INT. CL. 7. REG. 10-16-2001.
- 2,497,894. V2 (STYLIZED). INT. CL. 9. REG. 10-16-2001.
- 2,497,898. LINEMASTER AND DESIGN. INT. CL. 16. REG. 10-16-2001.
- 2,497,900. MAKE AWAY. INT. CL. 3. REG. 10-16-2001.
- 2,497,901. MAKE READY. INT. CL. 3. REG. 10-16-2001.
- 2,497,924. GOATS. INT. CL. 42. REG. 10-16-2001.
- 2,497,926. YOUR PURCHASE FUNDS RESEARCH AND DESIGN. INT. CL. 16. REG. 10-16-2001.
- 2,497,936. PICTUREQUEST. INT. CL. 35. REG. 10-16-2001.
- 2,497,941. CHESAPEAKEHOME. INT. CL. 16. REG. 10-16-2001.

- 2,497,945. ARMR.NET. INT. CL. 36. REG. 10-16-2001.
 2,497,959. CP AND DESIGN. INT. CLS. 36, 41 AND 42. REG. 10-16-2001.
 2,497,964. IDEAS SENCILLAS. INT. CLS. 16 AND 35. REG. 10-16-2001.
 2,497,967. Q-KNOWS. INT. CLS. 3 AND 5. REG. 10-16-2001.
 2,497,990. BIG CHEF AND DESIGN. INT. CL. 42. REG. 10-16-2001.
 2,497,998. PRIVATE COMPANY DIRECTORS AND OFFICERS LIABILITY PLUS+. INT. CL. 36. REG. 10-16-2001.
 2,498,003. ARLISS (STYLIZED). INT. CL. 41. REG. 10-16-2001.
 2,498,010. JOHNNY ROCKS. INT. CL. 41. REG. 10-16-2001.
 2,498,021. PANACHE (STYLIZED). INT. CL. 42. REG. 10-16-2001.
 2,498,022. THOUGHT ADJUSTERS. INT. CL. 16. REG. 10-16-2001.
 2,498,039. COLLECTORLINE. INT. CL. 16. REG. 10-16-2001.
 2,498,043. BROADWAY ON TOUR, INC. AND DESIGN. INT. CL. 41. REG. 10-16-2001.
 2,498,053. DAI BAI DANG CHINA STREET CAFE AND DESIGN. INT. CL. 42. REG. 10-16-2001.
 2,498,054. MISCELLANEOUS DESIGN. INT. CL. 20. REG. 10-16-2001.
 2,498,064. MYHEADSETS.COM. INT. CL. 35. REG. 10-16-2001.
 2,498,077. CIRCLE STAR BLANKETS. INT. CL. 18. REG. 10-16-2001.
 2,498,086. THE FOUNTAINS AND DESIGN. INT. CL. 42. REG. 10-16-2001.
 2,498,099. ICON IDENTITY SOLUTIONS AND DESIGN. INT. CLS. 37, 40 AND 42. REG. 10-16-2001.
 2,498,110. FASA. INT. CL. 42. REG. 10-16-2001.
 2,498,115. WOLF POINT CAPITAL MANAGEMENT, L.L.C.. INT. CL. 36. REG. 10-16-2001.
 2,498,122. INTELISTAF HEALTHCARE. INT. CL. 35. REG. 10-16-2001.
 2,498,134. V A L L I A N O. INT. CL. 3. REG. 10-16-2001.
 2,498,139. WHAMTECH. INT. CL. 42. REG. 10-16-2001.
 2,498,147. VISION PRINTING STUDIO. INT. CL. 9. REG. 10-16-2001.
 2,498,151. SYRUP (STYLIZED). INT. CLS. 35 AND 42. REG. 10-16-2001.
 2,498,172. HY O SILVER. INT. CL. 35. REG. 10-16-2001.
 2,498,189. LEMON DUST. INT. CL. 3. REG. 10-16-2001.
 2,498,196. OVER 40 ROCKS! (STYLIZED). INT. CL. 25. REG. 10-16-2001.
 2,498,216. SOFWEAR. INT. CL. 9. REG. 10-16-2001.
 2,498,233. SDX. INT. CL. 23. REG. 10-16-2001.
 2,498,234. STUDIO DESIGNS. INT. CL. 16. REG. 10-16-2001.
 2,498,247. THE BUZZ. INT. CL. 16. REG. 10-16-2001.
 2,498,250. MORE POWER, MORE MILEAGE!. INT. CL. 12. REG. 10-16-2001.
 2,498,266. E EVANS T E L E P H O N E AND DESIGN. INT. CL. 38. REG. 10-16-2001.
 2,498,270. MULTI-PAY POKER. INT. CL. 9. REG. 10-16-2001.
 2,498,273. SAINTRYAN. INT. CL. 16. REG. 10-16-2001.
 2,498,280. WINTER HILL. INT. CL. 36. REG. 10-16-2001.
 2,498,284. SMART & SAFE SENIORS AND DESIGN. INT. CL. 41. REG. 10-16-2001.
 2,498,285. MISCELLANEOUS DESIGN. INT. CL. 36. REG. 10-16-2001.
 2,498,299. IT'S ALL ABOUT CREATIVITY. INT. CL. 35. REG. 10-16-2001.
 2,498,302. THE CONGRUENT CORPORATION. INT. CL. 41. REG. 10-16-2001.
 2,498,314. BRIO. INT. CL. 42. REG. 10-16-2001.
 2,498,315. BREAKAWAY. INT. CL. 42. REG. 10-16-2001.
 2,498,320. ARCCA. INT. CL. 16. REG. 10-16-2001.
 2,498,325. COMOTION. INT. CL. 16. REG. 10-16-2001.
 2,498,335. FUZZY. INT. CL. 16. REG. 10-16-2001.
 2,498,342. POWER ZONE MAGNUM POWER SYSTEMS AND DESIGN. INT. CL. 7. REG. 10-16-2001.
 2,498,345. REFURB-ESEARCH. INT. CL. 35. REG. 10-16-2001.
 2,498,349. TROPHY TUBE. INT. CL. 28. REG. 10-16-2001.
 2,498,351. AIG NETADVANTAGE SECURITY. INT. CL. 36. REG. 10-16-2001.
 2,498,382. ART OF WELLBEING. INT. CL. 16. REG. 10-16-2001.
 2,498,413. MP-FUN (STYLIZED). INT. CL. 9. REG. 10-16-2001.
 2,498,435. LEVELROCK. INT. CL. 19. REG. 10-16-2001.
 2,498,459. TECHNODYKE. INT. CL. 42. REG. 10-16-2001.
 2,498,465. AUSTRALIAN CATTLE DOG CLUB OF AMERICA, INC.. INT. CL. 41. REG. 10-16-2001.
 2,498,480. SPORTWALL. INT. CL. 9. REG. 10-16-2001.
 2,498,481. COUNTRY ELEGANCE. INT. CLS. 31 AND 35. REG. 10-16-2001.
 2,498,486. H HUSQVARNA TOUGH NAME. TOUGH EQUIPMENT. AND DESIGN. INT. CLS. 7 AND 8. REG. 10-16-2001.
 2,498,492. SKILLSELEX. INT. CL. 35. REG. 10-16-2001.
 2,498,504. GRIZZIES. INT. CL. 21. REG. 10-16-2001.
 2,498,514. MORNING STAR. INT. CL. 35. REG. 10-16-2001.
 2,498,521. LAKEBEST. INT. CL. 29. REG. 10-16-2001.
 2,498,523. ROOT 66. INT. CL. 32. REG. 10-16-2001.
 2,498,528. THE SELLER'S PLAYBOOK. INT. CL. 35. REG. 10-16-2001.
 2,498,529. MEDIAGUARD. INT. CLS. 9, 16 AND 38. REG. 10-16-2001.
 2,498,541. INLUX. INT. CL. 10. REG. 10-16-2001.
 2,498,546. MISCELLANEOUS DESIGN. INT. CL. 28. REG. 10-16-2001.
 2,498,560. IMAGEMOVERS. INT. CL. 41. REG. 10-16-2001.
 2,498,571. SELECT-A-FIT. INT. CL. 10. REG. 10-16-2001.
 2,498,572. AUTO-FIT. INT. CL. 10. REG. 10-16-2001.
 2,498,573. ISLAND REEF. INT. CL. 33. REG. 10-16-2001.
 2,498,576. TOTAL PACKAGE AND DESIGN. INT. CL. 41. REG. 10-16-2001.
 2,498,582. SIERRA PACIFIC EK ENERGYKIDS AND DESIGN. INT. CL. 41. REG. 10-16-2001.
 2,498,591. VARI-LOK. INT. CL. 12. REG. 10-16-2001.
 2,498,602. CRUMB CASTLE. INT. CL. 30. REG. 10-16-2001.
 2,498,611. L. A. EXCHANGE. INT. CL. 25. REG. 10-16-2001.
 2,498,631. CHARACTER FOR LIFE. INT. CL. 16. REG. 10-16-2001.
 2,498,632. CHARACTER FOR LIFE. INT. CL. 41. REG. 10-16-2001.
 2,498,642. CHUMMIES. INT. CLS. 9, 14, 16, 20, 21, 25 AND 28. REG. 10-16-2001.
 2,498,643. XD105F. INT. CL. 9. REG. 10-16-2001.
 2,498,644. ASPEN CATREF. INT. CL. 9. REG. 10-16-2001.
 2,498,647. FEVERDREAM. INT. CL. 42. REG. 10-16-2001.
 2,498,657. RXKINETIX. INT. CL. 1. REG. 10-16-2001.
 2,498,658. BARONESSA. INT. CL. 29. REG. 10-16-2001.
 2,498,696. CONMEX. INT. CL. 25. REG. 10-16-2001.
 2,498,704. HUMAN VALUES INTEGRITY INNOVATIVE SOLUTION VALUE FOR MONEY AND DESIGN. INT. CL. 42. REG. 10-16-2001.
 2,498,706. STORMTITE. INT. CL. 19. REG. 10-16-2001.
 2,498,709. RAPIDBUILDER. INT. CL. 9. REG. 10-16-2001.
 2,498,711. WINNING COMMUNITIES. INT. CL. 42. REG. 10-16-2001.
 2,498,718. PIVOTAL. INT. CL. 42. REG. 10-16-2001.
 2,498,726. OMNIPRINT. INT. CLS. 35 AND 42. REG. 10-16-2001.
 2,498,729. METARESPONSE SCIENCES. INT. CL. 42. REG. 10-16-2001.
 2,498,731. THE SAMUEL GOMPERS SOCIETY. INT. CL. 36. REG. 10-16-2001.
 2,498,738. VI TECHNOLOGY (STYLIZED). INT. CL. 9. REG. 10-16-2001.
 2,498,769. EAGLE PACK SENIOR CARE FORMULA. INT. CL. 31. REG. 10-16-2001.
 2,498,770. SPECIAL UNIT 2. INT. CL. 41. REG. 10-16-2001.
 2,498,772. LIBERTY TELECOM. INT. CL. 38. REG. 10-16-2001.
 2,498,779. APERTURE. INT. CL. 20. REG. 10-16-2001.
 2,498,793. NATURAL ENERGY TECHNOLOGY. INT. CL. 31. REG. 10-16-2001.
 2,498,794. APPLIANCE PARTS, HELP & MORE. INT. CL. 35. REG. 10-16-2001.
 2,498,795. PRAEDIUM. INT. CL. 37. REG. 10-16-2001.

- 2,498,801. FILETRAX RETRIEVAL. INT. CL. 9. REG. 10-16-2001.
- 2,498,809. PERFECT BREW. INT. CL. 11. REG. 10-16-2001.
- 2,498,810. SINGULES. INT. CL. 20. REG. 10-16-2001.
- 2,498,814. FORE THE LINKS AND DESIGN. INT. CL. 35. REG. 10-16-2001.
- 2,498,838. 2XT. INT. CL. 20. REG. 10-16-2001.
- 2,498,845. THE .AFRO DOMAIN NAME SPACE. INT. CL. 42. REG. 10-16-2001.
- 2,498,846. SURF TILL U DIE. INT. CL. 25. REG. 10-16-2001.
- 2,498,855. CD-ROLL. INT. CL. 9. REG. 10-16-2001.
- 2,498,860. WAMU.COM. INT. CL. 36. REG. 10-16-2001.
- 2,498,862. CAREERSURF. INT. CL. 35. REG. 10-16-2001.
- 2,498,864. MANAQI. INT. CL. 30. REG. 10-16-2001.
- 2,498,880. ANNUAL REPORTS FOR THE 21ST CENTURY. INT. CL. 35. REG. 10-16-2001.
- 2,498,897. 800 CEO READ. INT. CL. 35. REG. 10-16-2001.
- 2,498,912. PLANTSCOPE. INT. CLS. 35 AND 42. REG. 10-16-2001.
- 2,498,916. @STAKE. INT. CLS. 35 AND 42. REG. 10-16-2001.
- 2,498,920. SUPER NOVA. INT. CL. 9. REG. 10-16-2001.
- 2,498,930. SOJOURNAL AND DESIGN. INT. CL. 16. REG. 10-16-2001.
- 2,498,932. CATERWORKS. INT. CL. 9. REG. 10-16-2001.
- 2,498,948. G-TECH. INT. CL. 25. REG. 10-16-2001.
- 2,498,973. INVOCIA. INT. CL. 9. REG. 10-16-2001.
- 2,498,977. WE CLEAN MORE THAN YOU THINK. INT. CL. 35. REG. 10-16-2001.
- 2,498,985. RYNO WEAVE. INT. CL. 18. REG. 10-16-2001.
- 2,498,986. BEACHREADER. INT. CL. 16. REG. 10-16-2001.
- 2,498,989. NEUROLOGYCHANNEL YOUR NEUROLOGY COMMUNITY AND DESIGN. INT. CL. 42. REG. 10-16-2001.
- 2,499,004. SOUTHEASTERN ACCEPTANCE CORPORATION. INT. CL. 36. REG. 10-16-2001.
- 2,499,008. AMBEE HOUSE PUBLISHING. INT. CL. 16. REG. 10-16-2001.
- 2,499,017. HAVABALL. INT. CL. 28. REG. 10-16-2001.
- 2,499,018. STELLAR. INT. CL. 28. REG. 10-16-2001.
- 2,499,027. STUDIO DANCE. INT. CLS. 14, 16, 18, 20, 25 AND 26. REG. 10-16-2001.
- 2,499,047. PRIME PACKAGE. INT. CL. 36. REG. 10-16-2001.
- 2,499,050. INCISIVE. INT. CL. 36. REG. 10-16-2001.
- 2,499,054. I LOVE A MYSTERY. INT. CL. 35. REG. 10-16-2001.
- 2,499,056. ZINGER X. INT. CL. 28. REG. 10-16-2001.
- 2,499,057. MIRAI. INT. CL. 31. REG. 10-16-2001.
- 2,499,059. POWERCYCLER. INT. CL. 9. REG. 10-16-2001.
- 2,499,062. METALIGHT. INT. CL. 9. REG. 10-16-2001.
- 2,499,063. PS AND DESIGN. INT. CL. 24. REG. 10-16-2001.
- 2,499,064. BOCINSKY. INT. CL. 25. REG. 10-16-2001.
- 2,499,065. METERMAN. INT. CL. 9. REG. 10-16-2001.
- 2,499,074. CXI (STYLIZED). INT. CL. 42. REG. 10-16-2001.
- 2,499,089. SKIP. INT. CL. 10. REG. 10-16-2001.
- 2,499,096. FREEWALKERS. INT. CL. 25. REG. 10-16-2001.
- 2,499,111. AQUACOSMOS. INT. CL. 9. REG. 10-16-2001.
- 2,499,116. WWD THE MAGAZINE. INT. CL. 16. REG. 10-16-2001.
- 2,499,125. MISCELLANEOUS DESIGN. INT. CL. 42. REG. 10-16-2001.
- 2,499,131. 3 TOMATOES & A MOZZARELLA THE PLACE FOR PIZZA AND DESIGN. INT. CL. 42. REG. 10-16-2001.
- 2,499,132. SMARTERLIVING. INT. CL. 42. REG. 10-16-2001.
- 2,499,144. SIERRA TRAVEL. INT. CL. 35. REG. 10-16-2001.
- 2,499,147. THE EXECUTIVE STANDUP STAPLER. INT. CL. 16. REG. 10-16-2001.
- 2,499,150. WOOD DINING SERVICES. INT. CLS. 35 AND 42. REG. 10-16-2001.
- 2,499,174. MCCULLOCH AND DESIGN. INT. CL. 12. REG. 10-16-2001.
- 2,499,186. DESIGN OPTIONS. INT. CL. 40. REG. 10-16-2001.
- 2,499,197. AMERICAN PRODUCTS COMPANY. INT. CLS. 11 AND 12. REG. 10-16-2001.
- 2,499,199. OUTDOOR ACADEMY. INT. CL. 41. REG. 10-16-2001.
- 2,499,200. MISCELLANEOUS DESIGN. INT. CLS. 1 AND 3. REG. 10-16-2001.
- 2,499,201. CROSS MATCH. INT. CL. 9. REG. 10-16-2001.
- 2,499,205. CE-COMMERCE. INT. CL. 35. REG. 10-16-2001.
- 2,499,207. PROJECT REVIEW. INT. CL. 9. REG. 10-16-2001.
- 2,499,209. JAVANESE LULUR. INT. CL. 42. REG. 10-16-2001.
- 2,499,221. ORIGINAL MOUNTAIN SCOOTER. INT. CL. 28. REG. 10-16-2001.
- 2,499,225. BUSINESS OF FASHION. INT. CL. 35. REG. 10-16-2001.
- 2,499,231. WORKFLOW MANAGEMENT. INT. CL. 42. REG. 10-16-2001.
- 2,499,240. NUTRITION SERVICE SUITE. INT. CL. 9. REG. 10-16-2001.
- 2,499,241. FASHION 101 (STYLIZED). INT. CL. 16. REG. 10-16-2001.
- 2,499,244. RUBBA DUCKS (STYLIZED). INT. CL. 16. REG. 10-16-2001.
- 2,557,549. SMARTBOARD. INT. CL. 42 ONLY. REG. 4-9-2002.
- 2,565,987. G E Z E R AND DESIGN. INT. CL. 18 ONLY. REG. 4-30-2002.
- 2,568,918. DIRECTPREP. INT. CL. 5 ONLY. REG. 5-14-2002.
- 2,568,958. LIFA AIR AND DESIGN. INT. CL. 37 ONLY. REG. 5-14-2002.
- 2,569,129. LISA HO. INT. CLS. 3 AND 24 ONLY. REG. 5-14-2002.
- 2,569,334. IMS. INT. CL. 37 ONLY. REG. 5-14-2002.
- 2,570,954. BOUMATIC AND DESIGN. INT. CLS. 5, 6, 8, 11 AND 21 ONLY. REG. 5-21-2002.
- 2,574,120. POINTING YOU TO POSSIBILITIES. INT. CL. 40 ONLY. REG. 5-28-2002.
- 2,607,442. BLOOM. INT. CL. 17 ONLY. REG. 8-13-2002.
- 2,662,387. CITYMEALS. INT. CL. 35 ONLY. REG. 12-17-2002.
- 2,869,223. NOTAMARK STANDARD CHARACTER MARK. INT. CLS. 7 AND 9. REG. 8-3-2004.
- 2,907,427. NANOBLEND. INT. CL. 1. REG. 11-30-2004.
- 2,916,257. BODY DOUBLE (STYLIZED). INT. CL. 3. REG. 1-4-2005.
- 2,922,731. JOHNNY HANDSOME. INT. CL. 25. REG. 2-1-2005.
- 2,922,933. ZIVIO STANDARD CHARACTER MARK. INT. CL. 33. REG. 2-1-2005.
- 2,922,946. G AIR AND DESIGN. INT. CL. 11. REG. 2-1-2005.
- 2,930,440. INFOPRO STANDARD CHARACTER MARK. INT. CL. 41. REG. 3-8-2005.
- 2,932,721. SPORT NS-I. INT. CL. 12. REG. 3-15-2005.
- 2,934,526. THE NIGHTHAWKS AND DESIGN. INT. CL. 41. REG. 3-22-2005.
- 2,935,045. NEWMERIX STANDARD CHARACTER MARK. INT. CL. 42. REG. 3-22-2005.
- 2,935,046. NEWMERIX AND DESIGN. INT. CL. 42. REG. 3-22-2005.
- 2,935,874. FUNGUS STANDARD CHARACTER MARK. INT. CL. 41. REG. 3-29-2005.
- 2,937,965. ENCIRCLE, INFINITE OPTIONS...DEFINITE SOLUTIONS AND DESIGN. INT. CL. 36. REG. 4-5-2005.
- 2,941,871. AMOURETTE STANDARD CHARACTER MARK. INT. CL. 25. REG. 4-19-2005.
- 2,944,032. BANDUST STANDARD CHARACTER MARK. INT. CL. 5. REG. 4-26-2005.
- 2,945,875. MISCELLANEOUS DESIGN. INT. CL. 10. REG. 5-3-2005.
- 2,945,918. NUTRISYSTEM NOURISH. INT. CL. 5. REG. 5-3-2005.
- 2,947,525. CORPUS STANDARD CHARACTER MARK. INT. CL. 25. REG. 5-10-2005.
- 2,947,906. NEWMERIX STANDARD CHARACTER MARK. INT. CL. 9. REG. 5-10-2005.
- 2,947,907. NEWMERIX AND DESIGN. INT. CL. 9. REG. 5-10-2005.
- 2,951,213. A DIFFERENT KIND OF LABOR PLACE STANDARD CHARACTER MARK. INT. CL. 35. REG. 5-17-2005.
- 2,954,951. COSMIC BLOBS STANDARD CHARACTER MARK. INT. CL. 9. REG. 5-24-2005.
- 2,954,954. ALS ANGELS STANDARD CHARACTER MARK. INT. CL. 41. REG. 5-24-2005.

- 2,962,735. IPADS.COM AND DESIGN. INT. CL. 16. REG. 6-21-2005.
- 2,962,736. IPADS.COM. INT. CL. 16. REG. 6-21-2005.
- 2,963,177. PONLE. INT. CL. 25. REG. 6-21-2005.
- 2,963,545. J.R CLEAR HABANA AND DESIGN. INT. CL. 34. REG. 6-21-2005.
- 2,964,110. POWERPLAY (STYLIZED). INT. CL. 9. REG. 6-28-2005.
- 2,964,182. IMAGENOW STANDARD CHARACTER MARK. INT. CL. 9. REG. 6-28-2005.
- 2,965,199. POWERPLAY STANDARD CHARACTER MARK. INT. CL. 9. REG. 7-5-2005.
- 2,965,269. LECG STANDARD CHARACTER MARK. INT. CLS. 36 AND 42. REG. 7-5-2005.
- 2,965,354. NUTRISYSTEM NOURISH. INT. CLS. 29, 30 AND 44. REG. 7-5-2005.
- 2,968,933. NAKED WOMEN'S WRESTLING LEAGUE STANDARD CHARACTER MARK. INT. CL. 41. REG. 7-12-2005.
- 2,970,652. XL STANDARD CHARACTER MARK. INT. CL. 3. REG. 7-19-2005.
- 2,974,183. N MOTION STANDARD CHARACTER MARK. INT. CLS. 29 AND 32. REG. 7-19-2005.
- 2,974,760. COMMERCIAL DIRECT STANDARD CHARACTER MARK. INT. CL. 36. REG. 7-19-2005.
- 2,975,027. GOAL. INT. CLS. 9, 35 AND 42. REG. 7-26-2005.
- 2,975,231. TEKNOVATION. INT. CL. 9. REG. 7-26-2005.
- 2,975,270. REO STARR. INT. CL. 25. REG. 7-26-2005.
- 2,978,188. THE THREE CROONERS. INT. CL. 41. REG. 7-26-2005.
- 2,980,093. BICI. INT. CLS. 12, 25 AND 35. REG. 7-26-2005.
- 2,980,972. ILL WILL PRESS STANDARD CHARACTER MARK. INT. CL. 41. REG. 8-2-2005.
- 2,983,093. TRUETRANSIT STANDARD CHARACTER MARK. INT. CL. 42. REG. 8-9-2005.
- 2,983,288. CHROME BONES STANDARD CHARACTER MARK. INT. CL. 18. REG. 8-9-2005.
- 2,983,707. EVERY PERSON. EVERY MEAL. EVERY DAY. STANDARD CHARACTER MARK. INT. CL. 16. REG. 8-9-2005.
- 2,984,692. SLIKLOC SECURITY SYSTEM STANDARD CHARACTER MARK. INT. CL. 6. REG. 8-16-2005.
- 2,985,423. NOKA STANDARD CHARACTER MARK. INT. CL. 30. REG. 8-16-2005.
- 2,985,495. TVA STANDARD CHARACTER MARK. INT. CLS. 37 AND 42. REG. 8-16-2005.
- 2,985,518. LECG (STYLIZED). INT. CLS. 35, 36 AND 42. REG. 8-16-2005.
- 2,985,539. NOKA CHOCOLATE (STYLIZED). INT. CL. 30. REG. 8-16-2005.
- 2,988,393. DISTINGUISHED HOTELS INTERNATIONAL STANDARD CHARACTER MARK. INT. CLS. 9, 16, 35 AND 43. REG. 8-23-2005.
- 2,988,498. LEAF & RUSHER. INT. CLS. 3 AND 5. REG. 8-30-2005.
- 2,989,874. DATA DIRECT. INT. CL. 9. REG. 8-30-2005.
- 2,990,110. TT TORY BY TRB AND DESIGN. INT. CL. 35. REG. 8-30-2005.
- 2,990,770. ALPINA SPRINGS STANDARD CHARACTER MARK. INT. CL. 32. REG. 8-30-2005.
- 2,990,873. BACKROADS INTERNATIONAL AND DESIGN. INT. CL. 39. REG. 9-6-2005.
- 2,991,010. W5 STANDARD CHARACTER MARK. INT. CL. 42. REG. 9-6-2005.
- 2,992,319. GOCLAWS STANDARD CHARACTER MARK. INT. CL. 12. REG. 9-6-2005.
- 2,992,553. ARTHROXIN STANDARD CHARACTER MARK. INT. CL. 5. REG. 9-6-2005.
- 2,992,847. INTELLIVID. INT. CL. 9. REG. 9-6-2005.
- 2,995,044. BIGHOLER STANDARD CHARACTER MARK. INT. CL. 8. REG. 9-13-2005.
- 2,995,357. TOMOTHERAPY STANDARD CHARACTER MARK. INT. CLS. 9 AND 10. REG. 9-13-2005.
- 2,995,358. MISCELLANEOUS DESIGN. INT. CL. 9. REG. 9-13-2005.
- 2,995,359. TOMO STANDARD CHARACTER MARK. INT. CL. 9. REG. 9-13-2005.
- 2,996,873. HIPAL STANDARD CHARACTER MARK. INT. CL. 1. REG. 9-20-2005.
- 2,998,044. BRANDWATCH STANDARD CHARACTER MARK. INT. CL. 35. REG. 9-20-2005.
- 2,998,140. AGGCOTE STANDARD CHARACTER MARK. INT. CL. 19. REG. 9-20-2005.
- 2,999,219. PAOLO STANDARD CHARACTER MARK. INT. CL. 25. REG. 9-20-2005.
- 3,003,103. CERTIFIED MEDICAL HYPNOTHERAPIST STANDARD CHARACTER MARK. INT. CL. 41. REG. 9-27-2005.
- 3,005,268. POTATO JACK. INT. CL. 29. REG. 10-11-2005.
- 3,005,270. TESA. INT. CL. 9. REG. 10-11-2005.
- 3,005,271. FASALEX. INT. CLS. 1 AND 17. REG. 10-11-2005.
- 3,005,272. RAG. INT. CL. 9. REG. 10-11-2005.
- 3,005,273. ZAXES. INT. CL. 5. REG. 10-11-2005.
- 3,005,283. ITOUCH. INT. CLS. 38 AND 42. REG. 10-11-2005.
- 3,005,284. MISCELLANEOUS DESIGN. INT. CL. 25. REG. 10-11-2005.
- 3,005,290. RACING (STYLIZED). INT. CLS. 16 AND 18. REG. 10-11-2005.
- 3,005,291. MOZOC. INT. CL. 5. REG. 10-11-2005.
- 3,005,292. MOZOK. INT. CL. 5. REG. 10-11-2005.
- 3,005,293. NOCTURIN. INT. CL. 5. REG. 10-11-2005.
- 3,005,294. ILOMEDIN. INT. CL. 5. REG. 10-11-2005.
- 3,005,295. PHARMALIBS (STYLIZED). INT. CL. 9. REG. 10-11-2005.
- 3,005,296. CASHMERE CAUSE. INT. CLS. 24 AND 25. REG. 10-11-2005.
- 3,005,298. KEEPING IT SIMPLE. INT. CLS. 38 AND 42. REG. 10-11-2005.
- 3,005,299. ARTPILOT (STYLIZED). INT. CLS. 14, 16, 20, 35 AND 39. REG. 10-11-2005.
- 3,005,300. PSST. INT. CL. 28. REG. 10-11-2005.
- 3,005,301. ART IN MOTION GALLERY COLLECTION. INT. CL. 16. REG. 10-11-2005.
- 3,005,304. WORKFIELD APPAREL. INT. CL. 25. REG. 10-11-2005.
- 3,005,306. FOTOPRIX AND DESIGN. INT. CLS. 35 AND 40. REG. 10-11-2005.
- 3,005,307. INFACE DENMARK. INT. CL. 9. REG. 10-11-2005.
- 3,005,308. MISCELLANEOUS DESIGN. INT. CLS. 7, 9, 11, 16, 38, 39 AND 42. REG. 10-11-2005.
- 3,005,320. IMPORTED MADE FROM PURE FRESH HONEY FABRIQUEE OF MIEL PUR ET FRAIS IMPORTEE OLD AND DESIGN. INT. CL. 33. REG. 10-11-2005.
- 3,005,324. BAUMA BAUMA AND DESIGN. INT. CL. 9. REG. 10-11-2005.
- 3,005,325. CAP NOR. INT. CL. 33. REG. 10-11-2005.
- 3,005,326. URBAN HEALING. INT. CLS. 3, 5, 35 AND 44. REG. 10-11-2005.
- 3,005,328. MESSAGE IN A BOTTLE. INT. CLS. 9 AND 28. REG. 10-11-2005.
- 3,005,332. REGARD SMART. INT. CL. 9. REG. 10-11-2005.
- 3,005,336. VIRTOONS. INT. CL. 9. REG. 10-11-2005.
- 3,005,338. SKIRTS. INT. CLS. 9, 35 AND 41. REG. 10-11-2005.
- 3,005,339. DRISTONE. INT. CL. 19. REG. 10-11-2005.
- 3,005,352. EMMA HOPE. INT. CLS. 3, 14, 18 AND 25. REG. 10-11-2005.
- 3,005,359. HYPOSURE. INT. CL. 5. REG. 10-11-2005.
- 3,005,361. MISCELLANEOUS DESIGN. INT. CLS. 1 AND 3. REG. 10-11-2005.
- 3,005,362. ROSINA WACHTMEISTER. INT. CL. 14. REG. 10-11-2005.
- 3,005,364. NIOVIST. INT. CL. 5. REG. 10-11-2005.
- 3,005,371. N'GENE (STYLIZED). INT. CL. 25. REG. 10-11-2005.
- 3,005,377. MAMMODETECTOR. INT. CLS. 9 AND 10. REG. 10-11-2005.
- 3,005,383. OTV. INT. CLS. 11 AND 40. REG. 10-11-2005.
- 3,005,389. DEXGATE AND DESIGN. INT. CL. 16 ONLY. REG. 10-11-2005.
- 3,005,417. HILOVE. INT. CL. 14. REG. 10-11-2005.
- 3,005,596. SAFEHEART. INT. CL. 5. REG. 10-11-2005.
- 3,005,597. VIRTOPSY. INT. CLS. 5, 9, 10, 37, 41 AND 42. REG. 10-11-2005.

- 3,005,599. TECHNIUM. INT. CLS. 35, 36, 41 AND 42. REG. 10-11-2005.
- 3,005,602. QIDIS. INT. CLS. 5 AND 10. REG. 10-11-2005.
- 3,005,605. SIGNSECURE. INT. CL. 42. REG. 10-11-2005.
- 3,005,607. ALSO. INT. CLS. 9, 16, 35, 37, 38, 39, 41 AND 42. REG. 10-11-2005.
- 3,005,608. ENERGYINTELLECT. INT. CLS. 35 AND 42. REG. 10-11-2005.
- 3,005,615. SHARON. INT. CL. 30. REG. 10-11-2005.
- 3,005,616. OXTAR AND DESIGN. INT. CLS. 9, 18 AND 25. REG. 10-11-2005.
- 3,005,618. PROOF OF VALUE. INT. CL. 16. REG. 10-11-2005.
- 3,005,629. OTOSIL (STYLIZED). INT. CLS. 1 AND 10. REG. 10-11-2005.
- 3,005,631. DAIRYHOX. INT. CL. 1. REG. 10-11-2005.
- 3,005,632. REMUS. INT. CLS. 7, 8 AND 11. REG. 10-11-2005.
- 3,006,078. SILICON ALLEY. INT. CL. 42. REG. 10-11-2005.
- 3,006,079. CONTEMPODESIGNONLINE. INT. CL. 9. REG. 10-11-2005.
- 3,006,080. EPOXONE. INT. CL. 1. REG. 10-11-2005.
- 3,006,081. P.B.. INT. CL. 9. REG. 10-11-2005.
- 3,006,084. BLACK CARD. INT. CL. 16. REG. 10-11-2005.
- 3,006,089. CLIFFHANGER. INT. CL. 28. REG. 10-11-2005.
- 3,006,093. NESCAFÉ AND DESIGN. INT. CL. 30. REG. 10-11-2005.
- 3,006,094. PROFIT CHECK. INT. CL. 35. REG. 10-11-2005.
- 3,006,096. WAVES. INT. CL. 41. REG. 10-11-2005.
- 3,006,097. ELEC.TRON LOVE THEORY (STYLIZED). INT. CLS. 9 AND 41. REG. 10-11-2005.
- 3,006,100. CHERUB SWEETIES. INT. CL. 16. REG. 10-11-2005.
- 3,006,101. CASHPIN. INT. CLS. 38, 39 AND 42. REG. 10-11-2005.
- 3,006,102. PURESTREAM. INT. CL. 40. REG. 10-11-2005.
- 3,006,103. S (STYLIZED). INT. CL. 9. REG. 10-11-2005.
- 3,006,109. P (STYLIZED). INT. CLS. 24, 25 AND 40. REG. 10-11-2005.
- 3,006,111. BARNES & NOBLE TELEVISION. INT. CLS. 38 AND 41. REG. 10-11-2005.
- 3,006,112. WE BRING LIFE TO PRODUCTS. INT. CL. 32. REG. 10-11-2005.
- 3,006,114. BEYOND YOGURT. INT. CL. 29. REG. 10-11-2005.
- 3,006,115. OCCASIO. INT. CL. 36. REG. 10-11-2005.
- 3,006,124. SINDY (STYLIZED). INT. CL. 28. REG. 10-11-2005.
- 3,006,125. GREGORY HORROR SHOW. INT. CLS. 9 AND 16. REG. 10-11-2005.
- 3,006,129. THERMALCAST 130. INT. CL. 6. REG. 10-11-2005.
- 3,006,132. INFINITE VITALITY. INT. CL. 42. REG. 10-11-2005.
- 3,006,133. STUDS 'N MORE. INT. CL. 14. REG. 10-11-2005.
- 3,006,134. CUMBY'S. INT. CL. 30. REG. 10-11-2005.
- 3,006,136. BYRON. INT. CL. 9. REG. 10-11-2005.
- 3,006,137. THE ESP GROUP. INT. CLS. 9 AND 41. REG. 10-11-2005.
- 3,006,140. POWERMAGIC MOBILE. INT. CL. 9. REG. 10-11-2005.
- 3,006,144. REGIS REXEL GLOBAL INFORMATION SYSTEM AND DESIGN. INT. CL. 35. REG. 10-11-2005.
- 3,006,145. TOUR SPIRIT. INT. CL. 28. REG. 10-11-2005.
- 3,006,146. GRAB THE MAXX. INT. CL. 9. REG. 10-11-2005.
- 3,006,147. BLUE SUN CREATIONS. INT. CL. 41. REG. 10-11-2005.
- 3,006,149. THE HEALTH CLUB. INT. CL. 3. REG. 10-11-2005.
- 3,006,159. ULTRAPET. INT. CL. 2. REG. 10-11-2005.
- 3,006,167. HISPANICTRENDS.COM. INT. CLS. 35, 36 AND 42. REG. 10-11-2005.
- 3,006,169. JAMWARE. INT. CL. 9. REG. 10-11-2005.
- 3,006,175. HELPING BUILD AMERICA'S BEST BRANDS. INT. CL. 35. REG. 10-11-2005.
- 3,006,177. EL GALLO GIRO. INT. CLS. 35 AND 43. REG. 10-11-2005.
- 3,006,178. HAVE YOU HAD YOUR MINERALS TODAY?. INT. CL. 32. REG. 10-11-2005.
- 3,006,182. CONSIDER THE POTENTIAL. INT. CL. 41. REG. 10-11-2005.
- 3,006,187. INSPIRING TRADITIONS. INT. CLS. 6, 15, 16, 20, 21, 24, 26, 28 AND 35. REG. 10-11-2005.
- 3,006,191. COLORSPACE. INT. CLS. 35 AND 42. REG. 10-11-2005.
- 3,006,193. COLORSTOR. INT. CLS. 35 AND 42. REG. 10-11-2005.
- 3,006,194. COLORVUE. INT. CL. 41. REG. 10-11-2005.
- 3,006,195. ONE TO ONE MD, P.A.. INT. CL. 44. REG. 10-11-2005.
- 3,006,196. CELESTA LUXURY GLASS ENCLOSURES. INT. CL. 11. REG. 10-11-2005.
- 3,006,198. PHOTOTAINER. INT. CL. 9. REG. 10-11-2005.
- 3,006,204. COBIZ BANK, N.A.. INT. CL. 36. REG. 10-11-2005.
- 3,006,205. WHO?. INT. CLS. 3 AND 25. REG. 10-11-2005.
- 3,006,212. FORMED IN THE EYE OF THE STORM. INT. CL. 6. REG. 10-11-2005.
- 3,006,213. ARCH RESISTOR IMPACT SERIES. INT. CL. 6. REG. 10-11-2005.
- 3,006,215. ANIMAL PLANET. INT. CL. 31. REG. 10-11-2005.
- 3,006,217. COMPUTERCRAIG. INT. CL. 9. REG. 10-11-2005.
- 3,006,218. FERROCARRIL MEXICANO AND DESIGN. INT. CL. 39. REG. 10-11-2005.
- 3,006,219. FERROCARRIL MEXICANO AND DESIGN. INT. CL. 39. REG. 10-11-2005.
- 3,006,220. BYSEN & BIDDY (STYLIZED). INT. CL. 25. REG. 10-11-2005.
- 3,006,227. PURRFORMA. INT. CL. 21. REG. 10-11-2005.
- 3,006,251. SMART'NMOIST. INT. CL. 10. REG. 10-11-2005.
- 3,006,253. UNGAVA RADICAL. INT. CLS. 18 AND 25. REG. 10-11-2005.
- 3,006,257. ENXCASE. INT. CL. 9. REG. 10-11-2005.
- 3,006,261. GOT YOUR LIME ON? STANDARD CHARACTER MARK. INT. CL. 32. REG. 10-11-2005.
- 3,006,264. WE TALK TOWELS STANDARD CHARACTER MARK. INT. CL. 24. REG. 10-11-2005.
- 3,006,321. VSE. INT. CL. 9. REG. 10-11-2005.
- 3,006,328. TENDERLOIN TECHNOLOGIES. INT. CL. 41. REG. 10-11-2005.
- 3,006,332. GATEHOUSE GRILLE AND DESIGN. INT. CL. 43. REG. 10-11-2005.
- 3,006,337. MISCELLANEOUS DESIGN. INT. CLS. 3, 5 AND 21. REG. 10-11-2005.
- 3,006,343. EDAI AND DESIGN. INT. CL. 16. REG. 10-11-2005.
- 3,006,346. SUN VALLEY ESSENCE. INT. CL. 3. REG. 10-11-2005.
- 3,006,348. LOOKS (STYLIZED). INT. CL. 35. REG. 10-11-2005.
- 3,006,351. INNOVATRACE (STYLIZED). INT. CL. 10. REG. 10-11-2005.
- 3,006,352. INNOVASPIN (STYLIZED). INT. CL. 10. REG. 10-11-2005.
- 3,006,357. TOOT. INT. CL. 5. REG. 10-11-2005.
- 3,006,359. FLOATING FORTRESS. INT. CL. 12. REG. 10-11-2005.
- 3,006,360. TOUGH-THERM. INT. CL. 4. REG. 10-11-2005.
- 3,006,362. EVERGY. INT. CL. 9. REG. 10-11-2005.
- 3,006,363. E EVERGY AND DESIGN. INT. CL. 9. REG. 10-11-2005.
- 3,006,365. BONUSES. INT. CL. 36. REG. 10-11-2005.
- 3,006,366. JUST T AND DESIGN. INT. CL. 30. REG. 10-11-2005.
- 3,006,367. GRACE LINE. INT. CL. 39. REG. 10-11-2005.
- 3,006,369. GRACE. INT. CL. 39. REG. 10-11-2005.
- 3,006,371. SOUND AVENGER. INT. CL. 9. REG. 10-11-2005.
- 3,006,372. SOUND AVENGER. INT. CL. 16. REG. 10-11-2005.
- 3,006,375. IXMUS IXM.US. INT. CLS. 42 AND 44. REG. 10-11-2005.
- 3,006,377. POSI-TATCH. INT. CL. 7. REG. 10-11-2005.
- 3,006,378. DEPEND ON US. INT. CLS. 7, 9 AND 11. REG. 10-11-2005.
- 3,006,379. OFFICERS ONLY AND DESIGN. INT. CL. 16. REG. 10-11-2005.
- 3,006,381. VIEWFINDER RECORDS. INT. CL. 9. REG. 10-11-2005.
- 3,006,385. GOT HITS!. INT. CL. 9. REG. 10-11-2005.
- 3,006,387. SKYWINDOWS. INT. CL. 19. REG. 10-11-2005.
- 3,006,389. CREATIVE PEACE. INT. CLS. 25 AND 30. REG. 10-11-2005.

- 3,006,390. MOPAR POWER PRO AND DESIGN. INT. CL. 9. REG. 10-11-2005.
- 3,006,391. DICE. INT. CL. 38. REG. 10-11-2005.
- 3,006,392. DICE. INT. CL. 41. REG. 10-11-2005.
- 3,006,393. QUICKFIT. INT. CL. 9. REG. 10-11-2005.
- 3,006,396. MOVE TO THE MUSIC. INT. CL. 41. REG. 10-11-2005.
- 3,006,397. MAKING A DIFFERENCE IN PEOPLES' LIVES. INT. CL. 41. REG. 10-11-2005.
- 3,006,404. THE FEE-FRIENDLY B/D. INT. CL. 36. REG. 10-11-2005.
- 3,006,405. NOGIN SOX (STYLIZED). INT. CL. 9. REG. 10-11-2005.
- 3,006,406. TRUOX. INT. CL. 1. REG. 10-11-2005.
- 3,006,407. OXIDATION WITHOUT IRRITATION. INT. CL. 1. REG. 10-11-2005.
- 3,006,409. SPEAKING OF WOMEN'S HEALTH. INT. CL. 14. REG. 10-11-2005.
- 3,006,411. UMR MD STANDARD CHARACTER MARK. INT. CL. 36. REG. 10-11-2005.
- 3,006,412. SECOND FOREST. INT. CL. 19. REG. 10-11-2005.
- 3,006,415. FABULOSO EARLY MORNING FRESCO AMANECER LIQUID CLEANER LIMPIADOR LIQUIDO AND DESIGN. INT. CL. 3. REG. 10-11-2005.
- 3,006,418. BAZOOKA. INT. CL. 25. REG. 10-11-2005.
- 3,006,423. MISCELLANEOUS DESIGN. INT. CLS. 9 AND 41. REG. 10-11-2005.
- 3,006,424. CARIZMA COLORS. INT. CL. 2. REG. 10-11-2005.
- 3,006,429. BROUGHT TO YOU IN FRIDSON VISION. INT. CL. 36. REG. 10-11-2005.
- 3,006,433. PALOMAR NEOLUX. INT. CL. 10. REG. 10-11-2005.
- 3,006,436. M-STYLE. INT. CL. 9. REG. 10-11-2005.
- 3,006,438. DEMFLOOD. INT. CLS. 6 AND 37. REG. 10-11-2005.
- 3,006,441. HIDEOUT CANYON. INT. CL. 37. REG. 10-11-2005.
- 3,006,449. WARCRAFT. INT. CL. 25. REG. 10-11-2005.
- 3,006,471. MEXIMERICA MEDIA. INT. CL. 41. REG. 10-11-2005.
- 3,006,474. LIVING WELL IN RETIREMENT. INT. CL. 36. REG. 10-11-2005.
- 3,006,478. MISCELLANEOUS DESIGN. INT. CL. 41. REG. 10-11-2005.
- 3,006,490. EFLOORTRADER. INT. CL. 9. REG. 10-11-2005.
- 3,006,491. WHEN IT HAS TO WORK. INT. CL. 9. REG. 10-11-2005.
- 3,006,494. SLIMWALL. INT. CL. 11. REG. 10-11-2005.
- 3,006,502. ESOVAL. INT. CL. 35. REG. 10-11-2005.
- 3,006,503. VH1 BOOTCAMP. INT. CL. 41. REG. 10-11-2005.
- 3,006,505. I FASHION. INT. CL. 9. REG. 10-11-2005.
- 3,006,507. ACTFLEX. INT. CL. 17. REG. 10-11-2005.
- 3,006,511. ENERGY HOG. INT. CL. 36. REG. 10-11-2005.
- 3,006,512. DIRTY 8. INT. CLS. 9 AND 25. REG. 10-11-2005.
- 3,006,515. COTTON STATES. INT. CL. 31. REG. 10-11-2005.
- 3,006,516. STAINAID. INT. CL. 3. REG. 10-11-2005.
- 3,006,527. SHADEBENDER. INT. CL. 3. REG. 10-11-2005.
- 3,006,532. LIBERTINE STANDARD CHARACTER MARK. INT. CL. 9. REG. 10-11-2005.
- 3,006,535. EVOLUTION STANDARD CHARACTER MARK. INT. CL. 9. REG. 10-11-2005.
- 3,006,544. ESTRELLA AND DESIGN. INT. CL. 30. REG. 10-11-2005.
- 3,006,545. MOTOTALK STANDARD CHARACTER MARK. INT. CL. 9. REG. 10-11-2005.
- 3,006,557. CHATTER BATS STANDARD CHARACTER MARK. INT. CL. 28. REG. 10-11-2005.
- 3,006,665. THE DREAM GIVER. INT. CL. 16. REG. 10-11-2005.
- 3,006,666. IMPROVING THE WAY BUSINESS GETS DONE STANDARD CHARACTER MARK. INT. CLS. 35, 39, 40, 41 AND 42. REG. 10-11-2005.
- 3,006,668. CARD CARRYING LIBERAL. INT. CL. 16. REG. 10-11-2005.
- 3,012,448. DATALOGIC AND DESIGN. INT. CL. 37 ONLY. REG. 11-8-2005.
- 3,013,864. JAVA CITY EXPRESS AND DESIGN. INT. CL. 32 ONLY. REG. 11-8-2005.
- 3,014,831. DRIVE-THRU RECORDS. INT. CL. 16 ONLY. REG. 11-15-2005.
- 3,014,853. MXPEG. INT. CLS. 42 AND 45 ONLY. REG. 11-15-2005.
- 3,038,552. CULINARY HALL OF FAME (STYLIZED). INT. CLS. 35 AND 43 ONLY. REG. 1-3-2006.
- 3,040,493. UNITEDHEALTH BASICS STANDARD CHARACTER MARK. INT. CL. 44 ONLY. REG. 1-10-2006.
- 3,062,963. BAKOTOPIA STANDARD CHARACTER MARK. INT. CLS. 35 AND 36 ONLY. REG. 2-28-2006.
- 3,068,146. THE LYLE ANDERSON COMPANY, INC. STANDARD CHARACTER MARK. INT. CL. 41 ONLY. REG. 3-14-2006.
- 3,081,616. EMERALD AND DESIGN. INT. CL. 9 ONLY. REG. 4-18-2006.
- 3,086,524. HENRY ROAD STANDARD CHARACTER MARK. INT. CL. 18 ONLY. REG. 4-25-2006.
- 3,086,956. PERROT (STYLIZED). INT. CL. 17 ONLY. REG. 5-2-2006.
- 3,088,936. FINANCIAL EXECUTIVES INTERNATIONAL STANDARD CHARACTER MARK. INT. CL. 9 ONLY. REG. 5-2-2006.
- 3,089,060. ACE AMERICAN COUNCIL ON EXERCISE (STYLIZED). INT. CL. 9 ONLY. REG. 5-9-2006.
- 3,091,814. IZO. INT. CL. 9 ONLY. REG. 5-16-2006.
- 3,092,154. MISCELLANEOUS DESIGN. INT. CLS. 38, 40 AND 43 ONLY. REG. 5-16-2006.
- 3,092,190. HALLMARK STANDARD CHARACTER MARK. INT. CL. 44 ONLY. REG. 5-16-2006.
- 3,092,233. LOCK & GO STANDARD CHARACTER MARK. INT. CL. 12 ONLY. REG. 5-16-2006.
- 3,092,645. MISCELLANEOUS DESIGN. INT. CL. 42 ONLY. REG. 5-16-2006.
- 3,094,895. SPIRIT OF THE DANCE STANDARD CHARACTER MARK. INT. CL. 25 ONLY. REG. 5-23-2006.
- 3,101,747. MISCELLANEOUS DESIGN. INT. CL. 41 ONLY. REG. 6-6-2006.
- 3,101,933. THIRST STANDARD CHARACTER MARK. INT. CLS. 16 AND 35 ONLY. REG. 6-6-2006.
- 3,114,677. FINNECON AND DESIGN. INT. CL. 35 ONLY. REG. 7-11-2006.
- 3,141,144. SOFTDRIVE STANDARD CHARACTER MARK. INT. CL. 12 ONLY. REG. 9-12-2006.
- 3,152,735. CHARISMA. INT. CLS. 16 AND 41 ONLY. REG. 10-10-2006.
- 3,155,282. NUTRITIOUS LIVING AND DESIGN. INT. CL. 29 ONLY. REG. 10-10-2006.
- 3,159,639. VARICOL. INT. CL. 11 ONLY. REG. 10-17-2006.
- 3,170,635. INSURANCE SOLUTIONS NEWSLETTER STANDARD CHARACTER MARK. INT. CLS. 36 AND 41 ONLY. REG. 11-14-2006.
- 3,190,417. IFES. INT. CL. 16 ONLY. REG. 1-2-2007.
- 3,216,073. AORTECH. INT. CL. 37 ONLY. REG. 3-6-2007.
- 3,232,692. D-OX STANDARD CHARACTER MARK. INT. CLS. 1 AND 2 ONLY. REG. 4-24-2007.
- 3,668,028. RCA (STYLIZED). INT. CL. 21. REG. 12-31-1968.
- 3,668,029. RCA. INT. CL. 21. REG. 12-31-1968.

SECTION 18

- 2,305,245. AXIOM FINANCIAL SERVICES AND DESIGN. INT. CL. 36. REG. 1-4-2000.
- 2,988,754. TAKE DOWN STANDARD CHARACTER MARK. INT. CL. 25. REG. 8-30-2005.
- 3,129,383. MOTION SPORTS STANDARD CHARACTER MARK. INT. CL. 5. REG. 8-15-2006.
- 3,204,390. EZ SHIELD STANDARD CHARACTER MARK. INT. CL. 6. REG. 1-30-2007.
- 3,303,929. VERONICA CREEK STANDARD CHARACTER MARK. INT. CL. 33. REG. 10-2-2007.

- 3,404,177. INNOVATIVE AUTODRAIN NANOMIST TECHNOLOGY STANDARD CHARACTER MARK. INT. CL. 11. REG. 4-1-2008.
- 3,404,739. UCTV STANDARD CHARACTER MARK. INT. CL. 41. REG. 4-1-2008.
- 3,504,658. CLIO STANDARD CHARACTER MARK. INT. CL. 9. REG. 9-23-2008.
- 3,622,144. MOVIL GUARD LA CLAVE PARA PROTEGER SU CELULAR AND DESIGN. INT. CL. 36. REG. 5-19-2009.
- 3,694,556. RARE GEAR AND DESIGN. INT. CL. 25. REG. 10-13-2009.
- 3,762,225. LIVEMARKETS STANDARD CHARACTER MARK. INT. CL. 35. REG. 3-23-2010.
- 3,861,406. LITTLE LULU AND DESIGN. INT. CL. 32. REG. 10-12-2010.
- 3,909,514. MIDWEST TILE & GRANITE STANDARD CHARACTER MARK. INT. CL. 35. REG. 1-18-2011.
- 3,964,639. LI-PRODRUG STANDARD CHARACTER MARK. INT. CLS. 5, 42 AND 44. REG. 5-24-2011.
- 4,020,363. BOX AND DESIGN. INT. CL. 9. REG. 8-30-2011.
- 3,046,413. SAND STANDARD CHARACTER MARK. INT. CLS. 9 AND 18 ONLY. REG. 1-17-2006.
- 3,046,461. MISCELLANEOUS DESIGN. INT. CL. 14. REG. 1-17-2006.
- 3,050,970. WÜRTH (STYLIZED). INT. CLS. 1 AND 22 ONLY. REG. 1-24-2006.
- 3,051,011. WHITEOUT STANDARD CHARACTER MARK. INT. CL. 18. REG. 1-24-2006.
- 3,051,061. MAXMAKERS STANDARD CHARACTER MARK. INT. CL. 28. REG. 1-24-2006.
- 3,051,069. INSPIRA STANDARD CHARACTER MARK. INT. CLS. 7, 8, 20 AND 23 ONLY. REG. 1-24-2006.
- 3,051,072. TAKE ACTION FOR HEALTHY BP STANDARD CHARACTER MARK. INT. CL. 41. REG. 1-24-2006.
- 3,051,078. WILKE TECHNOLOGY AND DESIGN. INT. CLS. 9, 41 AND 42 ONLY. REG. 1-24-2006.
- 3,051,086. LOGIPRINT STANDARD CHARACTER MARK. INT. CLS. 16 AND 39 ONLY. REG. 1-24-2006.
- 3,051,125. S SAFT AND DESIGN. INT. CL. 7. REG. 1-24-2006.
- 3,051,126. S AND DESIGN. INT. CL. 7. REG. 1-24-2006.
- 3,051,135. MOLD MIND STANDARD CHARACTER MARK. INT. CLS. 7 AND 42 ONLY. REG. 1-24-2006.
- 3,051,218. BARZANÓ & ZANARDO STANDARD CHARACTER MARK. INT. CLS. 36 AND 42 ONLY. REG. 1-24-2006.
- 3,055,685. MARIA TREBEN AND DESIGN. INT. CLS. 10 AND 29 ONLY. REG. 1-31-2006.
- 3,055,704. IMPERIA STANDARD CHARACTER MARK. INT. CLS. 8 AND 11 ONLY. REG. 1-31-2006.
- 3,055,725. POSSEHL STANDARD CHARACTER MARK. INT. CLS. 1, 6 AND 19 ONLY. REG. 1-31-2006.
- 3,057,963. GRANAROLO AND DESIGN. INT. CLS. 29, 30 AND 32 ONLY. REG. 2-7-2006.
- 3,060,487. CSB (STYLIZED). INT. CLS. 9 AND 16 ONLY. REG. 2-21-2006.
- 3,060,518. MYCROSINT STANDARD CHARACTER MARK. INT. CLS. 1, 9 AND 11 ONLY. REG. 2-21-2006.
- 3,063,864. JEPICO STANDARD CHARACTER MARK. INT. CLS. 9 AND 42 ONLY. REG. 2-28-2006.
- 3,068,394. MARIA TREBEN STANDARD CHARACTER MARK. INT. CLS. 3, 10 AND 29 ONLY. REG. 3-14-2006.
- 3,076,852. MISCELLANEOUS DESIGN. INT. CL. 18. REG. 4-4-2006.
- 3,133,208. MISCELLANEOUS DESIGN. INT. CLS. 25 AND 28 ONLY. REG. 8-22-2006.
- 3,142,373. SANOASA STANDARD CHARACTER MARK. INT. CLS. 11 AND 24 ONLY. REG. 9-12-2006.
- 3,189,661. ILUN@ GROUP AND DESIGN. INT. CLS. 23 AND 24 ONLY. REG. 12-26-2006.
- 3,194,714. MIYABI STANDARD CHARACTER MARK. INT. CLS. 8 AND 21 ONLY. REG. 1-2-2007.

SECTION 71

- 2,989,827. BARBARIAN MOTORCYCLES AUSTRALIA AND DESIGN. INT. CL. 12. REG. 8-30-2005.
- 2,989,828. OMNI SURVEYOR 3D AND DESIGN. INT. CL. 9. REG. 8-30-2005.
- 2,995,373. IDAFER STANDARD CHARACTER MARK. INT. CL. 5. REG. 9-13-2005.
- 2,998,375. MISCELLANEOUS DESIGN. INT. CL. 42. REG. 9-20-2005.
- 2,998,377. SHAPE STANDARD CHARACTER MARK. INT. CLS. 9 AND 42. REG. 9-20-2005.
- 2,998,378. SXEY STANDARD CHARACTER MARK. INT. CL. 25. REG. 9-20-2005.
- 3,002,035. SYPH-CHECK-1 STANDARD CHARACTER MARK. INT. CL. 5. REG. 9-27-2005.
- 3,004,541. BERNEY-BLONDEAU STANDARD CHARACTER MARK. INT. CL. 14. REG. 10-4-2005.
- 3,004,544. RASILEZ STANDARD CHARACTER MARK. INT. CL. 5. REG. 10-4-2005.
- 3,006,027. DATAGUARDSMAN STANDARD CHARACTER MARK. INT. CL. 9. REG. 10-11-2005.
- 3,006,028. ERA (STYLIZED). INT. CL. 10. REG. 10-11-2005.
- 3,041,911. DERMAVIDUALS STANDARD CHARACTER MARK. INT. CLS. 3 AND 5 ONLY. REG. 1-10-2006.
- 3,041,997. AMBROFIX STANDARD CHARACTER MARK. INT. CLS. 1 AND 3 ONLY. REG. 1-10-2006.
- 3,046,267. LC LAURENT CRISTANEL (STYLIZED). INT. CLS. 3 AND 25 ONLY. REG. 1-17-2006.
- 3,046,305. FRANKIE MORELLO STANDARD CHARACTER MARK. INT. CL. 3. REG. 1-17-2006.
- 3,046,354. IRREDUCTIBLE (STYLIZED). INT. CLS. 14 AND 25 ONLY. REG. 1-17-2006.
- 3,046,356. OCCIENT STANDARD CHARACTER MARK. INT. CLS. 35 AND 41 ONLY. REG. 1-17-2006.
- 3,046,372. WAREMA (STYLIZED). INT. CLS. 6 AND 19 ONLY. REG. 1-17-2006.
- 4,093,523. ORGANAMANIA STANDARD CHARACTER MARK. INT. CL. 35. REG. 1-31-2012. RESTORED TO SN 85-333,262.

INADVERTENTLY ISSUED REGISTRATION NUMBERS

* * * * *

TRADEMARK REGISTRATIONS AMENDED, CORRECTED, ETC.

The designation "U.S. Cl." appearing in this section refers to the U.S. class in effect prior to Sep. 1, 1973 rather than the international class which applies to applications filed on or after that date. For adoption of international classification see notice in the OFFICIAL GAZETTE of Jun. 26, 1973 (911 O.G. TM 210).

Any change to the registration will be indicated at the bottom of each entry under ELEMENTS AMENDED, CORRECTED OR RESTRICTED. With the exception of changes to the goods and services, additions to the registration will appear in asterisks and deletions of the registration will appear in brackets. Elements which are only changed will be listed with no punctuation. As to the goods/services statement, amendments to the goods/services will appear in asterisks and deletions will appear in brackets. In addition if any change to the goods/services occurs, the element "Goods/Services" will be listed under ELEMENTS AMENDED, CORRECTED OR RESTRICTED.

945,279. REG. 10-17-1972. GENERAL MILLS, INC. (DELAWARE CORPORATION) NUMBER ONE GENERAL MILLS BOULEVARD, MINNEAPOLIS, MN, 55426, SN 72-399,647. FILED 8-9-1971. PRINCIPAL REGISTER.

1,225,542. REG. 1-25-1983. EUROPEAN COFFEEHOUSES WORLDWIDE, LLC (GEORGIA LIMITED LIABILITY COMPANY) 4505 ASHFORD DUNWOODY ROAD, DUNWOODY, GA, 30346, SN 73-312,888. FILED 6-2-1981. PRINCIPAL REGISTER.

BETTY CROCKER

THE MARK CONSISTS OF STANDARD CHARACTERS WITHOUT CLAIM TO ANY PARTICULAR FONT, STYLE, SIZE, OR COLOR.

OWNER OF U.S. REG. NOS. 515,266, 916,853 AND OTHERS.

INT. CL. 16/U.S. CL. 38

FOR COOK BOOKS.

FIRST USE 0-0-1950; IN COMMERCE 0-0-1950.

ELEMENTS AMENDED
MARK



NO CLAIM IS MADE TO THE EXCLUSIVE RIGHT TO USE "CAFE", APART FROM THE MARK AS SHOWN.

THE LINING AND STIPPLING SHOWN IN THE MARK ON THE DRAWING IS A FEATURE OF THE MARK, AND DOES NOT INDICATE COLOR.

THE PORTRAITS SHOWN DO NOT DEPICT ANY PARTICULAR LIVING INDIVIDUALS.

INT. CL. 42/U.S. CL. 100

FOR RESTAURANT SERVICES.

FIRST USE 12-0-1979; IN COMMERCE 12-0-1979.

ELEMENTS AMENDED
DESCRIPTION OF MARK
MARK

957,203. REG. 4-17-1973. CARBOLINE INTERNATIONAL CORPORATION (DELAWARE CORPORATION) 2150 SCHUETZ ROAD, ST. LOUIS, MO, 63146, SN 72-420,856. FILED 4-10-1972. PRINCIPAL REGISTER.

CARBOWELD

THE MARK CONSISTS OF STANDARD CHARACTERS WITHOUT CLAIM TO ANY PARTICULAR FONT, STYLE, SIZE, OR COLOR.

OWNER OF U.S. REG. NOS. 843,074 AND 860,872.

INT. CL. 2/U.S. CL. 16

FOR PAINT-LIKE, TWO-COMPONENT, ZINC-FILLED INORGANIC COATINGS.

FIRST USE 0-0-1967; IN COMMERCE 0-0-1967.

ELEMENTS AMENDED
ASSIGNMENT/NAME CHANGE
MARK

1,340,177. REG. 6-11-1985. PROBLEM-KNOWLEDGE COUPLER CORPORATION (DELAWARE CORPORATION), DBA PKC CORPORATION, ONE MILL STREET, BOX C13, BURLINGTON, VT, 05401, SN 73-427,022. FILED 5-23-1983. PRINCIPAL REGISTER.

PROBLEM-KNOWLEDGE COUPLERS

NO CLAIM IS MADE TO THE EXCLUSIVE RIGHT TO USE "COUPLER", APART FROM THE MARK AS SHOWN.
INT. CL. 9/U.S. CL. 38

FOR COMPUTER PROGRAMS FOR USE IN MEDICAL DIAGNOSIS, TREATMENT, MANAGEMENT AND RECORD-KEEPING.
FIRST USE 12-16-1982; IN COMMERCE 12-16-1982.

ELEMENTS CORRECTED
DBA/AKA
OWNER NAME
OWNER ADDRESS

1,342,110. REG. 6-18-1985. PROBLEM-KNOWLEDGE COUPLER CORPORATION (DELAWARE CORPORATION), DBA PKC CORPORATION, ONE MILL STREET, BOX C13, BURLINGTON, VT, 05401, SN 73-427,021. FILED 5-23-1983. PRINCIPAL REGISTER.

PKC

INT. CL. 9/U.S. CL. 38
FOR COMPUTER PROGRAMS FOR USE IN MEDICAL DIAGNOSIS, TREATMENT, MANAGEMENT AND RECORD-KEEPING.
FIRST USE 12-16-1982; IN COMMERCE 12-16-1982.

ELEMENTS CORRECTED
DBA/AKA
OWNER NAME

1,437,312. REG. 4-21-1987. GENERAL PENCIL COMPANY, INC. (NEW JERSEY CORPORATION) 67-73 FLEET STREET, JERSEY CITY, NJ, 07306, SN 73-622,675. FILED 9-29-1986. PRINCIPAL REGISTER.

SEMI-HEX

INT. CL. 16/U.S. CLS. 2, 5, 22, 23, 29, 37, 38 AND 50
FOR WRITING AND DRAWING IMPLEMENTS, NAMELY, PENCILS [AND BALL PENS].
FIRST USE 9-20-1918; IN COMMERCE 9-20-1918.

ELEMENTS CORRECTED
OWNER ADDRESS
CITIZENSHIP
ENTITY
OWNER NAME

1,562,484. REG. 10-24-1989. STAG'S LEAP WINE CELLARS, LLC (CALIFORNIA LIMITED LIABILITY COMPANY) 5766 SILVERADO TRAIL, NAPA, CA, 94558, SN 73-780,726. FILED 2-14-1989. PRINCIPAL REGISTER.

S.L.V.

THE MARK CONSISTS OF STANDARD CHARACTERS WITHOUT CLAIM TO ANY PARTICULAR FONT, STYLE, SIZE, OR COLOR.
INT. CL. 33/U.S. CL. 47

FOR WINES.
FIRST USE 12-10-1986; IN COMMERCE 12-10-1986.

ELEMENTS AMENDED
MARK

1,688,661. REG. 5-26-1992. THE YANKEE CANDLE COMPANY, INC. (MASSACHUSETTS CORPORATION) POST OFFICE BOX 110, SOUTH DEEFFIELD, MA, 013730110, SN 74-154,332. FILED 4-5-1991. PRINCIPAL REGISTER.

COUNTRY KITCHEN

INT. CL. 4/U.S. CL. 15
FOR CANDLES.
FIRST USE 5-25-1978; IN COMMERCE 5-25-1978.

ELEMENTS CORRECTED
OWNER NAME

1,690,882. REG. 6-2-1992. DECISION ANALYST, INC. (TEXAS CORPORATION) 604 AVENUE H EAST, ARLINGTON, TX, 76011, SN 74-036,299. FILED 3-9-1990. PRINCIPAL REGISTER.

CopyCheck

INT. CL. 35/U.S. CL. 101
FOR CONDUCTING MARKETING RESEARCH SURVEYS AND ANALYSES IN THE FIELD OF ADVERTISING PRE-TESTING TO DETERMINE THE EFFECTIVENESS OF PRINT, RADIO, AND TELEVISION ADVERTISING PRIOR TO PUBLICATION OF SUCH ADVERTISING.
FIRST USE 3-31-1990; IN COMMERCE 3-31-1990.

ELEMENTS AMENDED
DESCRIPTION OF MARK
MARK

1,699,568. REG. 7-7-1992. AMERICAN TRAVELER MOTOR CLUB, INC., THE (DELAWARE CORPORATION) 1440 MAIN STREET, SARASOTA, FL, 34236, SN 74-114,551. FILED 11-13-1990. PRINCIPAL REGISTER.



NO CLAIM IS MADE TO THE EXCLUSIVE RIGHT TO USE "MOTOR CLUB", APART FROM THE MARK AS SHOWN.

THE MARK CONSISTS IN PART OF A STYLIZED REPRESENTATION OF A BALD EAGLE IN FRONT OF A BELL CIRCLED BY THE WORDS "THE AMERICAN TRAVELER MOTOR CLUB".
INT. CL. 42/U.S. CLS. 100 AND 102
FOR AUTOMOBILE CLUB.
FIRST USE 10-27-1980; IN COMMERCE 10-27-1980.

2,256,516. REG. 6-29-1999. E. & J. GALLO WINERY (CALIFORNIA CORPORATION) 600 YOSEMITE BOULEVARD, MODESTO, CA, 95354, SN 75-353,797. FILED 9-8-1997. PRINCIPAL REGISTER.

ELEMENTS CORRECTED
CITIZENSHIP

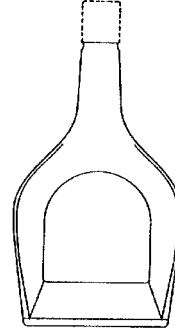

1,701,282. REG. 7-21-1992. PRESSTEK, INC. (DELAWARE CORPORATION) 55 EXECUTIVE DRIVE, HUDSON, NH, 03051, SN 74-154,011. FILED 4-4-1991. PRINCIPAL REGISTER.

THE LINING SHOWN IN THE DRAWING IS A FEATURE OF THE MARK AND IS NOT INTENDED TO INDICATE COLOR.

THE MARK CONSISTS OF A CONFIGURATION OF A BOTTLE WITH A CURVED, BEVELED BOTTOM AND AN OBLONG SHAPED INDENTATION ON THE FRONT AND BACK OF THE BOTTLE. THE CAP IS DEPICTED IN DOTTED LINES AND IS NOT PART OF THE MARK.

PRESSTEK

SEC. 2(F).

INT. CL. 33/U.S. CLS. 47 AND 49

FOR BRANDY.

FIRST USE 12-31-1980; IN COMMERCE 12-31-1980.

INT. CL. 2/U.S. CLS. 6, 11 AND 16
FOR PRINTING INKS.
FIRST USE 9-1-1987; IN COMMERCE 9-1-1987.
INT. CL. 7/U.S. CLS. 13, 19, 21, 23, 31, 34 AND 35
FOR PRINTING PRESSES AND PRINTING PLATES.
FIRST USE 9-1-1987; IN COMMERCE 9-1-1987.

ELEMENTS CORRECTED
DATE OF FIRST USE
DATE OF FIRST USE IN COMMERCE

ELEMENTS CORRECTED
GOODS/SERVICES
OWNER ADDRESS

2,360,451. REG. 6-20-2000. RETAIL ROYALTY COMPANY (NEVADA CORPORATION) 300 S. FOURTH STREET, BANK OF AMERICA PLAZA, SUITE 1100, LAS VEGAS, NV, 89101, SN 74-478,577. FILED 1-12-1994. PRINCIPAL REGISTER.

AE

1,750,602. REG. 2-2-1993. NEW VAVIN, INC. (VIRGINIA CORPORATION) 3222 EHLERS LANE, ST. HELENA, VA, 94574, SN 74-219,838. FILED 11-7-1991. PRINCIPAL REGISTER.

INT. CL. 25/U.S. CLS. 22 AND 39
FOR FOOTWEAR, SLIPPERS, LEATHER AND RUBBER BOOTS [AND INSOLES].
FIRST USE 7-15-1994; IN COMMERCE 7-15-1994.

LE DUCQ

ELEMENTS AMENDED
GOODS/SERVICES

INT. CL. 33/U.S. CLS. 47 AND 49
FOR WINE.
FIRST USE 11-0-1989; IN COMMERCE 11-0-1989.

2,435,921. REG. 3-13-2001. KOMBI LTD. (CONNECTICUT CORPORATION) 6 THOMPSON DRIVE, ESSEX JUNCTION, VT, 05451, SN 75-757,066. FILED 7-19-1999. PRINCIPAL REGISTER.

ELEMENTS CORRECTED
GOODS/SERVICES
MARK TYPE
INTERNATIONAL CLASS(ES)
DATE OF FIRST USE
DATE OF FIRST USE IN COMMERCE

HOT PAWS

INT. CL. 25/U.S. CLS. 22 AND 39

FOR GLOVES AND MITTENS FOR USE IN SKIING AND SNOWBOARDING.
FIRST USE 7-21-2000; IN COMMERCE 7-21-2000.

2,569,898. REG. 5-14-2002. BRADY WORLDWIDE, INC. (WISCONSIN CORPORATION) 6555 WEST GOOD HOPE ROAD, MILWAUKEE, WI, 53223, SN 76-254,321. FILED 5-7-2001. PRINCIPAL REGISTER.

ELEMENTS CORRECTED
CITIZENSHIP



2,508,336. REG. 11-20-2001. WHEEL PROS, LLC (DELAWARE LIMITED LIABILITY COMPANY) 44 UNION BOULEVARD, SUITE 620, LAKEWOOD, CO, 80228, SN 75-431,825. FILED 2-10-1998. PRINCIPAL REGISTER.

OWNER OF U.S. REG. NOS. 1,509,925, 1,534,285 AND 2,441,599.
INT. CL. 35/U.S. CLS. 100, 101 AND 102
FOR MAIL ORDER AND ELECTRONIC CATALOG SERVICES FEATURING SIGNS, LABELS AND TAGS.
FIRST USE 9-30-1985; IN COMMERCE 9-30-1985.

TORQ THRUST II

ELEMENTS AMENDED
MARK

THE MARK CONSISTS OF STANDARD CHARACTERS WITHOUT CLAIM TO ANY PARTICULAR FONT, STYLE, SIZE, OR COLOR.
OWNER OF U.S. REG. NO. 1,985,148.
INT. CL. 12/U.S. CLS. 19, 21, 23, 31, 35 AND 44
FOR AUTOMOTIVE VEHICLE WHEELS AND PARTS THEREFOR.
FIRST USE 11-0-1996; IN COMMERCE 11-0-1996.

2,571,341. REG. 5-21-2002. DATAVOX, INC. (TEXAS CORPORATION) 2000 W. SAM HOUSTON PKWY SOUTH, 9TH FL, HOUSTON, TX, 77042, SN 76-276,453. FILED 6-25-2001. PRINCIPAL REGISTER.

DATAVOX

ELEMENTS AMENDED
CITIZENSHIP
MARK

INT. CL. 41/U.S. CLS. 100, 101 AND 107
FOR TRAINING ON TELECOMMUNICATIONS EQUIPMENT, COMPUTER NETWORKS, COMPUTER TELEPHONY INTERFACES, CUSTOM WRITTEN SOFTWARE, AND ON DEMONSTRATION OF PHONE EQUIPMENT.
FIRST USE 9-0-1990; IN COMMERCE 9-0-1990.

2,512,540. REG. 11-27-2001. PROBLEM-KNOWLEDGE COUPLER CORPORATION (DELAWARE CORPORATION) ONE MILL STREET, BOX C13, BURLINGTON, VT, 05401, SN 76-205,918. FILED 2-7-2001. PRINCIPAL REGISTER.

ELEMENTS CORRECTED
OWNER NAME



2,579,436. REG. 6-11-2002. TOM HOM GROUP, LLC, THE (CALIFORNIA LIMITED LIABILITY COMPANY) SUITE H-525, 7660 FAY AVENUE, LA JOLLA, CA, 92037, SN 75-807,739. FILED 9-24-1999. PRINCIPAL REGISTER.

CAMPAIGNE

INT. CL. 9/U.S. CLS. 21, 23, 26, 36 AND 38
FOR COMPUTER PROGRAMS FOR USE IN MEDICAL TREATMENT, MEDICAL ASSESSMENT, MEDICAL DIAGNOSIS, MANAGEMENT OF DISEASES AND MEDICAL CONDITIONS, MEDICAL RECORD KEEPING, WELLNESS, PREVENTIVE MEDICAL CARE, AND OCCUPATIONAL HEALTH.
FIRST USE 10-0-1993; IN COMMERCE 10-0-1993.

INT. CL. 36/U.S. CLS. 100, 101 AND 102
FOR REAL ESTATE EQUITY SHARING, NAMELY, MANAGING AND ARRANGING FOR COOWNERSHIP OF REAL ESTATE; REAL ESTATE MANAGEMENT AND INVESTMENT; AND FINANCIAL SERVICES, NAMELY, FINANCIAL MANAGEMENT, FINANCIAL PLANNING, FINANCIAL ANALYSIS AND CONSULTATION.
FIRST USE 0-0-1990; IN COMMERCE 0-0-1997.
INT. CL. 37/U.S. CLS. 100, 103 AND 106
FOR REAL ESTATE SITE SELECTION AND DEVELOPMENT; AND CONSTRUCTION OF RESIDENTIAL AND COMMERCIAL BUILDINGS.
FIRST USE 0-0-1990; IN COMMERCE 0-0-1997.

ELEMENTS CORRECTED
OWNER NAME
OWNER ADDRESS

ELEMENTS CORRECTED
OWNER ADDRESS
ENTITY

2,609,117. REG. 8-20-2002. PROBLEM-KNOWLEDGE COUPLER CORPORATION (DELAWARE CORPORATION) ONE MILL STREET, BOX C13, BURLINGTON, VT, 05401, SN 76-205,919. FILED 2-7-2001. PRINCIPAL REGISTER.



OWNER OF U.S. REG. NO. 1,342,110.
 INT. CL. 42/U.S. CLS. 100 AND 101
 FOR PROVIDING ONLINE INFORMATION VIA THE INTERNET IN THE FIELDS OF MEDICAL TREATMENT, MEDICAL ASSESSMENT, MEDICAL DIAGNOSIS, MANAGEMENT OF DISEASES AND MEDICAL CONDITIONS, MEDICAL RECORD KEEPING, WELLNESS, PREVENTIVE MEDICAL CARE, AND OCCUPATIONAL HEALTH, VIA GLOBAL COMPUTER NETWORKS; PROVIDING TEMPORARY USE OF ONLINE NON-DOWNLOADABLE SOFTWARE FOR USE IN THE FIELDS OF MEDICAL TREATMENT, MEDICAL ASSESSMENT, MEDICAL DIAGNOSIS, MANAGEMENT OF DISEASES AND MEDICAL CONDITIONS, MEDICAL RECORD KEEPING, WELLNESS, PREVENTIVE MEDICAL CARE, AND OCCUPATIONAL HEALTH.
 FIRST USE 10-0-1997; IN COMMERCE 10-0-1997.

ELEMENTS CORRECTED
 OWNER NAME
 OWNER ADDRESS

2,696,835. REG. 3-11-2003. MARICH CONFECTIONARY COMPANY, INC. (CALIFORNIA CORPORATION) 2101 BERT DRIVE, HOLLISTER, CA, 95023, SN 76-230,491. FILED P.R. 3-23-2001; AM. S.R. 6-6-2002. SUPPLEMENTAL REGISTER.

TRUFLZ

INT. CL. 30/U.S. CL. 46
 FOR CANDY.
 FIRST USE 3-13-2001; IN COMMERCE 6-28-2001.

ELEMENTS CORRECTED
 OWNER NAME

2,709,874. REG. 4-22-2003. H.D.D. LLC (CALIFORNIA LIMITED LIABILITY COMPANY) P.O. BOX 1532, HEALDSBURG, CA, 95448, SN 76-186,559. FILED 12-26-2000. PRINCIPAL REGISTER.

BRADFORD MOUNTAIN

INT. CL. 33/U.S. CLS. 47 AND 49
 FOR WINE [AND DISTILLED SPIRITS].
 FIRST USE 0-0-1997; IN COMMERCE 0-0-2000.

ELEMENTS AMENDED
 GOODS/SERVICES

2,753,752. REG. 8-19-2003. CHICAGO MERCANTILE EXCHANGE INC. (DELAWARE CORPORATION) 20 S. WACKER DRIVE, CHICAGO, IL, 60606, SN 76-203,511. FILED 2-1-2001. PRINCIPAL REGISTER.

I-LINK

INT. CL. 36/U.S. CLS. 100, 101 AND 102
 FOR CONDUCTING COMMODITIES, SECURITIES, MONETARY AND FINANCIAL INSTRUMENTS FUTURES AND OPTIONS EXCHANGE SERVICES.
 FIRST USE 11-0-2001; IN COMMERCE 11-0-2001.

ELEMENTS CORRECTED
 CITIZENSHIP

2,798,945. REG. 12-23-2003. BRIGGS & RILEY TRAVELWARE, LLC (NEW YORK LIMITED LIABILITY COMPANY) 400 WIRELESS BOULEVARD, HAUPPAUGE, NY, 11788, SN 76-431,635. FILED 7-8-2002. PRINCIPAL REGISTER.



INT. CL. 18/U.S. CLS. 1, 2, 3, 22 AND 41
 FOR LUGGAGE.
 FIRST USE 6-0-2002; IN COMMERCE 6-0-2002.

ELEMENTS CORRECTED
 CITIZENSHIP
 ENTITY

2,828,376. REG. 3-30-2004. CHICAGO MERCANTILE EXCHANGE INC. (DELAWARE CORPORATION) 20 S. WACKER DRIVE, CHICAGO, IL, 60606, SN 76-416,132. FILED 5-31-2002. PRINCIPAL REGISTER.

SPAN RISK MANAGER

NO CLAIM IS MADE TO THE EXCLUSIVE RIGHT TO USE "RISK MANAGER", APART FROM THE MARK AS SHOWN.
 INT. CL. 9/U.S. CLS. 21, 23, 26, 36 AND 38
 FOR SOFTWARE FOR USE IN PERFORMING FINANCIAL PORTFOLIO RISK ANALYSIS.
 FIRST USE 11-0-2001; IN COMMERCE 11-0-2001.

ELEMENTS CORRECTED
 CITIZENSHIP

2,871,615. REG. 8-10-2004. MARK USA LLC (DELAWARE LIMITED LIABILITY COMPANY) 1874 NORTH YOUNG CIRCLE, HOLLYWOOD, FL, 33020, SN 78-242,077. FILED 4-25-2003. PRINCIPAL REGISTER.

CARE CLEANERS

NO CLAIM IS MADE TO THE EXCLUSIVE RIGHT TO USE "CLEANERS", APART FROM THE MARK AS SHOWN. INT. CL. 37/U.S. CLS. 100, 103 AND 106 FOR DRY CLEANING AND LAUNDRY SERVICES FOR CLOTHING. FIRST USE 9-15-2002; IN COMMERCE 9-15-2002.

ELEMENTS CORRECTED
OWNER NAME
CITIZENSHIP

2,894,112. REG. 10-19-2004. INTELLIDYNE, L.L.C. (VIRGINIA CORPORATION) TWO SKYLINE PLACE, 5203 LEESBURG PIKE, SUITE 400, FALLS CHURCH, VA, 22041, SN 76-331,900. FILED 10-31-2001. PRINCIPAL REGISTER.



INT. CL. 42/U.S. CLS. 100 AND 101 FOR CONSULTING SERVICES IN THE FIELD OF INFORMATION TECHNOLOGY. FIRST USE 4-0-1998; IN COMMERCE 4-0-1998.

ELEMENTS AMENDED
MARK
[LINING/STIPPLING STATEMENT]

2,899,774. REG. 11-2-2004. CREATIVE KNITWEAR INC. (GEORGIA CORPORATION) P.O. BOX 921852, NORCROSS, GA, 30010, SN 78-298,735. FILED 9-10-2003. PRINCIPAL REGISTER.



NO CLAIM IS MADE TO THE EXCLUSIVE RIGHT TO USE "KNITWEAR", APART FROM THE MARK AS SHOWN. THE COLOR(S) BLUE, WHITE, BLACK AND GREEN IS/ARE CLAIMED AS A FEATURE OF THE MARK.

THE COLORS BLUE AND GREEN ARE A FEATURE OF THE MARK; AND THE COLOR BLUE APPEARS IN THE GLOBE DESIGN PORTION OF THE MARK, REPRESENTING THE WORLD'S OCEANS, AND IN PORTIONS OF THE COMPASS POINTS AND THE INTERIOR OF THE OUTER CIRCLE; AND THE COLOR GREEN APPEARS IN THE GLOBE DESIGN PORTION OF THE MARK REPRESENTING LAND MASSES.

THE MARK CONSISTS OF A CIRCULAR COMPASS POINT DESIGN WITH A BLUE AND GREEN GLOBE DESIGN IN THE CENTER, SURROUNDED BY THE WORDS CREATIVE KNITWEAR IN WHITE ON A BLUE BACKGROUND WITH THE LETTERS N E S W IN BLACK OUTSIDE THE CIRCULAR DESIGN WHICH IS OUTLINED IN BLACK AND WITH COMPASS POINTS IN BLACK AND BLUE.

INT. CL. 25/U.S. CLS. 22 AND 39

FOR CLOTHING, NAMELY, INFANT BODY SUITS, CREEPERS, T-SHIRTS, SWEATSHIRTS, JOGGING SUITS, SHIRTS, SOCKS, HOSIERY, SLIPPERS, OVERALLS AND CAPS.

FIRST USE 8-19-2003; IN COMMERCE 9-8-2003.

ELEMENTS AMENDED
DESCRIPTION OF MARK
MARK

2,907,879. REG. 12-7-2004. THE INTERNATIONAL AIR CARGO ASSOCIATION, INC. (FLORIDA CORPORATION) 5600 NW 36TH STREET, SUITE 620, MIAMI, FL, 33122, SN 76-539,414. FILED 8-11-2003. PRINCIPAL REGISTER.



THE COLOR(S) BLACK AND REFLEX BLUE IS/ARE CLAIMED AS A FEATURE OF THE MARK.

THE MARK CONSISTS OF AN AIRPLANE IN THE COLOR BLACK TRAILED BY SEVENTEEN HORIZONTAL LINES DEPICTING SPEED ALSO IN THE COLOR BLACK. THE SEVENTEEN HORIZONTAL LINES COVER A GLOBAL MAP IN THE COLOR REFLEX BLUE WITH THE PHRASE TIACA IN THE CENTER OF THE GLOBAL MAP IN THE COLOR BLACK.

INT. CL. 35/U.S. CLS. 100, 101 AND 102

FOR NON-PROFIT ASSOCIATION SERVICES TO PROMOTE INDUSTRY COOPERATION, INNOVATION, KNOWLEDGE SHARING, ENHANCEMENT OF QUALITY AND EFFICIENCY, INDUSTRY DEVELOPMENTS AND TECHNICAL TRENDS IN THE FIELD OF AIR CARGO.

FIRST USE 6-26-1995; IN COMMERCE 6-26-1995.

ELEMENTS AMENDED
OWNER NAME
OWNER ADDRESS
CITIZENSHIP
ENTITY
DESCRIPTION OF MARK
MARK
COLOR DESCRIPTION STATEMENT

2,948,057. REG. 5-10-2005. BISHOP'S BARBERSHOP, LLC (OREGON LIMITED LIABILITY COMPANY) PO BOX 4120 / RCM#24017, PORTLAND, OR, 97208, SN 78-413,803. FILED 5-5-2004. PRINCIPAL REGISTER.

2,990,129. REG. 8-30-2005. FRANKLY CONSULTING LLC (NEW JERSEY LIMITED LIABILITY COMPANY) 7599 GATHERING DRIVE, REUNION, FL, 34747, SN 76-559,041. FILED 11-13-2003. PRINCIPAL REGISTER.

BISHOPS

THE MARK CONSISTS OF STANDARD CHARACTERS WITHOUT CLAIM TO ANY PARTICULAR FONT, STYLE, SIZE, OR COLOR.

INT. CL. 44/U.S. CLS. 100 AND 101

FOR HAIRDRESSING SALONS, BEAUTY SALONS AND HAIRCUTTING SERVICES.

FIRST USE 6-1-2001; IN COMMERCE 8-18-2001.

ELEMENTS CORRECTED
OWNER NAME
ENTITY

2,964,562. REG. 7-5-2005. NTV, L.L.C. (MASSACHUSETTS LIMITED LIABILITY COMPANY) 4 NORTH WATER STREET, NANTUCKET, MA, 02554, SN 76-539,051. FILED 8-19-2003. PRINCIPAL REGISTER.

PLUM TV

NO CLAIM IS MADE TO THE EXCLUSIVE RIGHT TO USE TV, APART FROM THE MARK AS SHOWN.

INT. CL. 41/U.S. CLS. 100, 101 AND 107

FOR TELEVISION PRODUCTION, PROGRAMMING, AND DISTRIBUTION SERVICES.

FIRST USE 5-1-2003; IN COMMERCE 5-1-2003.

ELEMENTS CORRECTED
OWNER NAME
OWNER ADDRESS

2,965,785. REG. 7-12-2005. GENERAL PENCIL COMPANY, INC. (NEW JERSEY CORPORATION) 67-73 FLEET STREET, JERSEY CITY, NJ, 07306, SN 76-554,438. FILED 10-27-2003. PRINCIPAL REGISTER.

PEEL & SKETCH

NO CLAIM IS MADE TO THE EXCLUSIVE RIGHT TO USE "SKETCH", APART FROM THE MARK AS SHOWN.

INT. CL. 16/U.S. CLS. 2, 5, 22, 23, 29, 37, 38 AND 50

FOR ARTISTS' PENCILS.

FIRST USE 1-0-1999; IN COMMERCE 1-0-1999.

ELEMENTS CORRECTED
OWNER NAME

FRANKLY FROG

THE MARK CONSISTS OF STANDARD CHARACTERS WITHOUT CLAIM TO ANY PARTICULAR FONT, STYLE, SIZE, OR COLOR.

INT. CL. 28/U.S. CLS. 22, 23, 38 AND 50

FOR GOLF PUTTERS.

FIRST USE 3-31-2004; IN COMMERCE 3-31-2004.

ELEMENTS CORRECTED
OWNER ADDRESS
ENTITY

2,996,505. REG. 9-20-2005. GENERAL PENCIL COMPANY, INC (NEW JERSEY CORPORATION) 67-73 FLEET STREET, JERSEY CITY, NJ, 07306, SN 76-569,385. FILED 1-2-2004. PRINCIPAL REGISTER.

LAYOUT

THE MARK CONSISTS OF STANDARD CHARACTERS WITHOUT CLAIM TO ANY PARTICULAR FONT, STYLE, SIZE, OR COLOR.

SEC. 2(F).

INT. CL. 16/U.S. CLS. 2, 5, 22, 23, 29, 37, 38 AND 50

FOR ARTISTS' PENCILS.

FIRST USE 1-5-1936; IN COMMERCE 1-5-1936.

ELEMENTS CORRECTED
OWNER ADDRESS
CITIZENSHIP
ENTITY
OWNER NAME

2,998,364. REG. 9-20-2005. AGIO SIGARENFABRIEKEN N.V. (NETHERLANDS NAAMLOZE VENNOOTSCHAP) WOLVERSTRAAT 3, NL-5525 AR DUIZEL, NETHERLANDS., SN 79-000,493. FILED 11-25-2003. PRINCIPAL REGISTER.

SILHOUETTE

THE MARK CONSISTS OF STANDARD CHARACTERS WITHOUT CLAIM TO ANY PARTICULAR FONT, STYLE, SIZE, OR COLOR.

OWNER OF INTERNATIONAL REGISTRATION 0537068 DATED 4-12-1989, EXPIRES 4-12-2019.

OWNER OF U.S. REG. NO. 1,602,698 AND OTHERS.

INT. CL. 34/U.S. CLS. 2, 8, 9 AND 17

FOR CIGARS.
FIRST USE ; IN COMMERCE .

3,046,865. REG. 1-17-2006. BRIGGS & RILEY TRAVELWARE, LLC (NEW YORK LIMITED LIABILITY COMPANY) 400 WIRELESS BOULEVARD, HAUPPAUGE, NY, 11788, SN 78-352,674. FILED 1-15-2004. PRINCIPAL REGISTER.

ELEMENTS CORRECTED
MARK

3,022,888. REG. 12-6-2005. MARK USA LLC (DELAWARE LIMITED LIABILITY COMPANY) 1874 NORTH YOUNG CIRCLE, HOLLYWOOD, FL, 33020, SN 78-242,069. FILED 4-25-2003. PRINCIPAL REGISTER.

TRANSCEND

CARE CARD

INT. CL. 37/U.S. CLS. 100, 103 AND 106
FOR DRY CLEANING AND LAUNDRY SERVICES
FOR CLOTHING.
FIRST USE 9-15-2002; IN COMMERCE 9-15-2002.

ELEMENTS CORRECTED
OWNER NAME
CITIZENSHIP

THE MARK CONSISTS OF STANDARD CHARACTERS WITHOUT CLAIM TO ANY PARTICULAR FONT, STYLE, SIZE, OR COLOR.

INT. CL. 18/U.S. CLS. 1, 2, 3, 22 AND 41

FOR LUGGAGE, TRAVEL BAGS, TOTE BAGS, DUFFEL BAGS, TOILETRY CASES SOLD EMPTY, BACKPACKS, ALL PURPOSE SPORT BAGS, WALLETS, HAND BAGS, TRAVEL POUCHES, SHOULDER BAGS, BRIEF CASES, SHOE BAGS, COSMETIC CASES SOLD EMPTY, GARMENT BAGS, PULLMANS, CARRY ON BAGS.
FIRST USE 2-0-2004; IN COMMERCE 2-0-2004.

ELEMENTS CORRECTED
CITIZENSHIP
ENTITY

3,024,812. REG. 12-6-2005. MICRON TECHNOLOGY, INC. (DELAWARE CORPORATION) 8000 SOUTH FEDERAL WAY, BOISE, ID, 83707, SN 78-495,553. FILED 10-6-2004. PRINCIPAL REGISTER.

BALLISTIX TRACER

3,057,106. REG. 2-7-2006. MARICH CONFECTIONERY COMPANY, INC. (CALIFORNIA CORPORATION) 2101 BERT DRIVE, HOLLISTER, CA, 95023, SN 78-311,555. FILED 10-9-2003. PRINCIPAL REGISTER.

HOLLAND MINTS

THE MARK CONSISTS OF STANDARD CHARACTERS WITHOUT CLAIM TO ANY PARTICULAR FONT, STYLE, SIZE, OR COLOR.

INT. CL. 9/U.S. CLS. 21, 23, 26, 36 AND 38

FOR PERSONAL COMPUTER COMPONENTS, NAMELY, MEMORY MODULES [AND VIDEO CARDS].
FIRST USE 11-30-2004; IN COMMERCE 11-30-2004.

ELEMENTS AMENDED
GOODS/SERVICES

NO CLAIM IS MADE TO THE EXCLUSIVE RIGHT TO USE MINTS, APART FROM THE MARK AS SHOWN.

INT. CL. 30/U.S. CL. 46

FOR CANDY, NAMELY, CREAMY CANDY CENTERS DIPPED IN DARK CHOCOLATE AND A FLAVORED CANDY SHELL.

FIRST USE 10-24-1985; IN COMMERCE 10-24-1985.

ELEMENTS CORRECTED
OWNER NAME

3,057,375. REG. 2-7-2006. GLOBAL SMOKED FOODS LIMITED FOUNDATION (ST.KITTS-NEVIS FOUNDATION) 9 SPRINGATES EAST, GOVERNMENT ROAD, CHARLESTON, NEVIS, ST.KITTS-NEVIS,, SN 78-489,497. FILED 9-24-2004. PRINCIPAL REGISTER.

3,084,640. REG. 4-25-2006. CHICAGO MERCANTILE EXCHANGE INC. (DELAWARE CORPORATION) 20 S. WACKER DRIVE, CHICAGO, IL, 60606, SN 78-496,071. FILED 10-7-2004. PRINCIPAL REGISTER.

COASTAL HARBOR

CME

THE MARK CONSISTS OF STANDARD CHARACTERS WITHOUT CLAIM TO ANY PARTICULAR FONT, STYLE, SIZE, OR COLOR.

INT. CL. 29/U.S. CL. 46

FOR * SMOKED FISH;* SALMON [, LOX, TUNA, HALIBUT, SHELLFISH AND SEAFOOD FOR FOOD PURPOSES, PREPARED FISH FILLETS, PREPARED SHELLFISH, PREPARED MEAT FILLETS, PREPARED BEEF, CHICKEN, PORK, LAMB AND VENISON FOR FOOD PURPOSES, COOKED FISH AND MEAT].

FIRST USE 7-7-2003; IN COMMERCE 7-7-2003.

ELEMENTS AMENDED
GOODS/SERVICES

THE MARK CONSISTS OF STANDARD CHARACTERS WITHOUT CLAIM TO ANY PARTICULAR FONT, STYLE, SIZE, OR COLOR.

OWNER OF U.S. REG. NOS. 2,829,913, 2,831,871 AND 2,840,360.

INT. CL. 9/U.S. CLS. 21, 23, 26, 36 AND 38

FOR COMPUTER HARDWARE AND SOFTWARE FOR USE IN PROVIDING FINANCIAL EXCHANGE SERVICES.

FIRST USE 8-21-2003; IN COMMERCE 8-21-2003.

INT. CL. 42/U.S. CLS. 100 AND 101

FOR PROVIDING TEMPORARY USE OF NON-DOWNLOADABLE SOFTWARE FOR USE IN PROVIDING FINANCIAL EXCHANGE SERVICES.

FIRST USE 8-21-2003; IN COMMERCE 8-21-2003.

ELEMENTS CORRECTED
CITIZENSHIP

3,075,976. REG. 4-4-2006. CHICAGO MERCANTILE EXCHANGE INC. (DELAWARE CORPORATION) 20 S. WACKER DRIVE, CHICAGO, IL, 60606, SN 78-496,095. FILED 10-7-2004. PRINCIPAL REGISTER.

3,092,859. REG. 5-16-2006. TAKE-TWO INTERACTIVE SOFTWARE, INC (DELAWARE CORPORATION) 622 BROADWAY, NEW YORK, NY, 10012, SN 78-627,491. FILED 5-11-2005. PRINCIPAL REGISTER.



MIDNIGHT CLUB 3

OWNER OF U.S. REG. NOS. 2,829,913, 2,840,360 AND OTHERS.

CHICAGO MERCANTILE EXCHANGE.

INT. CL. 9/U.S. CLS. 21, 23, 26, 36 AND 38

FOR COMPUTER HARDWARE AND SOFTWARE FOR USE IN PROVIDING FINANCIAL EXCHANGE SERVICES.

FIRST USE 8-21-2003; IN COMMERCE 8-21-2003.

INT. CL. 42/U.S. CLS. 100 AND 101

FOR PROVIDING TEMPORARY USE OF NON-DOWNLOADABLE SOFTWARE FOR USE IN PROVIDING FINANCIAL EXCHANGE SERVICES.

FIRST USE 8-21-2003; IN COMMERCE 8-21-2003.

ELEMENTS CORRECTED
CITIZENSHIP

THE MARK CONSISTS OF STANDARD CHARACTERS WITHOUT CLAIM TO ANY PARTICULAR FONT, STYLE, SIZE, OR COLOR.

OWNER OF U.S. REG. NO. 2,962,851.

INT. CL. 9/U.S. CLS. 21, 23, 26, 36 AND 38

FOR COMPUTER GAME PROGRAMS; COMPUTER GAME SOFTWARE [AND COMPUTER GAME CARTRIDGES].

FIRST USE 4-12-2005; IN COMMERCE 4-12-2005.

INT. CL. 41/U.S. CLS. 100, 101 AND 107

FOR PROVIDING A COMPUTER GAME THAT MAY BE ACCESSED NETWORK-WIDE BY GLOBAL COMPUTER NETWORK USERS.

FIRST USE 4-12-2005; IN COMMERCE 4-12-2005.

ELEMENTS CORRECTED
CITIZENSHIP

3,097,034. REG. 5-30-2006. GARY FRANSCIONI, INC. (CALIFORNIA CORPORATION) 32721 RIVER ROAD, SOLEDAD, CA, 93960, SN 76-521,489. FILED 6-9-2003. PRINCIPAL REGISTER.



INT. CL. 33/U.S. CLS. 47 AND 49
FOR WINE.
FIRST USE 2-24-2003; IN COMMERCE 2-24-2003.

ELEMENTS AMENDED
MARK
[DISCLAIMER]

3,107,162. REG. 6-20-2006. RICH PRODUCTS CORPORATION (DELAWARE CORPORATION) ATTN: LEGAL DEPARTMENT, 1150 NIAGARA STREET, BUFFALO, NY, 14213, SN 76-344,214. FILED 11-30-2001. PRINCIPAL REGISTER.

RICH'S

OWNER OF U.S. REG. NOS. 843,306, 1,034,011 AND OTHERS.

INT. CL. 29/U.S. CL. 46

FOR DAIRY AND NONDAIRY WHIPPED, NON-WHIPPED, FRUIT AND NUT TOPPINGS, ALL BEING FROZEN OR NON-FROZEN, AND BEING READY-TO-USE; DAIRY AND NON-DAIRY WHIPPED, NON-WHIPPED AND FRUIT-BASED FILLINGS, ALL BEING FROZEN OR NON-FROZEN, AND BEING READY-TO-USE OR NOT READY-TO-USE; FRUIT TOPPINGS AND FILLINGS FOR BAKERY PRODUCTS, PASTRY AND CONFECTIONERY; CARMEL NUT TOPPING FOR BAKERY PRODUCTS, PASTRY AND CONFECTIONERY, CREAMS FOR USE IN THE MANUFACTURE OF BAKERY GOODS OR CONFECTIONERY; BARBECUE POULTRY AND BARBECUE PORK; SMOKED BEEF, PORK AND POULTRY; FROZEN MEALS CONSISTING PRIMARILY OF MEAT AND POULTRY, NAMELY, PORK BARBECUE, BEEF BARBECUE, POULTRY BARBECUE, AND BARBECUE SANDWICHES; WHIPPED VEGETABLE SPREAD USED AS A SUBSTITUTE FOR MARGARINE OR BUTTER; PROCESSED MEATS; FROZEN OR REFRIGERATED PROCESSED MEAT AND MEAT ENTREES; ARTIFICIAL DAIRY BASED BEVERAGES AND CONCENTRATES AND BASES THEREOF; AND VEGETABLE-BASED FOOD BEVERAGES AND CONCENTRATES AND BASES THEREFORE; FROZEN MEALS CONSISTING PRIMARILY OF BEEF WITH A GRAVY MEAT SAUCE.

FIRST USE 3-1-1945; IN COMMERCE 3-1-1945.

INT. CL. 30/U.S. CL. 46

FOR ICINGS BEING FROZEN OR NON-FROZEN AND BEING READY-TO-USE OR NOT READY-TO-USE; CHOCOLATE, ARTIFICIAL CHOCOLATE, MARSHMALLOW AND ARTIFICIAL MARSHMALLOW TOPPINGS FOR CAKES AND DESSERTS, BEING FROZEN OR NON-FROZEN, AND BEING READY-TO-USE OR NOT READY-TO-USE; CHOCOLATE AND ARTIFICIAL CHOCOLATE TOPPINGS, ICINGS AND FILLINGS; LIQUID TOPPING SYRUP FOR CAKES AND DESSERTS; BAKERY PRODUCTS; BAKERY DESSERTS, FROZEN DOUGH; FROZEN, FRESH OR PACKED BAKERY PRODUCTS, NAMELY ROLLS, PIZZA CRUSTS, BAVARIAN CREAM PUFFS, CHOCOLATE PUFFS, PIES, CAKES, COOKIES, BROWNIES, PASTRIES, CROISSANTS,

BREADS, BREADSTICKS, SCONES, PUFF PASTRIES, BAGELS, AND MUFFINS; MIXES FOR MAKING BAKERY PRODUCTS; MIXES FOR MAKING DESSERTS IN THE NATURE OF CAKES, CHEESECAKES, BROWNIES, COOKIES, PIES, OR CUPCAKES; PUDDINGS; MOUSSE-CAKE; CHEESECAKE; ICE CREAM CAKE; FROZEN YOGURT CAKES; ICE CREAM; FRUIT SORBETS; FONDANTS FOR USE IN THE MANUFACTURE OF BAKERY GOODS OR CONFECTIONERY; GRAVY MIXES; DRY VERSIONS OF GRAVY SAUCES AND CHEESE SAUCES; STUFFED PASTA SHELLS; BASES FOR MAKING MILK SHAKES.

FIRST USE 3-1-1945; IN COMMERCE 3-1-1945.

INT. CL. 32/U.S. CLS. 45, 46 AND 48

FOR CONCENTRATES AND BASES FOR MAKING FRUIT DRINKS AND SMOOTHIES.

FIRST USE 10-20-2000; IN COMMERCE 10-20-2000.

INT. CL. 35/U.S. CLS. 100, 101 AND 102

FOR RETAIL BAKERY STORE SERVICES; [BUSINESS] * BUSINESS * CONSULTATION SERVICES, NAMELY, PROVIDING MARKETING INFORMATION SPECIALLY DESIGNED FOR IMPROVING SALES AND ENHANCING CUSTOMER SERVICE IN THE FOOD SERVICE, IN-STORE BAKERY, AND COMMERCIAL BAKERY INDUSTRIES; ELECTRONIC AND MAIL ORDER CATALOG SERVICES DIRECTED TOWARDS FOOD SERVICE BUSINESSES, FEATURING EQUIPMENT, SUPPLIES, APPAREL, TRAINING MATERIALS AND PROMOTIONAL MATERIALS.

FIRST USE 1-1-1990; IN COMMERCE 1-1-1990.

INT. CL. 41/U.S. CLS. 100, 101 AND 107

FOR EDUCATIONAL SERVICES, NAMELY CONDUCTING IN-STORE PIE AND CAKE DECORATING CLASSES.

FIRST USE 12-1-1972; IN COMMERCE 12-1-1972.

INT. CL. 43/U.S. CLS. 100 AND 101

FOR RESTAURANT SERVICES; CONSULTATION SERVICES, NAMELY CONSULTING WITH FOOD SERVICE ENTITIES IN THE FIELD OF RECIPE ENHANCEMENT, MENU PLANNING AND PRESENTATION TECHNIQUES FOR ITALIAN FOOD PREPARERS.

FIRST USE 12-1-1972; IN COMMERCE 12-1-1972.

ELEMENTS CORRECTED
GOODS/SERVICES

3,109,285. REG. 6-27-2006. PENSACOLA CHRISTIAN COLLEGE, INC. (FLORIDA CORPORATION) 250 BRENT LANE, PENSACOLA, FL, 32503, SN 78-668,089. FILED 7-12-2005. PRINCIPAL REGISTER.

ACADEMIC EXCELLENCE IN A
CARING, CHRISTIAN
ATMOSPHERE

THE MARK CONSISTS OF STANDARD CHARACTERS WITHOUT CLAIM TO ANY PARTICULAR FONT, STYLE, SIZE, OR COLOR.

OWNER OF U.S. REG. NO. 2,916,688.

INT. CL. 41/U.S. CLS. 100, 101 AND 107

FOR EDUCATIONAL SERVICES, NAMELY, PROVIDING COLLEGE LEVEL COURSES AND GRANTING OF DEGREES.

FIRST USE 5-20-2005; IN COMMERCE 5-20-2005.

ELEMENTS AMENDED
OWNER NAME

3,125,967. REG. 8-8-2006. POOCHIE-PETS, LLC (CONNECTICUT LIMITED LIABILITY COMPANY) 1280 HOPMEADOW STREET, SUITE A, SIMSBURY, CT, 06070, SN 78-563,232. FILED 2-8-2005. PRINCIPAL REGISTER.

3,153,506. REG. 10-10-2006. FLAMBEAU, INC. (WISCONSIN CORPORATION) 801 LYNN AVENUE, BARABOO, WI, 53913, SN 78-695,211. FILED 8-18-2005. PRINCIPAL REGISTER.

POOCHIEBELLS

THE MARK CONSISTS OF STANDARD CHARACTERS WITHOUT CLAIM TO ANY PARTICULAR FONT, STYLE, SIZE, OR COLOR.

NO CLAIM IS MADE TO THE EXCLUSIVE RIGHT TO USE "POOCHIE", APART FROM THE MARK AS SHOWN. INT. CL. 6/U.S. CLS. 2, 12, 13, 14, 23, 25 AND 50

FOR DOG DOORBELL SYSTEM COMPRISED OF METAL BELLS USED BY PETS TO ALERT THE OWNER WHEN THEY NEED TO GO OUT.

FIRST USE 1-1-2005; IN COMMERCE 1-1-2005.

ELEMENTS AMENDED
MARK



3,130,470. REG. 8-15-2006. THE CARROLL HALL SHELBY TRUST, THE TRUSTEES COMPRISING M. NEIL CUMMINGS AND JOECONWAY, UNITED STATES CITIZENS (TEXAS TRUST) 11150 W. OLYMPIC BLVD., SUITE 1050, LOS ANGELES, CA, 90064, SN 78-161,524. FILED 9-6-2002. PRINCIPAL REGISTER.

GT-500

INT. CL. 12/U.S. CLS. 19, 21, 23, 31, 35 AND 44
FOR AUTOMOBILES.
FIRST USE 1-1-1967; IN COMMERCE 1-1-1967.

ELEMENTS CORRECTED
ENTITY
DATE OF FIRST USE
DATE OF FIRST USE IN COMMERCE



3,150,487. REG. 10-3-2006. GLAETZER WINES PTY LTD (AUSTRALIA CORPORATION) 34 BAROSSA VALLEY WAY, TANUNDA, SOUTH AUSTRALIA, AUSTRALIA, 5352, SN 78-463,967. FILED 8-9-2004. PRINCIPAL REGISTER.



PRIORITY CLAIMED UNDER SEC. 44(D) ON AUSTRALIA APPLICATION NO. 996001, FILED 3-31-2004, REG. NO. 996001, DATED 3-31-2004.

INT. CL. 33/U.S. CLS. 47 AND 49

FOR WINES [, BRANDY SPIRITS, POTABLE SPIRITS, DISTILLED SPIRITS, AND LIQUEURS].

FIRST USE ; IN COMMERCE .

ELEMENTS AMENDED
GOODS/SERVICES

VLCHEK

THE MARK CONSISTS OF STANDARD CHARACTERS WITHOUT CLAIM TO ANY PARTICULAR FONT, STYLE, SIZE, OR COLOR.

OWNER OF U.S. REG. NOS. 254,241, 528,105 AND 778,361. SEC. 2(F).

INT. CL. 21/U.S. CLS. 2, 13, 23, 29, 30, 33, 40 AND 50

FOR FLOWER BASKETS; FLOWER BOWLS; FLOWER VASES AND BOWLS; HOLDERS FOR FLOWERS AND PLANTS; PLANTERS FOR FLOWERS AND PLANTS.

FIRST USE 12-20-1946; IN COMMERCE 12-20-1946.

ELEMENTS CORRECTED
CITIZENSHIP



3,160,610. REG. 10-17-2006. RETAIL ROYALTY COMPANY (NEVADA CORPORATION) 101 CONVENTION CENTER DRIVE, LAS VEGAS, NV, 89109, SN 78-570,385. FILED 2-18-2005. PRINCIPAL REGISTER.

AMERICAN EAGLE OUTFITTERS

THE MARK CONSISTS OF STANDARD CHARACTERS WITHOUT CLAIM TO ANY PARTICULAR FONT, STYLE, SIZE, OR COLOR.

OWNER OF U.S. REG. NOS. 1,597,199, 2,344,282 AND OTHERS.

NO CLAIM IS MADE TO THE EXCLUSIVE RIGHT TO USE "OUTFITTERS", APART FROM THE MARK AS SHOWN.

INT. CL. 30/U.S. CL. 46

FOR CANDY [, CHEWING GUM].

FIRST USE 11-24-2005; IN COMMERCE 11-24-2005.

ELEMENTS AMENDED
GOODS/SERVICES

3,199,288. REG. 1-16-2007. BRIGGS & RILEY TRAVELWARE, LLC (NEW YORK LIMITED LIABILITY COMPANY) 400 WIRELESS BOULEVARD, HAUPPAUGE, NY, 11788, SN 78-154,370. FILED 8-14-2002. PRINCIPAL REGISTER.



INT. CL. 18/U.S. CLS. 1, 2, 3, 22 AND 41
FOR LUGGAGE.
FIRST USE 4-0-2003; IN COMMERCE 4-0-2003.

ELEMENTS CORRECTED
CITIZENSHIP

3,200,832. REG. 1-23-2007. SOCIETY OF CRITICAL CARE MEDICINE (CALIFORNIA NON-PROFIT ASSOCIATION) SUITE 200, 701 LEE STREET, DES PLAINES, IL, 60016, AND EUROPEAN SOCIETY OF INTENSIVE CARE MEDICINE (BELGIUM NONPROFIT SOCIETY) 40 AVENUE JOSEPH WYBRAN, BRUSSELS, BELGIUM, B-1070, AND INTERNATIONAL SEPSIS FORUM (FLORIDA NON-PROFIT ORGANIZATION) C/O ELAINE RINICKER, 7024 PALMETTO PINES LANE, LAND O'LAKES, FL, 34637, SN 78-691,223. FILED 8-12-2005. PRINCIPAL REGISTER.



NO CLAIM IS MADE TO THE EXCLUSIVE RIGHT TO USE "SEPSIS CAMPAIGN", APART FROM THE MARK AS SHOWN.

THE STIPPLING IS FOR SHADING PURPOSES ONLY.
THE MARK CONSISTS OF THREE LINKED HANDS TO FORM A STYLIZED TRIANGLE.

INT. CL. 44/U.S. CLS. 100 AND 101

FOR PROVIDING HEALTH INFORMATION AND GUIDELINES PERTAINING TO SEPSIS.

FIRST USE 2-1-2002; IN COMMERCE 3-1-2004.

ELEMENTS CORRECTED
CITIZENSHIP

3,204,655. REG. 1-30-2007. TRULIA, INC. (DELAWARE CORPORATION) 116 NEW MONTGOMERY STREET, SUITE 300, SAN FRANCISCO, CA, 94105, SN 78-717,938. FILED 9-21-2005. PRINCIPAL REGISTER.

TRULIA

THE MARK CONSISTS OF STANDARD CHARACTERS WITHOUT CLAIM TO ANY PARTICULAR FONT, STYLE, SIZE, OR COLOR.

INT. CL. 42/U.S. CLS. 100 AND 101

FOR COMPUTER SERVICES, NAMELY, PROVIDING * A WEBSITE FEATURING A * SEARCH [ENGINES] * ENGINE * FOR OBTAINING DATA *, NAMELY, REAL ESTATE INFORMATION, ACCESSED VIA * [ON] A GLOBAL COMPUTER NETWORK, WIDE AREA NETWORKS AND LOCAL AREA NETWORKS; REAL ESTATE RESEARCH SERVICES, NAMELY, SEARCHING, RETRIEVING, SUMMARIZING AND PROVIDING INFORMATION RELATED TO REAL ESTATE MARKETS, TRENDS, PROPERTIES, LISTINGS AND PRICING.

FIRST USE 9-1-2005; IN COMMERCE 9-1-2005.

ELEMENTS AMENDED
GOODS/SERVICES
OWNER ADDRESS

3,210,901. REG. 2-20-2007. YELLOWSTONE MOUNTAIN CLUB, LLC (MONTANA LIMITED LIABILITY COMPANY) PO BOX 161097, BIG SKY, MT, 59716, SN 78-821,853. FILED 2-23-2006. PRINCIPAL REGISTER.



YELLOWSTONE CLUB

OWNER OF U.S. REG. NOS. 2,439,219 AND 2,508,037.

NO CLAIM IS MADE TO THE EXCLUSIVE RIGHT TO USE CLUB IN CLASSES 41 AND 43, APART FROM THE MARK AS SHOWN.

INT. CL. 25/U.S. CLS. 22 AND 39

FOR CLOTHING, NAMELY PANTS, JACKETS, VESTS, UNDERWEAR, HATS, GLOVES, SCARVES, T-SHIRTS, TURTLENECKS, SWEATSHIRTS AND SWEATERS; SKI WEAR.

FIRST USE 1-1-2001; IN COMMERCE 1-1-2001.

INT. CL. 36/U.S. CLS. 100, 101 AND 102

FOR REAL ESTATE BROKERAGE, REAL ESTATE ACQUISITION SERVICES AND REAL ESTATE LISTING.

FIRST USE 1-1-2001; IN COMMERCE 1-1-2001.

INT. CL. 41/U.S. CLS. 100, 101 AND 107

FOR ALPINE AND NORDIC SKI RESORT SERVICES; PROVIDING FACILITIES FOR RECREATIONAL ACTIVITIES, NAMELY, GOLF, SKIING, AND HORSEBACK RIDING; HEALTH CLUB SERVICES, NAMELY PROVIDING INSTRUCTION AND EQUIPMENT IN THE FIELD OF PHYSICAL EXERCISE.

FIRST USE 1-1-2001; IN COMMERCE 1-1-2001.

INT. CL. 43/U.S. CLS. 100 AND 101

FOR FOOD PREPARATION, RESTAURANT AND BANQUET SERVICES.

FIRST USE 1-1-2001; IN COMMERCE 1-1-2001.

ELEMENTS AMENDED
MARK

3,222,627. REG. 3-27-2007. THE CHEMICAL HERITAGE FOUNDATION (PENNSYLVANIA NON-PROFIT CORPORATION) 315 CHESTNUT STREET, PHILADELPHIA, PA. 19106, SN 78-892,388. FILED 5-25-2006. PRINCIPAL REGISTER.



THE COLOR(S) BLUE AND WHITE IS/ARE CLAIMED AS A FEATURE OF THE MARK.

THE MARK CONSISTS OF THE CAPITAL LETTERS CHF IN WHITE WITH A BLUE BACKGROUND IN A HEXAGON SHAPE.

INT. CL. 41/U.S. CLS. 100, 101 AND 107

FOR EDUCATION SERVICES, NAMELY, PROVIDING SEMINARS, CLASSES, WORKSHOPS, CONFERENCES, PRESENTATIONS, EVENTS, EXHIBITS, LIBRARY RESOURCES AND PROGRAMS IN THE FIELD(S) OF CHEMICAL AND MOLECULAR SCIENCES.

FIRST USE 0-0-1992; IN COMMERCE 0-0-1992.

ELEMENTS AMENDED

DESCRIPTION OF MARK

COLOR DESCRIPTION STATEMENT
MARK

3,250,187. REG. 6-12-2007. INSOURCE SOFTWARE SOLUTIONS, INC. (VIRGINIA CORPORATION) 11321 BUSINESS CENTER DRIVE, RICHMOND, VA. 23236, SN 76-651,953. FILED 12-14-2005. PRINCIPAL REGISTER.



OWNER OF U.S. REG. NO. 2,138,425.

THE STIPPLING IN THE DRAWING IS TO SHOW SHADING NOT COLOR.

INT. CL. 35/U.S. CLS. 100, 101 AND 102

FOR VALUE-ADDED RESELLER SERVICES, NAMELY, DISTRIBUTORSHIP SERVICES IN THE FIELD OF COMPUTER HARDWARE AND SOFTWARE.

FIRST USE 7-0-2004; IN COMMERCE 7-0-2004.

INT. CL. 42/U.S. CLS. 100 AND 101

FOR CONSULTING AND CONFIGURATION SERVICES IN THE FIELD OF COMPUTER HARDWARE, SOFTWARE AND SYSTEMS.

FIRST USE 7-0-2004; IN COMMERCE 7-0-2004.

ELEMENTS CORRECTED

OWNER NAME
ENTITY

3,225,233. REG. 4-3-2007. CAMERA DI COMMERCIO INDUSTRIA, ARTIGIANATO E AGRICOLTURA DI VERONA (ITALY GOVERNMENTAL BODY) CORSO PORTA NUOVA, 96, I-37122 VERONA, ITALY., AND CAMERA DI COMMERCIO INDUSTRIA, ARTIGIANATO E AGRICOLTURA DI VICENZA (ITALY GOVERNMENTAL BODY) CORSO ANTONIO FOGAZZARO, 37, I-36100 VICENZA, ITALY., SN 79-008,464. FILED 11-3-2004. PRINCIPAL REGISTER.

RECIOTO

THE MARK CONSISTS OF STANDARD CHARACTERS WITHOUT CLAIM TO ANY PARTICULAR FONT, STYLE, SIZE, OR COLOR.

OWNER OF INTERNATIONAL REGISTRATION 0842088 DATED 11-3-2004, EXPIRES 11-3-2014.

THE CERTIFICATION MARK, AS USED BY PERSONS AUTHORIZED BY THE CERTIFIER, CERTIFIES A WINE PRODUCED IN THE VALPOLICELLA REGION OF ITALY.

INT. CL. 33/U.S. CLS. 47 AND 49

FOR ALCOHOLIC BEVERAGES, NAMELY, WINE.

FIRST USE ; IN COMMERCE .

ELEMENTS CORRECTED

OWNER NAME
CERTIFICATION STATEMENT

3,257,730. REG. 7-3-2007. THE FAIRHAVEN GROUP, INC. (WASHINGTON CORPORATION) 321 3RD AVENUE SOUTH, SUITE 403, SEATTLE, WA. 98104, SN 78-597,472. FILED 3-29-2005. PRINCIPAL REGISTER.



THE MARK CONSISTS OF TWO OVERLAPPING INVERTED "V" SHAPES THAT REPRESENT A MOUNTAIN RANGE.

INT. CL. 18/U.S. CLS. 1, 2, 3, 22 AND 41

FOR MERCHANTILE SOFT GOODS, NAMELY CARRY-ON BAGS, OVERNIGHT BAGS, TRAVEL BAGS, LUGGAGE, BRIEFCASES, SHOULDER BAGS, AND COMPUTER BAGS.

FIRST USE 7-31-1997; IN COMMERCE 7-31-1998.

ELEMENTS AMENDED

OWNER ADDRESS
MARK

3,261,743. REG. 7-10-2007. M. NEIL CUMMINGS AND JOE CONWAY, TRUSTEES OF THE CARROLL HALL SHELBY TRUST U/D/T/ DATED MARCH 28, 1985, AS AMENDED (UNITED STATES TRUST) 11150 W. OLYMPIC BLVD., SUITE 1050, LOS ANGELES, CA. 90064, SN 78-161,519. FILED 9-6-2002. PRINCIPAL REGISTER.

[DISCLAIMER]

G.T.350

THE MARK CONSISTS OF STANDARD CHARACTERS WITHOUT CLAIM TO ANY PARTICULAR FONT, STYLE, SIZE, OR COLOR.

INT. CL. 12/U.S. CLS. 19, 21, 23, 31, 35 AND 44 FOR AUTOMOBILES.

FIRST USE 1-1-1965; IN COMMERCE 1-1-1965.

ELEMENTS CORRECTED
OWNER ADDRESS
ENTITY
DATE OF FIRST USE IN COMMERCE

3,319,446. REG. 10-23-2007. BRIGGS & RILEY TRAVEL-WARE, LLC (NEW YORK LIMITED LIABILITY COMPANY) 400 WIRELESS BOULEVARD, HAUPPAUGE, NY, 11788, SN 78-381,130. FILED 3-9-2004. PRINCIPAL REGISTER.

TUFF-LITE

3,274,053. REG. 8-7-2007. BLOOMBERG FINANCE ONE L.P. (DELAWARE LIMITED PARTNERSHIP) 731 LEXINGTON AVENUE, NEW YORK, NY, 10022, SN 77-050,014. FILED 11-22-2006. PRINCIPAL REGISTER.

BVAL

THE MARK CONSISTS OF STANDARD CHARACTERS WITHOUT CLAIM TO ANY PARTICULAR FONT, STYLE, SIZE, OR COLOR.

INT. CL. 36/U.S. CLS. 100, 101 AND 102

FOR FINANCIAL SERVICES, NAMELY, GENERATION OF PRICES OF FINANCIAL INSTRUMENTS.

FIRST USE 10-15-2006; IN COMMERCE 10-15-2006.

ELEMENTS AMENDED
OWNER NAME
OWNER ADDRESS
CITIZENSHIP
ENTITY
MARK

THE MARK CONSISTS OF STANDARD CHARACTERS WITHOUT CLAIM TO ANY PARTICULAR FONT, STYLE, SIZE, OR COLOR.

INT. CL. 18/U.S. CLS. 1, 2, 3, 22 AND 41

FOR FABRIC COMPONENT OF LUGGAGE, TRAVEL BAGS, TOTE BAGS, DUFFEL BAGS, TOILETRY CASES SOLD EMPTY, BACKPACKS, ALL PURPOSE SPORT BAGS, WALLETS, HAND BAGS, TRAVEL POUCHES, SHOULDER BAGS, BRIEFCASES, SHOE BAGS, COSMETIC CASES SOLD EMPTY, GARMENT BAGS, PULLMANS, CARRY ON BAGS.

FIRST USE 3-0-2005; IN COMMERCE 3-0-2005.

ELEMENTS CORRECTED
CITIZENSHIP

3,289,427. REG. 9-11-2007. OHIO TABLE PAD COMPANY, INC. (OHIO CORPORATION) 1270 FLAGSHIP DRIVE, PERRYSBURG, OH, 435529932, SN 76-668,837. FILED 11-13-2006. PRINCIPAL REGISTER.

GUARDIAN

THE MARK CONSISTS OF STANDARD CHARACTERS WITHOUT CLAIM TO ANY PARTICULAR FONT, STYLE, SIZE, OR COLOR.

OWNER OF U.S. REG. NO. 1,682,996.

INT. CL. 24/U.S. CLS. 42 AND 50 FOR TABLE PADS.

FIRST USE 9-0-1989; IN COMMERCE 9-0-1989.

ELEMENTS AMENDED
MARK

3,372,241. REG. 1-22-2008. KACO SOLAR, INC. (DELAWARE CORPORATION) 1002 B O'REILLY AVENUE, THE PRESIDIO, SAN FRANCISCO, CA, 94129, SN 77-182,117. FILED 5-16-2007. PRINCIPAL REGISTER.

BLUE PLANET

THE MARK CONSISTS OF STANDARD CHARACTERS WITHOUT CLAIM TO ANY PARTICULAR FONT, STYLE, SIZE, OR COLOR.

INT. CL. 9/U.S. CLS. 21, 23, 26, 36 AND 38

FOR PHOTOVOLTAIC INVERTER.

FIRST USE 8-31-2005; IN COMMERCE 8-31-2005.

ELEMENTS CORRECTED
CITIZENSHIP

3,379,392. REG. 2-5-2008. SANMINA-SCI CORPORATION (DELAWARE CORPORATION) 2700 N. FIRST STREET, SAN JOSE, CA, 95134, SN 78-716,169. FILED 9-19-2005. PRINCIPAL REGISTER.

FIRECOMM

THE MARK CONSISTS OF STANDARD CHARACTERS WITHOUT CLAIM TO ANY PARTICULAR FONT, STYLE, SIZE, OR COLOR.

INT. CL. 9/U.S. CLS. 21, 23, 26, 36 AND 38

FOR COMMUNICATIONS SOFTWARE FOR CONNECTING AEROSPACE AND AVIONIC COMMUNICATIONS SYSTEMS WITH DIGITAL AUDIO AND DATA DISTRIBUTION; COMPUTER FIRMWARE FOR AEROSPACE AND AVIONIC COMMUNICATIONS SYSTEMS WITH DIGITAL AUDIO AND DATA DISTRIBUTION; COMPUTER HARDWARE; COMPUTER HARDWARE FOR TELECOMMUNICATIONS; TELECOMMUNICATIONS AND DATA NETWORKING HARDWARE, NAMELY, DEVICES FOR TRANSPORTING AND AGGREGATING VOICE, DATA, AND VIDEO COMMUNICATIONS ACROSS MULTIPLE NETWORK INFRASTRUCTURES AND COMMUNICATIONS PROTOCOLS.

FIRST USE 3-31-2006; IN COMMERCE 3-31-2006.

ELEMENTS CORRECTED
OWNER NAME
OWNER ADDRESS

FOR LEATHER AND IMITATIONS OF LEATHER, AND GOODS MADE OF THESE MATERIALS, NAMELY TRUNKS AND TRAVELING BAGS; UMBRELLAS; PARASOLS; LUGGAGE, NAMELY SUITCASES, WHEELED SUITCASES, TRAVEL BAGS, GARMENT BAGS, PULLMANS, BACKPACKS, TOTE BAGS, VANITY CASES SOLD EMPTY, CLUTCHES, SATCHELS, SCHOOL BAGS, BRIEFCASES, INFANT DIAPER BAGS, SPORT BAGS, ATHLETIC BAGS, TRAVEL POUCHES, LUGGAGE HANGERS, LUGGAGE STRAPS, AND LUGGAGE TAGS; HANDBAGS, ALL PURPOSE SPORTS BAGS, ATTACHE CASES, SUITCASES, BRIEF CASE TYPE PORTFOLIOS, BOOK BAGS, WAIST PACKS, DUFFEL BAGS; WOMEN'S HANDBAGS, SHOULDER BAGS, TOILETRY CASES SOLD EMPTY; LEATHER SHOPPING BAGS, SCHOOL BAGS, KEY CASES, POCKET WALLETS, BILLFOLDS, PASSPORT CASES, BUSINESS CARD CASES.

FIRST USE 4-1-1993; IN COMMERCE 4-1-1993.

ELEMENTS CORRECTED
CITIZENSHIP

3,426,482. REG. 5-13-2008. AUGMENTIX CORPORATION (DELAWARE CORPORATION) 4030 W. BRAKER LANE, BUILDING 2-100, AUSTIN, TX, 78759, SN 77-270,902. FILED 9-4-2007. PRINCIPAL REGISTER.

RUGGED REDEFINED.

3,382,899. REG. 2-12-2008. BRIGGS & RILEY TRAVELWARE, LLC (NEW YORK LIMITED LIABILITY COMPANY) 400 WIRELESS BOULEVARD, HAUPPAUGE, NY, 11788, SN 78-664,946. FILED 7-6-2005. PRINCIPAL REGISTER.

BRIGGS & RILEY

THE MARK CONSISTS OF STANDARD CHARACTERS WITHOUT CLAIM TO ANY PARTICULAR FONT, STYLE, SIZE, OR COLOR.

OWNER OF U.S. REG. NOS. 2,300,565 AND 2,422,792.

INT. CL. 9/U.S. CLS. 21, 23, 26, 36 AND 38

FOR PHOTOGRAPHIC CAMERA AND VIDEO CAMERA BAGS, CAMERA BAGS, CASES FOR ELECTRONIC PERSONAL ORGANIZERS, CASES FOR COMPUTERS AND RELATED COMPUTER ACCESSORIES, COMPUTER SLEEVES AND PROTECTORS.

FIRST USE 4-2-1993; IN COMMERCE 4-2-1993.

INT. CL. 18/U.S. CLS. 1, 2, 3, 22 AND 41

THE MARK CONSISTS OF STANDARD CHARACTERS WITHOUT CLAIM TO ANY PARTICULAR FONT, STYLE, SIZE, OR COLOR.

INT. CL. 9/U.S. CLS. 21, 23, 26, 36 AND 38

FOR LAPTOP AND NOTEBOOK COMPUTERS; COMPUTER SERVERS; COMPUTER SERVER OPERATING SOFTWARE; INTEGRATED COMPUTER SERVER HARDWARE AND SOFTWARE FOR THE MONITORING, REPORTING, AUTONOMOUS RECOVERY AND REMOTE MANAGEMENT OF COMPUTERS AND SERVERS OVER A GLOBAL COMPUTER NETWORK, AND INSTRUCTION MANUALS SOLD THEREWITH.

FIRST USE 8-31-2007; IN COMMERCE 8-31-2007.

ELEMENTS CORRECTED
CITIZENSHIP

3,468,705. REG. 7-15-2008. BRIGGS & RILEY TRAVELWARE, LLC (NEW YORK LIMITED LIABILITY COMPANY) 400 WIRELESS BOULEVARD, HAUPPAUGE, NY, 11788, SN 77-091,910. FILED 1-26-2007. PRINCIPAL REGISTER.



THE MARK CONSISTS OF THE WORDS "SHOCK STOP" IN SPECIAL FORM WITH LINES APPEARING UNDER THE LETTERS HOC IN THE WORD "SHOCK" AND THE WORD "STOP" APPEARING ON A RECTANGLE.
 INT. CL. 9/U.S. CLS. 21, 23, 26, 36 AND 38
 FOR WHEELS AND SHOULDER STRAPS FOR LUGGAGE, NAMELY, LAPTOP CASES.
 FIRST USE 10-0-2007; IN COMMERCE 10-0-2007.
 INT. CL. 18/U.S. CLS. 1, 2, 3, 22 AND 41
 FOR WHEELS AND SHOULDER STRAPS FOR LUGGAGE, NAMELY, SUITCASES.
 FIRST USE 10-0-2007; IN COMMERCE 10-0-2007.

ELEMENTS CORRECTED
 CITIZENSHIP



3,469,708. REG. 7-15-2008. BRIGGS & RILEY TRAVELWARE, LLC (NEW YORK LIMITED LIABILITY COMPANY) 400 WIRELESS BOULEVARD, HAUPPAUGE, NY, 11788, SN 78-928,965. FILED 7-13-2006. PRINCIPAL REGISTER.

SHOCK STOP

THE MARK CONSISTS OF STANDARD CHARACTERS WITHOUT CLAIM TO ANY PARTICULAR FONT, STYLE, SIZE, OR COLOR.
 INT. CL. 18/U.S. CLS. 1, 2, 3, 22 AND 41
 FOR WHEELS FOR LUGGAGE, SHOULDER STRAPS FOR LUGGAGE.
 FIRST USE 10-0-2007; IN COMMERCE 10-0-2007.

ELEMENTS CORRECTED
 CITIZENSHIP

3,501,073. REG. 9-16-2008. COULTER VENTURES, LLC (OHIO LIMITED LIABILITY COMPANY) 1080 STEEL WOOD RD., COLUMBUS, OH, 43212, SN 77-307,193. FILED 10-18-2007. PRINCIPAL REGISTER.

ROGUE FITNESS

THE MARK CONSISTS OF STANDARD CHARACTERS WITHOUT CLAIM TO ANY PARTICULAR FONT, STYLE, SIZE, OR COLOR.
 NO CLAIM IS MADE TO THE EXCLUSIVE RIGHT TO USE "FITNESS", APART FROM THE MARK AS SHOWN.
 INT. CL. 41/U.S. CLS. 100, 101 AND 107
 FOR PERSONAL TRAINER SERVICES.
 FIRST USE 10-17-2007; IN COMMERCE 10-17-2007.

ELEMENTS CORRECTED
 OWNER NAME



3,518,393. REG. 10-14-2008. THE CARROLL HALL SHELBY TRUST, THE TRUSTEES COMPRISING M. NEIL CUMMINGS AND JOECONWAY, UNITED STATES CITIZENS (TEXAS TRUST) 11150 W. OLYMPIC BLVD., SUITE 1050, LOS ANGELES, CA, 90064, SN 78-876,659. FILED 5-4-2006. PRINCIPAL REGISTER.

SHELBY GT-H

THE MARK CONSISTS OF STANDARD CHARACTERS WITHOUT CLAIM TO ANY PARTICULAR FONT, STYLE, SIZE, OR COLOR.
 OWNER OF U.S. REG. NOS. 864,154, 2,357,468 AND OTHERS.
 INT. CL. 7/U.S. CLS. 13, 19, 21, 23, 31, 34 AND 35
 FOR PARTS FOR AUTOMOTIVE ENGINES, NAMELY, CAM SHAFTS, CYLINDER HEADS, VALVE COVERS, OIL PANS, OIL COOLERS, PISTONS AND PISTON PINS, PISTON VALVES, VALVE SPRINGS, FUEL INJECTORS, SUPER CHARGERS, INTAKE MANIFOLDS, CARBURETORS, EXHAUST PIPES, EXHAUST HEADERS, TRANSMISSIONS.
 FIRST USE 1-1-1966; IN COMMERCE 1-1-1966.
 INT. CL. 12/U.S. CLS. 19, 21, 23, 31, 35 AND 44
 FOR AUTOMOBILES AND ENGINES FOR LAND VEHICLES; CLUTCHES FOR LAND VEHICLES.
 FIRST USE 1-1-1966; IN COMMERCE 1-1-1966.
 INT. CL. 25/U.S. CLS. 22 AND 39
 FOR CLOTHING, NAMELY, T-SHIRTS, GOLF SHIRTS, JACKETS, JEANS, CAPS AND HATS.
 FIRST USE 1-1-1966; IN COMMERCE 1-1-2006.
 INT. CL. 28/U.S. CLS. 22, 23, 38 AND 50
 FOR TOYS, NAMELY, DIE-CAST METAL MODEL CARS.
 FIRST USE 1-1-1966; IN COMMERCE 1-1-2006.

ELEMENTS CORRECTED
 DATE OF FIRST USE
 DATE OF FIRST USE IN COMMERCE

3,545,841. REG. 12-16-2008. SPIRIT IMPORTS, INC. (FLORIDA CORPORATION) 10210 N. W. 50TH STREET, SUNRISE, FL, 33351, SN 77-199,917. FILED 6-7-2007. PRINCIPAL REGISTER.



OWNER OF CANADA REG. NO. TMA456868, DATED 4-26-1996.

NO CLAIM IS MADE TO THE EXCLUSIVE RIGHT TO USE "SCOTCH MALT WHISKY" AND "LEITH SCOTLAND", APART FROM THE MARK AS SHOWN.

THE MARK CONSISTS OF DOUBLE COAXIAL CIRCLES WITH THE WORDS "THE SCOTCH" APPEARING IN THE UPPER PORTION OF THE OUTER CIRCLE AND "MALT WHISKY SOCIETY" APPEARING IN THE LOWER PORTION OF THE OUTER CIRCLE AND WITH THE INNER CIRCLE CONTAINING AN ILLUSTRATION OF A BUILDING WITH THE LETTERS AND WORDS "ESTD THE VAULTS" ABOVE THE BUILDING AND THE WORDS "LEITH SCOTLAND" BELOW THE BUILDING.

INT. CL. 33/U.S. CLS. 47 AND 49

FOR SCOTCH WHISKEY.

FIRST USE 10-1-1983; IN COMMERCE 5-0-1993.

ELEMENTS AMENDED
DESCRIPTION OF MARK
MARK

3,569,400. REG. 2-3-2009. LEGALZOOM.COM, INC. (DELAWARE CORPORATION) 101 N. BRAND BLVD., GLENDALE, CA, 91203, SN 77-471,025. FILED 5-9-2008. PRINCIPAL REGISTER.

LegalZoom.com

THE MARK CONSISTS OF STANDARD CHARACTERS WITHOUT CLAIM TO ANY PARTICULAR FONT, STYLE, SIZE, OR COLOR.

OWNER OF U.S. REG. NOS. 2,540,549, 3,210,861 AND OTHERS.

INT. CL. 35/U.S. CLS. 100, 101 AND 102

FOR PROVIDING ONLINE DIRECTORY INFORMATION ON ATTORNEY LISTINGS AND ATTORNEY REFERRAL AND MATCHING SERVICES .

FIRST USE 6-20-2000; IN COMMERCE 7-15-2000.

INT. CL. 45/U.S. CLS. 100 AND 101

FOR LEGAL SERVICES; LEGAL DOCUMENT PREPARATION SERVICES AND PROVIDING GENERAL LEGAL INFORMATION VIA A WEBSITE ON GLOBAL COMPUTER NETWORKS.

FIRST USE 6-20-2000; IN COMMERCE 7-15-2000.

ELEMENTS CORRECTED
OWNER ADDRESS

CITIZENSHIP

3,582,392. REG. 3-3-2009. TELAIR INTERNATIONAL GMBH (FED REP GERMANY CORPORATION) BODENSCHNEIDSTRASSE 2, MIESBACH D-83714, FED REP GERMANY., SN 77-378,856. FILED 1-23-2008. PRINCIPAL REGISTER.

TELAIR

THE MARK CONSISTS OF STANDARD CHARACTERS WITHOUT CLAIM TO ANY PARTICULAR FONT, STYLE, SIZE, OR COLOR.

INT. CL. 7/U.S. CLS. 13, 19, 21, 23, 31, 34 AND 35

FOR CARGO HANDLING SYSTEMS COMPRISING AN ELECTRO-MECHANICAL DRIVE UNIT, PANELS, MOVING BULKHEAD, SLIDE GUIDES, CARPET, AND RAMP; CARGO LOADING MACHINES; POWER DRIVE SYSTEMS FOR CARGO HANDLING MACHINES; ACTUATORS, NAMELY, HYDRAULIC VALVE ACTUATORS, LINEAR ACTUATORS, PNEUMATIC VALVE ACTUATORS.

FIRST USE 12-0-1986; IN COMMERCE 12-0-1986.

INT. CL. 37/U.S. CLS. 100, 103 AND 106

FOR INSTALLATION, MAINTENANCE AND REPAIR OF AIRCRAFT CARGO SYSTEMS, ACTUATORS AND PARTS THEREFOR.

FIRST USE 12-0-1986; IN COMMERCE 12-0-1986.

ELEMENTS CORRECTED
OWNER NAME
OWNER ADDRESS

3,590,670. REG. 3-17-2009. ANON ARTS LLC (TENNESSEE LIMITED LIABILITY COMPANY) 2145 DONALD DRIVE, APARTMENT 6, MORAGA, CA, 945561451, SN 77-536,013. FILED 7-31-2008. PRINCIPAL REGISTER.

FlipBook

THE MARK CONSISTS OF STANDARD CHARACTERS WITHOUT CLAIM TO ANY PARTICULAR FONT, STYLE, SIZE, OR COLOR.

INT. CL. 9/U.S. CLS. 21, 23, 26, 36 AND 38

FOR DOWNLOADABLE COMPUTER SOFTWARE FOR MAKING MOVIES FOR USE IN TOUCH SCREEN * MOBILE * APPLICATIONS.

FIRST USE 7-29-2008; IN COMMERCE 7-29-2008.

ELEMENTS AMENDED
GOODS/SERVICES

3,608,302. REG. 4-21-2009. LEGALZOOM.COM, INC (DELAWARE CORPORATION) 101 N. BRAND BLVD., GLENDALE, CA, 91203, SN 77-427,654. FILED 3-20-2008. PRINCIPAL REGISTER.

3,612,662. REG. 4-28-2009. SHINHAN DIAMOND IND. CO., LTD. (REPUBLIC OF KOREA CORPORATION) 36BLOCK 10LOT., 610-9 NAMCHON-DONG.; NAMDONG-GU; INCHEON-SI 405-100, REPUBLIC OF KOREA., SN 79-053,671. FILED 9-12-2007. PRINCIPAL REGISTER.

WE PUT THE LAW ON YOUR SIDE

THE MARK CONSISTS OF STANDARD CHARACTERS WITHOUT CLAIM TO ANY PARTICULAR FONT, STYLE, SIZE, OR COLOR.

INT. CL. 35/U.S. CLS. 100, 101 AND 102

FOR PROVIDING ONLINE DIRECTORY INFORMATION ON ATTORNEY LISTINGS; ATTORNEY REFERRAL AND MATCHING SERVICES.

FIRST USE 8-1-2006; IN COMMERCE 8-1-2006.

INT. CL. 45/U.S. CLS. 100 AND 101

FOR LEGAL DOCUMENT PREPARATION SERVICES AND PROVIDING GENERAL LEGAL INFORMATION VIA A WEBSITE ON GLOBAL COMPUTER NETWORKS.

FIRST USE 8-1-2006; IN COMMERCE 8-1-2006.

ELEMENTS CORRECTED
OWNER ADDRESS
CITIZENSHIP

3,608,956. REG. 4-21-2009. MATEST SYSTEMTECHNIK GMBH (FED REP GERMANY LIMITED LIABILITY COMPANY) ULRICHSTR. 23, 72116 MÖSSINGEN, FED REP GERMANY., SN 79-042,310. FILED 4-20-2007. PRINCIPAL REGISTER.

RAPID STAT

THE MARK CONSISTS OF STANDARD CHARACTERS WITHOUT CLAIM TO ANY PARTICULAR FONT, STYLE, SIZE, OR COLOR.

OWNER OF INTERNATIONAL REGISTRATION 0933737 DATED 4-20-2007, EXPIRES 4-20-2017.

THE WORDING "RAPID STAT" HAS NO MEANING IN A FOREIGN LANGUAGE.

INT. CL. 5/U.S. CLS. 6, 18, 44, 46, 51 AND 52

FOR DIAGNOSTIC REAGENT TEST STRIPS FOR THE DETECTION OF DRUGS IN SALIVA AND URINE; DRUG TEST KITS FOR MEDICAL PURPOSES COMPRISED OF CHEMICALS IN THE FORM OF DIAGNOSTIC REAGENTS; SANITARY PREPARATIONS FOR MEDICAL PURPOSES; DIETETIC PRODUCTS, NAMELY, BABY FOOD; MEDICAL PLASTERS, NAMELY, MATERIAL FOR DRESSINGS; DENTAL MATERIAL FOR TEETH FILLINGS AND CASTING COMPOUNDS FOR DENTAL PURPOSES; ALL PURPOSE DISINFECTANTS FOR HANDS AND SURFACES; PREPARATIONS FOR DESTROYING VERMIN; FUNGICIDES, HERBICIDES.

FIRST USE ; IN COMMERCE .

INT. CL. 9/U.S. CLS. 21, 23, 26, 36 AND 38

FOR PHOTOGRAPHIC, CINEMATOGRAPHIC AND OPTICAL, APPARATUS, NAMELY, BLANK MAGNETIC DATA CARRIERS AND RECORDING DISCS; CASH REGISTERS, CALCULATORS, DATA PROCESSORS AND COMPUTERS; FIRE EXTINGUISHERS.

FIRST USE ; IN COMMERCE .

INT. CL. 16/U.S. CLS. 2, 5, 22, 23, 29, 37, 38 AND 50

FOR [PHOTOGRAPHS; STATIONERY; ADHESIVES FOR PAPER, STATIONERY AND HOUSEHOLD PURPOSES;] PAINT BRUSHES; PRINTERS' TYPE; PRINTING BLOCKS.

FIRST USE ; IN COMMERCE .

ELEMENTS CORRECTED
GOODS/SERVICES

SDICO

OWNER OF INTERNATIONAL REGISTRATION 0963880 DATED 9-12-2007, EXPIRES 9-12-2017.

INT. CL. 7/U.S. CLS. 13, 19, 21, 23, 31, 34 AND 35

FOR POWER-OPERATED TOOLS, NAMELY, GRINDERS; ELECTRICAL DRILLS; DRILL BITS FOR POWER-OPERATED MACHINES; MILLING CUTTERS * FOR MILLING MACHINES *; GEAR WHEEL CUTTERS; POWER OPERATED CUP-TYPE ABRASIVE AND GRINDING WHEELS; BITS FOR POWER DRILLS; POWER OPERATED POLISHING DISK MACHINES; [POWER SAWBLADES;] POWER CORING DRILLS; SCRIBING WHEELS FOR POWER-OPERATED TOOLS; WAFER BACK GRINDING ELECTRIC WHEELS FOR POWER-OPERATED TOOLS; WAFER EDGE GRINDING ELECTRIC WHEELS FOR POWER-OPERATED TOOLS; GLASS EDGE GRINDING ELECTRIC WHEELS FOR POWER-OPERATED TOOLS; ELECTRIC DIAMOND WHEELS FOR POWER-OPERATED TOOLS; PAD CONDITIONING ELECTRIC DIAMOND POLISHING TOOLS FOR CHEMICAL AND MECHANICAL POLISHING; ELECTRIC ROUTER WHEELS FOR POWER-OPERATED TOOLS; POWER-OPERATED WIRESAWS FOR CUTTING STONES AND CONCRETE; ROTARY ELECTRIC WHEELS FOR POWER-OPERATED TOOLS; [METAL WORKING MACHINES;] DIAMOND METAL CUTTING MACHINES; DRILLING MACHINES; DRILL BITS FOR ROCK DRILLING; WIRE MOLDING MACHINES, NAMELY, BENDING MACHINES; POWER-OPERATED STONE WORKING MACHINES FOR CUTTING, POLISHING AND GRINDING [; ELECTRIC HAND-OPERATED TOOLS, NAMELY, HAMMER DRIVERS, REAMERS, END MILLS, SCROLL SAWS, COUNTER-SINKS AND BURRS; INSTALLABLE HAND-OPERATED TOOLS, NAMELY, DRILL PRESSES] .

FIRST USE ; IN COMMERCE .

INT. CL. 8/U.S. CLS. 23, 28 AND 44

FOR HAND TOOLS, NAMELY, DRILLS; BITS FOR HAND DRILLS, NAMELY, DRILL SCREWS; DRILL BITS FOR HAND DRILLS; HAND-TOOLS, NAMELY, MANUALLY OPERATED GRINDING WHEELS, DIAMOND WHEELS, WIRE SAWS, AND GRINDING STONES; HAND TOOLS, NAMELY, MANUALLY-OPERATED DIAMOND DRESSERS FOR TRUING AND DRESSING OF GRINDING STONES; HAND TOOLS, NAMELY, MANUALLY-OPERATED PAD CONDITIONING DIAMOND INSTRUMENTS FOR CHEMICAL OR MECHANICAL GRINDING; HAND TOOLS, NAMELY, MANUALLY-OPERATED WAFER BACK GRINDER; HAND TOOLS, NAMELY, MANUALLY-OPERATED WAFER EDGE GRINDER; GLASS EDGE GRINDER; HAND TOOLS AND HAND IMPLEMENTS FOR GRINDING, NAMELY, RASPS AND FILES; SHARPENING STONES; STEELS FOR GRINDING.

FIRST USE ; IN COMMERCE .

ELEMENTS CORRECTED
GOODS/SERVICES

3,613,800. REG. 4-28-2009. JOHNSON & JOHNSON (NEW JERSEY CORPORATION) ONE JOHNSON & JOHNSON PLAZA, NEW BRUNSWICK, NJ, 089337001, SN 78-417,875. FILED 5-13-2004. PRINCIPAL REGISTER.

3,639,419. REG. 6-16-2009. BRIGGS & RILEY TRAVELWARE, LLC (NEW YORK LIMITED LIABILITY COMPANY) 400 WIRELESS BOULEVARD, HAUPPAUGE, NY, 11788, SN 77-620,189. FILED 11-22-2008. PRINCIPAL REGISTER.

**WHOLE MOUTH CLEAN
FEELING**

THE MARK CONSISTS OF STANDARD CHARACTERS WITHOUT CLAIM TO ANY PARTICULAR FONT, STYLE, SIZE, OR COLOR.

OWNER OF U.S. REG. NOS. 2,709,986 AND 2,772,597. NO CLAIM IS MADE TO THE EXCLUSIVE RIGHT TO USE "WHOLE MOUTH CLEAN", APART FROM THE MARK AS SHOWN.

INT. CL. 3/U.S. CLS. 1, 4, 6, 50, 51 AND 52 FOR NON-MEDICATED MOUTHWASH. FIRST USE 2-19-2009; IN COMMERCE 2-19-2009.

ELEMENTS AMENDED
DISCLAIMER

SpeedThru

THE MARK CONSISTS OF STANDARD CHARACTERS WITHOUT CLAIM TO ANY PARTICULAR FONT, STYLE, SIZE, OR COLOR.

INT. CL. 9/U.S. CLS. 21, 23, 26, 36 AND 38 FOR COMPUTER LAPTOP BAGS AND CASES. FIRST USE 6-0-2007; IN COMMERCE 6-0-2007.

INT. CL. 18/U.S. CLS. 1, 2, 3, 22 AND 41 FOR LUGGAGE AND BUSINESS CASES. FIRST USE 10-0-2005; IN COMMERCE 10-0-2005.

ELEMENTS CORRECTED
CITIZENSHIP

3,643,070. REG. 6-23-2009. KACO SOLAR, INC. (DELAWARE CORPORATION) THE PRESIDIO, 1002 B O'REILLY AVENUE, SAN FRANCISCO, CA, 94129, SN 77-620,504. FILED 11-24-2008. PRINCIPAL REGISTER.

3,622,704. REG. 5-19-2009. ILLUMINATI S.R.L. (ITALY CORPORATION) VIA LOMBARDIA, 12D, PAESE (TV), ITALY, 31038, SN 77-589,994. FILED 10-10-2008. PRINCIPAL REGISTER.



THE COLOR(S) RED IS/ARE CLAIMED AS A FEATURE OF THE MARK.

THE MARK CONSISTS OF THREE STYLIZED COMMAS, IN RED, THE FIRST AND THIRD UPSIDE DOWN, OVER A BAR, IN RED, WITH THE WORD "ILLUMINATI" IN RED, BENEATH THE RED BAR.

INT. CL. 11/U.S. CLS. 13, 21, 23, 31 AND 34 FOR CEILING LIGHTS; CHANDELIERS. FIRST USE 11-1-2007; IN COMMERCE 11-1-2007.

ELEMENTS CORRECTED
DATE OF FIRST USE
DATE OF FIRST USE IN COMMERCE

BLUEPLANET

THE MARK CONSISTS OF STANDARD CHARACTERS WITHOUT CLAIM TO ANY PARTICULAR FONT, STYLE, SIZE, OR COLOR.

OWNER OF U.S. REG. NO. 3,372,241. INT. CL. 9/U.S. CLS. 21, 23, 26, 36 AND 38 FOR PHOTOVOLTAIC INVERTERS. FIRST USE 9-0-2006; IN COMMERCE 9-0-2006.

ELEMENTS CORRECTED
CITIZENSHIP

3,655,881. REG. 7-14-2009. PARKER SYNERGIES LLC (FLORIDA LIMITED LIABILITY COMPANY) 10670 RIVERSIDE DR. EAST, WINDSOR, ONTARIO, CANADA, N8P1A4, SN 77-977,328. FILED 9-6-2007. PRINCIPAL REGISTER.

SPEED AND STRENGTH

THE MARK CONSISTS OF STANDARD CHARACTERS WITHOUT CLAIM TO ANY PARTICULAR FONT, STYLE, SIZE, OR COLOR.

INT. CL. 25/U.S. CLS. 22 AND 39

FOR CLOTHING, NAMELY, JACKETS, SHIRTS, PANTS, DENIM JEANS, VESTS, GLOVES AND HATS. * ALL OF THE FOREGOING SOLD TO POWERSPORT VEHICLE USERS OR THROUGH POWERSPORT-SPECIFIC RETAILERS. POWERSPORT-SPECIFIC TRADE SHOWS, OR POWERSPORT-SPECIFIC RACES; CLOTHING, NAMELY, JACKETS, SHIRTS, PANTS, DENIM JEANS, VESTS, GLOVES AND HATS, NONE OF THE FOREGOING SOLD TO POWERSPORT VEHICLE USERS OR THROUGH POWERSPORT-SPECIFIC RETAILERS. POWERSPORT-SPECIFIC TRADE SHOWS, OR POWERSPORT-SPECIFIC RACES *.
FIRST USE 9-20-2008; IN COMMERCE 9-20-2008.

ELEMENTS AMENDED
GOODS/SERVICES

3,683,767. REG. 9-15-2009. MARK USA LLC (DELAWARE LIMITED LIABILITY COMPANY) 1874 NORTH YOUNG CIRCLE, HOLLYWOOD, FL, 33020, SN 77-334,352. FILED 11-20-2007. PRINCIPAL REGISTER.

KIND TO YOUR CLOTHES.
FRIENDLY TO THE ENVIRONMENT

THE MARK CONSISTS OF STANDARD CHARACTERS WITHOUT CLAIM TO ANY PARTICULAR FONT, STYLE, SIZE, OR COLOR.
INT. CL. 37/U.S. CLS. 100, 103 AND 106
FOR LAUNDERING OF CLOTH, CLOTHING, FABRIC, LINEN AND TEXTILES; DRY CLEANING; WASHING OF LINEN; TEXTILE IRONING, NAMELY, LINEN IRONING .
FIRST USE 8-31-2004; IN COMMERCE 8-31-2004.

ELEMENTS CORRECTED
CITIZENSHIP

3,705,578. REG. 11-3-2009. NOKIA CORPORATION (FINLAND CORPORATION) KEILALAHDENTIE 4, FI-02150 ESPOO, FINLAND., SN 79-062,598. FILED 11-7-2008. PRINCIPAL REGISTER.



PRIORITY DATE OF 5-8-2008 IS CLAIMED.
OWNER OF INTERNATIONAL REGISTRATION 0986237 DATED 11-7-2008, EXPIRES 11-7-2018.

THE MARK CONSISTS OF THE WORDING "WE:" WITH A DESIGN INCORPORATING AN INCOMPLETE CIRCLE AND A VERTICAL LINE OVER THE W INTENDED TO EVOKE BOTH A TREE DESIGN AND A POWER ON/OFF SYMBOL.

INT. CL. 9/U.S. CLS. 21, 23, 26, 36 AND 38
FOR MOBILE PHONES AND MOBILE TABLET COMPUTERS; COMPUTER SOFTWARE FOR MOBILE PHONES AND MOBILE TABLET COMPUTERS.
FIRST USE ; IN COMMERCE .
INT. CL. 40/U.S. CLS. 100, 103 AND 106
FOR RECYCLING SERVICES * AS TREATMENT OF MATERIALS AND OBJECTS *.
FIRST USE ; IN COMMERCE .
INT. CL. 42/U.S. CLS. 100 AND 101
FOR SCIENTIFIC RESEARCH AND DEVELOPMENT IN THE FIELD OF ENVIRONMENTALLY FRIENDLY MOBILE TECHNOLOGY; PRODUCT RESEARCH INTO THE DEVELOPMENT OF ENVIRONMENTALLY FRIENDLY MOBILE PHONES AND ACCESSORIES THERETO.
FIRST USE ; IN COMMERCE .

ELEMENTS CORRECTED
GOODS/SERVICES

3,718,194. REG. 12-1-2009. APARTIS INFORMATION MANAGEMENT, AG (FED REP GERMANY CORPORATION) GEWERBEPARK DIETERSHEIM, IM TIERGARTEN 20, BINGEN, FED REP GERMANY, 55411, SN 77-725,777. FILED 4-30-2009. PRINCIPAL REGISTER.



NO CLAIM IS MADE TO THE EXCLUSIVE RIGHT TO USE "INFORMATION MANAGEMENT", APART FROM THE MARK AS SHOWN.

THE COLOR(S) BLUE AND RED IS/ARE CLAIMED AS A FEATURE OF THE MARK.

THE MARK CONSISTS OF THE WORD "APARTIS" IN THE COLOR BLUE WITH THE EXCEPTION OF THE LETTER "P", WHICH IS IN RED. THE WORDS "INFORMATION MANAGEMENT" ARE UNDERNEATH IT IN RED. A HORIZONTAL LINE IN BLUE RUNS ABOVE THE WORD "APARTIS". A RED DIAGONAL LINE IS ATTACHED TO THE LEFT END OF THE BLUE LINE AND POINTS IN THE DIRECTION OF AND ENDS RIGHT ABOVE THE LETTER "P", IN "APARTIS". A VERTICAL LINE IN RED RUNS DOWN THE RIGHT SIDE OF ALL OF THE WORDS. A BLUE DIAGONAL LINE IS ATTACHED TO THE END OF THE RED LINE AND POINTS IN THE DIRECTION OF AND ENDS RIGHT BELOW THE LAST LETTER "E" IN THE WORD "MANAGEMENT". THE ENDS OF THE HORIZONTAL BLUE LINE AND THE VERTICAL RED LINE INTERSECT EACH OTHER IN THE RIGHT UPPER CORNER OF THE WORD "APARTIS".

INT. CL. 42/U.S. CLS. 100 AND 101
FOR SOFTWARE DEVELOPMENT SERVICES, NAMELY, INTEGRATED HIGH-QUALITY WORKFLOW AND POOLING MANAGEMENT, DATA MANAGEMENT AND DATA MINING SOFTWARE SOLUTIONS FOR PHARMACEUTICAL, BIOTECHNOLOGY, BLOOD LABS, CLINICAL TRIAL, AND MEDICAL DEVICE COMPANIES.
FIRST USE 11-1-1997; IN COMMERCE 11-1-1997.

ELEMENTS CORRECTED
OWNER NAME

3,720,104. REG. 12-1-2009. NEW CENTURY HOLDINGS, INC. (MINNESOTA CORPORATION) SUITE 301, 10400 VIKING DRIVE, EDEN PRAIRIE, MN, 55344, SN 78-705,126. FILED 9-1-2005. PRINCIPAL REGISTER.

3,771,095. REG. 4-6-2010. TISH & SNOOKY'S N.Y.C. INC. (NEW YORK CORPORATION) 4TH FLOOR, 21-07 BORDEN AVENUE, LONG ISLAND CITY, NY, 11101, SN 77-810,688. FILED 8-22-2009. PRINCIPAL REGISTER.



TISH & SNOOKY'S

OWNER OF U.S. REG. NOS. 1,766,866 AND 2,700,112.
 NO CLAIM IS MADE TO THE EXCLUSIVE RIGHT TO USE "ORGANIC", APART FROM THE MARK AS SHOWN.
 THE MARK CONSISTS OF A DESIGN OF A BARN, FARM FIELD, FENCE AND HILLS SURROUNDED BY THE WORDS "COUNTRY CHOICE ORGANIC" AND AN OVAL FRAME.
 INT. CL. 30/U.S. CL. 46
 FOR BREAKFAST CEREALS; CEREAL BASED SNACK FOOD; COOKIES; OATMEAL; PROCESSED CEREALS; PROCESSED GRAINS; PROCESSED OATS; PROCESSED WHEAT; READY TO EAT, CEREAL DERIVED FOOD BARS; ROLLED OATS; WAFERS.
 FIRST USE 7-31-2005; IN COMMERCE 7-31-2005.

THE MARK CONSISTS OF STANDARD CHARACTERS WITHOUT CLAIM TO ANY PARTICULAR FONT, STYLE, SIZE, OR COLOR.
 INT. CL. 44/U.S. CLS. 100 AND 101
 FOR BEAUTY SALONS; BODY WAXING SERVICES; HAIR CUTTING; HAIR SALON SERVICES; HAIR STYLING; HAIRDRESSING SALONS; [NAIL CARE SALON] *NAIL CARE SERVICES;* PROVIDING INFORMATION IN THE FIELD OF HAIR STYLING; PROVIDING ON-SITE BEAUTY SERVICES, NAMELY, HAIR STYLING AND MAKE-UP APPLICATION SERVICES; [SKIN CARE SALONS] *COSMETIC SKIN CARE SERVICES*.
 FIRST USE 2-18-2009; IN COMMERCE 2-18-2009.

ELEMENTS CORRECTED
 DATE OF FIRST USE
 DATE OF FIRST USE IN COMMERCE

ELEMENTS AMENDED
 GOODS/SERVICES

3,757,473. REG. 3-9-2010. MARROKAL CONSTRUCTION COMPANY (CALIFORNIA CORPORATION) 9842 RIVER STREET, LAKESIDE, CA, 92040, SN 77-792,338. FILED 7-29-2009. PRINCIPAL REGISTER.

3,781,611. REG. 4-27-2010. SILVER CROSS (IP) LIMITED (UNITED KINGDOM LIMITED COMPANY) MICKLETHORN, BROUGHTON, SKIPTON, UNITED KINGDOM, BD233JA, SN 77-286,078. FILED 9-21-2007. PRINCIPAL REGISTER.

Trust Your Home to Us

FIZZ

THE MARK CONSISTS OF STANDARD CHARACTERS WITHOUT CLAIM TO ANY PARTICULAR FONT, STYLE, SIZE, OR COLOR.
 REGISTRATION IS RESTRICTED TO THE AREA COMPRISING THE STATE OF CALIFORNIA.
 INT. CL. 37/U.S. CLS. 100, 103 AND 106
 FOR REMODELING OF RESIDENTIAL BUILDINGS, ROOMS, AND KITCHENS .
 FIRST USE 11-1-2008; IN COMMERCE 11-1-2008.
 INT. CL. 42/U.S. CLS. 100 AND 101
 FOR DESIGN FOR OTHERS IN THE FIELD OF RESIDENTIAL BUILDINGS, ROOMS, AND KITCHENS.
 FIRST USE 11-1-2008; IN COMMERCE 11-1-2008.

THE MARK CONSISTS OF STANDARD CHARACTERS WITHOUT CLAIM TO ANY PARTICULAR FONT, STYLE, SIZE, OR COLOR.
 PRIORITY CLAIMED UNDER SEC. 44(D) ON ERPN CMNTY TM OFC APPLICATION NO. 6109755, FILED 7-18-2007.
 INT. CL. 12/U.S. CLS. 19, 21, 23, 31, 35 AND 44
 FOR BABY CARRIAGES; PUSHCHAIRS; PRAMS; PARTS AND FITTINGS THEREOF.
 FIRST USE 5-31-2009; IN COMMERCE 11-30-2009.

ELEMENTS AMENDED
 ORDER RESTRICTING THE SCOPE OF REG.

ELEMENTS CORRECTED
 FOREIGN COUNTRY OF ORIGIN

3,845,320. REG. 9-7-2010. OLDE TYME REMEDIES, LLC (OHIO LIMITED LIABILITY COMPANY) P.O. BOX 53308, CINCINNATI, OH, 45253, SN 78-862,497. FILED 4-17-2006. PRINCIPAL REGISTER.

UNKER'S

THE MARK CONSISTS OF STANDARD CHARACTERS WITHOUT CLAIM TO ANY PARTICULAR FONT, STYLE, SIZE, OR COLOR.

INT. CL. 3/U.S. CLS. 1, 4, 6, 50, 51 AND 52

FOR LIQUID SOAP, BARS OF SOAP, BODY MIST, LIP BALM, LIP PROTECTOR, AND LIP ENHANCER.

FIRST USE 4-0-1982; IN COMMERCE 4-0-1982.

INT. CL. 5/U.S. CLS. 6, 18, 44, 46, 51 AND 52

FOR MULTIPURPOSE MEDICATED ANTIBACTERIAL CREAM, ANALGESIC BALM AND MENTHOLATED SALVE; MEDICATED LIP BALM.

FIRST USE 4-0-1982; IN COMMERCE 4-0-1982.

ELEMENTS CORRECTED
OWNER NAME
OWNER ADDRESS
CITIZENSHIP
ENTITY

3,897,355. REG. 12-28-2010. AVFUSION, INC. (COLORADO CORPORATION) 100 FILLMORE ST., 5TH FLOOR, DENVER, CO, 80206, SN 85-038,262. FILED 5-13-2010. PRINCIPAL REGISTER.

AVCONNECT

THE MARK CONSISTS OF STANDARD CHARACTERS WITHOUT CLAIM TO ANY PARTICULAR FONT, STYLE, SIZE, OR COLOR.

INT. CL. 42/U.S. CLS. 100 AND 101

FOR COMPUTER SERVICES, NAMELY, REMOTE AND ON-SITE MANAGEMENT OF THE INFORMATION TECHNOLOGY (IT) SYSTEMS OF OTHERS; INFORMATION TECHNOLOGY CONSULTATION.

FIRST USE 1-5-2005; IN COMMERCE 5-1-2006.

ELEMENTS AMENDED
OWNER ADDRESS

3,888,333. REG. 12-7-2010. THE DIVERSITY IN NURSE ANESTHESIA MENTORSHIP PROGRAM (NEW JERSEY CORPORATION) P.O. BOX 202, MICKLETON, NJ, 08056, SN 85-074,847. FILED P.R. 6-30-2010; AM. S.R. 10-19-2010. SUPPLEMENTAL REGISTER.



NO CLAIM IS MADE TO THE EXCLUSIVE RIGHT TO USE "MENTORSHIP PROGRAM", APART FROM THE MARK AS SHOWN.

THE COLOR(S) WHITE, GRAY AND NAVY BLUE IS/ARE CLAIMED AS A FEATURE OF THE MARK.

THE MARK CONSISTS OF THE LETTERS "DIVERSITY IN NURSE ANESTHESIA" IN NAVY BLUE ABOVE THE WORDS "MENTORSHIP PROGRAM" ALSO IN NAVY BLUE AGAINST A WHITE BACKGROUND AND A GRAY AND BLUE STRIPE APPEARING BELOW THE WORDING. THE WORDS "DIVERSITY IN NURSE ANESTHESIA" ARE WRITTEN IN A NARROW ARIAL FONT WITH INITIAL CAPITAL LETTERS AND THE WORDS "MENTORSHIP PROGRAM" ARE WRITTEN IN BOLD AND ALL CAPS.

INT. CL. 41/U.S. CLS. 100, 101 AND 107

FOR EDUCATION SERVICES, NAMELY, MENTORING IN THE FIELD OF NURSE ANESTHESIA.; EDUCATION SERVICES, NAMELY, ONE-ON-ONE MENTORING IN THE FIELD OF NURSE ANESTHESIA.; EDUCATION SERVICES, NAMELY, PROVIDING MENTORING, TUTORING, CLASSES, SEMINARS AND WORKSHOPS IN THE FIELD OF NURSE ANESTHESIA.; PROVIDING EDUCATIONAL MENTORING SERVICES AND PROGRAMS IN THE FIELD OF NURSE ANESTHESIA.

FIRST USE 10-1-2007; IN COMMERCE 10-1-2007.

ELEMENTS CORRECTED
OWNER NAME

3,913,056. REG. 2-1-2011. KHS GMBH (FED REP GERMANY LIMITED LIABILITY COMPANY) JUCHOSTRASSE 20, DORTMUND, FED REP GERMANY, 44143, SN 77-936,636. FILED 2-16-2010. PRINCIPAL REGISTER.

Innoline MES

THE MARK CONSISTS OF STANDARD CHARACTERS WITHOUT CLAIM TO ANY PARTICULAR FONT, STYLE, SIZE, OR COLOR.

PRIORITY CLAIMED UNDER SEC. 44(D) ON FED REP GERMANY APPLICATION NO. 302009051584, FILED 8-24-2009, REG. NO. 302009051584, DATED 1-20-2010, EXPIRES 8-31-2019.

NO CLAIM IS MADE TO THE EXCLUSIVE RIGHT TO USE "MES", APART FROM THE MARK AS SHOWN.

THE WORDING "INNOLINE MES" HAS NO MEANING IN A FOREIGN LANGUAGE.

INT. CL. 39/U.S. CLS. 100 AND 105

FOR STORING DATA IN COMPUTER DATA BANKS; ELECTRONIC DATA STORAGE.

INT. CL. 42/U.S. CLS. 100 AND 101

FOR SCIENTIFIC RESEARCH, TECHNICAL PROJECT ANALYSIS IN THE AREAS OF INDUSTRIAL AUTOMATION, INFORMATION TECHNOLOGY AND COMMUNICATIONS TECHNOLOGY; TECHNICAL CONSULTANCY SERVICES IN THE AREAS OF INDUSTRIAL AUTOMATION, INFORMATION TECHNOLOGY AND COMMUNICATIONS TECHNOLOGY, WITH REFERENCE TO HARDWARE AND SOFTWARE; TECHNICAL CONSULTANCY WITH REGARD TO INDUSTRIAL AUTOMATION, COMPUTER SOFTWARE AND HARDWARE; INSTALLATION OF SOFTWARE UPDATES; SOFTWARE MAINTENANCE; TECHNICAL CONSULTANCY FOR COMPUTER SOFTWARE; RENTAL OF COMPUTER SOFTWARE; TECHNICAL CONSULTANCY IN THE AREA OF THE PACKAGING DESIGN; RESEARCH AND DESIGN RELATING TO PACKAGING DESIGN; INDUSTRIAL ANALYSIS AND RESEARCH SERVICES IN THE NATURE OF INDUSTRIAL ENGI-

NEERING; DESIGN AND DEVELOPMENT OF COMPUTER HARDWARE AND COMPUTER SOFTWARE; SERVICES OF A CHEMIST; SERVICES OF AN ENGINEER IN THE FIELD OF INDUSTRIAL DESIGN; INSTALLATION AND MAINTENANCE OF COMPUTER SOFTWARE; TECHNICAL CONSULTANCY IN THE FIELD OF INDUSTRIAL ENGINEERING; SCIENTIFIC RESEARCH FOR THIRD PARTIES; INDUSTRIAL RESEARCH FOR THIRD PARTIES; MATERIALS TESTING; SERVICES OF ENGINEERS THAT ADDRESS EVALUATIONS, ESTIMATIONS, INVESTIGATIONS AND EXPERTISE IN THE FIELD OF INDUSTRIAL ENGINEERING .

INT. CL. 45/U.S. CLS. 100 AND 101

FOR LICENSING OF COMPUTER SOFTWARE, IN PARTICULAR FOR THE BEVERAGE, FOODSTUFFS, PHARMACEUTICAL, CHEMICAL AND PLASTICS PROCESSING INDUSTRIES; LICENSING OF COMPUTER SOFTWARE FOR PRODUCTION MANAGEMENT; LEGAL CONSULTANCY CONCERNING SOFTWARE LICENCES.

ELEMENTS CORRECTED
OWNER NAME
ENTITY

3,929,722. REG. 3-8-2011. LEGALZOOM.COM, INC. (DELAWARE CORPORATION) 101 N. BRAND BLVD., 11TH FLOOR, GLENDALE, CA, 91203, SN 77-880,345. FILED 11-24-2009. PRINCIPAL REGISTER.

LZ FINANCIAL SERVICES

THE MARK CONSISTS OF STANDARD CHARACTERS WITHOUT CLAIM TO ANY PARTICULAR FONT, STYLE, SIZE, OR COLOR.

OWNER OF U.S. REG. NOS. 3,210,728, 3,211,009 AND OTHERS.

NO CLAIM IS MADE TO THE EXCLUSIVE RIGHT TO USE "FINANCIAL SERVICES", APART FROM THE MARK AS SHOWN.

INT. CL. 35/U.S. CLS. 100, 101 AND 102

FOR ACCOUNTING SERVICES; BOOKKEEPING; TAX CONSULTATION; TAX PREPARATION; DATA COLLECTION AND MANAGEMENT SERVICES IN THE FIELD OF ACCOUNTING, TAX AND FINANCES; PROVIDING INFORMATION ABOUT AND MAKING REFERRALS IN THE FIELD OF PROFESSIONALS WHO PROVIDE ACCOUNTING, TAX AND OTHER FINANCIAL SERVICES.

FIRST USE 9-1-2009; IN COMMERCE 9-1-2009.

ELEMENTS CORRECTED
CITIZENSHIP

3,938,788. REG. 3-29-2011. BRIGGS & RILEY TRAVELWARE, LLC (NEW YORK LIMITED LIABILITY COMPANY) 400 WIRELESS BOULEVARD, HAUPPAUGE, NY, 11788, SN 77-894,196. FILED 12-15-2009. PRINCIPAL REGISTER.

B · R · X

THE MARK CONSISTS OF THE LETTERS "BRX" IN STYLIZED LETTERS FORM WITH SMALL SQUARES APPEARING BETWEEN THE LETTERS.

INT. CL. 18/U.S. CLS. 1, 2, 3, 22 AND 41

FOR LUGGAGE, BUSINESS CASES AND ALL-PURPOSE CARRYING BAGS.

FIRST USE 5-2-2010; IN COMMERCE 5-2-2010.

ELEMENTS CORRECTED
CITIZENSHIP

3,959,944. REG. 5-10-2011. D.ROSE STORE, INC. (CALIFORNIA CORPORATION) 1018 1/2 WALL ST., LOS ANGELES, CA, 90015, SN 85-100,573. FILED 8-5-2010. PRINCIPAL REGISTER.

LOVE L.A.

THE MARK CONSISTS OF STANDARD CHARACTERS WITHOUT CLAIM TO ANY PARTICULAR FONT, STYLE, SIZE, OR COLOR.

NO CLAIM IS MADE TO THE EXCLUSIVE RIGHT TO USE "L.A.", APART FROM THE MARK AS SHOWN.

INT. CL. 25/U.S. CLS. 22 AND 39

FOR CLOTHING, NAMELY, JACKETS, SHIRTS, PANTS, SHORTS, VESTS, JOGGING SUITS, WARM UP SUITS, CAPS, BELTS, SOCKS, T SHIRTS [AND SHOES].

FIRST USE 2-1-2011; IN COMMERCE 2-1-2011.

ELEMENTS AMENDED
GOODS/SERVICES

3,968,494. REG. 5-31-2011. MACPAW INC (DELAWARE CORPORATION) 5201 GREAT AMERICA PARKWAY, SUITE 320, SANTA CLARA, CA, 95054, SN 77-934,595. FILED 2-12-2010. PRINCIPAL REGISTER.

MacPaw

THE MARK CONSISTS OF STANDARD CHARACTERS WITHOUT CLAIM TO ANY PARTICULAR FONT, STYLE, SIZE, OR COLOR.

INT. CL. 9/U.S. CLS. 21, 23, 26, 36 AND 38

FOR ANTI-SPYWARE SOFTWARE; COMPUTER ANTI-VIRUS SOFTWARE; COMPUTER GAME SOFTWARE; COMPUTER GAME SOFTWARE FOR USE ON MOBILE AND CELLULAR PHONES; COMPUTER SOFTWARE FOR HOME OFFICE PRODUCTIVITY; COMPUTER SOFTWARE FOR PROTECTING CONFIDENTIAL INFORMATION FROM THIRD PARTIES THAT MAY BE DOWNLOADED FROM A GLOBAL COMPUTER NETWORK; COMPUTER SOFTWARE FOR HOME OFFICE PRODUCTIVITY THAT MAY BE DOWNLOADED FROM A GLOBAL COMPUTER NETWORK; DOWNLOADABLE COMPUTER GAME SOFTWARE VIA A GLOBAL COMPUTER NETWORK AND WIRELESS DEVICES; EDUCATIONAL SOFTWARE FEATURING INSTRUCTION IN PERSONAL PRODUCTIVITY.

FIRST USE 7-17-2008; IN COMMERCE 7-17-2008.

ELEMENTS CORRECTED
ENTITY

COMPUTER SOFTWARE, COMPUTER PROGRAMS, COMPUTER OPERATING PROGRAMS, DOWNLOADABLE COMPUTER SOFTWARE, APPLICATION SOFTWARE, COMMUNICATION SOFTWARE, COMPUTER E-COMMERCE SOFTWARE, COMPUTER INTERFACE SOFTWARE, ALL THE AFORESAID FOR USE IN FINANCIAL RISK ASSESSMENT AND MANAGEMENT AND PORTFOLIO MANAGEMENT IN THE FIELD OF FINANCIAL SERVICES; COMPUTER SOFTWARE DEVELOPMENT TOOLS, NAMELY, COMPUTER SOFTWARE USED FOR DEVELOPING COMPUTER SOFTWARE FOR FINANCIAL ANALYSIS AND RISK AND PORTFOLIO MANAGEMENT; COMPUTER SOFTWARE PACKAGES, NAMELY, COMPUTER SOFTWARE PACKAGES USED FOR FINANCIAL RISK ASSESSMENT AND MANAGEMENT AND PORTFOLIO MANAGEMENT IN THE FIELD OF FINANCIAL SERVICES; COMPUTER SOFTWARE PLATFORMS, NAMELY, COMPUTER SOFTWARE PLATFORMS USED FOR FINANCIAL RISK ASSESSMENT AND MANAGEMENT AND PORTFOLIO MANAGEMENT IN THE FIELD OF FINANCIAL SERVICES; INTERFACE SOFTWARE, NAMELY, INTERFACE SOFTWARE FOR USE IN FINANCIAL RISK ASSESSMENT AND MANAGEMENT AND PORTFOLIO MANAGEMENT IN THE FIELD OF FINANCIAL SERVICES; SECURITY DEVICES FOR COMPUTER SOFTWARE, NAMELY, PASSWORD GENERATION SOFTWARE, AND ALL OF THE AFORESAID GOODS FOR USE IN THE FIELD OF FINANCE, FINANCIAL RISK ASSESSMENT AND MANAGEMENT AND INVESTMENT WITHIN THIS CLASS; * NONE RELATING TO COMPUTER ANTIVIRUS SOFTWARE OR HARDWARE, COMPUTER ANTI-MALWARE SOFTWARE OR HARDWARE, COMPUTER SOFTWARE OR HARDWARE FOR DATA ENCRYPTION, COMPUTER SOFTWARE OR HARDWARE FOR FILTERING SPAM AND SPYWARE OR HARDWARE FOR PROVIDING DATA SECURITY *.

FIRST USE ; IN COMMERCE .

3,983,410. REG. 6-28-2011. SOPHIS TECHNOLOGY (IRELAND) LIMITED (IRELAND COMPANY) 61-62 FITZWILLIAM LANE, DUBLIN 2, IRELAND., SN 79-074,192. FILED 9-25-2009. PRINCIPAL REGISTER.



iSOPHIS

PRIORITY DATE OF 9-24-2009 IS CLAIMED.
OWNER OF INTERNATIONAL REGISTRATION 1016768 DATED 9-25-2009, EXPIRES 9-25-2019.

THE MARK CONSISTS OF THE PROFILE OF A HELMETED HEAD WITH THE WORD "ISOPHIS" UNDERNEATH.

INT. CL. 9/U.S. CLS. 21, 23, 26, 36 AND 38

FOR COMPUTER SOFTWARE FOR USE IN FINANCIAL MANAGEMENT; COMPUTER SOFTWARE FOR USE IN FINANCIAL ANALYSIS, COMPUTER SOFTWARE FOR USE IN PERSONAL FINANCIAL ANALYSIS; COMPUTER SOFTWARE FOR USE IN PAYROLL MANAGEMENT; COMPUTER SOFTWARE FOR USE IN FACILITATING SECURE CREDIT CARD TRANSACTIONS; COMPUTER SOFTWARE FOR USE IN THE FIELD OF FINANCIAL RISK ASSESSMENT AND MANAGEMENT, FINANCIAL PORTFOLIO ANALYSIS, FINANCIAL INVESTMENT AND HEDGE FUNDS; COMPUTER SOFTWARE FOR BUSINESS PURPOSES,

INT. CL. 36/U.S. CLS. 100, 101 AND 102

FOR FINANCIAL SERVICES, NAMELY, FINANCIAL ADVISORY AND CONSULTANCY SERVICES; BROKERAGE SERVICES, NAMELY, CAPITAL INVESTMENT SERVICES; FINANCIAL EVALUATION SERVICES, NAMELY, FINANCIAL EVALUATION FOR INSURANCE AND FINANCIAL RISK ALLOCATION PURPOSES, FINANCIAL APPRAISAL SERVICES IN THE NATURE OF COST EVALUATIONS; FINANCIAL MANAGEMENT, FINANCIAL INFORMATION PROCESSING; FINANCING SERVICES; CONSULTANCY, ADVISORY AND INFORMATION SERVICES FOR ALL OF THE ABOVE SERVICES IDENTIFIED WITHIN THIS CLASS .

FIRST USE ; IN COMMERCE .

INT. CL. 42/U.S. CLS. 100 AND 101

FOR COMPUTER PROGRAMMING SERVICES; COMPUTER SOFTWARE DESIGN; INSTALLATION OF COMPUTER SOFTWARE; MAINTENANCE AND REPAIR OF COMPUTER SOFTWARE; UPDATING OF COMPUTER SOFTWARE; EDITING OF COMPUTER SOFTWARE AND COMPUTER PROGRAMS; COMPUTER SOFTWARE CONSULTANCY; RECOVERY OF COMPUTER DATA; COMPUTER SYSTEM DESIGN; COMPUTER SYSTEMS ANALYSIS; DATA CONVERSION OF COMPUTER PROGRAMS AND DATA, NOT PHYSICAL CONVERSION; HOSTING COMPUTER SITES, NAMELY, HOSTING ON-LINE WEBSITES FOR OTHERS TO ACCESS WEB-BASED COMPUTER APPLICATIONS FOR RISK AND PORTFOLIO MANAGEMENT IN THE FIELD OF FINANCIAL SERVICES; COMPUTER SYSTEMS AND COMPUTER HARDWARE DESIGN; COMPUTER SOFTWARE RENTAL; COMPUTER PROGRAMMING FOR OTHERS; COMPUTER SOFTWARE DESIGN FOR OTHERS; COMPUTER SOFTWARE RESEARCH; COMPUTER SOFTWARE ANALYSIS; CUSTOMIZATION OF COMPUTER HARDWARE AND SOFTWARE; CONSULTANCY, ADVISORY AND INFORMATION SERVICES FOR ALL OF THE ABOVE SERVICES WITHIN THIS CLASS; * ALL OF THE

AFOREMENTIONED SERVICES FOR USE IN THE FIELD OF FINANCE, RISK MANAGEMENT AND INVESTMENT AND NONE RELATING TO THE DESIGN, DEVELOPMENT OR PROVISION OF COMPUTER ANTI-VIRUS SOFTWARE OR HARDWARE, COMPUTER ANTI-MALWARE SOFTWARE OR HARDWARE, COMPUTER SOFTWARE OR HARDWARE FOR DATA ENCRYPTION, COMPUTER SOFTWARE OR HARDWARE FOR FILTERING SPAM AND SPYWARE OR COMPUTER SOFTWARE OR HARDWARE FOR PROVIDING DATA SECURITY OR INFORMATION AND ADVICE SERVICES RELATED THERETO *.
FIRST USE ; IN COMMERCE .

ELEMENTS CORRECTED
GOODS/SERVICES

3,995,717. REG. 7-19-2011. M. NEIL CUMMINGS AND JOE CONWAY, TRUSTEE OF THE CAROLL HALL SHELBY TRUST U/D/T DATED MARCH 28, 1985, AS AMENDED (UNITED STATES TRUST) 11150 W. OLYMPIC BLVD., SUITE 1050, LOS ANGELES, CA, 90064, SN 77-981,501. FILED 12-19-2007. PRINCIPAL REGISTER.

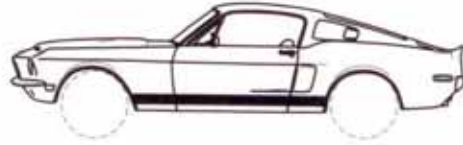

THE MARK CONSISTS OF THE OUTWARD APPEARANCE OF A VEHICLE.
SEC. 2(F).
INT. CL. 28/U.S. CLS. 22, 23, 38 AND 50
FOR DIE-CAST METAL MODEL CARS AND PLASTIC MODEL CARS.
FIRST USE 9-1-1967; IN COMMERCE 1-1-1982.

ELEMENTS CORRECTED
OWNER ADDRESS
DATE OF FIRST USE IN COMMERCE

3,987,392. REG. 6-28-2011. COWBOY LIFESTYLE NETWORK LLC (ARIZONA LIMITED LIABILITY COMPANY) 3104 E. CAMELBACK ROAD #612, PHOENIX, AZ, 85016, SN 85-094,261. FILED P.R. 7-27-2010; AM. S.R. 5-9-2011. SUPPLEMENTAL REGISTER.

Cowboy Lifestyle

THE MARK CONSISTS OF STANDARD CHARACTERS WITHOUT CLAIM TO ANY PARTICULAR FONT, STYLE, SIZE, OR COLOR.
INT. CL. 41/U.S. CLS. 100, 101 AND 107
FOR ENTERTAINMENT, NAMELY, A CONTINUING SHOW ABOUT COWBOYS AND THEIR LIFESTYLES BROADCAST OVER INTERNET, SATELLITE, AUDIO, AND VIDEO MEDIA.
FIRST USE 7-25-2010; IN COMMERCE 7-25-2010.

ELEMENTS CORRECTED
OWNER NAME
OWNER ADDRESS

4,002,425. REG. 7-26-2011. LEGALZOOM.COM, INC. (DELAWARE CORPORATION) 11TH FLOOR, 101 NORTH BRAND BLVD., GLENDALE, CA, 91203, SN 85-203,827. FILED 12-22-2010. PRINCIPAL REGISTER.

Start Your Business. Protect Your Family. Launch Your Dreams.

3,995,716. REG. 7-19-2011. THE CARROLL HALL SHELBY TRUST, THE TRUSTEES COMPRISING M. NEIL CUMMINGS AND JOECONWAY, UNITED STATES CITIZENS (TEXAS TRUST) 11150 W. OLYMPIC BLVD., SUITE 1050, LOS ANGELES, CA, 90064, SN 77-981,498. FILED 12-19-2007. PRINCIPAL REGISTER.

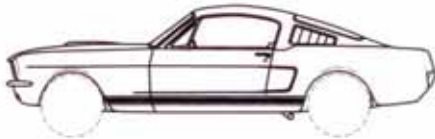

THE MARK CONSISTS OF THE OUTWARD APPEARANCE OF A VEHICLE.
SEC. 2(F).
INT. CL. 28/U.S. CLS. 22, 23, 38 AND 50
FOR DIE-CAST METAL MODEL CARS AND PLASTIC MODEL CARS.
FIRST USE 1-1-1965; IN COMMERCE 1-1-1982.

ELEMENTS CORRECTED
OWNER ADDRESS
DATE OF FIRST USE IN COMMERCE

THE MARK CONSISTS OF STANDARD CHARACTERS WITHOUT CLAIM TO ANY PARTICULAR FONT, STYLE, SIZE, OR COLOR.

NO CLAIM IS MADE TO THE EXCLUSIVE RIGHT TO USE "START YOUR BUSINESS, PROTECT YOUR FAMILY.", APART FROM THE MARK AS SHOWN.
INT. CL. 35/U.S. CLS. 100, 101 AND 102

FOR PROVIDING ONLINE DIRECTORY INFORMATION ON ATTORNEY LISTINGS; ATTORNEY REFERRALS AND ATTORNEY-CLIENT MATCH-UP SERVICES.
FIRST USE 7-1-2009, THE MARK WAS FIRST USED ANYWHERE IN A DIFFERENT FORM OTHER THAN THAT SOUGHT TO BE REGISTERED AT LEAST AS EARLY AS 01/01/2008.; IN COMMERCE 7-1-2009, THE MARK WAS FIRST USED IN COMMERCE IN A DIFFERENT FORM OTHER THAN THAT SOUGHT TO BE REGISTERED AT LEAST AS EARLY AS 01/01/2008..
INT. CL. 45/U.S. CLS. 100 AND 101

FOR LEGAL DOCUMENT PREPARATION SERVICES AND PROVIDING GENERAL LEGAL INFORMATION VIA A WEBSITE ON GLOBAL COMPUTER NETWORKS.
FIRST USE 7-1-2009, THE MARK WAS FIRST USED ANYWHERE IN A DIFFERENT FORM OTHER THAN THAT SOUGHT TO BE REGISTERED AT LEAST AS EARLY AS 01/01/2008; IN COMMERCE 7-1-2009, THE MARK WAS FIRST USED IN COMMERCE IN A DIFFERENT FORM OTHER THAN THAT SOUGHT TO BE REGISTERED AT LEAST AS EARLY AS 01/01/2008.

ELEMENTS CORRECTED
OWNER ADDRESS
CITIZENSHIP

4,010,128. REG. 8-9-2011. BRAND MANAGEMENT GROUP LLC (DELAWARE LIMITED LIABILITY COMPANY) 14414 DUNWOODY COURT, GAINESVILLE, VA, 20155, SN 77-962,478. FILED 3-18-2010. PRINCIPAL REGISTER.

COUNTRY CRUNCH

THE MARK CONSISTS OF STANDARD CHARACTERS WITHOUT CLAIM TO ANY PARTICULAR FONT, STYLE, SIZE, OR COLOR.

INT. CL. 30/U.S. CL. 46

FOR BREAKFAST CEREALS; PROCESSED CEREALS; PROCESSED CEREAL-BASED FOOD TO BE USED AS BREAKFAST FOOD; READY-TO-EAT CEREALS; MUESLI; MUESLI-BASED BREAKFAST CEREALS.

FIRST USE 3-29-2011; IN COMMERCE 3-29-2011.

ELEMENTS CORRECTED
OWNER ADDRESS

OWNER OF INTERNATIONAL REGISTRATION 1059422 DATED 11-3-2010, EXPIRES 11-3-2020.

INT. CL. 1/U.S. CLS. 1

FOR CHEMICAL FOOD ADDITIVES, NAMELY FOR MINERAL ENRICHMENT; CHEMICALS FOR THE MANUFACTURE OF FOODSTUFFS AND FOOD ADDITIVES.

INT. CL. 5/U.S. CLS. 6, 18, 44, 46, 51 AND 52

FOR [ADDITIVES FOR DIETETIC FOODSTUFFS AND FOOD FOR BABIES, NAMELY, ADDITIVES WITH A BASE OF MINERALS AND TRACE ELEMENTS].

FIRST USE ; IN COMMERCE .

ELEMENTS CORRECTED
GOODS/SERVICES

4,017,704. REG. 8-30-2011. CONVERTIGO SOCIÉTÉ ANONYME (FRANCE CORPORATION) 21 AVENUE DU QUÉBEC, F-91951 LES ULIS, FRANCE., SN 79-078,897. FILED 12-15-2009. PRINCIPAL REGISTER.

CONVERTIGO

THE MARK CONSISTS OF STANDARD CHARACTERS WITHOUT CLAIM TO ANY PARTICULAR FONT, STYLE, SIZE, OR COLOR.

PRIORITY DATE OF 6-18-2009 IS CLAIMED.

OWNER OF INTERNATIONAL REGISTRATION 1028784 DATED 12-15-2009, EXPIRES 12-15-2019.

INT. CL. 9/U.S. CLS. 21, 23, 26, 36 AND 38

FOR SOFTWARE AND SOFTWARE PACKAGE COMPOSED PRIMARILY OF DATA PROCESSING SOFTWARE * EXCLUDING SOFTWARE AND SOFTWARE PACKAGES IN THE FIELD OF MUSIC *; COMPUTERS, COMPUTER PERIPHERAL DEVICES; DATA PROCESSING EQUIPMENT; APPARATUS FOR RECORDING, TRANSMISSION OR REPRODUCTION OF SOUND OR IMAGES; MAGNETIC RECORDING MEDIA, NAMELY, PRE-RECORDED CD-ROM, PRE-RECORDED DVD, PRE-RECORDED HDV, PRE-RECORDED HD-DVD AND PRE-RECORDED COMPUTER DISCS, PRE-RECORDED LASERDISCS CONTAINING INFORMATION AND SOFTWARE IN THE FIELD OF CREATION, DEVELOPMENT, MAINTENANCE AND UPDATING COMPUTER APPLICATIONS AND WEB PAGES. * EXCLUDING MAGNETIC RECORDING MEDIA IN THE FIELD OF MUSIC *.

FIRST USE ; IN COMMERCE .

INT. CL. 35/U.S. CLS. 100, 101 AND 102

FOR MARKET RESEARCH STUDIES; SERVICES WITH REGARD TO DATA PROCESSING SOFTWARE PRODUCT PRESENTATION TO THE PUBLIC; RETAIL AND ONLINE RETAIL STORE SERVICES FEATURING COMPUTER SOFTWARE IN THE FIELD OF CREATION, DEVELOPMENT, MAINTENANCE AND UPDATING COMPUTER APPLICATIONS AND WEB PAGES; ADVERTISING FOR DATA PROCESSING SOFTWARE AND HOSTING SERVICES, CONTENT AGGREGATION, SUPPLYING HOSTED APPLICATIONS, CLOUD COMPUTING, OUTSOURCING SERVICES; BUSINESS MANAGEMENT; DISSEMINATION OF ADVERTISING MATERIALS, NAMELY, LEAFLETS, PROSPECTUS, PRINTED MATTER, SAMPLE; DOCUMENT REPRODUCTION; COMPUTERIZED FILE MANAGEMENT; ORGANIZATION OF EXHIBITIONS FOR COMMERCIAL OR ADVERTISING PURPOSES; ONLINE ADVERTISING ON A COMPUTER NETWORK; PUBLICATION OF ADVERTISING TEXTS, PUBLIC RELATIONS. * ALL THE ABOVE-MENTIONED SERVICES WILL NOT BE PROVIDED IN THE FIELD OF MUSIC *.

FIRST USE ; IN COMMERCE .

INT. CL. 38/U.S. CLS. 100, 101 AND 104

4,012,030. REG. 8-16-2011. ONE MAN LEFT STUDIOS, LLC (ALABAMA LIMITED LIABILITY COMPANY) NO. 303, 1301 TAYLOR OAKS CIRCLE, MONTGOMERY, AL, 36116, SN 85-220,630. FILED 1-19-2011. PRINCIPAL REGISTER.

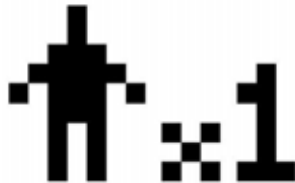

THE MARK CONSISTS OF PIXELATED FIGURE WITH THE LETTER "X" AND THE NUMBER "1" ADJACENT TO THE FIGURE.

INT. CL. 9/U.S. CLS. 21, 23, 26, 36 AND 38

FOR DOWNLOADABLE MUSIC; DOWNLOADABLE ELECTRONIC GAMES.

FIRST USE 12-14-2009; IN COMMERCE 2-24-2010.

ELEMENTS CORRECTED
DESCRIPTION OF MARK

4,014,604. REG. 8-23-2011. CHEMISCHE FABRIK BUDENHEIM KG (FED REP GERMANY PRIVATE LIMITED PARTNERSHIP) RHEINSTRASSE 27, 55257 BUDENHEIM, FED REP GERMANY., SN 79-090,333. FILED 11-3-2010. PRINCIPAL REGISTER.

Puremin

THE MARK CONSISTS OF STANDARD CHARACTERS WITHOUT CLAIM TO ANY PARTICULAR FONT, STYLE, SIZE, OR COLOR.

PRIORITY DATE OF 5-3-2010 IS CLAIMED.

FOR TELECOMMUNICATION SERVICES, NAMELY, TRANSMISSION OF WEBCASTS, EMAILS, DATA AND VOICE COMMUNICATIONS VIA THE INTERNET AND WIRELESS TELEPHONE SYSTEMS; PROVIDING INFORMATION ABOUT TELECOMMUNICATIONS; COMMUNICATIONS VIA COMPUTER TERMINALS OR VIA FIBER-OPTIC NETWORKS; ELECTRONIC DISPLAY SERVICES IN THE NATURE OF ELECTRONIC DATA TRANSMISSION; PROVIDING DISCUSSION FORUMS ON THE INTERNET; PROVIDING ACCESS TO DATABASES.

FIRST USE ; IN COMMERCE .
INT. CL. 42/U.S. CLS. 100 AND 101

FOR RESEARCH AND DEVELOPMENT OF NEW PRODUCTS FOR OTHERS; TECHNICAL PROJECT STUDIES, NAMELY, INFORMATION TECHNOLOGY PROJECTS CONSISTING OF DEVELOPMENT, INSTALLATION, INTEGRATION, HOSTING, CLOUD COMPUTING, MAINTENANCE AND UPDATING OF DATA PROCESSING SOFTWARE; DEVELOPMENT, INSTALLATION, INTEGRATION, HOSTING, MAINTENANCE, UPDATING, RENTAL OF COMPUTER SOFTWARE; COMPUTER PROGRAMMING; CONVERSION OF COMPUTER DATA AND PROGRAMS, NOT PHYSICAL CONVERSION; CONVERSION OF DATA OR DOCUMENTS FROM PHYSICAL TO ELECTRONIC MEDIA; QUALITY CONTROL SERVICES FOR OTHERS; DUPLICATION OF COMPUTER PROGRAMS; PROVIDING ADVICE FOR COMPUTER HARDWARE AND SOFTWARE FOR OTHERS; HOSTING DIGITAL CONTENT; SUPPLYING APPLICATION SERVICES IN THE NATURE OF PROVIDING AN INTERACTIVE WEBSITE FEATURING TECHNOLOGY THAT ALLOWS USERS TO UPLOAD, DOWNLOAD, SHARE AND SELL CUSTOM AND BRANDED DIGITAL PUBLICATIONS; SUPPLYING HOSTED APPLICATIONS, NAMELY, HOSTING SOFTWARE, WEBSITES AND COMPUTER APPLICATIONS OF OTHERS ON A VIRTUAL PRIVATE SERVER; SUPPLYING SOFTWARE AND COMPUTING SERVICES FOR OTHERS FOR INSTALLATION, MAINTENANCE AND UPDATING OF COMPUTER SOFTWARE FOR OTHERS VIA THE INTERNET.

FIRST USE ; IN COMMERCE .
INT. CL. 45/U.S. CLS. 100 AND 101

FOR COMPUTER SOFTWARE LICENSING, SECURITY CONSULTANCY, SECURITY SERVICES FOR THE PROTECTION OF PROPERTY AND INDIVIDUALS.

ELEMENTS CORRECTED
GOODS/SERVICES

4,021,873. REG. 9-6-2011. COSWAY COMPANY, INC. (CALIFORNIA CORPORATION) 20633 FORDYCE AVENUE, CARSON, CA, 90810, SN 85-180,286. FILED 11-18-2010. PRINCIPAL REGISTER.



OWNER OF U.S. REG. NO. 3,826,368.
THE MARK CONSISTS OF A CIRCULAR DESIGN WITH STARS IN GROUPS OF THREE AROUND THE PERIPHERY, WITH PLANTS IN THE NEXT INNER RING, WITH THE NEXT INSIDE RING CONSISTING OF INTERLOCKING PATTERNS, WITH THE INNERMOST CIRCLE CONSISTING OF A SUNBURST SURROUNDED BY WAVES.
INT. CL. 3/U.S. CLS. 1, 4, 6, 50, 51 AND 52

FOR HAIR CARE PRODUCTS, NAMELY, HAIR CARE PREPARATIONS, HAIR SHAMPOO, HAIR CLEANING PREPARATIONS, HAIR CONDITIONERS, HAIR RINSES, HAIR CREME, HAIR GEL, AND HAIR STYLING PREPARATIONS; BODY CARE PRODUCTS, NAMELY, BODY CLEANSING SOAP AND GEL, BODY CREAMS AND LOTIONS, SKIN MOISTURIZER, MOISTURIZING CREAMS, NON-MEDICATED FOOT CREAM, NON-MEDICATED FOOT LOTIONS, HAND CREAMS AND LOTIONS; BATH PRODUCTS, NAMELY, BATH AND SHOWER GELS, BATH AND SHOWER WASHES, BATH AND SHOWER FOAMS; ESSENTIAL OILS FOR USE IN THE MANUFACTURE OF SCENTED PRODUCTS [; SKIN CARE PRODUCTS, NAMELY, FACIAL CLEANSERS, UNDER EYE CREAMS, FACIAL CREAMS, FACIAL LOTION, FACIAL TONER, FACIAL EMULSIONS, FACIAL MASKS, ANTI-WRINKLE CREAM, ANTI-AGING CREAM, FACIAL WASH, FACIAL SCRUB, FACIAL EXFOLIANT, FACIAL MOISTURIZER, FACIAL MOISTURIZER WITH SUN PROTECTION FACTOR, EYE CREAM, UNDER EYE GELS, MASKS AND ASTRINGENTS FOR COSMETIC PURPOSES; FACIAL COSMETICS, NAMELY, LIP CREAM, LIP BALM, LIP BALM WITH SUN PROTECTION FACTOR, LIP STICK, LIP GLOSS; BODY SCRUB EXFOLIANT, SKIN TONER, SKIN MOISTURIZER WITH SUN PROTECTION FACTOR, SELF TANNING LOTION, SUN SCREEN PREPARATIONS, PERSONAL DEODORANTS AND ANTIPERSPIRANTS, MASSAGE OILS; BATH PRODUCTS, NAMELY, BUBBLE BATHS, MILK BATHS, NON-MEDICATED BATH SALTS, BATH OILS, BODY OILS, BATH CRYSTALS, BATH PEARLS, BATH POWDER, SHAVING CREAM, SHAVING GEL, PRE-SHAVING PREPARATIONS, AFTER-SHAVE LOTIONS AND BALM, TOILET WATER, TALCUM POWDER AND SKIN SOAP; COSMETICS; SCENTED PRODUCTS, NAMELY, PERFUMES, COLOGNE, ESSENTIAL OILS FOR PERSONAL USE].

FIRST USE 10-1-2009; IN COMMERCE 9-17-2010.

ELEMENTS AMENDED
GOODS/SERVICES

4,021,874. REG. 9-6-2011. COSWAY COMPANY, INC. (CALIFORNIA CORPORATION) 20633 FORDYCE AVENUE, CARSON, CA, 90810, SN 85-180,325. FILED 11-18-2010. PRINCIPAL REGISTER.



NEUMA

OWNER OF U.S. REG. NOS. 3,823,203 AND 3,826,368.
THE MARK CONSISTS OF A CIRCULAR DESIGN WITH STARS IN GROUPS OF THREE AROUND THE PERIPHERY, WITH PLANTS IN THE NEXT INNER RING, WITH THE NEXT INSIDE RING CONSISTING OF INTERLOCKING PATTERNS, WITH THE INNERMOST CIRCLE CONSISTING OF A SUNBURST SURROUNDED BY WAVES. THE WORD "NEUMA" APPEARS BELOW THE DESIGN.
THE WORDING "NEUMA" HAS NO MEANING IN A FOREIGN LANGUAGE.
INT. CL. 3/U.S. CLS. 1, 4, 6, 50, 51 AND 52

FOR HAIR CARE PRODUCTS, NAMELY, HAIR CARE PREPARATIONS, HAIR SHAMPOO, HAIR CLEANING PREPARATIONS, HAIR CONDITIONERS, HAIR RINSES, HAIR CRÈME, HAIR GEL, AND HAIR STYLING PREPARATIONS; BODY CARE PRODUCTS, NAMELY, BODY CLEANSING SOAP AND GEL, BODY CREAMS AND LOTIONS, SKIN MOISTURIZER, MOISTURIZING CREAMS, NON-MEDICATED FOOT CREAM, NON-MEDICATED FOOT LOTIONS, HAND CREAMS AND LOTIONS; BATH PRODUCTS, NAMELY, BATH AND SHOWER GELS, BATH AND SHOWER WASHES, BATH AND SHOWER FOAMS; ESSENTIAL OILS FOR USE IN THE MANUFACTURE OF SCENTED PRODUCTS []; SKIN CARE PRODUCTS, NAMELY, FACIAL CLEANSERS, UNDER EYE CREAMS, FACIAL CREAMS, FACIAL LOTION, FACIAL TONER, FACIAL EMULSIONS, FACIAL MASKS, ANTI-WRINKLE CREAM, ANTI-AGING CREAM, FACIAL WASH, FACIAL SCRUB, FACIAL EXFOLIANT, FACIAL MOISTURIZER, FACIAL MOISTURIZER WITH SUN PROTECTION FACTOR, EYE CREAM, UNDER EYE GELS, MASKS AND ASTRINGENTS FOR COSMETIC PURPOSES; FACIAL COSMETICS, NAMELY, LIP CREAM, LIP BALM, LIP BALM WITH SUN PROTECTION FACTOR, LIP STICK, LIP GLOSS, BODY SCRUB EXFOLIANT, SKIN TONER, SKIN MOISTURIZER WITH SUN PROTECTION FACTOR, SELF TANNING LOTION, SUN SCREEN PREPARATIONS, PERSONAL DEODORANTS AND ANTIPERSPIRANTS, MASSAGE OILS; BATH PRODUCTS, NAMELY, BUBBLE BATHS, MILK BATHS, NON-MEDICATED BATH SALTS, BATH OILS, BODY OILS, BATH CRYSTALS, BATH PEARLS, BATH POWDER, SHAVING CREAM, SHAVING GEL, PRE-SHAVING PREPARATIONS, AFTER-SHAVE LOTIONS AND BALM, TOILET WATER, TALCUM POWDER AND SKIN SOAP; COSMETICS; SCENTED PRODUCTS, NAMELY, PERFUMES, COLOGNE, ESSENTIAL OILS FOR PERSONAL USE]

FIRST USE 10-1-2009; IN COMMERCE 9-17-2010.

ELEMENTS AMENDED
GOODS/SERVICES

4,030,460. REG. 9-27-2011. KVERNELAND GROUP MECHANICS B.V. (NETHERLANDS BESLOTEN VENNOOTSCHAP) HOOFDWEG 1278, NL-2153 LR NIEUW-VENNEP, NETHERLANDS., SN 79-083,895. FILED 11-11-2009. PRINCIPAL REGISTER.

IsoMatch 

PRIORITY DATE OF 11-4-2009 IS CLAIMED.

OWNER OF INTERNATIONAL REGISTRATION 1042449 DATED 11-11-2009, EXPIRES 11-11-2019.

THE COLOR(S) RED AND BLACK IS/ARE CLAIMED AS A FEATURE OF THE MARK.

THE MARK CONSISTS OF THE WORDING "ISOMATCH" APPEARING IN BLACK STYLIZED FONT APPEARING NEXT TO A STYLIZED "I" APPEARING IN THE COLOR RED NEXT TO A STYLIZED "M" APPEARING IN THE COLOR BLACK.

INT. CL. 9/U.S. CLS. 21, 23, 26, 36 AND 38

FOR ELECTRICAL AND ELECTRONIC COMMUNICATION AND TELECOMMUNICATION APPARATUS AND INSTRUMENTS, NAMELY, ELECTRICAL PLUG DEVICE ENABLING CONNECTION AND DISCONNECTION OF POWER AND/OR CONTROL CABLES, COMPUTER HARDWARE, TABLET COMPUTERS, COMPUTER JOYSTICKS, SWITCHBOXES, DIGITAL TRANSMITTERS, WIRELESS TRANSMITTERS, RADIO TRANSMITTERS, TEMPERATURE TRANSMITTERS, TRANSMITTERS OF ELECTRONIC SIGNALS, OPTICAL TRANSMITTERS, WIRELESS ADAPTERS USED TO LINK COMPUTERS TO A TELECOMMUNICATIONS NETWORK, DEVICES FOR TRANSPORTING AND AGGREGATING VOICE, DATA, IMAGES, AND VIDEO COMMUNICATIONS ACROSS MULTIPLE NETWORK INFRASTRUCTURES AND COMMUNICATIONS PRO-

TOCOLS; ELECTRICAL TRANSFORMERS, ELECTRICAL RESISTOR; COMMUNICATION AND TELECOMMUNICATION APPARATUS AND INSTRUMENTS, NAMELY, VIDEO CAMERAS, COMPUTER HARDWARE, PLUG CONNECTORS, PLUG ADAPTERS, TELECOMMUNICATIONS BASE STATION EQUIPMENT FOR CELLULAR AND FIXED NETWORKING AND COMMUNICATIONS APPLICATIONS, DEVICES FOR TRANSPORTING AND AGGREGATING VOICE, DATA, AND VIDEO COMMUNICATIONS ACROSS MULTIPLE NETWORK INFRASTRUCTURES AND COMMUNICATIONS PROTOCOLS, TELECOMMUNICATION LINE INTEGRITY TESTING APPARATUS, FIBER-OPTIC TRANSCIEVERS, FIBER OPTIC REPEATERS, CONVERTERS AND OPTIMIZERS, WAVE DIVISION MULTIPLEXERS, FREE-SPACE OPTICS TRANSMISSION SYSTEMS, SWITCHES INCLUDING ETHERNET SWITCHES AND ROUTERS, FIBER-TO-THE-HOME AND ETHERNET-OVER-VDSL ACCESS AGGREGATORS, TERMINATORS AND REPEATERS, AND REMOTE PRESENCE MANAGEMENT PRODUCTS, NAMELY, SWITCHES, AND CONSOLE, ALARM, SENSOR AND POWER MANAGEMENT DEVICES, MICROPHONES; ELECTRIC AND ELECTRONIC APPARATUS AND INSTRUMENTS FOR PROCESSING, WRITING, STORING, TRANSMISSION, CALLING BACK OR RECEIVE DATA, NAMELY, ELECTRONIC DATA RECORDERS; APPARATUS AND INSTRUMENTS FOR REGISTERING, TRANSMITTING, AMPLIFYING OR REPRODUCTION OF SOUND, IMAGES, INFORMATION OR CODED DATA, NAMELY, SOUND AMPLIFIERS, COMPUTER HARDWARE, AND PERIPHERALS FOR COMPUTERS; COMPUTERS; PERIPHERALS FOR COMPUTERS; ELECTRONIC CIRCUITS CONTAINING PROGRAMMED DATA; RECORDED COMPUTER PROGRAMS FOR USE IN DATABASE MANAGEMENT, USE AS A SPREADSHEET, WORD PROCESSING, ELECTRONIC STORAGE OF DATA, THE INTEGRATION OF TEXT, AUDIO, GRAPHICS, STILL IMAGES AND MOVING PICTURES INTO AN INTERACTIVE DELIVERY FOR MULTIMEDIA APPLICATIONS, FOR REMOTELY MONITORING ENVIRONMENTAL CONDITIONS AND CONTROLLING DEVICES WITHIN A BUILDING, FACILITY, GROUNDS, OR DESIGNATED SPATIAL AREA, ACCESSING INFORMATION DIRECTORIES THAT MAY BE DOWNLOADED; COMPUTER SOFTWARE FOR USE IN DATABASE MANAGEMENT, USE AS A SPREADSHEET, WORD PROCESSING, ELECTRONIC STORAGE OF DATA, THE INTEGRATION OF TEXT, AUDIO, GRAPHICS, STILL IMAGES AND MOVING PICTURES INTO AN INTERACTIVE DELIVERY FOR MULTIMEDIA APPLICATIONS, FOR REMOTELY MONITORING ENVIRONMENTAL CONDITIONS AND CONTROLLING DEVICES WITHIN A BUILDING, FACILITY, GROUNDS, OR DESIGNATED SPATIAL AREA, ACCESSING INFORMATION DIRECTORIES THAT MAY BE DOWNLOADED; BLANK MAGNETIC DATA CARRIERS IN THE NATURE OF DISCS, TAPES AND MAGNETIC WIRES, PRE-RECORDED MAGNETIC DATA CARRIERS FEATURING INFORMATION AND DATA FOR USE IN THE AGRICULTURAL INDUSTRY, FARMING EQUIPMENT, VEHICLES; BLANK SMART CARDS AND MAGNETIC CODED CARDS FEATURING INFORMATION AND DATA FOR USE IN THE AGRICULTURAL INDUSTRY, FARMING EQUIPMENT, VEHICLES; BLANK SMART CARDS, MICROPROCESSOR CARDS; CARDS WITH INTEGRATED CIRCUIT; ELECTRONICALLY ENCODED IDENTIFICATION CARDS; BLANK CD-ROMS FOR SOUND OR VIDEO RECORDING, PRE-RECORDED MULTIMEDIA SOFTWARE FOR SHARING AND DISSEMINATING FILES, MESSAGES, INFORMATION, DATA, STATISTICS, ARTICLES, NEWS, MULTIMEDIA CONTENT, AND OTHER DIGITIZED MATERIAL FOR USE IN THE AGRICULTURAL INDUSTRY, FARMING EQUIPMENT, VEHICLES; BLANK MAGNETIC AND OPTICAL DATA CARRIERS; DIGITAL DATA CARRIERS, NAMELY, OPTICAL CABLES, BLANK OPTICAL DATA CARRIERS; BLANK MAGNETIC AND OPTICAL DATA RECORDING AND STORAGE MEDIA, NAMELY, BLANK MAGNETIC AND OPTICAL DISCS; PRE-RECORDED MAGNETIC AND OPTICAL DATA RECORDING AND STORAGE MEDIA, NAMELY, PRERECORDED MAGNETIC DATA CARRIERS AND OPTICAL DISCS FEATURING INFORMATION AND DATA FOR USE IN THE AGRICULTURAL INDUSTRY, FARMING EQUIPMENT, VEHICLES; DOWNLOADABLE COMPUTER SOFTWARE FOR USE IN DATABASE MANAGEMENT, USE AS A SPREADSHEET, WORD

PROCESSING, ELECTRONIC STORAGE OF DATA, THE INTEGRATION OF TEXT, AUDIO, GRAPHICS, STILL IMAGES AND MOVING PICTURES INTO AN INTERACTIVE DELIVERY FOR MULTIMEDIA APPLICATIONS, FOR REMOTELY MONITORING ENVIRONMENTAL CONDITIONS AND CONTROLLING DEVICES WITHIN A BUILDING, FACILITY, GROUNDS, OR DESIGNATED SPATIAL AREA, ACCESSING INFORMATION DIRECTORIES; COMPUTER SOFTWARE FOR USE IN DATABASE MANAGEMENT, USE AS A SPREADSHEET, WORD PROCESSING, ELECTRONIC STORAGE OF DATA, THE INTEGRATION OF TEXT, AUDIO, GRAPHICS, STILL IMAGES AND MOVING PICTURES INTO AN INTERACTIVE DELIVERY FOR MULTIMEDIA APPLICATIONS, FOR REMOTELY MONITORING ENVIRONMENTAL CONDITIONS AND CONTROLLING DEVICES WITHIN FARM EQUIPMENT, BUILDING, FACILITY, GROUNDS, OR DESIGNATED SPATIAL AREA, ACCESSING INFORMATION DIRECTORIES THAT MAY BE DOWNLOADED FROM THE GLOBAL COMPUTER NETWORK AND TELECOMMUNICATION APPARATUS, NAMELY, ELECTRONIC PERSONAL ORGANIZERS, HAND HELD COMPUTERS, TABLET COMPUTERS, CABLES FOR ELECTRICAL OR OPTICAL SIGNAL TRANSMISSION, COMPUTER CABLES, CONNECTION CABLES, COAXIAL CABLES, ETHERNET CABLES, FIBER OPTIC CABLES, ELECTRONIC CABLES, POWER CABLES, TELECOMMUNICATION CABLES, BLANK AND PRE-RECORDED USB FLASH DRIVES FEATURING INFORMATION AND DATA FOR USE IN THE AGRICULTURAL INDUSTRY, FARMING EQUIPMENT, VEHICLES; OPTICAL, DIGITAL OR ELECTRONIC SIGNAL TRANSMITTERS USED TO MAKE CONNECTIONS WITH DATABASES POSSIBLE; COMPUTER SOFTWARE TO GET TO ACCESS DATABASES; ELECTRONIC PERSONAL ORGANIZERS; ANTENNAS; BATTERIES; MICROPROCESSORS; KEYBOARDS; MODEMS; DISPLAY SCREENS, NAMELY, FLAT PANEL DISPLAY SCREENS, ELECTRONIC DISPLAY SCREENS, ELECTRONIC TOUCH SCREEN DISPLAYS, VIDEO DISPLAY SCREENS, EXTERNAL ELECTRONIC DISPLAY SCREEN, MULTIPLE IMAGE ELECTRONIC DISPLAY SCREEN, HAND HELD ELECTRONIC DISPLAY SCREEN; ELECTRONIC GLOBAL POSITIONING SYSTEMS; ELECTRONIC NAVIGATION, TRACING, AND POSITIONING APPARATUS AND INSTRUMENTS, NAMELY, GLOBAL POSITIONING SYSTEM (GPS); OPTICAL AND ELECTRO-OPTICAL APPARATUS AND INSTRUMENTS, NAMELY, OPTICAL CABLES, BLANK OPTICAL DATA CARRIERS, CABLES FOR ELECTRICAL OR OPTICAL SIGNAL TRANSMISSION, OPTICAL TRANSMITTERS, OPTICAL RECEIVERS, OPTICAL DATA LINKS, DIGITAL TRANSMITTERS, OPTICAL COMMUNICATIONS SYSTEMS COMPRISED OF OPTICAL AND ELECTRONIC HARDWARE AND COMPUTER SOFTWARE FOR THE TRANSMISSION OF DATA BETWEEN TWO POINTS; * ALL THE AFORESAID GOODS SOLELY FOR THE AGRICULTURAL SECTOR *.

FIRST USE ; IN COMMERCE .

INT. CL. 12/U.S. CLS. 19, 21, 23, 31, 35 AND 44

FOR LAND VEHICLES; VEHICLES FOR TRANSPORT BY WATER, NAMELY, BOATS, SHIPS; VEHICLES FOR TRANSPORT BY AIR, NAMELY, AIRPLANES, AMPHIBIOUS AIRPLANE; * ALL THE AFORESAID GOODS SOLELY FOR THE AGRICULTURAL SECTOR *.

FIRST USE ; IN COMMERCE .

INT. CL. 42/U.S. CLS. 100 AND 101

FOR COMPUTER PROGRAMMING; SERVICES OF INFORMATION AND COMMUNICATION TECHNOLOGY, NAMELY, CONSULTING IN THE FIELD OF INFORMATION TECHNOLOGY; TECHNICAL CONSULTANCY IN THE FIELD OF COMPUTERS, SOFTWARE, COMPUTER SYSTEMS, SOFTWARE FOR DATABASES AND COMPUTER NETWORKS; TECHNICAL CONSULTANCY IN THE FIELD OF COMPUTER SOFTWARE DELIVERED VIA INTERNET FOR USE IN DATABASE MANAGEMENT, USE AS A SPREADSHEET, WORD PROCESSING, ELECTRONIC STORAGE OF DATA, THE INTEGRATION OF TEXT, AUDIO, GRAPHICS, STILL IMAGES AND MOVING PICTURES INTO AN INTERACTIVE DELIVERY FOR MULTIMEDIA APPLICATIONS, FOR REMOTELY MONITORING ENVIRONMENTAL CONDITIONS AND CONTROLLING DEVICES WITHIN A BUILDING, FACILITY, GROUNDS, OR DESIGNATED SPATIAL AREA, ACCESSING INFORMATION DIRECTORIES; COMPUTER SYSTEM ANALYSIS; PRODUCT RESEARCH AND DEVELOP-

MENT; PRODUCT RESEARCH AND DEVELOPMENT IN THE FIELD OF SOFTWARE AND COMPUTER SYSTEMS; CONSULTING IN THE FIELD OF SOFTWARE AND PRODUCT DEVELOPMENT FOR OTHERS; UPDATING AND MAINTENANCE OF SOFTWARE; AUTOMATION SERVICES, NAMELY, DESIGN, DEVELOPMENT, AND CONSULTING SERVICES IN THE FIELD OF COMPUTER HARDWARE AND SOFTWARE IN THE FIELD OF AGRICULTURAL AND VEHICLE INDUSTRIES; CONSULTING IN THE FIELD OF COMPUTER SYSTEMS; * ALL THE AFORESAID SERVICES SOLELY FOR THE AGRICULTURAL SECTOR *.

FIRST USE ; IN COMMERCE .

ELEMENTS CORRECTED
GOODS/SERVICES

4,036,047. REG. 10-4-2011. VIRENT, INC. (DELAWARE CORPORATION) 3571 ANDERSON STREET, MADISON, WI, 53704, SN 85-087,900. FILED 7-19-2010. PRINCIPAL REGISTER.

BIOFORMATE

THE MARK CONSISTS OF STANDARD CHARACTERS WITHOUT CLAIM TO ANY PARTICULAR FONT, STYLE, SIZE, OR COLOR.

OWNER OF U.S. REG. NO. 3,418,993.

INT. CL. 1/U.S. CLS. 1

FOR CHEMICALS FOR USE IN INDUSTRY.

FIRST USE 8-26-2010; IN COMMERCE 8-26-2010.

INT. CL. 4/U.S. CLS. 1, 6 AND 15

FOR FUELS .

FIRST USE 8-26-2010; IN COMMERCE 8-26-2010.

ELEMENTS CORRECTED
CITIZENSHIP

4,043,733. REG. 10-25-2011. THE CARROLL HALL SHELBY TRUST, THE TRUSTEES COMPRISING M. NEIL CUMMINGS AND JOECONWAY, UNITED STATES CITIZENS (TEXAS TRUST) 11150 W. OLYMPIC BLVD., SUITE 1050, LOS ANGELES, CA, 90064, SN 77-981,499. FILED 12-19-2007. PRINCIPAL REGISTER.

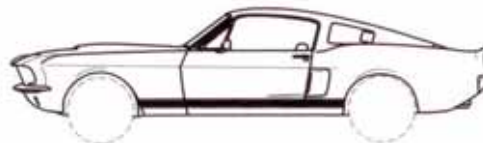

THE MARK CONSISTS OF THE OUTWARD APPEARANCE OF A VEHICLE.

SEC. 2(F).

INT. CL. 28/U.S. CLS. 22, 23, 38 AND 50

FOR DIE-CAST METAL MODEL CARS AND PLASTIC MODEL CARS.

FIRST USE 1-1-1967; IN COMMERCE 1-1-1982.

ELEMENTS CORRECTED
OWNER ADDRESS
DATE OF FIRST USE
DATE OF FIRST USE IN COMMERCE

4,043,785. REG. 10-25-2011. TYCOONAIRES HOLDING SA (UNITED KINGDOM SHARE COMPANY) AVENUE JP PESCATORE 4, L-2324 LUXEMBOURG, LUXEMBOURG., SN 79-088,821. FILED 6-2-2010. PRINCIPAL REGISTER.

TYCOONAIRES

THE MARK CONSISTS OF STANDARD CHARACTERS WITHOUT CLAIM TO ANY PARTICULAR FONT, STYLE, SIZE, OR COLOR.

OWNER OF INTERNATIONAL REGISTRATION 1055192 DATED 6-2-2010, EXPIRES 6-2-2020.

INT. CL. 3/U.S. CLS. 1, 4, 6, 50, 51 AND 52

FOR SOAPS; PERFUMERY, ESSENTIAL OILS, COSMETICS, HAIR LOTIONS; DENTIFRICES CARDBOARD.

FIRST USE ; IN COMMERCE .

INT. CL. 9/U.S. CLS. 21, 23, 26, 36 AND 38

FOR LIFE-SAVING APPARATUS AND INSTRUMENTS, NAMELY, SAFETY AND PROTECTIVE CLOTHING, NAMELY, UNDERWEAR, SHIRTS, PANTS, DRIVING SUITS, SOCKS, SHOES, BOOTS, SAFETY HELMETS, HOODS, NECK BRACES, AND GLOVES FOR USE IN PROTECTING RACE CAR DRIVERS, PROTECTIVE EYEWEAR.

FIRST USE ; IN COMMERCE .

INT. CL. 12/U.S. CLS. 19, 21, 23, 31, 35 AND 44

FOR LAND MOTOR VEHICLES, NAMELY, MOTOR CARS, AUTOMOBILES, SPORT CARS, STRUCTURAL PARTS AND COMPONENTS THEREFOR.

FIRST USE ; IN COMMERCE .

INT. CL. 16/U.S. CLS. 2, 5, 22, 23, 29, 37, 38 AND 50

FOR PAPER, NAMELY, WRITING PAPER; PRINTED MATTER, NAMELY, JOURNALS, NEWSPAPERS, BROCHURES ABOUT SPORTS, CARS, DRIVING, TRAVEL AND VACATIONS; PHOTOGRAPHS; TYPEWRITERS AND OFFICE REQUISITES, NAMELY, ENVELOPES, BUSINESS CARDS, CALENDARS, POSTCARDS; PENS; INSTRUCTIONAL AND TEACHING MATERIAL, RELATED TO TRAVEL, TOURISM, EDUCATION, CARS, DRIVING, ENTERTAINMENT, MUSIC, FINANCE, SPORTS AND SPORTING ACTIVITIES, FITNESS, NUTRITION, AND HEALTH; PRINTERS' TYPE; PRINTING BLOCKS.

FIRST USE ; IN COMMERCE .

INT. CL. 24/U.S. CLS. 42 AND 50

FOR TEXTILES GOODS, NAMELY, BED COVERS; TABLE COVERS, NAMELY, PLASTIC TABLE COVERS AND TEXTILE TABLE CLOTHS; HOUSEHOLD LINEN; CURTAINS; BATH SHEETS; BED SHEETS; PILLOWCASES; BEDSPREADS; DUVETS; DUVET COVERS; BED BLANKETS; TOWELS; TEA-TOWELS; TABLE CLOTHS NOT OF PAPER; TEXTILE NAPKINS; HANDKERCHIEFS; CLOTH FLAGS; CLOTH PENNANTS.

FIRST USE ; IN COMMERCE .

INT. CL. 25/U.S. CLS. 22 AND 39

FOR CLOTHING, NAMELY, MEN'S, WOMEN'S AND CHILDREN'S KNITWEAR, NAMELY, KNIT SWEATERS, KNIT PULLOVERS, KNIT JACKETS; BATHING SUITS; BEACH WEAR; SWIM WEAR; SAILOR SUITS; WET SUITS, NAMELY, YACHTING WET SUITS; COATS, TOPCOATS AND OVERCOATS; SHIRTS; T-SHIRTS; BLOUSES; SWEATERS; SHORTS, PANTS AND TROUSERS; SKIRTS; TIES; NECKTIES; DRESSES; SUITS; JACKETS; DRESS UNIFORMS; SPORTSWEAR, NAMELY, SWEAT PANTS, SWEATSHIRTS, SWEAT JACKETS, TRACK SUITS AND SWEAT SUITS; AUTOMOBILE RACING SUITS NOT IN THE NATURE OF PROTECTIVE CLOTHING; UNDERWEAR; BRASSIERES; STOCKINGS; SOCKS; SCARVES; GLOVES AND GLOVES FOR APPAREL; HEADGEAR, NAMELY, HATS AND CAPS; FOOTWEAR, NAMELY, SHOES, SAILING SHOES, BOOTS, SANDALS AND SLIPPERS, YACHTING BOOTS AND SHOES, GOLF SHOES, DIVING SHOES, FISHING BOOTS, CLIMBING SHOES; HEAD WEAR; BELTS.

FIRST USE ; IN COMMERCE .

INT. CL. 28/U.S. CLS. 22, 23, 38 AND 50

FOR GAMES AND PLAYTHINGS, NAMELY, BOARD GAMES, MODEL MOTORBIKES AND MODEL CARS FOR SALE IN AN ASSEMBLY KIT FORM, TOY MODEL VEHICLES, TOY COLLECTIBLE MODELS REPRODUCING MOTORBIKES, AUTOMOBILES AND OTHER VEHICLES, TOY VEHICLE TRUCKS, TOY REAL-SIZE NON OPERATING REPLICAS OF MOTORBIKES AND AUTOMOBILES FOR ORNAMENT, ENTERTAINMENT AND EXHIBITION PURPOSES; GYMNASIUM AND SPORTING ARTICLES, NAMELY, BODY-BUILDING FITNESS EQUIPMENT AND WELLNESS EQUIPMENT, SPORT PROGRAMS AND SPORTING OFFICE PROGRAMS .

FIRST USE ; IN COMMERCE .

INT. CL. 32/U.S. CLS. 45, 46 AND 48

FOR BEER; [MINERAL WATER; AERATED AND CARBONATED WATERS; SPRING WATER; DRINKING WATER WITH VITAMINS;] NON-ALCOHOLIC FRUIT-BASED BEVERAGES AND FRUIT FLAVOURED BEVERAGES; FRUIT JUICES AND VEGETABLE JUICES; FRUIT NECTARS; LEMONADES; SODA WATER; NON-ALCOHOLIC BEVERAGES, NAMELY, SOFT DRINKS; SYRUPS AND PREPARATIONS FOR MAKING BEVERAGES, NAMELY, FRUIT DRINKS; SYRUPS FOR MAKING NON-ALCOHOLIC BEVERAGES; ISOTONIC BEVERAGES; ENERGY DRINKS.

FIRST USE ; IN COMMERCE .

INT. CL. 34/U.S. CLS. 2, 8, 9 AND 17

FOR TOBACCO; SMOKERS' ARTICLES, NAMELY, CIGARETTES; CIGARS; CIGARILLOS; LIGHTERS AND ASHTRAYS; MATCHES.

FIRST USE ; IN COMMERCE .

INT. CL. 35/U.S. CLS. 100, 101 AND 102

FOR ADVERTISING; BUSINESS MANAGEMENT; BUSINESS ADMINISTRATION; PROVIDING OFFICE FUNCTIONS; * ALL THESE SERVICES NOT IN THE FIELD OF MINERAL AND AERATED WATERS, WATER DISPENSERS, WATER CONTAINERS, WATER DUCTS AND OTHER WATER CONDUIT DEVICES *.

FIRST USE ; IN COMMERCE .

INT. CL. 36/U.S. CLS. 100, 101 AND 102

FOR INSURANCE AGENCIES; FINANCIAL AFFAIRS AND MONETARY AFFAIRS, NAMELY, FINANCIAL INFORMATION, MANAGEMENT AND ANALYSIS SERVICES; REAL ESTATE AGENCIES; REAL ESTATE CONSULTANCY; AND REAL ESTATE ACQUISITION SERVICES.

FIRST USE ; IN COMMERCE .

INT. CL. 38/U.S. CLS. 100, 101 AND 104

FOR TELECOMMUNICATIONS SERVICES, NAMELY, PROVIDING ACCESS TO INTERACTIVE ENTERTAINMENT WEB SITES RELATING TO THE FIELD OF SPORTS, CAR, MOTORBIKE AND RACING COMPETITIONS; PROVISION OF ACCESS TO THE INTERNET; PROVIDING MULTIPLE-USER ACCESS TO COMPUTER NETWORKS FOR THE ELECTRONIC TRANSMISSION OF DATA, COMMUNICATION, DOCUMENTS AND INFORMATION IN THE AUTOMOBILE AND SPORT FIELDS; ELECTRONIC MAIL SERVICES THROUGH WIRED AND WIRELESS ACCESS; SOCIAL NETWORKS.

FIRST USE ; IN COMMERCE .

INT. CL. 41/U.S. CLS. 100, 101 AND 107

FOR EDUCATIONAL SERVICES, NAMELY, PROVIDING SEMINARS AND WORKSHOPS IN THE FIELD OF SPORT DRIVING, SAFE DRIVING AND RACE DRIVING; CONDUCTING DRIVER EDUCATION COURSES; PROVIDING PERSONAL TRAINING SERVICES IN THE FIELD OF CAR AND MOTORCYCLE REPAIR, SPORT DRIVING, SAFE DRIVING AND RACE DRIVING; ENTERTAINMENT IN THE NATURE OF CAR RACES, SPORTING AND CULTURAL ACTIVITIES, NAMELY, PRODUCTION OF VIDEOS IN THE FIELD OF DRIVING COMPETITIONS; ENTERTAINMENT SERVICES IN THE NATURE OF ORGANIZING AND CONDUCTING MOTORCYCLE RIDING EXCURSIONS FOR MEMBERS OF AUTOMOBILE CLUBS; ORGANIZING MOTORBIKE AND AUTOMOBILE RACING EXHIBITIONS AND COMPETITIONS FOR SPORTING PURPOSES; ORGA-

NIZING WORKSHOPS IN THE FIELD OF MOTORBIKES AND AUTOMOBILES; PROVIDING INFORMATION IN THE FIELD OF SPORTS; ORGANIZING MOTORBIKE EXHIBITIONS FOR ENTERTAINMENT PURPOSES; CONDUCTING CLASSES RELATING TO MOTOR CARS AND MOTOR RACING; SPORTING TRAINING SERVICES IN THE NATURE OF DRIVING CARS AND SPORTS CARS; PRODUCTION OF RADIO PROGRAMS, TELEVISION PROGRAMS, MOVIES AND VIDEO CLIPS ALL FOCUSED ON THE WORLD OF AUTOMOBILE AND DRIVERS.; ORGANIZING COMMUNITY SPORTING AND CULTURAL ACTIVITIES.

FIRST USE ; IN COMMERCE .
 INT. CL. 43/U.S. CLS. 100 AND 101
 FOR SERVICES FOR PROVIDING FOOD AND DRINK; PROVIDING TEMPORARY ACCOMMODATION.

FIRST USE ; IN COMMERCE .
 INT. CL. 45/U.S. CLS. 100 AND 101
 FOR LEGAL SERVICES; SECURITY GUARDING FOR FACILITIES; SECURITY GUARD SERVICES; SOCIAL SERVICES, NAMELY, SOCIAL SERVICES RENDERED BY OTHERS TO MEET THE NEEDS OF INDIVIDUALS, NAMELY, CONCIERGE SERVICES PROVIDED TO THIRD PARTIES COMPRISING MAKING REQUESTED PERSONAL ARRANGEMENTS AND RESERVATIONS AND PROVIDING CUSTOMER-SPECIFIC INFORMATION TO MEET INDIVIDUALS NEEDS RENDERED TOGETHER IN A TRADE SHOW, COLLOQUIUMS, CONFERENCES, CONVENTIONS AND EXHIBITIONS.
 FIRST USE ; IN COMMERCE .

ELEMENTS CORRECTED
 GOODS/SERVICES

4,048,750. REG. 11-1-2011. PHAM, JERRY V (UNITED STATES INDIVIDUAL) 2016 S OLYMPIA AVE, TULSA, OK, 74107, SN 85-283,310. FILED 4-1-2011. PRINCIPAL REGISTER.

AIRMEKONG

THE MARK CONSISTS OF STANDARD CHARACTERS WITHOUT CLAIM TO ANY PARTICULAR FONT, STYLE, SIZE, OR COLOR.
 INT. CL. 9/U.S. CLS. 21, 23, 26, 36 AND 38
 FOR DOWNLOADABLE VIDEO RECORDINGS FEATURING AVIATION.
 FIRST USE 2-3-2008; IN COMMERCE 2-3-2008.

ELEMENTS AMENDED
 MARK

4,049,877. REG. 11-1-2011. GOLDEN CUISINE, LLC (GEORGIA LIMITED LIABILITY COMPANY) 73-D ENTERPRISE DRIVE, PENDERGRASS, GA, 305674712, SN 77-905,883. FILED 1-6-2010. PRINCIPAL REGISTER.

GOLDEN GOURMET

THE MARK CONSISTS OF STANDARD CHARACTERS WITHOUT CLAIM TO ANY PARTICULAR FONT, STYLE, SIZE, OR COLOR.
 NO CLAIM IS MADE TO THE EXCLUSIVE RIGHT TO USE "GOURMET", APART FROM THE MARK AS SHOWN.
 INT. CL. 29/U.S. CL. 46

FOR FROZEN ENTREES CONSISTING PRIMARILY OF MEAT, FISH, OR POULTRY, FOR INSTITUTIONAL USE AND SOLD TO INSTITUTIONAL MEAL SERVICE PROVIDERS.
 FIRST USE 7-1-2009; IN COMMERCE 7-1-2009.

ELEMENTS CORRECTED
 OWNER NAME

4,058,224. REG. 11-22-2011. FMS WERTMANAGEMENT AÖR (FED REP GERMANY PUBLIC-LAW INSTITUTION) FREISINGER STRASSE 11, 85716 UNTERSCHLEISSHEIM, FED REP GERMANY., SN 79-092,125. FILED 10-27-2010. PRINCIPAL REGISTER.



OWNER OF INTERNATIONAL REGISTRATION 1063896 DATED 10-27-2010, EXPIRES 10-27-2020.
 NO CLAIM IS MADE TO THE EXCLUSIVE RIGHT TO USE "WERTMANAGEMENT", APART FROM THE MARK AS SHOWN.

THE COLOR(S) PETROL AND ORANGE IS/ARE CLAIMED AS A FEATURE OF THE MARK.
 THE MARK CONSISTS OF THE WORDING "FMS WERTMANAGEMENT" IN PETROL AND A DESIGN OF A DIAMOND-SHAPED RHOMBUS IN ORANGE WITH MULTIPLE LINES UNDER THE RHOMBUS AND BEHIND THE "FMS" WORDING IN PETROL.

THE ENGLISH TRANSLATION OF "WERTMANAGEMENT" IN THE MARK IS "VALUE MANAGEMENT".
 INT. CL. 16/U.S. CLS. 2, 5, 22, 23, 29, 37, 38 AND 50
 FOR PRINTED MATTER, NAMELY, BOOKS, MANUALS, NEWSLETTERS, PRESS-RELEASES, BOOKLETS, BROCHURES, LEAFLETS AND PAMPHLETS, ALL IN THE FIELDS OF INSURANCE, BANKING AND FINANCIAL SERVICES.
 FIRST USE ; IN COMMERCE .

INT. CL. 35/U.S. CLS. 100, 101 AND 102
 FOR ADVERTISING, PARTICULARLY ADVERTISING FOR BANKING AND FINANCIAL SERVICES; BUSINESS MARKETING SERVICES FOR OTHERS IN THE FIELD OF FINANCE, INSURANCE AND INVESTMENTS.
 FIRST USE ; IN COMMERCE .

INT. CL. 36/U.S. CLS. 100, 101 AND 102
 FOR INSURANCE SERVICES, NAMELY, INSURANCE UNDERWRITING CONSULTATION; FINANCIAL SERVICES, NAMELY, FINANCIAL ASSET MANAGEMENT AND ADMINISTRATION, FINANCIAL ANALYSIS AND PLANNING; FINANCIAL ADVISORY AND CONSULTANCY SERVICES * IN CONNECTION WITH SERVICES OF CREDIT AND FINANCIAL SERVICES INSTITUTIONS, FINANCIAL INVESTMENT ADVISORY SERVICES, FINANCIAL INSOLVENCY CONSULTANCY *; FINANCIAL TRANSACTION SERVICES, NAMELY, FINANCING OF REAL ESTATE AND INFRASTRUCTURE PROJECTS, PROVIDING FINANCING AND LOANS TO CORPORATIONS AND INDUSTRY; TAKEOVER OF INSURANCE AND SECURITIES TRANSACTIONS EMISSION GUARANTEES, NAMELY, GUARANTEE ASSURANCE UNDERWRITING.
 FIRST USE ; IN COMMERCE .

ELEMENTS CORRECTED
 GOODS/SERVICES

4,060,643. REG. 11-22-2011. HACIENDA SAN JOSE DE MIRAVALLE S DE RL DE CV (MEXICO CORPORATION) ALVARO OBREGON 13, COL. CENTRO, SAN MARTIN HIDALGO, JA CP46770, MEXICO., SN 77-939,441. FILED 2-18-2010. PRINCIPAL REGISTER.

FOR [TOY TRAINS AND] PARTS AND ACCESSORIES [THEREFOR] * FOR TOY TRAINS *. FIRST USE 7-5-2011; IN COMMERCE 7-5-2011.

ELEMENTS AMENDED
GOODS/SERVICES

PLATOON

THE MARK CONSISTS OF STANDARD CHARACTERS WITHOUT CLAIM TO ANY PARTICULAR FONT, STYLE, SIZE, OR COLOR.
INT. CL. 33/U.S. CLS. 47 AND 49
FOR TEQUILA.
FIRST USE 1-1-2011; IN COMMERCE 1-1-2011.

ELEMENTS CORRECTED
OWNER NAME
OWNER ADDRESS

4,062,965. REG. 11-29-2011. NZT PRODUCTS, LLC (NEW JERSEY LIMITED LIABILITY COMPANY) 25 ROSE COURT, TOMS RIVER, NJ, 08753, SN 85-299,061. FILED 4-19-2011. PRINCIPAL REGISTER.

NZT PRODUCTS

THE MARK CONSISTS OF STANDARD CHARACTERS WITHOUT CLAIM TO ANY PARTICULAR FONT, STYLE, SIZE, OR COLOR.
NO CLAIM IS MADE TO THE EXCLUSIVE RIGHT TO USE "PRODUCTS", APART FROM THE MARK AS SHOWN.
INT. CL. 28/U.S. CLS. 22, 23, 38 AND 50
FOR [TOY TRAINS AND] PARTS AND ACCESSORIES [THEREFOR] * FOR TOY TRAINS *.
FIRST USE 7-5-2011; IN COMMERCE 7-5-2011.

ELEMENTS AMENDED
GOODS/SERVICES

4,062,967. REG. 11-29-2011. NZT PRODUCTS, LLC (NEW JERSEY LIMITED LIABILITY COMPANY) 25 ROSE COURT, TOMS RIVER, NJ, 08753, SN 85-299,185. FILED 4-19-2011. PRINCIPAL REGISTER.



NZT Products

NO CLAIM IS MADE TO THE EXCLUSIVE RIGHT TO USE "PRODUCTS", APART FROM THE MARK AS SHOWN.
THE MARK CONSISTS OF A GEOMETRIC PATTERN HAVING A DIAMOND SHAPE WITHIN A SQUARE AND THE WORDS "NZT PRODUCTS".
INT. CL. 28/U.S. CLS. 22, 23, 38 AND 50

4,065,154. REG. 12-6-2011. EBM-PAPST MULFINGEN GMBH & CO. KG (FED REP GERMANY CORPORATION) BACHMÜHLE 2, MULFINGEN, FED REP GERMANY, 74673, SN 77-965,121. FILED 3-22-2010. PRINCIPAL REGISTER.



PRIORITY CLAIMED UNDER SEC. 44(D) ON FED REP GERMANY APPLICATION NO. 302009057203, FILED 9-24-2009, REG. NO. 302009057203, DATED 1-21-2010, EXPIRES 9-30-2019.

OWNER OF U.S. REG. NOS. 1,363,205, 3,041,998 AND OTHERS.

NO CLAIM IS MADE TO THE EXCLUSIVE RIGHT TO USE "GREEN TECH", APART FROM THE MARK AS SHOWN.

THE COLOR(S) GREEN, WHITE, BLACK, BLUE AND GREY IS/ARE CLAIMED AS A FEATURE OF THE MARK.

THE MARK CONSISTS OF A GREEN CIRCULAR DEVICE HAVING THE WORDS "GREEN TECH" IN WHITE AND A CHECK MARK IN WHITE, LOCATED ABOVE THE WORDS "BY EBM-PAPST" ON A GREY BACKGROUND, THE TERMS "BY" AND "EBM" IN BLACK AND THE TERM "PAPST" IN BLUE.

INT. CL. 7/U.S. CLS. 13, 19, 21, 23, 31, 34 AND 35

FOR ELECTRIC DRIVE MOTORS, OTHER THAN FOR LAND VEHICLES; ELECTRIC FANS, VENTILATORS AND BLOWERS FOR MOTORS AND ENGINES; ELECTRIC MOTOR-OPERATED PUMPS.

FIRST USE : IN COMMERCE .
INT. CL. 9/U.S. CLS. 21, 23, 26, 36 AND 38

FOR REGULATING APPARATUS AND CONTROL APPARATUS, NAMELY, APPARATUS AND INSTRUMENTS FOR CONVEYING, DISTRIBUTING, TRANSFORMING, STORING OR CONTROLLING ELECTRIC CURRENT; ELECTRONIC COMMUTATION CIRCUITS FOR MOTORS.

FIRST USE : IN COMMERCE .
INT. CL. 11/U.S. CLS. 13, 21, 23, 31 AND 34

FOR HEATING APPARATUS, NAMELY, ELECTRIC HEATING FANS, ELECTRIC SPACE HEATERS, CENTRAL HEATING RADIATORS, ELECTRIC HEATING BLOWERS; AIR COOLING APPARATUS; DRYING APPARATUS FOR USE IN HEATING, VENTILATION SYSTEMS, AIR CONDITIONING SYSTEMS AND REFRIGERATING SYSTEMS; ELECTRIC HOT AIR HAND DRYERS; HAIR DRYERS FOR HOUSEHOLD PURPOSES; INDUSTRIAL DISH DRYING MACHINES; INDUSTRIAL DRYERS FOR HEATING AND DEHUMIDIFYING; CLOTHES DRYING MACHINES; INDUSTRIAL APPARATUS USING AIR FOR DRYING COMPONENTS IN THE ELECTRONICS, SEMICONDUCTOR

TOR, CIRCUIT BOARD, PHARMACEUTICAL, MEDICAL, AND FOOD BEVERAGES INDUSTRIES; VENTILATING APPARATUS, NAMELY, VENTILATING FANS FOR COMMERCIAL AND INDUSTRIAL USE, VENTILATING EXHAUST FANS, HOT AIR BLOWERS, ELECTRIC FANS; AIR CONDITIONING APPARATUS; COOLING UNITS FOR INDUSTRIAL PURPOSES, HEATING UNITS FOR INDUSTRIAL PURPOSES; EXTRACTOR HOODS FOR KITCHEN, VENTILATION HOODS; CHEST FREEZERS, REFRIGERATORS, REFRIGERATING CABINETS, REFRIGERATING DISPLAY CABINETS.

FIRST USE ; IN COMMERCE .

ELEMENTS CORRECTED

FOREIGN APPLICATION NO.

FOREIGN APPLICATION FILING DATE

GOODS/SERVICES

PRIORITY CLAIMED STATEMENT

4,073,466. REG. 12-20-2011. BEACHMINT, INC. (DELAWARE CORPORATION) 101 SOUTH ROSSMORE AVENUE, LOS ANGELES, CA, 90004, SN 85-290,792. FILED 4-8-2011. PRINCIPAL REGISTER.

STYLEMINT

THE MARK CONSISTS OF STANDARD CHARACTERS WITHOUT CLAIM TO ANY PARTICULAR FONT, STYLE, SIZE, OR COLOR.

INT. CL. 35/U.S. CLS. 100, 101 AND 102

FOR RETAIL STORE AND ON-LINE RETAIL STORE SERVICES FEATURING [HAND BAGS,] ACCESSORIES [SHOES, JEWELRY,] AND CLOTHING.

FIRST USE 8-25-2007; IN COMMERCE 8-25-2007.

INT. CL. 41/U.S. CLS. 100, 101 AND 107

FOR PROVIDING ON-LINE ARTICLES AND MAGAZINES IN THE FIELD OF FASHION, FASHION DESIGN, FASHION COLLECTION, AND FASHION TRENDS.

FIRST USE 8-25-2007; IN COMMERCE 8-25-2007.

INT. CL. 42/U.S. CLS. 100 AND 101

FOR PROVIDING A WEB SITE FEATURING INFORMATION IN THE FIELD OF FASHION DESIGN.

FIRST USE 8-25-2007; IN COMMERCE 8-25-2007.

INT. CL. 45/U.S. CLS. 100 AND 101

FOR ONLINE SOCIAL NETWORKING SERVICES PROVIDED THROUGH A FASHION COMMUNITY WEBSITE; PROVIDING A WEB SITE FEATURING INFORMATION IN THE FIELD OF FASHION, FASHION TRENDS AND FASHION CLOTHING COLLECTIONS.

FIRST USE 8-25-2007; IN COMMERCE 8-25-2007.

ELEMENTS AMENDED
GOODS/SERVICES

4,073,480. REG. 12-20-2011. LISTENER DRIVEN RADIO LLC (OHIO LIMITED LIABILITY COMPANY) 26202 DETROIT ROAD, SUITE 300, WESTLAKE, OH, 44145, SN 85-293,143. FILED 4-12-2011. PRINCIPAL REGISTER.

LDR

THE MARK CONSISTS OF STANDARD CHARACTERS WITHOUT CLAIM TO ANY PARTICULAR FONT, STYLE, SIZE, OR COLOR.

INT. CL. 9/U.S. CLS. 21, 23, 26, 36 AND 38

FOR COMPUTER SERVICES FOR USE WITH BROADCAST PROGRAMMING WHICH INCORPORATES AUDIENCE INPUT.

FIRST USE 7-30-2009; IN COMMERCE 7-30-2009.

INT. CL. 38/U.S. CLS. 100, 101 AND 104

FOR SERVICES RELATING TO BROADCAST PROGRAMMING, NAMELY, AUDIO BROADCASTING WHICH INCORPORATES AUDIENCE INPUT.

FIRST USE 7-30-2009; IN COMMERCE 7-30-2009.

ELEMENTS CORRECTED
OWNER ADDRESS

4,073,481. REG. 12-20-2011. LISTENER DRIVEN RADIO LLC (OHIO LIMITED LIABILITY COMPANY) 26202 DETROIT ROAD, SUITE 300, WESTLAKE, OH, 44145, SN 85-293,180. FILED 4-12-2011. PRINCIPAL REGISTER.

LISTENER DRIVEN RADIO

THE MARK CONSISTS OF STANDARD CHARACTERS WITHOUT CLAIM TO ANY PARTICULAR FONT, STYLE, SIZE, OR COLOR.

NO CLAIM IS MADE TO THE EXCLUSIVE RIGHT TO USE "LISTENER" AND "RADIO", APART FROM THE MARK AS SHOWN.

INT. CL. 9/U.S. CLS. 21, 23, 26, 36 AND 38

FOR COMPUTER SERVICES FOR USE WITH BROADCAST PROGRAMMING WHICH INCORPORATES AUDIENCE INPUT.

FIRST USE 7-30-2009; IN COMMERCE 7-30-2009.

INT. CL. 38/U.S. CLS. 100, 101 AND 104

FOR SERVICES RELATING TO BROADCAST PROGRAMMING, NAMELY, AUDIO BROADCASTING WHICH INCORPORATES AUDIENCE INPUT.

FIRST USE 7-30-2009; IN COMMERCE 7-30-2009.

ELEMENTS CORRECTED
OWNER ADDRESS

4,075,735. REG. 12-27-2011. ISH INTERNATIONAL SPORT HOLDING AG (SWITZERLAND SOCIÉTÉ ANONYME) SPORTSTRASSE 49, CH-2540 GRENCHE, SWITZERLAND., SN 79-086,630. FILED 8-24-2010. PRINCIPAL REGISTER.

TEAMMACHINE

THE MARK CONSISTS OF STANDARD CHARACTERS WITHOUT CLAIM TO ANY PARTICULAR FONT, STYLE, SIZE, OR COLOR.

PRIORITY DATE OF 4-30-2010 IS CLAIMED.

OWNER OF INTERNATIONAL REGISTRATION 1049133 DATED 8-24-2010, EXPIRES 8-24-2020.

INT. CL. 12/U.S. CLS. 19, 21, 23, 31, 35 AND 44

FOR BICYCLES; BICYCLE RIMS; HANDLE BARS FOR BICYCLES; PEDALS FOR BICYCLES; BICYCLE HUBS; BICYCLE FRAMES; WHEELS FOR BICYCLES; ALL OF THE FOREGOING EXCLUDING THREE-WHEELED RIDE-ON BICYCLES OR VEHICLES.

FIRST USE ; IN COMMERCE .

ELEMENTS CORRECTED
GOODS/SERVICES

4,077,213. REG. 12-27-2011. LISTENER DRIVEN RADIO LLC (OHIO LIMITED LIABILITY COMPANY) 26202 DETROIT ROAD, SUITE 300, WESTLAKE, OH, 44145, SN 85-340,208. FILED 6-7-2011. PRINCIPAL REGISTER.

TAKEOVER

THE MARK CONSISTS OF STANDARD CHARACTERS WITHOUT CLAIM TO ANY PARTICULAR FONT, STYLE, SIZE, OR COLOR.

INT. CL. 9/U.S. CLS. 21, 23, 26, 36 AND 38

FOR COMPUTER SERVICES FOR USE WITH BROADCAST PROGRAMMING WHICH INCORPORATES AUDIENCE INPUT.

FIRST USE 2-15-2011; IN COMMERCE 2-15-2011.

INT. CL. 38/U.S. CLS. 100, 101 AND 104

FOR SERVICES RELATING TO BROADCAST PROGRAMMING, NAMELY, AUDIO WHICH INCORPORATES AUDIENCE INPUT.

FIRST USE 2-15-2011; IN COMMERCE 2-15-2011.

ELEMENTS CORRECTED
OWNER ADDRESS

4,077,847. REG. 12-27-2011. THE FOREIGN CANDY COMPANY, INC. (IOWA CORPORATION) 1 FOREIGN CANDY DRIVE, HULL, IA, 51239, SN 85-125,632. FILED 9-9-2010. PRINCIPAL REGISTER.

UPNEXT

THE MARK CONSISTS OF STANDARD CHARACTERS WITHOUT CLAIM TO ANY PARTICULAR FONT, STYLE, SIZE, OR COLOR.

INT. CL. 30/U.S. CL. 46

FOR CANDY.
FIRST USE 9-0-2010; IN COMMERCE 6-22-2011.

ELEMENTS AMENDED
MARK

4,084,551. REG. 1-10-2012. INSPIRED GOURMET FOODS INC. (CANADA CORPORATION) 22 ABBOTSFORD ROAD, TORONTO, ONTARIO, CANADA, M2N2P8, SN 85-021,522. FILED 4-23-2010. PRINCIPAL REGISTER.

BUNDLE OF MUNDEL

THE MARK CONSISTS OF STANDARD CHARACTERS WITHOUT CLAIM TO ANY PARTICULAR FONT, STYLE, SIZE, OR COLOR.

NO CLAIM IS MADE TO THE EXCLUSIVE RIGHT TO USE "MUNDEL", APART FROM THE MARK AS SHOWN.

THE ENGLISH TRANSLATION OF "MUNDEL" IN THE MARK IS ALMOND.

INT. CL. 30/U.S. CL. 46

FOR BAKED GOODS, NAMELY, COOKIES.

FIRST USE 7-20-2011; IN COMMERCE 7-20-2011.

ELEMENTS CORRECTED
OWNER NAME

4,089,145. REG. 1-17-2012. CROOKED CREATIVE LLC (NEW YORK LIMITED LIABILITY COMPANY), DBA WING CHUN MASTERS, 343 EAST 84TH STREET, NEW YORK, NY, 10028, SN 85-975,006. FILED 8-12-2010. PRINCIPAL REGISTER.



OWNER OF U.S. REG. NO. 3,858,571.

NO CLAIM IS MADE TO THE EXCLUSIVE RIGHT TO USE "WING CHUN", APART FROM THE MARK AS SHOWN.

THE MARK CONSISTS OF A CHOP WITH STYLIZED "WING CHUN DA SHI" INSCRIBED IN CHINESE.

THE NON-LATIN CHARACTERS IN THE MARK TRANSLITERATE TO "WING CHUN DA SHI" AND THIS MEANS "PRAISING SPRING MASTERS" IN ENGLISH.

INT. CL. 18/U.S. CLS. 1, 2, 3, 22 AND 41

FOR ATHLETIC BAGS; BAGS AND HOLDALLS FOR SPORTS CLOTHING; BAGS FOR SPORTS; CARRY-ALL BAGS; DUFFEL BAGS; GYM BAGS.

FIRST USE 9-21-2011; IN COMMERCE 9-21-2011.

INT. CL. 25/U.S. CLS. 22 AND 39

FOR ATHLETIC APPAREL, NAMELY, SHIRTS, PANTS, JACKETS, FOOTWEAR, HATS AND CAPS, ATHLETIC UNIFORMS; SHIRTS; T-SHIRTS; WEARABLE GARMENTS AND CLOTHING, NAMELY, SHIRTS.

FIRST USE 11-8-2009; IN COMMERCE 11-8-2009.

ELEMENTS CORRECTED
 GOODS/SERVICES
 INTERNATIONAL CLASS(ES)
 DATE OF FIRST USE
 DATE OF FIRST USE IN COMMERCE

4,089,648. REG. 1-24-2012. TRANSOL CORPORATION (PENNSYLVANIA CORPORATION) 604 HEMLOCK ROAD, MORGANTOWN, PA, 19543, SN 85-027,701. FILED 4-30-2010. PRINCIPAL REGISTER.



OWNER OF U.S. REG. NO. 1,336,278.
 THE MARK CONSISTS OF A THREE DIMENSIONAL CONFIGURATION OF THE GOODS, NAMELY A HOIST. THE CONSTRUCTION OF THE HOIST IS CLAIMED, EXACTLY AS SHOWN, INCLUDING: AN ELONGATED POLYGON HAVING A HOOK ELEMENT EXTENDING FROM A TOP END THEREOF AND A EYELET EXTENDING FROM A BOTTOM END THEREOF; A FIRST PAIR OF CONCENTRIC CIRCLES AND A SECOND PAIR OF CONCENTRIC CIRCLES LOCATED WITHIN THE ELONGATED POLYGON AND ARRANGED VERTICALLY SPACED AND HORIZONTALLY OFFSET FROM ONE ANOTHER; A FIRST CLOSED-PERIMETER SHAPE LOCATED WITHIN THE ELONGATED POLYGON ADJACENT THE FIRST PAIR OF CONCENTRIC CIRCLES, THE FIRST CLOSED-PERIMETER SHAPE GENERALLY TAPERING IN WIDTH MOVING UPWARD AND AWAY FROM THE FIRST PAIR OF CONCENTRIC CIRCLES, A SECOND CLOSED-PERIMETER SHAPE LOCATED WITHIN THE ELONGATED POLYGON AND EXTENDING FROM A POSITION ADJACENT THE FIRST PAIR OF CONCENTRIC CIRCLES AND THE SECOND PAIR OF CONCENTRIC CIRCLES, THE SECOND CLOSED-PERIMETER SHAPE GENERALLY TAPERING IN WIDTH MOVING FROM THE FIRST PAIR OF CONCENTRIC CIRCLES TO THE SECOND PAIR OF CONCENTRIC CIRCLES; A GENERALLY RECTANGULAR ARM EXTENDING OBLIQUELY FROM A SIDE OF THE ELONGATED POLYGON; AND AN ARC EXTENDING FROM A LOWER SIDE OF THE GENERALLY RECTANGULAR ARM TO THE SIDE OF THE ELONGATED POLYGON. ANY MATTER SHOWN IN BROKEN OR DOTTED LINES IN NOT PART OF THE MARK AND SERVES ONLY TO SHOW POSITION OR PLACEMENT OF THE MARK.

SEC. 2(F).
 INT. CL. 7/U.S. CLS. 13, 19, 21, 23, 31, 34 AND 35
 FOR WINCH HOISTS.
 FIRST USE 0-0-1974; IN COMMERCE 0-0-1974.

ELEMENTS CORRECTED
 CITIZENSHIP

4,094,112. REG. 1-31-2012. DONALD F. KERR (NEW YORK LIMITED LIABILITY COMPANY), DBA WET-TEK LLC., 183 MAIN STREET, NEW PALTZ, NY, 12561, SN 77-816,426. FILED 8-31-2009. PRINCIPAL REGISTER.

P3 BIOSAND BAG FILTER

THE MARK CONSISTS OF STANDARD CHARACTERS WITHOUT CLAIM TO ANY PARTICULAR FONT, STYLE, SIZE, OR COLOR.

NO CLAIM IS MADE TO THE EXCLUSIVE RIGHT TO USE "BIOSAND BAG FILTER", APART FROM THE MARK AS SHOWN.

INT. CL. 11/U.S. CLS. 13, 21, 23, 31 AND 34

FOR GRAVITY FILTERING UNITS FOR PROVIDING POTABLE DRINKING WATER FOR COMMUNITY USE; GRAVITY FILTERS FOR PROVIDING POTABLE DRINKING WATER FOR COMMUNITY USE; GRAVITY WATER FILTERING UNITS FOR PROVIDING POTABLE DRINKING WATER FOR COMMUNITY USE.

FIRST USE 6-8-2010; IN COMMERCE 6-8-2010.

ELEMENTS AMENDED
 MARK
 DISCLAIMER

4,094,464. REG. 1-31-2012. CORE EDUCATION AND CONSULTING SOLUTIONS, INC. (TENNESSEE CORPORATION) SUITE 1900, ATLANTA, GA, 30346, SN 85-161,263. FILED 10-26-2010. PRINCIPAL REGISTER.

CORE ECS UNIQUE ID

THE MARK CONSISTS OF STANDARD CHARACTERS WITHOUT CLAIM TO ANY PARTICULAR FONT, STYLE, SIZE, OR COLOR.

OWNER OF U.S. REG. NOS. 3,350,913 AND 3,725,967.
 NO CLAIM IS MADE TO THE EXCLUSIVE RIGHT TO USE "UNIQUE ID", APART FROM THE MARK AS SHOWN.
 INT. CL. 42/U.S. CLS. 100 AND 101

FOR COMPUTER SERVICES, NAMELY, PROVIDING ON-LINE NON-DOWNLOADABLE SOFTWARE ON A GLOBAL COMPUTER NETWORK FOR GENERATING UNIQUE STUDENT IDENTIFICATION TO TRACK STUDENT INFORMATION; DATA WAREHOUSING; AND COMPUTER SOFTWARE DEVELOPMENT.

FIRST USE 2-1-2003; IN COMMERCE 2-1-2003.

ELEMENTS CORRECTED
 OWNER NAME
 OWNER ADDRESS

4,094,959. REG. 2-7-2012. THE BOARD OF REGENTS OF THE UNIVERSITY OF TEXAS SYSTEM (TEXAS STATE AGENCY) 201 WEST 7TH STREET, AUSTIN, TX, 78701, SN 77-750,955. FILED 6-3-2009. PRINCIPAL REGISTER.



THE MARK CONSISTS OF A CONFIGURATION OF A THREE DIMENSIONAL BOTTLE IN THE SHAPE OF THE TOWER OF THE MAIN BUILDING ON THE UNIVERSITY OF TEXAS AT AUSTIN CAMPUS, HAVING FOUR STRAIGHT SIDES AND DEPICTING ARCHITECTURAL DETAILING AT THE TOP, NAMELY, A SQUARE BASE WITH A CLOCK FACE IN THE MIDDLE PORTION OF THE BASE AND A SMALLER SQUARE ON TOP OF THE BASE THAT HAS FOUR COLUMNS MAKING UP EACH SIDE OF THE SQUARE ON ALL FOUR SIDES. THE MATTER SHOWN IN THE MARK WITH DOTTED LINES IS NOT A PART OF THE MARK AND SERVES ONLY TO SHOW THE POSITION OR PLACEMENT OF THE MARK.

INT. CL. 32/U.S. CLS. 45, 46 AND 48

FOR NON-ALCOHOLIC BEVERAGES, NAMELY, BOTTLED WATER [AND FLAVORED WATER].

FIRST USE 8-25-2010; IN COMMERCE 8-25-2010.

ELEMENTS CORRECTED
GOODS/SERVICES

4,095,018. REG. 2-7-2012. GEORGIA-PACIFIC CONSUMER PRODUCTS LP (DELAWARE LIMITED PARTNERSHIP) 133 PEACHTREE STREET, N.E., GA030-41N, ATLANTA, GA, 30303, SN 78-726,372. FILED 10-4-2005. PRINCIPAL REGISTER.

BRAWNY INDUSTRIAL

THE MARK CONSISTS OF STANDARD CHARACTERS WITHOUT CLAIM TO ANY PARTICULAR FONT, STYLE, SIZE, OR COLOR.

OWNER OF U.S. REG. NOS. 1,062,207, 3,420,118 AND OTHERS.

NO CLAIM IS MADE TO THE EXCLUSIVE RIGHT TO USE "INDUSTRIAL", APART FROM THE MARK AS SHOWN.

INT. CL. 16/U.S. CLS. 2, 5, 22, 23, 29, 37, 38 AND 50

FOR CELLULOSE WIPERS; DISPOSABLE WIPES NOT IMPREGNATED WITH CHEMICALS OR COMPOUNDS.

FIRST USE 3-0-2005; IN COMMERCE 3-0-2005.

ELEMENTS CORRECTED
OWNER NAME
OWNER ADDRESS
CITIZENSHIP
ENTITY

4,105,882. REG. 2-28-2012. OBSHESTVO S OGRANICHEN-NOY OTVETSTVENNOSTJU "FB MEDIA SOLUTIONS" (RUSSIAN FED. LIMITED LIABILITY COMPANY), DBA OOO "FB MEDIA SOLUTIONS", 12 MEDIKOV, MOSCOW, RUSSIAN FED., 115304, SN 77-616,274. FILED 11-18-2008. PRINCIPAL REGISTER.

FLIPPINGBOOK

THE MARK CONSISTS OF STANDARD CHARACTERS WITHOUT CLAIM TO ANY PARTICULAR FONT, STYLE, SIZE, OR COLOR.

INT. CL. 9/U.S. CLS. 21, 23, 26, 36 AND 38

FOR COMPUTER PROGRAMS FOR DOCUMENT MANAGEMENT; COMPUTER PROGRAMS FOR PRE-RECORDED GAMES; COMPUTER PROGRAMS FOR USING THE INTERNET AND THE WORLD WIDE WEB; COMPUTER PROGRAMS FOR CONVERTING DOCUMENTS CREATED BY ONE COMPUTER PROGRAM TO ANOTHER FORMAT; COMPUTER SOFTWARE TO ENHANCE THE AUDIO-VISUAL CAPABILITIES OF MULTIMEDIA APPLICATIONS, NAMELY, FOR THE INTEGRATION OF TEXT, AUDIO AND GRAPHICS; DOWNLOADABLE COMPUTER PROGRAMS FEATURING POSITIONABLE GAME PIECE FIGURES FOR USE IN THE FIELD OF COMPUTER GAMES; DOWNLOADABLE COMPUTER SOFTWARE FOR ELECTRONIC DESIGN AUTOMATION; DOWNLOADABLE MULTIMEDIA FILE CONTAINING ARTWORK, TEXT, AUDIO, GAMES AND INTERNET WEB LINKS RELATING TO EDUCATIONAL BOOKS AND TRAINING IN FIELDS OF ADVERTISEMENT AND EDUCATION; INTERACTIVE MULTIMEDIA COMPUTER GAME PROGRAMS; INTERACTIVE VIDEO GAMES OF VIRTUAL REALITY COMPRISED OF COMPUTER HARDWARE AND SOFTWARE.

FIRST USE 3-8-2005; IN COMMERCE 3-8-2005.

INT. CL. 35/U.S. CLS. 100, 101 AND 102

FOR ADVERTISING AND COMMERCIAL INFORMATION SERVICES, VIA THE INTERNET; ADVERTISING AND PROMOTION SERVICES AND RELATED CONSULTING; ADVERTISING AND PROMOTIONAL SERVICES; ADVERTISING AND PUBLICITY SERVICES, NAMELY, PROMOTING THE GOODS, SERVICES, BRAND IDENTITY AND COMMERCIAL INFORMATION AND NEWS OF THIRD PARTIES THROUGH PRINT, AUDIO, VIDEO, DIGITAL AND ON-LINE MEDIUM; ADVERTISING PARTICULARLY SERVICES FOR THE PROMOTION OF GOODS; ADVICE AND INFORMATION ABOUT CUSTOMER SERVICES AND PRODUCT MANAGEMENT AND PRICES ON INTERNET SITES IN CONNECTION WITH PURCHASES MADE OVER THE INTERNET; DISSEMINATION OF ADVERTISING FOR OTHERS VIA AN ON-LINE COMMUNICATIONS NETWORK ON THE INTERNET; DISSEMINATION OF ADVERTISING FOR OTHERS VIA THE INTERNET; INTERNET ADVERTISING SERVICES; ON-LINE ADVERTISING AND MARKETING SERVICES.

FIRST USE 3-8-2005; IN COMMERCE 3-8-2005.

INT. CL. 41/U.S. CLS. 100, 101 AND 107

FOR COMPUTER EDUCATION TRAINING; COMPUTER EDUCATION TRAINING SERVICES; CONTINUING EDUCATION SERVICES, NAMELY, PROVIDING LIVE AND ON-LINE CONTINUING PROFESSIONAL EDUCATION SEMINARS IN THE FIELD OF PRIMARY SCHOOL DISCIPLINES; EDUCATION INFORMATION; EDUCATIONAL AND ENTERTAINMENT SERVICES, NAMELY, PROVIDING ON-LINE INTERACTIVE CHILDREN'S STORIES; EDUCATIONAL DEMONSTRATIONS; MULTIMEDIA PUBLISHING OF BOOKS, MAGAZINES, JOURNALS, SOFTWARE, GAMES, MUSIC, AND ELECTRONIC PUBLICATIONS; PROVIDING A WEB SITE FEATURING A SEARCHABLE DATABASE OF INFORMATION RELATED TO RADIO CONTROLLED MODEL VEHICLES; PROVIDING A WEB SITE WHERE USERS CAN POST RATINGS, REVIEWS AND RECOMMENDATIONS ON EVENTS AND ACTIVITIES IN THE FIELD OF ENTERTAINMENT AND EDUCATION; PROVIDING ADVICE AND INFORMATION IN THE FIELD OF EDUCATIONAL AND ENTERTAINMENT ACTIVITIES AND EVENTS FOR CHILDREN.

FIRST USE 3-8-2005; IN COMMERCE 3-8-2005.

ELEMENTS CORRECTED
OWNER ADDRESS
DBA/AKA

4,110,532. REG. 3-13-2012. MADLOVE, INC. (NEW YORK CORPORATION) P.O. BOX 4, NEW YORK, NY, 10021, SN 76-703,872. FILED 7-23-2010. PRINCIPAL REGISTER.

MADLOVE

THE MARK CONSISTS OF STANDARD CHARACTERS WITHOUT CLAIM TO ANY PARTICULAR FONT, STYLE, SIZE, OR COLOR.

INT. CL. 25/U.S. CLS. 22 AND 39

FOR FOOTWEAR AND CLOTHING, NAMELY, HOODED SWEATSHIRTS, SWEATSHIRTS, TEE SHIRTS, SHIRTS, AND PANTS.

FIRST USE 8-31-2010; IN COMMERCE 8-31-2010.

ELEMENTS CORRECTED
OWNER NAME
OWNER ADDRESS
CITIZENSHIP
ENTITY

4,112,998. REG. 3-13-2012. CONTRAIL VINTNERS, LLC (DELAWARE LIMITED LIABILITY COMPANY) 4944 CHINA GARDEN DR, AUSTIN, TX, 78730, SN 85-245,083. FILED 2-17-2011. PRINCIPAL REGISTER.

BOOKMARK

THE MARK CONSISTS OF STANDARD CHARACTERS WITHOUT CLAIM TO ANY PARTICULAR FONT, STYLE, SIZE, OR COLOR.

INT. CL. 33/U.S. CLS. 47 AND 49

FOR [FORTIFIED WINES; FRUIT WINE; GRAPE WINE; PORT WINES; RED WINE; RED WINES; SPARKLING FRUIT WINE; SPARKLING GRAPE WINE; SPARKLING WINES; STILL WINES; SWEET WINES; TABLE WINES; WHITE WINE; WINE;] WINES [; WINES AND FORTIFIED WINES; WINES AND LIQUEURS; WINES AND SPARKLING WINES; WINES DERIVED FROM GRAPES GROWN IN THE UNITED STATES, LABELED AND ADVERTISED IN COMPLIANCE WITH FEDERAL AND STATE LAWS FOR WINE PRODUCTION AND SALES].

FIRST USE 10-1-2008; IN COMMERCE 4-1-2009.
INT. CL. 39/U.S. CLS. 100 AND 105

FOR [WINE CLUB SERVICES FEATURING PERIODIC SHIPMENTS OF WINE TO MEMBERS].

FIRST USE 10-1-2008; IN COMMERCE 4-1-2009.

ELEMENTS AMENDED
GOODS/SERVICES

4,113,283. REG. 3-13-2012. THE VACCINE CENTER, LLC (NEVADA LIMITED LIABILITY COMPANY) 500 EAST WINDMILL LANE, SUITE 115, LAS VEGAS, NV, 89123, SN 85-360,655. FILED P.R. 6-30-2011; AM. S.R. 1-12-2012. SUPPLEMENTAL REGISTER.

THE VACCINE CENTER

THE MARK CONSISTS OF STANDARD CHARACTERS WITHOUT CLAIM TO ANY PARTICULAR FONT, STYLE, SIZE, OR COLOR.

NO CLAIM IS MADE TO THE EXCLUSIVE RIGHT TO USE "CENTER", APART FROM THE MARK AS SHOWN.

INT. CL. 44/U.S. CLS. 100 AND 101

FOR MEDICAL CLINICS .

FIRST USE 11-1-2010; IN COMMERCE 11-1-2010.

ELEMENTS CORRECTED
OWNER NAME
OWNER ADDRESS
CITIZENSHIP
ENTITY

4,115,285. REG. 3-20-2012. BERNSTEIN-REIN ADVERTISING, INC. (MISSOURI CORPORATION) 4600 MADISON, SUITE 1500, KANSAS CITY, MO, 64112, SN 77-703,425. FILED 3-31-2009. PRINCIPAL REGISTER.

INTERACTIVISTS

THE MARK CONSISTS OF STANDARD CHARACTERS WITHOUT CLAIM TO ANY PARTICULAR FONT, STYLE, SIZE, OR COLOR.

INT. CL. 35/U.S. CLS. 100, 101 AND 102

FOR ADVERTISING AND MARKETING SERVICES.

FIRST USE 5-0-2009; IN COMMERCE 7-0-2009.

ELEMENTS CORRECTED
MARK

4,115,351. REG. 3-20-2012. THREE TOWNS CAPITAL LTD. (HONG KONG CORPORATION) WU CHUNG HOUSE, SUITE 3506, 213 QUEEN'S ROAD EAST, WANCHAI, HONG KONG., SN 77-818,128. FILED 9-2-2009. PRINCIPAL REGISTER.

ATLANTIKA

THE MARK CONSISTS OF STANDARD CHARACTERS WITHOUT CLAIM TO ANY PARTICULAR FONT, STYLE, SIZE, OR COLOR.

INT. CL. 29/U.S. CL. 46
FOR FRESH SEAFOOD.
FIRST USE 11-11-2011; IN COMMERCE 11-11-2011.

ELEMENTS CORRECTED
OWNER NAME
OWNER ADDRESS
CITIZENSHIP

4,120,730. REG. 4-3-2012. SNAP CAP MARKERS, LLC (FLORIDA LIMITED LIABILITY COMPANY), DBA SNAP CAP MARKERS, P.O BOX 740375, BOYNTON BEACH, FL, 33474, SN 85-277,749. FILED 3-26-2011. PRINCIPAL REGISTER.



NO CLAIM IS MADE TO THE EXCLUSIVE RIGHT TO USE "MARKERS", APART FROM THE MARK AS SHOWN. THE COLOR(S) BLUE, GREEN, MAGENTA, ORANGE, PINK, PURPLE, WHITE AND YELLOW IS/ARE CLAIMED AS A FEATURE OF THE MARK.

THE MARK CONSISTS OF THE WORDS "SNAP CAP MARKERS" IN MAGENTA AND WHITE WITH BLUE SHADOWING, CENTERED OVER A WAVY LINE IN SEGMENTS OF MAGENTA, YELLOW, GREEN, PURPLE, ORANGE, BLUE AND PINK, FROM LEFT TO RIGHT.

INT. CL. 16/U.S. CLS. 2, 5, 22, 23, 29, 37, 38 AND 50
FOR HIGHLIGHTING PENS; MARKERS; MARKING PENS.

FIRST USE 11-5-2010; IN COMMERCE 11-5-2010.

ELEMENTS CORRECTED
OWNER NAME

4,121,404. REG. 4-3-2012. A2M ENTERTAINMENT, INC. (CALIFORNIA CORPORATION) 1877 PETALUMA DR, CHULA VISTA, CA, 91913, SN 85-392,388. FILED 8-8-2011. PRINCIPAL REGISTER.

XPLODE

THE MARK CONSISTS OF STANDARD CHARACTERS WITHOUT CLAIM TO ANY PARTICULAR FONT, STYLE, SIZE, OR COLOR.

INT. CL. 41/U.S. CLS. 100, 101 AND 107

FOR ENTERTAINMENT IN THE NATURE OF BOXING CONTESTS; ORGANIZING LIVE MIXED MARTIAL ARTS EVENTS AND COMPETITIONS; PRESENTATION OF MIXED MARTIAL ARTS (MMA) EVENTS .

FIRST USE 2-1-2011; IN COMMERCE 2-1-2011.

ELEMENTS CORRECTED
OWNER NAME

4,122,700. REG. 4-3-2012. COHERENT SOUND DESIGN INC. (NEW JERSEY CORPORATION) 56 LAKEWOOD DR, DENVER, NJ, 07834, SN 85-200,196. FILED 12-17-2010. PRINCIPAL REGISTER.

RESONATION

THE MARK CONSISTS OF STANDARD CHARACTERS WITHOUT CLAIM TO ANY PARTICULAR FONT, STYLE, SIZE, OR COLOR.

INT. CL. 15/U.S. CLS. 2, 21 AND 36

FOR CHIN RESTS FOR VIOLINS AND VIOLAS; MUSICAL INSTRUMENT ACCESSORIES, NAMELY, STANDS, CASES, CARRYING BAGS AND STORAGE BAGS; MUSICAL INSTRUMENTS.

FIRST USE 6-0-2011; IN COMMERCE 6-0-2011.

ELEMENTS CORRECTED
OWNER NAME
CITIZENSHIP
ENTITY

4,123,528. REG. 4-10-2012. EMI (IP) LIMITED (UNITED KINGDOM CORPORATION) 27 WRIGHTS LANE, LONDON, UNITED KINGDOM, W8 5SW, SN 79-089,516. FILED 8-10-2010. PRINCIPAL REGISTER.

ANGEL

THE MARK CONSISTS OF STANDARD CHARACTERS WITHOUT CLAIM TO ANY PARTICULAR FONT, STYLE, SIZE, OR COLOR.

PRIORITY DATE OF 7-13-2010 IS CLAIMED.

OWNER OF INTERNATIONAL REGISTRATION 1057035 DATED 8-10-2010, EXPIRES 8-10-2020.

OWNER OF U.S. REG. NOS. 1,193,889, 2,828,844 AND OTHERS.

INT. CL. 9/U.S. CLS. 21, 23, 26, 36 AND 38

FOR APPARATUS AND INSTRUMENTS FOR RECORDING, REPRODUCING AND/OR TRANSMITTING SOUND AND/OR VISUAL INFORMATION OR RECORDINGS; SOUND AND/OR VISUAL RECORDINGS FEATURING MUSIC AND MUSICAL ENTERTAINMENT; ENHANCED SOUND AND/OR VISUAL RECORDINGS FEATURING MUSIC AND MUSICAL ENTERTAINMENT; INTERACTIVE SOUND AND/OR VISUAL RECORDINGS FEATURING MUSIC AND MUSICAL ENTERTAINMENT; SOUND AND/OR VISUAL RECORDING MEDIA, NAMELY, UNRECORDED COMPACT DISCS, TAPES AND CASSETTES; VIDEO GAMES SOFTWARE; COMPUTER SOFTWARE AND HARDWARE FOR MUSIC RECORDING, MIXING, PRODUCING, SAMPLING, MASTERING, ARRANGING AND SEQUENCING; DOWNLOADABLE PUBLICATIONS, NAMELY, MAGAZINES AND NEWSLETTERS IN THE FIELD OF MUSIC AND MUSICAL ENTERTAINMENT PROVIDED ON-LINE FROM DATABASES, FROM THE INTERNET OR FROM ANY OTHER COMMUNICATIONS NETWORK INCLUDING WIRELESS, CABLE OR SATELLITE; COMPACT DISCS FEATURING MUSIC AND MUSICAL ENTERTAINMENT; SUPER AUDIO COMPACT DISCS FEATURING MUSIC AND MUSICAL ENTERTAINMENT; DVDS FEATURING MUSIC AND MUSICAL ENTERTAINMENT; DOWNLOADABLE DIGITAL MUSIC; MP3 PLAYERS; PERSONAL DIGITAL ASSISTANTS AND ELECTRONIC HANDHELD UNITS FOR THE WIRELESS RECEIPT AND/OR TRANSMISSION OF SOUND; DOWNLOADABLE DIGITAL MUSIC FROM THE INTERNET; HAND-HELD ELECTRONIC GAMES ADAPTED FOR USE WITH TELEVISION RECEIVERS ONLY; ELECTRONIC GAME SOFTWARE DESIGNED FOR USE WITH TELEPHONES, CELLULAR TELEPHONES; CD-ROM GAMES IN THE NATURE OF COMPUTER GAME SOFTWARE; DOWNLOADABLE TELEPHONE RING TONES; ALL OF THE FOREGOING NOT RELATING TO SPORTS, SPORTS TEAMS, OR SPORTS ENTERTAINMENT.

FIRST USE ; IN COMMERCE .

INT. CL. 35/U.S. CLS. 100, 101 AND 102

FOR ADVISORY SERVICES FOR BUSINESS MANAGEMENT; BUSINESS MANAGEMENT OF PERFORMING ARTISTS; BUSINESS ADMINISTRATION SERVICES FOR THE PROCESSING OF SALES MADE ON THE INTERNET; NEGOTIATION OF COMMERCIAL TRANSACTIONS FOR PERFORMING ARTISTS; TALENT CASTING SERVICES IN THE NATURE OF AUDITIONING OF PERFORMING ARTISTS; ADVERTISING AND PUBLICITY SERVICES; PROMOTION AND ADVERTISING SERVICES AND CONSULTANCY RELATED THERETO IN THE FIELD OF SOUND AND/OR VISUAL ENTERTAINMENT; RETAIL STORE SERVICES AND ONLINE RETAIL STORE SERVICES RELATING TO APPARATUS AND INSTRUMENTS FOR RECORDING, REPRODUCING AND/OR TRANSMITTING SOUND AND/OR VISUAL INFORMATION OR RECORDINGS, SOUND AND/OR VISUAL RECORDINGS, ENHANCED SOUND AND/OR VISUAL RECORDINGS, INTERACTIVE SOUND AND/OR VISUAL RECORDINGS, SOUND AND/OR VISUAL RECORDING MEDIA, VIDEO GAMES, DOWNLOADABLE PUBLICATIONS, COMPACT DISCS, SUPER AUDIO COMPACT DISCS, DVDS, DOWNLOADABLE DIGITAL MUSIC, MP3 PLAYERS, ELECTRONIC GAMES, CD-ROM GAMES, TELEPHONE RING TONES, PERSONAL DIGITAL ASSISTANTS AND ELECTRONIC HANDHELD UNITS FOR THE WIRELESS RECEIPT AND/OR TRANSMISSION OF SOUND, CABLES, PRINTED MATTER, PRINTED PUBLICATIONS, BOOKS, MAGAZINES, BROCHURES, SHEET MUSIC, PAPER ARTICLES, TICKETS, LABELS, CARDS, GREETING CARDS, PHOTOGRAPHS, POSTERS, STATIONERY, STICKERS, GIFT VOUCHERS, CLOTHING, FOOTWEAR AND HEADGEAR, MUSICAL INSTRUMENTS; TALENT AGENCY SERVICES; INFORMATION AND ADVISORY SERVICES RELATING TO THE AFORESAID SERVICES; INFORMATION AND ADVISORY SERVICES RELATING TO THE AFORESAID SERVICES PROVIDED ON-LINE FROM A COMPUTER DATABASE OR THE INTERNET; INFORMATION AND ADVISORY SERVICES RELATING TO THE AFORESAID SERVICES PROVIDED OVER A TELECOMMUNICATIONS NETWORK; ALL OF THE FOREGOING NOT RELATING TO SPORTS, SPORTS TEAMS, OR SPORTS ENTERTAINMENT.

FIRST USE ; IN COMMERCE .

INT. CL. 41/U.S. CLS. 100, 101 AND 107

FOR MUSIC PUBLISHING SERVICES; RECORDING STUDIO SERVICES; INFORMATION SERVICES RELATING TO MUSIC, ENTERTAINMENT, GAMES AND ENTERTAINMENT-RELATED EVENTS PROVIDED ON-LINE FROM A COMPUTER DATABASE, FROM THE INTERNET OR ANY OTHER COMMUNICATIONS NETWORK INCLUDING WIRELESS, CABLE OR SATELLITE; PROVIDING NON-DOWNLOADABLE PLAYBACK OF MUSIC VIA THE INTERNET; PROVISION OF PLAYBACK OF NON-DOWNLOADABLE DIGITAL MUSIC FROM MP3 WEBSITES; PRODUCTION OF LIVE ENTERTAINMENT FEATURES; ORGANISATION, PRODUCTION AND PRESENTATION OF QUIZ SHOWS, ENTERTAINMENT-RELATED EXHIBITIONS, ENTERTAINMENT-RELATED SHOWS AND ROAD SHOWS, ENTERTAINMENT-RELATED STAGED EVENTS, THEATRICAL PERFORMANCES, CONCERTS, ENTERTAINMENT RELATED LIVE PERFORMANCES AND AUDIENCE PARTICIPATION EVENTS; PROVISION OF ON-LINE NON-DOWNLOADABLE ELECTRONIC PUBLICATIONS, NAMELY, MAGAZINES AND NEWSLETTERS IN THE FIELD OF MUSIC AND MUSICAL ENTERTAINMENT; DIGITAL IMAGING SERVICES; EDITING SERVICES RELATING TO AUDIO AND AUDIO VISUAL RECORDINGS; ELECTRONIC GAME SERVICES, NAMELY, PROVIDING ON-LINE ELECTRONIC GAMES PROVIDED FROM A COMPUTER DATABASE, THE INTERNET OR ANY OTHER COMMUNICATIONS NETWORK INCLUDING WIRELESS, CABLE, SATELLITE; INFORMATION RELATING TO MUSIC AND THE MUSIC INDUSTRY; PROVIDING SUCH ENTERTAINMENT SERVICES OVER A GLOBAL COMPUTER NETWORK; ADVISORY AND CONSULTANCY SERVICES RELATED TO THE AFORESAID SERVICES; ALL OF THE FOREGOING NOT RELATING TO SPORTS, SPORTS TEAMS, OR SPORTS ENTERTAINMENT.

FIRST USE ; IN COMMERCE .

INT. CL. 45/U.S. CLS. 100 AND 101

FOR ADMINISTRATION, EXPLOITATION AND GRANTING OF RIGHTS FOR PRODUCTION OF MUSICAL AND/OR LYRICAL WORKS; ACQUISITION, MANAGEMENT, PROTECTION AND EXPLOITATION OF COPYRIGHTS IN MUSICAL AND/OR LYRICAL WORKS FOR AND ON BEHALF OF AUTHORS, COMPOSERS, OR CONDUCTORS OF SUCH WORKS; LICENSING OF INTELLECTUAL PROPERTY; INFORMATION RELATING TO THE AFORESAID SERVICES PROVIDED ON-LINE FROM A COMPUTER DATABASE, FROM THE INTERNET OR ANY OTHER COMMUNICATIONS NETWORK INCLUDING WIRELESS, CABLE OR SATELLITE; ALL OF THE FOREGOING NOT RELATING TO SPORTS, SPORTS TEAMS, OR SPORTS ENTERTAINMENT.

FIRST USE ; IN COMMERCE .

ELEMENTS CORRECTED
GOODS/SERVICES

4,123,686. REG. 4-10-2012. RUD KETTEN RIEGER & DIETZ GMBH U. CO. KG (FED REP GERMANY A COMPANY ORGANIZED UNDER GERMAN LAW) FRIEDENSINSEL, 73432 AALEN-UNTERKOCHEN, FED REP GERMANY., SN 79-096,889. FILED 1-19-2011. PRINCIPAL REGISTER.

RUDID-Point

THE MARK CONSISTS OF STANDARD CHARACTERS WITHOUT CLAIM TO ANY PARTICULAR FONT, STYLE, SIZE, OR COLOR.

PRIORITY DATE OF 7-28-2010 IS CLAIMED.

OWNER OF INTERNATIONAL REGISTRATION 1075758 DATED 1-19-2011, EXPIRES 1-19-2021.

INT. CL. 6/U.S. CLS. 2, 12, 13, 14, 23, 25 AND 50

FOR CHAINS, CHAIN LINKS, LINK PINS, CHAIN JOINTS, CHAIN SPROCKETS, AND SWIVEL SHACKLE, ALL MADE OF METAL; METAL DEVICES AND COMPONENTS OF METAL FOR THE SECURING, COUPLING, SHORTENING, GUIDING AND TENSIONING OF CHAINS, BELTS AND/OR ROPES; GRABS, HOOKS, EYES, RETAINING LOOPS, EXPANSION BRACES, CLAWS AND SHACKLES, ALL OF METAL, FOR USE IN CONNECTION WITH CHAINS, BELTS AND/OR ROPES; SHAPED METAL PARTS; METAL CHAIN HARNESSSES FOR LIFTING AND SUSPENDING LOADS, COMPRISING METAL CHAIN ASSEMBLIES; ALL THE AFORESAID GOODS IN PARTICULAR WITH INTEGRATED DATA TRANSMISSION AND DATA RECORDING DEVICES, IN PARTICULAR RFID TRANSPONDERS, AND/OR SENSORS, IN PARTICULAR LOAD SENSORS.

FIRST USE ; IN COMMERCE .

INT. CL. 7/U.S. CLS. 13, 19, 21, 23, 31, 34 AND 35
 FOR MECHANICAL APPARATUS FOR LIFTING AND SUSPENDING LOADS WITH THE AID OF CHAINS, STRAPS AND/OR ROPES; CHAIN CONVEYORS, AND COGGED WHEELS, DEFLECTOR WHEELS, CONVEYOR WHEELS, CONVEYOR ROLLERS, TRACK ROLLERS AND CONVEYOR RAILS; MECHANICAL EXPANSION DEVICES FOR CHAIN HARNESSSES, OTHER THAN HAND-OPERATED; MECHANICAL TENSIONING APPARATUS AND SPRING BUFFERS FOR LASHING LOADS, OTHER THAN HAND-OPERATED; ALL THE AFORESAID GOODS IN PARTICULAR WITH INTEGRATED DATA TRANSMISSION AND DATA RECORDING DEVICES, IN PARTICULAR RFID TRANSPONDERS, AND/OR SENSORS, IN PARTICULAR LOAD SENSORS.

FIRST USE ; IN COMMERCE .

INT. CL. 8/U.S. CLS. 23, 28 AND 44
 FOR HAND-OPERATED EXPANSION DEVICES FOR CHAIN HARNESSSES; HAND-OPERATED TENSIONING APPARATUS AND SPRING BUFFERS FOR LASHING LOADS; HAND-OPERATED APPARATUS FOR LIFTING AND SUSPENDING LOADS WITH THE AID OF CHAINS, STRAPS AND/OR ROPES; ALL THE AFORESAID GOODS IN PARTICULAR WITH INTEGRATED DATA TRANSMISSION AND DATA RECORDING DEVICES, IN PARTICULAR RFID TRANSPONDERS, AND/OR SENSORS, IN PARTICULAR LOAD SENSORS.

FIRST USE ; IN COMMERCE .

INT. CL. 9/U.S. CLS. 21, 23, 26, 36 AND 38
 FOR MEASURING, SIGNALING AND TESTING AND REGULATING APPARATUS AND INSTRUMENTS, NAMELY, ELECTRIC SENSORS, LOAD SENSORS, WEAR SENSORS, STRAIN SENSORS, AND STRESS SENSORS, FOR USE IN MEASURING AND INSPECTING THE WEAR, LIFETIME, LOAD, STRAIN AND STRESS OF LIFTING, SUSPENDING AND LASHING MEANS; APPARATUS FOR RECORDING, TRANSMISSION AND REPRODUCTION OF ELECTRIC DATA; BLANK MAGNETIC DATA CARRIERS, DATA PROCESSING EQUIPMENT AND COMPUTERS; COMPUTER PERIPHERAL DEVICES, IN PARTICULAR DOCKING STATIONS; ELECTRIC DISPLAY APPARATUS; COMPUTER PROGRAMS AND COMPUTER SOFTWARE FOR USE IN MAINTENANCE, ANALYSIS, ADMINISTRATION AND DOCUMENTATION OF DATA, REPORTS AND DOCUMENTS, FOR USE IN TEST INSPECTION, FOR USE IN FORMING A CONNECTION TO INFORMATION AND DOCUMENTS AS WELL AS IN ACCESSING A WEB PORTAL; BLANK DATA CARRIERS; MATERIALS TESTING APPARATUS AND MACHINES FOR USE IN THE INSPECTION OF LIFTING, SUSPENDING AND LASHING MEANS; ELECTRICAL SIGNAL TRANSMITTERS AND RECEIVERS; TRANSPONDERS; IN PARTICULAR RADIO-FREQUENCY TRANSPONDERS; WRITING AND READING APPARATUS FOR ELECTRIC DATA; RFID HARDWARE AND ACCESSORIES, NAMELY, RFID-CHIPS, RFID-TAGS, RFID-TRANSPONDERS, RFID-READERS; ELECTRIC IDENTIFICATION SYSTEMS, IN PARTICULAR RFID SYSTEMS, NAMELY, RFID-CHIPS, RFID-TAGS, RFID-TRANSPONDERS, RFID-READERS; ELECTRONIC TESTING SYSTEMS, IN PARTICULAR INSPECTION TESTING SYSTEMS FOR MEASURING AND INSPECTING THE WEAR, LIFETIME, LOAD, STRAIN AND STRESS OF LIFTING, SUSPENDING AND LASHING MEANS; ELECTRONIC INFORMATION DELIVERY SYSTEMS COMPRISING AN ELECTRONIC INTERFACE EQUIPMENT TO INPUT OR OUTPUT OF DATA AND

AT LEAST ONE OF AN IDENTIFICATION TAG AND A SENSOR, IN PARTICULAR A LOAD SENSOR; ELECTRONIC LOAD AND OVERLOAD INDICATOR DEVICES AND ELEMENTS FOR CHAINS, ROPES AND/OR STRAPS, AND LOADING FORKS, IN PARTICULAR WITH INTEGRATED DATA TRANSMISSION AND DATA RECORDING DEVICES AND/OR SENSORS, IN PARTICULAR LOAD SENSORS; ALL THE AFORESAID GOODS IN PARTICULAR FOR THE MONITORING AND/OR TESTING, CONTROLLING AND/OR LOAD MONITORING OF LOAD-SECURING AND LASHING DEVICES .

FIRST USE ; IN COMMERCE .

ELEMENTS CORRECTED
GOODS/SERVICES

4,125,730. REG. 4-10-2012. THORLEY INDUSTRIES LLC (PENNSYLVANIA LIMITED LIABILITY COMPANY), DBA 4MOMS, 40 24TH STREET, 3RD FLOOR, PITTSBURGH, PA, 15222, SN 77-502,209. FILED 6-18-2008. PRINCIPAL REGISTER.

ORIGAMI

THE MARK CONSISTS OF STANDARD CHARACTERS WITHOUT CLAIM TO ANY PARTICULAR FONT, STYLE, SIZE, OR COLOR.

THE FOREIGN WORDING IN THE MARK TRANSLATES INTO ENGLISH AS THE ART OF FOLDING PAPER.

INT. CL. 12/U.S. CLS. 19, 21, 23, 31, 35 AND 44

FOR STROLLERS; STRUCTURAL PARTS AND ACCESSORIES SPECIFICALLY ADAPTED FOR USE ON STROLLERS.

FIRST USE 8-26-2011; IN COMMERCE 8-26-2011.

ELEMENTS CORRECTED
OWNER NAME

4,125,773. REG. 4-10-2012. FILLMORE PEARL HOLDING, LTD (CAYMAN ISLANDS CORPORATION) UGLAND HOUSE, SOUTH CHURCH STREET, GEORGE TOWN, CAYMAN ISLANDS, KY11104, SN 77-595,380. FILED 10-17-2008. PRINCIPAL REGISTER.

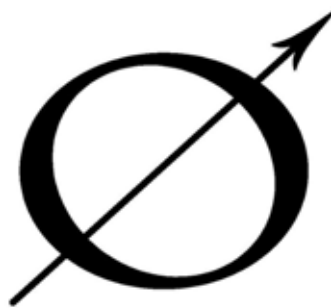

THE MARK CONSISTS OF THE LETTER "O" WITH AN ARROW RUNNING THROUGH THE LETTER "O" POINTING UP AND DIAGONALLY TO THE RIGHT.

INT. CL. 39/U.S. CLS. 100 AND 105

FOR TRAVEL SERVICES, NAMELY, CRUISE SHIP SERVICES, TRAVEL, EXCURSION AND CRUISE ARRANGEMENT, ARRANGING CRUISES AND TOURS, CONDUCTING BOAT CHARTERS.
FIRST USE 12-31-2010; IN COMMERCE 12-31-2010.

ELEMENTS CORRECTED
OWNER NAME

4,126,746. REG. 4-10-2012. JEWISH LEARNING VENTURE (PENNSYLVANIA NON-PROFIT CORPORATION) 7607 OLD YORK ROAD, MELROSE PARK, PA, 19126, SN 85-264,495. FILED 3-11-2011. PRINCIPAL REGISTER.

JEWISH LEARNING VENTURE

THE MARK CONSISTS OF STANDARD CHARACTERS WITHOUT CLAIM TO ANY PARTICULAR FONT, STYLE, SIZE, OR COLOR.

NO CLAIM IS MADE TO THE EXCLUSIVE RIGHT TO USE "JEWISH LEARNING", APART FROM THE MARK AS SHOWN.

INT. CL. 35/U.S. CLS. 100, 101 AND 102

FOR PROMOTING THE INTERESTS OF THE JEWISH COMMUNITY.

FIRST USE 9-21-2011; IN COMMERCE 9-21-2011.

INT. CL. 41/U.S. CLS. 100, 101 AND 107

FOR JEWISH COMMUNITY OUTREACH SERVICES, NAMELY, PROVIDING EDUCATIONAL PROGRAMS IN THE FIELD OF JEWISH COMMUNITY PRACTICES; AND JEWISH RELIGIOUS EDUCATIONAL SERVICES, NAMELY, WORKSHOPS, CONFERENCES, CONSULTATION, COACHING AND MENTORING TO INDIVIDUALS AND INSTITUTIONS.

FIRST USE 9-21-2011; IN COMMERCE 9-21-2011.

ELEMENTS CORRECTED
OWNER NAME

4,128,556. REG. 4-17-2012. REVOLUTIONARY WAR VETERANS ASSOCIATION, INC. (NORTH CAROLINA CORPORATION), AKA RWVA, P.O. BOX 965, MOREHEAD, KY, 40351, SN 85-394,771. FILED 8-10-2011. PRINCIPAL REGISTER.

PROJECT APPLESEED

THE MARK CONSISTS OF STANDARD CHARACTERS WITHOUT CLAIM TO ANY PARTICULAR FONT, STYLE, SIZE, OR COLOR.

NO CLAIM IS MADE TO THE EXCLUSIVE RIGHT TO USE "PROJECT", APART FROM THE MARK AS SHOWN.

INT. CL. 25/U.S. CLS. 22 AND 39

FOR MEN'S, WOMEN'S AND CHILDREN'S CLOTHING AND FOOTWEAR, NAMELY, HATS, BASEBALL CAPS, T-SHIRTS, GOLF SHIRTS, SWEATSHIRTS, ALL USED TO PROMOTE ASSOCIATION SERVICES, NAMELY, PROMOTING THE INTEREST AND OPPORTUNITIES FOR MEN, WOMEN AND CHILDREN IN THE FIELDS OF EARLY AMERICAN HERITAGE AND RIFLE MARKSMANSHIP.

FIRST USE 3-1-2011; IN COMMERCE 3-1-2011.

INT. CL. 28/U.S. CLS. 22, 23, 38 AND 50

FOR RIFLE TARGETS.

FIRST USE 3-1-2006; IN COMMERCE 3-1-2006.
INT. CL. 41/U.S. CLS. 100, 101 AND 107

FOR EDUCATIONAL SERVICES, NAMELY, ARRANGING AND CONDUCTING EDUCATIONAL PROGRAMS FOR EXPOSING PARTICIPANTS TO EARLY AMERICAN HISTORY, AMERICAN HERITAGE AND PROVIDING RIFLE MARKSMANSHIP TRAINING.

FIRST USE 3-1-2006; IN COMMERCE 3-1-2006.

ELEMENTS CORRECTED
CITIZENSHIP

4,129,715. REG. 4-17-2012. KARSTEN MANUFACTURING CORPORATION (ARIZONA CORPORATION) 2201 WEST DESERT COVE, PHOENIX, AZ, 85029, SN 85-263,829. FILED 3-10-2011. PRINCIPAL REGISTER.



THE MARK CONSISTS OF A STYLIZED VERSION OF THE LETTER "G" AND THE NUMERAL "20".

INT. CL. 28/U.S. CLS. 22, 23, 38 AND 50

FOR GOLF BAGS; GOLF CLUBS; HEAD COVERS FOR GOLF CLUBS.

FIRST USE 2-8-2012; IN COMMERCE 2-8-2012.

ELEMENTS CORRECTED
DATE OF FIRST USE
DATE OF FIRST USE IN COMMERCE

4,130,084. REG. 4-24-2012. INTERNATIONAL ROAD DYNAMICS, INC. (CANADA CORPORATION) 702 43RD STREET EAST, SASKATOON, SASKATCHEWAN, CANADA, S7K 3T9, SN 76-695,451. FILED 1-26-2009. PRINCIPAL REGISTER.

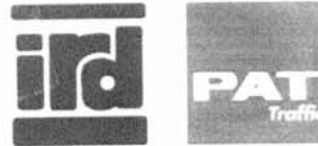

PRIORITY CLAIMED UNDER SEC. 44(D) ON CANADA APPLICATION NO. 1405576, FILED 7-28-2008, REG. NO. TMA797733, DATED 5-17-2011, EXPIRES 5-17-2026.

NO CLAIM IS MADE TO THE EXCLUSIVE RIGHT TO USE "TRAFFIC", APART FROM THE MARK AS SHOWN.

THE MARK CONSISTS OF A STYLIZED VERSION OF THE LETTERS "IRD", WITH A HORIZONTAL LINE ABOVE AND BENEATH THE LETTERS; AND A STYLIZED VERSION OF THE WORDS "PAT" AND "TRAFFIC" WITH THE WORD "PAT" IN ALL CAPS, POSITIONED ABOVE THE WORD "TRAFFIC". THE WORD "TRAFFIC" IS IN INITIAL CAPS AND POSITIONED SLIGHTLY TO THE LEFT BENEATH THE WORD "PAT", BOTH WORDS CENTERED HORIZONTALLY ON A SOLID SQUARE.

INT. CL. 9/U.S. CLS. 21, 23, 26, 36 AND 38

FOR TRUCK AND OTHER VEHICLE TRAFFIC MONITORING SYSTEMS, NAMELY, ENGINEERING PRODUCTS, NAMELY, TRAFFIC COUNTERS, COMBINED TRAFFIC COUNTERS, CLASSIFIERS; HIGH SPEED WEIGH-IN-MOTION SYSTEMS, NAMELY, WEIGH PADS, LEVELING GRIDS AND PADS, AND AN INTEGRATED COMPUTER THEREFOR; CIRCUIT BOARDS, ACCIDENT RECONSTRUCTION UNITS, MANUAL TRAFFIC COUNTERS; AUTOMATIC VEHICLE IDENTIFICATION HARDWARE AND SOFTWARE SYSTEMS, NAMELY, VEHICLE TYPE AND OWNERSHIP CLASSIFIERS, PARKING LOT MONITORS USED AS VEHICLE MONITORING CONTROLLERS; TOLL PLAZA AND TOLL ROAD DATA COLLECTION HARDWARE AND SOFTWARE SYSTEMS, NAMELY, TOTAL VOLUME COUNTERS, INTERVAL COUNTERS AND VEHICLE SPEED AND VEHICLE TYPE CLASSIFIERS, VEHICLE MONITORING CONTROLLER, NAMELY, PARKING LOT MONITORS; HIGH SPEED WEIGH-IN-MOTION SCALES, LOW SPEED WEIGH-IN-MOTION SCALES, ROAD SURFACE ANALYSERS, PORTABLE WHEEL LOAD SCALES, ON-VEHICLE WEIGHING SYSTEMS, NAMELY, COMPUTER HARDWARE AND SOFTWARE, DISPLAY INDICATORS, ON-BOARD COMPUTERS, AND STATIC SCALES, HIGHWAY SCALES AND WEIGH-IN-MOTION SCALES FOR THE WEIGHING OF HIGHWAY VEHICLES, ACOUSTIC SENSORS AND MICROPROCESSOR EMBEDDED SMART CARDS WHICH WILL BE USED BY FEDERAL, PROVINCIAL, LOCAL, AND PRIVATE ROADWAY AUTHORITIES TO COUNT AND CLASSIFY MOTOR VEHICLES; AXLE SENSORS FOR WEIGHING SCALES; TRAFFIC COUNTERS; AXLE SENSORS FOR WEIGHING SCALES; APPARATUS FOR AUTOMATED WEIGHING AND ACCESS CONTROL OF VEHICLES WITH RECORDAL OF DATA, NAMELY, A WEIGH IN MOTION OR STATIC SCALE AND TRANSPONDER; TRAFFIC MONITORING STATION TO BE USED ON ROADS; TRAFFIC CONTROL SYSTEMS, NAMELY, ILLUMINATED SIGNS, NAMELY, PORTABLE AND CHANGEABLE MESSAGE SIGNS TO BE USED ON ROADS; ROAD TRAFFIC MONITORING STATIONS, NAMELY, PORTABLE TRAILER AND MESSAGE DISPLAY SIGN; TRAFFIC DETECTION SENSOR TO MEASURE AND MONITOR CURRENT CONDITIONS; COMPUTER PROCESSOR TO GATHER DATA, CONTROL COMMUNICATIONS AND CONTROL SYSTEM OPERATION, COMPUTER COMMUNICATION SYSTEM, NAMELY, HARDWARE AND SOFTWARE TO COMMUNICATE MESSAGES AND INFORMATION TO ROAD MONITORING STATIONS; AND POWER SUPPLY, NAMELY, SOLAR PANELS AND BATTERIES; VARIABLE SPEED LIMIT SYSTEM COMPRISED OF ELECTRONIC TRAFFIC SENSORS AND DISPLAYS FOR PROVIDING VARIABLE SPEED LIMIT INFORMATION BASED UPON TRAFFIC FLOW, CONSTRUCTION PROBLEMS AND WEATHER CONDITIONS FOR USE IN THE FIELD OF HIGHWAY SAFETY AND TRAFFIC CONTROL; DOWNLOADABLE REPORTS WHICH PROVIDE DATA ABOUT THE LOCATION AND MOVEMENT OF TRUCKS, TRUCK TRACTORS AND TRUCK TRAILERS AND THEIR CARGO; APPARATUS FOR AUTOMATED WEIGHING AND ACCESS CONTROL OF VEHICLES WITH RECORDAL OF DATA, NAMELY, A

WEIGH IN MOTION OR STATIC SCALE AND TRANSPONDER; ROAD TRAFFIC MONITORING STATIONS, NAMELY, PORTABLE TRAILER AND MESSAGE DISPLAY SIGN; TRAFFIC DETECTION SENSOR TO MEASURE AND MONITOR CURRENT CONDITIONS; COMPUTER PROCESSOR TO GATHER DATA, CONTROL COMMUNICATIONS AND CONTROL SYSTEM OPERATION, COMPUTER ICOMMUNICATION SYSTEM, NAMELY, HARDWARE AND SOFTWARE TO COMMUNICATE MESSAGES AND INFORMATION TO ROAD MONITORING STATIONS; AND POWER SUPPLY, NAMELY, SOLAR PANELS AND BATTERIES.

FIRST USE ; IN COMMERCE .
INT. CL. 42/U.S. CLS. 100 AND 101

FOR TRAFFIC MONITORING SERVICES; TRUCK TRAFFIC MONITORING AND INFORMATION SERVICES; CONSULTING SERVICES, NAMELY, ASSISTING OTHERS IN IMPLEMENTING INTELLIGENT VEHICLE MANAGEMENT SYSTEMS; APPLICATION SERVICE PROVIDER, NAMELY, PROVIDING ACCESS TO SOFTWARE WHICH PROVIDES PRINT OR WORLDWIDE WEB AND INTERNET VIEWABLE AND DOWNLOADABLE DATA GIVING INFORMATION AS TO THE MOVEMENT OF THE TRUCKS, TRUCK TRACTORS AND TRUCK TRAILERS AND THEIR CARGO.

FIRST USE ; IN COMMERCE .

ELEMENTS CORRECTED
GOODS/SERVICES

4,130,169. REG. 4-24-2012. WOODSTREAM CORPORATION (PENNSYLVANIA CORPORATION) 69 NORTH LOCUST STREET, LITITZ, PA, 17543, SN 78-884,643. FILED 5-16-2006. PRINCIPAL REGISTER.

MOSQUITO MORGUE

THE MARK CONSISTS OF STANDARD CHARACTERS WITHOUT CLAIM TO ANY PARTICULAR FONT, STYLE, SIZE, OR COLOR.

PRIORITY CLAIMED UNDER SEC. 44(D) ON CANADA APPLICATION NO. 1,299,625, FILED 4-28-2006, REG. NO. 750365, DATED 10-15-2009, EXPIRES 10-15-2024.

NO CLAIM IS MADE TO THE EXCLUSIVE RIGHT TO USE "MOSQUITO", APART FROM THE MARK AS SHOWN. INT. CL. 21/U.S. CLS. 2, 13, 23, 29, 30, 33, 40 AND 50

FOR INSECT TRAPS; PARTS AND FITTINGS FOR INSECT TRAPS IN THE NATURE OF INFLATABLE BALLOONS AND GAS VALVES FOR CONTAINING AND DISPERSING INSECT ATTRACTANT SPRAYS AND GASES, AND OTHER INSECT CHEMICAL ATTRACTANTS.

FIRST USE ; IN COMMERCE .

ELEMENTS CORRECTED
OWNER NAME
OWNER ADDRESS

* * * * *

TRADEMARK REGISTRATIONS—NEW CERTIFICATES

New Certificates issued under section 7(d) of the Trademark Act of 1946 for the unexpired term of the original registrations.

1,542,526. INFLUENCE. INT. CL. 16. CHAMPION INTERNATIONAL CORPORATION, STAMFORD, CT. REG. 6-6-1989. NEW CERT. SEC. 7(D) TO REGISTRANT.

CERT. SEC. 7(D) TO REGISTRANT.

2,038,575. ULTRA PINK. INT. CL. 25. ULTRAPINK, INC., NEW YORK, NY. REG. 2-18-1997. NEW CERT. SEC. 7(D) TO REGISTRANT.

2,698,738. TRILOGY. INT. CL. 16. INTERNATIONAL PAPER COMPANY, PURCHASE, NY. REG. 3-18-2003. NEW CERT. SEC. 7(D) TO REGISTRANT.

2,477,965. LIVE LARGE. INT. CL. 42. WHATAPARTNERSHIP, L.P., WILMINGTON, DE. REG. 8-14-2001. NEW

3,275,410. NBETDZ AND DESIGN. INT. CLS. 21, 24 AND 25. NINGBO ETDZ IMPORT & EXPORT CORP., CHINA. REG. 8-7-2007. NEW CERT. SEC. 7(D) TO REGISTRANT.

* * * * *

This page is intentionally blank

INDEX OF REGISTRANTS

JUNE 26, 2012

(Registered; Renewed; Canceled; Amended, Corrected, etc.; New Certificates; 12c Publications.)

The designation "U.S. Cl." appearing in this section refers to the U.S. class in effect prior to Sep. 1, 1973 rather than the international class which applies to applications filed on or after that date. For adoption of international classification see notice in the OFFICIAL GAZETTE of Jun. 26, 1973 (911 O.G. TM 210).

"BELMAG" JOINT-STOCK COMPANY, RUSSIAN FED.:
4,162,905, PUB. 4-10-2012. INT. CL. 12.

"CARLSBERG SRBIJA" D.O.O., 21413 CELAREVO, SERBIA:
4,162,815, PUB. 4-10-2012. INT. CL. 32.

"LLER" NAHRUNGSMITTEL GMBH, A-6820 FRASTANZ, AUSTRIA:
3,005,268, CANC. INT. CL. 29.

"21" CLUB SELECTED ITEMS, LTD., NEW YORK, NY:
810,949, CANC. U.S. CL. 17.

ÅLÖ AB, UMEÅ, SWEDEN:
3,092,233, CANC. INT. CL. 12.
3,141,144, CANC. INT. CL. 12.

A BETTER YOU, LLC, CHATTANOOGA, TN:
4,164,981, INT. CL. 3.

A F.I.T. LLC, NEWBERG, OR:
4,165,883, INT. CL. 41.

A. HANHART GMBH & CO. KG, FED REP GERMANY:
4,162,805, PUB. 4-10-2012. INT. CL. 14.

A.O. SMITH-INLAND, INC., LITTLE ROCK, AR:
781,979, CANC. U.S. CL. 21.

A.P. GREEN INDUSTRIES, INC., PITTSBURGH, PA, A.P.
GREEN FIRE BRICK COMPANY, MEXICO, MO:
561,015, REN. 5-24-12. U.S. CL. 12 (INT. CL. 19).

A&D TRADING, INC., FAYETTEVILLE, AR:
4,165,409, INT. CL. 29.

A&E TELEVISION NETWORKS, LLC, NEW YORK, NY:
4,165,506, MULTIPLE CLASS, INT. CLS. 9 AND 41.
4,165,905, MULTIPLE CLASS, INT. CLS. 9 AND 41.

A&L O.C. INNOVATIONS, INC., FOOTHILL RANCH, CA, DBA COOL CAPP:
2,620,520, REN. 5-21-12. INT. CL. 30.

AAF-MCQUAY INC., LOUISVILLE, KY:
4,165,395, INT. CL. 9.

AARON NACE, CHICAGO, IL:
4,164,291, PUB. 4-10-2012. INT. CL. 41.

AASTRA TECHNOLOGIES LIMITED, CONCORD, ONTARIO, CANADA:
2,497,547, CANC. INT. CL. 9.

ABB TURBO SYSTEMS LTD., 5400 BADEN, SWITZERLAND:
2,580,693, REN. 5-19-12. INT. CL. 7.

ABBAY PARK, L.L.C., FARMINGTON HILLS, MI:
4,164,520, PUB. 4-10-2012. INT. CL. 43.

ABBOTT LABORATORIES, NORTH CHICAGO, IL:
855,437, CANC. U.S. CL. 18.

ABBOTT LABORATORIES, ABBOTT PARK, IL:
1,225,706, REN. 5-23-12. INT. CL. 5.

ABERCROMBIE & FITCH TRADING CO., NEW ALBANY, OH:
4,165,858, INT. CL. 35.

ABG FINANCIAL SERVICES, INC., ATLANTA, GA:
2,608,912, REN. 5-18-12. INT. CL. 36.

ABIDE FAMILY BLESSINGS, LLC, ELLICOTT CITY, MD:
4,165,261, INT. CL. 28.

ABITEC CORPORATION, COLUMBUS, OH:
4,164,004, PUB. 4-10-2012. INT. CL. 1.
4,164,005, PUB. 4-10-2012. INT. CL. 1.
4,164,006, PUB. 4-10-2012. INT. CL. 1.
4,164,007, PUB. 4-10-2012. INT. CL. 1.
4,164,008, PUB. 4-10-2012. INT. CL. 1.

ABSORBEST AB, SWEDEN:
4,162,865, PUB. 4-10-2012. MULTIPLE CLASS, INT. CLS.
5, 10 AND 16.

ABU AB, SVANGSTA, SWEDEN:
4,164,664, PUB. 4-10-2012. INT. CL. 28.
4,164,665, PUB. 4-10-2012. INT. CL. 28.

AB7 INDUSTRIES, FRANCE:
4,163,006, PUB. 4-10-2012. MULTIPLE CLASS, INT. CLS.
5, 10 AND 24.

ACABIZ S.R.L., I-20122 MILANO, ITALY:
4,162,870, PUB. 4-10-2012. MULTIPLE CLASS, INT. CLS.
35 AND 42.

ACARDO TECHNOLOGIES AG, FED REP GERMANY:
4,163,026, PUB. 4-10-2012. MULTIPLE CLASS, INT. CLS.
9, 36, 38 AND 42.

ACCREDITED HOME CAPITAL, INC., SAN DIEGO, CA:
2,305,245, CANC. INT. CL. 36.

ACCURIST WATCHES LIMITED, UNITED KINGDOM:
4,163,037, PUB. 4-10-2012. INT. CL. 14.

ACCUWEATHER, INC., STATE COLLEGE, PA:
4,162,759, PUB. 4-10-2012. INT. CL. 42.

ACE COMB COMPANY, INC., KEARNY, NJ:
503,065, CANC. U.S. CL. 40.

ACERBIS ITALIA SPA, ALBINO-BERGAMO, ITALY:
4,163,418, PUB. 4-10-2012. MULTIPLE CLASS, INT. CLS.
9, 11, 12, 18 AND 25.

ACHIEVE3000, INC., LAKEWOOD, NJ:
4,163,640, PUB. 4-10-2012. INT. CL. 41.

ACI INTERNATIONAL, LOS ANGELES, CA:
4,165,819, INT. CL. 25.

ACI WORLDWIDE CORP., ELKHORN, NE:
4,165,123, MULTIPLE CLASS, INT. CLS. 42 AND 45.

ACQUISITION MEDIA, LLC, SCOTTSDALE,, AZ:
4,163,759, PUB. 4-10-2012. INT. CL. 41.

ACTELIS NETWORKS INC., FREMONT, CA:
2,499,062, CANC. INT. CL. 9.

ACTIENT PHARMACEUTICALS LLC, DEERFIELD, IL:
4,165,007, MULTIPLE CLASS, INT. CLS. 35 AND 42.

ACTIFIO, INC., WALTHAM, MA:
4,165,467, INT. CL. 9.

ACTION AMERICA, INC., WILMINGTON, DE:
4,165,838, MULTIPLE CLASS, INT. CLS. 25 AND 35.

ACTION TARGET INC., PROVO, UT:
2,676,806, REN. 5-21-12. INT. CL. 13.

ACUMED LLC, HILLSBORO, OR:
4,165,020, INT. CL. 10.

ADAMS, MICHAEL C, LOS ALAMITOS, CA:
4,165,640, INT. CL. 43.

ADDITION TECHNOLOGY, INC., DES PLAINES, IL, ADDITION TECHNOLOGY, INC., DES PLAINES, IL:
2,572,088, REN. 5-21-12. INT. CL. 10.

ADECCO SA, CHÈSEREX, 1275, SWITZERLAND:
4,163,537, PUB. 4-10-2012. MULTIPLE CLASS, INT. CLS.
35, 41 AND 42.

ADELPHI UNIVERSITY, GARDEN CITY, NY:
4,164,257, PUB. 4-10-2012. INT. CL. 41.
4,164,263, PUB. 4-10-2012. INT. CL. 41.
4,164,265, PUB. 4-10-2012. INT. CL. 41.

ADESA, INC., CARMEL, IN:
4,163,724, PUB. 4-10-2012. INT. CL. 9.

ADEY HOLDINGS (2008) LIMITED, UNITED KINGDOM:
4,162,806, PUB. 4-10-2012. MULTIPLE CLASS, INT. CLS.
9, 11 AND 35.

- ADM21 CO., LTD., GYEONGGI-DO, REPUBLIC OF KOREA:
4,165,953, INT. CL. 12.
4,165,954, INT. CL. 12.
- ADP DEALER SERVICES, INC., HOFFMAN ESTATES, IL:
4,164,272, PUB. 4-10-2012. INT. CL. 42.
- ADVA AG OPTICAL NETWORKING, MEININGEN, FED
REP GERMANY:
4,163,128, PUB. 2-28-2012. INT. CL. 9.
- ADVANCE MAGAZINE PUBLISHERS INC., NEW YORK,
NY:
2,499,116, CANC. INT. CL. 16.
4,163,432, PUB. 4-10-2012. INT. CL. 9.
4,165,294, INT. CL. 9.
- ADVANCED FRESH CONCEPTS FRANCHISE CORPORA-
TION, RANCHO DOMINGUEZ, CA:
4,163,336, PUB. 4-10-2012. INT. CL. 30.
- ADVANCED NUTRACEUTICAL ENGINEERS & MARKET-
ERS, BOYNTON BEACH, FL:
4,165,748, INT. CL. 5.
- ADVANCED SLEEP PRODUCTS, CARSON, CA:
1,273,534, CANC. INT. CL. 20.
- ADVENA ARTEMIS LLC, HOUSTON, TX:
4,165,879, INT. CL. 35.
- AE TENT, LLC, MIAMI, FL:
4,165,650, INT. CL. 22.
- AEP NETWORKS, INC., SOMERSET, NJ:
4,163,462, PUB. 4-10-2012. INT. CL. 9.
4,163,463, PUB. 4-10-2012. INT. CL. 9.
- AERO DESIGN AND MANUFACTURING COMPANY, INC.,
DULUTH, MN:
2,581,314, REN. 5-18-12. INT. CL. 35.
- AERO PNEUDRAULICS, INC., TORRANCE, CA:
4,165,615, MULTIPLE CLASS, INT. CLS. 6, 35 AND 37.
- AEROFFICIENT, LLC, WINNETKA, IL:
4,165,034, MULTIPLE CLASS, INT. CLS. 12 AND 36.
- AEROLUNG CORP, WESLEY CHAPEL, FL:
4,164,258, PUB. 4-10-2012. INT. CL. 10.
- AETREX WORLDWIDE, INC., TEANECK, NJ:
4,164,775, PUB. 4-10-2012. INT. CL. 25.
- AFB PRODUCTIONS, INC, WEST ORANGE, NJ:
4,165,951, INT. CL. 38.
- AFFILIATED RESOURCES, INC., PORTLAND, OR:
2,571,935, REN. 5-22-12. INT. CL. 19.
2,571,936, REN. 5-22-12. INT. CL. 19.
- AFFINION PUBLISHING, LLC, LAS VEGAS, NV:
4,165,059, MULTIPLE CLASS, INT. CLS. 36, 38, 42 AND
45.
4,165,658, INT. CL. 36.
- AFFINITY HEALTH SYSTEM, MENASHA, WI:
4,165,619, MULTIPLE CLASS, INT. CLS. 16 AND 41.
- AFP ADVANCED FOOD PRODUCTS LLC, NEW HOL-
LAND, PA:
2,597,476, REN. 5-23-12. INT. CL. 29.
- AG-CHEM EQUIPMENT CO., INC., MINNEAPOLIS, MN:
1,295,995, CANC. INT. CL. 12.
- AGATHA DIFFUSION, 75006 PARIS, FRANCE:
1,686,293, REN. 5-19-12. INT. CL. 14.
- AGIE CHARMILLES MANAGEMENT SA, CH-1242 SA-
TIGNY, SWITZERLAND:
2,497,852, CANC. INT. CL. 7.
- AGILENT TECHNOLOGIES, INC., SANTA CLARA, CA:
4,163,278, PUB. 4-10-2012. INT. CL. 9.
4,165,533, INT. CL. 9.
- AGIO SIGARENFABRIEKEN N.V., NETHERLANDS:
2,998,364, COR. INT. CL. 34.
- AGRAPLUS, INC., EAGLE, ID:
4,165,539, INT. CL. 31.
- AGREEANCE LLC, ARLINGTON, VA:
4,164,220, PUB. 4-10-2012. INT. CL. 35.
- AGRICULTURAL MEDIA SUMMIT, LLC, CHESTERFIELD,
MO:
4,163,114, PUB. 4-10-2012. INT. CL. 41.
- AGROEXPORTADORA DEL NOROESTE, S.A. DE C.V.,
NAVOLATO, SINALOA, MEXICO:
2,587,524, REN. 5-24-12. INT. CL. 31.
- AGRU/AMERICA, INC., GEORGETOWN, SC, A/A MANU-
FACTURING INC., MEDFORD, MA:
1,739,043, REN. 5-18-12. INT. CL. 17.
1,746,410, REN. 5-18-12. INT. CL. 17.
1,746,411, REN. 5-18-12. INT. CL. 17.
- AGS LABS, INC., DALLAS, TX:
4,164,984, INT. CL. 21.
- AIA CALIFORNIA COUNCIL, SACRAMENTO, CA:
2,498,320, CANC. INT. CL. 16.
- AICHI TIRE INDUSTRY COMPANY, LIMITED, SHOWA-
KU, NAGOYA, JAPAN:
1,205,358, REN. 5-19-12. INT. CL. 12.
- AIM INTERNATIONAL, INC., NAMP, ID, AKA THE AIM
COMPANIES:
1,706,191, REN. 5-21-12. INT. CL. 5.
- AIR SYSTEM COMPONENTS, INC., RICHARDSON, TX:
4,164,974, INT. CL. 11.
- AIRBRUSH ACTION, INC., ALLENWOOD, NJ:
4,166,066, INT. CL. 41.
- AIRFLOW SYSTEMS, INC., DALLAS, TX:
1,688,935, REN. 5-24-12. INT. CL. 11.
- AIRPAX ELECTRONICS INCORPORATED, CAMBRIDGE,
MD:
859,678, CANC. U.S. CL. 26.
- AJKA CRYSTAL, LLC, CARLSBAD, CA:
4,163,112, PUB. 4-10-2012. INT. CL. 21.
- AJMANI, S. SINGH, MURRYSVILLE, PA:
2,570,157, REN. 5-21-12. INT. CL. 42.
- AJMANI, SUHENDRA SINGH, MURRYSVILLE, PA:
2,602,850, REN. 5-21-12. INT. CL. 42.
- AKCINE BENDROVE "KLAIPEDOS PIENAS", LITHUANIA:
4,162,990, PUB. 4-10-2012. INT. CL. 30.
4,162,991, PUB. 4-10-2012. INT. CL. 30.
- AKIYO HENNA INC., ASTORIA, NY:
4,164,519, PUB. 4-10-2012. INT. CL. 44.
- AKOTT EVOLUTION INC, MORRISTOWN, NJ:
4,163,822, PUB. 4-10-2012. INT. CL. 1.
4,163,823, PUB. 4-10-2012. INT. CL. 1.
4,163,824, PUB. 4-10-2012. INT. CL. 1.
4,163,842, PUB. 4-10-2012. INT. CL. 1.
- AKZO NOBEL COATINGS INTERNATIONAL B.V., ARN-
HEM, NETHERLANDS, POLYMER CORPORATION,
THE, READING, PA:
729,354, REN. 5-18-12. U.S. CL. 16 (INT. CL. 2).
- AKZO NOBEL COATINGS INTERNATIONAL B.V., 6824 BM
ARNHEM, NETHERLANDS:
2,554,825, REN. 5-18-12. INT. CL. 16.
- AL MATERIEL A/S, LEMVIG, DENMARK:
4,162,836, PUB. 4-10-2012. INT. CL. 7.
- AL NYMAN & SON, INC., MIAMI, FL:
861,696, CANC. U.S. CL. 37.
862,705, CANC. U.S. CL. 26.
- ALABAMA SPACE SCIENCE EXHIBIT COMMISSION,
HUNTSVILLE, AL:
1,698,138, REN. 5-18-12. INT. CL. 41.
- ALAMO CEMENT COMPANY, SAN ANTONIO, TX:
2,597,670, REN. 5-24-12. INT. CL. 19.
2,600,785, REN. 5-24-12. INT. CL. 19.
2,600,786, REN. 5-21-12. INT. CL. 19.
2,620,638, REN. 5-24-12. INT. CL. 19.
- ALAMO RESTAURANTS, INC., SAN ANTONIO, TX:
2,577,817, REN. 5-18-12. INT. CL. 42.
- ALBANY STEEL AND BRASS CORP., CHICAGO, IL:
1,707,768, REN. 5-21-12. INT. CL. 6.
- ALBER, WILLIAM F., SAN FRANCISCO, CA:
4,165,775, MULTIPLE CLASS, INT. CLS. 37 AND 39.
- ALBERTO-CULVER COMPANY, MELROSE PARK, IL:
864,068, CANC. U.S. CL. 51.
- ALBERTO-CULVER INTERNATIONAL, INC., MELROSE
PARK, IL:
856,707, CANC. U.S. CL. 51.
860,288, CANC. MULTIPLE CLASS, U.S. CLS. 51 AND 52.
- ALBIN, CRAIG, HAMPTON, NJ:
2,497,757, CANC. MULTIPLE CLASS, INT. CLS. 9 AND
41.
- ALCOA INC., PITTSBURGH, PA:
4,163,497, PUB. 4-10-2012. INT. CL. 42.

ALCOHOL COUNTERMEASURE SYSTEMS (INTERNATIONAL) INC., TORONTO, ONTARIO, CANADA:
4,162,786, PUB. 12-7-2010. INT. CL. 10.

ALCORE, INC., EDGEWOOD, MD:
4,165,156, INT. CL. 12.

ALDEN MEDICAL LLC, WEST SPRINGFIELD, MA:
4,165,894, INT. CL. 3.

ALDER OPTOMECHANICAL CORP., TAOYUAN COUNTY, TAIWAN:
4,163,281, PUB. 4-10-2012. INT. CL. 11.

ALDI INC., BATAVIA, IL:
2,580,104, REN. 5-21-12. INT. CL. 29.

ALERE WELLOGIC, LLC, WALTHAM, MA:
2,514,055, REN. 5-19-12. INT. CL. 9.

ALEXANDER KLEE, SWITZERLAND:
4,162,947, PUB. 4-10-2012. MULTIPLE CLASS, INT. CLS. 2, 3, 9, 14, 16, 18, 21, 24, 25, 27, 28, 35, 38, 41, 42, 43 AND 45.

ALEXANDRIA CHAMBER OF COMMERCE, ALEXANDRIA, VA:
4,164,147, PUB. 4-10-2012. INT. CL. 35.

ALFA LAVAL CORPORATE AB, LUND, SWEDEN:
2,591,999, REN. 5-22-12. INT. CL. 7.

ALFA-PET INC., ST. LOUIS, MO, AKA ALFAPET INC.:
1,195,332, REN. 5-18-12. INT. CL. 31.

ALFRED BENESCH & COMPANY, CHICAGO, IL:
4,165,387, MULTIPLE CLASS, INT. CLS. 35 AND 42.

ALL AMERICAN PAINT CO., KANSAS CITY, MO:
4,163,250, PUB. 4-10-2012. INT. CL. 2.

ALL FOR KIDZ, INC., LYNNWOOD, WA:
4,163,067, PUB. 4-10-2012. INT. CL. 28.

ALL-AMERICAN PUBLISHING, LLC, BOISE, ID:
4,164,678, PUB. 4-10-2012. INT. CL. 36.

ALLEGIANCE EA FUND LLC, CHARLOTTE, NC:
4,165,179, INT. CL. 35.

ALLEN CANNING COMPANY, INC., SILOAM SPRINGS, AR:
571,130, CANC. U.S. CL. 46.

ALLEN MORRIS COMPANY, THE, CORAL GABLES, FL:
1,766,200, REN. 5-18-12. INT. CL. 36.

ALLER, JARED, SAN FRANCISCO, CA:
4,163,499, PUB. 4-10-2012. INT. CL. 21.

ALLERGAN, INC., IRVINE, CA:
858,811, CANC. U.S. CL. 18.

ALLIANCE DATA SYSTEMS CORPORATION, PLANO, TX:
4,165,213, MULTIPLE CLASS, INT. CLS. 35 AND 36.
4,165,214, MULTIPLE CLASS, INT. CLS. 35 AND 36.

ALLIANCE TO SAVE ENERGY, WASHINGTON, DC:
3,006,511, CANC. INT. CL. 36.

ALLOYA CORPORATE FCU, ALBANY, NY:
4,165,503, INT. CL. 36.

ALLSUP, INC., BELLEVILLE, IL:
4,163,692, PUB. 4-10-2012. INT. CL. 36.

ALLYSON AMES COMPANY, INC., CORONA DEL MAR, CA:
4,163,399, PUB. 4-10-2012. INT. CL. 31.

ALMADA, ANTHONY, LAGUNA NIGUEL, CA:
2,498,729, CANC. INT. CL. 42.

ALOECORP., INC., LACEY, WA, ALOECORP., INC., LACEY, WA:
2,695,994, REN. 5-21-12. INT. CL. 1.

ALPHA AROMATICS, LP, PITTSBURGH, PA:
4,164,795, INT. CL. 1.
4,164,796, INT. CL. 1.
4,164,797, INT. CL. 1.

ALPHA CASERO, INC, SAN JOSE, CA, DBA EZQUAILFY:
4,164,894, INT. CL. 36.

ALPHA PRO TECH, INC., NOGALES, AZ:
2,498,216, CANC. INT. CL. 9.

ALPHA RESOURCES, INC., STEVENSVILLE, MI:
2,623,386, REN. 5-21-12. INT. CL. 1.

ALPHATEC SPINE, INC., CARLSBAD, CA:
4,165,220, INT. CL. 5.

ALS SCAN, INC., COLUMBIA, MD:
2,954,954, CANC. INT. CL. 41.

ALSO HOLDING AG, HERGISWIL CH 6052, SWITZERLAND:
3,005,607, CANC. MULTIPLE CLASS, INT. CLS. 9, 16, 35, 37, 38, 39, 41 AND 42.

ALTA EQUIPMENT COMPANY, INC., WIXOM, MI:
4,162,769, PUB. 3-6-2012. INT. CL. 37.

ALTA VISTA CENTER FOR AUTISM, DENVER, CO:
4,165,345, INT. CL. 44.

ALTERNATIVE RESOLUTION CENTERS, LLC, LOS ANGELES, CA:
2,571,076, REN. 5-19-12. INT. CL. 42.

ALTICOR INC., ADA, MI:
3,006,337, CANC. MULTIPLE CLASS, INT. CLS. 3, 5 AND 21.
4,164,871, INT. CL. 9.

ALTORR CORPORATION, LARGO, FL:
4,166,063, INT. CL. 12.

ALUM-A-POLE CORP., SCRANTON, PA:
1,238,000, REN. 5-23-12. INT. CL. 6.

AM EYEWEAR PTY LTD, AUSTRALIA:
4,162,892, PUB. 4-10-2012. MULTIPLE CLASS, INT. CLS. 9 AND 25.

AMA INSURANCE AGENCY, INC., CHICAGO, IL:
4,163,362, PUB. 4-10-2012. INT. CL. 36.
4,163,412, PUB. 4-10-2012. INT. CL. 36.

AMARADIDIS, THEODOROS, DELRAY BEACH, FL:
4,163,084, PUB. 4-10-2012. INT. CL. 41.

AMAZON TECHNOLOGIES, INC., RENO, NV:
4,165,077, INT. CL. 35.
4,165,078, INT. CL. 41.

AMCHEM PRODUCTS, INC., AMBLER, PA TO RHONE-POULENC NEDERLAND B.V., 1180 AA AMSTELVEEN, NETHERLANDS:
855,792, CANC. U.S. CL. 10.

AMCRAFT BUILDING PRODUCTS CO., INC., BELOIT, WI:
2,498,706, CANC. INT. CL. 19.

AMELIA'S DREAM, INC, NEW YORK, NY:
4,165,129, MULTIPLE CLASS, INT. CLS. 9, 25 AND 41.

AMERICAN REGISTRY OF RADIOLOGIC TECHNOLOGISTS, THE, ST. PAUL, MN:
4,163,179, PUB. 4-10-2012. U.S. CL. B.

AMERICA ACTION, INC., POMONA, CA:
4,165,170, INT. CL. 9.

AMERICA'S PROMISE -THE ALLIANCE FOR YOUTH, INC., WASHINGTON, DC:
4,163,143, PUB. 4-10-2012. INT. CL. 41.

AMERICAN ACADEMY OF ACHIEVEMENT, WASHINGTON, DC:
2,569,059, REN. 5-21-12. INT. CL. 41.

AMERICAN ACADEMY OF DERMATOLOGY, INC., SCHAUMBURG, IL:
1,237,768, REN. 5-18-12. INT. CL. 42.
1,237,769, REN. 5-18-12. INT. CL. 42.

AMERICAN ACADEMY OF NEUROLOGY, THE, MINNEAPOLIS, MN:
2,570,314, REN. 5-19-12. INT. CL. 16.

AMERICAN ASSOCIATION OF MEDICAL HYPNOTHERAPISTS, FLUSHING QUEENS, NY:
3,003,103, CANC. INT. CL. 41.

AMERICAN ASSOCIATION OF PHYSICIAN SPECIALISTS, INC., TAMPA, FL:
4,165,993, INT. CL. 42.

AMERICAN BANKERS ASSOCIATION, WASHINGTON, DC, DC:
4,163,073, PUB. 4-10-2012. U.S. CL. B.

AMERICAN BIOSCIENCES, INC., BLAUVELT, NY:
4,163,869, PUB. 4-10-2012. INT. CL. 5.

AMERICAN BIOSYSTEMS, INC., ROANOKE, VA:
4,163,943, PUB. 4-10-2012. INT. CL. 1.

AMERICAN BOARD OF OBESITY MEDICINE, DENVER, CO:
4,166,038, INT. CL. 42.

AMERICAN BRIDGE HOLDING COMPANY, CORAOPOLIS, PA, CONTINENTAL INVESTMENT CORP. B.V., 1077 XX AMSTERDAM, NETHERLANDS:
1,743,561, REN. 5-18-12. INT. CL. 37.

AMERICAN COLLEGE OF RADIOLOGY, RESTON, VA:
4,163,625, PUB. 4-10-2012. INT. CL. 9.

AMERICAN COLLEGE OF VETERINARY BEHAVIORISTS, COLLEGE STATION, TX:
2,581,471, REN. 5-22-12. U.S. CL. 200.

- AMERICAN COLOR GRAPHICS, INC., BRENTWOOD, TN, DBA AMERICAN COLOR:
3,006,191, CANC. MULTIPLE CLASS, INT. CLS. 35 AND 42.
3,006,193, CANC. MULTIPLE CLASS, INT. CLS. 35 AND 42.
3,006,194, CANC. INT. CL. 41.
- AMERICAN COUNCIL ON EXERCISE, SAN DIEGO, CA:
3,089,060, CANC. INT. CL. 9.
- AMERICAN CYANAMID COMPANY, WAYNE, NJ:
863,830, CANC. U.S. CL. 18.
- AMERICAN DENTAL SUPPORT, LLC, FALL CITY, WA:
3,170,635, CANC. MULTIPLE CLASS, INT. CLS. 36 AND 41.
- AMERICAN EXPRESS MARKETING & DEVELOPMENT CORP., NEW YORK, NY:
1,688,113, REN. 5-23-12. INT. CL. 36.
- AMERICAN FELT & FILTER COMPANY, NEWBURGH, NY:
502,288, CANC. U.S. CL. 50.
- AMERICAN FENCE ASSOCIATION, INC., GLEN ELLYN, IL:
2,571,455, REN. 5-18-12. INT. CL. 35.
- AMERICAN GEOLOGICAL INSTITUTE, ALEXANDRIA, VA:
1,236,829, REN. 5-19-12. INT. CL. 42.
- AMERICAN GILSONITE CO., MENLO PARK, CA:
2,998,140, CANC. INT. CL. 19.
- AMERICAN GIRL, LLC, EL SEGUNDO, CA:
2,559,666, REN. 5-18-12. MULTIPLE CLASS, INT. CLS. 35 AND 42.
- AMERICAN GOLD EXCHANGE, INC., AUSTIN, TX:
4,164,240, PUB. 4-10-2012. INT. CL. 35.
4,164,602, PUB. 4-10-2012. INT. CL. 35.
- AMERICAN INDUSTRIAL SERVICES, LLC, INDIANAPOLIS, IN:
2,709,268, REN. 5-19-12. MULTIPLE CLASS, INT. CLS. 39 AND 40.
- AMERICAN INSTITUTE OF CERTIFIED PUBLIC ACCOUNTANTS, NEW YORK, NY:
4,165,968, INT. CL. 41.
- AMERICAN INTERNATIONAL GROUP, INC., NEW YORK, NY:
2,498,351, CANC. INT. CL. 36.
- AMERICAN INTERNATIONAL INDUSTRIES, LOS ANGELES, CA:
1,192,936, REN. 5-18-12. INT. CL. 3.
- AMERICAN LICORICE CO., BEND, OR:
4,163,221, PUB. 4-10-2012. INT. CL. 30.
- AMERICAN MEDICAL ASSOCIATION, CHICAGO, IL:
4,164,750, PUB. 4-10-2012. INT. CL. 35.
- AMERICAN NURSES CREDENTIALING CENTER, SILVER SPRING, MD:
4,164,812, INT. CL. 41.
4,164,813, INT. CL. 41.
4,164,814, INT. CL. 41.
4,164,815, INT. CL. 41.
- AMERICAN OATS, INC., MINNETONKA, MN:
2,701,053, REN. 5-21-12. INT. CL. 30.
- AMERICAN PRODUCTION AND INVENTORY CONTROL SOCIETY, INC., CHICAGO, IL:
1,705,524, REN. 5-23-12. INT. CL. 41.
- AMERICAN PROMOTIONAL EVENTS, INC., FLORENCE, AL, CHINA PYROTECHNICS, INC., FLORENCE, AL:
1,692,858, REN. 5-21-12. INT. CL. 13.
1,692,861, REN. 5-24-12. INT. CL. 13.
- AMERICAN RAC CIE, LLC, LOS ANGELES, CA:
2,710,769, REN. 5-18-12. INT. CL. 25.
- AMERICAN REGISTRY OF RADIOLOGIC TECHNOLOGISTS, THE, ST. PAUL, MN:
4,163,180, PUB. 4-10-2012. U.S. CL. B.
- AMERICAN RISK MANAGEMENT RESOURCES NETWORK, BRENTWOOD, TN:
2,497,945, CANC. INT. CL. 36.
- AMERICAN SAFETY AND HEALTH INSTITUTE, INC., NEW YORK, NY:
2,508,510, REN. 5-18-12. MULTIPLE CLASS, INT. CLS. 9 AND 16.
- AMERICAN SOCIETY FOR BIOCHEMISTRY AND MOLECULAR BIOLOGY, BETHESDA, MD:
2,574,693, REN. 5-24-12. INT. CL. 16.
- AMERICAN SOCIETY OF CLINICAL ONCOLOGY, ALEXANDRIA, VA:
4,164,242, PUB. 4-10-2012. INT. CL. 16.
- AMERICAN SOCIETY OF PLANT BIOLOGISTS, ROCKVILLE, MD:
4,163,164, PUB. 4-10-2012. INT. CL. 42.
- AMERICAN TEL-A-SYSTEMS, INC., MCFARLAND, WI, AKA AMTELCO:
4,163,744, PUB. 4-10-2012. MULTIPLE CLASS, INT. CLS. 9 AND 38.
- AMERICAN TRAVELER MOTOR CLUB, INC., THE, SARASOTA, FL:
1,699,568, REN. 5-19-12. INT. CL. 42.
- AMERICAN TRAVELER MOTOR CLUB, INC., THE, ENGLEWOOD, FL:
1,699,568, COR. INT. CL. 42.
- AMERICAN WESTERN, INC., CINCINNATI, OH:
502,019, CANC. U.S. CL. 17.
- AMERICANFAMILY THEATER INC., PHILADELPHIA, PA:
2,498,043, CANC. INT. CL. 41.
- AMERICINN INTERNATIONAL, LLC, CHANHASSEN, MN:
2,640,802, REN. 5-18-12. INT. CL. 42.
- AMERIWOOD INDUSTRIES, WRIGHT CITY, MO:
4,163,891, PUB. 4-10-2012. INT. CL. 20.
- AMETEK PROGRAMMABLE POWER, INC., SAN DIEGO, CA:
2,596,187, REN. 5-18-12. INT. CL. 9.
- AMF TUBOSCOPE, INC., HOUSTON, TX:
859,835, CANC. U.S. CL. 103.
- AMI ENTERTAINMENT NETWORK, INC., BRISTOL, PA:
2,570,815, REN. 5-21-12. INT. CL. 28.
2,572,136, REN. 5-21-12. INT. CL. 28.
- AMNEAL PHARMACEUTICALS, LLC, PISCATAWAY, NJ:
4,163,617, PUB. 4-10-2012. INT. CL. 5.
- AMOREPACIFIC CORPORATION, SEOUL, REPUBLIC OF KOREA:
4,163,052, PUB. 4-10-2012. INT. CL. 3.
- AMPEGY, LLC, HOUSTON, TX:
4,165,405, INT. CL. 35.
- AMPHORA INTERNATIONAL, INC, LAKE FOREST, CA:
4,163,919, PUB. 4-10-2012. MULTIPLE CLASS, INT. CLS. 29 AND 30.
- AMRICON CORPORATION, APPLETON, WI:
857,508, CANC. U.S. CL. 37.
- AMS HEALTH SCIENCES LLC, OKLAHOMA CITY, OK:
4,164,656, PUB. 4-10-2012. INT. CL. 5.
- AMULET MANUFACTURING COMPANY, INC., ARCATA, CA:
2,497,446, CANC. INT. CL. 7.
- AMUSEMENT ART LLC, LOS ANGELES, CA:
4,165,336, INT. CL. 14.
- ANANDA CHURCH OF SELF-REALIZATION OF NEVADA COUNTY, NEVADA CITY, CA:
4,163,171, PUB. 4-10-2012. MULTIPLE CLASS, INT. CLS. 41 AND 45.
- ANARCHY BMX, INC., VALENCIA, CA:
2,497,850, CANC. INT. CL. 9.
- ANCIENT WATERS OF GREECE, INC., COLLEGE POINT, NY:
3,006,178, CANC. INT. CL. 32.
- ANDE ROONEY INC., HIGHLAND, NY:
2,571,362, REN. 5-24-12. INT. CL. 21.
2,662,200, REN. 5-24-12. INT. CL. 21.
- ANDRE BROWN, DECATUR, GA, DBA NU LOOK FURNITURE, INC.:
4,163,690, PUB. 4-10-2012. INT. CL. 35.
- ANDREW ACKERMANN, OXNARD, CA:
4,165,039, INT. CL. 18.
- ANDREW BARNEY, SIOUX FALLS, SD:
4,164,521, PUB. 4-10-2012. INT. CL. 14.
- ANDRY HEALTH AND WELLNESS, LLC, BLOOMINGTON, IN:
4,164,298, PUB. 4-10-2012. INT. CL. 44.
- ANEW LEGWEAR LLC, NEW YORK, NY:
4,164,337, PUB. 4-10-2012. INT. CL. 25.

ANGRY LITTLE GIRLS, INC., LOS ANGELES, CA:
2,570,641. REN. 5-19-12. MULTIPLE CLASS, INT. CLS. 16 AND 41.

ANGSTROM PHARMACEUTICALS, INC., SOLANA BEACH, CA:
4,164,842. INT. CL. 5.

ANHING CORPORATION, LOS ANGELES, CA:
1,765,348. REN. 5-19-12. INT. CL. 30.

ANIMARK, INC., AURORA, CO:
4,164,541. PUB. 4-10-2012. INT. CL. 10.

ANJEL GUNNARSHAUG, STUDIO CITY, CA:
4,162,712. PUB. 4-10-2012. INT. CL. 30.

ANN MARIE ZORZI, HENDERSON, NV:
4,164,662. PUB. 4-10-2012. INT. CL. 35.

ANN'S CHOICE, INC., BALTIMORE, MD:
2,607,528. REN. 5-21-12. INT. CL. 43.

ANSCO, INC., NEW YORK, NY:
4,165,719. INT. CL. 35.

ANNE-MARIE WEBER, INC., CRYSTAL BAY, NV:
4,165,628. INT. CL. 16.

ANON ARTS LLC, MORAGA, CA:
3,590,670. AM. INT. CL. 9.

ANSI-ASQ NATIONAL ACCREDITATION BOARD, LLC, MILWAUKEE, WI:
2,569,557. REN. 5-21-12. INT. CL. 42.

ANTAAR&S S.P.A., ITALY:
4,162,823. PUB. 4-10-2012. MULTIPLE CLASS, INT. CLS. 29 AND 30.

ANTEA USA, INC., SHOREVIEW, MN:
4,165,325. MULTIPLE CLASS, INT. CLS. 35, 40, 41, 42 AND 45.

ANTHONY COMELLA, NOGALES, AZ:
4,164,617. PUB. 4-10-2012. INT. CL. 3.

ANTHONY M. RAGO, WESTERN SPRINGS, IL:
4,164,850. INT. CL. 25.

ANTONIO CORTES CAZARES, MORELOS. 62220, MEXICO:
4,163,099. PUB. 4-10-2012. INT. CL. 28.

ANTONIO PUIG S.A., BARCELONA, SPAIN:
861,477. CANC. U.S. CL. 51.

ANVIL KNITWEAR, INC., NEW YORK, NY:
4,165,224. MULTIPLE CLASS, INT. CLS. 35 AND 40.

AOC, LLC, COLLIERVILLE, TN:
2,571,815. REN. 5-18-12. INT. CL. 1.
2,625,477. REN. 5-18-12. INT. CL. 1.

AOL INC., DULLES, VA:
4,165,918. INT. CL. 41.

AOPS INCORPORATED, ALPINE, CA:
4,165,223. INT. CL. 41.

AORTECH INTERNATIONAL PLC, BELLSHILL, LANARKSHIRE ML3 4NJ, SCOTLAND:
3,216,073. CANC. INT. CL. 37.

APACHE MICRO PERIPHERALS, INC., FOUNTAIN VALLEY, CA:
2,568,832. REN. 5-18-12. INT. CL. 9.

APARTIS INFORMATION MANAGEMENT, INC., NEWPORT BEACH, CA:
3,718,194. COR. INT. CL. 42.

APEX BRANDS, INC., APEX, NC, MASTER POWER CORPORATION, SOLON, OH:
742,647. REN. 5-23-12. U.S. CL. 23 (INT. CLS. 6, 7, 8, 9, 11, 12, 16, 21 AND 28).

APEX BRANDS, INC., APEX, NC:
4,163,484. PUB. 4-10-2012. INT. CL. 8.

APEXIGEN, INC., BURLINGAME, CA:
4,165,148. MULTIPLE CLASS, INT. CLS. 42 AND 45.

APOLLO OIL, LLC, WINCHESTER, KY:
1,756,318. REN. 5-24-12. INT. CL. 1.

APOLLO PRODUCTS, INC., KANSAS CITY, MO:
2,606,373. REN. 5-18-12. INT. CL. 3.

APOTHECARY PRODUCTS, INC., BURNSVILLE, MN:
4,165,466. MULTIPLE CLASS, INT. CLS. 35 AND 44.

APPERSON, SEAN, SANTA BARBARA, CA:
4,164,238. PUB. 4-10-2012. INT. CL. 41.

APPLE ANNIES CATERING CORP., AUSTIN, TX:
2,498,602. CANC. INT. CL. 30.

APPLE INC., CUPERTINO, CA:
1,758,137. REN. 5-21-12. INT. CL. 9.

APPLE SUPPLY COMPANY, LLC, FALL RIVER, MA:
4,165,782. INT. CL. 35.

APPLEWOOD LANE ALPACAS, LLC, WITTENBERG, WI:
4,163,810. PUB. 4-10-2012. INT. CL. 23.

APPLIED BUSINESS SOFTWARE, INC., LONG BEACH, CA:
4,163,226. PUB. 4-10-2012. INT. CL. 9.

APPLIED PROCESS, INC., LIVONIA, MI:
4,163,632. PUB. 4-10-2012. INT. CL. 40.
4,163,633. PUB. 4-10-2012. INT. CL. 40.

APPLIED SCIENCES, INC., CEDARVILLE, OH:
2,553,137. REN. 5-18-12. INT. CL. 17.

APPLIED VISUAL COMMUNICATIONS INC., HERNDON, VA:
4,163,108. PUB. 4-10-2012. MULTIPLE CLASS, INT. CLS. 36, 37 AND 42.
4,163,109. PUB. 4-10-2012. INT. CL. 36.

APPTERA, INC., SUNNYVALE, CA:
4,165,509. MULTIPLE CLASS, INT. CLS. 9, 35, 38 AND 42.

APRICUS SOLAR CO., LTD., NANJING, CHINA:
4,164,129. PUB. 4-10-2012. INT. CL. 11.

AQS, INC, HARTLAND, WI:
2,569,426. REN. 5-18-12. MULTIPLE CLASS, INT. CLS. 9 AND 42.

ARAMATIC COFFEE SYSTEM OF THE HUDSON VALLEY, INC., RIFTON, NY:
4,164,035. PUB. 4-10-2012. INT. CL. 35.
4,164,047. PUB. 4-10-2012. INT. CL. 35.
4,164,048. PUB. 4-10-2012. INT. CL. 35.

ARANDAS FRANCHISES, INC., HOUSTON, TX:
2,561,494. REN. 5-19-12. MULTIPLE CLASS, INT. CLS. 16, 25, 35 AND 42.

ARARAT COGNAC FACTORY "A.K.Z." LLC, MARZ ARARAT, ARMENIA:
4,162,847. PUB. 4-10-2012. INT. CL. 33.

ARC MANOR LLC, DERWOOD, MD:
4,163,072. PUB. 4-10-2012. INT. CL. 41.

ARC TECHNOLOGIES, LLC, OVERLAND PARK, KS:
4,163,148. PUB. 4-10-2012. MULTIPLE CLASS, INT. CLS. 35, 36, 41, 44 AND 45.

ARCASUN LLC, FAIRFAX STATION, VA:
4,164,492. PUB. 4-10-2012. INT. CL. 35.

ARCH CHEMICALS, INC., NORWALK, CT:
4,164,874. INT. CL. 3.

ARCHIE COMIC PUBLICATIONS, INC., MAMARONECK, NY:
4,164,915. INT. CL. 16.

ARCHIPHYTE, LLC, SEQUIM, WA:
4,163,411. PUB. 4-10-2012. MULTIPLE CLASS, INT. CLS. 19 AND 37.

ARCHTECH ELECTRONICS CORPORATION, DAYTON, NJ:
2,702,167. REN. 5-18-12. INT. CL. 9.

AREAS USA, INC., MIAMI, FL:
4,166,032. INT. CL. 43.

ARENA PHARMACEUTICALS GMBH, CH-4800 ZOFINGEN, SWITZERLAND:
4,163,932. PUB. 4-10-2012. INT. CL. 5.
4,163,933. PUB. 4-10-2012. INT. CL. 5.

AREVA NP INC., LYNCHBURG, VA, EXXON CORPORATION, FLEMINGTON, NJ:
1,195,087. REN. 5-23-12. INT. CL. 9.

ARGENTINO, WILLIAM, STREAMWOOD, IL:
4,162,751. PUB. 4-10-2012. INT. CL. 25.

ARISTOCRAT TECHNOLOGIES AUSTRALIA PTY LTD., NORTH RYDE, NSW, AUSTRALIA:
4,165,705. INT. CL. 9.
4,165,706. INT. CL. 9.

ARISTOCRAT TECNOLOGIES AUSTRALIA PTY LTD., NORTH RYDE, NSW, AUSTRALIA:
4,165,675. INT. CL. 9.

ARISTOTLE INC., LITTLE ROCK, AR:
2,591,631. REN. 5-21-12. MULTIPLE CLASS, INT. CLS. 21 AND 35.
2,703,488. REN. 5-21-12. INT. CL. 42.

ARIZONA INSTRUMENT LLC, CHANDLER, AZ:
2,714,366. REN. 5-21-12. INT. CL. 10.

- ARKANSAS BUSINESS LIMITED PARTNERSHIP, LITTLE ROCK, AR:
2,598,115. REN. 5-22-12. INT. CL. 42.
- ARLEN, MICHAEL W, LOS ANGELES, CA:
4,164,760, PUB. 4-10-2012. INT. CL. 5.
4,164,761, PUB. 4-10-2012. INT. CL. 5.
- ARMADILLO BIOMEDICAL, ENCINO, CA:
4,165,215, INT. CL. 10.
- ARMADILLO BIOMEDICAL LLC, ENCINO, CA:
4,165,145, INT. CL. 10.
- ARMSTRONG GLOBAL HOLDINGS, INC., STUART, FL:
4,164,040, PUB. 4-10-2012. INT. CL. 42.
- ARNOLD PRODUCTS, INC., HORSHAM, PA, OROWEAT BAKING CO., MONTEBELLO, CA:
932,957. REN. 5-23-12. U.S. CL. 46 (INT. CL. 30).
- ARON STREIT, INC., NEW YORK, NY:
1,696,341. REN. 5-23-12. INT. CL. 30.
- ARONS, RONALD E, OAKLAND, CA:
4,165,633, INT. CL. 16.
- ARRIS, LLC, ALEXANDRIA, LA, DBA SIGMA DESIGN INTERNATIONAL:
4,164,253, PUB. 4-10-2012. INT. CL. 9.
- ARROW EXTERMINATORS, INC., ATLANTA, GA:
4,163,259, PUB. 4-10-2012. INT. CL. 37.
- ARROWHEAD SYSTEMS, INC., OSHKOSH, WI:
2,600,689. REN. 5-18-12. MULTIPLE CLASS, INT. CLS. 7 AND 42.
- ART BY LENNE', LLC, ST. PETE BEACH, FL:
4,164,243, PUB. 4-10-2012. MULTIPLE CLASS, INT. CLS. 14 AND 16.
- ART EATABLES, LLC, LOUISVILLE, KY:
4,164,203, PUB. 4-10-2012. INT. CL. 30.
4,164,308, PUB. 4-10-2012. INT. CL. 30.
- ART PORTER MUSIC EDUCATION INC, LITTLE ROCK, AR:
4,165,475, MULTIPLE CLASS, INT. CLS. 36 AND 41.
- ART.SY, INC., NEW YORK, NY:
4,165,234, INT. CL. 41.
- ARTE CORPORATION, JAPAN:
4,162,907, PUB. 4-10-2012. INT. CL. 10.
- ARTISIN L.L.C., NEWARK, NJ:
4,163,586, PUB. 4-10-2012. INT. CL. 35.
- ARTIST GROWTH, LLC, NASHVILLE, TN:
4,165,803, INT. CL. 35.
4,165,804, INT. CL. 9.
- ARTISTOTLE.NET INC., LITTLE ROCK, AR:
2,570,199. REN. 5-21-12. INT. CL. 35.
- ARTISTRY CONCEPTS, LLC, ENGLEWOOD, FL, DBA ARTISTRY CONCEPTS:
4,164,317, PUB. 4-10-2012. INT. CL. 44.
- ARTIX ENTERTAINMENT, LLC, LAND O' LAKES, FL:
4,165,848, INT. CL. 41.
- ARTURO TAVERNA INTERNATIONAL PTY. LTD., REGENCY PARK, SOUTH, AUSTRALIA:
4,163,959, PUB. 4-10-2012. INT. CL. 3.
- ASAHI DENSO CO., LTD., SHIZUOKA, JAPAN:
4,162,738, PUB. 4-10-2012. MULTIPLE CLASS, INT. CLS. 6, 7, 9, 11 AND 12.
- ASC PROFILES, INC., WEST SACRAMENTO, CA:
2,564,008. REN. 5-18-12. INT. CL. 6.
- ASCENA RETAIL GROUP, INC., SUFFERN, NY:
4,165,141, MULTIPLE CLASS, INT. CLS. 35 AND 36.
4,165,142, MULTIPLE CLASS, INT. CLS. 35 AND 36.
- ASCEND EAGLE, INC, PINOLE, CA:
4,166,036, INT. CL. 10.
- ASCENSION ORTHOPEDICS, INC., AUSTIN, TX:
4,163,287, PUB. 4-10-2012. INT. CL. 10.
- ASCENT TECHNOLOGY, INC., CAMBRIDGE, MA:
2,615,800. REN. 5-19-12. INT. CL. 39.
- ASEPSIS PHARMACEUTICALS INC., NORTH STONINGTON, CT:
4,166,064, INT. CL. 5.
- ASH EQUIPMENT CO., INC., BALTIMORE, MD:
4,162,763, PUB. 11-1-2011. INT. CL. 40.
- ASH GROVE CEMENT COMPANY, OVERLAND PARK, KS:
4,163,340, PUB. 4-10-2012. INT. CL. 19.
- ASICS CORPORATION, CHUO-KU KOBE 650-8555, JAPAN:
2,988,754, CANC. INT. CL. 25.
- ASO CORPORATION, SARASOTA, FL:
4,164,905, INT. CL. 5.
- ASPEN TECHNOLOGY, INC., BURLINGTON, MA:
2,498,644, CANC. INT. CL. 9.
- ASPIRE BRANDS, INC., WESTLAKE, OH:
4,164,999, INT. CL. 3.
- ASPN PHARMACIES, LLC, FLORHAM PARK, NJ:
4,164,507, PUB. 4-10-2012. INT. CL. 35.
- ASSELIN, BRAD, MARSHALL, MI, DBA CARMAPS LLC:
4,166,058, INT. CL. 42.
- ASSET MANAGEMENT OUTSOURCING, INC., NORCROSS, GA:
4,163,237, PUB. 4-10-2012. MULTIPLE CLASS, INT. CLS. 35 AND 36.
- ASSOCIATED BANC-CORP, GREEN BAY, WI:
2,575,804. REN. 5-22-12. INT. CL. 36.
- ASSOCIATION FOR SUPERVISION AND CURRICULUM DEVELOPMENT, ALEXANDRIA, VA:
2,571,731. REN. 5-22-12. INT. CL. 42.
- ASSOCIATION OF CHRISTIAN SCHOOLS INTERNATIONAL, COLORADO SPRINGS, CO:
4,164,712, PUB. 4-10-2012. MULTIPLE CLASS, INT. CLS. 9, 16 AND 41.
- ASSOCIATION OF JUNIOR LEAGUES INTERNATIONAL, INC., THE, NEW YORK, NY:
2,688,305. REN. 5-24-12. INT. CL. 35.
- ASSOLUTO, INC., LAMIRADA, CA:
2,498,611, CANC. INT. CL. 25.
- ASTRAZENECA AB, S-151 85 SODERTALJE, SWEDEN:
3,005,291, CANC. INT. CL. 5.
3,005,292, CANC. INT. CL. 5.
- AT&T INTELLECTUAL PROPERTY II, L.P., RENO, NV:
4,164,735, PUB. 4-10-2012. INT. CL. 9.
4,165,927, INT. CL. 9.
- ATC HEALTHCARE SERVICES, INC., LAKE SUCCESS, NY:
2,639,133. REN. 5-18-12. MULTIPLE CLASS, INT. CLS. 35 AND 42.
- ATLANTIKA, INC., NEW CANAAN, CT:
4,115,351, COR. INT. CL. 29.
- ATLAS ALARM CORPORATION, WEYMOUTH, MA:
936,999. REN. 5-18-12. U.S. CL. 21 (INT. CL. 9).
- ATLAS COPCO TOOLS AB, STOCKHOLM, SWEDEN:
4,163,245, PUB. 4-10-2012. MULTIPLE CLASS, INT. CLS. 9 AND 42.
- ATLAS SOUND, LP, ENNIS, TX:
2,573,786. REN. 5-19-12. INT. CL. 9.
- ATRIUM COMPANIES, INC., DALLAS, TX:
2,497,433, CANC. INT. CL. 19.
- ATRONIC INTERNATIONAL GMBH, LUBBECKE, FED REP GERMANY:
3,005,328, CANC. MULTIPLE CLASS, INT. CLS. 9 AND 28.
- AUDIOVOX CORPORATION, HAUPPAUGE, NY:
3,668,028, CANC. INT. CL. 21.
3,668,029, CANC. INT. CL. 21.
- AUERBACH CENTRAL AGENCY FOR JEWISH EDUCATION/JEWISH OUTREACH PARTNERSHIP, MELROSE PARK, PA:
4,126,746, COR. MULTIPLE CLASS, INT. CLS. 35 AND 41.
- AUGMENTIX CORPORATION, AUSTIN, TX:
3,426,482, COR. INT. CL. 9.
- AURORA INTERNATIONAL, LLC, HOUSTON, TX:
4,164,096, PUB. 4-10-2012. INT. CL. 28.
- AUSTIN FUSION MUSIC LLC, AUSTIN, TX:
4,164,462, PUB. 4-10-2012. INT. CL. 41.
4,164,463, PUB. 4-10-2012. INT. CL. 41.
- AUSTRALIAN BLADESMITHS PTY LTD, AUSTRALIA:
4,162,996, PUB. 4-10-2012. MULTIPLE CLASS, INT. CLS. 8, 35 AND 39.
- AUSTRALIAN CATTLE DOG CLUB OF AMERICA, INC., RANCHO SANTA FE, CA:
2,498,465, CANC. INT. CL. 41.
- AUSTRALIAN GOLD, LLC, INDIANAPOLIS, IN:
4,165,415, INT. CL. 3.
- AUTISM UNTANGLED LLC, BOTHELL, WA:
4,165,839, INT. CL. 35.

AUTO PRIDE NETWORK, LLC, GERMANTOWN, TN:
2,597,972. REN. 5-18-12. INT. CL. 35.

AUTO-GRAPHIC, INC., POMONA, CA:
4,163,091. PUB. 4-10-2012. MULTIPLE CLASS, INT. CLS. 9 AND 42.

AUTOMATED SECURITIES CLEARANCE LLC, JERSEY CITY, NJ:
4,164,991. MULTIPLE CLASS, INT. CLS. 9 AND 42.

AUTOMATIC SYSTEMS, INC., KANSAS CITY, MO:
1,195,879. REN. 5-22-12. MULTIPLE CLASS, INT. CLS. 37 AND 42.

AUTOMOTIVE RENTALS, INC., MT. LAUREL, NJ:
2,686,000. REN. 5-24-12. INT. CL. 35.

AUTOMOTIVE WEBMERCIALS, LLC, BOCA RATON, FL:
4,164,533. PUB. 4-10-2012. INT. CL. 35.
4,164,537. PUB. 4-10-2012. INT. CL. 35.

AVALERE HEALTH, LLC, WASHINGTON, DC:
4,165,243. INT. CL. 44.
4,165,244. INT. CL. 44.

AVALON TATTOO STUDIO, INC., SAN DIEGO, CA:
2,514,952. REN. 5-19-12. INT. CL. 42.

AVANT DATACOMM SOLUTIONS, INC., GOLDEN, CO:
4,163,335. PUB. 4-10-2012. MULTIPLE CLASS, INT. CLS. 37 AND 42.

AVANTECH, INC., NAPLES, FL:
4,165,688. INT. CL. 10.

AVANTOR PERFORMANCE MATERIALS, INC., PHILLIPS-BURG, NJ:
2,573,149. REN. 5-18-12. INT. CL. 3.

EVERY DENNISON RETAIL INFORMATION SERVICES LLC, PASADENA, CA:
2,569,334. REN. 5-24-12. MULTIPLE CLASS, INT. CLS. 7 AND 16.
2,569,334. CANC. INT. CL. 37.

AVEUS, LLC, ST PAUL, MN:
4,164,210. PUB. 4-10-2012. MULTIPLE CLASS, INT. CLS. 35 AND 41.

AVFUSION, INC., DENVER, CO:
3,897,355. AM. INT. CL. 42.

AVI-SPL, INC., TAMPA, FL:
4,165,442. INT. CL. 38.

AVISION INC., HSINCHU, TAIWAN:
2,635,759. REN. 5-22-12. INT. CL. 9.

AVOX SYSTEMS INC., LANCASTER, NY:
860,349. CANC. U.S. CL. 44.

AVRIL LAVIGNE MUSIC & ENTERTAINMENT LLC, LOS ANGELES, CA:
4,164,810. MULTIPLE CLASS, INT. CLS. 18 AND 25.

AWAKEN MY SENSES INC., TORONTO, CANADA:
4,163,752. PUB. 4-10-2012. INT. CL. 3.

AXELLNA, LTD., FLORIDA, NY:
2,602,017. CANC. INT. CL. 16.

AXIGN PTY LTD AS TRUSTEE FOR AXIGN FOOTWEAR UNIT TRUST, AUSTRALIA AND AXIGN PTY LTD AS TRUSTEE FOR AXIGN FOOTWEAR UNIT TRUST, AUSTRALIA:
4,162,919. PUB. 4-10-2012. MULTIPLE CLASS, INT. CLS. 10 AND 25.

AZAR, ELIE P., NEW YORK, NY:
4,164,159. PUB. 4-10-2012. INT. CL. 36.

AZURE DYNAMICS, INC., BRITISH COLUMBIA, CANADA:
4,162,694. PUB. 9-20-2011. INT. CL. 9.

A2M ENTERTAINMENT, INC., CHULA VISTA, CA:
4,121,404. COR. INT. CL. 41.

B 2 SQUARED, LLC, SAN JOSE, CA:
4,165,493. MULTIPLE CLASS, INT. CLS. 9 AND 41.

B. BRAUN MEDICAL INC., BETHLEHEM, PA. AMERICAN HOSPITAL SUPPLY CORPORATION, EVANSTON, IL:
933,806. REN. 5-23-12. U.S. CL. 18 (INT. CL. 5).

B. F. GOODRICH COMPANY, THE, AKRON, OH:
441,766. CANC. U.S. CL. 1.

B. V. DE METEOR, RHEDEN, NETHERLANDS:
504,995. CANC. U.S. CL. 12.

B'NAI B'RITH, WASHINGTON, DC, DBA B'NAI B'RITH INTERNATIONAL:
1,699,600. REN. 5-22-12. INT. CL. 42.

BA-TAMPTÉ PICKLE PRODUCTS, INC., BROOKLYN, NY:
4,163,183. PUB. 4-10-2012. INT. CL. 29.

BABCOX MEDIA, INC., AKRON, OH:
4,163,709. PUB. 4-10-2012. MULTIPLE CLASS, INT. CLS. 16 AND 41.

BABEL CLOTHING L.L.C., COLLINSVILLE, IL:
4,164,869. INT. CL. 25.

BABY BLUES BOTTLING LLC, VENICE, CA:
4,165,139. INT. CL. 43.

BABY'S COFFEE LLC, MIAMI, FL:
2,574,742. REN. 5-24-12. INT. CL. 30.

BACKROADS, BERKELEY, CA:
2,990,873. CANC. INT. CL. 39.

BACONERY, LLC, NEW YORK, NY:
4,165,757. INT. CL. 35.

BAF INDUSTRIES, TUSTIN, CA, BURFORD AUTO FINISHES, SANTA ANA, CA:
934,285. REN. 5-24-12. MULTIPLE CLASS, U.S. CLS. 2 (INT. CL. 20), 4 (INT. CLS. 3 AND 21), 6 (INT. CL. 5), 15 (INT. CL. 4), 16 (INT. CL. 2), 23 (INT. CLS. 7 AND 8), 29 (INT. CL. 21) AND 39 (INT. CL. 25).

BAFIST, INC., BAYPORT, NY, DBA THE FISH STORE:
4,164,065. PUB. 4-10-2012. MULTIPLE CLASS, INT. CLS. 35 AND 43.

BAGELS FOREVER, INC., MADISON, WI:
2,602,670. REN. 5-23-12. INT. CL. 30.

BAICOR, L.C., LOGAN, UT:
2,573,506. REN. 5-19-12. INT. CL. 1.
2,578,310. REN. 5-18-12. INT. CL. 1.

BAILEY, BARRY L., MAYNARD, MA:
2,585,174. REN. 5-18-12. INT. CL. 41.

BAKER, DAVID, MEADOW VISTA, CA:
4,165,988. INT. CL. 9.

BAKOTIC PATHOLOGY ASSOCIATES, LLC, ALPHARETTA, GA:
4,163,730. PUB. 4-10-2012. INT. CL. 44.
4,163,739. PUB. 4-10-2012. INT. CL. 44.

BAKTARI, JONATHAN, LAS VEGAS, NV:
4,113,283. COR. INT. CL. 44.

BALB, INC, HOUSTON, TX:
4,163,603. PUB. 4-10-2012. MULTIPLE CLASS, INT. CLS. 11, 20 AND 28.

BALCAN PLASTICS LIMITED/LES PLASTIQUES BALCAN LIMITEE, MONTREAL, QUEBEC, CANADA:
2,576,932. REN. 5-22-12. INT. CL. 17.

BALLY GAMING, INC., LAS VEGAS, NV, DBA BALLY TECHNOLOGIES:
4,165,295. INT. CL. 9.
4,165,296. INT. CL. 9.
4,165,297. INT. CL. 9.
4,165,411. INT. CL. 9.
4,165,412. INT. CL. 9.
4,165,697. INT. CL. 9.

BALLY TOTAL FITNESS HOLDING CORPORATION, CHICAGO, IL:
4,165,414. INT. CL. 41.

BALOGH, ERIN, SAN MARCOS, CA:
4,165,723. INT. CL. 21.

BANANA KRAZE, WASHINGTON, UT:
4,165,265. INT. CL. 43.

BANDAI ENTERTAINMENT INC., CYPRESS, CA:
3,006,391. CANC. INT. CL. 38.
3,006,392. CANC. INT. CL. 41.

BANDER-NET COMMUNICATIONS, INC., PHOENIX, AZ, DBA FASTQ COMMUNICATIONS:
4,166,084. INT. CL. 38.

BANEY, DAVID, CHICAGO, IL:
4,165,153. MULTIPLE CLASS, INT. CLS. 35 AND 36.

BANG ZOOM DESIGN INC., CINCINNATI, OH:
1,763,466. REN. 5-23-12. INT. CL. 42.

BANKS, PATRICIA, LUTZ, FL:
4,163,749. PUB. 4-10-2012. INT. CL. 5.

BARBARIAN V8 MOTORCYCLES PTY LTD, AUSTRALIA:
2,989,827.

BARBELLE, INC., SWANSEA, MA:
4,164,469. PUB. 4-10-2012. INT. CL. 41.

BARBERS, HAIRSTYLING FOR MEN & WOMEN, INC., THE, MINNEAPOLIS, MN, DBA COST CUTTERS:
1,724,880. REN. 5-23-12. MULTIPLE CLASS, INT. CLS. 3 AND 42.

- BARNES & NOBLE BOOKSELLERS, INC., NEW YORK, NY:
3,006,111, CANC. MULTIPLE CLASS, INT. CLS. 38 AND 41.
- BARNES, BRIAN, ISLAMORADA, FL:
4,165,701, INT. CL. 28.
- BARNES, TERRENCE D, ALCOLU, SC, DBA MIND OVER MONEY:
4,165,449, INT. CL. 9.
- BARON SBD LLC, SARASOTA, FL:
4,164,832, INT. CL. 39.
- BARONESSA ITALIAN IMPORTS INC., HOWARD BEACH, NY:
2,498,658, CANC. INT. CL. 29.
- BAROUKH, DIDIER, HALLANDALE, FL:
4,163,474, PUB. 4-10-2012. INT. CL. 25.
- BARRACUDA SERVICES, JONESBORO, GA:
4,164,010, PUB. 4-10-2012. INT. CL. 37.
- BARREL SPORTSWEAR, LTD, NEW YORK, NY:
4,165,672, INT. CL. 25.
- BARRON PUBLISHING CO., LANCASTER, PA:
2,578,278. REN. 5-21-12. MULTIPLE CLASS, INT. CLS. 16 AND 41.
- BARRY CALLEBAUT AG, ZURICH, SWITZERLAND, C. J. VAN HOUTEN & ZOON, INC., ST. ALBANS, VT:
1,693,375. REN. 5-24-12. INT. CL. 30.
- BARRY W. DUECK, SUNSET BEACH, CA, DBA DUECK DEFENSE:
4,163,492, PUB. 4-10-2012. INT. CL. 13.
- BARTENDERS411, INC., WESTMINSTER, CA:
4,164,084, PUB. 4-10-2012. INT. CL. 35.
- BARTER PLANET INC., BETHEL, CT:
4,165,082, INT. CL. 35.
- BASAL, DERON, WINDERMERE, FL, DBA BASAL ENTERPRISES:
4,164,618, PUB. 4-10-2012. INT. CL. 9.
- BASCO MANUFACTURING COMPANY, MASON, OH:
3,006,196, CANC. INT. CL. 11.
- BASEBALL EXPOS, L.P., NEW YORK, NY, MONTREAL BASEBALL CLUB LTD., MONTREAL, QUEBEC, CANADA:
1,216,796. REN. 5-23-12. INT. CL. 25.
- BASEBALL EXPOS, L.P., MONTREAL, QUEBEC, CANADA:
1,725,787. REN. 5-23-12. INT. CL. 25.
- BASF CORPORATION, FLORHAM PARK, NJ:
3,006,424, CANC. INT. CL. 2.
- BASIC AMERICAN, INC., SAN FRANCISCO, CA:
2,712,864. REN. 5-24-12. INT. CL. 31.
- BASS & HAYS FOUNDRY, INC., GRAND PRAIRIE, TX:
2,578,001. REN. 5-23-12. INT. CL. 6.
- BATALLA, YESENIA, NORTHRIDGE, CA, DBA YB CREATIONS:
4,165,337, INT. CL. 35.
- BATTAGLIA, ANTHONY, JUPITER, FL:
4,164,440, PUB. 4-10-2012. INT. CL. 3.
- BATTLE CREEK EQUIPMENT COMPANY, BATLE CREEK, MI:
246,722, CANC. U.S. CL. 44.
- BATTLE CREEK EQUIPMENT COMPANY, BATTLE CREEK, MI:
247,181, CANC. U.S. CL. 44.
- BAUER INNER CITY LIMITED, CHESHIRE WA2 7NR, ENGLAND:
3,006,438, CANC. MULTIPLE CLASS, INT. CLS. 6 AND 37.
- BAUMGARTNER ENVIRONICS, INC., OLIVIA, MN:
4,165,772, INT. CL. 9.
- BAVARIA N.V., NETHERLANDS:
4,162,888, PUB. 4-10-2012. INT. CL. 32.
- BAXTER INTERNATIONAL INC., DEERFIELD, IL, BAXTER LABORATORIES, INC., MORTON GROVE, IL:
559,151. REN. 5-18-12. U.S. CL. 18 (INT. CL. 5).
- BAYADERA MANAGEMENT LIMITED, CYPRUS:
4,162,915, PUB. 4-10-2012. INT. CL. 33.
- BAYCOM OPTO-ELECTRONICS TECHNOLOGY CO., LTD., TAIWAN, TAIWAN:
2,611,648. REN. 5-21-12. INT. CL. 9.
- BAYER AKTIENGESELLSCHAFT, LEVERKUSEN-BAYERWERK, FED REP GERMANY:
863,815, CANC. U.S. CL. 15.
- BAYER AKTIENGESELLSCHAFT, FED REP GERMANY:
4,162,837, PUB. 11-1-2011. MULTIPLE CLASS, INT. CLS. 16 AND 44.
- BAYER AKTIENGESELLSCHAFT, LEVERKUSEN, FED REP GERMANY:
4,163,560, PUB. 4-10-2012. INT. CL. 5.
4,163,561, PUB. 4-10-2012. INT. CL. 5.
4,163,693, PUB. 3-6-2012. MULTIPLE CLASS, INT. CLS. 5 AND 10.
- BAYER PHARMA AG, BERLIN, FED REP GERMANY, FORMERLY BAYER SCHERING PHARMA AG:
4,164,743, PUB. 3-6-2012. INT. CL. 5.
- BAYER SCHERING PHARMA AKTIENGESELLSCHAFT, BERLIN, FED REP GERMANY:
3,005,294, CANC. INT. CL. 5.
3,005,364, CANC. INT. CL. 5.
- BAYERISCHE MOTOREN WERKE AKTIENGESELLSCHAFT, D-80788 MUENCHEN, FED REP GERMANY:
2,569,328. REN. 5-21-12. MULTIPLE CLASS, INT. CLS. 7, 9 AND 12.
- BAYLOR HEALTH CARE SYSTEM, DALLAS, TX:
4,165,396, MULTIPLE CLASS, INT. CLS. 41 AND 44.
4,165,407, MULTIPLE CLASS, INT. CLS. 41 AND 44.
- BAYVIEW FINANCIAL, L.P., CORAL GABLES, FL:
2,974,760, CANC. INT. CL. 36.
- BAZAR GROUP, INC. THE, EAST PROVIDENCE, RI:
1,660,766, CANC. INT. CL. 14.
- BB ENDEAVORS LLC, NEW YORK, NY:
4,163,376, PUB. 4-10-2012. MULTIPLE CLASS, INT. CLS. 41 AND 44.
- BBCN BANCORP, INC., LOS ANGELES, CA:
4,164,670, PUB. 4-10-2012. INT. CL. 36.
4,164,700, PUB. 4-10-2012. INT. CL. 36.
4,164,701, PUB. 4-10-2012. INT. CL. 36.
4,164,704, PUB. 4-10-2012. INT. CL. 36.
- BCTLD, LLC, SEATTLE, WA:
4,165,664, INT. CL. 33.
- BE AEROSPACE, INC., WELLINGTON, FL:
4,165,732, INT. CL. 11.
- BEACHBODY, LLC, SANTA MONICA, CA:
4,164,891, MULTIPLE CLASS, INT. CLS. 5 AND 9.
- BEACHMINT, INC., LOS ANGELES, CA:
4,073,466, AM. MULTIPLE CLASS, INT. CLS. 35, 41, 42 AND 45.
- BEACON APPLICATION SERVICES CORPORATION, FRAMINGHAM, MA:
2,935,045, CANC. INT. CL. 42.
2,935,046, CANC. INT. CL. 42.
2,947,906, CANC. INT. CL. 9.
2,947,907, CANC. INT. CL. 9.
- BEATPORT, LLC, DENVER, CO:
4,163,489, PUB. 1-3-2012. INT. CL. 41.
- BEAUDOIN, JEFFREY, ELYRIA, OH:
4,165,821, INT. CL. 31.
- BEAUTY BOOTH LLC, CHICAGO, IL:
4,165,159, INT. CL. 3.
- BEAUTYBANK INC., NEW YORK, NY:
4,165,131, INT. CL. 3.
- BECK AG, INC., WAYNE, NE:
4,164,230, PUB. 4-10-2012. INT. CL. 35.
4,164,635, PUB. 4-10-2012. INT. CL. 35.
4,164,636, PUB. 4-10-2012. INT. CL. 35.
- BECTON, DICKINSON AND COMPANY, FRANKLIN LAKES, NJ:
3,374,298, CANC. INT. CL. 10.
- BEDFORD REINFORCED PLASTICS INC., BEDFORD, PA:
4,165,610, INT. CL. 19.
4,165,611, INT. CL. 19.
- BEECH-NUT NUTRITION CORPORATION, AMSTERDAM, NY:
4,165,499, MULTIPLE CLASS, INT. CLS. 29 AND 30.
- BEENE, LONDON, GRAY, TN:
4,166,030, INT. CL. 39.

BEETLEFARM, LLC, SAN FRANCISCO, CA, DBA CUBAN COUNCIL:
4,163,780, PUB. 4-10-2012. MULTIPLE CLASS, INT. CLS. 35 AND 42.

BEIJING OUTSELL HEALTH PRODUCT DEVELOPMENT CO., LTD, BEIJING, CHINA:
4,163,079, PUB. 2-28-2012. MULTIPLE CLASS, INT. CLS. 5, 10, 29, 30, 32, 36, 40 AND 43.

BEIJING RED STAR (STOCK) CO., LTD., BEIJING, CHINA:
2,674,129, REN. 5-23-12. INT. CL. 33.

BEIJING ZHIRUI TECHNOLOGY LIMITED, BEIJING, CHINA:
4,165,579, INT. CL. 9.

BELANGER, INC., NORTHVILLE, MI:
4,165,525, INT. CL. 7.

BELING, JOEL L, DALLAS, VICTORIA, AUSTRALIA, DBA SUPA CHARACTERS PTY LTD:
4,163,456, PUB. 4-10-2012. MULTIPLE CLASS, INT. CLS. 16, 25, 28 AND 41.

BELL, CHELSEA L, BOULDER CREEK, CA:
4,164,465, PUB. 4-10-2012. INT. CL. 35.

BELL'S BREWERY, INC., GALESBURG, MI:
4,163,296, PUB. 4-10-2012. MULTIPLE CLASS, INT. CLS. 20, 25 AND 32.

BELLE MUD & SALT LTD., ARAD, ISRAEL:
4,164,893, MULTIPLE CLASS, INT. CLS. 3 AND 35.

BELLOFRAM CORPORATION, NEWELL, WV:
1,196,112, REN. 5-21-12. MULTIPLE CLASS, INT. CLS. 6 AND 9.

BELTWAY MOVERS ASSOCIATES, INC., ALEXANDRIA, VA:
4,164,148, PUB. 4-10-2012. INT. CL. 39.

BEMIS ASSOCIATES, INC., SHIRLEY, MA:
2,668,279, REN. 5-19-12. INT. CL. 17.

BENCOM S.R.L., TREVISO, ITALY:
2,508,283, REN. 5-18-12. MULTIPLE CLASS, INT. CLS. 18, 25 AND 35.

BENCOM SRL, TREVISO, ITALY:
4,164,691, PUB. 4-10-2012. INT. CL. 25.

BENEFICIAL MANAGEMENT CORPORATION, WILMINGTON, DE:
505,618, CANC. U.S. CL. 102.

BENEFICIAL MANAGEMENT CORPORATION OF AMERICA, WILMINGTON, DE:
505,508, CANC. U.S. CL. 102.

BENKOWSKI, DON V, AVON, MN:
4,163,220, PUB. 4-10-2012. INT. CL. 19.

BENNIGAN'S IP, LLC, ATLANTA, GA:
862,523, CANC. U.S. CL. 100.

BENNINGTON COMPANY, THE, UNION, NJ:
863,515, CANC. U.S. CL. 32.

BENSON MEDICAL SERVICES PTY LTD, CORAL COVE, QUEENSLAND, AUSTRALIA:
4,164,286, PUB. 4-10-2012. INT. CL. 10.

BENTHOS, INC., NORTH FALMOUTH, MA:
863,117, CANC. U.S. CL. 26.

BENTLEY INSTRUMENTS INC, CHASKA, MN:
4,165,996, INT. CL. 9.

BENTLEY SYSTEMS, INCORPORATED, EXTON, PA:
2,499,207, CANC. INT. CL. 9.

BENTLY NEVADA, INC., MINDEN, NV:
4,165,089, INT. CL. 9.

BENTON THERAPEUTICS, INC., DIAMOND BAR, CA:
4,165,474, INT. CL. 5.

BENZ RESEARCH AND DEVELOPMENT CORPORATION, SARASOTA, FL:
2,573,992, REN. 5-22-12. INT. CL. 9.

BERARDI, JOSEPH, PHILADELPHIA, PA:
4,162,776, PUB. 6-22-2010. INT. CL. 44.

BERETTA U.S.A. CORP., ACCOKEEK, MD:
4,165,282, INT. CL. 13.

BERG + SCHMIDT GMBH & CO. KG, FED REP GERMANY:
4,162,944, PUB. 4-10-2012. MULTIPLE CLASS, INT. CLS. 1 AND 4.
4,162,973, PUB. 4-10-2012. MULTIPLE CLASS, INT. CLS. 1, 4 AND 29.

BERKELEY ELECTRIC COOPERATIVE, INC., MONCKS CORNER, SC:
2,510,788, REN. 5-18-12. INT. CL. 39.

BERKELEY HEARTLAB, INC., BURLINGAME, CA:
2,571,576, REN. 5-24-12. INT. CL. 42.

BERLIN KING OF PIZZA, INC., BERLIN, NJ:
2,569,105, REN. 5-21-12. INT. CL. 30.

BERNARD, MARY C., HOUSTON, TX:
4,165,201, INT. CL. 25.

BERNAT YARN & CRAFT, UXBRIDGE, MA:
863,580, CANC. U.S. CL. 43.

BERNSTEIN-REIN ADVERTISING, INC., KANSAS CITY, MO:
4,115,285, COR. INT. CL. 35.

BEST BEVERAGE, LLC, NEWPORT BEACH, CA:
4,166,048, MULTIPLE CLASS, INT. CLS. 32 AND 33.

BEST OF TASTE, INC., THE, SCOTTSDALE, AZ:
1,742,546, REN. 5-21-12. U.S. CL. B.

BEST WOOL CARPETS BV, NETHERLANDS:
4,162,891, PUB. 4-10-2012. INT. CL. 27.

BESTDISC TECHNOLOGY CORP., KEELUNG, TAIWAN:
4,165,715, INT. CL. 11.

BESTWAY, INC., DALLAS, TX:
4,163,934, PUB. 4-10-2012. INT. CL. 35.

BETCO CORPORATION, TOLEDO, OH:
4,164,687, PUB. 4-10-2012. INT. CL. 1.

BETEILIGUNGEN SORG GMBH & CO. KG, LOHR/MAIN, FED REP GERMANY:
4,163,239, PUB. 4-10-2012. MULTIPLE CLASS, INT. CLS. 7, 9, 11 AND 19.
4,163,240, PUB. 4-10-2012. MULTIPLE CLASS, INT. CLS. 7, 9, 11 AND 19.

BETH ISRAEL DEACONESS MEDICAL CENTER, INC., BOSTON, MA:
4,163,994, PUB. 4-10-2012. INT. CL. 44.

BETHANY'S BEST, LLC, ATLANTIC HIGHLANDS, NJ:
4,164,671, PUB. 4-10-2012. INT. CL. 30.

BETTY BOSSI AG, ZÜRICH, SWITZERLAND:
4,163,029, PUB. 4-10-2012. MULTIPLE CLASS, INT. CLS. 4, 8, 20, 21, 24, 35, 39 AND 42.

BEVERLY HILLS ONCOLOGY MEDICAL GROUP, INC., BEVERLY HILLS, CA:
4,166,025, INT. CL. 44.
4,166,026, INT. CL. 44.

BEVERLY L. HAWKINSON, ESCONDIDO, CA, DBA CURTAIN CALL:
4,163,303, PUB. 1-3-2012. INT. CL. 42.

BEYAZ, ADRIAN, INGLEWOOD, CA:
2,983,288, CANC. INT. CL. 18.

BEYOND CLEAN, LLC, JUPITER, FL:
2,572,279, REN. 5-18-12. INT. CL. 3.

BEYOND THE BOX, INC., LEWISVILLE, NC:
4,164,959, INT. CL. 25.

BGB PET SUPPLY, INC., BURTON, MI:
1,572,252, CANC. INT. CL. 31.

BHANDARI, SANJAY, LONDON, NW2 4DS, UNITED KINGDOM:
3,005,326, CANC. MULTIPLE CLASS, INT. CLS. 3, 5, 35 AND 44.

BI INCORPORATED, BOULDER, CO:
2,574,311, REN. 5-22-12. INT. CL. 9.

BIANCA OF NEVADA, INC., LAS VEGAS, NV:
858,399, CANC. U.S. CL. 101.

BIAS, STACY, PORTLAND, OR:
2,498,459, CANC. INT. CL. 42.

BIBES AB, SWEDEN:
4,162,864, PUB. 4-10-2012. MULTIPLE CLASS, INT. CLS. 3, 21 AND 24.

BIC CORPORATION, SHELTON, CT:
4,164,259, PUB. 4-10-2012. INT. CL. 16.

BICOR PROCESSING CORP., BROOKLYN, NY:
4,165,242, INT. CL. 20.

BIEN, STEPHANIE, WESLEY CHAPEL, FL:
4,163,782, PUB. 4-10-2012. INT. CL. 44.

BIER DESIGNS INC, FRESNO, CA, DBA E13CTRON:
4,164,417, PUB. 4-10-2012. INT. CL. 9.

BIERMANN PRODUCTIONS LLC, WICHITA, KS:
4,164,808, INT. CL. 41.

- BIG CHEF CHINESE RESTAURANT INC., JERSEY CITY, NJ:
2,497,990, CANC. INT. CL. 42.
- BIG D INDUSTRIES, INC., OKLAHOMA CITY, OK:
1,721,351. REN. 5-18-12. INT. CL. 5.
- BIG DOG LICENSING, LLC, SANTA BARBARA, CA:
2,570,563. REN. 5-22-12. INT. CL. 35.
- BIG ROCK BREWERY LIMITED PARTNERSHIP, CALGARY, CANADA:
1,696,391. REN. 5-24-12. INT. CL. 32.
- BIG TWELVE CONFERENCE, INC., THE, IRVING, TX:
2,608,756. REN. 5-18-12. INT. CL. 25.
- BIG Y FOODS, INC., SPRINGFIELD, MA:
4,162,791, PUB. 4-10-2012. INT. CL. 35.
- BIGJIGS TOYS LTD., FOLKESTONE, KENT, GREAT BRITAIN:
4,163,181, PUB. 4-10-2012. INT. CL. 28.
- BIL-JAX, INC., ARCHBOLD, OH:
2,579,365. REN. 5-18-12. INT. CL. 6.
- BILLY AND BROOKE WOLFF PRODUCTIONS, LOS ANGELES, CA:
2,497,759, CANC. MULTIPLE CLASS, INT. CLS. 9 AND 41.
- BIOCONTROL SYSTEMS, INC., BELLEVUE, WA:
1,665,381. REN. 5-24-12. INT. CL. 1.
- BIOFEEDBACK CERTIFICATION INSTITUTE OF AMERICA, WHEAT RIDGE, CO:
4,166,054, U.S. CL. B.
- BIOLYST, LLC, MINNEAPOLIS, MN:
4,165,483, MULTIPLE CLASS, INT. CLS. 10, 35 AND 44.
- BIOMASS MARKETING, LLC, ROCKY MOUNT, NC:
4,164,130, PUB. 4-10-2012. INT. CL. 7.
- BIOMED REALTY TRUST, INC., SAN DIEGO, CA:
4,165,885, MULTIPLE CLASS, INT. CLS. 36 AND 37.
- BIOMEDICAL POLYMERS, INC., GARDNER, MA:
4,162,698, PUB. 4-10-2012. INT. CL. 42.
- BIOMEDTRIX, LLC, BOONTON, NJ:
4,162,700, PUB. 4-10-2012. INT. CL. 10.
- BIOPHARMA SCIENTIFIC, LLC, CARLSBAD, CA:
4,163,806, PUB. 4-10-2012. INT. CL. 5.
- BIOREM ENVIRONMENTAL INC., GUELPH, ONTARIO, CANADA:
2,627,689. REN. 5-18-12. INT. CL. 11.
- BIORIGINAL FOOD & SCIENCE CORP, SASKATOON, SASKATCHEWAN, CANADA:
2,644,247. REN. 5-23-12. INT. CL. 5.
- BIOTRONIK SE & CO. KG, FED REP GERMANY:
3,006,028.
- BIRCH GROVE SOFTWARE, INC., DALLAS, TX:
4,163,522, PUB. 11-1-2011. INT. CL. 9.
- BIROCHEM KUTATASI-, FEJLESZTESI ES KERESKEDELMI KFT., HEGEDUS GYULA U.63. II/27, HUNGARY:
2,599,892. REN. 5-23-12. INT. CL. 5.
- BISCOTTI INC., BOULDER, TX:
4,165,691, INT. CL. 38.
- BISHOP'S BARBERSHOP, LLC, PORTLAND, OR:
2,948,057. COR. INT. CL. 44.
- BISMARK, MAXIMILIAN GRAF VON, REINBEK, FED REP GERMANY:
2,527,707. REN. 5-24-12. INT. CL. 33.
- BISON CORPORATION, CANTON, OH:
858,746, CANC. U.S. CL. 4.
- BISSLAND, MARVIN, MT PLEASANT, SC:
4,165,841, INT. CL. 25.
- BIZETA IP S.R.L., ITALY:
3,051,218.
- BLACK & VEATCH HOLDING COMPANY, OVERLAND PARK, KS, PRITCHARD CORPORATION, THE, KANSAS CITY, MO:
1,201,467. REN. 5-18-12. MULTIPLE CLASS, INT. CLS. 37 AND 42.
- BLACK DIAMOND GAMING LLC., NORTHBROOK, IL:
4,163,453, PUB. 4-10-2012. INT. CL. 30.
- BLACK TOOTH BRAND, LLC, BURBANK, CA:
4,164,917, INT. CL. 30.
- BLACK'S 14TH STREET LLC, BETHESDA, MD:
4,165,818, INT. CL. 43.
- BLACKSTONE ALTERNATIVE ASSET MANAGEMENT L.P., NEW YORK, NY:
4,163,686, PUB. 4-10-2012. INT. CL. 36.
- BLAIR, ELIZABETH L., KANSAS CITY, MO:
4,165,737, INT. CL. 9.
- BLAKE PROJECT, INC., THE, PALM BAY, FL:
4,164,646, PUB. 4-10-2012. INT. CL. 35.
- BLAST OFF, INC., LOS ANGELES, CA:
4,164,025, PUB. 4-10-2012. INT. CL. 41.
- BLISSFIELD MANUFACTURING CO., BLISSFIELD, MI:
4,164,685, PUB. 4-10-2012. MULTIPLE CLASS, INT. CLS. 6, 7, 11 AND 40.
- 4,164,686, PUB. 4-10-2012. MULTIPLE CLASS, INT. CLS. 6, 7, 11 AND 40.
- BLIZZARD ENTERTAINMENT, INC., IRVINE, CA:
3,006,449, CANC. INT. CL. 25.
- BLOOM ENGINEERING COMPANY, INC., PITTSBURGH, PA:
2,607,442. REN. 5-18-12. MULTIPLE CLASS, INT. CLS. 9, 11 AND 42.
- 2,607,442, CANC. INT. CL. 17.
- BLOOMBERG FINANCE ONE L.P., NEW YORK, NY:
3,274,053, AM. INT. CL. 36.
- BLUE FOX NEDGRAPHICS, INC., NEW YORK, NY:
2,498,147, CANC. INT. CL. 9.
- BLUE GEM SUNGLASSES, INC., CARPINTERIA, CA:
4,164,466, PUB. 4-10-2012. INT. CL. 9.
- BLUE MOON HOLDINGS, LLC, CINCINNATI, OH:
4,165,454, INT. CL. 5.
- BLUE MOOSE TRADING CO., WESTERVILLE, OH, BLUE MOOSE TRADING CO., WESTERVILLE, OH:
2,618,563. REN. 5-18-12. INT. CL. 25.
- BLUE MOUNTAIN WALLCOVERINGS CANADA INC., BOUCHERVILLE, CANADA:
4,163,150, PUB. 4-10-2012. MULTIPLE CLASS, INT. CLS. 16 AND 27.
- BLUE SPYDER MOBILE MEDIA, SHERTZ, TX, DBA PHUNRAISER:
4,164,509, PUB. 4-10-2012. INT. CL. 35.
- BLUE SUN PUBLISHING, LLC, CLEARWATER, FL:
3,006,147, CANC. INT. CL. 41.
- BLUEPAY PROCESSING, LLC, NAPERVILLE, IL:
2,646,932. REN. 5-18-12. INT. CL. 36.
- BLUESHIFT RESEARCH LLC, SAN FRANCISCO, CA:
4,163,304, PUB. 4-10-2012. INT. CL. 35.
- BLUEWATER CHEMGROUP, INC., BRADENTON BEACH, FL:
4,164,397, PUB. 4-10-2012. INT. CL. 2.
- 4,164,401, PUB. 4-10-2012. INT. CL. 1.
- 4,164,404, PUB. 4-10-2012. INT. CL. 5.
- 4,164,407, PUB. 4-10-2012. INT. CL. 5.
- 4,164,409, PUB. 4-10-2012. INT. CL. 1.
- BML ISTISHARAT SAL, BEIRUT, LEBANON:
2,570,027. REN. 5-18-12. INT. CL. 42.
- BNG ENTERPRISES, INC., TEMPE, AZ:
2,705,331. REN. 5-24-12. INT. CL. 5.
- BOARD OF REGENTS, THE UNIVERSITY OF TEXAS SYSTEM, AUSTIN, TX:
2,581,764. REN. 5-18-12. MULTIPLE CLASS, INT. CLS. 41 AND 42.
- BOARD OF TRUSTEES OF THE GEORGE WASHINGTON UNIVERSITY, THE, WASHINGTON, DC:
1,691,680. REN. 5-24-12. INT. CL. 25.
- BOARDROOM INC., STAMFORD, CT:
4,164,411, PUB. 4-10-2012. INT. CL. 16.
- BOARDROOM, INC., STAMFORD, CT:
2,574,026. REN. 5-22-12. INT. CL. 42.
- BOB WEISS, NEW YORK, NY:
4,165,802, INT. CL. 35.
- BOB'S SPACE RACERS, INC., DAYTONA BEACH, FL:
1,697,776. REN. 5-23-12. INT. CL. 28.
- BOB'S YOUR UNCLE, INC., NEW YORK, NY:
4,163,511, PUB. 4-10-2012. INT. CL. 35.
- BOBRICK WASHROOM EQUIPMENT, INC., NORTH HOLLYWOOD, CA:
2,574,319. REN. 5-21-12. INT. CL. 20.
- BODEGAS FARIÑA, S.L., SPAIN:
4,162,801, PUB. 4-10-2012. INT. CL. 33.

BODEGAS VEGA SICILIA, S.A., 47359 VALBUENA DE DUERO (VALLADOLID), SPAIN:
1,724,102. REN. 5-22-12. INT. CL. 33.

BODYBLOCKS NUTRITION SYSTEMS, INC., ATLANTA, GA:
2,974,183. CANC. MULTIPLE CLASS, INT. CLS. 29 AND 32.

BODYMIND INSTITUTE - IBSR LLC, WHEELING, WV:
4,164,149. PUB. 4-10-2012. INT. CL. 41.

BOGHOSIAN, CHARLIE, JAMUL, CA:
4,165,970. INT. CL. 30.

BOLDT ENTERTAINMENT INC., MINNEAPOLIS, MN:
2,499,244. CANC. INT. CL. 16.

BOLLYDOLL, LLC, LOS ANGELES, CA:
4,165,937. INT. CL. 18.

BOMASS LIMITED, KWAI CHUNG, N.T., HONG KONG:
2,690,855. REN. 5-22-12. MULTIPLE CLASS, INT. CLS. 9 AND 14.

BONITA BAY CLUB, INC., BONITA SPRINGS, FL:
2,569,433. REN. 5-18-12. INT. CL. 25.

BONNE BELL, INC., WESTLAKE, OH:
2,617,932. REN. 5-21-12. MULTIPLE CLASS, INT. CLS. 3 AND 5.

BOOKS-A-MILLION, INC., BIRMINGHAM, AL:
2,569,473. REN. 5-19-12. INT. CL. 35.

BOOM RIGHT, PHOENIX, AZ:
4,164,923. INT. CL. 9.

BORGHESE TRADEMARKS, INC., WILMINGTON, DE:
4,164,284. PUB. 4-10-2012. INT. CL. 25.

BORRI S.P.A., BIBBIENA (AR), ITALY:
4,163,016. PUB. 4-10-2012. INT. CL. 9.

BOSLEY, INC., BEVERLY HILLS, CA:
4,163,893. PUB. 4-10-2012. INT. CL. 10.

BOSTIK, INC., WAUWATOSA, WI, NEVER-SEEZ COMPOUND CORP., BROADVIEW, IL:
937,412. REN. 5-22-12. U.S. CL. 15 (INT. CL. 4).

BOULDER MARATHON, LLC, BOULDER, CO:
4,166,035. INT. CL. 41.

BRACES DIRECT, LLC, COCONUT CREEK, FL:
4,165,865. INT. CL. 35.

BRADY CORPORATION LIMITED, BANBURY, OXFORDSHIRE OX16 3JU, UNITED KINGDOM:
1,684,462. REN. 5-18-12. INT. CL. 20.

BRADY WORLDWIDE, INC., MILWAUKEE, WI:
2,569,898. REN. 5-19-12. INT. CL. 35.
2,569,898. AM. INT. CL. 35.
2,590,083. REN. 5-18-12. INT. CL. 20.

BRAND MANAGEMENT GROUP LLC, GAINESVILLE, VA:
4,010,128. COR. INT. CL. 30.

BRAND, CHRISTOPHER, WOODBURY, MN:
4,164,535. PUB. 4-10-2012. INT. CL. 45.

BRANDY LIBRARY LOUNGE, LLC, NEW YORK, NY:
4,165,482. INT. CL. 41.

BRAR NATURAL FLOUR MILLING INC., WINNIPEG, MANITOBA, CANADA:
4,163,498. PUB. 4-10-2012. INT. CL. 30.

BRASSTECH, INC., SANTA ANA, CA:
2,574,555. REN. 5-22-12. INT. CL. 21.

BRAZABRA CORPORATION, LEE, MA:
4,164,415. PUB. 4-10-2012. INT. CL. 26.

BRAZOS PRIVATE EQUITY PARTNERS, LLC, DALLAS, TX:
2,711,894. REN. 5-18-12. INT. CL. 36.

BRENT A. WILLIAMS, TOPSHAM, ME AND JESSICA C. WILLIAMS, TOPSHAM, ME:
4,164,539. PUB. 4-10-2012. INT. CL. 14.

BRENT, DOUG, LOUISVILLE, KY:
4,164,472. PUB. 4-10-2012. INT. CL. 25.

BREUCKELEN DISTILLING COMPANY INCORPORATED, BROOKLYN, NY:
4,164,948. INT. CL. 33.

BRIAN MCALISTER, NEWTON, NJ, DBA MACSIMUM PUBLISHING LLC:
4,163,193. PUB. 4-10-2012. INT. CL. 45.

BRIAN STEVENS COLLECTION LLC, BOSTON, MA:
4,164,141. PUB. 4-10-2012. INT. CL. 25.

BRIC-A-BRAC, LLC, HONOLULU, HI:
1,679,565. REN. 5-23-12. INT. CL. 30.

BRICKER & ECKLER LLP, COLUMBUS, OH:
2,569,377. REN. 5-19-12. MULTIPLE CLASS, INT. CLS. 16 AND 42.

BRIDGE BRANDS, SAN FRANCISCO, CA:
4,165,621. INT. CL. 30.

BRIDGESTONE BANDAG, LLC, MUSCATINE, IA:
2,581,373. REN. 5-21-12. INT. CL. 12.

BRIDGESTONE SPORTS CO., LTD., TOKYO, JAPAN:
4,163,751. PUB. 4-10-2012. INT. CL. 28.

BRIGGEMAN, ELIZABETH, KETCHUM, ID:
4,164,175. PUB. 4-10-2012. INT. CL. 45.

BRIGGS & RILEY TRAVELWARE, LLC, HAUPPAUGE, NY:
2,798,945. COR. INT. CL. 18.
3,046,865. COR. INT. CL. 18.
3,199,288. COR. INT. CL. 18.
3,319,446. COR. INT. CL. 18.
3,382,899. COR. MULTIPLE CLASS, INT. CLS. 9 AND 18.
3,468,705. COR. MULTIPLE CLASS, INT. CLS. 9 AND 18.
3,469,708. COR. INT. CL. 18.
3,639,419. COR. MULTIPLE CLASS, INT. CLS. 9 AND 18.
3,938,788. COR. INT. CL. 18.

BRILLKIDS, INC., CENTRAL, HONG KONG:
4,163,991. PUB. 4-10-2012. INT. CL. 9.
4,163,992. PUB. 4-10-2012. MULTIPLE CLASS, INT. CLS. 9, 16 AND 41.

BRINN'S CHINA AND GLASSWARE CO., INC., PITTSBURGH, PA:
861,359. CANC. U.S. CL. 30.

BRISTOL-MYERS SQUIBB COMPANY, NEW YORK, NY:
4,164,840. INT. CL. 41.
4,165,272. MULTIPLE CLASS, INT. CLS. 16 AND 41.

BRITANNIA PHARMACEUTICALS LIMITED, SURREY, UNITED KINGDOM:
3,005,602. CANC. MULTIPLE CLASS, INT. CLS. 5 AND 10.

BRITELYT, INC., NEW PORT RICHEY, FL:
4,162,711. PUB. 4-10-2012. INT. CL. 11.

BROAD, VOGT AND CONANT, INC., RIVER ROUGE, MI:
1,277,383. CANC. INT. CL. 37.

BROADRIDGE FINANCIAL SOLUTIONS, INC., JERSEY CITY, NJ:
4,165,203. INT. CL. 42.

BROAN MFG. CO., INC., HARTFORD, WI:
860,081. CANC. U.S. CL. 34.

BROASTER COMPANY, THE, BELOIT, WI:
1,690,034. REN. 5-19-12. MULTIPLE CLASS, INT. CLS. 11 AND 30.

BRODAR, ERIC, KENNEBUNK, ME:
4,164,817. INT. CL. 25.

BRONKHORST, MARK VAN, ALBANY, CA:
3,006,532. CANC. INT. CL. 9.

BROOKDALE LIVING COMMUNITIES, INC., CHICAGO, IL:
3,092,190. CANC. INT. CL. 44.

BROOKS CAMERAS, INC., SAN FRANCISCO, CA:
1,219,802. CANC. MULTIPLE CLASS, INT. CLS. 9, 40 AND 42.

BROOKSHIRE BROTHERS, INC., LUFKIN, TX:
4,165,638. INT. CL. 35.

BROTHER RECORDS, INC., DEL MAR, CA:
2,631,628. REN. 5-18-12. INT. CL. 9.

BROWN BAG BIBLE BUDDIES MINISTRY, CANTON, MS:
4,165,172. INT. CL. 45.
4,165,173. INT. CL. 41.

BROWN BROTHERS HARRIMAN & CO., NEW YORK, NY:
2,713,892. REN. 5-19-12. INT. CL. 36.

BROWN SHOE COMPANY, INC., ST. LOUIS, MO:
854,945. CANC. U.S. CL. 3.

BROWN, WESLEY B., LOS ANGELES, CA:
4,165,693. MULTIPLE CLASS, INT. CLS. 9 AND 41.
4,165,694. INT. CL. 41.

BRT HOLDINGS, INC., GREENSBORO, NC, DBA HOMEWAY FURNITURE:
1,295,201. CANC. INT. CL. 42.

BRUNO INDEPENDENT LIVING AIDS, INC., OCONOMOWOC, WI:
4,165,692. INT. CL. 12.

- BRYANT-MCNEIL, RASHEEDA, CHARLOTTE, NC:
4,163,788, PUB. 4-10-2012. INT. CL. 35.
- BSA COMPANY LIMITED, SOUTHAMPTON, UNITED KINGDOM:
4,165,950, INT. CL. 25.
- BUCKEYE CELLULOSE CORPORATION, THE, CINCINNATI, OH:
501,998, CANC. U.S. CL. 46.
- BUCKHEAD LIFE RESTAURANT GROUP, INC., ATLANTA, GA:
2,545,703, REN. 5-24-12. INT. CL. 42.
- BUGNON, DAVID, WOODBURY, MN:
4,165,545, INT. CL. 16.
- BUILD-A-BEAR WORKSHOP, INC., ST. LOUIS, MO TO BUILD-A-BEAR RETAIL MANAGEMENT, INC., ST. LOUIS, MO:
2,497,717, CANC. INT. CL. 28.
- BULLY BLING ENERGY, LLC, ST. PETERSBURG, FL:
4,163,251, PUB. 4-10-2012. INT. CL. 32.
- BULOVA WATCH COMPANY, INC., NEW YORK, NY:
505,673, CANC. U.S. CL. 27.
- BUNGE MILLING, INC., ST. LOUIS, MO:
2,623,082, REN. 5-24-12. INT. CL. 30.
- BURGOYNE, ADAM, MIAMI, FL:
4,163,894, PUB. 4-10-2012. INT. CL. 3.
- BURKEY, DARYLE W, LYNN HAVEN, FL AND BURKEY, MELANIE F, LYNN HAVEN, FL:
4,163,232, PUB. 4-10-2012. INT. CL. 41.
- BURLINGTON INDUSTRIES LLC, GREENSBORO, NC:
855,166, CANC. U.S. CL. 43.
858,995, CANC. U.S. CL. 42.
- BURR & FORMAN LLP, BIRMINGHAM, AL:
2,645,153, REN. 5-18-12. INT. CL. 42.
- BURRESS, TIFFANY J., TOTOWA, NJ:
4,164,793, INT. CL. 25.
- BURRUSS INVESTMENTS, LLC, ANNAPOLIS, MD:
2,988,393, CANC. MULTIPLE CLASS, INT. CLS. 9, 16, 35 AND 43.
- BUSCH AGRICULTURAL RESOURCES, LLC, ST. LOUIS, MO:
2,616,547, REN. 5-24-12. INT. CL. 30.
- BUSHNELL INC., OVERLAND PARK, KS:
3,006,512, CANC. MULTIPLE CLASS, INT. CLS. 9 AND 25.
- BUSINESS LITERACY SERVICES, LLC, MILWAUKEE, WI:
2,498,897, CANC. INT. CL. 35.
- BUSINESS RECOVERY SERVICES, INC., ALAMEDA, CA, G & J, INC., SAN RAMON, CA, DBA BANK UP:
1,716,751, REN. 5-18-12. INT. CL. 42.
- BUSY BEES COLLECTION, INC., ROSS, CA:
4,164,603, PUB. 4-10-2012. INT. CL. 25.
- BUTLER ANIMAL HEALTH SUPPLY, LLC, DUBLIN, OH, DBA BUTLER SCHEIN ANIMAL HEALTH:
4,165,479, INT. CL. 35.
4,165,480, INT. CL. 35.
- BUTLER, DAVID MARK, KANSAS CITY, MO:
4,165,462, INT. CL. 16.
- BUTTERFLY ARTISTIC MEDIA, LLC, NEW YORK, NY:
4,165,933, INT. CL. 41.
- BWF TEXTIL GMBH & CO. KG, OFFINGEN, FED REP GERMANY:
4,165,248, MULTIPLE CLASS, INT. CLS. 7, 41 AND 42.
- BYCOSIN AB, 652 21, KARLSTAD, SWEDEN:
779,739, CANC. U.S. CL. 15.
- BYCOSIN AB, 652 21 KARLSTAD, SWEDEN:
779,740, CANC. U.S. CL. 15.
- BYSEN & BIDDY, CHARLOTTE, NC:
3,006,220, CANC. INT. CL. 25.
- C & L SERVICE CORPORATION, PORTSMOUTH, VA, DBA EXCLUSIVELY FOR MEN:
4,165,568, INT. CL. 45.
- C.A.B. ROOFING AND CONSTRUCTION, INC., NEW PHILADELPHIA, OH, DBA BEATTY'S BUILDERS:
4,163,609, PUB. 4-10-2012. MULTIPLE CLASS, INT. CLS. 19 AND 37.
- C.D.C. S.R.L., 63-56012 FORNACETTE DI CALCINAIA (PISA), ITALY:
3,005,389, CANC. INT. CL. 16.
- C.E. BRADLEY LABORATORIES, INC., BRATTLEBORO, VT, INDUSTRIAL COATINGS, INC., BRATTLEBORO, VT:
1,744,171, REN. 5-23-12. INT. CL. 2.
- C.R. BARD, INC., MURRAY HILL, NJ:
863,316, CANC. U.S. CL. 44.
- C.R. GIBSON COMPANY, THE, NORWALK, CT:
859,325, CANC. U.S. CL. 38.
- C&A INTERNATIONAL, LLC, BROKEN ARROW, OK:
4,163,267, PUB. 4-10-2012. INT. CL. 21.
- C-QUEST, INC., COMMERCE, CA:
4,164,547, PUB. 4-10-2012. INT. CL. 25.
- CAANES, LLC, ALBUQUERQUE, NM:
4,165,472, INT. CL. 9.
- CABLE MANAGEMENT LLC, MERIDEN, CT:
4,163,781, PUB. 4-10-2012. MULTIPLE CLASS, INT. CLS. 7 AND 40.
- CABLE NEWS NETWORK, INC., ATLANTA, GA:
4,165,491, INT. CL. 41.
- CACHE, INC., NEW YORK, NY, ATOURS, INC., MIAMI, FL:
1,194,124, REN. 5-23-12. INT. CL. 42.
- CADUCEUS OCCUPATIONAL MEDICINE, LLC, ATLANTA, GA:
4,165,342, INT. CL. 35.
- CADVISION MEDICAL TECHNOLOGIES LTD., JERUSALEM 91531, ISRAEL:
3,005,377, CANC. MULTIPLE CLASS, INT. CLS. 9 AND 10.
- CAESARS WORLD, INC., LAS VEGAS, NV:
2,707,034, REN. 5-22-12. INT. CL. 41.
- CAFE NEGRO GALLERIA, S. DE R.L. DE C.V., ZAPOPAN, JALISCO, MEXICO:
4,162,781, PUB. 4-10-2012. INT. CL. 36.
- CAICEDO, CARLOS A., BOSTON, MA:
1,662,288, REN. 5-23-12. INT. CL. 9.
- CALAVO GROWERS OF CALIFORNIA, SANTA PAULA, CA, DBA CALAVO:
856,109, CANC. U.S. CL. 46.
- CALEDONIAN INDUSTRIES LIMITED, GLASGOW, UNITED KINGDOM:
4,162,904, PUB. 4-10-2012. MULTIPLE CLASS, INT. CLS. 7 AND 40.
- CALIFORNIA CHAMBER OF COMMERCE, SACRAMENTO, CA:
4,163,985, PUB. 4-10-2012. INT. CL. 35.
- CALIFORNIA PRODUCTS CORPORATION, ANDOVER, ME:
4,165,847, INT. CL. 2.
- CALIFORNIA STATE RAILROAD MUSEUM FOUNDATION, SACRAMENTO, CA:
4,164,703, PUB. 4-10-2012. INT. CL. 36.
- CALIFORNIA SUPERBIKE SCHOOL, INC., GLENDALE, CA:
2,598,026, REN. 5-21-12. INT. CL. 41.
2,598,067, REN. 5-23-12. INT. CL. 41.
- CALLAWAY GARDENS RESORT, INC., PINE MOUNTAIN, GA, GARDENS SERVICES, INC., PINE MOUNTAIN, GA:
1,216,030, REN. 5-23-12. INT. CL. 30.
- CALLIET, DOLTON, NEW ORLEANS, LA:
4,165,668, INT. CL. 25.
- CALPIPE INDUSTRIES, DOWNEY, CA:
4,164,350, PUB. 4-10-2012. INT. CL. 6.
- CALZIFICIO PINELLI S.R.L., ITALY:
4,162,989, PUB. 4-10-2012. INT. CL. 10.
- CALZIFICIO PINELLI SRL, ITALY:
4,162,988, PUB. 4-10-2012. INT. CL. 25.
- CAMERA DI COMMERCIO INDUSTRIA, ARTIGIANATO E AGRICOLTURA DI VERONA, ITALY:
3,225,233, COR. INT. CL. 33.
- CAMP HOSIERY COMPANY, INC., BOWLING GREEN, KY:
863,967, CANC. U.S. CL. 39.
- CAMPBELL, NATALIE MONACO, VIENNA, OH:
4,164,875, INT. CL. 24.
- CAMPBELL, RAYMOND F, LOS ANGELES, CA:
4,163,533, PUB. 4-10-2012. INT. CL. 41.
- CAMPBELL, ROY LEONARD, LONDON, UNITED KINGDOM:
4,163,225, PUB. 4-10-2012. MULTIPLE CLASS, INT. CLS. 9 AND 41.

CAMPION BARROW AND ASSOCIATES OF ILLINOIS, INC., CHAMPAIGN, IL:
4,164,413, PUB. 4-10-2012. INT. CL. 35.

CAMPUS MENTORS, LLC, OXFORD, OH:
4,166,007, INT. CL. 41.

CAMPUS PARTY, INC., PHILADELPHIA, PA:
2,497,959, CANC. MULTIPLE CLASS, INT. CLS. 36, 41 AND 42.

CAMX OUTDOORS, INC., KENT, OH:
4,164,420, PUB. 4-10-2012. INT. CL. 28.

CAN TECHNOLOGIES, INC., MINNETONKA, MN:
2,498,793, CANC. INT. CL. 31.

CANDEN SCHULTZ, LAKEWOOD, CA AND ROBERT SCHULTZ, LAKEWOOD, CA:
4,163,713, PUB. 4-10-2012. MULTIPLE CLASS, INT. CLS. 26 AND 40.

CANDID CULTURE, INC., DENVER, CO:
4,163,777, PUB. 4-10-2012. MULTIPLE CLASS, INT. CLS. 16 AND 41.

CANDIDATE SEEKER, INC., ROBBINSVILLE, NJ:
4,166,002, INT. CL. 35.

CANNER, SARAH, NEW YORK, NY:
4,164,451, PUB. 4-10-2012. INT. CL. 25.

CANTILES DE MITA, S.A. DE C.V., C/P 05120, MEXICO CITY, MEXICO:
2,598,380. REN. 5-20-12. MULTIPLE CLASS, INT. CLS. 35 AND 37.

CANYONROAD CAPITAL LP, SANTA FE, NM:
4,166,045, INT. CL. 36.

CAO, JIANHUA, WALNUT, CA:
4,163,437, PUB. 4-10-2012. MULTIPLE CLASS, INT. CLS. 9 AND 38.

CAPCOM CO., LTD., OSAKA, JAPAN:
4,165,134, INT. CL. 9.

CAPESTORM OUTDOOR APPAREL (PTY) LTD., WYNBERG, CAPE TOWN, SOUTH AFRICA:
4,162,780, PUB. 4-10-2012. INT. CL. 25.

CAPITAL LINK, INC., NEW YORK, NY:
2,609,915. REN. 5-18-12. INT. CL. 36.

CAPITOL EATS, INC., WASHINGTON, DC:
4,164,628, PUB. 4-10-2012. INT. CL. 43.

CAPITOL RECORDS, INC., NEW YORK, NY:
3,006,385, CANC. INT. CL. 9.

CAPT'N NEMO'S GROUP, LLC, CHICAGO, IL:
1,193,442. REN. 5-18-12. INT. CL. 29.

CARAN D'ACHE S.A., 1226 THONEX, SWITZERLAND:
395,596. REN. 5-23-12. U.S. CL. 37 (INT. CL. 16).

CARAUSTAR INDUSTRIES, INC., AUSTELL, GA:
2,569,625. REN. 5-21-12. INT. CL. 16.

CARAVAN PRODUCTIONS, INCORPORATED, LOS ANGELES, CA:
2,978,188, CANC. INT. CL. 41.

CARBOLINE COMPANY, ST. LOUIS, MO TO CARBOLINE INTERNATIONAL CORPORATION, ST. LOUIS, MO:
957,203, AM. U.S. CL. 16.

CARBONELL Y COMPANIA DE CORDOBA, S.A., CORDOBA, SPAIN:
440,911, CANC. U.S. CL. 49.

CARD CARRYING LIBERAL, LLC, PROVIDENCE, RI:
3,006,668, CANC. INT. CL. 16.

CARDIAC PACEMAKERS, INC., ST. PAUL, MN:
2,564,422. REN. 5-23-12. INT. CL. 10.

CARDINAL PATH HOLDING COMPANY, MEDFORD, MA:
4,164,245, PUB. 4-10-2012. INT. CL. 35.
4,164,255, PUB. 4-10-2012. INT. CL. 35.

CARDINAL SERVICES, INC., MAUMEE, OH:
4,164,092, PUB. 4-10-2012. INT. CL. 35.

CAREER EDUCATION CORPORATION, SCHAUMBURG, IL:
4,164,931, INT. CL. 42.

CAREERIMP, INC., PITTSBURGH, PA:
4,164,302, PUB. 4-10-2012. MULTIPLE CLASS, INT. CLS. 35 AND 42.

CAREERSURF LLC, DENVER, CO:
2,498,862, CANC. INT. CL. 35.

CAREINGTON INTERNATIONAL CORPORATION, FRISCO, TX:
4,165,362, INT. CL. 35.

CARGILL, INCORPORATED, WAYZATA, MN:
2,575,349. REN. 5-22-12. INT. CL. 31.

CARGO AIRPORT SERVICES USA, LLC, JAMAICA, NY:
4,164,249, PUB. 4-10-2012. INT. CL. 42.
4,164,268, PUB. 4-10-2012. INT. CL. 42.

CARL ZEISS VISION GMBH, AALEN, FED REP GERMANY:
4,163,819, PUB. 4-10-2012. INT. CL. 9.

CARLA MARINA INC., FORT LEE, NJ:
4,165,505, INT. CL. 14.

CARLISLE INTANGIBLE COMPANY, SYRACUSE, NY:
2,497,444, CANC. INT. CL. 12.

CARLO PAZOLINI TM GLOBAL SERVICE LIMITED, IRELAND:
4,162,818, PUB. 4-10-2012. MULTIPLE CLASS, INT. CLS. 16, 18 AND 25.

CARLOS PALACIOS, HOUSTON, TX:
4,164,335, PUB. 4-10-2012. MULTIPLE CLASS, INT. CLS. 16 AND 35.

CARMEN DUPETIT, FED REP GERMANY:
4,162,839, PUB. 4-10-2012. INT. CL. 32.

CAROLINA GIRLS PERSONALIZED, CHARLESTON, SC:
4,164,394, PUB. 4-10-2012. INT. CL. 25.

CAROLINE H. TOWNSEND, BOSTON, MA:
4,165,971, INT. CL. 41.

CAROTRON, INC., HEATH SPRINGS, SC:
1,692,549. REN. 5-23-12. INT. CL. 9.

CARPENTER CO., RICHMOND, VA:
4,165,915, INT. CL. 20.

CARRELL, QUENTON, HOUSTON, TX:
4,164,139, PUB. 4-10-2012. INT. CL. 41.

CARRIER CORPORATION, FARMINGTON, CT:
739,370. REN. 5-18-12. U.S. CL. 34 (INT. CL. 11).

CARROLL HALL SHELBY TRUST, LOS ANGELES, CA:
3,130,470, COR. INT. CL. 12.
3,261,743, COR. INT. CL. 12.
3,995,716, COR. INT. CL. 28.
3,995,717, COR. INT. CL. 28.
4,043,733, COR. INT. CL. 28.

CARROLL HALL SHELBY TRUST, COMPRISING CARROLL HALL SHELBY, A UNITED STATES CITIZEN, LOS ANGELES, CA:
3,518,393, COR. MULTIPLE CLASS, INT. CLS. 7, 12, 25 AND 28.

CARTER-WALLACE, INC., NEW YORK, NY:
854,675, CANC. U.S. CL. 39.
855,247, CANC. U.S. CL. 51.

CARTIER INTERNATIONAL A.G., 6312 STEINHAUSEN, SWITZERLAND:
3,005,417, CANC. INT. CL. 14.

CARTIER, IAN SHANE, INDIANAPOLIS, IN, AKA D.J. PROPHET:
4,163,940, PUB. 4-10-2012. INT. CL. 41.

CAS PRODUCTION, INC., LOS ANGELES, CA:
4,164,190, PUB. 4-10-2012. INT. CL. 42.

CASCADE DESIGNS, INC., SEATTLE, WA:
4,163,097, PUB. 4-10-2012. MULTIPLE CLASS, INT. CLS. 20 AND 21.

CASE-MATE, INC., TUCKER, GA:
4,164,638, PUB. 4-10-2012. INT. CL. 9.

CASHFLOW TECHNOLOGIES, INC., SCOTTSDALE, AZ:
3,006,343, CANC. INT. CL. 16.
3,006,423, CANC. MULTIPLE CLASS, INT. CLS. 9 AND 41.

CASHMERE SUITCASE LLC, MENDHAM, NJ:
4,163,796, PUB. 4-10-2012. INT. CL. 35.

CASHPIN CORPORATION, NEW YORK, NY:
3,006,101, CANC. MULTIPLE CLASS, INT. CLS. 38, 39 AND 42.

CASTEL JEAN-LOUIS, FRANCE:
4,163,008, PUB. 4-10-2012. MULTIPLE CLASS, INT. CLS. 6, 19, 22 AND 37.

CASTELLA IMPORTS, INC., HAUPPAUGE, NY:
4,164,909, INT. CL. 29.

CASTING MATERIALS COMPANY, INC., WHITE PLAINS, NY:
854,503, CANC. U.S. CL. 14.

- CASTOL LIMITED, SWINDON, WILTSHIRE, UNITED KINGDOM:
4,164,063, PUB. 4-10-2012. INT. CL. 4.
- CAT & THE CUSTARD CUP, LTD., THE, LA HABRA, CA:
1,230,577. REN. 5-24-12. INT. CL. 42.
- CATALINA MARKETING CORPORATION, ST. PETERSBURG, FL:
2,624,986. REN. 5-19-12. INT. CL. 35.
2,664,875. REN. 5-23-12. INT. CL. 35.
- CATALYTICA PHARMACEUTICALS, INC., GREENVILLE, NC:
3,006,080, CANC. INT. CL. 1.
- CATCHPOINT PARTNERS LLC, BOSTON, MA, DBA CATCHPOINT PARTNERS LLC:
4,164,133, PUB. 4-10-2012. INT. CL. 35.
- CATTLEMEN'S DAYS, INC., GUNNISON, CO:
4,163,971, PUB. 4-10-2012. INT. CL. 41.
- CAVINESS WOODWORKING COMPANY, INC., CALHOUN CITY, MS:
1,720,109. REN. 5-18-12. INT. CL. 12.
- CBORD GROUP, INC., THE, ITHACA, NY:
2,499,240, CANC. INT. CL. 9.
- CBS STUDIOS INC., NEW YORK, NY:
2,498,770, CANC. INT. CL. 41.
- CBS STUDIOS PRODUCTIONS LLC, NEW YORK, NY:
2,564,398. REN. 5-24-12. INT. CL. 41.
- CBW CHEMIE GMBH; BITTERFELD WOLFEN, 06732 BITTERFELD, FED REP GERMANY:
4,163,019, PUB. 4-10-2012. INT. CL. 1.
- CCC ACQUISITION CORP., COMMERCE, CA:
2,497,391, CANC. MULTIPLE CLASS, INT. CLS. 14, 16, 18, 24 AND 25.
- CCH INCORPORATED, RIVERWOODS, IL, ASPEN PUBLISHERS, INC., NEW YORK, NY:
2,624,521. REN. 5-24-12. INT. CL. 16.
- CCW MOBIL TECHNOLOGIES INC., NORTHRIDGE, CA:
4,164,016, PUB. 4-10-2012. INT. CL. 34.
- CDM TECHNOLOGIES, INCORPORATED, SAN LUIS OBISPO, CA:
2,625,778. REN. 5-18-12. INT. CL. 9.
- CEASER, ROBERT J., DENVER, CO:
858,891, CANC. U.S. CL. 23.
- CEDERBERG GMBH, BINNINGEN, SWITZERLAND:
4,163,271, PUB. 4-10-2012. MULTIPLE CLASS, INT. CLS. 1, 5, 10 AND 44.
- CELESTRON ACQUISITION, LLC, TORRANCE, CA:
4,165,247, INT. CL. 9.
- CELLULAR SOUTH, INC., RIDGELAND, MS:
4,166,043, INT. CL. 35.
- CELU-LITE, LONDON, UNITED KINGDOM, TA ZAGORA:
4,163,673, PUB. 4-10-2012. INT. CL. 1.
- CENTENARY MUSIC HOLDINGS LIMITED, LONDON, UNITED KINGDOM:
2,497,894, CANC. INT. CL. 9.
- CENTENNIAL AG SUPPLY CO., GREELEY, CO:
2,569,726. REN. 5-18-12. INT. CL. 35.
- CENTER FOR INNOVATION & APPLIED DESIGN, HOLLAND, MI:
4,165,004, INT. CL. 41.
- CENTEST, INC., HARVARD, IL:
2,499,057, CANC. INT. CL. 31.
- CENTRAL KNITWEAR, INC., NEW YORK, NY:
860,150, CANC. U.S. CL. 39.
- CENTRAL REGIONAL AGROPECUARIA INDUSTRIA DE COOPERATIVAS "EL CEIBO" LTDA., EL ALTO, LA PAZ, BOLIVIA:
4,164,094, PUB. 4-10-2012. INT. CL. 30.
- CENTRAL VERMONT PUBLIC SERVICE CORPORATION, RUTLAND, VT:
4,164,788, INT. CL. 35.
- CENTRAX LIMITED, NEWTON ABBOT, DEVON, ENGLAND:
855,478, CANC. MULTIPLE CLASS, U.S. CLS. 21 AND 23.
- CEOS INC., TAIPEI, TAIWAN:
3,006,436, CANC. INT. CL. 9.
- CERASA S.P.A., ITALY:
4,162,918, PUB. 4-10-2012. MULTIPLE CLASS, INT. CLS. 11, 20 AND 21.
- CERDA, DEANNA, MURRIETA, CA AND CERDA, JUAN, MURRIETA, CA:
2,963,177, CANC. INT. CL. 25.
- CERTIFIED COLLECTIBLES GROUP, SARASOTA, FL:
4,163,812, PUB. 4-10-2012. INT. CL. 42.
- CERVECERIA MODELO, S.A. DE C.V., 11320 MEXICO, D.F., MEXICO:
3,006,261, CANC. INT. CL. 32.
- CETERA FINANCIAL HOLDINGS, INC., EL SEGUNDO, CA:
4,165,371, INT. CL. 36.
- CG4 SOLUTIONS, INC., CENTERVILLE, UT:
2,602,320. REN. 5-18-12. INT. CL. 9.
- CHAFFIN, TIMOTHY R., GREAT FALLS, MT:
4,165,586, INT. CL. 25.
- CHAIN & CHARM, INC., LOS ANGELES, CA, CHAIN & CHARM, INC., LOS ANGELES, CA:
1,734,011. REN. 5-19-12. INT. CL. 14.
- CHALLENGER CIRCLE F INC., TRENTON, NJ:
863,845, CANC. U.S. CL. 21.
- CHAMPION COLLEGE SERVICES, INC., TEMPE, AZ:
4,164,342, PUB. 4-10-2012. INT. CL. 42.
- CHAMPION COLLEGE SERVICES, INC., SCOTTSDALE, AZ:
4,164,344, PUB. 4-10-2012. INT. CL. 42.
- CHAMPION COLLEGE SERVICES, INC., TEMPE, AZ:
4,164,346, PUB. 4-10-2012. INT. CL. 42.
4,164,347, PUB. 4-10-2012. INT. CL. 42.
4,164,349, PUB. 4-10-2012. INT. CL. 42.
4,164,352, PUB. 4-10-2012. INT. CL. 42.
- CHAMPION COOLER CORPORATION, LITTLE ROCK, AR:
3,006,494, CANC. INT. CL. 11.
- CHAN, KWOK HUNG, HONG KONG, HONG KONG:
4,162,772, PUB. 11-9-2010. MULTIPLE CLASS, INT. CLS. 18 AND 25.
- CHANCEUSE PRODUCTIONS LLC, BELLINGHAM, WA:
4,163,319, PUB. 4-10-2012. MULTIPLE CLASS, INT. CLS. 14, 25 AND 33.
- CHANEL, INC., NEW YORK, NY:
4,164,548, PUB. 4-10-2012. INT. CL. 8.
4,164,727, PUB. 4-10-2012. INT. CL. 3.
- CHANGO INC., TORONTO, ONTARIO, CANADA:
4,163,160, PUB. 4-10-2012. INT. CL. 35.
- CHANTAL GUILLON DI DONATO, SAN FRANCISCO, CA:
4,164,261, PUB. 4-10-2012. INT. CL. 35.
- CHAPEL HILL DAY CARE CENTER, CHAPEL HILL, NC:
4,163,783, PUB. 4-10-2012. INT. CL. 43.
- CHAPEL HILL REPORTING, LLC, CHAPEL HILL, NC:
4,164,416, PUB. 4-10-2012. INT. CL. 45.
- CHARACTER TRAINING INSTITUTE, INC., OKLAHOMA CITY, OK:
2,498,631, CANC. INT. CL. 16.
2,498,632, CANC. INT. CL. 41.
- CHARCO 2000, INC., SHELTON, CT, AKA CHARTER ARMS:
4,163,268, PUB. 11-1-2011. INT. CL. 13.
- CHARDONNAY CORP., TARZANA, CA:
4,163,860, PUB. 4-10-2012. INT. CL. 9.
- CHARLES J. MATTINGLY, LEXINGTON, KY:
4,164,055, PUB. 4-10-2012. INT. CL. 40.
4,164,056, PUB. 4-10-2012. INT. CL. 40.
- CHARLOTTE RUSSE MERCHANDISING, INC., SAN DIEGO, CA:
2,511,011. REN. 5-22-12. INT. CL. 25.
- CHARM CITY ORGANIZERS, LLC, BALTIMORE, MD:
4,166,075, INT. CL. 45.
- CHART INC., GARFIELD HEIGHTS, OH:
4,163,421, PUB. 4-10-2012. INT. CL. 10.
4,163,422, PUB. 4-10-2012. INT. CL. 10.
- CHATAM INTERNATIONAL INCORPORATED, PHILADELPHIA, PA:
856,158, CANC. U.S. CL. 47.
- CHATHAM IMPORTS, INC., NEW YORK, NY:
1,729,719. REN. 5-19-12. INT. CL. 33.
1,759,225. REN. 5-24-12. INT. CL. 33.
- CHATTER, INC., IRVINE, CA:
4,165,495, INT. CL. 38.

CHELSEA & SCOTT, LTD, LAKE BLUFF, IL:
 4,164,780, PUB. 4-10-2012. INT. CL. 25.
 CHELSEA RHONE COMPANY, ANN ARBOR, MI:
 2,704,234. REN. 5-18-12. INT. CL. 36.
 CHEMICAL EXCHANGE INDUSTRIES, INC., GALENA
 PARK, TX:
 1,213,724. REN. 5-18-12. MULTIPLE CLASS, INT. CLS. 1
 AND 4.
 CHEMICAL PRODUCTS CORPORATION, CARTERSVILLE,
 GA:
 780,532, CANC. U.S. CL. 6.
 CHEMISCHE FABRIK BUDENHEIM KG, FED REP GER-
 MANY:
 4,014,604, COR. INT. CL. 1.
 CHEMPLEX INDUSTRIES, INC., PALM CITY, FL:
 4,165,990, INT. CL. 1.
 CHEMTEC S.R.L., ITALY:
 4,162,912, PUB. 4-10-2012. MULTIPLE CLASS, INT. CLS. 1
 AND 2.
 CHEN HSONG ASSET MANAGEMENT LIMITED, TAI
 PO, NEW TERRITORIES, HONG KONG:
 4,165,218, INT. CL. 7.
 CHEN, SHI YONG, BROOKLYN, NY, DBA FUSHIMI AND
 CHEN, DANIEL, BROOKLYN, NY, DBA FUSHIMI AND
 LIN, XIAN, BROOKLYN, NY, DBA FUSHIMI:
 4,163,646, PUB. 4-10-2012. INT. CL. 43.
 CHENGPIN, HUANG, TAIPEI COUNTY, TAIWAN:
 4,164,877, INT. CL. 9.
 CHESAPEAKE HOSPITAL AUTHORITY, NORTH CHESA-
 PEAKE, VA:
 4,165,092, MULTIPLE CLASS, INT. CLS. 25 AND 36.
 CHIA KHIM LEE FOOD INDUSTRIES PTE LTD, SINGA-
 PORE, SINGAPORE:
 4,164,410, PUB. 4-10-2012. INT. CL. 30.
 CHICAGO AND NORTH WESTERN TRANSPORTATION
 COMPANY, CHICAGO, IL:
 504,854, CANC. U.S. CL. 105.
 CHICAGO BOARD OPTIONS EXCHANGE INCORPO-
 RATED, CHICAGO, IL:
 2,506,411. REN. 5-21-12. INT. CL. 36.
 CHICAGO JACK SERVICES, INC., LYONS, IL:
 2,579,009. REN. 5-21-12. MULTIPLE CLASS, INT. CLS. 6,
 22 AND 37.
 CHICAGO MERCANTILE EXCHANGE INC., CHICAGO, IL:
 1,689,883. REN. 5-21-12. INT. CL. 9.
 2,753,752. COR. INT. CL. 36.
 2,828,376. COR. INT. CL. 9.
 3,075,976. COR. MULTIPLE CLASS, INT. CLS. 9 AND 42.
 3,084,640. COR. MULTIPLE CLASS, INT. CLS. 9 AND 42.
 CHICAGO METALLIC CORPORATION, CHICAGO, IL,
 ALCAN ALUMINUM CORPORATION, CLEVELAND,
 OH:
 1,237,046. REN. 5-18-12. INT. CL. 6.
 CHICKEN SOUP FOR THE SOUL PUBLISHING, LLC, COS
 COB, CT:
 2,666,777. REN. 5-18-12. INT. CL. 16.
 CHICO'S BRANDS INVESTMENTS, INC., FORT MYERS,
 FL:
 4,164,922, INT. CL. 25.
 CHILD S.H.A.R.E. PROGRAM, INC., GLENDALE, CA:
 4,163,222, PUB. 4-10-2012. MULTIPLE CLASS, INT. CLS.
 35 AND 41.
 CHINA NATIONAL HEAVY DUTY TRUCK GROUP CO.,
 LTD., CHINA:
 4,162,857, PUB. 1-3-2012. MULTIPLE CLASS, INT. CLS. 7
 AND 37.
 4,162,862, PUB. 1-3-2012. MULTIPLE CLASS, INT. CLS. 7
 AND 37.
 CHINOOK ASIA LLC, LAKE OSWEGO, OR:
 2,499,096, CANC. INT. CL. 25.
 CHIQUITA BRANDS L.L.C., CINCINNATI, OH:
 2,574,376. REN. 5-21-12. INT. CL. 39.
 2,589,433. REN. 5-21-12. INT. CL. 39.
 CHIROSPA, P.A., NORTH MIAMI, FL:
 3,129,383, CANC. INT. CL. 5.
 CHOCOLADENFABRIK LINDT & SPRÜNGLI AG, SWIT-
 ZERLAND:
 4,162,980, PUB. 4-10-2012. INT. CL. 30.
 CHOCOLATES GAROTO S.A., ESPIRITO SANTO, BRAZIL:
 2,582,867. REN. 5-19-12. INT. CL. 30.
 CHONGQING LIUYISHOU RESTAURANT MANAGE-
 MENT CO., LTD., CHONGQING, CHINA:
 4,165,154, INT. CL. 43.
 CHORNEY, JUDY LYNN, BRITISH COLUMBIA, CANADA:
 4,162,691, PUB. 4-10-2012. MULTIPLE CLASS, INT. CLS.
 25, 36, 41 AND 42.
 CHRISTIAN COUNSELING & TRAINING CENTER, INC.,
 RICHMOND, VA:
 2,609,571. REN. 5-21-12. INT. CL. 41.
 2,631,173. REN. 5-21-12. INT. CL. 16.
 CHRISTIAN DIOR COUTURE, FRANCE:
 3,046,354.
 4,162,831, PUB. 4-10-2012. MULTIPLE CLASS, INT. CLS.
 9, 14, 18 AND 25.
 CHRISTOPH DECHLER, DENMARK:
 4,163,012, PUB. 4-10-2012. MULTIPLE CLASS, INT. CLS.
 18, 25, 29, 32 AND 41.
 CHRISTOPHER D. STOUT, TWIN FALLS, ID:
 4,165,581, INT. CL. 35.
 CHRISTOPHER F. O'HARE, INC, BOYNTON BCH., FL, DBA
 PINEAPPLE GROVE DESIGNS:
 4,163,192, PUB. 4-10-2012. INT. CL. 19.
 CHRISTOPHER F. VAN MAARSEVEEN, NEW YORK, NY,
 DBA OTHERLIFE:
 4,163,980, PUB. 4-10-2012. INT. CL. 25.
 CHRISTY MACHINE COMPANY, FREMONT, OH,
 CHRISTY, DANIEL LAMAR, FREMONT, OH:
 930,470. REN. 5-18-12. U.S. CL. 23 (INT. CL. 7).
 CHRISTY MACHINE COMPANY, FREMONT, OH:
 2,553,026. REN. 5-21-12. INT. CL. 7.
 2,635,627. REN. 5-18-12. INT. CL. 20.
 CHRONO AG, CH4502 SOLOTHURN, SWITZERLAND:
 2,497,595, CANC. INT. CL. 14.
 CHRYSLER GROUP LLC, AUBURN HILLS, MI, CHRYSLER
 CORPORATION, HIGHLAND PARK, MI:
 1,709,824. REN. 5-18-12. INT. CL. 9.
 CHRYSLER LLC, AUBURN HILLS, MI:
 2,498,591, CANC. INT. CL. 12.
 3,006,390, CANC. INT. CL. 9.
 CHURCH & DWIGHT CO., INC, NEW YORK, NY:
 503,871, CANC. U.S. CL. 52.
 CHURCH & DWIGHT CO., INC., NEW YORK, NY:
 502,069, CANC. U.S. CL. 6.
 CHURCH & DWIGHT CO., INC., PRINCETON, NJ:
 502,264, CANC. U.S. CL. 6.
 502,265, CANC. U.S. CL. 46.
 CHURCH & DWIGHT CO., INC., NEW YORK, NY:
 503,869, CANC. U.S. CL. 52.
 CHURCH & DWIGHT CO., INC., NEW YORK, NJ:
 504,752, CANC. U.S. CL. 46.
 CHURCH & DWIGHT CO., INC., PRINCETON, NJ:
 505,302, CANC. U.S. CL. 18.
 856,180, CANC. U.S. CL. 51.
 861,581, CANC. U.S. CL. 18.
 4,165,831, INT. CL. 3.
 CHURCH COMMUNITIES, INC., RIFTON, NY:
 4,164,848, U.S. CL. 200.
 CIBA SPECIALTY CHEMICAL CORPORATION, TARRY-
 TOWN, NY:
 2,574,257. REN. 5-22-12. INT. CL. 5.
 CIBA-GEIGY CORPORATION, ARDSLEY, NY:
 862,982, CANC. U.S. CL. 6.
 CIDA CORP, PALOS VERDES PENINSULA, CA:
 4,162,743, PUB. 4-10-2012. INT. CL. 3.
 CIGARS INTERNATIONAL, INC., BETHLEHEM, PA:
 2,688,553. REN. 5-21-12. INT. CL. 34.
 CINCINNATI BAR ASSOCIATION, CINCINNATI, OH:
 1,708,552. REN. 5-22-12. MULTIPLE CLASS, INT. CLS. 35,
 41 AND 42.
 1,710,333. REN. 5-22-12. MULTIPLE CLASS, INT. CLS. 35,
 41 AND 42.
 CINCINNATI MINE MACHINERY CO., THE, CINCINNATI,
 OH:
 863,492, CANC. U.S. CL. 23.
 CINEMA ASIA RELEASING, SANTA MONICA, CA:
 4,165,999, INT. CL. 41.

- CINNAMON REEF LIMITED, LITTLE HARBOUR, ANGUILLA, ST. KITTS-NEVIS:
1,295,134, CANC. INT. CL. 42.
- CIPHERCLOUD, INC., SAN JOSE, CA:
4,165,941, INT. CL. 9.
- CIRCLE F INDUSTRIES, INC., TRENTON, NJ:
859,630, CANC. U.S. CL. 21.
- CIRCLE STAR BLANKETS, INC., BUFFALO, WY:
2,498,077, CANC. INT. CL. 18.
- CIRCUS AND ELDORADO JOINT VENTURE, LAS VEGAS, NV:
2,510,740, REN. 5-23-12. INT. CL. 25.
- CIRRUS THINKING LLC, NEW YORK, NY:
4,165,856, MULTIPLE CLASS, INT. CLS. 9, 39 AND 42.
- CITADEL, THE MILITARY COLLEGE OF SOUTH CAROLINA, THE, CHARLESTON, SC:
1,668,578, REN. 5-24-12. INT. CL. 25.
- CITIBANK, N. A., NEW YORK, NY:
862,899, CANC. U.S. CL. 102.
- CITIC GROUP, 100004 BEIJING, CHINA:
4,162,802, PUB. 3-3-2009. INT. CL. 36.
- CITIGROUP GLOBAL MARKETS INC., NEW YORK, NY:
3,006,365, CANC. INT. CL. 36.
- CITIGROUP INC., NEW YORK, NY:
4,164,757, PUB. 4-10-2012. INT. CL. 35.
- CITIZEN HOLDINGS KABUSHIKI KAISHA, NISHI-TOKYO-SHI, TOKYO, JAPAN, TA CITIZEN HOLDINGS CO., LTD.:
2,589,213, REN. 5-22-12. INT. CL. 14.
- CITIZENLINK, COLORADO SPRINGS, CO:
2,597,253, REN. 5-18-12. INT. CL. 42.
- CITRA-SOLV LLC, RIDGEFIELD, CT:
2,585,545, REN. 5-19-12. INT. CL. 5.
- CITRUS WORLD, INC., LAKE WALES, FL:
1,729,706, REN. 5-18-12. INT. CL. 32.
- CITY AND COUNTY OF SAN FRANCISCO, SAN FRANCISCO, CA:
4,164,614, PUB. 4-10-2012. INT. CL. 36.
- CITYMEALS-ON-WHEELS, NEW YORK, NY:
2,624,422, REN. 5-18-12. MULTIPLE CLASS, INT. CLS. 36 AND 42.
2,662,387, REN. 5-18-12. MULTIPLE CLASS, INT. CLS. 36 AND 42.
2,662,387, CANC. INT. CL. 35.
- CITYSCAPE COMEDY, LLC, DELRAY BEACH, FL:
4,165,279, INT. CL. 43.
- CITYXPRESS LTD., VANCOUVER, BC, CANADA:
4,163,131, PUB. 4-10-2012. MULTIPLE CLASS, INT. CLS. 9, 35 AND 42.
- CJ CHEILJEDANG CORPORATION, SEOUL, REPUBLIC OF KOREA:
4,163,493, PUB. 4-10-2012. MULTIPLE CLASS, INT. CLS. 29 AND 30.
- CK3 LLC, NEW YORK, NY:
4,164,946, INT. CL. 33.
- CLARIANT AG, MUTTENZ, SWITZERLAND:
1,196,576, REN. 5-23-12. INT. CL. 1.
4,163,053, PUB. 4-10-2012. MULTIPLE CLASS, INT. CLS. 9, 35 AND 42.
- CLARIANT GMBH, SULZBACH, FED REP GERMANY, HOECHST AKTIENGESELLSCHAFT, FRANKFURT AM MAIN - 80, FED REP GERMANY:
1,197,547, REN. 5-23-12. INT. CL. 1.
- CLASSICAL COMMUNICATIONS LIMITED, OXFORDSHIRE, OX29 4SZ, UNITED KINGDOM:
4,165,021, MULTIPLE CLASS, INT. CLS. 9 AND 41.
- CLAUD S. GORDON COMPANY, RICHMOND, IL:
860,519, CANC. U.S. CL. 26.
- CLAUSEN, CAMERON N, MIAMI, FL:
4,164,306, PUB. 4-10-2012. INT. CL. 35.
- CLEAN AMERICA, INC., BREA, CA:
2,656,720, REN. 5-24-12. INT. CL. 9.
- CLEAN ENERGY, SEAL BEACH, CA:
4,164,785, INT. CL. 35.
- CLEARVISION OPTICAL COMPANY, HAUPPAUGE, NY:
4,164,674, PUB. 4-10-2012. INT. CL. 9.
- CLESTRA CLEANROOM (SOCIÉTÉ PAR ACTIONS SIMPLIFIÉE), F-67200 STRASBOURG, FRANCE:
4,162,821, PUB. 4-10-2012. MULTIPLE CLASS, INT. CLS. 9 AND 11.
- CLEVER GIRL INNOVATIONS, LLC, SIMI VALLEY, CA:
4,163,648, PUB. 4-10-2012. INT. CL. 24.
- CLICK BOND, INC., CARSON CITY, NV:
4,163,270, PUB. 4-10-2012. MULTIPLE CLASS, INT. CLS. 6 AND 20.
- CLINTEC INTERNATIONAL LIMITED, UNITED KINGDOM:
4,162,941, PUB. 4-10-2012. MULTIPLE CLASS, INT. CLS. 35, 41, 42 AND 45.
- CLOTHES THE DEAL, DOWNEY, CA:
4,163,710, PUB. 4-10-2012. INT. CL. 45.
- CLOTHING GATEWAY CORPORATION, DON MILLS, ONTARIO:
4,162,734, PUB. 4-10-2012. INT. CL. 35.
- CLOUD PARTNERS, WESTFIELD, NJ:
4,166,071, INT. CL. 35.
- CLOUD 9 PERFORMANCE SOLUTIONS, LLC, LOS ALTOS, CA:
4,164,759, PUB. 4-10-2012. INT. CL. 9.
- CLOVER MFG. CO., LTD., OSAKA, JAPAN:
2,586,864, REN. 5-19-12. INT. CL. 26.
- CMC GROUP, INC., BOWLING GREEN, OH:
2,577,365, REN. 5-19-12. INT. CL. 40.
- CMERIT USA, INC., CHINO, CA:
4,165,753, MULTIPLE CLASS, INT. CLS. 18 AND 25.
- CMI PRODUCTIONS LIMITED, MALAHIDE, CO. DUBLIN, IRELAND:
4,164,570, PUB. 4-10-2012. INT. CL. 9.
- COALESCENCE, LLC, COLUMBUS, OH:
4,165,446, MULTIPLE CLASS, INT. CLS. 29, 30 AND 40.
- COASTAL LUXURY MANAGEMENT, LLC, MONTEREY, CA:
4,163,337, PUB. 4-10-2012. MULTIPLE CLASS, INT. CLS. 35 AND 41.
- COASTAL STATES CONTRACTORS, INC., MIRAMAR BEACH, FL:
4,163,696, PUB. 4-10-2012. INT. CL. 37.
- COASTWISE CAPITAL GROUP, LLC, LA JOLLA, CA:
4,164,485, PUB. 4-10-2012. INT. CL. 36.
- COBIZ, INC., DENVER, CO:
3,006,204, CANC. INT. CL. 36.
- COBRA ELECTRONICS CORPORATION, CHICAGO, IL:
3,006,535, CANC. INT. CL. 9.
- COBRIDGE COMMUNICATIONS, ST. LOUIS, MO:
4,165,176, INT. CL. 38.
- COFFEE HOLDING COMPANY INC., STATEN ISLAND, NY:
1,707,031, REN. 5-18-12. INT. CL. 30.
- COGA INVESTMENTS, INC. GP, ST. PAUL, MN, DBA HISTORICAL REMEDIES, L.P.:
2,512,046, REN. 5-23-12. INT. CL. 5.
- COHEED AND CAMBRIA, ENCINO, CA:
4,163,219, PUB. 4-10-2012. INT. CL. 25.
- COHEN, AMANDA, NEW YORK, NY:
4,163,941, PUB. 4-10-2012. MULTIPLE CLASS, INT. CLS. 41 AND 43.
- COHEN, STACY J., LOUISVILLE, KY:
4,163,275, PUB. 4-10-2012. INT. CL. 35.
- COHERENT SOUND DESIGN INC., DENVILLE, NJ:
4,122,700, COR. INT. CL. 15.
- COIN LAUNDRY ASSOCIATION, DOWNERS GROVE, IL:
4,165,235, MULTIPLE CLASS, INT. CLS. 16, 35 AND 41.
- COLBOND B.V., ARNHEM, NETHERLANDS, COLBOND B.V., ARNHEM, NETHERLANDS:
2,568,843, REN. 5-21-12. INT. CL. 22.
- COLGATE-PALMOLIVE COMPANY, NEW YORK, NY:
250,435, CANC. U.S. CL. 52.
505,077, CANC. U.S. CL. 52.
860,784, CANC. U.S. CL. 4.
862,870, CANC. U.S. CL. 52.
3,006,415, CANC. INT. CL. 3.
- COLLEGE CENTRAL NETWORK, INC., NEW YORK, NY:
4,164,781, PUB. 12-13-2011. INT. CL. 16.

COLLEGES.COM, INC., SAN DIEGO, CA:
2,497,670, CANC. MULTIPLE CLASS, INT. CLS. 35 AND 38.

COLLEGETOWN RELOCATION, L.L.C., PRINCETON, NJ:
2,569,674, REN. 5-18-12, INT. CL. 36.

COLLETTA, FRANKLIN, FORT PIERCE, FL:
4,165,435, INT. CL. 35.

COLLINS AUTO GROUP, LLC, LOUISVILLE, KY:
4,163,924, PUB. 4-10-2012, INT. CL. 35.

COLOPLAST A/S, DENMARK:
4,162,863, PUB. 4-10-2012, INT. CL. 10.

COLOR IMAGE APPAREL, INC., COMMERCE, CA:
4,163,125, PUB. 4-10-2012, INT. CL. 35.

COLUMBIA BIBLE COLLEGE BROADCASTING CO., COLUMBIA, SC:
4,165,992, INT. CL. 38.

COLUMBIA GEM HOUSE, INC./ TRIGEM DESIGNS, VANCOUVER, WA:
2,576,989, REN. 5-22-12, INT. CL. 14.

COLUMBIA INSURANCE COMPANY, OMAHA, NE:
4,164,927, INT. CL. 25.

COLUMBIA SPORTSWEAR NORTH AMERICA, INC., PORTLAND, OR:
4,164,890, INT. CL. 20.

COMANOR-COMPANHIA DE MANUFACTURAS METALICAS DO NORTE, SARL, OPORTO, PORTUGAL:
863,801, CANC. U.S. CL. 13.

COMART CORPORATION, NEW TAIPEI CITY, TAIWAN:
4,164,131, PUB. 4-10-2012, INT. CL. 9.

COMBE INCORPORATED, WHITE PLAINS, NY:
935,779, REN. 5-18-12, U.S. CL. 51 (INT. CL. 3).

COMCOASTER, UTRECHT, NETHERLANDS:
4,163,993, PUB. 4-10-2012, MULTIPLE CLASS, INT. CLS. 35 AND 42.

COMETIC TECHNOLOGY INC., MONTREAL, QUEBEC, CANADA:
855,897, CANC. U.S. CL. 21.

COMM GROUP, INC., DOYLESTOWN, PA:
4,163,380, PUB. 4-10-2012, MULTIPLE CLASS, INT. CLS. 39, 42 AND 43.

COMMAND CENTER, INC., SPOKANE, WA:
2,951,213, CANC. INT. CL. 35.

COMMERCIAL BAKERIES CORP., TORONTO ONTARIO M3L 1G5, CANADA:
2,643,925, REN. 5-22-12, INT. CL. 30.

COMMERCIAL METALS COMPANY, IRVING, TX:
4,164,262, PUB. 4-10-2012, INT. CL. 35.

COMMENTS, DECATUR, GA:
4,163,859, PUB. 4-10-2012, INT. CL. 45.

COMMUNION SYSTEMS INC., ALDERSYDE, ALBERTA, CANADA:
4,162,767, PUB. 9-20-2011, INT. CL. 40.

COMMUNITY COFFEE COMPANY OF TEXAS, INC., HOUSTON, TX, COMMUNITY COFFEE COMPANY, INC., BATON ROUGE, LA:
1,735,073, REN. 5-19-12, INT. CL. 30.

COMMUNITY TECHKNOWLEDGE, INC., AUSTIN, TX:
4,164,023, PUB. 4-10-2012, INT. CL. 41.

COMPANY CONNECT, SAUSALITO, CA:
2,602,827, REN. 5-22-12, INT. CL. 42.

COMPETITOR GROUP, INC., SAN DIEGO, CA:
4,165,049, INT. CL. 41.

COMPOSITE IDEAS, LLC, RONKONKOMA, NY:
2,573,629, REN. 5-21-12, INT. CL. 9.

COMPRESSCO PARTNERS SUB, INC., OKLAHOMA CITY, OK AND COMPRESSCO PARTNERS OPERATING, LLC, OKLAHOMA CITY, OK, ECONOFAB, INC., OKLAHOMA CITY, OK:
1,688,270, REN. 5-21-12, MULTIPLE CLASS, INT. CLS. 7 AND 37.

COMPRESSORWORKS, INC., DALLAS, TX:
4,163,761, PUB. 4-10-2012, MULTIPLE CLASS, INT. CLS. 1, 4 AND 11.

COMPUT-ABILITY, INC, CHARLOTTE, NC:
4,163,878, PUB. 4-10-2012, INT. CL. 9.

COMPUTE (BRIDGEND) LIMITED, BRIDGEND, UNITED KINGDOM:
2,591,880, REN. 5-21-12, INT. CL. 9.

COMPUTER CRAIG, LLC, EGG HARBOR TOWNSHIP, NJ:
3,006,217, CANC. INT. CL. 9.

CONAGRA FOODS LAMB WESTON, INC., OMAHA, NE:
2,570,084, REN. 5-18-12, INT. CL. 29.

CONAIR CORPORATION, STAMFORD, CT:
4,166,027, INT. CL. 8.

CONCORD INTERNATIONAL TRADING P/L, SYDNEY, AUSTRALIA:
4,163,535, PUB. 4-10-2012, MULTIPLE CLASS, INT. CLS. 5 AND 30.

CONCRETE & PAVEMENT REPAIR, LLC, BLUFFTON, SC, AKA CPR, LLC:
4,163,217, PUB. 4-10-2012, INT. CL. 1.

CONCRETE CMS, INC., PORTLAND, OR:
4,164,297, PUB. 4-10-2012, INT. CL. 9.

CONESTOGA COMPANY, INC., THE, ALLENTOWN, PA:
559,919, REN. 5-23-12, U.S. CL. 9 (INT. CL. 28).

CONFORMAL SYSTEMS LLC, CHICAGO, IL:
4,165,637, INT. CL. 39.

CONGOLEUM-NAIRN INC., KEARNY, NJ:
859,613, CANC. U.S. CL. 20.
859,614, CANC. U.S. CL. 20.

CONGRESS FINANCIAL CORPORATION (FLORIDA), AS AGENT, FORT LAUDERDALE, FL:
862,455, CANC. U.S. CL. 39.

CONJUNCTION ENTERTAINMENT INC., LOS ANGELES, CA:
4,164,494, PUB. 4-10-2012, MULTIPLE CLASS, INT. CLS. 9, 16, 25, 26 AND 41.

CONN-SELMER, INC., ELKHART, IN:
2,578,055, REN. 5-18-12, INT. CL. 15.
2,581,638, REN. 5-18-12, INT. CL. 15.

CONNECTING POINT MARKETING GROUP, INC., RYE, NH:
4,165,152, INT. CL. 35.

CONSENSURE, INC., REDDING, CT:
3,005,618, CANC. INT. CL. 16.

CONSERVISE, LLC, LOGAN, UT:
4,164,667, PUB. 4-10-2012, MULTIPLE CLASS, INT. CLS. 35 AND 39.

CONSOLIDATED ENERGY SOLUTIONS INC., TORONTO, ONTARIO, CANADA:
4,163,582, PUB. 4-10-2012, MULTIPLE CLASS, INT. CLS. 11 AND 42.

CONSOLIDATED MERCHANTS GROUP, INC., WEST JORDAN, UT:
4,164,223, PUB. 4-10-2012, INT. CL. 35.
4,164,224, PUB. 4-10-2012, INT. CL. 35.

CONSTRUCTION RESEARCH & TECHNOLOGY GMBH, TROSTBERG, FED REP GERMANY:
2,510,468, REN. 5-23-12, INT. CL. 19.

CONSTRUCTION TECHNIQUES, INC., CLEVELAND, OH:
854,458, CANC. U.S. CL. 12.

CONTEMPO DESIGN, INC., LIBERTYVILLE, IL:
3,006,079, CANC. INT. CL. 9.

CONTINENTAL DISC CORPORATION, LIBERTY, MO:
1,686,019, REN. 5-18-12, INT. CL. 6.

CONTINENTAL VINEYARDS, LLC, PASO ROBLES, CA:
4,165,859, INT. CL. 33.
4,165,860, INT. CL. 33.

CONTITECH AG, FED REP GERMANY:
4,162,833, PUB. 4-10-2012, INT. CL. 17.
4,162,834, PUB. 4-10-2012, INT. CL. 17.

CONTITECH SCHLAUCH GMBH, HANNOVER, FED REP GERMANY:
1,172,828, CANC. MULTIPLE CLASS, INT. CLS. 6, 7 AND 17.

CONTRACTOR MARKETPLACE, INC., LOUISVILLE, KY:
2,571,962, REN. 5-18-12, INT. CL. 35.

CONTRAIL VINTNERS, LLC, AUSTIN, TX:
4,112,998, AM. INT. CL. 33.

CONTROLTEC, INC., ESCONDIDO, CA:
4,163,549, PUB. 4-10-2012, INT. CL. 9.

CONTROMATICS, INC., EAST HARTFORD, CT:
861,868, CANC. U.S. CL. 13.

CONVATEC INC., SKILLMAN, NJ:
3,006,397, CANC. INT. CL. 41.

- CONVERGINT TECHNOLOGIES LLC, SCHAUMBURG, IL:
4,163,264, PUB. 4-10-2012. INT. CL. 37.
- CONVERTER LAB, MIAMI BEACH, FL:
4,165,832, INT. CL. 10.
- CONVERTIGO SOCIÉTÉ ANONYME, FRANCE:
4,017,704, COR. MULTIPLE CLASS, INT. CLS. 9, 35, 38, 42 AND 45.
- CONVIO, INC., AUSTIN, TX:
2,570,166, REN. 5-18-12. INT. CL. 42.
- CONWAY & FRATES, LLC, TULSA, OK:
2,497,787, CANC. INT. CL. 9.
- CONWAY, MICHAEL W., CALIFON, NJ:
4,165,513, INT. CL. 36.
- COOPER TECHNOLOGIES COMPANY, HOUSTON, TX:
4,165,519, INT. CL. 9.
- COPHAR SA, SWITZERLAND:
2,995,373.
- COPPER CELLAR CORPORATION, KNOXVILLE, TN:
1,724,417, REN. 5-22-12. INT. CL. 42.
- COPPER WEST, INC., BOILING SPRINGS, SC:
4,163,137, PUB. 4-10-2012. INT. CL. 43.
- CORBETT, ROBERT A., HERMOSA BEACH, CA:
4,164,549, PUB. 4-10-2012. INT. CL. 25.
- CORD-WEAR, LLC, SUMMIT, NJ:
4,165,221, INT. CL. 14.
- CORDA-ROY'S ORIGINALS, INC., GAINESVILLE, FL:
2,637,654, REN. 5-18-12. INT. CL. 20.
- CORDELIA LIGHTING INC., RANCHO DOMINGUEZ, CA:
4,164,914, MULTIPLE CLASS, INT. CLS. 9 AND 11.
- CORDIS CORPORATION, BRIDGEWATER, NJ:
2,612,953, REN. 5-18-12. INT. CL. 10.
- CORE DISTRIBUTION, INC., MINNEAPOLIS, MN:
4,165,769, INT. CL. 20.
- CORE EDUCATION AND CONSULTING SOLUTIONS ,INC., ATLANTA, GA:
4,094,464, COR. INT. CL. 42.
- CORNING INCORPORATED, CORNING, NY:
2,584,173, REN. 5-18-12. INT. CL. 21.
2,675,475, REN. 5-18-12. INT. CL. 9.
- CORONA FRUITS & VEGGIES, INC., SANTA MARIA, CA,
DBA CORONA MARKETING:
2,641,954, REN. 5-24-12. INT. CL. 31.
- CORPORATE INTERNATIONAL ASSOCIATES, LTD.,
ATLANTA, GA:
2,573,929, REN. 5-18-12. INT. CL. 41.
- CORPUS, INC., LOS ANGELES, CA:
2,947,525, CANC. INT. CL. 25.
- CORRAL WEST SPICES, L.L.C., TAYLORSVILLE, UT:
4,165,750, INT. CL. 30.
- CORRELATED MAGNETICS RESEARCH, LLC, NEW
HOPE, AL:
4,164,925, INT. CL. 9.
- CORSAIR MEMORY INC, FREEMONT, CA:
4,165,120, INT. CL. 9.
- COSMETIC DERMATOLOGY, INC., MIAMI, FL:
4,165,313, INT. CL. 3.
- COSMETICS LIMITED, NASSAU, BAHAMAS:
2,664,274, REN. 5-19-12. INT. CL. 42.
- COSTANZA, ROCCO, STANHOPE, NJ:
4,165,344, INT. CL. 41.
- COSWAY COMPANY, INC., CARSON, CA:
4,021,873, AM. INT. CL. 3.
4,021,874, AM. INT. CL. 3.
- COTY GERMANY GMBH, FED REP GERMANY:
4,162,959, PUB. 4-10-2012. INT. CL. 3.
- COUNTS OF BARCELONA LLC, MOORPARK, CA, DBA
SWETEEZ:
4,163,970, PUB. 4-10-2012. INT. CL. 25.
- COUNTYTRAC LIMITED, ASHFORD, KENT, UNITED
KINGDOM:
4,163,515, PUB. 4-10-2012. INT. CL. 12.
- COUPONMAT, LLC, AVENTURA, FL:
4,163,905, PUB. 4-10-2012. MULTIPLE CLASS, INT. CLS.
9, 35, 41 AND 42.
- COURTNEY, MARTEL, NORWALK, CA:
4,163,662, PUB. 4-10-2012. INT. CL. 25.
- COVEME SPA, ITALY:
4,163,011, PUB. 4-10-2012. INT. CL. 17.
- COVIDIEN AG, NEUHAUSEN AM RHEINFALL, SWITZER-
LAND, AMERICAN CYANAMID COMPANY, NEW
YORK, NY:
740,701, REN. 5-23-12. U.S. CL. 44 (INT. CL. 10).
- COVIDIEN AG, NEUHAUSEN AM RHEINFALL, SWITZER-
LAND, AMERICAN CYANAMID COMPANY, WAYNE,
NJ:
936,158, REN. 5-24-12. U.S. CL. 44 (INT. CL. 10).
- COVIDIEN AG, NEUHAUSEN AM RHEINFALL, SWITZER-
LAND, VALLEYLAB, INC., BOULDER, CO:
1,198,551, REN. 5-24-12. INT. CL. 9.
- COWBOY LIFESTYLE NETWORK LLC, PHOENIX, AZ:
3,987,392, COR. INT. CL. 41.
- COZZINI, ADAM, CHICAGO, IL:
4,163,800, PUB. 4-10-2012. INT. CL. 41.
- CP BURGER, LLC, ASPEN, CO:
4,163,653, PUB. 4-10-2012. INT. CL. 43.
4,163,657, PUB. 4-10-2012. INT. CL. 43.
- CPTC GROUP, INC.:
1,248,424, CANC. INT. CL. 25.
- CRAM, DOUGLAS, ACWORTH, GA:
4,165,816, INT. CL. 9.
- CRANBERRY BARN KITCHENS, LLC, CARVER, MA:
4,164,459, PUB. 4-10-2012. INT. CL. 30.
- CRANIAL EXPANSION LEARNING SOLUTIONS INC.,
MARKHAM, ONTARIO, CANADA:
4,163,468, PUB. 4-10-2012. MULTIPLE CLASS, INT. CLS.
35 AND 41.
4,163,469, PUB. 4-10-2012. MULTIPLE CLASS, INT. CLS.
35 AND 41.
- CRASH MY PAD, INC., FOSTER CITY, CA AND EVANS,
DAVID W, GILBERT, AZ:
4,165,591, INT. CL. 43.
- CRAVEN, JAKE, STUDIO CITY, CA:
4,164,448, PUB. 4-10-2012. MULTIPLE CLASS, INT. CLS. 9
AND 41.
- CRAZY FROG, INC., TORONTO, ONTARIO, CANADA:
3,006,089, CANC. INT. CL. 28.
- CREATEFORLESS, LLC, BEAVERTON, OR:
2,678,739, REN. 5-18-12. INT. CL. 35.
- CREATIONS METAPHORES, PARIS, FRANCE:
2,531,511, REN. 5-18-12. INT. CL. 24.
- CREATIVE CONCEPTS OF CHARLOTTE, INC., CHAR-
LOTTE, NC:
2,498,814, CANC. INT. CL. 35.
- CREATIVE DESIGN FZ, LLC, DUBAI, UNITED ARAB
EMIR.:
4,163,092, PUB. 4-10-2012. MULTIPLE CLASS, INT. CLS.
41 AND 43.
- CREATIVE DIRECT RESPONSE, INC., BOWIE, MD:
2,614,182, REN. 5-18-12. MULTIPLE CLASS, INT. CLS. 35
AND 36.
- CREATIVE EDUCATION INSTITUTE, INC., WACO, TX:
4,163,593, PUB. 4-10-2012. MULTIPLE CLASS, INT. CLS. 9
AND 16.
- CREATIVE KNITWEAR INC., NORCROSS, GA:
2,899,774, AM. INT. CL. 25.
- CREATIVE LEARNING STUDIOS, LLC, GREENVILLE, DE:
4,165,512, INT. CL. 16.
- CREATIVE MOBILE OÜ, TALLINN, ESTONIA:
4,164,424, PUB. 4-10-2012. MULTIPLE CLASS, INT. CLS. 9
AND 42.
- CREATIVE NAPKIN, AUSTIN, TX, DBA PINKOINK:
4,164,966, INT. CL. 35.
- CREMER OLEO GMBH & CO. KG, 20095 HAMBURG, FED
REP GERMANY:
4,162,872, PUB. 4-10-2012. MULTIPLE CLASS, INT. CLS.
1, 3 AND 5.
- CRESCENDO INTERACTIVE, INC., CAMARILLO, CA:
2,516,366, REN. 5-19-12. INT. CL. 9.
- CRESCENT REAL ESTATE EQUITIES LIMITED PARTNER-
SHIP, FORT WORTH, TX:
4,166,085, MULTIPLE CLASS, INT. CLS. 35 AND 36.
- CREW WORKS, INC., THE, BALTIMORE, MD:
2,570,993, REN. 5-22-12. INT. CL. 37.
2,570,994, REN. 5-22-12. INT. CL. 37.

CRIMSON ENGINEERED SOLUTIONS, L.L.C., FORT WORTH, TX:
2,591,580. REN. 5-18-12. INT. CL. 9.

CRISP, CONSTANCE, CHICAGO, IL:
4,164,376, PUB. 4-10-2012. INT. CL. 35.

CROOKED COTTON DESIGN, INC., EDGEWOOD, WA:
4,163,236, PUB. 4-10-2012. INT. CL. 40.

CROOKED CREATIVE LLC, NEW YORK, NY, DBA WING CHUN MASTERS:
4,089,145, COR. MULTIPLE CLASS, INT. CLS. 18 AND 25.

CROSS MATCH TECHNOLOGIES, INC., PALM BEACH GARDENS, FL:
2,497,608, CANC. INT. CL. 9.
2,499,201, CANC. INT. CL. 9.

CROSS OPTICAL GROUP, INC., DAYTONA BEACH, FL:
4,163,647, PUB. 4-10-2012. INT. CL. 35.

CROSSTEX INTERNATIONAL, INC., HAUPPAUGE, NY:
4,165,285, INT. CL. 10.

CROWN CASTLE INVESTMENT CORP., HOUSTON, TX, CROWN CASTLE UK LIMITED, WARWICK, UNITED KINGDOM:
2,568,828. REN. 5-21-12. MULTIPLE CLASS, INT. CLS. 9, 16, 19, 20, 21, 25, 36, 37 AND 38.

CROWN GASKETS (INDIA), NEW DELHI, INDIA:
4,163,602, PUB. 4-10-2012. INT. CL. 7.

CRYOGENIC VESSEL ALTERNATIVES, INC., MONT BELVIEU, TX:
4,163,862, PUB. 4-10-2012. INT. CL. 42.
4,163,863, PUB. 4-10-2012. INT. CL. 42.

CRYPTON FUTURE MEDIA INC., SAPPORO 060-0042, JAPAN:
4,163,035, PUB. 4-10-2012. MULTIPLE CLASS, INT. CLS. 9 AND 28.

CRYSTAL COMPUTER GRAPHICS LIMITED, CENTRAL, HONG KONG:
4,164,779, PUB. 4-10-2012. INT. CL. 42.

CRYSTAL RIVER ORGANICS LLC, CARBONDALE, CO:
4,165,630, INT. CL. 30.
4,165,631, INT. CL. 30.
4,165,632, INT. CL. 30.

CSB-SYSTEM AG, FED REP GERMANY:
3,060,487.

CSM BAKERY PRODUCTS NA, INC., TUCKER, GA:
2,574,421. REN. 5-22-12. INT. CL. 30.

CUIPO, LLC, SOLANA BEACH, CA:
4,164,624, PUB. 4-10-2012. INT. CL. 25.

CULINARY HALL OF FAME, LLC, CENTENNIAL, CO:
3,038,552, CANC. MULTIPLE CLASS, INT. CLS. 35 AND 43.

CULVER ENTERPRISES, INC., PRAIRIE DE SAC., WI:
4,163,962, PUB. 4-10-2012. INT. CL. 43.

CUMBERLAND FARMS, INC., FRAMINGHAM, MA:
3,006,134, CANC. INT. CL. 30.

CURBSIDE HOSPITALITY, INC., BEVERLY, MA:
4,163,329, PUB. 4-10-2012. MULTIPLE CLASS, INT. CLS. 35, 39 AND 45.
4,163,330, PUB. 4-10-2012. MULTIPLE CLASS, INT. CLS. 35, 39 AND 45.
4,163,331, PUB. 4-10-2012. MULTIPLE CLASS, INT. CLS. 35, 39 AND 45.

CURRENT MEDIA, LLC, SAN FRANCISCO, CA:
4,163,954, PUB. 4-10-2012. INT. CL. 41.

CURTIS INDUSTRIES, INC., EASTLAKE, OH:
861,487, CANC. U.S. CL. 52.

CUSO MORTGAGE CORP., HAMPDEN, ME:
4,163,907, PUB. 4-10-2012. INT. CL. 36.
4,163,910, PUB. 4-10-2012. INT. CL. 36.

CVP SYSTEMS, INC., DOWNERS GROVE, IL:
4,164,275, PUB. 4-10-2012. INT. CL. 7.
4,164,277, PUB. 4-10-2012. MULTIPLE CLASS, INT. CLS. 7 AND 17.
4,164,301, PUB. 4-10-2012. MULTIPLE CLASS, INT. CLS. 7 AND 17.

CYBER-ARK SOFTWARE LTD., PETACH-TIKVA, ISRAEL:
2,568,572. REN. 5-23-12. INT. CL. 9.

CYBERSPA, LLC, BALTIMORE, MD:
4,165,161, INT. CL. 9.
4,165,167, INT. CL. 9.

CYBERTECH, INC., AURORA, CO, DBA ENERGY CENTRAL:
4,164,192, PUB. 4-10-2012. INT. CL. 35.

CYMBET CORPORATION, ELK RIVER, MN:
4,164,827, INT. CL. 9.

CYPHERPATH LLC, HERNDON, VA:
4,164,165, PUB. 4-10-2012. INT. CL. 41.

CYTEC TECHNOLOGY CORP., WILMINGTON, DE, AMERICAN CYANAMID COMPANY, NEW YORK, NY:
741,478. REN. 5-18-12. U.S. CL. 6 (INT. CL. 1).

CYTEC TECHNOLOGY CORP., WILMINGTON, DE:
2,550,568. REN. 5-21-12. INT. CL. 1.

C1 TRUCK DRIVER TRAINING, LLC, INDIANAPOLIS, IN:
4,163,753, PUB. 4-10-2012. INT. CL. 41.
4,163,754, PUB. 4-10-2012. INT. CL. 41.

D & D GROUP PTY LTD., BROOKVALE, NEW SOUTH WALES, 2 100, AUSTRALIA:
2,508,197. REN. 5-21-12. INT. CL. 20.

D.C. HUMPHRYS CO., INC., PHILADELPHIA, PA, DBA HUMPHRYS TEXTILE PRODUCTS, INC.:
2,569,850. REN. 5-21-12. INT. CL. 19.

D.P. DOUGH FRANCHISING, LLC, COLUMBUS, OH:
2,555,808. REN. 5-18-12. INT. CL. 30.

D.ROSE STORE, INC., LOS ANGELES, CA:
3,959,944, AM. INT. CL. 25.

D'ARTAGNAN WINES CORPORATION, NAPA, CA, DBA Y ROUSSEAU WINES:
4,164,177, PUB. 4-10-2012. INT. CL. 33.

DABAAN, MOHAMED S., DAMASCUS, SYRIAN ARAB REP:
2,619,719. REN. 5-23-12. INT. CL. 14.

DAFFY'S, INC., SECAUCUS, NJ, DAFFY'S, INC., SECAUCUS, NJ:
1,719,647. REN. 5-23-12. INT. CL. 42.

DAHLGREN FOOTWEAR, INC., TUALATIN, OR:
4,162,790, PUB. 4-10-2012. INT. CL. 25.

DAI-ICHI DENPA KOGYO KABUSHIKI KAISHA, TOKYO, JAPAN, TA DAI-ICHI DENPA KOGYO CO., LTD.:
4,163,832, PUB. 4-10-2012. INT. CL. 9.

DAIRY ASSOCIATION COMPANY, INC., LYNDONVILLE, VT:
738,733. REN. 5-18-12. U.S. CL. 44 (INT. CL. 10).

DAIYA INDUSTRY CO., LTD., JAPAN:
4,162,880, PUB. 4-10-2012. INT. CL. 10.

DAKTRONICS, INC., BROOKINGS, SD:
2,689,325. REN. 5-23-12. INT. CL. 9.

DAL BELLO, PETER T., SANTA BARBARA, CA:
4,163,918, PUB. 4-10-2012. INT. CL. 35.

DALE MCQUEEN, LOVELAND, CO, DBA GAND ENTERPRISE:
4,165,489, INT. CL. 5.

DALY FRANCHISE COMPANY, LIVONIA, MI, DALY RESTAURANTS, INC., BIRMINGHAM, MI:
930,659. REN. 5-18-12. U.S. CL. 100 (INT. CL. 42).

DANA CANADA CORPORATION, OAKVILLE, ONTARIO, CANADA:
2,584,450. REN. 5-18-12. INT. CL. 7.

DANA CANADA CORPORATION, OAKVILLE, CANADA:
2,590,502. REN. 5-19-12. INT. CL. 7.

DANA CORPORATION, TOLEDO, OH TO DANA LIMITED, MAUMEE, OH:
1,200,853, CANC. MULTIPLE CLASS, INT. CLS. 9, 20 AND 34.

DANA LIMITED, MAUMEE, OH, DANA CORPORATION, TOLEDO, OH:
1,200,853. REN. 5-18-12. MULTIPLE CLASS, INT. CLS. 8, 11, 14, 16, 18, 21, 24, 25, 26 AND 28.

DANA LIMITED, TOLEDO, OH:
2,590,875. REN. 5-19-12. INT. CL. 17.

DANA LIMITED, MAUMEE, OH:
4,165,686, INT. CL. 12.

DANIEL POWELL, JERSEY CITY, NJ:
4,163,732, PUB. 4-10-2012. INT. CL. 41.

DANIELE DOMINICK, OAK BLUFFS, MA:
4,164,431, PUB. 4-10-2012. MULTIPLE CLASS, INT. CLS.

- 30 AND 43.
DANIELLE STEEL, SAN FRANCISCO, CA:
4,163,805, PUB. 4-10-2012. INT. CL. 41.
DANISCO A/S, COPENHAGEN K, DENMARK:
3,005,631, CANC. INT. CL. 1.
DAO INC., ARCADIA, CA:
4,164,906, MULTIPLE CLASS, INT. CLS. 14, 18 AND 25.
DARDEN CONCEPTS, INC., ORLANDO, FL:
4,164,769, PUB. 4-10-2012. INT. CL. 43.
DARE2..., WOODBURY, MN:
4,164,325, PUB. 4-10-2012. INT. CL. 25.
DAÏNÉ D'ARENBERG, B-1180 BRUXELLES, BELGIUM:
4,162,945, PUB. 4-10-2012. MULTIPLE CLASS, INT. CLS.
2, 16, 20, 27 AND 42.
DASSAULT SYSTEMES SOLIDWORKS CORPORATION,
WALTHAM, MA:
2,954,951, CANC. INT. CL. 9.
DATA BASED SYSTEMS INTERNATIONAL, INC., BETH-
LEHEM, PA:
2,574,147, REN. 5-24-12. INT. CL. 42.
DATA RESEARCH NETWORK, INC., ELK GROVE, CA,
DBA HIRESAFE:
4,163,765, PUB. 4-10-2012. INT. CL. 45.
DATABANK IMX LLC, BELTSVILLE, DE:
2,498,801, CANC. INT. CL. 9.
DATACARD CORPORATION, MINNETONKA, MN:
2,573,921, REN. 5-21-12. INT. CL. 9.
DATALOGIC S.P.A., BOLOGNA, ITALY:
3,012,448, CANC. INT. CL. 37.
DATAMAX-O'NEIL CORPORATION, ORLANDO, FL:
4,163,791, PUB. 4-10-2012. INT. CL. 9.
DATAVOX, INC., HOUSTON, TX:
2,571,341, REN. 5-22-12. INT. CL. 41.
2,571,341, COR. INT. CL. 41.
DAVID HAAG, LAS VEGAS, NV:
4,164,088, PUB. 4-10-2012. INT. CL. 16.
4,164,104, PUB. 4-10-2012. INT. CL. 16.
DAVID MICHAEL & CO., INC., PHILADELPHIA, PA:
4,164,054, PUB. 4-10-2012. INT. CL. 42.
DAVIS, JAMES M., NAPLES, FL:
2,498,541, CANC. INT. CL. 10.
DAY-GLO COLOR CORP., CLEVELAND, OH, SWITZER
BROTHERS, INC., CLEVELAND 3, OH:
558,481, REN. 5-23-12. U.S. CL. 16 (INT. CL. 2).
DAY-GLO COLOR CORP., CLEVELAND, OH, SWITZER
BROTHERS, INC., CLEVELAND, OH:
562,386, REN. 5-22-12. U.S. CL. 6 (INT. CLS. 1, 2, 3, 4 AND
5).
DAYCO PRODUCTS, INC., TULSA, OK:
1,689,837, REN. 5-18-12. MULTIPLE CLASS, INT. CLS. 7
AND 12.
DAZOR MANUFACTURING CORP., ST. LOUIS, MO:
503,877, CANC. U.S. CL. 21.
DCA DESIGN INTERNATIONAL LTD, UNITED KING-
DOM:
4,162,842, PUB. 4-10-2012. MULTIPLE CLASS, INT. CLS.
35 AND 42.
DCI CHEESE COMPANY, INC., RICHFIELD, WI:
1,766,051, REN. 5-21-12. INT. CL. 29.
DCWV ACQUISITION CORPORATION, PROVO, UT:
4,163,530, PUB. 4-10-2012. MULTIPLE CLASS, INT. CLS.
16 AND 19.
DE BEST GOURMET FOOD PRODUCTS LTD., NIAGARA
FALLS, ONTARIO, CANADA:
4,165,613, INT. CL. 30.
DE CEUSTER MESTSTOFFEN, IN HET KORT GENAAMD
D.C.M., NAAMLOZE VENNOOTSCHAP, SINT-KATE-
LIJNE-WAVER, BELGIUM:
4,162,998, PUB. 4-10-2012. MULTIPLE CLASS, INT. CLS.
1, 5 AND 31.
DE LA CRUZ, MICHAEL, PORTSMOUTH, NH:
4,163,349, PUB. 4-10-2012. INT. CL. 42.
DE SOTO, INC., DES PLAINES, IL:
857,794, CANC. U.S. CL. 16.
DEAD RINGER, LLC, ROCHESTER, NY:
4,165,558, INT. CL. 13.
DEBBIE RHODES BARNWELL, CAMPOBELLO, SC:
4,163,958, PUB. 4-10-2012. INT. CL. 41.
4,163,960, PUB. 4-10-2012. INT. CL. 41.
DEBORAH DICKINSON, SOUTH DENNIS, NJ:
4,165,546, INT. CL. 9.
DEBRA GIRARD, WAREHAM, MA:
3,147,229, CANC. INT. CL. 31.
DEBRUYN HOLDINGS, INC., MANHATTAN, KS:
4,163,311, PUB. 4-10-2012. INT. CL. 41.
DECATHLON SA, VILLENEUVE D'ASCQ, FRANCE:
4,162,983, PUB. 4-10-2012. MULTIPLE CLASS, INT. CLS.
12, 18 AND 28.
DECEASED CREDIT MANAGEMENT, LLC, MINNEAPO-
LIS, MN:
4,164,030, PUB. 4-10-2012. INT. CL. 35.
DECISION ANALYST, INC., ARLINGTON, TX:
1,690,882, AM. INT. CL. 35.
DEE, JESSE, MEDFORD, MA:
4,164,009, PUB. 4-10-2012. INT. CL. 9.
DEEM CORPORATION, THE, OMAHA, NE:
2,569,640, REN. 5-18-12. INT. CL. 42.
DEER ISLE GROUP, LLC, NEW YORK, NY:
4,165,370, INT. CL. 36.
DEFENDER MOUTHGUARD LABORATORIES, LLC, WEST
NYACK, NY:
4,164,710, PUB. 4-10-2012. MULTIPLE CLASS, INT. CLS.
28 AND 40.
4,164,718, PUB. 4-10-2012. MULTIPLE CLASS, INT. CLS.
28 AND 40.
DEGERENERGIE GMBH, FED REP GERMANY:
4,162,855, PUB. 4-10-2012. INT. CL. 9.
DELICIOUS POPCORN & DISTRIBUTORS CO., INC., WAU-
PACA, WI:
1,694,632, REN. 5-18-12. MULTIPLE CLASS, INT. CLS. 29
AND 30.
DELSON GROUP INC, CUPERTINO, CA:
4,165,991, INT. CL. 9.
DELTA GREEN, MADERA, CA:
4,165,408, INT. CL. 36.
DELUXE DIGITAL MEDIA MANAGEMENT, INC., VALEN-
CIA, CA:
3,006,102, CANC. INT. CL. 40.
DENISE MURPHY, TOWSON, MD:
4,164,136, PUB. 4-10-2012. INT. CL. 35.
DENMARK, THEODORE C., SCOTTSDALE, AZ AND DEN-
MARK, KATHLEEN L., SCOTTSDALE, AZ:
4,165,401, INT. CL. 5.
DENNISON MANUFACTURING COMPANY, FRAMING-
HAM, MA:
855,125, CANC. U.S. CL. 38.
DENNISON NATIONAL COMPANY, HOLYOKE, MA:
854,628, CANC. U.S. CL. 37.
854,629, CANC. U.S. CL. 37.
DENSO CORPORATION, KARIYA-CITY, AICHI-PREF. 448-
8661, JAPAN:
4,162,695, PUB. 4-10-2012. MULTIPLE CLASS, INT. CLS.
35, 37 AND 42.
DENSO CORPORATION, KARIYA, AICHI, JAPAN:
4,162,747, PUB. 4-26-2011. MULTIPLE CLASS, INT. CLS. 7
AND 9.
DENTAL USA, MCHENRY, IL:
4,163,681, PUB. 4-10-2012. INT. CL. 10.
DENTSPLY INTERNATIONAL INC., YORK, PA:
2,944,032, CANC. INT. CL. 5.
4,164,758, PUB. 4-10-2012. INT. CL. 10.
DENYSE, TAMMIE, SACRAMENTO, CA:
4,163,820, PUB. 4-10-2012. INT. CL. 35.
DEPAOLO, DAVID J., CAMARILLO, CA:
2,686,073, REN. 5-23-12. INT. CL. 35.
DEPARTMENT OF THE ARMY, WASHINGTON, DC:
4,166,033, INT. CL. 45.
DEPIERRO, MICHAEL JOHN, BOSTON, MA:
1,696,727, REN. 5-18-12. MULTIPLE CLASS, INT. CLS. 16
AND 20.
DEPUY SPINE, INC., RAYNHAM, MA:
1,687,728, REN. 5-22-12. INT. CL. 10.
DEQ SYSTEMES CORP., ST-ROMUALD, CANADA:
4,162,732, PUB. 4-10-2012. INT. CL. 9.

DERMA SCIENCES, INC., PRINCETON, NJ:
1,697,316. REN. 5-24-12. INT. CL. 5.

DERMADOCTOR, INC., KANSAS CITY, MO:
4,165,064. INT. CL. 3.

DEROYAL INDUSTRIES, INC., POWELL, TN:
2,714,461. REN. 5-24-12. INT. CL. 10.

DESMOND TUTU PEACE FOUNDATION, NEW YORK, NY:
4,164,926. INT. CL. 35.

DESNOES & GEDDES, LTD., KINGSTON 11, JAMAICA:
1,686,630. REN. 5-18-12. INT. CL. 32.

DESTILERIA SERRALLES, INC., MERCEDITA, PUERTO RICO:
4,165,162. INT. CL. 33.

DESTINY OUTREACH, CHICAGO, IL:
2,510,318. REN. 5-18-12. INT. CL. 41.

DESTYLARNIA SOBIESKI S.A., STAROGARD GDANSKI, POLAND:
3,005,320. CANC. INT. CL. 33.

DETREX CHEMICAL INDUSTRIES, INC., DETROIT, MI:
859,908. CANC. U.S. CL. 6.

DETROIT GAUGE AND TOOL COMPANY, THE, SOUTH-FIELD, MI:
2,641,828. REN. 5-18-12. MULTIPLE CLASS, INT. CLS. 9 AND 42.

DEUTSCHE BANK AG, UNITED KINGDOM:
4,162,885. PUB. 4-10-2012. MULTIPLE CLASS, INT. CLS. 9, 16, 35, 36 AND 42.

DEUTSCHE EDELSTAHLWERKE GMBH, 58452 WITTEN, FED REP GERMANY:
4,162,811. PUB. 2-15-2011. INT. CL. 6.

DEUTSCHE TELEKOM AG, BONN, 53113, FED REP GERMANY:
3,007,023. CANC. INT. CL. 16.
3,007,067. CANC. INT. CL. 42.

DEUTSCHE TELEKOM AG, BONN, FED REP GERMANY:
3,008,694. CANC. INT. CL. 38.

DEVRY EDUCATIONAL DEVELOPMENT CORPORATION, DOWNERS GROVE, IL:
4,165,050. INT. CL. 41.

DGM (HK) LIMITED, KOWLOON, HONG KONG:
4,165,461. INT. CL. 9.

DGMB CASINO, LLC, ATLANTIC CITY, NJ, DBA RESORTS CASINO HOTEL:
4,164,731. PUB. 4-10-2012. INT. CL. 41.

DIAGEO BRANDS B.V., AMSTERDAM, NETHERLANDS:
860,266. CANC. U.S. CL. 49.

DIAGEO NORTH AMERICA, INC., NORWALK, CT:
860,273. CANC. U.S. CL. 49.

DIAL, JR., TED C., MOBILE, AL:
4,162,717. PUB. 4-10-2012. INT. CL. 19.

DIAMOND TECH INTERNATIONAL, TAMPA, FL:
4,163,238. PUB. 4-10-2012. INT. CL. 8.

DIAMOND V MILLS, INC., CEDAR RAPIDS, IA:
1,685,962. REN. 5-18-12. INT. CL. 5.

DIANA E. KELLY, INC., SARASOTA, FL:
4,163,864. PUB. 4-10-2012. INT. CL. 25.

DIANA MALERBA, BAY SHORE, NY:
4,163,427. PUB. 4-10-2012. INT. CL. 45.

DIET DIRECT, INC., WILMINGTON, NC:
2,582,429. REN. 5-18-12. INT. CL. 5.

DIGGLER, INC., PETALUMA, CA:
2,499,221. CANC. INT. CL. 28.

DIGITAL AUDIO CORPORATION, DURHAM, NC:
2,644,546. REN. 5-18-12. INT. CL. 9.

DIGITAL DEIVERY NETWORKS, INC., SCOTTS VALLEY, CA:
4,164,932. INT. CL. 9.

DIGITAL ENTERTAINMENT CORPORATION OF AMERICA, SANTA MONICA, CA:
4,165,710. INT. CL. 41.

DILLARD UNIVERSITY, NEW ORLEANS, LA:
4,164,085. PUB. 4-10-2012. INT. CL. 41.
4,164,086. PUB. 4-10-2012. INT. CL. 41.
4,164,089. PUB. 4-10-2012. INT. CL. 41.

DILLARD'S, INC., LITTLE ROCK, AR:
1,743,805. REN. 5-18-12. INT. CL. 24.

DILLIN ENGINEERED SYSTEMS CORPORATION, PERRYSBURG, OH, DILLIN ENGINEERED SYSTEMS CORPORATION, PERRYSBURG, OH:
2,716,014. REN. 5-21-12. INT. CL. 7.

DIMALANTA, ERNIE, MAINEVILLE, OH:
4,164,623. PUB. 4-10-2012. MULTIPLE CLASS, INT. CLS. 35 AND 41.

DINER, MELISSA, BEVERLY HILLS, CA AND PAGE, BRETT A., BEVERLY HILLS, CA:
4,164,889. MULTIPLE CLASS, INT. CLS. 14, 18 AND 25.

DINUNZIO, ROBERT, CHERRY HILL, NJ:
4,164,155. PUB. 4-10-2012. INT. CL. 10.

DIPOC INTERNATIONAL, FAYETTEVILLE, GA:
4,163,779. PUB. 4-10-2012. INT. CL. 37.

DIRCKSEN & TALLEYRAND, INC., BROOKLYN, NY:
1,710,574. REN. 5-18-12. INT. CL. 42.

DIRECT ENERGY MARKETING LIMITED, TORONTO ONTARIO, CANADA:
3,092,154. CANC. MULTIPLE CLASS, INT. CLS. 38, 40 AND 43.

DIRECT GLOBAL SALES, INC., SEATTLE, WA:
4,166,001. INT. CL. 35.

DIRT ON A CAKE, LLC, WINDHAM, ME:
4,163,475. PUB. 4-10-2012. INT. CL. 30.

DISCOVERY COMMUNICATIONS, LLC, SILVER SPRING, MD:
3,006,215. CANC. INT. CL. 31.
4,163,103. PUB. 4-10-2012. INT. CL. 41.
4,165,360. INT. CL. 41.

DISCUS DENTAL, LLC, LOS ANGELES, CA:
2,497,751. CANC. INT. CL. 42.
2,498,810. CANC. INT. CL. 20.

DISNEY ENTERPRISES, INC., BURBANK, CA:
2,601,335. REN. 5-18-12. INT. CL. 16.
4,165,928. INT. CL. 9.

DISPLAY INDUSTRIES, LLC., NORCROSS, GA:
2,607,592. REN. 5-18-12. INT. CL. 20.

DISPRESIVE MEDICAL, LLC, CUMMING, GA:
4,164,191. PUB. 4-10-2012. INT. CL. 38.

DISTILLED SPIRITS EPICENTER, LLC, LOUISVILLE, KY:
4,164,057. PUB. 4-10-2012. INT. CL. 42.
4,164,060. PUB. 4-10-2012. MULTIPLE CLASS, INT. CLS. 33 AND 42.

DISTINCT MEDICAL EQUIPMENT, LLC, CORAL SPRINGS, FL:
3,006,251. CANC. INT. CL. 10.

DITA, INC., LOS ANGELES, CA:
4,162,792. PUB. 2-14-2006. MULTIPLE CLASS, INT. CLS. 18 AND 25.

DITR, LLC, CINCINNATI, OH, ROOKWOOD POTTERY COMPANY, THE, CINCINNATI, OH:
155,517. REN. 5-23-12. U.S. CL. 30 (INT. CL. 21).
155,518. REN. 5-23-12. U.S. CL. 30 (INT. CL. 21).

DIVECHA, COLBY, DRAPER, UT:
4,163,555. PUB. 4-10-2012. INT. CL. 30.

DIXON, ROD, SILVER SPRING, MD:
2,498,845. CANC. INT. CL. 42.

DIZZY DEAN BASEBALL, INC., HERNANDO, MS:
4,163,118. PUB. 4-10-2012. INT. CL. 41.

DJ YACHT ENTERPRISES, LLC, NEW YORK, NY:
4,163,684. PUB. 4-10-2012. INT. CL. 39.

DJF ENTERPRISES, NEW YORK, NY:
4,165,182. INT. CL. 3.

DMK ENTERPRISES LLC, MANAHAWKIN, NJ:
4,164,246. PUB. 4-10-2012. INT. CL. 41.

DNA (HOUSEMARKS) LIMITED, LONDON, UNITED KINGDOM:
2,621,023. REN. 5-18-12. INT. CL. 12.

DO IT BEST CORP., FORT WAYNE, IN, HARDWARE WHOLESALERS, INC., FT. WAYNE, IN:
1,213,646. REN. 5-23-12. INT. CL. 42.

DOAN, THAI CHAU, PHOENIX, AZ:
4,164,491. PUB. 4-10-2012. INT. CL. 35.

DOCTATIONS, INC., GARDEN CITY, NY:
4,165,948. INT. CL. 42.

DOCTOR'S ASSOCIATES INC., MILFORD, CT:
4,163,547. PUB. 4-10-2012. INT. CL. 43.

- DOCTORS COMPANY, THE, NAPA, CA:
1,688,097. REN. 5-20-12. INT. CL. 36.
- DOGFISH HEAD MARKETING, LLC, MILTON, DE:
4,164,232, PUB. 4-10-2012. INT. CL. 33.
4,164,234, PUB. 4-10-2012. INT. CL. 32.
- DOMBIA ENTERPRISE INCORPORATED, VILLA PARK,
IL:
4,165,288, INT. CL. 35.
4,165,289, INT. CL. 35.
- DOMES SECURITY, MENLO PARK, CA:
4,166,065, INT. CL. 42.
- DOMINANT BRANDS LLC, NEW YORK, NY:
4,165,363, INT. CL. 36.
- DON QUIJOTE USA, INC., MADRID, SPAIN:
2,569,976. REN. 5-19-12. INT. CL. 41.
- DONALD F. KERR, NEW PALTZ, NY, DBA WET-TEK LLC.:
4,094,112, AM. INT. CL. 11.
- DONNI CHARM, INC., ENGLEWOOD, CO:
4,163,717, PUB. 4-10-2012. MULTIPLE CLASS, INT. CLS.
14 AND 25.
- DORAL FINANCIAL CORPORATION, SAN JUAN, PUERTO
RICO:
4,163,288, PUB. 4-10-2012. INT. CL. 36.
- DORGAN ASSOCIATES, INC., MADISON, WI:
2,499,074, CANC. INT. CL. 42.
- DOROTHEA KNITTING MILLS LIMITED, TORONTO,
ONTARIO, CANADA:
2,599,952. REN. 5-18-12. INT. CL. 25.
- DORPAN, S.L., PALMA DE MALLORCA, SPAIN:
4,163,513, PUB. 4-10-2012. MULTIPLE CLASS, INT. CLS.
16 AND 43.
- DOSKOCIL MANUFACTURING COMPANY, INC., AR-
LINGTON, TX:
3,006,227, CANC. INT. CL. 21.
- DOT HILL SYSTEMS CORP, LONGMONT, CO:
4,165,501, INT. CL. 9.
- DOTS, LLC, SOLON, OH:
2,568,849. REN. 5-21-12. INT. CL. 35.
- DOTSGOOD, INC., BLUE RIDGE, GA:
2,497,804, CANC. INT. CL. 35.
- DOUBLE DIAMOND DISTILLERY, LLC, PUEBLO, CO:
4,165,067, INT. CL. 33.
- DOUBLE-COLA CO.-U.S.A., CHATTANOOGA, TN, SEMI-
NOLE FLAVOR COMPANY, CHATTANOOGA, TN:
572,477. REN. 5-24-12. U.S. CL. 45 (INT. CL. 32).
- DOUGLAS ELLIMAN REALTY, LLC, NEW YORK, NY:
4,164,300, PUB. 4-10-2012. INT. CL. 36.
- DOW AGROSCIENCES LLC, INDIANAPOLIS, IN:
4,164,961, INT. CL. 5.
- DOW CHEMICAL COMPANY, THE, MIDLAND, MI:
735,843. REN. 5-18-12. U.S. CL. 6 (INT. CL. 1).
941,806. REN. 5-22-12. U.S. CL. 6 (INT. CL. 1).
- DOW CONSUMER PRODUCTS INC., INDIANAPOLIS, IN:
853,936, CANC. U.S. CL. 6.
- DOW JONES & COMPANY, INC., NEW YORK, NY:
2,575,504. REN. 5-24-12. INT. CL. 42.
2,575,505. REN. 5-24-12. INT. CL. 35.
2,580,479. REN. 5-23-12. INT. CL. 16.
- DOWBRANDS INC., MINNEAPOLIS, MN:
862,032, CANC. U.S. CL. 40.
- DR MUSIC INC., EMERSON, NJ:
4,164,860, INT. CL. 15.
- DR PEPPER/SEVEN UP, INC., PLANO, TX:
863,207, CANC. U.S. CL. 45.
- DR SYSTEMS, INC., SAN DIEGO, CA:
1,737,507. REN. 5-18-12. INT. CL. 9.
- DR. ALAN Z MARKOWITZ, DMD PA, BOCA RATON, FL:
4,164,076, PUB. 4-10-2012. INT. CL. 44.
- DR. CHRISTINA T. SCHLACHTER, PHD, BOULDER, CO,
DBA LSSL:
4,163,157, PUB. 4-10-2012. INT. CL. 41.
- DR. G'S FRANCHISING COMPANIES, LLC., DAVIE, FL
AND JDJ OF MIAMI, INC., AVENTURA, FL:
4,165,312, INT. CL. 44.
- DR. HANS LAUTENSCHLAGER, FED REP GERMANY:
3,041,911.
- DR. JEAN BAUSCH GMBH & CO. KG, 50769 COLOGNE,
FED REP GERMANY:
2,603,043. REN. 5-18-12. INT. CL. 10.
2,603,044. REN. 5-18-12. INT. CL. 10.
- DR. JOHN W. NESBITT INC., BRITISH COLUMBIA, CANA-
DA:
4,130,169, COR. INT. CL. 21.
- DR. PALMER'S LLC, GREENWICH, CT:
4,164,892, INT. CL. 3.
- DR. ROBERT S. IVKER, D.O., P.C., LITTLETON, CO:
4,164,558, PUB. 4-10-2012. INT. CL. 44.
- DR. SPILLER BIOCOSMETIC GMBH, FED REP GERMANY:
4,162,804, PUB. 4-10-2012. INT. CL. 3.
- DRAEGER SAFETY UK LIMITED, NORTHUMBERLAND,
NE24, 4RG, ENGLAND, FORMERLY DRAEGER LIM-
ITED:
3,005,332, CANC. INT. CL. 9.
- DRAFTFCB, INC., NEW YORK, NY:
4,163,442, PUB. 4-10-2012. INT. CL. 35.
- DRESSER INDUSTRIES, INC., DALLAS, TX:
863,375, CANC. U.S. CL. 12.
- DRESSER, KEVIN P, NEW PALTZ, NY:
4,165,861, MULTIPLE CLASS, INT. CLS. 9 AND 16.
- DREXEL INDUSTRIES, INC., HORSHAM, PA:
856,987, CANC. U.S. CL. 23.
- DREXEL UNIVERSITY, PHILADELPHIA, PA:
4,164,826, INT. CL. 41.
- DREYMILLER AND KRAY, INC., HAMPSHIRE, IL:
4,163,523, PUB. 4-10-2012. INT. CL. 29.
- DRILLING INFO, INC., AUSTIN, TX:
4,164,331, PUB. 4-10-2012. INT. CL. 42.
4,164,340, PUB. 4-10-2012. INT. CL. 42.
4,164,692, PUB. 4-10-2012. INT. CL. 42.
- DRIVE TRADEMARK HOLDINGS LP, DALLAS, TX:
2,503,943. REN. 5-18-12. INT. CL. 36.
2,503,946. REN. 5-18-12. INT. CL. 36.
- DRIVE-THRU RECORDS, LLC, LOS ANGELES, CA:
3,014,831, CANC. INT. CL. 16.
- DROPTHOUGHT, INC., SANTA CLARA, CA:
4,164,526, PUB. 4-10-2012. INT. CL. 35.
- DRUCKER IP, LLC, PLANO, TX:
4,166,015, INT. CL. 5.
- DRYVIT SYSTEMS INC., WEST WARWICK, RI:
1,697,272. REN. 5-21-12. INT. CL. 2.
- DSM IP ASSETS B.V., HEERLEN, NETHERLANDS:
2,577,941. REN. 5-24-12. INT. CL. 16.
- DU PAREIL AU MEME, FRANCE:
4,162,894, PUB. 4-10-2012. MULTIPLE CLASS, INT. CLS.
18, 24 AND 25.
4,162,928, PUB. 4-10-2012. MULTIPLE CLASS, INT. CLS.
18, 24 AND 25.
- DUAL GROUP, LLC, NEW YORK, NY:
4,164,872, INT. CL. 41.
- DUCLAW BREWERY, LLC, BEL AIR, MD:
2,571,434. REN. 5-21-12. INT. CL. 32.
2,571,435. REN. 5-21-12. INT. CL. 32.
- DUDALINA S/A, BLUMENAU, BRAZIL:
4,163,880, PUB. 4-10-2012. INT. CL. 35.
4,163,881, PUB. 4-10-2012. INT. CL. 25.
4,163,882, PUB. 4-10-2012. INT. CL. 25.
4,163,883, PUB. 4-10-2012. INT. CL. 35.
- DUFFY STEPHEN J, NASHVILLE, TN, DBA ECO FILTER
TECHNOLOGIES:
4,163,814, PUB. 4-10-2012. INT. CL. 19.
- DUGUE, JEAN, J, FORT LAUDERDALE, FL AND DUGUE,
JUNIOR, FORT LAUDERDALE, FL:
4,165,552, INT. CL. 9.
- DUNCAN CHRISTOPHER WALSH, THE PARK, NOTTING-
HAM, UNITED KINGDOM:
4,163,184, PUB. 4-10-2012. MULTIPLE CLASS, INT. CLS.
9, 10 AND 14.
- DUNDEE CORPORATION, TORONTO, ONTARIO, CANA-
DA:
4,162,796, PUB. 4-10-2012. INT. CL. 36.
- DUNKELMAN & SON LTD., KETTERING, NORTHANTS,
NN14 2PF, GREAT BRITAIN:
1,666,769. REN. 5-18-12. INT. CL. 21.

DUNN AND MCCARTHY, INC., AUBURN, NY:
863,566, CANC. U.S. CL. 39.

DUNSTON, MICHELANTONY, EL CERRITO, CA:
4,164,142, PUB. 4-10-2012. INT. CL. 41.

DUPONT SHIAH ENTERPRISES LLC, DANVILLE, CA:
4,165,813, INT. CL. 44.

DUROTEX CHEMICAL COMPANY, WEATHERFORD, OK,
DBA STAM-AIDS ATHLETIC PRODUCTS, INC.:
862,293, CANC. U.S. CL. 18.

DUSTY FEET, INC., BRANSON, MO:
4,163,445, PUB. 11-8-2011. INT. CL. 36.

DVCC, INC., CHESTERTOWN, MD:
4,164,801, INT. CL. 37.

DWS, INC., SOUTH BURLINGTON, VT, DBA SELECTION
UNLIMITED:
2,666,588. REN. 5-23-12. INT. CL. 32.

DYAX CORP., BURLINGTON, MA:
4,163,643, PUB. 4-10-2012. INT. CL. 42.
4,165,884, INT. CL. 44.

DYCONN, INC., WALNUT, CA:
4,163,938, PUB. 4-10-2012. MULTIPLE CLASS, INT. CLS. 6
AND 9.

DYNA VOX SYSTEMS LLC, PITTSBURGH, PA, SENTIENT
SYSTEMS TECHNOLOGY, INC., PITTSBURGH, PA:
1,687,116. REN. 5-18-12. INT. CL. 16.

DYNAMIC MEASUREMENT GROUP, INC., EUGENE, OR:
4,164,609, PUB. 4-10-2012. INT. CL. 42.

DYNAMIC VISION INTERNATIONAL, INC., REDONDO
BEACH, CA:
4,163,976, PUB. 4-10-2012. INT. CL. 41.

DYNASTY CONSOLIDATED INDUSTRIES, INC., DALLAS,
TX:
2,713,657. REN. 5-21-12. INT. CL. 20.

DYNASTY CONSOLIDATED INDUSTRIES, INC., FORT
WORTH, TX, DBA SLEEPTRONIC SLEEP PRODUCTS:
2,715,894. REN. 5-21-12. INT. CL. 20.

D2INTERIEURS, LLC, WESTON, CT:
4,163,645, PUB. 4-10-2012. INT. CL. 42.

E S ROBBINS CORPORATION, MUSCLE SHOALS, AL:
4,165,830, INT. CL. 43.

E. & J. GALLO WINERY, MODESTO, CA:
2,256,516, COR. INT. CL. 33.
4,165,636, INT. CL. 41.

E. A. SWEEN COMPANY, EDEN PRAIRIE, MN:
1,665,521. REN. 5-21-12. INT. CL. 30.

E. WALDO WARD & SON, INC., SIERRA MADRE, CA:
4,163,208, PUB. 4-10-2012. MULTIPLE CLASS, INT. CLS.
29 AND 30.

E.A. ISSA & BROS. LTD., KINGSTON 4, JAMAICA:
4,162,749, PUB. 8-11-2009. INT. CL. 43.

E.A. SWEEN COMPANY, EDEN PRAIRIE, MN:
4,165,271, INT. CL. 35.

E.J. BOGNAR, INC., PITTSBURGH, PA:
563,580. REN. 5-22-12. U.S. CL. 12 (INT. CL. 19).

E.J. CONFIDENTIAL, INC., SOUTHFIELD, MI, DBA MAR-
RYMEYESTERDAY.COM:
4,165,427, INT. CL. 45.

E.M.E. (ELECTRO MEDICAL EQUIPMENT) LTD., BRIGHT-
ON, EAST SUSSEX, ENGLAND:
2,526,192. REN. 5-18-12. INT. CL. 10.

E.S.T. EYÜP SABRI TUNCER KOZMETİK SANAYİ ANO-
NİM SİRKETİ, TURKEY:
4,162,829, PUB. 8-16-2011. MULTIPLE CLASS, INT. CLS.
3, 4, 5, 14, 21, 24, 25, 26, 29, 30, 32 AND 35.

E&B GIFTWARE, LLC, YONKERS, NY:
4,164,799, INT. CL. 9.
4,164,800, INT. CL. 28.

E-JEWELRY, LLC, FAIRFIELD, OH:
3,006,094, CANC. INT. CL. 35.

E-SELEX.COM, SAN DIEGO, CA:
2,498,492, CANC. INT. CL. 35.

E-SLIPS, INC., CHICAGO, IL:
2,497,730, CANC. INT. CL. 9.

E-THINGS SOLUCIONES, S.L., 28016 MADRID, SPAIN:
4,163,350, PUB. 4-10-2012. INT. CL. 41.

EAGLE INVESTMENT SYSTEMS CORP., WEST HART-
FORD, CT:
4,163,703, PUB. 4-10-2012. INT. CL. 9.

EARLEX LIMITED, SURREY, UNITED KINGDOM:
3,005,632, CANC. MULTIPLE CLASS, INT. CLS. 7, 8 AND
11.

EARTH SERVICES & SUPPLY, LLC, GRAND RAPIDS, MI:
4,164,018, PUB. 4-10-2012. INT. CL. 1.

EARTHLINK, INC., ATLANTA, GA:
4,163,177, PUB. 4-10-2012. INT. CL. 38.
4,163,248, PUB. 4-10-2012. INT. CL. 38.
4,163,249, PUB. 4-10-2012. INT. CL. 42.

EASTERN PNEUMATICS & HYDRAULICS, HIGHGATE
SPRINGS, VT:
2,663,378. REN. 5-23-12. INT. CL. 8.

EASTMAN CHEMICAL RESINS, INC., KINGSPORT, TN,
HERCULES POWDER COMPANY, WILMINGTON, DE:
566,735. REN. 5-24-12. U.S. CL. 6 (INT. CL. 1).

EASTMAN SPORTO GROUP, LLC, NEW YORK, NY:
1,278,120, CANC. INT. CL. 25.

EASTMAN, JOHN KELLY, AMERICAN FORK, UT AND
EASTMAN, CHARLETTE, AMERICAN FORK, UT:
2,499,056, CANC. INT. CL. 28.

EASY TRACK, LLC, N. MIAMI, FL, DBA MOVIL GUARD:
3,622,144, CANC. INT. CL. 36.

EAT SHOP GIVE, LLC, NORRISTOWN, PA:
4,163,865, PUB. 4-10-2012. INT. CL. 35.

EATON OIL/AUTOMOTIVE CHEMICAL COMPANY, LLC,
TEQUESTA, FL:
4,164,368, PUB. 4-10-2012. INT. CL. 3.

EBARA CORPORATION, TOKYO, JAPAN:
4,163,786, PUB. 4-10-2012. INT. CL. 7.

EBBERT, PHILIP D., PASADENA, CA:
4,165,649, INT. CL. 9.

EBBS, JUSTIN, HUNTINGDON CAMBRIDGESHIRE PE28
2TH, ENGLAND:
2,498,039, CANC. INT. CL. 16.

EBM-PAPST MULFINGEN GMBH & CO. KG, MULFINGEN,
FED REP GERMANY:
4,065,154, COR. MULTIPLE CLASS, INT. CLS. 7, 9 AND
11.

EBONITE HOLDINGS, INC., HOPKINSVILLE, KY, TRACK,
INC., SOLON, OH:
1,729,564. REN. 5-24-12. INT. CL. 28.

EC-LEASING CO., MOSCOW, RUSSIAN FED.:
4,162,856, PUB. 1-3-2012. MULTIPLE CLASS, INT. CLS. 9,
36, 38 AND 42.

ECKER, ROBERT J., CHICOPEE, MA:
2,995,044, CANC. INT. CL. 8.

ECLIPSE JAMAICAN FOODS, INC., CHICAGO, IL:
4,163,477, PUB. 4-10-2012. INT. CL. 30.

ECOCERT, FRANCE:
4,162,950, PUB. 4-10-2012. INT. CL. 42.

EDELSON, REBECCA, AMHERST, MA:
2,589,794. REN. 5-21-12. INT. CL. 41.

EDGENET, INC., WAUKESHA, WI:
4,165,328, MULTIPLE CLASS, INT. CLS. 35 AND 45.
4,165,329, MULTIPLE CLASS, INT. CLS. 35 AND 45.

EDGEWEBHOSTING, INC., BALTIMORE, MD:
4,163,809, PUB. 4-10-2012. MULTIPLE CLASS, INT. CLS.
39 AND 42.

EDUCATIONAL TESTING SERVICE, PRINCETON, NJ:
559,686. REN. 5-18-12. U.S. CL. 38 (INT. CL. 16).

EDUCATIONDYNAMICS, LLC, HOBOKEN, NJ:
4,166,082, MULTIPLE CLASS, INT. CLS. 35 AND 41.

EDUCAUSE, LOUISVILLE, CO:
2,575,155. REN. 5-21-12. MULTIPLE CLASS, INT. CLS. 16
AND 42.

EDWARDS LIFESCIENCES CORPORATION, IRVINE, CA:
2,506,769. REN. 5-21-12. INT. CL. 10.

EDWARDS, CHARLES, AUSTIN, TX AND ALLSUP, RO-
MALDA, AUSTIN, TX:
4,162,797, PUB. 4-10-2012. INT. CL. 35.

EDWARDS, JON SCOTT, VENICE, CA:
2,573,193. REN. 5-19-12. INT. CL. 15.

EELVELLE, CARLSBAD, CA:
4,164,716, PUB. 4-10-2012. INT. CL. 12.

EFFA, LOUIS, GREAT MILLS, MD:
4,163,536, PUB. 4-10-2012. MULTIPLE CLASS, INT. CLS.
25 AND 41.

- EFFIGI INC., LAVAL QUEBEC, CANADA:
3,006,253, CANC. MULTIPLE CLASS, INT. CLS. 18 AND 25.
- EFFORTLESS BEDDING LLC, FREEHOLD, NJ:
4,163,408, PUB. 4-10-2012. INT. CL. 24.
- EFFRON, MARVIN TANNER, ORLANDO, FL:
4,164,498, PUB. 4-10-2012. INT. CL. 16.
- EFIL LIFE, INC., WESTHAMPTON, NM:
4,165,829, INT. CL. 3.
- EFP ARTISAN PRODUCTS LLC, CHATSWORTH, CA:
4,164,566, PUB. 4-10-2012. MULTIPLE CLASS, INT. CLS. 29 AND 30.
- EGT, LLC, LONGVIEW, WA:
4,165,219, INT. CL. 39.
- EGYED, PETER, GOODYEAR, AZ:
4,164,320, PUB. 4-10-2012. INT. CL. 25.
- EIGHT DAYS, INC., TORONTO, CANADA:
2,569,798. REN. 5-21-12. INT. CL. 42.
- EIGHT-O-MANAGEMENT, INC., DALLAS, TX:
4,162,714, PUB. 4-10-2012. INT. CL. 43.
- EINARSON, LAURA, WINNIPEG, MANITOBA, CANADA:
3,005,338, CANC. MULTIPLE CLASS, INT. CLS. 9, 35 AND 41.
- EISENMANN AG, FED REP GERMANY:
4,162,992, PUB. 4-10-2012. MULTIPLE CLASS, INT. CLS. 7 AND 11.
- EK SUCCESS, LTD., CLIFTON, NJ:
4,164,862, INT. CL. 14.
- EKHO BRAND AMERICAS, LLC, MINNEAPOLIS, MN, AKA EKHO HEART RATE MONITORS:
4,163,691, PUB. 4-10-2012. MULTIPLE CLASS, INT. CLS. 9 AND 10.
- EL GALLO GIRO CORPORATION, DOWNEY, CA:
3,006,177, CANC. MULTIPLE CLASS, INT. CLS. 35 AND 43.
- ELARA FOODSERVICE DISPOSABLES LLC, JERICHO, NY:
4,163,811, PUB. 4-10-2012. MULTIPLE CLASS, INT. CLS. 8, 16, 21 AND 25.
- ELDORADO COFFEE DISTRIBUTORS, LTD., MASPETH, NY:
2,680,570. REN. 5-22-12. INT. CL. 30.
- ELEBRA, LLC, IRVINE, CA:
4,164,217, PUB. 4-10-2012. INT. CL. 5.
- ELEGILITY, INC., SAN FRANCISCO, CA:
2,610,386. REN. 5-18-12. INT. CL. 9.
2,610,387. REN. 5-19-12. INT. CL. 42.
- ELEMATIC GROUP OY, FINLAND:
4,162,822, PUB. 4-10-2012. INT. CL. 37.
- ELEVAGE EVENTS, INC., CHICAGO, IL:
4,164,481, PUB. 4-10-2012. INT. CL. 41.
- ELEVATION PARTNERS LLC, LAWRENCE, KS:
4,165,939, MULTIPLE CLASS, INT. CLS. 35 AND 38.
4,165,940, MULTIPLE CLASS, INT. CLS. 35 AND 38.
- ELIAZ BINYAMINA (18-18) LTD., BINYAMINA, ISRAEL:
4,164,189, PUB. 4-10-2012. INT. CL. 33.
4,164,705, PUB. 4-10-2012. INT. CL. 33.
4,164,706, PUB. 4-10-2012. INT. CL. 33.
- ELLISON'S GREENHOUSES, INC., BRENHAM, TX:
2,578,370. REN. 5-21-12. INT. CL. 31.
2,578,371. REN. 5-19-12. INT. CL. 31.
- ELMER'S PRODUCTS, INC., COLUMBUS, OH:
2,499,147, CANC. INT. CL. 16.
- ELVIS PRESLEY ENTERPRISES, INC., MEMPHIS, TN:
2,565,767. REN. 5-21-12. MULTIPLE CLASS, INT. CLS. 8 AND 28.
- ELX FUTURES, L.P., NEW YORK, NY:
4,164,816, MULTIPLE CLASS, INT. CLS. 36 AND 42.
- EMAP CONSUMER MEDIA LIMITED, LONDON, UNITED KINGDOM:
2,497,588, CANC. MULTIPLE CLASS, INT. CLS. 9, 16 AND 41.
- EMAX'S, LLC, BOULDER, CO:
3,959,706, CANC. INT. CL. 30.
- EMBARCADERO TECHNOLOGIES, INC., SAN FRANCISCO, CA:
4,164,940, INT. CL. 9.
- EMC CORPORATION, HOPKINTON, MA:
4,165,055, INT. CL. 9.
- EMERALD GROUP PUBLISHING LIMITED, BINGLEY, UNITED KINGDOM:
3,081,616, CANC. INT. CL. 9.
- EMERALD TOUCH INC., KELLER, TX:
4,164,988, INT. CL. 10.
- EMERALD TOUCH INC., KELLAR, TX:
4,164,989, INT. CL. 10.
- EMERSON ELECTRIC CO., ST. LOUIS, MO:
4,162,752, PUB. 4-10-2012. INT. CL. 35.
- EMI (IP) LIMITED, LONDON, UNITED KINGDOM:
4,123,528, COR. MULTIPLE CLASS, INT. CLS. 9, 35, 41 AND 45.
- EMMA PAGE, INC., LOS ANGELES, CA:
1,171,705, CANC. INT. CL. 42.
- EMPIRE CRABHOUSE, LLC, BOULDER, CO:
4,164,105, PUB. 4-10-2012. INT. CL. 43.
- EMPIRE ENTERPRISES, INC., SHELBYVILLE, TN:
864,278, CANC. U.S. CL. 37.
- EMPIRE SCIENTIFIC CORPORATION, GARDEN CITY, NY:
860,094, CANC. U.S. CL. 36.
- EMPOWER TECHNOLOGIES, INC., REDMOND, WA:
2,964,110, CANC. INT. CL. 9.
2,965,199, CANC. INT. CL. 9.
- EMPTY TOMB, INC., CHAMPAIGN, IL:
2,584,427. REN. 5-19-12. INT. CL. 45.
- EMS-PATENT AG, SWITZERLAND:
4,162,832, PUB. 4-10-2012. INT. CL. 1.
- EMTEK PRODUCTS, INC., CITY OF INDUSTRY, CA:
3,064,196, CANC. MULTIPLE CLASS, INT. CLS. 6 AND 21.
4,165,626, INT. CL. 9.
- ENCANA CORPORATION, CALGARY, AB T2P 2T5, CANADA:
4,163,055, PUB. 2-21-2012. MULTIPLE CLASS, INT. CLS. 4, 7, 37, 39, 40 AND 42.
4,163,056, PUB. 2-21-2012. MULTIPLE CLASS, INT. CLS. 4, 7, 37, 39, 40 AND 42.
- ENCLOS CORP., EAGAN, MN:
2,701,296. REN. 5-24-12. MULTIPLE CLASS, INT. CLS. 37, 40 AND 42.
- ENCORE HEALTH RESOURCES, LLC, HOUSTON, TX:
4,164,652, PUB. 4-10-2012. INT. CL. 41.
- ENDESA, S.A., 28002 MADRID, SPAIN:
3,005,308, CANC. MULTIPLE CLASS, INT. CLS. 7, 9, 11, 16, 38, 39 AND 42.
- ENDO PHARMACEUTICALS COLORADO, INC., BOULDER, CO:
2,498,657, CANC. INT. CL. 1.
- ENERGY ABSORPTION SYSTEMS, INC., DALLAS, TX:
1,700,568. REN. 5-18-12. INT. CL. 19.
- ENERGY INTELLECT LIMITED, WELLINGTON, NEW ZEALAND:
3,005,608, CANC. MULTIPLE CLASS, INT. CLS. 35 AND 42.
- ENERGY NEUTRAL LLC, EAGLE, ID:
4,163,746, PUB. 4-10-2012. INT. CL. 35.
- ENGLISH MOUNTAIN SPRING WATER COMPANY, DANDRIDGE, TN:
2,711,056. REN. 5-24-12. INT. CL. 40.
- ENHANCED INFORMATION SOLUTIONS, INC., STILLWATER, MN:
4,165,820, INT. CL. 9.
- ENLIVEN MARKETING TECHNOLOGIES CORPORATION, NEW YORK, NY:
2,497,451, CANC. MULTIPLE CLASS, INT. CLS. 35 AND 42.
- ENPORION, INC., CLARK, NJ:
2,569,624. REN. 5-21-12. INT. CL. 35.
- ENSOLVE BIOSYSTEMS, INC., RALEIGH,, NC:
4,163,762, PUB. 4-10-2012. INT. CL. 40.
- ENTONE, INC., CUPERTINO, CA:
4,165,166, MULTIPLE CLASS, INT. CLS. 9 AND 38.
- ENTREDA, INC., LOS ALTOS, CA:
4,163,716, PUB. 4-10-2012. INT. CL. 42.
- ENVESTNET ASSET MANAGEMENT, INC., CHICAGO, IL, ENVESTNET GROUP, INC., THE, CHICAGO, IL:
2,593,459. REN. 5-21-12. INT. CL. 36.

ENVIA SYSTEMS, INC., NEWARK, CA:
4,163,077, PUB. 9-20-2011. MULTIPLE CLASS, INT. CLS. 1 AND 9.

ENVIRONMENTAL CONTROL SYSTEMS, INC., EAST PROVIDENCE, RI, DBA AQUASGROUP:
4,163,165, PUB. 4-10-2012. INT. CL. 11.

ENVIRONMENTAL QUALITY MANAGEMENT, INC., CINCINNATI, OH:
2,497,472, CANC. INT. CL. 42.

ENVISION PERIPHERALS INC., FREMONT, CA:
4,165,317, INT. CL. 9.
4,165,318, INT. CL. 9.

ENXNET, INC., TULSA, OK:
3,006,257, CANC. INT. CL. 9.

EPIC MEDIA GROUP, LLC, WEST PALM BEACH, FL:
4,163,921, PUB. 4-10-2012. MULTIPLE CLASS, INT. CLS. 35 AND 42.

EPICOR USERS GROUP, LANCASTER, PA:
4,163,902, PUB. 4-10-2012. MULTIPLE CLASS, INT. CLS. 35, 38 AND 41.

EPILOG CORPORATION, GOLDEN, CO:
4,163,502, PUB. 4-10-2012. INT. CL. 7.

EPISCOPAL SCHOOL OF JACKSONVILLE, INC., JACKSONVILLE, FL:
4,163,629, PUB. 4-10-2012. INT. CL. 41.

EPNER, PAUL, RAMONA, CA:
2,999,219, CANC. INT. CL. 25.

EPOQ GROUP LTD., LONDON, UNITED KINGDOM:
2,574,118, REN. 5-18-12. INT. CL. 9.

EPSILON ELECTRONICS, INC., 1550 S. MAPLE AVENUE, CA:
2,711,178, REN. 5-22-12. INT. CL. 9.

EQUEST, WYLIE, TX:
4,163,351, PUB. 4-10-2012. INT. CL. 41.

EQUITY FOCUS GROUP, LLC, WILMINGTON, DE:
2,990,770, CANC. INT. CL. 32.

EQUITY STAFFING GROUP INCORPORATED, ENGLEWOOD, CO:
4,164,093, PUB. 4-10-2012. INT. CL. 35.
4,164,095, PUB. 4-10-2012. INT. CL. 35.

EREDI SCABINI S.R.L., SIZIANO (PAVIA), ITALY:
3,005,339, CANC. INT. CL. 19.

ERICA MEADE COUNSELING LLC, SEATTLE, WA:
4,163,896, PUB. 4-10-2012. INT. CL. 45.

ERICSSON TELEVISION INC., DULUTH, GA:
3,006,103, CANC. INT. CL. 9.

ERNI ELECTRONICS GMBH, ADELBERG, FED REP GERMANY:
4,162,985, PUB. 4-10-2012. MULTIPLE CLASS, INT. CLS. 9 AND 17.
4,162,986, PUB. 4-10-2012. MULTIPLE CLASS, INT. CLS. 9 AND 17.

ERNST BENARY SAMENZUCHT GMBH, HANN MUENDEN, FED REP GERMANY:
1,738,550, REN. 5-23-12. INT. CL. 31.

ERNST MÜHLBAUER GMBH & CO. KG, NORDERFRIEDRICHSKOOG, FED REP GERMANY:
3,005,629, CANC. MULTIPLE CLASS, INT. CLS. 1 AND 10.

ESCA TECH, INC., MILWAUKEE, WI:
4,165,974, INT. CL. 3.

ESCHMANN BROS. & WALSH LTD., LONDON NW11 8DS, ENGLAND:
1,695,276, REN. 5-18-12. INT. CL. 10.

ESG OPERATIONS, INC., MACON, GA:
4,163,922, PUB. 4-10-2012. MULTIPLE CLASS, INT. CLS. 35, 36, 37, 40, 42 AND 45.

ESHELMAN, DONNA, WEST HOLLYWOOD, CA:
4,164,460, PUB. 4-10-2012. INT. CL. 41.

ESK CERAMICS GMBH & CO. KG, FED REP GERMANY:
3,060,518.

ESP GROUP, LLC, THE, CHESTERFIELD, VA:
3,006,137, CANC. MULTIPLE CLASS, INT. CLS. 9 AND 41.

ESPADA ENTERTAINMENT, INC., HIALEAH GARDENS, FL:
4,164,371, PUB. 4-10-2012. INT. CL. 9.

ESPRIT IP LIMITED, TORTOLA BRITISH VIRGIN ISLANDS ROAD TOWN, BR. VIRGIN ISLANDS:
2,470,108, REN. 5-18-12. INT. CL. 35.

ESS-JAY LTD., INCORPORATED, MONTGOMERY, AL:
862,928, CANC. U.S. CL. 38.

ESSELTE IPR AB, SOLNA, SWEDEN, LEITZ, LOUIS, STUTTGART-FEUERBACH, FED REP GERMANY:
733,064, REN. 5-23-12. U.S. CL. 23 (INT. CL. 7).

ESSENTIA PHARMA, L.L.C., ROSENBERG, TX:
4,165,930, MULTIPLE CLASS, INT. CLS. 35, 42 AND 44.

ESSENTIAL BEGINNINGS, LLC, MILL VALLEY, CA:
4,165,464, INT. CL. 5.

ESSENTIAL MEDIA PARTNERS, LLC, WASHINGTON, DC, AKA EMP LLC:
4,165,249, INT. CL. 16.

ESSENTIAL SOUND PRODUCTS, INC., ROCHESTER, MI:
4,162,758, PUB. 6-8-2010. INT. CL. 9.

ESTORA PRODUCTS COMPANY, LLC, CHIPPEWA FALLS, IN:
4,164,995, MULTIPLE CLASS, INT. CLS. 11 AND 21.

ESTRELLITA, INC., CAMARILLO, CA:
4,164,362, PUB. 4-10-2012. INT. CL. 16.

ETABLISSEMENTS LARDENOIS, HERMES, OISE, FRANCE:
864,335, CANC. U.S. CL. 51.

ETHYL CORPORATION, RICHMOND, VA:
859,520, CANC. U.S. CL. 6.

EU YAN SANG INTERNATIONAL LTD., SINGAPORE:
3,005,359, CANC. INT. CL. 5.

EUCLID SYSTEMS CORPORATION, HERNDON, VA:
2,498,571, CANC. INT. CL. 10.
2,498,572, CANC. INT. CL. 10.

EUGENE GEER III, ANDREW, CHARLESTON, SC:
4,165,216, MULTIPLE CLASS, INT. CLS. 3, 30 AND 31.

EUROFRESH, INC., WILLCOX, AZ:
4,165,275, INT. CL. 31.

EUROPEAN COFFEEHOUSES WORLDWIDE, LLC, DUNWOODY, GA:
1,225,542, AM. INT. CL. 42.

EUROPEANMARKET LLC, MIDDLETON, WI:
4,166,069, MULTIPLE CLASS, INT. CLS. 35 AND 41.

EVANS MINING CORPORATION, DETROIT, MI:
504,937, CANC. U.S. CL. 1.

EVANS TELEPHONE COMPANY, TURLOCK, CA:
2,498,266, CANC. INT. CL. 38.

EVAPCO, INC., TANEYTOWN, MD:
4,165,125, MULTIPLE CLASS, INT. CLS. 1 AND 11.

EVE PEARL, LLC, NEW YORK, NY:
4,165,612, INT. CL. 41.

EVED LLC, SKOKIE, IL:
4,164,379, PUB. 4-10-2012. INT. CL. 35.

EVEDEN HUIT SAS, RENNES CEDEX, FRANCE:
4,163,482, PUB. 4-10-2012. INT. CL. 25.

EVER ENERGY, INC., SPRINGVILLE, UT, DBA RUSTICA HARDWARE:
4,166,061, INT. CL. 6.

EVERBANK, JACKSONVILLE, FL:
4,164,615, PUB. 4-10-2012. INT. CL. 36.
4,164,616, PUB. 4-10-2012. INT. CL. 36.

EVEREADY BATTERY COMPANY, INC., ST. LOUIS, MO:
3,006,491, CANC. INT. CL. 9.

EVERGLADES AIRBOAT RESORTS, LLC, FORT MYERS, FL:
4,164,531, PUB. 4-10-2012. INT. CL. 39.

EVERYCHILD FOUNDATION, PACIFIC PALISADES, CA:
2,635,122, REN. 5-19-12. INT. CL. 36.

EVOLIS, INC., FORT LAUDERDALE, FL:
4,164,445, PUB. 4-10-2012. INT. CL. 9.

EVONIK DEGUSSA GMBH, ESSEN, FED REP GERMANY:
2,569,064, REN. 5-21-12. INT. CL. 1.

EXCEL INDUSTRIES, INC., HESSTON, KS:
4,165,168, INT. CL. 7.

EXCELLENCE IN MOTIVATION, INC., DAYTON, OH, DBA EXCELLENCE IN MOTIVATION:
4,164,506, PUB. 4-10-2012. INT. CL. 42.

EXERCISE TECHNOLOGY INC, OXNARD, CA:
2,498,480, CANC. INT. CL. 9.

- EXETER-IVANHOE CITRUS ASSOCIATION, EXETER, CA,
EXETER CITRUS ASSOCIATION, EXETER, CA:
959,030. REN. 5-22-12. U.S. CL. 46 (INT. CL. 31).
- EXIDE CORPORATION, MILTON, GA:
2,499,059. CANC. INT. CL. 9.
- EXIM-DYNAMICS INC, KETTERING, OH, DBA EXIM
GAMES:
4,165,130. INT. CL. 28.
- EXM SERVICES INTERNATIONAL PTY LTD, SYDNEY,
AUSTRALIA:
4,163,534. PUB. 4-10-2012. INT. CL. 42.
- EXOTIX LIMITED, LONDON, UNITED KINGDOM:
4,163,085. PUB. 2-14-2012. INT. CL. 36.
4,163,086. PUB. 2-14-2012. INT. CL. 36.
- EXPANDING THOUGHT, INC., BOULDER, CO:
4,164,090. PUB. 4-10-2012. INT. CL. 41.
- EXPORTADORA DOS REALES, S. DE R.L. DE C.V.,
GUADALAJARA, JALISCO, MEXICO:
4,164,338. PUB. 4-10-2012. INT. CL. 33.
- EXPRESS MOBILE, INC., NOVATO, CA:
4,164,343. PUB. 4-10-2012. INT. CL. 35.
- EXPRESS TELLER SERVICES, INC., PHOENIX, AZ:
4,163,057. PUB. 4-10-2012. INT. CL. 9.
- EXTREME PITA IP INC., MISSISSAUGA, ONTARIO, CA-
NADA:
2,574,081. REN. 5-21-12. MULTIPLE CLASS, INT. CLS. 35
AND 42.
- EXTREMETIX, INC., HOUSTON, TX:
4,165,793. U.S. CL. 200.
- EYE CLOUD LLC, TARZANA, CA:
4,164,066. PUB. 4-10-2012. INT. CL. 9.
- F.B.T. ENTERPRISES, INC., ROME, GA:
4,163,104. PUB. 4-10-2012. INT. CL. 39.
- F-MATIC, INC., LEHI, UT:
4,165,677. INT. CL. 9.
- FABULOUS AMERICAN BEVERAGES LTD., PALISADES,
NY:
4,166,041. INT. CL. 33.
- FACILICORP, SAN JOSE, CA:
1,899,139. CANC. INT. CL. 35.
- FACILITYFORECAST, INC., ATLANTA, GA:
2,583,863. REN. 5-22-12. INT. CL. 9.
- FADAL MACHINING CENTERS, LLC, CHATSWORTH, CA:
3,006,136. CANC. INT. CL. 9.
- FAIR HOME BUYERS, LLC, CHEYENNE, WY:
4,163,630. PUB. 4-10-2012. INT. CL. 25.
- FAIRVIEW IMPORT CORPORATION, SANTA FE SPRINGS,
CA:
4,165,553. INT. CL. 9.
4,165,554. INT. CL. 9.
4,165,555. INT. CL. 9.
- FAMILY OF FAITH FOUNDATION INC., LAS VEGAS, NV:
4,164,565. PUB. 4-10-2012. INT. CL. 45.
4,164,679. PUB. 4-10-2012. INT. CL. 45.
- FANCY AUTO, INC., LOS ANGELES, CA:
4,163,478. PUB. 4-10-2012. INT. CL. 42.
- FANFUN, INC., PLANO, TX:
3,006,557. CANC. INT. CL. 28.
- FAPCO, INC., BUCHANAN, MI:
1,689,254. REN. 5-18-12. INT. CL. 35.
- FARBER, JASON, MONTREAL, QUEBEC, CANADA:
4,164,651. PUB. 4-10-2012. INT. CL. 26.
- FARGO BASEBALL, LLC, FARGO, ND:
2,568,773. REN. 5-21-12. INT. CL. 41.
- FARIBA INC., RICHMOND, VA:
4,164,582. PUB. 4-10-2012. INT. CL. 25.
- FARMHAND FOODS, DURHAM, NC:
4,164,427. PUB. 4-10-2012. MULTIPLE CLASS, INT. CLS.
25 AND 29.
- FARRELL LINES INCORPORATED, NORFOLK, VA:
4,163,398. PUB. 4-10-2012. INT. CL. 39.
- FASALEX PATENT-UND LIZENZVERWERTUNGS GMBH,
A-4794 KOPFING, AUSTRIA:
3,005,271. CANC. MULTIPLE CLASS, INT. CLS. 1 AND
17.
- FAST TRACK TECHNOLOGIES LIMITED, GRAND CAY-
MAN, CAYMAN ISLANDS:
4,163,856. PUB. 4-10-2012. INT. CL. 9.
- FASTENAL IP COMPANY, WINONA, MN:
4,163,652. PUB. 4-10-2012. MULTIPLE CLASS, INT. CLS.
1, 6, 8, 9 AND 17.
4,165,900. MULTIPLE CLASS, INT. CLS. 25 AND 36.
- FAUN UMWELTECHNIK GMBH & CO. KG, FED REP
GERMANY:
4,162,997. PUB. 4-10-2012. INT. CL. 12.
- FCG INVESTMENTS COMPANY, INC., LONG BEACH, CA:
2,497,728. CANC. INT. CL. 35.
- FCPGROTON, LLC, OLD SAYBROOK, CT:
4,164,269. PUB. 4-10-2012. INT. CL. 35.
- FDL FOODS, INC., DUBUQUE, IA:
856,665. CANC. U.S. CL. 46.
- FEDER, ELLIOT, KING CITY, ONTARIO L7B 1J9, CANADA:
3,006,084. CANC. INT. CL. 16.
- FEDERAL EXPRESS CORPORATION, MEMPHIS, TN:
2,595,150. REN. 5-18-12. MULTIPLE CLASS, INT. CLS. 35
AND 39.
2,652,337. REN. 5-18-12. MULTIPLE CLASS, INT. CLS. 35
AND 39.
- FEDERAL SIGNAL CORPORATION, OAK BROOK, IL,
WARN INDUSTRIES, INC., SOUTH KENT, WA, DBA
WARN INDUSTRIES:
1,207,084. REN. 5-23-12. INT. CL. 9.
- FEDERAL-MOGUL BURSCHEID GMBH, 51399 BURSC-
HEID, FED REP GERMANY:
2,612,281. REN. 5-18-12. INT. CL. 7.
- FEDERKEIL, EDWARD, FT. LAUDERDALE, FL:
4,165,258. INT. CL. 41.
- FEHRMAN, KATHRYN, WAUWATOSA, WI:
4,163,111. PUB. 4-10-2012. INT. CL. 35.
- FENG LI, CHINA:
4,162,962. PUB. 4-10-2012. INT. CL. 25.
- FENN WRIGHT AND MANSON LIMITED, LONDON, SE1
8QH, UNITED KINGDOM, FENN WRIGHT AND MAN-
SON, INC., NEW YORK, NY:
1,173,395. REN. 5-18-12. INT. CL. 25.
- FEONIC PLC, UNITED KINGDOM:
4,162,883. PUB. 4-10-2012. INT. CL. 9.
- FERNANDEZ, REBECCA, GREENWOOD, SC:
4,165,667. INT. CL. 20.
- FERRING B.V., 2130 KC HOOFDDORP, NETHERLANDS:
3,005,293. CANC. INT. CL. 5.
- FERROCARRIL MEXICANO, S.A. DE C.V., 11700 MEXICO,
D.F., MEXICO:
3,006,218. CANC. INT. CL. 39.
3,006,219. CANC. INT. CL. 39.
- FESSLER, MARTIN, TRAVERSE CITY, MI:
4,163,318. PUB. 4-10-2012. INT. CL. 35.
- FESTFARE, INC, LAS VEGAS, NV:
4,163,540. PUB. 11-8-2011. INT. CL. 45.
- FESTINA - CANDINO WATCH AG (FESTINA - CANDINO
WATCH SA) (FESTINA - CANDINO WATCH LTD),
SWITZERLAND:
3,004,541.
- FESTIVAL FUN PARKS, LLC, NEWPORT BEACH, CA:
2,497,594. CANC. INT. CL. 25.
- FIAT GROUP MARKETING & CORPORATE COMMUNI-
CATION S.P.A., ITALY:
4,162,910. PUB. 4-10-2012. MULTIPLE CLASS, INT. CLS.
14, 25, 35 AND 37.
- FIBERBUILT UMBRELLAS, LAUDERDALE LAKES, FL:
4,163,294. PUB. 4-10-2012. INT. CL. 20.
- FIBERIO TECHNOLOGY CORPORATION, MCALLEN, TX:
4,165,110. INT. CL. 7.
- FIBERWAVE CORPORATION, BROOKLYN, NY:
2,570,416. REN. 5-18-12. INT. CL. 9.
- FIBRE-CRAFT MATERIALS CORPORATION, NILES, IL:
2,570,013. REN. 5-18-12. INT. CL. 28.
- FICHERA, JAMES, AMHERST, NH:
4,165,942. MULTIPLE CLASS, INT. CLS. 41 AND 43.
- FIELD & STREAM LICENSES COMPANY, LLC, WEST-
PORT, CT:
1,687,750. REN. 5-23-12. MULTIPLE CLASS, INT. CLS. 11,
14, 18 AND 21.
1,687,750. CANC. INT. CL. 16.
- FIERA DI VICENZA S.P.A., ITALY:
3,046,461.

FIESTA CATERING INTERNATIONAL, INC., THE VALLEY, ANGUILLA:
4,166,056, INT. CL. 45.

FIFTH THIRD BANCORP, CINCINNATI, OH:
4,165,319, INT. CL. 36.

FIFTHROOM MARKETS, INC., GIBSONIA, PA:
4,163,500, PUB. 4-10-2012. INT. CL. 20.

FIGHTERLINK, HERNDON, VA:
4,163,608, PUB. 4-10-2012. MULTIPLE CLASS, INT. CLS. 9, 38 AND 41.

FIGHTIN UNCLE LLC, NEWPORT BEACH, CA:
4,164,140, PUB. 4-10-2012. INT. CL. 25.

FIGUEREDO, DANIEL, MIAMI, FL:
4,164,899, INT. CL. 43.

FIGUEROA, ERIC J., AVENTURA, FL:
4,165,146, INT. CL. 35.

FILENE'S BASEMENT, LLC, SEACAUCUS, NJ:
854,222, CANC. U.S. CL. 39.

FILLMORE PEARL HOLDING, LTD, GEORGE TOWN, CAYMAN ISLANDS:
4,125,773, COR. INT. CL. 39.

FINANCIAL EXECUTIVES INSTITUTE, FLORHAM PARK, NJ:
3,088,936, CANC. INT. CL. 9.

FINANCIAL INFORMATION TECHNOLOGIES, INC., TAMPA, FL:
2,646,394, REN. 5-18-12. MULTIPLE CLASS, INT. CLS. 36 AND 38.

FINANCIAL PARTNERS INTERNATIONAL, INC., SAN DIEGO, CA:
1,195,352, CANC. INT. CL. 35.

FINNERTY ECONOMIC CONSULTING, LLC, NEW YORK, NY:
3,114,677, CANC. INT. CL. 35.

FIO CORPORATION, TORONTO, CANADA:
4,164,822, MULTIPLE CLASS, INT. CLS. 10, 35, 39, 42 AND 44.

FIREDROPS, LLC, BEVERLY, MA:
4,165,722, INT. CL. 30.

FIREYE, INC., DERRY, NH:
4,165,771, INT. CL. 9.

FIRST AIRBORNE SERVICE TRADING CORP, MIAMI, FL:
4,165,498, INT. CL. 5.

FIRST MANUFACTURING CO., INC., OCEANSIDE, NY:
2,694,650, REN. 5-23-12. INT. CL. 25.

FIRST MANUFACTURING, INC., OCEANSIDE, NY:
2,640,653, REN. 5-18-12. INT. CL. 25.

FIRST RELIANCE BANK, FLORENCE, SC:
4,164,596, PUB. 4-10-2012. INT. CL. 36.
4,164,597, PUB. 4-10-2012. INT. CL. 36.

FISCHER JACQUES, CH-1992 LES MAYENS DE SION, SWITZERLAND:
4,162,884, PUB. 4-10-2012. INT. CL. 41.
4,162,887, PUB. 4-10-2012. INT. CL. 41.

FISCHER PACKING COMPANY, LLC, HAMPTON, VA,
FISCHER PACKING COMPANY, LOUISVILLE, KY:
1,687,997, REN. 5-23-12. INT. CL. 29.

FISERV, INC., BROOKFIELD, WI:
4,162,756, PUB. 4-10-2012. INT. CL. 36.

FISH TALES, LLC, ORO VALLEY, AZ:
4,165,352, INT. CL. 8.

FISONS PLC, IPSWICH, SUFFOLK, ENGLAND:
861,351, CANC. U.S. CL. 26.

FIT AND TRIM CORP., SUNRISE, FL:
4,165,730, INT. CL. 44.

FIVE STARS LOYALTY, INC., MOUNTAIN VIEW, CA:
4,163,926, PUB. 4-10-2012. MULTIPLE CLASS, INT. CLS. 9 AND 35.

FIVES, FRANCE:
4,162,933, PUB. 4-10-2012. MULTIPLE CLASS, INT. CLS. 7, 11 AND 37.

FIZGIG PRODUCTIONS, LLC, OLD GREENWICH, CT:
2,570,722, REN. 5-19-12. MULTIPLE CLASS, INT. CLS. 35 AND 42.

FIZZ TECHNOLOGIES, LLC, DEL MAR, CA:
4,166,014, INT. CL. 35.

FLAMBEAU, INC., BARABOO, WI:
3,153,506, COR. INT. CL. 21.

FLAME SEAL PRODUCTS, INC., HOUSTON, TX:
2,632,579, REN. 5-18-12. INT. CL. 1.

FLANDERS PROVISION COMPANY, LLC, JACKSONVILLE, FL:
4,164,073, PUB. 4-10-2012. INT. CL. 29.

FLASH WIRELESS, LLC, CONCORD, NC:
4,165,656, INT. CL. 38.

FLASHVIC, INC., SUNNY ISLES, FL:
4,164,663, PUB. 4-10-2012. INT. CL. 35.
4,164,666, PUB. 4-10-2012. INT. CL. 35.

FLEAVAC, LLC, SAN MARCOS, CA:
4,164,204, PUB. 4-10-2012. INT. CL. 5.

FLEET/NORSTAR FINANCIAL GROUP, INC., ALBANY, NY:
1,302,040, CANC. INT. CL. 36.

FLEMING, NICHOLAS JOHN, NEW YORK, NY, AKA NICK FLEMING:
4,162,745, PUB. 4-10-2012. MULTIPLE CLASS, INT. CLS. 35, 38 AND 41.

FLETCHER PAPER COMPANY, ALPENA, MI:
504,340, CANC. U.S. CL. 37.

FLEUR DE LIRE, PARIS, FRANCE:
4,163,981, PUB. 4-10-2012. INT. CL. 39.

FLEXICON CORPORATION, BETHLEHEM, PA:
4,165,749, INT. CL. 7.

FLOOR TRADE, INC., ALTAMONTE SPRINGS, FL:
3,006,490, CANC. INT. CL. 9.

FLORES, RALPH, CANYON COUNTRY, CA:
2,582,830, REN. 5-18-12. INT. CL. 15.

FLOWERS, INC., BOGART, GA:
4,163,875, PUB. 4-10-2012. INT. CL. 28.
4,163,876, PUB. 4-10-2012. INT. CL. 28.

FLOYD, SKEREN & KELLY, LLP, CALABASAS, CA:
4,165,678, INT. CL. 45.

FLUKE CORPORATION, EVERETT, WA:
2,499,065, CANC. INT. CL. 9.

FLYING TIGER ENTERTAINMENT, INC., FULLERTON, CA:
4,163,801, PUB. 4-10-2012. INT. CL. 9.

FLYNN ENTERPRISES, LLC, HOPKINSVILLE, KY:
1,196,554, REN. 5-24-12. INT. CL. 25.

FLYWHEEL VENTURES, INC., SANTA FE, NM:
2,642,107, REN. 5-18-12. MULTIPLE CLASS, INT. CLS. 9, 35, 36, 41 AND 42.

FMG HOLDINGS, LLC, GRAND RAPIDS, MI:
4,163,187, PUB. 4-10-2012. MULTIPLE CLASS, INT. CLS. 35 AND 37.

FMS WERTMANAGEMENT AÖR, 85716 UNTERSCHLEIS-SHEIM, FED REP GERMANY:
4,058,224, COR. MULTIPLE CLASS, INT. CLS. 16, 35 AND 36.

FOCRON, INC., ROSELAND, NJ:
4,165,805, INT. CL. 1.

FOCUS BRAND LIMITED, 379-381 KING'S ROAD,, HONG KONG:
4,165,057, INT. CL. 28.

FOCUS ON LIFE ENTERPRISES, INC., CARLSBAD, CA:
4,165,284, INT. CL. 35.

FOCUS ON THE FAMILY, COLORADO SPRINGS, CO:
2,498,314, CANC. INT. CL. 42.
2,498,315, CANC. INT. CL. 42.
3,006,478, CANC. INT. CL. 41.

FOGLEMEN MANAGEMENT GROUP, L.L.C., MEMPHIS, TN:
2,497,665, CANC. INT. CL. 36.

FOITLE, CHRIS, MARINA DEL REY, CA AND MARGOL, CALE, MARINA DEL REY, CA:
4,163,722, PUB. 4-10-2012. INT. CL. 25.

FOKKER TECHNOLOGY B.V., NETHERLANDS:
4,162,913, PUB. 4-10-2012. MULTIPLE CLASS, INT. CLS. 6, 9, 12, 13, 19, 37, 39 AND 42.

FOLTZ, TIMOTHY JOSEPH, PHILADELPHIA, PA:
4,165,422, INT. CL. 32.

FONDAZIONE ISTITUTO ITALIANO DI TECNOLOGIA, ITALY:
4,162,940, PUB. 4-10-2012. MULTIPLE CLASS, INT. CLS. 7 AND 9.

- FONG, PETER SUI LUN, MONTEREY PARK, CA:
2,574,352. REN. 5-18-12. INT. CL. 28.
- FOOD AND CULINARY TECHNOLOGY GROUP, INC.,
CALGARY, CANADA:
4,165,270. INT. CL. 30.
- FOOD FAMILY FARMING FOUNDATION, BOULDER, CO:
4,165,741. INT. CL. 41.
- FOODMAKER, INC., SAN DIEGO, CA:
858,388. CANC. U.S. CL. 100.
- FOODSCIENCE CORPORATION, ESSEX JUNCTION, VT:
2,707,822. REN. 5-24-12. INT. CL. 5.
- FOODSERVICE TECHNOLOGIES, INC., ALEXANDRIA,
VA. AKA TECH-24:
4,163,211. PUB. 4-10-2012. INT. CL. 37.
- FOODSERVICEPLANET.COM LLC, HARRISON, OH:
4,165,496. INT. CL. 35.
4,165,497. INT. CL. 35.
- FOR EYES OPTICAL COMPANY, HIALEAH, FL:
2,572,905. REN. 5-21-12. INT. CL. 35.
- FOREST GIANT, INC., LOUISVILLE, KY:
4,163,370. PUB. 4-10-2012. INT. CL. 42.
- FORT HOWARD CUP CORPORATION, GREEN BAY, WI:
856,994. CANC. U.S. CL. 23.
856,995. CANC. U.S. CL. 23.
856,996. CANC. U.S. CL. 23.
- FORT JAMES OPERATING COMPANY, ATLANTA, GA:
4,095,018. COR. INT. CL. 16.
- FORT MAGIC, LLC, SARASOTA, FL:
4,165,062. INT. CL. 28.
- FORTESSA, INC., STERLING, VA:
4,165,807. INT. CL. 21.
- FORTUNEGOLF INDUSTRIAL (HK) CO., LIMITED, CAU-
SEWAY BAY, HONG KONG:
4,165,724. INT. CL. 28.
- FORWARD FOODS LLC, CARSON CITY, NV:
4,163,050. PUB. 4-10-2012. INT. CL. 5.
- FORZASTONE, LLC, MESA, AZ:
4,164,930. INT. CL. 19.
- FOSHAN NANHAI CHEVAN OPTICAL OPTICAL ELEC-
TRONICS CO., LTD., FOSHAN, GUANDDONG, CHINA:
4,162,879. PUB. 4-10-2012. INT. CL. 9.
- FOTL, LLC, CONSHOHOCKEN, PA:
4,165,529. INT. CL. 41.
- FOTOPRIX S.A., 08018 BARCELONA, SPAIN:
3,005,306. CANC. MULTIPLE CLASS, INT. CLS. 35 AND
40.
- FOTOWATIO RENEWABLE VENTURES, INC., SAN FRAN-
CISCO, CA:
4,165,926. MULTIPLE CLASS, INT. CLS. 39 AND 40.
- FOUNDATION FOR AMBULATORY SURGERY IN AMER-
ICA, PHOENIX, AZ:
2,498,110. CANC. INT. CL. 42.
- FOUNDATION FOR FRAUD ABATEMENT & ACTIVISM,
PROSPER, TX:
4,164,170. PUB. 4-10-2012. INT. CL. 45.
- FOUNDATIONS WORLDWIDE, INC., MEDINA, OH:
2,580,044. REN. 5-19-12. INT. CL. 20.
4,164,333. PUB. 4-10-2012. INT. CL. 20.
- FOUR HORSEMEN BREWING COMPANY, INC., SOUTH
BEND, IN:
4,164,111. PUB. 4-10-2012. INT. CL. 32.
- FOUR NINES INC., TOKYO, JAPAN:
2,568,999. REN. 5-21-12. INT. CL. 9.
2,569,000. REN. 5-21-12. INT. CL. 9.
- FOURINVEST HOLDING AG, SWITZERLAND:
3,889,326. CANC. INT. CL. 33.
- FOX ENTERPRISES, INC., FORT MYERS, FL:
4,165,127. MULTIPLE CLASS, INT. CLS. 9 AND 40.
4,165,128. MULTIPLE CLASS, INT. CLS. 9 AND 40.
- FOX RUN USA, LLC, IVYLAND, PA:
2,580,469. REN. 5-23-12. INT. CL. 21.
- FPDUGAN, LLC, MINNEAPOLIS, MN:
4,163,166. PUB. 4-10-2012. INT. CL. 35.
- FRANK & ADAM APPAREL LLC, CLEARWATER, FL:
4,165,887. INT. CL. 25.
- FRANK RUSSELL COMPANY, SEATTLE, WA:
2,574,342. REN. 5-23-12. INT. CL. 36.
- FRANK-LIN DISTILLERS PRODUCTS, LTD., SAN JOSE,
CA:
4,163,656. PUB. 4-10-2012. INT. CL. 33.
- FRANKLIN COVEY CO., SALT LAKE CITY, UT:
4,163,333. PUB. 4-10-2012. MULTIPLE CLASS, INT. CLS.
9, 16 AND 41.
- FRANKLIN SPORTS, INC., STOUGHTON, MA:
4,165,417. INT. CL. 28.
- FRANKLY CONSULTING LLC, CHAMPIONSGATE, FL:
2,990,129. COR. INT. CL. 28.
- FRANTZ WARD LLP, CLEVELAND, OH:
2,692,651. REN. 5-24-12. INT. CL. 42.
- FRANZ HAAS S.R.L., MONTAGNA (BOLZANO), ITALY
AND WINEBOW, INC, MONTVALE, NJ:
2,570,718. REN. 5-22-12. INT. CL. 33.
- FRASER-VOLPE LLC, WARMINSTER, PA:
2,684,644. REN. 5-24-12. INT. CL. 9.
- FRED GARCIA, SAN BRUNO, CA:
4,164,867. INT. CL. 25.
- FREDERICK WARNE & COMPANY, INC., NEW YORK, NY:
1,188,599. REN. 5-18-12. INT. CL. 15.
- FREDRIK KOERFER, LUXEMBOURG:
3,046,356.
- FRERMAN, ANTHONY H., VERSAILLES, KY:
4,164,868. INT. CL. 25.
- FRESH PRODUCE & FLORAL COUNCIL, LA MIRADA, CA:
4,163,939. PUB. 4-10-2012. INT. CL. 36.
- FRIDSON VISION, LLC, NEW YORK, NY:
3,006,429. CANC. INT. CL. 36.
- FRIENDS OF THE SPRING LAKE 5, A NEW JERSEY
NONPROFIT CORPORATION, SPRING LAKE, NJ:
4,165,955. INT. CL. 41.
- FRIENDSHIP DAIRIES, LLC, DALLAS, TX:
4,165,746. INT. CL. 29.
- FRIGOSCANDIA CONTRACTING AKTIEBOLAG, HAL-
SINGBORG, SWEDEN:
857,029. CANC. U.S. CL. 31.
- FRIISTYLE.COM, INC., HONOLULU, HI:
4,164,125. PUB. 4-10-2012. INT. CL. 9.
- FRITO-LAY NORTH AMERICA, INC., PLANO, TX:
1,196,365. CANC. INT. CL. 29.
- FRITSCHNET, INC., ARCADIA, CA, DBA HOSTGO.COM:
4,164,330. PUB. 4-10-2012. INT. CL. 42.
- FRÖHLICH UND STAINES GBR, SULZBACH, FED REP
GERMANY:
4,165,923. MULTIPLE CLASS, INT. CLS. 28 AND 41.
- FROMM FAMILY FOODS, LLC, MEQUON, WI:
4,165,824. INT. CL. 31.
- FROST CUTLERY COMPANY LLC, OOLTEWAH, TN:
4,166,028. INT. CL. 8.
- FRUITION CONSULTING GROUP PTY. LTD., CAULFIELD
NORTH, AUSTRALIA:
4,164,511. PUB. 4-10-2012. MULTIPLE CLASS, INT. CLS.
38 AND 45.
- FRUMOVITZ, ANDREW A., MARINA DEL REY, CA:
4,164,863. INT. CL. 20.
- FUGRO AIRBORNE SURVEYS CORP., MISSISSAUGA,
ONTARIO, CANADA:
4,164,938. INT. CL. 42.
- FUJIFILM CORPORATION, TOKYO, JAPAN:
4,164,980. INT. CL. 10.
- FUJIKURA DIESEL CO., LTD., SHENZHEN, CHINA:
4,162,977. PUB. 4-10-2012. INT. CL. 12.
- FUJITSU LIMITED, KANAGAWA 211-8588, JAPAN:
4,163,205. PUB. 4-10-2012. MULTIPLE CLASS, INT. CLS.
9, 35, 37, 38, 41, 42 AND 45.
4,163,206. PUB. 4-10-2012. MULTIPLE CLASS, INT. CLS.
9, 35, 37, 38, 41, 42 AND 45.
4,163,207. PUB. 4-10-2012. MULTIPLE CLASS, INT. CLS.
9, 35, 37, 38, 41, 42 AND 45.
- FUJITSU TEN LIMITED, KOBE, JAPAN:
781,295. CANC. U.S. CL. 21.
- FULL SPEED PRODUCTIONS INC, RENO, NV:
2,968,933. CANC. INT. CL. 41.
- FULLCONTACT, INC., DENVER, CO:
4,163,619. PUB. 4-10-2012. INT. CL. 42.

FUNCTIONAL HEALTHCARE SOLUTIONS, PC, WAKE FOREST, NC:
4,163,598, PUB. 4-10-2012. INT. CL. 44.

FUNEDUCATION.COM, INC., SAN DIEGO, CA, AKA FUNEDUCATION, INC.:
4,164,733, PUB. 4-10-2012. INT. CL. 41.

FURUKAWA ELECTRIC CO., LTD., THE, CHIYODA-KU, TOKYO, JAPAN:
2,593,777. REN. 5-18-12. INT. CL. 9.

FUSE ANALYTICS, INC., NEW YORK, NY:
4,164,449, PUB. 4-10-2012. INT. CL. 42.

FUSION LOGISTICS, INC., MIAMI, FL:
4,165,438, MULTIPLE CLASS, INT. CLS. 35 AND 39.

FUSION 360, TURLOCK, CA:
4,165,181, INT. CL. 1.

FUTURE FRUIT, LLC, VISALIA, CA:
4,164,858, INT. CL. 31.

FXECOSYSTEM, INC., NEW YORK, NY:
4,163,405, PUB. 4-10-2012. INT. CL. 38.

FIRSTMARK, INC., CAMPTON, NH:
1,736,961. REN. 5-23-12. INT. CL. 35.

G & F PRODUCTS, INC., CROYDON, PA, DBA G & F GLOVES:
4,163,550, PUB. 4-10-2012. INT. CL. 9.

G. A. ANDRON & CO., INC., LINDENHURST, NY:
1,664,326. REN. 5-18-12. INT. CL. 34.

G.G. MARCK & ASSOCIATES, INC., TOLEDO, OH:
4,164,127, PUB. 4-10-2012. INT. CL. 21.

G.M. STUDIO DESIGN & FASHION S.R.L., ITALY:
3,046,305.

G&G COMMERCE, LTD., YEONGDEUNGPO-GU, SEOUL, REPUBLIC OF KOREA:
4,165,376, INT. CL. 42.

GABRIELLE STUDIO, INC., NEW YORK, NY:
4,164,237, PUB. 4-10-2012. INT. CL. 18.

GADGETELL, LLC, PHILADELPHIA, PA:
4,163,255, PUB. 4-10-2012. MULTIPLE CLASS, INT. CLS. 35, 41 AND 42.

GADO S.R.L., I-20129 MILANO, ITALY:
4,162,965, PUB. 4-10-2012. INT. CL. 3.
4,162,966, PUB. 4-10-2012. INT. CL. 3.

GAHR, JAMES, MURRIETA, CA:
4,165,784, INT. CL. 25.

GAJWANI, ANIL H, MIAMI, FL:
2,937,965, CANC. INT. CL. 36.

GAKM RESOURCES LLC, NEWTON, NC:
4,166,009, INT. CL. 25.

GALAXIA ELECTRONICS CO., LTD., GYEONGGI-DO, REPUBLIC OF KOREA:
4,162,784, PUB. 4-10-2012. INT. CL. 9.

GALE BANKS ENGINEERING, AZUSA, CA:
4,164,122, PUB. 4-10-2012. INT. CL. 7.

GALERA THERAPEUTICS LLC, ST. LOUIS, MO:
4,163,833, PUB. 4-10-2012. INT. CL. 42.

GALLAGHER, NANCY, STAMFORD, CT, DBA THE JONA FUND:
1,893,848, CANC. INT. CL. 42.

GALUZZI, JOHN, SCARSDALE, NJ:
2,498,010, CANC. INT. CL. 41.

GAMATEC INTERNATIONAL, INC., MEDLEY, FL:
2,922,946, CANC. INT. CL. 11.

GAMBRO HOSPAL (SCHWEIZ) AG, BASEL, SWITZERLAND:
2,589,207. REN. 5-19-12. INT. CL. 10.

GAMBRO LUNDIA AB, LUND, SWEDEN, FORMERLY GAMBRO AB:
2,595,136. REN. 5-18-12. INT. CL. 9.

GAME DAY PICKS LLC, HOWELL, NJ:
4,164,471, PUB. 4-10-2012. INT. CL. 41.

GAME READY SCOUT DAY, INC., EAGLE LAKE, FL:
4,164,053, PUB. 4-10-2012. INT. CL. 35.

GAMING PARTNERS INTERNATIONAL USA, INC., LAS VEGAS, NV:
2,579,724. REN. 5-24-12. INT. CL. 40.

GAMO OUTDOOR USA, INC., FORT LAUDERDALE, FL:
2,504,638. REN. 5-19-12. INT. CL. 9.

GANDER MOUNTAIN COMPANY, ST. PAUL, MN, GANDER MOUNTAIN COMPANY, BLOOMINGTON, MN:
2,526,278. REN. 5-19-12. INT. CL. 42.

GANIMIAN; SAMMY E., FRESNO, CA, DBA HYE QUALITY BAKERY:
1,202,217. REN. 5-23-12. INT. CL. 30.

GARDNER ASPHALT CORPORATION, TAMPA, FL:
2,419,526. REN. 5-18-12. INT. CL. 19.

GARGYLE CORPORATION, NEW YORK, NY, DBA GARGYLE:
4,163,479, PUB. 4-10-2012. INT. CL. 14.

GARLAND INDUSTRIES, INC., COVENTRY, RI:
1,694,316. REN. 5-19-12. INT. CL. 16.

GARRISON, MARTIN ANDREW, ALBUQUERQUE, NM:
4,163,434, PUB. 4-10-2012. INT. CL. 41.

GARTNERIET PKM A/S, DENMARK:
4,163,030, PUB. 4-10-2012. MULTIPLE CLASS, INT. CLS. 31 AND 44.

GARY FRANSCIONI, INC., SOLEDAD, CA:
3,097,034, AM. INT. CL. 33.

GARY H. ARMOUR, HULL, GA:
4,165,087, INT. CL. 43.

GATAN, INC., PLEASANTON, CA:
1,688,542. REN. 5-18-12. INT. CL. 9.

GATES CORPORATION, THE, DENVER, CO, GATES RUBBER COMPANY, THE, DENVER, CO:
1,214,823. REN. 5-23-12. INT. CL. 17.

GATES CORPORATION, THE, DENVER, CO:
2,603,422. REN. 5-23-12. INT. CL. 35.

GAUMARD SCIENTIFIC COMPANY, INC., MIAMI, FL:
4,165,190, INT. CL. 9.

GAY & LESBIAN ALLIANCE AGAINST DEFAMATION, INC., LOS ANGELES, CA:
4,165,827, INT. CL. 41.

GB FOODS CORPORATION, ANAHEIM, CA:
1,689,454. REN. 5-23-12. INT. CL. 42.

GEAUX YO, LLC., BATON ROUGE, LA:
4,163,321, PUB. 4-10-2012. INT. CL. 30.

GEBR. HELLER MASCHINENFABRIK GMBH, 72622 NURTINGEN, FED REP GERMANY:
2,569,366. REN. 5-18-12. INT. CL. 7.

GEERPRES, INC., MUSKEGON, MI:
1,770,804. REN. 5-18-12. INT. CL. 21.
1,770,805. REN. 5-18-12. INT. CL. 21.

GEIST, ROBERT, NEEDHAM, MA:
4,165,256, INT. CL. 20.

GELLER, WOLFGANG-PETER, FED REP GERMANY:
4,162,902, PUB. 4-10-2012. MULTIPLE CLASS, INT. CLS. 9 AND 18.

GENEOS LTD., LONDON EC2A 2DX, UNITED KINGDOM:
2,497,514, CANC. INT. CL. 9.

GENERAL CASUALTY COMPANY OF WISCONSIN, SUN PRAIRIE, WI:
2,682,773. REN. 5-18-12. INT. CL. 36.

GENERAL CIGAR CO., INC., NEW YORK, NY:
854,010, CANC. U.S. CL. 17.

GENERAL CIGAR CO., INC., RICHMOND, VA:
854,014, CANC. U.S. CL. 17.

GENERAL COUNCIL OF THE ASSEMBLIES OF GOD, THE, SPRINGFIELD, MO:
2,595,504. REN. 5-21-12. INT. CL. 16.

GENERAL DYNAMICS C4 SYSTEMS, INC., SCOTTSDALE, AZ:
2,571,063. REN. 5-19-12. INT. CL. 9.

GENERAL ELECTRIC COMPANY, SCHENECTADY, NY:
863,170, CANC. U.S. CL. 38.
1,197,111. REN. 5-18-12. INT. CL. 7.
1,689,275. REN. 5-18-12. MULTIPLE CLASS, INT. CLS. 36, 37, 38, 39 AND 42.

GENERAL ELECTRIC COMPANY, WAUKESHA, WI:
3,006,351, CANC. INT. CL. 10.

GENERAL ELECTRIC COMPANY, SCHENECTADY, NY:
3,006,352, CANC. INT. CL. 10.

GENERAL HYDROPONICS, INC., SEBASTOPOL, CA:
2,595,318. REN. 5-24-12. INT. CL. 1.

- GENERAL MILLS, INC., MINNEAPOLIS, MN:
856,472, CANC. U.S. CL. 23.
945,279, AM. U.S. CL. 38.
4,165,274, INT. CL. 35.
4,165,925, MULTIPLE CLASS, INT. CLS. 29 AND 30.
- GENERAL MOTORS LLC, DETROIT, MI:
1,683,678, REN. 5-23-12. INT. CL. 9.
1,686,723, REN. 5-18-12. INT. CL. 36.
- GENERAL PENCIL COMPANY, JERSEY CITY, NJ:
1,437,312, COR. INT. CL. 16.
2,965,785, COR. INT. CL. 16.
2,996,505, COR. INT. CL. 16.
- GENERAL SPORTS AND ENTERTAINMENT, LLC, ROCHESTER, MI:
2,627,867, REN. 5-18-12. INT. CL. 36.
- GENERATIONS FINANCIAL ADVISORS, INC., SALISBURY, MD:
2,571,928, REN. 5-18-12. INT. CL. 36.
- GENESIS BRADFORD LIMITED, BRADFORD BD10 9TF, UNITED KINGDOM:
3,006,109, CANC. MULTIPLE CLASS, INT. CLS. 24, 25 AND 40.
- GENESIS TIME GROUP, LLC, NEW YORK, NY:
4,164,937, INT. CL. 14.
- GENETIC TECHNOLOGIES, LTD., FITZROY, VICTORIA, AUSTRALIA:
4,164,902, INT. CL. 44.
- GENIECO, INC., CHICAGO, IL:
1,698,744, REN. 5-23-12. INT. CL. 5.
- GENNERO; JIMMIE F., HELOTES, TX, DBA PICOSOS' PEANUTS CO., INC.:
1,201,319, REN. 5-22-12. INT. CL. 29.
- GENTIUM SPA, ITALY:
4,162,914, PUB. 4-10-2012. INT. CL. 5.
- GENTLE GIANTS DRAFT HORSE RESCUE SOCIETY, LTD., MOUNT AIRY, MD, AKA GENTLE GIANTS:
4,163,539, PUB. 4-10-2012. MULTIPLE CLASS, INT. CLS. 36 AND 45.
- GENTRACK LIMITED, PONSONBY, AUCKLAND, NEW ZEALAND:
2,634,169, REN. 5-21-12. INT. CL. 9.
- GEOFROY, DAVID, DORAL, FL:
4,164,578, PUB. 4-10-2012. INT. CL. 10.
- GEORG FISCHER AKTIENGESELLSCHAFT, SCHAFFHAUSEN, SWITZERLAND:
563,056, REN. 5-23-12. U.S. CL. 23 (INT. CL. 7).
- GEORGE , ZAK, WESTBOROUGH, MA, DBA PLAY2HELP.ORG:
4,165,273, INT. CL. 28.
- GEORGE STOVER ADVENTURE PRODUCTIONS, LLC, BALTIMORE, MD:
2,592,666, REN. 5-19-12. INT. CL. 41.
- GEORGE WARNER SEED COMPANY, INC., HEREFORD, TX:
854,928, CANC. U.S. CL. 1.
- GEORGETOWN RAIL EQUIPMENT COMPANY, GEORGETOWN, TX:
4,164,214, PUB. 4-10-2012. INT. CL. 42.
- GEORGIA-PACIFIC CONSUMER PRODUCTS LP, ATLANTA, GA:
1,769,050, REN. 5-24-12. MULTIPLE CLASS, INT. CLS. 11 AND 21.
4,164,711, PUB. 4-10-2012. INT. CL. 16.
4,164,764, PUB. 4-10-2012. MULTIPLE CLASS, INT. CLS. 16 AND 21.
- GEORGIA-PACIFIC CONSUMER PRODUCTS LP, ATLANTA, GA:
4,165,233, INT. CL. 16.
- GEORGIOS SAMIOS, EAST ELMHURST, NY, DBA SAMIOS FOODS:
4,163,141, PUB. 4-10-2012. INT. CL. 29.
- GERARD, MILTON E., NORTHVALE, NJ AND ELIAS, JACOB, FLUSHING, NY:
3,006,505, CANC. INT. CL. 9.
- GERONIMO'S, LTD., NANTUCKET, MA:
4,163,685, PUB. 4-10-2012. INT. CL. 35.
- GESTALT HOLDINGS, LP, HAVERFORD, PA:
4,164,195, PUB. 4-10-2012. INT. CL. 16.
- GESTION LOUIS-MARIELE INC., MONTREAL, QUEBEC, CANADA:
4,163,059, PUB. 4-10-2012. MULTIPLE CLASS, INT. CLS. 9 AND 35.
- GEZER AYAKKABI DERI SANAYI VE TICARET ANONIM SIRKETI, BUYUK CEKMECE - ISTANBUL, TURKEY:
2,565,987, REN. 5-24-12. INT. CL. 25.
2,565,987, CANC. INT. CL. 18.
- GFM LICENSING GROUP LLC, WESTBROOK, CT:
4,165,986, INT. CL. 25.
4,165,987, INT. CL. 25.
- GHOSTSTAR LLC, LAS VEGAS, NV:
4,164,963, MULTIPLE CLASS, INT. CLS. 9 AND 28.
- GHP PRODUCTS, LLC, SAN BERNARDINO, CA:
4,163,677, PUB. 4-10-2012. INT. CL. 40.
- GIBBS CONTRACTING INC., WASHINGTON, DC:
4,164,112, PUB. 4-10-2012. MULTIPLE CLASS, INT. CLS. 35 AND 39.
- GIBILISCO, JOHN M., BOULDER, CO, DBA ANALOG SOLUTIONS:
1,689,425, REN. 5-23-12. INT. CL. 42.
- GIBSON, DUNN & CRUTCHER LLP, LOS ANGELES, CA:
2,614,712, REN. 5-21-12. INT. CL. 42.
- GID INVESTMENT ADVISERS CORPORATION, BOSTON, MA:
4,164,367, PUB. 4-10-2012. MULTIPLE CLASS, INT. CLS. 36 AND 37.
- GIFT IT GREEN, LLC, CHICAGO, IL:
4,165,252, INT. CL. 16.
- GIGASTONE CORPORATION, TAIPEI CITY, TAIWAN:
4,163,705, PUB. 4-10-2012. INT. CL. 9.
- GIGMARK, LLC, KNOXVILLE, TN:
4,166,012, INT. CL. 9.
- GILBERT INDUSTRIES, INC., JONESBORO, AR:
1,197,156, REN. 5-23-12. INT. CL. 9.
- GILLESPIE, THOMAS E., CLEVELAND, OH:
4,165,997, INT. CL. 28.
- GILLMAN, MATTHEW JOHN, MELBOURNE, AUSTRALIA AND WHITE, JASON SAMUEL, MELBOURNE, AUSTRALIA AND DOE, ALYSSA PAMELA, MELBOURNE, AUSTRALIA:
4,164,929, INT. CL. 41.
- GINES, JACQUELINE M, OMAHA, NE, AKA JACQUIE GINES:
4,163,623, PUB. 4-10-2012. MULTIPLE CLASS, INT. CLS. 9 AND 41.
- GIRARD, RENE, E, CHULA VISTA, CA:
4,163,139, PUB. 3-29-2011. INT. CL. 36.
- GIRLS CIRCLE ASSOCIATION, SAN RAFAEL, CA, AKA ONE CIRCLE FOUNDATION:
4,163,999, PUB. 4-10-2012. INT. CL. 16.
- GITTER, MICHAEL, NEW YORK, NY AND BONOMI, GERRY, NEW YORK, NY:
4,110,532, COR. INT. CL. 25.
- GIVAUDAN SA, SWITZERLAND:
3,041,997.
4,162,911, PUB. 4-10-2012. INT. CL. 42.
- GIVE BACK BRANDS FOUNDATION, NEW YORK, NY:
4,164,146, PUB. 4-10-2012. INT. CL. 3.
- GIVE CLEAN WATER INC, SAN DIEGO, CA:
4,163,262, PUB. 4-10-2012. INT. CL. 36.
- GIVE TO WIN, INC., ATHENS, GA:
4,164,182, PUB. 4-10-2012. INT. CL. 36.
4,164,184, PUB. 4-10-2012. INT. CL. 36.
- GLAETZER WINES PTY LTD, TANUNDA, SOUTH AUSTRALIA, AUSTRALIA:
3,150,487, AM. INT. CL. 33.
- GLASER DESIGNS, INC., SAN FRANCISCO, CA:
1,694,383, REN. 5-23-12. INT. CL. 18.
- GLASS PACKAGING INSTITUTE, ALEXANDRIA, VA:
1,731,057, REN. 5-22-12. INT. CL. 16.
- GLAXO GROUP LIMITED, GREENFORD, MIDDLESEX, ENGLAND:
4,164,128, PUB. 4-10-2012. INT. CL. 44.
- GLEMBY COMPANY, INC., THE, NEW YORK, NY:
854,311, CANC. U.S. CL. 51.

GLEN RAVEN, INC., GLEN RAVEN, NC, GLEN RAVEN, INC., GLEN RAVEN, NC:
2,559,029. REN. 5-21-12. INT. CL. 24.

GLENWOOD, L.L.C., ENGLEWOOD, NJ, GLENWOOD INC., TENAFLY, NJ:
1,685,037. REN. 5-23-12. INT. CL. 5.

GLITTERATI INCORPORATED, NEW YORK, NY:
4,164,231, PUB. 4-10-2012. INT. CL. 41.

GLOBAL ALLIANCE FOR IMPROVED NUTRITION, THE, 1202 GENEVA, SWITZERLAND:
4,165,024, INT. CL. 42.

GLOBAL BRAND LLC, BOSTON, MA:
854,677, CANC. U.S. CL. 39.

GLOBAL INDEMNITY, PLC, DUBLIN 2, IRELAND:
4,165,335, INT. CL. 36.

GLOBAL INTELLISYSTEMS LLC, EVERGREEN, CO:
4,163,851, PUB. 4-10-2012. INT. CL. 35.

GLOBAL LOGISTICS SYSTEM WORLDWIDE COMPANY FOR DEVELOPMENT OF FREIGHT INFORMATION NETWORKS GMBH, FED REP GERMANY:
4,162,858, PUB. 4-10-2012. MULTIPLE CLASS, INT. CLS. 38 AND 42.

GLOBAL SAFETY SOURCES INCORPORATED, PASADENA, TX:
4,163,912, PUB. 4-10-2012. MULTIPLE CLASS, INT. CLS. 35, 41 AND 45.
4,163,913, PUB. 4-10-2012. MULTIPLE CLASS, INT. CLS. 35, 41 AND 45.
4,163,961, PUB. 4-10-2012. MULTIPLE CLASS, INT. CLS. 35, 41 AND 45.

GLOBAL SMOKED FOODS LIMITED FOUNDATION, CHARLESTON, NEVIS, ST.KITTS-NEVIS:
3,057,375, AM. INT. CL. 29.

GLOBAL TEXTILE ALLIANCE, INC., REIDSVILLE, NC:
4,164,532, PUB. 4-10-2012. INT. CL. 24.

GLOBAL WINE HOUSE OÜ, ESTONIA:
4,162,982, PUB. 4-10-2012. INT. CL. 33.

GLOBE UNION INDUSTRIAL CORP., TAICHUNG, TAIWAN, GERBER PLUMBING FIXTURES CORP., CHICAGO, IL:
1,197,796. REN. 5-18-12. INT. CL. 11.

GLOBECOM ONE, LLC, PALO ALTO, CA:
4,165,236, INT. CL. 42.

GLOBERIDE, INC., TOKYO, JAPAN:
4,164,771, PUB. 4-10-2012. INT. CL. 28.

GLOCKL, JOSEF, KIRCHHEIM B.M., FED REP GERMANY:
3,019,586, CANC. MULTIPLE CLASS, INT. CLS. 20 AND 27.

GLOW INDUSTRIES, INC., PERRYSBURG, OH:
4,164,386, PUB. 4-10-2012. INT. CL. 10.

GLT FOODS, LLC, IRVINE, CA, DBA FRIENDS FOODS:
4,165,587, MULTIPLE CLASS, INT. CLS. 29 AND 30.

GMB, INC., WINSTON-SALEM, NC:
862,286, CANC. U.S. CL. 17.

GMSX LLC, HERCULES, CA:
4,164,256, PUB. 4-10-2012. MULTIPLE CLASS, INT. CLS. 30 AND 43.

GNCO CO.,LTD. SEOUL, REPUBLIC OF KOREA:
3,005,371, CANC. INT. CL. 25.

GO FOR LANGUAGES US LLC, CORAL GABLES, FL, DBA GO FOR LANGUAGES:
4,163,436, PUB. 4-10-2012. INT. CL. 41.

GO GUNG-HO, LLC, HIGHLAND, UT:
4,165,684, INT. CL. 32.

GO THINK LLC, THE WOODLANDS, TX:
4,164,293, PUB. 4-10-2012. INT. CL. 35.
4,164,295, PUB. 4-10-2012. INT. CL. 42.

GOAL.COM (HOLDCO) S.A., L-2449 LUXEMBOURG, LUXEMBOURG:
4,162,799, PUB. 4-10-2012. MULTIPLE CLASS, INT. CLS. 9, 25, 35 AND 41.

GOATS, LLC, COURTLAND MANOR, NY:
2,497,924, CANC. INT. CL. 42.

GODIN, MICHAEL, RICHMOND, VA:
4,164,542, PUB. 4-10-2012. INT. CL. 44.

GOEBEL PORZELLANMANUFAKTUR GMBH, RODENTAL, FED REP GERMANY:
3,005,362, CANC. INT. CL. 14.

GOLD MEDAL GYMNASTICS ACADEMY, L.L.C., CHANDLER, AZ:
4,164,289, PUB. 4-10-2012. INT. CL. 41.

GOLD MEDAL PRODUCTS CO., CINCINNATI, OH:
1,729,161. REN. 5-23-12. INT. CL. 11.

GOLD, IRWIN L., BRENTWOOD, MD:
1,143,570, CANC. INT. CL. 29.

GOLDEN FRANCHISING CORPORATION, RICHARDSON, TX, AKA GOLDEN CHICK:
4,163,612, PUB. 4-10-2012. INT. CL. 29.

GOLDEN ISLES MARKETING ASSOCIATES, LLC, BRUNSWICK, GA, FORMERLY GOLDEN ISLES PRODUCTS GROUP, LLC:
4,163,763, PUB. 4-10-2012. INT. CL. 29.

GOLDEN TEMPLE OF OREGON, LLC, SPRINGFIELD, OR:
4,164,173, PUB. 4-10-2012. INT. CL. 30.

GOLDEN WEST BIOLOGICALS, INC., TEMECULA, CA:
4,164,447, PUB. 4-10-2012. INT. CL. 1.
4,164,450, PUB. 4-10-2012. INT. CL. 1.

GOLDING FARMS FOODS, INC., WINSTON-SALEM, NC:
4,164,282, PUB. 4-10-2012. INT. CL. 30.

GOLDMAN, MITCHELL W., POTOMAC, MD:
3,006,100, CANC. INT. CL. 16.

GOLF CAR DEALERS ASSOCIATION OF AMERICA, LLC, JACKSONVILLE, FL:
4,163,890, PUB. 4-10-2012. INT. CL. 35.

GOLF COURSE SERVICES, LLC, ROCHESTER, MI:
3,006,332, CANC. INT. CL. 43.

GONATION, LLC, MILFORD, CT:
4,165,527, INT. CL. 9.

GONZALES, MARY NINA, BEAUMONT, CA:
4,164,610, PUB. 4-10-2012. INT. CL. 35.

GONZALEZ, BERTHA A., SAN ANTONIO, TX:
3,861,406, CANC. INT. CL. 32.

GONZALEZ, EDGAR, HUNTINGTON BEACH, CA:
4,165,704, INT. CL. 25.

GOOD GIRL LLC, SAN FRANCISCO, CA:
4,164,029, PUB. 4-10-2012. INT. CL. 41.

GOOD NEWS PUBLISHERS, WHEATON, IL:
4,164,612, PUB. 4-10-2012. INT. CL. 45.
4,164,613, PUB. 4-10-2012. INT. CL. 9.

GOODYEAR TIRE & RUBBER COMPANY, THE, AKRON, OH:
855,610, CANC. U.S. CL. 39.
859,703, CANC. U.S. CL. 35.
860,086, CANC. U.S. CL. 35.

GORDON BROTHERS GROUP, LLC, BOSTON, MA:
4,164,990, MULTIPLE CLASS, INT. CLS. 35 AND 36.

GORDON, JEFFREY M., SANTA MONICA, CA:
4,164,864, INT. CL. 41.

GORECKI, TERESA, SCOTTSDALE, AZ:
4,164,633, PUB. 4-10-2012. INT. CL. 25.

GORILLA COFFEE, INC., BROOKLYN, NY:
4,162,707, PUB. 4-10-2012. MULTIPLE CLASS, INT. CLS. 16, 21, 25 AND 30.
4,162,709, PUB. 4-10-2012. MULTIPLE CLASS, INT. CLS. 16, 21, 25 AND 30.

GOSNAY, RICHARD, BATON ROUGE, LA:
4,164,395, PUB. 4-10-2012. INT. CL. 37.

GOSS INTERNATIONAL AMERICAS, INC., DURHAM, NH:
2,497,504, CANC. MULTIPLE CLASS, INT. CLS. 7 AND 9.

GOT POWER, INC., MARTINEZ, CA:
4,165,796, MULTIPLE CLASS, INT. CLS. 37 AND 40.

GOTTAGETTACOACH!, INC., NORTHBROOK, IL:
4,164,101, PUB. 4-10-2012. INT. CL. 41.

GOULART, PETER M., SAN DIEGO, CA:
4,163,671, PUB. 4-10-2012. INT. CL. 9.

GOULD, DAVID, CONCORD, NC:
4,164,227, PUB. 4-10-2012. INT. CL. 3.

GOYA FOODS, INC., SECAUCUS, NJ:
1,221,099. REN. 5-18-12. INT. CL. 30.

GPPR, LLC., LOS ANGELES, CA:
4,164,789, MULTIPLE CLASS, INT. CLS. 9, 14, 18 AND 25.

GRADY & GRADY, LLC, OPELIKA, AL:
4,166,008, INT. CL. 35.

GRAHAM CORPORATION, BATAVIA, NY:
2,704,853. REN. 5-18-12. INT. CL. 11.

- GRAHAM-FIELD, INC., HAUPPAUGE, NY:
860,512, CANC. U.S. CL. 26.
- GRANAROLO SPA, BOLOGNA, ITALY:
3,057,963.
- GRAND HALL ENTERPRISE CO., LTD., TAIPEI, TAIWAN:
4,164,124, PUB. 4-10-2012. INT. CL. 11.
- GRAND UNION COMPANY, THE, EAST PATERSON, NJ:
855,169, CANC. U.S. CL. 45.
- GRANITE STATE MANAGEMENT & RESOURCES, CONCORD, NH:
2,569,950. REN. 5-22-12. INT. CL. 41.
- GRANT DESIGN COLLABORATIVE, INC., CANTON, GA:
2,588,024. REN. 5-19-12. MULTIPLE CLASS, INT. CLS. 35, 37 AND 42.
- GRANT, TECORA, J, CROCKETT, CA, DBA MR. GREEN JEANS APPLIANCE REPAIR:
4,163,946, PUB. 4-10-2012. INT. CL. 37.
- GRAPE TECHNOLOGY GROUP, INC, BETHLEHEM, PA:
2,930,440, CANC. INT. CL. 41.
- GRAPESEED MEDIA LIMITED, CENTRAL, HONG KONG:
4,163,888, PUB. 4-10-2012. MULTIPLE CLASS, INT. CLS. 9 AND 16.
- GRAPESEED MEDIA LTD., CENTRAL, HONG KONG:
4,164,637, PUB. 4-10-2012. MULTIPLE CLASS, INT. CLS. 9 AND 16.
4,164,672, PUB. 4-10-2012. INT. CL. 41.
- GRAPHIC PACKAGING CORPORATION, GOLDEN, CO:
749,432. REN. 5-19-12. U.S. CL. 37 (INT. CL. 16).
- GRASSHOPPER HOUSE, LLC, MALIBU, CA:
4,165,010, MULTIPLE CLASS, INT. CLS. 44 AND 45.
- GRASSHOPPER PACKING COMPANY, LLC, PITTSBURG, KS, NATURAL LIFE PET PRODUCTS, INC., FRONTE-NAC, KS:
1,734,131. REN. 5-21-12. INT. CL. 31.
- GRAVES, LEWIS, BROOMFIELD, CO:
4,165,875, INT. CL. 35.
- GREAT AMERICAN INSURANCE COMPANY, CINCINNATI, OH:
2,499,047, CANC. INT. CL. 36.
- GREAT-WEST LIFE ASSURANCE COMPANY, THE, GREENWOOD VILLAGE, CO AND GREAT-WEST LIFE & ANNUITY INSURANCE COMPANY, GREENWOOD VILLAGE, CO:
1,686,715. REN. 5-18-12. INT. CL. 36.
- GREELEY SEED COMPANY LLC, GREELEY, CO, L. A. PET FOODS, INC., ALTADENA, CA:
1,697,883. REN. 5-23-12. INT. CL. 31.
- GREEN GOOSE, INC., CAMBRIDGE, MA:
4,165,562, INT. CL. 9.
- GREEN, BOB, CARMEL, CA:
4,163,467, PUB. 4-10-2012. INT. CL. 8.
- GREENFISH LLC, SAN CLEMENTE, CA:
4,165,788, INT. CL. 9.
4,165,789, INT. CL. 25.
- GREG OTT'S CENTER FOR PHYSICAL THERAPY & SPORTS PERFORMANCE, LLC, CHARLOTTE, NC:
4,164,576, PUB. 4-10-2012. INT. CL. 44.
- GREIF PACKAGING LLC, DELAWARE, OH:
853,912, CANC. U.S. CL. 2.
- GRENERA NUTRIENTS PVT LTD, ERODE, TAMILNADU, INDIA:
4,164,414, PUB. 4-10-2012. INT. CL. 5.
- GRIBALDI & SALVIA S.P.A., ITALY:
4,162,838, PUB. 4-10-2012. INT. CL. 7.
- GRIDTEST SYSTEMS, INC., WESTLAKE VILLAGE, CA:
4,165,561, INT. CL. 9.
- GRIECO, MICHELLE, BEDMINSTER, NJ:
4,165,109, INT. CL. 42.
- GRIGGS, CHRISTOPHER R, NORTH LAS VEGAS, NV:
4,164,001, PUB. 4-10-2012. INT. CL. 3.
- GRIGNARD COMPANY, LLC, RAHWAY, NJ:
4,165,470, INT. CL. 3.
- GRIP I.T. SOLUTIONS, INC., ELYRIA, OH:
4,163,266, PUB. 4-10-2012. INT. CL. 42.
4,163,377, PUB. 4-10-2012. INT. CL. 42.
- GRIT DESIGN LLC, DETROIT, MI:
4,163,872, PUB. 4-10-2012. INT. CL. 42.
- GRIT INC., LORETTO, ON, CANADA:
4,163,317, PUB. 4-10-2012. INT. CL. 28.
- GROOM VENTURES, LLC, PHOENIX, AZ:
4,163,454, PUB. 4-10-2012. INT. CL. 41.
- GROSS, DENNIS, NEW YORK, NY:
4,165,855, INT. CL. 3.
- GROTELL CONSULTING, INC., PORT JEFFERSON, NY:
4,163,419, PUB. 4-10-2012. INT. CL. 42.
- GROTENHUIS, ERIC, FOLSOM, CA:
4,164,911, MULTIPLE CLASS, INT. CLS. 9 AND 20.
- GROTTO S.P.A., CHIUPPANO (VI), ITALY:
4,162,726, PUB. 9-27-2011. MULTIPLE CLASS, INT. CLS. 9, 16, 28, 35, 41, 42, 43 AND 45.
- GROUND EFFECTS LANDSCAPING, INC., AUBURN, WA:
2,597,488. REN. 5-19-12. INT. CL. 42.
- GROUP PMX LLC, PORT WASHINGTON, NY:
4,165,031, MULTIPLE CLASS, INT. CLS. 35 AND 37.
- GROUP USA, INC., SECAUCUS, NJ:
2,676,748. REN. 5-18-12. INT. CL. 25.
- GRUPE CABICO INC., COATICOOK (QUEBEC), CANADA:
4,165,655, INT. CL. 20.
- GROVE ARCADE RESTORATION, LLC, ASHEVILLE, NC:
4,164,020, PUB. 4-10-2012. INT. CL. 36.
- GROWING VOICES, INC., SAN FRANCISCO, CA:
4,164,567, PUB. 4-10-2012. INT. CL. 36.
- GROWSAFE SYSTEMS LTD., AIRDRIE, CANADA:
4,163,233, PUB. 4-10-2012. INT. CL. 42.
- GRUIDEL, RYAN, BOULDER, CO AND GRUIDEL, DALTON, BOULDER, CO AND KRAMER, COLE, BOULDER, CO:
4,165,844, MULTIPLE CLASS, INT. CLS. 16 AND 25.
- GRUNEISEN, ALBERT H. III, LOUISVILLE, KY:
2,498,855, CANC. INT. CL. 9.
- GRUPO ANTOLIN-INGENIERIA, S.A., SPAIN:
4,162,924, PUB. 4-10-2012. MULTIPLE CLASS, INT. CLS. 11, 12 AND 42.
- GRUPO BIMBO, S.A. B. DE C.V., MEXICO CITY, MEXICO:
4,164,607, PUB. 4-10-2012. INT. CL. 30.
- GRUPO PEÑAFLORES S.A., BUENOS AIRES, ARGENTINA:
4,164,677, PUB. 4-10-2012. INT. CL. 33.
- GT BEVERAGE COMPANY, LLC, LAGUNA NIGUEL, CA:
4,164,962, INT. CL. 32.
- GUANGXI YULIN PHARMACEUTICAL GROUP CO., LTD., YULIN CITY, GUANGXI, CHINA:
4,164,206, PUB. 4-10-2012. INT. CL. 5.
- GUANGZHOU AUTOMOBILE GROUP CO., LTD., GUANGZHOU, CHINA:
4,162,853, PUB. 4-10-2012. MULTIPLE CLASS, INT. CLS. 7, 12 AND 37.
- GUANGZHOU UNIASIA COSMETIC TECHNOLOGY CO.,LTD., 510663 GUANGDONG PROVINCE, CHINA:
4,162,852, PUB. 4-10-2012. INT. CL. 3.
- GUANGZHOU YUE YUAN TONG INTERNATIONAL INDUSTRY CO., LTD., CHINA:
4,163,005, PUB. 4-10-2012. MULTIPLE CLASS, INT. CLS. 8 AND 21.
- GUARD RFID SOLUTIONS INC., DELTA, BC, CANADA:
4,164,895, INT. CL. 9.
- GUARDIAN INDUSTRIES CORP., AUBURN HILLS, MI:
4,165,443, INT. CL. 19.
- GUHRING OHG, ALBSTADT, FED REP GERMANY:
4,163,908, PUB. 4-10-2012. INT. CL. 7.
- GUIDEPOSTS A CHURCH CORPORATION, DANBURY, CT:
4,165,100, MULTIPLE CLASS, INT. CLS. 35 AND 45.
- GUIDRY, II, HAROLD J., LAFAYETTE, LA:
4,163,466, PUB. 4-10-2012. INT. CL. 19.
- GUILFORD INTERNATIONAL GROUP LIMITED, ROAD TOWN, TORTOLA, BR.VIRGIN ISLANDS:
4,163,100, PUB. 4-10-2012. INT. CL. 41.
- GUILLERMO, TENA, MEXICO, MEXICO:
4,165,768, INT. CL. 28.
- GUNS BUILDER CLUB AND BULIDING 3D GUN DISASSEMBLY GUNAPP MAKER CO., LIMITED, HOUSTON, TX:
4,166,052, INT. CL. 9.

GUTTER INDUSTRIES, INC., AUGUSTA, NJ:
3,204,390, CANC. INT. CL. 6.

G100 INC., ASPEN, CO, DBA G100:
4,165,620, MULTIPLE CLASS, INT. CLS. 35 AND 41.

H & H INDUSTRIES, INC., ELMWOOD, IL:
2,654,973. REN. 5-18-12. INT. CL. 11.

H & W COMPUTER SYSTEMS, INC., BOISE, ID:
1,238,120. REN. 5-24-12. INT. CL. 9.

H. J. HEINZ COMPANY, PITTSBURGH, PA, ORE-IDA
FOODS, INC., BOISE, ID:
1,735,763. REN. 5-24-12. INT. CL. 29.

H. LUNDBECK A/S, DENMARK:
4,163,043, PUB. 4-10-2012. INT. CL. 5.

H.D.D. LLC, HEALDSBURG, CA:
2,709,874, AM. INT. CL. 33.

H.D.D. LLC, HEALDSBURG, CA, DBA TRUETT HURST
WINERY:
4,165,277, INT. CL. 33.

H.F.Z. CORPORATION, CLEARWATER, FL:
4,163,473, PUB. 4-10-2012. INT. CL. 35.

H-P PRODUCTS, INC., LOUISVILLE, OH:
2,590,877. REN. 5-22-12. INT. CL. 7.

HACH COMPANY, LOVELAND, CO:
559,086. REN. 5-18-12. U.S. CL. 6 (INT. CL. 1).

HACIENDA SAN JOSE DE MIRAVALLE S DE RL DE CV,
SAN BERNARDO, JALISCO, MEXICO:
4,060,643, COR. INT. CL. 33.

HAIDEN SURF, VERONA, WI:
4,163,423, PUB. 4-10-2012. INT. CL. 25.

HAL SMITH MARKETING GROUP LLC, NORMAN, OK:
4,164,264, PUB. 4-10-2012. INT. CL. 35.

HALABI, ANTONY, BROOKLYN, NY:
4,163,892, PUB. 4-10-2012. MULTIPLE CLASS, INT. CLS.
25 AND 42.

HALCON CORPORATION, STEWARTVILLE, MN:
2,498,779, CANC. INT. CL. 20.

HALLA CLIMATE CONTROL CORPORATION, DAEJEON,
REPUBLIC OF KOREA:
4,164,947, MULTIPLE CLASS, INT. CLS. 7, 9, 11 AND 12.

HALLBURTON ENERGY SERVICES, INC., CARROLL-
TON, TX:
4,164,732, PUB. 4-10-2012. INT. CL. 1.

HALLOWELL II, ROBERT LEROY, LOS ANGELES, CA:
2,580,057. REN. 5-21-12. INT. CL. 3.

HALLOWELL, ROBERT LEROY II, LOS ANGELES, CA:
2,583,532. REN. 5-21-12. INT. CL. 3.
2,583,533. REN. 5-21-12. INT. CL. 3.

HALLSTAR INNOVATIONS CORP., CHICAGO, IL:
4,163,272, PUB. 4-10-2012. MULTIPLE CLASS, INT. CLS.
1, 3, 4 AND 5.

HALTER, VOLKER, FED REP GERMANY AND KRETSCH-
MER, FELIX, FED REP GERMANY:
4,162,961, PUB. 4-10-2012. MULTIPLE CLASS, INT. CLS.
10, 11 AND 34.

HAMAMATSU PHOTONICS K.K., HAMAMATSU-SHI SHI-
ZUOKA, JAPAN:
2,499,111, CANC. INT. CL. 9.

HAMMEL RECYCLINGTECHNIK GMBH, FED REP GER-
MANY:
4,162,813, PUB. 4-10-2012. INT. CL. 7.

HAMMERHEAD INDUSTRIES, INC., VENTURA, CA:
4,165,126, INT. CL. 17.

HAMMERMILL PAPER COMPANY, STRATHMORE PAPER
COMPANY DIVISION, WEST SPRINGFIELD, MA:
860,104, CANC. U.S. CL. 37.

HAMRICK, MARK, PRINCETON, NJ:
4,165,809, INT. CL. 35.

HAN, PAUL, CERRITOS, CA:
4,162,740, PUB. 4-10-2012. INT. CL. 29.
4,162,742, PUB. 4-10-2012. INT. CL. 29.

HANDI-FOIL CORPORATION, WHEELING, IL:
4,165,689, INT. CL. 21.
4,165,690, INT. CL. 6.

HANGER HEADQUARTERS, NEW YORK, NY:
4,164,435, PUB. 4-10-2012. INT. CL. 21.

HANGZHOU SANXIN PAPER CO., LTD, ZHEJIANG PRO-
VINCE, CHINA:
4,163,002, PUB. 4-10-2012. INT. CL. 22.

HANIMEX PTY. LIMITED, BROOKVALE, NEW SOUTH
WALES, AUSTRALIA:
854,602, CANC. U.S. CL. 26.

HANLEY-WOOD, LLC, WASHINGTON, DC, CONCRETE
CONSTRUCTION PUBLICATIONS, INC., ADDISON, IL:
1,215,200. REN. 5-23-12. MULTIPLE CLASS, INT. CLS. 35
AND 41.

HANNA, MICHAEL A., GOLDEN, CO:
2,498,022, CANC. INT. CL. 16.

HANNAH STORM FOUNDATION INC., RIVERSIDE, CT:
4,163,965, PUB. 4-10-2012. MULTIPLE CLASS, INT. CLS.
35 AND 36.

HANS-JOACHIM WOLF, FED REP GERMANY:
4,162,845, PUB. 4-10-2012. MULTIPLE CLASS, INT. CLS.
9, 11, 12, 20, 21, 35 AND 39.

HAPPY NIBBLES LLC, EUGENE, OR:
4,164,176, PUB. 4-10-2012. INT. CL. 29.

HARBINGER MEDICAL GROUP, LLC, MARBLEHEAD,
MA:
4,164,965, INT. CL. 10.

HARBOUR-SHORES BAPTIST CHURCH INC., CICERO, IN:
4,164,365, PUB. 4-10-2012. INT. CL. 41.

HARCROS CHEMICALS INC., KANSAS CITY, KS:
1,687,452. REN. 5-21-12. INT. CL. 1.

HARD NINETY, INC., GILROY, CA:
4,165,634, INT. CL. 25.

HARD 8 BEVERAGE COMPANY, SEATTLE, WA:
4,165,197, INT. CL. 32.

HARD 8 BEVERAGE COMPANY, SEATTLE, WA, DBA
HARD 8 BEVERAGE:
4,165,316, INT. CL. 33.

HARDMETALLSERVICE I MOCKFJARD AB, MOCK-
FJARD, SWEDEN:
2,579,093. REN. 5-22-12. INT. CL. 30.

HARLAND FINANCIAL SOLUTIONS, INC., PORTLAND,
OR, CFI BANKERS SERVICE GROUP, INC., PORTLAND,
OR:
1,710,718. REN. 5-23-12. INT. CL. 9.

HARMONIC VISION, INC., GENEVA, IL:
2,715,676. REN. 5-22-12. INT. CL. 9.

HARPER COLLINS PUBLISHERS, INC., NEW YORK, NY:
1,198,674. REN. 5-23-12. INT. CL. 16.

HARPERCOLLINS PUBLISHERS L.L.C., NEW YORK, NY:
4,163,122, PUB. 4-10-2012. INT. CL. 16.
4,163,123, PUB. 4-10-2012. INT. CL. 16.
4,163,147, PUB. 4-10-2012. INT. CL. 41.

HARRY AND DAVID, MEDFORD, OR:
1,683,115. REN. 5-23-12. INT. CL. 30.
1,683,344. REN. 5-23-12. INT. CL. 42.

HARTMAN, STANLEY E., BEAVERTON, OR, DBA PACIFIC
TOBACCO COMPANY:
855,427, CANC. U.S. CL. 17.

HARVEY & ASSOCIATES IN PARADISE P.A., FORT
MYERS, FL, DBA HARVEY & ASSOCIATES:
4,164,374, PUB. 4-10-2012. INT. CL. 36.

HATCH, INC., WINSTON-SALEM, NC:
4,163,563, PUB. 11-1-2011. INT. CL. 9.

HATTERAS INVESTMENT PARTNERS, LLC, RALEIGH,
NC:
4,164,579, PUB. 4-10-2012. INT. CL. 36.

HBI BRANDED APPAREL LIMITED, INC., WINSTON-
SALEM, NC:
4,165,305, INT. CL. 25.

HEAL THE BAY, SANTA MONICA, CA:
2,578,180. REN. 5-22-12. MULTIPLE CLASS, INT. CLS. 25
AND 42.

HEALING NONI CO., LLC, HILO, HI:
4,163,983, PUB. 4-10-2012. INT. CL. 32.

HEALTH INSURANCE OPTIONS LLC, MANSFIELD, OH:
4,163,273, PUB. 4-10-2012. INT. CL. 36.

HEALTHCOMMUNITIES.COM, INC., NORTHAMPTON,
MA TO HEALTHCOMMUNITIES.COM, INC., NORTH-
AMPTON, MA:
2,498,989, CANC. INT. CL. 42.

HEALTHSTAR COMMUNICATIONS, MAHWAH, NJ:
4,164,208, PUB. 4-10-2012. INT. CL. 42.
4,164,211, PUB. 4-10-2012. INT. CL. 42.
4,164,622, PUB. 4-10-2012. INT. CL. 42.

- HEALTHSTREAM, INC., NASHVILLE, TN:
4,165,983, INT. CL. 42.
4,165,984, INT. CL. 42.
- HEALTHWEBAMERICA.COM INC., DALLAS, TX:
2,675,534, REN. 5-18-12, INT. CL. 42.
- HEALTHWEBAMERICA.COM, INC., DALLAS, TX:
2,678,544, REN. 5-18-12, INT. CL. 42.
- HEALTHY FOODS, LLC, CLEVELAND, OH:
4,165,549, INT. CL. 11.
- HEALTHY LIFE AND NUTRITION, LLC, VESTAVIA, AL:
4,165,872, INT. CL. 44.
- HEARST HOLDINGS, INC., NEW YORK, NY, HEARST CORPORATION, THE, NEW YORK, NY:
557,353, REN. 5-18-12, U.S. CL. 38 (INT. CL. 16).
- HEART + MIND STRATEGIES, RESTON, VA:
4,164,318, PUB. 4-10-2012, INT. CL. 35.
- HEARTLAND PAYMENT SYSTEMS, INC., PRINCETON, NJ:
4,163,416, PUB. 4-10-2012, INT. CL. 9.
- HEARTLAND RECREATIONAL VEHICLES, LLC, ELKART, IN:
4,165,913, INT. CL. 12.
- HEB GROCERY COMPANY, LP, SAN ANTONIO, TX:
4,164,072, PUB. 4-10-2012, INT. CL. 18.
4,164,188, PUB. 4-10-2012, INT. CL. 18.
- HEESEMANM, ELIZABETH, CHARLOTTE, NC:
4,163,826, PUB. 3-6-2012, INT. CL. 3.
- HEINZMANN GMBH & CO. KG, SCHÖNAU, FED REP GERMANY:
1,719,838, REN. 5-23-12, INT. CL. 7.
- HEIRLOOM HOLDINGS, LLC, MIAMI, FL:
4,165,188, INT. CL. 24.
- HELENA HOLDING COMPANY, WILMINGTON, DE:
2,608,230, REN. 5-18-12, INT. CL. 1.
2,619,074, REN. 5-18-12, INT. CL. 1.
4,165,878, INT. CL. 1.
- HELENA LABORATORIES CORPORATION, BEAUMONT, TX:
4,165,622, INT. CL. 9.
- HELMAC PRODUCTS CORPORATION, FLINT, MI:
781,744, CANC. U.S. CL. 29.
- HELMUT FISCHER GMBH INSTITUT FUR ELEKTRONIK UND MESSTECHNIK, SINDELFINGEN, FED REP GERMANY:
1,195,580, REN. 5-21-12, INT. CL. 9.
- HENKEL AG & CO. KGAA, DUESSELDORF, FED REP GERMANY:
864,007, CANC. MULTIPLE CLASS, U.S. CLS. 51 AND 52.
2,587,880, REN. 5-19-12, INT. CL. 1.
- HENNESSY INDUSTRIES, INC., LAVERGNE, TN, AMMCO TOOLS, INC., NORTH CHICAGO, IL:
933,943, REN. 5-24-12, U.S. CL. 26 (INT. CL. 9).
- HENNESSY INDUSTRIES, INC., LAVERGNE, TN, AMMCO TOOLS INC., NORTH CHICAGO, IL:
933,944, REN. 5-24-12, U.S. CL. 26 (INT. CL. 9).
- HENRI BENDEL, INC., NEW YORK, NY:
4,164,657, PUB. 4-10-2012, INT. CL. 18.
4,164,737, PUB. 4-10-2012, MULTIPLE CLASS, INT. CLS. 14 AND 18.
- HENRY FRANCIS DU PONT WINTERTHUR MUSEUM, INC., WINTERTHUR, DE:
2,578,867, REN. 5-24-12, INT. CL. 41.
- HENSLEY & COMPANY, PHOENIX, AZ:
4,164,562, PUB. 4-10-2012, INT. CL. 35.
- HERAEUS KULZER GMBH, HANAU, FED REP GERMANY:
2,569,385, REN. 5-21-12, INT. CL. 5.
- HERAEUS QUARZGLAS GLBH & CO. KG, D-63450 HANAU, FED REP GERMANY, HERAEUS QUARZSCHMELZE G.M.B.H., HANAU AM MAIN, FED REP GERMANY:
724,796, REN. 5-18-12, U.S. CL. 26 (INT. CLS. 1, 9 AND 10).
- HERCULES INCORPORATED, WILMINGTON, DE:
4,165,709, INT. CL. 1.
- HERETIC BREWING COMPANY, ELK GROVE, CA:
4,164,689, PUB. 4-10-2012, INT. CL. 32.
- HERMES SCHLEIFMITTEL GMBH & CO. KG, HAMBURG, FED REP GERMANY:
2,571,151, REN. 5-18-12, INT. CL. 3.
- HERNANDEZ PASTOR, MATILDE, 03291 ELCHE (ALICANTE), SPAIN AND LOPEZ GARCIA, MARIA, 03291 ELCHE (ALICANTE), SPAIN:
2,600,321, REN. 5-21-12, INT. CL. 25.
- HERO BOY, INC., NEW YORK, NY:
863,993, CANC. U.S. CL. 46.
- HERRERA, ORLANDO A., HOLLYWOOD, FL AND GOLDMEER, CONSTANCE, HOLLYWOOD, FL AND THE WORLD PEACE PROGRAM, LLC, HOLLYWOOD, FL:
4,163,904, PUB. 4-10-2012, INT. CL. 41.
- HERRING, CECIL, DELTONA, FL:
4,163,424, PUB. 4-10-2012, INT. CL. 16.
- HERSHEY CHOCOLATE & CONFECTIONERY CORPORATION, WHEAT RIDGE, CO:
4,163,102, PUB. 4-10-2012, INT. CL. 4.
- HERTZFELDT, DON, FREMONT, CA:
2,497,667, CANC. INT. CL. 41.
- HEW-KABEL GMBH & CO. KG, 51688 WIPPERFÜRTH, FED REP GERMANY:
4,162,893, PUB. 4-10-2012, INT. CL. 9.
- HEWLETT-PACKARD COMPANY, PALO ALTO, CA:
862,308, CANC. MULTIPLE CLASS, U.S. CLS. 21, 26 AND 44.
- HEWLETT-PACKARD DEVELOPMENT COMPANY, L.P., HOUSTON, TX, COMPAQ INFORMATION TECHNOLOGIES GROUP, LP., HOUSTON, TX:
2,574,047, REN. 5-21-12, INT. CL. 42.
- HEWLETT-PACKARD DEVELOPMENT COMPANY, L.P., HOUSTON, TX:
2,594,038, REN. 5-22-12, INT. CL. 40.
- HI TECH ELECTRONICS, BROOKLYN, CA:
4,164,456, PUB. 4-10-2012, INT. CL. 9.
- HICKORY SPECIALTIES, INC., BRENTWOOD, TN:
2,619,673, REN. 5-18-12, INT. CL. 30.
- HIGH COTTON TIES LLC, CHARLOTTE, NC:
4,162,782, PUB. 7-12-2011, INT. CL. 25.
- HIJOS DE PABLO ESPARZA - BODEGAS NAVARRAS, S.A., VILLAVA/ATARRABIA, SPAIN:
4,163,606, PUB. 1-10-2012, INT. CL. 33.
- HILLEL SEGAL, INC., BOULDER, CO, DBA ORGANIMANIA, INC.:
4,093,523, CANC. IIRN, RESTORED TO S.N. 85-333,262.
- HILLHOUSE, JANE, EL GRANADA, CA, DBA FINAL FOOTPRINT, "GREENING YOUR FINAL FOOTPRINT":
4,163,156, PUB. 4-10-2012, INT. CL. 20.
- HINDA, INC., CHICAGO, IL:
2,633,178, REN. 5-23-12, INT. CL. 35.
- HIPCHAT, INC., SUNNYVALE, CA:
4,163,202, PUB. 4-10-2012, INT. CL. 9.
- HIPSTAR LLC, BROOKLYN, NY:
4,164,538, PUB. 4-10-2012, INT. CL. 25.
- HISPANIC PUBLISHING ASSOCIATES, LLC, CORAL GABLES, FL:
3,006,167, CANC. MULTIPLE CLASS, INT. CLS. 35, 36 AND 42.
- HITACHI SOLUTIONS, LTD., TOKYO, JAPAN:
4,165,041, INT. CL. 9.
- HJC CORP., YONGIN-SI, GYEONGGI-DO, REPUBLIC OF KOREA:
4,020,363, CANC. INT. CL. 9.
- HME INCORPORATED, WYOMING, MI:
4,165,593, INT. CL. 9.
- HOBBICO, INC., CHAMPAIGN, IL, DBA GREAT PLANES MODEL DISTRIBUTORS COMPANY:
1,722,179, REN. 5-19-12, INT. CL. 28.
- HOBBY LOBBY STORES, INC., OKLAHOMA CITY, OK:
4,163,901, PUB. 4-10-2012, MULTIPLE CLASS, INT. CLS. 2, 8 AND 16.
- HOFER, TIMOTHY, MANCHESTER, MO:
4,166,068, INT. CL. 9.
- HOHNER, INC., GLEN ALLEN, VA:
4,165,477, INT. CL. 15.
- HOKUSAN LTD., KOTO-KU, TOKYO, JAPAN:
2,622,203, REN. 5-23-12, INT. CL. 19.
- HOLIWELL EXECUTIVE TRAINING LLC, SEATTLE, WA:
4,165,812, INT. CL. 13.

HOLLANDIA FLOWERS, INC., SANTA BARBARA, CA,
DBA HOLLANDIA PRODUCE:
2,569,851. REN. 5-21-12. INT. CL. 31.

HOLLER, INC., SAN FRANCISCO, CA:
4,164,179. PUB. 4-10-2012. INT. CL. 9.

HOLMBERG, TRISTA J, FREDERICKSBURG, VA:
4,165,230. INT. CL. 14.

HOLMES, CHARLES, ROXIE, MS:
4,165,043. INT. CL. 28.

HOLTEC INTERNATIONAL, MARLTON, NJ:
4,163,140. PUB. 4-10-2012. MULTIPLE CLASS, INT. CLS.
6, 11 AND 42.

HOLZHAUSEN PTY LTD AS TRUSTEE FOR VONLIFE
TRUST, MELBOURNE, AUSTRALIA:
4,162,877. PUB. 4-10-2012. INT. CL. 36.

HOME BOX OFFICE, INC., NEW YORK, NY:
2,498,003. CANC. INT. CL. 41.
4,165,652. INT. CL. 41.

HOME BREW MART, INC., SAN DIEGO, CA:
4,165,046. INT. CL. 35.

HOME MARKET FOODS, INC., NORWOOD, MA:
4,164,859. INT. CL. 29.

HOMETOWN BANCORP, INC., KENT, OH:
4,165,752. INT. CL. 36.

HOMETOWNE TELEVISION, INC., SUMMIT, NJ:
4,163,428. PUB. 4-10-2012. INT. CL. 38.

HONEYMOON PIXIE, LLC, WOODINVILLE, WA, DBA
HONEYMOONPIXIE.COM:
4,164,474. PUB. 4-10-2012. INT. CL. 35.

HOO COME CORP, CITY OF INDUSTRY, CA:
1,733,355. REN. 5-21-12. INT. CL. 29.

HOOPER, JOSHUA P., HONOLULU, HI AND HOOPER,
NIKOLAYA S., HONOLULU, HI AND JACKSON, THO-
MAS E., HONOLULU, HI AND JACKSON, ASTRID I.,
HONOLULU, HI:
4,165,232. INT. CL. 28.

HOPE MICHELLE HOLMAN, SUFFOLK, VA:
4,165,488. INT. CL. 16.

HOPE, EMMA, LONDON W11 1RQ, UNITED KINGDOM:
3,005,352. CANC. MULTIPLE CLASS, INT. CLS. 3, 14, 18
AND 25.

HORIZON GROUP USA, INC., WARREN, NJ:
4,163,355. PUB. 4-10-2012. MULTIPLE CLASS, INT. CLS.
18 AND 25.

HORIZON KINETICS LLC, NEW YORK, NY:
4,163,723. PUB. 4-10-2012. INT. CL. 36.

HORMEL FOODS, LLC, AUSTIN, MN:
2,596,615. REN. 5-19-12. INT. CL. 29.

HORN, SUSAN, WEST LINN, OR:
4,163,415. PUB. 4-10-2012. INT. CL. 35.
4,163,527. PUB. 4-10-2012. INT. CL. 35.

HORSEHEAD ACQUISITION CORP., BOCA RATON, FL:
762,562. CANC. U.S. CL. 6.

HORSETRAIL, INC., PLANTATION, FL:
4,163,505. PUB. 4-10-2012. INT. CL. 43.

HOSHIZAKI ELECTRIC CO., LTD., TOYOAKE-SHI, AICHI,
JAPAN:
1,230,979. REN. 5-19-12. INT. CL. 11.

HOSOO CO., LTD., KYOTO, JAPAN:
4,162,984. PUB. 4-10-2012. INT. CL. 24.

HOSPICE OF EL PASO, INC., EL PASO, TX:
4,163,441. PUB. 4-10-2012. INT. CL. 44.

HOSPITALITY 3, LLC, NEW HAVEN, CT:
4,164,429. PUB. 4-10-2012. INT. CL. 43.
4,164,433. PUB. 4-10-2012. INT. CL. 43.

HOUGHTON MIFFLIN HARCOURT PUBLISHING COM-
PANY, BOSTON, MA:
1,691,439. REN. 5-18-12. INT. CL. 16.

HOUSEWARES INTERNATIONAL, INC., CITY OF COM-
MERCE, CA:
2,569,441. REN. 5-19-12. INT. CL. 21.

HOWARD BERGER CO., INC., CRANBURY, NJ:
2,497,764. CANC. MULTIPLE CLASS, INT. CLS. 8, 16
AND 21.

HOWMEDICA OSTEONICS CORP., MAHWAL, NJ, PFIZER
HOSPITAL PRODUCTS GROUP, INC., NEW YORK, NY:
1,767,983. REN. 5-24-12. INT. CL. 10.

HP HOOD LLC, LYNNFIELD, MA:
4,164,721. PUB. 4-10-2012. INT. CL. 30.
4,164,774. PUB. 4-10-2012. INT. CL. 32.

HS TM, LLC, NEWARK, DE:
4,164,381. PUB. 4-10-2012. INT. CL. 10.

HSY SYSTEME FÜR PROZESS-IT GMBH, FED REP GER-
MANY:
4,162,868. PUB. 4-10-2012. MULTIPLE CLASS, INT. CLS.
6, 7, 9 AND 42.

HUBBELL INCORPORATED, SHELTON, CT:
2,578,996. REN. 5-22-12. INT. CL. 9.

HUCK PATENTS, INC., WILMINGTON, DE, FAIRCHILD
HOLDING CORP., DULLES, VA:
2,505,728. REN. 5-21-12. INT. CL. 6.

HUMPHREYS' H & H LURE COMPANY, INC, BATON
ROUGE, LA:
4,164,550. PUB. 4-10-2012. INT. CL. 28.

HUNTER DOUGLAS INC., PEARL RIVER, NY:
2,497,802. CANC. INT. CL. 20.

HUNTER, CHIP, HOLBROOK, NY:
4,164,021. PUB. 4-10-2012. INT. CL. 19.

HUNTSMAN ADVANCED MATERIALS (SWITZERLAND)
GMBH, BASEL, SWITZERLAND:
4,165,914. INT. CL. 2.

HUNTSMAN INTERNATIONAL LLC, A DELAWARE COR-
PORATION, SALT LAKE CITY, UT:
4,162,851. PUB. 4-10-2012. MULTIPLE CLASS, INT. CLS.
1, 17 AND 19.

HURON VALLEY FINANCIAL, INC., ANN ARBOR, MI:
4,164,508. PUB. 4-10-2012. INT. CL. 36.
4,164,516. PUB. 4-10-2012. INT. CL. 36.

HUSQVARNA AB, STOCKHOLM, SWEDEN:
2,499,174. CANC. INT. CL. 12.

HUSQVARNA AKTIEBOLAG, SE-561 82 HUSKVARNA,
SWEDEN:
2,498,486. CANC. MULTIPLE CLASS, INT. CLS. 7 AND 8.

HUSQVARNA HOLDING AB, HUSKVARNA, SWEDEN:
1,694,018. REN. 5-18-12. MULTIPLE CLASS, INT. CLS. 7
AND 12.

HUTCHINGS, LEROI E., CRYSTAL LAKE, IL:
4,165,627. INT. CL. 28.

HUTZLER MANUFACTURING COMPANY, INC., CA-
NAAN, CT:
2,671,231. REN. 5-21-12. INT. CL. 21.

HWA FONG RUBBER (USA), INC., COVINGTON, GA, DBA
DURO TIRE & WHEEL:
4,165,494. INT. CL. 12.

HWB, L.L.C., FAIRFAX, IA:
4,165,108. INT. CL. 21.

HYATT CORPORATION, CHICAGO, IL:
1,688,521. REN. 5-23-12. INT. CL. 42.

HYDE TOOLS, INC., SOUTHBRIDGE, MA:
2,578,211. REN. 5-24-12. INT. CL. 8.

HYDROFARM, INC., PETALUMA, CA:
2,668,273. REN. 5-18-12. INT. CL. 11.

HYDROFLO CORPORATION, PLUMSTEADVILLE, PA:
1,271,518. CANC. MULTIPLE CLASS, INT. CLS. 7 AND 9.

HYLAND SOFTWARE, INC., WESTLAKE, OH:
4,165,566. INT. CL. 42.

HYPERTHERM, INC., HANOVER, NH:
2,568,105. REN. 5-19-12. INT. CL. 9.
2,568,106. REN. 5-19-12. INT. CL. 9.

HYPNOTIC HATS, LTD., NEW YORK, NY:
2,604,997. REN. 5-18-12. INT. CL. 25.

I C D C, INC., SALT LAKE CITY, UT, DBA DEXTERITY
HAIR DESIGN:
4,165,931. INT. CL. 44.

I LIFE WITH PURPOSE LLC, BOSTON, MA, DBA IPUR-
POSE:
4,165,864. MULTIPLE CLASS, INT. CLS. 35 AND 42.

I.C.E.D. MANAGEMENT, INC., CYPRESS, TX:
4,163,293. PUB. 4-10-2012. INT. CL. 35.

I.F.I. S.R.L. INIZIATIVE FIERISTICHE INTERNAZIONALI,
BOLOGNA, ITALY:
3,006,348. CANC. INT. CL. 35.

I.S.T. ITALIA SISTEMI TECNOLOGICI S.R.L., MODENA,
ITALY:
4,163,366. PUB. 4-10-2012. INT. CL. 7.

- IAM ENTERPRISING CORP., CHESAPEAKE, VA, DBA KEYSTONE CERTIFICATION:
4,165,070, INT. CL. 42.
- IBATTZ PRIVATE LIMITED, SINGAPORE, SINGAPORE:
4,165,390, INT. CL. 9.
- IBRAHIM, ZAFAR Y., LAKEWOOD, WA:
2,498,986, CANC. INT. CL. 16.
- ICL PERFORMANCE PRODUCTS LP, ST. LOUIS, MO, MONSANTO COMPANY, ST. LOUIS, MO:
934,272. REN. 5-23-12. U.S. CL. 46 (INT. CL. 1).
- ICON IDENTITY SOLUTIONS, INC., ELK GROVE VILLAGE, IL:
2,498,099, CANC. MULTIPLE CLASS, INT. CLS. 37, 40 AND 42.
- ICONNEWMEDIA, INC., HENDERSON, NV:
4,163,316, PUB. 3-6-2012. INT. CL. 41.
- IDDEA CALIFORNIA, LLC, BREA, CA:
4,166,059, INT. CL. 12.
- IDEA BOX SA, SWITZERLAND:
4,162,900, PUB. 4-10-2012. MULTIPLE CLASS, INT. CLS. 3, 18 AND 25.
4,162,901, PUB. 4-10-2012. MULTIPLE CLASS, INT. CLS. 3, 18 AND 25.
- IDEAL HOME LOANS, LLC, ENGLEWOOD, CO:
4,164,577, PUB. 4-10-2012. INT. CL. 36.
- IDEAL INDUSTRIES, INC., SYCAMORE, IL:
734,799. REN. 5-19-12. U.S. CL. 15 (INT. CL. 4).
- IDEMITSU KOSAN CO.,LTD, CHIYODA-KU, TOKYO, JAPAN:
3,091,814, CANC. INT. CL. 9.
- IDEX CORPORATION, LAKE FOREST, IL:
4,163,315, PUB. 4-10-2012. INT. CL. 17.
- IFP ENERGIES NOUVELLES, RUEIL-MALMAISON, CEDEX, FRANCE:
2,568,938. REN. 5-21-12. MULTIPLE CLASS, INT. CLS. 40 AND 42.
- IGLOO PRODUCTS CORP., KATY, TX:
4,165,606, INT. CL. 21.
- IGT, RENO, NV:
4,165,174, INT. CL. 9.
4,165,186, INT. CL. 9.
4,165,871, INT. CL. 9.
- IKAN MINISTRIES, EDMOND, OK:
4,164,087, PUB. 4-10-2012. INT. CL. 9.
- IKEGOSHI AKIHIRO, JAPAN:
2,998,375.
- IKORPE CHEMICALS LTD., TORONTO, ONTARIO, CANADA:
4,164,235, PUB. 4-10-2012. INT. CL. 3.
- ILANN PEREZ, FRANCE:
4,162,897, PUB. 4-10-2012. INT. CL. 25.
- ILLINOIS TOOL WORKS INC., GLENVIEW, IL:
731,368. REN. 5-19-12. U.S. CL. 13 (INT. CL. 6).
4,163,338, PUB. 4-10-2012. INT. CL. 12.
4,165,324, INT. CL. 6.
- ILLVA SARONNO S.P.A., SARONNO, ITALY, S.P.A. I.L.L.V.A. INDUSTRIA LOMBARDA LIQUORI VINI AFFINI, SARONNO,VARESE, ITALY:
936,879. REN. 5-22-12. U.S. CL. 49 (INT. CL. 33).
- ILUNA GROUP S.P.A., BERGAMO, ITALY:
3,189,661.
- IMAGE HOUSE, INC., CINCINNATI, OH:
4,164,345, PUB. 4-10-2012. INT. CL. 44.
- IMAGEMOVERS, L.L.C., BEVERLY HILLS, CA:
2,498,560, CANC. INT. CL. 41.
- IMALIVE LLC, CENTREVILLE, MD:
4,164,408, PUB. 4-10-2012. INT. CL. 45.
- IMALLIN CORPORATION, JERSEY CITY, NJ:
4,165,695, INT. CL. 43.
- IMG MEDIA LIMITED, UNITED KINGDOM:
4,162,963, PUB. 4-10-2012. MULTIPLE CLASS, INT. CLS. 38, 41 AND 45.
- IMI PLC, BIRMINGHAM, UNITED KINGDOM:
4,165,398, INT. CL. 41.
- IMMUNOGENETIX THERAPEUTICS, INC., LENEXA, KS:
4,164,844, INT. CL. 5.
- IMPACT SELECTOR, INC., HEATH, TX:
4,165,099, MULTIPLE CLASS, INT. CLS. 37 AND 41.
- IMPAX, SAN FRANCISCO, CA:
2,498,196, CANC. INT. CL. 25.
- IMPERIA & MONFERRINA S.P.A., ITALY:
3,055,704.
- IMPULSIVE ENTERPRISES LTD., GRAND CAYMAN, CAYMAN ISLANDS:
4,164,294, PUB. 4-10-2012. INT. CL. 35.
4,164,304, PUB. 4-10-2012. INT. CL. 37.
4,164,309, PUB. 4-10-2012. INT. CL. 39.
4,164,327, PUB. 4-10-2012. INT. CL. 43.
- IN HOME TECH SOLUTIONS INC., PLYMOUTH, MN:
4,163,510, PUB. 4-10-2012. INT. CL. 37.
- INC INTERNATIONAL COMPANY, KENNETT SQUARE, PA:
4,163,341, PUB. 4-10-2012. INT. CL. 25.
4,165,742, INT. CL. 28.
- INCLUSIV NATURALS LIMITED, AUCKLAND, NEW ZEALAND:
4,163,589, PUB. 4-10-2012. MULTIPLE CLASS, INT. CLS. 3, 5 AND 35.
- INCREDIBLE TECHNOLOGIES, INC., ARLINGTON HEIGHTS, IL:
2,497,784, CANC. INT. CL. 41.
- INDA, ASSOCIATION OF THE NONWOVEN FABRICS INDUSTRY, CARY, NC:
4,165,906, INT. CL. 35.
- INDAR, 95880 ENGHUEN-LES-BAINS, FRANCE:
858,439, CANC. U.S. CL. 46.
- INDIANA ARTS COMMISSION, INDIANAPOLIS, IN:
2,589,121. REN. 5-18-12. INT. CL. 41.
- INDSPIRE LLC, HOUSTON, TX, DBA PERSOURCE:
4,163,725, PUB. 4-10-2012. INT. CL. 9.
- INDUSTRIAL INFORMATION RESOURCES, INC., SUGAR LAND, TX:
4,162,706, PUB. 4-10-2012. INT. CL. 42.
- INDUSTRIAL LABOR AND EQUIPMENT SERVICES, LLC, MARRERO, LA:
4,165,418, INT. CL. 1.
- INDUSTRIAL RAW MATERIALS CORP., NEW YORK, NY:
503,092, CANC. U.S. CL. 15.
- INDUSTRIAL STRENGTH SOFTWARE COMPANY, POLAR GROVE, IL:
1,688,308. REN. 5-23-12. INT. CL. 9.
- INFACE COMPANY A/S, DENMARK:
3,005,307, CANC. INT. CL. 9.
- INFANTINO, LLC, SAN DIEGO, CA:
4,165,852, INT. CL. 18.
- INFINIT SOFTWARE SOLUTIONS, INC., FAIRFAX, VA:
4,164,421, PUB. 4-10-2012. INT. CL. 42.
- INFORMATIONAL DATA TECHNOLOGIES, LLC, WATERTOWN, SD:
4,165,975, INT. CL. 9.
- INFORMED FAMILIES, MIAMI, FL:
4,163,372, PUB. 4-10-2012. INT. CL. 35.
- INFOTERIA CORPORATION, TOKYO 140-0011, JAPAN:
2,570,761. REN. 5-21-12. INT. CL. 9.
- INFRARED RESOURCES,LLC, PORTLAND, OR:
4,163,817, PUB. 3-6-2012. INT. CL. 9.
- INGERSOLL-RAND COMPANY, PISCATAWAY, NJ:
2,570,381. REN. 5-18-12. INT. CL. 7.
- INGRAM ENTERPRISES, INC., SPRINGFIELD, MO:
1,768,029. REN. 5-18-12. INT. CL. 13.
- INISOFT LIMITED, EDINBURGH, SCOTLAND, UNITED KINGDOM:
2,580,673. REN. 5-21-12. MULTIPLE CLASS, INT. CLS. 9, 16, 35 AND 42.
- INITIALS, CLARKESVILLE, GA:
4,163,799, PUB. 4-10-2012. INT. CL. 18.
- INJURY SCIENCES LLC, SAN ANTONIO, TX:
4,164,620, PUB. 4-10-2012. INT. CL. 9.
- INMON CORP., SAN FRANCISCO, CA:
2,705,216. REN. 5-19-12. INT. CL. 9.
- INMUSIC, LLC, FT. LAUDERDALE, FL:
4,164,557, PUB. 4-10-2012. INT. CL. 35.
- INNERTHRIVE, LLC, MINDEN, NV:
4,166,018, INT. CL. 5.
- INNOPLUS CO., LTD., SEOUL, REPUBLIC OF KOREA:
3,006,198, CANC. INT. CL. 9.

- INNOVAR SYSTEMS LIMITED, NORTH JACKSON, OH:
4,164,391, PUB. 4-10-2012. INT. CL. 9.
- INNOVATION GLOBAL NETWORK, LLC, RANDOLPH, NJ:
4,164,987, INT. CL. 35.
4,164,993, INT. CL. 35.
- INNOVATION STONES LTD., COQUITLAM, B.C., CANADA:
4,163,064, PUB. 4-10-2012. INT. CL. 19.
- INNOVATIVE TIMING SYSTEMS, LLC, ST. LOUIS, MO:
4,165,530, INT. CL. 9.
- INSOURCE SOFTWARE SOLUTIONS, INC., RICHMOND, VA:
3,250,187, COR. MULTIPLE CLASS, INT. CLS. 35 AND 42.
- INSPIRAGE, LLC, MALVERN, PA:
4,164,160, PUB. 4-10-2012. MULTIPLE CLASS, INT. CLS. 35 AND 42.
- INSPIRE FOUNDATION, BALMAIN NSW, AUSTRALIA:
4,164,884, INT. CL. 42.
- INSPIRED GOURMET FOODS INC., TORONTO, ONTARIO, CANADA:
4,084,551, COR. INT. CL. 30.
- INSTA-GATOR CHOPPERS, LLC, LONGWOOD, FL:
4,164,634, PUB. 4-10-2012. MULTIPLE CLASS, INT. CLS. 35 AND 37.
- INSTAKNOW.COM, INC., EDISON, NJ, DBA INSTAKNOW, INC.:
2,576,555, REN. 5-24-12. INT. CL. 9.
2,576,556, REN. 5-24-12. INT. CL. 9.
2,589,230, REN. 5-24-12. INT. CL. 9.
- INSULATION DISTRIBUTORS, INC., CHANHASSEN, MN:
4,166,060, INT. CL. 35.
- INSURMARK, INC., HOUSTON, TX:
2,652,888, REN. 5-21-12. INT. CL. 36.
- INTEGA LIFESCENCES CORPORATION, PLAINSBORO, NJ, INTEGA LIFESCENCES CORPORATION, PLAINSBORO, NJ:
2,635,696, REN. 5-19-12. INT. CL. 5.
- INTEGRATED CHINESE MEDICINE HOLDINGS, LTD., TSIM SHA TSUI EAST, HONG KONG:
2,640,865, REN. 5-23-12. INT. CL. 5.
- INTEGRATED RESEARCH LTD, NORTH SYDNEY NSW 2059, AUSTRALIA, INTEGRATED RESEARCH PTY. LIMITED, NORTH SYDNEY, NSW 2059, AUSTRALIA:
1,725,503, REN. 5-24-12. INT. CL. 16.
- INTEGRATED RESEARCH LTD, NORTH SYDNEY NSW 1059, AUSTRALIA, INTEGRATED RESEARCH PTY. LIMITED, NORTH SYDNEY NSW 2059, AUSTRALIA:
1,726,436, REN. 5-22-12. INT. CL. 42.
- INTEGRES GLOBAL LOGISTICS, INC., GOLD RIVER, CA:
2,983,093, CANC. INT. CL. 42.
- INTEL CORPORATION, SANTA CLARA, CA:
2,497,572, CANC. INT. CL. 9.
4,163,639, PUB. 4-10-2012. INT. CL. 9.
- INTELSTAF HEALTHCARE, INC., BOCA RATON, FL:
2,498,122, CANC. INT. CL. 35.
- INTELLAMED, INC., BRYAN, TX:
2,498,345, CANC. INT. CL. 35.
- INTELLIDYNE, L.L.C., FALLS CHURCH, VA:
2,894,112, AM. INT. CL. 42.
- INTELLIGENT SOFTWARE SOLUTIONS, INC., COLORADO SPRINGS, CO:
4,165,079, INT. CL. 9.
- INTELLISHARE, LLC, CHICAGO, IL:
2,578,430, REN. 5-24-12. INT. CL. 42.
- INTELPROPLIST LLC, MACEDON, NY:
1,690,800, REN. 5-23-12. INT. CL. 16.
1,690,816, REN. 5-23-12. INT. CL. 20.
- INTERCONTINENTAL ART, INC., COMPTON, CA:
3,005,301, CANC. INT. CL. 16.
- INTERCONTINENTAL COFFEE SERVICE, INC., ROSEMONT, IL:
859,463, CANC. U.S. CL. 100.
- INTERFACE, INC., ATLANTA, GA:
1,693,203, REN. 5-20-12. INT. CL. 27.
- INTERMAS NETS, S.A., 08450-LLINARS DEL VALLES (BARCELONA), SPAIN:
2,578,694, REN. 5-21-12. MULTIPLE CLASS, INT. CLS. 16 AND 22.
- INTERNATIONAL AUTOMOTIVE COMPONENTS GROUP NORTH AMERICA, INC., DEARBORN, MI:
4,165,002, INT. CL. 27.
- INTERNATIONAL BATTERY, INC., ALLENTOWN, PA:
4,164,314, PUB. 4-10-2012. INT. CL. 9.
4,164,316, PUB. 4-10-2012. INT. CL. 9.
- INTERNATIONAL FOUNDATION FOR ELECTORAL SYSTEMS, WASHINGTON, DC:
3,190,417, CANC. INT. CL. 16.
- INTERNATIONAL FRANCHISE INC., MARKHAM, ONTARIO, CANADA, SWENSEN'S ICE CREAM COMPANY, PHOENIX, AZ:
1,195,835, REN. 5-18-12. MULTIPLE CLASS, INT. CLS. 30, 35 AND 42.
- INTERNATIONAL HARVESTER COMPANY, CHICAGO, IL TO CASE CORPORATION, RACINE, WI:
1,163,061, CANC. INT. CL. 37.
- INTERNATIONAL HUNTER EDUCATION ASSOCIATION, FEDERAL HEIGHTS, CO:
4,163,804, PUB. 4-10-2012. INT. CL. 41.
- INTERNATIONAL MUSEUM OF PHOTOGRAPHY AT GEORGE EASTMAN HOUSE, ROCHESTER, NY, GEORGE EASTMAN HOUSE, INC., ROCHESTER, NY:
567,779, REN. 5-23-12. U.S. CL. 38 (INT. CL. 16).
- INTERNATIONAL NUTRITION, INC., OMAHA, NE:
4,163,308, PUB. 4-10-2012. MULTIPLE CLASS, INT. CLS. 5 AND 31.
- INTERNATIONAL PAPER COMPANY, STAMFORD, CT:
860,111, CANC. U.S. CL. 37.
- INTERNATIONAL PAPER COMPANY, MEMPHIS, TN:
4,163,458, PUB. 4-10-2012. INT. CL. 35.
- INTERNATIONAL PET AND ANIMAL TRANSPORTATION ASSOCIATION, HOLLY LAKE RANCH, TX:
4,163,866, PUB. 4-10-2012. INT. CL. 35.
- INTERNATIONAL PLASTICS, INC., MIAMI, FL:
864,387, CANC. U.S. CL. 106.
- INTERNATIONAL RISK MANAGEMENT INSTITUTE, INC., DALLAS, TX:
1,760,382, REN. 5-22-12. INT. CL. 41.
- INTERNATIONAL ROAD DYNAMICS, INC., SASKATOON, SASKATCHEWAN, CANADA:
4,130,084, COR. MULTIPLE CLASS, INT. CLS. 9 AND 42.
- INTERNATIONAL TRADEMARKS S.A., LUXEMBOURG:
4,162,951, PUB. 4-10-2012. INT. CL. 3.
- INTERNET COMMERCE CITY CORPORATION, WILLOW STREET, PA:
2,654,645, REN. 5-24-12. INT. CL. 35.
- INTERNETFITNESS.COM, INC., MOUNT LAUREL, NJ:
2,497,721, CANC. INT. CL. 35.
- INTERSTATE BAKERIES CORPORATION, KANSAS CITY, MO:
862,090, CANC. U.S. CL. 46.
- INTERTEK TESTING SERVICES NA INC., OAK BROOK, IL:
4,164,952, MULTIPLE CLASS, INT. CLS. 42 AND 45.
- INTEX DIY, INC., VILLA RICA, GA, AKA INTEX SUPPLY:
4,164,970, INT. CL. 21.
- INTIMIDATION CLOTHING, LLC, ROAMING SHORES, OH:
4,162,771, PUB. 4-10-2012. INT. CL. 25.
- INTOWN SUITES MANAGEMENT, INC., ATLANTA, GA:
2,624,085, REN. 5-21-12. INT. CL. 42.
- INTRUST FINANCIAL CORPORATION, WICHITA, KS:
2,580,214, REN. 5-23-12. INT. CL. 36.
- INTUIT INC., MOUNTAIN VIEW, CA:
2,572,710, REN. 5-18-12. INT. CL. 16.
4,165,052, INT. CL. 42.
- INVENTIV MEDICAL MANAGEMENT LLC, AUGUSTA, GA:
4,163,295, PUB. 4-10-2012. INT. CL. 35.
- INVERSIONES TRIUNVIRATO S.A., SANTIAGO, CHILE:
4,164,809, MULTIPLE CLASS, INT. CLS. 3, 12 AND 35.
- INVIDIATA, SHAE, OAKVILLE, CANADA:
4,165,095, INT. CL. 41.
- INVOICE CLOUD, INC., BRAINTREE, VA:
4,166,013, MULTIPLE CLASS, INT. CLS. 35 AND 36.
- INXIGHT SOFTWARE, INC., SUNNYVALE, CA:
2,497,567, CANC. INT. CL. 9.

- IN2WIT, LLC, KINGSPORT, TN:
4,164,823, MULTIPLE CLASS, INT. CLS. 9, 16, 35, 41 AND 42.
- IOANNIS LAZARIDIS, BELTSVILLE, MD:
4,164,109, PUB. 4-10-2012. INT. CL. 43.
- IPADS.COM, INC., SEATTLE, WA:
2,962,735, CANC. INT. CL. 16.
2,962,736, CANC. INT. CL. 16.
- IPANEMA TECHNOLOGIES, F-92260 FONTENAY AUX ROSES, FRANCE:
4,162,835, PUB. 4-10-2012. MULTIPLE CLASS, INT. CLS. 9 AND 38.
- IPAYMENT, INC., NASHVILLE, TN:
4,165,785, INT. CL. 42.
- IPS CORPORATION, GARDENA, CA:
2,581,432, REN. 5-21-12. INT. CL. 11.
- IRA HOROWITZ, SHERMAN OAKS, CA:
4,165,353, INT. CL. 38.
- IRIS GROUP, INC., CARLSBAD, CA, DBA MODERN POST-CARD:
4,165,962, INT. CL. 41.
- IRIS MEDIA INC., EUGENE, OR, DBA IRIS EDUCATIONAL MEDIA:
4,164,591, PUB. 4-10-2012. MULTIPLE CLASS, INT. CLS. 9, 16, 35, 38, 41 AND 42.
- IRON FIST INTERNATIONAL, INC., LOS ANGELES, CA:
4,165,394, INT. CL. 18.
- ISH INTERNATIONAL SPORT HOLDING AG, SWITZERLAND:
4,075,735, COR. INT. CL. 12.
- ISLE OF CAPRI CASINOS, INC., ST. LOUIS, MO:
2,580,176, REN. 5-18-12. INT. CL. 42.
- ISYS TECHNOLOGIES, INC., SALT LAKE CITY, UT:
4,165,311, INT. CL. 9.
- IT'S GIRL STUFF, TROPHY CLUB, TX:
4,164,580, PUB. 4-10-2012. INT. CL. 24.
- ITHACA GUN COMPANY, UPPER SANDUSKY, OH:
862,249, CANC. U.S. CL. 9.
- ITM BIKE COMPONENTS S.R.L., ITALY:
4,163,036, PUB. 4-10-2012. INT. CL. 12.
- IVALO LIGHTING INC., COOPERSBURG, PA:
4,165,764, INT. CL. 11.
- IWATA, NAOMI, TOKYO, JAPAN:
3,006,125, CANC. MULTIPLE CLASS, INT. CLS. 9 AND 16.
- J O HAMBRO CAPITAL MANAGEMENT LIMITED, UNITED KINGDOM:
4,162,999, PUB. 4-10-2012. MULTIPLE CLASS, INT. CLS. 9, 16, 35, 36 AND 41.
- J. & P. COATS, LIMITED, GLASGOW, SCOTLAND:
4,164,266, PUB. 4-10-2012. MULTIPLE CLASS, INT. CLS. 8, 23 AND 26.
- J. R. CARLSON LABORATORIES, INC., ARLINGTON HEIGHTS, IL:
2,693,276, REN. 5-18-12. INT. CL. 5.
- J. RETTENMAIER & SOHNE GMBH & CO. KG, ROSENBERG, GERMAN DEM REP, EDWARD MENDELL CO., INC., CARMEL, NY:
1,207,700, REN. 5-18-12. INT. CL. 1.
- J. SAFRA IP HOLDING CO., SOCIÉTÉ DE DROIT LUXEMBOURGEOIS, LUXEMBOURG:
4,162,881, PUB. 4-10-2012. INT. CL. 35.
- J. SCHNEIDER POWER SUPPLIES, INC., DENVER, CO:
4,165,434, INT. CL. 9.
- J.J.B. HILLIARD, W.L. LYONS, LLC, LOUISVILLE, KY, DBA HILLIARD LYONS:
4,164,496, PUB. 4-10-2012. MULTIPLE CLASS, INT. CLS. 35 AND 36.
- J.S. JOHNSON, LTD., COLUMBUS, OH:
4,165,559, INT. CL. 14.
- J&M INDUSTRIES, INC., PONCHATOULA, LA, CAJUN BAG & SUPPLY COMPANY, CROWLEY, LA:
1,733,395, REN. 5-23-12. INT. CL. 30.
- JACK BROWN PRODUCE, INC., SPARTA, MI:
726,326, REN. 5-19-12. U.S. CL. 46 (INT. CL. 31).
- JACK ECKERD CORPORATION, CLEARWATER, FL:
857,787, CANC. MULTIPLE CLASS, U.S. CLS. 13 AND 35.
- JACK HENRY SOFTWARE/COMMLINK, L.P., MONETT, MO:
2,609,548, REN. 5-24-12. INT. CL. 9.
- JACK RUSSELL TERRIER CLUB OF AMERICA, INC., THE, TIMONIUM, MD:
2,506,536, REN. 5-19-12. INT. CL. 16.
- JACKSON BASEBALL CLUB, L.P., JACKSON, TN:
4,165,157, INT. CL. 16.
4,165,158, INT. CL. 41.
- JACKSON, FREDDIE, GARLAND, TX, DBA TRIPLE D JAMZ:
4,164,772, PUB. 4-10-2012. INT. CL. 41.
- JACQUES VERT PLC, LONDON N1 8AF, UNITED KINGDOM:
4,162,850, PUB. 4-10-2012. MULTIPLE CLASS, INT. CLS. 14, 18, 25 AND 35.
- JAGADGURU KRIPALUJI YOG, PLANO, TX:
4,163,151, PUB. 4-10-2012. MULTIPLE CLASS, INT. CLS. 36, 41 AND 45.
- JAIL LIFE GREETING CARDS LLC, COLORADO SPRINGS, CO:
4,165,537, INT. CL. 16.
- JAL COFFEE, LLC, GAITHERSBURG, NY, DBA SANTA LUCIA ESTATE COFFEE:
4,163,903, PUB. 4-10-2012. INT. CL. 30.
- JAMES N O'CONNOR PTY LTD, AUSTRALIA:
4,163,025, PUB. 4-10-2012. MULTIPLE CLASS, INT. CLS. 9, 28 AND 41.
- JAMESTOWN CHEMICAL COMPANY, INC., WEST HAVEN, CT:
1,728,762, REN. 5-21-12. INT. CL. 1.
- JAMU ASIAN SPA RITUALS, INC., WHITEFISH, MT:
2,499,209, CANC. INT. CL. 42.
- JAMZ AMERICAN SPIRIT CONNECTION, INC., MODESTO, CA, DBA JAMZ:
2,674,870, REN. 5-24-12. INT. CL. 41.
- JAN DE KESEL, MONACO:
4,163,007, PUB. 4-10-2012. MULTIPLE CLASS, INT. CLS. 9, 35 AND 42.
- JANET E. BROWN, MILTON, FL:
4,164,490, PUB. 4-10-2012. INT. CL. 10.
- JANKOVIC LLC, DENVER, CO:
4,164,464, PUB. 4-10-2012. INT. CL. 35.
- JAPAN TOBACCO INC., MINATO-KU, TOKYO 105, JAPAN:
1,697,069, REN. 5-22-12. INT. CL. 34.
- JAPONESQUE, INC., SAN FRANCISCO, CA:
1,766,384, REN. 5-21-12. INT. CL. 42.
- JARKEZIAN, HRATCH ROGER, SEASIDE HEIGHTS, NJ:
4,162,773, PUB. 4-10-2012. INT. CL. 25.
- JARROW FORMULAS, INC., LOS ANGELES, CA:
2,582,460, REN. 5-18-12. INT. CL. 5.
- JARVIS PRODUCTS CORPORATION, MIDDLETOWN, CT:
1,701,428, REN. 5-21-12. INT. CL. 7.
- JASPER STATE BRAND, INC., BEVERLY HILLS, CA:
4,165,065, INT. CL. 16.
- JAVA CITY, SACRAMENTO, CA:
2,623,576, REN. 5-23-12. INT. CL. 30.
2,630,403, REN. 5-22-12. INT. CL. 42.
- JAVA CITY, INC., SACRAMENTO, CA:
3,013,864, CANC. INT. CL. 32.
- JAX LTD., INC., PLYMOUTH, MN:
2,567,270, REN. 5-18-12. INT. CL. 28.
- JAZZ AT LINCOLN CENTER, INC., NEW YORK, NY:
4,164,436, PUB. 4-10-2012. INT. CL. 9.
- JB LINE, INC, CORONA, CA, DBA JB COSMETICS:
4,163,483, PUB. 4-10-2012. INT. CL. 3.
- JC PUBLISHING, INC., PORTLAND, OR:
4,164,587, PUB. 4-10-2012. INT. CL. 16.
- JCES MANAGEMENT LLC, NEW YORK, NY:
4,165,729, MULTIPLE CLASS, INT. CLS. 41 AND 43.
- JEAN LIN, NORTHBORO, MA, DBA OTTO ARCHITECTURE AND DESIGN:
4,164,038, PUB. 4-10-2012. INT. CL. 35.
- JEANMARIE CREATIONS, LLC, TULSA, OK:
1,662,960, CANC. INT. CL. 16.
- JEANNIE DEVA ENTERPRISES, INC., SUNLAND, CA:
2,581,103, REN. 5-19-12. INT. CL. 41.
2,617,948, REN. 5-19-12. MULTIPLE CLASS, INT. CLS. 9

AND 41.
JEFFERY, INC., MIAMI BEACH, FL:
4,166,039, INT. CL. 41.
JEFFREY DOORNBOS, BURR RIDGE, IL, DBA BAD ROMANCE:
4,165,091, INT. CL. 25.
JEFFREY FLEISCHMAN, MORGANVILLE, NJ:
4,163,818, PUB. 4-10-2012. MULTIPLE CLASS, INT. CLS. 35 AND 42.
JELMAR LLC, SKOKIE, IL:
2,498,977, CANC. INT. CL. 35.
JENKINS, DARNELL A., LOS ANGELES, CA, DBA FLESH N BLOOD:
2,570,230. REN. 5-18-12. MULTIPLE CLASS, INT. CLS. 9 AND 41.
JENSEN ENTERPRISES, SPARKS, NV:
4,165,421, INT. CL. 6.
JEPICO CORPORATION, SHINJUKU-KU, TOKYO 163-0729, JAPAN:
3,063,864.
JEREMY PTY LTD, AUSTRALIA:
4,162,846, PUB. 1-3-2012. MULTIPLE CLASS, INT. CLS. 9, 16, 18, 25, 27, 28 AND 35.
JERK'NPICKLE, BELMONT, CA:
4,163,620, PUB. 4-10-2012. INT. CL. 29.
JESSE'S TOY BOX, LLC, GOWANDA, NY:
4,164,366, PUB. 4-10-2012. INT. CL. 28.
JESSICA MORENO, BOCA RATON, FL:
4,163,935, PUB. 4-10-2012. INT. CL. 45.
JET AVIATION INTERNATIONAL, INC., WEST PALM BEACH, FL:
4,163,279, PUB. 4-10-2012. MULTIPLE CLASS, INT. CLS. 35, 36, 37, 39 AND 42.
4,163,280, PUB. 4-10-2012. MULTIPLE CLASS, INT. CLS. 35, 36, 37, 39 AND 42.
JET'S AMERICA, INC., STERLING HEIGHTS, MI:
4,164,378, PUB. 4-10-2012. INT. CL. 30.
JETBRAINS S.R.O., PRAGUE 4, 147 00, CZECH REPUBLIC:
4,163,664, PUB. 4-10-2012. INT. CL. 9.
4,163,665, PUB. 4-10-2012. INT. CL. 9.
JEWELX NEW YORK, LTD., NEW YORK, NY:
4,165,192, INT. CL. 35.
JEWISH COMMUNITY CENTER OF THE GREATER PALM BEACHES, INC., PALM BEACH GARDENS, FL:
4,163,175, PUB. 4-10-2012. INT. CL. 41.
JFFALASKA, LLC, FAIRBANKS, AK:
4,165,770, INT. CL. 31.
JIFFY INTERNATIONAL AS, KRISTIANSAND, NORWAY:
4,165,504, INT. CL. 1.
JIM DANDY COMPANY, INC., THE, ATLANTA, GA:
863,226, CANC. U.S. CL. 46.
JIMMY JOHN'S ENTERPRISES, LLC, CHAMPAIGN, IL:
2,604,292. REN. 5-18-12. INT. CL. 30.
JING FU, LLC, CHICAGO, IL:
4,165,854, INT. CL. 25.
JJ&K HOSPITALITY, INC., WILLINGBORO, NJ:
4,165,452, INT. CL. 43.
JJCT ENTERPRISES, INC., LAYTON, UT:
2,568,387. REN. 5-18-12. MULTIPLE CLASS, INT. CLS. 6 AND 7.
JLJ HEALTH PRODUCTS, LLC, BEAUMONT, TX:
4,165,490, INT. CL. 30.
JKL PROJECTS INC., ASTORIA, NY:
4,163,984, PUB. 4-10-2012. INT. CL. 16.
JKLM CONSULTING, LLC, DAYTON, OH:
4,163,979, PUB. 4-10-2012. INT. CL. 35.
JMI SPORTSWEAR PTE. LTD., SINGAPORE, SINGAPORE:
4,165,665, MULTIPLE CLASS, INT. CLS. 9 AND 25.
4,165,666, MULTIPLE CLASS, INT. CLS. 9 AND 25.
JO MALONE INC., NEW YORK, NY:
4,164,919, INT. CL. 11.
JOANNE SYMONS, INC. DBA HY O SILVER, BANDERA, TX:
2,498,172, CANC. INT. CL. 35.
JOE CORBI'S WHOLESALE PIZZA, INC., BALTIMORE, MD:
1,688,006. REN. 5-24-12. INT. CL. 30.
JOE, LINDA, MONTEBELLO, CA:
2,498,642, CANC. MULTIPLE CLASS, INT. CLS. 9, 14, 16, 20, 21, 25 AND 28.
JOH. BARTH & SOHN GMBH & CO. KG, FED REP GERMANY:
4,162,995, PUB. 4-10-2012. MULTIPLE CLASS, INT. CLS. 5, 30, 31, 32, 35, 36, 38, 41, 42 AND 44.
JOHANNES ARTMAYR, A-5310 MONDSEE, AUSTRIA:
4,162,925, PUB. 4-10-2012. INT. CL. 11.
JOHANSSON, KEITH G., FORT WORTH, TX:
4,165,881, INT. CL. 31.
4,165,882, INT. CL. 31.
JOHN B. SANFILIPPO & SON, INC., ELGIN, IL:
4,165,104, MULTIPLE CLASS, INT. CLS. 18 AND 25.
4,165,105, MULTIPLE CLASS, INT. CLS. 18 AND 25.
JOHN DAHLGREN, CH-2074 MARIN-EPAGNIER, SWITZERLAND:
4,162,960, PUB. 4-10-2012. INT. CL. 3.
JOHN HANCOCK LIFE INSURANCE COMPANY (U.S.A.), BOSTON, MA:
3,006,474, CANC. INT. CL. 36.
JOHN HORNBY SKEWES & CO LTD, LEEDS LS25 2HR, UNITED KINGDOM:
4,163,718, PUB. 4-10-2012. INT. CL. 15.
JOHN I. HAAS, INC., WASHINGTON, DC:
4,164,654, PUB. 4-10-2012. INT. CL. 5.
JOHN LESLIE ROOSE FRANCIS, AUSTRALIA:
4,162,926, PUB. 4-10-2012. INT. CL. 15.
JOHN MEZZALINGUA ASSOCIATES, INC., EAST SYRACUSE, NY, DBA PPC:
4,165,895, INT. CL. 9.
JOHN MEZZALINGUA ASSOCIATES, INC. DBA PPC, EAST SYRACUSE, NY:
4,163,889, PUB. 4-10-2012. INT. CL. 9.
JOHN PAUL MERKEL, ORLANDO, FL:
4,165,714, INT. CL. 25.
JOHNSON & JOHNSON, NEW BRUNSWICK, NJ:
733,222. REN. 5-23-12. U.S. CL. 6 (INT. CL. 5).
942,927. REN. 5-24-12. U.S. CL. 51 (INT. CL. 3).
1,200,955. REN. 5-24-12. INT. CL. 10.
1,585,477, CANC. INT. CL. 10.
1,689,537. REN. 5-19-12. INT. CL. 10.
2,510,338. REN. 5-21-12. INT. CL. 10.
3,613,800, AM. INT. CL. 3.
4,163,328, PUB. 4-10-2012. INT. CL. 5.
4,163,390, PUB. 4-10-2012. INT. CL. 43.
4,164,918, INT. CL. 5.
4,164,992, INT. CL. 29.
4,165,584, MULTIPLE CLASS, INT. CLS. 9 AND 44.
4,165,963, INT. CL. 5.
4,165,964, INT. CL. 5.
4,165,965, INT. CL. 5.
4,165,966, INT. CL. 5.
4,165,967, INT. CL. 5.
JOHNSON LAMBERT & CO. LLP, RALEIGH, NC:
4,163,378, PUB. 4-10-2012. MULTIPLE CLASS, INT. CLS. 35 AND 41.
4,163,379, PUB. 4-10-2012. MULTIPLE CLASS, INT. CLS. 35 AND 41.
JOHNSON, SADIE, CANAL WINCHESTER, OH:
2,504,831. REN. 5-18-12. INT. CL. 16.
JOHNSON DIVERSEY, INC., SHARONVILLE, WI, DIVERSEY CORPORATION, MISSISSAUGA, ONTARIO, CANADA:
1,702,687. REN. 5-23-12. INT. CL. 1.
JOINT COMMISSION RESOURCES, INC., OAKBROOK TERRACE, IL:
2,563,178. REN. 5-19-12. INT. CL. 41.
JOKER AG/SA, KERZERS, SWITZERLAND:
4,163,058, PUB. 3-15-2011. MULTIPLE CLASS, INT. CLS. 9, 16, 25 AND 28.
JOLI DIAGNOSTIC, INC., WILLIAMSVILLE, NY:
2,706,654. REN. 5-19-12. INT. CL. 42.
JONATHAN MEIZLER LLC, NEW YORK, NY:
4,164,502, PUB. 4-10-2012. INT. CL. 25.
JONES JR., GREGORY BRIAN, PERRIS, CA:
4,164,503, PUB. 4-10-2012. INT. CL. 25.

- JONES, AVERY, BROOKLYN, NY AND JONES JR, AVERY, BROOKLYN, NY AND EMMANUEL, JOSHUA, BROOKLYN, NY AND GARCIA, KAHMIL, QUEENS, NY AND EMMANUEL, DARRYL, BROOKLYN, NY AND VINES, ZAYANAHLA, BROOKLYN, NY AND GRAY JR., GARFIELD, BROOKLYN, NY AND BARROW JR., RONY, BROOKLYN, NY AND LIVERMAN, OLIVIA, BROOKLYN, NY:
4,166,081, INT. CL. 25.
- JORDAN DREW CORPORATION, TARRYTOWN, NY:
4,165,646, INT. CL. 8.
- JOSIE ACCESSORIES INC., NEW YORK, NY:
2,576,753, REN. 5-18-12, INT. CL. 24.
- JOURNEY 360 ENTERTAINMENT, LLC, ORLANDO, FL, DBA ISHOWCASE:
4,163,045, PUB. 4-10-2012, INT. CL. 41.
- JOY, KEVIN, AMHERST, MA:
4,164,631, PUB. 4-10-2012, INT. CL. 25.
- JOYA DE NICARAGUA, ESTELI, NICARAGUA:
4,164,049, PUB. 4-10-2012, INT. CL. 34.
- JOYBOT LLC, GREENDELL, NJ:
4,163,687, PUB. 4-10-2012, INT. CL. 25.
- JPMORGAN CHASE & CO., NEW YORK, NY:
2,498,860, CANC. INT. CL. 36.
3,006,115, CANC. INT. CL. 36.
- JSA INTERNATIONAL, INC., MEQUON, WI:
2,691,219, REN. 5-21-12, INT. CL. 1.
- JSK FOODS INC., RICHMOND, BRITISH COLUMBIA, CANADA:
4,162,744, PUB. 4-10-2012, INT. CL. 29.
- JUAREZ MATA, GUSTAVO, DURANGO 34236, MEXICO:
4,163,291, PUB. 4-10-2012, INT. CL. 41.
- JUERGENS & ANDERSEN CO., CHICAGO, IL:
2,615,180, REN. 5-19-12, INT. CL. 14.
- JUKNELIS, MATTHEW JUSTIN, FULLERTON, CA:
4,164,387, PUB. 4-10-2012, INT. CL. 42.
- JUMAN INC., SOUTH EL MONTE, CA:
4,164,215, PUB. 4-10-2012, INT. CL. 25.
- JUNG PUMPEN GMBH, STEINHAGEN, FED REP GERMANY:
4,165,175, INT. CL. 7.
- JUPITERIMAGES CORPORATION, TUCSON, AZ:
2,497,936, CANC. INT. CL. 35.
- JUST A PINCH RECIPE CLUB, LLC, FRANKLIN, TN:
4,163,301, PUB. 4-10-2012, MULTIPLE CLASS, INT. CLS. 16 AND 41.
- JVC KENWOOD CORPORATION, KANAGAWA, JAPAN:
735,246, REN. 5-18-12, U.S. CL. 21 (INT. CL. 9).
- K & COMPANY LLC, KANSAS CITY, MO 64108, MO:
4,165,432, INT. CL. 16.
- K. HANSOTIA & CO., INC., MIAMI, FL:
4,165,056, INT. CL. 18.
- K-G SPRAY-PAK INC., VAUGHAN, ONTARIO, CANADA:
4,163,142, PUB. 4-10-2012, MULTIPLE CLASS, INT. CLS. 1, 2, 3, 4 AND 5.
- K-RISE SYSTEMS, INC, AURORA, IL:
4,164,486, PUB. 4-10-2012, INT. CL. 9.
- K-2 CORPORATION, SEATTLE, WA:
4,165,726, INT. CL. 9.
4,165,727, INT. CL. 9.
- KABAM, INC., REDWOOD CITY, CA:
4,165,212, INT. CL. 41.
- KABUSHIKI KAISHA NAILS UNIQUE OF JAPAN (DOING BUSINESS AS NAILS UNIQUE OF JAPAN CO., LTD.), JAPAN:
4,162,974, PUB. 4-10-2012, MULTIPLE CLASS, INT. CLS. 3 AND 44.
4,162,975, PUB. 4-10-2012, MULTIPLE CLASS, INT. CLS. 3 AND 44.
- KABUSHIKI KAISHA SONY COMPUTER ENTERTAINMENT, MINATO-KU, TOKYO 107-0052, JAPAN, TA SONY COMPUTER ENTERTAINMENT INC.:
3,005,300, CANC. INT. CL. 28.
- KABUSHIKI KAISHA SONY COMPUTER ENTERTAINMENT, TOKYO 107-0062, JAPAN, TA SONY COMPUTER ENTERTAINMENT INC.:
4,162,753, PUB. 4-10-2012, MULTIPLE CLASS, INT. CLS. 9, 16, 28, 35, 38, 41 AND 42.
- KABUSHIKI KAISHA TAITO, SHIBUYAKU, TOKYO, JAPAN:
4,164,794, INT. CL. 9.
- KACO SOLAR, INC., SAN FRANCISCO, CA:
3,372,241, COR. INT. CL. 9.
3,643,070, COR. INT. CL. 9.
- KAI VODKA LLC, HONOLULU, HI:
4,164,714, PUB. 4-10-2012, INT. CL. 33.
- KAIROS INSTITUTE OF SOUND HEALING, LLC, LLANO DE SAN JUAN, NM, KAIROS INSTITUTE OF SOUND HEALING LLC, SEATTLE, WA:
2,699,136, REN. 5-18-12, INT. CL. 41.
- KAJEET, INC., BETHESDA, MD:
4,166,057, MULTIPLE CLASS, INT. CLS. 9 AND 38.
- KALAMATA FOOD PURVEYORS, INC., HAYWARD, CA:
4,164,866, INT. CL. 29.
- KALENBORN INTERNATIONAL GMBH & CO. KG, VETTELSCHOSS, FED REP GERMANY:
4,163,574, PUB. 4-10-2012, MULTIPLE CLASS, INT. CLS. 19, 37 AND 42.
- KALOGIANNI, ALEXANDER, HUNTINGTON, NY:
4,165,388, MULTIPLE CLASS, INT. CLS. 9 AND 41.
- KALSEC, INC., KALAMAZOO, MI:
2,602,059, REN. 5-23-12, MULTIPLE CLASS, INT. CLS. 1, 2 AND 30.
- KALYPSO LP, BEACHWOOD, OH:
4,164,442, PUB. 4-10-2012, INT. CL. 35.
- KANDRIS, THOMAS P., SACRAMENTO, CA, DBA PACK-AGEONE INC:
4,163,481, PUB. 4-10-2012, INT. CL. 16.
- KANFI, YANIV, BROOKLYN, NY AND BUSHELLE, CHANTAL A, BROOKLYN, NY:
4,165,976, INT. CL. 25.
- KANGAROO MEDIA, INC., BOISBRIAND, QUEBEC, CANADA:
4,164,477, PUB. 4-10-2012, MULTIPLE CLASS, INT. CLS. 9, 38 AND 41.
4,164,478, PUB. 4-10-2012, MULTIPLE CLASS, INT. CLS. 9, 38 AND 41.
- KAPPA ALPHA THETA FRATERNITY, INC., INDIANAPOLIS, IN:
1,697,558, REN. 5-18-12, INT. CL. 16.
1,697,674, REN. 5-18-12, INT. CL. 21.
- KARA ROSS NEW YORK, LLC, NEW YORK, NY:
4,164,505, PUB. 4-10-2012, INT. CL. 14.
- KARA VITA, INC., ST. PETERSBURG, FL:
4,164,851, INT. CL. 3.
- KARMALoop, INC., BOSTON, MA:
4,165,982, INT. CL. 35.
- KARSTEN MANUFACTURING CORPORATION, PHOENIX, AZ:
4,129,715, COR. INT. CL. 28.
- KASH N° GOLD, LTD., DEER PARK, NY:
2,498,973, CANC. INT. CL. 9.
- KATE ASPEN, INC., DULUTH, GA, DBA BABY ASPEN:
4,164,341, PUB. 4-10-2012, MULTIPLE CLASS, INT. CLS. 24, 25 AND 28.
- KATE HOPPER, LLC, MINNEAPOLIS, MN:
4,164,406, PUB. 4-10-2012, INT. CL. 41.
- KATE LEXI DELLON, ALBERTSON, NY:
4,163,154, PUB. 4-5-2011, INT. CL. 25.
- KATE SHIFRIN STYLE CONSULTANTS, INC., CHICAGO, IL:
2,571,312, REN. 5-19-12, INT. CL. 42.
- KATE SPADE, LLC, NEW YORK, NY:
2,613,247, REN. 5-18-12, INT. CL. 25.
- KATENA PRODUCTS, INC., DENVER, NJ:
1,235,667, REN. 5-24-12, INT. CL. 10.
- KATHY IRELAND WORLDWIDE, RANCHO MIRAGE, CA:
4,164,709, PUB. 4-10-2012, INT. CL. 35.
- KATO MASAYOSHI, KANAGAWA 249-0007, JAPAN:
4,162,824, PUB. 4-10-2012, MULTIPLE CLASS, INT. CLS. 30 AND 35.
- KB HOME, LOS ANGELES, CA:
2,509,611, REN. 5-23-12, INT. CL. 37.
- KBA-NOTASYS SA, LAUSANNE 22, SWITZERLAND:
2,869,223, CANC. MULTIPLE CLASS, INT. CLS. 7 AND 9.

KBRA HOLDINGS, INC., NEW YORK, NY:
 4,165,977, INT. CL. 36.
 KCI LICENSING, INC., SAN ANTONIO, TX:
 4,164,957, MULTIPLE CLASS, INT. CLS. 5 AND 10.
 KEATING OF CHICAGO, INC., CHICAGO, IL:
 854,151, CANC. U.S. CL. 31.
 KEE-TAH ENTERTAINMENT, LLC LIMITED LIABILITY
 COMPANY, BOURG, LA:
 4,163,383, PUB. 4-10-2012. INT. CL. 25.
 KEEP THE FAITH FOUNDATION, INC., RAMSEY, NJ, DBA
 KEEP THE FAITH AND DAVID SAMS INDUSTRIES,
 INC., AGOURA HILLS, CA, AKA TV FIRST:
 4,163,899, PUB. 4-10-2012. INT. CL. 45.
 KEINAN, SHLOMO, HOLON, ISRAEL:
 4,164,574, PUB. 4-10-2012. INT. CL. 12.
 KELLOGG BROWN & ROOT LLC, HOUSTON, TX:
 4,163,409, PUB. 4-10-2012. INT. CL. 36.
 4,163,410, PUB. 4-10-2012. MULTIPLE CLASS, INT. CLS.
 35, 36, 37, 40 AND 42.
 KELLWOOD COMPANY, CHESTERFIELD, MO:
 4,165,662, INT. CL. 9.
 KELLY FOODS CORPORATION, BERLIN, MD:
 4,165,535, INT. CL. 31.
 KELLY WEARSTLER LLLP, LOS ANGELES, CA:
 4,165,115, INT. CL. 14.
 KELLY-SPRINGFIELD TIRE COMPANY, CUMBERLAND,
 MD:
 856,522, CANC. U.S. CL. 35.
 KELLY-SPRINGFIELD TIRE COMPANY, THE, CUMBER-
 LAND, MD:
 502,356, CANC. U.S. CL. 35.
 504,039, CANC. U.S. CL. 35.
 KEMP & ASSOCIATES RETIREMENT SERVICES, INC.,
 HARLEYSVILLE, PA:
 4,165,755, INT. CL. 36.
 KEN'S ENTERPRISES, INC., TORONTO, SD:
 3,006,377, CANC. INT. CL. 7.
 KENCO CONSTRUCTION PRODUCTS, INC., LIGONIER,
 PA:
 2,586,811, REN. 5-21-12. INT. CL. 7.
 KENRA PROFESSIONAL, LLC, INDIANAPOLIS, IN:
 4,164,278, PUB. 4-10-2012. INT. CL. 3.
 KENT INTERNATIONAL PRODUCTS, INC., NEWBURY,
 MA:
 1,696,744, REN. 5-24-12. INT. CL. 3.
 KENT NUTRITION GROUP, INC., MUSCATINE, IA:
 2,583,017, REN. 5-24-12. INT. CL. 31.
 KENYON COLLEGE, GAMBIER, OH:
 2,618,084, REN. 5-19-12. INT. CL. 16.
 KERATIN 4 U LLC, MIAMI, FL:
 4,164,157, PUB. 4-10-2012. INT. CL. 3.
 KERRY GROUP SERVICES LTD., KERRY, IRELAND:
 863,220, CANC. U.S. CL. 46.
 KERRY GROUP SERVICES, LTD., TRALEE, COUNTY
 KERRY, IRELAND:
 1,201,682, REN. 5-18-12. INT. CL. 1.
 KETTLEBELL SEMINARS LIMITED, LANCASHIRE, UNI-
 TED KINGDOM:
 4,163,825, PUB. 4-10-2012. MULTIPLE CLASS, INT. CLS.
 9, 16, 28 AND 41.
 KEY CODE MEDIA, INC., BURBANK, CA, DBA KEY CODE
 MEDIA, INC.:
 4,164,754, PUB. 4-10-2012. INT. CL. 35.
 KEYGENE N.V., NETHERLANDS:
 4,162,987, PUB. 4-10-2012. MULTIPLE CLASS, INT. CLS.
 6, 9, 35 AND 42.
 KEYSTONE LABORATORIES, INC., MEMPHIS, TN, DBA
 KEYSTONE COMPANY:
 858,447, CANC. U.S. CL. 51.
 KEYWARE, INC., TUCSON, AZ:
 4,162,708, PUB. 4-10-2012. INT. CL. 9.
 KHAZANIE, NIRDHAR, GREENVILLE, NC:
 4,164,059, PUB. 4-10-2012. INT. CL. 35.
 KHS AG, DORTMUND, FED REP GERMANY:
 3,913,056, COR. MULTIPLE CLASS, INT. CLS. 39, 42
 AND 45.
 KIDDE FIRE TRAINERS, INC., FAIR LAWN, NJ, AAI
 CORPORATION, HUNT VALLEY, MD:
 1,723,385, REN. 5-23-12. MULTIPLE CLASS, INT. CLS. 9
 AND 37.
 KIDSSTREET, LLC, NEEDHAM HEIGHTS, MA:
 4,163,047, PUB. 4-10-2012. INT. CL. 41.
 KIDZART TEXAS, LLC, JACKSON, MI:
 4,163,774, PUB. 4-10-2012. INT. CL. 41.
 KIM, JAY S., SANTA FE SPRINGS, CA:
 2,498,250, CANC. INT. CL. 12.
 KIM, YONG, KOYANG-SHI, KYUNGKI-DO, REPUBLIC OF
 KOREA:
 2,571,779, REN. 5-22-12. INT. CL. 42.
 KIMBALL PROPERTIES LLC, EUGENE, OR:
 4,164,569, PUB. 4-10-2012. INT. CL. 37.
 KIMBERLY-CLARK CORPORATION, NEENAH, WI:
 1,229,747, REN. 5-23-12. INT. CL. 16.
 KIMSAPRINCESS INC., WOODLAND HILLS, CA:
 4,165,116, INT. CL. 14.
 KIND SHOCK HI-TECH CO., LTD., TAINAN CITY 709,
 TAIWAN:
 4,163,172, PUB. 4-10-2012. INT. CL. 12.
 KINETIC TECHNOLOGIES, LLC, LEXINGTON, KY:
 4,162,713, PUB. 4-10-2012. INT. CL. 5.
 KING TECHNOLOGY, INC., MINNEAPOLIS, MN:
 2,508,507, REN. 5-22-12. INT. CL. 11.
 KING TECHNOLOGY, INC., HOPKINS, MN:
 2,508,509, REN. 5-22-12. MULTIPLE CLASS, INT. CLS. 1
 AND 11.
 KING, CHARLES H. JR., TULSA, OK:
 2,575,582, REN. 5-22-12. MULTIPLE CLASS, INT. CLS. 19
 AND 37.
 KING, DAVID, BUSHEY, HERTFORDSHIRE, UNITED
 KINGDOM:
 3,094,895, CANC. INT. CL. 25.
 KING, STEFON W., KANSAS CITY, KS, DBA FIRST
 ROUND:
 2,567,224, REN. 5-21-12. INT. CL. 25.
 KINGDEE SOFTWARE (CHINA) CO., LTD., SHENZHEN,
 GUANGDONG, CHINA:
 4,163,736, PUB. 4-10-2012. INT. CL. 9.
 4,163,737, PUB. 4-10-2012. INT. CL. 35.
 4,163,738, PUB. 4-10-2012. INT. CL. 38.
 4,163,770, PUB. 4-10-2012. INT. CL. 42.
 KINGDOM GENERATION, LLC, PLAINFIELD, NJ:
 4,165,199, MULTIPLE CLASS, INT. CLS. 3, 4, 9, 16 AND
 30.
 4,165,200, MULTIPLE CLASS, INT. CLS. 3, 4, 9, 16 AND
 30.
 KINGPIN TATTOO SUPPLY, INC., ST. PETERSBURG, FL,
 FORMERLY KINGPIN BRAND TATTOO NEEDLES, INC.:
 4,163,323, PUB. 4-10-2012. INT. CL. 35.
 KINGSDOWN, INC., MEBANE, NC:
 2,569,910, REN. 5-24-12. INT. CL. 20.
 KINLEY, JEFFREY TODD, GREENSBORO, NC AND AN-
 DERSON, LESLIE LEIGH, GREENSBORO, NC:
 4,165,989, MULTIPLE CLASS, INT. CLS. 25 AND 35.
 KIRIN HOLDINGS KABUSHIKI KAISHA A/T/A KIRIN
 HOLDINGS CO., LTD., TOKYO, JAPAN:
 2,604,185, REN. 5-24-12. INT. CL. 32.
 2,612,137, REN. 5-24-12. INT. CL. 32.
 KISS NAIL PRODUCTS, INC., PORT WASHINGTON, NY,
 DAE DO INTERNATIONAL, INC., QUEENS VILLAGE,
 NY:
 1,759,380, REN. 5-18-12. INT. CL. 3.
 KITAMURA MACHINERY CO., LTD., TAKAOKA-SHI,
 TOYAMA-KEN, JAPAN:
 1,195,519, REN. 5-24-12. INT. CL. 7.
 KITAMURA VALVE SEIZO KABUSHIKI KAISHA, TOKYO,
 JAPAN:
 1,169,886, CANC. INT. CL. 7.
 KITARU INNOVATIONS INC., LASCELLES, BARBADOS:
 4,163,105, PUB. 4-10-2012. INT. CL. 16.
 4,163,152, PUB. 4-10-2012. INT. CL. 16.
 4,163,153, PUB. 4-10-2012. INT. CL. 16.
 KITCHELL CORPORATION, PHOENIX, AZ:
 4,163,384, PUB. 4-10-2012. MULTIPLE CLASS, INT. CLS.

- 36, 37, 39 AND 42.
4,163,385, PUB. 4-10-2012. MULTIPLE CLASS, INT. CLS. 36, 37, 39 AND 42.
- KITCHEN CONSERVATORY, INC., ST. LOUIS, MO:
2,581,174, REN. 5-19-12. MULTIPLE CLASS, INT. CLS. 35 AND 41.
- KITMAKER ENTERTAINMENT S.A., PALMA DE MAL-LORCA, SPAIN:
4,164,233, PUB. 4-10-2012. INT. CL. 9.
- KITZ CORPOTATION, CHIBA, JAPAN:
1,197,701, REN. 5-18-12. INT. CL. 6.
- KLINKY, INC., BURBANK, CA:
4,164,482, PUB. 4-10-2012. INT. CL. 6.
4,164,483, PUB. 4-10-2012. INT. CL. 6.
4,164,484, PUB. 4-10-2012. INT. CL. 6.
- KLUTZ, PALO ALTO, CA:
2,711,910, REN. 5-19-12. INT. CL. 28.
- KNIGHT DISTRIBUTING CO INC., LAWRENCEVILLE, GA, DBA REGENCY COSMETICS:
4,163,868, PUB. 4-10-2012. INT. CL. 3.
- KNIGHT FRANK (NOMINEES) LIMITED, LONDON, UNITED KINGDOM:
3,092,645, CANC. INT. CL. 42.
- KNIGHTON, CHRISTINE, SPRINGFIELD, VA:
4,165,343, INT. CL. 41.
- KNOSH ENTERPRISES, LLC, CANON CITY, CO:
4,164,169, PUB. 4-10-2012. INT. CL. 43.
- KNOWLAGENT, INC., ALPHARETTA, GA:
2,600,316, REN. 5-18-12. INT. CL. 9.
- KNOX JEWELERS LLC, MINNEAPOLIS, MN:
4,164,153, PUB. 4-10-2012. INT. CL. 40.
- KNOX, ANNE DILLON, SPRINGFIELD, MA:
4,166,067, INT. CL. 44.
- KOGANEI CORPORATION, TOKYO, JAPAN:
4,164,978, MULTIPLE CLASS, INT. CLS. 6, 7, 9, 11 AND 17.
- KOKAI, STEPHEN J., LONG VALLEY, NJ:
4,164,673, PUB. 4-10-2012. INT. CL. 28.
- KOLLMANN, TOBIAS, 53115 BONN, FED REP GERMANY AND FESEL, BERND, 40593 DUSSELDORF, FED REP GERMANY:
3,005,299, CANC. MULTIPLE CLASS, INT. CLS. 14, 16, 20, 35 AND 39.
- KOMBI LTD., ESSEX JUNCTION, VT:
2,435,921, COR. INT. CL. 25.
- KONAMI GAMING, INC., LAS VEGAS, NV:
4,165,338, INT. CL. 9.
4,165,339, INT. CL. 9.
4,165,340, INT. CL. 9.
4,165,380, INT. CL. 9.
- KONINKLIJKE BOON EDAM INTERNATIONAL B.V., EDAM, NETHERLANDS:
2,614,630, REN. 5-21-12. MULTIPLE CLASS, INT. CLS. 6 AND 9.
2,620,366, REN. 5-21-12. MULTIPLE CLASS, INT. CLS. 6 AND 9.
- KONINKLIJKE PHILIPS ELECTRONICS N.V., NETHERLANDS:
2,998,377.
- KONINKLIJKE PHILIPS ELECTRONICS N.V., NL-5621 BA EINDHOVEN, NETHERLANDS:
4,162,830, PUB. 4-10-2012. MULTIPLE CLASS, INT. CLS. 9, 11, 35 AND 45.
- KOPPLA LTD., NEW YORK, NY, DBA KOPPLA NUTRI-ENTS:
4,164,075, PUB. 4-10-2012. INT. CL. 5.
- KORAL BRASIL CONFECÇÃO LTDA ME, SÃO PAULO, BRAZIL:
4,163,604, PUB. 1-3-2012. MULTIPLE CLASS, INT. CLS. 18 AND 25.
- KOSS CORPORATION, MILWAUKEE, WI:
3,006,371, CANC. INT. CL. 9.
3,006,372, CANC. INT. CL. 16.
- KOTKAMILLS OY, FINLAND:
4,162,860, PUB. 4-10-2012. INT. CL. 16.
- KOUBA, BRIGITTE LAUREN, SANTA MONICA, CA:
3,006,389, CANC. MULTIPLE CLASS, INT. CLS. 25 AND 30.
- KRAFT FOODS BELGIUM INTELLECTUAL PROPERTY BVBA, 1500 HALLE, BELGIUM, ALIMENTA SOCIETE COOPERATIVE, CUREGHEM, BELGIUM:
294,075, REN. 5-23-12. U.S. CL. 46 (INT. CL. 30).
- KRAFT FOODS GLOBAL BRANDS LLC, NORTHFIELD, IL:
859,127, CANC. U.S. CL. 46.
2,572,410, REN. 5-23-12. INT. CL. 30.
- KRAMER, BRADLEY T., NEW YORK, NY:
4,163,996, PUB. 4-10-2012. INT. CL. 20.
- KRAUSZ, ASHER, BROOKLYN, NY:
4,164,904, MULTIPLE CLASS, INT. CLS. 10 AND 25.
- KREITZER, JULIE L, ESCONDIDO, CA:
4,163,509, PUB. 4-10-2012. INT. CL. 16.
- KREPS DEMARIA, CORAL GABLES, FL:
4,166,029, INT. CL. 35.
- KRIEGER, MICHAEL W, YOUNGSTOWN, OH, DBA THE HIGHER PLANE:
4,165,003, INT. CL. 25.
- KROES, TARA, BURLINGTON, ONTARIO, CANADA:
4,163,062, PUB. 4-10-2012. MULTIPLE CLASS, INT. CLS. 38 AND 39.
- KROGER COMPANY, THE, CINCINNATI, OH:
858,800, CANC. U.S. CL. 14.
- KRUGER PRODUCTS L.P., MISSISSAUGA, ON, CANADA:
4,162,727, PUB. 4-10-2012. INT. CL. 16.
- KSIN LUXEMBOURG II, S.A.R.L., LUXEMBOURG:
3,051,069.
- KUHN KRAUSE, INC., HUTCHINSON, KS:
4,165,136, INT. CL. 7.
- KUHNAU, SR., STEPHEN C., BUSH, LA:
2,497,967, CANC. MULTIPLE CLASS, INT. CLS. 3 AND 5.
- KUMAR, SRINIVAS, LOS ANGELES, CA:
4,164,225, PUB. 4-10-2012. INT. CL. 9.
- KURT MANUFACTURING COMPANY, INC., FRIDLEY, MN:
4,163,302, PUB. 4-10-2012. MULTIPLE CLASS, INT. CLS. 9, 12, 27 AND 28.
- KVERNELAND GROUP MECHATRONICS B.V., NETHERLANDS:
4,030,460, COR. MULTIPLE CLASS, INT. CLS. 9, 12 AND 42.
- KVZ INTERNATIONAL LIMITED, TORTOLA, BR. VIRGIN ISLANDS:
2,573,709, REN. 5-24-12. INT. CL. 14.
- KWEKERIJ "DE STADSWEIDEN", GEBR. J. EN J. VAN STRAATEN, HARDERWIJK, NETHERLANDS:
2,611,272, REN. 5-19-12. INT. CL. 31.
- KYORITSU GOKIN, MFG. CO., LTD., HYOGO-KEN, JAPAN:
1,702,836, REN. 5-18-12. INT. CL. 7.
- L. J. SMITH, INC., BOWERSTON, OH:
2,639,309, REN. 5-23-12. INT. CL. 19.
- L. POSSEHL & CO MBH, FED REP GERMANY:
3,055,725.
- L&P PROPERTY MANAGEMENT COMPANY, SOUTH GATE, CA:
4,165,787, INT. CL. 27.
- L'OREAL, PARIS, FRANCE:
859,065, CANC. U.S. CL. 52.
- L'OREAL, 75008 PARIS, FRANCE:
2,602,468, REN. 5-22-12. INT. CL. 3.
- L'OREAL, PARIS, FRANCE:
4,163,374, PUB. 4-10-2012. INT. CL. 3.
4,164,900, INT. CL. 3.
- L'OREAL USA CREATIVE, INC., NEW YORK, NY:
2,569,752, REN. 5-19-12. INT. CL. 3.
4,163,389, PUB. 4-10-2012. INT. CL. 3.
- LA BUONA TAVOLA USA INC., SEATTLE, WA:
4,163,884, PUB. 4-10-2012. MULTIPLE CLASS, INT. CLS. 29 AND 30.
- LA PALETERA FRANCHISE SYSTEMS, INC., VICTORIA, TX:
2,601,934, REN. 5-19-12. INT. CL. 42.
- LA TOUR EIFFEL PARIS, PARIS, FRANCE:
2,569,968, REN. 5-19-12. INT. CL. 18.
- LA-CO INDUSTRIES, INC., ELK GROVE VILLAGE, IL:
1,698,659, REN. 5-21-12. INT. CL. 1.

LABOR ONE, INC., ELMWOOD PARK, IL:
2,581,513. REN. 5-24-12. INT. CL. 35.

LABORATORIOS MK, S.A., SANTO DOMINGO, DOMINICAN REP:
4,163,076. PUB. 4-10-2012. INT. CL. 3.

LACKEY, RON J., EDEN, UT:
4,163,414. PUB. 4-10-2012. INT. CL. 35.

LACOSTE ALLIGATOR S.A., GENEVA, SWITZERLAND:
251,201. CANC. U.S. CL. 39.

LAGGIS, MELISSA, WASILLA, AK:
4,165,304. INT. CL. 41.

LAKE FORK TROPHY BAIT & TACKLE INC., EMORY, TX:
2,498,349. CANC. INT. CL. 28.

LAKE MURRAY DENTISTRY, LLC., LEXINGTON, SC:
4,163,951. PUB. 4-10-2012. INT. CL. 44.

LAKE, III, CLIFFORD F., MINNETONKA, MN:
4,165,534. INT. CL. 35.

LANCE CONSTRUCTION SUPPLIES, INC., CHICAGO, IL:
859,941. CANC. U.S. CL. 13.

LANCER ARABIANS, INC., OCALA, FL:
858,687. CANC. U.S. CL. 100.

LAND O'LAKES PURINA FEED LLC., SHOREVIEW, MN, RALSTON PURINA COMPANY, ST. LOUIS, MO:
936,979. REN. 5-23-12. U.S. CL. 18 (INT. CL. 31).

LANDMARK GRAPHICS CORPORATION, HOUSTON, TX:
4,165,717. INT. CL. 9.

LANNETT HOLDINGS, INC., WILMINGTON, DE:
4,165,093. INT. CL. 5.

LARA DE DONNO, SWITZERLAND:
4,162,859. PUB. 4-10-2012. MULTIPLE CLASS, INT. CLS. 41 AND 44.

LAROCQUE, MAURICE, MONTREAL, QUEBEC, CANADA:
2,650,112. REN. 5-18-12. MULTIPLE CLASS, INT. CLS. 41 AND 42.

LARRY FANG, MONTEREY PARK, CA:
2,498,521. CANC. INT. CL. 29.

LARSON, JOHN, FOND DU LAC, WI:
4,165,487. INT. CL. 41.

LAS JOYAS DEL AGAVE, SA DE CV, GUADALAJARA, JAL, MEXICO:
4,165,147. INT. CL. 33.

LASTERTECH ALASKA, ANCHORAGE, AK:
2,498,504. CANC. INT. CL. 21.

LATIN STAR CORPORATION, BEVERLY HILLS, CA:
4,163,204. PUB. 4-10-2012. INT. CL. 16.

LATTICE ENGINES, INC., SAN MATEO, CA:
4,165,773. INT. CL. 42.

LAUNCH INTERNATIONAL, INC., DOYLESTOWN, PA:
4,165,981. INT. CL. 35.

LAURA JEANNE DESIGN, LLC, CHESAPEAKE, VA:
4,163,766. PUB. 4-10-2012. MULTIPLE CLASS, INT. CLS. 41 AND 42.

LAUREL HILL ENTERPRISES, INC., KENNEBUNKPORT, ME:
2,498,481. CANC. MULTIPLE CLASS, INT. CLS. 31 AND 35.

LAWTER, INC., CHICAGO, IL:
2,571,473. REN. 5-23-12. INT. CL. 1.

LAYFIELD GROUP LIMITED, RICHMOND, B.C., CANADA:
4,163,218. PUB. 4-10-2012. INT. CL. 42.

LBI NEW YORK, LLC, NEW YORK, NY:
2,498,151. CANC. MULTIPLE CLASS, INT. CLS. 35 AND 42.

LCA-VISION, INC., CINCINNATI, OH:
4,165,833. INT. CL. 44.

LCR ELECTRONICS, INC., NORRISTOWN, PA:
2,569,140. REN. 5-18-12. INT. CL. 9.

LDB MEDICAL, INC., NORCROSS, GA:
1,687,736. REN. 5-19-12. INT. CL. 10.

LDM YORKTON CORP., YORKTON, SASK, CANADA:
4,164,939. MULTIPLE CLASS, INT. CLS. 29 AND 35.

LE BARON HOTEL, INC., SAN DIEGO, CA:
864,036. CANC. U.S. CL. 100.

LEAD BY SALES, TARPON SPRINGS, FL:
4,164,619. PUB. 4-10-2012. INT. CL. 34.

LEADERSHIP EDUCATION & DEVELOPMENT, INC., HILTON HEAD ISLAND, SC:
2,574,120. REN. 5-22-12. MULTIPLE CLASS, INT. CLS. 35 AND 41.
2,574,120. CANC. INT. CL. 40.

LEADING EDGE INNOVATIONS, INC., VANCOUVER, CANADA:
4,165,060. INT. CL. 6.

LEADING EDGE MARKETING, INC. PTE LTD., SINGAPORE, SINGAPORE:
4,165,851. INT. CL. 32.

LEAF & RUSHER CORPORATION, BEVERLY HILLS, CA:
2,988,498. CANC. MULTIPLE CLASS, INT. CLS. 3 AND 5.

LEARNING MEDIA LIMITED, WELLINGTON, NEW ZEALAND:
2,572,309. REN. 5-18-12. INT. CL. 16.

LEARNING WITH MOMMY, ANNA, TX:
4,165,740. INT. CL. 9.

LECG, LLC, EMERYVILLE, CA:
2,965,269. CANC. MULTIPLE CLASS, INT. CLS. 36 AND 42.
2,985,518. CANC. MULTIPLE CLASS, INT. CLS. 35, 36 AND 42.

LEE, HAROLD D. C/O., SAN ANTONIO, TX, DBA JENIX:
4,165,866. INT. CL. 9.

LEGACY CAPITAL GROUP CALIFORNIA, LOS GATOS, CA:
2,572,151. REN. 5-18-12. INT. CL. 36.

LEGACY CHAPELS, L.L.C., HAMBURG, MI:
4,163,595. PUB. 4-10-2012. INT. CL. 45.

LEGACY HEALTHCARE FINANCIAL SERVICES, LLC, LINCOLNWOOD, IL:
4,166,053. INT. CL. 45.

LEGAL SEA FOODS, LLC, BOSTON, MA:
2,713,727. REN. 5-18-12. INT. CL. 30.

LEGALZOOM.COM, INC, LOS ANGELES, CA:
3,608,302. COR. MULTIPLE CLASS, INT. CLS. 35 AND 45.

LEGALZOOM.COM, INC., LOS ANGELES, CA:
3,569,400. COR. MULTIPLE CLASS, INT. CLS. 35 AND 45.

LEGALZOOM.COM, INC., GLENDALE, CA:
3,929,722. COR. INT. CL. 35.
4,002,425. COR. MULTIPLE CLASS, INT. CLS. 35 AND 45.

LEGION OF YOUNG POLISH WOMEN, CHICAGO, IL:
4,163,885. PUB. 4-10-2012. INT. CL. 36.

LEHMAN BROTHERS HOLDINGS INC., NEW YORK, NY:
2,506,974. REN. 5-21-12. MULTIPLE CLASS, INT. CLS. 36, 37 AND 42.

LEISAWITZ, JEFFREY B., SEATTLE, WA, DBA ELECTRON LOVE THEORY:
3,006,097. CANC. MULTIPLE CLASS, INT. CLS. 9 AND 41.

LEL ENVIRONMENTAL, LTD., PASADENA, TX:
4,163,957. PUB. 4-10-2012. INT. CL. 37.

LELAS, TIHOMIR, ZAGREB, CROATIA:
3,005,361. CANC. MULTIPLE CLASS, INT. CLS. 1 AND 3.

LEMONADE RESTAURANT GROUP, LLC, LOS ANGELES, CA:
4,166,083. INT. CL. 43.

LEMTRONICS SDN. BHD, MALAYSIA:
4,162,803. PUB. 1-12-2010. MULTIPLE CLASS, INT. CLS. 40 AND 42.

LENG HENG AGRI FOODS CO., LTD., PATHUMTHANI 12120, THAILAND:
2,571,755. REN. 5-21-12. MULTIPLE CLASS, INT. CLS. 29 AND 30.

LENOX CORPORATION, BRISTOL, PA:
2,497,792. CANC. MULTIPLE CLASS, INT. CLS. 16 AND 35.

LENS.COM, INC., LAS VEGAS, NV:
2,571,563. REN. 5-23-12. INT. CL. 35.

LENTRADE, INC., HOUSTON, TX:
2,717,570. REN. 5-23-12. INT. CL. 20.

LEON PRODUCTS, INC., JACKSONVILLE, FL:
854,316. CANC. U.S. CL. 51.

- LEONE S.P.A., 50019 SESTO FIORENTINO (FIRENZE), ITALY:
2,680,370. REN. 5-18-12. INT. CL. 10.
- LEONHARD KURZ STIFTUNG & CO. KG, 90763 FÜRTH, FED REP GERMANY:
4,162,848. PUB. 4-10-2012. MULTIPLE CLASS, INT. CLS. 9, 16, 17, 39 AND 42.
- LESHER, ROBERT MICHAEL, CORONA DEL MAR, CA:
4,165,696. MULTIPLE CLASS, INT. CLS. 35 AND 45.
- LESLIE CONTROLS, INC., TAMPA, FL:
934,895. REN. 5-19-12. U.S. CL. 23 (INT. CL. 9).
- LESLIE D. CIBOROWSKI, INVERNESS, IL, DBA TRAINS-MARTGLOBAL, INC.:
4,165,420. MULTIPLE CLASS, INT. CLS. 16 AND 41.
- LEVECK LIGHTING PRODUCTS, INC., TIPP CITY, OH:
4,164,522. PUB. 4-10-2012. INT. CL. 35.
- LEVENDUSKY, PAUL L., WHITE ROCK, BRITISH COLUMBIA, CANADA:
2,704,209. REN. 5-24-12. INT. CL. 44.
- LEVINE, MICHAEL, LORTON, VA:
2,497,800. CANC. INT. CL. 3.
- LEVINS TAX LAW, LLC, HOPKINTON, MA:
4,164,281. PUB. 4-10-2012. INT. CL. 45.
- LEVRIDGE RESOURCES, LLC, CHARLOTTE, NC:
4,163,425. PUB. 4-10-2012. INT. CL. 35.
- LEWIS BROTHERS BAKERIES, INCORPORATED, EVANSVILLE, IN, DBA LEWIS BAKERIES, INC.:
4,165,384. INT. CL. 30.
4,165,385. INT. CL. 30.
4,165,386. INT. CL. 30.
4,165,543. INT. CL. 30.
- LEWIS, KHARI, SIMPSONVILLE, SC:
4,164,196. PUB. 4-10-2012. INT. CL. 41.
- LEWIS, SR., RALPH A., PHILADELPHIA, PA:
4,165,960. INT. CL. 25.
- LEXINGTON PARTNERS ADVISORS L.P., NEW YORK, NY, FORMERLY LEXINGTON PARTNERS ADVISORS L.P.:
4,163,229. PUB. 4-10-2012. INT. CL. 36.
4,163,230. PUB. 4-10-2012. INT. CL. 36.
- LEXMARK INTERNATIONAL TECHNOLOGY SA, MEYRIN, SWITZERLAND:
2,964,182. CANC. INT. CL. 9.
- LF, LLC, MOUNT MOURNE, NC:
4,163,159. PUB. 4-10-2012. INT. CL. 35.
- LG ELECTRONICS INC., SEOUL, REPUBLIC OF KOREA:
4,162,761. PUB. 4-10-2012. MULTIPLE CLASS, INT. CLS. 7, 9, 10, 11 AND 35.
4,162,762. PUB. 4-10-2012. MULTIPLE CLASS, INT. CLS. 7, 9, 10, 11 AND 35.
4,162,777. PUB. 4-10-2012. INT. CL. 11.
- LG HOUSEHOLD & HEALTH CARE LTD., SEOUL, REPUBLIC OF KOREA:
4,162,731. PUB. 4-10-2012. INT. CL. 3.
- LI, ZHI YONG, GUANGZHOU, GUANGDONG., CHINA:
4,165,383. INT. CL. 18.
- LIBERMOTUS LOGISTICS, LLC, GREENSBORO, NC:
4,165,081. INT. CL. 39.
- LIBERTY COACH, INC., NORTH CHICAGO, IL:
4,164,845. INT. CL. 42.
- LIBERTY SAFE AND SECURITY PRODUCTS, INC., SPRINGVILLE, UT:
2,648,543. REN. 5-24-12. INT. CL. 6.
- LIBERTY TELECOM, RENO, NV:
2,498,772. CANC. INT. CL. 38.
- LIBRI GMBH, 22763 HAMBURG, FED REP GERMANY:
2,599,990. REN. 5-21-12. MULTIPLE CLASS, INT. CLS. 9, 16, 35, 38, 41 AND 42.
- LICCIARDELLO, MARY A., WRIGHTSTOWN, NJ:
2,636,967. REN. 5-23-12. INT. CL. 18.
- LIDESTRI FOODS, INC., FAIRPORT, NY:
4,163,132. PUB. 4-10-2012. MULTIPLE CLASS, INT. CLS. 39 AND 40.
- LIFE IS SPORTS LLC, WELLESLEY, MA:
4,164,661. PUB. 4-10-2012. INT. CL. 24.
- LIFE MAGIC ENTERPRISES, INC., CEDAR GROVE, TN, DBA DRAGONHAWK PUBLISHING:
2,569,775. REN. 5-18-12. INT. CL. 16.
- LIFE MAGIC ENTERPRISES, INC., JACKSON, TN, DBA DRAGONHAWK PUBLISHING:
2,573,339. REN. 5-18-12. INT. CL. 16.
- LIFE PAINT CORP., SANTA FE SPRINGS, CA:
1,762,283. REN. 5-23-12. INT. CL. 2.
- LIFELOCK, INC., TEMPE, AZ:
4,165,114. MULTIPLE CLASS, INT. CLS. 36 AND 45.
- LIFESTYLE ENTERTAINMENT, INC., EVERGREEN, CO:
4,165,291. INT. CL. 45.
- LIFETIME BRANDS, INC., GARDEN CITY, NY, GORHAM MANUFACTURING COMPANY, PROVIDENCE, RI:
561,950. REN. 5-18-12. U.S. CL. 28 (INT. CLS. 8 AND 14).
- LIFETIME BRANDS, INC., GARDEN CITY, NY:
4,165,511. INT. CL. 21.
4,165,544. INT. CL. 21.
- LIFETIME PRODUCTS, INC., CLEARFIELD, UT:
2,580,225. REN. 5-18-12. INT. CL. 28.
- LIFUNG TRINITY MANAGEMENT (SINGAPORE) PTE. LTD., SINGAPORE, SINGAPORE:
4,163,634. PUB. 4-10-2012. INT. CL. 9.
- LIGHT OF HEALING HOPE FOUNDATION, WASHINGTON, DC:
4,165,744. MULTIPLE CLASS, INT. CLS. 9, 16 AND 41.
- LIGHT WITHOUT HEAT, INC., ENCINO, CA:
4,165,998. INT. CL. 41.
- LIGHTING SERVICES, INC., STONY POINT, NY:
1,200,354. REN. 5-23-12. INT. CL. 11.
- LIGNUM-2, INC., BOWLING GREEN, KY:
4,164,377. PUB. 4-10-2012. INT. CL. 34.
- LIHIT LAB., INC., OSAKA-SHI, OSAKA, JAPAN:
861,629. CANC. U.S. CL. 23.
- LIL' DRUG STORE PRODUCTS, INC., CEDAR RAPIDS, IA, LIL' DRUG STORE PRODUCTS, INC., CEDAR RAPIDS, IA:
1,739,583. REN. 5-22-12. INT. CL. 11.
- LILLY-HESTER, MICHELLE, MISSOURI CITY, TX:
4,163,395. PUB. 4-10-2012. INT. CL. 14.
- LIN R. ROGERS ELECTRICAL CONTRACTORS, INC., ALPHARETTA, GA:
4,165,250. INT. CL. 37.
4,165,307. INT. CL. 37.
- LIN, XIAOGU, ARCADIA, CA:
4,165,623. INT. CL. 25.
- LINCOLN GLOBAL, INC., CITY OF INDUSTRY, CA:
4,163,107. PUB. 4-10-2012. INT. CL. 1.
- LINDEN, PAUL R., COLUMBUS, OH, DBA PAUL LINDEN, PH.D.:
1,698,136. REN. 5-22-12. INT. CL. 41.
- LINE GENIE LLC, ALLSTON, MA:
4,163,666. PUB. 4-10-2012. INT. CL. 41.
4,163,668. PUB. 4-10-2012. INT. CL. 41.
- LINE 6, INC., CALABASAS, CA:
3,006,169. CANC. INT. CL. 9.
- LINGUIS-TECHS, NEWTOWN, PA:
2,498,528. CANC. INT. CL. 35.
- LINX DATING LLC, PALO ALTO, CA:
4,163,283. PUB. 4-10-2012. INT. CL. 41.
4,163,284. PUB. 4-10-2012. INT. CL. 41.
4,163,285. PUB. 4-10-2012. INT. CL. 41.
- LIONS GATE ENTERTAINMENT, INC., SANTA MONICA, CA:
4,165,014. INT. CL. 14.
- LIP ELIXIRS LLC, LOS ANGELES, CA:
4,163,189. PUB. 4-10-2012. INT. CL. 3.
- LIQUID AGENCY, INC., SAN JOSE, CA:
4,163,895. PUB. 4-10-2012. INT. CL. 35.
- LIQUID DIGITAL MEDIA, LLC, AMARILLO, TX:
4,164,955. MULTIPLE CLASS, INT. CLS. 9 AND 41.
- LIQUID KNITS CORPORATION, LONG ISLAND CITY, NY:
2,570,105. REN. 5-21-12. INT. CL. 25.
- LIQUID ROBOTICS, INC., SUNNYVALE, CA:
4,165,781. INT. CL. 12.
- LISA DOYLE, ORTING, WA:
4,164,226. PUB. 4-10-2012. INT. CL. 43.
- LISA FRANK, INC., TUCSON, AZ, DBA LISA FRANK COMPANY:
4,164,934. INT. CL. 35.

LISA HO DESIGNS PTY. LIMITED, NEW SOUTH WALES 2010, AUSTRALIA:
2,569,129. REN. 5-18-12. MULTIPLE CLASS, INT. CLS. 18 AND 25.
2,569,129. CANC. MULTIPLE CLASS, INT. CLS. 3 AND 24.

LISEP, LLC, REYNOLDSBURG, OH, DBA TECHR2:
4,163,448, PUB. 4-10-2012. INT. CL. 42.

LISTENER DRIVEN RADIO LLC, WESTLAKE, OH:
4,073,480, COR. MULTIPLE CLASS, INT. CLS. 9 AND 38.
4,073,481, COR. MULTIPLE CLASS, INT. CLS. 9 AND 38.
4,077,213, COR. MULTIPLE CLASS, INT. CLS. 9 AND 38.

LITTLE BUSY BODIES, INC., BEAVERTON, OR:
4,162,748, PUB. 4-10-2012. INT. CL. 3.

LITTLE CIGARS, INC., YUCCA VALLEY, CA, DBA VAPE-SAFE:
4,163,110, PUB. 4-10-2012. INT. CL. 34.

LITTLE FINGERS, INC., WHITE PLAINS, NY:
2,506,229. REN. 5-18-12. INT. CL. 21.

LITTLE THUMBKIN, INC., CHICAGO, IL:
4,165,707, INT. CL. 25.

LITTLE WOMAN DESIGN LLC, NORTH WALES, PA:
4,164,241, PUB. 4-10-2012. INT. CL. 42.

LIU, YE RONG, NEW YORK, NY:
4,164,452, PUB. 4-10-2012. INT. CL. 18.
4,164,455, PUB. 4-10-2012. INT. CL. 18.

LIVING STREAM MINISTRY, ANAHEIM, CA:
2,573,200. REN. 5-21-12. INT. CL. 16.

LIVING WORLD ENTERTAINMENT, ESCONDIDO, CA:
4,164,185, PUB. 4-10-2012. INT. CL. 41.

LM WIND POWER A/S, DENMARK:
4,162,909, PUB. 4-10-2012. MULTIPLE CLASS, INT. CLS. 37, 40 AND 42.

LOANA CHIOCCHI, 98713 PAPEETE, FRENCH POLYNESIA:
4,163,115, PUB. 9-13-2011. INT. CL. 25.

LOC DAC DUONG, GARDEN GROVE, CA, DBA CALI BEAUTY SUPPLY #2:
4,163,575, PUB. 1-3-2012. INT. CL. 3.

LOCAL KETCH, LLC, BROKEN ARROW, OK:
4,163,552, PUB. 4-10-2012. INT. CL. 35.

LONE SURVIVOR FOUNDATION, HOUSTON, TX:
4,163,702, PUB. 4-10-2012. INT. CL. 35.

LONESTAR SOCCER CLUB OF AUSTIN, INC., AUSTIN, TX:
4,165,947, INT. CL. 36.

LONG-LOK FASTENERS CORPORATION, CINCINNATI, OH:
726,887. REN. 5-18-12. U.S. CL. 13 (INT. CL. 6).

LONGBERGER COMPANY, THE, NEWARK, OH:
2,590,733. REN. 5-21-12. MULTIPLE CLASS, INT. CLS. 24, 25 AND 28.
2,590,743. REN. 5-21-12. MULTIPLE CLASS, INT. CLS. 6 AND 14.

LONGFIELD GARDENS LLC, LAKEWOOD, NJ:
4,163,095, PUB. 4-10-2012. INT. CL. 31.

LOOKLAB INC., NEW YORK, NY:
4,165,331, MULTIPLE CLASS, INT. CLS. 35, 42 AND 45.

LOOSEMONKIES.COM LLC, ORLANDO, FL:
4,163,874, PUB. 4-10-2012. INT. CL. 35.

LORO PIANA S.P.A., QUARONA (VC), ITALY:
4,164,958, INT. CL. 24.

LOS ANGELES LAKERS, INC., THE, EL SEGUNDO, CA:
1,767,505. REN. 5-23-12. INT. CL. 25.

LOSETAS ASFALTICAS, S. DE R.L. DE C.V., DELEG. IZTACALCO, C.P., MEXICO:
4,165,122, INT. CL. 19.

LOUDOUN COLLISION CENTER, INC., PURCELLVILLE, VA:
2,656,312. REN. 5-23-12. INT. CL. 37.

LOUIE, RYAN K., SAN FRANCISCO, CA:
4,163,326, PUB. 4-10-2012. INT. CL. 42.

LOVETT, MELANIE J., NAPLES, FL:
4,164,536, PUB. 4-10-2012. INT. CL. 45.

LOWER, MICHAEL SEAN, CHARLOTTE, NC, DBA PEER-PARTY:
4,163,949, PUB. 4-10-2012. INT. CL. 41.

LPS IP HOLDING COMPANY, LLC, JACKSONVILLE, FL:
4,164,039, PUB. 4-10-2012. MULTIPLE CLASS, INT. CLS. 9 AND 42.

LTF S.P.A., 24051 ANTEGNATE (BG), ITALY:
4,165,419, INT. CL. 7.

LUBE HOLDING S.R.L., TREIA, ITALY:
4,165,259, INT. CL. 20.

LUBERSKI, INC., SAN MARCOS, CA:
4,164,821, INT. CL. 29.

LUBROMATION INC., CHARLOTTE, NC:
4,165,567, INT. CL. 7.

LUDOVICO MARTELLI S.R.L., ITALY:
4,163,024, PUB. 4-10-2012. INT. CL. 3.

LUEBBE, DOUGLAS, IRVINE, CA AND BOUCHEZ, KEVIN, IRVINE, CA:
3,006,405, CANC. INT. CL. 9.

LUMETA, INC., IRVINE, CA:
4,164,841, INT. CL. 19.

LUMMUS TECHNOLOGY INC., BLOOMFIELD, NJ:
2,578,313. REN. 5-21-12. INT. CL. 11.

LUNG CANCER RESEARCH FOUNDATION, NEW YORK, NY:
4,165,763, INT. CL. 36.

LUTHERAN SENIORLIFE, CRANBERRY TOWNSHIP, PA:
4,162,739, PUB. 4-6-2010. MULTIPLE CLASS, INT. CLS. 43 AND 44.

LUU, VAN, ORLANDO, FL:
2,658,666. REN. 5-18-12. INT. CL. 3.

LUX PREMIER - LUX PUBLICATIONS, LLC, FISHERS, IN:
4,163,506, PUB. 4-10-2012. INT. CL. 35.

LUXCO, INC., ST. LOUIS, MO:
860,271, CANC. U.S. CL. 49.

LUXNET CORPORATION, YAO-YUAN HSIEN, TAIWAN:
2,684,245. REN. 5-23-12. INT. CL. 9.

LVD ACQUISITION, LLC, COLUMBUS, OH:
504,066, CANC. U.S. CL. 31.

LWRC INTERNATIONAL, LLC, CAMBRIDGE, MD:
4,163,597, PUB. 4-10-2012. INT. CL. 13.

LYLE ANDERSON COMPANY, INC., THE, SCOTTSDALE, AZ:
3,068,146, CANC. INT. CL. 41.

LYNDEN INCORPORATED, SEATTLE, WA:
1,666,986. REN. 5-22-12. INT. CL. 39.
1,691,914. REN. 5-22-12. MULTIPLE CLASS, INT. CLS. 36 AND 39.
1,768,902. REN. 5-22-12. INT. CL. 39.

M & I ELECTRIC INDUSTRIES, INC., BEAUMONT, TX:
1,753,601. REN. 5-21-12. MULTIPLE CLASS, INT. CLS. 7 AND 9.

M & W, LLC, ATLANTA, GA:
4,165,834, INT. CL. 16.

M & Y TRADING, CARTERET, NJ, DBA HELBY IMPORT CO.:
4,163,748, PUB. 4-10-2012. INT. CL. 7.

M CHEMICAL COMPANY, INC., LOS ANGELES, CA:
4,164,221, PUB. 4-10-2012. INT. CL. 1.
4,164,222, PUB. 4-10-2012. INT. CL. 1.

M SQUARED ENTERPRISES, INC., PALMER LAKE, CO, DBA TRIBLOOM, INC.:
4,164,117, PUB. 4-10-2012. INT. CL. 42.

M EAGLES TOOL WAREHOUSE, INC., NEWARK, NJ, DBA S & G TOOL AID CORP.:
1,687,707. REN. 5-18-12. INT. CL. 9.

M. M. HAYES COMPANY, INC., MENANDS, NY:
4,163,585, PUB. 4-10-2012. INT. CL. 9.

M. SAMIR QAMAR, M.D., INC., MONTEREY, CA:
4,165,550, INT. CL. 44.

M.P. MERCHANDISE LLC, LOS ANGELES, CA:
4,163,386, PUB. 4-10-2012. MULTIPLE CLASS, INT. CLS. 3 AND 25.

M/A/R/C INC., IRVING, TX:
2,603,292. REN. 5-21-12. INT. CL. 35.

M/S GARDEX, JALANDHAR, PUNJAB, INDIA:
4,164,921, INT. CL. 8.

MAAX SPAS INDUSTRIES CORP., CHANDLER, AZ:
4,165,817, INT. CL. 11.

MACCO LLC, RESTON, VA:
4,163,928, PUB. 4-10-2012. INT. CL. 37.

MACHEEN INC., AUSTIN, TX:
4,165,073, INT. CL. 42.

- MACHINERY TOOLING & SUPPLY, LLC, SCHAUMBURG, IL:
4,163,596, PUB. 4-10-2012. MULTIPLE CLASS, INT. CLS. 35 AND 39.
- MACK TRUCKS, INC., GREENSBORO, NC:
2,601,351. REN. 5-18-12. INT. CL. 12.
- MACMILLAN, INC., NEW YORK, NY:
503,584, CANC. U.S. CL. 38.
- MACPAW INC, SALEM, OR:
3,968,494, COR. INT. CL. 9.
- MAD MAN INTERNATIONAL, INC., PALM BEACH GARDENS, FL:
4,165,160, INT. CL. 25.
- MADERE, CHARLES STANTON, AUSTIN, TX:
4,164,052, PUB. 4-10-2012. INT. CL. 35.
- MAERCKS, RIAN A., MIAMI, FL:
4,164,280, PUB. 4-10-2012. INT. CL. 44.
- MAGAZINE PUBLISHERS OF AMERICA, INC., NEW YORK, NY:
1,768,931. REN. 5-18-12. INT. CL. 41.
- MAGENTA STUDIO PHOTO INC., MONTREAL QC, CANADA:
4,162,730, PUB. 4-10-2012. INT. CL. 41.
- MAGLIFICIO LOREL MISS S.P.A., 41012 CARPI, ITALY:
2,497,575, CANC. INT. CL. 25.
- MAGMATIC LIMITED, UNITED KINGDOM:
4,163,015, PUB. 4-10-2012. MULTIPLE CLASS, INT. CLS. 18, 20, 21, 24 AND 28.
- MAGNA INTERNATIONAL INC., AURORA, ONTARIO L4G 7K1, CANADA:
4,162,693, PUB. 4-10-2012. INT. CL. 42.
- MAGNETIC ANALYSIS CORPORATION, ELMSFORD, NY:
1,198,575. REN. 5-19-12. INT. CL. 9.
- MAGNUM POWER PRODUCTS, LLC, WAUKESHA, WI:
2,498,342, CANC. INT. CL. 7.
- MAIDENFORM, INC., NEW YORK, NY:
854,227, CANC. U.S. CL. 39.
854,696, CANC. U.S. CL. 39.
854,700, CANC. U.S. CL. 39.
- MAIN RESOURCE, INC., PORTLAND, ME:
2,498,064, CANC. INT. CL. 35.
- MAINE STANDARDS COMPANY, LLC, WINDHAM, ME:
2,677,461. REN. 5-22-12. INT. CL. 1.
- MAINMAST ENTERPRISES, LTD., PORTSMOUTH, NH:
2,602,707. REN. 5-19-12. INT. CL. 39.
2,602,708. REN. 5-19-12. INT. CL. 39.
- MAISATIVO INTERMEDIACAO DE ATIVOS LTDA., SAO PAULO, BRAZIL:
4,164,825, INT. CL. 35.
- MAISON A.E. DOR, JARNAC, FRANCE:
4,163,155, PUB. 4-10-2012. INT. CL. 33.
- MAISON PIERRE SPARR SUCCESEURS, 68980 BEBLENHEIM, FRANCE:
2,497,602, CANC. INT. CL. 33.
- MAJA-MASCHINENFABRIK HERMANN SCHILL GMBH, KEHL-GOLDSCHUEUR, FED REP GERMANY:
2,617,783. REN. 5-21-12. INT. CL. 41.
- MAJRANI EUROPE S.R.L., ITALY:
4,162,958, PUB. 4-10-2012. MULTIPLE CLASS, INT. CLS. 20 AND 35.
- MAKE UP FOR EVER (SOCIÉTÉ ANONYME), F-75008 PARIS, FRANCE:
4,162,861, PUB. 4-10-2012. INT. CL. 3.
- MAKE-UP ART COSMETICS INC., NEW YORK, NY:
3,006,527, CANC. INT. CL. 3.
- MAKO DEEPWATER, INC., HOUSTON, TX:
4,164,658, PUB. 4-10-2012. MULTIPLE CLASS, INT. CLS. 7 AND 37.
- MALANDRINO, QUIRINO, NEW YORK, NY:
2,998,044, CANC. INT. CL. 35.
- MALIN, AMY, SHERMAN OAKS, CA, FORMERLY BALSAM, AMY:
4,163,345, PUB. 4-10-2012. INT. CL. 36.
- MALLORCA MAGNETICS, INC., LAS VEGAS, NV:
4,164,113, PUB. 4-10-2012. INT. CL. 26.
4,164,118, PUB. 4-10-2012. INT. CL. 26.
- MAMADOC, MASON, OH:
4,165,000, INT. CL. 10.
- MAN-D-TEC, INC., SCOTTSDALE, AZ:
4,165,155, INT. CL. 11.
- MANA PRODUCTS, INC., LONG ISLAND CITY, NY:
2,497,900, CANC. INT. CL. 3.
2,497,901, CANC. INT. CL. 3.
- MANAGERENTHOUSES.COM, INC., HOUSTON, TX:
4,163,325, PUB. 4-10-2012. MULTIPLE CLASS, INT. CLS. 35 AND 36.
- MANAR, INC., COLUMBUS, IN:
1,725,744, REN. 5-19-12. INT. CL. 20.
- MANCHU WOK HOLDINGS, INC., MARKHAM, ONTARIO, CANADA:
2,498,053, CANC. INT. CL. 42.
- MANDOUR & ASSOCIATES, APC, SAN DIEGO, CA:
4,166,047, INT. CL. 45.
- MANGUSTA, LTD., SAN FRANCISCO, CA:
2,570,372. REN. 5-21-12. INT. CL. 12.
- MANHATTAN MINI STORAGE, LLC, NEWARK, NJ:
2,635,263. REN. 5-22-12. INT. CL. 35.
- MANOWITZ, BRIAN, ORLANDO, FL:
4,164,207, PUB. 4-10-2012. INT. CL. 43.
- MANSON WESTERN CORPORATION, LOS ANGELES, CA, DBA WESTERN PSYCHOLOGICAL SERVICES:
4,163,292, PUB. 4-10-2012. INT. CL. 28.
- MANTISSA CORPORATION, CHARLOTTE, NC:
1,694,013. REN. 5-24-12. INT. CL. 7.
- MANUFACTURERA DE BOTAS CUADRA, S.A. DE C.V. CORPORATION, LEON, MEXICO:
2,637,326. REN. 5-18-12. MULTIPLE CLASS, INT. CLS. 18 AND 25.
- MAPLEWOOD SOFTWARE, INC., SPOKANE, WA:
4,164,067, PUB. 4-10-2012. INT. CL. 42.
4,164,077, PUB. 4-10-2012. INT. CL. 42.
4,164,081, PUB. 4-10-2012. INT. CL. 42.
4,164,083, PUB. 4-10-2012. INT. CL. 42.
- MAR SEAFOOD INC., WARWICK, RI:
2,712,672. REN. 5-18-12. INT. CL. 29.
- MARACAS LLC, WASHINGTON, DC:
4,164,423, PUB. 4-10-2012. INT. CL. 30.
4,164,426, PUB. 4-10-2012. INT. CL. 30.
- MARAZZI GROUP S.P.A., MODENA, ITALY, MARAZZI CERAMICHE S.P.A., SASSUOLO, ITALY:
1,195,214. REN. 5-18-12. INT. CL. 19.
- MARAZZI GROUP S.P.A., MODENA, ITALY:
2,572,558. REN. 5-18-12. INT. CL. 19.
- MARCH OF DIMES FOUNDATION, WHITE PLAINS, NY:
2,682,373. REN. 5-22-12. INT. CL. 28.
- MARCHESE, MICHAEL A., CHICAGO, IL:
4,162,705, PUB. 4-10-2012. INT. CL. 35.
- MARCHFIVE LLC, WYNDMOOR, PA:
4,165,761, INT. CL. 21.
- MARDAR MANAGEMENT PTY. LTD., SUTHERLAND NSW, AUSTRALIA:
2,617,195. REN. 5-23-12. INT. CL. 41.
- MAREN IHRlich-BRAUN, 52224 STOLBERG, FED REP GERMANY AND BERND IHRlich, 52224 STOLBERG, FED REP GERMANY:
3,055,685.
3,068,394.
- MARGUERITE E. GRAY, COATS, NC:
4,165,202, INT. CL. 35.
- MARIA BALINSKA, CAMBRIDGE, MA:
4,165,758, INT. CL. 41.
- MARIA CURCIO, FREEHOLD, NJ:
4,165,536, INT. CL. 21.
- MARICELA SANCHEZ ART, CORPUS CHRISTI, TX:
4,163,605, PUB. 4-10-2012. INT. CL. 35.
- MARICH CONFECTIONARY COMPANY, INC., HOLLISTER, CA:
2,696,835, COR. INT. CL. 30.
- MARICH CONFECTIONERY COMPANY, INC., HOLLISTER, CA:
3,057,106, COR. INT. CL. 30.
- MARICOPA COUNTY COMMUNITY COLLEGE DISTRICT, THE, TEMPE, AZ:
2,651,568. REN. 5-19-12. INT. CL. 16.
2,651,569. REN. 5-19-12. INT. CL. 18.

MARIDAN CORPORATION, PELHAM, AL:
2,602,523. REN. 5-19-12. INT. CL. 29.

MARIE LEFFINGWELL, ROUND ROCK, TX:
4,163,977. PUB. 4-10-2012. INT. CL. 16.

MARIE-HÉLÈNE PLANTIER ÉPOUSE GIRARD, LA TESTE DE BUCH, FRANCE:
4,162,875. PUB. 4-10-2012. INT. CL. 3.

MARITZ HOLDINGS INC., FENTON, MO:
4,165,571. INT. CL. 35.

MARK ANTHONY INTERNATIONAL SRL, ST. MICHAEL, BARBADOS:
4,164,311. PUB. 4-10-2012. MULTIPLE CLASS, INT. CLS. 32 AND 33.
4,165,733. MULTIPLE CLASS, INT. CLS. 32 AND 33.

MARK KOTCH, LIVERMORE, CA:
4,165,712. INT. CL. 36.

MARK USA LLC, HOLLYWOOD, FL:
2,871,615. COR. INT. CL. 37.
3,022,888. COR. INT. CL. 37.
3,683,767. COR. INT. CL. 37.

MARKET GROUNDS FOOD CONCEPTS GMBH, 20099 HAMBURG, FED REP GERMANY:
3,006,366. CANC. INT. CL. 30.

MARKS, ROBERT, LOS ANGELES, CA:
4,163,583. PUB. 4-10-2012. MULTIPLE CLASS, INT. CLS. 35 AND 38.

MARKUS R DIERSBOCK, MARBLEHEAD, MA:
4,163,327. PUB. 4-10-2012. INT. CL. 9.

MARKY SPARKY, INC., ESCONDIDO, NY:
4,165,459. INT. CL. 28.

MARLOW FOODS LIMITED, LONDON, UNITED KINGDOM:
4,163,252. PUB. 4-10-2012. MULTIPLE CLASS, INT. CLS. 5, 29 AND 30.

MARPAC LLC, ROCKY POINT, NC:
4,165,835. INT. CL. 9.

MARROKAL CONSTRUCTION COMPANY, LAKESIDE, CA:
3,757,473. AM. MULTIPLE CLASS, INT. CLS. 37 AND 42.

MARSH INC., CINCINNATI, OH:
4,165,903. INT. CL. 40.

MARSHALL QUENTIN LLC, NEW YORK, NY:
4,165,660. INT. CL. 24.

MARTHA STEWART LIVING OMNIMEDIA, INC., NEW YORK, NY:
4,164,857. MULTIPLE CLASS, INT. CLS. 20 AND 24.

MARTHA WESTERGAARD, CASA GRANDE, AZ, DBA TREASURE ME PHOTOGRAPHY:
4,164,097. PUB. 4-10-2012. INT. CL. 41.

MARTIAL ARTS MARKETING, INC., GOLDEN, CO:
4,163,704. PUB. 4-10-2012. MULTIPLE CLASS, INT. CLS. 9 AND 41.

MARTIN FLUID POWER COMPANY, TROY, MI:
4,164,013. PUB. 4-10-2012. INT. CL. 7.
4,164,017. PUB. 4-10-2012. INT. CL. 7.
4,164,648. PUB. 4-10-2012. INT. CL. 7.

MARTIN, DALTON, SPETTEL CPA REVIEW, LLC, COLUMBUS, OH:
2,569,089. REN. 5-21-12. MULTIPLE CLASS, INT. CLS. 16 AND 41.

MARTIN, PATRICK, CHICAGO, IL:
4,164,419. PUB. 4-10-2012. INT. CL. 11.

MARVEL CHARACTERS, INC., MANHATTAN BEACH, CA, MARVEL ENTERTAINMENT GROUP, INC., NEW YORK, NY:
1,685,314. REN. 5-18-12. INT. CL. 16.

MARVEL CHARACTERS, INC., MANHATTAN BEACH, CA:
2,498,247. CANC. INT. CL. 16.
2,591,650. REN. 5-24-12. INT. CL. 16.

MARVELL FOODS, INC., BOCA RATON, FL:
4,165,890. MULTIPLE CLASS, INT. CLS. 29 AND 30.

MARY BARTON, NEW YORK CITY, NY:
4,164,560. PUB. 4-10-2012. INT. CL. 14.

MARY JANE PICKENS ROBERTS, LITTLE ROCK, AR:
2,499,008. CANC. INT. CL. 16.

MARY KAY INC., ADDISON, TX:
4,165,932. INT. CL. 3.

MASALA DANCE & FITNESS, INC., IRVINE, CA:
4,166,070. MULTIPLE CLASS, INT. CLS. 9, 28 AND 41.

MASLANKA, HERBERT, 78532 TUTTLINGEN, FED REP GERMANY:
4,163,013. PUB. 4-10-2012. INT. CL. 10.

MASORI, SANDI, SAN DIEGO, CA:
4,163,307. PUB. 4-10-2012. MULTIPLE CLASS, INT. CLS. 41 AND 42.

MASSINGALE, CLIFTON, CORONA, CA:
4,165,774. INT. CL. 35.

MASSMAN CONSTRUCTION CO., KANSAS CITY, MO:
4,163,790. PUB. 4-10-2012. MULTIPLE CLASS, INT. CLS. 37, 39 AND 42.

MASTER LOCK COMPANY LLC, OAK CREEK, WI:
4,165,934. INT. CL. 9.

MASTER WINDOW REPAIR, INC, BROOKLYN, NY:
4,166,051. INT. CL. 37.

MASTER'S TRANSPORTATION, INC., BELTON, MO:
4,164,601. PUB. 4-10-2012. MULTIPLE CLASS, INT. CLS. 35, 37 AND 39.

MASTERCARD INTERNATIONAL INCORPORATED, PURCHASE, NY:
4,164,807. INT. CL. 36.

MASTRONARDI PRODUCE LTD., SANTA BARBARA, CA:
4,162,746. PUB. 4-10-2012. INT. CL. 37.

MATCAL, INC., HADLEY, MA:
2,628,248. REN. 5-18-12. INT. CL. 29.
2,642,708. REN. 5-18-12. INT. CL. 29.

MATEST SYSTEMTECHNIK GMBH, 72116 MÖSSINGEN, FED REP GERMANY:
3,608,956. COR. MULTIPLE CLASS, INT. CLS. 5, 9 AND 16.

MATHERS, JONATHAN IAN, YONKERS, NY:
2,980,972. CANC. INT. CL. 41.

MATHY, FRANCINE, PALM DESERT, CA:
4,164,037. PUB. 4-10-2012. INT. CL. 45.

MATT GROENING PRODUCTIONS, INC., LOS ANGELES, CA:
4,164,454. PUB. 4-10-2012. INT. CL. 16.

MATT OLMSTEAD PRODUCTIONS, INC., SANTA MONICA, CA:
4,165,526. INT. CL. 41.

MATTEL, INC., EL SEGUNDO, CA:
4,163,514. PUB. 4-10-2012. INT. CL. 28.
4,165,238. INT. CL. 28.
4,165,594. INT. CL. 28.
4,165,595. INT. CL. 28.
4,165,596. INT. CL. 28.
4,165,597. INT. CL. 28.
4,165,840. INT. CL. 28.

MATTRESS DEALZZ, LLC, PLEASANT GROVE, UT:
4,163,944. PUB. 4-10-2012. INT. CL. 20.

MATZOT AVIV, LTD., BENEI-BRAK, ISRAEL:
3,005,615. CANC. INT. CL. 30.

MAWA MCQUEEN, ASPEN, CO, DBA WINE IN HEELS LLC:
4,163,831. PUB. 4-10-2012. INT. CL. 41.

MAX-TRAC TIRE CO., INC., STOW, OH:
2,581,071. REN. 5-18-12. INT. CL. 12.

MAXIM LLC, FORT MYERS, FL:
4,164,504. PUB. 4-10-2012. INT. CL. 36.

MAXIME COSSOGUY LLC, NEW YORK, NY:
4,163,430. PUB. 4-10-2012. INT. CL. 25.

MAXIMUS, INC., RESTON, VA:
2,701,050. REN. 5-18-12. INT. CL. 9.

MAXLINER LLC, MARTINSVILLE, VA:
2,649,010. REN. 5-18-12. INT. CL. 7.

MAXMAKERS AG, SWITZERLAND:
3,051,061.

MAXON CORPORATION, MUNCIE, IN:
1,749,349. REN. 5-23-12. INT. CL. 11.

MAYO FOUNDATION FOR MEDICAL EDUCATION AND RESEARCH, ROCHESTER, MN:
2,540,462. REN. 5-21-12. INT. CL. 42.

MAYTAG PROPERTIES, LLC, ST. JOSEPH, MI:
3,006,378. CANC. MULTIPLE CLASS, INT. CLS. 7, 9 AND 11.

- MCCALLIN DIVERSIFIED INDUSTRIES, INC., COMMERCE CITY, CO:
2,713,032. REN. 5-22-12. INT. CL. 35.
- MCCARTHY, ROBERT, MELVILLE, NY:
4,164,897. INT. CL. 5.
- MCCOMMAS, JEFFREY, DRACUT, MA:
4,164,403. PUB. 4-10-2012. INT. CL. 41.
- MCCULLOUGH, CHERYL, NORTHRIDGE, CA:
4,165,565. INT. CL. 21.
- MCDONALD, KAREN L, NEW YORK, NY:
4,164,514. PUB. 4-10-2012. INT. CL. 41.
- MCDONALD'S CORPORATION, OAK BROOK, IL, MARKET BAR-B-QUE, INC., MINNEAPOLIS, MN:
1,191,424. REN. 5-24-12. INT. CL. 42.
- MCDONOUGH, DAVID, SAN ANGELO, TX:
4,164,659. PUB. 4-10-2012. INT. CL. 42.
- MCFARLANE, ANDREW L, TRAVERSE CITY, MI:
4,164,588. PUB. 4-10-2012. INT. CL. 35.
- MCINTYRE & YOUNGBLOOD RECRUITING, LLC, HOUSTON, TX:
4,164,489. PUB. 4-10-2012. INT. CL. 35.
- MCKEE FOODS KINGMAN, INC., KINGMAN, AZ:
4,164,400. PUB. 4-10-2012. INT. CL. 30.
4,164,402. PUB. 4-10-2012. INT. CL. 30.
- MCKEE, MARIA, CLEVELAND, OH:
3,006,381. CANC. INT. CL. 9.
- MCKEON, THOMAS, LARGO, FL:
4,166,031. INT. CL. 18.
- MCKINNEY & SILVER LLC, DURHAM, NC:
4,163,622. PUB. 4-10-2012. INT. CL. 35.
- MCLAUGHLIN, PATRICK R, BURBANK, CA AND MCGRANN, COLLEEN R, BURBANK, CA:
4,163,117. PUB. 4-10-2012. INT. CL. 41.
- MCLEOD, K. WAYNE, JACKSONVILLE, FL:
2,497,586. CANC. INT. CL. 36.
- MCNEIL NUTRITIONALS LLC, FORT WASHINGTON, PA:
4,165,028. INT. CL. 30.
4,165,029. INT. CL. 30.
- MCNEILL, GAVIN, LOS ANGELES, CA:
4,164,592. PUB. 4-10-2012. INT. CL. 35.
- MDS GLOBAL HOLDING LTD., SLIEMA, MALTA:
4,163,258. PUB. 4-10-2012. MULTIPLE CLASS, INT. CLS. 11, 30 AND 32.
- MDT MICRO DIAMOND TECHNOLOGIES LTD, AFULA, ISRAEL:
4,163,672. PUB. 4-10-2012. INT. CL. 10.
- MEAN, KIMLY, LAKEWOOD, CA:
4,164,171. PUB. 4-10-2012. MULTIPLE CLASS, INT. CLS. 9 AND 25.
- MEATHEAD MOVERS, INC., SAN LUIS OBISPO, CA:
4,163,332. PUB. 4-10-2012. INT. CL. 39.
- MEDAPHOR LIMITED, CARDIFF, UNITED KINGDOM:
4,163,068. PUB. 4-10-2012. MULTIPLE CLASS, INT. CLS. 9, 10, 16 AND 41.
- MEDBAG INC., COMMERCE, CA:
4,165,959. INT. CL. 10.
- MEDIA DESIGN GROUP, LLC, SANTA MONICA, CA:
4,163,195. PUB. 4-10-2012. INT. CL. 35.
- MEDIATION INTERNATIONAL LLC, PALM HARBOR, FL:
4,164,528. PUB. 4-10-2012. INT. CL. 45.
- MEDIATRIUM, FRANCE:
4,162,809. PUB. 4-10-2012. MULTIPLE CLASS, INT. CLS. 35, 38 AND 41.
- MEDICAL JUSTICE SERVICES, INC., GREENSBORO, NC:
4,165,777. INT. CL. 35.
- MEDICAL MANAGEMENT INTERNATIONAL, INC., PORTLAND, OR:
4,164,174. PUB. 4-10-2012. INT. CL. 44.
- MEGA BRANDS INTERNATIONAL, LUXEMBOURG, ZUG BRANCH, ZUG, SWITZERLAND:
2,498,335. CANC. INT. CL. 16.
- MEGATREX OY, LEMPAALA, FINLAND:
2,569,715. REN. 5-18-12. INT. CL. 7.
- MEGGITT AEROSPACE LIMITED, COVENTRY, UNITED KINGDOM:
3,232,692. CANC. MULTIPLE CLASS, INT. CLS. 1 AND 2.
- MEGSAM, NAPA, CA, DBA O.A.S.I.S.:
2,499,199. CANC. INT. CL. 41.
- MEIER, CLAUDE J., SCOTTSDALE, AZ, DBA C & A MEIER FOODS:
1,687,400. REN. 5-18-12. INT. CL. 29.
- MEJIA, JESSE A., LANDOVER, MD, DBA MBA CATALYST:
4,164,172. PUB. 4-10-2012. INT. CL. 41.
- MEL KIPER ENTERPRISES, INC., BALDWIN, MD:
4,163,802. PUB. 4-10-2012. INT. CL. 16.
- MELALEUCA, INC., IDAHO FALLS, ID:
1,689,810. REN. 5-22-12. INT. CL. 5.
2,579,050. REN. 5-22-12. INT. CL. 5.
2,656,385. REN. 5-24-12. INT. CL. 5.
3,006,346. CANC. INT. CL. 3.
- MELDRUM PHILIPS AUSTRALIA PTY LTD, AUSTRALIA:
4,163,017. PUB. 4-10-2012. MULTIPLE CLASS, INT. CLS. 30 AND 32.
- MELE MANUFACTURING COMPANY, INC., UTICA, NY:
502,936. CANC. U.S. CL. 2.
- MELEXIS TESSENDERLO NV, BELGIUM:
4,162,908. PUB. 4-10-2012. MULTIPLE CLASS, INT. CLS. 9, 41 AND 42.
- MELITTA HAUSHALTSPRODUKTE GMBH AND CO. KOMMANDITGESELLSCHAFT, MINDEN D-32427, FED REP GERMANY:
2,498,809. CANC. INT. CL. 11.
- MELLANOX TECHNOLOGIES, LTD., YOKNEAM, ISRAEL:
4,165,718. INT. CL. 9.
- MEMEC GROUP LIMITED, THAME, OXON, UNITED KINGDOM:
2,597,953. REN. 5-18-12. INT. CL. 35.
- MEMORIAL HEALTH SERVICES, FOUNTAIN VALLEY, CA:
4,163,256. PUB. 4-10-2012. INT. CL. 44.
- MEMY ISH SHALOM, WESTBOROUGH, MA:
4,164,510. PUB. 4-10-2012. INT. CL. 9.
- MEN'S APPAREL GUILD IN CALIFORNIA, INC., DULUTH, MN:
2,499,225. CANC. INT. CL. 35.
- MENDIAS & MILTON, LLC, HOUSTON, TX:
4,165,485. INT. CL. 44.
- MENDOCINO BREWING COMPANY, INC., UKIAH, CA:
2,509,464. REN. 5-19-12. INT. CL. 42.
- MERCANTILE STORES COMPANY, INC., WILMINGTON, DE:
251,257. CANC. U.S. CL. 42.
- MERCANTILE STORES COMPANY, INC., NEW YORK, NY:
857,090. CANC. U.S. CL. 41.
- MERCHANT GENERAL CORPORATION, OLDSMAR, FL:
4,163,682. PUB. 4-10-2012. INT. CL. 16.
4,163,683. PUB. 4-10-2012. INT. CL. 16.
- MERCI NEW YORK, LLC, NEW YORK, NY:
4,163,461. PUB. 4-10-2012. INT. CL. 41.
- MERCK & CO., INC., WHITEHOUSE STATION, NJ:
697,005. CANC. U.S. CL. 18.
703,160. CANC. U.S. CL. 18.
- MERCY SHIPS, GARDEN VALLEY, TX:
2,569,313. REN. 5-21-12. INT. CL. 41.
2,570,865. REN. 5-21-12. INT. CL. 42.
- MEREDITH COLLEGE, RALEIGH, NC:
4,163,090. PUB. 4-10-2012. INT. CL. 16.
- MERIDIAN HEALTH SYSTEM, INC., NEPTUNE, NJ:
4,165,193. INT. CL. 44.
- MERRITT ATHLETIC CLUBS, LLC, BALTIMORE, MD:
4,163,767. PUB. 4-10-2012. INT. CL. 41.
- METABANK, SIOUX FALLS, SD:
4,165,151. INT. CL. 35.
- METAL COATINGS CORP., HOUSTON, TX:
1,702,816. REN. 5-23-12. INT. CL. 6.
- METALÚRGICA HASSMANN S.A., IMIGRANTE, RS, BRAZIL:
4,165,653. INT. CL. 6.
- METHOD PRODUCTS, INC., SAN FRANCISCO, CA:
4,163,494. PUB. 4-10-2012. INT. CL. 3.
- METROPOLITAN LIFE INSURANCE COMPANY, NEW YORK, NY:
4,164,725. PUB. 4-10-2012. INT. CL. 16.
4,165,441. INT. CL. 36.

METROPOLITAN MUSEUM OF ART, THE, NEW YORK, NY:
1,687,836. REN. 5-18-12. INT. CL. 16.

METZ FRESH, KING CITY, CA:
2,583,441. REN. 5-18-12. INT. CL. 31.

MEXIMERICA MEDIA, INC., NEW YORK, NY:
3,006,471. CANC. INT. CL. 41.

MGIP, LLC, HILLSIDE, NJ, VIDEO CONNECTION, INC., THE, TOLEDO, OH:
1,665,300. REN. 5-24-12. INT. CL. 42.

MGT INDUSTRIES, INC., LOS ANGELES, CA:
2,507,647. REN. 5-21-12. INT. CL. 25.

MIAMI MERCHANDISING SALES, INC., MIAMI, FL:
4,165,080. INT. CL. 25.

MICHAEL ANTHONY MAHARAJH, SILVER SPRING, MD:
4,164,575. PUB. 4-10-2012. INT. CL. 42.

MICHAEL SIEGEL, LAGUNA NIGUEL, CA:
4,163,191. PUB. 4-10-2012. MULTIPLE CLASS, INT. CLS. 35 AND 41.

MICHAËL MASSAT, F-83990 SAINT TROPEZ, FRANCE:
4,162,955. PUB. 4-10-2012. MULTIPLE CLASS, INT. CLS. 9, 14 AND 18.

MICHELIN NORTH AMERICA, INC., GREENVILLE, SC:
2,571,183. REN. 5-19-12. INT. CL. 12.
2,572,517. REN. 5-18-12. INT. CL. 12.

MICHIGAN MASONIC HOME INCORPORATED, ALMA, MI, DBA MASONIC PATHWAYS:
4,165,822. INT. CL. 45.

MICKLES, DEMETRIUS, HASLET, TX:
4,165,072. INT. CL. 25.

MICRO FOCUS (US), INC., ROCKVILLE, MD, ACUCORP, INC., SAN DIEGO, CA:
2,507,350. REN. 5-21-12. INT. CL. 9.

MICRO SOLUTIONS ENTERPRISES, VAN NUYS, CA:
4,166,022. INT. CL. 2.

MICRO-CLEAN, INC., BETHLEHEM, PA:
4,165,137. INT. CL. 9.
4,165,138. INT. CL. 9.

MICRO-TRAINS LINE CO., TALENT, OR, KADEE COMPANY, MEDFORD, OR, DBA KADEE METAL PRODUCTS COMPANY:
934,410. REN. 5-19-12. U.S. CL. 22 (INT. CL. 28).

MIKRON TECHNOLOGY, INC., BOISE, ID:
3,024,812. AM. INT. CL. 9.

MICRONAS SEMICONDUCTOR HOLDING AG, ZURICH, SWITZERLAND:
2,570,624. REN. 5-18-12. INT. CL. 9.

MICROS SYSTEMS, INC., COLUMBIA, MD:
2,554,964. REN. 5-21-12. MULTIPLE CLASS, INT. CLS. 9, 35 AND 42.

MICROSOFT CORPORATION, REDMOND, WA:
4,165,382. INT. CL. 9.

MICROVOTE GENERAL CORP., INDIANAPOLIS, IN:
2,546,303. REN. 5-21-12. INT. CL. 9.
2,631,070. REN. 5-21-12. INT. CL. 9.

MIDDLE TENNESSEE STATE UNIVERSITY, MURFREESBORO, TN:
2,588,204. REN. 5-23-12. MULTIPLE CLASS, INT. CLS. 25 AND 41.
2,607,347. REN. 5-24-12. MULTIPLE CLASS, INT. CLS. 16 AND 25.

MIDSOUTH SERVICES, INC., AUBURN, AL:
2,497,466. CANC. INT. CL. 35.

MIDWEST BISCUIT COMPANY, BURLINGTON, IA:
848,256. CANC. U.S. CL. 46.

MIDWEST INDUSTRIAL SUPPLY, INC., CANTON, OH:
2,574,701. REN. 5-21-12. INT. CL. 1.

MIDWEST TILE AND GRANITE, LLC, CHESTERFIELD, MO:
3,909,514. CANC. INT. CL. 35.

MIGHTY-MAC, INC., NEW YORK, NY:
856,611. CANC. U.S. CL. 39.

MIINTO APS, DK-2100 COPENHAGEN Ø, DENMARK:
4,163,042. PUB. 4-10-2012. MULTIPLE CLASS, INT. CLS. 35 AND 45.

MIKO GROUP, INC., NORMAN, OK:
4,163,199. PUB. 4-10-2012. INT. CL. 35.

MIKRON INDUSTRIES, INC., KENT, WA:
4,163,948. PUB. 4-10-2012. INT. CL. 19.

MILANO CONCEPTS LLC, MERCER ISLAND, WA:
4,164,699. PUB. 4-10-2012. INT. CL. 14.

MILAT WINE COMPANY LLC, SAINT HELENA, CA:
2,922,933. CANC. INT. CL. 33.

MILITARY WRAPS RESEARCH & DEVELOPMENT, INC., LUMBERTON, NC:
4,165,196. INT. CL. 17.

MILK RUN LLC, STEAMBOAT SPRINGS, CO, AKA MILK RUN DONUT CAFE:
4,164,151. PUB. 4-10-2012. INT. CL. 43.

MILL CREEK CAPITAL ADVISORS, LLC, CONSHOHOCKEN, PA:
4,163,532. PUB. 4-10-2012. INT. CL. 36.

MILLER III, DONALD CURTIS, LANDSDOWNE, PA:
4,164,332. PUB. 4-10-2012. INT. CL. 25.

MIMOCO, INC., BOSTON, MA:
4,163,829. PUB. 4-10-2012. INT. CL. 41.
4,163,830. PUB. 4-10-2012. INT. CL. 9.

MIN KIM, SAN BERNARDINO, CA:
4,164,102. PUB. 4-10-2012. INT. CL. 25.
4,164,103. PUB. 4-10-2012. INT. CL. 35.

MINDFIELD PRODUCTIONS, INC., NEW YORK, NY:
4,163,854. PUB. 4-10-2012. INT. CL. 41.

MINIKIM HOLLAND B.V., TILBURG, NETHERLANDS, TIMES MIRROR COMPANY, THE, LOS ANGELES, CA:
938,882. REN. 5-18-12. U.S. CL. 38 (INT. CL. 16).

MINNESOTA GOLD MEATS, INC., WAITE PARK, MN, ST. CLOUD MEAT & PROVISION, INC., ST. CLOUD, MN:
1,697,811. REN. 5-19-12. INT. CL. 29.

MINNESOTA STREET ROD ASSOCIATION, WYOMING, MN:
2,577,386. REN. 5-18-12. INT. CL. 42.
2,584,482. REN. 5-18-12. INT. CL. 42.
2,616,540. REN. 5-18-12. INT. CL. 41.

MINOVA INTERNATIONAL LIMITED, CHESTERFIELD-DERBYSHIRE, UNITED KINGDOM:
1,690,186. REN. 5-20-12. INT. CL. 19.

MINOVA INTERNATIONAL LIMITED, UNIT 8 FRESH-WATER ROAD PARK ROAD, UNITED KINGDOM:
1,690,193. REN. 5-21-12. INT. CL. 19.

MIRA INTERNATIONAL FOODS, INC., EAST BRUNSWICK, NJ:
4,163,847. PUB. 4-10-2012. INT. CL. 32.

MIRAGE RESORTS, INCORPORATED, LAS VEGAS, NV:
2,570,928. REN. 5-24-12. INT. CL. 41.

MISCO/MINNEAPOLIS SPEAKER COMPANY, INC., MINNEAPOLIS, MN:
958,913. REN. 5-18-12. U.S. CL. 21 (INT. CL. 9).

MISENHEIMER, COREY, MONROE, NC:
4,165,090. INT. CL. 42.

MISSION PHARMACAL COMPANY, SAN ANTONIO, TX:
858,815. CANC. U.S. CL. 18.
4,164,908. INT. CL. 5.

MISSION YOGURT, INC., WESTMINSTER, CO:
2,570,656. REN. 5-18-12. INT. CL. 42.

MISSIORECK, LAURA, MANHATTAN BEACH, CA:
4,166,034. INT. CL. 35.

MISSISSIPPI STATE UNIVERSITY, MISSISSIPPI STATE, MS:
4,163,407. PUB. 4-10-2012. MULTIPLE CLASS, INT. CLS. 9 AND 42.

MISSOURI BANK AND TRUST COMPANY OF KANSAS CITY, KANSAS CITY, MO:
4,164,439. PUB. 4-10-2012. INT. CL. 36.

MISSOURI BOTANICAL GARDEN, ST. LOUIS, MO:
1,741,792. REN. 5-19-12. INT. CL. 41.

MITCHELL, NATE, LOS ANGELES, CA:
4,165,919. INT. CL. 25.

MITECH-IDEA SRL, ITALY:
4,163,023. PUB. 4-10-2012. MULTIPLE CLASS, INT. CLS. 1, 3 AND 5.

MITEK HOLDINGS, INC., WILMINGTON, DE:
4,163,731. PUB. 4-10-2012. INT. CL. 6.

MIZUNO KABUSHIKI KAISHA (MIZUNO CORPORATION), OSAKA, 541-8538, JAPAN:
3,006,145. CANC. INT. CL. 28.

- MOBELIFE, NAAMLOZE VENNOOTSCHAP, BELGIUM:
4,163,027, PUB. 4-10-2012. MULTIPLE CLASS, INT. CLS.
10, 40 AND 44.
- MOBI WIRELESS MANAGEMENT, LLC, INDIANAPOLIS,
IN:
4,163,711, PUB. 4-10-2012. MULTIPLE CLASS, INT. CLS.
35 AND 42.
- MOBILE 500 ALLIANCE, SEATTLE, WA:
4,165,177, INT. CL. 35.
4,165,183, INT. CL. 35.
- MOBOTIX AG, KAISERSLAUTERN, FED REP GERMANY:
3,014,853, CANC. MULTIPLE CLASS, INT. CLS. 42 AND
45.
- MODA MEYA, INC., NEW YORK, NY:
3,006,205, CANC. MULTIPLE CLASS, INT. CLS. 3 AND
25.
- MODEL MODEL HAIR FASHION, INC., COLLEGE POINT,
NY:
4,162,764, PUB. 4-10-2012. INT. CL. 26.
- MODERN BUILDERS SUPPLY, INC., TOLEDO, OH:
1,689,570. REN. 5-22-12. INT. CL. 19.
- MODINE MANUFACTURING COMPANY, RACINE, WI:
4,165,096, INT. CL. 11.
4,165,857, INT. CL. 11.
- MOGO MARKETING & MEDIA, INC., LARKSPUR, CA:
4,164,078, PUB. 4-10-2012. INT. CL. 35.
- MOGO MARKETING AND MEDIA, INC., LARKSPUR, CA:
4,164,655, PUB. 4-10-2012. INT. CL. 35.
- MOHAWK CARPET DISTRIBUTION, INC., CHATSWORTH,
GA:
4,165,598, INT. CL. 27.
4,165,599, INT. CL. 27.
- MOHAWK FINE PAPERS INC., COHOES, NY:
4,164,742, PUB. 4-10-2012. INT. CL. 16.
- MOJO ENTERTAINMENT, LLC, ELMHURST, IL:
4,163,750, PUB. 4-10-2012. INT. CL. 41.
- MOLINO DE TRIGO DE JIQUILPAN SA DE CV, JIQUIL-
PAN, MICHOACAN, MEXICO:
3,006,544, CANC. INT. CL. 30.
- MOLSON CANADA 2005, TORONTO, ONTARIO:
1,688,037. REN. 5-19-12. INT. CL. 32.
- MOM BRANDS COMPANY, MINNEAPOLIS, MN:
4,164,973, INT. CL. 30.
4,165,556, INT. CL. 30.
- MONARCH MEDIA, INC., SANTA CRUZ, CA:
4,164,556, PUB. 4-10-2012. INT. CL. 9.
- MONARCH SOAP & CHEMICAL CO., MINNEAPOLIS, MN
TO ECOLAB USA INC., ST. PAUL, MN:
501,699, CANC. U.S. CL. 6.
- MONEYCOPS.COM, LLC, GRAND RAPIDS, MI:
2,569,430. REN. 5-19-12. INT. CL. 36.
- MONKEY N MIDDLE, INC., HOBOKEN, NJ:
4,164,392, PUB. 4-10-2012. INT. CL. 35.
4,164,393, PUB. 4-10-2012. INT. CL. 35.
- MONSANTO TECHNOLOGY LLC, ST. LOUIS, MO:
3,006,515, CANC. INT. CL. 31.
4,165,187, INT. CL. 5.
- MONSIEUR JEAN LUC HAURAS, FRANCE AND MON-
SIEUR FRANCK ROSSET, BELGIUM:
4,162,871, PUB. 4-10-2012. MULTIPLE CLASS, INT. CLS.
9, 10, 35, 38, 41 AND 42.
- MONTALVAN'S SALES, INC., ONTARIO, CA:
2,606,162. REN. 5-18-12. INT. CL. 29.
- MONTCLAIR IMPORTS INC., WESTBURY, NY:
864,242, CANC. U.S. CL. 29.
- MONTE, ERIC, STAMFORD, CT AND BIGOS, DONNA,
STAMFORD, CT:
4,163,769, PUB. 4-10-2012. INT. CL. 43.
- MONTGOMERY WARD & CO., INCORPORATED, CHICA-
GO, IL:
250,601, CANC. U.S. CL. 32.
- MONTGOMERY WARD, INC., MONROE, WI:
4,163,343, PUB. 4-10-2012. INT. CL. 35.
4,164,853, MULTIPLE CLASS, INT. CLS. 25 AND 35.
- MONTICELLO INTERNATIONAL, LLC, DALTON, GA:
2,498,233, CANC. INT. CL. 23.
- MONTLACK, CARA, HUBBARD, OH:
4,164,326, PUB. 4-10-2012. INT. CL. 42.
- MOON VALLEY NURSERY, LLC, PHOENIX, AZ:
4,163,828, PUB. 4-10-2012. INT. CL. 44.
- MOONTOAST, LLC, NASHVILLE, TN:
4,163,429, PUB. 4-10-2012. INT. CL. 42.
4,164,267, PUB. 4-10-2012. MULTIPLE CLASS, INT. CLS.
35 AND 42.
- MOOSEHEAD BREWERIES LIMITED, ST. JOHN, NEW
BRUNSWICK, CANADA:
1,217,629. REN. 5-19-12. INT. CL. 25.
- MOREJON, LILIANA, POMPANO, FL:
4,165,891, INT. CL. 14.
- MORENA VISTA TRADING, LLC, LAS VEGAS, NV:
2,992,553, CANC. INT. CL. 5.
- MORGAN, LISA BAKER, LOS ANGELES, CA:
4,164,843, INT. CL. 16.
- MORICONI, ALFIO, WASHINGTON, DC:
2,678,684. REN. 5-21-12. INT. CL. 33.
- MORITEX CORPORATION, 170-0013 TOKYO, JAPAN:
4,163,074, PUB. 4-10-2012. INT. CL. 9.
- MORNING STAR CHRISTIAN BOOK AND MUSIC STORES
OF AMERICA, INC., LEOMINSTER, MA:
2,498,514, CANC. INT. CL. 35.
- MORRIS EXPORT CRATING COMPANY, HOUSTON, TX:
4,164,513, PUB. 4-10-2012. INT. CL. 42.
- MOSAERT SPRL, B-1180 BRUXELLES, BELGIUM:
4,162,827, PUB. 4-10-2012. MULTIPLE CLASS, INT. CLS.
9, 16, 25, 26, 35 AND 41.
- MOSAICOON S.P.A., ITALY:
4,162,810, PUB. 4-10-2012. MULTIPLE CLASS, INT. CLS.
35, 38, 41 AND 42.
- MOSLEY, MELISSA M., BURLINGTON, IA:
2,571,288. REN. 5-21-12. INT. CL. 41.
- MOSS BEACH HOMES, INC., SOUTH SAN FRANCISCO, CA,
DBA ASPIRA FOSTER & FAMILY SERVICES:
2,511,211. REN. 5-21-12. INT. CL. 42.
- MOSS INSURANCE AGENCY, INC., JENISON, MI, DBA
PIONEER BUSINESS INSURANCE AGENCY:
4,163,923, PUB. 4-10-2012. INT. CL. 36.
- MOTHER IMAGE LLC, JERSEY CITY, NJ:
4,164,784, INT. CL. 45.
- MOTIVE POWER INDUSTRY CO., LTD., TAIPEI, TAIWAN:
2,710,774. REN. 5-21-12. INT. CL. 12.
- MOTOCOMPONENTS PTY LTD, MOUNT CROSBY, AUS-
TRALIA, AKA GAZI SUSPENSION:
4,164,986, INT. CL. 12.
- MOTOROLA TRADEMARK HOLDINGS, LLC, LIBERTY-
VILLE, IL:
3,006,545, CANC. INT. CL. 9.
- MOTOWORKS, INC., LAKE ELSINORE, CA:
4,165,035, INT. CL. 7.
4,165,036, INT. CL. 7.
- MOUNT SAINT MARY'S UNIVERSITY, INC., EMMITS-
BURG, MD:
4,164,523, PUB. 4-10-2012. INT. CL. 41.
4,164,524, PUB. 4-10-2012. INT. CL. 41.
- MOUNT VERNON MILLS, INC., MAULDIN, SC:
780,113, CANC. U.S. CL. 6.
- MOUNTAIN CREST SRL, MAXWELL, CHRIST CHURCH,
BARBADOS:
4,162,787, PUB. 4-10-2012. INT. CL. 32.
4,162,788, PUB. 4-10-2012. INT. CL. 32.
- MOUNTAIN STATES HEALTH ALLIANCE, JOHNSON
CITY, TN:
4,164,372, PUB. 4-10-2012. INT. CL. 44.
- MOUNTAINSIDE FARMS - A DIVISION OF WORCESTER
CREAMERIES CORP., ROXBURY, NY:
4,166,023, INT. CL. 29.
- MOVE COLLECTIVE LLC, NEW YORK, NY:
4,164,473, PUB. 4-10-2012. INT. CL. 11.
- MOZART NETWORKS, LLC, NEW YORK, NY:
4,165,306, INT. CL. 42.
- MPEG LA, LLC, GREENWOOD VILLAGE, CO:
4,164,935, INT. CL. 45.
- MR. STEAK, INC., DENVER, CO:
859,814, CANC. U.S. CL. 100.
- MSA VANITY FAIR ENTERPRISES, LLC, WILKES-BARRE,
PA, S. A. PECK & COMPANY, CHICAGO, IL:
727,481. REN. 5-23-12. U.S. CL. 28 (INT. CL. 14).

MSCRIPTS, LLC, SAN FRANCISCO, CA:
 4,164,838, MULTIPLE CLASS, INT. CLS. 9, 35 AND 42.
 MSD CONSUMER CARE, INC., MEMPHIS, TN:
 4,165,308, INT. CL. 25.
 MSI CONSULTING GROUP, LLC, FORT SMITH, AR:
 2,578,844, REN. 5-18-12, INT. CL. 9.
 MUÑOZ WATANABE, ENRIQUE GUILLERMO, CHULA
 VISTA, CA:
 4,163,516, PUB. 4-10-2012, INT. CL. 35.
 MUELLER INTERNATIONAL, INC., ATLANTA, GA,
 MUELLER CO., DECATUR, IL:
 937,392, REN. 5-18-12, U.S. CL. 13 (INT. CL. 6).
 MUL-T-LOCK LTD., YAVNE, ISRAEL:
 4,162,783, PUB. 4-10-2012, MULTIPLE CLASS, INT. CLS. 6
 AND 9.
 MULCH, CLYDE, MANAHAWKIN, NJ:
 4,165,657, INT. CL. 25.
 MULLINS, MICHAEL PATRICK, SIMI VALLEY, CA, DBA
 THE GYM DOCTOR:
 4,163,460, PUB. 4-10-2012, INT. CL. 37.
 MULTI DIMENSIONAL IMAGING, LLC, HALLANDALE
 BEACH, FL, DBA SONOSMILE:
 4,164,276, PUB. 4-10-2012, INT. CL. 42.
 MULTI PACKAGING SOLUTIONS, INC., LANSING, MI:
 4,165,098, MULTIPLE CLASS, INT. CLS. 16 AND 44,
 4,165,102, INT. CL. 16,
 4,165,103, INT. CL. 16.
 MULTIFARIOUS PUBLICA GROUP, LLC, WHITE RIVER
 JCT, VT:
 4,164,458, PUB. 4-10-2012, INT. CL. 3.
 MULTIMEDIA GAMES, INC., AUSTIN, TX:
 4,163,695, PUB. 4-10-2012, MULTIPLE CLASS, INT. CLS. 9
 AND 41.
 MULTITASK123, LLC, SUNRISE, FL:
 4,165,920, INT. CL. 42.
 MULTNOMAH PUBLISHERS, INC., SISTERS, OR:
 3,006,665, CANC. INT. CL. 16.
 MUNNINGS, MICHAEL F., MELBOURNE, FL:
 4,164,079, PUB. 4-10-2012, INT. CL. 30.
 MUNSON REALTY CO., INC., CHESTERLAND, OH:
 4,163,449, PUB. 4-10-2012, INT. CL. 41.
 MURPHY, BRENT P., LEWISVILLE, TX:
 4,163,209, PUB. 4-10-2012, INT. CL. 42.
 MURRAY'S CHEESE LLC, NEW YORK, NY:
 4,164,824, INT. CL. 30.
 MUSIC COMPASS LLC, NASHVILLE, TN:
 4,164,357, PUB. 4-10-2012, INT. CL. 41.
 MUSIC DOING GOOD, INC., HOUSTON, TX:
 4,163,950, PUB. 4-10-2012, INT. CL. 35.
 MUSIC SUPPLY CO., INC., ARLINGTON, TX:
 1,194,493, REN. 5-18-12, INT. CL. 7.
 MUSICAL INSTRUMENT MUSEUM, PHOENIX, AZ:
 4,165,888, INT. CL. 41.
 MUSICAS LLC, SAN JOSE, CA:
 4,165,476, MULTIPLE CLASS, INT. CLS. 38 AND 42.
 MUSIDOR B.V., AMSTERDAM, NETHERLANDS:
 1,358,893, CANC. MULTIPLE CLASS, INT. CLS. 9 AND
 41.
 MUSTANG DEVELOPMENT, LLC, SALT LAKE CITY, UT:
 3,006,441, CANC. INT. CL. 37.
 MUTLUKAN, ERKAN, WESTBORO, MA:
 3,006,375, CANC. MULTIPLE CLASS, INT. CLS. 42 AND
 44.
 MUTOH HOLDINGS CO., LTD., JAPAN:
 4,163,039, PUB. 4-10-2012, INT. CL. 2.
 MUTUAL MATERIALS COMPANY, BELLEVUE, WA:
 4,163,735, PUB. 4-10-2012, INT. CL. 19.
 MUTUAL OF OMAHA INSURANCE COMPANY, OMAHA,
 NE:
 2,702,353, REN. 5-22-12, INT. CL. 36.
 MUTUAL SERVICE CORPORATION, WEST PALM BEACH,
 FL:
 3,006,404, CANC. INT. CL. 36.
 MVP GROUP INTERNATIONAL, INC., CHARLESTON, SC:
 3,006,187, CANC. MULTIPLE CLASS, INT. CLS. 6, 15, 16,
 20, 21, 24, 26, 28 AND 35.
 MY LITTLE UNIVERSE LTD, VICTORIA, SEYCHELLES:
 4,163,517, PUB. 4-10-2012, INT. CL. 3.
 4,163,518, PUB. 4-10-2012, INT. CL. 35.
 MY MUSIC MACHINES, INC., SCOTIA, NY:
 4,164,287, PUB. 4-10-2012, INT. CL. 15.
 MY PAYBOOK, LLC, SAN ANTONIO, TX:
 4,163,531, PUB. 4-10-2012, INT. CL. 42.
 MYCONE DENTAL SUPPLY CO., INC., CHERRY HILL, NJ:
 2,592,917, REN. 5-21-12, INT. CL. 10.
 MYERS INDUSTRIES, INC., AKRON, OH:
 2,694,511, REN. 5-19-12, INT. CL. 35.
 MYKITA STUDIO GMBH, FED REP GERMANY:
 4,162,814, PUB. 4-10-2012, INT. CL. 9.
 MYPERFECTCOLOR LLC, LIVINGSTON, NJ:
 4,163,747, PUB. 4-10-2012, INT. CL. 2.
 N.V. PERRICONE LLC, MERIDEN, CT:
 4,165,901, INT. CL. 3.
 NAC MARKETING COMPANY, LLC, FARMINGDALE, NY:
 2,582,447, REN. 5-18-12, INT. CL. 5.
 NADIA ALLAUDIN, NORTHRIDGE, CA:
 4,164,945, INT. CL. 41.
 NAGRA FRANCE SAS, PARIS, FRANCE:
 2,498,529, CANC. MULTIPLE CLASS, INT. CLS. 9, 16
 AND 38.
 NAGY-BURNS, GINA K., WEEHAWKEN, NJ:
 4,163,305, PUB. 4-10-2012, MULTIPLE CLASS, INT. CLS.
 37 AND 42.
 NAJOOM, DENNIS GEORGE, MUSKEGO, WI, DBA NA-
 JOOM MUSIC PRODUCTS, INC.:
 4,163,701, PUB. 4-10-2012, MULTIPLE CLASS, INT. CLS. 4
 AND 15.
 NAKANO, ROY, Y, MONROVIA, CA:
 2,578,893, REN. 5-19-12, INT. CL. 42.
 NALCO COMPANY, NAPERVILLE, IL:
 4,165,346, MULTIPLE CLASS, INT. CLS. 9 AND 42.
 NAMASTE LABORATORIES, L.L.C., BLUE ISLAND, IL:
 2,570,801, REN. 5-21-12, INT. CL. 3.
 NAMCO BANDAI GAMES INC., SHINAGAWA-KU TOKYO,
 JAPAN:
 4,165,185, INT. CL. 9.
 NAMET GIDA SANAYI VE TICARET ANONIM SIRKETI,
 TURKEY:
 4,162,936, PUB. 4-10-2012, INT. CL. 29.
 NAN YANG FABRIC CO., LTD, AMPHOR KHOA-YOI,
 THAILAND:
 4,165,206, MULTIPLE CLASS, INT. CLS. 24 AND 25.
 NANCY LEE, D. D. S., INC., BURBANK, CA:
 2,549,618, REN. 5-19-12, INT. CL. 42.
 NANKANG RUBBER TIRE CORP., LTD., TAIPEI, TAIWAN:
 2,932,721, CANC. INT. CL. 12.
 NANOTROPIC S.A., ATHENS, GREECE:
 4,165,314, INT. CL. 9.
 NANTONG AUBADE ENTERPRISE CO.,LTD, CHINA:
 4,162,952, PUB. 4-10-2012, INT. CL. 25.
 NANYANG TECHNOLOGICAL UNIVERSITY, SINGA-
 PORE:
 4,162,917, PUB. 4-10-2012, MULTIPLE CLASS, INT. CLS.
 16 AND 36.
 4,162,920, PUB. 4-10-2012, MULTIPLE CLASS, INT. CLS.
 16 AND 36.
 4,162,921, PUB. 4-10-2012, MULTIPLE CLASS, INT. CLS.
 16 AND 36.
 4,162,922, PUB. 4-10-2012, MULTIPLE CLASS, INT. CLS.
 16 AND 36.
 4,162,923, PUB. 4-10-2012, MULTIPLE CLASS, INT. CLS.
 16 AND 36.
 NARCO INVESTORS, INC., CLEVELAND, OH:
 857,773, CANC. U.S. CL. 12.
 857,774, CANC. U.S. CL. 12.
 857,775, CANC. U.S. CL. 12.
 NASUNI CORPORATION, NATICK, MA:
 4,164,896, INT. CL. 9.
 NATIONAL AGRICULTURAL AVIATION ASSOCIATION,
 WASHINGTON, DC:
 2,573,409, REN. 5-19-12, INT. CL. 42.
 NATIONAL AIR FILTRATION ASSOCIATION, VIRGINIA
 BEACH, VA:
 4,165,222, MULTIPLE CLASS, INT. CLS. 35, 41 AND 42.

- NATIONAL ASSOCIATION OF CHILD CARE RESOURCE & REFERRAL AGENCIES, ARLINGTON, VA:
4,162,775, PUB. 4-10-2012. MULTIPLE CLASS, INT. CLS. 16, 35 AND 41.
- NATIONAL ASSOCIATION OF MINIATURE ENTHUSIASTS, CARMEL, IN:
4,164,595, PUB. 4-10-2012. INT. CL. 35.
- NATIONAL ASSOCIATION OF SECURITIES DEALERS, INC., WASHINGTON, DC:
1,280,122, CANC. INT. CL. 36.
- NATIONAL ASSOCIATION OF TOURNAMENT DIRECTORS, LLC, FLEMINGTON, NJ:
4,166,040, MULTIPLE CLASS, INT. CLS. 16, 35 AND 41.
- NATIONAL CAPITAL GROUP, LLC, SALT LAKE CITY, UT:
4,164,043, PUB. 4-10-2012. INT. CL. 36.
- NATIONAL CENTER FOR CONSTRUCTION EDUCATION AND RESEARCH, GAINESVILLE, FL:
4,163,528, PUB. 4-10-2012. INT. CL. 35.
4,163,529, PUB. 4-10-2012. INT. CL. 35.
- NATIONAL COMMERCE BANCORPORATION, MEMPHIS, TN:
1,206,488, CANC. INT. CL. 36.
- NATIONAL CONDO & APARTMENT INSURANCE GROUP, LLC, WEST CHESTER, OH:
4,164,003, PUB. 4-10-2012. INT. CL. 36.
- NATIONAL COUNCIL OF YOUNG MEN'S CHRISTIAN ASSOCIATIONS OF THE UNITED STATES OF AMERICA, CHICAGO, IL:
4,166,074, INT. CL. 41.
- NATIONAL DEMOGRAPHICS & LIFESTYLES INC., DENVER, CO:
1,319,806, CANC. INT. CL. 35.
- NATIONAL DIVERSIFIED SALES, INC., WOODLAND HILLS, CA:
4,165,979, INT. CL. 19.
- NATIONAL ELEVATOR INDUSTRY EDUCATIONAL PROGRAM, ATTLEBORO FALLS, MA:
1,750,472, REN. 5-21-12. INT. CL. 41.
- NATIONAL GARDENING ASSOCIATION, INC., SOUTH BURLINGTON, VT:
4,162,710, PUB. 4-10-2012. INT. CL. 41.
- NATIONAL HEALTH PROMOTION ASSOCIATES, INC., WHITE PLAINS, NY:
2,571,031, REN. 5-22-12. INT. CL. 41.
- NATIONAL HERITAGE ACADEMIES, INC., GRAND RAPIDS, MI:
3,006,182, CANC. INT. CL. 41.
- NATIONAL INDEPENDENT DISTRIBUTOR ASSOCIATES, INC., MINNEAPOLIS, MN:
861,305, CANC. U.S. CL. 19.
- NATIONAL INSTITUTE OF MILITARY JUSTICE, WASHINGTON, DC:
4,163,228, PUB. 4-10-2012. MULTIPLE CLASS, INT. CLS. 16, 41 AND 45.
4,163,231, PUB. 4-10-2012. MULTIPLE CLASS, INT. CLS. 16, 41 AND 45.
- NATIONAL INTERFRATERNITY CONFERENCE, INC., INDIANAPOLIS, IN:
860,304, CANC. U.S. CL. 100.
- NATIONAL OVARIAN CANCER COALITION, INC., PLEASANTAN, CA:
4,165,659, MULTIPLE CLASS, INT. CLS. 35, 44 AND 45.
- NATIONAL REGISTRY OF EMERGENCY MEDICAL TECHNICIANS, COLUMBUS, OH:
4,165,374, U.S. CL. B.
- NATIONAL RESTAURANT ASSOCIATION EDUCATIONAL FOUNDATION, THE, CHICAGO, IL:
2,983,707, CANC. INT. CL. 16.
- NATIONAL STARCH LLC, BRIDGEWATER, NJ:
502,067, CANC. U.S. CL. 6.
- NATIONAL TOBACCO COMPANY, L.P., LOUISVILLE, KY:
501,533, CANC. U.S. CL. 17.
4,164,901, INT. CL. 34.
- NATREN, INC., LOS ANGELES, CA:
1,690,706, REN. 5-18-12. INT. CL. 5.
- NATURAL FACTORS NUTRITIONAL PRODUCTS LTD., COQUITLAM, BRITISH COLUMBIA:
2,570,247, REN. 5-18-12. INT. CL. 5.
- NATURAL HEALTH TRENDS CORP., DALLAS, TX:
4,164,375, PUB. 4-10-2012. INT. CL. 5.
- NATURAL TECHNOLOGIES INC., AUBURN, NH:
4,163,925, PUB. 4-10-2012. INT. CL. 1.
- NATURAL WELLNESS CENTERS OF AMERICA, LAGUNA HILLS, CA:
2,624,530, REN. 5-24-12. INT. CL. 5.
2,696,528, REN. 5-24-12. INT. CL. 5.
- NATURAL WELLNESS, LLC, DEERFIELD BEACH, FL:
4,164,353, PUB. 4-10-2012. INT. CL. 5.
4,164,354, PUB. 4-10-2012. INT. CL. 5.
- NAVON, SAAR, BROOKLYN, NY:
4,163,216, PUB. 4-10-2012. MULTIPLE CLASS, INT. CLS. 40 AND 42.
- NAVSYS CORPORATION, COLORADO SPRINGS, CO:
4,163,635, PUB. 4-10-2012. INT. CL. 9.
- NAYA IP, LLC, WILMINGTON, DE:
2,573,255, REN. 5-22-12. INT. CL. 5.
- NBA PROPERTIES, INC., NEW YORK, NY, NATIONAL BASKETBALL ASSOCIATION, NEW YORK, NY:
938,213, REN. 5-19-12. U.S. CL. 100 (INT. CL. 42).
- NEASE CORPORATION, HARRISON, OH, RUETGERS-NEASE CHEMICAL COMPANY, INC., STATE COLLEGE, PA:
1,695,653, REN. 5-18-12. INT. CL. 1.
- NEBRASKA FURNITURE MART, INC, OMAHA, NE:
4,165,720, MULTIPLE CLASS, INT. CLS. 6 AND 9.
- NEC CORPORATION OF AMERICA, IRVING, TX:
2,599,689, REN. 5-19-12. INT. CL. 9.
- NEIL A WHITWORTH JR., FERNLEY, NV:
4,163,789, PUB. 4-10-2012. INT. CL. 35.
- NEIL S. SEMMEL, BEAR, DE:
2,702,664, REN. 5-23-12. INT. CL. 41.
- NELLCOR PURITAN BENNETT LLC, BOULDER, CO:
2,573,302, REN. 5-19-12. INT. CL. 9.
- NELSON BROTHERS, INC., BIRMINGHAM, AL:
4,164,820, INT. CL. 1.
- NELSON, ROBERT, DIMMITT, TX:
4,165,853, INT. CL. 37.
- NEMAT INTERNATIONAL INC., FREMONT, CA:
4,163,836, PUB. 4-10-2012. INT. CL. 3.
- NEON RAIN INTERACTIVE, LLC, THORNTON, CO:
4,163,688, PUB. 4-10-2012. INT. CL. 9.
- NER DATA CORPORATION, GLASSBORO, NJ:
2,580,508, REN. 5-21-12. INT. CL. 9.
- NERGECO (S.A.), DUNIERES, FRANCE, KRAEUTLER, BERNARD, 43220 DUNIERER, FRANCE:
1,666,746, REN. 5-23-12. INT. CL. 19.
- NESTEOR OURANITSAS, LEVITTOWN, NY, AKA NASTY NESS:
4,163,764, PUB. 4-10-2012. INT. CL. 9.
- NETWORK ENTERPRISES, INC., NEW YORK, NY:
4,165,898, INT. CL. 41.
- NETWORK SOLUTIONS, LLC, HERNDON, VA:
2,516,314, REN. 5-21-12. MULTIPLE CLASS, INT. CLS. 35, 38 AND 42.
- NEUROSKY, INC., SAN JOSE, CA:
4,165,280, INT. CL. 9.
- NEUTROGENA CORPORATION, LOS ANGELES, CA:
2,583,648, REN. 5-18-12. INT. CL. 3.
- NEVADA PROPERTY 1 LLC, LAS VEGAS, NV:
4,163,600, PUB. 4-10-2012. MULTIPLE CLASS, INT. CLS. 41 AND 43.
- NEW BERRY, INC., HARMONY, PA:
1,172,837, REN. 5-18-12. MULTIPLE CLASS, INT. CLS. 6, 7 AND 11.
- NEW CENTURY HOLDINGS, INC., EDEN PRAIRIE, MN:
3,720,104, COR. INT. CL. 30.
- NEW COLT HOLDING CORP., WEST HARTFORD, CT, CF INTELLECTUAL PROPERTY LIMITED PARTNERSHIP, WETHERSFIELD, CT:
1,686,290, REN. 5-18-12. INT. CL. 13.
- NEW DOVER GROUP, VALLEY COTTAGE, NY:
4,165,399, INT. CL. 14.
- NEW ENGLAND CONFECTIONERY COMPANY, INC., REVERE, MA:
4,165,557, INT. CL. 30.

NEW ENGLAND SOUP FACTORY, LTD., NEWTON, MA:
2,460,877. REN. 5-24-12. INT. CL. 42.

NEW ENGLAND SPORTS NETWORK, LP, BOSTON, MA:
4,163,246. PUB. 4-10-2012. MULTIPLE CLASS, INT. CLS.
35 AND 41.

NEW ENGLAND TEA & COFFEE CO., INC., MALDEN, MA:
4,165,237. INT. CL. 30.

NEW ERA CAP CO., INC., BUFFALO, NY:
4,164,724. PUB. 4-10-2012. INT. CL. 25.

NEW ERA PUBLISHING, INC., AUSTIN, TX:
4,163,719. PUB. 4-10-2012. INT. CL. 35.

NEW HERMES, INCORPORATED, NEW YORK, NY:
780,468. CANC. U.S. CL. 14.

NEW IMAGE COATINGS, LLC, MANCHESTER, NH:
4,164,382. PUB. 4-10-2012. INT. CL. 1.

NEW PROCESS COMPANY, WARREN, PA:
854,692. CANC. U.S. CL. 39.

NEW WAVE GROUP LICENSING S.A., CORTAILLOD 2016,
SWITZERLAND:
4,165,023. INT. CL. 28.

NEW WORLD AVIATION, INC, ALLENTOWN, PA:
4,164,586. PUB. 4-10-2012. MULTIPLE CLASS, INT. CLS.
35, 37, 39 AND 45.

NEW YORK BATTERY AND ENERGY STORAGE TECHNOLOGY
CONSORTIUM, INC., ALBANY, NY:
4,163,133. PUB. 4-10-2012. MULTIPLE CLASS, INT. CLS.
35, 41 AND 42.

NEW YORK STATE DEPARTMENT OF ECONOMIC DEVELOPMENT,
ALBANY, NY:
2,573,186. REN. 5-18-12. MULTIPLE CLASS, INT. CLS. 35,
36 AND 42.

NEW YORK STATE OFFICE FOR TECHNOLOGY, ALBANY,
NY:
2,571,013. REN. 5-24-12. INT. CL. 38.

NEWMAN, JEFFREY, ST. PETERSBURG, FL:
2,499,050. CANC. INT. CL. 36.

NEWS CAFE, INC., MIAMI BEACH, FL:
1,724,400. REN. 5-24-12. INT. CL. 42.
1,741,975. REN. 5-19-12. INT. CL. 42.

NEWS CANADA INC., TORONTO, ONTARIO, CANADA:
4,165,985. INT. CL. 35.

NEXON KOREA CORPORATION, SEOUL, DEM REP OF KOREA:
4,164,983. MULTIPLE CLASS, INT. CLS. 9 AND 41.

NEXT GENERATIONS, INC., MAME, MI:
2,497,837. CANC. INT. CL. 20.

NEXT ISSUE MEDIA, LLC, NEW YORK, NY:
4,165,484. MULTIPLE CLASS, INT. CLS. 35, 38 AND 41.

NEXTAGE REALTY INTERNATIONAL, LLC, JOHNS CREEK,
GA:
4,163,299. PUB. 4-10-2012. INT. CL. 41.

NEXTROM OY, VANTAA, FINLAND:
2,568,798. REN. 5-21-12. MULTIPLE CLASS, INT. CLS. 7
AND 9.

NEXTSPACE COWORKING & INNOVATION, INC., SANTA CRUZ,
CA:
4,163,649. PUB. 4-10-2012. MULTIPLE CLASS, INT. CLS.
35, 36 AND 42.

NIAMANIA, INC., BROOKLYN, NY:
4,162,798. PUB. 4-10-2012. INT. CL. 41.

NICELY DONE SOLUTIONS, INC., BERKELEY, CA:
2,498,932. CANC. INT. CL. 9.

NICHOLAS HASLAM LIMITED, LONDON, UNITED KINGDOM:
4,163,444. PUB. 4-10-2012. MULTIPLE CLASS, INT. CLS.
11, 18, 20, 21, 24, 27, 35 AND 42.

NICOLON CORPORATION, PENDERGRASS, GA, NICOLON
CORPORATION, PENDERGRASS, GA:
1,206,221. REN. 5-18-12. INT. CL. 22.

NIEMANN FOODS, INC., QUINCY, IL:
4,166,055. MULTIPLE CLASS, INT. CLS. 29 AND 30.

NIGHT FURY, INC., LAGUNA BEACH, CA:
4,163,775. PUB. 4-10-2012. INT. CL. 43.

NIKE, INC., BEAVERTON, OR, NIKE, INC., BEAVERTON,
OR:
1,686,515. REN. 5-18-12. INT. CL. 25.

NIKE, INC., BEAVERTON, OR:
2,571,314. REN. 5-23-12. MULTIPLE CLASS, INT. CLS. 25
AND 28.

NIKSOR, INC., SCOTTSDALE, AZ:
2,499,131. CANC. INT. CL. 42.

NINE TREASURES LLC, ESPANOLA, NM, AKA NINE
TREASURES:
4,165,076. INT. CL. 14.

NINE WEST DEVELOPMENT CORPORATION, WILMINGTON,
DE:
2,571,795. REN. 5-21-12. MULTIPLE CLASS, INT. CLS. 1,
3 AND 21.

NINETEENTH SPIRITS, INC., RYE BROOK, NY:
4,164,660. PUB. 4-10-2012. INT. CL. 33.

NINGBO ETDZ HOLDINGS LTD., ZONE 315012, CHINA:
3,275,410 NEW CERT. 6-26-2012. MULTIPLE CLASS, INT.
CLS. 21, 24 AND 25.

NINGBO XINYANG WEIYE IMPORT & EXPORT CO., LTD.,
NINGBO, CHINA:
4,165,541. INT. CL. 6.

NINTENDO OF AMERICA INC., REDMOND, WA:
1,689,015. REN. 5-21-12. MULTIPLE CLASS, INT. CLS. 16,
28 AND 37.
2,578,692. REN. 5-24-12. INT. CL. 9.
4,165,027. INT. CL. 9.
4,165,097. INT. CL. 9.

NIQUE DENTAL PLLC, SUGAR LAND, TX:
4,165,843. INT. CL. 44.

NISA INVESTMENT ADVISORS, L.L.C., ST. LOUIS, MO:
4,164,058. PUB. 4-10-2012. INT. CL. 36.

NISO BIOMED SRL, ITALY:
4,162,841. PUB. 4-10-2012. INT. CL. 10.

NISSAN JIDOSHA KABUSHIKI KAISHA, YOKOHAMA-SHI,
KANAGAWA, JAPAN, DBA NISSAN MOTOR CO., LTD.:
4,164,943. INT. CL. 12.

NISSIN CHEMICAL INDUSTRY CO. LTD., JAPAN:
4,162,820. PUB. 4-10-2012. MULTIPLE CLASS, INT. CLS.
1, 2, 17 AND 19.

NIT, LLC, NEW YORK, NY:
2,569,491. REN. 5-19-12. INT. CL. 41.
2,577,594. REN. 5-19-12. INT. CL. 41.

NM NEVADA TRUST, LAS VEGAS, NV:
863,351. CANC. MULTIPLE CLASS, U.S. CLS. 3 AND 39.

NOKA COMPANY, PLANO, TX:
2,985,423. CANC. INT. CL. 30.
2,985,539. CANC. INT. CL. 30.

NOKIA CORPORATION, FINLAND:
3,705,578. COR. MULTIPLE CLASS, INT. CLS. 9, 40 AND
42.

NOONAN, SPENCER, LONDON, CANADA:
4,165,502. INT. CL. 35.

NOR-LAKE, INCORPORATED, SALEM, NH:
2,653,484. REN. 5-24-12. MULTIPLE CLASS, INT. CLS. 9
AND 11.

NORCRAFT COMPANIES, L.P., EAGAN, MN, STARMARK,
INC., SIOUX FALLS, SD:
1,761,395. REN. 5-23-12. INT. CL. 20.

NORCRAFT COMPANIES, LLC, EAGAN, MN:
2,499,186. CANC. INT. CL. 40.

NORMAN DOIDGE, M.D., TORONTO, ONTARIO, CANADA:
4,165,017. MULTIPLE CLASS, INT. CLS. 9, 41 AND 42.

NORMARK CORPORATION, MINNEAPOLIS, MN:
857,855. CANC. U.S. CL. 22.

NORRØNA SPORT AS, NORWAY:
3,051,011.

NORRØNA SPORT AS, N-1395 HVALSTAD, NORWAY:
3,076,852.

NORTH AMERICAN BICI INC., MISSISSAUGA, ONTARIO,
CANADA:
2,980,093. CANC. MULTIPLE CLASS, INT. CLS. 12, 25
AND 35.

NORTH AMERICAN PHARMACAL, INC., WILTON, CT:
4,164,050. PUB. 4-10-2012. INT. CL. 5.

NORTH AMERICAN ROCKWELL CORPORATION, PITTSBURGH,
PA TO BRUNSWICK CORPORATION, LAKE FOREST, IL:
862,299. CANC. U.S. CL. 19.

NORTH BANK, CHICAGO, IL:
2,678,214. REN. 5-24-12. INT. CL. 16.

- NORTH COUNTY BASEBALL LLC, SAN DIEGO, CA:
2,567,269. REN. 5-18-12. INT. CL. 41.
- NORTH SHORE ADVENTURES, LLC, BEULAH, MI, DBA
MANISTEE RIVER SALMON GUIDE SERVICE:
4,163,650. PUB. 4-10-2012. INT. CL. 39.
- NORTH SHORE ADVENTURES, LLC, TRAVERSE CITY,
MI, DBA TRAVERSE CITY BASS:
4,164,777. PUB. 4-10-2012. INT. CL. 39.
- NORTHCAN GROUP INC., SAINT-JOHN (NEW BRUNS-
WICK), CANADA, AKA MEGA FOREST PRODUCTS:
3,006,412. CANC. INT. CL. 19.
- NORTHEAST GARAGE DOOR SYSTEMS, LLC, PLAIN-
VILLE, CT:
2,570,690. REN. 5-19-12. INT. CL. 37.
- NORTHERN CUSTOM DEVELOPMENT AND INTEGRA-
TION, FARGO, ND:
4,164,385. PUB. 4-10-2012. INT. CL. 35.
- NORTHERN INNOVATIONS HOLDING CORP., OAK-
VILLE, CANADA:
4,165,171. INT. CL. 5.
- NORTHERN PACIFIC RESOURCES, LLC, MINNEAPOLIS,
MN:
4,164,865. MULTIPLE CLASS, INT. CLS. 40 AND 42.
- NORTHSTAR RESTAURANTS, INC., LENEXA, KS:
4,164,583. PUB. 4-10-2012. INT. CL. 43.
- NORTHWEST FLORIDA PROFESSIONAL BASEBALL, LLC,
PENSACOLA, FL:
4,165,721. INT. CL. 41.
- NORTHWEST HEALTHCARE CORPORATION, KALIS-
PELL, MT:
4,163,988. PUB. 4-10-2012. INT. CL. 44.
- NORTHWEST MOTORSPORT, INC., PUYALLUP, WA:
4,164,028. PUB. 4-10-2012. INT. CL. 35.
- NORTHWOOD PL HOLDINGS, LLC, NEW YORK, NY:
4,166,078. INT. CL. 35.
- NOS S.R.L., 20123 MILAN, ITALY:
3,005,284. CANC. INT. CL. 25.
- NOURBEL S.A., GENEVA, SWITZERLAND:
4,163,906. PUB. 4-10-2012. MULTIPLE CLASS, INT. CLS.
14 AND 35.
- NOVAGALI PHARMA SA, F-91058 EVRY CEDEX, FRANCE:
3,964,639. CANC. MULTIPLE CLASS, INT. CLS. 5, 42
AND 44.
- NOVALED AG, FED REP GERMANY:
4,162,899. PUB. 4-10-2012. MULTIPLE CLASS, INT. CLS. 1
AND 9.
- NOVAQUEST LLC, CHARLOTTE, NC:
4,164,197. PUB. 4-10-2012. INT. CL. 9.
- NOVARTIS AG, SWITZERLAND:
3,004,544.
- NOVARTIS AG, BASEL, SWITZERLAND:
3,005,596. CANC. INT. CL. 5.
- NOVARTIS AG, SWITZERLAND:
3,051,072.
- NOVARTIS AG, BASEL, SWITZERLAND:
4,163,553. PUB. 4-10-2012. INT. CL. 44.
4,165,266. INT. CL. 10.
- NOVASEP PROCESS, POMPEY, FRANCE:
3,159,639. CANC. INT. CL. 11.
- NOVATION S.P.A., 31044 MONTEBELLUNA (TV), ITALY:
3,005,616. CANC. MULTIPLE CLASS, INT. CLS. 9, 18
AND 25.
- NOWPAK, INC., BURLINGAME, CA:
4,164,641. PUB. 4-10-2012. INT. CL. 20.
4,164,642. PUB. 4-10-2012. INT. CL. 20.
- NRG ENERGY, INC., PRINCETON, NJ:
4,165,842. MULTIPLE CLASS, INT. CLS. 35 AND 37.
4,165,874. MULTIPLE CLASS, INT. CLS. 36, 37 AND 40.
- NSF INTERNATIONAL, ANN ARBOR, MI:
4,165,281. MULTIPLE CLASS, INT. CLS. 41, 42 AND 45.
- NTV, L.L.C., NANTUCKET, MA:
2,964,562. COR. INT. CL. 41.
- NULAIID FOODS, INC., RIPON, CA:
1,748,680. REN. 5-19-12. INT. CL. 29.
- NUNATURALS, INC., EUGENE, OR:
4,163,816. PUB. 4-10-2012. MULTIPLE CLASS, INT. CLS. 5
AND 30.
- NUPLA CORPORATION, SUN VALLEY, CA:
858,248. CANC. U.S. CL. 23.
- NURSE JAMIE, INC., SANTA MONICA, CA:
4,165,045. INT. CL. 3.
- NURSETOGETHER LLC, SAGAMORE, MA:
4,163,127. PUB. 4-10-2012. MULTIPLE CLASS, INT. CLS.
35 AND 44.
- NURSING HOME QUALITY, LLC, CENTENNIAL, CO:
4,165,944. INT. CL. 42.
- NUTRA FOOD INGREDIENTS, LLC, KENTWOOD, MI:
4,163,565. PUB. 4-10-2012. INT. CL. 1.
- NUTRAFUELS, PARKLAND, FL:
4,164,434. PUB. 4-10-2012. INT. CL. 5.
- NUTRI/SYSTEM IPHC, INC., WILMINGTON, DE:
2,945,918. CANC. INT. CL. 5.
2,965,354. CANC. MULTIPLE CLASS, INT. CLS. 29, 30
AND 44.
- NUTRITION CENTER, INC., DOUGLAS, WY:
2,616,958. REN. 5-22-12. INT. CL. 5.
- NUVASIVE, INC., SAN DIEGO, CA:
4,165,332. INT. CL. 10.
- NUVERA FUEL CELLS, INC., BILLERICA, MA:
4,165,163. INT. CL. 9.
- NV ENERGY, INC., RENO, NV:
2,498,582. CANC. INT. CL. 41.
- NYCOMED GMBH, KONSTANZ, FED REP GERMANY:
3,005,273. CANC. INT. CL. 5.
- NZT PRODUCTS, LLC, TOMS RIVER, NJ:
4,062,965. AM. INT. CL. 28.
4,062,967. AM. INT. CL. 28.
- O'BRIEN, MARK C., WHITE LAKE, MI:
1,689,394. REN. 5-23-12. INT. CL. 42.
- O'CONNOR JR., HAROLD JOHN, FAIRFAX, VA:
4,164,982. INT. CL. 41.
- OAKENHALL CLOTHING COMPANY LIMITED, THE,
HUCKNALL, NOTTINGHAM NG15 7BH, ENGLAND:
3,005,296. CANC. MULTIPLE CLASS, INT. CLS. 24 AND
25.
- OAKLEY, INC., FOOTHILL RANCH, CA, OAKLEY, INC.,
IRVINE, CA:
1,687,647. REN. 5-22-12. INT. CL. 9.
- OBJECT PUBLISHING SOFTWARE, INC., SEATTLE, WA:
4,165,779. INT. CL. 42.
- OBSHESTVO S OGRANICHENNOY OTVETSTVENNOS-
TYU "DRIMMI", RU-115191 MOSKVA, RUSSIAN FED.:
4,162,844. PUB. 4-10-2012. MULTIPLE CLASS, INT. CLS.
9, 35, 38, 41 AND 42.
- OBSHCHESTVO S OGRANICHENNOY OTVETSTVENNOS-
TYU "FONTINALIS", RUSSIAN FED.:
4,162,993. PUB. 4-10-2012. INT. CL. 9.
- OBSHESTVO S OGRANICHENNOY OTVETSTVENNOSTJU
"FB MEDIA SOLUTIONS", MOSCOW, RUSSIAN FED.,
DBA OOO "FB MEDIA SOLUTIONS":
4,105,882. COR. MULTIPLE CLASS, INT. CLS. 9, 35 AND
41.
- OCCIDENTAL CHEMICAL CORPORATION, NIAGARA
FALLS, NY:
857,729. CANC. U.S. CL. 6.
- OCHS, JOSHUA, SANTA MONICA, CA:
4,164,389. PUB. 4-10-2012. INT. CL. 35.
- OCLC ONLINE COMPUTER LIBRARY CENTER, INC.,
DUBLIN, OH:
2,569,357. REN. 5-21-12. INT. CL. 41.
- OCTOPUS CREATIVE, LLC, SANTA CRUZ, CA:
4,163,658. PUB. 4-10-2012. MULTIPLE CLASS, INT. CLS.
35 AND 42.
- ODL, INCORPORATED, ZEELAND, MI:
4,165,500. INT. CL. 19.
- OEM CONTROLS, INC., SHELTON, CT:
1,198,562. REN. 5-24-12. INT. CL. 9.
- OFFICE OF MEDICAL & SCIENTIFIC JUSTICE, INC.,
STUDIO CITY, CA:
4,164,161. PUB. 4-10-2012. INT. CL. 45.
4,164,162. PUB. 4-10-2012. INT. CL. 45.
4,164,163. PUB. 4-10-2012. INT. CL. 45.
- OFFICE OF THE COMMISSIONER OF BASEBALL, NEW
YORK, NY:
4,163,198. PUB. 4-10-2012. INT. CL. 41.

OFFICER, MICHAEL R., SANTA ROSA, CA AND OFFICER, KENDALL H., SANTA ROSA, CA:
4,164,802, INT. CL. 33.

OFFICERS ONLY INCORPORATED, ORDEN, UT:
3,006,379, CANC. INT. CL. 16.

OFFICINE PANERAI A.G., 6312 STEINHAUSEN, SWITZERLAND:
2,569,251, REN. 5-18-12. MULTIPLE CLASS, INT. CLS. 16, 18 AND 25.

OFFIT KURMAN, P.A., MAPLE LAWN, MD, AKA OFFIT KURMAN:
4,164,356, PUB. 4-10-2012. INT. CL. 45.

OFS FITEL, LLC, NORCROSS, GA:
4,164,776, PUB. 4-10-2012. INT. CL. 9.

OGUDO, PETER, CULVER CITY, CA:
4,164,790, MULTIPLE CLASS, INT. CLS. 18 AND 25.

OH! NUTS, BROOKLYN, NY:
2,580,536, REN. 5-24-12. INT. CL. 35.

OHIO TABLE PAD COMPANY, INC., PERRYSBURG, OH:
3,289,427, AM. INT. CL. 24.

OILGEAR COMPANY, THE, MILWAUKEE, WI:
557,611, REN. 5-23-12. U.S. CL. 13 (INT. CL. 7).

OJEDA MENDEZ, VICTOR MANUEL, SANTIAGO DE CHILE, CHILE:
2,619,129, REN. 5-23-12. INT. CL. 16.

OKI BERING MANAGEMENT CO., CINCINNATI, OH:
2,577,149, REN. 5-18-12. MULTIPLE CLASS, INT. CLS. 6 AND 9.

OKLAHOMA CITY MUSEUM OF ART, INC., OKLAHOMA CITY, OK:
4,164,285, PUB. 4-10-2012. INT. CL. 41.
4,164,290, PUB. 4-10-2012. INT. CL. 41.

OLCOTT, CARTER, MORRISTOWN, NJ:
4,165,357, MULTIPLE CLASS, INT. CLS. 25 AND 26.
4,165,361, MULTIPLE CLASS, INT. CLS. 25 AND 26.

OLDEMARK LLC, BURLINGTON, VT:
935,110, REN. 5-21-12. U.S. CL. 100 (INT. CL. 42).

OLGA COMPANY, VAN NUYS, CA:
780,385, CANC. U.S. CL. 39.

OLIVER INSTRUMENT COMPANY, ADRIAN, MI:
855,521, CANC. U.S. CL. 23.

OLSON VENTURES, LLC, SOLANA BEACH, CA:
4,163,450, PUB. 4-10-2012. INT. CL. 42.

OLSSON ASSOCIATES, INC., LINCOLN, NE:
4,165,799, INT. CL. 9.

OLUKAI, INC., IRVINE, CA:
4,163,947, PUB. 4-10-2012. INT. CL. 25.

OLY-OLA EDGINGS, INC., VILLA PARK, IL:
4,164,941, INT. CL. 20.

OLYMPIA DENTAL LHSO, INC, CHICAGO, IL:
2,497,768, CANC. INT. CL. 36.

OLYMPIA FABRIC STRUCTURES, LUCKNOW, ONTARIO, CANADA:
4,165,309, INT. CL. 6.

OMADA NUTRITION, INC., FORT MYERS, FL:
4,165,391, INT. CL. 5.

OMEGA ACQUISITION CORPORATION, HAMPSTEAD, MD, CASCHEM, INC., BAYONNE, NJ:
1,760,879, REN. 5-18-12. INT. CL. 1.

OMEGA MORGAN, INC., HILLSBORO, OR:
4,163,857, PUB. 4-10-2012. MULTIPLE CLASS, INT. CLS. 37 AND 39.

OMNI SERVICES, INC., CULPEPER, VA TO OMNI SERVICES, INC., CULPEPER, VA:
1,750,602, COR. INT. CL. 33.

OMNICOM ENGINEERING LIMITED, UNITED KINGDOM:
2,989,828.

OMNIPRINT, INC., LANHAM, MD:
2,498,726, CANC. MULTIPLE CLASS, INT. CLS. 35 AND 42.

ON-THE-TRACKS BREWERY LLC, CARLSBAD, CA:
4,164,358, PUB. 4-10-2012. INT. CL. 32.

ONDAL HOLDING GMBH, HUNFELD, FED REP GERMANY:
4,163,161, PUB. 4-10-2012. MULTIPLE CLASS, INT. CLS. 10, 11, 37 AND 42.
4,163,162, PUB. 4-10-2012. MULTIPLE CLASS, INT. CLS. 10, 11, 37 AND 42.

ONE CLICK MOTORS, LLC, COLUMBIA, MD:
4,164,964, MULTIPLE CLASS, INT. CLS. 35, 36 AND 42.

ONE EARTH RECYCLING, INC., EL CAJON, CA:
4,163,808, PUB. 4-10-2012. INT. CL. 37.

ONE HUNDRED SKIES LLC, HOBOKEN, NJ:
4,163,426, PUB. 4-10-2012. MULTIPLE CLASS, INT. CLS. 35 AND 41.

ONE MAN LEFT STUDIOS, LLC, MONTGOMERY, AL:
4,012,030, COR. INT. CL. 9.

ONE SHOT, INC., NEWTOWN, OH:
4,163,508, PUB. 4-10-2012. INT. CL. 13.

ONE TO ONE MD, P.A., FORT WORTH, TX:
3,006,195, CANC. INT. CL. 44.

ONEENERGY, INC., SEATTLE, WA, DBA ONEENERGY RENEWABLES:
4,163,054, PUB. 4-5-2011. MULTIPLE CLASS, INT. CLS. 36 AND 40.

ONESKY, INC., TOKYO 151-0051, JAPAN:
4,162,972, PUB. 4-10-2012. INT. CL. 25.

ONLY FASHION S.R.L., SAN BENEDETTO DEL TRONTO (AP), ITALY:
2,499,064, CANC. INT. CL. 25.

ONQ WORLDWIDE, INC., IRVINE, CA:
4,164,119, PUB. 4-10-2012. INT. CL. 34.

ONTEX BVBA, BELGIUM:
4,163,028, PUB. 4-10-2012. MULTIPLE CLASS, INT. CLS. 3, 5, 10 AND 16.

OOI, WUI YUH, WHEATON, MD:
4,163,670, PUB. 1-3-2012. INT. CL. 9.

OPDETOP, INC., CASTLE ROCK, CO:
4,164,324, PUB. 4-10-2012. INT. CL. 42.
4,164,328, PUB. 4-10-2012. INT. CL. 42.

OPEN RANGE RV COMPANY, INC., SHIPSHAWANA, IN:
4,165,538, INT. CL. 12.

OPEN SOURCE GROUP LLC, HENDERSON, NV:
4,166,079, MULTIPLE CLASS, INT. CLS. 41 AND 42.

OPEN THINK INC., TORONTO, CANADA:
4,164,782, PUB. 9-6-2011. INT. CL. 12.
4,164,783, PUB. 8-30-2011. INT. CL. 12.

OPENGLOBE, INC., INDIANAPOLIS, IN:
2,499,205, CANC. INT. CL. 35.

OPENNETWORK TECHNOLOGIES, INC., CLEARWATER, FL:
2,497,641, CANC. INT. CL. 9.

OPERATION WALK, INC., LOS ANGELES, CA:
2,716,606, REN. 5-23-12. INT. CL. 42.

OPTICON, INC., RENTON, WA:
2,642,063, REN. 5-19-12. INT. CL. 9.

OPTILINGUA US, INC, HICKORY, NC, DBA ALPHATRAD:
4,164,561, PUB. 4-10-2012. MULTIPLE CLASS, INT. CLS. 41 AND 42.

ORACLE AMERICA, INC., REDWOOD SHORES, CA:
2,497,599, CANC. INT. CL. 37.

ORAPHARMA INC., HORSHAM, PA:
2,601,899, REN. 5-18-12. MULTIPLE CLASS, INT. CLS. 5 AND 10.

ORCAS POWER AND LIGHT COOPERATIVE, EAST-SOUND, WA:
4,163,116, PUB. 4-10-2012. INT. CL. 39.

ORCHARD SUPPLY HARDWARE LLC, SAN JOSE, CA:
4,165,239, INT. CL. 31.

ORCID, INC., WILMINGTON, DE:
4,163,194, PUB. 4-10-2012. MULTIPLE CLASS, INT. CLS. 35 AND 42.

ORECK HOLDINGS, LLC, CHEYENNE, WY:
2,970,652, CANC. INT. CL. 3.

ORECK HOLDINGS, LLC, NASHVILLE, TN:
4,163,298, PUB. 4-10-2012. INT. CL. 7.

OREI LLC, NILES, IL, AKA OREI:
4,164,034, PUB. 4-10-2012. INT. CL. 9.

ORFEO MUSIC FESTIVAL, HOUSTON, TX:
4,163,257, PUB. 4-10-2012. INT. CL. 41.

ORFEVERIE CHRISTOFLE, 75008 PARIS, FRANCE:
1,205,177, REN. 5-23-12. INT. CL. 8.

ORGANIC BEVERAGES GROUP B.V., NETHERLANDS:
4,162,869, PUB. 4-10-2012. INT. CL. 32.

- ORGANIC BRONZE BAR, LLC, PORTLAND, OR:
4,163,997, PUB. 4-10-2012. INT. CL. 44.
- ORGANIC MILLING ACQUISITION LLC, SAN DIMAS, CA:
3,155,282, CANC. INT. CL. 29.
- ORI AYONMIKE, LOS ANGELES, CA:
4,163,182, PUB. 4-10-2012. INT. CL. 45.
- ORIENTAL INTERNATIONAL EQUIPMENT TRADING LIMITED, CENTRAL, HONG KONG:
4,163,669, PUB. 4-10-2012. MULTIPLE CLASS, INT. CLS. 6, 35 AND 39.
- ORION CORPORATION, SEOUL, REPUBLIC OF KOREA:
4,162,741, PUB. 4-10-2012. INT. CL. 30.
- ORISSA HOLDINGS, LLC, ARMONK, NY:
4,163,361, PUB. 4-10-2012. INT. CL. 9.
4,163,567, PUB. 4-10-2012. INT. CL. 9.
- ORLANDO/ORANGE COUNTY CONVENTION & VISITORS BUREAU, INC., ORLANDO, FL:
2,578,017. REN. 5-18-12. INT. CL. 35.
- ORLANE S.A., 75008 PARIS, FRANCE:
2,497,736, CANC. INT. CL. 3.
- OROGRAIN BAKERIES PRODUCTS, INC., HORSHAM, PA:
1,196,372. REN. 5-23-12. INT. CL. 30.
- ORTADOGU RULMAN SANAVI VE TICARET, A.S., LODUMLU, ANKARA, TURKEY:
2,603,329. REN. 5-20-12. INT. CL. 7.
- ORTHOPAEDIC SPECIALTY CENTER, BALTIMORE, MD:
4,164,515, PUB. 4-10-2012. INT. CL. 44.
- OSMOSE, INC., BUFFALO, NY:
4,164,768, PUB. 4-10-2012. INT. CL. 2.
- OTF GROUP, INC., BELMONT, MA:
2,506,652. REN. 5-21-12. INT. CL. 35.
- OTOVATION, LLC, KING OF PRUSSIA, PA:
4,164,399, PUB. 4-10-2012. INT. CL. 9.
- OTTIMINO LLC, OCCIDENTAL, CA:
2,589,300. REN. 5-21-12. INT. CL. 33.
- OTTO MÄNNER INNOVATION GMBH, FED REP GERMANY:
3,051,135.
- OTV SA, 94410 SAINT MAURICE, FRANCE:
3,005,383, CANC. MULTIPLE CLASS, INT. CLS. 11 AND 40.
- OUTCAST MARINE, INC., PINECREST, FL:
4,164,247, PUB. 4-10-2012. INT. CL. 45.
- OUTDOOR INSITE, LLC, MADISON, WI:
4,163,365, PUB. 4-10-2012. MULTIPLE CLASS, INT. CLS. 38, 42 AND 45.
- OVATIONS FOOD SERVICES, L.P., LUTZ, FL:
4,165,794, MULTIPLE CLASS, INT. CLS. 25 AND 43.
4,165,795, MULTIPLE CLASS, INT. CLS. 25 AND 43.
- OVERDRIVE, INC., CLEVELAND, OH:
4,163,223, PUB. 4-10-2012. MULTIPLE CLASS, INT. CLS. 9, 41 AND 42.
4,163,234, PUB. 4-10-2012. MULTIPLE CLASS, INT. CLS. 41 AND 42.
- OVERSTREET, J'ME, OKLAHOMA CITY, OK:
4,165,645, INT. CL. 28.
- OWENS CORNING INTELLECTUAL CAPITAL, LLC, TOLEDO, OH:
4,165,995, INT. CL. 19.
- OWENS-ILLINOIS GLASS CONTAINER INC., TOLEDO, OH:
505,963, CANC. U.S. CL. 33.
- OWENS, MARY ANN, N. CHARLESTON, SC:
4,163,843, PUB. 4-10-2012. INT. CL. 28.
- OY LIFA IAQ LTD, HELSINKI, FINLAND:
2,568,958. REN. 5-21-12. MULTIPLE CLASS, INT. CLS. 7 AND 11.
2,568,958, CANC. INT. CL. 37.
- OYSTER CONSULTING LLC, NEEDHAM, MA:
4,164,882, INT. CL. 9.
- OZ E TRADING POST PTY LTD, AUSTRALIA:
2,998,378.
- OZAKI INTERNATIONAL CO., LTD., SANCHONG CITY, TAIWAN:
4,164,121, PUB. 4-10-2012. INT. CL. 9.
- OZAKI INTERNATIONAL CO., LTD., NEW TAIPEI CITY, TAIWAN:
4,164,639, PUB. 4-10-2012. INT. CL. 9.
4,164,697, PUB. 4-10-2012. INT. CL. 9.
4,164,745, PUB. 4-10-2012. INT. CL. 9.
4,164,746, PUB. 4-10-2012. MULTIPLE CLASS, INT. CLS. 9 AND 10.
4,164,747, PUB. 4-10-2012. INT. CL. 9.
4,164,748, PUB. 4-10-2012. INT. CL. 9.
4,164,749, PUB. 4-10-2012. INT. CL. 9.
- P. H. GLATFELTER COMPANY, YORK, PA:
4,165,083, INT. CL. 35.
- PACIFIC BROTHERS WINE COMPANY, LLC, SAN FRANCISCO, CA:
4,165,601, INT. CL. 35.
- PACIFIC BUSINESS INSIGHTS, INC., PORT ANGELES, WA:
2,498,864, CANC. INT. CL. 30.
- PACIFIC CLINICS, ARCADIA, CA:
4,163,697, PUB. 4-10-2012. INT. CL. 43.
4,163,698, PUB. 4-10-2012. INT. CL. 44.
4,163,699, PUB. 4-10-2012. INT. CL. 44.
- PACIFIC COAST FEATHER COMPANY, SEATTLE, WA:
2,569,503. REN. 5-19-12. INT. CL. 20.
4,163,367, PUB. 4-10-2012. INT. CL. 20.
4,163,568, PUB. 4-10-2012. INT. CL. 20.
4,164,690, PUB. 4-10-2012. INT. CL. 20.
- PACIFIC COAST LIGHTING, CHATSWORTH, CA:
1,697,518. REN. 5-19-12. INT. CL. 11.
- PACIFIC CONTINENTAL TEXTILES, INC., RANCHO DOMINGUEZ, CA:
4,164,585, PUB. 4-10-2012. INT. CL. 25.
- PACKAGING DEPOT INC., NORTH VANCOUVER, BRITISH COLUMBIA, CANADA:
1,660,772, CANC. MULTIPLE CLASS, INT. CLS. 16, 17, 36, 39 AND 42.
- PACKET CLEARING HOUSE, INC., SAN FRANCISCO, CA, PACKET CLEARING HOUSE, INC., SAN FRANCISCO, CA:
2,570,176. REN. 5-21-12. MULTIPLE CLASS, INT. CLS. 41 AND 42.
- PADDINGTON & COMPANY, LTD., HERTFORDSHIRE, SG14 1JA, UNITED KINGDOM:
3,006,081, CANC. INT. CL. 9.
- PADDOCK LABORATORIES, LLC, ALLEGAN, MI:
2,618,255. REN. 5-18-12. INT. CL. 5.
- PADRES, L.P., SAN DIEGO, CA:
2,498,546, CANC. INT. CL. 28.
- PAINFUL PLEASURES, INC., HANOVER, MD:
4,163,743, PUB. 4-10-2012. MULTIPLE CLASS, INT. CLS. 9, 35, 38 AND 41.
- PAJALA B.V., 1076 AMSTERDAM, NETHERLANDS:
3,005,283, CANC. MULTIPLE CLASS, INT. CLS. 38 AND 42.
- PALINTEST LIMITED, GATESHEAD, TYNE & WEAR, UNITED KINGDOM:
4,163,577, PUB. 4-10-2012. INT. CL. 9.
- PALM BAY INTERNATIONAL, INC., PORT WASHINGTON, NY:
4,163,480, PUB. 4-10-2012. INT. CL. 33.
- PALM BEACH GARDENS COMMUNITY HOSPITAL, INC., DALLAS, TX:
4,164,164, PUB. 4-10-2012. INT. CL. 44.
- PALOMAR MEDICAL TECHNOLOGIES, INC., BURLINGTON, MA:
3,006,433, CANC. INT. CL. 10.
- PAM LERNER JEWELRY, INC., NEWTON CENTRE, MA, DBA PAGEO:
2,658,185. REN. 5-19-12. MULTIPLE CLASS, INT. CLS. 35 AND 42.
- PAMELA SMITH D/B/A MATHTYME, MILWAUKEE, WI:
4,164,305, PUB. 4-10-2012. INT. CL. 41.
- PAN AMERICAN GRAIN MFG. CO., INC., GUAYNABO, PUERTO RICO:
2,570,410. REN. 5-19-12. INT. CL. 32.
- PAN-OSTON CO., BOWLING GREEN, KY:
4,165,058, INT. CL. 10.
- PANACHE HOLDING, LLC, EAST HAVEN, CT:
2,498,021, CANC. INT. CL. 42.

PANDA CONCEPTS LLC, VOORHEES, NJ:
4,163,591, PUB. 4-10-2012. INT. CL. 35.
4,163,592, PUB. 4-10-2012. INT. CL. 35.

PANDIA SEEDS, INC., OJAI, CA:
4,163,203, PUB. 4-10-2012. MULTIPLE CLASS, INT. CLS. 31, 35 AND 42.

PANOS SERETIS, NEW YORK, NY, DBA FOODONI GRILL:
4,164,675, PUB. 4-10-2012. INT. CL. 43.

PAPA MURPHY'S INTERNATIONAL, LLC, VANCOUVER, WA:
4,164,027, PUB. 4-10-2012. INT. CL. 30.

PAPER MAGIC GROUP, INC., THE, WILMINGTON, DE, SPEARHEAD INDUSTRIES, INC., MINNEAPOLIS, MN:
1,234,065. REN. 5-18-12. INT. CL. 2.

PAR EMPRIZES, INC, SALINAS, CA, DBA CLUB 19 GOLF & TRAVEL CLUB:
4,163,455, PUB. 4-10-2012. INT. CL. 35.

PARAMOUNT CITRUS PACKING COMPANY LLC, LOS ANGELES, CA AND SUN PACIFIC SHIPPERS, L.P., LOS ANGELES, CA:
4,163,101, PUB. 4-10-2012. INT. CL. 31.

PARAMOUNT PICTURES CORPORATION, HOLLYWOOD, CA:
4,164,643, PUB. 4-10-2012. INT. CL. 21.
4,164,644, PUB. 4-10-2012. INT. CL. 18.
4,164,645, PUB. 4-10-2012. INT. CL. 25.

PARFUMERIE TIKI, FRANCE:
4,163,010, PUB. 4-10-2012. INT. CL. 3.

PARHAM, LUCIANA, CAPE CORAL, FL:
4,165,030, INT. CL. 9.

PARIS TECHNOLOGIES, INC., DOYLESTOWN, PA:
4,164,833, INT. CL. 9.

PARKER HANNIFIN FRANCE SAS, FRANCE:
4,162,943, PUB. 4-10-2012. MULTIPLE CLASS, INT. CLS. 6, 11 AND 17.

PARKER INTANGIBLES LLC, CLEVELAND, OH, PARKER-HANNIFIN CORPORATION, CLEVELAND, OH:
731,371. REN. 5-23-12. U.S. CL. 13 (INT. CL. 6).

PARKER SYNERGIES LLC, WINDSOR, ONTARIO, CANADA:
3,655,881, AM. INT. CL. 25.

PARKLAND AMBULANCE SERVICE, INC., SCHENECTADY, NY:
2,658,328. REN. 5-18-12. MULTIPLE CLASS, INT. CLS. 39 AND 44.

PARKRUN LIMITED, UNITED KINGDOM:
4,163,022, PUB. 4-10-2012. MULTIPLE CLASS, INT. CLS. 25, 35 AND 41.

PARLU, INC., SAN FRANCISCO, CA:
4,164,818, MULTIPLE CLASS, INT. CLS. 42 AND 45.

PARSONS-FEIN TRAINING INSTITUTE, INC., THE, NEW YORK, NY:
2,568,917. REN. 5-21-12. INT. CL. 41.

PARTS EXPRESS INTERNATIONAL, INC., SPRINGBORO, OH:
2,703,624. REN. 5-21-12. INT. CL. 9.

PASADERA CAPITAL, LLC, SAN ANTONIO, TX, DBA PASADERA CAPITAL:
4,164,497, PUB. 4-10-2012. INT. CL. 36.

PATAGONIA, INC., VENTURA, CA:
2,498,985, CANC. INT. CL. 18.

PATCH AND PAINT, INC., BURBANK, CA:
4,163,346, PUB. 4-10-2012. INT. CL. 37.

PATEL, MITA, MEMPHIS, TN:
4,165,738, INT. CL. 9.

PATENT DEVELOPMENT COMPANY, LLC, CLEVELAND, TN:
2,992,319, CANC. INT. CL. 12.

PATH SOLUTIONS K.S.C., SAFAT, KUWAIT:
4,163,371, PUB. 4-10-2012. INT. CL. 9.

PATRICK FOCART, CEBAZAT, FRANCE:
4,165,257, INT. CL. 3.

PATUXENT PUBLISHING COMPANY, COLUMBIA, MD:
2,497,941, CANC. INT. CL. 16.

PAUL YAFFE DESIGN, INC., PHOENIX, AZ:
4,163,968, PUB. 4-10-2012. INT. CL. 12.

PAULIST EVANGELIZATION MINISTRIES, WASHINGTON, DC:
4,165,286, MULTIPLE CLASS, INT. CLS. 9, 16 AND 41.

PAYLESS SHOESOURCE WORLDWIDE, INC., TOPEKA, KS:
4,165,209, INT. CL. 25.
4,165,210, INT. CL. 18.
4,165,211, INT. CL. 14.

PB SWISS TOOLS GMBH, SWITZERLAND:
4,162,939, PUB. 4-10-2012. MULTIPLE CLASS, INT. CLS. 8 AND 10.

PBM CAPITAL, LLC, LAGUNA NIGUEL, CA, DBA PLATINUM BRANDS:
4,165,528, INT. CL. 11.

PBS ENTERPRISES, INC., LAGUNA NIGUEL, CA, DBA PREMIER BEAUTY SOLUTIONS:
4,165,315, INT. CL. 35.

PC MARKETING, INC., RIDGEFIELD, NJ:
2,575,082. REN. 5-18-12. INT. CL. 11.

PCC LICENSING, INC., CALABASAS, CA:
4,165,225, INT. CL. 3.

PCT FEDERAL SERVICES, LLC, WASHINGTON, DC:
4,164,239, PUB. 4-10-2012. INT. CL. 35.

PDA PROS, LLC, PORTLAND, OR:
4,165,846, INT. CL. 35.

PEABODY MANAGEMENT, INC., MEMPHIS, TN:
2,590,521. REN. 5-18-12. INT. CL. 21.
2,590,522. REN. 5-18-12. INT. CL. 21.
2,645,098. REN. 5-18-12. INT. CL. 21.

PEACEBIKE, LAFAYETTE, OR:
2,571,271. REN. 5-18-12. INT. CL. 41.

PEACH STREET CAFE, INC., MADISON, MS:
4,164,279, PUB. 4-10-2012. INT. CL. 43.

PEAK BRANDS LLC, HINGHAM, MA:
4,164,778, PUB. 4-10-2012. INT. CL. 3.

PEAK ENTERPRISES, INC., SARASOTA, FL:
4,165,698, INT. CL. 3.
4,165,699, INT. CL. 21.

PEAK 10 XODIAX, INC., CHARLOTTE, NC:
2,594,304. REN. 5-19-12. MULTIPLE CLASS, INT. CLS. 38 AND 42.

PEAPACK-GLADSTONE BANK, BEDMINSTER, NJ:
2,695,278. REN. 5-18-12. INT. CL. 36.

PEARCE & ASSOCIATES, INC., GASTONIA, NC, DBA METROLINA CRATING:
4,163,937, PUB. 4-10-2012. INT. CL. 39.

PEARL, KEN, DANVILLE, CA:
4,163,590, PUB. 4-10-2012. INT. CL. 35.

PEARSON EDUCATION, INC., UPPER SADDLE RIVER, NJ:
4,164,752, PUB. 4-10-2012. INT. CL. 41.

PEBCO, INC., PADUCAH, KY, PROCESS EQUIPMENT BUILDERS, INC., PADUCAH, KY:
1,223,142. REN. 5-21-12. INT. CL. 7.

PEDIGREE DOLLS & TOYS LIMITED, ST LEONARDS, EXETER EX2 4PS, UNITED KINGDOM:
3,006,124, CANC. INT. CL. 28.

PEERLESS ENTERPRISES, INC., WEST CHICAGO, IL:
2,577,919. REN. 5-18-12. INT. CL. 37.

PEERLESS TYRE CO., DENVER, CO:
943,251. REN. 5-21-12. U.S. CL. 35 (INT. CL. 12).

PELLA CORPORATION, PELLA, IA:
558,955. REN. 5-24-12. U.S. CL. 12 (INT. CL. 6).

PEN PAL GIRLS INC., FREMONT, CA:
4,163,712, PUB. 4-10-2012. INT. CL. 28.

PENGUIN GROUP (USA) INC., NEW YORK, NY, NEW AMERICAN LIBRARY, INC., THE, NEW YORK, NY:
949,816. REN. 5-23-12. U.S. CL. 38 (INT. CL. 16).

PENHALIGON'S LIMITED, LONDON, UNITED KINGDOM:
4,163,244, PUB. 4-10-2012. INT. CL. 4.

PENNINGTON SEED, INC. OF NEBRASKA, MADISON, GA:
4,165,373, INT. CL. 31.

PENNY-FARTHING PRESS, INC., HOUSTON, TX:
4,164,994, INT. CL. 41.

PENSACOLA CHRISTIAN COLLEGE, INC., PENSACOLA, FL:
3,109,285, AM. INT. CL. 41.

PENSHURST TRADING INC., STAMFORD, CT:
4,165,392, MULTIPLE CLASS, INT. CLS. 4, 8, 11 AND 24.

- PENTAIR RESIDENTIAL FILTRATION, LLC, GOLDEN VALLEY, MN:
4,165,440, INT. CL. 36.
- PENTON BUSINESS MEDIA, INC., NEW YORK, NY:
2,700,006, REN. 5-19-12, INT. CL. 35.
4,163,771, PUB. 4-10-2012, MULTIPLE CLASS, INT. CLS. 16 AND 35.
- PENTON MEDIA, INC., NEW YORK, NY:
4,163,726, PUB. 4-10-2012, MULTIPLE CLASS, INT. CLS. 35 AND 41.
4,163,727, PUB. 4-10-2012, MULTIPLE CLASS, INT. CLS. 41 AND 42.
- PENTUCKET BANK, HAVERHILL, MA:
4,163,793, PUB. 4-10-2012, INT. CL. 36.
- PEPSICO, INC., PURCHASE, NY:
1,259,591, CANC. INT. CL. 32.
- PERFECT PERFORMANCE PRODUCTS, LLC, FORT WORTH, TX:
2,679,886, REN. 5-19-12, INT. CL. 9.
- PERFECT UNION CO., LTD., TAIPEI, TAIWAN:
2,498,413, CANC. INT. CL. 9.
- PERFECT WORLD SOLUTIONS, INC., PHOENIX, AZ:
4,165,731, INT. CL. 3.
- PERFECTION FENCE CORP., MARSHFIELD, MA:
2,569,755, REN. 5-18-12, MULTIPLE CLASS, INT. CLS. 6 AND 19.
2,569,756, REN. 5-18-12, MULTIPLE CLASS, INT. CLS. 6 AND 19.
- PERFICIO NETWORKS, INC., IRVINE, CA:
4,165,140, INT. CL. 36.
- PERFORM GROUP, LLC, YORK, PA:
2,591,335, REN. 5-18-12, INT. CL. 35.
- PERGO (EUROPE) AB, TRELLEBORG, SWEDEN:
4,164,002, PUB. 4-10-2012, INT. CL. 19.
- PERLA S. MCDONALD SANCHEZ, MISSION, TX, DBA STAR KIDS MUSIKTOWN:
4,163,224, PUB. 4-10-2012, INT. CL. 41.
- PERLIS, INC., NEW ORLEANS, LA:
1,200,501, REN. 5-23-12, INT. CL. 25.
- PERLMAN, STACEY C., SANAT MONICA, CA AND ALTSHUL, SARA BETH, SANTA MONICA, CA:
4,163,654, PUB. 4-10-2012, INT. CL. 41.
- PERNAZZA-CAMARENA, ALESSANDRO, ZAPOPAN JALISCO, MEXICO:
4,163,794, PUB. 4-10-2012, INT. CL. 43.
- PERRON, STEPHEN, HARTSVILLE, TN AND PERRON, ANNE, HARTSVILLE, TN AND PERRON, SEAN, HARTSVILLE, TN:
4,164,248, PUB. 4-10-2012, INT. CL. 16.
- PERRY BEVERAGE DISTRIBUTORS, INC., TUCKAHOE, NY:
1,316,025, CANC. INT. CL. 32.
- PET BYTES, LLC, MATTHEWS, NC:
4,163,570, PUB. 4-10-2012, INT. CL. 42.
- PETE'S GOURMET CONFECTIONS, INC., CENTRAL POINT, OR, DBA PETE'S GOURMET CONFECTIONS:
4,163,909, PUB. 4-10-2012, INT. CL. 30.
- PETER CHRISTIAN WOLDRICH, JOHANNESBURG, GAUTENG, SOUTH AFRICA:
4,163,119, PUB. 4-10-2012, MULTIPLE CLASS, INT. CLS. 9 AND 11.
- PETER KIEWIT SONS', INC., OMAHA, NE:
2,569,239, REN. 5-21-12, MULTIPLE CLASS, INT. CLS. 35 AND 37.
- PETERS, LEO, GRAND RAPIDS, MI:
1,260,594, CANC. INT. CL. 29.
- PETHUB, INC., ISSAQUAH, WA:
4,163,334, PUB. 4-10-2012, INT. CL. 39.
- PETROL INJECTION LIMITED, PLYMOUTH, DEVON, ENGLAND:
855,952, CANC. U.S. CL. 23.
- PETROLEUM ANALYZER COMPANY, L.P., HOUSTON, TX:
4,163,613, PUB. 4-10-2012, INT. CL. 9.
- PETRONAS LUBRICANTS ITALY S.P.A., ITALY:
4,163,041, PUB. 4-10-2012, INT. CL. 4.
4,163,044, PUB. 4-10-2012, INT. CL. 1.
- PETROSSIAN SA, FRANCE:
4,162,886, PUB. 4-10-2012, MULTIPLE CLASS, INT. CLS. 29, 30 AND 33.
- PETRUS BRASIL ACESSORIOS DA MODA LTDA., 01023-050 SAO PAULO-SP, BRAZIL:
4,164,951, MULTIPLE CLASS, INT. CLS. 9, 14, 16, 18 AND 28.
- PETSPORT USA, INC., PITTSBURG, CA:
4,164,568, PUB. 4-10-2012, INT. CL. 28.
- PFIZER INC., NEW YORK, NY:
503,951, CANC. U.S. CL. 51.
4,164,979, INT. CL. 5.
- PH INTERNATIONAL, LLC, MADISON, VA, HEARTHSONG, INC., ROHNERT PARK, CA:
1,714,548, REN. 5-23-12, INT. CL. 42.
- PHAM, JERRY V, TULSA, OK:
4,048,750, AM. INT. CL. 9.
- PHAM, THE, ALHAMBRA, CA:
4,163,742, PUB. 4-10-2012, INT. CL. 25.
- PHARMA LASER INC., LAVAL, H7E 1B1 QUEBEC, CANADA:
3,005,295, CANC. INT. CL. 9.
- PHARMACIA & UPJOHN COMPANY, PEAPACK, NJ:
1,290,699, CANC. INT. CL. 5.
- PHARMACUMEN CONSULTING INC., FRANKLIN, MA:
4,164,380, PUB. 4-10-2012, INT. CL. 35.
- PHARMAFREAK HOLDINGS INC., TORONTO, ONTARIO, CANADA:
4,163,297, PUB. 4-10-2012, INT. CL. 5.
- PHARMAQUEST INDUSTRIES, MINIAC MORVAN, FRANCE:
4,165,111, MULTIPLE CLASS, INT. CLS. 5 AND 10.
- PHI DELTA THETA FRATERNITY, OXFORD, OH:
4,163,838, PUB. 4-10-2012, MULTIPLE CLASS, INT. CLS. 25, 35, 36 AND 41.
4,163,839, PUB. 4-10-2012, MULTIPLE CLASS, INT. CLS. 25, 35, 36 AND 41.
- PHIL'S BBQ, INC., SAN DIEGO, CA:
4,163,381, PUB. 4-10-2012, INT. CL. 30.
4,163,382, PUB. 4-10-2012, INT. CL. 43.
4,163,490, PUB. 4-10-2012, INT. CL. 43.
- PHILADELPHIA 76ERS BASKETBALL CLUB, INC., PHILADELPHIA, PA:
856,615, CANC. U.S. CL. 39.
- PHILLIES, THE, PHILADELPHIA, PA:
1,214,054, REN. 5-19-12, INT. CL. 25.
- PHILOSOPHY, INC., PHOENIX, AZ:
3,006,149, CANC. INT. CL. 3.
- PHOENIX INTANGIBLES HOLDING COMPANY, GREENVILLE, DE:
4,163,046, PUB. 4-10-2012, INT. CL. 29.
- PHOENIX MEDICAL DEVICES, LLC, IRVINE, CA:
4,164,626, PUB. 4-10-2012, INT. CL. 10.
- PHOENIX PRODUCTS COMPANY, TERRYVILLE, CT:
4,165,669, MULTIPLE CLASS, INT. CLS. 1 AND 5.
- PHOENIX VINTNERS, LLC, IPSWICH, MA, DBA THE TRAVELING VINEYARD:
3,303,929, CANC. INT. CL. 33.
- PHONETIC SYSTEMS LTD., PETAH TIKVA, ISRAEL:
3,006,321, CANC. INT. CL. 9.
- PICO MANUFACTURING SALES CORPORATION, NEW YORK, NY:
1,687,935, REN. 5-23-12, INT. CL. 25.
- PIDILITE USA, INC., HAZELTON, PA:
2,634,153, REN. 5-22-12, MULTIPLE CLASS, INT. CLS. 2 AND 16.
2,672,944, REN. 5-23-12, INT. CL. 16.
2,676,269, REN. 5-22-12, INT. CL. 2.
- PIERCE SALES CO. INC., ORLANDO, FL, DBA RESTAURANT EQUIPMENT WORLD:
2,656,096, REN. 5-24-12, INT. CL. 35.
- PIERRE BELVEDERE GROUP INC., MONTREAL, CANADA:
4,163,185, PUB. 4-10-2012, INT. CL. 28.
- PIERRE CRAWDEAUX AND COMPANY, INC., BATON ROUGE, LA, BOURGEOIS, DOROTHY LAMBERT, BATON ROUGE, LA, DBA PIERRE CRAWDEAUX AND COMPANY:
1,699,619, REN. 5-18-12, INT. CL. 42.
1,716,817, REN. 5-18-12, INT. CL. 42.

PIERRE FABRE DERMO-COSMETIQUE, BOULOGNE, FRANCE:
4,163,471, PUB. 4-10-2012. INT. CL. 3.
4,163,587, PUB. 4-10-2012. MULTIPLE CLASS, INT. CLS. 3 AND 5.
4,163,588, PUB. 4-10-2012. MULTIPLE CLASS, INT. CLS. 3 AND 5.

PIETROWSKI,PETER, 45770 MARL, FED REP GERMANY:
4,163,038, PUB. 4-10-2012. INT. CL. 12.

PIKE, DAVID R, NASHVILLE, TN:
4,164,598, PUB. 4-10-2012. INT. CL. 42.

PILOT AUTOMOTIVE, INC., CITY OF INDUSTRY, CA:
2,499,197, CANC. MULTIPLE CLASS, INT. CLS. 11 AND 12.

PIMENTEL, ALEJANDRO, MARACAIBO, ZUILA, VENEZUELA:
4,165,576, INT. CL. 9.
4,165,577, INT. CL. 9.

PING AN INSURANCE (GROUP) COMPANY OF CHINA, LTD., SHENZHEN, GUANGDONG, CHINA:
4,163,254, PUB. 1-24-2012. INT. CL. 36.

PINK'S HOT DOGS, INC., LOS ANGELES, CA:
4,163,369, PUB. 4-10-2012. MULTIPLE CLASS, INT. CLS. 29 AND 43.

PIOLA, TASSIN-LA-DEMI-LUNE, FRANCE:
4,163,227, PUB. 4-10-2012. INT. CL. 25.

PIONEER DRILLING COMPANY, SAN ANTONIO, TX:
4,162,716, PUB. 4-10-2012. INT. CL. 42.

PIONEER FOODS:
1,256,414, CANC. INT. CL. 42.
1,257,999, CANC. INT. CL. 42.

PIONEER HI-BRED INTERNATIONAL, INC., JOHNSTON, IA:
939,286, REN. 5-24-12. U.S. CL. 1 (INT. CL. 31).
4,163,599, PUB. 4-10-2012. INT. CL. 35.

PIPEDREAM PRODUCTS, INC., CHATSWORTH, CA:
4,165,071, INT. CL. 10.

PITA HOUSE, INC, GLEN ELLYN, IL:
4,163,841, PUB. 4-10-2012. INT. CL. 43.

PITT COMMUNITY COLLEGE, GREENVILLE, NC:
4,164,137, PUB. 4-10-2012. INT. CL. 41.

PIVA, SAMUEL, EUGENE, OR:
4,163,121, PUB. 4-10-2012. MULTIPLE CLASS, INT. CLS. 16, 22 AND 25.

PIVOTAL RESEARCH CENTERS, LLC, PEABODY, MA TO PREMIER RESEARCH ARIZONA, LLC, PHILADELPHIA, PA:
2,498,718, CANC. INT. CL. 42.

PIXEL THEORY INC, SEATTLE, WA, DBA PIXEL THEORY:
4,164,339, PUB. 4-10-2012. MULTIPLE CLASS, INT. CLS. 35 AND 42.

PIZZA, JOSEPH, PARAMUS, NJ:
2,698,036, REN. 5-18-12. INT. CL. 9.

PLANT SCIENCES, INC., WATSONVILLE, CA:
1,695,129, REN. 5-18-12. MULTIPLE CLASS, INT. CLS. 1 AND 31.
1,695,130, REN. 5-18-12. MULTIPLE CLASS, INT. CLS. 1 AND 31.

PLASTIBEC INC., BOISBRIAND QUEBEC, CANADA:
2,498,838, CANC. INT. CL. 20.

PLASTIC SPECIALTIES AND TECHNOLOGIES INVESTMENTS, INC., RIDGEFIELD, NJ:
857,487, CANC. U.S. CL. 35.

PLATINUM INDUSTRIAL EQUIPMENT, LAKE RONKONKOMA, NY:
4,165,648, INT. CL. 8.

PLAYWORLD SYSTEMS, INC., LEWISBURG, PA:
4,165,902, INT. CL. 16.

PLEASANT POPS, LLC, WASHINGTON, DC:
4,164,621, PUB. 4-10-2012. INT. CL. 30.

PLEWS, INC., DIXON, IL, THUNDER BAY MARINE, INC., CLEARWATER, FL:
1,700,556, REN. 5-23-12. INT. CL. 17.

PLEWS, INC., DIXON, IL:
4,166,050, INT. CL. 8.

PLOUGH, INC., MEMPHIS, TN:
250,691, CANC. U.S. CL. 18.

PLUG' N PAY TECHNOLOGIES, INC., HAUPPAUGE, NY:
2,497,766, CANC. INT. CL. 35.

PLURIBUS NETWORKS INC., PALO ALTO, CA:
4,165,375, INT. CL. 9.
4,165,377, INT. CL. 9.

PLYMOUTH ROCK ENERGY, WOODMERE, NY:
4,164,600, PUB. 4-10-2012. MULTIPLE CLASS, INT. CLS. 35 AND 36.

PM-INTERNATIONAL AG, LUXEMBOURG:
3,046,267.

PN II, INC., BLOOMFIELD HILLS, MI:
4,164,244, PUB. 4-10-2012. INT. CL. 37.

POCKETS FULLA PILLZ, LLC, MOUNT RAINIER, MD, DBA POKETS FULLA PILLZ:
4,163,772, PUB. 4-10-2012. INT. CL. 25.

PODSHADLEY, SUSAN E., WATERTOWN, MA, DBA FAIRYTALE FASHION:
2,497,470, CANC. INT. CL. 25.

POEM, SANTA MONICA, CA:
4,165,734, INT. CL. 41.

POINT HORIZON INSTITUTE, RAVENDALE, CA:
4,165,113, INT. CL. 9.

POLAR CORPORATION, WORCESTER, MA, POLAR WATER COMPANY (POLAR OHIO), COLUMBUS, OH:
1,177,537, REN. 5-18-12. INT. CL. 32.

POLARIS INDUSTRIES INC., MEDINA, MN:
4,165,458, INT. CL. 25.

POLLARD BANKNOTE LIMITED PARTNERSHIP, WINNIPEG, MB, CANADA:
4,165,532, INT. CL. 41.

POLLINI S.P.A., GATTEO (FC), ITALY, CALZATURIFICIO POLLINI S.P.A., 47030 GATTEO (FORLI), ITALY:
1,687,875, REN. 5-21-12. MULTIPLE CLASS, INT. CLS. 18 AND 25.

POLY PAK AMERICA, INC., LOS ANGELES, CA:
1,697,598, REN. 5-23-12. INT. CL. 16.

POLYGRAM INTERNATIONAL MUSIC B.V., BAARN, NETHERLANDS:
861,687, CANC. U.S. CL. 36.

POLYMERIC SYSTEMS, INC., ELVERSON, PA:
4,164,698, PUB. 4-10-2012. INT. CL. 17.

POLYMERS, INC., MIDDLEBURY, VT:
781,529, CANC. U.S. CL. 1.

POLYNESIAN LIMITED, APIA, AMERICAN SAMOA, DBA POLYNESIAN AIRLINES:
2,710,830, REN. 5-18-12. INT. CL. 39.

POLYONE CORPORATION, AVON LAKE, OH:
2,907,427, CANC. INT. CL. 1.

POOCHIE-PETS, LLC, SIMSBURY, CT:
3,125,967, AM. INT. CL. 6.

PORKLIFT, INC., DRIPPING SPRINGS, TX:
4,164,228, PUB. 4-10-2012. INT. CL. 7.

PORPLEMONTAGE ENTERPRISES, LLC, SURF CITY, NJ:
4,164,315, PUB. 4-10-2012. INT. CL. 35.

PORTIONPAC CHEMICAL CORPORATION, CHICAGO, IL:
4,166,017, INT. CL. 3.

POSITEC GROUP LIMITED, HONG KONG ADM. REGION, CHINA:
4,162,729, PUB. 3-15-2011. INT. CL. 7.

POTTER & BRUMFIELD, INC., PRINCETON, IN:
857,406, CANC. U.S. CL. 21.

POWER EQUIPMENT DIRECT, INC., BOLINGBROOK, IL:
4,164,361, PUB. 4-10-2012. INT. CL. 35.

POWER SOURCE ON-LINE, INC., LONGUEUIL, QUÉBEC, CANADA:
2,619,479, REN. 5-21-12. INT. CL. 35.

POWERGROUP INTERNATIONAL, LLC, AUGUSTA, GA:
4,163,476, PUB. 4-10-2012. INT. CL. 35.

PQ CORPORATION, VALLEY FORGE, PA:
2,569,790, REN. 5-18-12. INT. CL. 1.
2,573,354, REN. 5-18-12. INT. CL. 1.

PRADA S.A., LUXEMBOURG:
4,162,840, PUB. 4-10-2012. MULTIPLE CLASS, INT. CLS. 18 AND 25.

PRAEDIUM CORPORATION, CALGARY, ALBERTA:
2,498,795, CANC. INT. CL. 37.

PRE-FIXE LLC, KENTFIELD, CA:
4,163,758, PUB. 4-10-2012. MULTIPLE CLASS, INT. CLS.

- 35 AND 42.
 PREBIRD COATING CO., LTD, FLUSHING, NY:
 4,163,936, PUB. 4-10-2012. INT. CL. 2.
 PREFERRED GOVERNMENTAL INSURANCE TRUST,
 LAKE MARY, FL:
 4,163,356, PUB. 4-10-2012. INT. CL. 36.
 4,163,357, PUB. 4-10-2012. INT. CL. 36.
 4,163,525, PUB. 4-10-2012. INT. CL. 16.
 PREFERRED VEGETARIAN INC., FARMINGDALE, NY:
 3,006,114, CANC. INT. CL. 29.
 PREMIER CONSULTING INTERNATIONAL, MIAMI, FL:
 4,165,478, INT. CL. 42.
 PREMIER DEALER SERVICES, INC., SAN DIEGO, CA:
 4,165,522, INT. CL. 2.
 4,165,523, INT. CL. 2.
 4,165,524, INT. CL. 2.
 PREMIER FOOD CONCEPTS LLC, SAN DIEGO, CA:
 4,163,655, PUB. 4-10-2012. INT. CL. 43.
 PREMIER, INC., CHARLOTTE, NC:
 4,164,953, INT. CL. 35.
 PREMIUM SOURCE, INC., BOULDER, CO:
 4,164,205, PUB. 4-10-2012. INT. CL. 16.
 PRESORT SERVICES, INC., LANSING, MI:
 4,165,133, INT. CL. 42.
 PRESSSTEK, INC., HUDSON, NH:
 1,701,282, COR. MULTIPLE CLASS, INT. CLS. 2 AND 7.
 PRESSURE MANAGEMENT GROUP, INC., JACKSON-
 VILLE, FL, DBA ALTERNA PRODUCTS:
 4,163,576, PUB. 4-10-2012. INT. CL. 17.
 PRESS4, INC., MOUNT PLEASANT, SC:
 4,165,276, INT. CL. 35.
 PRESTIGE CLUB, FRANKLIN PARK, IL:
 4,165,531, INT. CL. 43.
 PRETZEL PERFECTION, LLC, LA CENTER, WA, DBA
 PRETZEL PERFECTION:
 4,163,821, PUB. 4-10-2012. INT. CL. 30.
 PRIACTA, INC., POWHATAN, VA:
 4,165,451, MULTIPLE CLASS, INT. CLS. 9 AND 42.
 PRIMANTI BROTHERS RESTAURANT CORPORATION,
 PITTSBURGH, PA:
 2,569,734, REN. 5-19-12. INT. CL. 42.
 PRIMARE SYSTEMS AB, VAXJO, SWEDEN:
 2,585,310, REN. 5-24-12. INT. CL. 9.
 PRIMARY INVESTMENTS GROUP LIMITED, ROAD
 TOWN, TORTOLA, BR. VIRGIN ISLANDS:
 4,163,080, PUB. 4-10-2012. INT. CL. 5.
 4,165,908, INT. CL. 5.
 PRIMAVERA FINANCIAL, INC., NEWPORT BEACH, CA:
 4,163,990, PUB. 4-10-2012. INT. CL. 36.
 PRIME SOURCE CAPITAL, INC., MONTECITO, CA:
 4,165,849, INT. CL. 9.
 4,165,850, INT. CL. 9.
 PRIMESOURCE BUILDING PRODUCTS, INC., IRVING, TX:
 4,165,569, INT. CL. 8.
 4,165,570, INT. CL. 8.
 PRINCE, JEANNETTE, CARDIFF, CA:
 4,165,518, INT. CL. 16.
 PRINCESS HOUSE, INC., TAUNTON, MA:
 2,497,964, CANC. MULTIPLE CLASS, INT. CLS. 16 AND
 35.
 PRINSCO, INC., WILLMAR, MN:
 4,165,101, MULTIPLE CLASS, INT. CLS. 17 AND 19.
 PRISON FELLOWSHIP MINISTRIES, LANSDOWNE, VA:
 4,165,578, INT. CL. 16.
 4,165,585, INT. CL. 16.
 PRIVATE OPERATIONS, INC., CUMMING, GA:
 4,165,671, INT. CL. 43.
 PRL USA HOLDINGS, INC., NEW YORK, NY:
 4,163,324, PUB. 4-10-2012. INT. CL. 3.
 4,165,608, INT. CL. 3.
 4,165,609, INT. CL. 3.
 PRO CUBE, LOS ANGELES, CA, TA TEE STAR ACTIVE
 WEAR, INC.:
 4,165,330, INT. CL. 25.
 PRO HEALTH, INC., SANTA BARBARA, CA:
 2,497,926, CANC. INT. CL. 16.
 PRO LINE MANUFACTURING CO., WAYNE, NJ:
 4,164,870, INT. CL. 25.
 PRO-CAD SOFTWARE, LTD., CALGARY, ALBERTA, CA-
 NADA:
 2,571,916, REN. 5-23-12. INT. CL. 9.
 PROBIOTICAL SPA, I-28100 NOVARA, ITALY:
 4,162,930, PUB. 4-10-2012. MULTIPLE CLASS, INT. CLS. 3
 AND 5.
 PROBLEM-KNOWLEDGE COUPLER CORPORATION,
 CAMBRIDGE, VT, DBA PKC CORPORATION:
 1,340,177, COR. INT. CL. 9.
 1,342,110, COR. INT. CL. 9.
 PROBLEM-KNOWLEDGE COUPLER CORPORATION,
 BURLINGTON, VT:
 2,512,540, COR. INT. CL. 9.
 2,609,117, COR. INT. CL. 42.
 PROCTER & GAMBLE COMPANY, THE, CINCINNATI, OH:
 862,857, CANC. U.S. CL. 51.
 4,165,756, INT. CL. 3.
 PRODUCE CAREERS INC., ARROYO GRANDE, CA:
 2,497,664, CANC. INT. CL. 35.
 PRODUCTOS CHOCOLATES SELECTOS DE JALISCO, S.A.
 DE C.V., GUADALAJARA, JALISCO, MEXICO:
 2,507,638, REN. 5-21-12. INT. CL. 30.
 PRODUCTOS INDUSTRIALES DE LEON S.A. DE C.V.,
 LEON, GTO, MEXICO:
 4,165,510, INT. CL. 29.
 PROFESSIONAL ASSOCIATION OF INNKEEPERS INTER-
 NATIONAL, CHARLESTON, SC:
 4,165,413, INT. CL. 35.
 PROFESSIONAL BASKETBALL ALUMNI ASSOCIATION
 MARKETING, INC., CEDAR GROVE, NJ:
 4,164,260, PUB. 4-10-2012. INT. CL. 35.
 PROFESSIONAL GOLFERS' ASSOCIATION OF AMERICA,
 THE, PALM BEACH GARDENS, FL:
 4,163,048, PUB. 9-20-2011. INT. CL. 35.
 PROFESSOR CONNOR'S, INC., SECAUCUS, NJ, DBA
 FRESHPET:
 4,163,352, PUB. 4-10-2012. INT. CL. 31.
 4,163,353, PUB. 4-10-2012. INT. CL. 31.
 PROFIT OR SAVINGS ENTERPRISE, INC., CLEVELAND,
 OH:
 2,570,119, REN. 5-21-12. MULTIPLE CLASS, INT. CLS. 35,
 41 AND 42.
 PROFITSTREAMS LLC, DENVER, CO:
 4,163,277, PUB. 4-10-2012. INT. CL. 42.
 PROGRESSIVE GROWTH CORP., GAYLORD, MN:
 2,715,002, REN. 5-23-12. INT. CL. 36.
 PROJECT BANDALOOP, SAN FRANCISCO, CA:
 4,164,476, PUB. 4-10-2012. INT. CL. 41.
 PROJECT O, LLC, MIAMI BEACH, FL:
 4,165,283, INT. CL. 33.
 PROJECT PAZ, INC., NEW YORK, NY:
 4,164,479, PUB. 4-10-2012. INT. CL. 36.
 4,164,480, PUB. 4-10-2012. INT. CL. 36.
 PROMATS ATHLETICS, LLC, SALISBURY, NC:
 4,163,963, PUB. 4-10-2012. INT. CL. 28.
 PROMOTION IN MOTION, INC., ALLENDALE, NJ:
 4,164,949, INT. CL. 29.
 PROPER, MARK D., HARBORCREEK, PA:
 4,163,953, PUB. 4-10-2012. INT. CL. 36.
 PRORODEOHORSES.COM, TEHACHAPI, CA:
 4,163,078, PUB. 4-10-2012. INT. CL. 35.
 PROSPER LAW GROUP, LLP, LOS ANGELES, CA:
 4,163,973, PUB. 4-10-2012. INT. CL. 45.
 PROSTHETIC DESIGN, INC., CLAYTON, OH:
 4,164,254, PUB. 4-10-2012. INT. CL. 10.
 PROTINGENT, INC., REDMOND, WA, DBA PROTINGENT
 STAFFING:
 4,163,734, PUB. 4-10-2012. INT. CL. 35.
 PROTOCOL II, INC., GIG HARBOR, WA:
 2,498,325, CANC. INT. CL. 16.
 PROTOGATE, INC., SAN DIEGO, CA:
 2,713,651, REN. 5-18-12. INT. CL. 9.
 PROTOPHARMA LIMITED, NORWICH, UNITED KING-
 DOM:
 4,162,978, PUB. 4-10-2012. INT. CL. 5.
 PROTREND CO., LTD., TAIPEI, TAIWAN:
 4,164,495, PUB. 4-10-2012. MULTIPLE CLASS, INT. CLS. 7
 AND 11.

PROX13 PRODUCTIONS STUDIO LLC, HONOLULU, UT:
4,165,241, MULTIPLE CLASS, INT. CLS. 9, 14, 25 AND 28.

PROX13 PRODUCTIONS STUDIO LLC, HONOLULU, HI:
4,165,246, MULTIPLE CLASS, INT. CLS. 9, 14, 25 AND 28.

PSC, LLC, HOUSTON, TX:
4,165,292, MULTIPLE CLASS, INT. CLS. 37 AND 40.

PSMJ RESOURCES, INC., NEWTON, MA:
4,163,964, PUB. 4-10-2012. INT. CL. 41.

PSS WORLD MEDICAL, INC., JACKSONVILLE, FL:
4,164,252, PUB. 4-10-2012. INT. CL. 35.

PSYCHOLOGICAL ASSOCIATES, INC., ST. LOUIS, MO:
2,567,801. REN. 5-18-12. INT. CL. 41.

PT BAUMA PRATAMA INDONESIA, JAKARTA 12920, INDONESIA:
3,005,324, CANC. INT. CL. 9.

PUIG FRANCE SOCIÉTÉ PAR ACTIONS SIMPLIFIÉE, F-92200 NEUILLY SUR SEINE, FRANCE:
4,162,866, PUB. 4-10-2012. INT. CL. 3.

PULLEN, JOSEPHUS, CHICAGO, IL, DBA J.P. COACH & CO.:
864,053, CANC. U.S. CL. 103.

PULLIAM FINANCE, INC., WINSTON-SALEM, NC:
2,499,004, CANC. INT. CL. 36.

PULSE CREATIONS, INC., PORT WASHINGTON, NY:
2,038,575 NEW CERT. 6-26-2012. INT. CL. 25.

PUMA-SPORTSCHUHFABRIKEN RUDOLF DASSLER KG, NURNBERG, FED REP GERMANY:
1,131,844, CANC. INT. CL. 25.

PURE POTENTIAL, LLC, VALENCIA, CA:
4,163,557, PUB. 4-10-2012. INT. CL. 25.
4,163,558, PUB. 4-10-2012. INT. CL. 35.
4,163,559, PUB. 4-10-2012. INT. CL. 41.
4,163,562, PUB. 4-10-2012. INT. CL. 35.
4,163,564, PUB. 4-10-2012. INT. CL. 41.

PURE STORAGE, INC., MOUNTAIN VIEW, CA:
4,165,143, INT. CL. 9.
4,165,144, INT. CL. 9.

PURITAN MEDICAL PRODUCTS COMPANY LLC, GUILFORD, ME:
4,163,916, PUB. 4-10-2012. INT. CL. 1.
4,164,061, PUB. 4-10-2012. INT. CL. 1.
4,164,062, PUB. 4-10-2012. INT. CL. 1.

PURITAN'S PRIDE, INC., RONKONKOMA, NY:
4,164,589, PUB. 4-10-2012. INT. CL. 3.

PUTCO, INC., STORY CITY, IA:
2,645,951. REN. 5-23-12. INT. CL. 12.

PUTERBAUGH FARMS PARTNERSHIP, MABTON, WA:
4,164,649, PUB. 4-10-2012. INT. CL. 32.

PV HARDWARE LLC, CARMICHAEL, CA:
4,163,680, PUB. 4-10-2012. INT. CL. 6.

PYP, LLC., AUBURN, IN:
4,163,571, PUB. 4-10-2012. INT. CL. 41.

PYRAMID INC., LOS ANGELES, CA:
4,164,019, PUB. 4-10-2012. INT. CL. 35.

PYRAMID PRODUCTIONS I INC., CALGARY, CANADA:
4,163,129, PUB. 4-10-2012. INT. CL. 41.

QDOBA RESTAURANT CORPORATION, WHEAT RIDGE, CO:
2,499,125, CANC. INT. CL. 42.

QIAGEN GMBH, HILDEN, FED REP GERMANY:
2,568,918. REN. 5-21-12. MULTIPLE CLASS, INT. CLS. 1 AND 9.
2,568,918, CANC. INT. CL. 5.

QS WHOLESALE, INC., HUNTINGTON BEACH, CA:
4,164,873, MULTIPLE CLASS, INT. CLS. 21 AND 24.

QSL INTELLECTUAL PROPERTIES CORP., SHARON, PA:
4,163,972, PUB. 4-10-2012. INT. CL. 29.

QUAD CITY VIRTUAL, INC., BETTENDORF, IA:
2,582,303. REN. 5-19-12. INT. CL. 35.

QUAD/GRAPHICS, INC., SUSSEX, WI:
4,163,420, PUB. 4-10-2012. INT. CL. 39.

QUADRANT CHEMPLAST (PTY) LTD, ELANDSFONTEIN, SOUTH AFRICA:
2,507,640. REN. 5-21-12. MULTIPLE CLASS, INT. CLS. 17, 40 AND 42.

QUAKER PET GROUP, LLC, NEW YORK, NY:
2,607,001. REN. 5-21-12. INT. CL. 18.

QUALICARE FRANCHISE CORPORATION, TORONTO, ONTARIO, CANADA:
4,165,806, MULTIPLE CLASS, INT. CLS. 35, 44 AND 45.

QUALITY DINING, INC., MISHAWAKA, IN:
2,706,724. REN. 5-18-12. INT. CL. 43.

QUALMARK CORPORATION, DENVER, CO:
4,165,404, INT. CL. 9.

QUETOS, INC, SAN FRANCISCO, CA:
4,165,463, INT. CL. 35.

QUICKCUE, LLC, CHATTANOOGA, TN:
4,163,920, PUB. 4-10-2012. INT. CL. 42.

QUINN, MARIA VIRGINIA F, TOWSON, MD, AKA GINNY QUINN:
4,164,487, PUB. 4-10-2012. INT. CL. 14.

QUINTESSENTIAL BRANDS S.A., LUXEMBOURG:
4,162,927, PUB. 4-10-2012. INT. CL. 33.

QVC, INC., WEST CHESTER, PA:
4,165,112, INT. CL. 24.

Q10 PRODUCTS LLC, TENAFLY, NJ:
4,165,617, INT. CL. 21.

R B & T'S EMPIRES, LLC, ST. LOUIS, MO:
4,165,641, INT. CL. 29.

R. C. BIGELOW INC., NORWALK, CT:
856,145, CANC. U.S. CL. 46.

R. F. SIMMONS COMPANY, INC., ATTLEBORO, MA:
860,534, CANC. U.S. CL. 28.

R.M. YOUNG CO., TRAVERSE CITY, MI:
4,164,729, PUB. 4-10-2012. INT. CL. 9.

R.N'OVATE, INC., LOS ANGELES, CA:
4,165,460, INT. CL. 25.

R + M, INC., CARY, NC:
3,101,933, CANC. MULTIPLE CLASS, INT. CLS. 16 AND 35.

RA SUSHI HOLDING CORP., SCOTTSDALE, AZ:
4,124,457, CANC. INT. CL. 41.
4,163,607, PUB. 4-10-2012. INT. CL. 35.

RABADAN-URUETA, LUIS ROBERTO, TIJUANA, MEXICO:
4,163,837, PUB. 4-10-2012. INT. CL. 28.

RACCIOPI, ROSE MARIE, TAPPAN, NY:
1,686,829. REN. 5-18-12. INT. CL. 41.

RAD DATA COMMUNICATIONS LTD., TEL AVIV, ISRAEL:
4,164,525, PUB. 4-10-2012. INT. CL. 9.

RADIALL, FRANCE:
4,162,934, PUB. 4-10-2012. INT. CL. 10.

RADIANT COMMUNICATIONS LTD., VANCOUVER, B.C. V6C 3E86, CANADA:
3,005,298, CANC. MULTIPLE CLASS, INT. CLS. 38 AND 42.

RADIANT SENIOR LIVING, INC., PORTLAND, OR:
4,164,457, PUB. 4-10-2012. INT. CL. 43.

RADIO CORPORATION OF AMERICA, NEW YORK, NY:
859,483, CANC. U.S. CL. 103.
859,484, CANC. U.S. CL. 103.

RADIO CORPORATION OF AMERICA, NEW YORK, NY TO RCA TRADEMARK MANAGEMENT, BOULOGNE-BILLANCOURT, FRANCE:
862,658, CANC. U.S. CL. 21.

RADIO DIRECT MARKETING 360, INC., FORT COLLINS, CO:
4,165,397, INT. CL. 35.

RADIUS CORPORATION, KUTZTOWN, PA:
4,164,625, PUB. 4-10-2012. INT. CL. 21.

RAFAELI, DAVID, LOS ANGELES, CA:
4,163,815, PUB. 4-10-2012. INT. CL. 14.

RAG AKTIENGESELLSCHAFT, 45128 ESSEN, FED REP GERMANY:
3,005,272, CANC. INT. CL. 9.

RAICO BAUTECHNIK GMBH, 87772 PFAFFENHAUSEN, FED REP GERMANY:
4,162,819, PUB. 4-10-2012. MULTIPLE CLASS, INT. CLS. 6, 17, 19 AND 37.

RAJ SUKUL, FONTANA, CA:
4,164,499, PUB. 4-10-2012. INT. CL. 30.

RAJIC, SAMIR, WALNUT CREEK, CA:
4,164,594, PUB. 4-10-2012. INT. CL. 35.

- RAMAR INTERNATIONAL CORPORATION, PITTSBURG, CA:
4,163,768, PUB. 4-10-2012. MULTIPLE CLASS, INT. CLS. 29 AND 30.
- RAMIREZ, ARNOLD, BREA, CA:
4,163,276, PUB. 4-10-2012. INT. CL. 9.
- RAMIREZ, ROLANDO, MISSOURI CITY, TX:
4,163,870, PUB. 4-10-2012. INT. CL. 10.
- RAMM TECHNOLOGIES, INC., DEERFIELD, IL:
4,163,566, PUB. 4-10-2012. INT. CL. 39.
- RAO, CHETHANA V., FAIRFAX, VA:
4,163,855, PUB. 4-10-2012. INT. CL. 44.
- RAPALA, GREGG R., ARLINGTON HEIGHTS, IL:
4,164,829, INT. CL. 21.
- RAPIDOTAX FINANCIAL CENTER, QUEENS, NY:
4,163,363, PUB. 4-10-2012. MULTIPLE CLASS, INT. CLS. 35 AND 36.
- RARITY BEAUTY, LLC, NEW HOPE, PA:
4,165,896, INT. CL. 3.
4,165,897, INT. CL. 3.
4,165,911, INT. CL. 3.
4,165,912, INT. CL. 3.
- RATTE, GEOFFREY S, SAINT PAUL, MN:
4,164,803, INT. CL. 16.
- RATTE, GEOFFREY S., SAINT PAUL, MN:
4,164,804, INT. CL. 25.
- RAUL CAMPILLO RODRIGUEZ, SPAIN:
4,163,021, PUB. 4-10-2012. INT. CL. 25.
- RAVEN CAPITAL MANAGEMENT LLC, NEW YORK, NY:
4,164,876, INT. CL. 36.
- RAY ELLIN PRODUCTIONS, INC., NEW YORK, NY:
4,164,907, INT. CL. 41.
- RAY ENTERPRISES OF CHESAPEAKE WALK, INC., ANNAPOLIS, MD:
4,165,015, MULTIPLE CLASS, INT. CLS. 9 AND 18.
- RAY WILLIAM JOHNSON, MARINA DEL REY, CA AND MAKER STUDIOS, INC., MARINA DEL REY, CA:
4,164,611, PUB. 4-10-2012. INT. CL. 41.
- RBC BEARINGS INC., OXFORD, CT:
4,162,795, PUB. 12-26-2006. INT. CL. 7.
- RBC MINISTRIES, GRAND RAPIDS, MI:
2,630,432. REN. 5-18-12. INT. CL. 16.
- RCC WESTERN STORES, INC., RAPID CITY, SD:
4,164,271, PUB. 4-10-2012. INT. CL. 35.
- RCC WESTERN STORES, INC., RAPID CITY, SD:
4,164,753, PUB. 4-10-2012. INT. CL. 35.
- RDA LIGHTING INC., TORONTO, ONTARIO, CANADA:
4,163,061, PUB. 4-10-2012. MULTIPLE CLASS, INT. CLS. 9, 11 AND 42.
- RDIO, INC., SAN FRANCISCO, CA:
4,163,741, PUB. 4-10-2012. MULTIPLE CLASS, INT. CLS. 16 AND 35.
- READ SOURCE, LTD., DUBLIN, OH:
2,648,326. REN. 5-21-12. INT. CL. 35.
- READING CO-OPERATIVE BANK, READING, MA:
4,164,296, PUB. 4-10-2012. INT. CL. 36.
- REAL PROPERTY MANAGEMENT, INC., LAYTON, UT:
4,164,283, PUB. 4-10-2012. INT. CL. 36.
- REBELLIOUS AT HEART INC., ELMHURST, NY:
4,164,348, PUB. 4-10-2012. INT. CL. 35.
- RECKITT BENCKISER LLC, PARSIPPANY, NJ:
4,165,471, INT. CL. 30.
- RECKITT BENCKISER N.V., HOOFDDORP, NETHERLANDS:
2,499,200, CANC. MULTIPLE CLASS, INT. CLS. 1 AND 3.
4,164,852, INT. CL. 3.
- RECLAIM RECOVERY GROUP, INC., NESCONSET, NY:
4,166,046, INT. CL. 36.
- RECOVERY POINT SYSTEMS, INC., GAITHERSBURG, MD:
4,164,303, PUB. 4-10-2012. INT. CL. 42.
4,164,313, PUB. 4-10-2012. INT. CL. 42.
- RED BRICK DESIGNS LLC, OKLAHOMA CITY, OK:
4,165,448, INT. CL. 42.
- RED FACE JACK'S, INC., WEST YARMOUTH, MA:
4,164,396, PUB. 4-10-2012. INT. CL. 43.
- RED LION HOTELS, INC., SPOKANE, WA:
2,524,923. REN. 5-24-12. INT. CL. 42.
2,527,331. REN. 5-24-12. INT. CL. 42.
2,534,139. REN. 5-24-12. INT. CL. 42.
- RED PIGGY PRESS, LLC, SAN DIEGO, CA:
4,163,995, PUB. 4-10-2012. INT. CL. 41.
- RED ROCK BREWING COMPANY, SALT LAKE CITY, UT:
4,165,607, INT. CL. 32.
- RED SEA FISH PHARM LTD, HERZLIA PITUACH, ISRAEL:
4,163,049, PUB. 4-10-2012. INT. CL. 21.
- REDCATS, 59100 ROUBAIX, FRANCE:
2,568,813. REN. 5-21-12. MULTIPLE CLASS, INT. CLS. 16 AND 20.
- REDMOND, ELAINA, LOS ANGELES, CA, DBA SPENCER PUBLISHING:
4,163,309, PUB. 4-10-2012. INT. CL. 41.
- REDSTONE FEDERAL CREDIT UNION, HUNTSVILLE, AL:
4,163,931, PUB. 4-10-2012. INT. CL. 36.
- REEBOK INTERNATIONAL LTD., CANTON, MA:
2,512,630. REN. 5-23-12. INT. CL. 25.
4,165,008, INT. CL. 25.
- REED ELSEVIER PROPERTIES INC., WILMINGTON, DE, REED PROPERTIES, INC., WILMINGTON, DE:
1,697,156. REN. 5-23-12. INT. CL. 16.
- REED ELSEVIER PROPERTIES INC., WILMINGTON, DE:
4,164,180, PUB. 4-10-2012. U.S. CL. B.
4,164,181, PUB. 4-10-2012. U.S. CL. B.
- REED LIGNIN INC., GREENWICH, CT:
503,191, CANC. U.S. CL. 6.
- REFINED LIVING, LLC, CHEVY CHASE, MD:
4,165,639, INT. CL. 45.
- REFRICENTER OF MIAMI, INC., MIAMI, FL:
2,539,903. REN. 5-24-12. INT. CL. 11.
- REGIONAL SERVICES CORPORATION, WASHINGTON, DC:
862,413, CANC. U.S. CL. 35.
- REGNERBAU CALW GMBH, 75382 ALTHENGSTETT, FED REP GERMANY:
3,086,956, CANC. INT. CL. 17.
- REGSOURCE INC, CARY, NC:
4,163,149, PUB. 4-10-2012. INT. CL. 42.
- REGULATION DIRECTIVE MEDICAL PHYSICS, LLC, FLATWOODS, KY:
4,164,488, PUB. 4-10-2012. INT. CL. 44.
- REICHEL FOODS, INC., ROCHESTER, MN:
2,646,658. REN. 5-21-12. INT. CL. 29.
- REID, LINDA J., MILWAUKEE, WI AND BRODESKE, KURT H., MILWAUKEE, WI:
4,165,033, INT. CL. 25.
- REINALT-THOMAS CORPORATION, THE, SCOTTSDALE, AZ:
1,195,643. REN. 5-19-12. INT. CL. 12.
- REJCA SRL, ITALY:
4,162,971, PUB. 4-10-2012. MULTIPLE CLASS, INT. CLS. 30 AND 43.
- RELCO, LLC, WILLMAR, MN:
2,713,065. REN. 5-24-12. MULTIPLE CLASS, INT. CLS. 6, 7, 9, 40 AND 42.
2,713,066. REN. 5-24-12. MULTIPLE CLASS, INT. CLS. 6, 7, 9, 40 AND 42.
- RELENTLESS AGAINST CANCER, INC., HAMBURG, NJ:
4,164,739, PUB. 4-10-2012. INT. CL. 36.
- RELIANT ENTERPRISES, SCOTTSDALE, AZ:
4,164,236, PUB. 4-10-2012. INT. CL. 9.
- RELIASOURCE, INC., BALTIMORE, MD:
4,163,572, PUB. 4-10-2012. MULTIPLE CLASS, INT. CLS. 35, 38, 39, 40, 42 AND 45.
4,163,573, PUB. 4-10-2012. MULTIPLE CLASS, INT. CLS. 35, 38, 39, 40, 42 AND 45.
- RELIEF INTERNATIONAL, LOS ANGELES, CA:
4,164,971, INT. CL. 36.
- REMICK, JOHN A., LOS ANGELES, CA:
4,165,044, INT. CL. 41.
- RENAISSANCE NEWARK FOUNDATION, INC., NEWARK, NJ:
4,163,501, PUB. 4-10-2012. INT. CL. 41.
- RENBJER & MAGNUSSON AB, SWEDEN:
4,162,807, PUB. 4-10-2012. INT. CL. 33.

RENEGADE TOBACCO COMPANY, MOCKSVILLE, NC:
4,164,996, INT. CL. 34.

RENEW ADVANTAGE LLC, NAPLES, FL:
4,163,387, PUB. 4-10-2012. MULTIPLE CLASS, INT. CLS.
35 AND 44.
4,163,388, PUB. 4-10-2012. MULTIPLE CLASS, INT. CLS.
35 AND 44.

RENZONI, ROBERTA, MILANO, ITALY:
4,163,065, PUB. 6-14-2011. MULTIPLE CLASS, INT. CLS.
9, 14, 16, 18 AND 25.

REPAIRCLINIC.COM, CANTON, MI:
2,498,794, CANC. INT. CL. 35.

RESCUE MISSION, INC., OMAHA, NE:
2,570,822, REN. 5-21-12. INT. CL. 42.

RESDEVCO LTD., 91033 JERUSALEM, ISRAEL:
4,162,878, PUB. 4-10-2012. INT. CL. 5.

RESOURCE WEST, INC., GRAND JUNCTION, CO:
4,163,556, PUB. 4-10-2012. MULTIPLE CLASS, INT. CLS.
35, 40 AND 42.

RESTONIC CORPORATION, ANTIOCH, IL:
4,164,446, PUB. 4-10-2012. INT. CL. 20.

RETAIL CONCEPTS, INC., HOUSTON, TX:
4,165,456, MULTIPLE CLASS, INT. CLS. 9 AND 18.

RETAIL ROYALTY COMPANY, LAS VEGAS, NV:
2,360,451, AM. INT. CL. 25.
3,160,610, AM. INT. CL. 30.
4,164,608, PUB. 4-10-2012. INT. CL. 18.
4,164,669, PUB. 4-10-2012. INT. CL. 3.

RETAIL 101, LLC, BEACON FALLS, CT:
4,165,333, INT. CL. 35.
4,165,334, INT. CL. 35.

REVENUEWIRE INC., VICTORIA, BC, CANADA:
4,164,912, MULTIPLE CLASS, INT. CLS. 35 AND 38.

REVERSE LOGISTICS GMBH, DORNACH, FED REP GER-
MANY:
4,163,364, PUB. 4-10-2012. MULTIPLE CLASS, INT. CLS.
16, 35, 38, 39, 40 AND 42.

REVISE CLOTHING, INC., TETERBORO, NJ:
2,585,985, REN. 5-18-12. INT. CL. 25.

REVOLUTIONARY WAR VETERANS ASSOCIATION, INC.,
MOREHEAD, KY, AKA RWVA:
4,128,556, COR. MULTIPLE CLASS, INT. CLS. 25, 28
AND 41.

REXEL, INC., DALLAS, TX:
3,006,144, CANC. INT. CL. 35.

REXNORD INDUSTRIES, LLC, MILWAUKEE, WI, LINK-
BELT COMPANY, CHICAGO, IL:
557,725, REN. 5-23-12. U.S. CL. 23 (INT. CL. 7).

REYNOLDS, CHARLES H., SAN JOSE, CA AND NEW-
COMB, DAVID VANCE, SOQUEL, CA AND OSTERHOUT,
GLEN WILLIAM, PLEASANTON, CA:
4,165,700, INT. CL. 22.

RHEINMETALL AIR DEFENCE AG, SWITZERLAND:
4,162,800, PUB. 4-10-2012. MULTIPLE CLASS, INT. CLS. 9
AND 13.

RHINO TOOL CO., KEWANEE, IL:
4,163,487, PUB. 4-10-2012. INT. CL. 7.
4,163,488, PUB. 4-10-2012. INT. CL. 7.

RHINOTUFF, INC., ENCINITAS, CA:
4,164,437, PUB. 4-10-2012. INT. CL. 25.

RIB CRIB BBQ, INC., THE, TULSA, OK:
2,621,284, REN. 5-24-12. INT. CL. 30.

RICE KING FOODS, INC., SAN DIEGO, CA:
2,395,297, CANC. INT. CL. 42.

RICE LAKE WEIGHING SYSTEMS, INC., RICE LAKE, WI:
2,607,463, REN. 5-18-12. INT. CL. 7.

RICH PRODUCTS CORPORATION, BUFFALO, NY:
3,107,162, COR. MULTIPLE CLASS, INT. CLS. 29, 30, 32,
35, 41 AND 43.

RICHARD A. HOPPER, FULLERTON, CA:
4,166,062, INT. CL. 9.

RICHARDSON FOODS CORPORATION, MACEDON, NY:
502,904, CANC. U.S. CL. 45.

RICHLINE GROUP, INC., NEW YORK, NY:
1,684,392, REN. 5-18-12. INT. CL. 14.
4,164,107, PUB. 4-10-2012. INT. CL. 14.

RICHMOND INTERNATIONAL RACEWAY, INC., DAY-
TONA BEACH, FL:
2,577,831, REN. 5-18-12. INT. CL. 25.

RICKYJIMMY LLC, NASHVILLE, TN, DBA R&J RECORDS:
4,165,790, INT. CL. 9.
4,165,791, INT. CL. 9.

RIDDER BEHEER B.V., NETHERLANDS:
4,162,967, PUB. 4-10-2012. MULTIPLE CLASS, INT. CLS.
7, 9 AND 37.

RIDGE VINEYARDS, INC., CUPERTINO, CA:
4,164,555, PUB. 4-10-2012. INT. CL. 33.

RIENZI, ARMANDO, TRENTON, NJ:
2,570,037, REN. 5-21-12. INT. CL. 29.

RIO STREAM PRODUCTS LLC, BROKEN ARROW, OK:
4,164,653, PUB. 4-10-2012. INT. CL. 12.

RIOT GAMES, INC., SANTA MONICA, CA:
4,164,849, INT. CL. 9.

RISING TIDE FOUNDATION, SCHAFFHAUSEN, SWIT-
ZERLAND:
4,165,743, INT. CL. 44.

RIVER LIGHT V, LLC, BERWYN, PA:
2,990,110, CANC. INT. CL. 35.

RIVER ROCK ENTERTAINMENT AUTHORITY, A GOV-
ERNMENT INSTRUMENTALITY OF THE DRY CREEK
RANCHERIA OF POMO INDIANS, GEYSERVILLE, CA,
DBA RIVER ROCK CASINO:
4,165,747, INT. CL. 41.

RIVERA, JULIO, NORTH BERGEN, NJ:
4,164,944, MULTIPLE CLASS, INT. CLS. 29 AND 30.

RIVERMARK, LLC, DOYLESTOWN, PA:
4,163,998, PUB. 4-10-2012. MULTIPLE CLASS, INT. CLS.
35 AND 42.

RIVERSIDE MEDICAL, LLC, RIVERSIDE, CT:
4,163,661, PUB. 4-10-2012. INT. CL. 35.

RIVKA'S CATERING, DEAL, NJ:
4,165,845, INT. CL. 43.

RLG INTERNATIONAL, INC., BURNABY BC, CANADA:
4,163,212, PUB. 4-10-2012. INT. CL. 35.
4,163,213, PUB. 4-10-2012. INT. CL. 35.

RM CHEVYS LLC, CYRPRESS, CA:
2,579,149, REN. 5-24-12. INT. CL. 42.

ROADSIDE BEVERAGE COMPANY, CHARLOTTESVILLE,
VA TO ROADSIDE BEVERAGE, L.L.C., GORDONSVILLE,
VA:
2,498,523, CANC. INT. CL. 32.

ROBBINS RESEARCH INTERNATIONAL, INC., ESCONDI-
DO, CA:
4,165,117, MULTIPLE CLASS, INT. CLS. 9, 41 AND 45.

ROBERT GUEVARA, SAN DIEGO, CA:
4,163,845, PUB. 4-10-2012. INT. CL. 25.

ROBERT J. BETTINARDI, TINLEY PARK, IL:
4,164,883, INT. CL. 28.

ROBERT P. NICKELL, TORRANCE, CA:
4,165,943, INT. CL. 18.

ROBERT W. HARDIE, ASTORIA, NY:
4,164,786, INT. CL. 28.

ROBERTO COIN S.P.A., VICENZA, ITALY:
2,576,874, REN. 5-23-12. INT. CL. 14.

ROBERTS, CLIFF, WENTZVILLE, MO:
4,163,887, PUB. 4-10-2012. INT. CL. 39.

ROBINSONS SOFT DRINKS LIMITED, ESSEX CM1 ITU,
UNITED KINGDOM:
4,162,968, PUB. 4-10-2012. MULTIPLE CLASS, INT. CLS.
32 AND 41.

ROCHESTER INSTITUTE OF TECHNOLOGY, ROCHE-
STER, NY:
859,143, CANC. U.S. CL. 107.
1,716,648, REN. 5-23-12. INT. CL. 41.
1,716,652, REN. 5-23-12. INT. CL. 41.

ROCKET GARDEN LABS LTD, READING, UNITED KING-
DOM:
4,164,467, PUB. 4-10-2012. INT. CL. 9.

ROCKY BRANDS WHOLESALE LLC, NELSONVILLE, OH:
1,689,129, REN. 5-18-12. INT. CL. 25.

ROCKY MOUNTAIN BROADBAND, ATLANTA, GA:
4,163,989, PUB. 4-10-2012. INT. CL. 38.

ROD'S FOOD PRODUCTS, INC., LOS ANGELES, CA:
780,079, CANC. U.S. CL. 46.

- RODAN & FIELDS, LLC, SAN FRANCISCO, CA:
4,165,958, MULTIPLE CLASS, INT. CLS. 3 AND 5.
- RODIN, RACHEL, NEW YORK, NY:
4,165,780, INT. CL. 45.
- RODRIGUEZ MORENO, LEONARDO, ATIZAPAN DE ZARAGOZA, MEXICO:
4,163,978, PUB. 4-10-2012. INT. CL. 33.
- RODRIGUEZ, JOSUE, MIAMI, FL:
4,164,383, PUB. 4-10-2012. INT. CL. 35.
- ROEBUCK, TIA M., LARGO, MD:
4,166,021, INT. CL. 35.
- ROECKL SPORHANDSCHUHE GMBH & CO. KG, FED REP GERMANY:
3,133,208.
- ROGERS CORPORATION, ROGERS, CT:
4,165,254, INT. CL. 17.
- ROGUE RIVER SPORTS, INC., ATLANTA, GA:
4,164,106, PUB. 4-10-2012. INT. CL. 12.
4,164,108, PUB. 4-10-2012. INT. CL. 12.
- ROI VENTURES, LLC, CHICAGO, IL:
4,166,019, INT. CL. 35.
- ROJAS, MARIO, BAKERSFIELD, CA AND BARRON, MARTIN, BAKERSFIELD, CA:
4,164,903, INT. CL. 25.
- ROMAR INTERNATIONAL CORP., NEW YORK, NY:
2,499,027, CANC. MULTIPLE CLASS, INT. CLS. 14, 16, 18, 20, 25 AND 26.
- ROOT INTERNATIONAL, INC., LUTZ, FL:
2,581,525, REN. 5-18-12. INT. CL. 18.
- ROPLAST INDUSTRIES, INC., OROVILLE, CA:
2,571,248, REN. 5-19-12. INT. CL. 16.
- ROPPE CORPORATION, FOSTORIA, OH:
2,619,313, REN. 5-21-12. INT. CL. 27.
- ROSE, VICTORIA LASDON, NEW YORK, NY:
4,164,835, INT. CL. 35.
- ROSEHIP LTD., GROOT KWARTIERWEG 12, CURACAO:
2,561,367, REN. 5-22-12. INT. CL. 41.
- ROSENTHAL, SUSAN, HIGHLANDS, NJ:
4,164,178, PUB. 4-10-2012. INT. CL. 41.
- ROSWELL PARK CANCER INSTITUTE CORPORATION, BUFFALO, NY:
4,165,437, MULTIPLE CLASS, INT. CLS. 35 AND 41.
- ROSY BLUE N.V., 2018 ANTWERP, BELGIUM:
3,006,133, CANC. INT. CL. 14.
- ROTARY CLUB OF ROSEVILLE, CALIFORNIA, ROSEVILLE, CA:
4,165,736, INT. CL. 36.
- ROTATION DYNAMICS CORPORATION, DARIEN, IL:
4,164,098, PUB. 4-10-2012. INT. CL. 7.
4,164,099, PUB. 4-10-2012. INT. CL. 7.
- ROVIO ENTERTAINMENT LTD, FINLAND:
4,162,825, PUB. 4-10-2012. MULTIPLE CLASS, INT. CLS. 9, 16, 28 AND 41.
- ROYAL IMEX INC., SANTA FE SPRINGS, CA:
4,165,436, INT. CL. 26.
- ROYAL WINE CORPORATION, BROOKLYN, NY:
1,171,543, CANC. INT. CL. 33.
- ROYSE MANUFACTURING CO., DALLAS, TX:
2,593,447, REN. 5-18-12. INT. CL. 11.
- RP SAFE S.P.A., MILANO, ITALY:
2,706,284, REN. 5-18-12. MULTIPLE CLASS, INT. CLS. 37 AND 42.
- RRHOT LLC, COLONIA, NJ:
4,163,644, PUB. 4-10-2012. INT. CL. 9.
- RSI HOME PRODUCTS MANAGEMENT, INC., ANAHEIM, CA:
4,165,268, MULTIPLE CLASS, INT. CLS. 11 AND 20.
4,165,269, MULTIPLE CLASS, INT. CLS. 11 AND 20.
- RTM INTERNATIONAL LLC, SORRENTO, FL:
4,163,729, PUB. 4-10-2012. INT. CL. 9.
- RUBIE'S COSTUME CO., INC., RICHMOND HILL, NY:
4,165,904, INT. CL. 25.
- RUD KETTEN RIEGER & DIETZ GMBH U. CO. KG, FED REP GERMANY:
4,123,686, COR. MULTIPLE CLASS, INT. CLS. 6, 7, 8 AND 9.
- RUDERER, RICHARD, ST. LOUIS, MO:
4,165,973, INT. CL. 36.
- RUDKIN, RONALD D, ORANGE, CA:
3,006,502, CANC. INT. CL. 35.
- RUNNING AWAY ENTERPRISES, LLC, DEERFIELD, IL:
4,163,472, PUB. 4-10-2012. INT. CL. 41.
- RUSH ASSOCIATED LABELS, INC., NEW YORK, NY:
4,163,545, PUB. 4-10-2012. INT. CL. 9.
4,163,546, PUB. 4-10-2012. INT. CL. 9.
- RUSH DIRECT, INC., WOOD DALE, IL:
4,163,313, PUB. 4-10-2012. INT. CL. 31.
- RUSH STAR WIRELESS, INC., WATERFORD, MI, DBA RUSHSTAR WIRELESS:
4,163,627, PUB. 4-10-2012. INT. CL. 36.
4,163,628, PUB. 4-10-2012. INT. CL. 35.
- RUTH TYSON, NORTHHAMPTONSHIRE, UNITED KINGDOM:
4,163,621, PUB. 4-10-2012. INT. CL. 3.
- RUTHERFORD, FRED, CONYERS, GA:
4,163,495, PUB. 4-10-2012. MULTIPLE CLASS, INT. CLS. 25 AND 45.
- RUTLAND PLASTIC TECHNOLOGIES, INC., PINEVILLE, NC:
4,163,158, PUB. 4-10-2012. MULTIPLE CLASS, INT. CLS. 1 AND 2.
- RX FOR FLEAS, INC., FT. LAUDERDALE, FL:
1,695,726, REN. 5-19-12. INT. CL. 5.
- RYAN, SALLY T., MILL CREEK, WA:
2,498,273, CANC. INT. CL. 16.
- R2 CONSTRUCTION SERVICES, INC., MESA, AZ:
4,164,501, PUB. 4-10-2012. INT. CL. 42.
- S. C. JOHNSON & SON, INC., RACINE, WI, KIWI POLISH COMPANY PROPRIETARY LIMITED, THE, RICHMOND, NEAR MELBOURNE, VICTORIA, AUSTRALIA:
294,323, REN. 5-18-12. U.S. CL. 4 (INT. CL. 3).
- S. D. MYERS, INC., TALLMADGE, OH:
4,166,020, INT. CL. 41.
- S.S. SARNA, INC., MANHASSET, NY:
2,497,725, CANC. INT. CL. 35.
- S.S.S. COMPANY, ATLANTA, GA:
1,663,920, REN. 5-19-12. INT. CL. 5.
- SA, SHUANG, RICHMOND, BC, CANADA:
4,165,191, MULTIPLE CLASS, INT. CLS. 7 AND 19.
- SABERTOOTH MOTORCYCLES, LLC, CHESTNUT HILL, MA:
4,164,713, PUB. 4-10-2012. INT. CL. 33.
4,164,715, PUB. 4-10-2012. INT. CL. 43.
4,164,719, PUB. 4-10-2012. INT. CL. 37.
4,164,720, PUB. 4-10-2012. INT. CL. 39.
- SABINE INC., ALACHUA, FL:
4,165,262, INT. CL. 9.
- SABRE INC., SOUTHLAKE, TX:
2,594,101, REN. 5-19-12. MULTIPLE CLASS, INT. CLS. 9 AND 42.
- SAFE HARBOR HOLDING II, LLC, MIAMI, FL:
4,163,795, PUB. 4-10-2012. MULTIPLE CLASS, INT. CLS. 39 AND 41.
- SAFE PASSAGE INTERNATIONAL, INC., ROCHESTER, NY, PUBLIC COMPUTER SYSTEMS, INCORPORATED, ROCHESTER, NY:
1,689,509, REN. 5-24-12. INT. CL. 9.
- SAFE-T-SLEEVE, LLC, LAS VEGAS, NV:
4,165,359, INT. CL. 10.
- SAFER, INC., LITITZ, PA, RINGER CORPORATION, EDEN PRAIRIE, MN AND W.R. GRACE & CO.-CONN., NEW YORK, NY:
1,764,000, REN. 5-23-12. INT. CL. 5.
- SAFETY JUNCTION, THE, SAINT LOUIS, MO:
4,165,876, INT. CL. 5.
- SAFETY TECHNOLOGY INTERNATIONAL, INC., WATERFORD, MI:
2,706,672, REN. 5-18-12. INT. CL. 9.
- SAFEWAY INC., PLEASANTON, CA:
4,164,740, PUB. 4-10-2012. INT. CL. 32.
4,164,741, PUB. 4-10-2012. INT. CL. 32.
- SAFEWAY STORES, INCORPORATED, OAKLAND, CA:
441,349, CANC. U.S. CL. 38.
- SAFT, FRANCE:
3,051,125.
3,051,126.

SAGE AUTOMOTIVE INTERIORS, INC., SPARTANBURG, SC:
2,499,063, CANC. INT. CL. 24.

SAGE SOFTWARE HEALTHCARE, LLC, TAMPA, FL:
2,497,830, CANC. INT. CL. 9.

SAGE SOFTWARE, INC., IRVINE, CA:
2,658,106, REN. 5-23-12. INT. CL. 9.

SAGES & SEEKERS, INCORPORATED, NATICK, MA:
4,164,529, PUB. 4-10-2012. MULTIPLE CLASS, INT. CLS. 36 AND 41.

SAHRANAVARD, M., LOS ANGELES, CA:
2,941,871, CANC. INT. CL. 25.

SAINT-GOBAIN CERAMICS & PLASTICS, INC., WORCESTER, MA:
4,163,168, PUB. 4-10-2012. MULTIPLE CLASS, INT. CLS. 1 AND 4.
4,163,169, PUB. 4-10-2012. INT. CL. 4.
4,163,170, PUB. 4-10-2012. INT. CL. 3.

SAINT-GOBAIN PERFORMANCE PLASTICS CORPORATION, AURORA, OH, FURON COMPANY, LAGUNA NIGUEL, CA:
1,687,581, REN. 5-18-12. MULTIPLE CLASS, INT. CLS. 7, 9 AND 20.

SAINT-GOBAIN PERFORMANCE PLASTICS CORPORATION, AURORA, OH:
4,165,229, INT. CL. 17.

SAJJA, GOPICHAND, ISELIN, NJ:
4,166,006, INT. CL. 42.

SAKAR ACQUISITION, LLC, EDISON, NJ:
4,164,791, INT. CL. 9.

SAKATA SEED CORPORATION, YOKOHAMA, JAPAN:
4,164,044, PUB. 4-10-2012. INT. CL. 31.

SAKURA COLOR PRODUCTS CORPORATION, OSAKA-SHI, OSAKA-FU 537-0025, JAPAN:
1,692,910, REN. 5-21-12. INT. CL. 16.

SALAD NATION, LLC, LUTZ, FL:
4,166,005, INT. CL. 42.

SALSA TAMAZULA, S.A. DE C.V., GUADALAJARA JALISCO, MEXICO:
2,558,727, REN. 5-18-12. INT. CL. 30.

SALVATION ARMY, THE, WEST NYACK, NY:
2,715,067, REN. 5-23-12. INT. CL. 42.

SALVATORE FERRAGAMO S.P.A., FLORENCE, ITALY:
2,574,883, REN. 5-18-12. INT. CL. 9.

SAMMY LEE ENTERPRISES, INC., BIRMINGHAM, AL:
4,165,961, INT. CL. 25.

SAMSUNG ELECTRONICS CO., LTD., SUWON-SI, GYEONGGI-DO, REPUBLIC OF KOREA:
4,162,770, PUB. 3-20-2012. MULTIPLE CLASS, INT. CLS. 7, 9 AND 11.
4,165,760, INT. CL. 9.

SAN ANTONIO WINERY, INC., LOS ANGELES, CA:
4,163,618, PUB. 4-10-2012. INT. CL. 33.

SANCHEZ-MANRIQUEZ, JUAN CARLOS, SAN FRANCISCO DEL RINCON, MEXICO:
2,498,696, CANC. INT. CL. 25.

SANCHEZ, JARED, RANCHO CUCAMONGA, CA:
4,164,336, PUB. 4-10-2012. INT. CL. 38.

SANCHEZ, JULIAN, ORLANDO, FL AND CECARELLI, EDWARD KODY, NEW YORK, NY:
4,164,834, INT. CL. 35.

SAND CPH A/S, DENMARK:
3,046,413.

SAND DOLLAR BEACH, LLC, WESTPORT, CT AND RANGER CAPITAL GROUP HOLDINGS, L.P., DALLAS, TX:
4,165,588, INT. CL. 36.
4,165,589, INT. CL. 36.

SANDERS, ROBIN RENEE, ALEXANDRIA, VA:
4,165,149, MULTIPLE CLASS, INT. CLS. 9 AND 16.

SANDFLY MEDIA, LLC, WYNANTSKILL, NY:
4,163,354, PUB. 4-10-2012. INT. CL. 42.

SADOW MEDIA, LLC, BOCA RATON, FL:
4,164,770, PUB. 4-10-2012. INT. CL. 9.

SANDOZ AG (SANDOZ LTD., SANDOZ S.A.), BASLE, SWITZERLAND:
864,345, CANC. U.S. CL. 52.
864,347, CANC. U.S. CL. 52.

SANDOZ AG (SANDOZ LTD., SANDOZ S.A.), BASLE, SWITZERLAND:
864,346, CANC. U.S. CL. 52.

SANDRO BOHNENBLUST, SWITZERLAND:
4,162,953, PUB. 4-10-2012. INT. CL. 41.

SANDTECH INC., MORTON GROVE, IL, DBA ALFA MANUFACTURING INDUSTRIES, INC. DBA ALFA TOOLS:
2,597,885, REN. 5-18-12. INT. CL. 7.

SANDVIK MINING AND CONSTRUCTION OY, 33311 TAMPERE, FINLAND, OY TAMPELLA AB, TAMPERE, FINLAND:
935,320, REN. 5-19-12. U.S. CL. 23 (INT. CL. 7).

SANDWICH ISLES TRADING CO., INC., KALAHEO, HI:
4,164,334, PUB. 4-10-2012. INT. CL. 32.

SANESE SERVICES, INC., COLUMBUS, OH:
2,569,113, REN. 5-21-12. MULTIPLE CLASS, INT. CLS. 35 AND 42.

SANFORD, PETER B., MORRO BAY, CA:
4,165,473, INT. CL. 20.

SANITY WINE AND SPIRITS, LLC, NAPA, CA:
4,165,231, INT. CL. 33.

SANLUIS CORPORACIÓN, S.A.B DE C.V., MEXICO, D.F., MEXICO:
4,163,282, PUB. 4-10-2012. INT. CL. 16.

SANMINA-SCI CORPORATION, SAN JOSE, CA:
3,379,392, COR. INT. CL. 9.

SANOFI, PARIS, FRANCE:
3,152,735, CANC. MULTIPLE CLASS, INT. CLS. 16 AND 41.

SANOFI-SYNTHELABO, 75008 PARIS, FRANCE:
2,966,955, CANC. INT. CL. 5.

SANTA CLARA, INC., BURLINGTON, NC:
2,963,545, CANC. INT. CL. 34.

SANTA ELENA HOLDINGS LTD., MIAMI, FL:
4,164,684, PUB. 4-10-2012. INT. CL. 43.

SAP AG, WALLDORF, FED REP GERMANY:
4,162,785, PUB. 4-10-2012. MULTIPLE CLASS, INT. CLS. 9, 16, 35, 38, 41 AND 42.

SAPUTO ACQUISITION, INC., LINCOLNSHIRE, IL, SAPUTO ACQUISITION, INC., LINCOLNSHIRE, IL:
2,629,574, REN. 5-18-12. INT. CL. 29.

SARA LEE TM HOLDINGS, LLC., DOWNERS GROVE, IL:
2,568,180, REN. 5-19-12. INT. CL. 30.

SARATOGA SPRING WATER COMPANY, SARATOGA SPRINGS, NY, SARATOGA SPRINGS COMPANY, INC., THE, SARATOGA SPRINGS, NY:
1,198,188, REN. 5-23-12. INT. CL. 32.

SAVAGE DESIGN GROUP, INC., HOUSTON, TX:
2,498,880, CANC. INT. CL. 35.

SAVESTA LIFESCIENCES PTE. LTD., SINGAPORE, SINGAPORE:
2,515,294, REN. 5-24-12. INT. CL. 5.

SAVORY SPICE SHOP, INC., DENVER, CO:
4,165,455, INT. CL. 35.

SAVVY CIE, INC., HOLLYWOOD, FL:
4,164,688, PUB. 4-10-2012. INT. CL. 14.

SAWLUZ CORPORATION, BOCA RATON, FL:
4,165,372, MULTIPLE CLASS, INT. CLS. 38 AND 42.

SAXX APPAREL LTD., VANCOUVER, CANADA:
4,164,218, PUB. 4-10-2012. INT. CL. 25.
4,164,219, PUB. 4-10-2012. INT. CL. 25.

SBARK CONSULTING, LLC, OVERLAND PARK, KS:
4,163,835, PUB. 4-10-2012. MULTIPLE CLASS, INT. CLS. 18 AND 28.

SCHENLEY INDUSTRIES, INC., NEW YORK, NY:
859,428, CANC. U.S. CL. 49.

SCHERING-PLOUGH ANIMAL HEALTH CORPORATION, SUMMIT, NJ:
863,821, CANC. U.S. CL. 18.

SCHEXNAYDER, VILMORE J, CARSON, CA:
4,163,626, PUB. 4-10-2012. INT. CL. 29.

SCHLAFENDER HASE GMBH, BISCHOFSEHEIM, FED REP GERMANY:
4,163,134, PUB. 4-10-2012. MULTIPLE CLASS, INT. CLS. 9, 16, 35 AND 42.

- SCHLEUNIGER HOLDING AG, CH-3608 THUN, SWITZERLAND:
4,162,843, PUB. 4-10-2012. MULTIPLE CLASS, INT. CLS. 7, 8, 9 AND 40.
- SCHLUMBERGER TECHNOLOGY CORPORATION, SUGAR LAND, TX:
4,165,180, INT. CL. 42.
- SCHMERLING AG, ZURICH, SWITZERLAND:
4,163,322, PUB. 4-10-2012. INT. CL. 33.
- SCHNEIDER, GALIT, COOPER CITY, FL:
4,165,836, INT. CL. 3.
- SCHNELL, DONALD, SARASOTA, FL:
4,163,861, PUB. 4-10-2012. MULTIPLE CLASS, INT. CLS. 5 AND 41.
- SCHOLASTIC INC., NEW YORK, NY:
2,711,978, REN. 5-19-12. INT. CL. 41.
- SCHOOL POWER, INC., FORT WORTH, TX, DBA RENT A FROG OF FORT WORTH:
2,671,864, REN. 5-19-12. INT. CL. 39.
- SCHOOLHOUSE OUTFITTERS, LLC, CINCINNATI, OH:
4,164,881, INT. CL. 35.
- SCHRODER - VAN DE CRAATS, ANKY GROOTHOF, MRS., 1446 RJ PURMEREND, NETHERLANDS:
2,568,905, REN. 5-21-12. INT. CL. 25.
- SCHUMANN, LAVERNE E., BLUE GRASS, IA, AKA SCHUMANN'S SALES & SERVICE AND WWW.SCHUMANNSDYNAMICPERFORMANCE.COM:
2,572,349, REN. 5-23-12. INT. CL. 7.
- SCHWAN'S IP, LLC, MARSHALL, MN:
4,165,348, INT. CL. 29.
4,165,349, INT. CL. 29.
- SCHWEIZER ELECTRONIC AG, SCHRAMBERG, FED REP GERMANY:
4,162,935, PUB. 4-10-2012. MULTIPLE CLASS, INT. CLS. 9, 35 AND 42.
- SCI DIRECT, LLC, NORTH CANTON, OH:
4,165,347, INT. CL. 9.
- SCI MANAGEMENT L.P., HOUSTON, TX:
2,498,284, CANC. INT. CL. 41.
- SCOTT PAPER COMPANY, DELAWARE COUNTY, PA:
854,412, CANC. U.S. CL. 2.
- SCOTT STRODE, DENVER, CO:
4,164,856, INT. CL. 25.
- SCOTT, EMILY, SAN CARLOS, CA:
4,164,563, PUB. 4-10-2012. INT. CL. 41.
- SCOTT, JOSEPH, HOUSTON, TX:
4,164,033, PUB. 4-10-2012. INT. CL. 9.
- SCOTT, RYAN A, BARTLESVILLE, OK:
4,163,406, PUB. 4-10-2012. INT. CL. 25.
- SCOTT'S SAUCE COMPANY, INC., GOLDSBORO, NC:
1,192,598, REN. 5-23-12. INT. CL. 30.
- SCRANTON MANUFACTURING COMPANY INC., SCRANTON, IA:
2,567,140, REN. 5-19-12. INT. CL. 12.
- SCRIP, INC., BOLINGBROOK, IL:
4,163,886, PUB. 4-10-2012. INT. CL. 3.
- SDI CORPORATION, TA JWU LI, CHANG HUA, TAIWAN:
1,687,816, REN. 5-23-12. INT. CL. 16.
- SEA TURTLE, INCORPORATED, SOUTH PADRE ISLAND, TX:
4,163,914, PUB. 4-10-2012. INT. CL. 44.
- SEACOAT TECHNOLOGY, LLC, HOUSTON, TX:
2,639,790, REN. 5-18-12. INT. CL. 2.
- SEAELECTRO CORPORATION, MAMARONECK, NY:
855,033, CANC. U.S. CL. 21.
855,481, CANC. U.S. CL. 21.
- SEALED AIR CORPORATION (US), ELMWOOD PARK, NJ:
4,165,514, INT. CL. 17.
- SEALMARK MANUFACTURING CORPORATION, DONORA, PA:
4,164,839, INT. CL. 19.
- SEALY TECHNOLOGY LLC, TRINITY, NC:
4,165,424, INT. CL. 20.
4,165,425, INT. CL. 20.
- SEAMLESS TECHNOLOGIES, INC., MORRISTOWN, NJ:
4,163,721, PUB. 4-10-2012. INT. CL. 9.
- SEARS BRANDS, LLC, HOFFMAN ESTATES, IL, SEARS, ROEBUCK & CO., HOFFMAN ESTATES, IL:
1,687,912, REN. 5-24-12. INT. CL. 25.
- SEARS BRANDS, LLC, HOFFMAN ESTATES, IL:
1,688,984, REN. 5-20-12. INT. CL. 14.
- SEASHELL INTERNATIONAL, INC., CARLSBAD, CA:
4,165,952, INT. CL. 6.
- SEASHELL TECHNOLOGY, LLC, LA JOLLA, CA:
4,164,120, PUB. 4-10-2012. INT. CL. 17.
- SEAT SACK, INC., NAPLES, FL:
4,166,044, MULTIPLE CLASS, INT. CLS. 18 AND 35.
- SEATTLE BIKE SUPPLY, INC., KENT, WA:
4,162,774, PUB. 4-10-2012. INT. CL. 12.
- SEATTLE CHOCOLATE COMPANY, L.L.C., SEATTLE, WA:
2,685,762, REN. 5-18-12. INT. CL. 30.
- SEBRANEK, INC., BURLINGTON, WI:
4,165,178, MULTIPLE CLASS, INT. CLS. 9, 16 AND 41.
- SECRET CHARM LLC, LOS ANGELES, CA:
4,165,674, INT. CL. 25.
- SECRET KISSES, LLC., WESLEY CHAPEL, FL:
4,165,676, INT. CL. 3.
- SECURIAN FINANCIAL GROUP, INC., ST. PAUL, MN:
4,164,418, PUB. 4-10-2012. INT. CL. 35.
- SECURITAS AB, SWEDEN:
4,162,812, PUB. 4-10-2012. MULTIPLE CLASS, INT. CLS. 6, 9, 14, 35, 36, 37, 39, 41, 42 AND 45.
- SEDATION ON CALL, PLLC, SPRING, TX:
4,166,024, INT. CL. 44.
- SEEDLAND, INC., WELLBORN, FL:
2,502,173, REN. 5-19-12. INT. CL. 35.
- SEGARRA, PAUL J., MIAMI, FL:
4,163,982, PUB. 4-10-2012. INT. CL. 3.
- SEIRUS INNOVATIVE ACCESSORIES, INC., POWAY, CA:
2,570,399, REN. 5-21-12. INT. CL. 10.
- SEITO SYSTEMS LIMITED, KWUN TONG, HONG KONG, HONG KONG:
4,163,396, PUB. 4-10-2012. INT. CL. 9.
- SEKKOIA, S.A.S., RUNGIS CEDEX, FRANCE:
4,165,198, INT. CL. 28.
- SELAME DESIGN INC., NEWTON, MA:
1,702,051, REN. 5-18-12. INT. CL. 35.
- SELEE CORPORATION, HENDERSONVILLE, NC:
2,599,150, REN. 5-18-12. INT. CL. 6.
- SELF-MASTERY CENTER, INC., THE, LEAWOOD, KS:
2,498,302, CANC. INT. CL. 41.
- SELMAN AND ASSOCIATES, LTD., MIDLAND, TX:
4,163,784, PUB. 4-10-2012. INT. CL. 42.
- SENGELMANN HALL, LLC, HOUSTON, TX, DBA SENGELMANN HALL:
4,165,164, INT. CL. 41.
- SENSIENT FLAVORS LLC, INDIANAPOLIS, IN, YEAST PRODUCTS INC., PATERSON, NJ:
730,194, REN. 5-23-12. U.S. CL. 46 (INT. CL. 30).
- SENSIENT TECHNOLOGIES CORPORATION, MILWAUKEE, WI:
3,006,112, CANC. INT. CL. 32.
- SENSORMATIC ELECTRONICS, LLC, BOCA RATON, FL:
2,992,847, CANC. INT. CL. 9.
- SENSORY UNIVERSITY LLC, BUFORD, GA:
4,164,200, PUB. 4-10-2012. INT. CL. 10.
- SENTRY INSURANCE A MUTUAL COMPANY, STEVENS POINT, WI:
504,858, CANC. U.S. CL. 102.
- SENTRY PROTECTION LLC, LAKEWOOD, OH:
2,583,319, REN. 5-19-12. INT. CL. 17.
- SEPRO CORPORATION, CARMEL, IN:
2,534,892, REN. 5-21-12. INT. CL. 5.
- SEQUIN CORP., BERKELEY, CA, DBA INNERCIRCLE.COM:
4,163,176, PUB. 9-20-2011. MULTIPLE CLASS, INT. CLS. 9 AND 35.
- SEREI; EDITH, MONTREAL, QUEBEC, CANADA, CANADA:
1,251,404, CANC. MULTIPLE CLASS, INT. CLS. 3 AND 21.
- SEREI; EDITH, PIERREFONDS, QUEBEC, CANADA:
1,252,633, CANC. MULTIPLE CLASS, INT. CLS. 3 AND 21.

SERGEJ LITVINOWSKIY, 22417 HAMBURG, FED REP GERMANY:
4,162,882, PUB. 4-10-2012. MULTIPLE CLASS, INT. CLS. 39, 41 AND 43.

SERGIO HAMERNIK, LOS ANGELES, CA:
4,164,158, PUB. 4-10-2012. INT. CL. 9.

SERIOUS CIVICS, LLC, HINTON, IA:
4,165,507, MULTIPLE CLASS, INT. CLS. 16 AND 41.

SERRA, BRENDON, GUTTENBERG, NJ:
4,164,116, PUB. 4-10-2012. INT. CL. 44.

SERVANT PC RESOURCES, INC., LOCK HAVEN, PA:
4,163,675, PUB. 4-10-2012. INT. CL. 9.

SETTON INTERNATIONAL FOODS, INC., COMMACK, NY:
4,164,606, PUB. 4-10-2012. INT. CL. 29.

SEVILLE CLASSICS, INC., TORRANCE, CA:
4,162,721, PUB. 4-10-2012. INT. CL. 6.

SEYDEL-WOLLEY & COMPANY, INC., ATLANTA, GA:
857,746, CANC. U.S. CL. 6.

SF INVESTMENTS, INC., WILMINGTON, DE:
4,163,541, PUB. 4-10-2012. INT. CL. 29.

SHALOM, MEMY ISH, WESTBOROUGH, MA:
4,164,512, PUB. 4-10-2012. INT. CL. 9.

SHANDONG KANGTAI INDUSTRY CO., LTD., ZHAOYUAN, SHANDONG, CHINA:
4,163,929, PUB. 4-10-2012. INT. CL. 10.

SHANGHAI CONWOOD INTERNATIONAL CO., LTD., CHINA:
4,162,932, PUB. 4-10-2012. INT. CL. 18.

SHANTOU LANACANE COEMETIC CO., LTD., CHINA:
4,163,033, PUB. 4-10-2012. INT. CL. 3.

SHARESPOST, INC. SAN BRUNO, CA:
4,163,733, PUB. 4-10-2012. MULTIPLE CLASS, INT. CLS. 35, 36 AND 42.

SHARK BAIT INTERNATIONAL, INC., VERO BEACH, FL:
4,164,928, INT. CL. 35.

SHARON TURRENTINE, INC., MONROE, LA:
1,758,869, REN. 5-23-12. INT. CL. 41.

SHARP IMAGE GAMING, INC., CHATSWORTH, CA:
3,006,146, CANC. INT. CL. 9.

SHARP KABUSHIKI KAISHA, OSAKA, JAPAN, TA SHARP CORPORATION:
4,164,792, MULTIPLE CLASS, INT. CLS. 35 AND 42.

SHASER, INC. WOBURN, MA:
4,163,844, PUB. 4-10-2012. INT. CL. 8.

SHAUN WHITE ENTERPRISES, INC., CARLSBAD, CA:
4,165,012, MULTIPLE CLASS, INT. CLS. 24 AND 25.

SHAW, HANK, ORANGEVALE, CA:
4,163,290, PUB. 4-10-2012. INT. CL. 41.

SHAW, SUSAN E., TERRE HAUTE, IN:
2,498,647, CANC. INT. CL. 42.

SHEHAB, ELAINE, SAN JUAN, PUERTO RICO:
4,164,425, PUB. 4-10-2012. INT. CL. 24.

SHELBY GROUP INTERNATIONAL, INC., MEMPHIS, TN:
2,574,704, REN. 5-19-12. INT. CL. 9.

SHELL VACATIONS L.L.C., NORTHBROOK, IL:
2,575,247, REN. 5-21-12. MULTIPLE CLASS, INT. CLS. 36 AND 42.

SHELTER-ALL COMPANY OF EASTERN PENNSYLVANIA, INC., EMMAUS, PA:
862,261, CANC. U.S. CL. 12.

SHENANDOAH MILLS, INC., LEBANON, TN:
4,162,724, PUB. 4-10-2012. INT. CL. 40.

SHENZHEN CAPCHEM TECHNOLOGY CO., LTD., CHINA:
4,163,032, PUB. 4-10-2012. INT. CL. 1.

SHENZHEN HIGHFOUND ELECTRONICS CO., LTD., SHENZHEN, CHINA:
4,165,465, INT. CL. 9.

SHEPHERD MATERIALS MANAGEMENT LLC, RAVENA, NY:
4,165,893, INT. CL. 1.

SHERMAN V. ALLEN, INC., RUTLAND, VT:
4,162,692, PUB. 4-21-2009. INT. CL. 39.

SHERMAN, DAVID J., CLAREMONT, CA:
4,165,278, INT. CL. 41.

SHIFAMED, LLC, SARATOGA, CA:
4,163,708, PUB. 4-10-2012. INT. CL. 42.

SHIN-ETSU CHEMICAL CO., LTD., TOKYO, JAPAN:
3,006,360, CANC. INT. CL. 4.

SHINE, LE CHE, GIBSONTON, FL:
4,165,629, INT. CL. 5.

SHINHAN DIAMOND IND. CO., LTD., REPUBLIC OF KOREA:
3,612,662, COR. MULTIPLE CLASS, INT. CLS. 7 AND 8.

SHINODA PLASMA CO., LTD., JAPAN:
4,162,929, PUB. 4-10-2012. INT. CL. 9.

SHIP NEW ENGLAND, INC, EAST WINDSOR, CT:
4,164,186, PUB. 4-10-2012. INT. CL. 39.

SHOATS, REGINALD, HONOLULU, HI:
4,165,068, MULTIPLE CLASS, INT. CLS. 9, 16 AND 28.

SHOFU DENTAL CORPORATION, SAN MARCOS, CA:
2,704,303, REN. 5-19-12. INT. CL. 10.

SHOP TO BE GREEN, LLC, SCOTTSDALE, AZ:
4,164,168, PUB. 4-10-2012. INT. CL. 35.

SHOP-VAC CORPORATION, WILLIAMSPORT, PA:
2,497,705, CANC. INT. CL. 7.

SHOPIFY INC., OTTAWA, ONTARIO, CANADA:
4,163,093, PUB. 4-10-2012. MULTIPLE CLASS, INT. CLS. 9 AND 42.

4,163,094, PUB. 4-10-2012. MULTIPLE CLASS, INT. CLS. 35 AND 42.

SHORT'S BREWING COMPANY, BELLAIRE, MI:
4,163,813, PUB. 4-10-2012. INT. CL. 32.

SHOW DISTRIBUTION GROUP INC., QUEBEC CITY, CANADA:
2,569,158, REN. 5-18-12. MULTIPLE CLASS, INT. CLS. 35 AND 41.

SHOWA BEST GLOVE, INC., MENLO, GA:
4,164,632, PUB. 4-10-2012. INT. CL. 9.

4,164,722, PUB. 4-10-2012. INT. CL. 9.

SHUFFLE MASTER AUSTRALASIA PTY LIMITED, MILLPERRA, NSW 2214, AUSTRALIA:
4,165,032, INT. CL. 9.

SHUFFLE MASTER, INC., LAS VEGAS, NV:
4,163,867, PUB. 4-10-2012. INT. CL. 41.

SHUG-A-BUG KIDS SPA LLC, CHARLOTTE, NC:
4,164,390, PUB. 4-10-2012. INT. CL. 44.

SHULMAN, NEIL B., DECATUR, GA:
2,695,146, REN. 5-22-12. INT. CL. 41.

SHURE INCORPORATED, NILES, IL, SHURE BROTHERS INCORPORATED, EVANSTON, IL:
1,689,982, REN. 5-19-12. INT. CL. 9.

SIBARTH REAL ESTATE, F-97133 ST BARTHÉLEMY, FRANCE:
4,162,979, PUB. 4-10-2012. MULTIPLE CLASS, INT. CLS. 16, 35 AND 36.

SIEGFRIED & PARZIFAL, INC., CITY OF INDUSTRY, CA:
2,683,700, REN. 5-22-12. INT. CL. 25.

SIEMENS HEALTHCARE DIAGNOSTICS INC., DEERFIELD, IL:
501,455, CANC. U.S. CL. 26.

SIENNA SINCLAIRE, LLC, SANTA MONICA, CA:
4,164,861, MULTIPLE CLASS, INT. CLS. 41 AND 45.

SIERRA TRADING POST, INC., CHEYENNE, WY:
2,499,144, CANC. INT. CL. 35.

SIEVER'S HAARKOSMETIK GMBH, 6000 FRANKFURT 1, FED REP GERMANY:
1,730,549, REN. 5-24-12. INT. CL. 3.

SIGMA-ALDRICH CO. LLC, ST. LOUIS, MO:
2,614,714, REN. 5-23-12. INT. CL. 1.

SIGNATURE FOOD MARKETING, LLC, PENDERGRASS, GA:
4,049,877, COR. INT. CL. 29.

SIGNATURE HEALTHCARE, LLC, LOUISVILLE, KY:
4,162,754, PUB. 10-18-2011. INT. CL. 44.

4,162,755, PUB. 10-19-2010. INT. CL. 44.

4,163,542, PUB. 1-24-2012. INT. CL. 44.

SIGNOM OY, HELSINKI, FINLAND:
4,162,828, PUB. 4-10-2012. MULTIPLE CLASS, INT. CLS. 35, 42 AND 45.

SILICON MESA CORPORATION, ALBUQUERQUE, NM:
4,165,837, INT. CL. 42.

SILICON VALLEY LAW GROUP, SAN JOSE, CA, AKA SVLG:
4,163,807, PUB. 4-10-2012. INT. CL. 45.

SILICONALLEY.COM, INC., NEW YORK, NY:
3,006,078, CANC. INT. CL. 42.

- SILIK SPA, ITALY:
4,162,964, PUB. 4-10-2012. MULTIPLE CLASS, INT. CLS. 20 AND 24.
- SILVER CROSS HOLDINGS LIMITED, NORTH YORKSHIRE, UNITED KINGDOM:
3,781,611, COR. INT. CL. 12.
- SILVERSTONE GROUP, INCORPORATED, OMAHA, NE:
4,163,720, PUB. 2-28-2012. INT. CL. 35.
- SILVERTON CASINO, LLC, LAS VEGAS, NV:
4,165,121, INT. CL. 41.
- SIMKO LLC, HERMOSA BEACH, CA:
4,165,364, INT. CL. 32.
4,165,365, INT. CL. 32.
4,165,366, INT. CL. 32.
4,165,367, INT. CL. 32.
4,165,368, INT. CL. 32.
- SIMMS FISHING PRODUCTS, LLC, BOZEMAN, MT:
4,165,929, INT. CL. 25.
- SIMON & SCHUSTER, INC., NEW YORK, NY:
1,195,693, REN. 5-18-12. INT. CL. 16.
- SIMON LEVI COMPANY, LTD., LOS ANGELES, CA, DBA SIMON LEVI CO. LTD.:
856,161, CANC. U.S. CL. 49.
- SIMON, DAVID, JERICHO, NY:
4,163,486, PUB. 4-10-2012. MULTIPLE CLASS, INT. CLS. 35 AND 36.
- SIMPACT STRATEGY GROUP INC., CALGARY, ALBERTA, CANADA:
4,163,051, PUB. 4-10-2012. INT. CL. 41.
- SIMPSON ELECTRIC COMPANY, ELGIN, IL:
2,989,874, CANC. INT. CL. 9.
- SINAK CORPORATION, SAN DIEGO, CA:
4,165,416, INT. CL. 1.
- SINCLAIR FINANCE COMPANY, SALT LAKE CITY, UT:
2,612,116, REN. 5-23-12. MULTIPLE CLASS, INT. CLS. 25, 41 AND 42.
- SINGHAL, TARA C., TORRANCE, CA:
2,579,453, REN. 5-19-12. INT. CL. 35.
- SINT, LLC, HICKSVILLE, NY:
4,165,118, INT. CL. 35.
- SINTOKOGIO, LTD., JAPAN:
4,162,970, PUB. 4-10-2012. INT. CL. 7.
- SIRIUS XM RADIO INC., NEW YORK, NY:
2,935,874, CANC. INT. CL. 41.
- SITKA DEVELOPMENTS PTY LTD, AUSTRALIA:
4,162,969, PUB. 4-10-2012. INT. CL. 6.
- SITV, INC., GLENDALE, CA:
4,165,580, MULTIPLE CLASS, INT. CLS. 38 AND 41.
- SJGY, LLC, TAMPA, FL:
4,163,447, PUB. 4-10-2012. MULTIPLE CLASS, INT. CLS. 5 AND 30.
- SJOERDSMA, TOM, AUSTIN, TX, DBA ART ATTACK GREETINGS:
4,165,547, INT. CL. 16.
- SKATE ONE CORP., SANTA BARBARA, CA:
4,162,768, PUB. 4-6-2010. MULTIPLE CLASS, INT. CLS. 25 AND 28.
- SKECHERS U.S.A., INC. II, MANHATTAN BEACH, CA:
2,498,948, CANC. INT. CL. 25.
4,165,013, INT. CL. 25.
- SKR INTERNATIONAL, LLC, WOODINVILLE, WA:
4,165,389, INT. CL. 25.
- SKYDANCE PRODUCTIONS, LLC, SANTA MONICA, CA:
4,164,976, INT. CL. 36.
- SKYFISH MEDIA LLC, SEATTLE, WA, DBA UNICORN BOOTY:
4,163,848, PUB. 4-10-2012. INT. CL. 36.
- SKYUNION PTE. LTD., 159308, SINGAPORE:
4,164,942, INT. CL. 41.
- SLANSKY, CINDY ANN, HUNTINGTON STATION, NY, AKA CINDY SCHIFF:
4,165,703, INT. CL. 20.
- SLY BOARD COMPANY, NORTH MIAMI BEACH, FL:
4,165,492, INT. CL. 21.
- SMAATO INC., UNITED STATES:
4,162,898, PUB. 4-10-2012. MULTIPLE CLASS, INT. CLS. 9, 38 AND 42.
- SMAIL, PAULA, WEST HOLLYWOOD, CA:
3,086,524, CANC. INT. CL. 18.
- SMALL DEMONS, INC., MARINA DEL REY, CA:
4,163,524, PUB. 4-10-2012. INT. CL. 42.
- SMART & FINAL STORES LLC, COMMERCE, CA:
2,597,177, REN. 5-22-12. INT. CL. 30.
- SMARTBOARD BUILDING PRODUCTS INC., MARKHAM, ONTARIO, CANADA:
2,557,549, REN. 5-22-12. INT. CL. 19.
2,557,549, CANC. INT. CL. 42.
- SMARTER TRAVEL MEDIA LLC, BOSTON, MA:
2,499,132, CANC. INT. CL. 42.
- SMARTORG, INC., MENLO PARK, CA:
1,690,725, REN. 5-21-12. INT. CL. 9.
- SMARTPOOL, INCORPORATED, LAKEWOOD, NJ:
4,165,066, MULTIPLE CLASS, INT. CLS. 9 AND 28.
- SMARTRUNK SYSTEMS, INC, CHULA VISTA, CA:
4,165,085, INT. CL. 9.
- SMITH, AMANDA, FAIRFIELD, CA:
4,165,515, INT. CL. 35.
- SMITH, DONALD, GUILFORD, CT:
4,165,207, INT. CL. 7.
- SMITH, HAROLD P., PANHANDLE, TX, DBA PLAINS ALUMINUM INDUSTRIES:
862,314, CANC. U.S. CL. 21.
- SMITH, MARK, PALO ALTO, CA:
4,164,312, PUB. 4-10-2012. INT. CL. 9.
- SMITH, STEPHEN, YARRAMAN, AUSTRALIA:
4,163,616, PUB. 4-10-2012. INT. CL. 12.
- SMITHS MEDICAL INTERNATIONAL LIMITED, KENT, TN25 4BF, UNITED KINGDOM, PORTEX LIMITED, HYTHE, KENT, ENGLAND:
1,193,557, REN. 5-18-12. INT. CL. 10.
1,193,558, REN. 5-22-12. INT. CL. 10.
- SMOKER FRIENDLY INTERNATIONAL LLC, BOULDER, CO:
4,165,711, INT. CL. 34.
- SMOOTH-ON, INC., EASTON, PA:
4,163,096, PUB. 4-10-2012. INT. CL. 1.
4,163,136, PUB. 4-10-2012. INT. CL. 17.
4,163,174, PUB. 1-3-2012. INT. CL. 1.
- SMS SOLUTIONS, INC., GAINESVILLE, TX:
4,166,049, INT. CL. 38.
- SNACK ALLIANCE, INC., VANCOUVER, BRITISH COLUMBIA, CANADA:
3,006,175, CANC. INT. CL. 35.
- SNACK KING CORP., CITY OF INDUSTRY, CA:
2,651,374, REN. 5-24-12. INT. CL. 30.
- SNAP CAP MARKERS, LLC, BOYNTON BEACH, FL, DBA SNAP CAP MARKERS:
4,120,730, COR. INT. CL. 16.
- SNAPTRACS, INC., SAN DIEGO, CA:
4,164,273, PUB. 4-10-2012. INT. CL. 45.
4,164,274, PUB. 4-10-2012. INT. CL. 45.
- SNIKIDDY, LLC, BOULDER, CO:
4,165,605, INT. CL. 29.
4,165,759, INT. CL. 29.
- SNUGZ/USA INCORPORATED, SALT LAKE CITY, UT:
4,166,080, INT. CL. 40.
- SO BILL HOLDINGS, INC., SCARBOROUGH, ONTARIO, CANADA:
4,165,430, INT. CL. 29.
- SO SO HAPPY STUDIO, INC., CALABASAS, CA:
4,164,693, PUB. 4-10-2012. MULTIPLE CLASS, INT. CLS. 18, 25 AND 28.
- SOAPTRONIC L.L.C., LAKE FOREST, CA:
2,353,788, CANC. INT. CL. 9.
- SOCIAL BUTTERFLY INTERNATIONAL, INC., WEST HILLS, CA:
4,164,910, INT. CL. 25.
- SOCIAL POWER LLC, MONSEY, NY:
4,164,134, PUB. 4-10-2012. INT. CL. 35.
4,164,135, PUB. 4-10-2012. INT. CL. 35.
- SOCIETE CIVILE DU CHATEAU DOISY-VEDRINES, 33720 BARSAC (GIRONDE), FRANCE:
1,199,015, REN. 5-23-12. INT. CL. 33.

SOCIETE DES PRODUITS NESTLE S.A., 1800 VEVEY, SWITZERLAND:
3,006,093, CANC. INT. CL. 30.
4,165,917, INT. CL. 30.

SOCIETE POUR LA CONCEPTION DES APPLICATIONS DES TECHNIQUES ELECTRONIQUES, SATELEC, SAS, 33700 MERIGNAC, FRANCE:
1,687,726, REN. 5-21-12. INT. CL. 10.

SOCIETY OF CRITICAL CARE MEDICINE, DES PLAINES, IL AND EUROPEAN SOCIETY OF INTENSIVE CARE MEDICINE, BRUSSELS, BELGIUM AND INTERNATIONAL SEPSIS FORUM, LAND O'LAKES, FL:
3,200,832, COR. INT. CL. 44.

SOCRATES, INC., PITTSBURGH, PA:
2,535,332, REN. 5-18-12. MULTIPLE CLASS, INT. CLS. 35 AND 36.
2,699,078, REN. 5-21-12. INT. CL. 9.

SOFTPRO GMBH, BOEBLINGEN, FED REP GERMANY:
3,005,605, CANC. INT. CL. 42.

SOFTWARE GARDEN, INC., NEWTON HIGHLANDS, MA, INTERNATIONAL DATA BASE SYSTEMS, INC., PHILADELPHIA, PA:
1,206,033, REN. 5-21-12. INT. CL. 9.

SOGAL FRANCE, LA JUMELIERE, FRANCE:
4,163,106, PUB. 1-3-2012. INT. CL. 9.

SOKA GAKKAI INTERNATIONAL - USA, SANTA MONICA, CA:
2,497,532, CANC. INT. CL. 16.

SOLAURO INDUSTRIES INC., SOUTH LAKE TAHOE, CA:
4,163,879, PUB. 4-10-2012. MULTIPLE CLASS, INT. CLS. 35, 37 AND 42.

SOLDAN HOLDING+ BONBONSPEZIALITÄTEN GMBH, FED REP GERMANY:
4,162,826, PUB. 4-10-2012. MULTIPLE CLASS, INT. CLS. 5 AND 30.

SOLINSKY, EMANUEL, LONDON E5 9LF, ENGLAND AND SOLINSKY, MIRIAM, LONDON E5 9LF, ENGLAND:
2,569,440, REN. 5-19-12. INT. CL. 33.

SOLO CUP OPERATING CORPORATION, HIGHLAND PARK, IL:
856,819, CANC. U.S. CL. 2.
856,993, CANC. U.S. CL. 23.
863,297, CANC. U.S. CL. 2.

SOLO INCORPORATED, NEWPORT NEWS, VA:
2,587,356, REN. 5-24-12. INT. CL. 8.

SOLOMON FRIEDMAN ADVERTISING LIMITED LIABILITY COMPANY, BLOOMFIELD HILLS, MI:
4,162,702, PUB. 4-10-2012. INT. CL. 35.
4,162,703, PUB. 4-10-2012. INT. CL. 35.
4,162,704, PUB. 4-10-2012. INT. CL. 35.

SOLTA MEDICAL, INC., HAYWARD, CA:
4,165,935, MULTIPLE CLASS, INT. CLS. 10 AND 44.

SOLVNT, LLC, WARRINGTON, PA:
4,164,554, PUB. 4-10-2012. INT. CL. 41.
4,164,702, PUB. 4-10-2012. INT. CL. 41.

SOMAK TRAVEL LIMITED, HARROW, MIDDLESEX HA1 3EK, UNITED KINGDOM:
2,619,524, REN. 5-18-12. MULTIPLE CLASS, INT. CLS. 39 AND 42.

SOMOSTV, LLC, MIAMI, FL:
4,163,871, PUB. 4-10-2012. INT. CL. 38.

SONNY'S FRANCHISE COMPANY, MAITLAND, FL:
4,163,551, PUB. 4-10-2012. INT. CL. 43.

SONOC COMPANY, LLC, WILMINGTON, DE:
2,569,107, REN. 5-21-12. INT. CL. 37.

SONS OF SOLOMON MOTORCYCLE CLUB, INC., LORTON, VA:
4,164,212, PUB. 4-10-2012. INT. CL. 35.

SONY CORPORATION, TOKYO, JAPAN:
4,164,956, INT. CL. 9.
4,165,074, INT. CL. 9.

SOP SERVICES, INC., LAS VEGAS, NV, KULITE TUNSTEN CORPORATION, EAST RUTHERFORD, NJ, AKA ACCUDART:
1,216,016, REN. 5-18-12. INT. CL. 28.

SOPHIS TECHNOLOGY (IRELAND) LIMITED, IRELAND:
3,983,410, COR. MULTIPLE CLASS, INT. CLS. 9, 36 AND 42.

SORORITY SPIRIT LLC, ATLANTA, GA:
4,164,936, INT. CL. 35.

SOSA, ALEJANDRO, MIAMI, FL:
4,165,019, INT. CL. 25.

SOUDRONIC AG, BERGDIETIKON, SWITZERLAND, SOUDRONIC AG, 8962 BERGDIETIKON, SWITZERLAND:
1,752,221, REN. 5-22-12. INT. CL. 7.

SOURCING INTERNATIONAL LLC, SIGNAL HILL, CA, DBA SOURCING INTERNATIONAL LLC:
4,163,927, PUB. 4-10-2012. INT. CL. 28.

SOURCINGPARTNER, INC., PLANO, TX, SOURCINGPARTNER, INC., PLANO, TX:
2,569,074, REN. 5-19-12. INT. CL. 35.

SOUTH COUNTY HYDROPONICS & ORGANICS, INC., LAKE FOREST, CA:
4,164,015, PUB. 4-10-2012. INT. CL. 35.

SOUTHCARE, LLC, MARIETTA, GA:
4,165,783, INT. CL. 45.

SOUTHEAST FOOD SYSTEMS, INC., RALEIGH, NC:
1,686,610, REN. 5-22-12. INT. CL. 30.
1,688,021, REN. 5-18-12. INT. CL. 30.
1,688,022, REN. 5-24-12. INT. CL. 30.

SOUTHEAST FOOD SYSTEMS, INC., DURHAM, NC:
1,688,023, REN. 5-22-12. INT. CL. 30.

SOUTHERN AGRICULTURAL INSECTICIDES, INC., PALMETTO, FL:
2,604,987, REN. 5-18-12. INT. CL. 1.

SOUTHERN COMFORT PROPERTIES, INC., SAN RAFAEL, CA:
4,165,040, INT. CL. 33.

SOUTHERN EXCHANGE, L.P., HOUSTON, TX, DBA EXPORT, SOUTHERN TRADING COMPANY:
1,202,483, REN. 5-18-12. MULTIPLE CLASS, INT. CLS. 9 AND 20.

SOUTHERN IONICS INCORPORATED, WEST POINT, MS:
2,996,873, CANC. INT. CL. 1.

SOUTHERN LURE COMPANY, COLUMBUS, MS:
1,687,235, REN. 5-18-12. INT. CL. 28.

SOUTHGATE RECREATION AND PARK DISTRICT, SACRAMENTO, CA:
3,101,747, CANC. INT. CL. 41.

SOUTHWESTERN PATHOLOGY ASSOCIATES, LAWTON, OK, DBA PATHOLOGY CORPORATION OF AMERICA:
4,166,073, INT. CL. 44.

SOUTHWIRE COMPANY, CARROLLTON, GA:
4,163,554, PUB. 4-10-2012. INT. CL. 9.

SPA BLENDS, PENN VALLEY, CA:
2,571,329, REN. 5-22-12. INT. CL. 3.

SPA FAVOURITES, LLC, WEST BLOOMFIELD, MI:
4,165,086, INT. CL. 3.

SPA NIAGARA, LLC, NIAGARA FALLS, NY:
4,164,500, PUB. 4-10-2012. MULTIPLE CLASS, INT. CLS. 3 AND 44.

SPACE NEEDLE LLC, SEATTLE, WA:
4,164,765, PUB. 4-10-2012. INT. CL. 41.

SPACEBOUND, INC., LAGRANGE, OH:
4,165,644, INT. CL. 35.

SPAMEDICA (CANADA) INC., TORONTO, ONTARIO, CANADA:
3,006,132, CANC. INT. CL. 42.

SPANFELLER MEDIA GROUP, INC., NEW YORK, NY:
4,165,603, MULTIPLE CLASS, INT. CLS. 35, 41 AND 43.

SPANGLER CANDY COMPANY, BRYAN, OH:
1,735,098, REN. 5-24-12. INT. CL. 30.

SPARTECH CORPORATION, ST. LOUIS, MO:
4,163,145, PUB. 4-10-2012. INT. CL. 17.

SPATZ ENTERTAINMENT MANAGEMENT, LLC, NORTHBROOK, IL:
4,163,167, PUB. 4-10-2012. MULTIPLE CLASS, INT. CLS. 41 AND 43.

SPAULDING COMPOSITES, INC., PEABODY, MA:
857,830, CANC. U.S. CL. 21.

SPCGE S.A.R.L., 1116 LUXEMBOURG, LUXEMBOURG:
4,163,797, PUB. 4-10-2012. INT. CL. 41.

SPECIAL OLYMPICS, INC., WASHINGTON, DC:
4,165,048, MULTIPLE CLASS, INT. CLS. 35 AND 41.

- SPECIALIZED BICYCLE COMPONENTS, INC., MORGAN HILL, CA:
2,576,406. REN. 5-21-12. INT. CL. 12.
- SPECMED, LLC, ST. ROSE, LA:
4,163,215, PUB. 4-10-2012. INT. CL. 10.
- SPEED CHANNEL, INC., LOS ANGELES, CA:
4,164,545, PUB. 4-10-2012. INT. CL. 41.
4,164,546, PUB. 4-10-2012. INT. CL. 38.
- SPENCER, ANDREW MICHAEL, GARDEN GROVE, CA:
4,162,766, PUB. 8-2-2011. MULTIPLE CLASS, INT. CLS. 9, 35 AND 42.
- SPENCER, RICHIE, N. MYRTLE BEACH, SC AND SPENCER, JANE, N. MYRTLE BEACH, SC:
4,163,689, PUB. 4-10-2012. MULTIPLE CLASS, INT. CLS. 14 AND 18.
- SPENCER, ROBERT J., LOS ANGELES, CA AND REICHHARD, DANIEL, LOS ANGELES, CA AND LONGORIA, MICHAEL, LOS ANGELES, CA AND HOFF, CHRISTIAN, LOS ANGELES, CA:
4,164,461, PUB. 4-10-2012. INT. CL. 41.
- SPENCO MEDICAL CORPORATION, WACO, TX:
1,208,129. REN. 5-21-12. INT. CL. 12.
- SPENGLER, KAREN, KANSAS CITY, MO:
2,499,054, CANC. INT. CL. 35.
- SPERIAN PROTECTION INVESTMENT, INC., SMITHFIELD, RI, GLENDALE OPTICAL CO., INC., WOODBURY, NY:
935,326. REN. 5-23-12. U.S. CL. 26 (INT. CL. 9).
- SPERO SOFTWARE, LLC, FRESNO, CA:
4,165,300, INT. CL. 42.
- SPICY SENSE INC, LOS ANGELES, CA, AKA SPICY SENSE INC:
4,165,327, MULTIPLE CLASS, INT. CLS. 29 AND 30.
- SPIDERROCK EXS, LLC, CHICAGO, IL:
4,165,681, INT. CL. 42.
4,165,682, INT. CL. 42.
- SPIL GAMES INTANGIBLES B.V., NETHERLANDS:
4,163,004, PUB. 4-10-2012. MULTIPLE CLASS, INT. CLS. 9, 35 AND 41.
- SPINNER, LAURA, FOREST HILLS, NY:
2,572,064. REN. 5-23-12. INT. CL. 37.
- SPIRIT IMPORTS, INC., SUNRISE, FL:
3,545,841, AM. INT. CL. 33.
- SPIROPLEX GMBH, 33415 VERL, FED REP GERMANY:
4,162,873, PUB. 4-10-2012. MULTIPLE CLASS, INT. CLS. 6, 7, 9, 10 AND 20.
- SPOETZL BREWERY, INC., SAN ANTONIO, TX:
4,164,744, PUB. 4-10-2012. INT. CL. 32.
- SPOKANE TEACHERS CREDIT UNION, SPOKANE, WA:
2,497,403, CANC. INT. CL. 36.
- SPORTS BRANDS CORPORATION, LUXEMBOURG, LUXEMBOURG:
4,164,806, INT. CL. 41.
- SPORTS INSURANCE SPECIALISTS, LLC, FORT WAYNE, IN, DBA SIS:
4,164,360, PUB. 4-10-2012. INT. CL. 36.
- SPORTS TRADE INVESTMENT S.R.L., TREVISO (TV), ITALY, BAKER, ERIC, ENCINITAS, CA:
1,746,447. REN. 5-23-12. INT. CL. 25.
- SPRAYING SYSTEMS CO., WHEATON, IL:
4,165,165, INT. CL. 12.
- SPRAYMATION INC, FT. LAUDERDALE, FL:
1,736,065. REN. 5-22-12. INT. CL. 7.
- SPRING TRADING, INC., SUMMIT, NJ:
4,164,398, PUB. 4-10-2012. INT. CL. 36.
- SPRINGBOARDS TO EDUCATION, INC., EDINBURG, TX:
4,162,765, PUB. 1-3-2012. INT. CL. 16.
- SPRINGFIN, LLC, BRADENTON, FL:
4,164,307, PUB. 4-10-2012. INT. CL. 42.
- SPX CORPORATION, CHARLOTTE, NC:
2,605,537. REN. 5-19-12. INT. CL. 8.
4,164,668, PUB. 4-10-2012. MULTIPLE CLASS, INT. CLS. 9 AND 11.
- SR HOLDINGS, LLC, LEXINGTON, MA:
4,164,683, PUB. 4-10-2012. INT. CL. 25.
- SRM ARMS, INC, MERIDIAN, ID:
4,162,720, PUB. 4-10-2012. INT. CL. 13.
- SSI GROUP, INC., THE, MOBILE, AL:
2,625,730. REN. 5-19-12. INT. CL. 9.
- ST ANDREWS LINKS, LTD., FIFE, UNITED KINGDOM:
4,164,967, MULTIPLE CLASS, INT. CLS. 9 AND 28.
- ST VINCENT'S HEALTH SYSTEM INC, JACKSONVILLE, FL:
4,164,726, PUB. 4-10-2012. INT. CL. 44.
- ST. LUKE'S HOSPITAL OF DULUTH, DULUTH, MN:
2,570,042. REN. 5-24-12. INT. CL. 42.
- ST. LUKE'S EPISCOPAL HEALTH SYSTEM, HOUSTON, TX:
4,163,126, PUB. 10-4-2011. INT. CL. 44.
- STACEY, PAUL E., COMPTON, CA:
4,164,201, PUB. 4-10-2012. INT. CL. 35.
- STACY A. CLARK, ST. HELENA, CA:
4,164,880, INT. CL. 33.
- STAFFENBERG, EDDIE, ODESSA, FL AND GARDNER, MICHAEL A., DUNEDIN, FL:
4,165,625, INT. CL. 32.
- STAG'S LEAP WINE CELLARS, LLC, NAPA, CA:
1,562,484, AM. INT. CL. 33.
- STAGED INCIDENT, L.L.C., BOULDER, CO:
4,163,827, PUB. 4-10-2012. INT. CL. 41.
- STAGGS, JACK, SAN CLEMENTE, CA:
3,694,556, CANC. INT. CL. 25.
- STAHLGRUBER OTTO GRUBER GMBH & CO., MUNICH, FED REP GERMANY:
868,186, CANC. U.S. CL. 35.
- STAMFORD SCIENTIFIC INTERNATIONAL INC., POUGHKEEPSIE, NY, DBA STAMFORD SCIENTIFIC INTERNATIONAL INC.:
4,163,439, PUB. 4-10-2012. INT. CL. 7.
- STAMPIN' UP!, INC., RIVERTON, UT:
2,498,299, CANC. INT. CL. 35.
- STANDARD MOTOR PRODUCTS, INC., LEWISVILLE, TX, HAYDEN, INC., CORONA, CA:
1,195,975. REN. 5-18-12. INT. CL. 12.
- STANDARD PUBLISHING GROUP LLC, CINCINNATI, OH:
2,619,802. REN. 5-19-12. INT. CL. 16.
- STANDARD REGISTER COMPANY, THE, DAYTON, OH:
1,223,196. REN. 5-23-12. INT. CL. 9.
1,223,196, CANC. INT. CL. 16.
- STANLEY STEEMER INTERNATIONAL, INC., DUBLIN, OH:
3,006,140, CANC. INT. CL. 9.
- STAR BRITE DISTRIBUTING, INC., FORT LAUDERDALE, FL:
4,164,080, PUB. 4-10-2012. INT. CL. 3.
4,164,082, PUB. 4-10-2012. INT. CL. 2.
- STAR-KIST FOODS, INC., LONG BEACH, CA:
505,009, CANC. U.S. CL. 46.
- STARCH/INRA/HOOPER, INC., MAMARONECK, NY:
862,883, CANC. MULTIPLE CLASS, U.S. CLS. 100 AND 101.
- STARCHTECH INTERNATIONAL PTE. LTD., KUALA LUMPUR, MALAYSIA:
4,165,124, INT. CL. 22.
- STARCOM MEDIAVEST GROUP, INC., CHICAGO, IL:
4,165,075, INT. CL. 35.
- STARLIGHT CREATIONS LLC, BELLEVUE, WA:
4,163,594, PUB. 4-10-2012. MULTIPLE CLASS, INT. CLS. 16, 35 AND 41.
- STATE BAR OF CALIFORNIA, THE, SAN FRANCISCO, CA:
2,569,669. REN. 5-18-12. INT. CL. 16.
2,573,230. REN. 5-19-12. INT. CL. 16.
- STATE INDUSTRIAL PRODUCTS CORPORATION, CLEVELAND, OH:
2,614,027. REN. 5-18-12. INT. CL. 16.
2,623,128. REN. 5-18-12. INT. CL. 41.
- STATTRADER, LLC, EAST GREENWICH, RI:
4,164,836, INT. CL. 36.
- STATUE OF LIBERTY-ELLIS ISLAND FOUNDATION, INC., THE, NEW YORK, NY:
1,688,495. REN. 5-19-12. INT. CL. 41.
1,689,478. REN. 5-19-12. INT. CL. 41.
- STAY FLY SOLUTIONS, LLC, WEST PALM BEACH, FL:
4,165,574, INT. CL. 26.

STAY IN PLACE INTERNATIONAL AB, 70006 ÖREBRO, SWEDEN:
4,165,088, INT. CL. 25.

STECCO, LUIGI, ARZIGNANO, ITALY:
4,163,339, PUB. 4-10-2012. MULTIPLE CLASS, INT. CLS. 41 AND 44.

STECHER, SCOTT, MARBLEHEAD, OH, DBA REEF RUNNER TACKLE COMPANY, FELTMAN, JIM, TOLEDO, OH:
940,435, REN. 5-18-12. U.S. CL. 22 (INT. CL. 28).

STEELE ENTERPRISES, INC., CERES, CA:
2,610,979, REN. 5-24-12. INT. CL. 31.

STEELWATERZ, LLC, CENTRE HALL, PA:
4,165,814, MULTIPLE CLASS, INT. CLS. 6 AND 19.

STEINER RANCH DERMATOLOGY, AUSTIN, TX:
4,162,789, PUB. 4-10-2012. INT. CL. 3.

STEKLEN & WALKER CO., INC., SPRINGFIELD, NJ:
2,599,978, REN. 5-18-12. INT. CL. 35.

STELLAR PETS, LLC, MEAD, CO:
2,499,017, CANC. INT. CL. 28.
2,499,018, CANC. INT. CL. 28.

STELMACK, AMY SUZANNE, CENTERVILLE, OH, DBA IVAN, AMY:
4,165,602, INT. CL. 16.

STEPAN COMPANY, NORTHFIELD, IL:
938,378, REN. 5-24-12. U.S. CL. 6 (INT. CLS. 1, 2, 3, 4 AND 5).

STEPHANIE R. DAWKINS INTERNATIONAL, INC., CHARLOTTE, NC:
4,165,042, INT. CL. 16.

STEPHEN L. LAFRANCE HOLDINGS, INC., LITTLE ROCK, AR, SELECT BRAND DISTRIBUTORS, INC., PINE BLUFF, AR:
1,682,571, REN. 5-23-12. MULTIPLE CLASS, INT. CLS. 3, 5 AND 8.

STEPHENS, MARK E., SANTA CRUZ, CA, DBA SANTA CRUZ YOGA:
4,163,368, PUB. 4-10-2012. INT. CL. 41.

STEREO OPTICAL COMPANY, INC., CHICAGO, IL:
1,694,363, REN. 5-19-12. INT. CL. 16.

STERLING DRUG INC., NEW YORK, NY:
1,233,449, CANC. INT. CL. 10.

STERLING GRACE INVESTMENT GROUP, LLC, GRAND CAYMAN, CAYMAN ISLANDS:
3,006,367, CANC. INT. CL. 39.
3,006,369, CANC. INT. CL. 39.

STERLING PACKERS LIMITED, BRAMPTON, ONTARIO, CANADA:
4,162,779, PUB. 9-27-2011. INT. CL. 39.

STERLING PUBLISHING CO., INC., NEW YORK, NY:
4,165,208, MULTIPLE CLASS, INT. CLS. 9, 16 AND 41.
4,165,245, MULTIPLE CLASS, INT. CLS. 9, 16 AND 41.

STEVEN P. DEMME, LITITZ, PA:
4,165,778, INT. CL. 16.

STEVENSONS OF NORWICH LIMITED, NORWICH NORFOLK, UNITED KINGDOM:
1,686,442, REN. 5-21-12. INT. CL. 19.

STEWART ENTERPRISES, INC., METAIRIE, LA:
2,640,811, REN. 5-21-12. MULTIPLE CLASS, INT. CLS. 36 AND 42.

STEWART ENTERPRISES, INC., JEFFERSON, LA:
4,164,647, PUB. 4-10-2012. MULTIPLE CLASS, INT. CLS. 36, 40 AND 45.

STEWART, GREGORY, REDDING, CT:
4,163,373, PUB. 4-10-2012. INT. CL. 35.

STEWART, TONY, INDIANAPOLIS, IN:
2,518,639, REN. 5-18-12. MULTIPLE CLASS, INT. CLS. 16, 25, 26 AND 28.

STI, LLC, EDEN, UT:
2,579,206, REN. 5-22-12. MULTIPLE CLASS, INT. CLS. 9 AND 41.

STICHTING DIALOGUE ADVISORY GROUP, AMSTERDAM, NETHERLANDS:
4,162,849, PUB. 4-10-2012. MULTIPLE CLASS, INT. CLS. 42 AND 45.

STICHTING NATIONAAL DEPOT SIERGEWASSEN, 1431 JV AALSMEER, NETHERLANDS:
2,498,912, CANC. MULTIPLE CLASS, INT. CLS. 35 AND 42.

STINGRAY SYSTEMS, LLC, INDIANAPOLIS, IN:
4,165,592, INT. CL. 11.

STINSON MORRISON HECKER LLP, KANSAS CITY, MO:
4,165,107, INT. CL. 45.

STMICROELECTRONICS NV, AMSTERDAM, NETHERLANDS:
4,164,854, INT. CL. 9.

STOCKADE COMPANIES, L.L.C., HUTCHINSON, KS:
855,279, CANC. U.S. CL. 100.

STONE AGE EQUIPMENT, INC., REDLANDS, CA:
4,164,123, PUB. 4-10-2012. INT. CL. 25.

STONE STEPS MANUFACTURING LLC, OCEANSIDE, CA, DBA SSM AND KKL:
4,163,135, PUB. 4-10-2012. INT. CL. 7.

STONE WOLF VINEYARDS, INC., MCMINNVILLE, OR:
4,165,994, INT. CL. 33.

STONEBRIDGE REALTY ADVISORS, INC., AURORA, CO, DBA STONEBRIDGE DEVELOPMENT CORPORATION, DBA STONEBRIDGE HOSPITALITY SERVICES, INC., DBA STONEBRIDGE COMPANIES:
2,498,285, CANC. INT. CL. 36.

STONEBROOK PUBLISHING, INC., SAN DIEGO, CA:
4,164,441, PUB. 4-10-2012. MULTIPLE CLASS, INT. CLS. 16 AND 40.
4,164,443, PUB. 4-10-2012. MULTIPLE CLASS, INT. CLS. 16 AND 40.

STOPINC AKTIENGESELLSCHAFT, HÜNENBERG, SWITZERLAND:
4,162,938, PUB. 4-10-2012. MULTIPLE CLASS, INT. CLS. 7 AND 19.

STOPTECH, LTD., HARRISON, OH:
2,650,427, REN. 5-18-12. INT. CL. 35.

STORA ENSO OYJ, HELSINKI, FINLAND:
4,162,808, PUB. 4-10-2012. INT. CL. 16.

STORAGE PROPERTY PROTECTION LLC, PEORIA, AZ:
4,163,438, PUB. 4-10-2012. INT. CL. 35.

STOUGH, DOWLING B., HOT SPRINGS, AR:
4,165,001, INT. CL. 5.

STRATEGEM, PARIS, FRANCE:
4,163,009, PUB. 4-10-2012. INT. CL. 3.

STRATEGIC FINANCIAL COMMUNICATIONS CORP., NEW YORK, NY:
1,692,903, REN. 5-20-12. INT. CL. 16.
2,579,800, REN. 5-21-12. INT. CL. 16.

STRATEGIC MARKS, LLC, NEWPORT COAST, CA:
4,165,969, INT. CL. 35.

STRATEGIC STORAGE HOLDINGS, LLC, LADERA RANCH, CA:
4,165,094, MULTIPLE CLASS, INT. CLS. 35 AND 39.

STRAW HAT RESTAURANTS, INC., SAN RAMON, CA:
4,165,217, INT. CL. 43.

STRENGTH OF NATURE, LLC, SAVANNAH, GA,
STRENGTH OF NATURE, LLC, SAVANNAH, GA:
2,576,557, REN. 5-21-12. INT. CL. 3.

STRENGTH OF NATURE, LLC, SAVANNAH, GA:
4,164,604, PUB. 4-10-2012. INT. CL. 3.

STROKIN, LLC, CHASKA, MN:
2,682,865, REN. 5-22-12. INT. CL. 35.

STRYKER CORPORATION, KALAMAZOO, MI:
4,163,210, PUB. 4-10-2012. INT. CL. 10.

STUDIO IP HOLDINGS LLC, WILMINGTON, DE:
4,164,766, PUB. 4-10-2012. INT. CL. 14.

STULLER, INC., LAFAYETTE, LA:
4,165,508, INT. CL. 14.
4,165,713, INT. CL. 41.

STYLEMARK, INC., SMITHFIELD, RI:
4,165,886, INT. CL. 9.

STYLEX, INC., KANSAS CITY, MO, C.B. MANUFACTURING, INC., SALT LAKE CITY, UT:
1,685,429, REN. 5-18-12. INT. CL. 26.

SUKUL, RAJ, FONTANA, CA:
4,164,627, PUB. 4-10-2012. INT. CL. 29.

SULLIVAN, DANIEL, BOSTON, MA:
4,163,966, PUB. 4-10-2012. INT. CL. 35.

SUMMIT ELECTRIC SUPPLY COMPANY, INC., ALBUQUERQUE, NM:
4,163,214, PUB. 4-10-2012. INT. CL. 37.

- SUMMIT ENTERTAINMENT, LLC, SANTA MONICA, CA:
4,165,921, INT. CL. 21.
- SUMMIT LIFE STRATEGIES, LLC, BOERNE, TX:
4,163,344, PUB. 4-10-2012. INT. CL. 41.
- SUMRIDGE PARTNERS, LLC, JERSEY CITY, NJ:
4,163,756, PUB. 4-10-2012. INT. CL. 36.
4,163,757, PUB. 4-10-2012. INT. CL. 36.
4,163,785, PUB. 4-10-2012. INT. CL. 36.
- SUN CHEMICAL CORPORATION, PARSIPPANY, NJ:
3,006,159, CANC. INT. CL. 2.
- SUN GRO HORTICULTURE CANADA LTD., SEBA BEACH,
ALBERTA, CANADA:
4,165,946, INT. CL. 1.
- SUN REFINING AND MARKETING COMPANY, PHILA-
DELPHIA, PA:
441,043, CANC. U.S. CL. 15.
- SUN YA TECHNOLOGY INDUSTRIAL CO., LTD., CHAN-
GHUA COUNTY, TAIWAN:
4,165,776, INT. CL. 18.
- SUNBEAM CORPORATION, DOWNERS GROVE, IL:
858,927, CANC. U.S. CL. 27.
- SUNBEAM PRODUCTS, INC., BOCA RATON, FL, RIVAL
MANUFACTURING COMPANY, KANSAS CITY, MO:
928,614, REN. 5-23-12. U.S. CL. 21 (INT. CL. 11).
- SUNBEAM PRODUCTS, INC., BOCA RATON, FL:
4,165,728, INT. CL. 11.
- SUNBELT AGRICULTURAL EXPOSITION, INC., MOUL-
TRIE, GA:
1,195,914, REN. 5-18-12. INT. CL. 41.
- SUNCOR ENERGY INC., CALGARY, ALBERTA, CANADA:
4,163,898, PUB. 4-10-2012. INT. CL. 1.
- SUNDANCE DENTAL PARTNERS, LLC, FARMINGTON,
NM:
4,163,849, PUB. 4-10-2012. INT. CL. 35.
4,163,850, PUB. 4-10-2012. INT. CL. 35.
4,163,852, PUB. 4-10-2012. INT. CL. 44.
4,163,853, PUB. 4-10-2012. INT. CL. 44.
- SUNDSTRAND CORPORATION, ROCKFORD, IL:
854,580, CANC. U.S. CL. 23.
- SUNGEVITY, OAKLAND, CA:
4,164,299, PUB. 4-10-2012. INT. CL. 41.
- SUNKIST GROWERS, INC., SHERMAN OAKS, CA:
1,692,224, REN. 5-22-12. MULTIPLE CLASS, INT. CLS. 29
AND 31.
2,709,582, REN. 5-22-12. INT. CL. 31.
- SUNNY HERBS INTERNATIONAL BEVERAGE CO. LTD.,
NONGHABURI, THAILAND:
392,325, REN. 5-18-12. U.S. CL. 46 (INT. CL. 32).
- SUNNYSIDE NURSERIES, INC., HAYWARD, CA:
862,201, CANC. U.S. CL. 1.
- SUNRISE MFG., INC., RANCHO CORDOVA, CA:
1,680,349, REN. 5-23-12. INT. CL. 16.
- SUNRISE SENIOR LIVING, INC., MCLEAN, VA:
2,498,086, CANC. INT. CL. 42.
- SUNSHINE MAKERS, INC., HUNTINGTON BEACH, CA:
4,164,564, PUB. 4-10-2012. INT. CL. 3.
- SUNSOUT, INC., COSTA MESA, CA:
4,163,858, PUB. 4-10-2012. INT. CL. 28.
- SUNTRITION INC., TECUMSEH, ONTARIO, CANADA:
4,165,548, INT. CL. 5.
- SUPER FAN SPORTS FUNDRAISING, LLC., WESTON, FL:
4,163,773, PUB. 4-10-2012. INT. CL. 36.
- SUPERIOR GLOBAL SOFTWARE, LLC, PLANO, TX:
1,697,476, REN. 5-22-12. INT. CL. 9.
- SUPERMERCADOS MORELOS, LLC, BROKEN ARROW,
OK:
4,164,143, PUB. 4-10-2012. INT. CL. 35.
- SUPERSPEED LLC, SUDBURY, MA, SUPERSPEED SOFT-
WARE, INC., SUDBURY, MA:
2,586,044, REN. 5-18-12. MULTIPLE CLASS, INT. CLS. 9
AND 16.
- SUPHACHATWONG INNOVATION CO, LTD., BANGPHRA,
CONBURI, THAILAND:
4,165,815, INT. CL. 31.
- SUPPLYPRO, INC., SAN DIEGO, CA:
4,165,797, INT. CL. 9.
- SUPREME METAL FABRICATORS, INC., WESTBURY, NY:
856,333, CANC. U.S. CL. 13.
- SUREFIRRE LLC, APPLETON, WI:
4,165,573, INT. CL. 9.
- SURFEASY, INC., TORONTO, ONTARIO, CANADA:
4,165,642, INT. CL. 9.
- SURPRISES BY MAIL, LTD, CINCINNATI, OH:
4,164,530, PUB. 4-10-2012. INT. CL. 35.
- SUSAN G. KOMEN BREAST CANCER FOUNDATION, INC.,
THE, DALLAS, TX:
2,497,712, CANC. INT. CL. 36.
- SUSAN LEONE, BROOKLYN, NY:
4,165,936, INT. CL. 29.
- SUSAN ROANE, GREENBRAE, CA:
4,164,310, PUB. 4-10-2012. INT. CL. 41.
- SUSTAINABLE AGING LLP, BRATTLEBORO, VT, DBA
SUSTAINABLE AGING:
4,164,110, PUB. 4-10-2012. INT. CL. 41.
- SUSTAINABLE AGRICO, LLC, SANTA FE, NM:
2,507,330, REN. 5-21-12. INT. CL. 31.
- SUTTER HOME WINERY, INC., ST. HELENA, CA:
2,569,676, REN. 5-18-12. INT. CL. 33.
4,164,819, INT. CL. 33.
4,165,575, INT. CL. 33.
- SUTTON STUDIOS & GALLERY, SAN FRANCISCO, CA:
4,163,435, PUB. 4-10-2012. INT. CL. 41.
- SUZUKI METAL INDUSTRY CO., LTD., JAPAN:
4,162,895, PUB. 4-10-2012. INT. CL. 6.
4,162,896, PUB. 4-10-2012. INT. CL. 6.
- SV MICROWAVE, INC., WEST PALM BEACH, FL:
4,164,534, PUB. 4-10-2012. INT. CL. 9.
- SWADE, CHERYL LYNNNE, LONG BEACH, CA:
4,162,728, PUB. 4-10-2012. INT. CL. 25.
- SWAIN CREATIONS, INC., SOLANA BEACH, CA, DBA
JER'S CHOCOLATES:
4,163,393, PUB. 4-10-2012. INT. CL. 30.
4,163,394, PUB. 4-10-2012. INT. CL. 30.
- SWANSON TOOL CO., INC., FRANKFORT, IL:
2,578,052, REN. 5-21-12. INT. CL. 9.
- SWEDE-O, INC., NORTH BRANCH, MN:
2,593,816, REN. 5-22-12. INT. CL. 10.
- SWEDISH ECOLOGY AB, GOTEBOURG, SWEDEN:
1,766,641, REN. 5-23-12. INT. CL. 11.
- SWEDISH MATCH LIGHTERS BV, ASSEN, NETHER-
LANDS:
732,906, REN. 5-18-12. U.S. CL. 8 (INT. CL. 34).
- SWEDISH MATCH NORTH EUROPE AB, STOCKHOLM,
SWEDEN:
4,163,431, PUB. 4-10-2012. INT. CL. 34.
- SWEET T 23, INC., RALEIGH, NC:
4,163,667, PUB. 4-10-2012. INT. CL. 14.
- SWEETWATER TRAVEL COMPANY, LIVINGSTON, MT:
4,164,194, PUB. 4-10-2012. INT. CL. 39.
- SWENCO PRODUCTS, INC., ST AUGUSTINE, FL, DBA
POSI-PRODUCTS:
2,570,493, REN. 5-22-12. INT. CL. 9.
- SWEZEY, RICHARD, SANTA MONICA, CA:
4,164,755, PUB. 4-10-2012. INT. CL. 20.
- SWIFF-TRAIN COMPANY, LLC, CORPUS CHRISTI, TX:
4,165,228, INT. CL. 19.
- SWIFT DISTRIBUTION, INC., TORRRENCE, CA, DBA
ULTIMATE SUPPORT SYSTEMS, INC.:
1,687,795, REN. 5-18-12. MULTIPLE CLASS, INT. CLS. 15
AND 20.
- SWIMC, INC., NEWARK, DE, SHERWIN-WILLIAMS COM-
PANY, THE, CLEVELAND 1, OH:
565,820, REN. 5-23-12. U.S. CL. 16 (INT. CL. 2).
- SWIMC, INC., NEWARK, DE, SHERWIN-WILLIAMS COM-
PANY, THE, CLEVELAND, OH:
1,756,325, REN. 5-18-12. INT. CL. 2.
- SWINDELL DRESSLER INTERNATIONAL COMPANY,
CORAOPOLIS, PA:
862,409, CANC. U.S. CL. 34.
- SWINGLEY, PAMELA, L, ORINDA, CA, DBA MOBILE PRM:
4,164,590, PUB. 4-10-2012. INT. CL. 42.
- SWISSQUAL HOLDING AG, ZUCHWIL, SWITZERLAND:
4,162,719, PUB. 4-10-2012. MULTIPLE CLASS, INT. CLS. 9
AND 42.
- SYBIL HARMON, INC., GREENSBORO, NC:
2,498,382, CANC. INT. CL. 16.

SYLCOM SRL, ITALY:
4,162,948, PUB. 4-10-2012. INT. CL. 11.

SYMANTEC CORPORATION, MOUNTAIN VIEW, CA:
2,498,916, CANC. MULTIPLE CLASS, INT. CLS. 35 AND 42.

SYMRISE AG, HOLZMINDEN, FED REP GERMANY:
4,165,310, INT. CL. 1.

SYNAPSE TRADE SOLUTIONS LLC, SUNNYVALE, CA:
4,165,119, INT. CL. 21.

SYNAPSE WIRELESS, INC., HUNTSVILLE, AL:
4,165,260, INT. CL. 35.

SYNCHRO MEDICAL SARL, WETTOLSHEIM LES ERLÉN, FRANCE:
4,164,364, PUB. 4-10-2012. INT. CL. 10.

SYNLUBE, INC., SANDY VALLEY, NV:
2,569,562. REN. 5-18-12. MULTIPLE CLASS, INT. CLS. 1 AND 4.

SYNOVIS LIFE TECHNOLOGIES, INC., ST. PAUL, MN:
4,165,956, INT. CL. 10.
4,165,957, INT. CL. 10.

SYNQOR, INC., BOXBOROUGH, MA:
4,165,823, INT. CL. 9.

SYNTHIA GODFREY, LAKE FOREST, CA:
4,163,584, PUB. 4-10-2012. INT. CL. 35.

SYRACUSE AREA MUSIC AWARDS, INC., SYRACUSE, NY:
4,164,100, PUB. 4-10-2012. MULTIPLE CLASS, INT. CLS. 35 AND 41.

S2 SYNERGY LLC, ADDISON, TX, DBA POO-POURRI DOODY FREE:
4,165,899, INT. CL. 5.

S99 APPAREL, INC., ENGLEWOOD, NJ:
2,922,731, CANC. INT. CL. 25.

T.K. KEITH COMPANY, INC., WAKEFIELD, MA:
2,703,482. REN. 5-18-12. INT. CL. 36.

T-MOBILE USA, INC., BELLEVUE, WA:
4,163,314, PUB. 4-10-2012. MULTIPLE CLASS, INT. CLS. 9, 38 AND 42.
4,164,198, PUB. 4-10-2012. INT. CL. 38.

TAAL DANCEWEAR LLC, STAMFORD, CT:
4,163,289, PUB. 4-10-2012. INT. CL. 25.

TABIO CORPORATION, OSAKA 547-0015, JAPAN:
4,162,906, PUB. 4-10-2012. INT. CL. 35.

TACO BELL CORP., IRVINE, CA:
1,691,822. REN. 5-21-12. INT. CL. 30.

TAFFORD UNIFORMS, LLC, MONTGOMERYVILLE, PA:
2,578,176. REN. 5-24-12. INT. CL. 35.

TAH DAH, INC., ROCKTON, IL:
1,716,073. REN. 5-22-12. INT. CL. 28.

TAHOE LUXURY PROPERTIES, INC., TAHOE CITY, CA:
4,163,975, PUB. 4-10-2012. INT. CL. 36.

TAKE 'EM OFFS, LTD., NEW YORK, NY:
4,164,968, INT. CL. 25.

TAKE-TWO INTERACTIVE SOFTWARE, INC, NEW YORK, NY:
3,092,859. COR. MULTIPLE CLASS, INT. CLS. 9 AND 41.

TAKE-TWO INTERACTIVE SOFTWARE, INC., NEW YORK, NY:
2,570,448. REN. 5-18-12. INT. CL. 9.

TAKEOUT ENTERTAINMENT LIMITED, HONG KONG, HONG KONG:
4,163,544, PUB. 2-7-2012. INT. CL. 41.

TALBOT HOSPICE FOUNDATION, INC., EASTON, MD:
4,164,024, PUB. 4-10-2012. MULTIPLE CLASS, INT. CLS. 44 AND 45.

TALENT MONDIAL LTEE, QUATRE-BORNES, MAURITIUS:
4,164,954, MULTIPLE CLASS, INT. CLS. 35 AND 41.

TALL PINES CARE AND REHAB, INC., SHOW LOW, AZ:
4,164,209, PUB. 4-10-2012. INT. CL. 44.

TAMAGAWA SEIKI CO., LTD., JAPAN:
4,163,031, PUB. 4-10-2012. MULTIPLE CLASS, INT. CLS. 7 AND 9.

TAMARA HENSICK, CHICAGO, IL, IL:
4,163,624, PUB. 4-10-2012. MULTIPLE CLASS, INT. CLS. 6 AND 14.

TAMI L. FEATHERSTON, GRAIN VALLEY, MO:
4,165,453, INT. CL. 10.

TAMPA BAY RAYS BASEBALL LTD., ST. PETERSBURG, FL:
2,569,777. REN. 5-19-12. INT. CL. 16.

TANJO, HARYANTO, OAKLAND, CA, DBA TALKING DONKEY:
4,164,126, PUB. 4-10-2012. INT. CL. 25.

TAOTAO GROUP CO., LTD., ZHEJIANG PROVINCE, CHINA:
4,162,903, PUB. 4-10-2012. INT. CL. 12.

TAPPAN CO., THE, MANSFIELD, OH:
859,667, CANC. U.S. CL. 23.

TAPPIN, INC., SEATTLE, WA:
4,165,635, INT. CL. 42.

TARGET BRANDS, INC., MINNEAPOLIS, MN:
4,164,696, PUB. 4-10-2012. INT. CL. 21.
4,164,730, PUB. 4-10-2012. INT. CL. 35.
4,165,302, INT. CL. 8.
4,165,303, INT. CL. 14.
4,165,924, MULTIPLE CLASS, INT. CLS. 4 AND 16.

TARRACINO, CORAL, KEY WEST, FL:
2,498,573, CANC. INT. CL. 33.

TASCO SALES, INC., MIAMI, FL:
863,111, CANC. U.S. CL. 26.

TASTE NIRVANA INT'L, INC., WALNUT, CA, DBA TASTE NIRVANA INTERNATIONAL INC.:
4,166,004, INT. CL. 32.

TASTE OF THE WORLD LLC, BENTONVILLE, AR:
4,163,955, PUB. 4-10-2012. INT. CL. 35.

TASTI D-LITE LLC, FRANKLIN, TN:
4,165,369, MULTIPLE CLASS, INT. CLS. 30, 32 AND 35.

TATE, INCORPORATED, ALEXANDRIA, VA:
4,165,184, MULTIPLE CLASS, INT. CLS. 41 AND 42.

TAYLOR & GRANT SPECIALTIES LIMITED, WATERLOO, ONTARIO, CANADA:
2,569,534. REN. 5-21-12. INT. CL. 30.

TAYLOR SEARCH PARTNERS, LLC, COLUMBUS, OH:
4,163,066, PUB. 4-10-2012. INT. CL. 35.

TAYLOR, SHELENE, TUCSON, AZ:
4,163,651, PUB. 4-10-2012. INT. CL. 44.

TBS PRODUCTIONS, INC., ATLANTA, GA:
1,718,897. REN. 5-20-12. INT. CL. 41.

TE-AMO GERYL, INC., MOONACHIE, NJ:
802,426, CANC. U.S. CL. 17.

TEAGARDEN JOSEPH C, ATLANTA, GA:
4,164,144, PUB. 4-10-2012. INT. CL. 9.

TEAM VELOCITY MARKETING, LLC, DULLES, VA:
4,164,014, PUB. 4-10-2012. INT. CL. 35.

TECHNOLOGIES HOLDINGS CORP., HOUSTON, TX:
2,570,954. REN. 5-23-12. MULTIPLE CLASS, INT. CLS. 3, 4, 7, 9, 17 AND 20.
2,570,954, CANC. MULTIPLE CLASS, INT. CLS. 5, 6, 8, 11 AND 21.

TECHNOLOGY ADVANCEMENT GROUP, INC., DULLES, VA:
2,570,911. REN. 5-18-12. INT. CL. 38.

TECHNOLOGY CONCEPTS & DESIGN, INC., GREENSBORO, NC:
4,164,369, PUB. 4-10-2012. INT. CL. 9.

TECMATE INTERNATIONAL S.A./N.V., B-3300 TIENEN, BELGIUM:
2,593,526. REN. 5-19-12. INT. CL. 9.

TECNOLOGICA S.A.S. DI VANELLA SIMONE & C., ITALY:
4,162,937, PUB. 4-10-2012. INT. CL. 11.

TECUMSEH PRODUCTS COMPANY, TECUMSEH, MI:
3,006,362, CANC. INT. CL. 9.
3,006,363, CANC. INT. CL. 9.

TEJON RANCH CO., LEBEC, CA:
1,683,157. REN. 5-22-12. INT. CL. 33.

TEKNOVATION CORPORATION, LONGMONT, CO:
2,975,231, CANC. INT. CL. 9.

TELAIR INTERNATIONAL GMBH, MIESBACH, FED REP GERMANY:
3,582,392, COR. MULTIPLE CLASS, INT. CLS. 7 AND 37.

TELALASKA, INC., ANCHORAGE, AK:
2,582,793. REN. 5-24-12. INT. CL. 38.

TELEFLEX INCORPORATED, LIMERICK, PA:
4,163,700, PUB. 4-10-2012. INT. CL. 20.

- TELGIAN CORPORATION, SAN DIEGO, CA:
2,985,495, CANC. MULTIPLE CLASS, INT. CLS. 37 AND 42.
- TELUCA, INC., NEWARK, NJ:
4,163,873, PUB. 4-10-2012. INT. CL. 35.
- TEMCARE MEDICAL DESIGN AND MANUFACTURING, INC., POMPANO BEACH, FL:
4,163,451, PUB. 4-10-2012. INT. CL. 10.
4,163,452, PUB. 4-10-2012. INT. CL. 10.
- TEMPER CORPORATION, FONDA, NY:
4,164,138, PUB. 4-10-2012. INT. CL. 6.
- TEN THIRTY ONE PRODUCTIONS, LLC, LOS ANGELES, CA:
4,165,716, INT. CL. 39.
- TENDERLOIN TECHNOLOGIES, INC., TREASURE ISLAND, CA:
3,006,328, CANC. INT. CL. 41.
- TENNESSEE AQUARIUM, CHATTANOOGA, TN:
1,691,531, REN. 5-23-12. INT. CL. 16.
- TEQUILAS DEL SENOR, GUADALAJARA JALISCO, MEXICO:
2,508,863, REN. 5-19-12. INT. CL. 33.
- TERRATECH MANUFACTURING, INC., HOUSTON, TX:
4,163,200, PUB. 4-10-2012. INT. CL. 7.
- TERROR OF THE UNDERSTOOD RECORDS, LLC, NEW YORK, NY:
4,165,351, MULTIPLE CLASS, INT. CLS. 9 AND 41.
- TERRYBERRY, LLC, GRAND RAPIDS, MI:
4,163,694, PUB. 4-10-2012. INT. CL. 35.
4,163,706, PUB. 4-10-2012. INT. CL. 35.
4,163,707, PUB. 4-10-2012. INT. CL. 35.
4,163,715, PUB. 4-10-2012. MULTIPLE CLASS, INT. CLS. 14 AND 35.
- TESA AG, HAMBURG, FED REP GERMANY:
3,005,270, CANC. INT. CL. 9.
- TESTA, ROBERT, SIERRA MADRE, CA:
4,163,974, PUB. 4-10-2012. INT. CL. 32.
- TEXAS HEALTH RESOURCES, ARLINGTON, TX:
2,651,505, REN. 5-21-12. INT. CL. 41.
4,162,715, PUB. 4-10-2012. INT. CL. 44.
- TEXAS PREPAID HIGHER EDUCATION TUITION BOARD, AUSTIN, TX:
4,163,433, PUB. 4-10-2012. INT. CL. 36.
- TEXTRON INNOVATIONS INC., PROVIDENCE, RI:
1,687,770, REN. 5-18-12. INT. CL. 12.
- TEXTRON INNOVATIONS INC., PROVIDENCE:
1,687,773, REN. 5-18-12. INT. CL. 12.
- TEXTRON INNOVATIONS INC., PROVIDENCE, RI:
1,690,070, REN. 5-24-12. INT. CL. 12.
1,690,071, REN. 5-24-12. INT. CL. 12.
- TEXTRONIC INC, MIAMI, FL:
4,163,286, PUB. 4-10-2012. INT. CL. 7.
- TEYS AUSTRALIA PTY LTD, AUSTRALIA:
4,162,976, PUB. 4-10-2012. INT. CL. 29.
- TF ENTERTAINMENT CORP., NEW YORK, NY:
4,164,933, MULTIPLE CLASS, INT. CLS. 20 AND 27.
- TGZ ACQUISITION COMPANY, LLC, CHERRY HILL, NJ:
1,688,931, REN. 5-21-12. INT. CL. 10.
- THACKREY, SEAN HALEY, BOLINAS, CA:
4,164,846, INT. CL. 33.
4,164,847, INT. CL. 33.
- THAI WORLD IMPORT & EXPORT CO., LTD, YANNAWA, BANGKOK 10120, THAILAND:
2,601,630, REN. 5-21-12. INT. CL. 30.
- THE ACTIVE NETWORK, INC., SAN DIEGO, CA:
2,671,958, REN. 5-23-12. MULTIPLE CLASS, INT. CLS. 35 AND 42.
- THE ALPHAMED COMPANY, INC., DURHAM, NC:
4,165,516, INT. CL. 38.
4,165,517, INT. CL. 38.
- THE AMCOR GROUP, LTD., CARLSTADT, NJ:
3,404,177, CANC. INT. CL. 11.
- THE AR GROUP, LLP, GREENWOOD VILLAGE, CO:
4,164,132, PUB. 4-10-2012. MULTIPLE CLASS, INT. CLS. 35 AND 45.
- THE AR GROUP, LLP, GREENWOOD VILLAGE, CO, DBA THE AR GROUP:
4,164,756, PUB. 4-10-2012. INT. CL. 45.
- THE ARISTOTLE CORPORATION, STAMFORD, CT:
2,497,898, CANC. INT. CL. 16.
- THE ARIZONA BOARD OF REGENTS ON BEHALF OF THE UNIVERSITY OF ARIZONA, TUCSON, AZ:
4,165,798, INT. CL. 44.
- THE ASSOCIATION FOR CORPORATE GROWTH, INC., CHICAGO, IL:
4,165,661, INT. CL. 35.
- THE BAKERSFIELD CALIFORNIAN, BAKERSFIELD, CA:
3,062,963, CANC. MULTIPLE CLASS, INT. CLS. 35 AND 36.
- THE BAUPOST GROUP, L.L.C., BOSTON, MA:
4,164,527, PUB. 4-10-2012. INT. CL. 36.
- THE BENEFIT PLANNING GROUP, INC., DURHAM, NC:
4,164,329, PUB. 4-10-2012. INT. CL. 36.
- THE BIG TEN CONFERENCE, INC., PARK RIDGE, IL:
4,164,707, PUB. 4-10-2012. INT. CL. 41.
- THE BOARD OF REGENTS OF THE UNIVERSITY OF TEXAS SYSTEM, AUSTIN, TX:
4,094,959, COR. INT. CL. 32.
- THE BRAIN SURGERY GROUP, INC., ATLANTA, GA:
4,164,593, PUB. 4-10-2012. INT. CL. 35.
- THE BRAKE SHOP, LLC, LINCOLN PARK, MI:
4,165,251, INT. CL. 37.
- THE BREAST CANCER RESEARCH FOUNDATION, NEW YORK, NY:
4,164,540, PUB. 4-10-2012. INT. CL. 36.
- THE BROOKESIDE GROUP, INC., ACTON, MA:
4,164,831, INT. CL. 35.
- THE BUFFALO CITY CEMETERY, INC., BUFFALO, NY:
4,165,326, MULTIPLE CLASS, INT. CLS. 44 AND 45.
4,165,916, INT. CL. 45.
- THE BUTCHER COMPANY, STURTEVANT, WI:
2,498,189, CANC. INT. CL. 3.
- THE CARLE FOUNDATION, URBANA, IL:
4,164,736, PUB. 4-10-2012. INT. CL. 35.
- THE CARTOON NETWORK, INC., ATLANTA, GA:
2,621,330, REN. 5-22-12. INT. CL. 16.
- THE CENTER FOR ORTHOPEDIC AND RESEARCH EXCELLENCE, INC., PHOENIX, AZ:
4,164,738, PUB. 4-10-2012. INT. CL. 44.
- THE CHAMBERLAIN GROUP, INC., ELMHURST, IL:
4,165,481, INT. CL. 9.
- THE CHEMICAL HERITAGE FOUNDATION, PHILADELPHIA, PA:
3,222,627, AM. INT. CL. 41.
- THE CITY UNIVERSITY OF NEW YORK THROUGH ITS COMMUNITY COLLEGE, LAGUARDIA COMMUNITY COLLEGE, NEW YORK, NY:
4,164,193, PUB. 4-10-2012. MULTIPLE CLASS, INT. CLS. 16, 21, 25 AND 41.
- THE CLEVELAND CLINIC FOUNDATION, CLEVELAND, OH:
3,006,409, CANC. INT. CL. 14.
- THE COLLECTOR CAR NETWORK, INC., PHOENIX, AZ, DBA CLASSICARS.COM:
4,166,016, INT. CL. 35.
- THE COOPER INSTITUTE, DALLAS, TX:
4,162,723, PUB. 4-10-2012. INT. CL. 41.
- THE CRIBLINE, LLC, WASHINGTON, DC:
4,164,444, PUB. 4-10-2012. INT. CL. 41.
- THE CRIMSON CUP, INC., COLUMBUS, OH:
4,165,006, MULTIPLE CLASS, INT. CLS. 30 AND 35.
- THE CURATORS OF THE UNIVERSITY OF MISSOURI, COLUMBIA, MO:
4,163,459, PUB. 4-10-2012. INT. CL. 41.
- THE DC MIX ENTERTAINMENT GROUP, COLUMBIA, MD:
4,163,714, PUB. 4-10-2012. INT. CL. 35.
- THE DELFIELD COMPANY LLC, WILMINGTON, DE:
2,573,485, REN. 5-19-12. INT. CL. 11.
- THE DENALI COMPANIES LLC, RED BANK, NJ:
4,163,098, PUB. 4-10-2012. INT. CL. 24.
- THE DIME SAVINGS BANK OF NEW YORK, FSB, NEW YORK, NY:
4,162,690, PUB. 4-10-2012. INT. CL. 36.
- THE DISCOVERY ORCHESTRA, INC., WARREN, NJ:
2,695,799, REN. 5-19-12. INT. CL. 41.

THE DIVERSITY IN NURSE ANESTHESIA MENTORSHIP PROGRAM, MICKLETON, NJ:
3,888,333, COR. INT. CL. 41.

THE ECHO SYSTEM CORP., NEW YORK, NY:
4,165,287, MULTIPLE CLASS, INT. CLS. 35 AND 42.

THE ELECTORAL BRAND COMPANY LIMITED, CHRISTCHURCH, NEW ZEALAND:
4,164,975, MULTIPLE CLASS, INT. CLS. 24 AND 25.

THE ERICSON MANUFACTURING CO., WILLOUGHBY, OH:
4,166,011, INT. CL. 9.

THE ESAB GROUP, INC., FLORENCE, SC:
4,162,701, PUB. 4-10-2012. INT. CL. 7.

THE EXCHANGE CLUB CENTER FOR THE PREVENTION OF CHILD ABUSE OF NORTH MISSISSIPPI, INCORPORATED, OXFORD, MS:
4,163,197, PUB. 4-10-2012. INT. CL. 45.

THE FAIRHAVEN GROUP, INC., SEATTLE, WA:
3,257,730, AM. INT. CL. 18.

THE FATDUX GROUP APS, 2100 COPENHAGEN, DENMARK:
4,164,551, PUB. 4-10-2012. INT. CL. 35.

THE FOREIGN CANDY COMPANY, INC., HULL, IA:
4,077,847, AM. INT. CL. 30.

THE FOSTER PORTER COMPANY, LLC, RIVERTON, UT:
4,165,320, INT. CL. 5.

THE FRANCES XAVIER WARDE SCHOOL NFP, CHICAGO, IL:
4,164,012, PUB. 4-10-2012. INT. CL. 41.

THE GARLIC COMPANY, BAKERSFIELD, CA:
4,165,263, INT. CL. 31.
4,165,264, INT. CL. 30.

THE GLITZ COMPANY, LLC, EAST HAMPTON, CT:
4,164,022, PUB. 4-10-2012. INT. CL. 26.

THE GOODYEAR TIRE & RUBBER COMPANY, AKRON, OH:
502,103, CANC. U.S. CL. 35.

THE GOYAK GROUP, INC., LAS VEGAS, NV:
4,165,600, INT. CL. 35.

THE GREATER GREENVILLE ASSOCIATION OF REALTORS, INC., GREENVILLE, SC:
4,163,413, PUB. 4-10-2012. INT. CL. 41.

THE GROVE LICENSING AND DESIGN CORPORATION, SANTA BARBARA, CA:
4,164,977, INT. CL. 25.

THE GSI GROUP, LLC, ASSUMPTION, IL:
4,163,507, PUB. 4-10-2012. MULTIPLE CLASS, INT. CLS. 6, 7, 9, 11, 12 AND 21.

THE GUARDIAN LIFE INSURANCE COMPANY OF AMERICA, NEW YORK, NY:
4,163,521, PUB. 4-10-2012. MULTIPLE CLASS, INT. CLS. 35 AND 36.

THE H. T. HACKNEY CO., KNOXVILLE, TN:
4,164,229, PUB. 4-10-2012. INT. CL. 30.

THE HADDAD APPAREL GROUP, LTD., BAYONNE, NJ:
127,985, CANC. U.S. CL. 39.

THE HOLLAND, INC., VANCOUVER, WA:
4,165,053, MULTIPLE CLASS, INT. CLS. 29, 30, 32 AND 43.

THE HOUSTON/BAYOU CITY ZOMBIE WALK, HOUSTON, TX:
4,163,485, PUB. 4-10-2012. INT. CL. 36.

THE INITIAL BABY, LLC, ST. LOUIS, MO:
4,163,300, PUB. 4-10-2012. INT. CL. 35.

THE INSURANCE STORE, LLC, ROCKVILLE, MD:
1,196,015, REN. 5-22-12. INT. CL. 36.

THE INTERNATIONAL AIR CARGO ASSOCIATION, INC., MIAMI, FL:
2,907,879, AM. INT. CL. 35.

THE JAMES VALLEY CO., INC., MELLETTE, SD:
4,164,916, INT. CL. 28.

THE JOHNS HOPKINS HEALTH SYSTEM CORPORATION, BALTIMORE, MD:
4,165,828, INT. CL. 43.

THE KITCHEN CAFE, LLC, BOULDER, CO:
4,165,447, INT. CL. 43.

THE KROGER CO. OF MICHIGAN, NOVI, MI:
4,163,945, PUB. 4-10-2012. INT. CL. 32.
4,164,728, PUB. 4-10-2012. INT. CL. 35.

THE KYJEN COMPANY, INC., CENTENNIAL, CO:
4,163,580, PUB. 1-3-2012. INT. CL. 18.

THE LAW OFFICE OF B. A. THOMAS, LLC, ATLANTA, GA:
4,164,599, PUB. 4-10-2012. INT. CL. 45.

THE LITTLE DRINKS COMPANY LIMITED T/A RETAIL IN MOTION, SANDYFORD, DUBLIN, 18, IRELAND:
4,163,196, PUB. 4-10-2012. MULTIPLE CLASS, INT. CLS. 14 AND 25.

THE MARICOPA COUNTY COMMUNITY COLLEGE DISTRICT, TEMPE, AZ:
2,662,286, REN. 5-19-12. INT. CL. 21.

THE MARK A. FORESTER FOUNDATION, INC., HALEYVILLE, AL:
4,165,762, INT. CL. 36.

THE MATH LEARNING CENTER, SALEM, OR:
4,163,163, PUB. 4-10-2012. MULTIPLE CLASS, INT. CLS. 16 AND 28.

THE MCGRAW-HILL COMPANIES, INC., NEW YORK, NY:
4,163,138, PUB. 4-10-2012. MULTIPLE CLASS, INT. CLS. 9 AND 16.

THE MERINO COMPANY PTY LTD, LEVIN, NEW ZEALAND, TA LEVANA TEXTILES:
4,163,397, PUB. 4-10-2012. INT. CL. 10.

THE MOYER FOUNDATION, SEATTLE, WA:
4,163,911, PUB. 4-10-2012. MULTIPLE CLASS, INT. CLS. 41 AND 44.

THE NIGHTHAWKS, KENSINGTON, MD:
2,934,526, CANC. INT. CL. 41.

THE OMAHA HOME FOR BOYS, OMAHA, NE:
4,163,740, PUB. 4-10-2012. MULTIPLE CLASS, INT. CLS. 41 AND 43.

THE ONE CAMPAIGN, WASHINGTON, DC:
4,165,022, MULTIPLE CLASS, INT. CLS. 16 AND 35.

THE OREGON PARTNERSHIP, INC., PORTLAND, OR:
4,164,114, PUB. 4-10-2012. INT. CL. 44.

THE ORVIS COMPANY, INC., SUNDERLAND, VT:
4,163,548, PUB. 4-10-2012. INT. CL. 41.

THE PARTY PORTFOLIO, INC., MCLEAN, VA:
4,165,811, INT. CL. 41.

THE PHIA GROUP, LLC, BRAINTREE, MA:
4,164,682, PUB. 4-10-2012. INT. CL. 36.

THE PINAX GROUP, INC., NEW ORLEANS, LA:
3,504,658, CANC. INT. CL. 9.

THE PINK RIBBON FOUNDATION, INC, FORT LAUDERDALE, FL:
4,166,072, INT. CL. 36.

THE PROCTER & GAMBLE COMPANY, CINCINNATI, OH:
4,164,605, PUB. 4-10-2012. INT. CL. 3.
4,164,680, PUB. 4-10-2012. INT. CL. 3.
4,164,717, PUB. 4-10-2012. INT. CL. 3.
4,164,734, PUB. 4-10-2012. INT. CL. 3.
4,165,321, INT. CL. 3.
4,165,322, INT. CL. 3.
4,165,323, INT. CL. 3.
4,165,870, MULTIPLE CLASS, INT. CLS. 44 AND 45.

THE RESEARCH FOUNDATION FOR MICROBIAL DISEASES OF OSAKA UNIVERSITY, JAPAN:
4,162,916, PUB. 4-10-2012. INT. CL. 5.

THE RIGHT PLAN, LLC, MEDFORD, OR:
4,164,640, PUB. 4-10-2012. INT. CL. 44.

THE ROSS GROUP INC., DAYTON, OH:
4,164,068, PUB. 4-10-2012. INT. CL. 45.

THE SALVATION ARMY NATIONAL CORPORATION, ALEXANDRIA, VA:
4,163,803, PUB. 4-10-2012. MULTIPLE CLASS, INT. CLS. 41, 43 AND 45.

THE SCOOTER STORE, LTD., NEW BRAUNFELS, TX:
2,623,482, REN. 5-23-12. MULTIPLE CLASS, INT. CLS. 35, 36, 37 AND 39.

THE SILVER STREET GROUP, LLC, PORTLAND, ME:
4,163,400, PUB. 4-10-2012. INT. CL. 37.
4,163,401, PUB. 4-10-2012. INT. CL. 37.

THE SKILLERY, LLC, NASHVILLE, TN:
4,164,412, PUB. 4-10-2012. INT. CL. 35.

- THE SMILEY COMPANY SPRL, BRUSSELS, BELGIUM:
2,566,529. REN. 5-18-12. INT. CL. 28.
- THE STANDARD REGISTER COMPANY, DAYTON, OH:
3,006,666. CANC. MULTIPLE CLASS, INT. CLS. 35, 39, 40,
41 AND 42.
- THE STATE OF TEXAS BY AND THROUGH THE GEN-
ERAL LAND OFFICE (STATE), AUSTIN, TX:
2,497,551. CANC. INT. CL. 32.
- THE STEPHAN CO., FORT LAUDERDASLE, FL:
4,163,201. PUB. 4-10-2012. INT. CL. 3.
- THE STEVE HARVEY RADIO NETWORK, INC., HOUSTON,
TX:
4,162,699. PUB. 4-10-2012. INT. CL. 9.
- THE STOCKROOM, INC., LOS ANGELES, CA:
4,164,046. PUB. 4-10-2012. INT. CL. 10.
- THE TENNIS CHANNEL, INC., SANTA MONICA, CA:
4,165,341. INT. CL. 41.
- THE TIFFEN COMPANY, LLC, HAUPPAUGE, NY:
4,163,663. PUB. 4-10-2012. INT. CL. 9.
- THE TJX COMPANIES, INC., FRAMINGHAM, MA:
4,165,132. MULTIPLE CLASS, INT. CLS. 16 AND 41.
- THE TOBIN PROJECT, CAMBRIDGE, MA:
4,164,997. INT. CL. 35.
4,164,998. INT. CL. 41.
- THE TOPLINE CORPORATION, BELLEVUE, WA:
4,164,811. INT. CL. 25.
- THE TOPPS COMPANY, INC., NEW YORK, NY:
3,006,418. CANC. INT. CL. 25.
- THE TRANZONIC COMPANIES, CLEVELAND, OH:
3,897,894. CANC. INT. CL. 11.
- THE TRAVELERS INDEMNITY COMPANY, HARTFORD,
CT:
2,497,998. CANC. INT. CL. 36.
- THE TRUSTEES OF INDIANA UNIVERSITY, BLOOMING-
TON, IN, TRUSTEES OF INDIANA UNIVERSITY, THE,
BLOOMINGTON, IN:
1,700,647. REN. 5-22-12. INT. CL. 25.
- THE TRUSTEES OF INDIANA UNIVERSITY, BLOOMING-
TON, IN:
2,575,610. REN. 5-22-12. INT. CL. 25.
- THE TRUSTEES OF THE WASHINGTON REAL ESTATE
INVESTMENT TRUST, ROCKVILLE, MD:
4,164,031. PUB. 4-10-2012. INT. CL. 36.
4,164,032. PUB. 4-10-2012. INT. CL. 36.
- THE TRUSTEES OF THE WHITLEY FAMILY TRUST,
DATED JULY 14, 2009, SCOTTSDALE, AZ:
4,165,150. INT. CL. 45.
- THE TRUTH - 34, INC., SAN FRANCISCO, CA:
4,165,018. MULTIPLE CLASS, INT. CLS. 14, 25, 35 AND
36.
- THE TWEED RUN, LONDON, UNITED KINGDOM:
4,163,081. PUB. 4-10-2012. MULTIPLE CLASS, INT. CLS.
12, 25 AND 41.
- THE UPPER DECK COMPANY, INC., CARLSBAD, CA,
FLEER/SKYBOX INTERNATIONAL LP, MT. LAUREL,
NJ:
2,579,190. REN. 5-21-12. INT. CL. 16.
- THE UPPER DECK COMPANY, INC., CARLSBAD, CA:
2,588,481. REN. 5-21-12. INT. CL. 16.
- THE VAN DER ROEST GROUP, INC., ORANGE, CA:
4,165,654. INT. CL. 9.
- THE WASHINGTON TRUST COMPANY, WESTERLY, RI:
4,162,793. PUB. 7-24-2007. INT. CL. 36.
- THE WELLA CORP., WOODLAND HILLS, CA:
2,916,257. CANC. INT. CL. 3.
- THE WHEREVILLE PROJECT PARTNERSHIP, SPARTAN-
BURG, SC:
4,164,011. PUB. 4-10-2012. INT. CL. 41.
- THE WHOLE BOWL, INC., PORTLAND, OR:
4,164,351. PUB. 4-10-2012. INT. CL. 43.
- THE WINE GROUP LLC, TRACY, CA:
4,164,878. INT. CL. 33.
- THE YANKEE CANDLE COMPANY, INC., SOUTH DEER-
FIELD, MA:
1,688,661. COR. INT. CL. 4.
- THE 101 CORPORATION, LOS ANGELES, CA:
4,165,725. INT. CL. 34.
- THEALLET, SOPHIE, NEW YORK, NY:
4,165,486. INT. CL. 25.
- THEINSURANCEADVISOR.COM, INC., TAMPA, FL:
4,163,942. PUB. 4-10-2012. INT. CL. 36.
- THELIQUORSTORECHANNEL.COM, LLC, COLORADO
SPRINGS, CO:
4,165,037. INT. CL. 38.
- THERMALCAST, L.L.C., WORCESTER, MA:
3,006,129. CANC. INT. CL. 6.
- THERMO ELECTRON LED GMBH, LANGENSELBOLD,
FED REP GERMANY:
4,163,260. PUB. 4-10-2012. INT. CL. 9.
- THERMO FISHER SCIENTIFIC (ASHEVILLE) LLC, ASHE-
VILLE, NC, INTERNATIONAL EQUIPMENT CO., NEED-
HAM HEIGHTS, MA:
2,626,194. REN. 5-18-12. INT. CL. 9.
- THERMOTEXNIX SYSTEMS LTD, CAMBRIDGE, UNITED
KINGDOM:
1,754,961. REN. 5-23-12. INT. CL. 9.
- THINK ON YOUR FEET INTERNATIONAL, INC., TORON-
TO ONTARIO, CANADA:
1,686,339. REN. 5-21-12. INT. CL. 16.
- THOMAS, CAROL TODD, BLACK MOUNTAIN, NC:
2,584,477. REN. 5-23-12. INT. CL. 35.
- THOMAS, DAN, PASADENA, CA AND VARNICA, NATA-
SHA, PASADENA, CA:
4,163,440. PUB. 4-10-2012. INT. CL. 42.
- THOMASVILLE HOME FURNISHINGS, INC., THOMAS-
VILLE, NC:
4,165,204. MULTIPLE CLASS, INT. CLS. 2, 3 AND 19.
4,165,205. MULTIPLE CLASS, INT. CLS. 2, 3 AND 19.
- THOMPSON, QUINN, LOS ANGELES, CA AND TOURGE-
MAN, MARK, LOS ANGELES, CA:
2,975,270. CANC. INT. CL. 25.
- THOMPSON, ROBERT, CHANTILLY, VA:
4,164,432. PUB. 4-10-2012. INT. CL. 41.
4,164,694. PUB. 4-10-2012. INT. CL. 41.
- THOMSEN, VERNE E., AMES, NE:
2,984,692. CANC. INT. CL. 6.
- THORLEY INDUSTRIES LLC, PITTSBURGH, PA, DBA
4MOMS:
4,125,730. COR. INT. CL. 12.
- THORNE RESEARCH, INC., SANDPOINT, ID:
4,164,629. PUB. 4-10-2012. INT. CL. 5.
- THREE RINGS DESIGN, INC., SAN FRANCISCO, CA:
4,165,393. INT. CL. 38.
- THRILLWORKS, INC., NEWCASTLE, CA:
4,163,745. PUB. 4-10-2012. MULTIPLE CLASS, INT. CLS.
28 AND 35.
4,163,787. PUB. 4-10-2012. MULTIPLE CLASS, INT. CLS.
28 AND 35.
4,163,956. PUB. 4-10-2012. INT. CL. 28.
- THRIV NP, INC., METAIRIE, LA:
4,165,938. INT. CL. 25.
- THRONEBURG, JAMES L., STATESVILLE, NC:
4,165,429. INT. CL. 25.
- THUNDER PERFORMANCE GROUP, INC., BATON
ROUGE, LA, DBA THUNDER RACING:
4,165,069. MULTIPLE CLASS, INT. CLS. 37 AND 39.
- TI-CARO, INC., GASTONIA, NC:
857,987. CANC. U.S. CL. 42.
- TIANJIN CENTRAL PHARMACEUTICAL CO., LTD., TIAN-
JIN, CHINA:
1,200,098. REN. 5-19-12. INT. CL. 5.
- TIBCO SOFTWARE INC., PALO ALTO, CA:
4,165,739. MULTIPLE CLASS, INT. CLS. 38 AND 42.
- TIBHAR TIBOR HARANGOZO GMBH, W-6601 SAAR-
BRÜCKEN-KLARENTHAL, FED REP GERMANY:
1,713,817. REN. 5-19-12. MULTIPLE CLASS, INT. CLS. 25
AND 28.
- TIC HOLDINGS, INC., STEAMBOAT SPRINGS, CO:
2,570,138. REN. 5-21-12. INT. CL. 42.
- TICKENOFF, JOSHUA, COSTA MESA, CA:
4,165,240. INT. CL. 42.
- TIDELAND SIGNAL CORPORATION, HOUSTON, TX:
935,580. REN. 5-18-12. U.S. CL. 19 (INT. CL. 6).

TIDES HOTELS, L.L.C., LOS ANGELES, CA:
4,164,322, PUB. 4-10-2012. INT. CL. 43.
4,164,323, PUB. 4-10-2012. INT. CL. 43.

TIEN HSIN INDUSTRIES CO., LTD., TAICHUNG COUNTY, TAIWAN:
4,164,091, PUB. 4-10-2012. INT. CL. 12.

TIER10 MARKETING, LLC, HERNDON, VA:
4,164,384, PUB. 4-10-2012. INT. CL. 35.

TIEWAY INTERNATIONAL INC., SOUTHLAKE, TX:
4,163,631, PUB. 4-10-2012. INT. CL. 2.

TIFFANY ROSE MOCKLER, SAN JOSE, CA:
3,501,073, COR. INT. CL. 41.

TIG HOLDINGS, INC., MANCHESTER, NH:
2,562,362, REN. 5-19-12. INT. CL. 36.

TIM KIGHT, DUBLIN, OH, DBA AND I WIN, LLC AND CAREY KIGHT, DUBLIN, OH, DBA AND I WIN, LLC AND DAVE MILLER, BOSTON, MA, DBA AND I WIN, LLC AND T. BRIAN KIGHT, DUBLIN, OH, DBA AND I WIN, LLC:
4,163,261, PUB. 4-10-2012. INT. CL. 42.
4,163,269, PUB. 4-10-2012. INT. CL. 42.

TIME INC., NEW YORK, NY:
2,499,241, CANC. INT. CL. 16.

TIME WARNER CABLE INC., NEW YORK, NY:
4,163,641, PUB. 4-10-2012. INT. CL. 35.
4,165,063, MULTIPLE CLASS, INT. CLS. 38 AND 41.

TIMES FIBER COMMUNICATIONS, INC., WALLINGFORD, CT:
4,165,356, INT. CL. 9.

TIMOTHY G.B. SIMMONS, NETHERLANDS:
4,162,931, PUB. 4-10-2012. MULTIPLE CLASS, INT. CLS. 18, 25 AND 35.

TINMAN TAILGATE TOOLCHEST CO, LLC, MORTON, TX:
4,164,422, PUB. 4-10-2012. INT. CL. 6.

TIONG LIONG INDUSTRIAL CO., LTD., TAICHUNG HSIEN, TAIWAN:
4,163,070, PUB. 4-26-2011. MULTIPLE CLASS, INT. CLS. 24 AND 25.

TIRESIAS TECHNOLOGIES, INC., LAUREL, MD:
4,164,199, PUB. 4-10-2012. INT. CL. 42.

TISH & SNOOKY'S N.Y.C. INC., LONG ISLAND CITY, NY:
3,771,095, AM. INT. CL. 44.

TISSOT SA, 2400 LE LOCLE, SWITZERLAND:
4,164,885, INT. CL. 14.

TMB, INC, PACOIMA, CA:
4,165,972, INT. CL. 11.

TNT SALES & DISTRIBUTING LLC, JENISON, MI:
4,164,359, PUB. 4-10-2012. INT. CL. 9.

TOCCATA GAMING INTERNATIONAL, LLC, NEENAH, WI:
4,163,519, PUB. 4-10-2012. INT. CL. 9.

TOHO CO., LTD., LOS ANGELES, CA:
1,173,164, CANC. MULTIPLE CLASS, INT. CLS. 16 AND 28.

TOKUYAMA CORPORATION, YAMAGUCHI, JAPAN:
4,163,877, PUB. 2-21-2012. INT. CL. 5.

TOM HOM GROUP, LLC, THE, SAN DIEGO, CA:
2,579,436, COR. MULTIPLE CLASS, INT. CLS. 36 AND 37.

TOMASETTI, SARAH, PASO ROBLES, CA:
4,164,319, PUB. 4-10-2012. INT. CL. 36.

TOMMY BAHAMA GROUP, INC., ATLANTA, GA:
2,641,036, REN. 5-18-12. INT. CL. 9.

TOMMY HILFIGER LICENSING LLC, NEW YORK, NY:
2,612,455, REN. 5-24-12. INT. CL. 25.

TOMOTHERAPY INCORPORATED, MADISON, WI:
2,995,359, CANC. INT. CL. 9.

TOMOTHERAPY, INC., MADISON, WI:
2,995,357, CANC. MULTIPLE CLASS, INT. CLS. 9 AND 10.
2,995,358, CANC. INT. CL. 9.

TOMOTHERAPY, INCORPORATED, MADISON, WI:
2,945,875, CANC. INT. CL. 10.

TONER2PRINT INC, ONTARIO, CA:
4,165,792, INT. CL. 37.

TONI & ASH ENTERTAINMENT, LLC, KNOXVILLE, TN:
4,163,464, PUB. 4-10-2012. INT. CL. 9.
4,163,465, PUB. 4-10-2012. INT. CL. 9.

TONI BRATTIN & CO., INC., OKLAHOMA CITY, OK:
4,165,643, INT. CL. 26.

TONY LITTLE ENTERRPISES, INC., ST. PETERSBURG, FL:
2,588,691, REN. 5-19-12. INT. CL. 41.

TOO FACED COSMETICS, INC., IRVINE, CA:
4,165,604, INT. CL. 3.

TOP HAT, INC., SHAKOPEE, MN:
4,164,292, PUB. 4-10-2012. INT. CL. 35.

TOP MACHINERY & EQUIPMENT (ZHENGZHOU) LTD., ZHENGZHOU, HENAN, CHINA:
4,163,512, PUB. 11-1-2011. INT. CL. 7.

TOPCO ASSOCIATES, LLC, SKOKIE, IL:
4,163,446, PUB. 4-10-2012. INT. CL. 29.

TOPCO HOLDINGS, INC., SKOKIE, IL:
2,576,689, REN. 5-22-12. INT. CL. 30.

TORAY KABUSHIKI KAISHA, TOKYO, JAPAN, AKA TORAY INDUSTRIES, INC. AND TEIJIN KABUSHIKI KAISHA, OSAKA, JAPAN, AKA TEIJIN LIMITED:
4,163,087, PUB. 4-10-2012. MULTIPLE CLASS, INT. CLS. 22, 23 AND 24.

TORAY KABUSHIKI KAISHA (TORAY INDUSTRIES, INC.), TOKYO, JAPAN:
4,163,792, PUB. 3-6-2012. MULTIPLE CLASS, INT. CLS. 18, 22 AND 23.
4,164,676, PUB. 3-6-2012. MULTIPLE CLASS, INT. CLS. 24 AND 25.

TORRES, VICTOR, SAN JUAN, PUERTO RICO:
4,166,000, INT. CL. 35.

TOSHIBA TEC KABUSHIKI KAISHA, ALSO TRADING AS TOSHIBA TEC CORPORATION, TOKYO 101-8442, JAPAN:
3,006,027.

TOTAL FITWORX, HOUSTON, TX:
2,570,365, REN. 5-21-12. INT. CL. 25.

TOTAL PACKAGE BAND, ATLANTA, GA:
2,498,576, CANC. INT. CL. 41.

TOURA, LLC, BROOKLYN, NY, DBA TOURA:
4,164,553, PUB. 4-10-2012. INT. CL. 9.

TOWER PADDLE BOARDS, INC., SAN DIEGO, CA:
4,164,041, PUB. 4-10-2012. INT. CL. 28.
4,164,045, PUB. 4-10-2012. INT. CL. 28.

TOY STATE INDUSTRIAL LTD., TSIMSHATSUI, KOW-LOON, HONG KONG:
2,583,617, REN. 5-19-12. INT. CL. 28.

TOZEN CORPORATION, YOSHIKAWA, SAITAMA, JAPAN:
3,006,507, CANC. INT. CL. 17.

TPK TOUCH SOLUTIONS INC., TAIPEI CITY 114, TAIWAN:
4,163,581, PUB. 4-10-2012. MULTIPLE CLASS, INT. CLS. 9 AND 42.

TRACTOR SUPPLY CO. OF TEXAS, LP, BRENTWOOD, TN:
4,165,431, INT. CL. 6.

TRACY, ALVA, LEXINGTON, KY:
4,165,563, INT. CL. 41.

TRAFFICMARKETPLACE, INC., EL SEGUNDO, CA:
3,762,225, CANC. INT. CL. 35.

TRAKLOK CORPORATION, KNOXVILLE, TN:
4,165,618, MULTIPLE CLASS, INT. CLS. 9 AND 35.

TRALY (USA) INC., BOCA RATON, FL:
4,164,584, PUB. 4-10-2012. INT. CL. 16.

TRANSCONTINENTAL INC., MONTREAL, QUEBEC, CANADA:
4,163,063, PUB. 4-10-2012. INT. CL. 35.

TRANSCRAFT CORPORATION, CADIZ, KY, TRANSCRAFT CORPORATION, ANNA, IL:
1,692,844, REN. 5-19-12. INT. CL. 12.

TRANSHIELD TECHNOLOGY AS, OSLO, NORWAY:
2,571,025, REN. 5-21-12. INT. CL. 16.

TRANSOL CORPORATION, MORGANTOWN, PA:
4,089,648, COR. INT. CL. 7.

TRASH ON WHEELS LLC, DALTON, OH:
4,165,402, INT. CL. 39.
4,165,403, INT. CL. 39.

TRAVELING TOWER LLC, SAINT ANTHONY, MN:
4,164,051, PUB. 4-10-2012. INT. CL. 7.

TREDEGAR FILM PRODUCTS CORPORATION, RICHMOND, VA, ETHYL CORPORATION, RICHMOND, VA:
1,210,473, REN. 5-23-12. INT. CL. 17.

- TREEHOUSE CALIFORNIA ALMONDS, LLC, MARINA DEL REY, CA:
4,163,235, PUB. 4-10-2012. INT. CL. 40.
- TREERESEARCH, ALLENTOWN, NJ:
1,690,413, REN. 5-18-12. INT. CL. 31.
- TREK BICYCLE CORPORATION, WATERLOO, WI:
2,652,326, REN. 5-18-12. INT. CL. 12.
- TREK BICYCLE CORPORATION, WATERLOO, WI:
4,165,400, INT. CL. 12.
- TREMEC CORPORATION, PLYMOUTH, MI:
2,567,893, REN. 5-18-12. INT. CL. 12.
- TRES AGUILAS ENTERPRISES LLC, SAN ANTONIO, TX:
2,477,965, REN. 5-24-12. INT. CL. 42.
2,477,965 NEW CERT. 6-26-2012. INT. CL. 42.
- TRETTIN, DOUGLAS FREDERICK, ATLANTA, GA:
4,165,862, INT. CL. 25.
- TREXEL, INC., WOBURN, MA:
2,565,932, REN. 5-19-12. INT. CL. 7.
- TRICON PRECAST, LTD., HOUSTON, TX:
4,165,551, INT. CL. 6.
- TRILLIANT NETWORKS (CANADA) INC., GRANBY, CANADA:
2,568,741, REN. 5-18-12. INT. CL. 9.
- TRILLION DIAMOND CO., INC., NEW YORK, NY:
1,686,317, REN. 5-18-12. INT. CL. 14.
- TRIOLOGY INVESTMENT GROUP LLC, ENCINAS, CA:
4,164,681, PUB. 4-10-2012. MULTIPLE CLASS, INT. CLS. 36 AND 37.
- TRIMACO, LLC, DURHAM, NC:
4,164,837, MULTIPLE CLASS, INT. CLS. 16 AND 17.
- TRIP EDITORA E PROPAGANDA S/A, PINHEIROS, SÃO PAULO, BRAZIL:
4,165,226, INT. CL. 16.
- TRIPGRAM, INC., NEW YORK, NY:
4,165,867, INT. CL. 42.
- TRIPPE MANUFACTURING COMPANY, CHICAGO, IL:
4,163,967, PUB. 4-10-2012. INT. CL. 9.
- TRISLER, TRISLER M., TRABUCO CANYON, CA:
4,163,543, PUB. 4-10-2012. INT. CL. 30.
- TRISTAR PRODUCTS, INC., EAST FAIRFIELD, NJ:
4,166,003, INT. CL. 25.
- TRITON DOOR SYSTEMS, INC., SAN MARCOS, CA:
4,163,088, PUB. 4-10-2012. INT. CL. 37.
- TRIVANTIS CORPORATION, CINCINNATI, OH:
2,571,196, REN. 5-19-12. INT. CL. 9.
- TRIWEST HEALTHCARE ALLIANCE CORP., PHOENIX, AZ:
4,164,042, PUB. 4-10-2012. INT. CL. 44.
- TRU-FIRE CORPORATION, NORTH FOND DU LAC, WI:
1,695,460, REN. 5-21-12. INT. CL. 28.
- TRUCK-LITE CO., LLC, FALCONER, NY:
1,688,343, REN. 5-18-12. INT. CL. 9.
- TRUE KNOWLEDGE LIMITED, CAMBRIDGE, UNITED KINGDOM:
4,165,765, INT. CL. 42.
4,165,766, INT. CL. 9.
- TRUE MANUFACTURING CO., INC., O'FALLON, MO:
2,640,731, REN. 5-21-12. INT. CL. 20.
- TRUE SITE CORPORATION, MARIETTA, GA:
4,165,945, MULTIPLE CLASS, INT. CLS. 8 AND 20.
- TRUE VALUE COMPANY, CHICAGO, IL:
4,165,025, MULTIPLE CLASS, INT. CLS. 35, 37, 39, 41, 43 AND 44.
- TRUECAR, INC., SANTA MONICA, CA:
4,165,572, MULTIPLE CLASS, INT. CLS. 35 AND 42.
- TRUGREEN LIMITED PARTNERSHIP, MEMPHIS, TN:
1,661,097, CANC. MULTIPLE CLASS, INT. CLS. 37 AND 42.
- TRULIA, INC., SAN FRANCISCO, CA:
3,204,655, AM. INT. CL. 42.
- TRULIANCES, LLC, WINSTON-SALEM, NC:
2,576,358, REN. 5-22-12. MULTIPLE CLASS, INT. CLS. 35 AND 36.
- TRULITE GLASS & ALUMINUM SOLUTIONS, LLC, TAMARAC, FL:
3,006,212, CANC. INT. CL. 6.
3,006,213, CANC. INT. CL. 6.
- TRUOX, INC., MCCLELLAN, CA:
3,006,406, CANC. INT. CL. 1.
3,006,407, CANC. INT. CL. 1.
- TRUSOUTH OIL, LLC, SHREVEPORT, LA:
4,165,428, INT. CL. 1.
- TRUSTEE OF THE LOUIS D. AND KATHERINE E. L'AMOUR 1983 TRUST, A CALIFORNIA TRUST, THE TRUSTEE COMPRISING KATHERINE E. L'AMOUR, A US CITIZEN, THE, LOS ANGELES, CA:
2,598,695, REN. 5-22-12. INT. CL. 41.
- TRUSTEES OF BOSTON UNIVERSITY, BOSTON, MA:
2,651,253, REN. 5-18-12. INT. CL. 36.
- TRUSTEES OF COLUMBIA UNIVERSITY IN THE CITY OF NEW YORK, THE, NEW YORK, NY:
2,568,882, REN. 5-21-12. INT. CL. 42.
- TRUSTEES, THE AMERICAN FUNDS TAX-EXEMPT SERIES I, WASHINGTON, DC:
4,163,391, PUB. 4-10-2012. INT. CL. 36.
4,163,392, PUB. 4-10-2012. INT. CL. 36.
- TRUSTY VET LICENSING, LLC, HUNTSVILLE, AL:
3,873,893, CANC. INT. CL. 43.
- TSB PLUS DEAL CORP, MIAMI, FL:
4,164,270, PUB. 4-10-2012. MULTIPLE CLASS, INT. CLS. 9 AND 35.
- TSI ACCESSORY GROUP, INC., ST. LOUIS, MO:
1,686,322, REN. 5-18-12. INT. CL. 14.
- TSUBAKIMOTO CHAIN CO., OSAKA, JAPAN:
4,164,969, INT. CL. 7.
- TTX COMPANY, CHICAGO, IL, TRAILER TRAIN COMPANY, CHICAGO, IL:
1,231,378, REN. 5-24-12. INT. CL. 39.
- TUBE PLASTICS LIMITED, UNITED KINGDOM:
4,162,954, PUB. 4-10-2012. INT. CL. 28.
- TUCKER DEAN D, SUMNER, GA:
4,165,061, INT. CL. 31.
- TUF-TITE, INC., LAKE ZURICH, IL:
4,163,834, PUB. 4-10-2012. MULTIPLE CLASS, INT. CLS. 11 AND 19.
4,163,846, PUB. 4-10-2012. MULTIPLE CLASS, INT. CLS. 11 AND 19.
- TUMBLEWOOD TEAS, LLC, BIG TIMBER, MT:
4,164,074, PUB. 4-10-2012. INT. CL. 30.
- TURN KEY WINE BRANDS LLC, SANTA BARBARA, CA:
4,165,358, INT. CL. 33.
- TURNER ENTERTAINMENT CO., BURBANK, CA:
2,569,551, REN. 5-21-12. INT. CL. 41.
- TURTLE POND PUBLICATIONS LLC, NEW YORK, NY:
4,164,888, INT. CL. 41.
- TURTLESAFE LLC, BRUNSWICK, GA:
4,163,457, PUB. 4-10-2012. INT. CL. 11.
- TUSKY, BARBARA, OCHTRUP, FED REP GERMANY:
4,164,920, MULTIPLE CLASS, INT. CLS. 20, 21, 29 AND 30.
- TVU NETWORKS CORPORATION, MOUNTAIN VIEW, CA:
4,163,402, PUB. 4-10-2012. INT. CL. 9.
- TWENTIETH CENTURY FOX FILM CORPORATION, LOS ANGELES, CA:
4,165,468, INT. CL. 41.
- TWO RIVER COMMUNITY BANK, MIDDLETOWN, NJ:
4,162,757, PUB. 7-6-2010. INT. CL. 36.
4,162,778, PUB. 7-27-2010. INT. CL. 36.
- TYCO VALVES & CONTROLS INC., HOUSTON, TX:
1,692,521, REN. 5-19-12. INT. CL. 9.
- TYCOONAIRES HOLDING SA, LUXEMBOURG:
4,043,785, COR. MULTIPLE CLASS, INT. CLS. 3, 9, 12, 16, 24, 25, 28, 32, 34, 35, 36, 38, 41, 43 AND 45.
- TYPESAFE, INC., MENLO PARK, MA:
4,165,433, INT. CL. 9.
- TYSON FOODS, INC., SPRINGDALE, AR:
1,277,231, CANC. INT. CL. 29.
- TYSONS FRIENDS KABOB LLC, VIENNA, VA:
4,165,267, INT. CL. 43.
- U GYM, LLC, LAFAYETTE, CA:
4,164,152, PUB. 4-10-2012. INT. CL. 41.
- U.S. BOLT MANUFACTURING, INC., HOUSTON, TX:
4,163,526, PUB. 4-10-2012. MULTIPLE CLASS, INT. CLS. 6 AND 42.

- U.S. COFFEE INC., HICKSVILLE, NY:
1,224,109. REN. 5-21-12. INT. CL. 42.
- U.S. DEPARTMENT OF HOMELAND SECURITY, WASHINGTON, DC:
4,164,708. PUB. 4-10-2012. MULTIPLE CLASS, INT. CLS. 35 AND 45.
- U.S. MEDICAL MANAGEMENT LLC, TROY, MI:
4,165,651. INT. CL. 35.
- U.S. NATURAL RESOURCES, INC., SAN ANTONIO, TX:
2,650,681. REN. 5-18-12. INT. CL. 11.
- U-HAUL INTERNATIONAL INC., PHOENIX, AZ:
2,583,267. REN. 5-18-12. MULTIPLE CLASS, INT. CLS. 35 AND 37.
- UAP LIMITED, BURY, UNITED KINGDOM:
4,163,188. PUB. 4-10-2012. INT. CL. 6.
- UBS AG, CH-8098 ZURICH, SWITZERLAND:
2,975,027. CANC. MULTIPLE CLASS, INT. CLS. 9, 35 AND 42.
- UCB PHARMA, INC., ATLANTA, GA:
856,902. CANC. U.S. CL. 18.
- UCTV, LLC, WASHINGTON, DC:
3,404,739. CANC. INT. CL. 41.
- UFP TECHNOLOGIES, INC., GEORGETOWN, MA:
4,165,680. INT. CL. 21.
- UIC, UPTON, WY:
3,845,320. COR. MULTIPLE CLASS, INT. CLS. 3 AND 5.
- UIP GENERAL CONTRACTING, INC., WASHINGTON, DC:
4,163,124. PUB. 4-10-2012. INT. CL. 37.
- ULTRA NUTRITIONAL INT'L INC., CHARLOTTESVILLE, VA:
1,750,501. CANC. INT. CL. 41.
- ULTRA PRO INTERNATIONAL, LLC, CITY OF COMMERCE, CA:
1,687,833. REN. 5-21-12. INT. CL. 16.
- UMAMI BURGER LICENSING USA, LLC, LOS ANGELES, CA:
4,165,863. INT. CL. 43.
- UNDERSEA SENSOR SYSTEMS, INC., COLUMBIA CITY, IN:
2,713,905. REN. 5-19-12. INT. CL. 9.
- UNDERWARES LLC, HIGHLAND PARK, IL:
4,165,647. INT. CL. 25.
- UNFINISHED MISSION, LLC, THE, LAKEWOOD, WA:
4,163,342. PUB. 4-10-2012. INT. CL. 35.
- UNICHEMA CHEMIE BV, GOUDA, NETHERLANDS, TI-OXIDE CHEMICALS LIMITED, LONDON W14 OQL, ENGLAND:
1,687,442. REN. 5-23-12. INT. CL. 1.
- UNICHEMA CHEMIE BV, GOUDA, 2802 BE, NETHERLANDS:
1,709,670. REN. 5-21-12. INT. CL. 4.
- UNIFI, INC., GREENSBORO, NC:
2,595,801. REN. 5-22-12. INT. CL. 23.
- UNILEVER N.V., AL ROTTERDAM, NETHERLANDS:
2,506,481. REN. 5-21-12. INT. CL. 30.
- UNION CARBIDE CORPORATION, MIDLAND, MI:
1,706,109. REN. 5-21-12. INT. CL. 1.
1,710,959. REN. 5-22-12. INT. CL. 1.
- UNION FORGE HERITAGE ASSOCIATION, HIGH BRIDGE, NJ:
4,164,543. PUB. 4-10-2012. INT. CL. 41.
- UNION SUPPLY COMPANY, RANCHO DOMINGUEZ, CA:
4,165,869. INT. CL. 30.
- UNISHIPERS GLOBAL LOGISTICS, LLC, SALT LAKE CITY, UT:
4,165,980. INT. CL. 39.
- UNITARIAN UNIVERSALIST ASSOCIATION, BOSTON, MA:
4,162,722. PUB. 4-10-2012. MULTIPLE CLASS, INT. CLS. 16 AND 35.
- UNITED FEATURE SYNDICATE, INC., NEW YORK, NY:
1,174,188. REN. 5-23-12. INT. CL. 16.
- UNITED FEATURE SYNDICATE, INC., CINCINNATI, OH:
1,213,953. REN. 5-18-12. INT. CL. 16.
- UNITED GENERAL SUPPLY CO., INC., HOUSTON, TX:
4,165,379. INT. CL. 7.
- UNITED MEDICAL RESOURCES, INC., CINCINNATI, OH:
3,006,411. CANC. INT. CL. 36.
- UNITED NEGRO COLLEGE FUND, INC., FAIRFAX, VA:
4,163,579. PUB. 4-10-2012. MULTIPLE CLASS, INT. CLS. 35 AND 36.
- UNITED SERVICES AUTOMOBILE ASSOCIATION, SAN ANTONIO, TX:
2,570,131. REN. 5-19-12. MULTIPLE CLASS, INT. CLS. 9 AND 16.
- UNITED SHIPPING SOLUTIONS, MIDVALE, UT:
4,162,733. PUB. 7-22-2008. INT. CL. 35.
- UNITED STATES ANTI-DOPING AGENCY, THE, COLORADO SPRINGS, CO:
2,638,944. REN. 5-23-12. INT. CL. 41.
- UNITED STATES CELLULAR CORPORATION, CHICAGO, IL:
2,596,531. REN. 5-18-12. INT. CL. 9.
2,640,129. REN. 5-18-12. INT. CL. 9.
2,650,943. REN. 5-18-12. INT. CL. 38.
- UNITED STATES FOOTBALL LEAGUE, LLC, SAN DIEGO, CA:
4,165,542. INT. CL. 25.
- UNITED STATES GYPSUM COMPANY, CHICAGO, IL:
2,498,435. CANC. INT. CL. 19.
4,165,751. INT. CL. 19.
- UNITED STATES NUTRITION, INC., RONKONKOMA, NY:
2,589,431. REN. 5-19-12. INT. CL. 5.
- UNITED STATES OF AMERICA AS REPRESENTED BY THE SECRETARY OF THE NAVY, THE, WASHINGTON, DC:
2,565,057. REN. 5-18-12. MULTIPLE CLASS, INT. CLS. 14, 16, 21, 25, 26 AND 41.
- UNITED STATES POSTAL SERVICE, WASHINGTON, DC:
4,165,801. MULTIPLE CLASS, INT. CLS. 35 AND 39.
- UNITED STATES POWER SQUADRONS, RALEIGH, NC:
2,497,459. CANC. INT. CL. 41.
- UNITED STATES RUST CONTROL CORPORATION, MIAMI, FL:
860,418. CANC. U.S. CL. 16.
860,419. CANC. U.S. CL. 16.
- UNITED STATES SHOE CORPORATION, THE, CINCINNATI, OH:
859,350. CANC. U.S. CL. 39.
- UNITED TECHNOLOGIES CORPORATION, PRATT & WHITNEY, EAST HARTFORD, CT:
2,651,995. REN. 5-18-12. INT. CL. 35.
- UNITED WAY WORLDWIDE, ALEXANDRIA, VA:
2,498,731. CANC. INT. CL. 36.
- UNITEDHEALTH GROUP INCORPORATED, MINNETONKA, MN:
3,040,493. CANC. INT. CL. 44.
- UNITRON ENTERPRISES ZHUHAI CO., LTD., CHINA:
4,162,876. PUB. 4-10-2012. MULTIPLE CLASS, INT. CLS. 12, 20, 25 AND 28.
- UNIVERSAL CITY STUDIOS LLC, UNIVERSAL CITY, CA:
2,610,580. REN. 5-21-12. INT. CL. 21.
- UNIVERSAL ENTERTAINMENT CORPORATION, KOTOKU, TOKYO, JAPAN:
4,165,616. INT. CL. 9.
- UNIVERSAL INTERNATIONAL MUSIC B.V., BAARN, NETHERLANDS:
4,165,624. INT. CL. 38.
- UNIVERSAL PROTEIN SUPPLEMENTS CORPORATION, NEW BRUNSWICK, NJ, DBA UNIVERSAL NUTRITION:
2,641,156. REN. 5-19-12. INT. CL. 5.
- UNIVERSAL SOFTWARE CORP., BROOKLYN, NY:
4,165,051. INT. CL. 42.
- UNIVERSAL TV LLC, UNIVERSAL CITY, CA:
2,588,627. REN. 5-18-12. INT. CL. 41.
- UNIVERSITY CENTER FOR ATMOSPHERIC RESEARCH, BOULDER, CO:
2,643,011. REN. 5-23-12. INT. CL. 42.
- UNIVERSITY OF BERNE, INSTITUTE OF LEGAL MEDICINE (ILM), CH -3012 BERN, SWITZERLAND:
3,005,597. CANC. MULTIPLE CLASS, INT. CLS. 5, 9, 10, 37, 41 AND 42.
- UNIVERSITY OF CINCINNATI, THE, CINCINNATI, OH:
1,692,019. REN. 5-24-12. INT. CL. 41.

- UNIVERSITY OF GEORGIA RESEARCH FOUNDATION, INC., ATHENS, GA:
4,165,708, INT. CL. 9.
- UNIVERSITY OF IOWA RESEARCH FOUNDATION, IOWA CITY, IA:
2,636,289. REN. 5-22-12. INT. CL. 1.
- UNIWELED PRODUCTS, INC., FORT LAUDERDALE, FL:
2,642,472. REN. 5-21-12. INT. CL. 9.
- UPHOLSTERY STUDIO, INC., THE, BROOKLYN PARK, MN:
2,498,234, CANC. INT. CL. 16.
- UPJOHN COMPANY, THE, KALAMAZOO, MI:
861,294, CANC. U.S. CL. 18.
- UPSHER-SMITH LABORATORIES, INC., MAPLE GROVE, MN:
2,589,801. REN. 5-24-12. INT. CL. 5.
- URBAN-MEDIA-COMMUNICATION VERLAGS GMBH, FED REP GERMANY:
3,051,086.
- URBANBOUND, LLC, CHICAGO, IL:
4,163,503, PUB. 4-10-2012. INT. CL. 35.
4,163,504, PUB. 4-10-2012. INT. CL. 35.
- URGENT GEAR, INC., LOS ANGELES, CA:
2,647,195. REN. 5-24-12. INT. CL. 25.
- USA SCIENTIFIC, INC., OCALA, FL:
4,163,840, PUB. 4-10-2012. MULTIPLE CLASS, INT. CLS. 37 AND 42.
- USA VOLLEYBALL, COLORADO SPRINGS, CO:
4,165,767, INT. CL. 35.
- USA*USA*USA, LLC, KANSAS CITY, KS, USA*USA*USA, LLC, KANSAS CITY, KS:
2,512,923. REN. 5-22-12. INT. CL. 38.
- USENBOR, STEPHEN, BROOKLYN, NY:
4,164,156, PUB. 4-10-2012. INT. CL. 25.
- UTC FIRE & SECURITY AMERICAS CORPORATION, INC., BRADENTON, FL, INTERLOGIX, INC., SALEM, OR:
2,564,414. REN. 5-23-12. INT. CL. 6.
- UTILIMASTER CORPORATION, WAKARUSA, IN, HOLIDAY RAMBLER CORPORATION, WAKARUSA, IN:
1,726,664. REN. 5-18-12. INT. CL. 12.
- UVG NEDERLAND BV, OSS, NETHERLANDS:
862,843, CANC. U.S. CL. 46.
- UWHARRIE APPAREL COMPANY, LLC, CONCORD, NC:
4,164,288, PUB. 4-10-2012. INT. CL. 25.
- UYEMURA INTERNATIONAL CORPORATION, ONTARIO, CA:
4,163,987, PUB. 4-10-2012. INT. CL. 1.
- V & S SANDWICH SHOPS, INC., READING, PA:
2,555,844. REN. 5-19-12. INT. CL. 42.
- V&S VIN & SPRIT AKTIEBOLAG, STOCKHOLM, SWEDEN:
3,005,325, CANC. INT. CL. 33.
- V-THONG LLC, DORAL, FL:
4,165,381, INT. CL. 25.
- VA BIEN INTERNATIONAL, INC., AGUAS BUENAS, PUERTO RICO:
4,165,406, INT. CL. 14.
- VACATION BLVD, LLC, OAKDALE, NY:
4,163,496, PUB. 4-10-2012. MULTIPLE CLASS, INT. CLS. 35 AND 41.
- VACPARTSWAREHOUSE.COM LLC, ROCKWALL, TX:
4,166,076, INT. CL. 35.
- VALASSIS COMMUNICATIONS, INC., LIVONIA, MI:
4,163,636, PUB. 4-10-2012. INT. CL. 16.
4,163,637, PUB. 4-10-2012. INT. CL. 16.
4,163,638, PUB. 4-10-2012. INT. CL. 19.
4,163,659, PUB. 4-10-2012. INT. CL. 19.
- VALEO COMMERCIAL REAL ESTATE, LLC, DALLAS, TX:
4,165,735, INT. CL. 36.
- VALIDUS INTERNATIONAL COMPANY, L.L.C., DALLAS, TX:
2,607,877. REN. 5-18-12. INT. CL. 7.
- VALLE, DEBRA, LOS ALAMITOS, CA:
2,570,053. REN. 5-19-12. INT. CL. 35.
- VALLIANOS, LAURA, SAN LEANDRO, CA:
2,498,134, CANC. INT. CL. 3.
- VAMPIAR EMPYRE, FAIRBORN, OH:
4,165,880, INT. CL. 41.
- VAN METER AG, UNTERAEGERI, SWITZERLAND:
2,573,849. REN. 5-22-12. INT. CL. 25.
- VAN'S INTERNATIONAL FOODS, INC., PHOENIX, AZ:
4,165,009, INT. CL. 30.
- VANITY FAIR INC, BOWLING GREEN, KY, MUNSINGWEAR, INC., MINNEAPOLIS, MN, DBA HOLLYWOOD VASSARETTE:
746,675. REN. 5-18-12. U.S. CL. 39 (INT. CLS. 10, 25 AND 26).
- VANITY FAIR, INC., BOWLING GREEN, KY:
740,677. REN. 5-18-12. U.S. CL. 25 (INT. CL. 25).
- VANS, INC., CYPRESS, CA:
4,163,146, PUB. 4-10-2012. INT. CL. 25.
- VANTAGE PRESS, INC., NEW YORK, NY:
4,164,571, PUB. 4-10-2012. INT. CL. 41.
4,164,572, PUB. 4-10-2012. INT. CL. 41.
- VAPOR 4 LIFE, INC., NORTHBROOK, IL:
4,163,538, PUB. 11-8-2011. INT. CL. 34.
- VARKEY, JOSE PUTHIAKUNNEL, HOLLYWOOD, CA, DBA FOOD(S) UNLIMITED:
4,163,776, PUB. 4-10-2012. INT. CL. 35.
- VAST RESOURCES, INC., CHATSWORTH, CA, DBA TOPCO SALES:
2,571,534. REN. 5-21-12. INT. CL. 10.
2,580,611. REN. 5-19-12. INT. CL. 3.
- VAUGHAN & BUSHNELL MFG. CO., CHICAGO, IL:
856,467, CANC. U.S. CL. 23.
- VECTOR MARKET SERVICES PTY LIMITED, CORNUBIA, QUEENSLAND 4130, AUSTRALIA:
1,686,346. REN. 5-19-12. MULTIPLE CLASS, INT. CLS. 16 AND 17.
- VEDALAB, F-61000 ALENÇON, FRANCE:
3,002,035.
- VEHICLE SERVICE GROUP, LLC, MADISON, IN:
2,570,302. REN. 5-22-12. INT. CL. 7.
- VELOCITYSHOP INC, RIVIERA BEACH, FL:
4,164,581, PUB. 4-10-2012. INT. CL. 12.
- VELTI PLC, DUBLIN, 2, IRELAND:
4,164,026, PUB. 4-10-2012. MULTIPLE CLASS, INT. CLS. 35 AND 42.
- VENICE BRUSH & ROLLERS, INC., HEWLETT, NY:
2,497,555, CANC. INT. CL. 8.
- VENTANA SYSTEMS, INC., HARVARD, MA:
1,725,205. REN. 5-21-12. INT. CL. 9.
- VENTUREBOX, INC., TRABUCO CANYON, CA:
4,163,986, PUB. 4-10-2012. INT. CL. 35.
- VERANDAGLOBAL.COM, INC, CLEARWATER, FL, DBA FIRST PLACE INTERNET, INC.:
2,694,707. REN. 5-23-12. INT. CL. 42.
- VERGENCE ENTERTAINMENT, LLC, GLENDALE, CA:
4,164,805, INT. CL. 41.
- VERIGREEN ENERGY & LIGHT SOLUTIONS LLC, ASHBURN, VA:
4,163,915, PUB. 4-10-2012. INT. CL. 35.
- VERSATILE SYSTEMS, INC., MECHANICSBURG, PA:
4,163,312, PUB. 4-10-2012. INT. CL. 9.
- VERSO PAPER LLC, MEMPHIS, TN:
1,542,526 NEW CERT. 6-26-2012. INT. CL. 16.
2,698,738 NEW CERT. 6-26-2012. INT. CL. 16.
- VERST GROUP LOGISTICS, INC., CINCINNATI, OH:
4,163,243, PUB. 4-10-2012. MULTIPLE CLASS, INT. CLS. 20, 35 AND 39.
- VERT, JAMES D., SEATTLE, WA AND STARK, JAMES W., SEATTLE, WA AND FINAMORE, NICOLE S., SEATTLE, WA:
4,165,469, INT. CL. 33.
- VERTAFORE, INC., BOTHELL, WA:
4,165,011, INT. CL. 9.
- VERTEX PHARMACEUTICALS INCORPORATED, CAMBRIDGE, MA:
2,704,913. REN. 5-18-12. INT. CL. 5.
4,164,630, PUB. 4-10-2012. INT. CL. 5.
- VERTICAL SEARCH WORKS, INC., VIENNA, VA:
4,164,552, PUB. 4-10-2012. INT. CL. 35.
- VERYFINE PRODUCTS, INC., CINCINNATI, OH:
4,164,518, PUB. 4-10-2012. INT. CL. 32.

VETEMENT SPORT NIKALDI INC., VILLE SAINT-LAURENT, QUEBEC, CANADA:
3,005,304, CANC. INT. CL. 25.

VETERANS OF FOREIGN WARS OF THE UNITED STATES, KANSAS CITY, MO:
4,163,660, PUB. 4-10-2012. INT. CL. 16.

VFINANCE, INC., BOCA RATON, FL:
4,164,430, PUB. 4-10-2012. INT. CL. 36.

VIÑEDOS DE PAGANOS, S.L., SPAIN:
4,163,034, PUB. 4-10-2012. INT. CL. 33.

VIACOM INTERNATIONAL INC., NEW YORK, NY:
2,507,291. REN. 5-18-12. INT. CL. 30.
3,006,396, CANC. INT. CL. 41.
3,006,503, CANC. INT. CL. 41.

VICKERS, CAMILLE S, FLEISCHMANN'S, NY:
2,498,930, CANC. INT. CL. 16.

VICTORIA'S SECRET STORES BRAND MANAGEMENT, INC., REYNOLDSBURG, OH:
4,164,695, PUB. 4-10-2012. INT. CL. 3.

VICTORY BREWING COMPANY, DOWNINGTOWN, PA:
2,571,439. REN. 5-21-12. INT. CL. 32.

VICTORY MEDIA, INC., CORAOPOLIS, PA:
4,165,520, INT. CL. 25.
4,165,521, INT. CL. 25.

VICTORY OPTICAL MANUFACTURING COMPANY, NEWARK, NJ:
502,481, CANC. U.S. CL. 26.

VICTUS, INC., MIAMI, FL:
2,570,124. REN. 5-21-12. INT. CL. 5.

VILLA HOLDING, LLC, MORRISTOWN, NJ:
4,165,423, INT. CL. 43.

VILLAROMAN, EMMANUEL E., HAWTHORNE, CA, DBA CERTIFIED COMPUTER SOLUTIONS A.K.A. COOL CAR-AT SOFTWARE:
4,164,762, PUB. 4-10-2012. INT. CL. 9.

VILLAVICENCIO, LEONARD W., SAN DIEGO, CA:
2,497,747, CANC. INT. CL. 25.

VINOMATCH, INC., SAN DIEGO, CA:
4,165,426, INT. CL. 43.

VIPS, INC., TOWSON, MD:
2,560,301. REN. 5-19-12. INT. CL. 9.

VIRBAC S.A., 06516 CARROS, FRANCE:
4,163,263, PUB. 3-13-2012. INT. CL. 10.

VIRENT ENERGY SYSTEMS, INC., MADISON, WI:
4,036,047, COR. MULTIPLE CLASS, INT. CLS. 1 AND 4.

VIRGINIA COOK REALTORS, DALLAS, TX:
4,163,642, PUB. 4-10-2012. INT. CL. 36.

VIRGINIA OPERA ASSOCIATION, INC., NORFOLK, VA:
4,164,573, PUB. 4-10-2012. INT. CL. 41.

VIRTOONS AG, CH-8006, ZURICH, SWITZERLAND:
3,005,336, CANC. INT. CL. 9.

VISIONSYNC, INC, PALO ALTO, CA:
4,163,173, PUB. 4-10-2012. INT. CL. 36.

VISIWARE, SEVRES CEDEX, FRANCE:
2,573,295. REN. 5-18-12. MULTIPLE CLASS, INT. CLS. 9 AND 41.

VISUAL APEX, BAINBRIDGE ISLAND, WA:
2,697,897. REN. 5-23-12. INT. CL. 35.

VIT, MOUANS SARTOUX CEDEX, FRANCE:
2,498,738, CANC. INT. CL. 9.

VITASCOPE MEDIA, LLC, ENGLEWOOD, NJ:
4,164,972, INT. CL. 9.

VITRAMON, INCORPORATED, MONROE, CT TO ANDERSON OIL AND CHEMICAL COMPANY, INC., PORTLAND, CT:
854,084, CANC. U.S. CL. 23.

VIVVVA.COM INC., PALO ALTO, CA:
4,163,060, PUB. 4-10-2012. INT. CL. 42.

VIZARI SPORT U.S.A. INC., PARAMOUNT, CA:
2,569,723. REN. 5-18-12. MULTIPLE CLASS, INT. CLS. 18, 25 AND 28.
2,606,982. REN. 5-18-12. MULTIPLE CLASS, INT. CLS. 18, 25 AND 28.

VKGS LLC, OMAHA, NE, DBA VIDEO KING:
4,164,985, INT. CL. 9.

VLG HOLDINGS, LLC, KALAMAZOO, MI:
4,163,274, PUB. 4-10-2012. INT. CL. 45.

VOCALTEC COMMUNICATIONS LTD., HERZELIYA 46140, ISRAEL:
2,497,604, CANC. MULTIPLE CLASS, INT. CLS. 16, 36 AND 38.

VODAX, A.S., SLOVAKIA:
4,162,949, PUB. 4-10-2012. MULTIPLE CLASS, INT. CLS. 5 AND 32.

VOIGTLÄNDER GMBH, FED REP GERMANY:
4,162,817, PUB. 4-10-2012. INT. CL. 9.

VOIP DIALING, INC., LAS VEGAS, NV:
4,166,037, INT. CL. 9.
4,166,077, INT. CL. 38.

VOLCOM, INC., COSTA MESA, CA:
1,725,875. REN. 5-18-12. INT. CL. 25.

VOLKSWAGEN AKTIENGESELLSCHAFT, D-38436 WOLFSBURG, FED REP GERMANY:
3,005,290, CANC. MULTIPLE CLASS, INT. CLS. 16 AND 18.

VOLT, LLC, TAMPA, FL:
4,163,241, PUB. 1-24-2012. INT. CL. 20.

VOLUNTARY PURCHASING GROUPS, INC., BONHAM, TX:
1,688,603. REN. 5-19-12. INT. CL. 1.
1,688,672. REN. 5-23-12. INT. CL. 5.

VOLUNTEENS.COM, L.L.C., BOCA RATON, FL:
4,164,036, PUB. 4-10-2012. INT. CL. 35.

VOTERZOOMUSA, INC., SPRING, TX:
4,164,887, MULTIPLE CLASS, INT. CLS. 16, 25 AND 35.

W. C. BRADLEY COMPANY, COLUMBUS, GA:
2,560,346. REN. 5-19-12. INT. CL. 11.

W. R. SWEENEY MFR., INC., LITITZ, PA:
731,965. REN. 5-23-12. U.S. CL. 6 (INT. CL. 5).

W.C. BRADLEY/ZEBCO HOLDINGS, INC., TULSA, OK:
1,682,125. REN. 5-23-12. INT. CL. 28.

W.L. PETREY WHOLESALE, INC., MONTGOMERY, AL:
4,165,808, INT. CL. 35.

W.M. BARR & COMPANY, INC., MEMPHIS, TN:
3,006,516, CANC. INT. CL. 3.

W.R. COBB COMPANY, EAST PROVIDENCE, RI:
4,164,830, INT. CL. 14.

W.W. GRAINGER, INC., LAKE FOREST, IL:
4,165,444, MULTIPLE CLASS, INT. CLS. 16 AND 35.
4,165,445, MULTIPLE CLASS, INT. CLS. 16 AND 35.

W-W-R.COM, INC., PORT ST. LUCIE, FL:
2,576,720. REN. 5-19-12. INT. CL. 35.
2,589,649. REN. 5-19-12. INT. CL. 35.

WABTEC HOLDING CORP., WILMERDING, PA:
4,163,247, PUB. 4-10-2012. MULTIPLE CLASS, INT. CLS. 7 AND 37.

WADLEY HOLDINGS, LLC, ATLANTA, GA:
2,498,054, CANC. INT. CL. 20.

WAGEWORKS, INC., SAN MATEO, CA:
2,695,904. REN. 5-21-12. INT. CL. 9.

WAGGONER, LINDA R., PLANO, TX:
4,165,439, INT. CL. 18.

WAHL CLIPPER CORPORATION, STERLING, IL:
4,163,491, PUB. 4-10-2012. INT. CL. 8.

WAHLBURGERS I, LLC, HINGHAM, MA:
4,164,723, PUB. 4-10-2012. INT. CL. 30.

WALDOCK, WILLIAM L, SANDUSKY, OH:
3,006,359, CANC. INT. CL. 12.

WALGREEN CO., DEERFIELD, IL:
2,581,946. REN. 5-18-12. INT. CL. 35.
4,165,354, MULTIPLE CLASS, INT. CLS. 29, 30 AND 31.
4,165,355, MULTIPLE CLASS, INT. CLS. 29, 30 AND 31.
4,165,889, MULTIPLE CLASS, INT. CLS. 16, 18, 20, 28 AND 31.

WALKER, DANNY, GEORGETOWN, TX:
4,165,663, INT. CL. 44.

WALKER, RICE & WISDOM, P.C., HOUSTON, TX:
4,164,438, PUB. 4-10-2012. INT. CL. 45.

WALLDORFGROUP LLC, HOUSTON, TX:
4,164,475, PUB. 4-10-2012. INT. CL. 42.

WALLIS OIL COMPANY, INC., CUBA, MO:
4,165,825, MULTIPLE CLASS, INT. CLS. 35 AND 43.

WALNES, KIM, MILFORD SQUARE, PA:
2,591,411. REN. 5-18-12. INT. CL. 41.

- WALTERS, ROBERT LEE, OVIEDO, FL:
2,498,846, CANC. INT. CL. 25.
- WALZ, TREVOR, NORRISTOWN, PA AND BRADY, SCOTT,
NORRISTOWN, PA:
4,165,106, INT. CL. 25.
- WANDL, INC., PISCATAWAY, NJ:
4,164,150, PUB. 4-10-2012. INT. CL. 9.
- WANG, SHEN, CHANGXING, CHINA:
4,164,886, MULTIPLE CLASS, INT. CLS. 18 AND 25.
- WAREHOUSE FASHIONS LIMITED, UNITED KINGDOM:
4,162,946, PUB. 4-10-2012. MULTIPLE CLASS, INT. CLS.
9, 14, 18, 25 AND 35.
- WAREHOUSE HOME FURNISHING DISTRIBUTORS, INC.,
DUBLIN, GA, DBA FARMERS FURNITURE:
2,569,395. REN. 5-18-12. INT. CL. 35.
- WAREMA RENKHOFF SE, FED REP GERMANY:
3,046,372.
- WARIMEX WAREN-IMPORT-EXPORT-HANDELS GMBH,
FED REP GERMANY:
4,162,890, PUB. 1-3-2012. INT. CL. 21.
- WARNER & WORTH, INC., COLUMBUS, GA, DBA THE
CANNON BREWPUB:
4,164,650, PUB. 4-10-2012. INT. CL. 32.
- WARNER BROS. ENTERTAINMENT INC., BURBANK, CA:
4,165,038, INT. CL. 9.
4,165,195, INT. CL. 41.
- WARNER, JASON N., BROOKLYN, NY:
4,165,614, INT. CL. 25.
- WARREN OIL COMPANY, INC., DUNN, NC:
4,164,879, INT. CL. 1.
- WARRIORS GROUP, LLC, FREDERICKSBURG, VA:
4,165,378, MULTIPLE CLASS, INT. CLS. 16 AND 35.
- WARWICK LADDERS INC., WARWICK, QUEBEC, CANA-
DA:
941,931. REN. 5-19-12. U.S. CL. 23 (INT. CL. 7).
- WASCO PRODUCTS, INC., SANFORD, ME:
3,006,387, CANC. INT. CL. 19.
- WASHINGTON GAS ENERGY SERVICES, INC., HERN-
DON, VA:
4,164,250, PUB. 4-10-2012. INT. CL. 35.
4,164,251, PUB. 4-10-2012. INT. CL. 35.
- WASHINGTON TRUST COMPANY, WESTERLY, RI:
4,162,794, PUB. 7-17-2007. INT. CL. 36.
- WASHINGTON, KENDALL J., NEW ORLEANS, LA:
4,163,520, PUB. 4-10-2012. INT. CL. 25.
- WASTE MANAGEMENT, INC., HOUSTON, TX:
4,165,745, MULTIPLE CLASS, INT. CLS. 9, 16 AND 18.
- WASTE SOLUTIONS, INC., MARSHFIELD, MA:
2,606,392. REN. 5-18-12. INT. CL. 37.
- WATERBABIES BIKINI, DACULA, GA:
4,162,750, PUB. 4-10-2012. INT. CL. 25.
- WATERMAN, PAMELA J., MESA, AZ:
4,163,679, PUB. 4-10-2012. INT. CL. 16.
- WATERSTONE VENTURES, LLP, BURTON, OH:
4,163,404, PUB. 4-10-2012. INT. CL. 1.
- WATSON CAMERON LLC, CLEVELAND, OH, DBA WAT-
CAM:
4,164,493, PUB. 4-10-2012. INT. CL. 35.
- WATSON, JOHN R SR., WINTER GARDEN, FL:
4,162,718, PUB. 4-10-2012. INT. CL. 34.
- WATTS, KENNETH E., DETROIT, MI:
4,162,696, PUB. 4-10-2012. INT. CL. 28.
4,162,697, PUB. 4-10-2012. INT. CL. 28.
- WAVE 5, INC., NASHVILLE, TN:
3,006,096, CANC. INT. CL. 41.
- WAVEFAX TECHNOLOGIES CO.,LTD., GUANGZHOU,-
GUANGDONG, CHINA:
4,164,363, PUB. 4-10-2012. INT. CL. 42.
- WAXMAN CONSUMER PRODUCTS GROUP, INC., BED-
FORD HEIGHTS, OH:
2,567,408. REN. 5-18-12. INT. CL. 11.
- WAYFAIR LLC, BOSTON, MA:
4,164,924, MULTIPLE CLASS, INT. CLS. 11, 14, 16, 20, 24,
27 AND 28.
- WAYNDAN ENTERPRISES, SAN ANTONIO, TX:
4,163,113, PUB. 1-3-2012. INT. CL. 41.
- WAYNE YEHIA LIMITED, MISSISSAUGA, CANADA AND
BREADKO NATIONAL BAKING LIMITED, MISSISSAU-
GA, CANADA:
4,165,005, INT. CL. 30.
- WBM INTERNATIONAL, LLC, NEWARK, NJ:
4,164,321, PUB. 4-10-2012. INT. CL. 11.
- WD-40 COMPANY, SAN DIEGO, CA:
4,165,582, MULTIPLE CLASS, INT. CLS. 2, 3 AND 4.
- WE ARE SCIENTISTS INCORPORATED, NEW YORK, NY:
2,659,593. REN. 5-18-12. INT. CL. 41.
- WE TALK PROMOTIONS, INC., ALPHARETTA, GA:
3,006,264, CANC. INT. CL. 24.
- WE: WOMEN'S ENTERTAINMENT LLC, NEW YORK, NY:
4,165,299, INT. CL. 41.
- WEAN GREEN INC, CALGARY, ALBERTA, CANADA:
4,164,798, INT. CL. 21.
- WEAVER, CAROLYN C., SPRING, TX, DBA FUNCPE:
4,163,375, PUB. 4-10-2012. INT. CL. 41.
- WEBMD LLC, NEW YORK, NY:
4,165,255, MULTIPLE CLASS, INT. CLS. 41 AND 42.
- WEDGEWORKS, LLC, MIAMI, FL:
4,163,403, PUB. 4-10-2012. INT. CL. 9.
- WEDI GMBH, FED REP GERMANY:
3,142,373.
- WEDNET LLC, WOODINVILLE, WA:
4,165,978, INT. CL. 41.
- WEEMS, BRUCE, CUMMING, GA:
4,165,754, INT. CL. 25.
- WEGOLOOK, LLC, OKLAHOMA CITY, OK:
4,163,089, PUB. 4-10-2012. INT. CL. 42.
- WEI FAZHI, GUANGDONG, CHINA:
3,622,704, COR. INT. CL. 11.
- WEINSTEIN, LEWIS A., NEEDHAM, MA:
2,537,981. REN. 5-19-12. INT. CL. 35.
- WELCH ALLYN, INC., SKANEATELES FALLS, NY:
1,197,185. REN. 5-18-12. INT. CL. 10.
- WELLMAN THERMAL SYSTEMS CORPORATION, SHEL-
BYVILLE, IN:
1,195,581. REN. 5-18-12. MULTIPLE CLASS, INT. CLS. 9
AND 11.
- WELLMARK INTERNATIONAL, SCHAUMBURG, IL, SAN-
DOZ AG (SANDOZ LTD., SANDOZ S.A.), BASLE, SWIT-
ZERLAND:
1,700,160. REN. 5-18-12. INT. CL. 5.
- WELLMARK, INC., DES MOINES, IA:
4,163,470, PUB. 4-10-2012. INT. CL. 41.
- WELLPET LLC, TEWKSBURY, MA:
2,498,769, CANC. INT. CL. 31.
- WELLS LAMONT INDUSTRY GROUP, INC., NILES, IL,
BETTCHER INDUSTRIES, INC., BIRMINGHAM, OH:
1,696,860. REN. 5-23-12. INT. CL. 9.
- WELLS, GRANVILLE, MEXIA, TX:
4,163,917, PUB. 4-10-2012. INT. CL. 11.
- WELSH DEVELOPMENT AGENCY, CARDIFF CF 10 3FE,
UNITED KINGDOM:
3,005,599, CANC. MULTIPLE CLASS, INT. CLS. 35, 36, 41
AND 42.
- WENDY J. CANNING, SARASOTA, FL:
4,164,428, PUB. 4-10-2012. INT. CL. 41.
- WESLEY CORPORATION, BROWNSTOWN, MI:
4,164,154, PUB. 4-10-2012. INT. CL. 21.
- WESLEY WOODS SENIOR LIVING, INC., ATLANTA, GA:
4,165,540, MULTIPLE CLASS, INT. CLS. 35, 43 AND 44.
- WEST ANGELES CHURCH OF GOD IN CHRIST, INC., LOS
ANGELES, CA:
4,164,064, PUB. 4-10-2012. MULTIPLE CLASS, INT. CLS.
38 AND 45.
- WEST COUNTY DERMATOLOGY, INC., CHESTERFIELD,
MO:
4,163,242, PUB. 4-10-2012. INT. CL. 44.
- WEST SPIRIT GROUP, ZAPOROZHYE, UKRAINE:
4,164,187, PUB. 4-10-2012. INT. CL. 33.
- WESTCHESTER FILMS, INC., NEW YORK, NY:
1,230,491, CANC. INT. CL. 41.
1,230,492, CANC. INT. CL. 41.
- WESTERN HOLDINGS, LLC, CARSON CITY, NV:
4,165,293, INT. CL. 5.

WESTINGHOUSE ELECTRIC CORPORATION, PITTSBURGH, PA:
856,939, CANC. U.S. CL. 21.

WESTINGHOUSE ELECTRIC CORPORATION, NEW YORK, NY:
2,569,791. REN. 5-21-12. INT. CL. 11.

WESTON SOLUTIONS (IPR), INC., WEST CHESTER, PA:
4,163,674, PUB. 4-10-2012. MULTIPLE CLASS, INT. CLS. 35, 37 AND 42.

WET MITT BRANDS, LLC, CLEVELAND, TN:
4,164,559, PUB. 4-10-2012. INT. CL. 21.

WEYERHAEUSER NR COMPANY, FEDERAL WAY, WA:
4,165,301, INT. CL. 19.

WHAMTECH, INC., DALLAS, TX:
2,498,139, CANC. INT. CL. 42.

WHAT SAY GOD, LLC, PERRY HALL, MD:
4,165,702, INT. CL. 25.
4,165,868, INT. CL. 25.

WHEAT, JARED R., NORCROSS, GA:
4,164,544, PUB. 4-10-2012. INT. CL. 5.
4,164,763, PUB. 4-10-2012. INT. CL. 5.
4,164,767, PUB. 4-10-2012. INT. CL. 5.
4,164,773, PUB. 4-10-2012. INT. CL. 5.

WHEEL PROS, LLC, LAKEWOOD, CO:
2,508,336, AM. INT. CL. 12.

WHEELER MANUFACTURING CO., INC., LEMMON, SD:
2,569,631. REN. 5-21-12. INT. CL. 14.

WHERE'S IT @? MEDIA, LLC, ST LOUIS, MO:
4,165,800, INT. CL. 16.

WHIRLPOOL PROPERTIES, INC, ST. JOSEPH, MI:
4,165,873, INT. CL. 11.

WHIRLY WEST, INC., CHICAGO, IL:
2,538,106. REN. 5-21-12. INT. CL. 41.

WHITCLEM ENTERPRISES, INC., PALO ALTO, CA:
4,165,679, INT. CL. 36.

WHITE, BARRY LEE, NASHVILLE, TN:
2,574,538. REN. 5-24-12. INT. CL. 9.

WHITE, NIKIA S, RESEDA, CA:
4,163,190, PUB. 4-10-2012. INT. CL. 25.

WHITMAN CONTROLS CORPORATION, BRISTOL, CT:
4,163,614, PUB. 4-10-2012. INT. CL. 9.
4,163,615, PUB. 4-10-2012. INT. CL. 9.

WHITMIRE MICRO-GEN RESEARCH LABORATORIES, INC., ST. LOUIS, MO:
2,498,920, CANC. INT. CL. 9.

WHIZZER U.S.A., INC., FARMERS BRANCH, TX:
1,696,905. REN. 5-19-12. INT. CL. 12.

WHOLE FOODS MARKET IP, L.P., AUSTIN, TX:
4,165,298, INT. CL. 5.

WHOLESOME GOODNESS LLC, LONG GROVE, IL:
4,164,950, MULTIPLE CLASS, INT. CLS. 29, 30, 31 AND 32.
4,165,084, MULTIPLE CLASS, INT. CLS. 29, 30, 31 AND 32.

WHOZAGOOD, INC., CALGARY, CANADA:
4,165,670, INT. CL. 35.

WHYTE AND MACKAY LIMITED, GLASGOW, UNITED KINGDOM:
4,163,186, PUB. 1-3-2012. INT. CL. 33.

WICKER, IZABEL, AUSTIN, TX:
4,166,010, INT. CL. 33.

WIDE BRAND (HONG KONG) LIMITED, WANCHAI, HONG KONG:
4,165,189, INT. CL. 8.

WIEBE H. VAN DER MEER, NETHERLANDS:
4,163,000, PUB. 4-10-2012. INT. CL. 16.

WILA B.V., NETHERLANDS:
4,162,874, PUB. 4-10-2012. MULTIPLE CLASS, INT. CLS. 7, 37 AND 42.

WILBUR CURTIS COMPANY, MONTEBELLO, CA:
4,164,787, INT. CL. 9.

WILDGAME INNOVATIONS, LLC, BROUSSARD, LA:
4,165,583, INT. CL. 31.

WILFORD STICH, FRANKLIN, TX:
4,165,194, INT. CL. 9.

WILKE, HANS-JÜRGEN, DIPL.-ING., FED REP GERMANY:
3,051,078.

WILLIAM BEAUMONT HOSPITAL, ROYAL OAK, MI:
2,499,089, CANC. INT. CL. 10.

WILLIAM BHASKAR, SCOTTSDALE, AZ:
4,165,253, INT. CL. 30.

WILLIAM MARSH RICE UNIVERSITY, HOUSTON, TX:
2,615,278. REN. 5-18-12. INT. CL. 18.
2,621,177. REN. 5-18-12. INT. CL. 16.
2,621,178. REN. 5-18-12. INT. CL. 28.

WILLIAM SCHWEIBINZ, ALBUQUERQUE, NM:
4,165,826, INT. CL. 41.

WILLIAMS & WILLIAMS, INC., LAKELAND, FL:
4,165,786, INT. CL. 18.

WILLIAMS IMPORT COMPANY, INC., FRESNO, CA AND MAINLINE WORLD FURNITURE, INC., NORTH BRUNSWICK, NJ:
4,164,453, PUB. 4-10-2012. INT. CL. 20.

WILLIAMS-SONOMA, INC., SAN FRANCISCO, CA:
1,661,260. REN. 5-23-12. INT. CL. 42.

WILLIAMS, LONNIE PAUL, JR., COLUMBIA, SC, AKA L.P. WILLIAMS:
4,165,290, INT. CL. 41.

WILLIAMS, MALVANIE, RAHWAY, NJ:
4,165,227, INT. CL. 41.

WILLIAMS, MARQUES E, DALLAS, TX:
4,164,898, MULTIPLE CLASS, INT. CLS. 3 AND 4.

WILLIAMS, RICARDO, CHICAGO, IL:
2,497,498, CANC. INT. CL. 42.

WILLIAMSON-DICKIE MANUFACTURING COMPANY, FORT WORTH, TX:
2,666,109. REN. 5-24-12. MULTIPLE CLASS, INT. CLS. 20 AND 25.

WILLOW GARAGE, INC., MENLO PARK, CA:
4,165,590, INT. CL. 9.

WILL2SWEAT, INC., BALDWIN, NY:
4,163,678, PUB. 4-10-2012. INT. CL. 41.

WILSHIRE ASSOCIATES INCORPORATED, SANTA MONICA, CA, WILSHIRE ASSOCIATES, SANTA MONICA, CA:
1,215,218. REN. 5-22-12. INT. CL. 36.

WILSON & CO., INC., CHICAGO, IL TO FISCHER PACKING COMPANY, LLC, CRESTVIEW HILLS, KY:
858,349, CANC. U.S. CL. 46.

WILSON AUDIO SPECIALTIES, INC., PROVO, UT:
2,584,146. REN. 5-21-12. INT. CL. 9.

WINDMÖLLER & HÖLSCHER KG, FED REP GERMANY:
4,162,994, PUB. 4-10-2012. MULTIPLE CLASS, INT. CLS. 7 AND 9.

WINERY EXCHANGE, INC., NOVATO, CA:
4,165,907, INT. CL. 33.

WINKING LIZARD, INC., BEDFORD HEIGHTS, OH, STYMIE, INC., BEDFORD HEIGHTS, OH, DBA THE WINKING LIZARD TAVERN, DBA WINKING LIZARD, AND DBA TWIN CITY TAVERN:
1,749,068. REN. 5-23-12. INT. CL. 42.

WINMAGINE, F-69002 LYON, FRANCE:
4,163,040, PUB. 4-10-2012. MULTIPLE CLASS, INT. CLS. 9, 38 AND 42.

WINN, MICHAEL, DURHAM, NC:
4,164,517, PUB. 4-10-2012. INT. CL. 43.

WINNING COMMUNITIES, INC., CARMEL, IN:
2,498,711, CANC. INT. CL. 42.

WINNIPEG PANTS AND SPORTSWEAR MFG. LTD., WINNIPEG, MANITOBA, CANADA:
4,162,725, PUB. 4-10-2012. INT. CL. 25.

WINOA, LE CHEYLAS, FRANCE:
4,163,020, PUB. 4-10-2012. MULTIPLE CLASS, INT. CLS. 3, 7 AND 40.

WINPLUS COMPANY, LTD., SHATIN, HONG KONG:
3,006,357, CANC. INT. CL. 5.

WINTER HILL FEDERAL SAVINGS BANK, SOMERVILLE, MA:
2,498,280, CANC. INT. CL. 36.

WIPRO INVESTMENT LIMITED, BANGALORE - 560 001, INDIA:
2,498,704, CANC. INT. CL. 42.

WIRED 4 MISCHIEF, LLC, WEDDINGTON, NC:
4,165,450, INT. CL. 25.

- WIRELESS SENSOR TECHNOLOGIES, INC., SPOKANE, WA:
4,163,728, PUB. 4-10-2012. MULTIPLE CLASS, INT. CLS. 9, 37 AND 42.
- WISCONSIN PHARMACAL COMPANY, LLC, JACKSON, WI:
2,624,941. REN. 5-21-12. INT. CL. 5.
- WISTEEZ, LLC, HAYWARD, CA:
4,165,685, INT. CL. 35.
- WITH & WESSEL LLC, NEW YORK, NY:
4,164,213, PUB. 4-10-2012. INT. CL. 25.
4,164,216, PUB. 4-10-2012. INT. CL. 25.
- WLK HOLDINGS, CAVE CREEK, AZ:
2,695,703. REN. 5-18-12. INT. CL. 3.
- WM. R. HAGUE, INC., GROVEPORT ROAD, OH, DBA HAGUE QUALITY WATER:
1,196,163. REN. 5-19-12. INT. CL. 11.
- WM. W. NUGENT & CO. (INC.), SKOKIE, IL:
1,687,709. REN. 5-18-12. MULTIPLE CLASS, INT. CLS. 9 AND 11.
- WMS GAMING INC., CHICAGO, IL:
2,498,270, CANC. INT. CL. 9.
- WOLF POINT CAPITAL MANAGEMENT LLC, CHICAGO, IL:
2,498,115, CANC. INT. CL. 36.
- WOLTERS KLUWER HEALTH, INC., PHILADELPHIA, PA:
2,576,849. REN. 5-22-12. INT. CL. 16.
- WOLVERINE OUTDOORS, INC., ROCKFORD, MI:
4,165,016, INT. CL. 35.
- WOLVERINE TECHNICAL STAFFING, INC., ANN ARBOR, MI:
2,567,326. REN. 5-21-12. INT. CL. 35.
- WOLVERINE WORLD WIDE, INC., ROCKFORD, MI:
4,165,922, INT. CL. 25.
- WOMEN'S PUBLISHING CO., INC., SOUTH PLAINFIELD, NJ:
1,748,393. REN. 5-19-12. INT. CL. 16.
- WONDERSTAR GAMES INC, WAYNE, NJ:
4,164,470, PUB. 4-10-2012. INT. CL. 9.
- WONG, PATRICK, BROOKINGS, OR:
4,163,952, PUB. 4-10-2012. INT. CL. 42.
- WOOD ROYALTY MANAGEMENT COMPANY, WILMINGTON, DE:
2,499,150, CANC. MULTIPLE CLASS, INT. CLS. 35 AND 42.
- WOODBINE MANUFACTURING CO., PHOENIX, AZ:
2,647,031. REN. 5-24-12. INT. CL. 7.
- WOODE, JAMIE, LAKE MARY, FL:
4,163,265, PUB. 4-10-2012. INT. CL. 5.
- WOODGRAIN MILLWORK, INC., FRUITLAND, ID:
2,680,844. REN. 5-24-12. INT. CL. 19.
2,683,351. REN. 5-24-12. INT. CL. 19.
2,683,396. REN. 5-24-12. INT. CL. 19.
- WOOSTER BRUSH COMPANY, THE, WOOSTER, OH:
1,678,523. REN. 5-23-12. INT. CL. 16.
- WORK CO., LTD., OSAKA, JAPAN:
2,583,175. REN. 5-22-12. INT. CL. 12.
- WORKFLOW MANAGEMENT, INC., NEW YORK, NY TO WORKFLOW MANAGEMENT, INC., NEW YORK, NY:
2,499,231, CANC. INT. CL. 42.
- WORLD OF MOTUS LAURAGE INC, HOLLYWOOD, FL:
4,165,687, INT. CL. 25.
- WORLD SUBUD ASSOCIATION, INC., WASHINGTON, DC:
859,106, CANC. U.S. CL. 200.
- WORLD WRESTLING ENTERTAINMENT, INC., STAMFORD, CT:
4,164,913, INT. CL. 16.
- WORLD'S FINEST CHOCOLATE, INC., CHICAGO, IL:
1,665,160. REN. 5-18-12. INT. CL. 30.
- WORLDSTAR LLC, WILMINGTON, DE, FORMERLY WORLD STAR HIP HOP INC.:
4,163,310, PUB. 4-10-2012. INT. CL. 41.
- WORNARDT III, WALTER, WILLIAM, SUGAR LAND, TX, DBA TROPHY TAG, INC.:
4,163,897, PUB. 4-10-2012. INT. CL. 16.
- WORTH, DOUGLAS, PARKER, CO, DBA WORTH GROUP MASTERBUILDERS:
2,700,164. REN. 5-22-12. MULTIPLE CLASS, INT. CLS. 37 AND 42.
- WORTHEN, MICHELLE I., PHOENIX, AZ:
4,165,026, MULTIPLE CLASS, INT. CLS. 9 AND 16.
- WPP PROPERTIES, SAN FRANCISCO, CA:
862,436, CANC. U.S. CL. 38.
- WPX ENERGY, INC., TULSA, OK:
4,165,560, MULTIPLE CLASS, INT. CLS. 40 AND 42.
- WRIGHT MEDICAL TECHNOLOGY, INC., ARLINGTON, TN:
4,165,047, INT. CL. 10.
- WRIGHT, TIMOTHY A, NEWARK, OH, DBA CHIP SHOT, LLC:
4,164,370, PUB. 4-10-2012. INT. CL. 21.
- WRIGHT, TIMOTHY A., NEWARK, OH, DBA CHIP SHOT, LLC:
4,164,373, PUB. 4-10-2012. INT. CL. 21.
- WRIGHT'S KNITWEAR CORPORATION, NEW YORK, NY:
503,620, CANC. U.S. CL. 39.
- WRITING INSTRUMENT MANUFACTURERS ASSOCIATION, INC., WASHINGTON, DC:
1,687,369. REN. 5-18-12. U.S. CL. A.
- WUXI TAIHU TRACTOR CO., LTD, WUXI, CHINA:
4,165,410, INT. CL. 20.
- WYKE FARMS LTD, UNITED KINGDOM:
4,163,001, PUB. 4-10-2012. INT. CL. 29.
- W5 TECHNOLOGIES INC., HOUSTON, TX:
2,991,010, CANC. INT. CL. 42.
- WÜRTH INTERNATIONAL AG, SWITZERLAND:
3,050,970.
- X-RITE EUROPE GMBH, REGENSDORF, SWITZERLAND:
2,572,977. REN. 5-19-12. INT. CL. 9.
- X-TECHNOLOGY SWISS GMBH, SWITZERLAND:
4,162,816, PUB. 1-3-2012. MULTIPLE CLASS, INT. CLS. 5 AND 32.
- X-TRADE BROKERS DOM MAKLESKI S.A., POLAND:
4,163,014, PUB. 4-10-2012. INT. CL. 36.
4,163,018, PUB. 4-10-2012. INT. CL. 36.
- XDRIVE, LLC, DULLES, VA:
2,497,531, CANC. INT. CL. 39.
- XEROX CORPORATION, NORWALK, CT:
2,498,643, CANC. INT. CL. 9.
- XICOM INCORPORATED, TUXEDO, NY:
859,821, CANC. U.S. CL. 101.
- XPLORE, INC., MCKINNEY, TX:
4,165,564, INT. CL. 35.
- XSTREAM SOFTWARE INC., OTTAWA, ONTARIO, CANADA TO XSTREAM SOFTWARE INC., OTTAWA, ONTARIO, CANADA:
2,498,709, CANC. INT. CL. 9.
- XYCHE WEB SOLUTIONS LLC, OKEANA, OH:
4,163,798, PUB. 4-10-2012. MULTIPLE CLASS, INT. CLS. 9 AND 42.
- Y.Z.Y. INC, MIAMI, FL:
4,164,960, INT. CL. 3.
- YAKULT U.S.A. INC., TORRANCE, CA:
4,163,120, PUB. 4-10-2012. INT. CL. 29.
4,163,144, PUB. 4-10-2012. INT. CL. 29.
- YAMAHA CORPORATION, HAMAMATSU-SHI SHIZUOKA, JAPAN:
2,586,495. REN. 5-21-12. MULTIPLE CLASS, INT. CLS. 9 AND 15.
- YANKEE CANDLE COMPANY, INC., THE, SOUTH DEERFIELD, MA:
1,682,603. REN. 5-18-12. INT. CL. 4.
- YAPPA CORPORATION, JAPAN:
4,162,889, PUB. 4-10-2012. INT. CL. 9.
- YELLOWSTONE MOUNTAIN CLUB, LLC, BIG SKY, MT:
3,210,901, AM. MULTIPLE CLASS, INT. CLS. 25, 36, 41 AND 43.
- YING, BIN, COLLEGE POINT, NY:
4,165,683, INT. CL. 3.
- YING, YIFENG, ST. LOUIS, MO:
4,165,457, INT. CL. 7.
- YOGASTAGE, LLC, CHATTANOOGA, TN:
4,164,069, PUB. 4-10-2012. INT. CL. 35.
4,164,070, PUB. 4-10-2012. INT. CL. 35.
4,164,071, PUB. 4-10-2012. INT. CL. 35.

YONGKANG XINSHIDAI INDUSTRY CO., LTD., CHINA:
4,163,003, PUB. 4-10-2012. INT. CL. 21.

YOPLAIT MARQUES, PARIS, FRANCE:
4,164,751, PUB. 4-10-2012. INT. CL. 29.

YORK TRADITIONS BANK, YORK, PA:
4,163,755, PUB. 4-10-2012. INT. CL. 36.

YOUNG CATHOLIC PROFESSIONALS, DALLAS, TX:
4,164,145, PUB. 4-10-2012. INT. CL. 35.

YOUNG WOMEN'S LEADERSHIP NETWORK, INC., NEW YORK, NY:
4,165,350, INT. CL. 41.

YOUNG, JENNIFER B. RANCHO MIRAGE, CA AND GREENBAUM, ROBERT S. RANCHO MIRAGE, CA:
4,163,569, PUB. 4-10-2012. INT. CL. 28.

YOUNG'S VALLEY CONTAX, INC., SPRINGFIELD, OR:
4,163,253, PUB. 4-10-2012. INT. CL. 9.

YOUNGMAN, JOEY, LOS ANGELES, CA:
4,165,135, MULTIPLE CLASS, INT. CLS. 9, 25 AND 41.

YOZOSOFT CO., LTD., CHINA:
4,162,854, PUB. 4-10-2012. INT. CL. 9.

YSIS INCORPORATED, BEAVERCREEK, OH:
856,406, CANC. U.S. CL. 21.

YUHUAN DINGSHENG SANITARY & PLUMBING CO., LTD., CHINA:
4,162,956, PUB. 4-10-2012. MULTIPLE CLASS, INT. CLS. 6 AND 11.
4,162,957, PUB. 4-10-2012. MULTIPLE CLASS, INT. CLS. 6 AND 11.

YUMMY INTERACTIVE, INC., VANCOUVER, BC, CANADA, YUMMY INTERACTIVE, INC., VANCOUVER, BC, CANADA:
2,580,887, REN. 5-21-12. INT. CL. 42.

YUNNAN HANDE BIO-TECH CO., LTD., KUNMING, CHINA:
4,163,930, PUB. 4-10-2012. INT. CL. 5.

ZANE'S INCORPORATED, BRANFORD, CT, DBA WORLD FAMOUS ZANE'S CYCLES:
4,164,000, PUB. 4-10-2012. INT. CL. 35.

ZANGAR ENTERPRISES, LLC, CHEYENNE, WY:
4,163,778, PUB. 4-10-2012. INT. CL. 5.

ZEIGLER BROS., INC., GARDNERS, PA:
4,163,578, PUB. 4-10-2012. INT. CL. 31.

ZEMBY, ZACHARY, LOS ANGELES, CA AND LIDEN, SERGIO PAUL, VAN NUYS, CA:
4,163,969, PUB. 4-10-2012. INT. CL. 16.

ZERION SOFTWARE, INC., HERNDON, VA:
4,163,610, PUB. 4-10-2012. INT. CL. 42.
4,163,611, PUB. 4-10-2012. INT. CL. 42.

ZHANG'S WINERY INC., SAN MARINO, CA:
4,165,892, INT. CL. 33.

ZHAO, GUOQING, MONTCLAIR, CA:
4,166,042, INT. CL. 9.

ZHEJIANG OVER-BOUNDARY (GROUP) CO., LTD., PUJIANG, ZHEJIANG, CHINA:
4,163,760, PUB. 4-10-2012. INT. CL. 24.

ZHEJIANG SHUANGHUAN DRIVELINE CO., LTD., ZHEJIANG, CHINA:
4,162,981, PUB. 4-10-2012. INT. CL. 12.

ZHEJIANG ULTRAFINE POWDERS & CHEMICALS CO., LTD, ZHEJIANG PROVINCE, CHINA:
4,163,130, PUB. 4-10-2012. INT. CL. 1.

ZIAMATIC CORP., YARDLEY, PA:
1,236,078, REN. 5-18-12. INT. CL. 9.

ZIFF BROTHERS INVESTMENTS, L.L.C., NEW YORK, NY:
4,163,069, PUB. 4-10-2012. INT. CL. 36.
4,163,071, PUB. 4-10-2012. INT. CL. 36.

ZINUS INC., HAYWARD, CA:
4,165,909, INT. CL. 20.
4,165,910, INT. CL. 20.

ZIPBOX LICENSE, LLC, MARLTON, NJ:
4,163,075, PUB. 11-9-2010. INT. CL. 16.
4,163,082, PUB. 11-9-2010. INT. CL. 16.
4,163,083, PUB. 11-9-2010. INT. CL. 16.

ZITRO IP S.AR.L., LUXEMBOURG, LUXEMBOURG:
4,162,735, PUB. 4-10-2012. MULTIPLE CLASS, INT. CLS. 9, 28, 35, 38, 41 AND 42.
4,162,736, PUB. 4-10-2012. MULTIPLE CLASS, INT. CLS. 9, 28, 35, 38, 41 AND 42.

4,162,737, PUB. 4-10-2012. MULTIPLE CLASS, INT. CLS. 9, 28, 35, 38, 41 AND 42.

ZIZA LIGHTING, INC., WADSWORTH, OH:
4,163,676, PUB. 4-10-2012. INT. CL. 11.

ZODIAC AEROSPACE, FRANCE:
4,162,942, PUB. 4-10-2012. MULTIPLE CLASS, INT. CLS. 9, 11 AND 12.

ZOE MARKETING, INC., SAN DIEGO, CA:
4,164,166, PUB. 4-10-2012. INT. CL. 25.
4,164,167, PUB. 4-10-2012. INT. CL. 25.

ZOJIRUSHI AMERICA CORPORATION, GARDENA, CA:
4,163,900, PUB. 4-10-2012. INT. CL. 11.

ZONE HOME SOLUTIONS, LLC, LAWRENCEVILLE, GA:
4,164,115, PUB. 4-10-2012. INT. CL. 37.

ZOOKEEPER INDUSTRIES, LLC, LOS ANGELES, CA:
4,164,468, PUB. 4-10-2012. INT. CL. 42.

ZT WEALTH, INC., PEARLAND, TX:
4,165,054, MULTIPLE CLASS, INT. CLS. 35 AND 36.

ZTARF ARTS, LLC, MEDWAY, MA:
4,164,183, PUB. 4-10-2012. INT. CL. 14.

ZWILLGEN PLLC, WASHINGTON, DC, FORMERLY ZWILLINGER GENESTKI LLP:
4,164,388, PUB. 4-10-2012. INT. CL. 45.

ZWILLGEN PLLC, WASHINGTON, DC, FORMERLY ZWILLINGER GENESTKI LLP:
4,164,405, PUB. 4-10-2012. INT. CL. 45.

ZWILLING J.A. HENCKELS AG, FED REP GERMANY:
3,194,714.

ZYNET LTD, EXETER, UNITED KINGDOM:
2,546,287, REN. 5-19-12. INT. CL. 42.

ZYNGA INC., SAN FRANCISCO, CA:
4,163,178, PUB. 4-10-2012. MULTIPLE CLASS, INT. CLS. 9 AND 41.
4,163,601, PUB. 4-10-2012. MULTIPLE CLASS, INT. CLS. 9 AND 41.

ZYXEL DEUTSCHAND GMBH, FED REP GERMANY:
4,162,867, PUB. 1-3-2012. MULTIPLE CLASS, INT. CLS. 9, 38 AND 42.

1-800-PET-TAXI, LLC, LOS ANGELES, CA:
4,163,417, PUB. 4-10-2012. INT. CL. 39.

1323-KATHY CORPORATION, BLACKWOOD, NJ:
4,165,877, INT. CL. 37.

14 NORTHVIEW, LLC, LAFAYETTE, LA:
4,165,169, INT. CL. 7.

2 HOUR HOUSE, LLC, TYLER, TX:
4,164,828, INT. CL. 41.

3 DAY BLINDS CORPORATION, IRVINE, CA:
4,163,306, PUB. 4-10-2012. MULTIPLE CLASS, INT. CLS. 20 AND 24.
4,165,810, INT. CL. 20.

3C INCORPORATED, COLUMBIA, MD:
4,164,202, PUB. 4-10-2012. INT. CL. 36.

3M COMPANY, ST. PAUL, MN:
3,006,393, CANC. INT. CL. 9.

300 STEWART AVENUE CORPORATION, LAS VEGAS, NV:
4,165,949, INT. CL. 41.

3074153 CANADA INC., QUEBEC CITY, CANADA:
4,163,347, PUB. 4-10-2012. INT. CL. 25.
4,163,348, PUB. 4-10-2012. INT. CL. 25.

360 PROFESSIONAL SERVICES GROUP, AMHERST, NY:
4,162,760, PUB. 4-10-2012. INT. CL. 42.

360 PUBLIC RELATIONS LLC, BOSTON, MA:
4,163,320, PUB. 4-10-2012. MULTIPLE CLASS, INT. CLS. 35 AND 45.

4 S TECHNOLOGIES, LLC, MOUNTAINSIDE, NJ:
4,163,358, PUB. 4-10-2012. INT. CL. 9.
4,163,359, PUB. 4-10-2012. INT. CL. 9.
4,163,360, PUB. 4-10-2012. INT. CL. 9.

42ND STREET DEVELOPMENT CORPORATION, THE, NEW YORK, NY:
2,679,068, REN. 5-18-12. INT. CL. 41.

5.11, INC., MODESTO, CA:
4,165,673, INT. CL. 25.

5FINITY PRODUCTIONS, TACOMA, WA:
4,164,355, PUB. 4-10-2012. INT. CL. 16.

6N SYSTEMS, INC., CLIFTON PARK, NY:
4,164,855, INT. CL. 42.

7-DIPPITY, INC., CORAL GABLES, FL:
2,624,490. REN. 5-24-12. MULTIPLE CLASS, INT. CLS. 16,
25, 28 AND 42.
9 CLOUDS, INC., SIOUX FALLS, SD:
4,163,443, PUB. 4-10-2012. MULTIPLE CLASS, INT. CLS.

35 AND 41.
99[CENTS] ONLY STORES, CITY OF COMMERCE, CA:
1,741,928. REN. 5-23-12. INT. CL. 42.

* * * * *